

FOR ENGINEERS AND ENGINEERING MANAGERS

200 YEARS OF PROGRESS

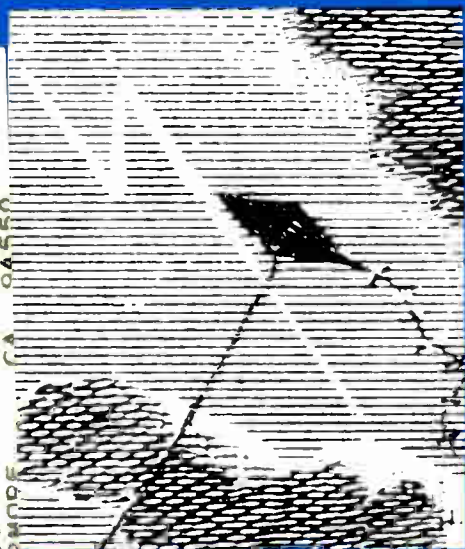

E1049
R H CASTERSON
L-4-38
BX 808
LIVERMORE (CA) 04550
SR/ENG

**A
LOT
MORE
FOR A
LITTLE
LESS**



BOURNS®
NEW

SINGLE-TURN CERMET TRIMMER

- VASTLY IMPROVED ADJUSTABILITY
- TWELVE TERMINAL STYLES
- SEALED FOR WAVE SOLDERING

45¢

in quantities of 5000 per individual resistance

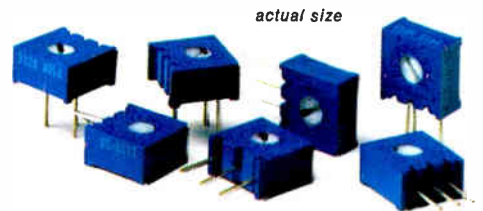

Meet Bourns new Model 3386, a product that both buyer and engineer can love . . . with super adjustability that makes for easy, accurate trimming, AND at a budget balancing price. Most importantly, it's a BOURNS product . . . and that means QUALITY and PERFORMANCE you can believe-in, and SERVICE you can depend-on.

SIGNIFICANT SPECIFICATIONS

- typical CRV less than 1% • infinite resolution • TC of $\pm 100\text{PPM}/^\circ\text{C}$ to 200K ohms • power of .5 watt at 85°C • thin $\frac{3}{8}$ " square size



For complete details, contact your local Bourns representative or distributor, or the factory direct.



TRIMPOT PRODUCTS DIVISION • 1200 COLUMBIA AVE., RIVERSIDE, CALIF. 92507

CIRCLE NUMBER 282
WorldRadioHistory

Gitchyseff an SFG.

**That's a synthesizer/
function generator, cousin—
the first one ever.**

Our new Model 171 combines the accuracy and stability of a synthesizer with the versatility of a function generator. This means you can generate sine, square, triangle, TTL pulse and dc outputs with synthesizer accuracy. Frequency range is 0.01 Hz to 2 MHz.

Sometimes all you'll need

to use is the generator dial, which is accurate to 3% of full scale. But for more precise operations, you'll want the synthesizer's 4½-digit accuracy which is 0.01% of setting. Synthesizer stability is $\pm 0.002\%$ from 0 to 50°C.

Now we all know that your average synthesizer goes for two grand or better. But the Model 171, which is also a function generator, goes for

just \$795. Which means you could have two of our SFGs for the price of an ordinary synthesizer and have some bucks left over. Gitchyseff a couple. WAVETEK, P.O. Box 651, San Diego, California 92112
Phone (714) 279-2200,
TWX 910-335-2007.

WAVETEK®

CIRCLE NUMBER 2

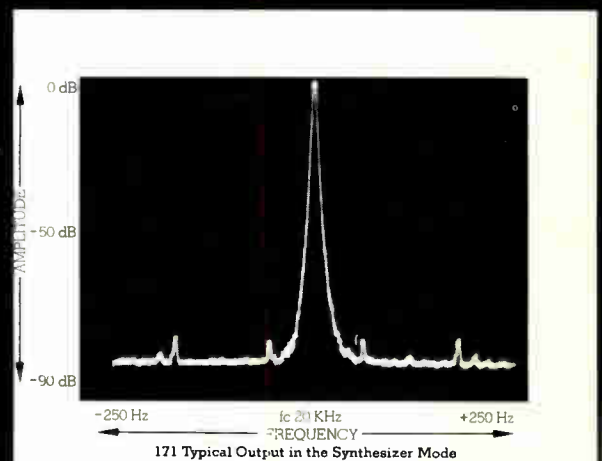
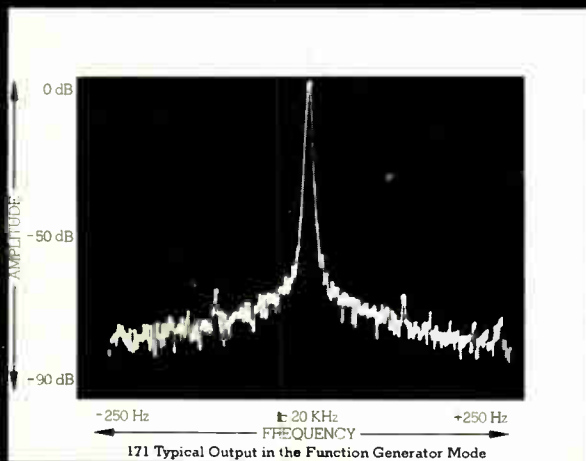

Actual spectrum analyzer photographs showing the improved waveform characteristics in the synthesizer mode.

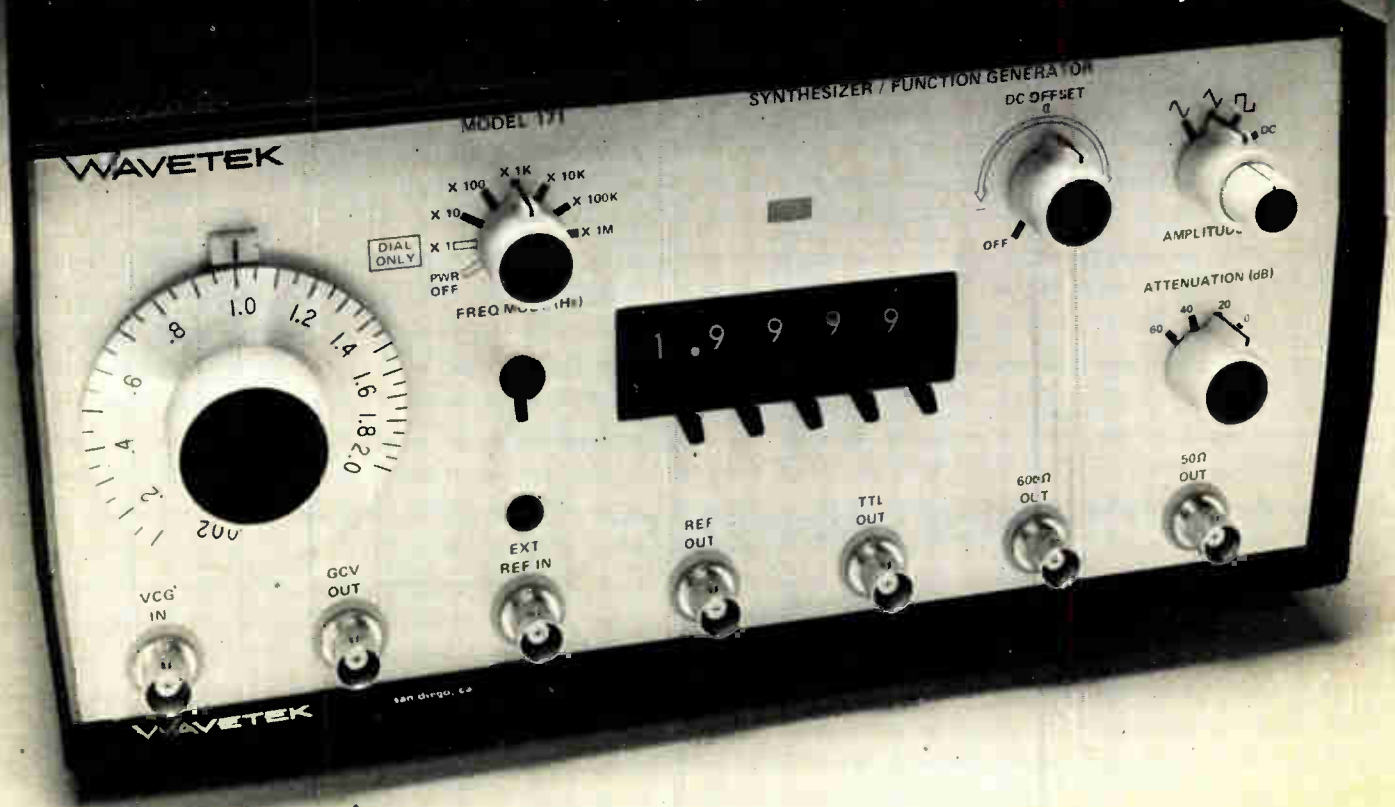

The only Double-Balanced Mixers with a 2-YEAR GUARANTEE*

featuring Hi-Rel tested diodes-

still only

\$7.95

(500 pieces)

\$9.95 (1-49)

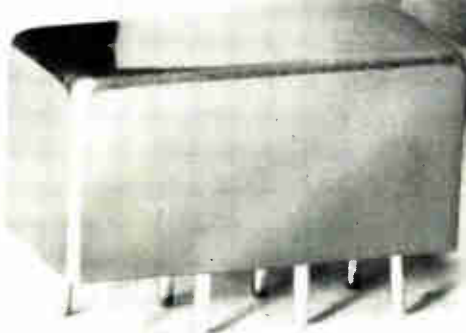

*including diodes!

Yes, a two-year guarantee for DBM's is now a reality . . . made possible by an accelerated-life diode screening program adopted at Mini-Circuits.

Each Schottky diode used in Mini-Circuits' SRA-1 mixers is now preconditioned by the HTRB (High Temperature Reverse Bias) technique, previously reserved almost exclusively for semiconductors assigned to space applications. With HTRB testing, each diode is operated for 168 hours at 150°C with one volt reverse bias applied.

To screen out "infant mortality", the diodes are deliberately stressed to accelerate aging and to force time-related failure modes to take their toll. In conventional testing or "baking", the diode does not experience anywhere near the stress encountered with the HTRB program. Hence, the ability at Mini-Circuits' to locate the potentially-unreliable diodes before they are assembled into SRA-1 units. And, with double-balanced mixers, the overall reliability hinges almost entirely on the diodes used.

Yes, the HTRB procedure costs us more and screens out more devices. But our goal is to improve reliability to a level unmatched for off-the-shelf DBM's at no increase in cost to our customers. You — our customers by your overwhelming confidence in our product line have made us the number one supplier of DBM's in the world.

To earn your continuing support, we are now employing HTRB Hi-Rel testing for every diode used in the SRA-1, at no increase in cost to you. So, for the same low price of \$7.95, you can purchase our SRA-1, with a two-year guarantee, including diodes.

To ensure highest system reliability demand highest quality diodes on your source-control drawings and purchase orders. Specify SRA-1 mixers, with HTRB tested diodes from Mini-Circuits! . . . where low price now goes hand-in-hand with unmatched quality.

MODEL SRA-1

Freq. range (MHz) LO: 0.5-500, RF: 0.5-500, IF: dc-500

Conversion loss (dB)	Typ.	Max.
One octave from band edge	5.5	7.5
Total range	6.5	8.5
Isolation (dB)	Typ.	Min.
Lower band edge to one decade higher	LO-RF: 50	35
	LO-RF: 45	30
Mid range	LO-RF: 45	30
	LO-IF: 40	25
Upper band edge to one octave lower	LO-RF: 35	25
	LO-IF: 30	20

Min. Electronic attenuation (20 mA) 3 dB

Signal, 1 dB compression level + 1 dBm

Impedance all ports 50 ohms



Mini-Circuits Laboratory

A Division Scientific Components Corp.

837-843 Utica Avenue, Brooklyn, NY 11203
(212) 342-2500 Int'l Telex 620156
Domestic Telex 125460

International Representatives: AUSTRALIA General Electronics Services, 99 Alexander Street, New South Wales, Australia, 06; ENGLAND Dale Electronics, Dale House, Wharf Road, Frimley Green, Camberley Surrey; FRANCE S. C. I. E. D. I. M. I. S., 11 Rue George Sand, 91100 Palaiseau, France; GERMANY, AUSTRIA, SWITZERLAND Industrial Electronics GmbH, Klüberstrasse 14, 6000 Frankfurt/Main, Germany; ISRAEL Vectorics Ltd., 69 Gordon Street, Tel Aviv, Israel; JAPAN Denshu Kaisha Ltd., 1-2-1, Chome, Hamamatsuchō, Minato-ku, Tokyo; EASTERN CANADA B. D. Hummel, 2224 Maynard Avenue, Utica, NY 13502, (515) 746-7821; NETHERLANDS, BELGIUM, LUXEMBOURG, Cormex, Veldweg 11, Haltem, Holland; NORWAY Dataamatik AS, Østernsveien 62, 0510 6, Norway

US DISTRIBUTORS: NORTHERN CALIFORNIA Cain White & Co., Foothill Office Center, 105 Fremont Avenue, Los Altos, CA 94022, (415) 948-6533; SOUTHERN CALIFORNIA, ARIZONA Crown Electronics, 11440 Collins Street, No. Hollywood, CA 91601, (213) 877-1550

For complete product specifications and U.S. Rep. listing see MicroWaves "Product Data Directory," Electronic Designs "Gold Book" or Electronic Engineers Master "EEM"

200 YEARS OF PROGRESS—A bicentennial tribute



- 57 **The great men**
- 60 **A century of giants**
- 61 **A tribute from President Gerald Ford**
- 66 **The foundation years (1754-1837):** Understanding that nature obeys rules, too.
- 78 **The era of giants (1837-1879):** Getting electricity to work for man.
- 88 **The communications era (1879-1905):** Extending man's voice by wire and radio.
- 98 **The vacuum tube era (1905-1948):** Taking the crucial step for modern technology.
- 108 **The transistor era (1948-1959):** Approaching the age of space exploration.
- 118 **The integrated circuit era (1959-1975):** Compressing the world of electronics.
- 130 **Bern Dibner speaks on our technological heritage.**

TECHNOLOGY

- 137 **MICROPROCESSOR DESIGN**
- 146 **Hold noise down with JFETS.** Circuit design and device selection are simple once the type and magnitude of the noise source are known.
- 156 **It could be the 'ideal' filter.** Consider the translating filter, which can be set digitally and is accurate to within 1 Hz of the cutoff frequency.
- 164 **Use CMOS in chopper designs.** Analog switches now available at low cost, considerably simplify the design of multiplexers and choppers.
- 170 **Ideas for Design:**
 - Measure small capacitance at the end of a long cable.
 - Sonar transmit-receive switch is compatible with most logic levels.
 - Power-supply voltage changed 2:1 with SPDT switch arrangement.
 - Circuit detects narrow spikes of either polarity, provides 150-ns output.

PRODUCTS

- 179 **Power Sources:** Linear supply rivals switchers in efficiency.
- 184 Integrated Circuits
- 192 Components
- 200 Modules & Subassemblies
- 206 Packaging & Materials
- 218 Data Processing
- 226 Instrumentation
- 230 Discrete Semiconductors
- 235 Microwaves & Lasers

DEPARTMENTS

- 57 **Editorial:** The great men
- 7 Across the Desk
- 37 News Scope
- 45 Washington Report
- 239 Application Notes
- 240 Evaluation Samples
- 241 New Literature
- 244 Vendors Report
- 244 Bulletin Board
- 250 Advertisers' Index
- 252 Product Index
- 254 Information Retrieval Card

Cover: Designed by Art Director, Bill Kelly. Photo Apollo 13 liftoff courtesy of NASA.

ELECTRONIC DESIGN is published biweekly by Hayden Publishing Company, Inc., 50 Essex St. Rochelle Park, NJ 07662. James S. Mulholland Jr., President. Printed at Brown Printing Co., Waseca, MN. Controlled circulation postage paid at Waseca, MN and New York, NY, postage pending Rochelle Park, NJ. Copyright © 1976. Hayden Publishing Company, Inc. All right reserved. POSTMASTER: Please send form 3579 to ELECTRONIC DESIGN, P.O. Box 13803, Philadelphia, PA 19101.

Pick a Plug-in Scope For

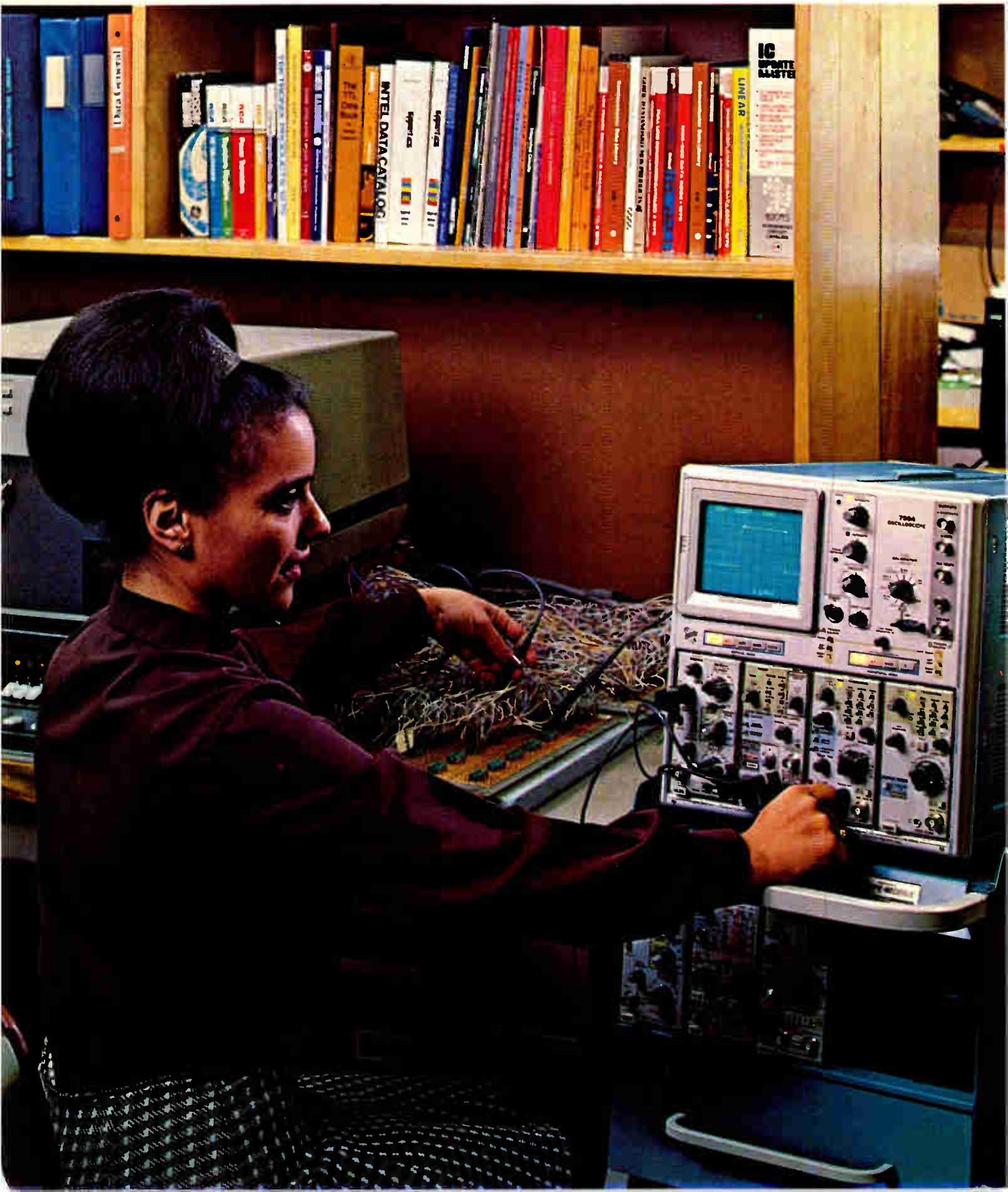

Future Expandability

With a 7000-Series plug-in laboratory oscilloscope, you're investing in the current state of the art while assuring your measurement viability for tomorrow. Whether your field is digital circuit design, applied physics research, or communications systems development, you can customize a 7000-Series oscilloscope system for your particular application and continually update your system to keep pace with technological advances.

The 7000-Series offers you superior performance, flexibility, and expandability. It gives you a wide choice in measurement parameters, ranges, and techniques so you can tailor the optimum system for your specific needs. And it continually adds new capabilities and techniques to the growing 7000-Series family of mainframes, amplifiers, and time-bases.

For example, the 7000-Series has recently expanded to make possible:

Easier, more accurate timing measurements with the 7B80 Series. The 7B80/7B85 Delta (Δ) Delay Time Bases allow you to display the main sweep with two intensified zones, both delayed sweeps displayed at their faster rate, and digital crt readout of time delay or Δ time delay—all in one powerful crt format. Your timing measurements are now more accurate and convenient; you can view both analog and digital information at a glance.



Tektronix' new 7B80/7B85 Delta (Δ) Delay Time Bases are being used in the 7904 oscilloscope to measure pulse width in a minicomputer interface circuit.

Faster single-shot signal measurements with the 7844 Dual Beam Oscilloscope. The 7844 offers you true dual beam performance at 400 MHz, so now you can view and photograph multiple events that couldn't be captured together before.

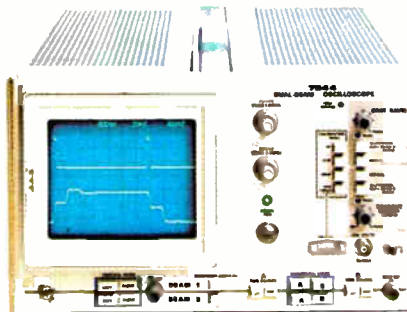

Faster and more versatile storage measurements with the 7633 Multi-mode Storage Oscilloscope. The 7633 gives you 100-MHz storage and multiple storage modes—bistable, variable persistence, and fast mesh transfer. With the 7633, you can store at writing speeds as fast as 1000 cm/ μ s.

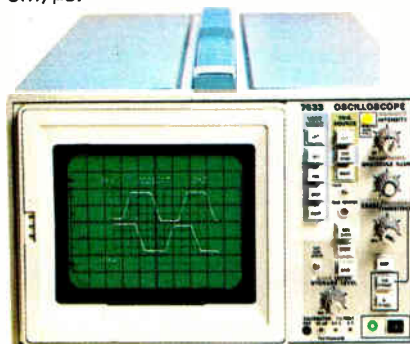

And the 7000-Series will continue to expand to incorporate the most advanced technology for your most sophisticated oscilloscope measurement needs.

But that's not the whole expandability story. With the 7000-Series oscilloscope system—truly more than an oscilloscope—you can make broad-based measurements beyond the conventional oscilloscope: sampling to 14-GHz equivalent band-

width; spectrum analysis to 1800 MHz together with time domain capability; digitally accurate, oscilloscope-controlled measurements of amplitude and time. And you'll be able to add more measurement capability like this as the 7000-Series continues to expand to the edge of technology.

Whether you work in the time domain, the frequency domain, or the data domain, the 7000-Series represents a commitment to your future.

The 7000-Series helps you defer obsolescence because it expands as new technology changes measurement needs. We are continually developing new measurement technology and adapting it for your convenience in the 7000-Series family.

For a catalog describing all the 7000-Series instrument mainframes and their plug-ins, call your local Tektronix Field Engineer, or write Tektronix, Inc., P.O. Box 500, Beaverton, OR 97077. In Europe, write Tektronix Limited, P.O. Box 36, St. Peter Port, Guernsey, Channel Islands.

**The 7000-Series . . .
more than an oscilloscope**



TEKTRONIX®

committed to
technical excellence

FOR TECHNICAL DATA CIRCLE # 273
FOR DEMONSTRATION CIRCLE # 274

WorldRadioHistory



Thin-Trim. capacitors

Tucked in the corner of this Pulsar Watch is a miniature capacitor which is used to trim the crystal. This Thin-Trim capacitor is one of our 9410 series, has an adjustable range of 7 to 45 pf, and is .200" x .200" x .050" thick.

The Thin-Trim concept provides a variable device to replace fixed tuning techniques and cut-and-try methods of adjustment. Thin-Trim capacitors are available in a variety of lead configurations making them easy to mount.

A smaller version of the 9410 is the 9402 series with a maximum capacitance value of 25 pf. These are perfect for applications in sub-miniature circuits such as ladies' electronic wrist watches and phased array MIC's.



Johanson Manufacturing Corporation
Rockaway Valley Road
Boonton, New Jersey 07005
(201) 334-2676 TWX 710-987-8367

Sr. Vice President, Publisher
Peter Coley

Editors

Editorial Offices
50 Essex St.
Rochelle Park, NJ 07662
(201) 843-0550
TWX: 710-990-5071
Cable: Haydenpubs Rochellepark

Editor-in-Chief George Rostky

Managing Editors:
Ralph Dobriner
Michael Elphick

Associate Editors:

Dave Bursky
Samuel Derman
Morris Grossman
John F. Mason
Stanley Runyon
Edward A. Torrero

Contributing Editors:

Peter N. Budzilovich
John Kessler
Alberto Socolovsky
Nathan Sussman

Editorial Field Offices

East

Jim McDermott, Eastern Editor
P.O. Box 272
Easthampton, MA 01027
(413) 527-3632

West

David N. Kaye, Senior Western Editor
8939 S. Sepulveda Blvd.
Suite 510
Los Angeles, CA 90045
(213) 641-6544
TWX: 1-910-328-7240

Editorial Production

Marjorie A. Duffy, Production Editor
Tom Collins, Copy Editor

Art

Art Director, William Kelly
Richard Luce
Anthony J. Fischetto

Production

Manager, Dollie S. Viebig
Helen De Polo
Anne Molfetas

Information Retrieval

Peggy Long

Promotion, Creative Layouts

Manager, Albert B. Stempel
Maxine Correal
Nancy Gordon (Reprints)

Across the Desk

Reliable rainfall sensor wanted

For several years we have been looking for a reliable sensor that closes a switch at the start of rainfall and opens it again when rainfall stops. We are wondering if you or any of your staff know of such a device.

Fair to good results have been obtained using grid layouts on PC board material. The water shorts the grids and closes a sensitive relay operated at about 6 V ac. Low voltage alternating current is used to reduce shock hazard and to prevent plating as is experienced with direct current. These grids are unreliable because an electrolyte is needed, since rain water is often too pure to be used as a good conductor. Often, the switch opens prematurely because the electrolyte is washed from the grids before the end of the rainfall.

I noticed in *Electronic Design* Vol. 23, No. 25, December 5, 1975, on page 96 the article "Piezoelectric Switch Is Environment Proof" that many proximity and touch-control switches in use are moisture sensitive. Could such a switch be used reliably to detect moisture? If so, is there a particular brand and model suited to this purpose?

David R. Gallwitz
Electronics Technician

U.S. Dept. of Agriculture
Agricultural Research Service
P.O. Box 478
Coshocton, OH 43812

BEN . . . BEN!

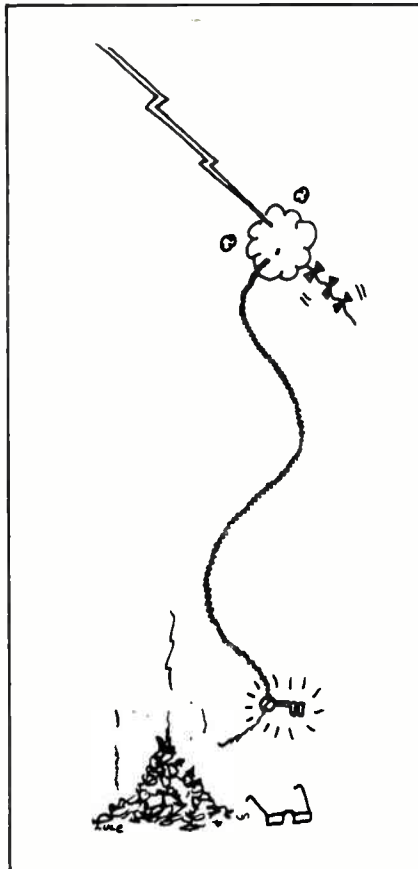

"There goes Ben, making an ash of himself."

Greetings from Poland

ELECTRONIC DESIGN does not normally publish letters of congratulations or other back-patting messages. But we feel the following letter contains such a heart-

(continued on page 22)

Switches-

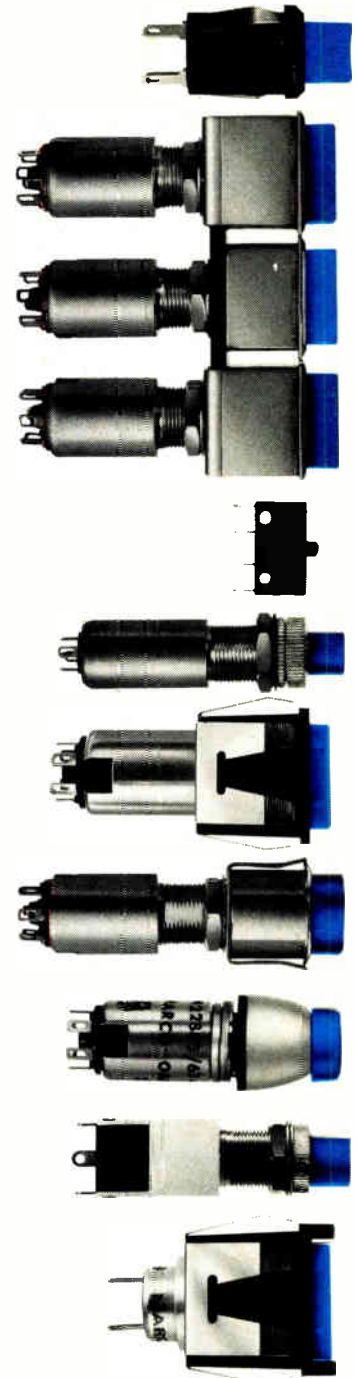

We've got them all

Lighten your decisions
contact . . .

ILLUMINATED PRODUCTS INC.

(formerly MARCO-OAK)
A Subsidiary of OAK Industries Inc.

207 S. Helena St., P.O. Box 4011
Anaheim, CA 92803
Tel: (714) 535-6037 TWX 910-591-1185

Electronic Design welcomes the opinions of its readers on the issues raised in the magazine's editorial columns. Address letters to Managing Editor, *Electronic Design*, 50 Essex St. Rochelle Park, N.J. 07662. Try to keep letters under 200 words. Letters must be signed. Names will be withheld on request.

Meet Sorensen's cool watt.

If your heat load is up and your cabinet space is down, our new SSD series can solve both problems at once.

Their power density is 3 times that of linears and 1½ times previous switchers yet they dissipate *less* heat (25 watts less in the 5-volt model).

No forced air cooling required.

SSDs come in 10 models covering the entire range from 1.8 to 56 volts, accept universal input voltages, and operate at efficiencies of 76 to 80%.

And they're guaranteed for five years.

We'd like to send you the information, along with our new catalog of over 200 power supply products. Sorensen, a Raytheon Company, 676 Island Pond Road, Manchester, N.H. 03103. (603) 668-4500. Sorensen A.G., Hohlstrasse 608/610, 8048 Zurich, Switzerland. Tel: 01/62 3400.

SORENSEN
POWER SUPPLIES

A Raytheon Company

CIRCLE NUMBER 7



Sorensen
POWER SUPPLIES

SSD

12-15

250V
5A

FUSE
FUSE

OVP

115VAC

10-11
INPUT



UNIVERSAL MODEMS

Making data move is the name of the game in today's switched or dedicated line networks. If you're moving it at any speed up to 2400 BPS, Universal Data Systems has the proper modem for reliability, economy and efficiency in your system.

UDS has more than 20,000 modems in active field service, and that total is growing by more than 1000 units per month. Our product line includes CMOS 201s, plus 103s, 202s and the multiple-modem RM-16 which contains up to 16 units in any configuration mix you desire.

In addition to our products, we're extremely proud of our customer service. Check us out: Call us on the telephone. You'll like what you hear.

SEE US AT

Labacomm 76



universal data systems

member of IDCMA

4900 Bradford Drive • Huntsville, Alabama 35805 • Telephone (205) 837-8100 • TWX 810-726-2100

Created by Hall & McKenzie Advertising Winter Park Florida

CIRCLE NUMBER 9

When you can buy all this for a total of \$701*

Expansion Slot for optional
Distributed I/O System
or Memory

Card Cage with
motherboard

10-Amp Power Supply
with cable assembly

Memory with 256 16-bit
words RAM and sockets
for 8k ROM

Operator's Console and
mounting plate

CPU with Real-Time Clock
and AutoLoad capability

 COMPUTER AUTOMATION, INC.



The ALPHA™ LSI-3/05 Millicomputer.
The lowest priced, 16-bit, full-scale, packaged computer in the world.

...building your own just doesn't add up.

Sum and substance. An unbeatable combination even for our competition, so you needn't feel too badly.

Especially when you consider everything we've got going for us.

Specialization, of course. OEM computers — *low-cost* OEM computers — are our only business. The NAKED MINI® people, remember? And when you do only one thing, you do it better.

Experience, too. Over 10,000 up-and-running, field-proven computers successfully integrated into all kinds of sophisticated OEM products.

Also, some things Henry Ford would have appreciated. Buying in volumes most OEM's can't manage. Building the same way.

Where all that gets you is on the down-hill side of the learning curve... where we get our pay-off and you get the lowest-priced, most reliable computers around.

That explains why we can, but not necessarily why you can't. Here's the rest of the rationale:

The chip shot: a hit or a myth?

The fallacy of the micro-processor is that a chip set isn't a computer. Even if you got your chip sets *free* you still couldn't build a computer equivalent to our ALPHA LSI-3/05 for \$701.

Price out the subassemblies shown in the picture and see what we mean. CPU, memory, card cage, power supply and console. All of that design and development time. Amortized over maybe a few hundred systems?

Heart of the ALPHA LSI-3/05 shown at left is this NAKED™ MILLI central processor and memory for \$395*

ComputerAutomation will build thousands of ALPHA LSI-3/05 systems.

Then there's the packaging and fabrication. Cable assemblies, too.

Just think about the procurement activity alone. The lead time. Getting our picture?



Maxi-Bus compatible ALPHA LSI-3/05 achieves unprecedented cost-effectiveness with ComputerAutomation's new Distributed I/O System.

Computers vs. computerization

How do you talk to a computer?

Mostly with money, it turns out. Interface money. And mostly a lot of it.

Interfacing a computer to one or two peripheral devices can easily cost as much or more than the computer itself.

Which is why we invented the Distributed I/O System. An optional interfacing system that simultaneously interfaces up to 32 peripherals and special devices, serial or parallel in any combination, for less than \$200* per interface.

What you see is not exactly what you get

Here's what else you get when you buy an ALPHA LSI-3/05 minicomputer:

- 95 powerful instructions
 - Individually vectored interrupts
 - Direct Memory Access
 - Memory expansion to 32K
 - Maxi-Bus interchangeability for easy upward expansion to our full line of compatible minicomputers
- Plus full-fledged mini-computer software.

From the people who brought you the NAKED MINI®

The people with the largest line of compatible computers in the world.

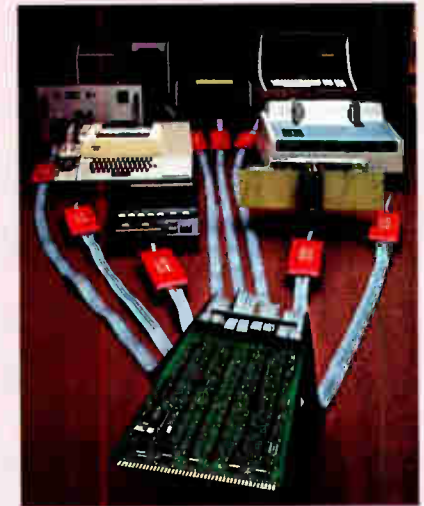

The ALPHA LSI-3/05 is offered in three series featuring a choice of card cages, consoles, memories and power supplies.

The people with the lowest-priced computers in the world.

The people with the first and only Distributed I/O System in the world.

The people who've been simplifying OEM build versus buy decisions for years.

ComputerAutomation
NAKED MINI Division

U.S.A. 18651 Von Karman, Irvine, CA 92715
(714) 833-8830
EUROPE Hertford House, Denham Way, Maple Cross, Rickmansworth WD3 2XD, Hertfordshire, England; Telephone: Rickmansworth 71211

*All prices shown are for lots of 100 (U.S.A. only)

Patent Pending

FOR FURTHER INFORMATION CIRCLE 261
FOR SALESMAN CALL CIRCLE 262

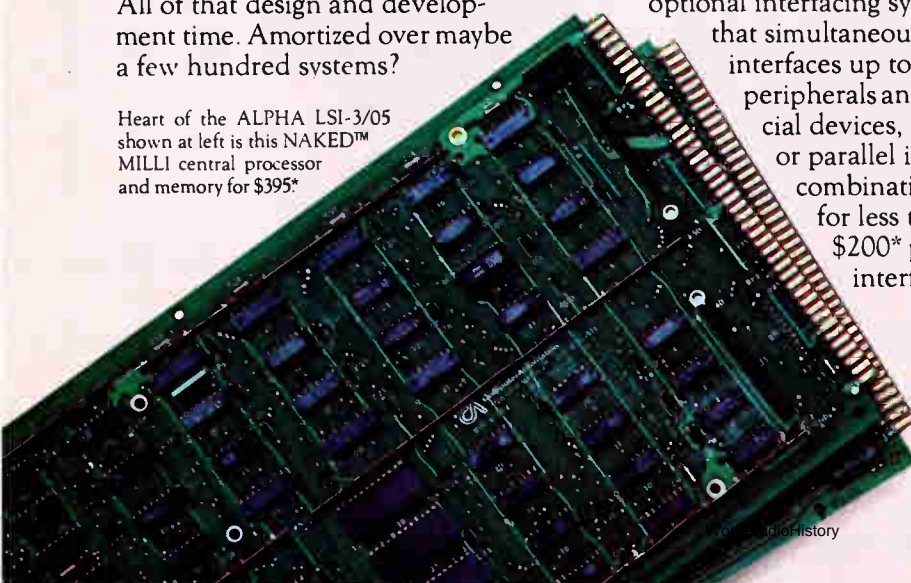

**KEITHLEY OFFERS:
A 3½-DIGIT MULTIMETER.
4 EXCLUSIVE FEATURES.
\$315.**

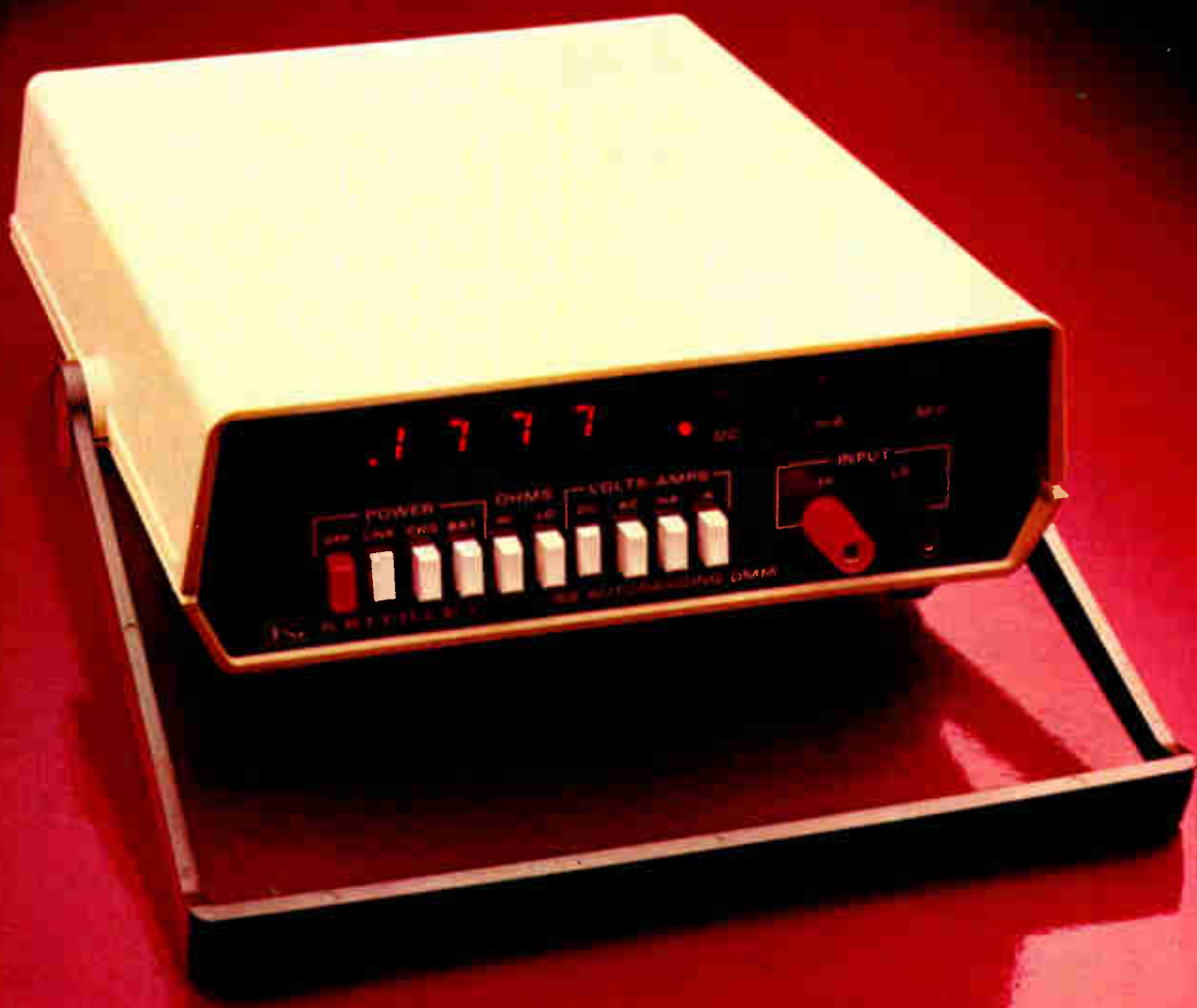

The Keithley 168 Digital Multimeter gives you every key performance feature offered by other first-line 3½-digit DMMs.

But only the Keithley 168 gives you 4 extra features—all useful and all at a competitive price. Compare our 3½ with the others and you'll come to an inescapable conclusion: the 168 is the best buy in 3½-digit DMMs.

For \$315: a superior DMM

For openers, you get a rugged, reliable, easy-to-read, general-purpose, 5-function DMM with more ranges than you'll normally need. Measure from 100 microvolts to 1000 volts dc, 100 microvolts to 500 volts ac, 100 milliohms to 20 megohms, 100 nanoamps to 1 amp, ac or dc. Basic accuracy is 0.1%. All modes fully overload protected. The 168 brings Keithley quality to general-purpose measurement.



4 extra features, no extra cost.

- *Automatic ranging* gives you the most accurate reading, with decimal in the right place, faster than you could do it with switches. Saves you time every time you make a measurement.
- *HI-LO Ohms* lets you turn on a semiconductor junction to see if it's good or measure an in-circuit resistance without turning on a semiconductor.
- *2-terminal input* for all measurements on all functions. You can't get it wrong. Terminals accept banana plugs, alligator clips, spade lugs or bare wire.
- *Lighted function indicator* so you know precisely what you're measuring, instantly.

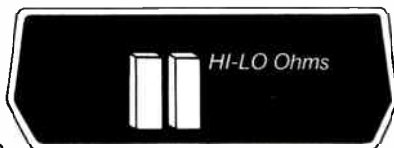

Surprise: more valuable features.

That's not all. We've packed even more value into the 168. Optional battery pack that you buy now or add later. Patented A-D converter to simplify circuitry. No-nonsense, full-year guarantee on parts, workmanship, and specs—including accuracy. Convenient calibration instructions right inside the cover. Light weight for easy portability.

Full complement of accessories.

Use these optional accessories to make your Keithley 168 DMM even more versatile: Wide-range RF probe. Test lead sets. Clamp-on ammeter. 50-amp shunt. High-voltage probe. Carrying case. Rack mount kit.



Now the logical choice.

The 168 is out-front in value. And it's backed up by our reputation for quality. Don't you wish all decisions were this easy?

Ordering a 168 is easy, too. Just contact: Keithley Instruments, 28775 Aurora Road, Cleveland, Ohio 44139. (216) 248-0400. Europe: D8000 München 70, Heighhofstrasse 5, West Germany. (089) 7144065.

DMMs for all your needs.

We know you have a variety of measurement requirements. So we offer a growing family of DMMs to meet your application and price objectives. Send for our Selector Guide.

180: 4½-digits, 30 nV sensitivity.

171: 4½-digits, wide ranging, 5-functions.

190: 5½-digits, high-stability, outstandingly low price.

616: dc, 3½-digits, down to 0.1 picoamp full scale!

160B:dc, 3½-digits, high-sensitivity, low price.



KEITHLEY

The measurement engineers.

Rockwell is there with a complete microcomputer on two chips.

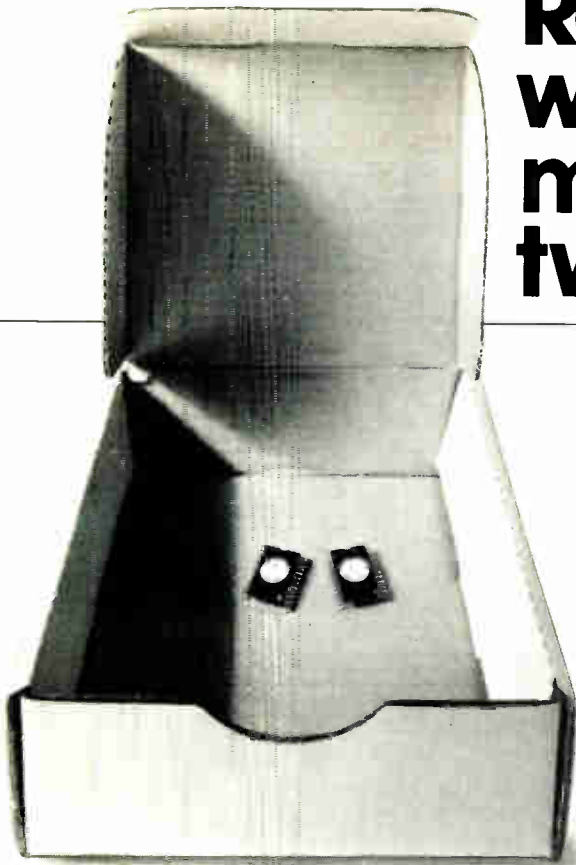

WE'VE CUT THE NUMBER OF COMPONENTS

One chip of our new PPS 4/2 contains a clock, CPU, and 12 I/O lines.

The other holds 2K x 8 ROM, 128 x 4 RAM and 16 bidirectional I/O lines.

There you have it: a complete microcomputer on two chips. For many applications, that's all you'll ever need.

SO YOU CAN CUT COSTS

For example, the complete PPS 4/2 system is priced at less than \$35 in quantities of 1000.

As your needs grow, you can add any of seventeen I/O, memory, or peripheral controller chips to your system at similar cost savings.

EIGHT-BIT PERFORMANCE FROM A FOUR-BIT MICROPROCESSOR

Rockwell's parallel processing and independently intelligent I/Os throughout the microprocessor system permit simultaneous performance of various functions, freeing the

CPU for system thinking. In fact, with Rockwell's unique parallel processing system (PPS), your 4-bit system will actually outperform many 8-bit systems.



APPLICATIONS GALORE

The PPS 4/2 will control any number of mechanical or electromechanical devices — office machines, vending machines, electronic

games and low-end cash registers to name a few.

It will also serve well as peripheral controller on larger microprocessing systems, including non-Rockwell CPUs you've already programmed.

For samples, specs or sage advice, call

714.632.3729

Because Rockwell's applications people and engineers all have backgrounds in systems and product design, they'll be able to give you specific answers as to how the PPS 4/2 relates to your product. Just call (714) 632-3729 and ask for Scotty Maxwell.

For technical literature or samples — without the advice — just drop us a line:

Department 4 C 214
Microelectronic Device
Division
Rockwell International
P.O. Box 3669
Anaheim, CA 92803

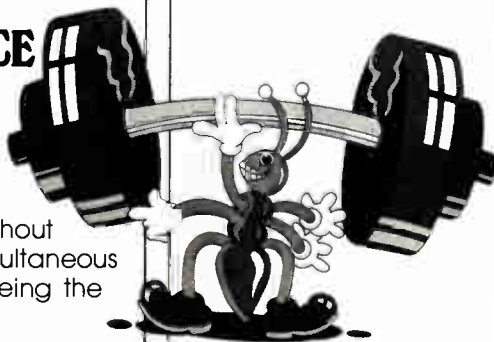

Rockwell International

...where science gets down to business



For the Engineer who needs the best Measuring Instruments...

6 new ideas

■ NEW INSTRUMENTS

- Spectrum Analyzers
- Impedance Plotters
- Sweep Test Systems
- Power Signal Generators
- Frequency Synthesizers
- Selective Microvoltmeters
- Programmable Attenuators
- TV Broadcast Test Equipment
- Semiconductor Test Equipment

■ NEW FACILITY

devoted to Engineering, Manufacturing, Quality Control, Sales and Service.

■ NEW CATALOG

286 pages describing over 1,500 instruments.

■ NEW EXTENDED WARRANTY

up to 3 years on all R&S equipment

■ NEW DIRECT LEASE PLAN

lease any instrument from R&S.

■ NEW QUICK DELIVERY PLAN

from stock.

Send for your new catalog today and see all our ideas.

World Leader in Test Inst. & Communications for Over 40 Years

ROHDE & SCHWARZ

14 Gloria Lane, Fairfield, N.J. 07006 ■ (201) 575-0750 ■ Telex 133310

WorldRadioHistory
CIRCLE NUMBER 13



PMI-Variety Store for DACs.

When you go shopping for D/A Converters, please swing by PMI. Ever since we opened our doors six years ago, we've been working hard to spice up our distributors' shelves with the widest line of monolithic DACs in the industry. 6-, 7-, 8-, 9-, and 10-bit DACs. Current or voltage outputs. Internal or external references. Routine MIL-STD 883A Level B processing, with Level A available. Guaranteed specs over full MIL Temp range. PMI pioneered monolithic DACs. It's only natural to find more here than anywhere.

And if DACs are new to you, lean on PMI's experience. We've helped designers and project managers put dependable PMI monolithic DACs to work in the most unusual spots. How can we help you?

Also, our price list, DAC data sheets and Ap. Notes are yours for the asking. Ask your distributor or call us at our store.



Precision Monolithics Incorporated
 1500 Space Park Drive, Santa Clara, CA 95050
 (408) 246-9222. TWX 910-338-0528.
 Cable MONO.

CIRCLE NUMBER 14

PMI's got your number!

WORLD'S BEST 6 BIT DAC

10 BITS Vout
 INTERNAL/EXTERNAL REF. FROM \$10.00

6 BITS Vout
 INTERNAL REF. FROM \$9.25

8 BITS Vout
 INTERNAL/EXTERNAL REF. FROM \$10.00

8 BITS I out
 EXTERNAL REF. FROM \$3.95

8 BITS I OUT
 INTERNAL REF. FROM \$9.95

more SOLD!
MORE MONOLITHIC DAC'S SOLD THAN BIG MAC'S (almost)



DAC-02's from \$15.00

10 BITS

9 BITS

8 BITS

7 BITS

Planar.

It makes lasting bonds in seconds.

AVX's Planar chip capacitor is a precision ceramic multi-layer with something new. Foil tab leads that are designed for fast, in-line bonding techniques. Planar eliminates the need for a separate wire attachment procedure. Lowers your component processing costs.

Planar also reduces reliability problems associated with traditional wire bonded chips. Its flexible foil tab resists cracking during subsequent assembly operations and during in-field service. It means higher yields for you. And greater reliability of your final product.

Get acquainted with AVX Planar in a size, voltage rating and capacitance value matched to your application needs. You'll make bonds that stick.

AVX: The Insiders

AVX Ceramics, P.O. Box 493, Olean, NY 14760 (716) 372-6611 TWX: 510-245-2815
P.O. Box 867, Myrtle Beach, SC 29577 (803) 448-3191 TWX: 810-661-2252

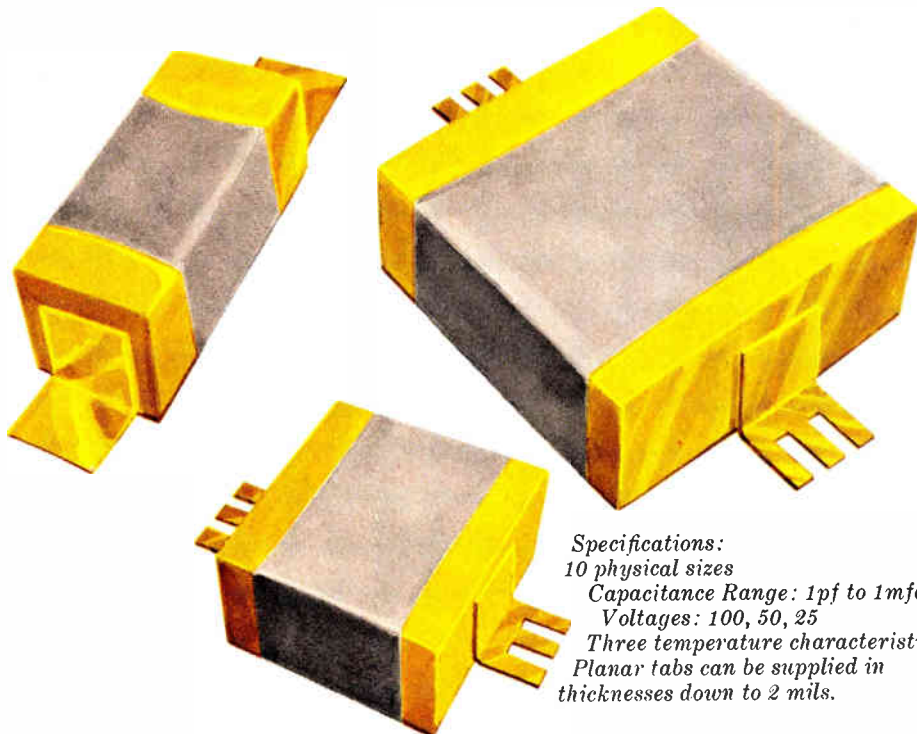

Specifications:
10 physical sizes
Capacitance Range: 1pf to 1mfd
Voltages: 100, 50, 25
Three temperature characteristics
Planar tabs can be supplied in
thicknesses down to 2 mils.

CIRCLE NUMBER 15

Surprise!



...in 25 years Dale has grown to be lots more than a great resistor supplier.

Dale is the efficient way to get a lot of things done at once. In addition to being the industry's most complete source of discrete resistors, we're strong, and getting stronger, in trimmer potentiometers, inductors, transformers, connectors and thick film networks. As a result, your man from Dale is better equipped than ever to help you save time and cut project costs. How old we are really doesn't matter, it's what we can do for you right now that counts. You'll be pleasantly surprised.

T-Pots



Check the price and performance on our low profile 700 Series and $\frac{3}{8}$ " single turn 100 Series. We'll match them against anyone in the industry...and we're ready to deliver all popular values from stock. See EEM, Gold Book or our full line catalog for complete details on Dale trimmers including Mil. Spec. models or call 402-564-3131.

Networks



Compare our DIP and SIP thick film networks with Beckman, CTS, et al. You'll find we have the facilities and the know-how to help you use networks to their best advantage. Our lineup of standard, military and custom thick-film circuitry is described in a brand new brochure. To get it, circle the Reply No. or call 402-371-0080.

Connectors



Working with displays? Dale ES Connectors expand to fit your special designs without burdensome tooling costs. And Dale also has a solid line of budget-stretching edgeboards that provide .100" and .156" spacing at low cost per contact. Rack and panel and umbilical styles, too. Ask your man from Dale or call 605-665-9301.

Inductors



Take a look at our growing line of epoxy molded and roll-coated chokes and toroids (MIL-C-15305D and MIL-T-27). Check the price and the extra reliability of our IR Series against the varnish-coated choke you're now using. Need low-cost industrial transformers? Our laminated PL Series offers models to 25 watts. Details begin on Page 179 of the catalog our rep is ready to deliver.

**The best in resistors
...and a lot more**



DALE ELECTRONICS, INC., 1300 28th Avenue, Columbus, Nebraska 68601

A subsidiary of the Lionel Corporation

In Canada: Dale Electronics Canada Ltd. • In Europe: Dale Electronics GmbH, 6 München 60, Falkweg 51, West Germany

OUR COMPLETE PRODUCT LINE CAN BE FOUND IN ELECTRONIC DESIGN'S GOLD BOOK.

CIRCLE NUMBER 16

SAVE A COUPLE OF HOURS ON YOUR NEXT PROJECT.

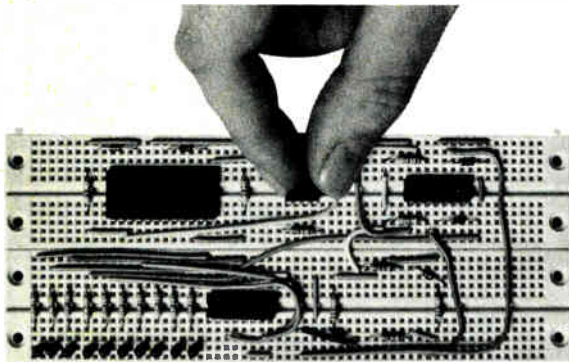

When you consider all the soldering, desoldering and resoldering done on every circuit you design and test, it adds up to a good portion of the time spent on most projects.

We have a better way. CSC QT Sockets and Bus Strips.* The expandable interlocking solderless breadboarding system that provides dozens to thousands of plug-in tie-points for easy connection—and interconnection—of all types of components. From resistors and capacitors to LED's

and IC's. As fast as you can push a lead into a hole...almost as fast as you can think...you can wire, test and modify all kinds of circuits.

Next project, why not do it the easy way? Save time. And save money too, because QT Sockets and Bus Strips won't destroy component leads either. Ask your electronics dealer about CSC's many helpful breadboarding aids... or contact us for our catalog and distributor list.

EASY DOES IT.

CONTINENTAL SPECIALTIES CORPORATION



44 Kendall Street, Box 1942
New Haven, CT 06509 • 203-624-3103 TWX: 710-465-1227
West Coast office: Box 7809, San Francisco, CA
94119 • 415-421-8872 TWX: 910-372-7992
Canada: Len Finkler Ltd., Ontario

*U.S. Pat. No. D 235,554

CIRCLE NUMBER 17

ACROSS THE DESK

(continued from page 7)

warming message for all engineers that we are printing it here verbatim.

I should like to thank you and your whole staff for such great and excellent work as Electronic Design Magazine.

I admire the magnitude and perfectness of your work. It is a great pleasure to read and look through the E.D. and, please, don't treat my words as plane one. I really think so. And I should like to thank you especially, Mr. Rostky, for your Editorial. Your Editorial is always the first article in ED I begin to read and always I read it from beginning to the end.

I was always interested (especially since my graduation in 1968) in what circumstances, in what conditions it is possible to attain so great achievements in technology and particularly in electronics, which U.S. have. As an electronic designer I meet with usual everyday problems of designing and developments in electronic field.

I know quite well what makes us happy and what makes us embittered, what gives us great own satisfaction and then makes us nervous because of irregularities in management, work conditions, supply of components and their quality. Our success in designing is usually treated as a normal thing, and our mistakes are always noticed. And therefore I was (and I am) curious to know how these problems are treated in your (that is in U.S.) laboratories and designing departments and how usual day look like there.

And thanks to your Editorial I have at least a partly picture of a thing I am interested in. You, of course, can say that there are many other articles in ED treated the same problem. I agree with you, and I read them as well, but your Editorial is for me different. It treats problems of usual people, who create electronics. And small events (I believe) create great progress. I think that your Editorial adds more to functions of E.D., which were given in ED 17, Aug. 16, 1975, p. 136.

For me ED functions also as a

joiner of members of electronic community, as a maker of electronic family undependently upon the nation and economic system. You (that is ED) have achieved much in this field.

But, I think, there is a small point disturbing this function of ED.

It is a short note in the advertisement about possibilities of obtaining the free subscription of ED. I suppose, that such free subscription of ED is a dream of most electronic engineers all over the world, not only in U.S. and West Europe. I am sure that we have many people in Poland and in East Europe who can be qualified to achieve the free subscription of ED. But there is a limit: U.S.A. and West Europe only. (ED 17, Aug. 16, 1975, p. 136).

My feeling is that the Great Politics is above the usual working people, although we must do as much as possible to assure the peaceful cooperation.

I think that we are all the same homo sapiens undependently upon where we live. The only difference between us are tools we have to work. And sometimes the worse quality of tools have to be compensated by harder work. But, as you want to say in your Editorial (I suppose): The only criteria to value The Man is His work.

So I want once more to express to you my acknowledgements and my admiration for your work—for the work, which give us—electronic designers—your Electronic Design Magazine.

*Dipl. Electronic Engineer
Czestaw Frac*

80-333 Gdansk-Oliwa
ul. Pomorska 14D/g
Poland

P.S. Please forgive my errors in English. And because there is a Christmas and New Year time please send my Christmas and New Year wishes for everybody who is involved in creating ED and for every Electronic Engineer in U.S.A.

Revised listing

"Focus on Printed Circuits" (ED No. 25, Dec. 6, 1975, p. 62) carried erroneous information for the

Sanders Associates, Inc. listing. The corrected listing should read:

Sanders Associates, Inc., Flexprint Div., Grenier Field, Manchester, NH 02103. (603) 669-4615. (v) vendors of single, double-sided or multilayer boards.

Misplaced Caption Dept.



"How would you like to see the ion-implant machine on my boat?"

Sorry. That's Edouard Manet's "Argenteuil," which hangs in the Beaux-Arts Museum in Tournai, Belgium.

Optimum performance from velocity servos

Having read the article "Keep Newton on your Side" (ED No. 19, Sept. 13, 1975, p. 80), it appears there is at least one paragraph that requires clarification.

In describing a velocity servo system the author states that "a second-order system is heavily damped (a ratio of about 5) to make its frequency response similar to that of a first-order system." He then goes on to state that with compensation by a first-order lead network, the frequency and phase response are superior to an equivalent second-order system.

On the contrary, it is recognized that optimum performance from a velocity servo-pen-motor system is achieved when the galvanometer/velocity transducer combination is treated as a second order—but not

(continued on page 24)

FREE/NEW

'76 Edition

RCL'S

Electromagnetic Delay Line Engineering Handbook



- △ DIP Delay Lines
- △ Power Inductors
- △ Low Priced Commercial DIPs
- △ Delay Line Drivers
- △ Digital Delay Modules
- △ Option Blocks

Terms... Test Methods...
Engineering Definitions...
Characteristics... Specifications

Send For Your **FREE**
Handbook Today!

AMF

RCL Electronics

195 McGregor Street
Manchester, N.H. 03102
(609) 627-3831

CIRCLE NUMBER 18

ACROSS THE DESK

(continued from page 23)

heavily damped—system. Under these conditions appropriate electronic compensation will exactly offset the rolloff characteristics of the galvanometer thus optimizing its frequency response without introducing unwanted phase shifts.

We have used this approach in the design of our new velocity servo-pen-motor systems. As a result, MFE strip-chart recorders using the velocity servo-pen-motor have provided a frequency response of 3 dB down at 150 Hz while complying with, or exceeding, all other American Heart Association requirements.

James E. Muckenhaupt
Product Manager—
Magnetic Devices

MFE
Keewaydin Dr.
Salem, NH 03079.

The author replies

I am glad to see that the new people at MFE are attempting to modernize the product line and that you can now reach 150 Hz like the rest of the industry. This is not a totally disinterested statement, as I receive royalties on all moving-iron galvanometers MFE sells.

In the article in question I did not review the classical approach of tachometer damping of second order systems, as it has received some degree of credibility in its century of use since the Dutch first applied it to windmill controls.

I am sorry I did not clearly express that the method described is, I believe, a valuable improvement over the classical solution. Basically it allows GSI to give more performance for less power (and lower cost). This is possible because the AHA recommended frequency response is a function of amplitude.

Jean Montagu
President

General Scanning, Inc.
150 Coolidge Ave.
Watertown, MA 02172

Interdata wins, 14-6 in second Data Bowl

Interdata, 14; Data General, 6.

Minicomputer sales scorecard? Nope. It's the final score of the second annual Data Bowl—a flag football slug-out between two competitors who normally clash on the computer-marketplace field.

A crowd of about 350 cheered the teams on, and only a broken collarbone and dislocated shoulder detracted from the balmy December day. Keeping time in the crucial last two minutes of each half was—what else—an Interdata 16-bit mini.

Firm cites experience in switching-supply area

We at Pioneer Magnetics were pleased to read the excellent article "Focus on Switching Regulator Power Supplies" (ED No. 20, Sept. 27, 1975, p. 52). It says many of the things we have been saying about specsmanship in the switcher business.

We were, however, disappointed that we were not included in the "Who's Who in Switching Regulated Power Supplies"—especially since switchers have been our main business for 17 years.

In being left out we learned a valuable lesson: that all of our experience in switching supplies will be for nought in the marketplace if potential customers do not know we exist. Thanks to your article we have decided to initiate a vigorous promotion campaign, in which this letter is a small first step.

Fred Heath
Product Manager

Pioneer Magnetics, Inc.
1745 Berkeley St.
Santa Monica, CA 90404

Developing software for microprocessors

After reading the article, "How to Pick a Microprocessor, a Mini, or Anything in Between," (ED No. 16, Aug. 2, 1975, p. 26), I would know a fair amount about how to pick a piece of hardware. I would know very little about how to examine the software problems I might be faced with once I actually had that hardware in-house.

In some sense, the smaller a processor becomes the more time consuming it is to develop soft-

ware to run on it. Minicomputers are harder to work on than maxicomputers, and microcomputers are harder yet. The reason for the developmental difficulties is that the smaller machines just don't have the large mass memories and peripheral pools that big machines typically do.

Because big machines are so much easier to use, projects get done quicker and are frequently more reliable once completed. Clearly, though, there is a problem. A program written to run on a maxi-computer won't be written in the assembly language of a microprocessor so there would have to be a conversion to run on the smaller machines.

To get around that problem and to have the advantages of a maxicomputer while writing microprocessor programs we have written a family of microprocessor cross-assemblers that run on maxicomputers. These cross-assemblers convert microprocessor assembly language statements to microprocessor object tapes, but do it quickly and cheaply on a maxicomputer.

Michael Rooney
President

The Boston Systems Office, Inc.
P.O. Box 32
Cambridge, MA 02139

Moon called source of raw materials

Thank you for your comprehensive reporting, "Wireless Power-Transmission Test Aims at Harnessing Sun One Day" (ED No. 25, Dec. 6, 1975, p. 32).

The economic stumbling block of high lift cost to orbit appears to be avoidable by obtaining most of the materials for construction of solar satellite power stations from the moon. The metal-refining and power-plant-manufacturing site probably would be located at Lagrange points L-4 or L-5, 60° from the moon in the same orbit.

The cost and time required to supply large blocs of power to the earth appears extremely competitive with earth-bound nuclear or coal-fired power plants.

Keith Henson
Coordinator, L-5 Society

President, Analog, Inc.
1620 N. Park Ave.
Tucson, AZ 85719



MEASUREMENT COMPUTATION

innovations from Hewlett-Packard

NEWS

FEBRUARY 1976

Measure AC volts, DC volts, AC current, DC current, and ohms with NEW autoranging digital multimeter—\$225

HP offers a new compact 3½ digit, five-function, fully autoranging digital multimeter at a low price achieved through a major technological advance. Development of fine-line, tantalum nitride resistor technology has eliminated the use of more costly discrete precision resistors. This not only reduces the cost but improves the reliability and temperature stability.

Typical accuracy for dc voltage measurements is 0.5%. Dc current accuracy is 1.0%. On ac voltage ranges, fre-

quency is specified to 10 kHz, while ac current measurement is to 5 kHz.

Voltages can be measured from ±100 microvolts to ±1000 volts dc and from 300 microvolts to 700 volts rms ac. Resistance is measured from 1 ohm to 11 megohms. Current can be measured from 100 microamperes to 1.1 ampere dc and 300 microamperes to 1.1 ampere ac. Autozero, autopolarity and autoranging are built in.

(continued on third page)

in this issue

New microwave switch for signals DC-18 GHz

Into the data domain with Logic State option

Measure binary and code errors with new digital test set

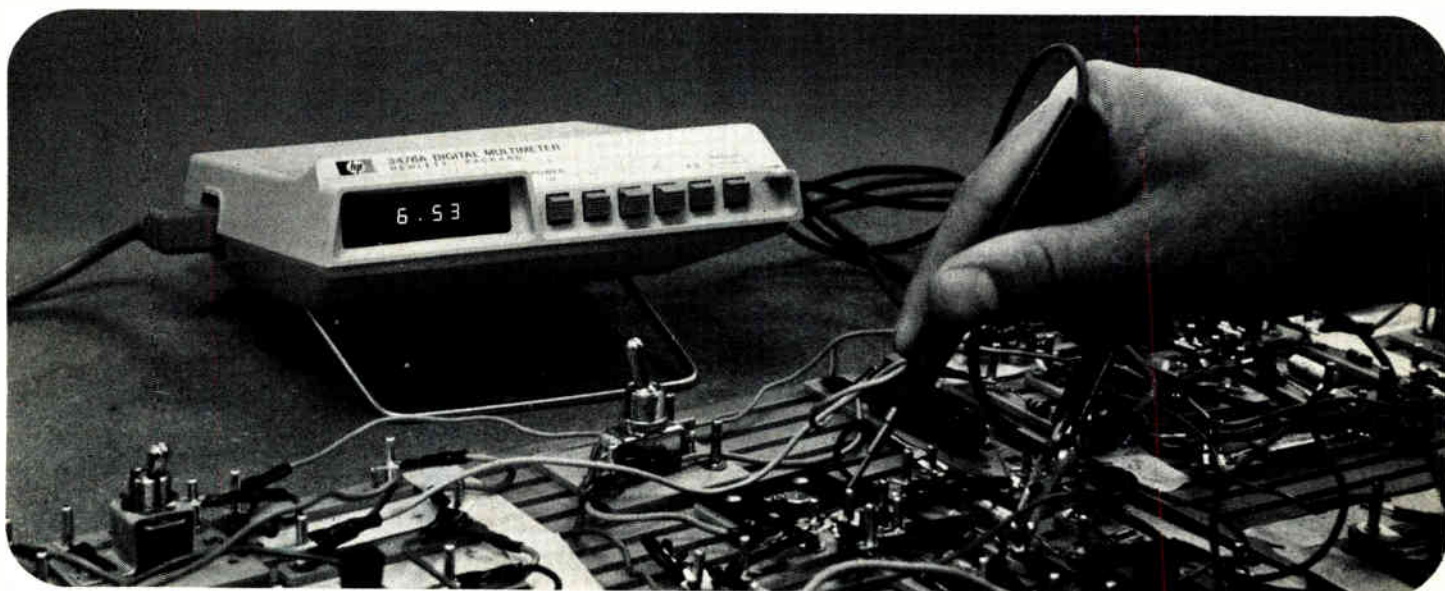

The 3476A/B with autorange is a faster, easier way to measure current, voltage, and resistance. It offers you measurement confidence by combining capability, convenience, and low cost.



The programmable calculator's capabilities are extended with such added peripherals as the 9862 graphic plotter.

More design time available when you verify network results with desk-top calculator system

Hewlett-Packard offers a broad line of calculating equipment and design techniques so that you no longer must plod through hand calculations and pencil annotations in order to verify network results right at your desk.

The HP 9830, utilizing BASIC, has the power and memory of a mini-computer without the inconvenience and expense often encountered. Plug-in read-only memories (ROMs) perform functions with the R/W memory without reducing memory size.

Verify hardware performance prior to committing to expensive prototypes. To graphically see the effects on circuit performance as you change component values, add an HP 9862A X-Y plotter to your system.

A new Application Summary, "Circuit Analysis on the HP 9830" describes the hardware and software necessary for such design applications as ac analysis, dc analysis all with calculator-aided design.

For your copy, check N on the HP Reply Card.

Graphically enhance your calculator system with an HP 9862A plotter

Adding the HP 9862A plotter to your calculator system provides hard copy graphic solutions to problems solved by any of the 9800 series programmable calculators. Whether your applications require the production of graphs under total program control or by manually entering data coordinates through the calculator, the 9872A provides fast, accurate transformation of tabulated data into meaningful graphics.

Features of the plotter include the use of disposable ink pens facilitating the rapid changing of ink colors plus the ability to plot on any paper up to 10 x 15 inches.

Maximum plotting versatility is obtained with a plotter ROM which provides complete alphanumeric capability, X-Y axis generator, automatic function scaling and special symbol plotting. The end result is a finished plot that is completely titled, scaled and labelled.

For more information, check O on the HP Reply Card.

Display baseband amplitude response with new accessory for microwave link analyzer

Measurement capability in the baseband (BB) region is now possible with the new HP 3744A BB Sweeper Accessory for use with an HP microwave link analyzer (MLA) having a center frequency of 70 MHz, and the newly-introduced 140 MHz IF MLA, (Model 3790A/3792A).

It is now convenient to perform swept level baseband measurements in the range 100 kHz to 15 MHz. The BB sweeper accessory allows the MLA to display the BB amplitude response of a microwave radio system. The 3744A can measure flatness of a system with an accuracy better than 0.1 dB.

Small and compact, the instrument consists of three operationally independent sections—transmitter, receiver and attenuator.

The 3744A allows local, remote or simultaneous two-way measurements to be made. The BB sweeper also has a range of connector options, allowing it to interface with HP MLA connector options and existing link equipment.

For more information, check C on the HP Reply Card.

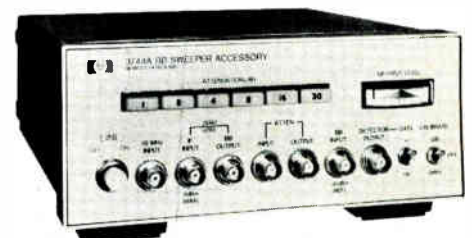

Baseband sweeper accessory accepts BB frequencies up to 15 MHz.

Measure AC volts, DC volts, AC current, DC current, and ohms with NEW autoranging digital multimeter

(continued from first page)

Repetitive measurements can be completed faster with the range hold feature that allows the instrument to be locked to any desired range. The LED readout gives all voltage readings in volts, all resistance readings in kilohms and all current readings in amperes.

Model 3476A is ac line powered only; Model 3476B is ac line powered and also includes rechargeable nickel cadmium batteries.

Both units measure 6.5 cm (2.3 in) high, 16.8 cm (6.6 in) wide and 26 cm (8.1 in) deep. Model 3476A weighs 0.7 kg (1 lb. 9 oz.) and Model 3476B weighs 0.91 kg (2 lb.)—small enough to fit into your attache case or your pocketbook.

To learn more about this easy-to-use, compact multimeter, check A on the HP Reply Card.

Fully protected, low voltage dc power supplies



HP's fully protected low-voltage dc supplies come in power ratings from 120 to 2000W.

If your system power requirements call for a dc supply with superior performance and the benefits of built-in overvoltage and overcurrent protection, take a close look at HP's family of low-voltage rack supplies.

These supplies boast load and line regulation of 0.02%, with less than 10mV peak-to-peak ripple and noise, and full load efficiencies from 54% to 80%. Output voltage and maximum current limit are fully adjustable, while the overvoltage crowbar trip point can be independently set between approxi-

mately 10 and 110% of rated output voltage. Other advantages include automatic crossover between constant-voltage and constant-current modes, remote programming, and remote sensing.

This power supply product line includes 13 models (6256B through 6274B) covering four output voltage ratings: 10V at 20, 50 or 100A; 20V at 10, 20, or 50A; 40V at 3, 5, 10, 30, or 50A; and 60V at 3 or 15A.

For additional information, check J on the HP Reply Card.

Fast, accurate TTL and ECL testing with a single pulse generator

HP's full-capability Model 8082A is the one *Pulse Generator* answer for all fast bipolar logic testing requirements. 250 MHz repetition rate with transition times **variable down to 1 ns** offers unparalleled performance to engineers working with ECL circuits and systems. In addition, its full 5 volt output (into 50 ohms) and speed reserves to cover future, faster designs make the 8082A an ideal choice for TTL applications.

Complementing its speed, the Pulser also brings new precision to high speed logic testing. Its **low-reactance 50 ohm source** absorbs 98% of all reflections from signals up to 4 volts. The result?

Clean pulses, not just from the generator but at the IC input, where you need them, even *without a terminating resistor*.

Switch-selectable fixed ECL levels, square wave mode to 250 MHz, and a human-engineered front panel that minimizes the chances of incompatible control settings, further contribute to making your high frequency pulse testing faster, easier, and more precise than ever before.

Note: for lower speed applications consider HP's lower cost Model 8007B with 100 MHz, 2 ns speed.



Sampling scope display of 8082A's 1 ns rise-time output pulse.

For more information on HP pulse generators, check K on the HP Reply Card.

Any scope in this family with the Logic State gold button can put you into the data domain

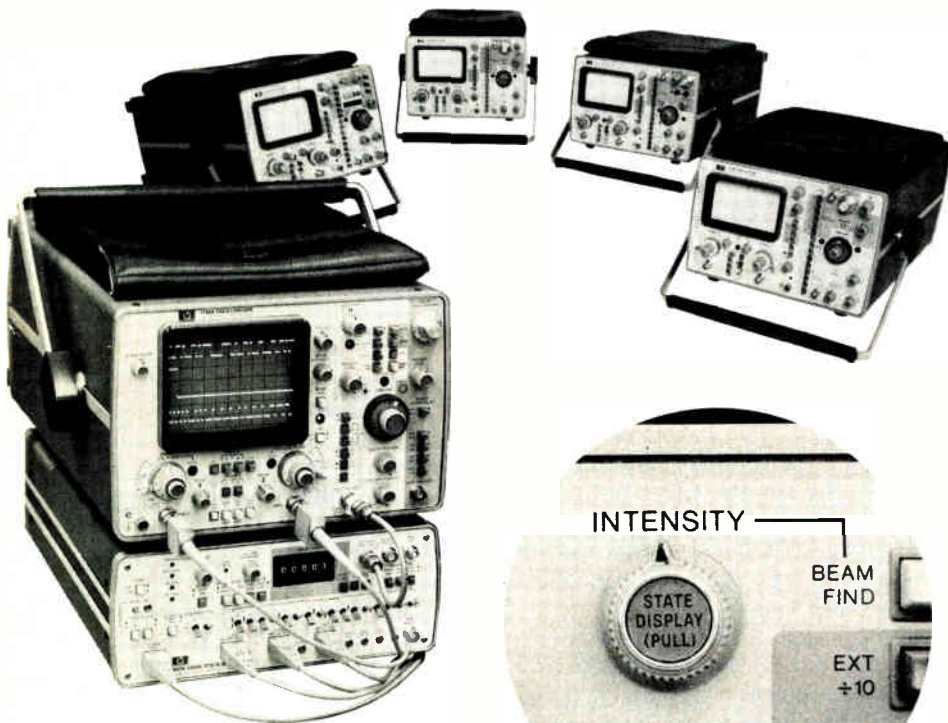

Now, you can display both functional and electrical measurements with the same instrument.

Pick any one of these HP scopes. Add the optional Logic State Switch, (Option 101) and the 1607A Logic State Analyzer, and you have an economical and convenient way to time-share the display between traditional time-domain measurements and the new data domain.

Select the data domain and your scope's CRT displays the results of your measurements in 1's and 0's. Select time domain and you have a display of electrical waveforms.

Data domain capability is an option available for the above scopes. Reading left to right, pictured are the:

1740A 100 MHz The third channel trigger view allows you to see the trigger signal simultaneously with the other two channels.

1722A 275 MHz Dual-delayed sweep, microprocessor and LED display in this scope giving you direct 3½-digit

readout of time, frequency, voltage and relative amplitude expressed in percent.

1712A 200 MHz Low-cost scope gives you the measurement convenience and accuracy of dual-delayed sweep, and scaled voltage output for direct readout of time intervals on your DVM.

1720A 275 MHz Here's real bandwidth value in a dual channel scope featuring exceptionally stable triggering.

1710B 200 MHz General purpose scope with dual-delayed sweep.

Pick the scope that best fits your needs and your budget. Then add the 1607A Logic Analyzer. Include the Logic State Switch Option and you're ready to begin tackling problems in both the time and data domain.

For additional details, check B on the HP Reply Card.

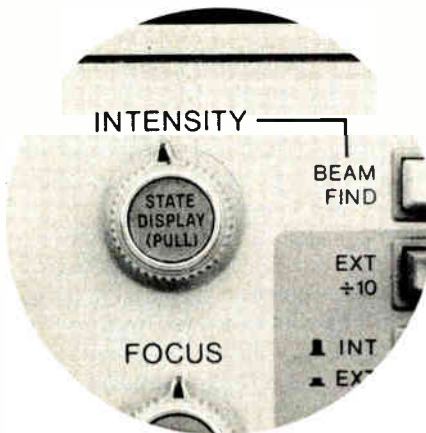

Four new sweeping Application Notes

Applications that capitalize on the versatility of the new HP 8620C Sweeper mainframe and its wideband RF plug-ins are described in several new application notes:

AN 187-2, "Configuration of a 2-18 GHz Synthesized Frequency Source Using the 8620C Sweep Oscillator," describes a calculator-controlled, phase-locked system whose stable signals can be easily set with high resolution. Program listings for HP calculators are included. (*AN 187-1* covers the same topic for the 8620A mainframe). For your free copy, check R on the HP Reply Card.

AN 187-3, "Three HP-IB Configurations for Making Microwave Scalar Measurements," uses the HP 436A Power Meter, 8755 Frequency Test Set, or 8410B Network Analyzer as the measurement partner of the 8620 sweeper for reflection and transmission measurements. Advantages and trade-offs of each alternative are discussed. The Hewlett-Packard Interface Bus permits these tests to be automatic; sample programs are included. Check S on the HP Reply Card.

AN 187-4, "Configuration of a Two-Tone Sweeping Generator," presents a system which generates two swept signals offset by a very stable fixed frequency. Such a system is extremely useful for testing broadband mixers and receiver front-ends; the difference frequency (or IF) can be anywhere from 10 to 300 MHz. This system can sweep test from 2-18 GHz using two HP 86290A/8620C sweepers. Check T on the HP Reply Card.

AN 187-5, "Calculator Control of the 8620C Sweep Oscillator," gives detailed information on the simple programming that puts the 8620C sweeper operation under calculator control. An example shows how to set operating frequencies with high precision by adding a frequency counter as the feedback element.

Check U on the HP Reply Card.

New high sensitivity sensor measures microwave power to -70 dBm

Combining ultra-high sensitivity and low SWR, the new HP 8484A Power Sensor further extends microwave power measurements down to -70 dBm (100 picowatts).

The new sensor is compatible with both the HP 435A analog power meter and the new HP 436A digital meter. Now, in conjunction with the 8481A sensor (-30 to $+20$ dBm) and 8481H (-10 to $+35$ dBm), a measuring range of 105 dB is available from 10 MHz to 18 GHz.

The important contribution of low barrier Schottky diode technology is the very low SWR which resulted, without sacrifice of sensitivity. Since the LBS diodes are so consistent, excellent match to a 50 ohm line is achieved without padding. SWR is 1.3 at 18 GHz (1.2 over 30 MHz to 10 GHz). Such low SWR substantially reduces overall measuring error, and nicely complements the high instrumentation accuracy of the 435A and 436A power meters.

The sensor is designed to minimize thermal drifts, a critical factor when measuring extremely low power levels. An individual calibration factor curve is attached to each unit. Rugged design allows overload limits to 200 mW.

Absolute calibration is achieved at -30 dBm by measuring the 1 mW calibrator signal available on the power meter using a highly accurate, low SWR, 30 dB, 50 MHz accessory pad (HP 11708A furnished).

For a data sheet, check M on the HP Reply Card.



Measure power from 100 pW to 10 μ W over a frequency range of 10 MHz to 18 GHz with new 8484A power sensor.

MEASUREMENT & COMPUTATION: NEWS

Now, eight channels of tape recording on quarter-inch tape



The 3968A is designed and packaged to meet the demands of the individual or OEM user.

The new HP 3968A Instrumentation Tape Recorder offers you significant benefits usually found in much larger tape systems. Eight channels of data collected on $\frac{1}{4}$ -inch tape provide significant savings including lower cost per reel, minimal storage space, and availability from many sources.

Capable of FM and Direct recording/reproducing, with six tape speeds from 15/32 ips to 15 ips, this recorder performs in a large assortment of applications—medical, chemical, geological, engineering, oceanographic, and scientific research.

Standard features include remote control and status of all tape speeds and operational modes, internal AC/DC

calibrator, tape/tach servo mode, and flutter compensation. Flutter compensation is available with the flip of a rear panel switch. The FM signal-to-noise ratio can be improved up to 12 dB in this mode.

In addition to recording data, channel eight may be interrupted for voice annotation. The Electronics-to-Electronics mode (FM only) automatically transfers the input to the output, bypassing the heads when the 2968A is in fast forward, rewind, or stop.

For a full color brochure with detailed specifications, check E on the HP Reply Card.

Quality control or troubleshooting with automatic x-ray system

Now, you can look inside encapsulated components, pinpoint defects in electronic assemblies, castings, or quickly view registration problems in PC boards right at your workbench with the HP 43805 cabinet x-ray.

Automatic exposure control simplifies operation of the unit. Place your object inside the fully radiation-shielded cabinet; the voltage setting is indicated to the operator. An ion sensor determines the correct exposure time and turns the machine off when sufficient radiation has reached the film.

The unit has adjustable output voltage from 10 to 130 kVp with 3 mA current, ensuring good contrast over a range of thicknesses and densities.

High resolution films and enlarge-

ments are possible or Polaroid prints can be produced in seconds.

Check H on the HP Reply Card.



Use x-rays to pinpoint defects in small intricate devices, occlusions in castings, critical points in contacts, relays, or connectors.

Ruggedized Cesium Standard for on-board applications

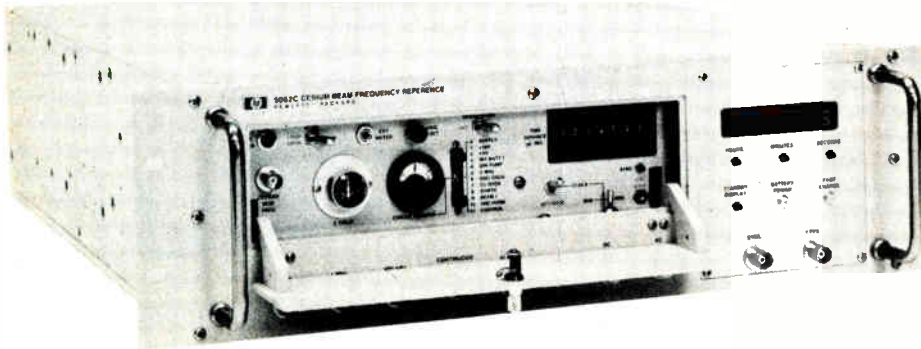

Operating temperature range: -28°C to $+65^{\circ}\text{C}$. Ruggedness: passed the 400-lb. hammer blow test under operating conditions.

The Hewlett-Packard 5062C Cesium Beam Frequency Standard offers both the precision of the best lab standard with the ruggedness of military hardware in a compact package. It maintains 3×10^{-11} accuracy over a wide operating temperature range and requires only 20 minutes of warm-up time even from -28°C .

With a calculated MTBF of 25,000+ hours, the 5062C is highly serviceable. Twelve critical circuits are monitored by the front panel meter. The unit is $5\frac{1}{4}$ " high and will fit into a standard 19" rack. The basic 5062C weighs 50 lbs.

This new frequency standard is ideally suitable for navigation, communication, guidance systems, among other on-line system applications where high performance in field environments is required.

Optional digital display clock and standby battery available at extra cost.

To receive complete technical data, and a copy of the just-off-the-press Application Note 52-2, "Timekeeping and Frequency Calibration," check G on the HP Reply Card.

Extend test equipment measurement range with these RF amplifiers

When RF measurements between 100 kHz and 1300 MHz are limited by sensitivity or power output, it's quite likely one of the HP 8447 series of broadband lab amplifiers can help. There are low-noise preamps spanning 100 kHz-400 MHz, 100 kHz-1300 MHz, and 400-1300 MHz. Power amplifiers covering 30-300 MHz and 100 kHz-1300 MHz are offered. These solid state units all feature high gain of 20 dB or more and flat frequency response.

Use the preamps to improve the effective sensitivity of such instrumentation as RF voltmeters and power meters, spectrum analyzers, oscilloscopes, and frequency counters. Dual-channel preamps are especially useful with wideband scopes and network analyzers.

The power amplifiers provide a simple convenient way to boost the output of RF signal sources and sweepers to above 20 mW.

Send for details on these general purpose amplifiers. Check L on the HP Reply Card.



Use the HP 8447 preamp with a spectrum analyzer to make accurate measurements of low-level signals.

New low noise microwave transistor

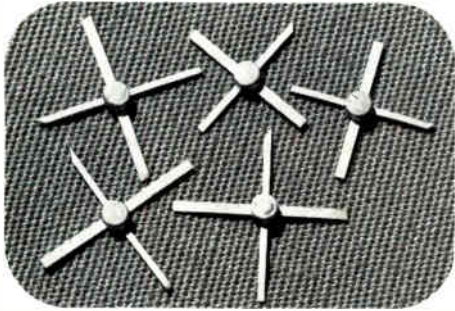

New transistors offer guaranteed tuned gain in rugged confined metal/ceramic package.

The new HP 35868 series is an NPN bipolar transistor optimized for low noise and high gain at 4 GHz. The 35868L features a guaranteed noise figure of 4.5 dB max at 4 GHz with a minimum associated gain of 7 dB. Typical G_a (max) is 14 dB at 2 GHz and 10 dB at 4 GHz.

Gain and noise are specific and guaranteed under fixed optimum source and load impedance conditions simplifying the designer's job in extracting the maximum performance possible from the device.

For detailed specifications, check Q on the HP Reply Card.

Now, four bright colors in subminiature solid state lamps

Choose from red, high efficiency red, yellow or green solid state lamps encapsulated in a radial lead subminiature package of molded epoxy. The 5082-4100/4150/60/90 series offer long life with solid state reliability.

High on-off contrast and wide-angle viewing are provided by the use of a tinted, diffused lens. The low-profile package and 2.21 mm center-to-center spacing are features of interest if you are working with space restrictions.

Arrays are available in a molded linear configuration with separately accessible radial leads for each device. Center-to-center spacing is then 2.54 mm.

For additional details, check F on the HP Reply Card.

Maximum average forward current for red lamps is 50 mA; 20 mA for high efficiency red and yellow, 30 mA for green.

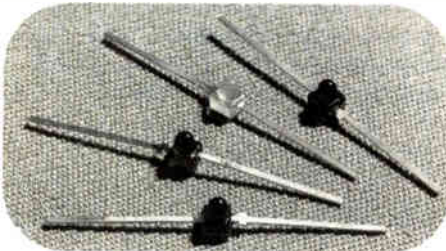

New microwave coaxial switch with 90 dB isolation at 18 GHz

A new microwave switch is available which provides single-pole, double-throw action for signals from dc to 18 GHz. The HP 33311B is distinctive because it features internally-switched 50 ohm loads which maintain a low-SWR match for the ungated secondary port. The switch has isolation greater than 90 dB at 18 GHz, important for applications requiring wide dynamic range.

The new switch is designed using "Edge-Line" transmission line techniques and switches only the center conductor to yield typical repeatability of ± 0.03 dB after 1,000,000 switchings. SWR is 1.4 and insertion loss is 0.8 dB at 18 GHz and the switch is usable to 24 GHz. The 33311B will handle 1 watt average with 100 W peak, and connectors are SMA.

The switch mechanism is self latching using a permanent magnet and provides special contacts which disconnect the coil after the switching operation, minimizing heat dissipated in the unit. Coil voltages are available for both 5 and 24 volts, and momentary energizing power is approximately 3 watts. Switching time is 30 mS.

The small size ($5.5 \times 7 \times 1.5$ cm) and environmentally rugged construction makes the 33311B particularly well-suited for designing into microwave instruments and systems.

For detailed specifications, check P on the HP Reply Card.

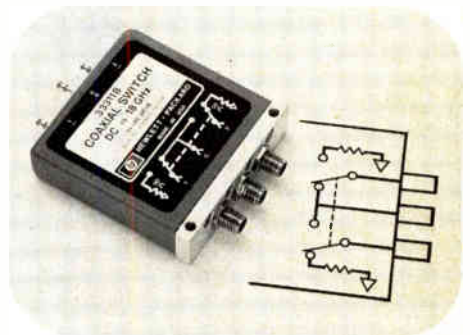

DC-18 GHz SPDT coaxial switch has internal matching loads.

LED digits for watches

In response to the high consumer demand for digital watches, Hewlett-Packard is currently shipping digits to several major watch manufacturers and willing to consider special digit requirements from other watch producers.

Also being developed is a new family of LED digits for watches. These digits which are scheduled for introduction this year have been designed to meet the specific needs of manufacturers of solid state watches. The digits will be

available in a variety of sizes and character styles.

Hewlett-Packard is able to do this because of our in-house materials capability, long experience in producing large quantities of digits for the calculator market, and our computer testing techniques.

Direct your inquiries to Hewlett-Packard Opto-electronics Division, 640 Page Mill Road, Palo Alto, CA. 94304.

New 50 Mb/s digital transmission test set for PCM/TDM systems

The 3780A Pattern Generator/Error Detector is a new bit-by-bit error measuring set. Data is provided at standard levels in both ternary-coded (AMI, HDB3, B6ZS, etc.) and binary format. Clock recovery, and frequency offset generation and measurement facilities are available at three internal crystal frequencies. The crystals can be chosen to cover measurements on the first three levels of the PCM hierarchies for CEPT, North American and Japanese systems.

Random or systematic binary errors are measured by stimulating the system under test with a PRBS pattern. The output of the system is compared bit-by-bit with a separate, internally generated error free pattern and any errors present are counted. Random errors can also be counted using Word patterns. Both binary errors and code errors can be counted over a chosen gating period and displayed directly as bit error rate or total error count.

Clock recovery performance evalua-



The 3780A Pattern Generator/Error Detector is a complete 1 kb/s to 50 Mb/s error measuring set in one portable package.

tion can be carried out using the zero add facility in the 3780A. For testing 4 ϕ PSK digital radio systems, an additional data output, 6 bits advanced on the main data output, is provided. Pattern-sensitive problems in digital transmission and terminal systems can be investigated with the selectable 4-bit or,

optionally, 16-bit Word patterns. Unattended long-term measurements are possible by using the BCD printer and/or strip chart recorder outputs.

For more details, check D on the HP Reply Card.

HEWLETT  **PACKARD**

East-4 Choke Cherry Road, Rockville, MD 20850
Ph. (301) 948-6370.
South-P.O. Box 28234, Atlanta, GA 30328,
Ph. (404) 434-4000.
Midwest-5500 Howard Street, Skokie, IL 60076,
Ph. (312) 677-0400.
West-3939 Lankershim Blvd, North Hollywood, CA
91604, Ph. (213) 877-1282.
Europe-P.O. Box 349, CH-1217 Meyrin 1, Geneva,
Switzerland, Ph. (022) 41 54 00.
Canada-6877 Goreway Drive, Mississauga, Ontario,
L4V 1L9, Ph. (416) 678-9430.
Japan-Yokogawa-Hewlett-Packard Ltd., Ohashi
Bldg., 59-1 Yoyogi, 1-chome, Shibuya-ku,
Tokyo 151, Ph. 03-370-2281/92.

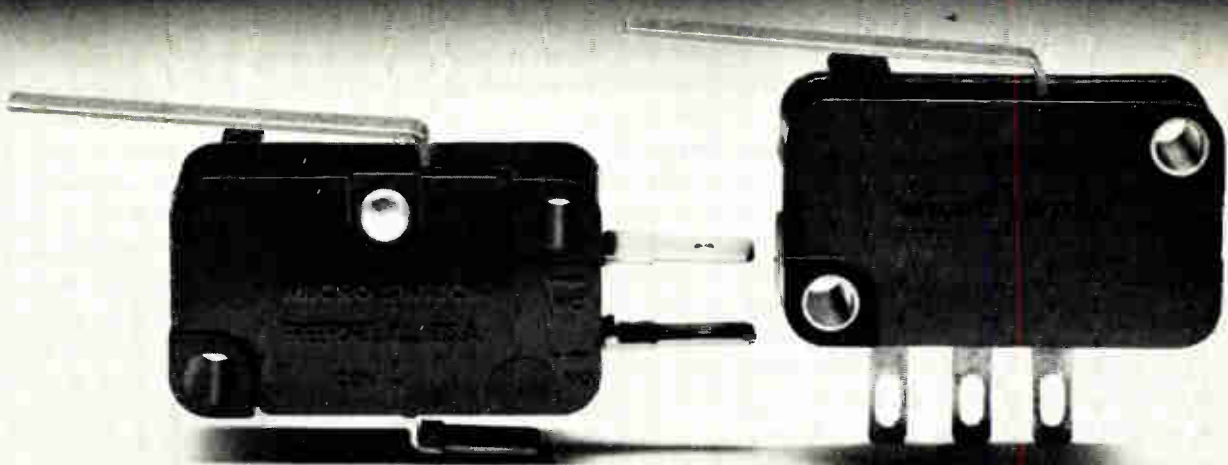

One of these is a new solid state switch. It's important that you can't tell which one.

The switch on the left is the V3. A mechanically-actuated snap-action switch the size of a postage stamp. It was an industry first when MICRO SWITCH introduced it in 1943. And it's gone on to become the industry standard, with hundreds of millions in use worldwide.

The switch on the right looks like the V3. Mounts like the V3. It's even actuated like the V3. And that's exactly where the similarities end. Because it's all solid state inside.

Designed around a Hall-effect integrated circuit perfected by MICRO SWITCH, the XL has been made to provide every benefit of true solid state design without the necessity of getting out of mechanical control.

Because the XL is all solid state, there are no contacts to bounce or become contaminated. And the Hall-effect integrated circuit has been performance tested through over 12 billion operations without a single failure. Unlike

standard mechanical switch designs, the XL can also interface directly with other solid state components. Its 20MA output eliminates the need for amplifiers, in most applications. And you can order it with either current sinking or current sourcing outputs.

It needs very little force for actuation—down to 10 grams. Even less with a lever. And the choice of actuator styles is the same as for the V3: over 500 different actuators in all. Including simple pin plunger, straight lever, simulated roller or roller lever.

Power supply requirements are also flexible. 5 VDC or 6 to 16 VDC with built-in regulator, over a temperature range of -40°C to $+100^{\circ}\text{C}$.

So the XL obviously offers some unique advantages. It's just one of a wide range of MICRO SWITCH solid state designs that do. Including a complete range of magnetically operated solid state position sensors, like the ones pictured here.

If you'd like more information on the XL, or any of the other MICRO SWITCH solid state switches, call your nearest MICRO SWITCH Branch Office or Authorized Distributor. Or write for literature.

We'll tell you the advantages of solid state design in your particular application.

And about a switch that looks very familiar. But works like nothing you've ever seen.



Products shown are actual size.

MICRO SWITCH
 FREEPORT, ILLINOIS 61032
 A DIVISION OF HONEYWELL

MICRO SWITCH products are available worldwide through Honeywell International.

CIRCLE 231 FOR DATA
 CIRCLE 232 FOR SALESMAN CALL

Model 9832. A very acquisitive little recorder—

— particularly acquisitive of the random data found in many engineering, scientific, geophysical and business applications. Model 9832 asynchronous recorder uses dual random-access memories to record time-independent data with no loss of data during gap insertion. Being truly asynchronous, Model 9832 can both read or write data at any rate up to 250,000 characters per second.

Model 9832 operates with RAM's of 512, 1024 or 2084 bytes. Input data is strobed into the first buffer asynchronously; when one buffer is filled, the data is transferred to the other buffer while the transport formats and records the first input data.

Model 9832 is the ideal recorder for applications characterized by brief periods of high-speed data followed by intervals of relatively slow data, such as data communications and telephone toll ticketing.

If you've an applications that wants it both ways — fast and slow — Model 9832 could be the economical answer. Write us. You might wind up acquiring one.

KENNEDY CO.

540 W. WOODBURY RD., ALTADENA, CALIF. 91001
(213) 798-0953



KENNEDY · QUALITY · COUNT ON IT

CIRCLE NUMBER 20

WorldRadioHistory

FEBRUARY 16, 1976

Two systems under study to peer inside arteries

Computerized image-processing techniques and ultrasonics are advancing the study of hardening of the arteries at two large medical centers. At one, the University of California's Specialized Center of Research and Atherosclerosis, a new system has provided the first evidence that the clogging of vital arteries with fatty deposits can be reversed.

Dr. David H. Blankenhorn, a heart specialist at the university, reports the use of vascular-image processing has permitted the Center to measure fatty deposits in the veins and to keep track of whether they are becoming larger, smaller, or remaining stationary in size.

The technique—X-ray angiography—uses injected dyes to show up the clogging or plaques under X-rays.

Developed in cooperation with the California Institute of Technology's Jet Propulsion Laboratory, the image-processing system is based on a National Aeronautics and Space Administration technique for clarifying pictures sent back to earth by spacecraft.

"You can look at an X-ray picture and see 70% occlusion one day and two days later you can see it reduced 50%," says Robert Seltzer, supervisor of biological image processing at JPL.

"To our knowledge there has never been a method for detecting these kind of short-term changes."

Blankenhorn says the JPL system can lead to treatment to correct the trouble before harm is done. It provides precise measurements of the artery plaque using film scanning and digitizing under the control of a PDP11/45 and an interactive display.

To eliminate discomfort or risk to the patient from the use of X-ray angiography, Stanford Research Institute has developed an

ultrasonic instrument that produces television images of a small cross-section of tissue, including arteries and surrounding muscles, veins and organs. The only contact with the skin, according to Philip S. Green, program manager for Ultrasonics at SRI, is a small water-filled bag that rests against the skin.

Plaque appears as a bright region in the normally dark interior of the artery, when viewed with the first model of the SRI artery-imaging instrument now undergoing tests at the Mayo Clinic, Rochester, MN.

Superimposed on the cross-sectional image of the artery is a graph showing the moment-to-moment velocity of the blood at each point across the vessel, according to Green. These data are derived from the ultrasonic waves that are scattered from the moving blood cells.

The SRI development program was initiated jointly by SRI and the Mayo clinic under the sponsorship of the National Heart and Lung Institute of the National Institute of Health.

While the present investigation has centered around the carotoid artery, which provides most of the blood supply to the brain, Green predicts that with slight alterations the instrument may be useful for detecting blood clots and for diagnosing diseases in other organs.

B-1 has first radiation-hardened digital avionics

The B-1 aircraft will be the first to have all of its digital avionics radiation-hardened. A test model has just been introduced and flight testing will begin in March.

The avionics installation in the test aircraft began in May of

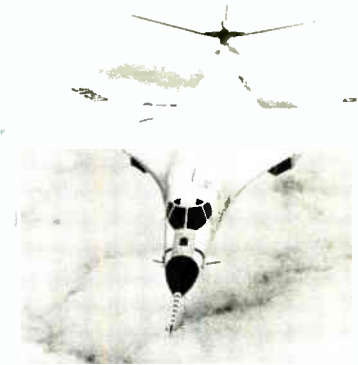

The B-1 bomber's avionics system will control the delivery of up to 24 short-range attack missiles or 75,000 pounds of bombs. The avionics are controlled by a pair of radiation-hardened digital cpu's.

1975. Flight testing is to be completed by November, according to Maj. Gen. Abner B. Martin, B-1 program director at Wright-Patterson AFB.

Boeing Aerospace Co., Seattle, WA, has developed a digital information system with a 7-channel multiplexed data-distribution architecture. Dual cpu's can each control the entire system by themselves or work together on separate functions.

The avionics systems will control navigation, weapons delivery, stores management, air vehicle electronics, a central integrated test system and a variety of displays.

Global navigation under all conditions is provided by a combination of Doppler and pure inertial guidance. The pilots main visual aid is a forward-looking infrared radar (FLIR).

Also included in the system are: forward-looking radar; terrain-following radar; Doppler radar; and a pair of radar altimeters.

The FLIR has better resolution than any other unit of its type used to date, according to A. M. S. Goo, offensive avionics integration program manager for Boeing. He says the avionics system will cost about \$4.9 million, about 12% of the aircraft's total cost.

AT&T system switches 150 calls per second

The world's highest-capacity electronic switching system for long-

distance telephone calls has been put into operation in Illinois by the American Telephone and Telegraph Co.

Called the No. 4 Electronic Switching System, the machine switches approximately 150 calls per second or 550,000 an hour. This is four times faster than the most advanced electromechanical toll-switching equipment used by the Bell System today.

Western Electric, the Bell System's manufacturing unit, spent more than \$400 million on the system over five years but by 1985 it is expected to save AT&T almost \$1.5 billion a year.

At the heart of the system is the 1A Processor, a new stored-program control unit with advanced integrated circuitry, including modified I²L and some TTL technology. An improved magnetic-core memory system is used in the processor and insulated-gate FET memories in the peripheral areas.

The processor executes call-processing instructions four to eight times faster than earlier electronic units and is expected to be more dependable, according to a Bell spokesman.

The machine uses time-division switching techniques instead of the traditional space-division technique. It can directly switch digital signals in the proper format, without first converting them to the traditional analog form.

Today, most of the signals passing through toll offices are analog, but time-division switching is making digital transmission systems increasingly advantageous. As digitized voice and data traffic grows on the long distance network, the inherent ability to switch signals without converting them back to analog will yield significant cost savings, the spokesman says.

The system is capable of diagnosing problems in its own circuitry and switching to alternate equipment before a customer is aware a problem exists. The No. 4 ESS requires 62 percent of the electrical power needed to run 4A systems handling the same volume of traffic. It also requires only 9000 square feet of floor space, compared to 36,000 square feet for a comparable 4A machine, the spokesman says.

The new system, which began

operation in Chicago in January, is jointly owned by Illinois Bell and AT&T Long Lines. Similar systems are scheduled to be in service during the next 12 months in Kansas City, Dallas, Jacksonville and Atlanta. About 20 of the new machines are expected to be operating in the long-distance network by the end of 1978.

Level-6 mini family announced by Honeywell

Honeywell's recently-introduced Level-6 minicomputer family combines some of the most advanced technology to date in minis—4-k MOS memory, TTL, MSI and LSI circuits—plus some rather unusual packaging concepts.

Three models of Level-6 minis—an expansion of Honeywell's Series 60 line—were offered at prices ranging from \$2634 each for the smallest configuration to about \$60,000 for the largest system.

The machines provide as many as 32-k words of memory on one 15-by-16-in. four-layer PC board. Most minicomputers use 16-k words per board. Each board can contain either the central processing unit, a peripheral controller for up to four devices, or a communications processor for up to eight full-duplex lines.

Etched wire connections, with signal paths on all levels, permits up to 252 components on the basic board. 120 components could be added with a full complement of adapter boards.

A 5-1/4-in.-high chassis can contain a central processor, 32-k words of memory, peripheral controllers for a console terminal, dual diskettes for cartridge discs; a line printer, and eight full-duplex communication lines.

A bidirectional asynchronous Megabus architecture provides the Level-6 minis with transfer capability of up to six million bytes per second. Cycle time is 300 ns. In addition, up to 1024 addresses are available for attaching peripheral and communication devices. The 24-bit address width of the Megabus provides the capacity for directly addressing up to 16-million bytes.

Other features of the Level-6 family include built-in testing and diagnostic devices, and memory

modules (of 8-k words each) that can be added by hand to computer boards.

CIRCLE NO. 300

New satellite boosts marine communications

Marisat, the first maritime satellite, designed to provide high-quality communications between land stations and ships at sea, is scheduled to go into stationary orbit over the mid-Atlantic on Feb. 19. A second Marisat, to be stationed over the mid-Pacific, is scheduled for launch in May.

Shore stations are located at Southbury, CT for the Atlantic satellite and Santa Paula, CA for the Pacific. The shore stations are connected with existing terrestrial public-telephone, telex and message-telegraph networks and linked with a system-control center in Washington, DC. Commercial service is planned in the Atlantic area by the end of March.

The National Aeronautics and Space Administration will launch the satellites from the Kennedy Space Center, Cape Canaveral, FL. They will then be operated by their owners, Comsat General, RCA Global Communications, Western Union and ITT World Communications.

Each satellite will contain three communication repeaters: a C-band repeater that receives at 6420 to 6424 MHz and transmits at 4195 to 4199 MHz; an L-band repeater that receives at 1638.5 to 1642.5 MHz and that transmits at 1537 to 1541 MHz. And a uhf-band unit receives at 300 to 312 MHz and transmits at 248 to 260 MHz.

The Navy has leased one wide-band and two narrowband channels in the Atlantic satellite, at uhf frequencies, for communications between its own fixed and mobile terminals. Channels are available in C and L-band frequencies for commercial ships and off-shore installations such as oil platforms.

Shipborne and off-shore terminals will use dish antennas four feet in diameter. With pedestal, the transceiver stands 80 inches high and weighs 500 pounds.

Navy and commercial ships now communicate with hf radio, which is subject to atmospheric disturbances.

We saw your microprocessor

coming. So we designed an entire family of socket homes for it. Socket cards for card file mounting, and we've even got the card files. Socket boards for LSI mounting in frames, drawers, and racks,

and we've even got the frames, drawers, and racks. Our socket cards, the 3D Series, come with built-in test points, a ceramic monolithic bypass capacitor

at each socket, and solder tab connection to pins on LSI chips. Our socket boards, the 2D Series,

offer a good selection of socket complements, and are compatible with other boards for hybrid installations. We also offer automated wiring service. We're ready for you.

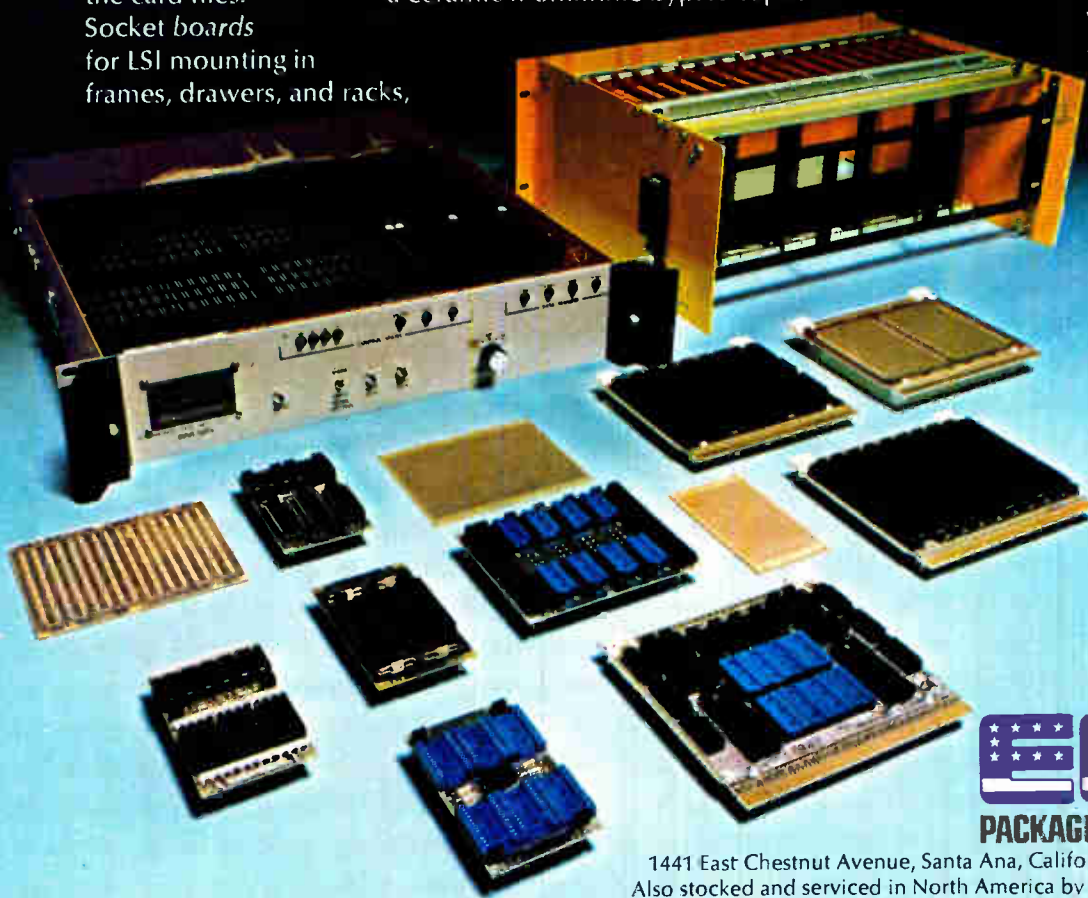

PACKAGING/SWITCHES/READERS

1441 East Chestnut Avenue, Santa Ana, California 92701 Phone 714/835-6000
Also stocked and serviced in North America by G. S. Marshall, R-A-E, Zentronics.

CIRCLE NUMBER 21

WorldRadioHistory

Finally.

**A self-locking connector that's
classified UL 94V-0 for flame resistance
and UL 486 for 600 volts.**

And recognizes that people aren't.

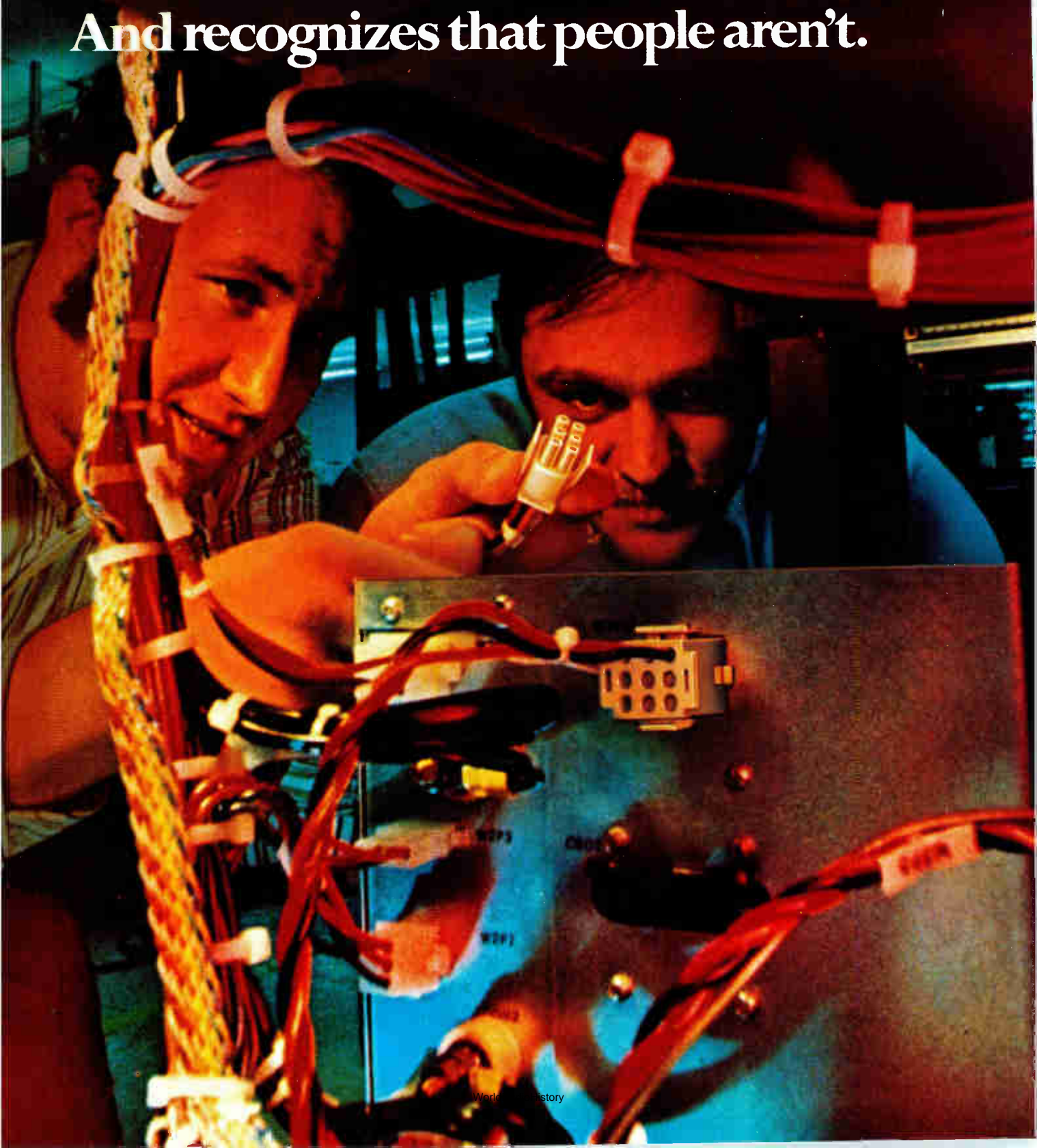

Our flame retardant Universal MATE-N-LOK series can take up to 600 volts with ease.

But people can't.

That's why, along with all the UL, CSA, and VDE/CEE credentials you need for worldwide and flame-retardant use, Universal MATE-N-LOK connectors offer you an exclusive safety feature:

A unique silo-design housing that makes it virtually impossible for you, or anybody else, to touch or mismatch the pins and sockets.

So, in addition to reducing the potential of a fire, you're eliminating the chance of a short—or a shock.

With Universal MATE-N-LOK connectors, you get versatility too. Wire-to-pc board or wire-to-wire. Panel mount or free hanging. Mix pins and sockets in either half, for all types of keying combinations. And no matter how you apply them, Universal MATE-N-LOK connectors are greedy for power—with dual-wire capabilities and other features that let you pack more action into less space.

Of course, Universal MATE-N-LOK connectors, for sophisticated through non-critical applications, are backed by AMP technical service. Not just ordinary service, but the kind that says we'll help you with design problems. Application tooling. Training for your people. And troubleshooting. Just call us.

Find out more about how Universal MATE-N-LOK connectors—and AMP—can help you get more power to your products.

Without getting power to the people who use them.

Call Customer Service at (717) 564-0100, or write:
AMP Incorporated, Harrisburg, Pa. 17105.

AMP

INCORPORATED

CIRCLE NUMBER 22

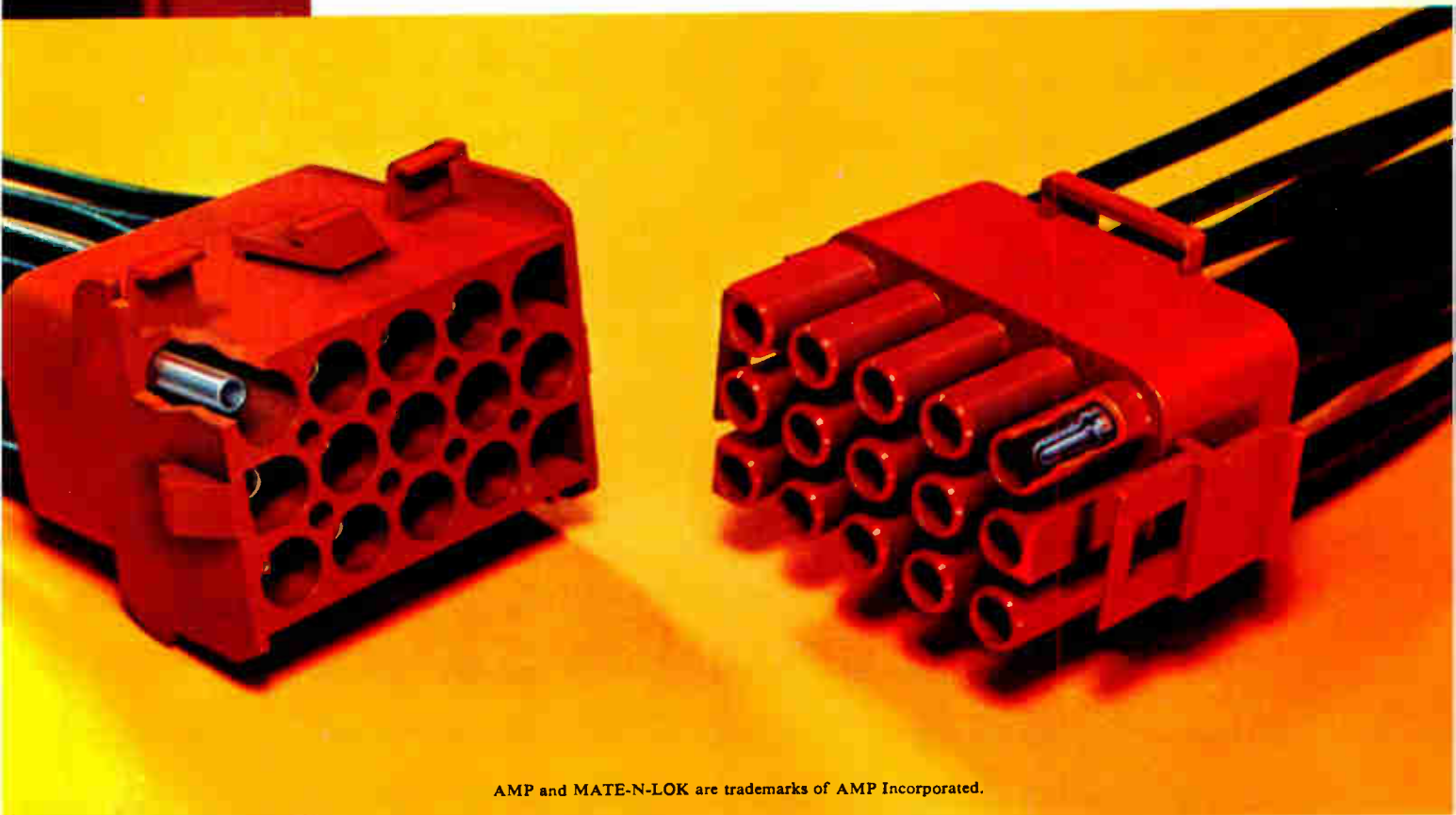

AMP and MATE-N-LOK are trademarks of AMP Incorporated.

Darlington that last.

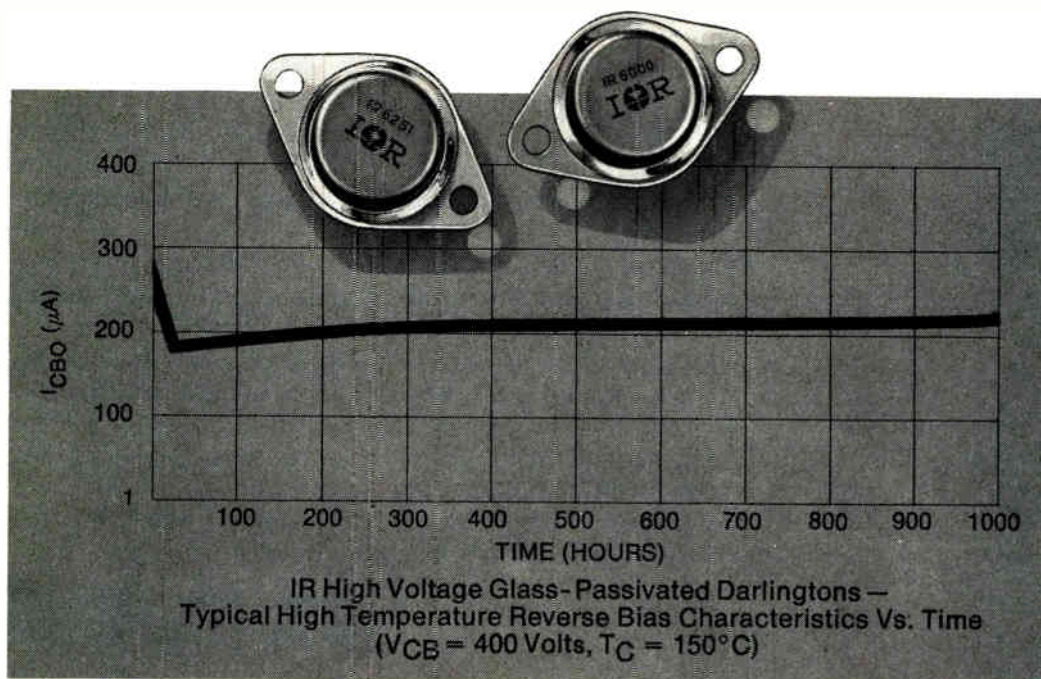

Whether you use Darlington or discretes, without high-temperature stability, you're dead. Failure may be a boon to the aftermarket, but for OEM's it can start something big... and bad.

Stability testing of IR Darlington shows a remarkable 210 microamps leakage after operating 1000 hours at 400 Volts V_{CB} and 150°C ! We don't think anyone can top it with present technology.

It's due to our hard-glass passivation techniques, plus 28 years' experience building high reliability power semiconductor devices.

New 20KHz Series

Our three new series of fast-switching Darlington (using an internal speed-up diode) give you this superb stability, plus the great per-

Series	Ic Peak	Total max tr/ts/ta	V _{CEO(SUS)}
IR6251	15A	3.75μs	350-450V
IR6000	20A	3.90μs	300-400V
IR6060	25A	3.90μs	300-400V

3 New Series for 20KHz Switchers.

formance you need for switching power supplies. Like a rise/storage/fall time total that's typically 50% below maximum rating, guaranteed minimum gains, plus lower sats and a wide SOA.

New 900V Darlington Series

While you're getting data, ask about our new super-voltage, 500 to 900 Volt $V_{CEO(SUS)}$ devices, and our many other high gain high-voltage series for 5KHz applications.

And if you're thinking of paralleling, ask for our "Paralleling Power Transistors" paper.

It's full of valuable information that can save you a lot of time and money.

Above all, think of our device stability. For more peace of mind... at no extra cost.

International Rectifier

the innovative power people

233 Kansas St., El Segundo, CA 90245, (213) 678-6281

CIRCLE NUMBER 23

CIRCLE NUMBER 24 ►

ANNOUNCING

a **totally new** line of high performance,
low-cost digital panel meters

WESTON
2460 Series

+1594

Actual size

Large, bright, easy-to-read LED display High reliability LSI design

New from Weston. The 2460 Series digital panel meters. An innovative line of meters that combines the best in semiconductor and display technology for all 3½ digit applications. The result is better performance, better reliability, and better price. In fact, you can now get the best in Weston DPM performance at a price of only \$80.*

The unique Weston two-chip LSI circuit design in the 2460 Series reduces the number of components. This provides added reliability and helps to cut cost. And Weston has done it without sacrificing the outstanding characteristics of its patented Dual Slope Conversion** method of circuit design for long term stability—an industry acknowledged superior method.

This LSI feature alone makes the 2460 Series a good buy. But Weston took it one step further. We replaced the gas discharge display with an LED display. Better reliability. And—our LED happens to be a big and bright 0.6".

This is the basic story on the new 2460 line of Weston high reliability/low price meters. The rest of it is basic to Weston quality

and performance. Single ended or balanced differential input—completely floating, with isolated systems interface. Industry standard pin connections to assure multiple sourcing and simple retrofit requirements. All of these outstanding features are packaged in the popular and industry standard Weston DPM case, requiring only seven square inches of panel space.

The 2460 Series is available in six models that include both AC line and DC powered units.

Ask your distributor for a look at the 2460 Series. It will improve your equipment's performance and reliability while it saves you money. Or, write direct to Weston for additional information. Weston Instruments, Inc., 614 Frelinghuysen Ave., Newark, NJ 07114

Canada: 1480 Dundas Highway, Mississauga, Ontario
Europe: Ingolstadter Str. 67a 8 Munchen 46, W. Germany

WESTON

WESTON
Schlumberger

LED Show Stoppers



Bright lights from a cast of thousands.

A great show of LED Panel and PCB lights from Data Display Products. Vivid colors . . . red, yellow, green and amber. Outstanding performance . . . brighter than many incandescents (50 MCD @ 20 mA — typical clear red). Direct replacements for incandescents. Immediately available at popular prices.

Subminiature Panel LED's (also suitable for PCB mounting) — available in hundreds of sizes, shapes and styles.

PCB LED's — horizontal or vertical viewing.

Bi-Pin (T1-3/4) LED's — direct replacements for incandescent types.

Midget Flanged (T1-3/4) LED's — direct replacements for incandescent types.

Send for our Catalog on the whole show: Data Display Products, 5428 W. 104th Street, Los Angeles, Ca. 90045, (213) 641-1232.

Produced by the Original "little light" people.



Washington Report

Commerce Dept. predicts record year in 1976 sales

If the recovery continues as forecast by the Dept. of Commerce, shipments by manufacturers of electronic equipment and components are predicted to reach a record \$28.3 billion this year and \$52.7 billion by 1985, reflecting a 7.5 percent annual growth rate.

The department's market analysts note, however, in a recently released industrial outlook for 1976, that long-range projections of industry trends are difficult because of the high rate of technological change.

Cautiously, Commerce forecasts that commercial, military and industrial electronics will grow at an 8.7 percent annual rate to \$23 billion; electronic components at a 5.7 percent rate to \$18.1 billion; and consumer electronics at an 8.4 percent rate to \$8.7 billion.

The prognosis is also good for computing and calculating equipment manufacturers with 1976 sales expected to reach \$13.4 billion, and a compound annual growth of 8 percent with shipments reaching \$26 billion in 1985.

Pilots say airports and airways are over-controlled

The Federal Aviation Administration's development and engineering program has come under attack from the nation's largest private pilots' association, which contends that 80 percent of the current budget could be shelved and \$75 million saved.

"Expenditures for radar," says the Aircraft Owners and Pilots Association, "have led to wasteful extensions of positive control areas around major airports and at altitudes above 12,000 feet."

The association, in a statement to the Senate Commerce Committee's aviation subcommittee, contends that the control of these areas forces aircraft owners to buy expensive electronic equipment they otherwise wouldn't need. The current hearings are on the continuation of federal aid to airports and expansion of the air traffic management systems.

Weapons procurement gets biggest boost

President Ford has asked Congress for a record \$112.7 billion in total obligational authority for defense for fiscal year 1977, which begins on Oct. 1. This is \$14.4 billion more than the amount approved for 1976. After discounting for inflation, however, the real increase comes to approximately \$7 billion.

For defense procurement the President asked for \$29.3 billion, an increase of \$7.9 billion. For R&D, \$11 billion—up \$1.5 billion.

Budget authority for the National Aeronautics and Space Administra-

tion will rise slightly, to \$3.7 billion. Space research and technology will increase by \$149 million and manned space flight by \$130 million.

Up \$87 million, is the budget for the National Science Foundation with FY 1977 authority to reach \$805 million; this includes a 20% rise in basic research funds.

An increase in defense funds of \$2.1 billion for strategic forces is requested to continue development of the B-1 bomber and the Trident missile system, to further development of a new ICBM, and develop a long-range cruise missile for aircraft, submarine, and surface vessels. The emphasis on general forces will be to restructure for short, intense conflicts. The Army is adding three divisions, and the Air Force is adding four tactical air wings without increases in the number of uniformed personnel.

The President is asking for 15 new ship starts for the Navy, plus long-lead-time items for a controversial nuclear-powered strike cruiser. Administration plans call for 13 attack and antisubmarine carriers by FY 1978, down from the present 15.

Subs join the primes under the klieg lights

Early indications suggest that Government subcontractors will get the same grilling about gratuities and entertainment expenses this year that prime contractors have been getting for some time.

A General Accounting Office probe into subcontractor activities has uncovered some activities the agency considers questionable and recommends that both the Defense Dept. and Congress do something about them.

The Defense Dept., the GAO says, should insert a clause in contracts that specifically prohibits payment of gratuities by subcontractors. And Congress, to block the practice on another front, should consider making such gifts illegal by legislation or should change the tax law to preclude the deduction of gratuities as a business expense.

Capital Capsules: As a continuation of its study of rf interference caused by auto spark-ignition systems, the FCC has asked for comments on interference of the systems with television, microwave and amateur operations. Until now the FCC has been primarily concerned with the effect on mobile radio operations in the 25-400 MHz range. Comments will be accepted through Mar. 19. . . . A new family of 64-channel transportable digital troposcatter radio terminals is being developed by the Air Force to replace the 24-channel AN/TRC-97 units now used in the Tactical Air Control System. Designated AN/TRC-170, the new units will be built in three versions: one for ranges under 100 miles, one for slightly over 100 miles, and one for up to 200 miles. Two parabolic antennas, 8 to 15 feet in diameter, will be used to send and receive the digitized messages. . . . The Federal Railroad Administration is seeking sources to investigate the projected impact of losing vhf rf assignments now used by railroads. Needed are data to support the need for the retention of railroad radio service. The threat is the reduction by one third of the currently-authorized band. . . . The Naval Electronic Systems Command is sounding out industry for a contractor to perform system integration and testing for the Fleet Command program and portions of other programs such as the World Wide Military Command and Control System. Navy targets this September for letting a 22-month-long contract.

Announcing..... A New Portable from Tektronix

The TEKTRONIX 455

- 50 MHz bandwidth. ● Dual trace. ● Delayed sweep. ● Sweep rates to 50 ns/div with 2% accuracy (5 ns/div with 3% accuracy.)
- Vertical deflection factors to 5 mV/div with 3% accuracy.
- Large 8 x 10 cm CRT display ● \$1695.

And that's not all. The 455 offers this performance combined with more convenience features to speed measurements and reduce human error. All at a budget-conscious price. Measurements are made easier and faster with trigger view; trigger hold-off; lighted deflection factor indicators; and a functionally laid out, easily understood control panel.

Servicing the 455 is faster and less expensive. Although monolithic in design, the instrument contains easily removable vertical amplifier and time-base modules for ready access to all components. That means quicker repairs and less down time. And the entire unit is housed in a shock-resistant, reinforced plastic case to withstand rough handling in factory or field environments.

Optional battery pack provides operation at remote sites and eliminates noise due to line transients. The 455 will operate up to 4 hours without a battery recharge. When AC power is available, the battery pack can be detached to reduce weight.

For specialized applications, the 455 can be equipped with emi protection or tv sync separator.

The 455 is the latest entry in the Tektronix 400 Series of Portable Oscilloscopes. Other dual channel delayed sweep units offer:

- 5 mV/div sensitivity at 100 MHz (the 465)
- 2 mV/div sensitivity at 200 MHz (the 475)
- 5 mV/div sensitivity at 350 MHz with simultaneous displays of intensified and delayed waveforms (the 485)
- Unique single-shot storage to 100 MHz (the 466)

For complete information on how the 455 Portable Oscilloscope delivers the performance, versatility, and cost-saving effectiveness you need, contact your local Tektronix Field Engineer. Or write: Tektronix, Inc., Beaverton, Oregon 97077, for the new 455 applications and specifications brochure. In Europe, write Tektronix Limited, P.O. Box 36, St. Peter Port, Guernsey, Channel Islands.

U.S. Sales Price FOB Beaverton, Oregon



TEKTRONIX®

committed to
technical excellence

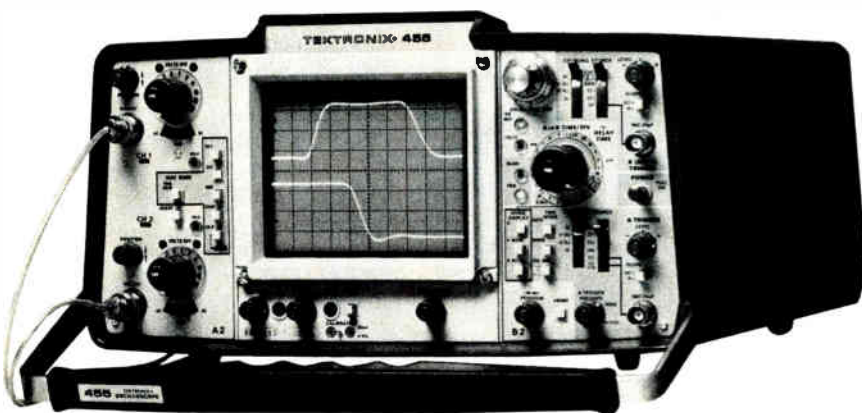

FOR TECHNICAL DATA CIRCLE #243

FOR DEMONSTRATION CIRCLE #244

Bliley

First name in frequency control.

We didn't invent this motto—the electronics industry gave it to us.

Only Bliley manufactures its own crystals, grows and sweeps (for radiation hardening) its own quartz. That means only Bliley can totally control its product quality from raw material to finished unit.

We have never been too interested in making Citizen Band or watch crystals.

What *does* interest us is the design and production of units whose specifications mandate a level of precision that's difficult—if not impossible—to find elsewhere. It's this emphatic commitment to quality that makes Bliley the preferred supplier at the more sophisticated levels of electronics.

Bliley components were selected for these critical aerospace and defense programs:

- Surveyor and Apollo space flights.
- Poseidon/Trident, Phoenix, Maverick and Minuteman missiles.
- F-14 and F-15 Guidance Systems.



Request our new Catalog C/A for complete product information.
BLILEY ELECTRIC COMPANY 2545 West Grandview Boulevard,
P.O. Box 3428, Erie, PA 16508
Tel. (814) 838-3571 TWX 510-696-6886

Tektronix TM 500

a line
of 29 test
instruments

that go
six-in-a-rack
including
custom circuits.

- digital multimeters
- counters
- generators
- amplifiers
- power supplies
- oscilloscopes
- a blank plug-in for your own circuitry
- and more

TEKTRONIX modular instrumentation offers your QC, production test, or built-in test equipment a highly compact, extensive line of test instruments . . . TM 500. They are designed to work totally independently or as a system with each other. Blank plug-in kits make it easier for you to build in your own testing circuits compatible with TM 500. The RTM 506 rackmounting power module/mainframe (only 5¼" high) provides six compartments to accommodate TM 500 plug-in modular instruments and the plug-in kits. It is available for benchtop or portable use (TM 506), as well as for rackmounting (RTM 506).

A common interface circuit board within the mainframe permits the intercommunication of inputs, output, and various parameters among the plug-ins. Tektronix will supply you with data on voltages, currents, and pin connection diagrams, so you can determine the feasibility of assembling your special circuits in blank TM 500 plug-in kits.

The TM 500 family of instruments is designed to fulfill your test and system needs in such widely divergent areas as high-speed logic; dc, power line frequency, audio, and rf to 550 MHz; oscilloscope and other instrumentation calibration; and even medical instrumentation calibration. They represent Tektronix standards of quality in design, performance, and ease of opera-

tion. Included are pulse generators with features such as independent pulse top and bottom controls and repetition rate to 250 MHz. And the DC 505A Universal Counter/Timer features direct counting to 225 MHz and time interval averaging with resolution to 100 ps.

Here is a growing, compatible family of 29 plug-in modular instruments, accessories, and one, three, four, and six-compartment mainframes providing the common power supply. All mainframe/power modules may be hand-carried, all go on the bench, and there are SCOPE-MOBILE® configurations as well. Some instruments are general purpose, such as DMMs, some are highly specialized, such as those for oscilloscope calibration. They comprise test and measurement systems that are difficult to duplicate with monolithic instruments.

Send for the 56-page TM 500 catalog A-3072 with full specifications and suggested selections of instruments for typical applications. Or contact your local Tektronix Field Engineer for a demonstration of how TM 500 instruments can solve your needs. Write to Tektronix, Inc., P.O. Box 500, Beaverton, Oregon 97077.

In Europe write Tektronix Limited, P.O. Box 36, St. Peter Port Guernsey, Channel Islands.



TEKTRONIX®

committed to
technical excellence

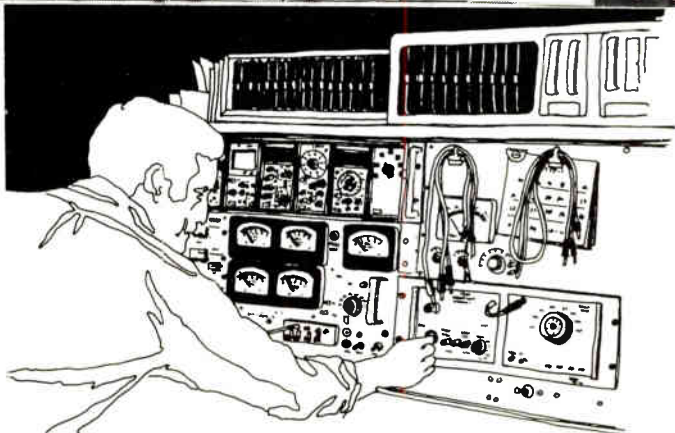
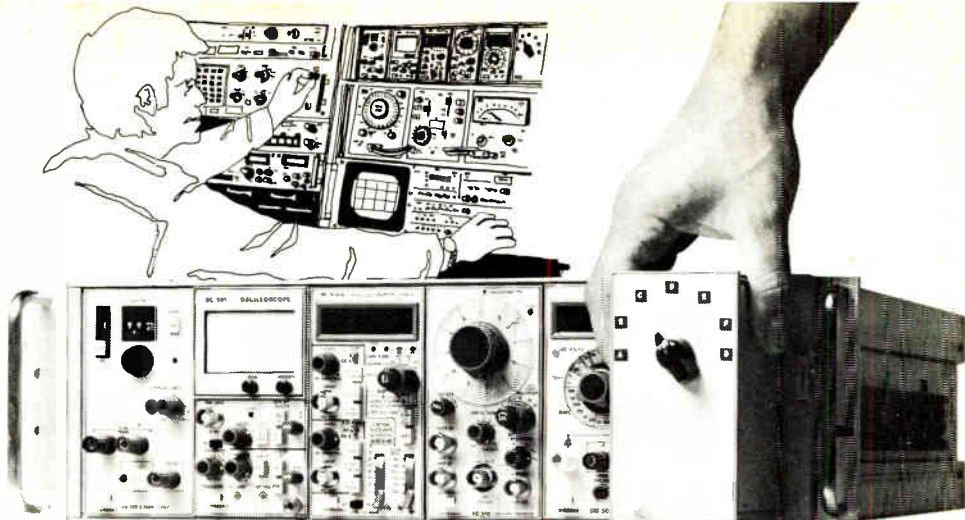

33% more power to the people.

Power/Mate presents Econo/Mate II.

The open frame power supply.

Series A

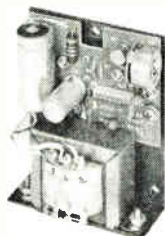

Model	Voltage/Current Rating Chart
EMA-5/6A	5V @ 1.5A 6V @ 1.3A
EMA-9/10A	9V @ 1.0A 10V @ 1.0A
EMA-12/15A	12V @ 0.7A 15V @ 0.7A
EMA-18/20A	18V @ 0.5A 20V @ 0.5A
EMA-24A	24V @ 0.5A

Same Day Shipment

\$24.

Series B



Model	Voltage/Current Rating Chart
EMA-5/6B	5V @ 4.0A 6V @ 3.3A
EMA-9/10B	9V @ 2.5A 10V @ 2.4A
EMA-12/15B	12V @ 2.0A 15V @ 1.7A
EMA-18/24B	18V @ 1.5A 20V @ 1.4A 24V @ 1.3A

Same Day Shipment

\$31.

Series C

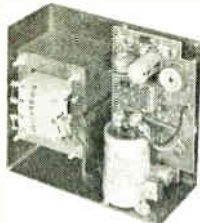

Model	Voltage/Current Rating Chart
EMA-5/6C	5V @ 7.5A 6V @ 6.5A
EMA-9/10C	9V @ 5.0A 10V @ 4.8A
EMA-12/15C	12V @ 4.0A 15V @ 3.5A
EMA-18/20C	18V @ 3.3A 20V @ 3.2A
EMA-24C	24V @ 3.0A

Same Day Shipment

\$53.

Series CC



Model	Voltage/Current Rating Chart
EMA-5/6CC	5V @ 11.0A 6V @ 10.0A
EMA-9/10CC	9V @ 8.0A 10V @ 7.5A
EMA-12/15CC	12V @ 6.0A 15V @ 5.0A
EMA-18/24CC	18V @ 4.5A 20V @ 4.0A 24V @ 3.8A

Same Day Shipment

\$66.

Series D

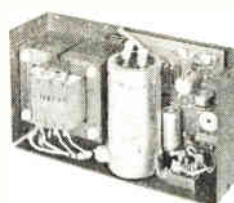

Model	Voltage/Current Rating Chart
EMA-5/6D	5V @ 15.0A 6V @ 12.5A
EMA-9/10D	9V @ 10.5A 10V @ 10.0A
EMA-12/15D	12V @ 8.8A 15V @ 8.0A
EMA-18/24D	18V @ 7.1A 20V @ 7.0A 24V @ 6.5A

Same Day Shipment

\$86.

Now Power/Mate brings you 33% more power in the same package size with the second generation of our Econo/Mate series.

The size is the same, the basic components are the same for easy interchangeability. But that's where the similarity ends.

Econo/Mate II adds features like dual AC primary and a plug-in IC regulator for improved regulation.

And Econo/Mate II is tough. Computer design, quality control, and Power/Mate's experience helps insure 100,000 hr. MTBF even at this higher power output.

But for all its features, Econo/Mate II is still, most of all, economical.

We wouldn't call it Econo/Mate if it wasn't.

Econo/Mate II is in stock, ready for delivery. Send for our free brochure.



Send for catalog describing 32,500 other models. For more information call or write:

POWER/MATE CORP.

World's largest manufacturer of quality power supplies.

514 South River Street/Hackensack, N.J. 07601/Phone (201) 343-6294 TWX 710-990-5023

CIRCLE NUMBER 29

We've taken one-step-beyond and made it the state-of-the-art in encoder technology



A. DIGISEC RI-/15C Incremental Encoder, 1" dia., utilizes modern, solid-state, LED light sources. Offers up to 2^{13} (8,192) counts per turn, square wave or pulse output. Meets rugged military specs.

CIRCLE NO. 631

B. DIGISEC RA-/23C Absolute Encoder, completely self-contained, in true Size 23 synchro configuration. Resolution 11 to 13 bits in non-ambiguous parallel, natural binary output code. Meets military specs.

CIRCLE NO. 632

C. DIGISEC RI-/27 Incremental Encoder, designed for OEM industrial and light military application. Utilizes solid-state, LED light sources for extra long life. Resolution to 10,000 counts per revolution. Several output options available.

CIRCLE NO. 633

D. DIGISEC RI-/35C Incremental and DIGISEC RA-/35C or S Absolute Encoder. $3\frac{1}{2}$ " diameter. *Incremental* version is completely self-contained, offers several output options, interfaces directly with DIGICOUNT® DP Counter/Displays and utilizes solid-state LED illuminators. *Absolute* version is self-contained or utilizes separate electronics depending on resolution. Output is non-ambiguous, parallel or serial, natural binary code or BCD, resolutions to 17 bits. Rugged military construction.

CIRCLE NO. 634

E. LAM10K/40S Linear Absolute Encoder with 1 micron resolution, accuracy better than 1 micron in 20 millimeters. Length up to 500 mm.

CIRCLE NO. 635

F. DIGISEC RI-/55C Bidirectional Incremental Encoder, $5\frac{1}{2}$ " dia., high resolution up to 19 bits in a completely self-contained package.

CIRCLE NO. 636

G. DIGISEC RAL-/60S Absolute Encoder. Itek's newest design offers up to 20 bits resolution in 6" dia. package— $2\frac{1}{4}$ " through-hole. Incorporates LED illuminators, separate electronics, natural binary code, parallel or serial outputs.

CIRCLE NO. 637

H. DIGISEC RAL-/100S Absolute Encoder, utilizes LED illumination, 10" dia. with $2\frac{3}{4}$ " through-hole with separate electronics for easier maintenance. Resolution to 21 bits in natural binary, non-ambiguous, parallel or serial, outputs. Accuracy commensurate with resolution. Also available in *Incremental* version with contained electronics, quadrature square wave or pulse output.

CIRCLE NO. 638

I. DIGISEC RAL-/106S Absolute Encoder, similar to RAL-/100S above except for 6" through-hole which makes it ideal for applications such as radar, telescopes, etc., requiring larger pass-through capability.

CIRCLE NO. 639

J. DIGISEC RA-/117S Absolute Encoder, offers up to 21 bits resolution in a 7" through-hole configuration, 11" outside diameter. Utilizes the same standard interchangeable separate electronics as Itek's other Absolute Encoders with comparable resolution.

CIRCLE NO. 640

K. DIGISEC RA-/158S Absolute Encoder, ultimate in high resolution and high accuracy, offers resolution to 22 bits (4,194,304 counts per turn) in an 8" through-hole, 15" dia. configuration. Chrome slit and disc assembly and redundant optical system are standard. Also available in *Incremental* version with contained electronics and resolution to 21 bits.

CIRCLE NO. 641

L. DIGICOUNT® Counter/Display is a versatile TTL/DTL compatible unit available either as a combination up/down counter and totalizing display, or a BCD input display only. Also available in 5, 6, or 7 decades with optional decimal point location, degree counting display.

CIRCLE NO. 642

M. Standard electronics box for use with all separate electronics DIGISEC Absolute Encoders. Utilizes field replaceable and repairable PC cards, offers binary lamp display and serial readout as options.

So, come all the way up, be the first in your company to have a complete update on the state-of-the-art in encoder technology. We've got some mighty good encoder info, and it's all yours just for the asking.

Itek Measurement Systems

A Division of Itek Corporation
27 Christina Street, Newton, MA 02161
Tel: (617) 969-7300 TWX: 710 335 6783

NEW

Digital Capacitance Meter permits High-Volume Testing with 0.1% Accuracy... for only \$2785



- Automatic measurement • Automatic GO/NO-GO indications for C and D • C range is 0.01 pF to 20,000 μ F
- 120 Hz and 1 kHz test frequencies • Adjustable test voltage • 0.1% basic accuracy
- Internal and external bias • Fast — 250 millisecond *unqualified measurement time* • Data output (BCD)

GR's new 1686 Digital Capacitance Meter provides the rapid throughput you need for high-volume testing plus the high accuracy you need for lab and QC work. Add to these two features wide measurement range, a built-in limit comparator, two test frequencies, and an attractive low price and you can easily get the idea that we have pulled off a performance/price breakthrough in measuring capacitance. Furthermore, no instrument is easier to

operate. Anyone can master the 1686's operation in a matter of minutes, partly because of the Pass/Fail lights on both the instrument and on the optional test fixture.

To get the full story, request a copy of the Data Sheet on the GR 1686. Better still, ask for a demonstration.

 **GenRad**
(formerly General Radio)

300 BAKER AVENUE, CONCORD, MASSACHUSETTS 01742

NEW YORK (N.Y.) 212 964-2722, (N.J.) 201 791-8990 • BOSTON 617 646-0550 • DAYTON 513 294-1500
CHICAGO 312 992-0800 • WASHINGTON, D. C. 301 948-7071 • ATLANTA 404 394-5380
DALLAS 214 234-3357 • LOS ANGELES 714 540-9830 • SAN FRANCISCO 408 985-8233
TORONTO 416 252-3395 • ZURICH (01) 55 24 20

The great men

We're deeply honored that President Gerald Ford should commend ELECTRONIC DESIGN (page 61) for its tribute to the 200th anniversary of the United States. But the commendation should belong, in fact, to the men to whom ELECTRONIC DESIGN's Bicentennial report is a tribute.

Our industry rests on the shoulders of these great men, as does the technological progress of the United States and, with it, the world. No nation today can long keep a technology to itself. It is the nature of technology to diffuse throughout the world, just as it spreads within a nation from one industrial company to others.

This is nothing new. Technology has always transcended national boundaries. The world has always quickly forgotten the national origins of great discoveries and inventions, just as it has quickly forgotten the geographical source of man's achievements in the arts.

People often forget their great men and almost always forget the nations that housed them. Who remembers today that Alessandro Volta was Italian, that André Marie Ampère was French, that James Watt was Scottish, that Georg Simon Ohm was German, that Michael Faraday was English and that Joseph Henry was American? And who cares?

Without the contributions of these great men, today's electronics would not have been possible. But their contributions alone were not enough. Other men laid bricks on the foundation set by the pioneers. They designed vacuum tubes, then transistors, then integrated circuits, then large-scale integrated circuits. Other men added mortar. They designed circuits to apply the tubes, transistors and integrated circuits. They built these circuits into equipment and systems that have made it possible—within the social and economic limits created by man—for man to live better.

Our industry's great men are dead. Or are they? Outside of a small circle, many of the great men who lived during the early days of the American nation were hardly recognized. Today, too, we hardly recognize the great men among us. But they are there. They'll be recognized and honored by our children.

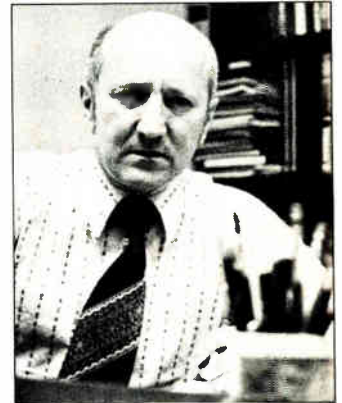

A handwritten signature in dark ink, which reads "George Rostky". The signature is fluid and cursive, with a long horizontal stroke at the end.

GEORGE ROSTKY
Editor-in-Chief

Designers'

Toggle Switches
 Bat, lever lock, Designer
 Line, sealed. Big, broad
 choice.

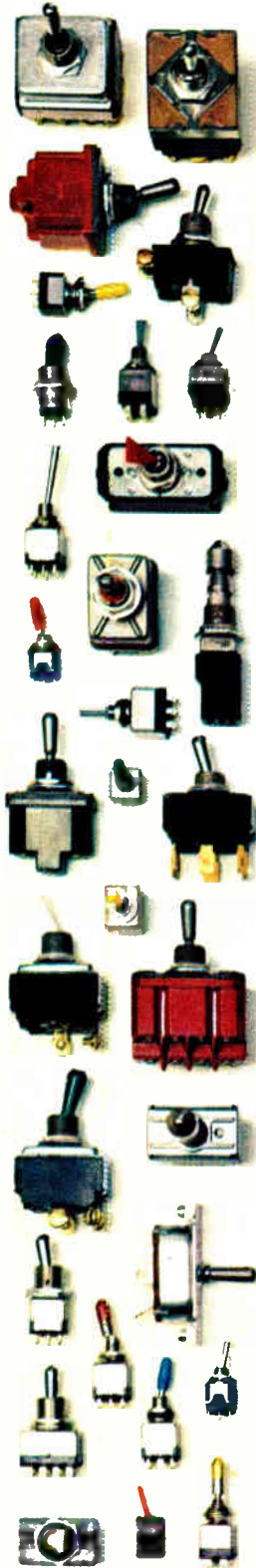

Rocker Switches
 Singles and multiples.
 Wide, colorful selection
 range. Legends, too.



Cutler-Hammer, of course! The broadest
 line. Styled to meet today's and tomorrow's
 requirements. They're solid quality, look
 great, work long and hard. Carried in stock
 for local availability by Switch Distributors.
 Backed by Cutler-Hammer sales engineers
 who can deliver innovative design help for

Pushbutton Switches
 Choice of sizes, colors,
 circuits, ratings. Styled
 to "turn you on".

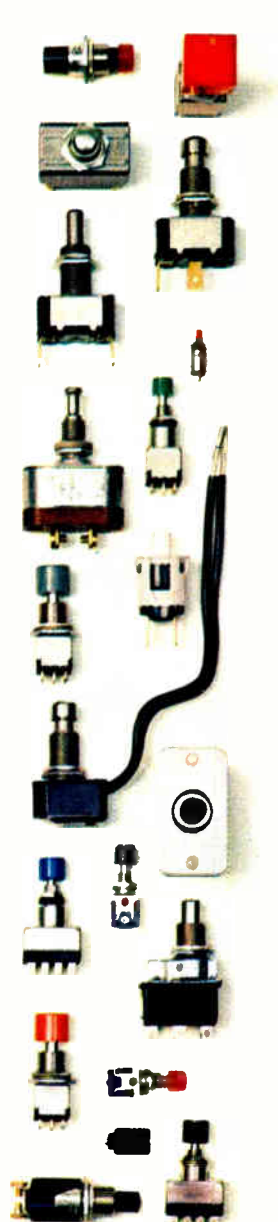

**Tool Handle &
 Slide Switches**
 Variable speed, reversing.
 Double insulated.

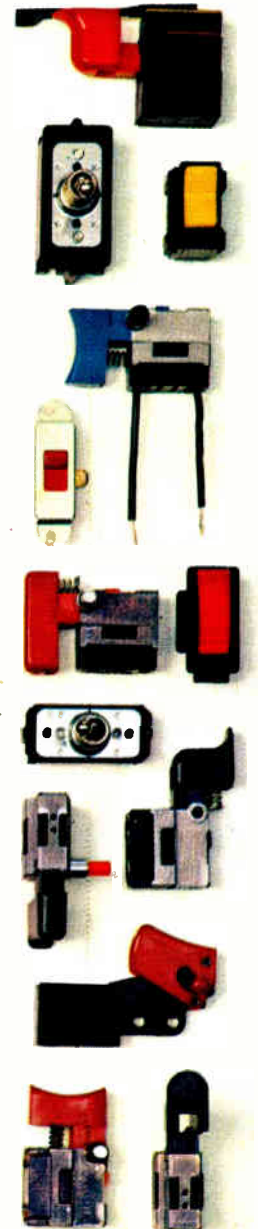

 **Switch to No. 1**

Choice.

the exact switch or relay you need—when you need it.

It's no wonder so many designers specify Cutler-Hammer. For quality, reliability, availability, and style. For commercial, industrial, and military applications.

We simply offer more—of everything!

Snap Switches

Lever, roller, leaf, and pushbutton actuators. Four terminal styles.

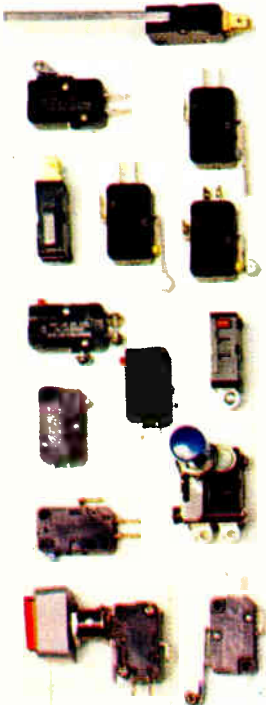

Switch Accessories

Guards. Boots. Seals. Caps. Decorator facenuts. And much more to protect, code or customize.



Rotary Switches

Precision and general purpose. Single and multiple wafer.

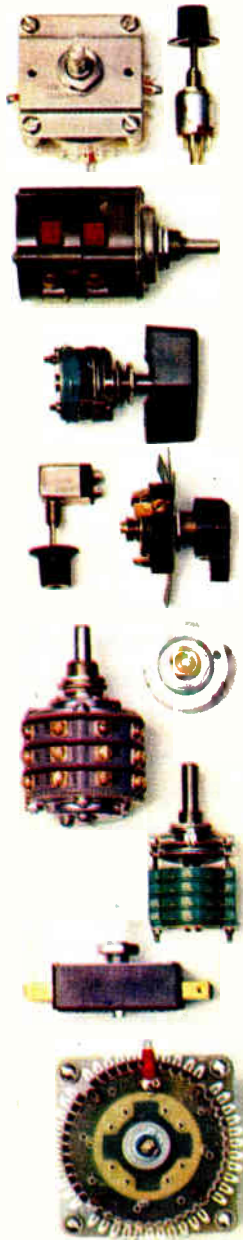

Illuminated Switches

Rockers, paddles, pushbuttons, indicators. Snap-in and bushing.

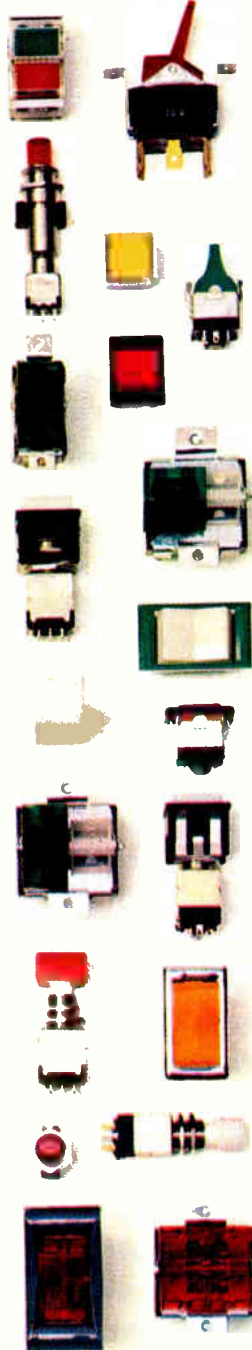

Relays

Hermetics, non-sealed, potted. Power, latching, and timing functions.

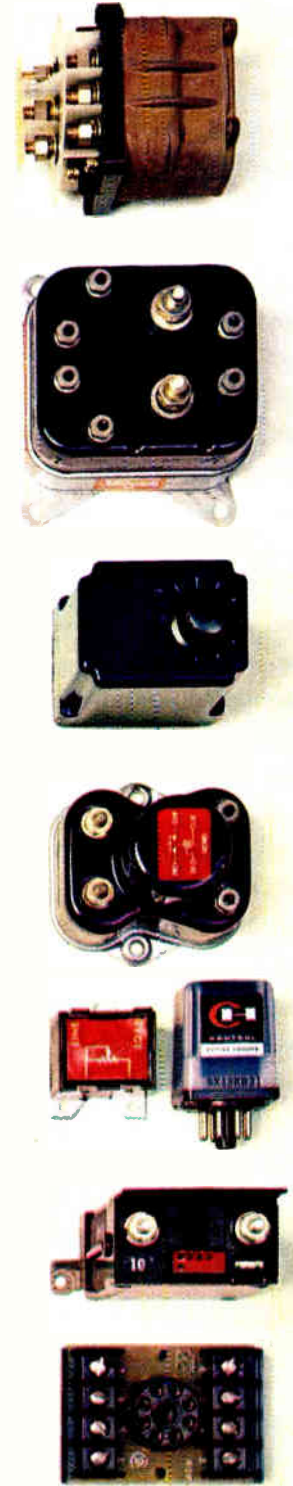

CUTLER-HAMMER

SPECIALTY PRODUCTS DIVISION, Milwaukee, Wis. 53201



CIRCLE NUMBER 34

A CENTURY OF GIANTS

We see history sharper at a distance. Today we can look back and see the importance of events that took place 200 years ago. But nearness blurs our vision.

Today we can look back (as we do in the following pages) at the contributions of our industry's pioneers—men like James Watt (1736-1819), Alessandro Volta (1745-1827), André Marie Ampère (1775-1836), Georg Simon Ohm (1787-1854), Michael Faraday (1791-1867) and Joseph Henry (1797-1878)—men who left their names as our units of measurement. We can see how much we owe them, and how much history depends on them, but their contemporaries were often too close to see the significance of their contributions.

Even as we look at these men of the 18th century from a 200-year-off peak, we look too closely. We see them distilled as engineers, inventors, chemists, physicists, mathematicians. We don't see flesh on their bones, and we don't see the society that molded them.

Yet the environment that gave us the grand old men of a brand new technology also gave us great masters of music, art, literature and architecture. Who were these men?

The century gave us revolutions

The 18th century was a busy one indeed. It gave the world two major political revolutions—one in America (1775-1783) and one in France (1789-1799)—along with the Industrial Revolution, and it gave us men who contributed to the history of mankind. In music alone, it gave us composers whose very names have become synonyms for greatness.

And musicians

Johann Sebastian Bach (1685-1750), a member of a German family that had provided musicians and composers for almost 200 years, set a standard for all composers who followed. Had he written only his Passion According to St. Matthew and his Mass in B-minor, he would have earned his place in history. But he wrote hundreds of great and lesser works. He was the father of 20 children, four of whom became important composers, albeit not of their father's stature.

The century would have given enough to music with Bach alone, but it gave us, too, the German-born British composer, George Frederick

Handel (1685-1759); the Italians, Antonio Vivaldi (1680-1743), Alessandro Scarlatti (1659-1725) and his more illustrious son, Domenico (1683-1757); the Austrians, Franz Joseph Haydn (1732-1809) and Wolfgang Amadeus Mozart (1756-1791)—a colossal composer of operas, symphonies, chamber music and choral works. In his brief life he achieved a record for achievement and versatility unmatched by any great composer.

And as if that were not enough, the 18th century gave us that towering musical genius, Ludwig van Beethoven (1770-1827).

And artists

It was the century of English painters like Thomas Gainsborough (1727-1788), William Hogarth (1697-1764), John Constable (1776-1837), color genius Joseph Mallord William Turner (1775-1851) and Sir Joshua Reynolds (1723-1792), president of the Royal Academy from its inception in 1768. A lifelong friend of Dr. Samuel Johnson, he was the painter of such great literary figures of the day as Laurence Sterne, Oliver Goldsmith, Edward Gibbon and statesman Edmund Burke.

France had an ample share of painters with Jean Honoré Fragonard (1732-1806); Francois Boucher (1703-1770), who was court painter to Louis XV; and Jacques Louis David (1748-1825), founder of the French classical school and court painter to Louis XVI and Napoleon I.

France gave us, too, the great sculptor, Jean Antoine Houdon (1740-1828)—who created busts of Voltaire, Jean Jacques Rousseau, Molière, Benjamin Franklin and George Washington; the world was smaller then.

The youthful American republic produced painters like John Singleton Copley (1738-1815), who painted Paul Revere; Benjamin West (1738-1820), who painted steamship inventor Robert Fulton; Gilbert Charles Stuart (1755-1828), who painted the first President of the new nation, George Washington; and Rembrandt Peale (1778-1860), who painted the third President, Thomas Jefferson.

And writers

Jefferson, in fact, was more than just a President. He founded the first professorship of law in the United States; he was a fine violinist, singer and dancer; he founded the University of Virginia near his home at Charlottesville, VA; he

was the architect of its buildings and of Monticello, his home.

History doesn't remember Jefferson as an author—though he drafted the Declaration of Independence. But it does remember many others of his time. There were the Englishmen, Samuel Richardson (1689-1761), who wrote the first novel, *Pamela (or Virtue Rewarded)*; and Henry Fielding (1707-1754), the second novelist, who wrote *The History of Tom Jones, a Foundling*, the greatest novel of the century.

What writers that century produced! It gave us Alexander Pope (1688-1744), poet, essayist, brilliant wit and satirist (*The Rape of the Lock*);

Jonathan Swift (1667-1745), who wrote some of the most perfect and powerful 18th century prose and is best remembered for his acrid satire, *Gulliver's Travels*; and John Gay (1685-1732), who wrote what might be called the first musical, *The Beggar's Opera*.

It was the century of Laurence Sterne (1713-1768), who wrote the wildly rollicking *The Life and Opinions of Tristram Shandy, Gentleman*; of James Boswell (1740-1795), best known for *The Life of Samuel Johnson, LL.D.*; of Samuel Johnson (1709-1784), whose *Dictionary of the English Language* was the foundation for modern dictionaries, though Johnson permitted more opinion

THE WHITE HOUSE

WASHINGTON

December 11, 1975

Next year marks the beginning of our Third Century as an Independent Nation as well as the 200th Anniversary of the American Revolution. For two centuries our Nation has grown, changed and flourished. A diverse people, drawn from all corners of the earth, have joined together to fulfill the promise of democracy.

America's Bicentennial is rich in history and in the promise and potential of the years that lie ahead. It is about the events of our past, our achievements, our traditions, our diversity, our freedoms, our form of government and our continuing commitment to a better life for all Americans. The Bicentennial offers each of us the opportunity to join with our fellow citizens in honoring the past and preparing for the future in communities across the Nation. Thus, in joining together as races, nationalities, and individuals, we also retain and strengthen our traditions, background and personal freedom.

As we lay the cornerstone of America's Third Century, the very special part in this great national undertaking being played by Electronic Design in a special Bicentennial issue recognizing those who helped make this country great is most commendable.



to invade the work than would be acceptable today. His definitions include, for example: oats—a grain which in England is generally given to horses, but in Scotland supports the people; patriotism—the last refuge of a scoundrel; politician—a man of artifice.

The 18th century gave us, too, the final years of the team of Joseph Addison (1672-1719) and Richard Steele (1672-1729), who produced those most influential literary periodicals, *The Tatler* and *The Spectator*. And it gave us Oliver Goldsmith (1730-1774), best remembered for his poem, "The Deserted Village," his novel, *The Vicar of Wakefield*, and his delightful comic drama, *She Stoops to Conquer*.

It gave us Jane Austen (1775-1887), the sensitive author of *Emma*, *Pride and Prejudice* and *Sense and Sensibility*; Edward Gibbon (1737-1794) of *The History of the Decline and Fall of the Roman Empire*; William Wordsworth, (1770-1850) and Samuel Taylor Coleridge (1772-1834), who joined to revolutionize English poetry by using everyday speech. And these were just the English.

While Germany produced poet and dramatist Johann Wolfgang von Goethe (1749-1832), France provided writer-philosophers—some of whom, perhaps unwittingly, were laying the foundations for the French Revolution.

There was Baron de Montesquieu (1689-1755), a philosopher, writer and jurist; Swiss-born Jean Jacques Rousseau (1712-1778), who wrote *The Social Contract*; Denis Diderot (1713-1784), philosopher, and encyclopedist; and François Marie Arouet (1694-1778), better known as Voltaire, whose *Candide* was just one example of the bitter cynicism and anti-authoritarianism that earned for Voltaire two sentences in the Bastille and repeated periods of exile.

And philosophers

While the century provided amply for future lovers of music, art and letters, it gave us philosophy, too. In Germany, there was Immanuel Kant (1724-1804) and Georg Wilhelm Friedrich Hegel (1770-1831), who wrote on logic, theology, the human mind, history and ethics. His approach to truth used the dialectic, a philosophical method taken from the Greek philosophers and that included the concept of the unity of opposites—ideal and real, general and specific, finite and infinite. This approach became part of the philosophical heritage of the next century's Communist philosophers, Karl Marx and Friedrich Engels.

While Hegel in Germany laid a philosophical foundation for Marx and Engels, John Wesley (1703-1791) in England founded a new Protes-

tant denomination, Methodism, and his brother, Charles (1707-1786), became a Methodist preacher and wrote 6500 hymns.

And scientists

The 18th century gave man a better understanding of nature, too. Among its great scientists were Antoine Lavoisier (1743-1794), the Frenchman regarded as the founder of modern chemistry; James Watt (1736-1819), the Scottish engineer who invented the modern steam engine and the centrifugal governor; and Luigi Galvani (1737-1798), an Italian physiologist who theorized about the production of electricity.

And Benjamin Franklin (1706-1790). This Boston-born Philadelphia printer wrote *Poor Richard's Almanack* and became wealthy. One of the most influential citizens of Philadelphia, he founded the first circulating library in America; founded the American Philosophical Society; and organized the first fire company.

Attracted by experiments with the Leyden jar, and continuing with other experiments, he proved the identity of lightning and electricity, and was first to propose the theory that there are two kinds of electricity—positive and negative.

Franklin invented many devices but his importance did not lay in contrivances like the Franklin stove and bifocals. He presented a new way to think about nature as being subject to rules.

This man, too, was a product of his times. And the times that gave us such great men of art, music and literature were the times that gave us the men who fathered the electronics industry we know today. ■■

Contents

The foundation years (1754-1837)	
Stanley Runyon	P. 66
The era of giants (1837-1879)	
Jim McDermott	P. 78
The communications era (1879-1905)	
Morris Grossman	P. 88
The vacuum-tube era (1905-1948)	
David N. Kaye	P. 98
The transistor era (1948-1959)	
Dave Bursky	P. 108
The integrated circuit era (1959-1975)	
Edward A. Torrero	P. 118
Our technological heritage	
Bern Dibner	P. 130

Announcing

THE PREFERRED

Digital Panel Meters

NOW IN THE
BALLANTINE TRADITION
OF HIGH RELIABILITY . . .

- **42 MODELS:** Voltage: 200 mV to 1000V
Current: 200 mA to 2A
 - **2½, 3½, 4½ DIGITS:** to 10 μ V resolution . . .
Engineering Units . . . Custom or Standard
 - **LOW POWER:** less than one watt — cool
running
 - **EASY TO READ:** high contrast, large 0.5" LCD's
with a THREE YEAR WARRANTY.
 - **RFI SHIELDED:** small, sturdy metal case.
 - **PURE QUIET INPUT:** no output hash from auto-
zeroing circuits.
 - **TRUE TRANSFORMER ISOLATION:** high CMR . . .
Input low isolated from power ground, case and digital
ground.
- Call or write for **EVALUATION SAMPLES** or use the reader
service number for our **NEW BROCHURE**.



Ballantine

Ballantine Laboratories, Inc.
P.O. Box 97, Boonton, New Jersey 07005
Phone (201) 335-0900, TWX (710) 987-8380



Manufactured under exclusive North American license from TEKELEK-AIRTRONIC.

CIRCLE NUMBER 36

New from Potter & Brumfield

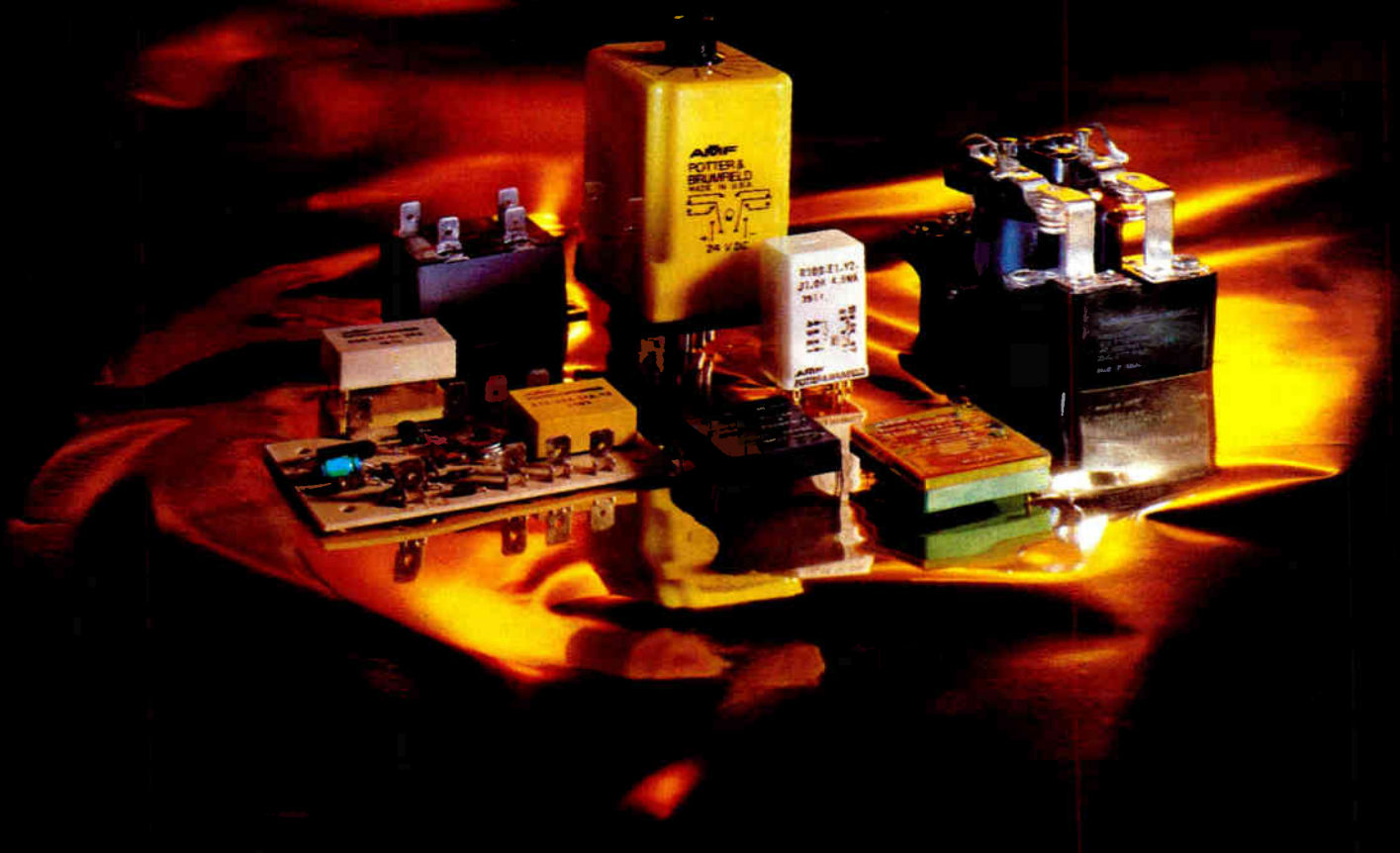

8 major P&B relays to solve today's design challenges.

1. R10S. Sensitivity to 5mW per pole. Available in 1, 2, and 4 Form C contacts. Ratings from dry circuit to 3 amps. Less than \$3.00 in lots of 500.

2. R50 relays. Help you solve cost and space problems. Less than \$2.00 in quantity, the R50 allows 0.6" center-to-center pc board spacing.

Coil ratings of 5, 6, 12, 24, and 48 VDC. Available in 1 and 2 Form C contacts.

3. CG relay. Extended-range CMOS IC time delay or interval timer. Repeatability including first cycle is typically .01% for DC units and 0.1% for AC units. Time delays up to 100 minutes standard.

4. R16 time delay module. Offers big savings at under \$7.00 in quantities. Timing ranges, potentiometer adjustable, are 0.2 to 2, 2 to 30 and 10 to 100 seconds for delay on operate.

5. T10 series relays. Only 0.375" high. Ideal for high density applications—permit pc boards to be mounted on 0.5" centers. Two and 4 Form C contacts provide 0.1 to 3 amp switching @ 30 VDC. Coil ratings: 6, 12, 24 and 48 VDC.

6. JDO relays. Solid state switching with total opto-coupler isolation. Zero voltage turn on and zero current turn off minimizes EMI and RFI. Low profile

permits pc board mounting on 0.5" centers. Coil ratings: 5, 6, 12 and 24 VDC. Shockproof.

7. EOT series relays. Opto-coupled, all solid state. Solve high cyclic switching problems. Synchronous zero crossover switching virtually eliminates EMI and RFI. Output: 2, 4, 5 or 7 amps @ 120 VAC standard.

8. PRD series power relays. New improved design. Interchangeable with famous PR series. Save 50¢ at list price! UL and CSA listed. Rugged terminals designed for power screwdrivers.

For detailed product specifications, contact the Potter & Brumfield sales representative or authorized distributor nearest you, or write Potter & Brumfield Division AMF Incorporated, Princeton, Indiana 47671. Telephone 812-385-5251.

EUROPE: Electrical Products Group,
AMF International Limited, AMF
House, Whitby Road,
BRISTOL BS4 4AZ.

England.
Telephone:
(0272) 778383
Telex: 449481
AMMAFOCO
BRSTL

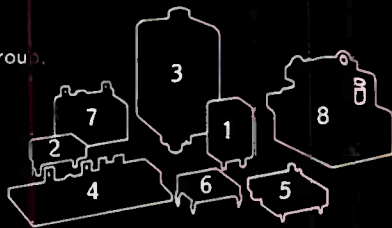

Solving switching problems is what we're all about.

CIRCLE NUMBER 240

THE FOUNDATION YEARS (1754-1837)

UNDERSTANDING THAT NATURE OBEYS RULES, TOO

- 700- Babylonians destroy the Assyrian capital
- 600 of Nineveh.
- B.C. Thales of Miletus observes the attraction of light objects to rubbed amber.
- 1600- William Shakespeare writes "Hamlet."
- 1610 "Othello," "Macbeth," "Henry V,"
- A.D. "King Lear," "Twelfth Night" and other plays.
- William Gilbert publishes the definitive work on magnetism, "De Magnete."
- 1650 Salem, Massachusetts exorcises its "witches."
- Otto von Guericke builds the first frictional electric machine.
- 1725- John Peter Zenger acquitted in famous
- 1735 freedom-of-the-press trial.
- Stephen Gray discovers that electricity can be transmitted. Charles Dufay splits electricity into two kinds: vitreous and resinous.
- 1745 British and American colonials fight the French in King George's War.
- E.G. von Kleist and Pieter van Musschenbroeck independently invent the Leyden jar.
- 1750- America and Great Britain adopt the
- 1754 Gregorian calendar
- French and Indian War begins.
- Benjamin Franklin flies a kite in a thunderstorm to prove the equivalency

One hundred sixty-nine years after the first Englishmen landed in Chesapeake Bay, 56 sweaty and worn men met on a sultry day in Philadelphia. Their object: to commit open treason against his Britannic Majesty, George III. The document each of those men signed that day proclaimed the independence of men as individuals and drastically changed the history of the world.

One of those affixing his signature had twenty years earlier helped reshape mankind in an entirely different manner. Benjamin Franklin's contributions to science and electricity had far greater significance than just the technological benefits—his findings steered man away from superstition and unfolded the true character of natural forces.

All that was known about electricity in Franklin's time was basically this: When certain substances—like sulfur or glass—were rubbed, they attracted other light substances, like feathers or pieces of cloth. If the feather touched the glass, it was violently repelled. No one really knew why.

Sparks could be made to jump from the rubbed material to the tip of a finger, and the accompanying smell and cracking noise, it was noted, were something like those produced by lightning.

- of electricity and lighting.
- 1780 Franz Joseph Haydn composes his famous Quartets.
Luigi Galvani notices that an electrical spark causes contractions in the leg muscle of a frog.
- 1800 Ludwig van Beethoven completes his First Symphony—the C major.
Alessandro Volta invents the first battery—the voltaic pile—and revolutionizes the study of electricity.
- 1819-1825 Missouri Compromise limits slavery in America.
Monroe Doctrine declared.
Hans Christian Oersted discovers electromagnetism.
Andre Ampere and Georg Ohm propound their great laws.
- 1830-1835 Joseph Smith founds the Mormon Church.
Slavery outlawed in the British Empire.
Joseph Henry and Michael Faraday independently discover electromagnetic induction and the generation of electricity by magnetism.
- 1835-1840 Battle of the Alamo.
Opium Wars break out between China and Britain.
Samuel Morse invents the first practical telegraph.

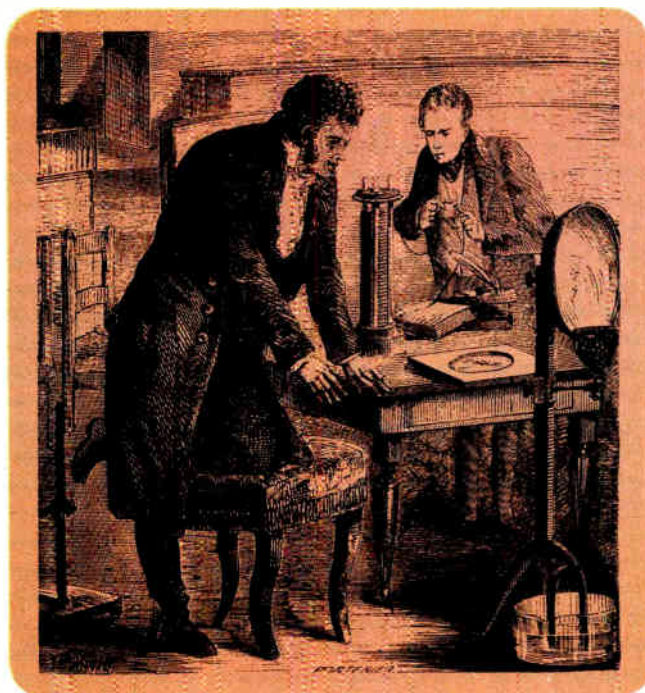

Serendipity alters the course of civilization: Oersted accidentally stumbles on electromagnetism during a private lecture to a group of students.

Though many investigators had accumulated a mass of detail, order was lacking. Only two things were clear: the phenomenon was not magnetism, and it was not gravity.

Both magnetism and electricity were first investigated in 600 B.C. by Thales of Miletus, a Greek philosopher. He noted that when amber was rubbed, it would pick up light objects; and he knew of the power of lodestone to attract iron.

The terms “electricity” and “magnetism” are, in fact, derived from the Greek; *ηλεκτρον* (electron) is the Greek word for amber, and the word magnet is thought to have come from Magnesia, a district where lodestones were found.

Magnets: living rocks

Thales apparently connected electricity with magnetism, but it would take another 2400 years before the actual relationship was established. In the meantime, other Greek and Roman writers recorded the properties of amber and lodestone.

Authors such as Pliny the Elder and Porphyry reflected the general opinion of their time when they endowed magnets with a soul, claiming that “the magnet attracts iron as a bridegroom would his bride.”

Pliny, before his unlucky encounter with Mount Vesuvius in 79 A.D., wrote that the Etruscans in 600 B.C. could draw lightning from the sky and turn it aside.

The birth of scientific magnetism waited for Peter Peregrini (Peregrinus), whose experimentation with magnetic poles in 1269 led some scholars to label him the father of magnetism. But Peregrinus’ work lay fallow for 300 years, until the arrival of William Gilbert. Aside from the general use of the magnetic compass—the first practical magnetic device—the intervening years produced little.

Giant minds were at work in other areas, however, and the resulting ideas laid much of the foundations for future thought. Roger Bacon in 1268 was accused of black magic when he insisted that human progress depended upon experimental research and scientific education. Nicholas Copernicus electrified the world of 1508—and got himself into trouble—when he wrote: “The appearance of daily revolutions belongs to the heavens, but the reality belongs to the earth.”

It remained for William Gilbert, personal physician to Queen Elizabeth I, to bring coherence to the study of electricity. It was Gilbert who coined the word “electricity”, who distinguished between electrics (conductors) and nonelectrics (insulators or dielectrics), who built the first electroscope-like instrument (the versorium, a pivoted, nonmagnetic needle).

Gilbert saw the earth as a huge magnet, and so explained the operation of the compass. Mag-

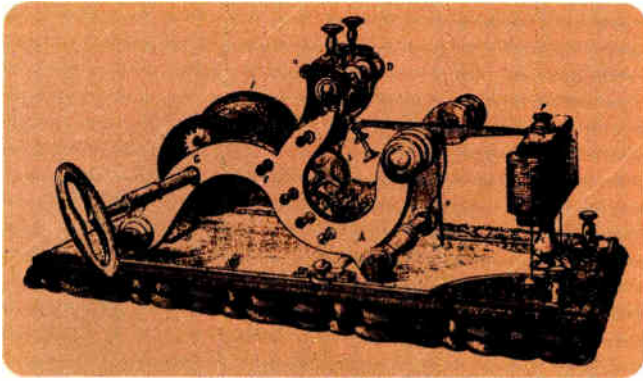

The original telegraph receiver wasn't the familiar keyed system but actually printed dots and dashes on paper with a stylus.

netic induction, polarity and the effects of heat on magnets—all were deduced by Gilbert. His volume, *De Magnete*, published in 1600, thus represented the greatest step forward in electrical and magnetic investigation up to that time. Gilbert is honored today on the pedestal of the lower case—by use of the gilbert as the unit of magnetomotive force.

Giant minds ignored electricity

Men like Galileo, Kepler, and Descartes (who drew the first magnetic lines of force), were influenced by Gilbert, but they focused their genius in other areas—mainly astronomy and mathematics—and contributed little to the study of electricity.

Other giants were at work: Francois Vieta in 1580 substituted letters for unknowns in mathematics; John Napier invented logarithms in 1614; the slide rule was introduced by Richard Delamain in 1630 and, independently, by William Oughtred two years later.

Dr. William Harvey discovered the circulation of blood in the body. The first thermometer was invented, the first microscope, the first telescope. Sir Isaac Newton dazzled the world with the beautiful colors of the spectrum, and Olaus Roemer in Denmark measured the velocity of light.

But it remained for an assorted collection of amateurs, philosophers and other scientists to carry on the exploration of electricity.

Otto von Guericke, burgomaster of Magdeburg, Germany, opened a new chapter in experimental science when he built the first electrical machine in 1660. The machine—a rotating sulfur globe excited by frictional contact with the hands or a cloth—produced quantities of electricity far greater than previously available and led to a host of new experiments.

Improved variations on his machine soon appeared. Sir Isaac Newton built such an apparatus

with a glass globe in 1675. With it, he explored attraction, repulsion, sparking and other phenomena. Francis Hauksbee, Newton's assistant, noticed luminous effects when a vessel containing mercury was shaken. (The first fluorescent light?)

Then in 1729, Stephen Gray—a pensioner in London—found that electricity could be transmitted along or induced into very long lines of thread when these were suitably suspended by filaments. With experimentation, Gray and a co-worker, Granville Wheeler, reached the remarkable distance of 765 feet.

Gray was thus led to make the fundamental distinction between insulators and conductors: silk filaments did not permit the electricity to leak away, while equally fine copper wires did. He may have been the first to use wires as conductors.

In Paris, Charles Du Fay repeated and continued Gray's work. He showed that all bodies could be electrified; in the case of conductors, it was necessary that they be insulated. The most important of Du Fay's contributions was his classification of electricity into two kinds: vitreous and resinous. These electricities, Du Fay said, repel similar charges and attract opposite kinds.

✕ The popular pastime of sparks

Events moved quickly after Du Fay. In Germany, E. G. von Kleist built the first apparatus to store electricity. Credit for the Leyden jar actually goes to von Kleist, even though Pieter van Musschenbrock of Leyden, Holland is often cited as the inventor.

In England, Sir William Watson, Henry Cavendish, a Dr. Bevis and others improved the jar and, with it, tried to measure the speed of electricity. They discharged the jar through a circuit 12,276 feet in length. The decision: Transmission was instantaneous.

Watson was the first to use the terms, plus and minus, and so may have shared Ben Franklin's great discovery that electricity was of one kind and not, as was then thought, two different fluids. Watson's book of 1746, the *Nature and Properties of Electricity*, was said to have first aroused Franklin's interest in the subject.

This, then, was the body of serious knowledge before Franklin. In England and Europe, electricity was a great curiosity, the scientific entertainment of the day.

In France, the Abbé Nollet, a student of Du Fay and later Franklin's rival, delighted King Louis XV with the sight of 700 monks, joined hand and hand, leaping into the air simultaneously, robes flying, at the shock of a Leyden jar.

Another oft-repeated trick was to hang a

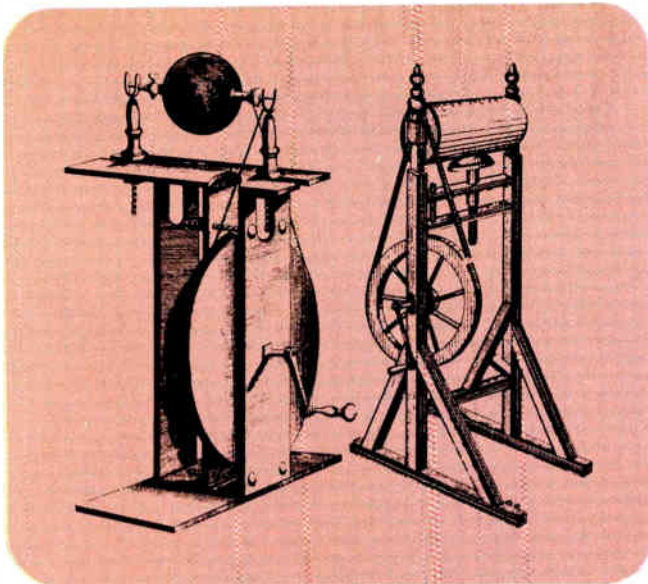

Two early frictional electrostatic machines. Franklin used the one on the right; the other was described by Priestley in his monumental book on electricity.

young boy by silk cords from the ceiling and draw “sparks of fire” from his face and hands after he had been electrified.

In the America of 1746, science—or natural philosophy, as it was then called—was practically nonexistent. Americans were forbidden by the British to engage in arts and crafts based on natural phenomena. Men were still cautious about new notions, and the Puritan ethic subsisted.

Into this vacuum stepped Franklin, a man of 40 about to retire from a successful career as a printer. Renaissance man, Rabelaisian figure, vigorous athlete, sexual intriguer, Franklin was totally unlike the dumpy figure depicted in his portraits of later years. And he was completely serious about electricity.

Franklin the demigod

In scarcely 10 years of investigation, Franklin established the positive-negative nature of electricity, proved the connection between lightning and electricity, explained the Leyden jar, invented the “condenser,” and performed other “miracles.”

Lacking terminology, Franklin invented words as he went along. His was the very lexicon of modern electricity: positive, negative, battery, condenser, charge, discharge, electric shock, electrician, armature, brush and conductor.

Although it was the lightning rod that made Franklin a demigod to his contemporaries (The French thought of him as the reincarnation of Socrates and kept his portrait under their pillows. In 1778, the latest Paris fashion was lightning-rod hats.), it was among the least of his achievements.

Franklin’s condenser (or “battery” as he called it) formed an evolutionary link between the short-time sparks of the Leyden jar and the continuous current of the later voltaic cell.

He hinted at the existence of a basic charge, and his single-fluid theory led directly to the concept of electrons moving through conductors. He unified the disorderly body of existing knowledge. These were the bases for all subsequent advances. The theory was not a contraption, it was a thought—one that snapped the encumbrances of the mind and left mankind free to explore new unknowns.

Other Americans contributed, but none held a candle to Franklin. Ebenezer Kinnersley, a fellow experimenter and neighbor, did some original work and went on to become a famous lecturer. Philip Syng, a local silversmith, built a rotating generator that “did away with the fatigue of rubbing.”

The legendary kite experiment did, in fact, take place in June, 1752. Franklin gave a brief and cryptic account in his *Autobiography*. But it was Joseph Priestly who told the details fifteen years later in his two-volume *History and Present State of Electricity*—the 18th century’s definitive work on the subject.

Actually, Franklin was beaten to the punch. It was in 1749 that he first suggested the “sameness of lightning with electricity.” A year later, Franklin communicated to Peter Collinson of the Royal Society the details of how the theory might be experimentally verified. Another two years passed before the paper was published in Paris, but then the experiment was immediately carried out:

Messieurs Jean Dalibard and Delor, carefully following Franklin’s instructions, drew sparks to a pointed rod during a thunderstorm in May, 1752—one month before Franklin’s kite flying episode.

In Russia, another experimenter, the Swede George Wilhelm Richmann, failed to ground his apparatus—as Franklin had suggested—and paid the consequences: A spark nearly a foot long leaped from the rod to Richmann’s head and made him the first martyr to the new science.

War strikes the Colonies

Franklin’s rapid success, starting almost from zero, is an indication of the primitive state of the subject, as well as of his own ability. All his work was done by hand, by trial and error, with simple tools. He made no quantitative efforts; as a schoolboy, he had flunked arithmetic. And it seemed that the more he read on the subject, the less original work he did.

By 1756 Franklin’s efforts in electricity had waned, and he turned to other interests. Social

storm clouds were gathering. The colonies were in foment, a distinctively American national character was developing, and Franklin was a political animal.

While the Crown had its hands full with the discontent in the colonies, others in Europe saw fit to attack Franklin's work. Abbé Nollet, sulking at being outshone by the new star in the west, opposed lightning rods and "kept his confidence in the ringing of church bells."

A controversy arose: Which was the best method to terminate the top of the rod? Some preferred a round knob, forgetting Franklin's reasoning that the rod worked best with a sharp point. Others, like Nollet, objected to the point, claiming it would tend to draw lightning to the location being protected.

In England, the argument was settled at the highest level. In a rage against the American revolution, King George III ordered all royal lightning rods to be fitted with rounded ends.

The Colonial pot boiled over in 1775, and the Revolutionary War began. The war for "the rights of Englishmen" became a war for independence. And on July 4, 1776, the Declaration of Independence was made. Thomas Paine's rabble-rousing tract, *Common Sense*, had done its job.

Only one other man of the day approached Franklin in achievement. What Franklin is to electricity, Massachusetts-born Benjamin Thompson (later Count Rumford) is to heat. But the analogy stops abruptly. In contrast to Franklin, Thompson was, among other things, a rogue, scoundrel and extortionist. Luckily for the colonies, Thompson spent most of his days away.

A military genius, Thompson founded the science of modern ballistics and contributed significantly to weapons improvement. Among his scientific and technological achievements: The founding of modern heat theory, the thermos bottle, the enclosed cooking range and the drip coffee pot.

He was the first to discover convection currents, to explain why clothing keeps the body warm. The first photometer is Thompson's, as is the term "candle power." He invented the steam-heat radiator and installed the first central heating system.

Thief, conniver and British spy that he was, the world lives better today because of Benjamin Thompson.

The age of measurement arrives

After Franklin, the focus of electrical discovery again shifted to Europe, where it would remain for another 75 years. Continued investigations into inductive effects led to Alessandro Volta's electrophorous—a disc-and-pan arrangement that

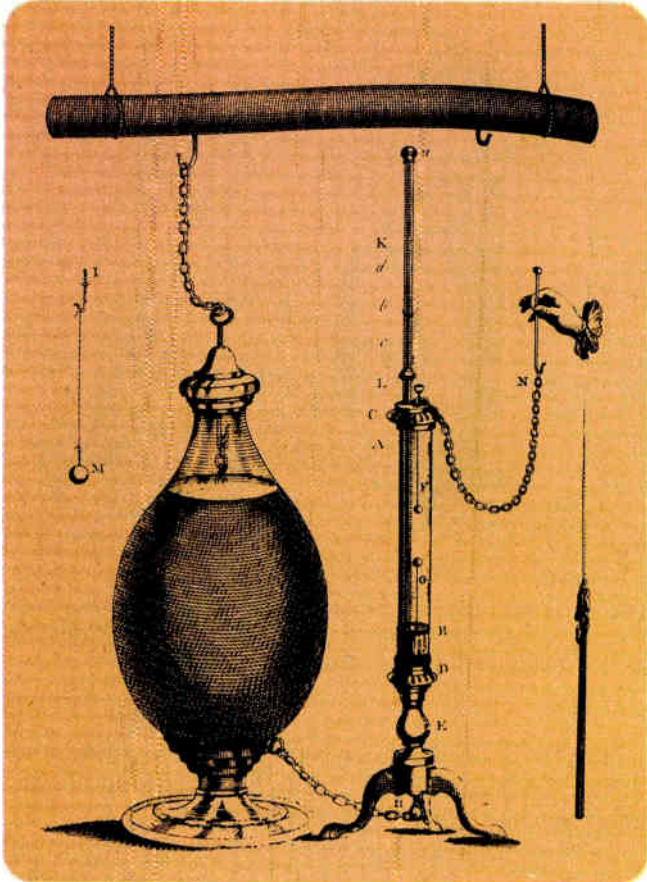

Franklin proved that a spark generates heat. Discharge of the Leyden jar across the gap (F-G) raised the reading on the thermometer (a).

conveniently produced large quantities of electricity with little effort.

Quantitative measurements arrived with a series of electrometers and electroscopes made with pith-balls or wire. The Reverend Abraham Bennet gets credit for the gold-leaf electroscope, with subsequent improvements by William Pepys. The device became the most sensitive detector of its day.

The most important device of this kind was the torsion balance invented by John Michell in England about 1770, and independently by Charles Coulomb in France about ten years later. With the instrument, Henry Cavendish determined the mean density of the earth and in 1771 discovered the inverse square law of force between two charged bodies.

It was Coulomb, however, who demonstrated with great accuracy the inverse-square law governing electric and magnetic fields. Others had stated the law, but none had proven it completely. Coulomb's work marked the start of quantitative analysis in electricity and, for his efforts, the unit of electric charge was named after him.

Work continued during the closing years of the 18th century. Electric lines of force were observed, huge frictional electrical machines and

connected Leyden jars were built. The magnetic properties of materials were investigated. Joseph Priestly wrote the first electrical history and prophesized many of the developments to come.

Rationality gains ground

But despite 200 years of progress, despite the long list of investigators and achievements, there was not yet a single practical application of electricity. Electricity had been lifted out of the realm of mystery but it remained for the 19th century to push it into the province of pragmatism.

Other areas of science and technology were making giant strides in the late 1700s: the science of acoustics was founded, Uranus was discovered, the torpedo was invented.

Men began to think more rationally. From Immanuel Kant came the *Critique of Pure Reason*; from Edward Gibbon, the *Decline and Fall of the Roman Empire*.

In the Colonies, the war for independence was won. A new republic was born and, in its infancy, produced two of the greatest documents of all time—the *Constitution of the United States of America* and the *Bill of Rights*.

By the year 1800, the new nation was ripe for a change. It was a year of political upheaval. Washington, Adams and the Federalists had established the government. Now it was the turn of the popular leaders: Jefferson, Hamilton and others.

In Europe, culture flourished. Beethoven's First Symphony appeared in 1799. In Italy, the La Scala Opera opened.

In England, technology manifested itself in the form of the Industrial Revolution—a movement away from cottage industries to factory towns.

In France—birthplace of automation—Joseph Marie Jacquard devised an automatic loom that could weave any design imaginable. Jacquard's secret was a series of cards with holes arranged to "program" the machine to produce the desired pattern. Thus Jacquard anticipated by 90 years the computer-type punch cards of 19-year-old Herman Hollerith.

Toys and revolution

But the ingenious automations of the French were lavished mostly on clever toys for rich or noble collectors. One such inventor was Pierre Caron, later Count Beaumarchais, who also had a talent for writing.

His play, *The Marriage of Figaro*, was, in fact, an early warning of the third of the triad of great 18th Century revolutions. When the play was first performed in 1784, it created a scandal throughout Europe. Mozart turned it into an

opera, which was produced in Vienna in 1786.

It was the revolutionary spirit of the play that excited Mozart. The Freemasons—a secret society to which Mozart belonged, and which he glorified in another opera, *The Magic Flute*—were the anti-establishment group of the time. Attending the Court of King Louis XVI in 1784, when the opera was first performed, was none other than the greatest Freemason of them all, Benjamin Franklin. Five years later a mob marched on the Bastille, and the French Revolution began.

So the year 1800 represents a watershed in the social, political and scientific development of man. Up to then, experiments in electrical science were brief, and resulted from an electrical discharge. But two independent avenues of investigation—those of Luigi Galvani and Alessandro Volta—finally led to the production of steady currents.

As in many other scientific investigations, it was an accident of fate that started Galvani on his now-famous work. An electrical machine was being used at the same time that Galvani, a professor of anatomy, was dissecting a frog. The spark occurring at the instant the scalpel touched the nerve caused the legs of the frog to contract.

Volta and others became interested in this amazing phenomenon, and the subsequent investigations became the source of one of the greatest scientific rivalries of all time.

Galvani was convinced that the muscles or nerves were the source of the electricity. Might not, he thought, the vital principle of life be electricity?

Volta felt otherwise—it was in the metals, not the muscles, he claimed. But Galvani proved that metals weren't even necessary—contact of the nerve with the muscle was sufficient to cause contractions.

Birth of the battery

The conflict polarized the scientific world. Battle lines were drawn, debate raged, and each camp accused the other of heresy. In the end—though there was truth on both sides—Volta's ideas prevailed. Sadly, Galvani died in 1798, never to know the outcome of the debate.

Then, in 1800, came the breakthrough that pushed electricity into new achievements. Volta discovered that two different metals in contact can generate electricity. His "pile" consisted of a column of stacked, circular discs of zinc and silver, with the dissimilar metals separated by cardboard pieces soaked in salt water or other conducting solutions.

Subsequent work produced bigger and better batteries, and the study of electricity became the study of currents rather than of static charges.

New developments came rapidly. Charging,

electroplating, the decomposition of water—all were discovered. In America, Dr. Robert Hare of the University of Pennsylvania built a battery strong enough to fuse large chunks of metal. Other important electrochemical studies took place.

With a battery, Sir Humphry Davy was able to lay the foundation for ionization theory and to isolate elements: sodium, potassium, strontium, barium, boron, calcium, chlorine, fluorine and iodine. In 1810, Davy unveiled the carbon-arc lamp, using the battery as the electrical source.

Strangely, it was Davy—not Volta—who explained that the electricity of the battery was due to chemical action. But Volta got the honors. From Napoleon came a gold medal, the Legion of Honor and 6000 francs. The scientific world named the unit of electromotive force after Volta.

A gap of 20 years spanned the interval between the discovery of voltaic electricity and the next great development. Again the breakthrough was an accident.

At a private lecture in the spring of 1820 Hans Christian Oersted happened to place a conducting wire over and parallel to a magnetic needle. The resulting swing of the needle startled Oersted, and he made a mental note to pursue the phenomenon.

In just three months of subsequent work, Oersted had resolved the problem. On July 21, 1820, he published his results. 2400 years after Thales, the connection between magnetism and electricity had been fused; electromagnetism was born.

Oersted's tract announced that an electric current in a conductor created a circular magnetic field around the conductor. Furthermore, not only was a compass needle deflected by the electric current, but a wire that carried current could be deflected by a magnet.

Incredibly simple as the relationship seems, two decades of investigation by scores of fine minds failed to make the connection.

In the years from 1820 to 1860, a lineup of brilliant men established practically all of the familiar electric and magnetic laws. The names include: Ampère, Biot, Coulomb, Faraday, Gauss, Green, Helmholtz, Henry, Joule, Kirchoff, Lenz, Kelvin, Maxwell, Ohm, Poisson, Savart and Weber.

The seeds of a giant

Among the discoveries and inventions during the period were the thermoelectric effects of Thomas Seebeck and Jean Peltier; the first crude galvanometers by Schweigger and Poggendorff; and the first electromagnet by William Sturgeon in 1825—16 turns of wire around a soft iron core bent into a horseshoe shape.

The first forty years of the 19th century

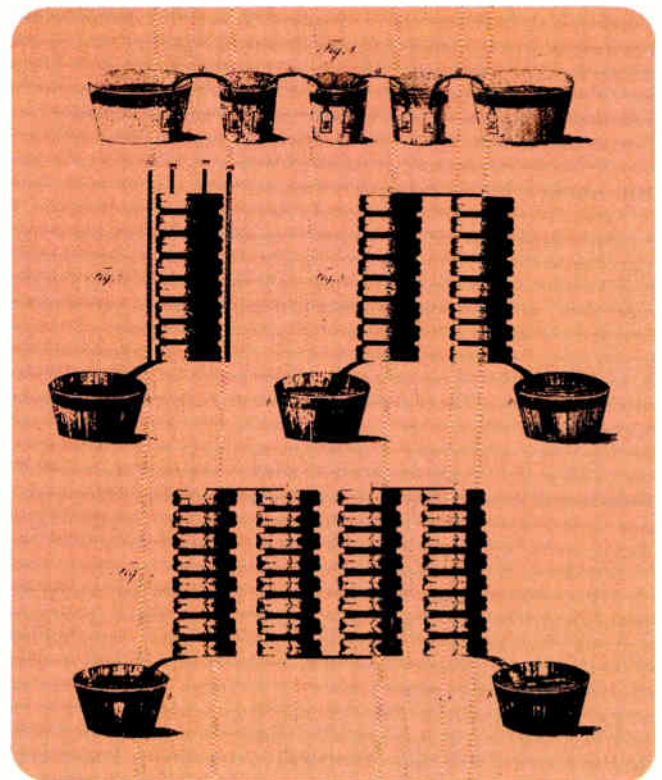

The first battery: Volta's pile as drawn by Volta himself in a letter to the president of the Royal Society. Four variations are shown.

brought progress the like of which may never be seen again. It was the time of Chopin and Beethoven, Dickens and Jane Austen. The year 1812 saw President Madison declare war on Great Britain, while Napoleon was beating a hasty retreat from Moscow and, in Germany, Beethoven was putting the finishing touches on both his 7th and 8th Symphonies. In London that year gas lighting was installed on all main streets.

The period also saw the first steam locomotive in the USA and the first steamship crossing of the Atlantic. Jefferson doubled the size of the United States with the Louisiana Purchase. Meriwether Lewis and William Clark explored the wilderness and, little by little, the original narrow coastal ribbon of the colonies spread westward. The Monroe Doctrine, the Missouri Compromise, the Indian Wars—all were burnt into the pages of history.

Meanwhile, the seeds of a giant new industry were being planted by the unlikely partnership of an English intellectual and a child mathematical prodigy. Charles Babbage collaborated with Lady Lovelace, daughter and only child of Lord Byron, on the first true binary computer, the "difference" engine. Despite a ten-year effort, from 1823 to 1833, the machine was never completed. But the ground had been plowed—and though it would take another 100 years—progress would have its way.

"Men of great soul, what astonishing things

have they arrived unto!" wrote Cotton Mather in *The Christian Philosopher*, the first American book of science aimed at a popular audience. One hundred years later Michael Faraday and Joseph Henry produced one of the most astonishing discoveries of all.

Ever since Oersted's announcement, a prime goal of investigators was the reciprocal condition—the generation of electricity by a magnetic source. In England, Michael Faraday, Davy's assistant, sought the elusive goal. For ten years he worked, with no success. Then, the breakthrough: The opening and closing of a battery circuit connected to a coil caused a deflection in a galvanometer. The meter was connected to a second coil wound on the same iron bar as the first coil but not connected to it.

Faraday then discarded the battery and moved the bar-and-coil arrangement near a large magnet. As the bar moved toward the magnet, the galvanometer needle spun violently. When Faraday pulled the bar away, the needle zoomed around in the opposite direction. Electromagnetic induction had been discovered.

Induction discovered—twice

In just ten days of work—after ten years of trying—Faraday in 1831 formulated the basic laws of electromagnetic generation. Again, the world was jolted. In terms of its effects on mankind, this was clearly one of the greatest discoveries of all time.

The genius of Faraday touched many other areas, especially the study of electrochemistry. Like Franklin before him, Faraday's work led him to create new terms. They include: diamagnetic, paramagnetic, dielectric, ion, anion, cation, lines of force, anode, cathode, electrode, electrolyte and others.

Three months after Faraday published his work on induction, an unknown American researcher casually picked up a magazine that carried a report of Faraday's findings. Joseph Henry was devastated by what he read.

Independently—and unknown to Faraday—Henry had a year earlier discovered induction. But Henry was reluctant to publish. His earlier theatrical training had convinced him that every demonstration must be foolproof, so he waited until he could build an overwhelming mass of data. He was to regret the delay for the rest of his life.

Not since Franklin had America seen a man of Henry's calibre, and the country needed such men to offset European criticism of the lack of culture in the New World. But America didn't sympathize with Henry when he finally published. It blamed him, and almost cut short his career.

Luckily, Henry continued. In subsequent work, he invented the relay and used the device to

build the first electromagnetic telegraph system. His work on mutual induction is considered definitive on step-up and step-down transformers. And earlier, by the "simple" process of insulating wire by hand with silk, Henry built powerful electromagnets that could lift as much as a ton.

In 1837—six years after Faraday's ascent to fame—a group of scientists in England attempted a simple experiment. The object: to draw sparks from a thermocouple. One end of the couple lay on a red-hot stove; the other was imbedded in ice.

Charles Wheatstone touched the free ends of the wires together. No spark. "No, no," Faraday exclaimed, "you're doing it all wrong." Then Faraday tried. Still no spark. Finally, a third man stepped up, coiled a length of wire around his finger and slipped it around an iron rod. The man added the coil to one of the thermocouple leads, then brushed the ends together. The result: clearly visible sparks.

"Hurrah for the Yankee experiment!" cried Faraday. "What in the world did you do?" And so Joseph Henry had to explain self induction to the man made famous for the discovery of induction.

Henry had described the phenomenon of self induction in his paper of 1832. He had observed the effect as early as 1831. But no one in Europe, apparently, had read Henry's paper.

A rabbit changes the course of history

The amazing similarity between the work of Henry and Faraday also extends to their lives. Accidents of history surrounded Henry: If it were not for a pet rabbit, he might never have become the man he did. When Henry was thirteen, the animal ran away. He dug after it and came up under a church, inside a locked room containing a library of romantic novels.

Henry began to read and was so enthralled by the melodrama, he resolved to study acting. Three years later, too ill to go to the theater for his lessons, Henry picked up a book left behind by a boarder. The opening paragraph read: "You throw a stone or shoot an arrow into the air, why does it not go forward in a line with the direction you give it?" Henry had discovered "natural philosophy."

In one of Henry's last experiments, in 1842, he observed that he could magnetize needles in a basement with an electric spark originating two floors above. Henry compared the effect with the propagation of light. Twenty-five years later, Maxwell quantized Henry's observations in the four equations of electrodynamics.

It was a nervous milieu in which Henry worked in the 1830s. The American West was opening up. Jacksonian democracy was spreading, and there was mounting interest in politics. The total vote

in the presidential election of 1824 was only 356,000; by 1836 it rose to 1,500,000. Four years later, the vote was 2,400,000.

Manners were loosening. Foreign observers were shocked at the widespread spitting of tobacco and the recklessness and violence of American society. Human life took a back seat to the progress of a fast developing country, and little attention was paid to safety. Railroad collisions and steamboat explosions were frequent. Hurriedly erected frame houses burned regularly in New York, while in 1836 two of the city's largest business buildings collapsed. Dueling and lynching became common. Law was undependable; Bowie knives and pistols weren't.

If America had little time for manners or culture, the deficiency was more than made up on the other side of the Atlantic. Chopin's *Etudes* and *Mazurkas* slipped from the keys to the printed page; Dickens wrote *The Pickwick Papers*; and from the soul of Donizetti came the opera *Lucia di Lammermoor*.

While Chopin worked on the first of his delightful "practice pieces," the packet ship *Sully* sailed from Europe on its way back across the Atlantic. Aboard was America's most successful portrait painter, Samuel Finley Breese Morse.

"What hath God wrought?"

On ship, Morse was excited. He had seen some European experiments dealing with electromagnetism. Faraday had published just a few months earlier. Morse wondered: Could not the effect be used to send messages over a wire?

During the voyage, Morse made sketches. He spent the next three years trying to build the device he had sketched. But Morse had little money and three small children; his wife had died earlier. Circumstances conspired against him: nothing came of his work. Perhaps a major reason for his trouble was that Morse knew next to nothing about the basic principles of electricity.

But lack of knowledge couldn't stop Morse. He lived in a time when inventors were popular heroes. A legend had taken root: Yankee inventiveness could do anything. Fueling the American myth were the almost unbelievable careers of such men as Charles Goodyear, Elias Howe, Eli Whitney, John Stevens, Robert Fulton and others.

So Morse plunged headlong into the search for a practical telegraph, one that could win the \$30,000 prize offered by Congress for a thousand-mile system. And in the end, the myth prevailed. American know-how triumphed. But the question remains: Did the know-how belong to Morse?

When Leonard Gale, a colleague at the newly opened University of the City of New York, saw one of Morse's contrivances, he took pity on him.

Gale had read Henry's papers. He pointed out to Morse the need for insulation on the windings of his electromagnets, and showed Morse how to arrange the battery circuit.

When Gale left to teach in the South, Morse journeyed to Princeton to seek advice from Henry himself. Henry corrected the errors in Morse's system and explained that a single battery couldn't send a signal over the desired distance. The solution: Henry's relay.

Morse's luck held. A backer, Stephen Vail, agreed to put up \$2000 if Morse would take on his son Alfred. Morse agreed and, as it turned out, Alfred Vail was a true inventor. It was he who worked out the final form of Morse's code, he who introduced the key, he who reduced the machine to the final, compact form. And it was Vail who invented the printing telegraph that was patented in Morse's name.

Meanwhile, others struggled to make their names. Goodyear was busy churning raw rubber with cream cheese, soup, salt, pepper and other exotic ingredients. His goal was to create a practical form of rubber that wouldn't melt or harden under temperature extremes. But hard times came in 1837. Morse was broke, without money to eat. McCormick's iron foundry was bankrupted, Goodyear's family was starving.

The panic of 1837 dashed Morse's hopes of financial aid from the government. He rushed to Europe to secure foreign patent protection.

In England, he was told Wheatstone had already invented the electromagnetic telegraph; in Russia, Baron Schilling had beaten Morse to the punch. But the Czar considered distant communication subversive and banned all publicity. On the continent, Morse was told that Steinheil had invented the device—it could be seen at any railroad station.

Morse persisted. In 1840, he received his U.S. patent, in 1843, assistance from the government. By 1850, Morse and his partners were organizing a telegraph company to build a New York-Philadelphia line. At this point, Morse kicked out Vail and most of his early helpers.

In retrospect, the first 40 years of the 1800s marked the turning point from the investigative, foundation years to the era of practical engineering. Dynamos and electric motors were being built, batteries were being improved.

Before 1838 only about 500 patents had been issued. Within three years after the patent law of 1838, over ten thousand patents were granted.

Soon to come were the first transatlantic cable, the telephone, the electric lamp. Each of these would lead to thousands of by-products and to new major industries.

Thus the decade ended, poised on the brink of a new, dramatic era in American technology. ■■

THE MICROCOMPUTER MEMORY THAT STAYS ON WHEN THE POWER GOES OFF.

Ampex MCM. Microcomputer Core Memory. It retains everything, even in the event of a total power failure. No batteries or other tricks, just the unflappable reliability of magnetic core technology.

Ampex MCM comes complete, with all timing and control, data and address registers, decoding and drive circuits and, of course, your choice of core capacity. You can specify the word length you need from 4 to 18 bits, and storage for 256 to 4096 words, in all popular binary increments.

Modest-capacity MCM modules are complete on a single board; use as many as required to achieve the total capacity you desire. All of them are available with a single connector strip, with pinouts to suit your design.

Ask yourself if your microcomputer-based system can afford a program loss due to power interruption. If you answer "no" to that question, then you'll answer "yes" to Ampex MCM modules. They offer the least expensive protection you can buy. When the power goes off, they stay on.

AMPEX MCM-1000
4096 x 8
450 nsec access
8.39" x 10" x 1.4"

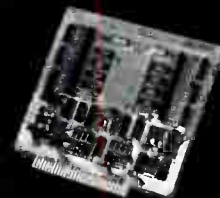
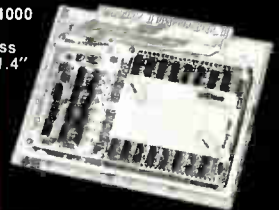

AMPEX MCM-4300
2048 x 4
450 nsec access
6.3" x 6.3" x 0.65"

Ampex Memory Products Division
13031 West Jefferson Boulevard
Marina del Rey, CA 90291, 213-821-8933

AMPEX

TRW's MAR™ ultra stable resistors. Performance plus.

Our ultra-precision MAR resistors match the performance of precision wirewound, *plus* they give the inherent advantages of TRW metal film.

Like smaller size, better frequency response, higher resistance values and lower cost.

And MAR's are not "selected" from a lower grade process. The entire facility was *designed* to yield *only* high accuracy devices.

And it *DOES*:



MAR axial lead family

Tolerances to $\pm 0.01\%$. TC's ± 5 to 25 ppm/ $^{\circ}\text{C}$. Where speed and precision count, the MAR does it all. In a dimensionally clean, axial lead molded package.

With the non-measurable noise, low voltage coefficient, load stability, resistance/size ratio and *reliability* of our metal film process.

Plus MAR matched sets and packaged networks have tolerance and TC matching to $\pm 0.005\%$ and 1 ppm/ $^{\circ}\text{C}$.

Specifications

IRC Type	Resistance Range* (Ohms)	Temperature Coefficients -20°C to $+85^{\circ}\text{C}$ (\pm ppm/ $^{\circ}\text{C}$)	Tolerances ($\pm\%$)	Power Rating** @ 85°C (Watts)	Voltage Ratings (Volts)
MAR3	20 - 100K	T10 = 15	1.00, 0.50, 0.25,	$\frac{1}{20}$	200
MAR5	20 - 250K	T13 = 10	0.10, 0.05, 0.02,	$\frac{1}{10}$	250
MAR6	20 - 500K	T16 = 5	0.01	$\frac{1}{8}$	300
MAR7	20 - 1 Meg			$\frac{1}{4}$	500

*Wider ranges available, contact factory.

**Higher power ratings available. Contact factory.



AR40 radial lead devices

This plug in configuration offers absolute accuracy and documented reliability. TC's to $\pm 2\text{ppm}/^{\circ}\text{C}$, tolerances to $\pm 0.01\%$ are standard.

Plus, AR40 uses only .03 in.² PCB area including lead attachment, and has the same mechanically rugged terminations used on all MAR resistors.

Specifications

TCR Class.	Standard Temp. Coeff. ($^{\circ}\text{C}$)	Resistance Range* (Ohms)	Standard Tolerance ($\pm\%$)	Wattage 85°C
T-18	2 ppm 0 to 60°C 5 ppm -55 to 125°C	20 to 100K	.01, .02, .05, .10, .25, .50, 1.00	.3 watts
T-16	5ppm 0 to 60°C 10 ppm -55 to 125°C			

*Wider ranges available, contact factory.

AR90 high range resistors

Designed for applications where you need values up to 10 Meg Ohms—such as precision voltage dividers, input attenuators.

Plus, despite its high resistance range, the AR90 has standard TC's to $\pm 5\text{ppm}/^{\circ}\text{C}$ and tolerances to $\pm 0.05\%$. And it is a *real* space saver.

Specifications

IRC Type	Resistance Range* (ohms)	Temperature Coefficients -20°C to $+85^{\circ}\text{C}$ (\pm PPM/ $^{\circ}\text{C}$)	Tolerances	Power Rating	Voltage Rating
AR90	1M - 10M	T10 = 5 T13 = 10 T16 = 15	1.0, 0.5, 0.25, 0.1, 0.05	.5W	1000

*Wider ranges available. Contact factory.

Need prototypes fast?

TRW has on stream another *big plus*—a short order production line (in addition to our regular facility) designed to give you quick delivery on bread board quantities. Delivery to satisfy your needs, typically 2-3 weeks.

For more information on ultra-precision resistors, contact TRW/IRC Burlington. TRW/IRC Resistors, an Electronic Components Division of TRW, Inc., 2850 Mt. Pleasant St., Burlington, Iowa 52601. (319) 754-8491.

TRW IRC RESISTORS

CIRCLE NUMBER 39

WorldRadioHistory

ELECTRONIC DESIGN 4, February 16, 1976

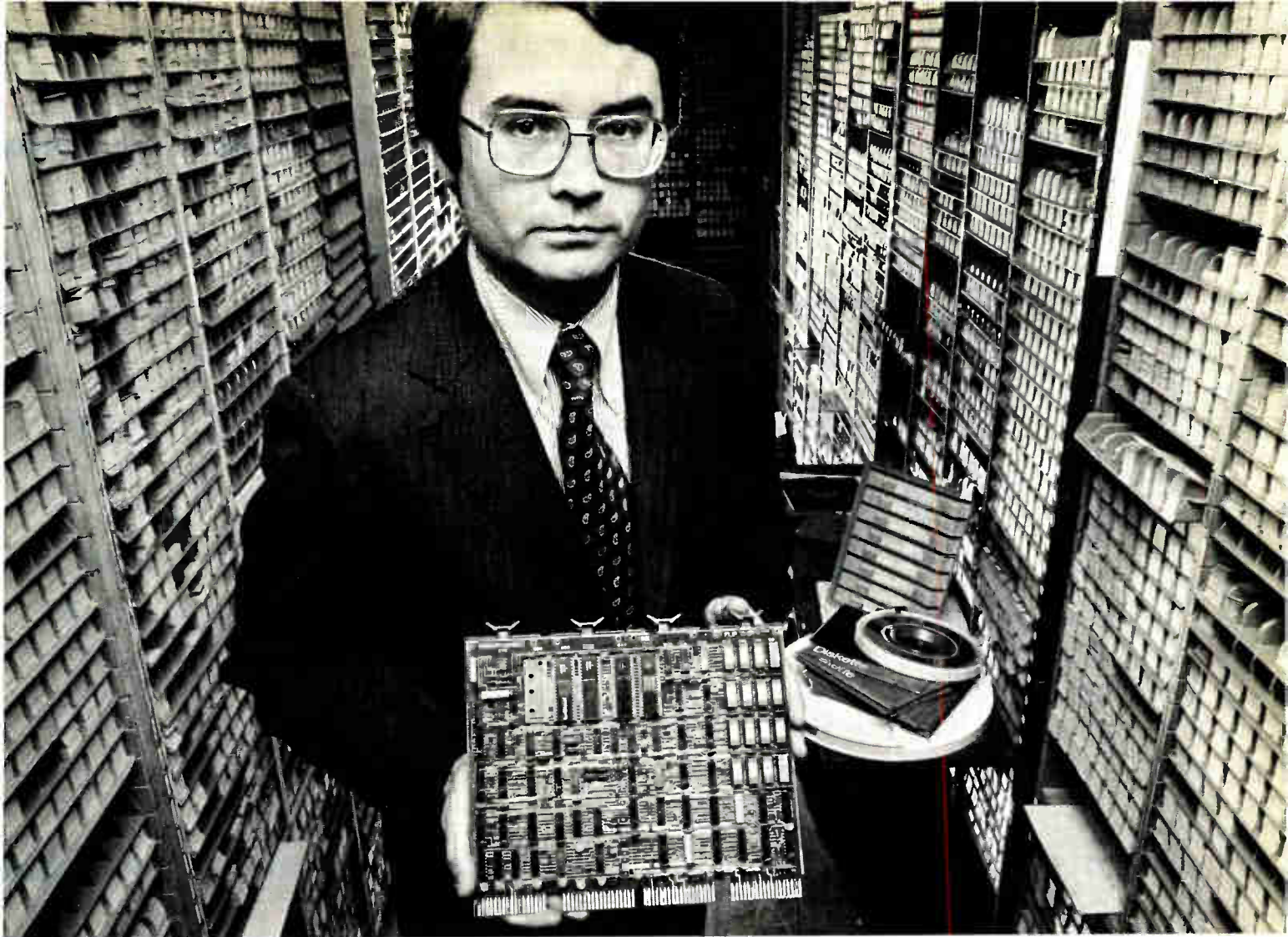

The complete solution to the micro madness: PDP-11 software for the LSI-11.

The most expensive part of using micros isn't paying for the hardware. It's developing the software. With every kind of micro device except one:

The LSI-11. Digital's powerful 16-bit microcomputer on an 8½" x 10" board.

Because thanks to our RXV11 Dual Floppy Disc Drive, you can use the proven software from our famous PDP-11 mini-computers. To get your applications going. Fast.

You can program in easy-to-use BASIC, FORTRAN, or FOCAL, in addition to the assembly-level language other micros force you to use from the start.

You get utilities for editing,

compiling, assembling, loading, linking, and de-bugging your programs. Our RT11 operating system for real time task-oriented control. Even applications programs, through our DECUS customer network.

The RXV11 also helps you develop programs right on the LSI-11, without using time-sharing facilities or development machines, although if you want, we have those too.

And we haven't forgotten the hardware either. In addition to the basic CPU and 4K of RAM, we also offer CORE, ROM, and PROM memories; additional modules for system expansion; plus the PDP-11/03 — the LSI-11 in a nice neat box,

ready to be plugged in.

And it's priced at just \$634 in 100's for the CPU and 4K of RAM.

LSI-11. Powerful software for the micro market.

For details, call 800-225-9480 (MA 617-481-7400, ext. 6410).

Components Group, Digital Equipment Corp., One Iron Way, Marlborough, Mass. 01752. Canada: Digital Equipment of Canada, Ltd. Europe: 81 Route de l'Aire, 1211 Geneva 26, Tel. 42 79 50.

Prices apply to USA only.

digital
COMPONENTS
GROUP

THE ERA OF GIANTS (1837-1879)

GETTING ELECTRICITY TO WORK FOR MAN

- 1839 Charles Darwin publishes his "Voyage of the 'Beagle'."
Karl Friedrich Gauss publishes his theory of "forces attracting according to the inverse square of the distances."
- 1841 The Preemption Act legalizes "squattling" on Western lands of the U.S.
Arc lights are demonstrated for the first time in the streets of Paris.
- 1844 Alexandre Dumas writes "The Three Musketeers."
Samuel Morse transmits the first message on a demonstration telegraph line erected between Washington and Baltimore.
- 1847 Gold is discovered in California.
George Boole establishes the foundation of computer operation in his "Mathematical Logic."
- 1848 Cyrus McCormick invents the reaper, which turns wheat farming into big business.
American Association for the Advancement of Science founded at Philadelphia.
- 1850 The Compromise Act is passed by Congress to relieve tensions between the North and South.
Heinrich Helmholtz determines the speed of the nervous impulse.
- 1851 Herman Melville writes "Moby Dick."
Charles G. Page makes a 19-mph trip from Washington to Bladensburg, MD, on his electric locomotive.
- 1858 Col. E. L. Drake devises a method of

One hundred years after the founding of the new republic, the age of transition from an agrarian to an industrial society was heralded by a huge, boisterous Centennial Fair that opened in Philadelphia on May 10, 1876 and played host to a celebration that lasted through the summer.

Eight million visitors from all walks of life came to wonder at the latest marvels, displayed in the Fair's biggest attraction, Machinery Hall, as the world paid homage to the fledgling nation and its accomplishments.

The symbol of entry into the industrial era was a monster Corliss steam engine—the largest that had ever been built—which generated 1600 horsepower. The output of its giant shaft turned the wheels for all the machinery in the hall.

German composer Richard Wagner wrote a special "Centennial Inauguration March" for the Fair's opening ceremonies. The British sent a delegation, and royalty was represented by the Emperor Dom Pedro of Brazil, who was personally responsible for calling attention to one of the exhibits, a "talking telegraph" invented by Alexander Graham Bell. It was solely upon Dom Pedro's insistence that the Fair's judging com-

- deep-well drilling and strikes oil.
Michael Faraday supervises the installation of Alliance dynamos for the first arc lights in English lighthouses.
- 1861 **Louis Pasteur** develops the germ theory of disease.
Johann Philipp Reis builds the first telephone in Germany.
Joseph Wilson Swan invents the first incandescent lamp in the U.S.
- 1863 **Abraham Lincoln** delivers the Gettysburg address.
Henry Wilde begins research that leads to the first practical generator.
- 1865 Lincoln is assassinated.
 A second attempt to lay an Atlantic cable fails after 1186 miles have been paid out. Cost \$3-million.
- 1866 **Alfred Nobel** invents dynamite.
Cyrus Field lays the first successful Atlantic Cable.
- 1869 Railroad service is established between the East and the West Coasts.
 The first gas-heated thermo-electric battery is developed in France.
- 1873 **Joseph Glidden** produces the barbed-wire fence and changes the development of the American West.
Maxwell publishes his treatise on the theory of electromagnetic radiation.
- 1876 General **George Custer's** last stand brings a public demand for the end of the "Indian menace."
Alexander Graham Bell develops the first practical telephone; **Thomas A. Edison** invents the phonograph.

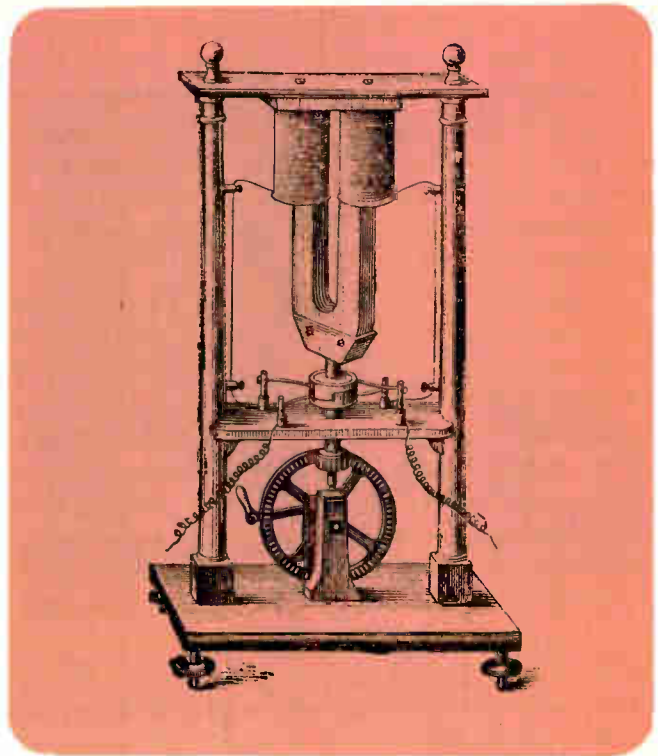

Pixii's magneto-electric machine, developed in 1832, was the first practical mechanical generator of electrical current that used concepts demonstrated by Faraday.

mittee listened to the new device on June 25.

The judges' overwhelming delight and praise for the instrument that could carry a voice over a wire ushered in what was to be the most exciting era in communications for many years to come. It was the culmination of an age that saw the telegraph grow from a single 40-mile demonstration line between Washington and Baltimore, in 1844, to thousands of lines that criss-crossed the United States and spanned the Atlantic.

Development of electric power

But the breakthroughs to make electrical power rival and exceed steam power were yet to come. Although the implications of Michael Faraday's work on electromagnetic generation remained to be developed, there were ceaseless efforts by many to produce an electric generator capable of providing massive amounts of power, and a motor able to use that energy.

The development of electricity as a motive power was taken up by a host of inventors as early as 1832, when a rotary electromagnetic engine was constructed in England by William Sturgeon. It was exhibited in London the follow-

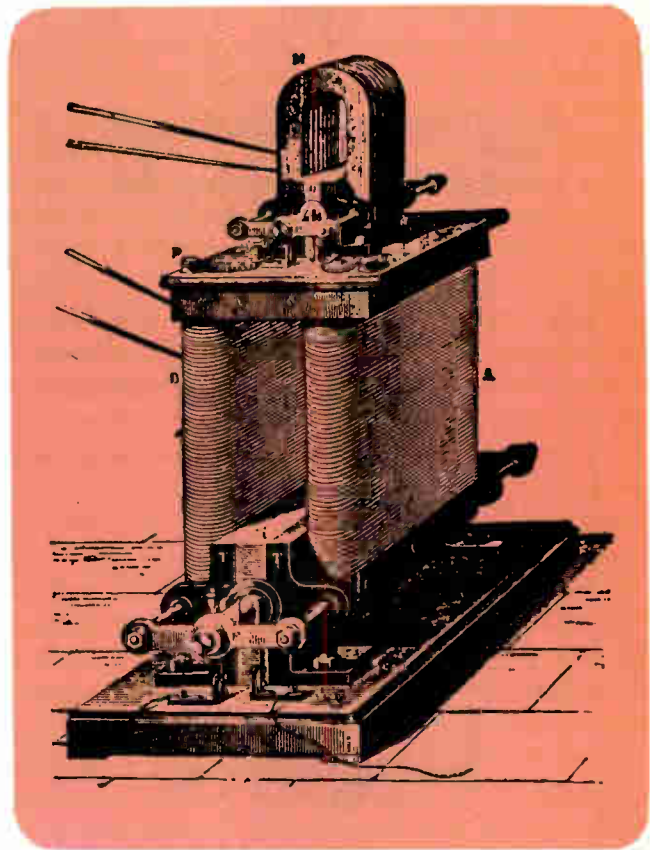

Henry Wilde's generator of 1866, considered to be "a machine of enormous and unprecedented power," employed a small, shaft-driven Siemens machine to energize the field coils of the larger dynamo.

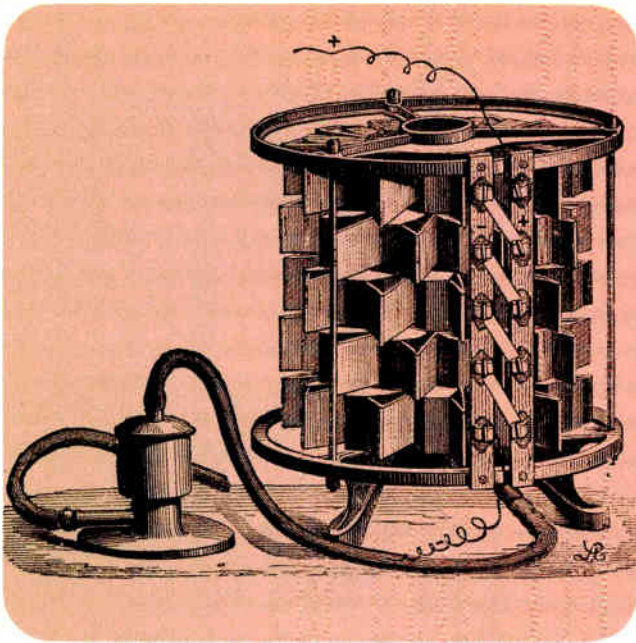

Thermo-electric generators were developed in Europe to replace costly battery power. Clamond's thermo-electric battery was heated with gas and was demonstrated in France in April, 1874.

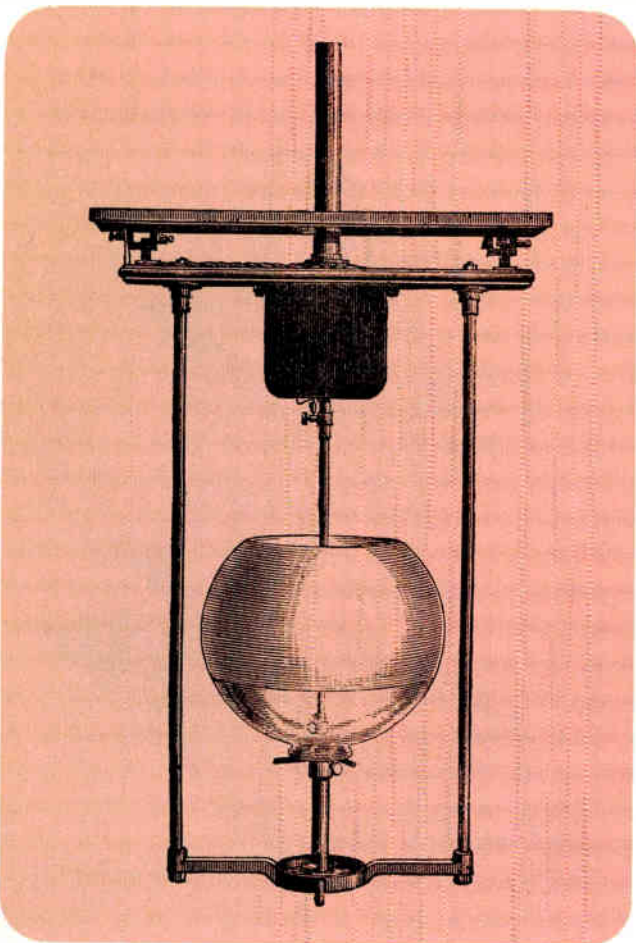

The first electric light was produced by arc "candles" and arc lights. Charles F. Brush invented an arc-lamp system that could light a greater number of lamps in a single circuit than could any competition.

ing spring.

In the United States the earliest practical electric motor was made a year later by Thomas Davenport, an ingenious Vermont blacksmith. A magnet used to extract iron from pulverized ore gave him the idea of applying magnetism to the propulsion of machinery.

Working independently, he produced his own rotary electromagnetic engine in 1834, and exhibited it in Springfield, MA, during the fall of 1835, using the motor to drive an electric locomotive model around a circular railway. In 1840 he used another of his own motors to drive a printing press, and produced a publication entitled *The Electro-Magnet and Mechanics Intelligencer*.

Others occupied themselves with similar undertakings. In St. Petersburg, Russia, Professor Moritz Hermann Jacobi invented a magnetic motor, and with the financial assistance of Czar Nicholas, constructed in 1839 a 28-ft boat propelled by an electric motor with a large number of battery cells. It carried 14 passengers, at a speed of three miles per hour. Robert Davidson of Scotland experimented in 1838-1839 with an electric railway car 16 feet long and weighing, with the batteries, six tons. It attained a speed of four miles per hour.

Probably the most spectacular demonstration of electricity as motive power was achieved by Dr. Charles Grafton Page, who for many years occupied an important position at the Patent Office in Washington. In 1838 Page exhibited in London a locomotive propelled by battery power around a circular railway track.

As early as 1845 it had been observed by Morse's partner Alfred N. Vail that a hollow coil of wire possesses the curious property of sucking a soft iron core into its center with considerable force when an electric current is applied.

Page saw this phenomenon demonstrated, and from it conceived the idea of using that force in an electric motor. In 1850, after numerous experiments, he constructed a machine that developed over 10 horsepower.

A battery driven train

The Congress of the United States was preoccupied at this time with the Compromise of 1850, a proposal by Henry Clay that temporarily settled differences between the North and South over states' rights and the extension of slavery. As a direct result, California was admitted to the Union as a free state, and the territories of Utah and New Mexico were permitted to practice slavery.

Despite the stormy political atmosphere, Congress found time to appropriate sufficient money

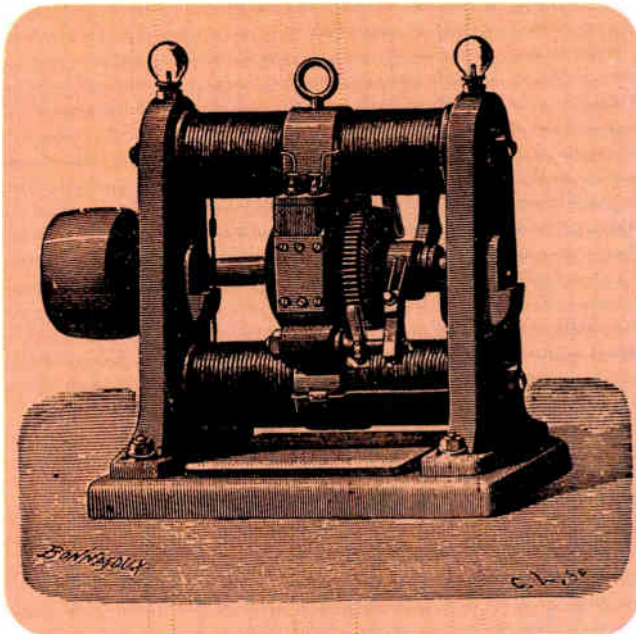

When two of Gramme's dynamos were accidentally connected together in 1873, with the first machine driven by a steam engine, the second began rotating backwards as a motor. It was the first demonstration of the transmission of mechanical power through electrical means.

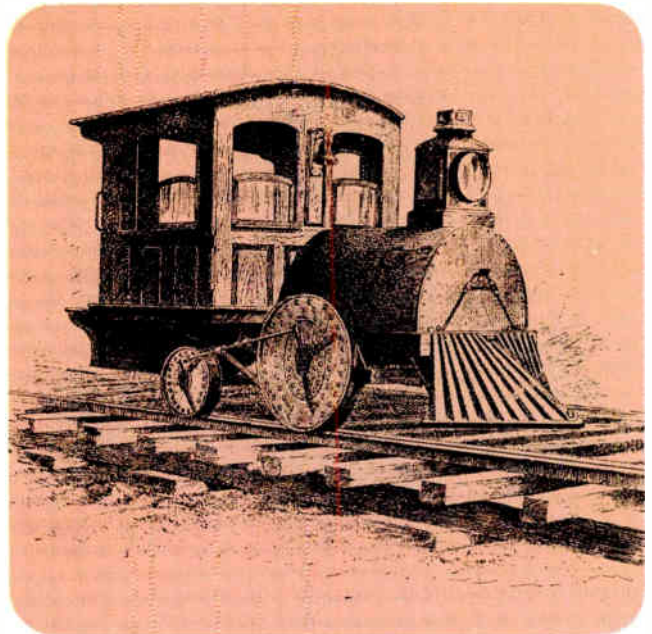

The vast improvements in dynamos of the late 1870s, and Gramme's discovery that they could be run as motors, led inventors to renewed interest in an electric railway. Edison's locomotive was demonstrated at Menlo Park, NJ, in 1880.

for Page to construct an electric locomotive and send it on an experimental trip from Washington, DC, to Bladensburg, MD, on April 29, 1851.

The electric engine reached a speed of 19 miles per hour on level ground. But with this battery-driven engine, as with other efforts of the period, the high cost of producing electricity by zinc primary batteries precluded commercial use.

Thomas Hall of Boston, who had constructed much of Page's apparatus, made a small model of an electric locomotive soon after, and established the practicality of carrying an electric current to a moving car by employing the wheels and rails as electrical conductors. This dispensed with the need for transporting batteries on board the vehicle.

One of the most enthusiastic experimenters with electromagnetic machinery was Dr. James Prescott Joule of Manchester, England. In a letter written in 1839 he said, "I can scarcely doubt that electromagnetism will eventually be substituted for steam in propelling machinery."

Some years later, after he had made his famous investigations into the mechanical equivalent of heat, his enthusiasm dimmed. From his researches he estimated that one grain of zinc could produce only about one-eighth the mechanical equivalent of a grain of coal. But the zinc cost 20 times as much.

His conclusions were accepted as authoritative and further efforts to apply electromagnetism as a prime mover were discouraged for many years. But efforts to overcome high costs continued to

stimulate efforts to generate electricity by mechanical means.

Faraday was the first one to produce a machine for mechanically producing electrical currents, but since he was interested only in discovery, not application, he went no further.

Producing current mechanically

In 1832, after the publication of Faraday's experiments, Hippolyte Pixii, an electrical instrument maker in Paris, constructed a device in which a rotating permanent magnet induced an alternating current in the field coils of a stationary horseshoe electromagnet. This was the first practical device for producing an electric current by mechanical means. Pixii called it a "magneto-electric" machine.

Later that same year Pixii produced a second machine, at Ampere's suggestion, with a commutator to rectify the ac currents.

Pixii's first device was improved upon in 1833 by Joseph Saxton of Philadelphia who used a rotating electromagnet, the inverse of Pixii's design. The resulting magneto-electric "shock machine" was regarded for many years as a toy, but later found widespread use as the crank-telephone bell ringer.

Another milestone in boosting the output of current-generating equipment was the substitution of electromagnets for the permanent magnet, patented by Sir Charles Wheatstone in 1845 and by James Watt in 1852. Both men used a

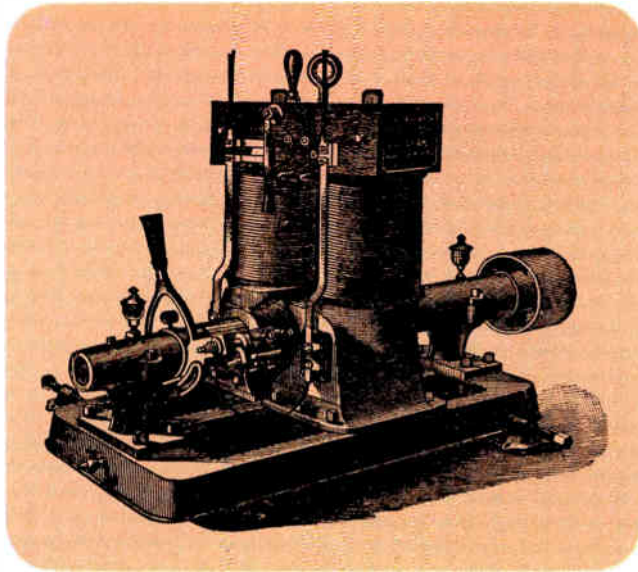

Edison's improvements on the dynamos of his contemporaries led to his efficient 1888 machine, which initiated the practical application of electricity throughout America.

battery to energize the coils.

By this time arc lights had been experimentally demonstrated using a set of carbons and primary batteries, but the first use came in 1846 at the new Paris Opera House, to light up the skating scene in Giacomo Meyerbeer's *The Prophet*. It required 360 Bunsen cells set up in a large room on the ground floor.

Such extravagance was an exception in the theater. Elsewhere, to illuminate a stage, lime-light—an intense light produced by the incandescence of a stick or ball of lime in the flame of a combination of oxygen and hydrogen gases—was universally used.

The production of oxygen and hydrogen was expensive, so in 1850 Professor M. Nollet of Brussels began making a high-current magneto-electric machine for decomposing water into hydrogen and oxygen. The gases were to be sold for limelights.

Nollet proceeded to work under the auspices of a combined French-and-English firm known as the Alliance Company. Experiments were made with a large machine in 1853, but were interrupted by Nollet's death. F. H. Holmes of England picked up the work. He studied the machine and made several alterations, producing a device admirably suited for the production of light between two carbon points.

Under the supervision of Faraday himself, Alliance dynamos were installed in two English lighthouses. The electric arc searchlight first cast a beam out over the sea from South Foreland lighthouse, December 8, 1858. Some three and a half years later the second light was in operation in Dungeness. Unforeseen flaws in the

machine's design caused frequent accidents to machine tenders and to the equipment itself, and the world's enjoyment of electricity as a means of illumination was postponed several years.

Still, the creation of powerful, reliable electric generating machines was getting closer. A significant but little-noticed link in the chain of development was forged in 1856 by the invention of a magneto-electric machine with a long, shuttle-wound armature. Produced by Werner Siemens in Germany, the machine was small and produced little power, but would gain significance later.

Maxwell interprets Faraday

Edouard Manet shocked the Parisian art world in 1862 with *Dejeuner sur L'Herbe* (Dinner on the Grass), which displayed a modern French lady in the nude. (It was acceptable to show ancient Greek or Roman women unclad, but . . .) The United States was deeply preoccupied with the Civil War. Many citizens in the North openly called for a strong stand against slavery. In response, Lincoln issued the Emancipation Proclamation on January 1, 1863.

At the same time, James Clerk Maxwell was hired by King's College, London, where he interpreted many of Faraday's ideas in a systematic mathematical form. These concepts gave the world precise mathematical definitions that even today stand unchallenged. They were published later in a series of historical documents on the theory of electromagnetic radiation and the dynamics of the electromagnetic field.

For seven years following Siemens' 1856 invention, no new developments of record appear. Then in 1863 the elusive trail of the practical, high-power electric generating machine was picked up by Henry Wilde of Manchester, England. For the next three years he carried on extensive experimentation, and in 1866 described a powerful generator he had designed. It used a Siemens armature revolving between the poles of a large electromagnet that was excited by a smaller Siemens generator driven by the same mechanical power source that turned the large machine's armature.

Wilde ultimately carried this "piggyback" arrangement a step further, using a third machine in a concanted sequence. With this system he was able, in 1867, to produce an arc capable of fusing an iron rod 15 inches long and one quarter inch thick.

The first self-excited machines

The final step in the development of the generator occurred suddenly, as if a flash of cogni-

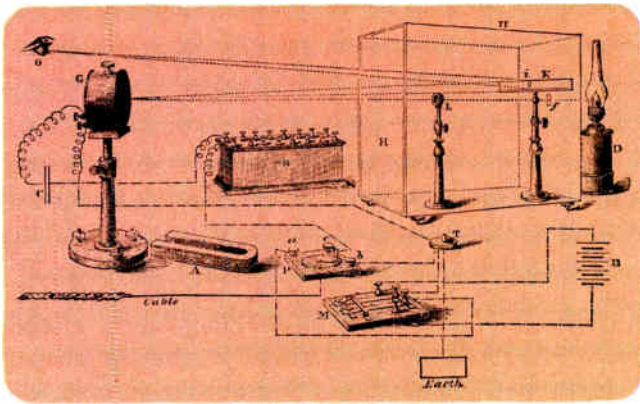

The mirror galvanometer, invented by Sir William Thomson, was the only instrument sensitive enough to receive messages over the early transatlantic cables. A typical setup is shown. In 1867 he invented a new receiver that recorded signals by spurring ink from a fine glass siphon, upon a moving paper ribbon.

tion had spread throughout the world. In 1866 Moses G. Farmer of Connecticut, Alfred Varley and Wheatstone in England, and Werner Siemens of Berlin announced independent discovery of the self-excited machine. Current generated by the new machine excited its own field coils. This was to be the final form for both ac and dc dynamo-electric machines.

Using principles set forth by Varley and the armature form employed by Antonio Pacinotti in 1860, Zenobe Theophile Gramme invented a continuous-current generator that produced remarkably large currents from a small machine. But a fortunate accident occurred in Gramme's career that completely overshadowed his invention.

At an industrial exhibition in Vienna, 1873, several Gramme machines were being placed in position to demonstrate the various uses to which they could be put.

In making the electrical connections to one of the machines that had not yet been belted to its engine shaft, a careless workman attached—by mistake—a pair of wires that were already connected to another dynamo machine, which was in rapid motion. To the worker's amazement, the second machine commenced to revolve rapidly in a reverse direction.

Gramme, hastily called to the scene, at once perceived that the second machine was performing like a motor. For the first time the world had seen the transference of mechanical power through the medium of electricity.

James Clerk Maxwell, when asked what he thought was the greatest discovery of the period said: The fact that the Gramme machine was found to run backwards.

The principle of converting mechanical energy into electric currents and reconverting them into mechanical power fired imaginations with the concept of transmitting power over great dis-

tances via conductors.

Charles W. Siemens of London insisted in 1877 that by such a means the enormous energy of the water coming over Niagara Falls could be transferred to New York City and used there for mechanical power. Two years later Sir William Thomson asserted his belief that an insulated copper wire half an inch in diameter could be used to extract 26,000 horsepower from water wheels driven by Niagara Falls and, with losses, could deliver 21,000 horsepower a distance of 300 miles.

While the enormous potential of such a system attracted general attention in scientific circles, its application to useful purposes was deferred several years by the profit opportunities in electric lighting, which promised investors larger and more immediate gains.

Electric trains

One of the earliest applications of the transmission of power was the revival of the electrically operated railway. Its commercial development had been suspended until machinery was available to furnish large quantities of electricity at moderate cost.

Werner Siemens devised and constructed a circular railway, 1000 feet long and with a one-meter gauge, for display at the Berlin Industrial Exhibition in the summer of 1879. A five horsepower steam engine drove the dynamo-electric machine.

Meanwhile, several American inventors were at work on electric transportation, among them Stephen D. Field of San Francisco, Dr. Joseph R. Finney of Pittsburgh, and Thomas Edison of New Jersey. Edison, in the spring of 1880, at Menlo Park, NJ, was the first to construct a dynamo-electric railway in America. The tracks carried the current.

Finney's plan used a wire suspended above the railway line. A small trolley ran on this wire and the return path for the current was through the rails. His first experimental car, exhibited in Allegheny, PA, in the summer of 1882, provided a model for the overhead power feed.

With the impetus given to the production and commercial use of electric power, and with the key developments that occurred from 1865 through 1867, the stage was set for the rapid expansion of electrical networks in cities, first for street lighting and industrial power, and in the final decades of the 19th century for home lighting and appliances.

Interestingly enough, the first dc watt-hour meters—called Weber meters—used a current shunt to plate zinc plates in a zinc sulfate solution. The amount of zinc transferred from one plate to another in a month was one one-thousandth of the quantity of electricity used. Each

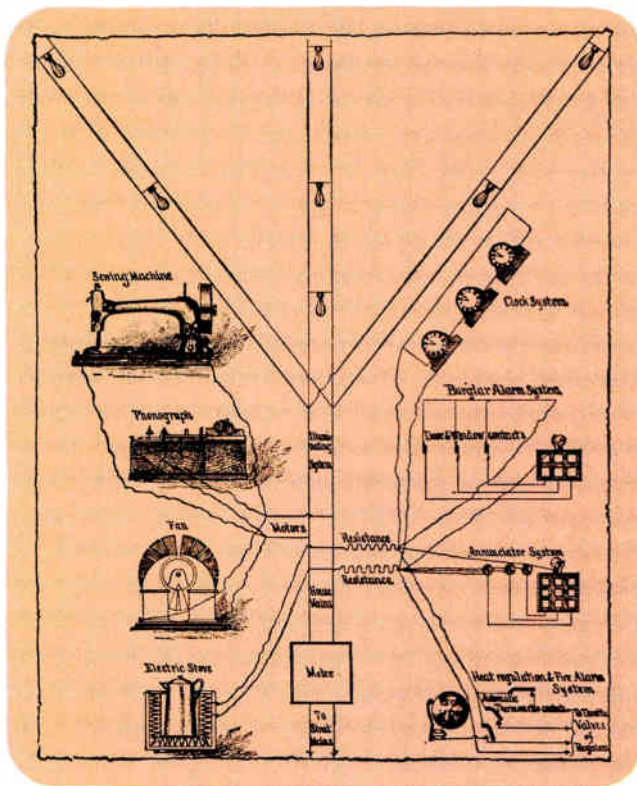

By the 1890s electricity was powering many of the same basic household lighting, cooking and appliances we have today. A wiring plan of that period shows the many items serviced by electricity.

month the plates were changed and weighed.

The age of wire communication began with Samuel F. B. Morse's invention of the telegraph in 1837, after which the system proceeded to expand slowly through the first few decades of its existence. Morse formed a private stock company in 1845 after problems resulting from the war with Mexico cut off government funding for the telegraph. Within a few years, hundreds of communities between the eastern seaboard and the Mississippi were connected with the rapidly expanding network of telegraph lines.

One major problem that confronted system users was that only a single operator could send at a time. Until 1852 no one had devised a system to make simultaneous use of the lines. But in that year, Moses G. Farmer invented a synchronous multiple telegraph in which he proposed to employ two rotation switches, one at each end of the line.

Farmer's system had all the basic elements of what in later years were to be successful time-division multiplexed equipment, but it never became practical; he was never able to keep both rotating switches in synchronism during trials of the system. That problem was not to be solved until 1872.

In the intervening years attempts to send a

telegraph message frequently proved to be a nightmare. Since there was no organized traffic system a dozen or more operators might be trying to send a message at the same time on the same wire. Order began to emerge from the chaos with the organization of Western Union in 1856.

Hardly had the system begun to be rationalized than the Civil War intervened. One week after it started the United States government closed down the Washington Office of the American Telegraph Company as a precaution against espionage.

U.S. General George McClellan was one of the first to appreciate the telegraph as a tactical weapon. The Union Army first used it in Virginia on June 3, 1861.

A conflict between the telegraph companies and the Signal Corps over jurisdiction was won by the telegraph companies, and a separate telegraph department was set up under the direct control of the Secretary of War.

All this time the system was still plagued by the inability of a line to carry more than one message at a time. It was not until the early part of 1872 that Joseph B. Stearns of Boston solved the major problem that had defeated earlier designs—the effects of the capacitive discharge of the line upon release of the key. Western Union rapidly acquired rights to Stearns' system and used his duplex system successfully.

The French connection

One of the most profound influences on multiplex printing-telegraph design was due to the inventive genius of Jean Maurice Emile Baudot, an officer of the French Telegraph Service.

Baudot developed a five-unit code—the shortest practicable code for land lines—and combined it with a division of line time originally suggested by Farmer, producing a practical multiple-user system of printing telegraphy. Its first trials, in 1875, used a system that allowed five messages to be sent at once. In 1877 the French officially adopted that system. Since then it has become universal.

After repeated failures in the 1850s to bridge the Atlantic with a cable that endured—failures costing millions of dollars—Cyrus Field, aboard The Great Eastern, linked Valentia Bay in Ireland with Heart's Content in Newfoundland in 1866.

It was a venture that proved the problems plaguing the laying and operation of the submarine cable had been licked. By the end of the 19th Century all the world's principal cities had been linked by a massive submarine cable network. ■■

12 reasons why *only* Buchanan® Terminal Blocks provide **Lowest Total Applied Cost!**

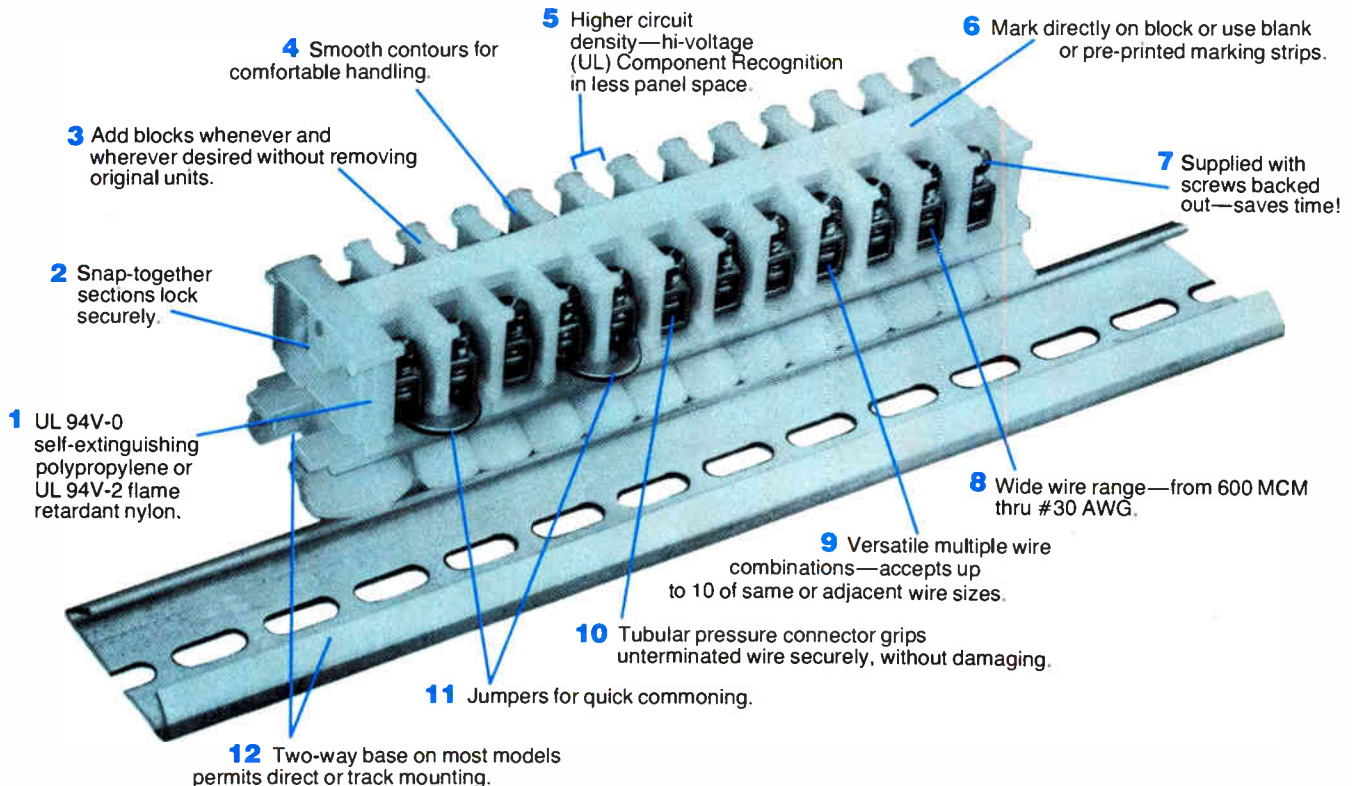

AND—you can get 'em when you need 'em!

No matter how many advantages offered by a specific terminal block, you can't get the advantages if you can't get the block!

Which is why we make sure Buchanan blocks are stocked in ample quantities throughout the country. Buchanan has anywhere from twice to eight times as many stocking distributors as other manufacturers—so you can get the blocks you need *when* you need them.

And only Buchanan distributors can give you *all* the advantages shown above.

Copper tubular contacts that really grip . . . higher circuit density . . . ease of assembly and add-on . . . everything that works together to provide Lowest Total Applied Cost!

Next time you order terminal blocks, specify Buchanan and be sure of *all* the advantages, *plus* prompt delivery. In the meantime, send for our handy Selector Chart and Catalog. Use the Reader Service Card. (If you have a special application, call one of our Regional Offices shown below.)



**CONTROL PRODUCTS
DIVISION**

Amerace Corporation
Control Products Division
Union, New Jersey

16

Atlanta—(404) 261-1224 • Cleveland—(216) 333-8540 • Chicago—(312) 437-8354 • New York Metro.—(201) 355-7770 • Los Angeles—(213) 863-5753

CIRCLE NUMBER 41



Nichicon quality makes a world of difference

Today, selecting the right capacitor is more than a job. It's an art. Applications vary so much. Home entertainment. Computer. Automotive. Industrial electronics.

To meet your capacitor needs and to do it right, you need a special kind of capacitor. A Nichicon capacitor. We make Electrolytic Capacitors, Ceramic Capacitors, Film Capacitors, Oil-Filled Capacitors (without P.C.B. available), Metalized Paper Capacitors, Wax Paper Capacitors, Mica Capacitors, and even Hybrid IC's and

P.T.C. Thermistors.

So call Nichicon or the Nichicon representative/distributor in your area. Discuss your specs with him or write us direct for your free technical catalogs. You'll see for yourself that Nichicon does make the difference. With quality capacitors, personal attention—a kind of human, one-on-one way of doing business.

A capacitor that's reliable and dependable, too? It's more than possible. It's available. Just give us a call.

REPRESENTATIVES

ALABAMA
Interep Assoc., Inc.
(205) 881-3677

ARIZONA
Chaparral-Dorton
(602) 263-0414

CALIFORNIA (Northern)
Caltron/Pyle, Inc.
(415) 964-3244

CALIFORNIA (L.A.)
Varigon Associates
(213) 679-0621

CALIFORNIA (San Diego)
Varigon Associates
(714) 299-5413

CONNECTICUT
Impact Sales Co., Inc.
(203) 281-1331

FLORIDA (Southern)
Reptronics, Inc.
(305) 251-5478

FLORIDA (Northern)
Reptronics, Inc.
(813) 522-8220

GEORGIA
Interep Assoc., Inc.
(404) 394-7756

ILLINOIS
Midwest Electronic Inds.
(312) 777-9700

INDIANA
Midwest Electronic Inds.
(317) 253-0590

MARYLAND
Component Sales, Inc.
(301) 484-3647

MASSACHUSETTS
Impact Sales Co., Inc.
(617) 893-2850

MICHIGAN
Greiner Assoc., Inc.
(313) 499-0188

MINNESOTA
Robert W. Marshall Co.
(612) 929-0457

NEW JERSEY (Northern)
DeJan Associates
(201) 382-2797

NEW JERSEY (Southern)
BGR Associates
(215) 643-4111

NEW YORK (Metro)
Nichicon (America) Corp.
(516) 567-2994

NEW YORK (State)
Leonard D. Allen, Inc.
(315) 458-7470

NORTH CAROLINA
Component Sales
(919) 782-8433

OHIO (Cleveland)
KW Electronic Sales, Inc.
(216) 831-8292

OHIO (Dayton)
KW Electronic Sales, Inc.
(513) 890-2150

PENNSYLVANIA (Eastern)
BGR Associates
(215) 643-4111

PENNSYLVANIA (Western)
KW Electronic Sales, Inc.
(412) 487-4300

TEXAS
William Reese Assoc.
(214) 638-6575

WASHINGTON
Ray Over Sales
(206) 454-4551

DISTRIBUTORS

WEST COAST

SEATTLE, WASH.
Bell Industries
(206) 747-1515

LOS ANGELES
JACO Electronics
(213) 887-6400

MIDWEST

BEACHWOOD, OHIO
Sheridan Sales Co.
(216) 831-0130

CHICAGO, ILL.
Hall Mark Electronics
(312) 437-8800

CHICAGO, ILL.
Midwest Electronic Inds.
(312) 777-9700

DALLAS, TEX.
Hall Mark Electronics
(214) 231-6111

DAYTON, OHIO
Sheridan Sales Co.
(513) 277-8911

FARMINGTON, MICH.
Sheridan Sales Co.
(313) 477-3800

FLORISSANT, MO.
Sheridan Sales Co.
(314) 837-5200

INDIANAPOLIS, IND.
Sheridan Sales Co.
(317) 547-7777

MINNEAPOLIS, MINN.
Hall Mark Electronics
(612) 925-2944

OVERLAND PARK, KA.
Sheridan Sales Co.
(913) 383-1636

READING, OHIO
Sheridan Sales Co.
(513) 761-5432

EAST COAST

HUNTSVILLE, ALA.
Hall Mark Electronics
(205) 539-0691

ORLANDO, FLA.
Hall Mark Electronics
(305) 855-4020

PHILADELPHIA, PA.
Hall Mark Electronics
(215) 355-7300

PITTSBURGH, PA.
Sheridan Sales Co.
(412) 244-1640

CANADA

MONTREAL, QUEBEC
Audio Electronics, Inc.
(514) 735-6197

TORONTO, ONTARIO
Audio Electronics, Inc.
(416) 495-0720



We help keep your world turned on.

NICHICON (AMERICA) CORP., 6435 N. Proesel Ave., Chicago, Ill. 60645 • 312/679-6530
New York Branch: 40 Orville Dr., Bohemia, N.Y. 11716 • 516/567-2994
Division of NICHICON CAPACITOR LTD., Kyoto, Japan

Discover what's happened while you were looking the other way.

Liquid Crystal Displays

What's happened is that Liquid Crystal Displays have come of age. The problems of several years ago when LCDs were first put on the market are now part of history.

What LCDs can now do, when you should use them—what some of those early problems were and how they've been solved—is summed up in our new *Basic Guide to the New Liquid Crystal Displays*.

Included:

- the next-to-nothing power requirements (we're in micro-watts) and why our new LCDs can go continuously for over 50,000 hours.
- the old approach (dynamic scattering) vs. the new

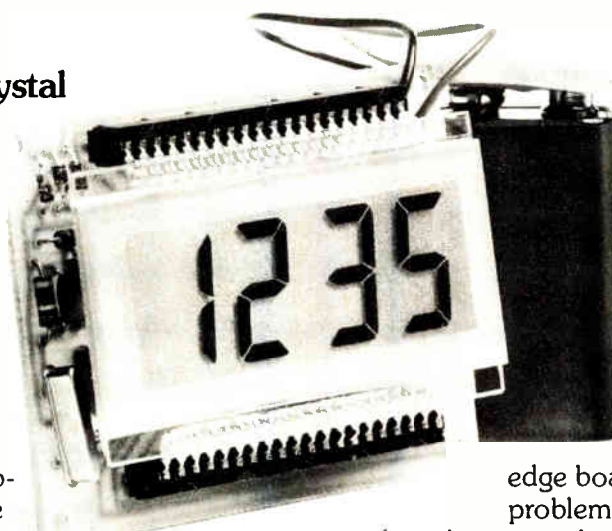

approach (field effect)—and why the “new” produces crisp, sharply-defined images in both bright and dim light.

- the “plug-in” dual in-line design that beats the old edge board connector and vibration problems.

- color—how it works and why you can have almost any one you want...

And more—C-MOS availability, price, safety (they're totally safe—in fact, always have been).

Your copy of our new guide is free. And it's a quick, easy way to make sure you're right up-to-date.

Send for it.

No kidding?

If LCDs are ready, I'm ready to find out about them. 7601
Send me your *Basic Guide to the New Liquid Crystal Displays*.

Name: _____

Title: _____

Company: _____

Address: _____

City: _____ State: _____ Zip: _____

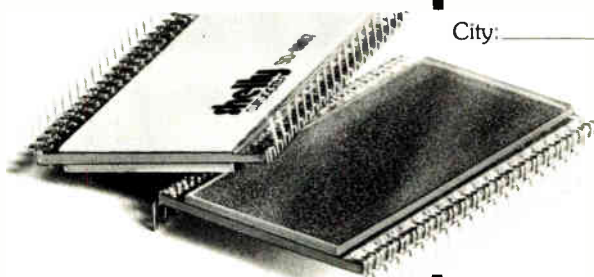

shelly

associates

A Subsidiary of
Datatron, Inc.

1562 Reynolds Avenue, Irvine, California 92714 • (714) 540-9330

CIRCLE NUMBER 43

THE COMMUNICATIONS ERA (1879-1905)

EXTENDING MAN'S VOICE BY WIRE AND RADIO

- 1879 Thomas Alva Edison and J. W. Swan independently invent the carbon-filament lamp.
Albert Einstein is born and James Clerk Maxwell dies.
- 1880 Jacques and Pierre Curie discover the piezoelectric effect, later applied to control the frequency of oscillators.
Edwin H. Hall discovers the Hall Effect, whereby a magnetic field can deflect current carriers in semiconductors.
Edison installs electric street lighting in New York City.
- 1881 President James A. Garfield is assassinated.
The Panama Canal is completed.
- 1882 Prof. Amos E. Dolbear patents a wireless communications apparatus.
- 1883 The Metropolitan Opera is founded in New York City.
Edison discovers the Edison Effect in which a hot filament in a vacuum emits electrons to an adjacent conductor.
- 1884 Mark Twain's "Huckleberry Finn" is published.
Paul Nipkow patents the television scanning disc, the basic device used in early mechanical TV systems.
- 1885 The Brooklyn Bridge is completed and the Statue of Liberty is unveiled.
Sir William H. Preece demonstrates induction "wireless" communications.
First electric street railway in U.S. opens in Baltimore.
- 1886 Heinrich Hertz proves experimentally that "electric" waves and light waves are identical.
Edison patents carbon microphone, which vastly improves telephone service.
Alternating current is first used in America for a commercial lighting system.
- 1887 Giuseppe Verdi writes the opera "Otello."
Dr. A. Conan Doyle's first Sherlock Holmes story is published.
Edison Phonograph Co. formed; Volta Graphophone Co. manufactures records based on wax recordings.
- 1888 Nikola Tesla invents the ac induction motor; Westinghouse manufactures it.
Columbia Phonograph Co. is organized

While some audiences in 1879 were being outraged by Ibsen's *A Doll's House*, others were listening to lectures on the latest electrical discoveries and inventions at England's Royal Institution, which held meetings each Friday during October and June. Ibsen dramatized the awakening of women from Victorian restrictions; the lecturing scientists sought to explain how electrical communications could liberate mankind from the tyranny of isolation.

These were forward-looking men, but they could barely imagine all the implications of their work. Could Ibsen foresee Sigmund Freud's *Three*

- by Edward D. Easton.
- 1889 Auguste F. Rodin finishes his sculpture, "The Thinker."
- 1890 Eiffel Tower in Paris is completed.
First "tube" railway passes beneath the Thames.
First execution by electrocution, at Auburn, NY.
Prof. Edouard Branly in France develops the coherer, used by Marconi to detect Hertzian waves.
Johnstone Stoney first introduces the term "electron."
Nikola Tesla patents the Tesla Coil for the production of high-voltage and high-frequency oscillations.
- 1892 Henri de Toulouse-Lautrec paints his famous "At the Moulin Rouge."
Sir William Preece signals across the Bristol Channel by induction.
The General Electric Co. forms by merger.
- 1893 Hawaii is annexed to the U.S.
Nikola Tesla lectures at the Franklin Institute on his plan for wireless power transmission.
The International Electrical Congress at Chicago adopts the "henry" as the unit of electrical inductance.
- 1894 Alfred Dreyfus is framed on treason charges in France.
Edison's Kinetoscope given first public showing in New York City.
- 1895 Guglielmo Marconi communicates via wireless signals near Bologna, Italy.
Alexander S. Popov claims to have sent wireless signals 600 yards.
- 1896 Eldridge R. Johnson makes phonographs in his Camden, NJ, machine shop; registers the trademark "Victor."
Marconi sends wireless signals two miles at Salisbury Plain, England.
Frank L. Capps develops a constant-speed spring-motor drive for phonographs.
- 1897 The discovery of gold in the Yukon leads to the Klondike gold rush.
Marconi demonstrates ship-to-shore wireless.
Karl Ferdinand Braun constructs first cathode-ray oscilloscope.
- 1898 Admiral Dewey destroys Spanish fleet at Manila.
- H. G. Wells writes "The War of Worlds."
The Paris subway becomes operational, and the Zeppelin is invented.
Pierre and Marie Curie discover radium and polonium.
First paid radio message is sent.
Aspirin is invented.
Sound is first recorded on magnetic wire.
Marconi comes to the U.S. to wireless bulletins of the American Cup races.
- 1899 Max Planck proposes the quantum theory.
Sir Oliver Heaviside and Prof. Arthur E. Kennelly suggest existence of a reflecting medium for radio waves in the upper levels of the atmosphere.
Michael Pupin invents the loading coil, which improves long-line telephony.
Marconi files for patent on "tuned," or synchronized system of wireless.
William D. Duddel discovers that an arc can be made to produce continuous oscillations.
Prof. Reginald A. Fessenden first transmits speech by wireless.
Nikola Tesla describes the principles of radar as reflected radio waves.
- 1900 Queen Victoria dies.
DeForest Wireless Telegraph Co. is organized, forerunner of the audion-tube development.
Marconi picks up first transatlantic wireless message.
- 1901 President William McKinley assassinated.
Prof. R. A. Fessenden introduces the electrolytic detector.
- 1902 Wright brothers make first successful aeroplane flight, at Kitty Hawk, NC.
Valdemar Poulsen designs a "singing arc" that produces continuous waves at 100 kHz.
Dr. Ernst F. W. Alexanderson builds first high-frequency alternator (100 kHz) at General Electric based on Prof. Reginald A. Fessenden's specifications.
- 1903 Prof. John Ambrose Fleming patents the two-element thermionic valve detector, based upon the Edison Effect.
- 1904 Albert Einstein publishes his Special Theory of Relativity and the equation, $E = mc^2$.

Treatises on the Theory of Sex, published 25 years later, or today's women's movement? Could Sir William Henry Preece—scholar, electrical researcher, inventor and lecturer—predict radio broadcasting, color TV, radar, and satellite repeaters for reliable world-wide communications and navigation?

In one of Preece's lectures at the Royal Institution in 1880, he described the "tremendous" improvements that Wheatstone's alphabetical telegraphic apparatus had made possible in Great Britain's telegraph network. He reported about 5000 units then in use—an increase from the

1200 units of only 10 years earlier.

The eight telegraphic circuits of 1870 had by then grown to the "enormous" quantity of 150, and where earlier equipment could handle only 70 to 80 words per minute, the improved units could carry 150 to 180 words per minute.

In his enthusiastic report Preece said the Wheatstone apparatus had reached a peak of perfection—"at the head of the world, and the time is not far distant when even America will take advantage of the invention we are now using."

But America had its own inventors. They were busily tinkering with the next step in communi-

cations—telephony, which was destined soon to overshadow telegraphy.

Americans talk over wires

Elisha Gray, co-founder of the Western Electric Company, and Alexander Graham Bell, were in a race to perfect a practical telephone. Gray was an expert electrician and Bell barely understood electrical principles, but ironically, Bell won the race. By 1880, when Preece was trumpeting the praise of Wheatstone's telegraphic apparatus in England, Bell in America was already selling some of his shares in the Bell Telephone Company, putting himself in the millionaire class.

However, because Bell and most of the telephone company founders sold too soon, no heirs to mighty telephone fortunes survive.

America also was making great strides in other electrical fields. In 1880 as telephone lines began to span America, Thomas Alva Edison was directing the installation of street lighting in New York City after patenting the electric-light lamp. He was self-educated, with only a minimal understanding of the work of Ampere, Faraday, Maxwell, Henry and Hertz.

It was only 1879 when William Edward Ayrton, an electrical engineer who did a great deal of work in electrical measurements and better known for his Ayrton shunt and the Ayrton-Mather galvanometer, pioneered electricity as a motive power for railways. Electric trolleys soon traversed the larger cities in the United States, and by 1895 the first main-line railway was electrified. Electric automobiles, such as the Runabout and the Electric Brougham (1900), made a tentative appearance, but were soon replaced by "gas guzzlers." However, it was 25 years after electric motive power was first used for railways before the Broadway-City Hall, electrically powered subway opened in New York City (1905).

Of course, Europe did a great deal of the pioneer work in electric-motive power. Siemens and Halske, a German company, exhibited what it claimed was the first electric railway at the 1879 Industrial Exhibition in Berlin; the Paris subway became operational in 1898, seven years before the New York system; and the first trolley bus, a light wagonette, is said to have run along the Kurfurstendamm in Berlin in 1882. Its rear axle was driven by two motors, each about 3 hp.

An age of great inventive activity

The end of the '70s ushered in a period of great activity and jealous competition among American and foreign inventors. The outcome of

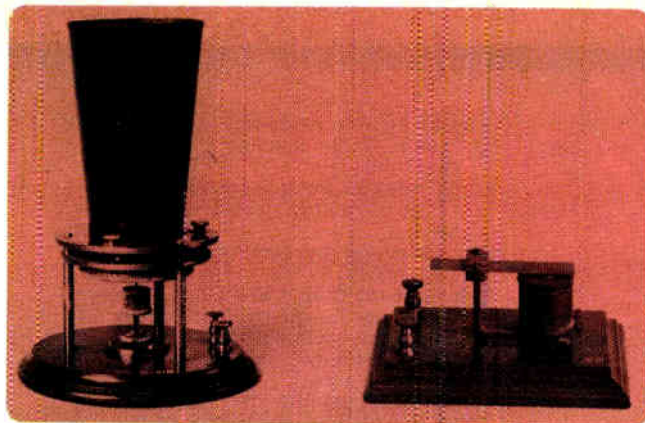

The first sentence ever spoken over the electric telephone was heard on this receiver (right) on March 10, 1876. The historic words: "Mr. Watson, come here; I want you," were uttered by Alexander Graham Bell into the transmitter. (Photo courtesy of Bell Labs.)

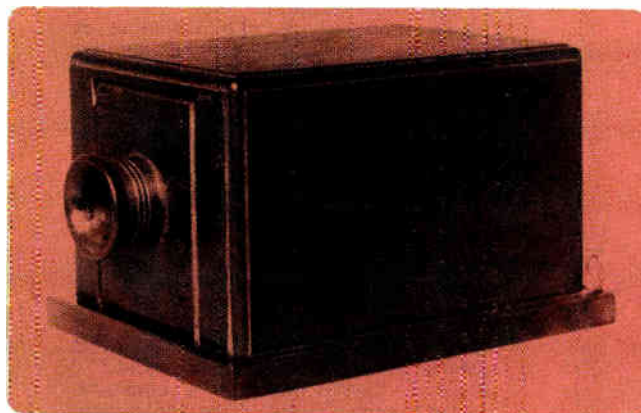

This first commercial telephone unit served as both a transmitter and receiver, and needed mouth-to-ear shifts. It went into service in 1877 when a Boston banker leased two instruments that were attached to a line between his office and his home in Somerville, MA. (Photo courtesy of Bell Labs.)

patent battles in the courts often hinged on proof that an idea was conceived days or even hours prior to another inventor's claim. Bell and his backers defended thousands of suits against his patent—No. 174,465, issued March 7, 1876. All the attacks proved unsuccessful.

Even in his days of success, Bell was not above envying other inventors. When Edison invented the phonograph (1876-1878), Bell was deeply upset. Although busy with his responsibilities of improving and promoting his telephone and battling patent-infringement cases in court, he is said to have remarked, "It is a most astonishing thing to me that I could possibly have let this invention [the phonograph] slip through my fingers."

Edison again topped Bell when he created a practical carbon microphone (patented 1886) that made long-distance telephone practical.

(Some historians attribute the carbon microphone to David Hughes in 1878.)

Bell's first liquid microphone wasn't practical, but his magnetic-inductive, or rather variable-reluctance, device, which he used as a microphone in later demonstrations and his first commercial system, developed very-low electrical outputs. Fortunately, the inductive device when used as a receiver was very sensitive, and allowed communications up to about 35 miles, but with a lot of shouting.

The carbon microphone, on the other hand, had amplifying qualities and could develop more power output than was present in the input energy of the sound, because of its valve-like modulation action. The induction microphone directly converted sound to electrical energy, but very inefficiently.

Edison's carbon microphone and Bell's magnetic receiver became, and remain to this day, the mainstay of the world's telephone systems. By 1887, the year Giuseppe Verdi composed the opera *Otello*, Hertz demonstrated that electromagnetic waves behave like light waves and Edward Bellamy was writing, *Looking Backwards*, Bell Telephone's subscribers had grown from hundreds to millions; calls once made by names, now were done by numbers.

America listens to the phonograph

The phonograph was being invented and developed almost simultaneously with the telephone. In the beginning, many experimenters tried—most were unsuccessful—to reproduce sound by mechanical means. At best, they created musical tones. The human voice eluded clear reproduction.

Sound was studied, analyzed and even recorded. In 1857 a French scientist named Leon Scott developed the "phonograph" that could record sound on a rotating, lamp-blackened cylinder, but the sound could not be played back. It was not until 1877, while experimenting with an automatic telegraph repeater, that Edison invented a recorder and reproducer of sound.

Interestingly, the U.S. Patent Office found no prior claims to any device bearing any resemblance to Edison's device. His phonograph used a spirally grooved, tinfoil-coated cylinder with a mouthpiece for recording sound by scratching "hill-and-dale" impressions in the foil with an attached needle. A crank rotated the cylinder. For listening, a funnel horn replaced the mouthpiece.

Four years later, inventors Chichester Bell and Charles Tainter developed the idea of using a wax cylinder as an improved sound recording medium. In 1887, ten years after Edison's basic

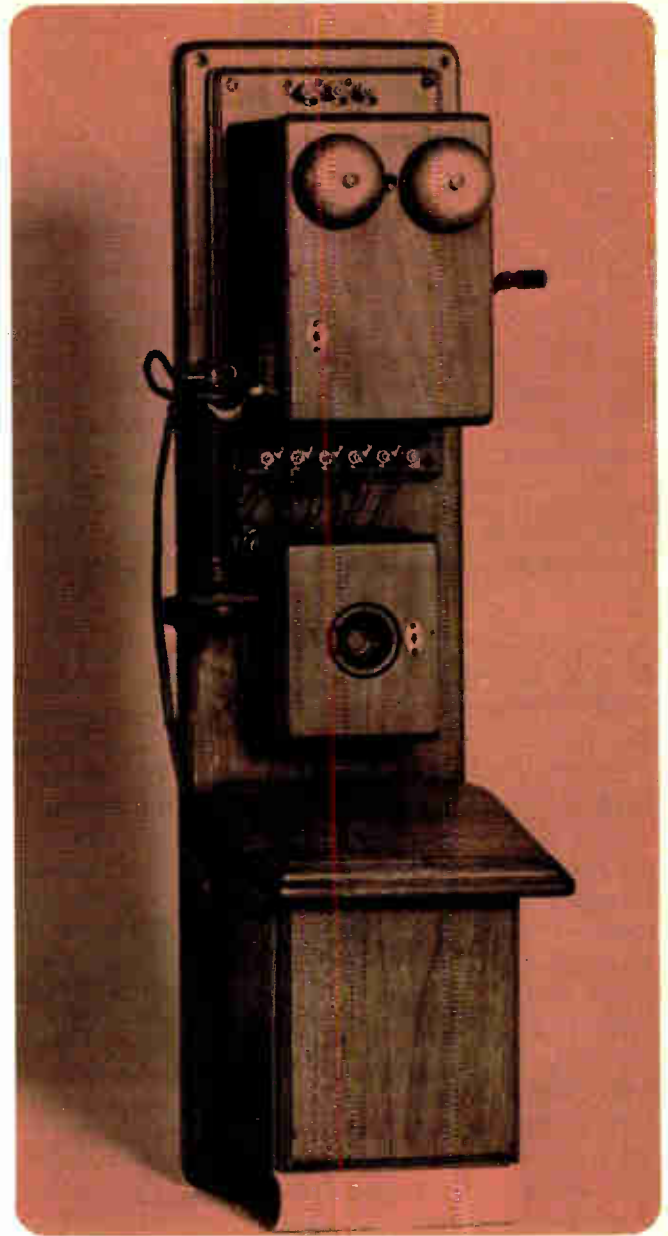

This 1882 magneto wall set, which used a Blake transmitter and Bell's hand receiver, was the first telephone built for the Bell System by Western Electric. You turned the crank to signal the operator.

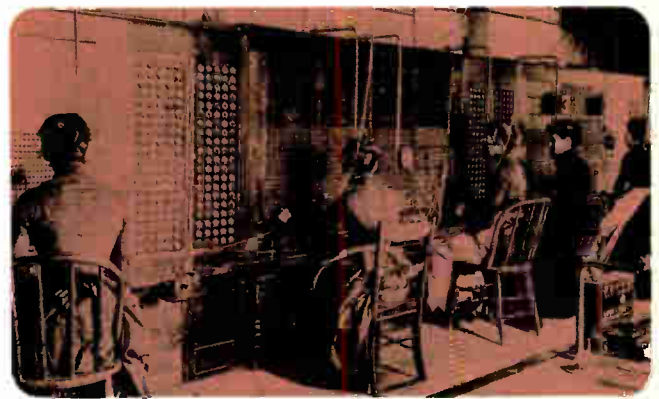

Switchboards in 1883 were separated by panels, known as annunciator drops, which gave visual indications of telephone lines requesting service. (Photo courtesy of Bell Labs.)

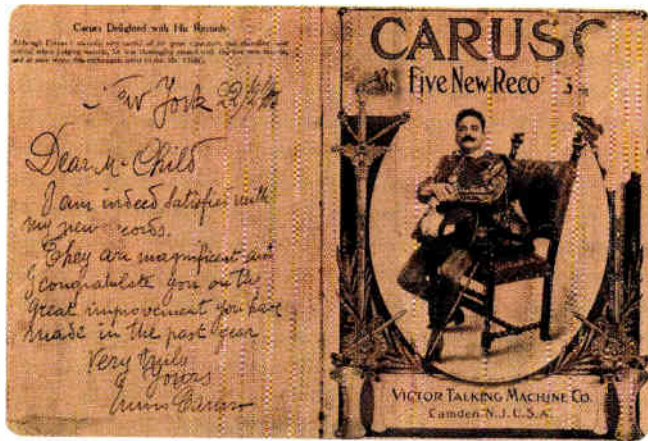

Enrico Caruso, the golden-voiced tenor, was as important to the initial success of the recording industry as the industry was to the widespread popularity of Caruso. Early recording techniques needed his powerful voice to achieve good results. (Photo courtesy of RCA.)

patent, the Volta Graphophone Company was formed to manufacture and merchandise the Graphophone, based upon the work of Bell and Tainter.

Other inventors also were at work. During 1888 to 1901 Emile Berliner and Eldridge Johnson developed flat-disc records that could be mass produced in hard rubber or shellac from a master record. These discs used lateral recording, as do today's records, a significant departure from Edison's hill-and-dale approach. To exploit these inventions, the Victor Talking Machine Co., forerunner of a major division of today's RCA, was founded. The rival Columbia Phonograph Company was organized by Edward D. Easton in 1888. Columbia later became RCA's competitor not only in records but also in broadcasting, color TV, and now in home-recorded TV, still in the development stage.

In England, an important merchandising innovation was tried in 1901, when the British Victor Talking Machine Company began recording noted opera singers. Under the name Monarch, it marketed recordings of dozens of celebrated European singers in 1903. A year later Victor released its first comprehensive Red Seal list of artists.

By 1905 Edison's phonograph company, following the lead of the British company, secured stars of New York's Metropolitan Opera for its recordings, featuring them under the trade name Diamond Disk records.

One of the most famous opera stars, who contributed substantially to the commercial success of the phonograph industry was the "golden tenor" Enrico Caruso. Born in Naples, Italy, in 1873, he became a tremendous success at the Metropolitan in 1904 after initial success in Europe. His powerful, melodious voice made hundreds of recordings, now valuable collectors

items. The early crude mechanical recording systems needed a powerful voice like his to produce effective results. Thus there was a perfect "marriage." There is no doubt that phonograph records, which easily could distribute music to the masses, contributed as much to Caruso's widespread popularity as Caruso's voice contributed to the phonograph's initial success.

Mechanical improvements followed along with improved marketing techniques. A spring-wound motor and mechanical speed governor replaced the crank, and a radial tone arm carried the sound from a pick-up needle to a large Victor-phonograph "morning glory" horn. By 1905, the horn disappeared into a cabinet and the phonograph was called a Victrola.

During all this time (1877 to 1905) Edison continued to make improvements on the phonograph, his favorite invention and one of his biggest moneymakers. By 1910 the phonograph and record market had reached \$7 million in sales.

The main use of the phonograph, of course, was for entertainment. Yet when he first invented it, Edison is said to have stated, "I don't want the phonograph used for amusement purposes. It is not a toy." Since today's multimillion-recording industry is mainly for entertainment, though it serves also many serious purposes—historical, educational and artistic—it's interesting to speculate if Edison would consider today's phonograph a toy.

In the 1860s and 1870s the very idea of telephony or speech reproduction was equated by the public with supernatural phenomena. Voices that traveled over wires and came out of a box could only be mystical, or the result of insane hallucinations. How would the public react to communication without even the wires? The answer was soon to come.

In 1884 messages sent through buried insulated wires—no doubt some carrying press releases of the success of Mark Twain's new novel, *Huckleberry Finn*—were picked up on telephone circuits erected on poles 80 ft above the ground. Telegraph circuits created electrical disturbances in telephone lines 2000 ft away, and distinct speech could be picked up from phone lines as far as a quarter mile away. By 1892 messages were deliberately sent, by such inductive methods, a distance of 3.3 miles across the Bristol Channel in England.

For shipping and lighthouses it's great

On June 4, 1897, Sir William Preece reported to the Royal Institution on progress in "Signaling Through Space Without Wires." His concluding remarks again show the difficulty of forseeing beyond solutions to immediate problems.

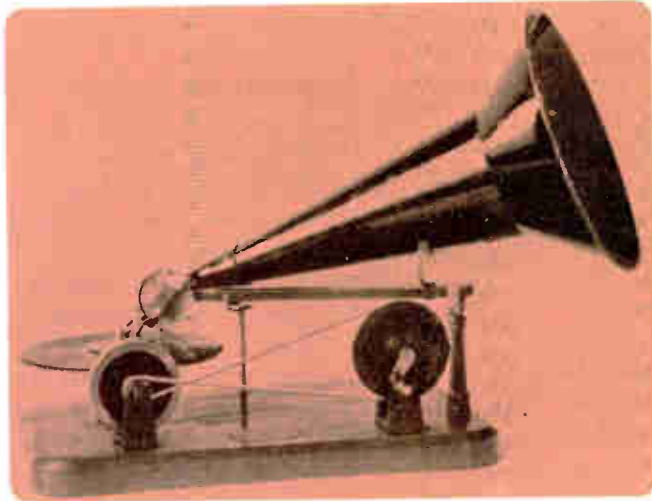
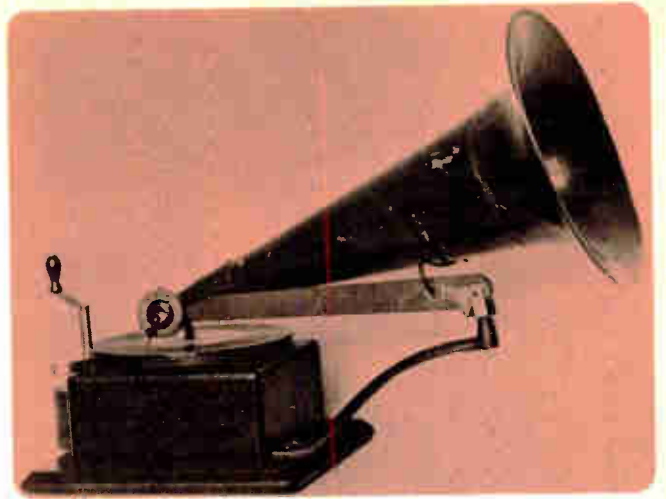
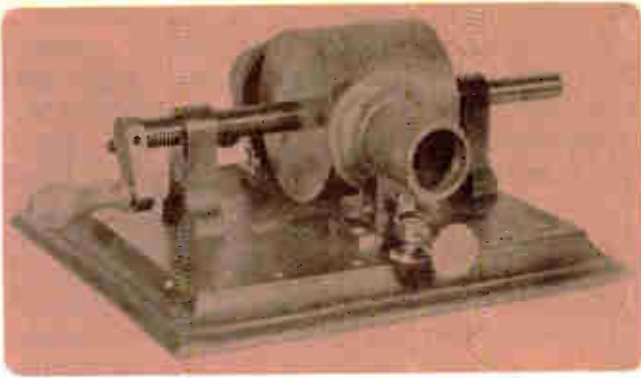

After tracing the developments of wireless communication from James Clerk Maxwell (1864) and Heinrich Hertz (1887) to Guglielmo Marconi, he concluded, “. . . enough has been done to prove its (wireless’) value; for shipping and lighthouse purposes it will be great. . . .”

Preece observed that many critics claimed: “Marconi invented nothing new; his transmitter was old—not much different from the one Hertz used over 10 years ago and his receiver was based upon Branly’s coherer (1890), invented about seven years earlier.” Preece, to his credit, nevertheless defended Marconi as a true inventor:

“Columbus did not invent the egg, but he showed how to make it stand on its end, and Marconi has produced from known means a new electric eye more delicate than any known electrical instrument, and a new system of telegraphy. . . .”

Unlike Bell, who was disappointed that he didn’t think of the phonograph first, young Marconi, only 23 years old, marveled that other workers in the field didn’t apply Hertz’ and Maxwell’s work before he did:

“When I started my first experiments with Hertzian waves, I could scarcely conceive it possible that their application to useful purposes escaped the notice of eminent scientists.”

The seers of the Victorian Era—men like Jules

The early models of Edison’s foil-on-a-drum recorders (1877-1880) used a hill-and-dale cut for impressing the sound on the foil (top). Later, improved disc-recording methods (1895) adopted a lateral-groove technique (bottom left). By 1901, governor-controlled spring drives replaced the hand crank (top right) and then the horn disappeared into a cabinet as in the 1906 RCA Victrola (bottom right). (Photos courtesy of RCA.)

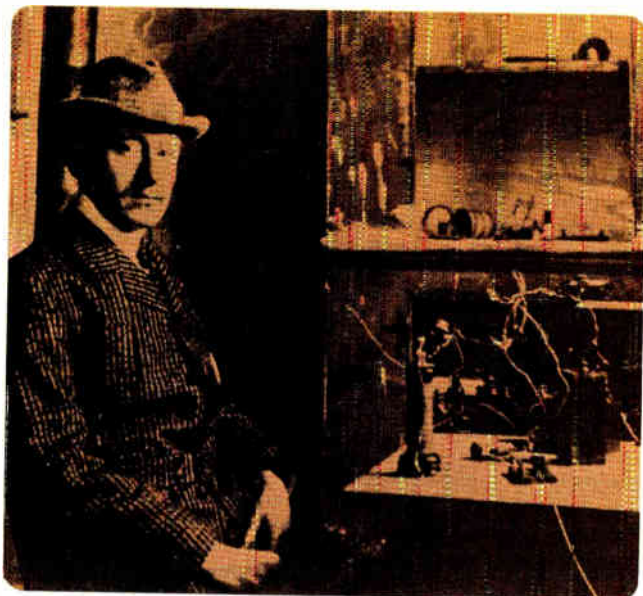

Guglielmo Marconi at the receiving set of his famous station in St. Johns, Newfoundland, where on December 12, 1901 he picked up the first transatlantic wireless signal—the letter "S" sent from his transmitter at Poldhu. (Photo courtesy of RCA.)

Verne, who wrote *Twenty Thousand Leagues Under the Sea*—were seldom the educated theoreticians and ivy-tower scholars. The doers were ambitious, practical men like Marconi and dedicated tinkers like Bell and Edison.

Preece described his own approach to wireless communications as being based upon very low frequencies. "It depends upon the rise and fall of *currents* in the primary wire." Though Preece considered his system to use electromagnetic waves, in reality it mostly involved magnetic induction and perhaps some capacitive coupling.

By contrast, he explained, "Mr. Marconi utilizes electric, or Hertzian waves, of very high frequency, and they depend upon the rise and fall of electric *force* [?] in a sphere or spheres." He continued, "the peculiarity of Mr. Marconi's system is that apart from the ordinary connecting wires of the apparatus, conductors of very moderate length only are needed, and even these can be dispensed with if reflectors are used."

Marconi's transmitter was described by Preece as a form of Prof. Righi's Hertzian radiator: "Righi's waves are measured in centimeters, while Hertz' are in meters. For this reason the distance at which effects are produced is increased.

"Mr. Marconi generally uses waves about 120 cm long. The frequency of oscillation is probably about 250 millions per second. The distance at which effects are produced depends chiefly on the energy in the discharge that passes between the transmitter's spheres. A 6-in. spark coil has sufficed up to four miles, but for greater distances we have a more powerful coil—one emit-

ing sparks 20-in. long."

Marconi's receiver was described as follows: "Marconi's relay consists of a small glass tube 4-cm long into which two silver pole pieces are tightly fitted, separated from each other by about half a millimeter—a thin space which is filled up by a mixture of fine nickel and silver filings mixed with a trace of mercury. The tube is exhausted to a vacuum of 4 mm and sealed. It forms part of a circuit containing a local cell and a sensitive telegraph relay. In its normal condition, the metallic powder is virtually an insulator. But when electrical waves fall upon them, they are 'polarized,' or as Prof. Oliver Lodge expresses it, they 'cohere.' The resistance of such a space falls from infinity to about five ohms.

"Mons. E. Branly in 1890 showed the same effect with copper, aluminum and iron filings. Marconi "decoheres" by making the local current very rapidly vibrate a small hammer head against the glass tube, and in doing so makes such a sound that reading Morse character is easy."

Then Preece described the distances Marconi achieved with his apparatus: "The distance to which signals have been sent is remarkable. On Salisbury Plain, Mr. Marconi covered a distance of four miles. In the Bristol Channel, this has been extended to over eight miles, and we have by no means reached the limit. It is interesting to read the surmises of others. Half a mile was the wildest dream."

But the dream, true to form, was not wild enough. By 1900, the year Giacomo Puccini's *Tosca* was being performed, Marconi was able to report to other audiences at the Royal Institution that the U.S. Navy easily communicated up to 36 miles in a demonstration to British authorities during maneuvers between the battleships New York and Massachusetts.

By 1902, he was able to report that with improved tuning techniques and new detectors he was able to pick up strong signals at a distance of up to 1551 miles and decipherable ones to 2099 miles—but only during the night. During the daytime, signals over 700 miles away failed entirely as a result of the Kennely-Heaviside effect.

RFI is born

By 1905 enough wireless activity had developed that Marconi was forced to report on how to cure radio-frequency interference among the growing number of radio stations. He noted: "One of the chief objections which is raised against wireless telegraphy is that it is possible to work only two, or a very limited number, of stations in the immediate vicinity of each other without causing mutual interference or producing a jumble by the confusion of the different messages."

Marconi pointed out that without organization and discipline similar problems can occur on telegraph lines: "Any message sent on a line will affect all instruments and can be read by all other telegraph offices on the line; but certain rules and regulations are laid down and adhered to by operators in the employ of the General Post Office. . . . It is obvious that these same rules are applicable to a group of equally tuned wireless telegraph stations that happen to be in proximity to each other."

Marconi then explained how his newly developed tuning system—"a proper form of oscillation transformer in conjunction with a condenser, so as to form a resonator tuned to respond best to waves emitted by a given length of vertical wire"—was a step in the right direction to a cure for the interference.

Marconi also worked on new detectors. He noted: "Up to the commencement of 1902, the only receivers that could be employed practically for the purposes of wireless telegraphy were based on what may be called the coherer principle." He claimed that his new magnetic detector "left all coherers and anti-coherers far behind." Improved versions of this detector could operate at 100 words per minute.

But the electrolytic detector, thermal detector crystal detector and the Fleming/Edison-Effect valve, which were more sensitive and better suited for continuous wireless and telephony were just being experimented with around 1905 and were to come into wide use to improve radio communications.

The Fleming valve, based on the Edison Effect, was the start of the science of electronics. Edison discovered in 1883 that a heated filament in one of his evacuated lamps produced a current flow to an adjacent metal plate, but he was 20 years ahead of the times. Professor John Ambrose Fleming of England in 1904 first put this effect to use as a rectifier to detect Hertzian waves. And Lee deForest in 1906 discovered that when a mesh, or grid, of wire was placed between the filament and collector "plate" in such a Fleming two-electrode valve, a large voltage-amplifying effect was produced. This discovery led to the birth of the Audion, or triode, tube and the beginnings of electronics.

A revolution in physics that would help later to overshadow electronics, was taking place at the same time: the powerful new science of quantum mechanics was emerging. Albert Einstein was born in 1879, the same year that James Clerk Maxwell died at the early age of 48. These events presaged the transition from continuum physics to quantum physics. The quantum concept was first formulated by Max Plank (1900), when he announced his theory of "black bodies."

Einstein, though better known for his work

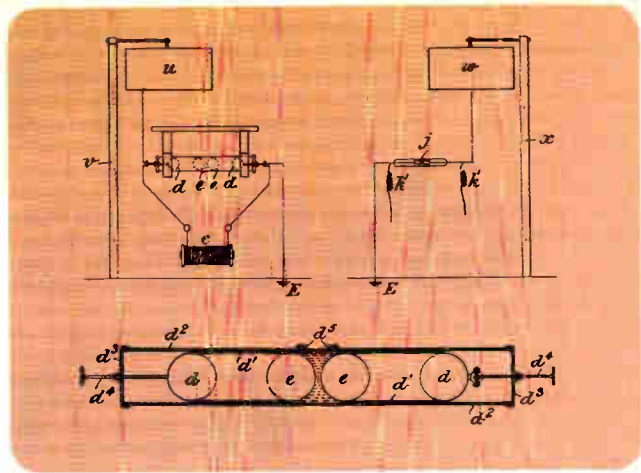

Marconi, in his U.S. Patent, issued July 13, 1897—his British patent was issued July 2, 1897—shows versions of a transmitter (left) and a receiver (right), and the blown-up section of the oscillator.

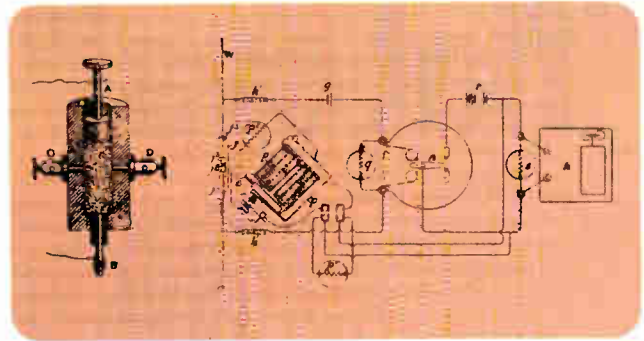

This diagram by Marconi of a Branly coherer shows how a tapper is connected to decohere the unit after detecting an electromagnetic pulse train.

in relativity (Special Theory, 1905; General Theory, 1915), contributed substantially to quantum mechanics with his work on electron photoemission phenomena, which helped establish the validity of quantum theory. In 1921 he received a Nobel Prize for this work. Quantum mechanics, of course, is today the basic tool in the design and understanding of solid-state devices.

The 26 years between 1879 and 1905 brought mankind from wired telegraphy and telephony to the beginnings of wireless communications.

The London Times of Saturday, December 21, 1901, reported in typically conservative fashion: "It would be difficult to exaggerate the good effect of wireless telegraphy if, as Mr. Marconi and Mr. Edison evidently believe, and as the Anglo-American Company [a transatlantic cable company] evidently fear, it can at no distant time be developed into a commercial success. . . . A cheap telegraphic service would unite families, however scattered, and would cement friendship between our own people and the Colonial nations, besides forging another link in the ties which bind this country to the United States." ■■

Fight chassis squeeze with these miniaturized "flat oval" capacitors

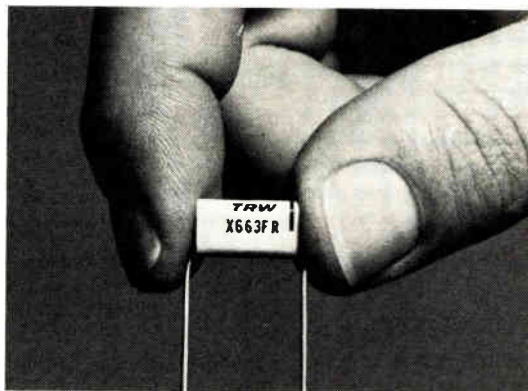

Buy yourself some elbow room—and save some weight in the bargain—with TRW's flat oval, metallized Mylar* capacitors.

This is ultra-miniaturization with *no* compromise on reliability. Capacitances: .01 to 10.0 mfd in 50, 100, 400, 600 vdc. Temp.: -55°C. to 100°C (to 125°C with derating). High IR—30,000 megohm-microfarads minimum; typically much higher. Low DF—usually less than 1.0%. Tolerances to $\pm 1\%$. Self-healing.

With their flat oval design, these metallized Mylar miniatures offer maximum space savings. And for maximum flexibility in assembly, they are available with axial or radial leads—Types X663F and X663FR respectively. Instrument quality, either way.

Write for catalog or application engineering assistance. TRW Capacitors, an Electronic Components Division of TRW, Inc., Box 1000, Ogallala, Neb. 69153. (308) 284-3611.

*Du Pont T.M. for polyester film

TRW CAPACITORS

Still the best and most versatile low-cost multiturn pot available!



THE SPECTROL MODEL 534

Standard, 10-turn, wirewound Model 534 — 100-piece price, \$4.75. Also offered as standard, 5 and 3-turn models. Send for a data sheet, or call for a quote.

Spectrol

SPECTROL ELECTRONICS GROUP

UNITED STATES Spectrol Electronics Corporation 17070 E. Gale Avenue, City of Industry, Calif. 91745, U.S.A. • (213) 964-6565 • TWX (910) 584-1314

UNITED KINGDOM Spectrol Reliance Ltd. Drakes Way, Swindon, Wiltshire, England • Swindon 21351 • TELEX 44692

ITALY SP Elettronica spa Via Carlo Pisacane 7, 20016 Pero (Milan) Italy • 35 30 241 • TELEX: 36091

THE VACUUM TUBE ERA (1905-1948)

TAKING THE CRUCIAL STEP FOR MODERN TECHNOLOGY

- 1905 Albert Einstein states Theory of Relativity— $E = mc^2$.
- 1906 Ernst Alexanderson develops high-frequency alternator.
Lee De Forest adds grid to Fleming valve and produces the first triode vacuum tube.
- 1912 Titanic sinks on maiden voyage.
Harold Arnold and Irving Langmuir both develop high-vacuum tube at different companies.
- 1914 World War I begins.
Lawrence Sperry builds gyropilot.
Reginald Fessenden discovers echo-ranging, a forerunner of radar and sonar.
- 1915 John Carson invents single-sideband transmission.
- 1917 Americans enter World War I.
George Campbell develops wave filter.
- 1920 Pittsburgh's KDKA is first broadcast radio station.
Magnetron invented by Albert Hull.
Albert Armstrong's superheterodyne circuit is forerunner to modern radio receivers.
- 1922 Harald Friis develops first superheterodyne radio receiver.
- 1923 Herbert Ives demonstrates telephotography.
Vladimir Zworykin patents Iconoscope TV camera tube.
- 1924 Lloyd Espenschied shows first radio altimeter.
Edward Appleton and M. F. Barrett measure the Heaviside layer.
- 1925 John B. Johnson explains thermal noise.
TV demonstrated by John L. Baird in England.
- 1926 Radiocompass conceived by Henri Busignies.
- 1927 Charles Lindbergh crosses Atlantic in 37 hours.
Harold S. Black tries negative feedback amplifier for first time.
- 1928 Zworykin demonstrates Kinescope TV tube.
- 1929 Stock market crash on Wall Street.
Coaxial cable developed by Herman Affel and Espenschied.
James K. Clapp and L. M. Hull show first commercial frequency standard.
- 1930 Basic radar patent for pulse-echo direction finding and ranging is granted to Col. William Blair.

An era was dawning that would produce more new technology than was born during the entire history of man until then. Starting with the vacuum tube, the 1905 to 1948 period was to produce radio, television, sound movies, computers, radar, inertial guidance and the transistor. But those are just a few of the highlights.

The world would not have been ready for the post-1948 developments in technology, most of them based on the transistor, if it were not for the work of those who had gone before. Among the important developments of the period were

- 1931 Quantum-mechanic model of solid semiconductor theorized by A. H. Wilson. Oscilloscope produced by Allen DuMont. Waveguide transmission demonstrated by George Southworth. Stroboscope by Harold Edgerton revolutionizes photography.
- 1932 Lindbergh kidnapping. Spectrum analyzer developed by Marcel Wallace.
- 1933 Karl Jansky discovers radio astronomy.
- 1934 Ernest O. Lawrence develops cyclotron.
- 1935 Arnold Beckman's pH-meter is variation on vacuum-tube voltmeter.
- 1937 Arturo Toscanini conducts NBC Symphony. Varian brothers Russell and Sigurd invent klystron. Pulse-code modulation conceived by A. H. Reeves.
- 1938 Constant potential transformer invented by Joseph Sola.
- 1939 World War II begins. Wien bridge audio oscillator patented by William Hewlett. RCA and Bell both develop FM altimeter.
- 1940 Electronic analog computer developed by D. B. Parkinson and C. A. Lovell. Arnold Beckman develops 10-turn helical potentiometer.
- 1941 Pearl Harbor attacked by Japanese. Manhattan Project begins.
- 1942 United Nations founded. Enrico Fermi splits atom.
- 1943 Term "radar" coined by Com. S. M. Tucker. Rudolph Kompfner invents TWT.
- 1944 Howard Aiken builds Automatic Sequence-Controlled Calculator. V-beam developed at MIT Radiation Laboratory.
- 1945 Thermonuclear device tested at Alamogordo, NM. Atom bombs are dropped on Hiroshima and Nagasaki.
- 1946 ENIAC developed by John W. Mauchly and J. Presper Eckert.
- 1947 First fully automatic flight control developed by Bendix and Sperry.
- 1948 Transistor invented by William Shockley, John Bardeen and Walter H. Brattain. Information Theory laid out by Claude Shannon.



Charles Proteus Steinmetz pioneered research in alternating current, artificial lightning, power transmission systems and several other areas while working for General Electric in the early 1900s.

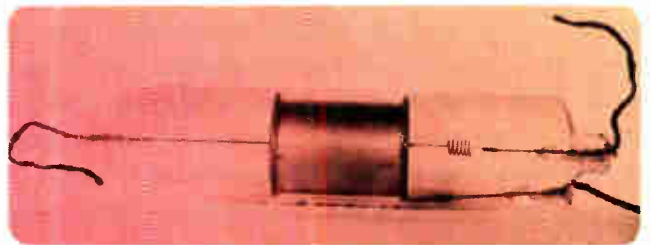

The magnetron, a vacuum tube whose electron current is controlled by a magnetic field, was invented by Albert W. Hull in 1920.

Fleming was working on a glass-enclosed device containing an anode, a cathode and a vacuum. In 1904, he found his device could be used as a rectifier. He called it a valve; Others started to call it a tube.

Times were simple in those days. The Great War was not yet in sight, and the mood of the times was relatively carefree. Neon signs showed up for the first time, and all over America, people were humming and whistling "Meet Me In St. Louis, Louis," written to commemorate the St. Louis Exposition, which had opened the previous year.

While Albert Einstein revolutionized the world of physics with his first Theory of Relativity, a whole new kind of science began to arrive. The publication that heralded it was *Three Treatises on the Theory of Sex*, by Sigmund Freud.

In 1906 Lee De Forest inserted a third element—a grid—into Fleming's valve, and created the triode, which permitted electronic amplification. He noticed that the stream of electrons moved from the filament to the plate at a rate that varied markedly with the charge placed on the grid.

A varying but very weak electric potential on the grid could be converted into a similarly varying but much stronger electron flow in the fila-

Einstein's Theories of Relativity, Bohr's studies of atomic structure, Carson's single-sideband transmission, Alexanderson's high-frequency alternator, Armstrong's superheterodyne circuit, Johnson's analysis of noise and Shannon's information theory.

It started with the tube

In 1903, the Wright brothers' flight at Kitty Hawk, NC, put the world on notice that man was going to reach faraway places easier and faster than before. At the same time, Sir John Ambrose



Ernest F. W. Alexanderson and his family watched the first home demonstration of television in 1929. He developed the broadcasting system based on mechanical scanning disc technology.

ment-plate combination. De Forest called the tube the "Audion." When it was incorporated into Guglielmo Marconi's wireless system, communications could take place over much greater distances.

Much else was happening in 1906. Ernst Alexanderson was developing the high-frequency alternator that was to make world-wide wireless possible. General H.C. Dunwoody had developed a carborundum-crystal detector to replace the coherer in primitive radios, and Greenleaf Pickard demonstrated a silicon-crystal detector.

Radios were becoming available to the general public. In 1906 the first advertisement for a radio appeared in print on Jan. 13, in *Scientific American*. The Electro Importing Co. of New York offered "a complete outfit comprising one-inch spark coil, balls, key, coherer with auto coherer and sounder, 50-ohm relay, 4-cell dry battery, send and catch wires and connections with instructions and drawings. Will work up to one mile." The cost: only \$7.50.

That year San Francisco was destroyed by the great earthquake and fire, and Reginald Fessenden broadcast phonograph music for the first time—from Brant Rock, MA, using a high-frequency alternator.

In 1907, the coherer officially died. Its death knell was sounded by a raft of crystal, magnetic, thermal and electrolytic detectors. In 1908 oil was discovered in the Middle East.

Charles Proteus Steinmetz was working for General Electric in 1909—on arc lamps, artificial lightning and power transmission lines. He had already set down the basic principles of alternating current.

Robert E. Peary caught the imagination of the world that year when he reached the North Pole

for the first time. And Henry Ford made traveling easier in 1909 by introducing the Model "T" automobile. Mass production was on its way.

Wireless continued to make great strides. In 1910 Enrico Caruso and Emmy Destinn sang arias backstage at New York's Metropolitan Opera House and were heard as far away as Bridgeport, CT. The De Forest Radio-Telephone Co. broadcast the concert by means of an arc-transmitter radiophone. Forty years later De Forest remarked: "I used the arc because I had yet to discover that the Audion would oscillate."

Wireless also played its first detective role in 1910 when Captain Kendall of the S. S. Montrose approaching Canada was notified by Scotland Yard that two fugitives, Dr. H. H. Crippen and Ethel le Neve, were on board.

The efficiency of the Audion as an amplifier was vastly increased when the vacuum was improved by Irving Langmuir at General Electric and Harold Arnold at AT&T. In 1912 they both developed high-vacuum tubes—tubes that were also more stable than De Forest's.

That was the year the Titanic sank, and the year Charles Pathé produced his first news film. Igor Stravinsky was busy writing his ballet *Petrouchka*, and major races were being timed electrically for the first time at the Olympic Games at Stockholm.

In 1913 the physics world was startled by Niels Bohr's theories of atomic structure and introduction of the "Bohr atom" model, with electrons spinning in orbits around a nucleus composed of neutrons and protons.

Even more startled were those who viewed "modern art" for the first time at the infamous "Armory Show" of contemporary French painting in New York City. Most viewers were puzzled by the canvases of such artists as Picasso, Matisse, Braque and Marcel Duchamp—whose "Nude Descending a Staircase" undoubtedly evoked the greatest comment.

Wireless and The Great War

The first war where air power meant something took place in 1914 to 1918. The keys to the war effort on both sides were wireless communications to aircraft, and better means of navigation.

In 1914, Lawrence Sperry dramatically introduced his gyropilot to the world demonstrating a hands-off low-level flight of his Curtiss flying boat while his mechanic walked along the wings to show the plane's stability.

Reginald Fessenden presented the theories of echo ranging that were later to be the basis of sonar and radar. And Edward Kleinschmidt invented the teletypewriter that year.

In an attempt to get people's minds off the

war, the movie industry came out with a series of comedies and introduced Charlie Chaplin to the world. And in Providence, RI, Howard P. Lovecraft, the greatest horror-story writer since Poe, wrote his first piece of fiction.

The war got worse in 1915, as London was subjected to the first of many Zeppelin attacks. But science continued. Einstein presented his general theory of relativity; German scientist Walter Schottky further improved on vacuum tubes by developing the screen-grid tube, and the vacuum-tube voltmeter was developed by R. A. Heising to minimize a voltmeter's influence on the circuit it's measuring.

John Carson of AT&T invented single-sideband transmission in 1914 by showing that either side frequency of a modulated carrier could carry as much information as the two sides together. The power and channel space saved made single-sideband an important method of radio communications for years to come.

By then the need for a better voice transducer was evident, so E. C. Wentz invented the condenser microphone.

At the Marconi Wireless Telegraph Company of America a famous memo was written that year by assistant traffic manager David Sarnoff. He proposed a "radio music box," and outlined the future possibilities of public broadcasting as well as its popular appeal. The recommendation was ignored. George Campbell developed the first electrical wave filter in 1917, making communication channels possible, and Ernst Alexanderson got his high-frequency alternator up to 200 kilowatts.

Even as the people in America became tired of hearing about the European war in 1917, the United States began sending its own men into the fray in an effort "to make the world safe for democracy."

World War I ended in 1918. The key technical events of the year were the introduction of H.M. Stoller's electronic voltage regulator and the three-color traffic signals that showed up in New York for the first time anywhere.

Post-war enthusiasm reigns

After the war people started looking for new interests. Amateur broadcasting became popular and Peter Jensen and Edwin Pridham interested the world in stereo by installing their system in a San Francisco nightclub called the "Hoo Hoo House."

A five-piece orchestra on the second floor had microphones attached to each instrument. Each microphone was connected to an individual amplifier that was then connected to a corresponding speaker on the main floor. The speakers were arranged in the same manner as the musicians

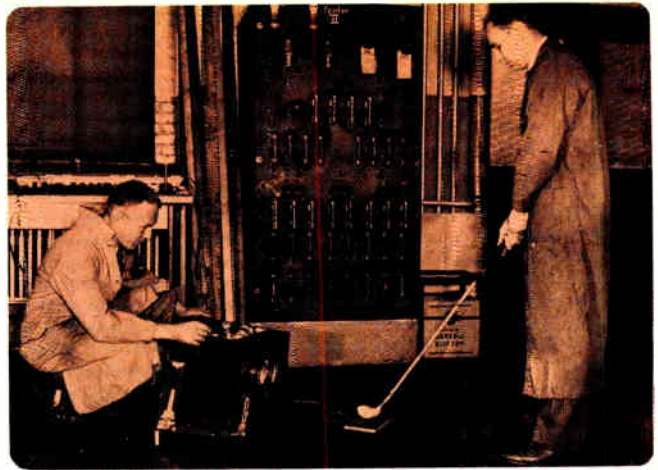

Harold E. Edgerton is about to take a swing at a golf ball. A unique electronic circuit for high-speed photography called the stroboscope is operated by Kenneth Germeshausen to record the event. Edgerton is credited with invention of the device. Germeshausen aided in the design. (Photo courtesy of Massachusetts Institute of Technology.)

and produced a stereophonic effect so startling the audience forgot to dance.

As the "Roaring Twenties" began the N.Y. Yankees had just purchased Babe Ruth from the Red Sox, and Mary Pickford had just married Douglas Fairbanks. In 1920 the League of Nations was formed. Prohibition began, and the world's first broadcast radio station, KDKA in Pittsburgh, started up. Alexanderson greatly improved ac-motor controls and the first radio communication network began, using the Alexanderson high-frequency alternators.

1920 also brought a pair of developments that have had a lasting impact on communications and radar. E. H. Armstrong designed the superheterodyne circuit—the circuit that made modern radio possible, by allowing a simple, tunable receiver that was stable and had high sensitivity.

Albert W. Hull of General Electric designed the magnetron. Magnetrons later became the first efficient source of microwaves and helped make modern radar possible.

The superheterodyne circuit was applied to radio by Harald Friis of Western Electric while he was working in a small shack in Elberon, NJ, in 1922. Also, that year, W. G. Cady built the first piezoelectric-resonator crystal oscillator.

It was becoming apparent that large amounts of capacitance would be needed for certain types of circuits. In the hope of minimizing the space needed for capacitors, H. O. Siegmund developed the electrolytic capacitor in 1921.

Marconi proposed a fairly practical radar system in 1922. He said: "As was first shown by Hertz, electric waves can be completely reflected by conducting bodies. In some of my tests, I have

noticed the effects of reflection and deflection of these waves by metallic objects miles away."

That year RCA put out its first catalog of radio equipment, entitled "Radio Enters The Home." The cheapest receiver listed was a steel box containing a single-circuit tuner and crystal. It sold for \$25.50 with headphones, antenna equipment and full instructions.

More elaborate crystal sets were available at \$32.50 and \$47.50. The most expensive was Westinghouse's "Aeriola Grand." It had four tubes, a regenerative detector and, in addition, four ballast tubes to avoid the use of a filament rheostat. This set sold for \$401. That year RCA's "Radiola II" became the first portable radio.

Television on the way

Although ideas about sending pictures through the air date back many years, the first practical developments leading to television came in 1923, the year Vladimir Zworykin of RCA received a patent for the Iconoscope, the tube that would go into all of the early TV cameras.

He actually had a complete television system operating on 60 hertz and demonstrated a rough test pattern on the face of the cathode ray tube. He also demonstrated the kinescope—the picture tube in the system.

At AT&T Herbert Ives was also interested in sending pictures. In 1923 he invented telephotography—a means of sending pictures over telephone lines.

Lloyd Espenschied's radio altimeter and Louis Hazeltine's tuned-radio-frequency circuit both came in 1924.

Edward Appleton and M. F. Barrett measured the Heaviside Layer of the earth's atmosphere, and coast-to-coast radio was carried over telephone lines for the first time in 1924.

A very practical method of TV was demonstrated in England by John Logie Baird in 1925, who showed it to about 40 members of the Royal Institution on Jan. 26, 1926. In April, 1925 the editor of an English journal visited Baird for a demonstration of the equipment.

"I attended a demonstration of Mr. Baird's apparatus," he later wrote, "and was very favorably impressed with the results. His machinery is, however, astonishingly crude and the apparatus in general is built out of derelict odds and ends. The optical system is composed of lenses out of bicycle lamps. The framework is an unimpressive erection of old sugar boxes and the electrical wiring a nightmare cobweb of improvisations. The outstanding miracle is that he has been able to produce any result at all with the

indifferent material at his disposal."

In 1925 circuit noise was a major problem, and not very well understood. One of the giants of the time, John Bertrand Johnson at Bell Telephone Laboratories, was the first to demonstrate the existence of thermal and other noise effects predicted years before by Schottky. Johnson was then able to define the limits to which communication signals could be amplified usefully. As a result of this work, thermal or white noise is now usually called Johnson noise.

Johnson was a modest man. One day while

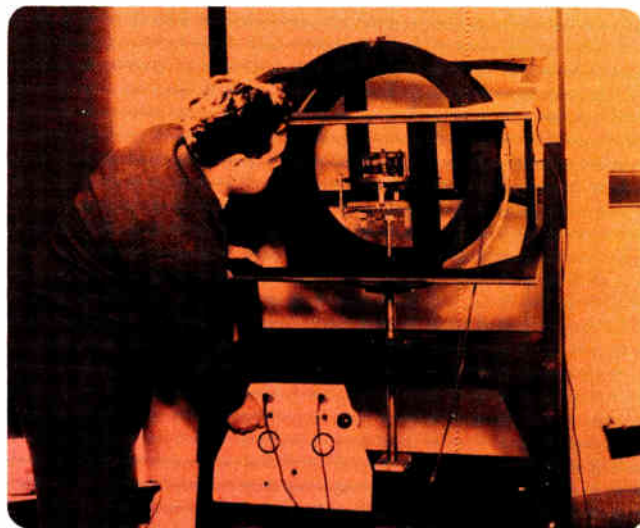

Charles Stark Draper is shown with his compass analyzer. It used two Helmholtz coils and the principles of Draper's gyroscope. This picture was taken about 1935 while Draper was developing inertial navigation. (Photo courtesy of Massachusetts Institute of Technology.)

answering a request for information about himself, he wrote ten short lines in longhand. The sixth line said, "Cleared up fundamental sources of circuit noise in 1925-1930."

1925 also saw Bell Labs license the Orthophonic phonograph to Victor. Clarence Birdseye extended the quick-freezing process to pre-cooked foods; and IBM introduced the first horizontal sorting machine.

Henri Busignies invented the radiocompass while still a student at Jules Ferry College in Versailles, France, in 1926. A related development was the work by H. Lowry of Vienna on using radio to determine the distance to an object. Lowry, who received the basic patent in 1926, called his technique "radio reflection ranging."

In 1927 Charles "Lucky Lindy" Lindbergh flew the Atlantic by himself, from New York to Paris, in 37 hours. Sound motion pictures advanced with

"The Jazz Singer," starring Al Jolson. It was the first movie with synchronized voice.

The first overseas radiotelephone call was sent from New York to London in 1927. The call was placed by Adolph S. Ochs, publisher of the *New York Times* to Geoffrey Dawson, editor of *The Times* of London. Said Ochs: "Who now has the temerity to say that prayers are not heard in Heaven?"

Ives at Bell Labs also demonstrated intercity TV transmission that year. He sent both image and sound on the same frequency band with a single radio transmitter from Whippany, NJ, to New York City.

At the same time, another worker at Bell Labs, Harold S. Black, invented the negative-feedback amplifier. It was used for minimum-distortion amplifiers in communication repeaters and later gave rise to feedback-control systems.

Black got the idea while on his way across the Hudson River by ferry to his laboratory on West St. in New York City. Shortly after, Harold Nyquist developed the Nyquist Diagram, which enabled designers to produce stable feedback circuits.

Five years after showing the first, crude model of a kinescope, Vladimir Zworykin at RCA demonstrated an improved version for viewing TV. This was 1928, the year the selenium rectifier was developed in Germany, the 80-column IBM punched card introduced, and the year Harold Wheeler developed the automatic-volume-control circuit.

The great crash

It was 1929, the year of the great crash on Wall Street. Alexanderson developed a scanning-disc TV broadcasting system; Herman Affel and Lloyd Espenschied developed the first coaxial cable; and James K. Clapp and L. M. Hull designed the first commercial frequency standard, the C21H Harmonic Frequency Standard at General Radio. It put out harmonics of 1, 10 and 50 kilohertz.

That year David Sarnoff went to Zworykin at RCA, convinced of the inevitability and desirability of a television system employing the Iconoscope as its eye. He asked what Zworykin thought the system development might require in facilities and funds.

Zworykin, thinking only in terms of a working laboratory system, estimated optimistically that it might be handled with a couple of rooms and half a dozen men, at a cost of about \$100,000.

What actually happened was a full-blown system development that cost about \$50 million. Sarnoff was later to refer to Zworykin as the

man who made the \$49.9 million mistake.

Although it was kept secret at the time, 1930 brought the patent for America's basic radar system. Col. William R. Blair of the U.S. Army Signal Corps was issued a patent for pulse-echo direction finding and ranging. In 1937, a complete, working radar set based on Blair's principles was demonstrated for the Secretary of War and members of Congress.

1931 was an important year for electronics. A.H. Wilson presented a quantum-mechanics model of a solid semiconductor that has since become fundamental for understanding the behavior of semiconductors. He pictured electrons as waves throughout the solid or crystal lattice.

At certain frequencies there is interference between these waves and the lattice; waves of such frequencies cannot exist in the lattice. From the relation between frequency and energy, certain energies were thus excluded. His model led to the idea of energy bands existing in the solid.

Marcel Wallace at Panoramic Radio Corp. designed the first spectrum analyzer, an automatic scanning receiver with two bands—355 to 555 kilohertz and 25 to 35 megahertz.

Great strides in vacuum tubes were made in 1933. RCA introduced the acorn tube, which operated down to 30 centimeters and laid the foundation for miniature high-frequency tubes in the future. At the same time Westinghouse was developing the ignitron as an efficient high-power rectifier. It was a steel-jacketed, water-cooled tube with a mercury-pool cathode. It ranged from a coffee canister in size, up to that of a two-foot tank, and was widely used during World War II.

Also, in 1933 Henrik Bode did important work with wave filters, General Radio developed the Impedance Bridge, and the first all-star baseball game was held. And on February 10 the Postal Telegraph Co. started to deliver singing telegrams.

Important events in 1934 included the introduction of the Q-meter by Boonton Radio and the development of the cyclotron at Berkeley by Ernest Orlando Lawrence.

Henri Busignies started a project in 1934 that spanned the next few years. He developed an automatic direction finder based on his earlier radiocompass. The new device, used during World War II, was called a High-Frequency Direction Finder or "Huff-Duff." It quickly pinpointed the direction from which a radio transmission was coming.

IBM introduced the first commercially successful electric typewriter in 1935, Robert Watson-Watt built the first practical radar for detecting aircraft and Arnold Beckman developed the pH-

meter to measure the acidity of lemon juice for a friend from Sunkist. He used a null-type slide-wire potentiometer bridge followed by a vacuum-tube voltmeter.

In the summer of 1937 Russell and Sigurd Varian and William Hansen invented the klystron. Hansen had developed cavity resonators, which he called rhumbatrons. The Varian brothers used Hansen's cavities and applied the principle of velocity modulation to come up with the klystron, a high power microwave oscillator that found a use during World War II in airborne radar.

That year A. H. Reeves of ITT suggested pulse code modulation to allow for more bandwidth than was available at the time in communication systems. RCA built the first airborne radar system and the first scanning radar, and Joseph Sola developed the constant-voltage transformer. At Bell Labs, W. P. Mason devised a method for cutting crystals so that they would be virtually unaffected by temperature changes.

1938 saw William Hewlett and David Packard get together in a one-car garage behind Packard's apartment in Palo Alto, CA, to produce a diathermy machine for the Stanford Hospital, a thyatron drive for a telescope and foul-line indicators for bowling alleys.

But the product that really launched the partnership was the 200A Audio Oscillator. The circuit used was unique in applying an amplitude-dependent resistor—an incandescent lamp—as a stabilizing element in the feedback loop of a Wien-bridge RC oscillator; the crackle finish on the cabinets was produced in Mrs. Packard's oven. The cost was \$85.

A presentation, made at an IRE meeting in Los Angeles, was heard by Walt Disney's chief sound engineer, who placed the largest order yet received—for nine units, to be used in connection with three-dimensional sound production in the movie *Fantasia*.

World War II—A revolution in technology

With 1939 came World War II.

On April 20 at the New York World's Fair RCA announced the first public television service. "Now we add sight to sound," said David Sarnoff. "It is with a feeling of humbleness that I come to this moment of announcing the birth in this country of a new art so important in its implications that it is bound to affect all society. . ."

In 1939, RCA announced the orthicon camera tube to replace the iconoscope in TV cameras and NBC broadcast the first televised big-league baseball game. RCA and Bell both developed radio

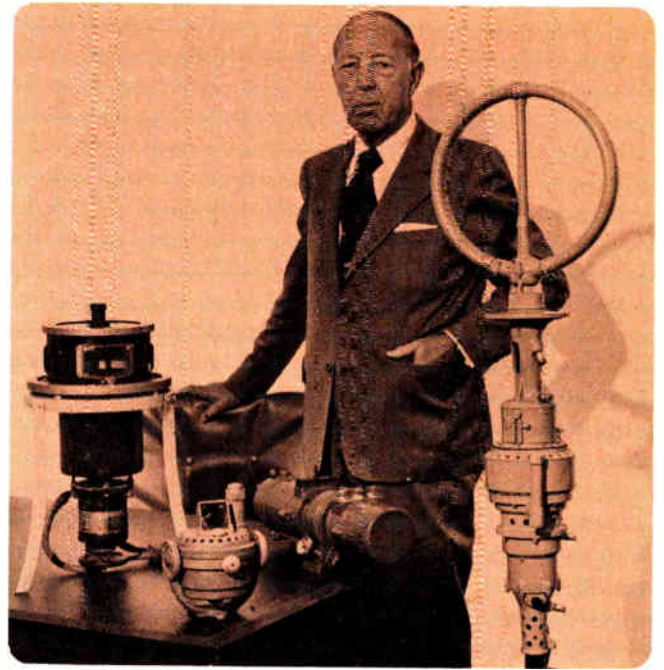

Henri Busignies gives the first model of his automatic direction finder to the Smithsonian. His device, developed in 1936, was an outgrowth of his earlier radiocompass.

altimeters that bounced FM signals off the surface of the earth and used a broadband receiver to track the reflections. To make microwave circuit analysis easier, P. H. Smith developed the Smith Chart for plotting impedance versus frequency.

Henri Busignies developed the moving target indicator for wartime radar. It scrubbed off the radar screen every echo from stationary objects and left only echoes from moving objects, such as aircraft.

During 1940, most of the technological organizations were switching over to develop equipment for the war. Radar research was being pursued at the MIT Radiation Laboratory, Harvard's Radio Research Laboratory, Bell Laboratories, GE, RCA and elsewhere.

The British brought their cavity magnetron from the University of Birmingham to the U.S. where it was given to MIT for radar development. RCA introduced the first commercial electron microscope and TV started carrying a variety of sports for the first time.

In 1940 D. B. Parkinson and C. A. Lovell at Bell Labs conceived the fundamental idea for electronic analog computers. The first application was controlling World War II anti-aircraft guns in the M9 gun director.

Arnold Beckman made a pair of significant developments in 1940. To improve the potentiometer in the pH-meter he invented the 10-turn helical-coil potentiometer, which he named Helipot. He

also developed the quartz ultra-violet spectrophotometer to measure accurately the vitamin A content of shark livers—a problem that arose as a result of wartime vitamin shortages.

Commercial FM broadcasting began on Jan. 1, 1941. That day 25 FM stations opened for business. Commercial TV was authorized on July 1 of the same year by the FCC. 21 stations started right up.

In Chicago and Los Angeles the Manhattan Project was begun to develop an atomic bomb. RCA contributed acoustical depth charges to the war effort and the Sniperscope infrared night-vision device.

On the early morning of Dec. 7, 1941, Private Joseph L. Lockard, just for practice, was scanning the skies off Pearl Harbor with a new radio-detection device. At 7:02 a.m. a swarm of aircraft swam into his detector's range. The detector told him their location, direction of flight and distance; They were offshore about 130 miles. At 7:20 a.m. he reported his findings to a superior officer, who dismissed them as a flight of B-17s expected from San Francisco. At 7:55 a.m. the Japanese Air Force hit Oahu. That was radar—and an historic example of the closed mind in action.

Magnetic tape was invented in 1942, and Chrysler built the first automobiles with alternators replacing dc generators. Selenium rectifiers were used, which turned out to be too large, and they corroded easily. The experiment was dropped for a few years.

In 1943 the term "radar" was coined by Commander S. M. Tucker of the U. S. Navy. And Rudolph Kompfner invented the traveling wave tube in England and RCA developed the image orthicon TV camera tube. Both tubes were used during the war.

The Allied Armies landed in Normandy in 1944, dooming the Nazi movement. V-beam radar emerged from the MIT Radiation Laboratory.

One of the first digital computers was developed in 1944, the Automatic-Sequence-Controlled Calculator invented by Howard Aiken at Harvard and used extensively by the U. S. Navy during the war. It had 78 adding machines and desk calculators all controlled by instructions punched onto a roll of paper tape.

World War II ends

Alamogordo, NM, was rocked in 1945 by the first detonation of a thermonuclear device. On Jan. 9, Gen. MacArthur's promise "I shall return" was fulfilled as American soldiers invaded Luzon in the Philippines. In all, 68,000 men landed.

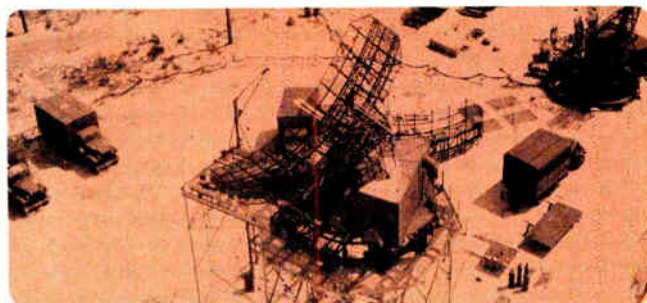

The V-beam radar was one of the most important developments to come out of MIT's Radiation Laboratory during World War II. It was considered the first practical do-everything radar. (Photo courtesy of Massachusetts Institute of Technology.)

On Feb. 23, six members of the Fifth Division of the U.S. Marines planted the American flag atop Mount Suribachi in Iwo Jima. Associated Press photographer Joe Rosenthal recorded the event in the most memorable photograph of World War II.

On Aug. 6, the atomic bomb was dropped on Hiroshima. On Aug. 8, another was dropped on Nagasaki. On Sept. 1 the war in the Pacific ended. Formal signing on board the U. S. S. Missouri in Tokyo Bay of the document of Japanese surrender was described in a world-wide radio broadcast.

In the May, 1946 issue of the *Proceedings of the IRE* Harald Friis finally published his formula for radio transmission in free space—a formula evolved in the thirties. All microwave communication systems are based on this formula.

Since the war was over, RCA and others got back to the business of television. Television's "Model T" was the RCA Victor 630TS. This 10-inch picture-tube set sold for \$375 and was the first postwar TV set to be mass-produced and marketed.

RCA demonstrated the first all-electronic color TV. It used red, blue and green transmitted images which were combined and displayed on a 15 × 20-inch screen. The same year saw the formation of the group at Bell Labs that would invent the transistor.

First amplification of a voice signal by a semiconductor crystal was seen at Bell Labs by John Bardeen, Walter Brattain and William Shockley in December, 1947.

In 1948, the transistor was announced. By that time 600,000 TV receivers were in use and 45 TV stations were on the air. Kinsey issued his revolutionary report on *Sexual Behavior in the Human Male*.

But when Claude Shannon's treatise on information theory was published the nation was at the dawning of a new era. The computer and the transistor were about to burst forth. ■■

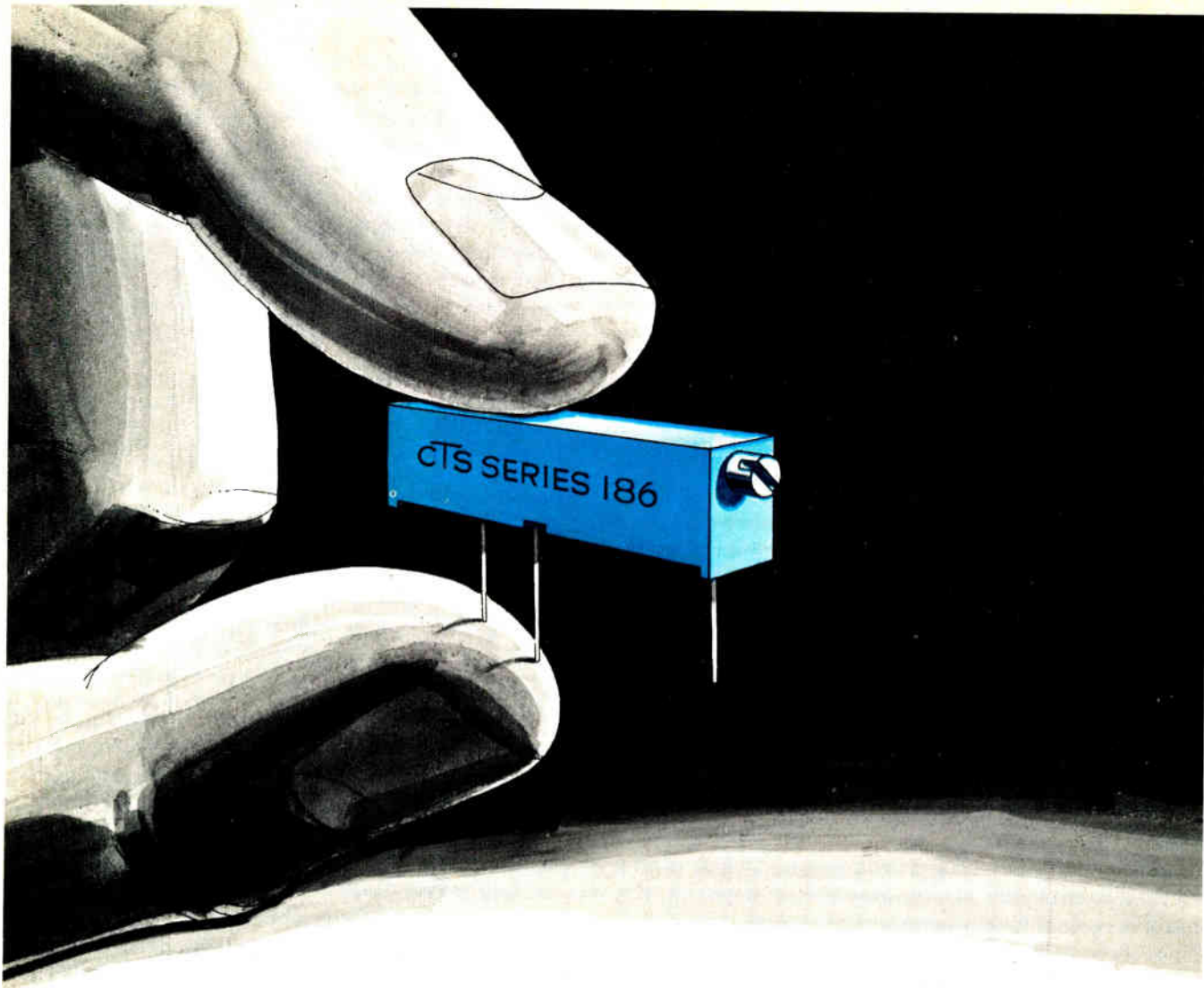

New multiturn trimmer... in low profile design.

From the trimmer specialists at CTS comes the new "low .250" profile"... "low cost" Series 186 cermet trimmer. A *double value* in 17-turn $\frac{3}{4}$ " rectilinear design.

Add to that the low ± 100 ppm/ $^{\circ}$ C standard TC, multipaddle contractor, clutch stops, reliable-stable CTS cermet resistance element and power rating to $\frac{3}{4}$ watt @ 25° C...and you have one super trimmer value!

It's available in two popular pin configurations —.100" and .200" offset side-to-side spacing.

Enjoy greater economy in data processing, communications, instrument or equipment applications by specifying the new CTS Series 186 cermet trimmer. For complete information write **CTS OF WEST LIBERTY, INC.**, 6800 County Road 189, P.O. Box 266, West Liberty, Ohio 43357. Phone (513) 465-3030.

CTS CORPORATION

Elkhart, Indiana

A world leader in cermet and variable resistor technology.



CIRCLE NUMBER 46
WorldRadioHistory

HUGHES

HUGHES AIRCRAFT COMPANY
CONNECTING DEVICES DIV

Today we
supply the spark
for America's
defense.

Connections were much simpler 200 years ago. Torch the fuse and the cannon fired.

Supplying the vital spark that makes a modern weapon system do its job is a lot more complicated.

That's where we come in. For many years, primes and OEMs for military and aerospace products have depended on us to provide the vital links in their electronic systems—flat cable, etched circuitry, connectors, and total interconnection systems.

Our high-rel connections have to be the best. They're used in systems like Phoenix, Maverick, Lance, Minuteman, AWACS, F-14, F-15, Space Shuttle, Viking, Sonobuoy, F-4, A-7, Condor, Standard Missile, F-18, AAH, Cruise Missile, F-8, Trident, Hobo, Sprint and many more.

To learn how we can serve your interconnection needs, contact Jack Maranto or Dave Cianciulli: Hughes Connecting Devices, 17150 Von Karman Ave., Irvine, CA 92714.

Or call (714) 549-5701.



**Hughes
Connecting Devices**

WorldRadioHistory
CIRCLE NUMBER 47

THE TRANSISTOR ERA (1948-1959)

APPROACHING THE AGE OF SPACE EXPLORATION

- 1947 Main Group of Dead Sea Scrolls are found in Palestine.
Edwin Land develops the Polaroid camera.
Charles Yeager breaks the sound barrier while piloting the experimental jet X-1.
John Bardeen, Walter Brattain and William Shockley at Bell Labs develop the first point-contact transistor.
- 1948 Mahatma Gandhi is assassinated in India.
Israel gains independence as British mandate ends.
James Clapp of General Radio designs the Clapp oscillator.
Claude Shannon at Bell Labs delivers paper on information theory.
EDSAC, one of the first stored-program digital computers, is introduced in England.
- 1949 George Orwell's book "1984" is published providing a frightening view of the future.
RCA develops the 45-rpm record and CBS introduces the 33-1/3 LP disc.
John von Neumann introduces his self-propagating-machine concept.
- 1950 Korean conflict heats up.
Jay Wright Forrester of MIT devises the magnetic core memory.
- 1951 U.N. building opens in New York City.
William Pfann at Bell Labs develops zone-refining process for germanium.
- 1952 General Dwight Eisenhower becomes President of the United States.
Jonas Salk starts development of poliomyelitis vaccine at Pittsburgh University.
U.S. explodes first hydrogen bomb.
Bourns develops the trimming potentiometer.
Andrew Kay at Non Linear Systems introduces commercial digital voltmeter.
- 1953 Ian Fleming introduces super spy James Bond in "Casino Royale."
Julius and Ethel Rosenberg executed for conspiracy to commit sabotage.
Korean War ends.
Charles Townes, J.P. Gordon and Herbert

The seeds of development that were planted during World War Two and nourished by urgent military requirements started to flower after the war and produced technological marvels that kept the United States in the forefront of science. Two of the major events include the development of the digital computer and the germanium point-contact transistor. The trillion-dollar economy of many large countries and the landing of men on the moon would not have been possible without these two essential inventions.

The first digital computer evolved from theories put forth by John Mauchly and John Presper Eckert in a proposal to the U.S. Army in 1943, when a machine that could rapidly calculate

- Zeiger of Columbia University develop the maser, a super-low-noise microwave amplifier.
- Tektronix develops the first plug-in oscilloscope.
- 1954 Roger Bannister breaks the four minute mile.
- United States Senator Joseph McCarthy censured by Senate 67 to 22.
- Daryl Chapin, Calvin Fuller and Gerald Pearson at Bell Labs develop the solar battery.
- Texas Instruments introduces commercial silicon junction transistors.
- First consumer transistor radio introduced by Regency.
- Gordon Teal and Ernest Buehler of Bell Labs develop single-crystal silicon.
- 1955 Walt Disney opens Disneyland.
- United States launches atomic submarine Nautilus.
- Arthur Uhlir and A. Bakanowski at Bell Labs develop the varactor diode.
- 1956 Scientists at Los Alamos discover neutrino.
- General Electric creates artificial diamonds and introduces first commercial silicon controlled rectifier.
- 1957 Dr. Albert E. Sabin introduces oral polio vaccine.
- RCA develops FM radio transmitter pill for medical telemetry.
- USSR launches Sputnik, first man-made orbital satellite.
- Burroughs introduces gas-discharge numeric display tube.
- Hughes introduces the storage oscilloscope.
- 1958 U.S. launches Explorer I satellite.
- Texas Instruments and Fairchild announce development of first integrated circuits.
- 1959 Alaska and Hawaii admitted to Union.
- RCA develops the nuvistor vacuum tube, the last small-signal vacuum tube to compete with transistors.
- Lumitron introduces the first commercial sampling scope, invented by Robert Sugarman at Brookhaven National Labs.

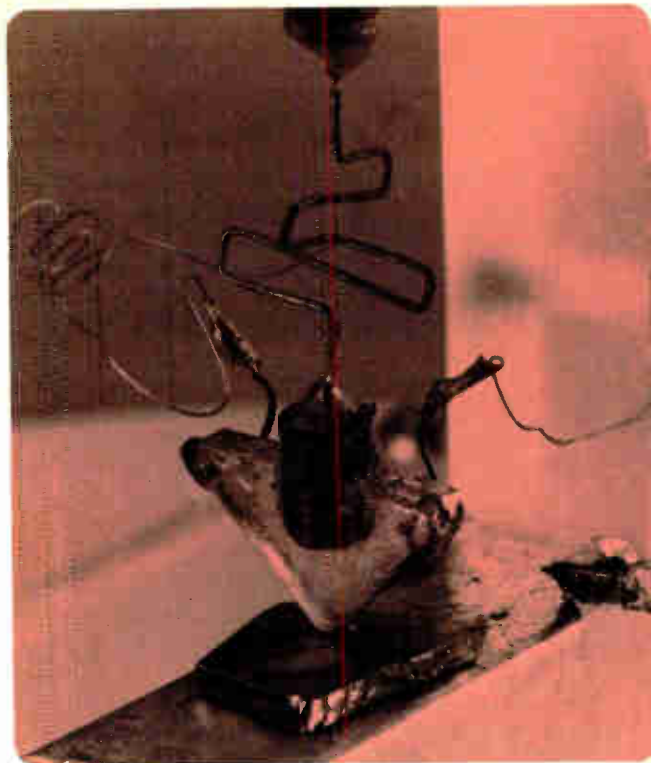

This crude version of the germanium point-contact transistor was developed by the research team of John Bardeen, Walter Brattain and William Shockley at Bell Laboratories in 1948.



In 1949 the 45-rpm phonograph record was developed by RCA, which also developed a fast record changer that connected to TV sets and played the records through the TV amplifier. Today, the 45-rpm disc is still the "pop" recording medium.

ballistic trajectories for large guns was desperately needed. However, it wasn't until 1946 at the University of Pennsylvania that Eckert and Mauchly had a working machine—the ENIAC.

But programming the ENIAC required large wiring panels and was not very flexible; a simple program change could take hours. Later that year John von Neumann, a mathematician who helped develop the atom bomb during World War Two, proposed an electronic computer, which he would eventually help develop, with a memory that would permit stored programs and other internally stored information.

The original ENIAC computer did over 5000 arithmetic calculations per second, weighed over

30 tons, contained more than 18,000 vacuum tubes and consumed 130 kilowatts. Large quantities of tubes, such as ENIAC used, were incorporated into many telecommunications networks being built at that time. But tubes, when grouped in large numbers, are power hungry. Many companies started to look for a low-power alternative.

Beginning the transistor age

Finally, in late 1947, the Bell Laboratories research team of John Bardeen, Walter Brattain and William Shockley succeeded. They developed what was later named the germanium point-con-

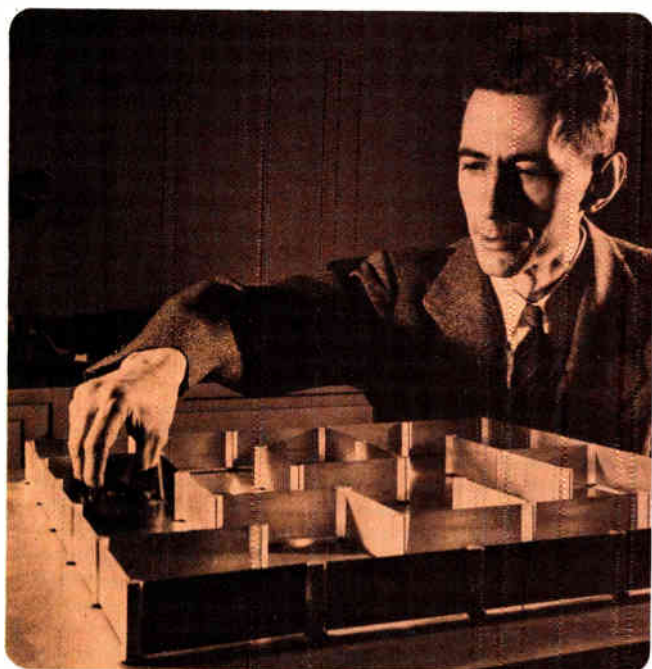

Claude Shannon, founder of information theory, uses an electrical mouse and maze to demonstrate at Bell Laboratories the capability of telephone relays to act as memory elements in communications systems.

tact transistor, considered the beginning of the modern electronics industry. If Edwin Land had been in the building when the team announced their discovery he could have snapped their picture with his new invention—the Polaroid camera.

Actually, the team only “rediscovered” the transistor concept, for back in 1929 an engineer named Julius Lilienfeld patented what today would be called a metal-oxide field-effect transistor.

His discovery faded away in a short time since the materials required to build the device just couldn't be made pure enough, and worse, the money needed for further development wasn't

available because the U.S. was just entering the Great Depression and venture capital for research projects just was not around.

As a result, the semiconductor age started in the late 1940s. Highlights of the day included the breaking of the sound barrier—a feat considered impossible only a few years earlier—by the experimental jet aircraft X-1, piloted by Charles Yeager. While the plane set speed records, Thor Heyerdahl left the shores of Peru in a balsa raft named Kon-Tiki, and headed toward Polynesia to prove a migration theory. At the same time a Bedouin shepherd came across caves in the northwest corner of the Dead Sea in Palestine. Inside he found some of the most important ancient documents ever discovered—the Dead Sea Scrolls—detailing life almost 2000 years ago.

In the following year, 1948, James Clapp, an engineer for the General Radio Co., found a way to make the Colpitts oscillator more stable and extend its tuning range. At that time the Colpitts oscillator was preferred because all the tuning elements were in the grid circuit where no high voltages were present.

The new version, known as the Clapp oscillator or series-tuned Colpitts, added a variable capacitance in series with the tank inductance to permit an increase of 400 times the frequency variation of the conventional Colpitts.

Another invention that year was the carrier frequency voltmeter, designed by Paul Byrne, an engineer for Sierra Electronic Corp. (now a division of Philco). Because it could take noncontacting measurements of power lines this instrument was a great boon to personal safety. The carrier-frequency voltmeter has since been adapted to take measurements in communications applications and wave-analysis research.

At the United States National Bureau of Standards a group of scientists measured atomic time to within 1 part in 20 million by measuring the absorption by molecules of ammonia of radio waves of a certain frequency. Today atomic clocks can be built with accuracies of better than 1 part in 100 billion—an error of only one second every 300 years. These clocks are used as time standards for both the astronomer and the electronic designer, and as frequency standards for many broadcasting stations.

Political events in 1948 included the assassination of India's Mahatma Gandhi and the independence of Israel. The Soviet Union blockaded the western half of Berlin after the city was divided into east and west sectors and the United States set up an airlift from Western Europe to carry in supplies. Harry Truman defeated Thomas Dewey in the race for President; his inauguration the following year, was the first of its kind to be telecast, and had an estimated audience of 10 million as the black-and-white receiver began

to make its way into nearly every American home.

The point-contact transistor developed by Bell Laboratories in late 1947 and announced to the world in 1948 was a delicate device and very hard to produce. The hardest problem was the manufacture of the semiconductor material itself. Germanium was readily available, but it had to be purer than available processing methods could produce in quantity.

Refinements improve transistors

Work was started on refining processes by Jack Scaff and William Pfann at Bell Laboratories. Research at General Electric, RCA and at Bell Labs paid off in an alloying technique that produced commercially feasible transistors. The Czochralski technique of growing large quantities of single crystal germanium was perfected—an absolute necessity if transistors were to be produced in high volume and at low cost.

At Cambridge University, in England, Stanley Gill, David Wheeler and Maurice Wilkes managed to apply some of von Neumann's theories about stored-program machines and developed EDSAC, one of the first stored-program digital computers. IBM (International Business Machines Corp.) introduced its first large-scale digital calculating machine—the selective-sequence electronic calculator. Development work started on machine programming led, in the late 1950s, to the computer language called Fortran.

Phonograph records get slower

The public benefited from many of these laboratory developments. RCA, then called Radio Corporation of America, introduced the 45-rpm phonograph record. Peter Goldmark of the Columbia Broadcasting System developed the 33-1/3 rpm record. Both the 45 and 33-1/3 records have totally replaced the 78-rpm disc and are still in use today—the 45 as the “pop” medium and the 33-1/3 as the primary recording medium for “serious” music.

1984, George Orwell's frightening novel of the future, was published. It described a totalitarian government that used electronics to maintain a watch over every individual, and coined the expression “Big Brother is Watching.”

As the Korean conflict started off the 1950s with a bang the concept of the plug-in circuit module took form and began to speed the production of electronic equipment. It permitted circuits to be assembled in different areas and then simply connected together. Dip soldering, still one of the simplest and fastest soldering methods available, was developed at this time.

Computers were in a constant state of revision, with improvements being made by many dif-

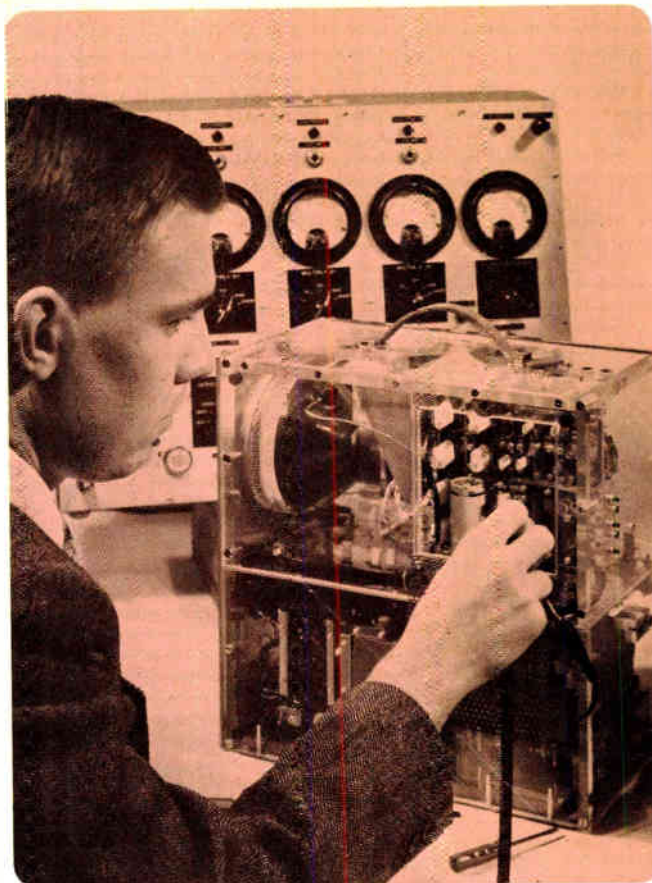

Researcher Gerald Herzog at RCA is shown making some laboratory tests in 1952 on the first all transistorized television set. It contained 37 semiconductors, could receive only a single channel and weighed 27 pounds. Herzog is now a staff vice president at the RCA Solid-State Technology Center.

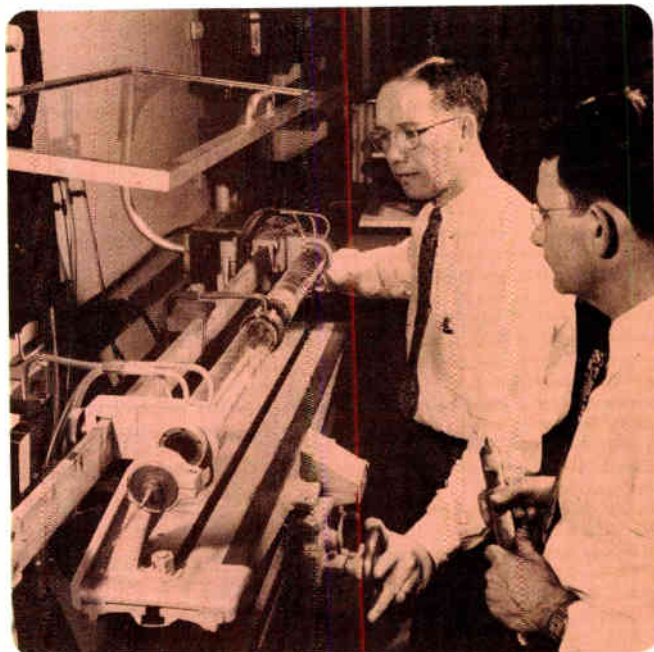

Extremely pure germanium, the key to semiconductors, was developed by this team of William Pfann (left) and Jack Scaff (right) at Bell Laboratories in 1954. The purity of the refined germanium can be likened to one pinch of salt in 35 boxcars filled with sugar.

ferent researchers. For instance, L. R. Harper developed the stepping register (a form of today's shift register), which was adapted and used by IBM.

At the Massachusetts Institute of Technology (MIT) Jay Wright Forrester developed the theory of data storage in small toroidal magnetic cores. Today every large computer system uses such cores for mass storage of data.

At about the same time, scientists at RCA

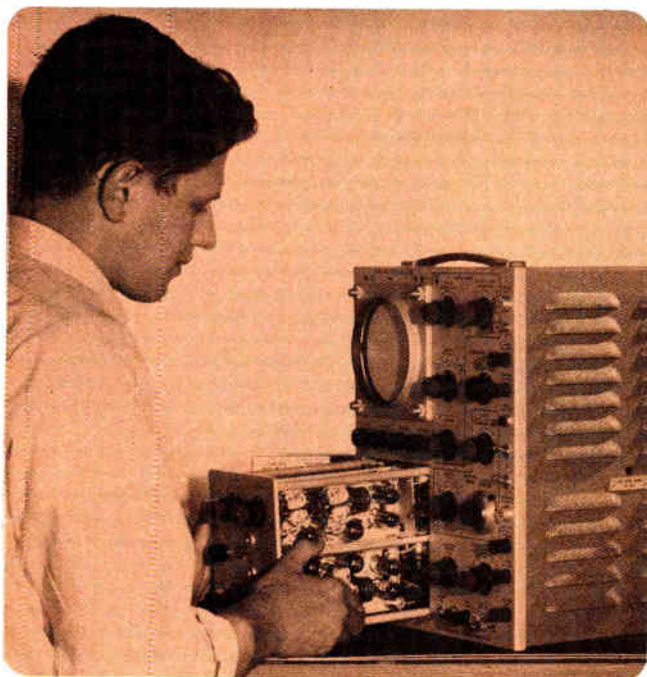

Putting the plug-in amplifier into the Model 535 oscilloscope is Bill Polits, a design engineer for Tektronix in 1954. The concept of the plug-in was first introduced in the Model 531 oscilloscope that was released several months earlier than the 535. Polits is presently a group vice president at Tektronix.

finally developed an electron emission system for reasonably simple and inexpensive multi-gun color picture tubes and color television receivers. Although RCA's all-electronic color television system was not at first accepted by the Federal Communications Commission it is now (with several modifications) the only system in use in the United States.

During their experiments with radioactive elements Glenn Seaborg, Kenneth Street Jr. and Stanley Thompson created elements 97 and 98—californium and berkelium—at the University of California at Berkeley.

Engineers at Berkeley Scientific devised an instrument that could count particles at rates of up to 40,000 per second to measure the quantities of neutrons or other atomic particles bombarding an atom. It used columnar readouts and electronic

decade counters, enabling scientists for the first time to count almost the exact number of particles emitted by a source.

Today the event counter has changed its name to a frequency counter, has accuracies approaching that of oven-controlled crystals, and is used in communications for monitoring frequencies of over 1 gigahertz; in servicing, to set frequencies; and in many other areas.

The junction transistor appears

Along with the promises that zone refining and crystal growing were soon to keep, improved semiconductor devices were starting to appear in the laboratory.

The junction transistor made its appearance as a result of work by Morgan Sparks at Bell Laboratories. It was free of the mechanical problems of the point-contact transistor and was much more rugged. The junction was constructed by heat alloying two "blobs" of indium (one on each side) onto a germanium crystal. The alloying process produced the collector and emitter regions on the crystal; the area in which no alloying occurred served as the base.

The alloy transistor offered the possibility of ultra-low-power operation because just one or two microwatts were needed to power the transistor. Hundreds or even thousands of these transistors could operate from the same power needed to heat the filament of a single vacuum tube.

With transistors on the verge of replacing vacuum tubes, many other advances were making the change a necessity rather than a nicety. The power drain of complex digital and telecommunications systems had to be cut.

Maurice Wilkes, at Cambridge, developed theories of microprogramming so that basic computer operations—such as all the steps needed for storing a number—could be permanently within the machine. Others tried with moderate success to program computers to play chess and other games.

Mauchly and Eckert, originators of ENIAC, the first digital computer, ran into a few legal entanglements with the University of Pennsylvania and in 1951 formed their own company—the Eckert and Mauchly Computer Corp. Under their direction the company produced a general purpose machine, UNIVAC I, that could be used for many scientific and recordkeeping applications. Soon after it was introduced Remington-Rand purchased the firm. It became part of Sperry-Rand in 1955.

In 1952, less than a decade after the A-bomb was used to end World War II, the U.S. exploded an even more powerful weapon—the hydrogen

bomb—on Eniwetok Atoll in the Pacific. In November, General Dwight D. Eisenhower was elected president.

The H-bomb opens up a new era

The same year, at Non Linear Systems, Andrew Kay decided to package the digital voltmeter, an instrument that was part of many ana-

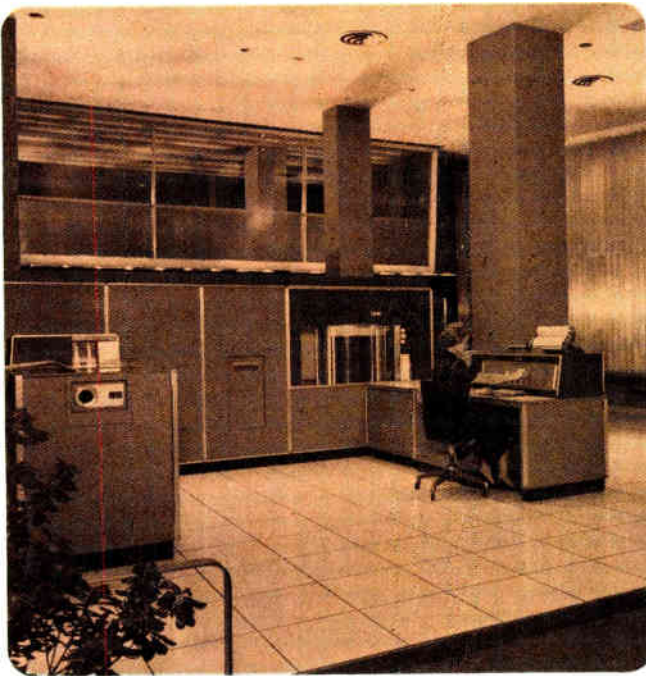

The RAMAC disc operating system, introduced by IBM in 1957, was the first data processing system to use record-like discs to store digital data. Each disc had a storage capacity of about 100,000 characters and could be randomly accessed.

log computers, as a separate instrument. In so doing, he provided the engineer with a tool that increased the accuracy of typical laboratory measurements by more than an order of magnitude over the analog instruments. Kay's digital voltmeter offered 0.01% accuracy and paved the way for digital-readout instruments.

Computer memory circuits and switching systems were undergoing revolutionary changes when Claude Shannon devised an experiment at Bell Labs that showed the memory capabilities of telephone relays. His electronic mouse found its way through a maze the first time by trial and error, and then unerringly repeated the correct path by using relay circuits to remember its mistakes.

With the advent of transistors and transistor-

ized circuitry the large potentiometers used to control voltages and currents were just too bulky. Bourns Corp. saw this and developed a potentiometer designed just for trimming voltages in transistorized circuits. The new device was called the Trimpot and today, in all sizes and shapes, is found in nearly every instrument. RCA probably used the Trimpot in its experimental solid-state (except for the picture tube) TV. The receiver used 37 semiconductor devices, had a five-inch screen and weighed only 27 pounds.

After President Eisenhower took office in 1953, the Korean conflict was finally brought to an end. In the United States, nonstop commercial flights between the east and west coasts were initiated while Elvis Presley and groups like Bill Haley and the Comets started the rock-and-roll era. In England, Ian Fleming introduced his fictional character, James Bond, super spy, in his novel *Casino Royale*.

Ian Fleming's super spy wasn't too far from reality for in 1953 Charles Townes, J. P. Gordon and H. J. Zeigler at Columbia University in New York, developed the beam maser—a device that could amplify microwave signals with light. The main advantage of the maser was its ability to amplify without adding any noise to the signal, since the amplifier could work at temperatures approaching absolute zero. This amplifier was the forerunner of the laser—a coherent light amplifier.

While Columbia developed microwave amplifiers, Tektronix developed a series of plug-in amplifiers for its oscilloscopes. The plug-in amplifiers for its Model 531 oscilloscope revolutionized the test-equipment industry by making it possible to change the input characteristics of an instrument just by plugging in different low-cost amplifiers. Many companies have adopted this technique to offer high versatility instruments.

Until 1954 many companies had been striving to perfect the germanium transistor. In the process, the team of Gordon Teal and Ernest Buehler at Bell Labs perfected a method of growing single-crystal silicon. This development, combined with the ground work done by William Pfann in creating the material-purification process known as zone refining, laid the foundation for today's multibillion-dollar semiconductor industry.

Silicon transistors—a step forward

Texas Instruments, building on the work of Calvin Fuller of Bell Labs, introduced the first silicon transistors in 1954. Fuller developed the process of diffusing impurities into the surface

of a silicon wafer, paving the way for the development of the integrated circuit, which was announced a few years later by TI.

The first consumer products that contained transistors appeared on the market between 1952 and 1954. A transistorized hearing aid and a four-transistor radio were two of the first.

William Shockley extended his original two-junction transistor with three and four-junction devices. His theories were put to use by Gerald Pearson at Bell Laboratories in 1954, in the development of thyristors.

Different types of power sources were also be-

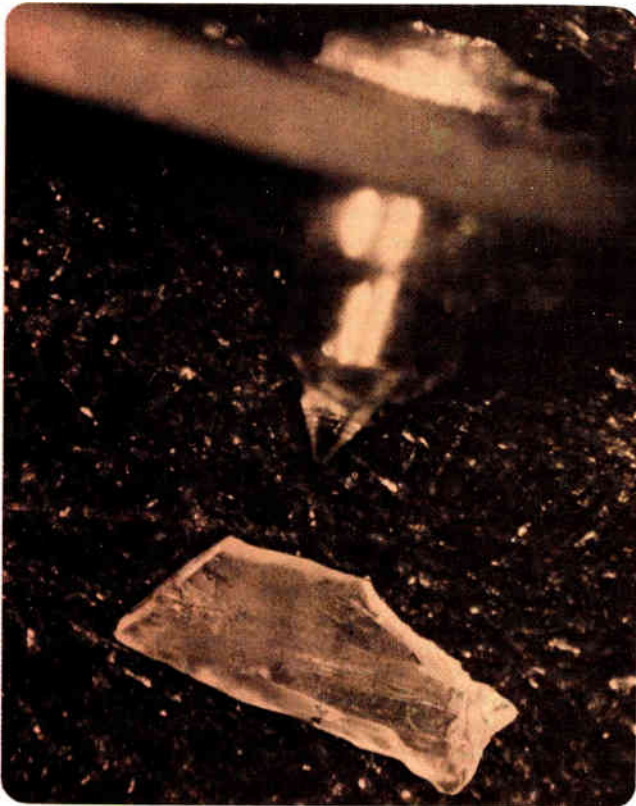

The first man-made diamonds, produced by General Electric's Dr. Herbert Strong in 1955, were only about 1/16 of an inch long. This photo shows a diamond just below a "standard" high-fidelity phonograph needle.

ing sought by these comparatively low-power-drain appliances. At Bell Labs, for example, Fuller, Daryl Chapin and Gerald Pearson developed the silicon solar battery—the first usable source of solar-generated electricity. At first it could barely supply enough energy for a small transistor radio, but a few years later was powering satellites and space probes to the farthest reaches of the solar system.

The first years of the transistor era had not particularly affected tube manufacturers. Transistors were very expensive and at high frequencies they were still quite limited in power-hand-

ling capability. In 1954 the highest rated transistor could handle about seven watts at a frequency of 5000 hertz. To boost the capabilities of the transistor, N. H. Fletcher, an engineer at Transistor Products, reshaped the emitter and base patterns into finger-like interwoven structures in a process that soon became known as interdigitation. This pattern is still used in almost every high-frequency power transistor made.

After Fletcher's developments transistors started to threaten some tube applications and the vacuum-tube industry began to fight back. Sylvania, using ceramic insulators instead of mica, developed the stacked vacuum tube to produce greater ruggedness than had previously been available.

It still had a filament, though, and as transistors improved in performance, the stacked tube fell by the wayside.

One of the earliest commercial products to evolve from the development of single-crystal silicon was the zener diode, originally manufactured by National Fabricated Products. The zener diode was the first solid-state voltage-regulating element.

Nuclear-powered submarines surface

The first nuclear-powered submarine, the Nautilus, was launched in 1955, the same year Walt Disney opened the world's first "theme" amusement park, Disneyland. The park made extensive use of technological developments in robotics and animation, as well as sound production and transmission.

The homemaker benefited from developments too; 1955 was the year Tappan introduced an electronic oven with a magnetron tube generating high levels of microwave energy to cook food.

Mucon Corp. and Bell Labs developed the voltage-variable capacitor—actually a diode that changes its reverse-biased capacitance value in proportion to changes in impressed voltage. Both companies opened the way for electronic tuning—with no moving parts—in radios and TVs.

The automobile industry also capitalized on the electronics windfall and in the mid-1950s introduced "hybrid" car radios in which tubes were used in the low-power stages, and germanium power transistors were used for the audio output.

Competition for the vast consumer market spurred companies to produce new products. In 1956 Bell & Howell introduced the all-electronic movie camera with a photocell-controlled iris, and TV set manufacturers started to add such convenience features as remote control. Bell Labs demonstrated the feasibility of the TV telephone. General Electric used a pressure of 150,000 atmospheres to produce small artificial diamonds—typically less than 1/16 of an inch long. These

diamonds were suitable only for industrial grinding and machine use. Today, companies have managed to produce stones that weigh nearly 20 carats.

GE also commercialized the silicon-controlled rectifier originally proposed by Shockley. It provided a fast, solid-state alternative to the power-consuming electromechanical relays needed to control large currents. SCRs are now found in everything from small appliances to power-generating plants and the most advanced satellites.

Russia startles the world with Sputnik

In 1957 Russia startled the world when it launched the first man-made orbital satellite—Sputnik. The United States was caught short, its space program was hardly off the ground.

Sputnik was followed in short order by another capsule from Russia that contained the first living space traveller, Laika—a Husky. The United States rallied, and in 1958 launched its own orbital satellite, Explorer I. These events led to manned landings on the moon and to probes sending back data from Venus, Mars, Jupiter and beyond.

What made these probes possible was the effort that many companies contributed to make the necessary equipment lighter, more precise and more efficient.

Burroughs Corp., for example, developed the gas-discharge numerical-readout tube—the Nixie. Until the late 1960s this display had almost no competition. Today, light emitting diode, incandescent, liquid-crystal and gas-discharge displays compete vigorously for many of the same applications.

In 1957 Hughes Aircraft developed the storage oscilloscope. Since it could capture a waveform and store the information indefinitely on the screen of a special cathode-ray tube, it was a great boon for analog waveform analysis.

In the same period, U. Gianola of Bell Labs developed the plated-wire memory. At IBM, large rotating discs were used for the first time to make a random-access memory capable of storing up to five million characters. This system, called RAMAC, was used with the Model 305 computer to provide huge amounts of on-line data storage.

About the same time, RCA unveiled an FM-radio transmitter small enough to be swallowed by a patient that made possible body measurements while the patient was moving around. Today's astronauts use modern versions of these pills to help send data back to earth.

Texas Instruments and Fairchild Corp. announced their development of integrated circuits in late 1958. The circuits were crude—they contained several transistors, a few resistors and

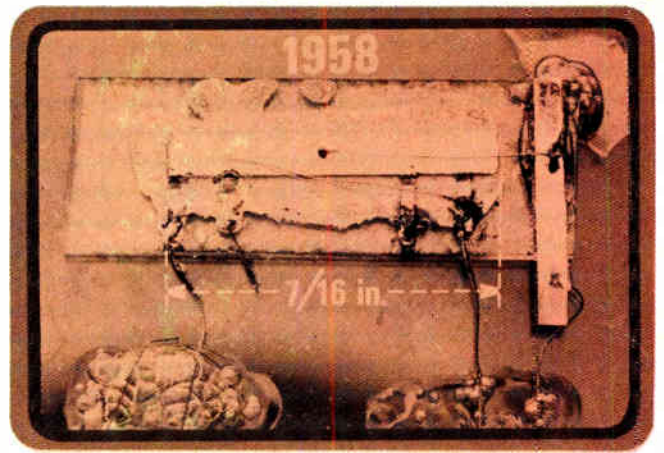

The first integrated circuit, developed by Jack Kilby at Texas Instruments, paved the way for today's pocket-sized computers and for men travelling to the moon.

some capacitors—compared with the ten thousand or so transistors now possible on a single silicon chip.

General Electric and Crystalonics introduced commercial field-effect transistors in 1958 as an outgrowth of theories put forth by Shockley in the early 1950s. Stereo phonograph recordings were starting to appear by then and even some radio stations were broadcasting music over two channels.

In the last year of the 1950s, both Alaska and Hawaii were admitted to the United States and a giant quiz scandal erupted over the television show "The \$64,000 Question." With RCA's introduction of the nuvistor vacuum tube, 1959 heralded the last attempts of tube manufacturers to hold onto a major portion of the small-signal amplification market. The nuvistor was a thimble-sized tube that offered high reliability and low power operation.

And at Brookhaven National Laboratories Dr. Robert Sugarman developed the sampling oscilloscope. In 1959 it was the only instrument that could display repetitive waveforms of frequencies above 1 gigahertz. It was first commercialized by Lumitron (now defunct) and is presently available in the same basic form from several companies.

Developments announced earlier by Texas Instruments and Fairchild had marked the beginning of the era of the integrated circuit. Within a few years the complexity of the circuits had grown so that entire systems could be economically placed onto a single quarter-inch-square silicon chip.

The space age was also beginning—with orbital satellites and attempts to get close-up pictures of the moon. When we looked at those attempts then, we marveled at them. And yet, on July 4, 1976 we will land an automated probe on the surface of the planet Mars. ■■

The Ten Most WANTED INSTRUMENTS

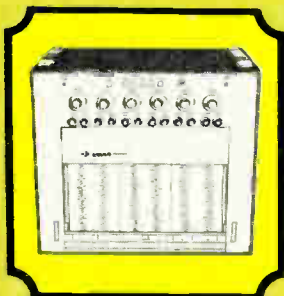

Brush Oscillograph 260

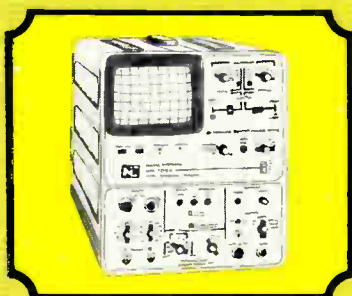

Nicolet
Digital Storage Oscilloscope



Hewlett-Packard 5302 A



Data Research
Transient Voltage Recorder

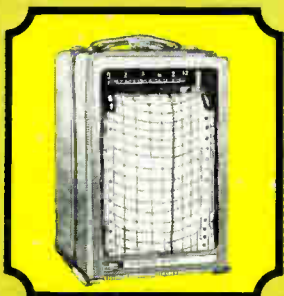

Esterline Angus Chart Recorder

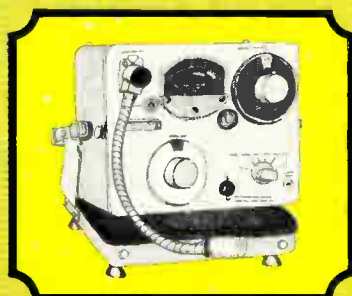

General Radio
Sound Level Analyzer

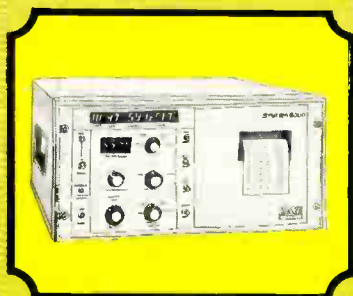

Kaye Data Acquisition System



Tektronix Oscilloscope



GE Chart Recorder

RENT'EM FROM GE

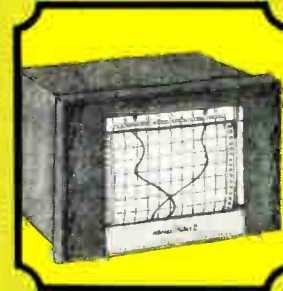

Texas Instruments
Temperature Recorder

What's at the top of your Most Wanted List? Quick • rental instruments has rounded up over 5,000 different instruments from all the manufacturers. Our 100 Sales/Service Centers are major-city located, coast-to-coast. And we'll ship

your instruments on the day you call, calibrated to the manufacturer's specs.

Short or long term rentals...money-savers when you want instruments. Want more information? Call 518-372-9900 collect.

Quick-rental*
instruments

GENERAL  ELECTRIC

*Trademark General Electric



A whole new crop of trimmers to pick from.

Mature, fully developed, and at their peak. It's our family of ceramic trimmers.

All of them offer good stability, a variety of capacitance ranges, ceramic stators, linear tuning, and a precision rotor.

Our Micro-J Capacitor is the Cadillac of the group, and features high performance, monolithic design, and horizontal and vertical PC and stripline mounts.

Our Micro-K Capacitor is the newest member of the family. Tiny enough for quartz watches. And it has a precision lapped titanate stator and finely machined brass rotor.

Our 10mm model is low cost and mounts interchangeably with similar ceramic disc trimmers.

The 5mm type is even less expensive and can be used in the same applications as monolithic types where maximum stability isn't required.

Just send in the coupon for more information about our newest crop of trimmers. We think they're ripe for the times.

E. F. Johnson Co./ED 9/Waseca, MN 56093

Please send me technical information.

I desire test samples. Please call me at

()

Area Code

Name _____

Title _____

Firm _____

Address _____

City _____ State _____ Zip _____



E. F. JOHNSON COMPANY
WASECA, MINNESOTA 56093

THE INTEGRATED CIRCUIT ERA (1959-1975)

COMPRESSING THE WORLD OF ELECTRONICS

- 1959 Fidel Castro assumes power in Cuba. Cold-cathode vacuum tube emerges from Tung-Sol.
- 1960 Kennedy wins close Presidential election over Nixon. Theodore Maiman develops ruby laser at Hughes Research Labs.
- 1961 Soviet astronaut becomes first human space traveler. Atlas computer, the world's largest, installed. It aids in atomic research and weather forecasting.
- 1962 Soviet missiles forced out of Cuba. Signetics introduces diode-transistor logic.
- 1963 Assassin kills President Kennedy. IBM's John Gunn develops active diode.
- 1964 Mainland China tests atomic bomb. RCA builds overlay-geometry radio-frequency transistor.
- 1965 Electric power failure blacks out north-eastern US.

The Kennedy-Nixon Presidential campaign of 1960 brought forth an unlikely issue: American science and technology. The Russians had beaten the United States to space with their Sputnik satellite, and many felt the Russians had even more guided missiles than did the U.S.

The years ahead would show the "missile gap" to be illusory, though the arms race would continue. By the end of the decade, American astronaut Neil Armstrong had set foot on the moon, a staggering achievement made possible by breakthroughs in electronics and other fields throughout the sixties. In fact, the next 15 years would teem with great discoveries in fields as diverse as microelectronics and microbiology.

While human life was being transported to the earth's nearest neighbor in space, scientists probing the mysteries of the living cell isolated the basic particle of life itself. And South African surgeon Christiaan Barnard shows that a man could survive with another man's heart, thereby raising hopes that organ transplants would one day cure patients once considered incurable.

Integrated circuits, spawned in the 1950s, dominated the '60s as much as transistors ruled the previous decade. ICs found their way into missiles, computers, electronic instruments, communications equipment and consumer products. The tiny, ever-more-complex circuits made possible systems that were smaller, cheaper and more reliable than before.

Further, steady and dramatic advances in IC complexity and fabrication led directly to "com-

- 1966 **Impatt diode emerges from Bell Labs.**
US begins Medicare program.
Andrew H. Bobeck announces development of magnetic-bubble devices.
- 1967 **Christiaan Barnard performs first successful heart transplant.**
Motorola introduces plastic-packaged silicon power transistors.
- 1968 **Assassins kill Sen. Robert Kennedy and civil-rights leader Martin Luther King.**
RCA introduces COS/MOS.
- 1969 **Neil Armstrong sets foot on the moon.**
IBM reports development of cache memory using bipolar storage integrated circuits.
- 1970 **Thor Heyerdahl crosses Atlantic in frail papyrus boat like one that could have been used by ancient Egyptians.**
Bell Labs' Willard Boyle and George Smith develop charge-coupled devices.
- 1971 **UN grants membership to mainland China.**
Intel introduces microprocessors.

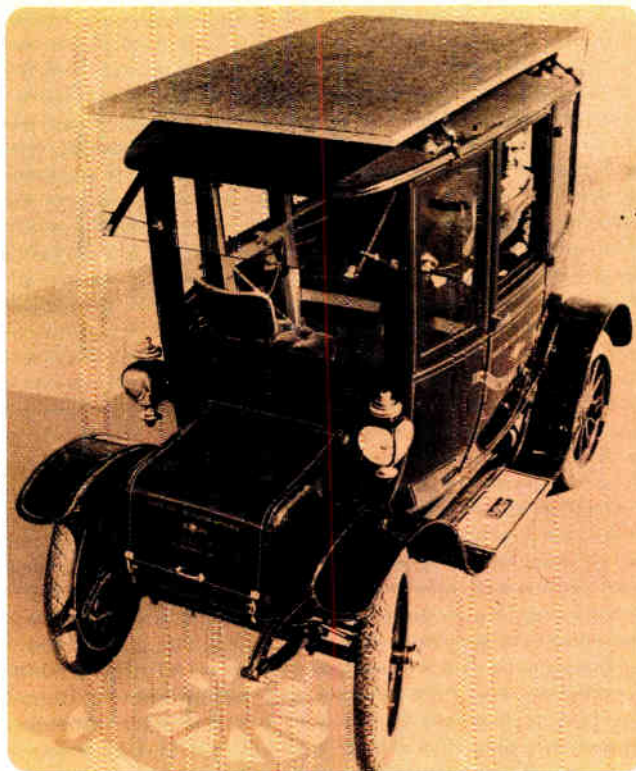

Long before energy conservation became a burning issue, International Rectifier in 1959 built a solar-cell energy source for autos and mounted the source on a 1912 Baker Electric. The solar cells put out about 200 watts.

puters on a chip" (microprocessors) in the 1970s, which were as much an advance over conventional ICs as ICs were over transistors.

But if the 1960s proved the best of times for science and technology, they were anything but that for the country's political and social institutions. Upheavals of one sort or another seemed to be the new way of life. President John F. Kennedy, his brother Robert, and black activist Martin Luther King were all assassinated. Parents acquired a new fear, that their children might succumb to the growing incidence of drug use. The war in Vietnam expanded throughout Southeast Asia as protests increased on campus and elsewhere.

Enter the IC era

Against this unsettling background, engineers and scientists strove to establish new frontiers of knowledge. By the late 1950s, the key techniques that would be used for the fabrication of ICs had been developed for transistors.

A young, Dallas-based company, Texas Instruments, successfully replaced germanium with silicon as the transistor's semiconductor material, thereby extending operating temperatures to military ranges.

About the same time, Bell Laboratories developed oxide masking and diffusion. These techniques led to improved quality control and reduced manufacturing costs.

The crucial next step was embarked on at

Fairchild and Texas Instruments. Engineers at both companies sought to produce, on a single chip of silicon, not only transistors and diodes, but also resistors and capacitors—and then join the components to form a complete circuit.

The special properties of the circuit elements were to be achieved by selectively diffusing traces of impurities into the silicon or oxidizing them to silicon dioxide. By the use of photolithography, selected regions of silicon would be exposed while other regions would be protected.

At first, TI used fine wires for bonding the various elements into a functional circuit. At Fairchild, engineers achieved the same result simply by evaporating a thin film of aluminum over the circuit elements and etching it selectively to leave a two-dimensional network. The Fairchild technique produced what became known as planar integrated circuits.

Fairchild invented the planar process in 1960 for the production of transistors. When it was found that passive components could be incorporated as easily as active devices, the process spread quickly to ICs. Two years later, Fairchild reached another milestone by producing the metal-oxide-semiconductor (MOS) transistor.

The first monolithic integrated circuit was built in 1958 at Texas Instruments. J.S. Kilby constructed a phase-shift oscillator from a single silicon bar. The device required no interconnections between one component and another; the

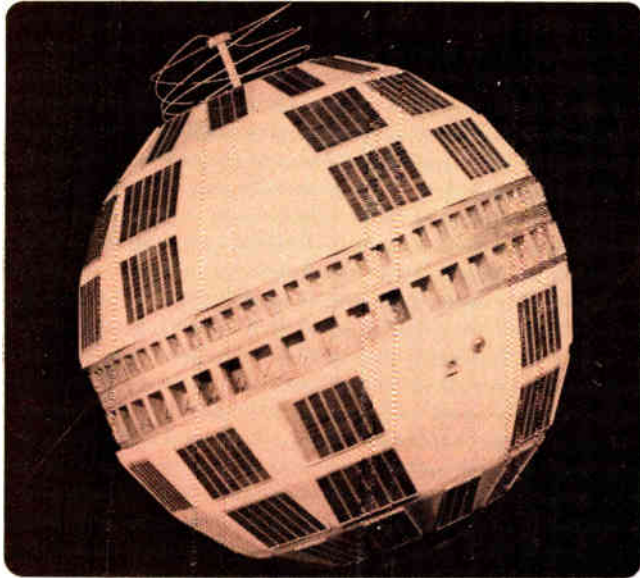

Telstar, the first active communications satellite, was also the first privately owned satellite. Its construction and launch in 1962 were financed by AT&T. The 170-lb satellite marked the first international attempt to transmit TV pictures and sound by use of an active-repeater station in space.

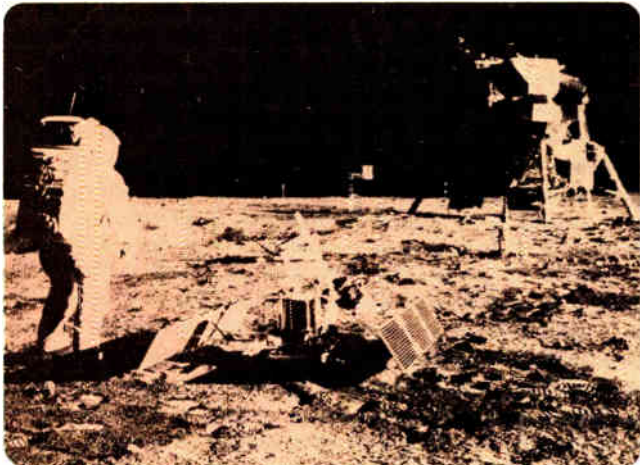

July 20, 1969: Apollo-11 astronauts land on the moon. Neil Armstrong and Edwin Aldrin spent a day there, while Michael Collins circled the moon in a command module. The successful landing and return from earth's nearest neighbor in space culminated a decade of breakthroughs in electronics.

electrical path was through the silicon. TI was also the first company to announce a product line of ICs. Called Solid Circuit Series 51, the initial offering in 1960 consisted of simple logic circuits.

Meanwhile Bell Labs developed the epitaxial process. With this important tool, junctions could be formed economically in production by growing one crystal structure on another. The technique rapidly became a mainstay of transistor and IC fabrication.

The birth-control pill wasn't the only inven-

tion to draw widespread attention at the start of the decade. Another was spawned in July, 1960, when Theodore H. Maiman at Hughes Research Labs reached the end of his tenacious efforts. Following a path of research that differed markedly from that of his colleagues, Maiman at long last obtained emission from an "optical maser"—better known as a laser—made from a ruby crystal. The emission was obtained by pumping the ruby with a pulsed mercury arc.

The invention of this spectacular electro-optic device touched off a frenetic laser-development race. By March, 1961—one month before the collapse of the invasion of Cuba by exiles at the Bay of Pigs—six different types of lasers were in use. Ruby lasers were operating at Hughes, Bell Labs, Raytheon and other plants; IBM had developed calcium-fluoride lasers; and Bell had also produced the first continuous-wave helium-neon gas-discharge laser, pumped by a 28-megahertz source.

Rapidly growing knowledge of the physics of semiconductor and other materials, triggered by the transistor, led to a solid-state laser, one that would work if current was simply passed through it. By the time of the Cuban missile crisis of October, 1962, such a solid-state laser had been developed independently at GE Research Labs and IBM Research Lab.

In the same year, the laser properties of gallium arsenide were verified by RCA and others. An important by-product of these studies would be the development of light-emitting diodes, or LEDs. Now available in yellow, green and red, LEDs were first introduced commercially, only in red, in 1968.

The government contributes heavily

A major factor in the rapid development of new devices was the heavy support and financial backing of space and military agencies. In the fifties the American military, seeing the value of Bell Labs' transistor, awarded contracts for its continued development. Significantly, the military did not classify the new device in order to let everyone explore its uses. Similar support in the years ahead would accelerate the development of integrated circuits.

A direct beneficiary of these efforts was NASA's space program. Giant strides were made with each successive manned spacecraft. Mercury, for example, flew in 1961 without an on-board computer. Gemini had one with about 4000 (4-k) words of memory. Apollo—whose eleventh mission was the 1969 moon landing—had a 32-k-memory computer both in the command and lunar modules. The latter even had a backup computer with 4-k memory.

NASA ushered in a new era in communica-

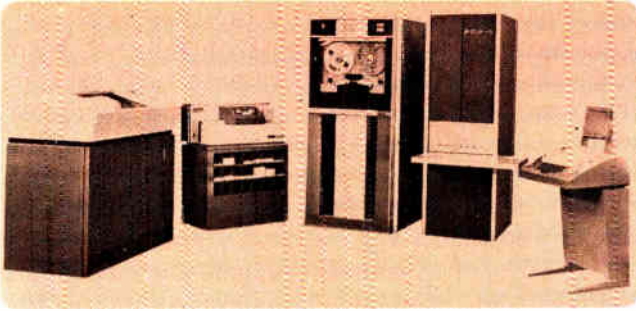

The first commercial minicomputer, a 12-bit machine with 1-k of memory, was introduced by Digital Equipment Corp. in 1963 as the PDP-5. It sold for \$27,000.



A computer the size of a two-drawer file cabinet, the PDP-8 became popularly known as a minicomputer. When Digital Equipment Corp. offered it in 1965, the mini cost \$9000 less than its less powerful and larger predecessor, the PDP-5.

tions with the first use of artificial satellites as relay stations. In August, 1960, the space agency orbited Echo I, a 100-ft sphere of aluminized Mylar plastic. On the very day of the launch—August 12—the first two-way-radio voice transmission was accomplished via the artificial satellite. Three days later the first transcontinental telephone call via satellite was made from New Jersey to California.

The first active communications satellite, Telstar, was launched by a Thor-Delta rocket almost two years later, on July 10, 1962—five months after John Glenn became the first American to orbit space. Telstar settled into a nearly perfect orbit, in which the satellite appeared to hover over the same spot. That night the first telephone call, television program and photofacsimile transmission were relayed to and from the satellite. For the next few weeks technical firsts filled the air as Telstar relayed telephone conversations and color and black-and-white TV signals.

Telstar may well have become the most well-known satellite. A song of the day, entitled appropriately enough "Telstar," recorded twice by the Tornados and the Ventures, became an international hit.

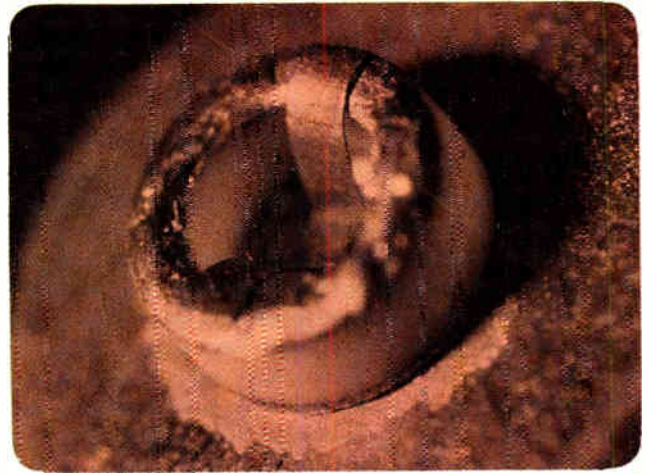

A solid-state device could oscillate at microwave frequencies. The unexpected development was discovered in 1963 by IBM's John Gunn, whose work led to the active diode that bears his name.

A series of communication satellites followed, beginning with Early Bird (Intelsat I) in 1965 and ending with Intelsat IV just five years ago. The result was a system of synchronous-orbit satellites and the realization of a dream: communications coverage between any two points on the globe.

Computers and instruments evolve rapidly

In the private sector, computers and instruments moved rapidly to embrace the fruits of the latest technologies. Computers moved up from vacuum tubes and transistors to so-called third-generation machines—which used microelectronic components—and gave birth to a new class—minicomputers. The touch of solid state in instruments led to drastic reductions in size and weight that allowed increased circuit density within a steadily shrinking package.

In April, 1964, IBM introduced its System 360 series. Intended as replacements for all existing IBM computer series, the 360 standardized such characteristics as instruction and character codes, units of information and modes of arithmetic. IBM developed a hybrid technology called Solid Logic Technology for the System 360. Many features of the series have since been accepted as the industry standard.

Shortly after the 360 was introduced, RCA announced a similar series, the Spectra 70, which used monolithic ICs rather than hybrids. RCA, has since dropped out of the computer business, as has General Electric, another firm that tried unsuccessfully to tackle IBM.

One year before the arrival of third-generation machines, a small Maynard, MA, company that had started in the late fifties selling logic-circuit modules came out with a parallel-data processor

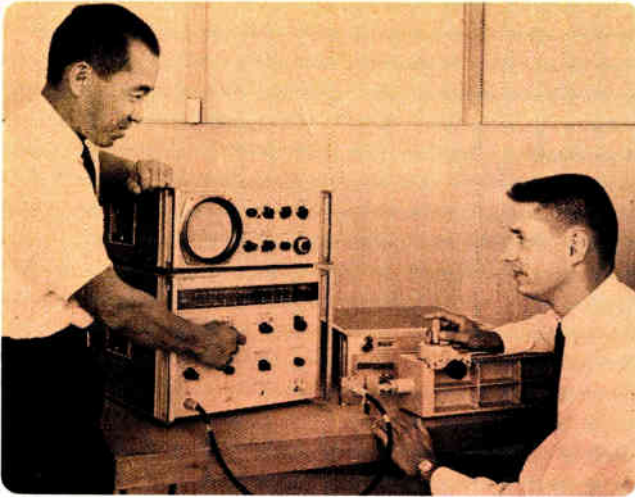

A 1964 microwave spectrum analyzer came with all basic functions fully calibrated. Hewlett-Packard developers Arthur Fong (left) and Harvey Halverson produced a unit with a 2-GHz bandwidth from 10 MHz to 40 GHz, and helped establish HP as an important supplier of spectrum analyzers.

called the PDP-5. Digital Equipment Corp.'s 1963 entry—the first “mini”—had a 12-bit word length and contained 1-k of memory. It sold for \$27,000—expensive by today's standards, but not compared with competitive machines then.

Two years later the company introduced the PDP-8, which was more powerful than the earlier model and cost only \$18,000. With a size approximating that of a two-drawer legal file cabinet, it was the first machine popularly called a mini-computer. The PDP-8 was widely imitated because it was nearly as powerful as much larger computers costing several times more, and within a few years had given rise to an entire industry.

New kinds of instruments appear

Different kinds of instruments also began to appear. A new signal source—the function generator—was unveiled by Hewlett-Packard in the late fifties. The vacuum-tube instrument was intended as the source for process-control systems and low-frequency mechanical vibrators and for testing servo-mechanisms. It covered a range of 1200 hertz down to several millihertz, but the 50 pound unit never caught on.

It was not until late 1961, when a new company called Wavetek introduced the solid-state Model 101, that function generators took hold. They have since evolved into general-purpose signal sources that can provide square waves, triangles, ramps and pulses, as well as sinusoids, over the entire range from a microhertz to 20 megahertz and higher.

The standard signal generator confronted another competitor in 1964 when HP unveiled its 5100A frequency synthesizer. The unit employed

over 2000 discrete semiconductors to provide frequencies to 50 MHz in 0.1-hertz increments. Four years later the signal generator struck back in the form of Logimetrics' 900 series, a generator with a built-in counter. Like the synthesizer, the counter made exact frequency settings possible. Similar signal generators were soon offered by Singer and then HP.

Designers of consumer products such as radios and televisions were equally quick to embrace the results of semiconductor technology. Today's digital watches, employing ICs and solid-state displays, trace their beginnings to 1960. In that year Bulova introduced its Accutron tuning-fork watch. The discrete-component watch established that electronic accuracies in timekeeping products were possible.

One of the first consumer products to successfully incorporate transistors and miniaturized components was the hearing aid. In August, 1958, Zenith produced the Solaris, a hearing aid powered by silicon solar cells mounted on the temple bar of eyeglasses, but space-saving ICs seemed destined for this application. In March, 1964, Zenith introduced the first IC-based hearing-aid. The unit's integrated circuit contained six transistors and 16 resistors, and it was small enough that 10 of these circuits could be stacked inside the head of a match.

Logic families vie for dominance

Much of the early activity of semiconductor manufacturers centered on digital logic families. From the beginning, a host of companies was attempting to establish the dominance of one logic family over the other, or they were second-sourcing the strong suit of a competitor.

At first, resistor-transistor logic (RTL) seemed the way to go. Fairchild and Texas Instruments were strongly behind it. Then diode-transistor logic (DTL) came along in 1962 from recently formed Signetics, and that type of logic took off.

The enormous impact of DTL stemmed from the fact that designers were familiar with the logic form from their work with discrete-component (nonintegrated) circuits. Fairchild, noting the fast rise of DTL, was not long in following Signetics' lead. In 1964, Fairchild came out with its 930 DTL series. Equipped with better noise immunity and less sensitivity to clock waveforms than Signetics' version, the Fairchild family became the most successful DTL line.

Meanwhile, work on transistor-transistor logic (TTL) was proceeding at Fairchild, Pacific Semiconductors and Signetics, among others. At Sylva, the effort was spearheaded by Thomas Longo, who had pushed it as early as 1961. The first TTL circuits had high speed, but suffered from poor noise immunity among other problems.



A new microwave source, the Impatt diode, was discovered in the mid 1960s by Bernard LeLoach (left) and Ralph Johnston (right), along with Barry Cohen. The three Bell Labs researchers made the diode emit microwaves by pulsing it until an avalanche of carriers had been produced internally.



Charge-coupled devices found use in experimental TV camera, demonstrated by Bell Labs' Willard Boyle (left) and George Smith—the inventors who received a patent for charge-coupled devices in 1974.

Longo developed improved versions that emerged from Sylvania as Sylvania's Universal High-Level Logic (SUHL) in 1963. The first practical application of SUHL followed soon after in the Phoenix missile being built by Hughes Aircraft.

1964: A year of sensational headlines

The year 1964 saw news headlines break from all parts of the globe. American planes bombed North Vietnam in retaliation for an attack against U.S. destroyers in the Gulf of Tonkin, and mainland China conducted a successful test explosion of its first atomic bomb.

The Warren Commission released a report that claimed Lee Harvey Oswald was solely responsible for the killing of President Kennedy. Lyndon Johnson, Kennedy's successor, won a lopsided

victory over Republican conservative Barry Goldwater. In the Soviet Union, a spacecraft launched with three men became the first space vehicle to carry more than a single man.

For the IC industry, the year marked the entrance of Texas Instruments' 5400 Series TTL family, and the beginning of its surge to the front of the pack. TI's strategy in 1964 was a frontal attack on DTL, the most widely used logic line of the time. The Dallas-based manufacturer used DTL-pin configurations and the same kind of packaging (first ceramic packaging, and later plastic, in the 7400 Series).

Very early in the game, TI also offered medium-scale integration (MSI) parts. With these ICs, and others that followed, designers could replace several circuits with a single, more complex, MSI circuit.

The beginnings of emitter-coupled logic (ECL) actually go back to 1962. Motorola introduced MECL I in that year, and has since upgraded it with faster versions. This evolutionary process was matched by TI's drive to develop faster versions of its 54/74 family.

Standard 54/74 offered 10 nanosecond (typical gate-propagation delay) and 10 milliwatts (typical gate-power dissipation). It was slower than MECL I (8 nanoseconds delay), but it consumed much less than the 31 milliwatts that a MECL gate did.

Succeeding versions of both the ECL and TTL families cut gate delays, though with an increase in dissipation. The top speed was reached in the late sixties when Motorola introduced MECL III. It offered 1 nanosecond gate delay and 60 milliwatt gate dissipation. However, MECL III didn't catch on. For many applications, the speed was too high to be useful without special and usually costly packaging techniques, and the power dissipation was just too high.

The result was the 1971 introduction of MECL 10,000 (sometimes referred to as MECL II 1/2), which offered 2 nanoseconds delay and 25 milliwatts dissipation. Currently MECL 10,000 competes with a TTL version that uses Schottky clamping to achieve the fastest speeds in TI's 54/74 line. Called 54S/74S, it boasts 3 nanoseconds delays and 20 milliwatts dissipation.

Standard logic lines haven't been limited to bipolar families, however. In 1968, RCA introduced CD4000 COS/MOS, the company's name for its complementary MOS (CMOS) logic series. Since then CMOS has become a strong competitor for TTL—especially for low-power applications—and the 4000 series has drawn more alternate sources than has any other logic line.

Linear ICs, too, made great strides in the sixties. Beginning with operational amplifiers, linear monolithics grew steadily in complexity and functions-per-chip.

In the early 1960s monolithic op amps were sold by at least two manufacturers, Texas Instruments and Westinghouse. Then in 1964 Fairchild came out with the 702, the result of the first collaboration between the now-legendary team of Bob Widlar and Dave Talbert. The new op amp found only limited acceptance, but its development led to the 709, one of the most successful products of its day.

Op amp alters design rules

The 709 marked a turning point in the design of linear microcircuits. Instead of translating a discrete design into a monolithic (IC) form—the standard approach—Widlar followed a different set of rules: “Use transistors and diodes, even matched ones, with impunity. But use resistors and capacitors, particularly those with large values, only where necessary.”

Even where use of a large resistor seemed inevitable, Widlar put a dc-biased transistor in its place. He exploited a monolith's natural ability to produce matched resistors and assumed only loose absolute values.

Improved op amps, like the 741, have since come along to replace the 709 in most new applications. Among the user benefits that have been added are internal compensation, and short-circuit protection. But the op amp and variations of it—like comparators and voltage regulators—account for a large portion of all the linear microcircuits available.

For both linear and digital ICs, packaging problems had to be overcome. Transistor packages were found to lack sufficient heat-sinking capability and an adequate number of interconnections. One solution was the flatpack, created by Yung Tao while at Texas Instruments. The original flatpack had 10 leads, and measured $1/4 \times 1/8$ inch. In 1964 Fairchild's Bryant (“Buck”) Rogers fostered the invention of the dual-inline package. The original DIP had 14 leads, and looked just as it does today. The same year, Martin Lepselter of Bell Labs invented the beam lead as a mechanical and electrical interconnection between the IC and its case.

IC advances help discrete devices

An important by-product of the technological innovations of the day was the development of improved discrete devices. Semiconductor technology had come of age in the IC era, though its birth had been due to the transistor. Now other discrete devices as well as the transistor would reap the benefits of the new frontiers of knowledge.

For example, the Gunn diode—discovered at

IBM in 1963—was one of the first important applications for the semiconducting material gallium arsenide. Researchers at Siemens in Germany more than a decade earlier had uncovered the material during work on semiconductors made from elements in the third and fifth groups of the periodic table.

Other high-frequency diodes followed. The first microwave gallium-arsenide field-effect transistor was built at IBM, also in 1963. Bell Labs introduced the Impatt diode oscillator in 1965, and in 1966 presented the theory for the Trapatt oscillator, which RCA developed in 1970. In the following year the Baritt oscillator emerged from Bell.

A major trend in transistors was toward ever-higher powers at higher frequencies. By 1964 epitaxial processing had been applied to commercial interdigitated rf devices. Refinements in geometry and better mask-production and alignment techniques also helped boost power ratings. A typical interdigitated transistor of the day could output 5 watts at 100 megahertz and 0.5 watts at 400 megahertz.

Then RCA came out with the first commercial transistor to employ an overlay structure—the 2N3375. It produced 10 watts of output power at 100 megahertz and could generate 4 watts at 400 megahertz. The key feature of the overlay structure was that part of the emitter metal lay over the base instead of adjacent to it. Emitter current was carried in metal conductors, formed into fingers that crossed over the base. Base and emitter areas were insulated from one another by a layer of silicon dioxide.

MOS makes its move

One of the most important developments of the last 10 years has been the emergence of MOS (metal-oxide semiconductor). For digital ICs, MOS types usually implied higher density and lower manufacturing costs, while bipolar types implied higher speed. In the early 1960s the benefits of MOS were more promise than reality—then engineers found how to overcome the tricky processing problems of MOS. Their success blazed the path to today's high capacity memories and to microprocessors, and led the way to the current proliferation of desk and pocket calculators—the largest commercial application of MOS circuits.

Much simpler than a bipolar device, a MOS device required fewer diffusion and masking steps, and its theory of operation had been known as far back as the 1930s. In fact, the research that led to the first transistor—a bipolar device—was actually intended to develop a MOS device.

The major obstacle to its development lay in the fact that a MOS device depended on the

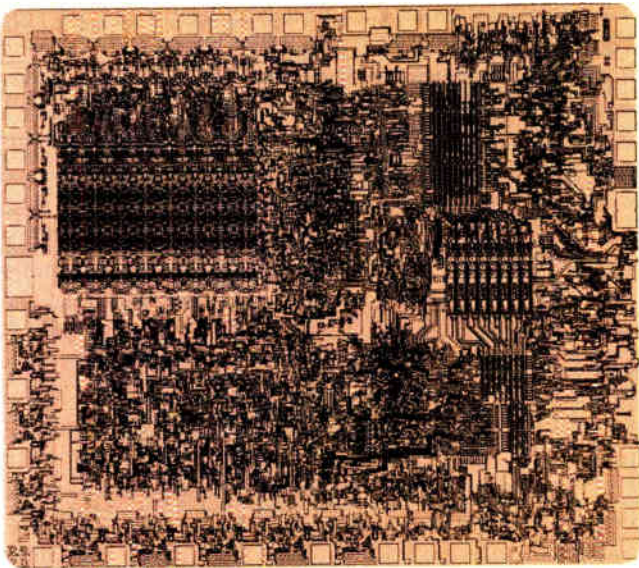

Not quite computers on chips, microprocessors do perform many of the functions of central processing units in conventional computers. The first emerged from Intel in 1971. It was a 4-bit unit called the 4004 (left). The

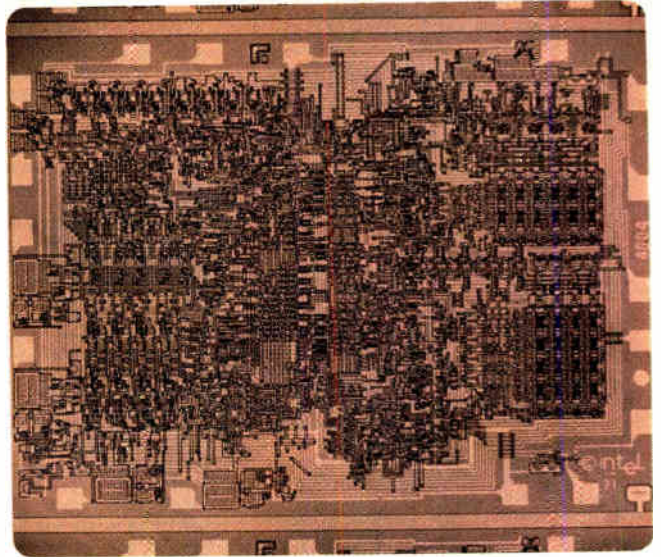

8008, the first 8-bit unit, followed shortly thereafter. Three years later Intel came out with its current high-flying 8080 (right) an 8-bit processor. By that time microprocessors had formed an entire industry.

properties of the semiconductor surface. In contrast, a bipolar version primarily used the easier-to-control bulk properties of the semiconductor crystal. By the middle sixties, however, engineers had solved the stability problems associated with the oxide-silicon interface and the behavior of the oxide itself.

Those early years also saw efforts aimed at increasing the speed of MOS circuits. In 1963 Rockwell International reported the first successful growth of single-crystal silicon on an insulating sapphire substrate. Better known today as silicon-on-sapphire, or SOS, the technique has been employed in the seventies to build microprocessors and memories. Recently RCA combined SOS with CMOS to produce memories having speeds comparable to bipolar memories, but at a fraction of the latter's dissipation.

Memories also marked some of the major successes of conventional MOS in the late sixties, when MOS memories began to seriously challenge magnetic cores for computer applications. Early bipolar memories had led the way into computers by creating a new class of memory systems: the cache (a high-speed low-capacity memory similar to a scratch-pad but with a larger capacity). It was the first large semiconductor memory system to be used in a computer, and was first reported by IBM in 1969. IBM designers had turned to costly bipolar ICs because no other memory component could provide the necessary high-speed performance.

But in the competition between cores and semiconductor memories, memories had to have the right combination of speed, density and price. Something of a breakthrough came in 1970 when

Intel developed the 1103, a 1024-bit dynamic MOS random-access memory (RAM). It had about the right specs and quickly caught on despite its initial price tag of \$60.

The 1103 wasn't the final step. Power dissipation was on the high side, and external devices were needed to make it work. But the 1103 signaled that computer manufacturers would hereafter have to regard MOS dynamic RAMs as serious alternatives to cores.

By the end of the decade, a new term—large-scale integration, or LSI—had been coined to describe the level of chip complexity possible with ICs, especially MOS. The technology had advanced to the point that an entire four-function calculator could be built with just four-to-eight MOS integrated circuits. However, the accomplishment would soon be dwarfed as MOS/LSI advances accelerated during the next few years.

In 1970—the year Thor Heyerdahl showed that ancient Egyptians could have crossed the Atlantic in a frail papyrus boat—Mostek, and then TI, showed that all the logic for a four-function calculator could be put on a single chip. The IC became the forerunner of chips used in today's low-cost pocket calculators.

Calculator ICs grow into microprocessors

But the next step, a multifunction calculator, proved too cumbersome for the usual logic techniques. Not only would the calculator have to handle the standard arithmetic functions, it would also have to accommodate exponential, logarithmic and trigonometric functions—an unwieldy assignment for a direct logic approach.

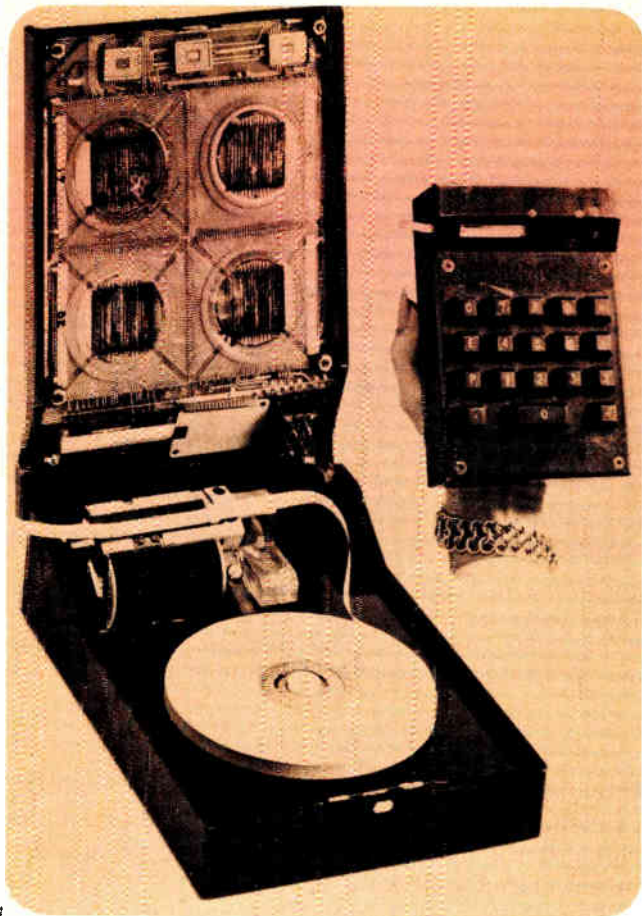

An IC array performs all computations in the first handheld electronic calculator. From Texas Instruments, the battery-operated instrument prints answers without impact on a narrow strip of heat-sensitive paper tape.

The problem was solved by the development of programmable calculators. In these, the necessary functions would be performed by algorithms stored in read-only memories, or ROMs. This concept was applied by Hewlett-Packard in its highly successful HP-35 "pocket slide rule."

Another company working on a programmable calculator was Busicom, a Japanese manufacturer that contracted Intel to produce the calculator's chips. Intel's Ted Hoff, a young Ph.D. from Stanford University who had worked on the 1103, condensed the Japanese design.

Originally spread around 11 chips, Hoff got the design down to three. One formed a central processing unit (CPU), or "brain." The other two were memory chips, one to move data in and out of the CPU and the other to provide the program to drive it. From this design emerged the first microprocessor, a 4-bit unit that Intel introduced in 1971 as the 4004.

Shortly thereafter, Intel introduced an 8-bit microprocessor chip, the 8008. It had more computing power and flexibility than the 4004, and was better suited for applications of data handling and control. However it also had serious

limitations, due mainly to a package constraint of 18 pins. Nevertheless, the 8008 remained the sole 8-bit microprocessor for two years. Then, Intel announced an upgraded version, the 8080, and National Semiconductor and Rockwell among others fielded their own entries.

By that time the microprocessor industry was off and running. Applications for them were sprouting up everywhere, from sales terminals and electronic games to instruments—possibly the most affected area. Virtually every type of instrument seemed to be touched by micros, speeding up design changes that had been in the wind for years. Space-saving, flexible microprocessors presented instrument and other designers with the means to build smaller, cheaper and more versatile equipment.

On the bipolar side of the seventies, advances in technology produced density-enhancing techniques—and a challenge to the lure of MOS. Fairchild's Isoplanar process, announced in 1971, achieved substantial reduction in chip real estate by eliminating the empty spaces between bipolar devices. The manufacturer employed the Isoplanar process in its highly successful 1-k bipolar RAM.

More recently the spotlight has turned full force on integrated-injection logic, I²L, which emerged simultaneously from research laboratories at IBM in Germany and Philips in the Netherlands. More a circuit technique than a new process, I²L allows chip densities that are comparable to MOS, yet offers higher speed and even lower dissipation. It combines readily with other bipolar structures—TTL, ECL and linear—on the same monolithic chip. As if that weren't enough, I²L needs as few as four to five masking steps. The first I²L products—a 4-bit microprocessor slice and a watch circuit—have been announced by Texas Instruments.

In addition to bipolar and MOS, two new memory technologies have recently started to catch on—charge-coupled-device (CCD) memories and magnetic-bubble memories. CCDs, a cousin of MOS devices, have considerably higher density but lower speed. They were invented at Bell Labs in 1970—the year Harris Semiconductor started to use the term PROM for its new user-programmable memories. Both Intel and Fairchild have announced CCD memories.

Magnetic-bubble memories—developed in the mid '60s—aren't semiconductor devices. They employ the material, yttrium garnet, and must have a magnetic drive field. But they can accommodate very high densities. Both CCDs and magnetic-bubble memories are serial-memory devices, though they can be organized into blocks to provide a pseudorandom-access memory. And both can be expected to play important roles in the years ahead. ■■

THE MULTI BREAKER

WE CAN HELP YOU DESIGN MORE VERSATILE CIRCUITS BECAUSE WE MAKE BREAKERS THAT DO MORE THAN YOU THINK.

If all you got when you bought a Heinemann circuit breaker was a convenient way to cut the power in case of an over-current, we wouldn't be the world's Number 1 choice in OEM breakers. And you wouldn't be getting enough for your protection dollar.

For years we've been giving circuit designers the chance to cut costs and enhance the value of their products by offering a variety of special function circuits that qualify our breakers for a variety of control and circuit-interlock applications.

breaker can actually perform a lot of valuable functions. Some examples are shown below.

If one of these functions gives you some ideas on how to put circuit breakers to work in your equipment, the man to see is your nearby Heinemann representative. He can help you get a lot more out of a circuit breaker. He can also fill you in on Quick-Draw delivery, our exclusive five-year warranty, and our manufacturing facilities in the U.S., Canada, West Germany, South Africa, and Australia. Write for a copy of our new circuit protection selection guide, Bulletin 304. Heinemann Electric Company, Trenton, NJ 08602. Phone (609) 882-4800.



HEINEMANN

We keep you out of trouble.

3. Limit control. Special function internal circuits let a Heinemann breaker fill in for a lot of expensive control devices.

4. Overvoltage protector. Hybrid device safeguards semiconductor circuits from transients or other harmful overvoltage conditions. Solid-state sensor and switch are built right into the breaker; 500 nanosec response.

5. On-off switch. Choice of handles—toggle, sealed, push-button, rocker, snap-in mount, colors—match any front-panel style. You save money by using a breaker as combined protector/on-off switch.

2. Short circuit protector. Fast non-time-delayed tripping to protect your valuable circuit components.

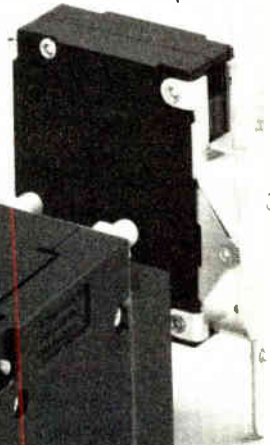
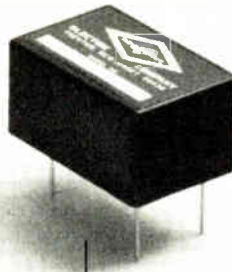
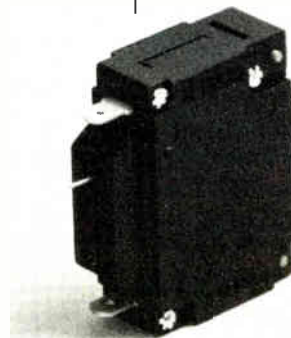
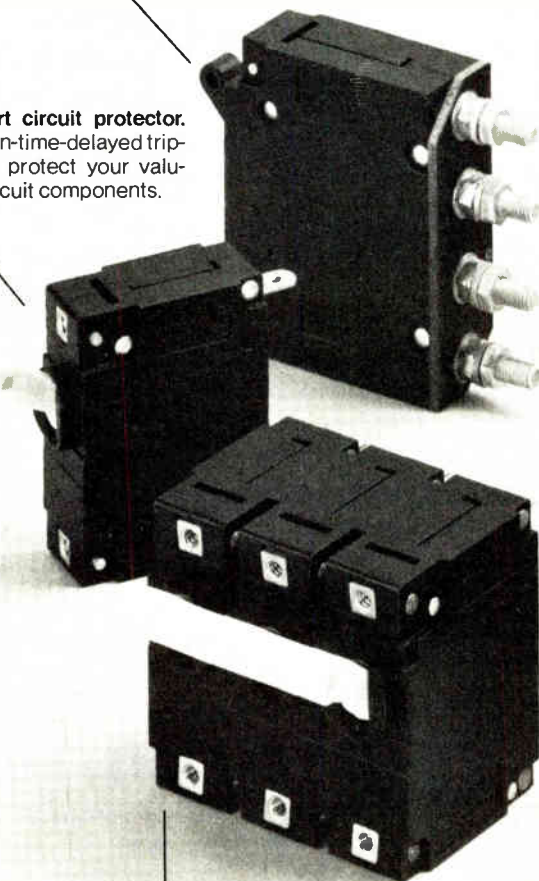

7. Solid-state breaker. Fast response (50 microsec), long life, and remote electronic resettability.

1. Overcurrent protector. With trip point and time delay precisely tuned to your requirements.

6. Undervoltage protector. Built-in solid-state module makes this a hybrid a brownout protector, tripping your equipment off-line when voltage approaches 90V; also provides over-current protection.

Two routes to better performance



 When you're building your logic circuits to meet new and more demanding requirements, you want the best noise protection for top performance at all times. And if the protection can be built compactly onto the circuit board, thus eliminating the need

for space-consuming components, then all the better. Well, Fujitsu — one of the world's largest computer makers — has two series of by-pass capacitors with just what you need.

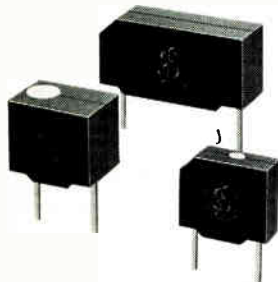

Fujitsu ALOXCON aluminum solid electrolytic and TANTALCON tantalum solid electrolytic by-pass capacitors are perfect for high-speed (TTL) and ultra-high-speed (CML) logic applications. Either offers the small size for high-density printed circuit board mounting, yet provide full performance by-pass characteristics for top operation under a wide range of environmental conditions. Other features include low ESR and inductance, large static capacity, full protection against burning down and lead spacing matching that of standard DIP ICs.

Remember, don't by-pass performance when you by-pass noise — use ALOXCON and TANTALCON from Fujitsu.

FUJITSU LIMITED
Communications and Electronics
Marunouchi, Tokyo, Japan

For further information please contact:

■ Components Division (Head Office): Syuwa Cnarimon B'dg., 1-1, Shinbashi 6-chome, Minato-ku, Tokyo 105, Japan Phone: Tokyo (03) 437-2111 Cable: FUJITSULIMITED TOKYO Telex: 2422808 FT SIN J ■ New York Office: 680 Fifth Avenue, New York, N.Y. 10019, U.S.A. Phone: (212) 265-5360 Telex: 23-234969 ■ London Office: Norman House, 105/109 Strand, London, W.C. 2, England Phone: 240-0461/0462 Telex: 51-22305

MAIN PRODUCTS □ Telephone Exchange Equipment □ Carrier Transmission Equipment □ Radio Communication Equipment □ Space Electronics Systems □ Electronic Computers & Peripheral Equipment (FACOM) □ Telegraph & Data Communication Equipment □ Remote Control & Telemetry Equipment □ Electronic Components

CIRCLE NUMBER 51
WorldRadioHistory

More digit for your dollar. No surprise, it's Monsanto!

The performance of LED displays has improved dramatically with the development of GaAsP:N on GaP, a technology patented by Monsanto. The luminous intensity of our orange units is several times higher than standard red, so you can have an extra-bright display. And you can run at lower currents and save power.

That means more performance for your dollar. Our MAN 3620 orange display gives you 2000 μcd at 20 mA, compared to 600 μcd for standard red. On a cost/performance basis, that's 3 times the output per dollar. Compare other displays, including gas plasma, and you'll see why you get more from Monsanto.

The whole story isn't just the incredible brightness, though; it's what that extra brightness lets the designer do. Like drive digits directly from IC's. No interfacing circuits. That's fewer parts, so reliability of your system is improved. Your whole display system is more cost efficient and has more added value.

Readability is improved too, with the new rounded font of our 0.4" digit. And you'll appreciate that the 0.4" models have a package size that is identical to the 0.3" models and are pin-for-pin compatible. You can use either size digit in the same space.

We'd like to show you the results of our technological improvements. Red. Bright Orange. Green. And a flashing yellow. Perfect for function differentiation. Here's a partial listing of our 28 different kinds and colors. All offer the long life, high reliability, and rugged nature of solid state components.

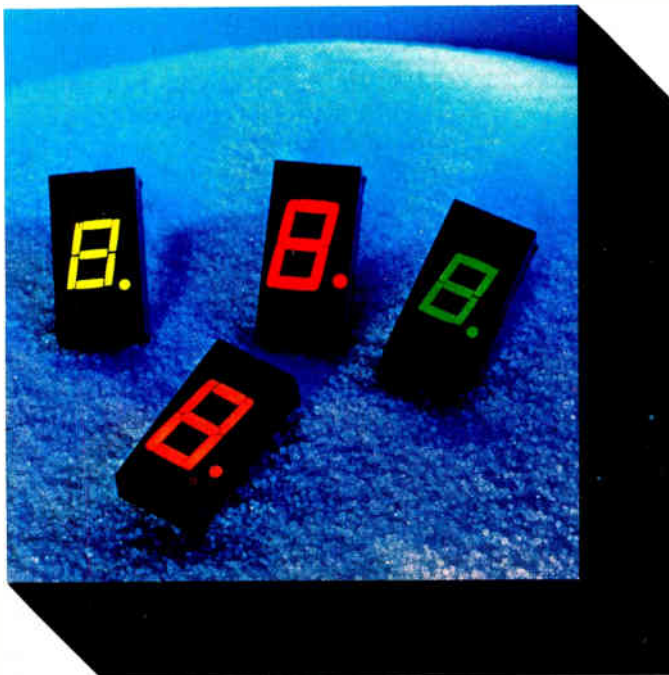

Model Number	Color	Description	Digit Size	Luminous Intensity** (μcd @10mA)
MAN3610*	Orange	Common Anode; RHDP	0.3"	1200
MAN3620*	Orange	Common Anode; LHDP	0.3"	1200
MAN3630*	Orange	Common Anode; Overflow (± 1)	0.3"	1200
MAN3640*	Orange	Common Cathode; RHDP	0.3"	1200
MAN4610*	Orange	Common Anode; RHDP	0.4"	1000
MAN4630*	Orange	Common Anode; Overflow (± 1)	0.4"	1000
MAN4640*	Orange	Common Cathode; RHDP	0.4"	1000

*Also available in Red, Green, and Yellow **Typical

Now is the time to increase the value of your display dollar investment. Our new displays give you better performance, high reliability, more system value. Delivery is from stock at your local distributor. Call your Monsanto man or write Monsanto Electronics Division, 3400 Hillview Avenue, Palo Alto, CA 94304. Phone: (415) 493-3300.

Putting Innovation to Work.

Monsanto:
the science
company.

Bern Dibner of Burndy Speaks on Our Technological Heritage

The grand old man of technology's history

It was 1924, the country was roaring with prosperity under President "Silent Cal" Coolidge, George Gershwin composed the *Rhapsody in Blue*, people were whistling "Lady Be Good," and one could buy a Ford motorcar without self-starter for \$290 (in any color as long as it was black). The national debt of the United States was only 25 billion dollars and there were radios in 2,500,000 U.S. homes.

About this time, a young engineer named Bern Dibner—believing he could make a better connector than anyone else—founded the Burndy Engineering Co. in New York City (now located in Norwalk, CT). The corporation has since become one of the largest suppliers of electrical connectors to the industry.

Dibner graduated an electrical engineer from the Polytechnic Institute of Brooklyn in 1921 and continued his studies at Columbia University in New York City and the University of Zurich in Switzerland. He joined the American Institute of Electrical Engineers in 1923, was elected Fellow in 1942 and is now a Life Member of the IEEE. He has had published more than a dozen books and papers on the history of science especially in electricity and magnetism. He was awarded an honorary doctorate in Engineering by the Polytechnic Institute of Brooklyn.

Early in Dibner's career, he began collecting items of scientific interest with

The great technological progress of the past 200 years should give us pause to consider many of the things we're doing now and they might even give us some insight into the future. Let's look back for a moment.

In the electrical and electronics engineering fields there are certain pioneers and technological developments both American and non-American that had a tremendous impact and have added infinitely to the greatness of our nation. There was, for example, Ben Franklin's lightning rod, a simple device, but revolutionary in concept. It not only protected structures from destruction and damage, but like the Copernican doctrine, it had a revolutionary impact on the mind and on civilization.

Until Copernicus, it was understood that the



emphasis on research in electricity and magnetism. His collection in this area is recognized as the most important assemblage anywhere.

In 1936 he made formal his collection, founding the Burndy Library, for which in 1964, a special building was completed next to the Burndy plant in Norwalk.

The library contains more than 40,000 rare books, plus numerous manuscripts, letters and experimental devices, estimated to be worth many millions of dollars.

Among the items are several manuscripts by Sir Isaac Newton, Einstein's corrected proof summary of his general theory of relativity and a copy of the first book on science to be printed: Pliny's

Historia Naturalis, published in Venice in 1461.

Also of special interest is a collection of 40 letters by Michael Faraday, 300 volumes from the library of Alessandro Volta and a letter from Galileo describing the invention of the magnetic water clock. Other pioneers in the electrical field that are represented include such notables as William Gilbert, Robert Boyle, Benjamin Franklin, André Ampère, Friedrich Gauss and James Maxwell.

A good part of the Burndy Library's collection has been deeded to the Smithsonian Institution by Dibner and is now being moved to the Institution's National Museum of History and Technology in Washington, DC. The Burndy Library will continue operations as before, replacing its depleted assets by other copies, reprints and less precious editions.

Dibner believes that his library should not wait—like the tomb of Tutankhamen—for the invasion of the curious and the scholarly. He has tried to make it a living library—giving and participating in dozens of exhibitions, lending items to other libraries and even sharing its collections with other institutions.

As Dibner observes, "One's belief and conviction on examining any evidence is best served when that evidence is in its primary form. When quoted, edited or interpreted, a lower order of conviction results. That is why scholars will travel long distances to examine an original disclosure."

earth was the center of the universe and the planets, the sun and the moon, all revolved around the earth. Then in 1543, Copernicus published his treatise saying it was indeed the sun in our planetary system that was the center of revolution. Here was a piece of observational evidence that had to be digested. That came about slowly.

We must realize the terrible wrench, the struggle within the church, to accept this concept. The adjustment took hundreds of years and was a very difficult process.

So it was with the lightning rod. Until Franklin, the only response to the terrors of lightning striking was to say it was an act of God. When a man was struck it was excused or rationalized but nothing was done. A German scientist of that

time who was interested in lightning phenomena and the damage done by lightning showed that 103 bell-ringers were killed by lightning in a period of something like 30 years. Still, Nollet, the greatest experimental physicist of his time, fought the installation of lightning rods because he was an abbé. It is a difficult adjustment to lose faith in the providence of God and to turn instead to a mechanical gadget such as a lightning rod.

There's a very dramatic incident of the installation of a lightning rod on the great tower facing a famous piazza in the charming city of Siena, Italy. The social head was a Marquis Chigi, who had written a book on lightning protection, and who was against the lightning rod. So when the Grand Duke of Tuscany approved the plan

to put in a lightning rod to protect the great tower, Chigi was against it. But the Grand Duke said to go ahead. It was put in and the people wondered what was going to happen next.

When storm rumblings began one day in the spring of 1777 the populace began to move toward the piazza. The thunder got heavier and everybody's eyes were on the tower, when at 5 o'clock in the afternoon, lightning struck. There was a terrific bang, a sulphurous smell, a moment of dramatic tension and then a grand roar: The rod had taken the blow. There were signs of stress in the rod, but their tower was safe. That helped settle the controversy but it took courageous people to install the lightning rod.

Another historical development of great importance was Alessandro Volta's chemical battery. It was announced in the *Transactions of the Royal Society*, of which Volta was a member. This electric battery provided direct current for the first time. Before that all electrical phenomena were transient, involving charge or discharge. But here we had an unimpressive, undramatic, steady flow of electricity. It was a dirty one because you had to have either sulphuric acid or a brine as the electrolyte, but nonetheless, direct current came from the battery. About a year later the electric battery was used to dissociate water into its elements. Humphrey Davy took the battery terminals and with pieces of charcoal drew an electric arc of great brilliance so we had electric light and, of course, the other developments that followed.

In 1820, Hans Christian Oersted discovered that electricity had a magnetic vector, that current generated intense magnetic fields. This was followed by Faraday's discovery of electromagnetic induction—that from intense magnetism electricity can be generated. From those events, beginning with the Volta pile, the electrical age opened up.

The next event of major importance is an American contribution, the invention of the electric telegraph by Samuel Morse in 1844. The first installation was the electric telegraph line between Washington and Baltimore. In any case, the effect was to put electrical usage on a vast scale. Ultimately it tied every community electrically with every other community.

That was followed in 1879 by the Edison electric light. Here we had less the introduction of a revolutionary concept than an engineering application. In other words, it was known that current could heat a wire to incandescence. The problem was to make the incandescence last, making a reasonably priced device from which emanated electric light. The result was an electric light industry because dynamos had to be built to sup-

ply the power. Once we had the dynamos we found other uses for the electricity in the wire.

There are two basic reasons technology has flourished to a greater extent in the United States than it has anywhere else. Primarily, it is due to the effervescence that comes from the presence of new people in a new place, the idea of the new broom that sweeps clean. The second reason is that we have always had the potential for absorbing new people. Historically, no country has expanded in so short a time as has this nation.

Stratification of society in other countries has kept many potential talents submerged. Here, they had a chance to flourish. Here we apply greater support to those talents that we recognize as having great potential, and we've provided a growing society. Our population increased from the first census of 1790, I think it was on the order of 4 million to our present 215 million. That growing affluence and numbers; that geography, the moving westward of the frontier from the 13 colonies to the Pacific Ocean and beyond, to Hawaii, Alaska; those moving frontiers, stimulated the development that we see today.

The evils or virtues of technology

Is there a negative side to technology? That, of course, is being debated wherever two serious people get together.

We could take every evil event—assuming we agree on the definition of evil—and say that it could have been prevented had we done so and so. But we must recognize that one of the most revolutionary ideas—American or non-American—was the idea of evolution introduced by Charles Darwin in his publication: the *Origin of Species by Means of Natural Selection*.

There we see that there is a curve, a line of development in which there are ups and downs, and that the natural selection of the curving element is determined by its ability to meet new conditions. Of course, that is also true with electrical development. Nothing is a straight line. Everything is up and down. We have days, we have nights. We have summers, we have winters. Each winter is followed by a summer. Each summer is followed by a winter.

One can't really put a subjective evaluation on the good or the evil of technology. It's what we do with it.

We should maintain an open, pragmatic attitude towards technology with a minimum of government controls. That's one of the reasons this society has moved as it has compared with other societies. The Chinese, for example, have not moved at all even though they were in business



Bern Dibner operates an electrostatic generator built in Paris in 1805. (Photo courtesy of Burndy Library.)

long before we were. Controls, limitations, for whatever reason—sociological or otherwise—tend to discourage development. We should maintain an open and pragmatic attitude, selecting the good through tests and moving on constantly, opening opportunities for talent. If it's poor, negate it. If it's good, encourage it. That is the way to progress.

There are a number of reasons the average

person holds a questionable view of technology. One is conservatism, the other is fear of the unknown. There's a resistance to moving forward, but progress has been made only by the bold and the strong of heart. I think there's enough of that in this country for us to continue our experimental attitudes. Let us try it. Let us assess each new development and I think we'll continue in this way. ■■



Electronic Design / GOLD BOOK

HAYDEN PUBLISHING COMPANY, INC. 50 ESSEX ST., ROCHELLE PARK, N.J. 07662 • (201) 843-0550

Dear Electronics Manufacturer:

My name is David Greenberg, Catalog Design Director of Electronic Design's GOLD BOOK. I'm here to help you make your print catalog programs more cost-effective than they've ever been before.

You can save anywhere from a few dollars to several hundreds, or even thousands of dollars in the planning, preparation, preprinting, distribution or reprinting of your catalogs. I think I know what I'm talking about because I've produced thousands of catalog pages for electronic companies.

- **SAVE ON CATALOG DISTRIBUTION** -- You reach 91,000 specifier/buyers in all: 78,000 engineers, engineering managers, distributors and purchasing agents throughout the U.S., plus 13,000 in key markets overseas. You get the best of both worlds. And rates are low. Probably less than you are paying now for limited catalog distribution.
- **SAVE ON CATALOG PREPARATION** -- We assist in many phases of your catalog preparation absolutely free. We provide:
 - FREE design consultation
 - FREE layouts
 - Production at cost
- **SAVE ON PRINTING** -- Our bulk purchases of paper and high-volume, high-speed press capability cut costs to the bone. You pocket the difference.

And you don't have to wait until the 1976-77 GOLD BOOK comes out. We can prepare your catalog right now (in collaboration with your advertising agency) and supply preprints for your own use or for your salesmen and distributors.

We can work directly from your long or short form catalogs or technical data sheets. We can shorten your catalogs, or lengthen them. We can prepare your catalog from scratch, or redesign existing material to make an effective GOLD BOOK presentation.

Look over the rate structure shown on the next page. Then mail the reply card or call me today. I'll be glad to discuss your catalog program based on your products and your needs. And, I'll show you the dollars you can save.

Sincerely,



David Greenberg
Catalog Design Director
Electronic Design's GOLD BOOK

1976 - 77 GOLD BOOK RATES AND SAVINGS

<u>PAGES</u>	<u>GOLD BOOK</u>	<u>OTHER LEADING DIRECTORY</u>	<u>YOU SAVE</u>
1	\$1,195	\$1,400	\$205
2	1,100	1,300	400
3	1,000	1,200	600
4	900	1,100	800
5 - 6	850	1,050	\$1,000 - \$1,200
7 - 9	800	1,000	1,400 - 1,800
10 - 11	750	950	2,000 - 2,200
12 - 15	700	900	2,400 - 3,000
16 - 19	660	860	3,200 - 3,800
20 - 23	630	825	4,900 - 5,635
24 - 29	595	750	5,280 - 6,380
30 - 39	530	700	5,700 - 7,410
40 - 49	490	650	6,400 - 7,840

Rates for catalogs 50 pages or more, on request.

Special Combination Discount for ELECTRONIC DESIGN and GOLD BOOK Advertisers.

NOTE: If you are an Electronic Design advertiser, add the number of pages you plan to run in Electronic Design in 1976 to determine your page rate in the GOLD BOOK.

- For example, if you are a 13 page advertiser in Electronic Design, eight pages in the GOLD BOOK would earn the 21 page rate, or only \$630 per page.

ADDITIONAL SAVINGS FOR PREPRINTS OR REPRINTS OF YOUR CATALOG

Look at these low, low rates for preprints or reprints (70# coated stock).

<u>Quantity</u>	<u>4-pages</u>		<u>8-pages</u>		<u>20-pages</u>	
	<u>b&w</u>	<u>2-color</u>	<u>b&w</u>	<u>2-color</u>	<u>b&w</u>	<u>2-color</u>
5,000	\$192	\$288	\$ 336	\$ 432	\$ 684	\$1,008
10,000	294	384	552	684	1,086	1,488
25,000	588	790	1,128	1,452	2,268	2,928

At today's spiraling printing and mailing costs it's worth a few minutes of your time to investigate the possibilities.

DON'T DELAY. THE NEW 1976 - 77 GOLD BOOK IS BEING PREPARED NOW. RETURN THE ABOVE CARD TODAY. THERE'S NO COST OR OBLIGATION.

LET ME SHOW YOU WHAT I CAN DO FOR YOUR COMPANY.

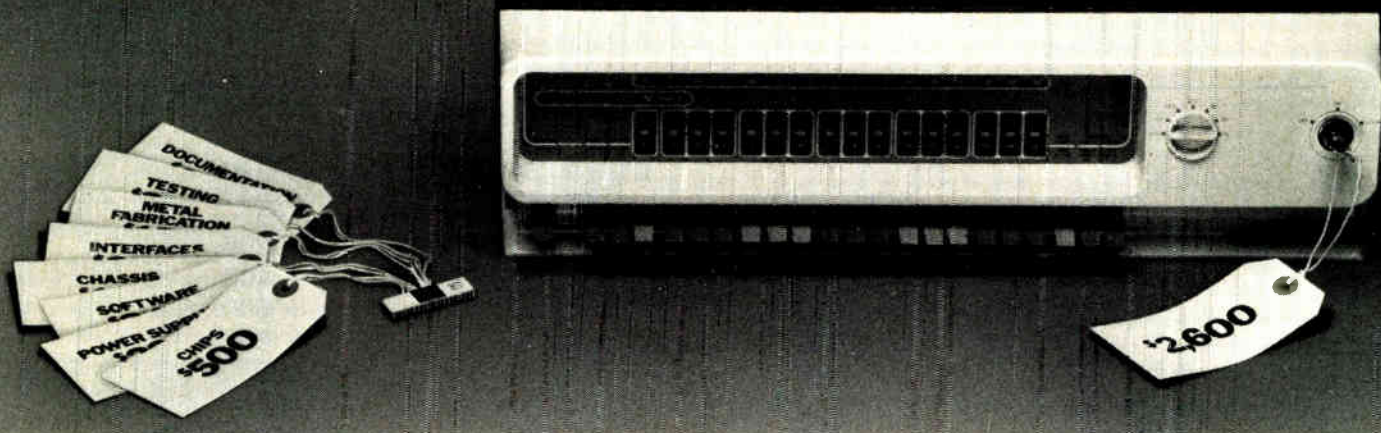

Has your \$500 micro ended up costing more than our \$2,600 mini?

If you've had to spend a lot of money on a low priced micro, you may be in a position to appreciate the cost advantages of a higher priced computer.

Our \$2600 Nova 3.*

When you buy a Nova 3, you don't have to put as much into it to get it to do your job.

You don't have to create your own operating systems. Nova 3 is software compatible with our other Novas. So you get to use all the existing Nova operating systems, language processors and utilities.

And you don't have to worry about performance. Nova 3 executes instructions in 700 nanoseconds using MOS memory. And its sophisticated architecture lets you use up to 128K Words with the optional Memory Management Unit.

You don't have to buy more

computer than you need. Nova 3 has the broadest range of compatible configurations you can get in an OEM minicomputer line. There's a 4 slot Nova 3. A 12 slot Nova 3. (It has an optional expansion chassis that gives you 12 more slots of I/O.) And you can configure multiple processor Nova 3 systems.

You don't have to worry about Nova 3 availability. We're manufacturing virtually every part of the Nova 3. Including the silicon gate N-channel MOS RAM memories. (They're coming from our Sunnyvale, California facility.)

And you don't have to go it alone. Because when you buy a Nova 3, you can get all the support Data General offers an OEM.

Write or call for the Nova 3 brochure. It may persuade you to buy more and spend less. *\$2600 is the single unit price for a 4K MOS memory Nova 3. Before the OEM and quantity discounts get figured in.

Data General

Nova 3: The biggest thing to ever hit the OEM market.

• Data General, Dept. I.4, Route 9, Southboro, Mass. 01772 (617) 485-9100. Data General (Canada) Ltd., Ontario. Data General Europe, 15 Rue Le Sueur, Paris 75116, France. Data General Australia, Melbourne (03) 82-1361/Sydney (02) 908-1366.

WorldRadioHistory
CIRCLE NUMBER 55

Microprocessor Design

Microcomputer kit based on 12-bit μ P works like PDP-8/E

A 12-bit microcomputer, designed around the Intersil IM6100 microprocessor, offers software compatibility with the Digital Equipment Corp. PDP-8/E series of minicomputers. The microcomputer, designated the PCM-12, made by PCM (P.O. Box 215, San Ramon, CA 94583. 415-837-5400) is available in kit form for \$400 to \$600, depending upon options.

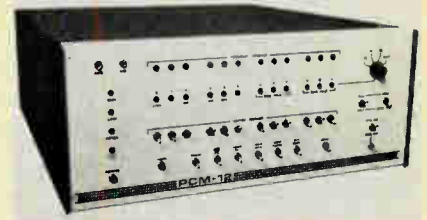

The PCM-12 has a bus-oriented architecture to ensure flexibility and future expandability. A TTL-compatible 80 line bus accommodates up to 15 cards for device interfaces and additional memory. The basic kit comes with 4 kwords of memory (expandable up to 32 k), the CPU, control panel TTY/CRT terminal interface, cassette recorder interface cabinet and power supply. All board interconnects are handled by a backplane bus and a single ribbon cable.

When assembled the machine can do a memory-to-accumulator addition in 5 μ s, and it has provision for vectored, priority interrupts. The control panel provides essentially all PDP-8/E functions plus a built-in bootstrap loader. The PCM-12 can execute most PDP-8 software, including assemblers, editors, debug routines and advanced languages like Basic and Fortran—much of which is available over-the-counter.

CIRCLE NO. 501

Desk-top μ C kit based on 16-bit Pace microprocessor

The Pacer desk-top microcomputer kit is built around the 16-bit Pace μ P made by National Semiconductor. The kit was developed by Hamilton/Avnet Electronics (10916 W. Washington Blvd., Culver City, CA 90230. 213-558-2121) and is a complete μ C, right down to the power cord.

The kit includes a new type of keyboard that is claimed to allow the user to easily enter the program directly into memory and also includes two 4-digit alphanumeric displays that allow the user to analyze data and programs. The Pacer costs \$675 in kit form and \$835 completely assembled.

CIRCLE NO. 502

Multipoint data acquisition system has programmable control

The Digitrend 220 digital multipoint recorder uses the Intel 8008 microprocessor. The unit is made by Doric Scientific (3883 Ruffin Rd., San Diego, CA 92123. 714-565-4415) and can scan 20 to 1000 points at speeds up to 20 points/s. A programmable point-by-point function select is available for up to six functions per system.



Standard ranges and functions include four ranges of linear dc voltages, with resolution to 1 μ V, and automatic ranging: six types of thermocouple inputs (J, K, T, E, S and R), with built-in

(continued on page 138)

(continued from page 137)

cold junction compensation and digital linearization for direct temperature display in C or F; and two ranges of current transmitter inputs to handle process signals of 4 to 20 and 10 to 50 mA.

Also, special functions, ranges, and scaling for standard or nonstandard transducers are available for slightly more than the base price of \$4000. Point-skip is included as a no-cost extra when point programming is ordered. Group programming is available instead of point programming for function selection in blocks of 10 points. Time is displayed and recorded in hours, minutes and seconds and includes a power-failure indication.

Nine interface circuit cards are available as options to couple to peripheral equipment, such as external alarm relays, computer random access with parallel BCD output, serial output for a seven-track or nine-track incremental magnetic tape recorder, serial output for paper tape punch, serial output for teletypewriter and output drive for modem. Digitrend 220 systems are available in 60 days.

CIRCLE NO. 503

Smart digitally controlled valves respond in under 100 ms

The Digital Dynamics, Inc. (830 E. Evelyn Ave., Sunnyvale, CA 94086. 408-733-4660) series of Smart Valves contains a microprocessor and direct digital control valve in one package. The valves can precisely control and meter liquid and gas flow without overshoot, drift, sticking, hunting or settling lags. In addition many other system functions, such as start-up, shutdown, safety switches and data logging, can be economically handled by the microprocessor.

The response time of the μ P valve combination is typically less than 100 ms, and the flow characteristics are determined by the programming, not the mechanical trim. No air lines or additional interface hardware are required, and the valve operates with standard in-

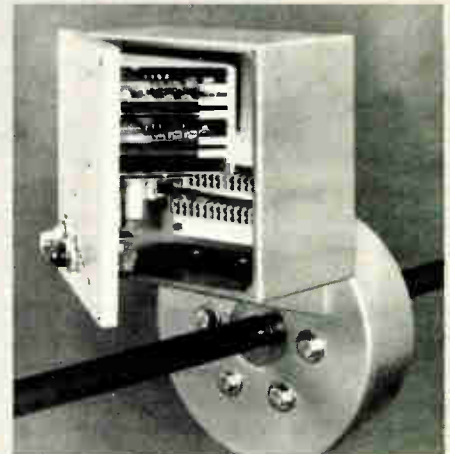

(continued on page 140)

Now...Mike 3!

The **MIKE 3** is a good example of the flexibility of the modular micro approach. An optimal small system — yet fully expandable. A three-board version, the AT813, includes the Model 471 CPU board (with 8080A); memory board with 8080 Monitor PROM, 512 bytes RAM (expandable to 2K PROM, 1K RAM); console board with keyboard, six LED digits; connectors; and Manual . . . only \$395. (Manual alone, \$35.) Priced at \$149. in quantities of one, with 8080A, the 471 CPU features:

- 3 interrupt levels (8-level priority interrupt board optional)
- Automatic hardware exit from masked interrupt after set interval
- Controls for one DMA channel (8-level prioritized DMA control optional)
- Power bus drivers for system expansion
- 8080, 6800, 8008 I/O address modes

martin research
3336 Commercial Ave.
Northbrook, IL 60062 (312) 498-5060

Solitron is very big on JAN, JAN-TX JAN-TXV

Many popular JAN, JAN TX and JAN TXV power transistors are available from Solitron. And more are on the way! Currently, 50 Solitron types are undergoing qualification testing to meet MIL-S-19500 requirements. Watch for our announcement soon of their availability to you. Meanwhile, look over the list of JAN, JAN TX and JAN TXV devices that are now available. Call us toll-free (800-327-8462) for complete information including specifications and pricing.

JAN, JAN TX

2N 3055
2N 3771
2N 3772

JAN, JAN TX, JAN TXV

2N 2880
2N 3749
2N 4150
2N 4865
2N 5237
2N 5238
2N 5250
2N 5251
2N 5664*
2N 5665*
2N 5666*
2N 5667*

Solitron
DEVICES, INC.

1177 Blue Heron Blvd./Riviera Beach, Florida 33404
(305) 848-4311/TWX: (510) 952-7610

**Pending Final Approval*

PLANTS IN: CALIFORNIA • FLORIDA • NEW YORK

CIRCLE NUMBER 57

(continued from page 138)

dustrial control signals (0 to 5 V, 4 to 20 mA, 120 V ac, contact closures, TTL, etc).

A typical medium-sized Smart Valve (Model 1-P3-6-607D-9-0) uses six digital outputs to drive its internal valve, and it has 10 additional control lines that can be used to control other equipment. The list price of this unit is \$2752. Larger, smaller, and custom configurations are available. Complete software support is offered for as low as \$400.

CIRCLE NO. 504

Software package permits easy development of 8080 programs

DEVELOP-80 is a powerful software package designed by MITS (6328 Linn, N.E., P.O. Box 8636, Albuquerque, NM 87108. 505-265-7553). It can help develop assembly language programs for 8080 μ P's on Digital Equipment Corp. System 10 time-sharing computers. The package consists of a macroassembler, an 8080 simulator, a modified version of the DDT debugging package and various support programs.

When used in conjunction with the debug package, the user can debug his assembly language program quickly and efficiently, claims MITS. Also included with DEVELOP-80 are programs to produce object tapes in Intel compatible or Altair compatible format. DEVELOP-80 is available on paper tape or 9-track magnetic tape for \$75.

CIRCLE NO. 505

Complete μ P module handles four bits and fits standard rack

A four-bit microprocessor module is claimed by International Microsystems (122 Hutton St., Gaithersburg, MD 20760. 301-840-1078) to be the first that is designed to fit a popular card cage—the Cambion bin. The μ P includes a 2-k \times 8 program memory that consists of 1-k of RAM and 1-k of PROM. All control lines and data I/O lines are TTL compatible.

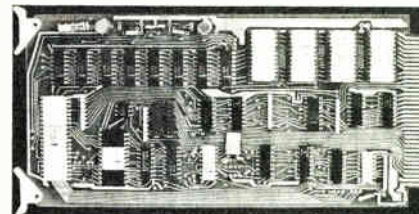

The module uses the Intel 4040 and fits a 4.5 \times 9-in. card rack. Additional features of the μ P card include a crystal clock and provision for an 80 \times 4-bit RAM. Also included is a test PROM that can check out the I/O lines. Separate input and output data busses as well as three latched designated command lines (DCL) are provided.

Cost for the module is \$395, and delivery is 30 days.

CIRCLE NO. 506

μ P software support assembles, simulates or analyzes

Support software programs for microprocessors are available on a nationwide computer network from University Computing Company (7200 Stemmons Freeway, P.O. Box 47911, Dallas, TX 75247. 214-637-5010). Special features of the software greatly speed development and checkout of microprocessor systems, claims UCC.

The assembler, for instance, has a powerful macrofacility, conditional assemblies and the capability to generate complex address expressions that involve multiplication and division. The simulators can handle the ROM/RAM environment, simulated interruptions and I/O operations. They also allow for debugging through tracing, breakpointing and

(continued on page 142)

Our years of working directly with design engineers on hybrid circuits for high-reliability military applications have given us the experience to eliminate your uncertainties in hybrid circuit planning and packaging. We can ease you through a smooth transition from your basic electronics to hybridization, or help you consolidate a preferred circuit, taking advantage of the space, handling, stock and inventory economies of the hybrid package.

With hybrids, the only limitation is imagination. You'll be surprised by the variety and number of parts we can put in a package. Our unique facility can supply thick film or thin film hybrid microcircuits ranging from simple multiple chip to complex multi-layer assemblies, all built and maxi-tested to meet the most stringent military standard, 883 Level A.

In addition, our experience has led us through an evolution of top quality hybrid analog gates and D-to-A switching circuits. We make an array of standard hybrids from which you might easily choose the one to answer your special design problem, at a cost much lower than you expected.

No matter what your hybrid requirement — small quantities of custom circuits or large quantities of our standard hybrids — Crystalonics is unbeatable on size, reliability and turn-around time. You can send for our microcircuits catalog today. Or for immediate design assistance, stop wrestling and call Jack Senoski, Art Pauk or Richard Antalik of our hybrid applications engineering squad.

Stop wrestling
over
hybridization

We're at your elbow to ease your design.
Crystalonics. We listen.

 **TELEDYNE**
CRYSTALONICS

147 Sherman Street, Cambridge, Mass. 02140
Tel: (617) 491-1670 • TWX: 710-320-1196

CIRCLE NUMBER 58

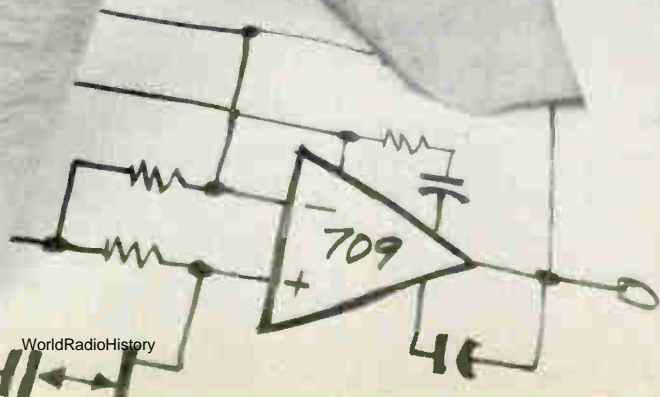

WorldRadioHistory

(continued from page 140)

selective memory dumps. Critical timing situations can be examined with the statistics feature which measures required clock cycles as well as other vital information.

Current software can support the Intel 4040, 4004, 8080, 8008, Fairchild F-8 and similar processors. Costs for the programs start at 3 cents per instruction entered for assemblers and approximately 40 cents per CPU second for simulator programs.

CIRCLE NO. 507

μ P-controlled data logger handles 160 channels

The Summa II 2200A data logger made by John Fluke Mfg. Co. Inc. (P.O. Box 43210, Mountlake Terrace, WA 98043. 800-426-0361) uses μ P control to handle up to 60 channels in the mainframe. Up to 100 more channels can be added with a scanner extender chassis.

The logger features a scan counter and a variable scan rate from 1 to 99 minutes. Range, function and channel skip can be programmed for 10 individual channels

or in blocks of 10 up to 100 channels. Resolution for the Summa II is down to 1 μ V and 0.1 C or F, while maximum output is a 40,000 count from the digitizer. Options include alarms, program memory expansion, mag and paper tape and RS-232-C interfaces. Base price for the Summa II is \$2865, with delivery from 60 to 90 days.

CIRCLE NO. 508



Low cost modular mini based on 6800 μ P

The Jupiter II modular minicomputer based on the M6800 μ P can be ordered in kit form or completely assembled. Important features of the mini include: easy to test, small pluggable cards; wrapped-wire interconnect between cards; modular plug-in power supply, socketed ICs for easy testing and replacement and file management capabilities. The Jupiter II computer system is available from Wave Mate (1015 W. 190th St., Gardena, CA 90248. 213-329-8941) for under \$1000. Delivery is 60 days.

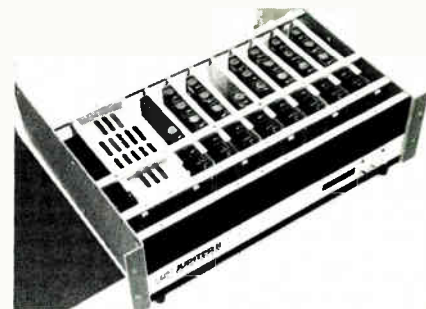

CIRCLE NO. 509

Cross-assemblers and simulators handle many μ P types

A series of programs designed to assist the engineers working on μ P applications is available on a country-wide time-sharing system from National CSS (430 S. Pistoria Ave., Sunnyvale, CA 94086. 408-739-6271). Included in the bank of programs are cross-assemblers and simulators for the following microprocessors: AMD9080A; TI 8080/1000; Intel 8080, 8008, 4040, 4004; Fairchild/Mostek F-8; National IMP-16, PACE; Motorola AMI 6800; MOS Technology MCS6501, 6502; Signetics 2650; and Rockwell PPS4, PPS8.

Also available is PLM—a high level language to generate code for the 8080, and Rapid—an all purpose cross-assembler from Scientific Micro Systems. The programs are available for use on a wide selection of terminals; low speed—10, 15, 30, 60 and 120 cps; and high speed—IBM 2780 and 1130 types. Costs for the programs depend upon processor time but typically range from \$10 to \$13 per hour connect and 20 cents per virtual processing unit.

CIRCLE NO. 510

WHY WOULD ANYONE WANT TO BUY NATIONAL 4K RAMs FROM SYNERTEK?

We can think of a number of good reasons:

- We are a true second source. Our parts are not "compatible with, similar to, or interchangeable with" the National part. They are **exactly** the same parts, built from the same mask sets.
- Synertek is an established high volume supplier of ion-implanted N-channel silicon gate parts. Our existing production process is being used to build parts from National-supplied tooling.
- We are committed to MOS memories and our present product line allows you to optimize your system design for power dissipation, speed, and configuration. RAMs, ROMs and shift registers—we're in the MOS memory business for keeps.
- If you're sensitive about buying memory components from a memory system manufacturer, rest easy. We have no intention of building systems, just the best RAMs you can buy.
- Oh, and one other good reason: We think National designed a hell of a good part!

Here's the list of parts:

F/N	Chip Enable Input	Access Time	Read/Write Cycle	Read/Modify/Write Cycle Time	Package
5280	MOS	200 nsec	400 nsec	520 nsec	22 pin
5270	MOS	200 nsec	400 nsec	580 nsec	18 pin
5281	Bipolar	250 nsec	400 nsec	510 nsec	22 pin
5271	Bipolar	250 nsec	400 nsec	560 nsec	18 pin

We decided to use the same part numbers as National with an SY prefix. The numbers game in 4K RAMs is confusing enough already without another handful of 4 digit product codes.

For more information write or call Synertek, 3050 Coronado Drive, Santa Clara, CA 95051. (408) 241-4300. TWX 910-338-0135.



Synertek

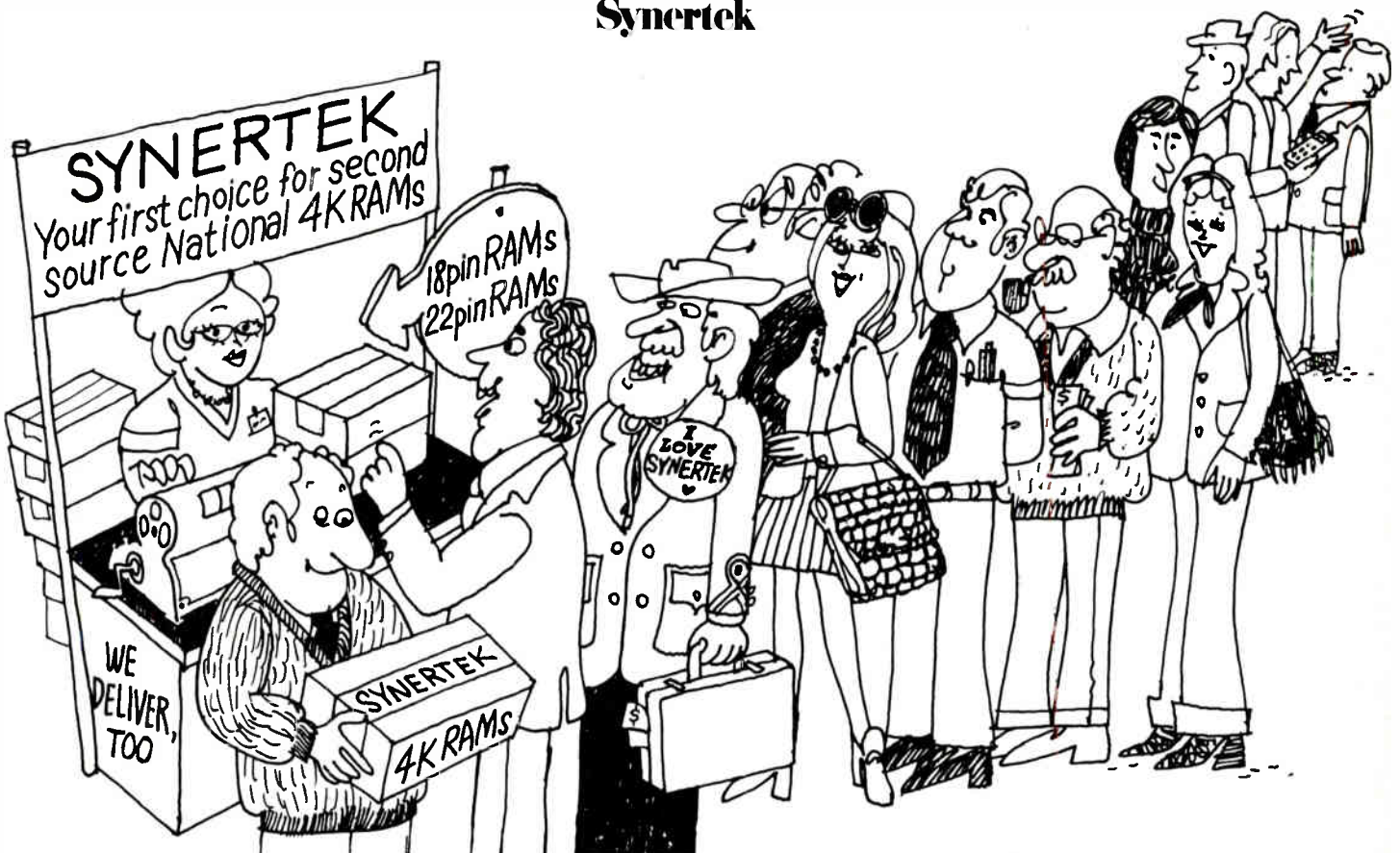

CIRCLE NUMBER 59

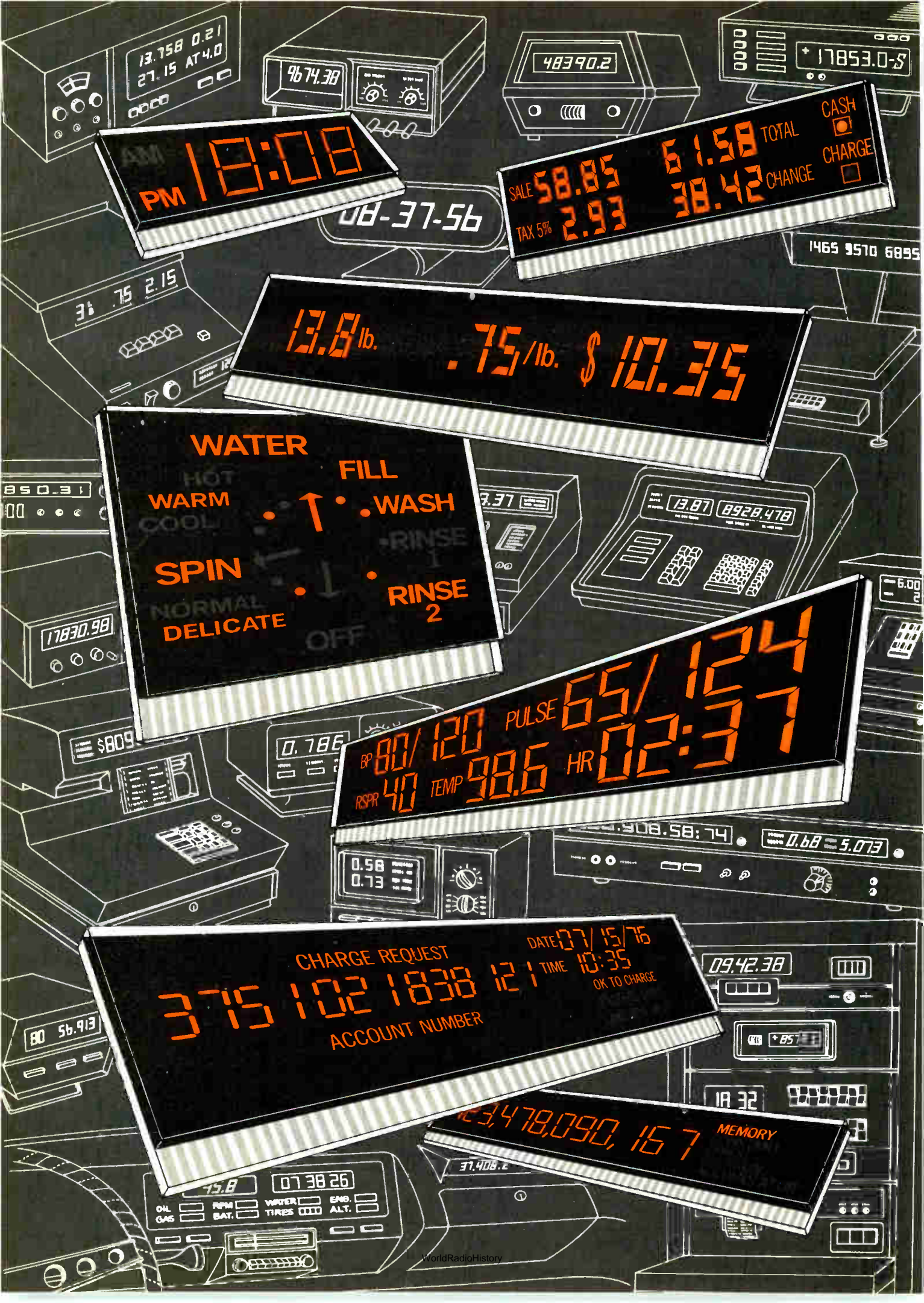

AM 10:08
PM 10:08

9674.38

48390.2

17853.0-S

SALE 58.85
TAX 5% 2.93
61.58 TOTAL
38.42 CHANGE
CASH
CHARGE

08-37-56

1465 9510 6895

13.8 lb.
.75/lb. \$ 10.35

WATER
HOT WARM COOL
FILL
WASH
RINSE
SPIN
NORMAL DELICATE
RINSE 2
OFF

BP 80/120 PULSE 65/124
RSR 40 TEMP 98.6 HR 02:37

CHARGE REQUEST
DATE 07/15/76
TIME 10:35
OK TO CHARGE
ACCOUNT NUMBER
375 102 1838 121

3,478,090, 157
MEMORY

07.38.26
OIL RPM WATER ENG.
GAS BAT. TIRES ALT.

Finally, the medium that fits your message.

Beckman Screened Image Displays... a new concept for communicating your total message in a customized, single-package, information display that's both reliable and cost-effective.

Now, for the first time, you choose the font, and the numeric style. Put together symbols, outline pictures, words, numbers. In any way necessary to make your point . . . and to make your display the focal point of your product.

When you understand this concept, you'll probably say, "they made that just for me." Or, "I can do practically anything I want with that display package." And, you can.

Screened Image Displays offer display areas of up to 10" by 2" . . . with characters that can range from 1/4" to 2" in height. In other words, you're no longer limited to a certain number of digits, or even character size and style. Within reason, virtually anything goes. At your direction, we will develop a display to fit your product's personality and specific requirements.

At last, there's a display medium that fits your message.

Screened Image Displays are like a breath of fresh air compared to the rigid confines of standard display formats. You choose your own special message — composed of numbers, characters, symbols, in your preferred style. Position the elements of your message as you like within the display area, to maximize the sales appeal of your product. We'll do the rest; and, with the fastest turnaround possible for custom displays.

Besides the versatility of visual effects, Screened Image Displays also offer technical flexibility. They can be operated Multiplexed or pulsed DC, and require, nominally, 180 Volts DC with standard drives (our own DD-700 for example). And, you can make connections with flying leads, or go with our edgeboard connector. Screened Image Displays also shine when it comes to brightness; and, they provide comfortable viewing angles as well (our 1" high character gives you a minimum of 150°).

It's like neon on a screen . . . to light-up your message in vivid oranges . . . filterable to red; and, it provides outstanding visibility, letter-perfect numbers and natural, flowing lines.

And, it's all in one very reliable package!

Given the 25-year reliability history of Planar Gas-discharge displays, you can almost calculate life-expectancy. More importantly, there's Beckman's long record of reliable products, fostered by outstanding materials R. & D. and enviable mass-production capability. As a result, we can give you a warranty that's good for 1 year. (Or, you may qualify for our Warranty Plus option.)

Whether you're designing a cash register, instrumentation panel, digital scales, electronic games, or highlighting a message of any kind, Screened Image Displays give you a new way of communicating your *total* message. In your style. A style that stands out from all others. Beckman Displays. The Visible Edge.

Even with this flexibility, we can deliver a truly cost-effective product. Imagine the savings you can achieve simply by incorporating in *one* integrated package *all* the display functions of your equipment. To introduce you to this new concept, we've developed a kit that contains a wealth of information about Screened Image Displays. It also contains the means for you to tell us about your design requirements. We'll respond promptly with a proposal that will make your eyes light up . . . like Screened Image Displays!

To get your Information Kit, write: "Screened Image Displays", Beckman Instruments, Inc., Information Displays Operations, P.O. Box 3579, Scottsdale, AZ. 85257: or call (602) 947-8371.

Screened Image Displays

Beckman®

INFORMATION DISPLAYS OPERATIONS

Hold noise down with JFETs. Circuit design and device selection are simple once the type and magnitude of the noise source are known.

You can build a low-noise amplifier using either a bipolar transistor or a junction field-effect transistor (JFET). The bipolar types are plagued by limited bandwidth, popcorn noise and complex design procedures to optimize noise performance—problems JFETs don't share. Instead, they offer low distortion and a wide dynamic range in low-noise-amplifier applications.

Early JFETs were identified with applications involving very-high source impedance. Today's JFETs offer noise figure (NF) superior to bipolars, for a source impedance as low as 500 ohms; even below 500 ohms, JFETs compete if popcorn noise, bandwidth and circuit component noise are included. (See Fig 1.)

Device selection and circuit design are much simpler for JFETs than bipolars once the type of source is known—resistive, capacitive or inductive. But before low-noise amplifier design procedure is outlined, a review of noise parameters and their characterization will be helpful.

First, a review of noise parameters

Before guidelines are established for designing low-noise JFET amplifiers, a method of noise characterization must be chosen. Designers are confronted with a multitude of different noise parameters including noise figure (NF), noise voltage and current densities, noise temperature, and noise resistance. Designers are primarily concerned with signal-to-noise (S/N ratios), preferring noise voltage (e_n), and current density (i_n).

Noise generally manifests itself in three forms: thermal noise, shot noise and flicker or "1/f" noise. Thermal noise arises from thermal agitation of electrons in a conductor and is given by Nyquist's relation:

$$\overline{V_R^2} = 4kTR\Delta f, \quad (1)$$

where $\overline{V_R^2}$ = mean square noise voltage
 k = Boltzmann constant,

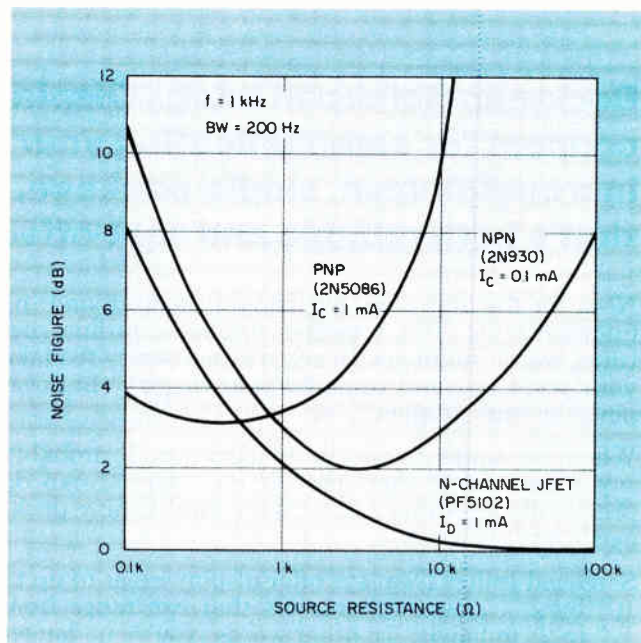

1. JFETs outperform bipolar transistors for low noise when source resistance exceeds 500 ohms.

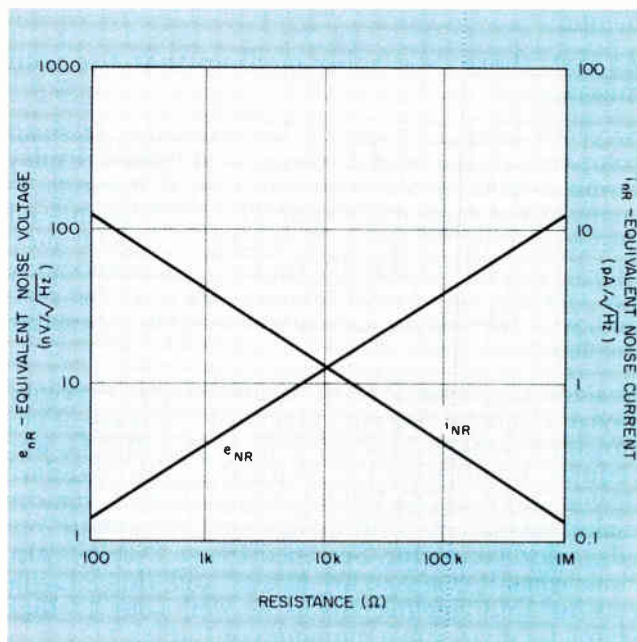

2. The equivalent noise voltage (e_{nR}) and equivalent noise current (i_{nR}) of a resistor may be quickly selected from this chart.

John Maxwell, Senior Engineer, National Semiconductor Corp., Santa Clara, CA 95051

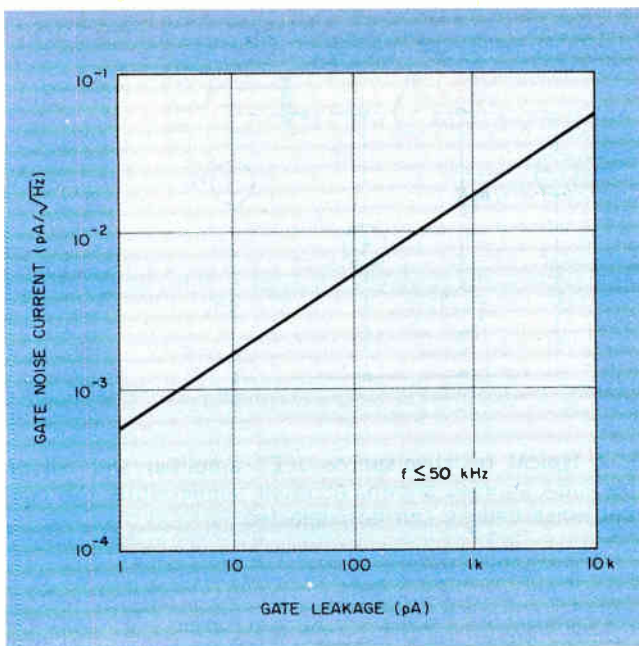

3. At 50 kHz or lower an increase in gate leakage current produces an increase in gate noise current.

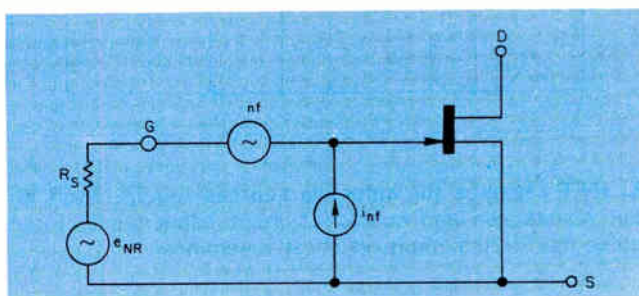

4. A simple JFET noise model may be constructed using thermal noise and shot noise sources.

$$(1.38 \times 10^{-23} \text{ VAS}/^\circ\text{K})$$

T = absolute temperature (K)

R = resistance (in ohms)

Δf = noise bandwidth (Hz)

The noise of a resistor (Fig. 2) may be represented as a spectral density (V^2/Hz) or more commonly in $\mu\text{V}/\text{Hz}$ or nV/Hz and is given by

$$e_{nR} = (\overline{V^2_R} \Delta f)^{1/2} \quad (2)$$

It is sometimes more convenient to represent thermal noise as noise current instead of a noise voltage. Using the Norton equivalent yields a noise-current density of

$$i_{nR} = \frac{e_{nR}}{R} = \left(\frac{4kT}{R} \right)^{1/2} \quad (3)$$

The second basic form of noise, shot noise, is due to the randomness of current flow (discrete charge particles) in semiconductor pn junctions.

$$\overline{i^2} = 2qI_{DC} \Delta f \quad (4)$$

$\overline{i^2}$ = mean square noise current

q = charge of an electron (1.6×10^{-19} As)

I_{DC} = dc current flowing through the junction (A)

Δf = noise bandwidth (Hz)

As with thermal noise, shot noise may be represented as a current density (A^2/Hz) or $\text{pA}/\sqrt{\text{Hz}}$.

$$i_n = (\overline{i^2}/\Delta f)^{1/2} \quad (5)$$

Note that both thermal noise and shot noise are "white" noise sources, i.e., frequency independent. For a JFET, current noise as a function of leakage current is shown in Fig. 3.

The third basic noise source is flicker (or "1/f") noise whose density is roughly inversely proportional to frequency (starting at about 1 kHz in both JFETs and bipolar transistors) and increases as frequency is decreased. Through careful processing, flicker noise in JFETs has been reduced to levels almost insignificant to the designer. In JFETs it is primarily a noise voltage and is source independent; in bipolar transistors it is a function of base and leakage currents, increasing with increased source impedance or operating currents.

A simple noise model of a JFET (Fig. 4) may be constructed using a thermal and shot-noise source that would adequately describe its noise performance, allowing signal-to-noise ratios to be calculated directly.

The input noise per unit bandwidth at some frequency may be calculated from the mean-square-sum of the noise sources (assuming the JFET noise sources are uncorrelated or independent of one another).

$$e_{nt}^2 = e_{nR}^2 + e_{nf}^2 + i_{nf}^2 R_s^2 \quad (6)$$

The total noise in the same bandwidth Δf , where the noise sources are independent of frequency, is simply:

$$V_{noise} = (e_{nt}^2 \Delta f)^{1/2} \quad (7)$$

In practice, noise sources are not frequency independent except for resistor noise with no dc bias applied. The total input noise for the non-ideal case may be calculated by breaking the spectrum up into several small bands and calculating the noise in each band where the noise sources are nearly frequency independent. The total input noise would then be the rms sum of the noise in each of the bands $N_1 \dots N_n$.

$$V_{noise} = (V_{N1}^2 + V_{N2}^2 + \dots + V_{Nn}^2)^{1/2} \quad (8)$$

The final circuit configuration and suitable JFET device will be determined by the following circuit constraints:

- Minimum signal-to-noise ratio (maximum amplifier noise).
- Type and magnitude of source impedance (resistive or reactive).
- Amplifier input impedance requirements.
- Bandwidth and maximum frequency of interest.
- Maximum operating temperature.
- Stage gain.
- Power supply voltage and current limitations.
- Circuit configuration (single or dual device).

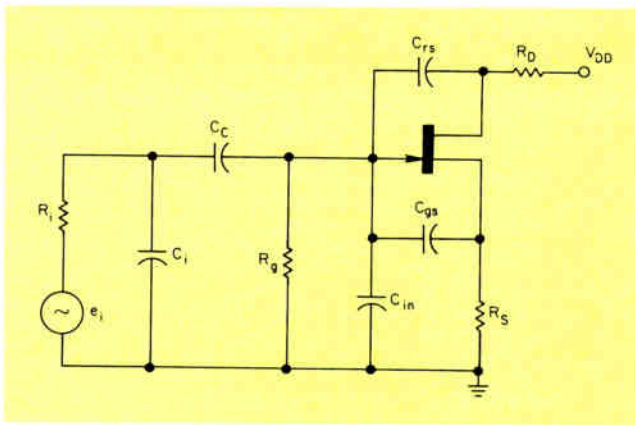

5. JFET preamplifiers with resistive sources rely on the maximum allowable input capacitance to determine the selected JFET geometry, and circuit configuration.

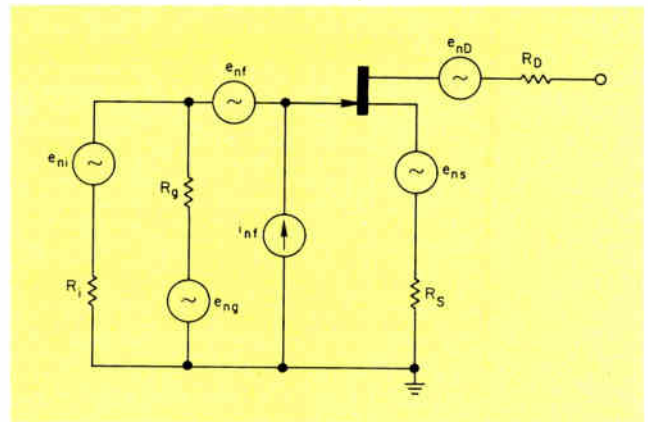

6. A typical resistive-source JFET amplifier with all of the noise sources shown. At room temperature, the current noise usually can be neglected.

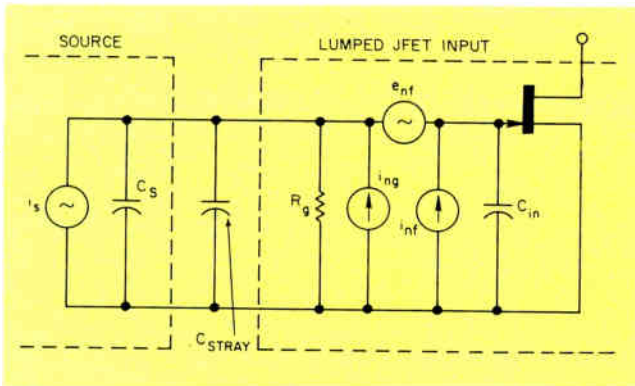

7. Preamplifiers for capacitive sources require high input resistance and controlled input capacitance to match the source capacitance.

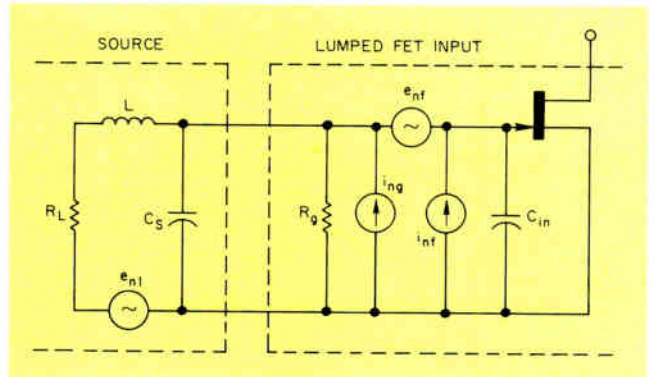

8. JFET preamps for inductive sources require fixed input resistances and controlled input capacitance. Input noise has its maximum value at resonance.

The design procedure is dependent on the type of source and each case must be considered separately. First, let's consider resistive sources since they are the least restrictive for the preamplifier.

Circuit design for resistive sources

Preamplifiers for resistive sources (Fig. 5) are typically voltage amplifiers requiring a fixed input resistance and capacitance consistent with the maximum frequency of interest and source resistance. In most cases, a resistor of the desired value connected between the gate and ground will satisfy the input-resistance requirement, leaving the maximum input capacitance as the major concern.

The maximum amplifier-input capacitance is a function of the JFET source resistor, input resistance, signal-source capacitance and maximum frequency. The maximum allowable input capacitance will be used to screen out unsuitable JFET geometries, thus optimizing the circuit configuration. Sometimes the JFET geometry (or type) with the lowest noise may also have an input capacitance that makes it unsuitable. The JFET input capacitance should be considered be-

fore noise in high-source-resistance, wideband-amplifier designs:

$$C_{in} = C_{rs} \left(1 + \frac{g_m R_D}{1 + g_m R_{rs}} \right) + \left(\frac{C_{gs}}{1 + g_m R_{rs}} \right), \quad (9)$$

where $C_{gs} = C_{is} - C_{rs}$.

If low input capacitance is required, a cascode configuration minimizes input capacitance and still allows high gain. This configuration also lowers the voltage across a device, reducing device heating (for high-current operation) and gate-leakage currents.

Once the basic circuit configuration has been decided upon (or dictated by gain, bandwidth and power-supply limitations), the final JFET selection will be based on noise. By redrawing the amplifier shown in Fig. 4 with all of the noise sources (Fig. 6), the total amplifier noise per unit bandwidth can be found:

$$e_{nt}^2 = e_{nig}^2 + e_{nf}^2 + e_{ns}^2 + \frac{e_{ni}^2}{A_v^2} + i_n^2 (R_i || R_g)^2, \quad (10)$$

where

e_{nig}^2 = the noise of the parallel connection of R_i and R_g

e_{nf}^2 = the noise voltage of the JFET

Converting noise parameters

Due to large values of noise current (i_n) it is more convenient to present noise data for bipolar transistors in the form of contours of constant noise figure at a fixed frequency, or plots of noise figure versus frequency at a fixed source resistance. Noise figure must be converted to an effective noise voltage (e_{nE}) for comparisons to be made between a bipolar transistor and a junction field-effect transistor (JFET); or by definition:

$$NF = 10 \log \left(\frac{\text{total output noise power}}{\text{output noise power of the source}} \right)$$

From Eqs. 1 and 2,

$$\text{source noise power} = \frac{e_{nR}^2 \Delta f}{R_s}$$

$$\text{total noise power} = \frac{e_{nR}^2 \Delta f}{R_s} + \frac{e_{nI}^2 \Delta f}{R_s} + i_{nI}^2 R_s^2 \Delta f$$

The noise power figure (NF) can now be expressed in terms of the noise generators e_{nR} , e_{nI} and i_{nI} . Noise figure can be converted to effective noise voltage (e_{nE}).

$$NF = 10 \log \left(1 + \frac{e_{nI}^2 + i_{nI}^2 R_s^2}{e_{nR}^2} \right),$$

yielding

$$e_{nI}^2 + i_{nI}^2 R_s^2 = e_{nE}^2 = (10^{NF/10} - 1) e_{nR}^2.$$

The effective noise-voltage density (e_n) and noise-current density (i_n) are found directly by

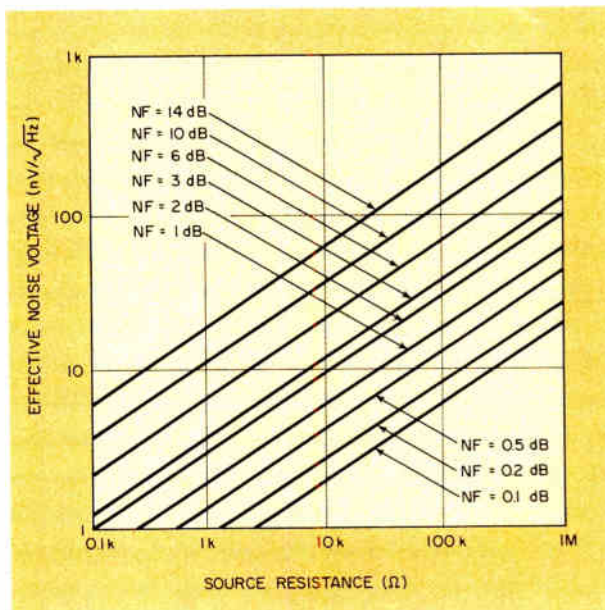

The effective noise voltage (e_{nE}) can be quickly converted to noise figure (NF) once the source resistance is given.

referring to the above curves, and reading the value for the corresponding noise resistance:

$$e_{nR} = (4KT)^{1/2}$$

$$i_{nR} = \frac{4KT}{R}$$

e_{nS} = the noise of the FET-source resistor R_s

$\frac{e_{nD}^2}{A_v^2}$ = the noise at the drain (thermal noise of the load plus the second stage noise)

$i_n^2 (R_i/R_g)^2$ = the current noise contribution of the JFET

Current noise can be ignored

When the amplifier is operated at room temperature and moderate drain voltages, the current-noise term is usually negligible at source resistances as high as 10 M Ω . Depending on the voltage gain of the stage, the drain-circuit noise may be negligible, thus simplifying the input noise expression:

$$e_{nI} = (e_{nR}^2 + e_{nI}^2 + e_{nS}^2)^{1/2} \quad (11)$$

The final JFET selection will be based on the noise requirements as given by the maximum allowable noise:

$$V_{MAX} = (e_{nI}^2 + e_{nS}^2)^{1/2} \quad (12)$$

Depending on V_{max} and e_{nI}^2 , the FET source resistor may have to be bypassed to ground to eliminate the noise of the bias resistor.

Preamplifiers for capacitive sources (Fig. 7) are primarily current amplifiers requiring very

high input resistance and controlled input capacitance to match the source capacitance.

The source capacitance should equal the sum of the preamplifier input capacitance and the stray capacitance for maximum frequency response and power transfer from the signal source. Assuming the gate resistor, R_g , is so large as to not load the capacitive source, the input-noise voltage is:

$$e_{nI} = \left[e_{nI}^2 + (i_{nI}^2 + i_{nR}^2) \frac{R_g^2}{(1 + \omega^2 R_g^2 C^2)} \right]^{1/2} \quad (13)$$

When the source and input capacitance are matched the final JFET geometry will be selected on two criteria—the noise voltage, e_n , and the current noise from the gate leakage, $I_{G(ON)}$ —to optimize the signal-to-noise ratio. As in the resistive-source case, the circuit configuration and JFET selection is an iterative process, using all of the external circuit constraints and device limitations.

Finally, the inductive source

Amplifiers designed for inductive sources (including transformers) require fixed input re-

Table 1. Steps for calculation of source-impedance noise

f range	(Hz)	50-100	100-200	200-400	400-800	800-1600	1600-3200	3200-6400	6400-12,800
f center	(Hz)	75	150	300	600	1200	2400	4800	9600
Δf	(Hz)	50	100	200	400	800	1600	3200	6400
Q	$\frac{\omega L_s}{R_s}$	0.174	0.349	0.698	1.4	2.79	5.58	11.16	223
Q ²		0.0304	0.122	0.487	1.95	7.79	31.2	124.6	498.6
14Q ²		1.0304	1.122	1.487	2.95	8.79	32.2	125.6	499.6
$\frac{1 + Q^2}{Q^2}$		33.9	9.2	3.05	1.51	1.13	1.03	1.008	1.00
R _p	(Ω)	1.39 k	1.52 k	2 k	3.98 k	11.9 k	43.5 k	169.6 k	674.5 k
L _p	(H)	17	4.6	1.53	0.76	0.57	0.52	0.5	0.5
R _p /R _s	(Ω)	1.35 k	1.47 k	1.93 k	3.67 k	9.5 k	22.6 k	36.8 k	43.9 k
X _L	(Ω)	8 k	4.33 k	2.88 k	2.86 k	4.3 k	7.85 k	15.11 k	30.1 k
X _c	(Ω)	10.6 M	5.3 M	2.65 M	1.33 M	0.662 M	0.331 M	0.165 M	82.8 k
R _s (Z _{in})	(Ω)	1.31 k	1.31 k	1.33 k	1.39 k	1.62 k	2.54 k	6.27 k	23.6 k
e _n	(nV/√Hz)	4.5	4.5	4.5	4.6	5	6.2	10	20
V _N	(nV)	31.8	45	63.6	92	141	248	566	1600
V _N ²	(nV ²)	1011	2025	4045	8460	19,870	61,500	318,000	2.56 M
$\Sigma V_N^2 = 2.97 \mu V^2$ or V _N = 1.72 μV									

sistances (as in the resistive-source case) and controlled input capacitance (as in the capacitive-source case). (See Fig. 8.) The input noise per unit bandwidth will rise with increasing frequency to a maximum value at resonance.

The inductive source amplifier is the most difficult to analyze because of the complex input impedance. The input noise per unit bandwidth is given by:

$$e_{nt}^2 = e_{nr}^2 + i_{nr}^2 |Z_{in}|^2 + 4kT \operatorname{Re}(Z_{in}) \quad (14)$$

where $Z = X_{c,IN} || R_s$

$$\text{and } Z_{in} = Z || (Z_L + R_L) \quad (15)$$

Usually the current noise of the JFET is negligible, simplifying the expression a little, but not much. The optimization process for inductive sources is very complex and it will require the spectrum to be broken up into several small bands to arrive at a final design. Generally a JFET with a minimum noise voltage will be the proper choice.

Transformers may be used with JFET amplifiers to minimize noise with very low source impedances. Transformers have both drawbacks and advantages and both must be examined before a transformer design is chosen. Poor frequency response, susceptibility to mechanical and magnetic pickup, and thermal noise head the list of disadvantages to be weighed against two very important advantages.

First, the noise voltage is transformed by the turns ratio, N; second, the resistance is transformed by N². These allow us to match very low values of source resistance to a relatively noisy amplifier and still maintain a good signal-to-noise ratio. The total noise at the source, assuming an ideal transformer is,

$$e_{nt}^2 = e_{nr,s}^2 + \frac{e_n^2 \operatorname{Amp}}{N^2} \quad (16)$$

Designing a low-noise inductive-source preamp

Let's proceed with a step-by-step design for a low-noise preamplifier with a magnetic phono-cartridge as the inductive source.

The requirements and circuit parameters are as follows:

Transducer characteristics: L_s = 0.5 H, R_s = 1.35 k.

Frequency response: 50 Hz to 12.8 kHz.

Minimum S/N: 60 dB.

Minimum signal: 2 mV/1 kHz.

Voltage gain: 30.

Input resistance: 47 kΩ.

Amplifier input capacitance: 50 pF max.

Total input capacitance: 200 pF.

Power available: ±15 V at 1 mA.

Step 1. Calculate maximum amplifier noise, V_{max}. (The FET noise current i_{nr} is negligible as in almost all low noise designs).

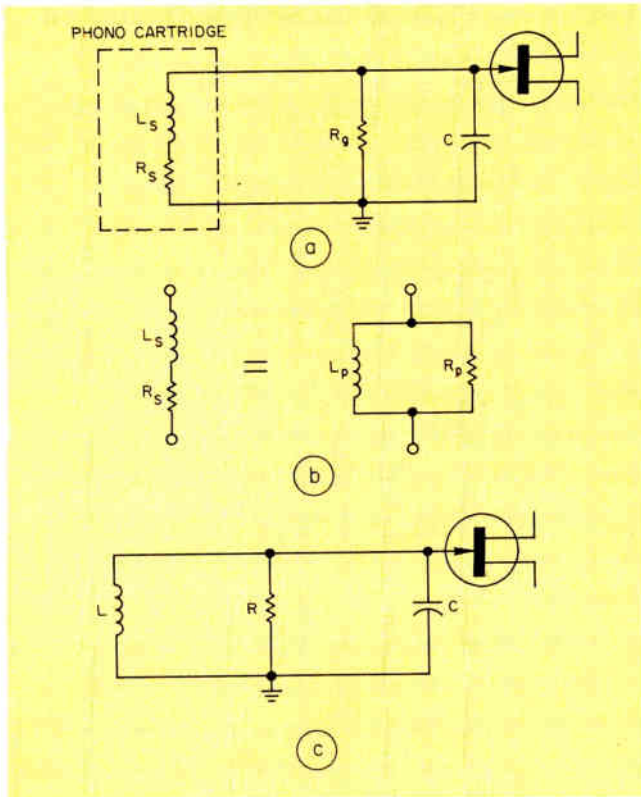

9. JFET low-noise preamp stage for a magnetic phono cartridge (a); simplified network is shown in (b) and final input network in (c).

From Eq. 14, $e_{n_{in}}^2 = e_{n_c}^2 + 4kT (\text{Re}(Z_{in}))$ where $4kT (\text{Re}(Z_{in}))$ is the noise spectral-density of the complex source impedance (only the real part generates noise).

Through the use of Q equations, we can transform series to parallel impedances—from Fig. 9 (a) to 9 (b):

$$Q = \frac{\omega L_s}{R_s}$$

$$R_p = R_s (1 + Q^2), L_p = L_s \frac{(1 + Q^2)}{Q^2}$$

Now the input network simplifies to Fig. 9 (c) where

$$L = L_p \text{ and } R = R_p \parallel R_s,$$

whose impedance is given by

$$Z_{in} = \frac{R X_L X_C^2 (X_L X_C - j (R X_L - R X_C))}{(R X_L - R X_C)^2 + X_L^2 X_C^2}$$

Then the real part is given by

$$\text{Re}(Z_{in}) = \frac{R X_L^2 X_C^2}{(R X_L - R X_C)^2 + X_L^2 X_C^2}$$

In this case,

$$V_{noise} = [(e_{n_c}^2 - e_{n_{in}}^2) \Delta f]^{1/2} = [4kT R_e (Z_{in}) \Delta f]^{1/2}$$

is the noise of the phono cartridge and the pre-amp input impedance. Because of the frequency dependence of the input network (and of the noise), the noise spectrum will have to be broken up into small bands and the noise per band found.

Octave bands should be adequate for approximating the noise. The impedance should be calculated at the center of each band. The noise should be calculated by multiplying $e_{n_c}^2$ by the bandwidth. Next, take the rms sum of all the bands to find the total noise. (See Table 1.)

Now the maximum amplifier noise may be found:

$$V_{MAX} = \left[\frac{(\text{min signal})^2}{\text{min S/N}} - V_{nf}^2 \right]^{1/2}$$

$$V_{MAX} = 1 \mu\text{V}.$$

Broadband-noise limit $e_{n, limit}$

$$\frac{V_{MAX}}{\sqrt{\Delta f}} = 8.9 \text{ nV}/\sqrt{\text{Hz}}.$$

Step 2. Determine maximum FET load resistance and minimum transconductance.

The maximum FET load is found as follows:

$$V_{DG, min} = 1/2 V_{DD} = 7.5 \text{ V}$$

$$R_{D, max} = \frac{V_{DG, min}}{I_{D, max}} = 7.5 \text{ k}\Omega.$$

Then minimum transconductance with a bypassed source is:

$$\text{min } g_m = \frac{A_V}{R_D} = 4 \text{ mmhos}.$$

PF5102, PN4393 and J309 type devices all meet the minimum gain requirement.

Step 3. Check maximum input capacitance.

For PN4393, PF5102 types,

$$C_{rss} = 4 \text{ pF}.$$

For J309,

$$C_{rss} = 1 \text{ pF}.$$

$$C_{rss, max} = \frac{C_{in, max}}{A_V} = 1.6 \text{ pF}$$

This capacitance level eliminates all but the J309 with $C_{in} = 30 \text{ pF}$, however, the PN4393 or PF5102 types could be used in a cascode configuration at the expense of an extra FET.

Step 4. Check J309 noise performance. Typical noise at $f = 1 \text{ kHz}$, $I_D = 1 \text{ mA}$; $e_n = 5 \text{ nV/Hz}$ (which is less than the broadband requirement of 8.9 nV/Hz). Typical J309 noise performance over the frequencies of interest is shown in Table 2. FET noise = $0.44 \mu\text{V}$, with a limit of $1 \mu\text{V}$.

Step 5. R_s (source-biasing resistor) considerations. For a J309, $I_{DSS} = 12\text{-}30 \text{ mA}$. Examining the geometry characterization we find

$$V_{p, min} = 1.8 \text{ V } (I_{DSS} = 12 \text{ mA})$$

$$V_{p, max} = 3.4 \text{ V } (I_{DSS} = 30 \text{ mA})$$

with a typical $I_{DSS} = 21 \text{ mA}$, $V_{p, typ} = 2.7 \text{ V}$.

The gate to source voltage will be

$$V_{GS, typ} = V_{p, typ} = \left[1 - \left(\frac{I_D}{I_{DSS}} \right)^{1/2} \right] = 2.1 \text{ V}.$$

Using the -15 V supply to bias the source, the bias resistor is found:

$$R_s = \frac{15 \text{ V} + V_{es, typ}}{I_{D, max}} = 17 \text{ k}\Omega,$$

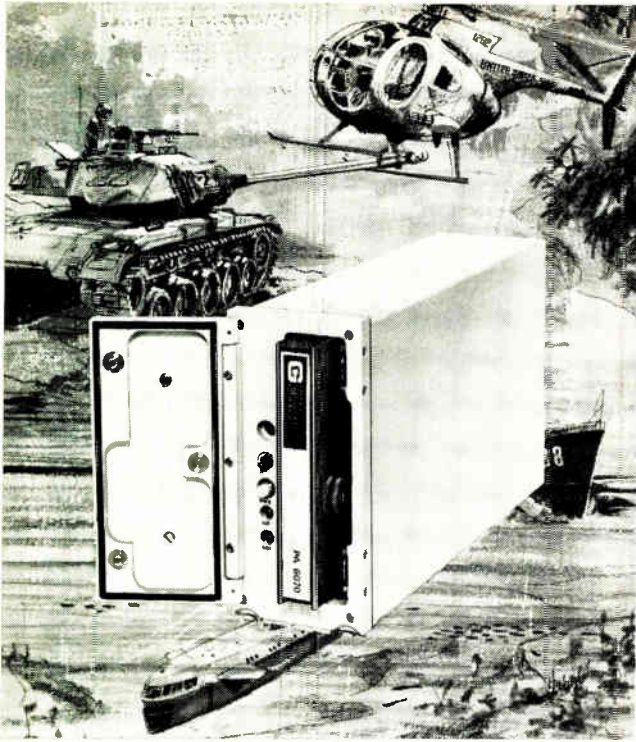

COMPACT MAGNETIC TAPE CARTRIDGE RECORDER/REPRODUCER

...for Cost Effective, Reliable
Operation in Severe Environments.

The Model ECR-10 features:

- Qualification to Army/Navy/Air Force environmental requirements.
- Complete recorder/reproducer with electronics and power supply in 3/8 ATR short case or standard rack mount (8.75" x 4.0" x 13.75").
- Record and playback speeds up to 60 ips; search and wind speeds up to 120 ips.
- Parallel 7, 8 or 9-track computer-compatible digital or analog recording.
- Up to 600 feet of 1/2-inch tape in a unique, environmentally capable, self-tensioning cartridge.
- Easy cartridge insertion and removal with positive positioning and locking in the transport.
- No reel motors required - tape directly driven by servo-controlled capstan motor
- Large reel recorder operational capabilities, including bi-directional Read After Write and Erase functions.
- Very fast Start and Stop for bilateral inter-changeability with computer generated tapes.

For complete ECR-10 details, call
Les Turner at (213) 537-4750

An Equal Opportunity Employer M/F
**GENISCO TECHNOLOGY
CORPORATION**
Systems Division

18435 Susana Road, Compton, CA 90221 (213) 537-4750

CIRCLE NUMBER 62

Table 2. Typical noise performance
for J309

f (Hz)	Δf (Hz)	$e_{n, 13P}$ (nV/ $\sqrt{\text{Hz}}$)	V_N (μV)	V_N^2 (μV^2)
75	50	10	0.071	0.005
150	100	8	0.08	0.0064
300	200	7	0.099	0.0098
600	400	5.5	0.110	0.0121
1200	800	4.8	0.136	0.0184
2400	1600	4	0.160	0.0256
4800	3200	3.5	0.198	0.0392
9600	6400	3	0.240	0.0576
Total $V_N^2 = 0.193 \mu\text{V}^2$				

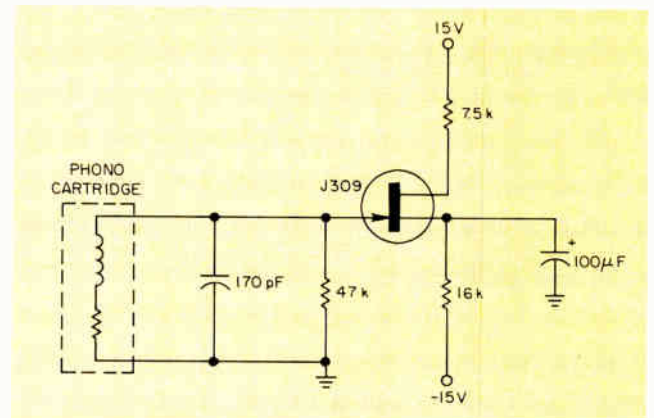

10. The completed magnetic-phono input design uses a J309 low-noise JFET.

the closest standard value is 16 k Ω .

$$V_{GS, \min} \text{ for } V_{p, \min} = 1.28$$

$$V_{SS(\max)} = 2.8 \text{ V}$$

This choice of resistor value will cause approximately $\pm 50 \mu\text{A}$ of change in the drain current for devices within the limits of a production spread.

Total input noise = [(source noise) 2 + (amp noise) 2] $^{1/2}$ = 1.73 μV

$$\text{Final S/N} = \frac{2 \text{ mV}}{1.73 \text{ mV}} = 1150 \text{ (61.2 dB).}$$

The completed magnetic phono preamp input stage is shown in Fig. 10. ■■

Bibliography:

Cobbold, Richard S. C., "Theory and Applications of Field-Effect Transistors," John Wiley & Sons, New York, NY, 1970.

Fristoe, H. T., "The Use of Q Equations to Solve Complex Electrical Networks," *Engineering Research Bulletin*, Oklahoma State University, 1964.

Korn, G. A. and Korn, T. M., "Basic Tables in Electrical Engineering," McGraw-Hill, New York, NY, 1965.

Motchenbacher, C. D., and Fitchen, F. C., "Low-Noise Electronic Design," John Wiley & Sons, 1973.

Van der Ziel, A., "Noise," Prentice-Hall, Englewood Cliffs, NJ, 1954.

Good news from Hughes for radio designers—

Now available a 1021-channel CMOS/LSI digital frequency synthesizer

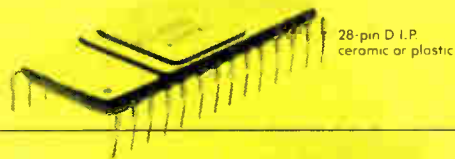

28-pin D I.P.
ceramic or plastic

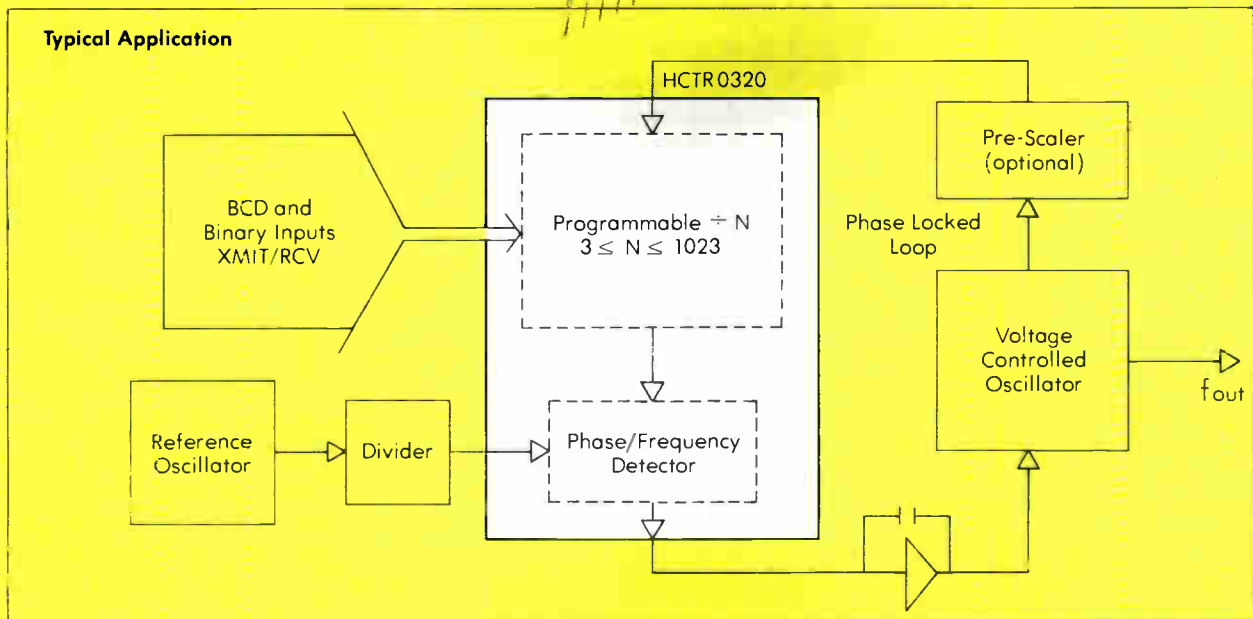

From the largest maker of watch chips comes a digital frequency synthesizer that provides up to 1,021 channels—all from one crystal.

It's the HCTR0320 from Hughes. It uses a phase locked loop technique to maintain the frequency of a voltage controlled oscillator at a selectable multiple of a reference frequency. So only one crystal is needed to generate many output frequencies. The fractional error of each output frequency is the same as

that of the reference. And when operated with a 5V supply, this ion-implanted CMOS is TTL compatible, dissipates only 5 mW and will accept up to 5 MHz input frequency.

The HCTR0320, here ahead of its time, is now available for citizen's band, industrial and military applications.

Mail the coupon for information and samples today and see for yourself how it can reduce your equipment costs as well as increase performance—and flexibility, too.



Mail \$19.76 for your sample today

To: Hughes Microelectronic Products Division
500 Superior Avenue, Newport Beach, Ca. 92663
Attn: MOS Dept. (714) 548-0671

Please send me _____ HCTR0320 Frequency Synthesizer(s)
(Send check or money order in the amount of \$19.76 for each sample, including handling and mailing costs)

Please send specifications.

name _____

company _____

address _____

city _____ state _____ zip _____

Announcing a in 4K RAM

Mostek packs all of this:

1. 200 nsec access time
2. $\pm 10\%$ tolerance on all supplies
3. low capacitance (< 5 pF),
TTL-compatible inputs
4. three-state TTL-compatible output
5. output data latched and valid
into next cycle
6. gated $\overline{\text{CAS}}$
7. $\overline{\text{RAS}}$ only refresh
8. page mode operation with page
access of 135 nsec.
9. read modify write operation

new standard performance.

Into this 16-pin package!

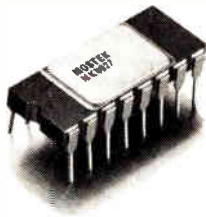

Mostek's new MK 4027 makes 4K RAM performance as revolutionary as the 16-pin package was two years ago. Now, every MK 4027 we ship has $\pm 10\%$ tolerance on all power supplies. And fast access time of 200 nsec. There are no high level clocks and the MK 4027 is Schottky TTL-compatible. That means your system performance can now match data sheet specifications.

Quality is another high standard at Mostek. This quality is inherent in the MK 4027. Mostek 4Ks work . . . and keep working.

Availability? *We've got them stocked on distributor's shelves for immediate delivery.* There's also a complete package of specification data and application information. Call or write Mostek. Or contact any Mostek sales representative or distributor.

DISTRIBUTORS

ARIZONA

Phoenix:
Cramer Electronics
602/267-7312
Kierulff Electronics
602/273-7331

CALIFORNIA

Irvine:
Cramer Electronics
213/771-8300
Los Angeles:
Kierulff Electronics
714/636-1030

Palo Alto:
Kierulff Electronics
415/968-6292
San Diego:
Cramer Electronics
714/565-1881
Kierulff Electronics
714/278-2112
Sunnyvale:
Cramer Electronics
408/739-3011

COLORADO

Denver:
Cramer Electronics
303/758-2100
Kierulff Electronics
303/371-6500

CONNECTICUT

Hamden:
Arrow Electronics
203/248-3807
North Haven:
Cramer Electronics
203/239-5641

FLORIDA

Clearwater:
Diplomat/Southland, Inc.
813/443-4514
Hollywood:
Cramer Electronics
305/923-8181
Orlando:
Cramer Electronics
305/894-1511

GEORGIA

Atlanta:
Cramer Electronics
404/448-9050

ILLINOIS

Elmhurst:
Semiconductor Specialists
312/279-1000
Mt. Prospect:
Cramer Electronics
312/593-8230
Skokie:
Bell Industries
312/965-7500

INDIANA

Anderson:
Graham Electronics
317/644-3381
Fort Wayne:
Graham Electronics
219/423-3422
Indianapolis:
Graham Electronics
317/634-8202
Semiconductor Specialists
317/243-8271
Lafayette:
Graham Electronics
317/423-5564
Muncie:
Graham Electronics
317/288-8837

MARYLAND

Baltimore:
Arrow Electronics
202/737-1700
Gaithersburg:
Cramer Electronics
301/948-0110

Hanover:
Cramer Electronics
301/796-5790

MASSACHUSETTS

Billerica:
Kierulff Electronics
617/667-8331
Newton:
Cramer Electronics
617/969-7700

MICHIGAN

Farmington:
Semiconductor Specialists
313/478-2700

MINNESOTA

Edina:
Cramer Electronics
612/835-7811
Minneapolis:
Semiconductor Specialists
612/854-8841
Stark Electronics
612/333-3361

MISSOURI

Hazelwood:
Semiconductor Specialists
314/731-2400
Kansas City:
Semiconductor Specialists
816/452-3900
St. Louis:
Olive Industrial Electronics
314/863-7800

NEW JERSEY

Cherry Hill:
Cramer Electronics
609/424-5993
Moonachie:
Cramer Electronics
201/935-5600
Moorestown:
Arrow Electronics
609/235-1900
Saddlebrook:
Arrow Electronics
201/797-5800

NEW MEXICO

Albuquerque:
Cramer Electronics
505/265-5767

NEW YORK

East Syracuse:
Cramer Electronics
315/437-6671
Farmingdale:
Arrow Electronics
516/694-6800

Hauppauge, L.I.:
Cramer Electronics
516/231-5600
Rochester:
Cramer Electronics
716/275-0300

NORTH CAROLINA

Winston-Salem:
Cramer Electronics
919/275-8711

OHIO

Cleveland:
Arrow Electronics
216/464-2000
Cramer Electronics
216/248-8400
Dayton:
Arrow Electronics
513/253-9176
Semiconductor Specialists
513/278-9455

PENNSYLVANIA

Pittsburgh:
Semiconductor Specialists
412/781-8120

TEXAS

Dallas:
Cramer Electronics
214/661-9300

UTAH

Salt Lake City:
Diplomat/Alta Electronics
801/486-7227
Cramer Electronics
801/487-4131

WASHINGTON

Seattle:
Cramer Electronics
206/762-5755
Kierulff Electronics
206/763-1550

WISCONSIN

Milwaukee:
Semiconductor Specialists
414/257-1300

CANADA

Downsview, Ontario:
Cramer Electronics
416/661-9222
Montreal:
Prelco Electronics
514/389-8051

MOSTEK

1215 W. Crosby Rd., Carrollton, Texas 75006
214/242-0444

In Europe, Contact:
MOSTEK GmbH, TALSTR. 172, 7024 Bernhausen, West Germany
Telephone: (0711) 701096

CIRCLE NUMBER 65

It could be the 'ideal' filter. Consider the translating filter, which can be set digitally and is accurate to within 1 Hz of the cutoff frequency.

A translating filter comes close to an engineer's "ideal" filter. Would you believe a variable frequency filter whose cutoff frequency is set digitally and boasts accuracy to within ± 1 Hz, whose characteristic is flat to within 1 Hz of the cutoff frequency and then drops 30 dB down a few Hz past cutoff?

Sure, there are drawbacks. The translating filter is ac-coupled so it won't pass dc in the low-pass mode. Total phase shift is large, and the number of components to build the filter is quite high. But it can separate a closely spaced undesired signal from a desired signal better than any presently available conventional filter.

How the translating filter works

The translation filter uses fixed filters but moves the signal spectrum by means of modulation techniques similar to single-sideband (SSB). A block diagram is shown in Fig. 1, and the double-sided frequency spectra at various points in the system are in Fig. 2. The signal first passes through a phase-shift network, where the amplitude is unchanged but the phase difference between the two outputs is 90° . These two outputs are then modulated up in frequency by quadrature phases of a carrier frequency (10 kHz in this instance) and summed. Since balanced modulators are used rather than linear multipliers, a low-pass filter is necessary to eliminate harmonics generated at odd multiples of the carrier frequency. The signal spectrum at point A has been shifted up by 10 kHz, and its mirror image has been eliminated. The dotted lines of Fig. 2 indicate the portions of the spectrum that have been removed by cancellation.

This signal is then modulated down by quadrature phases of a frequency ($10 \text{ kHz} + \Delta f$), where Δf will turn out to be the cutoff frequency. The two outputs pass through another 90° phase shifter and are summed. This signal goes through

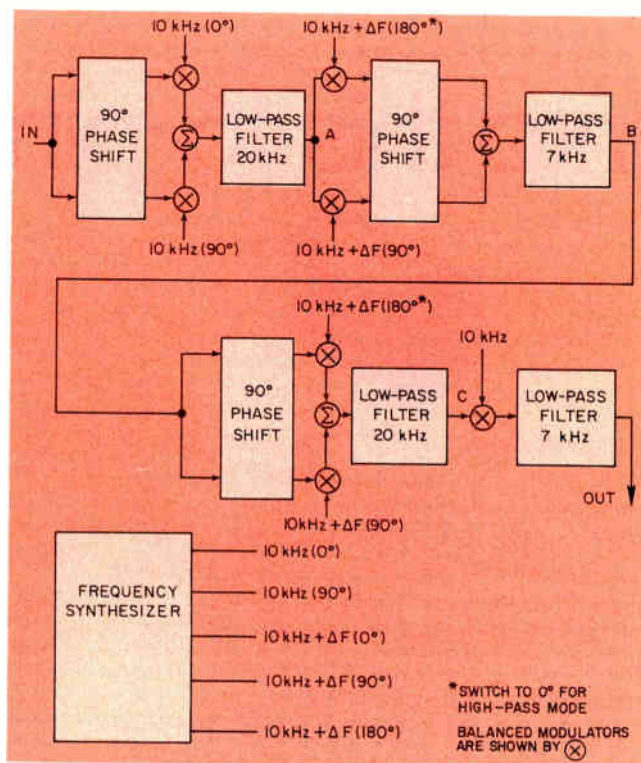

1. Balanced modulators are used to shift the input frequency spectrum in a translating filter.

a low-pass filter to eliminate the double-frequency components and again the harmonics. The signal spectrum has now been shifted partly through zero frequency, and that part of the spectrum not shifted through zero has been eliminated. At point B the filtering action has actually been performed, but the remaining part of the signal spectrum is reversed and shifted by Δf . Essentially the signal has been compared with a reference by frequency differencing, and those components having a difference of greater than zero have been removed. All that's left is to return the remaining portion of the signal to its original location in the frequency spectrum.

The signal once again goes through a 90° phase shifter, is modulated up by quadrature phases of the $10 \text{ kHz} + \Delta f$ signal, summed and low-pass-filtered. The signal spectrum at point C is the desired part of the input spectrum, but it

Dr. Arthur D. Delagrangé, Electronic Engineer, Naval Surface Weapons Center, White Oak, Silver Spring, MD 20910.

is shifted up by 10 kHz. To obtain the final output, this signal is modulated down by an arbitrary phase of the 10 kHz and low-pass-filtered.

To make the over-all filter function high-pass instead of low-pass, it is only necessary to invert the driving signal in one of each pair of (10 kHz + Δf) modulators. This causes the parts of the spectrum that previously canceled to add, and those that added to cancel.

The frequencies for driving the modulators are supplied by an internal synthesizer. If the

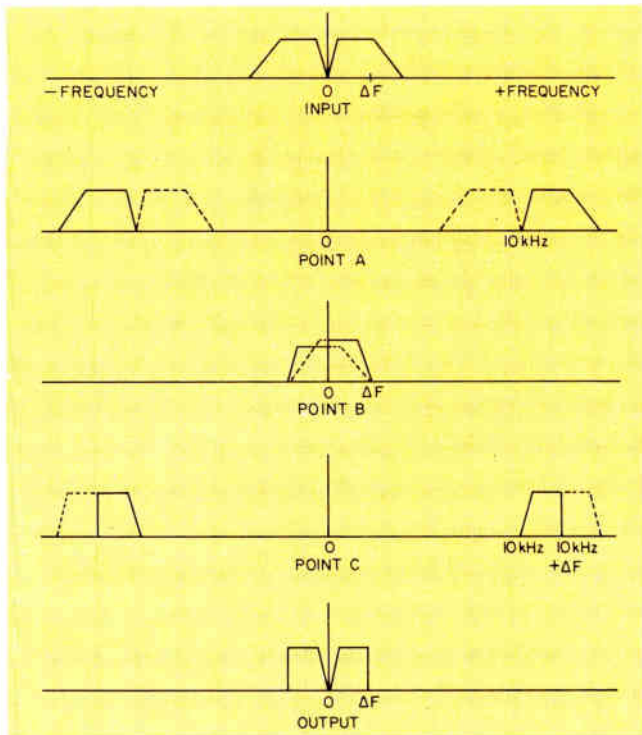

2. The frequency spectra of the translating filter in the low-pass mode. The dotted lines indicate the portions of the spectrum removed by cancellation.

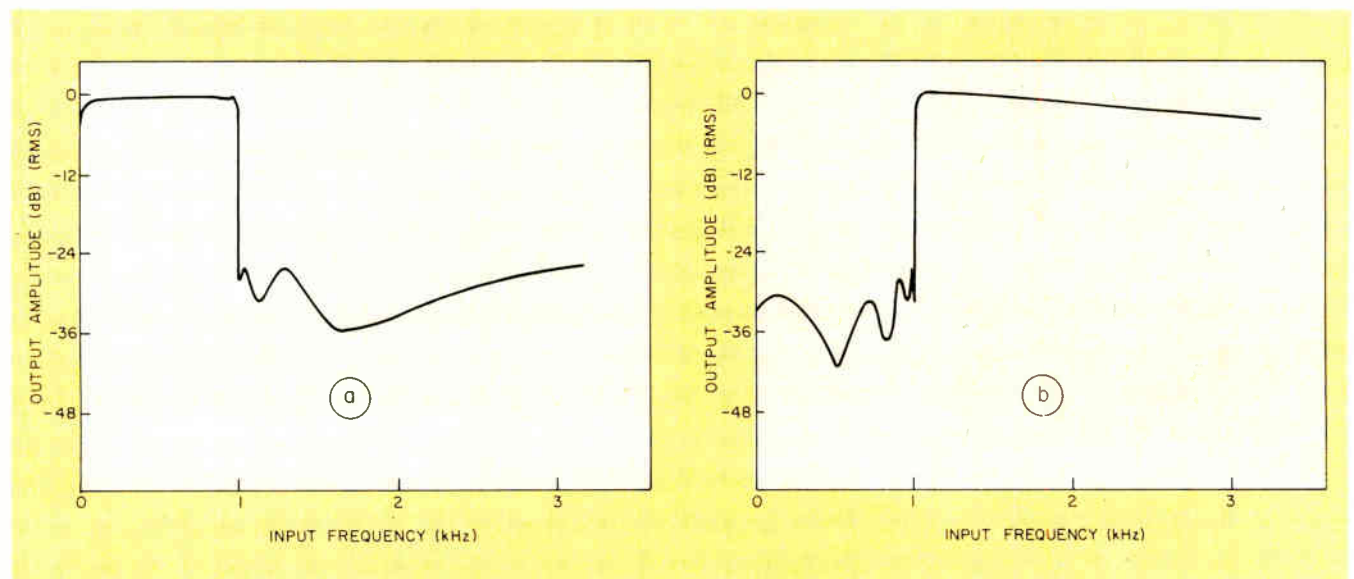

3. The filter output response for a sine-wave input set for 1 kHz low-pass (a) and high-pass (b).

input signal contains frequency components above 10 kHz, a prefilter must be added to prevent aliasing, a condition making it impossible to identify the constituent frequency terms of a complex signal because of sampling errors.

Compare advantages and disadvantages

Since the cutoff frequency of the filter is set by a frequency synthesizer, it is highly stable and repeatable. In addition it's easy to program the synthesizer externally, if desired. The sharpness of the cutoff is limited only by how close to zero frequency the phase shifters operate properly; about 1 Hz is as close as practicable. The passband response of the system is inherently flat, limited only by the flatness of the various fixed filters. All high-accuracy components are fixed; only the modulating frequency is varied, and this is done digitally. The only matched components necessary are pairs of fixed resistors. Also, the analog signals need not leave the circuit board, since only digital signals are handled by the panel controls.

Although the total parts count is rather large, there is considerable repetition. Relatively few different part types are required, and multi-section components, like DIP quads, can be used. Rejection is essentially fixed at about 30 dB, and this does not improve appreciably farther away from the cutoff frequency. Although in theory the filter is linear, in practice it is not; some of the leak-through becomes aliased and appears at the output at a frequency differing from that of the original input. Total phase shift through the system is large and cannot easily be made linear. Transient response exhibits ringing. The system does not pass dc in the low-pass mode, since it is ac-coupled. Passband gain is not inherently

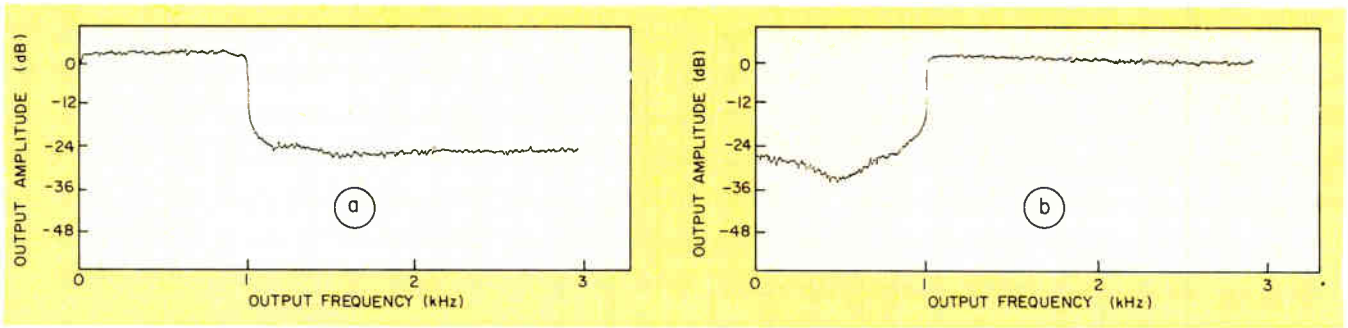

4. The output spectrum for broadband noise input with a 1-kHz low-pass setting (a) and a high-pass mode (b).

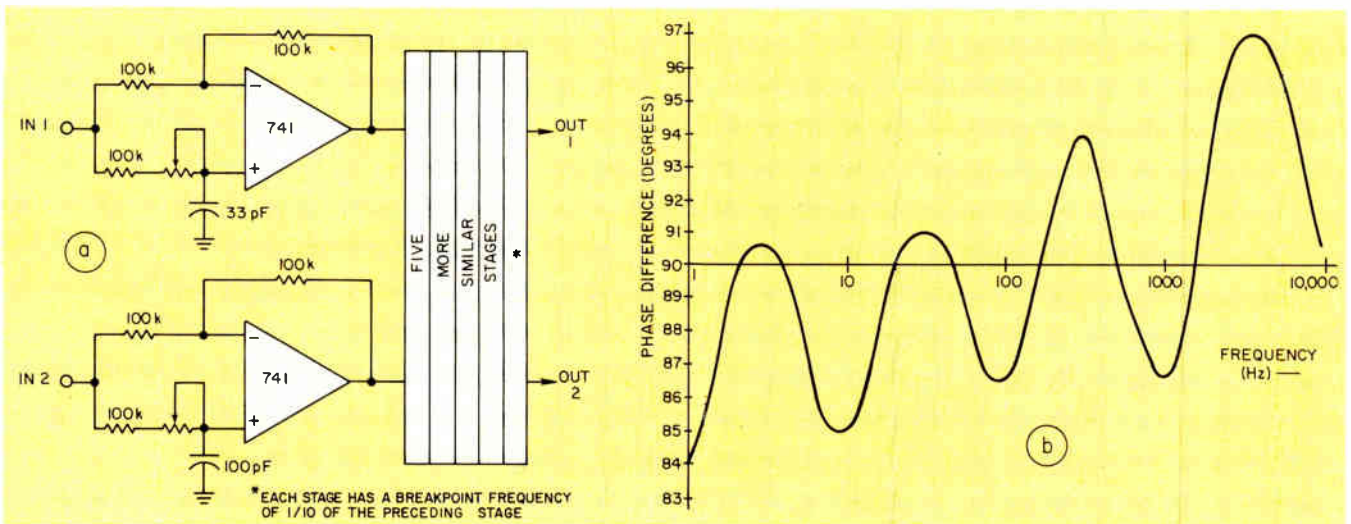

5. The phase shifter consists of a chain of pairs of all-pass networks (a). The over-all phase difference re-

sponse is shown in b. Deviation in phase shift from the ideal 90° limits filter performance.

unity, but is arbitrary and dependent on circuit resistance values.

Does the filter really work?

Yes, the filter has been built and has proved itself in use. Most parts of the system were borrowed from other systems and modified, so the filter is deficient in certain respects. The performance is still very impressive, however.

Fig. 3a shows the output response for a sine-wave input with the filter set for 1 kHz low-pass; Fig. 3b shows the output response for high-pass. Keep in mind that these are not strictly transfer functions, because the measured output isn't always the same frequency as the input.

Fig. 4a shows the output spectrum for broadband noise input with a 1-kHz, low-pass setting, and Fig. 4b shows the same for the high-pass mode. Note that for a linear filter Figs. 3a and 3b would be identical to Figs. 4a and 4b, but for this translating filter, they differ slightly.

Let's analyze circuit elements

The circuits used are shown in Figs. 5 to 8. The phase shifter in Fig. 5a is the only difficult

section of the system to design. It consists of a chain of pairs of all-pass networks. Each all-pass has a gain of 1 and a phase that varies from 0° at low frequency to 90° at the breakpoint frequency and then to 180° at high frequency. Each pair exhibits a phase difference that peaks near 90° between the breakpoint frequencies and falls to 0° above and below. Successive pairs have their breakpoint frequencies spaced logarithmically at decade intervals, somewhat like stagger-tuning a filter. The over-all phase difference characteristic is shown in Fig. 5b. The deviation of this characteristic from the ideal 90° causes incomplete sideband rejection and is the limiting factor for stopband attenuation and nonlinearity.

The balanced modulators (Fig. 6) are assembled from programmable (selectable) op amps, with one connected as a unity-gain follower and the other as a unity-gain inverter. These are adequate at 10 kHz, but for a more general system of higher frequency, high-speed balanced modulators should be used (for example, 796 type).

The 20-kHz low-pass filter (Fig. 7a) is a five-pole, passive constant-k ladder with an op-amp buffer at the output. The 7-kHz filter (Fig. 7b) is similar.

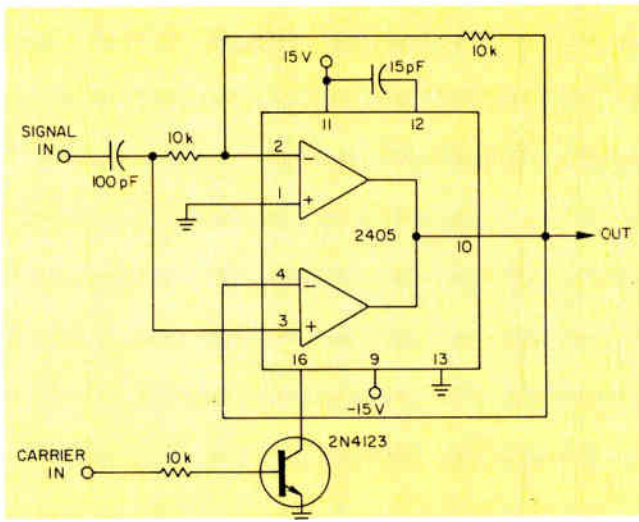

6. The balanced modulators are assembled from programmable (selectable) op amps.

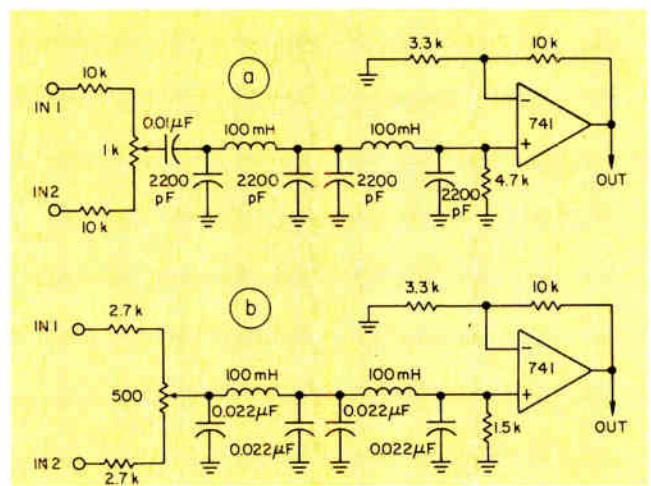

7. The 20-kHz low-pass filter (a) consists of a five-pole, passive constant-k ladder with an op-amp buffer at the output. The 7-kHz filter (b) is similar.

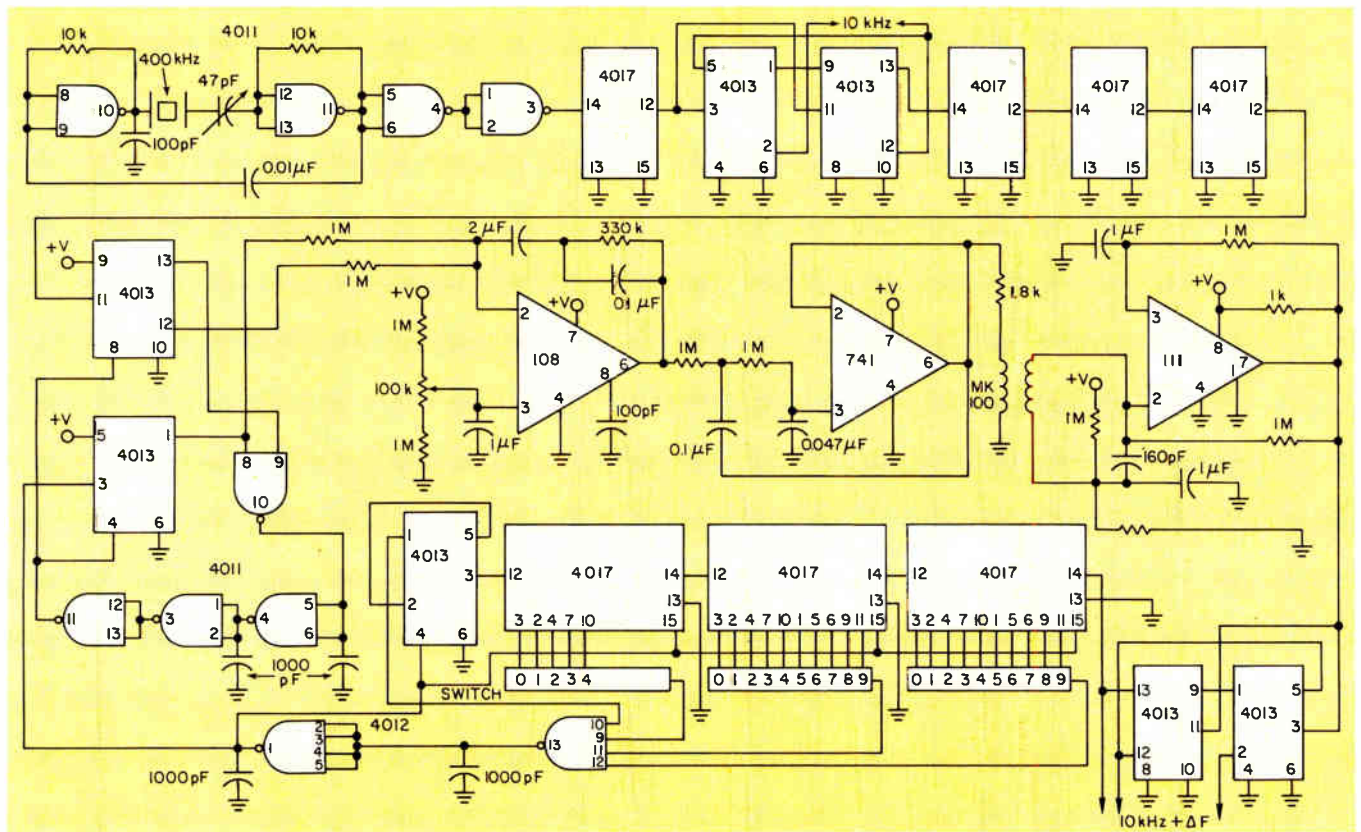

8. The frequency synthesizer uses CMOS logic. It provides 10-Hz frequency steps over a 5-kHz range.

The frequency synthesizer (Fig. 8) is of simple design and uses CMOS logic. A crystal oscillator drives a counter chain, which provides reference frequencies of 10 kHz and 10 Hz. A self-acquiring phase-locked loop^{1,2} with a programmable divider chain is slaved to the 10-Hz signal. The programmable part of the divider chain divides by any number from 1000 to 1499, so the synthesizer can provide a frequency from 10,000 to 14,990 Hz in 10-Hz steps. The control-

ling switch simply reads the actual system cut-off frequency, 0 to 4990 Hz, quantized in 10-Hz steps.

Conventional vs translating filter

Is the conventional filter obsolete? No. The properties of the two types are largely complementary; where one excels, the other is poor and vice versa. In fact, it is sometimes desirable to

Table 1. Performance of conventional³ vs translating filter

Conventional filter	Translating filter
Cutoff frequency is set by linear components, typically accurate to $\pm 5\%$ of reading.	Cutoff frequency is set digitally, accurate to ± 1 Hz.
Attenuation in stopband is basically proportional to frequency raised to some power (low-pass) or inverse of same (high-pass); typically 24 dB/octave per section.	Attenuation in stopband is basically fixed but is achieved about 1 Hz from cutoff frequency; about 30 dB per section in experimental design.
There is always passband attenuation and/or ripple, worse near cutoff, on the order of 3 dB.	There is no inherent droop or ripple, passband may be flat to within 1 Hz of cutoff.
Squareness of frequency cutoff may be traded off for phase linearity and transient response.	Frequency cutoff is inherently square; phase is inherently nonlinear; transient response rings.
Low-pass mode may include dc.	Inclusion of dc in low-pass mode is impractical.
Passband gain may be inherently unity (0-dB insertion loss).	Passband gain is inherently less than unity; must be corrected.
External programming of cutoff frequency is difficult.	Cutoff frequency may be programmed externally simply by a frequency reference.
Linearity is limited only by components.	Filter is not truly linear.
Component count is small, but includes precision ganged pots or decade resistance assemblies.	Component count is large, but all precision components are fixed.
Panel controls must handle analog signals.	Only digital signals are switched (cold switching).

Table 2. Parts needed for conventional filter³ vs translating filter

Part	Conventional filter	Translating filter
Frequency range switch	12-deck selector switch, 1 position per decade	None
Frequency vernier control	4-ganged matched potentiometer plus dial	Decimal thumbwheel switch, one digit per decade
High-pass/low-pass switch	8-pole, 2-throw	1-pole, 2-throw
Precision or trimmed capacitors	4 per decade	None
1% precision resistors	None (see next item)	18 plus 18/decade
Selected or trimmed resistors	16	3 plus 6/decade
Buffer amplifiers	7	4 plus 6/decade
Balanced modulators	None	7
Fixed filters	None	4
Digital circuitry	None	Frequency synthesizer

NOTES: (1) parts count refers to basic design; particular implementation may require more.
 (2) decade refers to decade of frequency coverage.

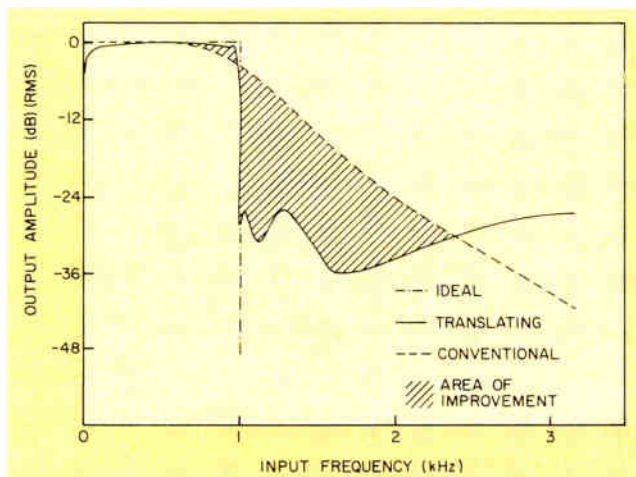

9. The output of a translating filter (solid line) resembles the ideal response closer than the conventional filter (dashed line) does. An ideal filter is shown dotted.

use a combination of the two. Table 1 shows a comparison of the translating filter and a conventional filter.³ A comparison of the parts used in a conventional filter and a translating filter is shown in Table 2.

Since the two filter types are quite different, it is difficult to make specific comparisons. The translating filter greatly simplifies the frequency switches and eliminates precision capacitors, but the design dictates precision resistors, balanced modulators, fixed filters and a frequency synthesizer.

The performance of a translating filter superimposed on the response of a conventional filter (Krohn-Hite 3200) is shown in Fig. 9. The shaded area indicates the area of improvement—as great as 24 dB at some points. Note that the translating filter response is clearly much closer

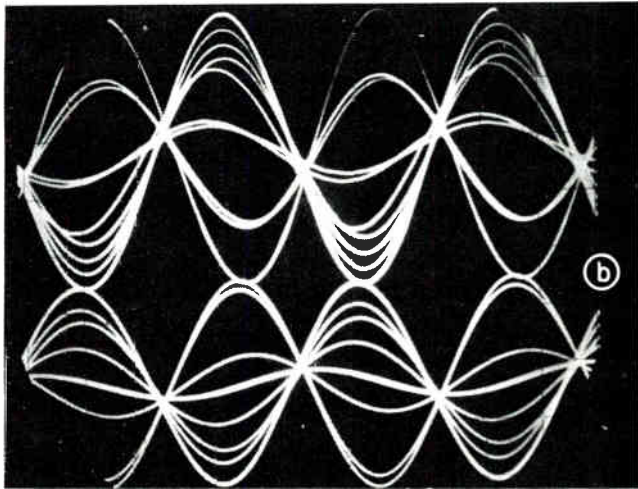
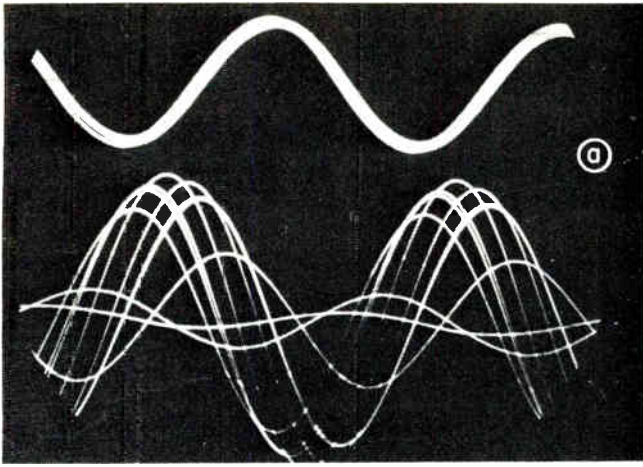

10. The translating filter rejects the closely spaced undesired signal from the desired signal (a), while the conventional filter (b) has little effect.

to the ideal rectangular shape demanded from filters.

An example of a practical application for the translating filter is shown in Fig. 10. The problem involves rejection of one signal, 1002 Hz, just above the filter cutoff frequency, while 998 Hz is retained just below cutoff. The translating filter (a) accomplishes the requirement, while the conventional filter (b) is useless, since its output is virtually the same as the input.

Performance and cost would be considerably higher than the Krohn-Hite 3200 which costs \$500 but considerably less than the Rockland 4136 digital filter⁴ which costs about \$10,000. ■■

References

1. Gardner, F. M., "Phaselock Techniques," Wiley, New York, NY, 1966.
2. Reed, L. J., and Treadway, Ron J., "Test Your PLL IQ," *EDN*, Dec. 20, 1974.
3. "Solid-State Variable Filter Model 3200, Operating and Maintenance Manual," Krohn-Hite Corp., Cambridge, MA 02139.
4. "1974 Short-Form Catalog," Rockland Systems Corp., West Nyack, NY 10994.

Dialight sees a need:

(Need: The widest choice for your every application.)



730 SERIES A new 0.600" LED character in super bright-red, seven-segmented readout . . . low power . . . draws 10mA/segment or less . . . operates with standard IC power supply levels. Very high contrast ratio . . . visible from 40°. Available with or without on-board decoder/driver, plus or minus bar, and with bezel mounting. In 1000-lot quantities each LED
730-6007 \$6.05. 730-6001 \$2.55.

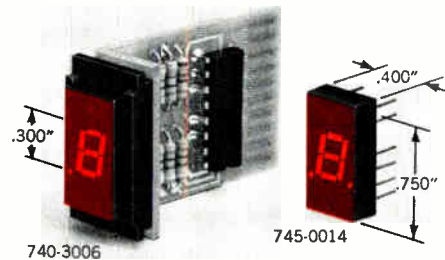

745 SERIES A new 0.300" LED character in a very bright red, seven-segmented readout . . . low power requirements. Standard 14-pin DIP . . . available with left and right decimal with ± 1 , and with and without on-board decoder/driver. Compatible with most TTL and DTL circuits. In 1000-lot quantities each
740-3006 \$6.43. 745-0014 \$2.10.



Dialight, the company with the widest choice in switches, LEDs, indicator lights and readouts, looks for needs . . . your needs . . . and then they develop solutions for your every application. No other company offers you one-stop shopping in all these product areas. And no other company has more experience in the visual display field. Dialight helps you do more with these products than any other company in the business, because we are specialists that have done more with them. Talk to the specialists at Dialight first. You won't have to talk to anyone else. Send for your free new copy of Dialight's current catalog.

DIALIGHT

Dialight, A North American Philips Company
 203 Harrison Place, Brooklyn, N. Y. 11237
 (212) 497-7600

See Dialight.

CIRCLE NUMBER 66

NOW CHOOSE FROM HIGH-VALUE DELCO

MAJOR PARAMETER LIMITS

TYPE	V _{CEO}	V _{CBO}	min h _{FE} @ I _c	Package*
DTS-4061	600V	—	8 @ 15A	TO-3
DTS-4059	600V	—	5 @ 15A	TO-3
DTS-4041	400V	—	8 @ 15A	TO-3
DTS-4039	400V	—	5 @ 15A	TO-3
DTS-4026	600V	—	150 @ 5A	TO-3
DTS-4025	400V	—	150 @ 5A	TO-3
DTS-4010	250V	—	150 @ 5A	TO-3
DTS-1010	120V	—	200 @ 10A	TO-3
DTS-1020	120V	—	500 @ 10A	TO-3
DTS-2000	—	40V	2000 @ 600 mA	TO-92*

*TO-92 package modified. TO-3 devices packaged in solid copper cases.

INDUCTIVE SWITCHING CAPABILITY OF THE DTS-4039, 41, 59, 61 DARLINGTONS

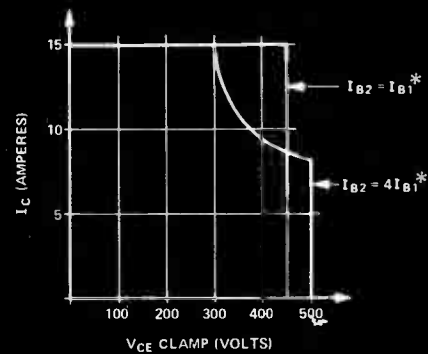

* WITH I_c = 8A I_{B1} = 1A
WITH I_c = 8A I_{B1} = 2A

MOTOR SPEED CONTROL INVERTER OUTPUT WITH DELCO DARLINGTONS

APPLICATIONS DATA AVAILABLE UPON REQUEST

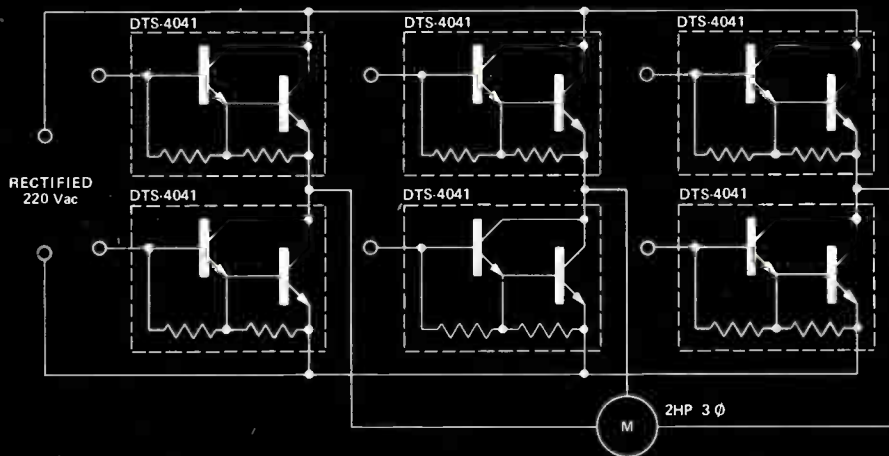

We've added three new ways to save you money on NPN triple diffused silicon power Darlington. Delco Electronics' new DTS-4010, 4025 and 4026 are high powered yet practically priced and give you exceptional energy handling value.

Delco power Darlington's triple diffused mesa construction gives them outstanding peak power handling capability (as shown in the graph of clamped inductive switching). The reverse biased switching data shown illustrates the high energy handling capabilities of these units.

And Delco Darlington's can be purchased with t_{off} grouping for improved current sharing in parallel operation.

The planar DTS-2000 is a TO-92 Darlington

and is applied in driver circuits designed for the referenced 2 and 10 hp induction motor speed controls. Five low voltage power supplies in the control circuit for this application use our DTS-1010, 120 V_{CEO} Darlington's.

All Delco Darlington's bring you the space saving design flexibility you expect from Darlington's, PLUS Delco's proven high energy handling capability.

Select any Delco Darlington up to 600 V_{CEO} and contact your Delco distributor for complete application and device data, prices and prompt delivery.

Specify Delco Darlington's for power at practical prices.

TEN HIGH-ENERGY, DARLINGTONS.



**NOW AVAILABLE FROM THESE DISTRIBUTORS
IN PRODUCTION QUANTITIES.**

ALABAMA, Birmingham
Forbes Distributing Co., Inc.
(205) 251-4104

ALABAMA, Huntsville
Powell Electronics
(205) 539-2731

ARIZONA, Phoenix
Sterling Electronics, Inc.
(602) 258-4531

CALIFORNIA, Gardena
Bell Industries
Electronics Distributors Div.
(213) 321-5802

CALIFORNIA, Goleta
R.P.S. Electronics, Inc.
(805) 964-6823

CALIFORNIA, Los Angeles
Kierulff Electronics, Inc.
(213) 685-5511

CALIFORNIA, Los Angeles
R.P.S. Electronics, Inc.
(213) 748-1271

CALIFORNIA, Palo Alto
Kierulff Electronics, Inc.
(415) 968-6292

CALIFORNIA, San Diego
Kierulff Electronics, Inc.
(714) 278-2112

CALIFORNIA, San Diego
R.P.S. Electronics, Inc.
(714) 292-5611

CALIFORNIA, Sunnyvale
Bell Industries
(408) 734-8570

COLORADO, Denver
Kierulff Electronics, Inc.
(303) 371-6500

CONNECTICUT, Norwalk
Harvey Electronics
(203) 853-1515

FLORIDA, Clearwater
Diplomat/Southland
(813) 443-4514

FLORIDA, Miami Springs
Powell Electronics/Florida
(305) 592-3260

ILLINOIS, Elk Grove Village
Kierulff Electronics, Inc.
(312) 640-0200

ILLINOIS, Skokie
Bell Industries
Electronics Distributors Div.
(312) 282-5400

INDIANA, Indianapolis
Graham Electronics Supply, Inc.
(317) 634-8202

MARYLAND, Baltimore
RESCO/Baltimore
(301) 823-0070

MARYLAND, Beltsville
RESCO/Washington
(301) 937-5890

MASSACHUSETTS, Billerica
Kierulff Electronics, Inc.
(617) 935-5134
(617) 667-8331

MASSACHUSETTS, Newton
The Greene-Shaw Co., Inc.
(617) 969-8900

MICHIGAN, Livonia
Pioneer/Michigan
(313) 525-1800

MINNESOTA, Minneapolis
Stark Electronics Supply Co.
(612) 332-1325

MISSOURI, Kansas City
Walters Radio Supply, Inc.
(816) 531-7015

MISSOURI, St. Louis
LCOMP-St. Louis
(314) 647-5505

NEW JERSEY, Cinnaminson
Wilshire Electronics/Philadelphia
(609) 786-8990 (215) 627-1920

NEW JERSEY, Clifton
Wilshire Electronics/New Jersey
(201) 340-1900 (212) 244-8930

NEW MEXICO, Albuquerque
Sterling Electronics
(505) 345-6601

NEW YORK, Binghamton
Harvey Electronics
(607) 748-8211

NEW YORK, Buffalo
Summit Distributors, Inc.
(716) 884-3450

NEW YORK, Farmingdale
Wilshire Electronics/Long Island
(516) 293-5775

NEW YORK, Freeport
Milgray/New York
(516) 546-6000

NEW YORK, Woodbury
Harvey Electronics
(516) 921-8700 (212) 895-9260

OHIO, Cincinnati
United Radio, Inc.
(513) 761-4030

OHIO, Cleveland
Pattison Supply Co.
Industrial Electronics Division
(216) 441-3000

OHIO, Dayton
Pioneer/Dayton
(513) 236-9900

PENNSYLVANIA, Philadelphia
Almo Electronics
(215) 698-4000

PENNSYLVANIA, Pittsburgh
CAM/RPC
(412) 288-2600

SOUTH CAROLINA, Columbia
Dixie Radio Supply Co., Inc.
(803) 253-5333

TEXAS, Dallas
Sterling Electronics
(214) 357-9131

TEXAS, Houston
Harrison Equipment Co., Inc.
(713) 652-4700

TEXAS, Houston
Sterling Electronics
(713) 627-9800

WASHINGTON, Seattle
Kierulff Electronics, Inc.
(206) 763-1550

IN CANADA: ONTARIO—Toronto
Zentronics Ltd.
(416) 787-1271

OVERSEAS: EUROPEAN INQUIRIES:
European Parts & Accessories
Marketing Group
General Motors Continental
Plant 2, Noorderlaan, Postbus 9
B-2030 Antwerp, Belgium

ALL OTHER OVERSEAS INQUIRIES:
General Motors Overseas
Operations
Plant & Accessories Dept.
767 Fifth Avenue
New York, N.Y. 10022
(212) 486-4412

Delco Electronics Regional Sales Offices
Union, New Jersey 07083
Box 1018 Chestnut Station
(201) 687-3770
Van Nuys, California 91404
Box 2968
(213) 988-7550

General Sales Office
700 E. Firmin, Kokomo, Ind. 46901
(317) 459-2175

Delco Electronics

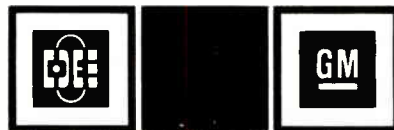

Division of General Motors

CIRCLE NUMBER 68

Use CMOS in chopper designs.

Analog switches, now available at low cost, considerably simplify the design of multiplexers and choppers.

Need an inexpensive chopper amplifier for conditioning low-level signals, such as those encountered with thermocouples? Combine a 709 and a 714 op amp with a CMOS analog switch, such as the CD4016-AE. You'll end up with a low-cost amplifier that has linearity of better than 0.1% and typical dc drift of only $0.3 \mu\text{V}/^\circ\text{C}$, ideal for your low-level application.

The basic design of the chopper amplifier is depicted in Fig. 1. It consists of ac amplifier A_1 , chopping and demodulating switches SW_A and SW_B and integrating amplifier A_2 . Negative feedback is provided through voltage divider R_1, R_2 . The attenuated output voltage, V_f , is thus compared with the input voltage, V_{in} , and the difference is chopped—that is, converted to a pulsating voltage—by switch SW_A and amplified by A_1 . Switch SW_B , which is driven in parallel to SW_A , synchronously rectifies the amplified ac signal, thus retaining the polarity of the amplified error. The demodulated signal is then fed to the integrating amplifier, A_2 , which produces the filtered output, V_o .

The over-all open-loop gain of the amplifier can be approximated by

$$A_{OL} = \frac{1}{2} \cdot \frac{R_{f1}}{R_{in}} \cdot \frac{R_{f2}}{R_i}, \quad (1)$$

where the factor $1/2$ accounts for the fact that the duty cycle is 50%.

The negative feedback factor of the amplifier is

$$\beta = \frac{R_2}{R_1 + R_2}. \quad (2)$$

Hence the closed-loop gain is

$$A_{CL} = \frac{\frac{R_{f1} \cdot R_{f2}}{R_{in} \cdot R_i} \cdot \frac{1}{2}}{1 + \frac{R_2 \cdot R_{f1} \cdot R_{f2}}{2(R_1 + R_2) \cdot R_{in} \cdot R_i}}. \quad (3)$$

If $\frac{R_2 \cdot R_{f1} \cdot R_{f2}}{2(R_1 + R_2) \cdot R_{in} \cdot R_i} > 1$,

$$\text{the closed-loop gain can be approximated by} \quad (4)$$

$$A_{CL} \approx \frac{R_1 + R_2}{R_2}. \quad (5)$$

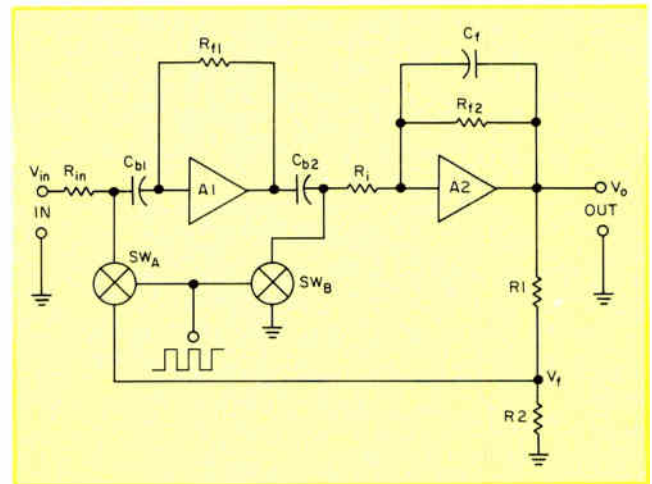

1. The chopper amplifier consists of ac amplifier A_1 , chopping and demodulating switches SW_A and SW_B , and integrating amplifier A_2 .

If ideal switches are assumed, the only contribution, to dc drift will be the input dc error, caused by the voltage offset and input bias current of amplifier A_2 . Analysis of the output dc offset due to this error can proceed as follows:

The open-loop gain for dc error at the input of A_2 is

$$A_{OL\epsilon} = \frac{R_1 + R_{f2}}{R_2}, \quad (6)$$

whereas the negative feedback factor is

$$B_\epsilon = \frac{1}{2} \cdot \frac{R_2}{R_1 + R_2} \cdot \frac{R_{f1}}{R_{in}}, \quad (7)$$

and the closed-loop gain

$$A_{CL\epsilon} = \frac{\frac{R_1 + R_{f2}}{R_2}}{1 + \frac{R_2 \cdot R_{f1} \cdot (R_1 + R_{f2})}{2 \cdot R_2 \cdot (R_1 + R_2) \cdot R_{in}}}, \quad (8)$$

or approximately

$$A_{CL\epsilon} \approx \frac{R_1 + R_2}{R_2} \cdot \frac{R_{in}}{R_{f1}}. \quad (9)$$

If the gain of A_1 , R_{f1}/R_{in} , is adjusted to be at the same order of magnitude of $R_1 + R_2/R_1$ (the closed-loop gain) $A_{CL\epsilon}$ can be made small—say, one. Hence for a properly designed amplifier, the dc error at the output will be in the same order of magnitude as the error at the input of A_2 .

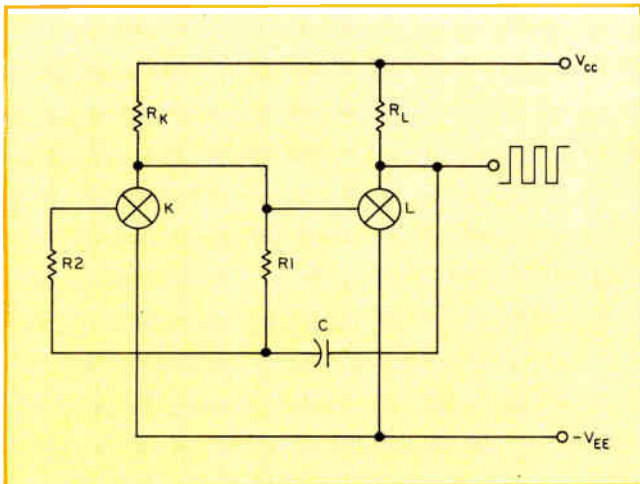

2. A standard CMOS bilateral switch, CD4016AE, includes four switches. Two of these switch sections are used as a square-wave oscillator.

Referred to the input of the chopper amplifier, these errors can be made very small, since the over-all closed-loop gain (Eq. 5) will generally be high.

Another source of dc error at the output is caused by current leakage at the input. Leakage between the two terminals of the chopping switch to ground, or finite switch resistance, are rather unimportant because of the high open-loop gain. However, parasitic current leakage to the supply voltage must be minimized.

Using surplus sections of CMOS

Since a standard CMOS bilateral switch, such as CD401, includes four switches, the two surplus switches can be used as the square-wave oscillator for driving the switches. This can be accom-

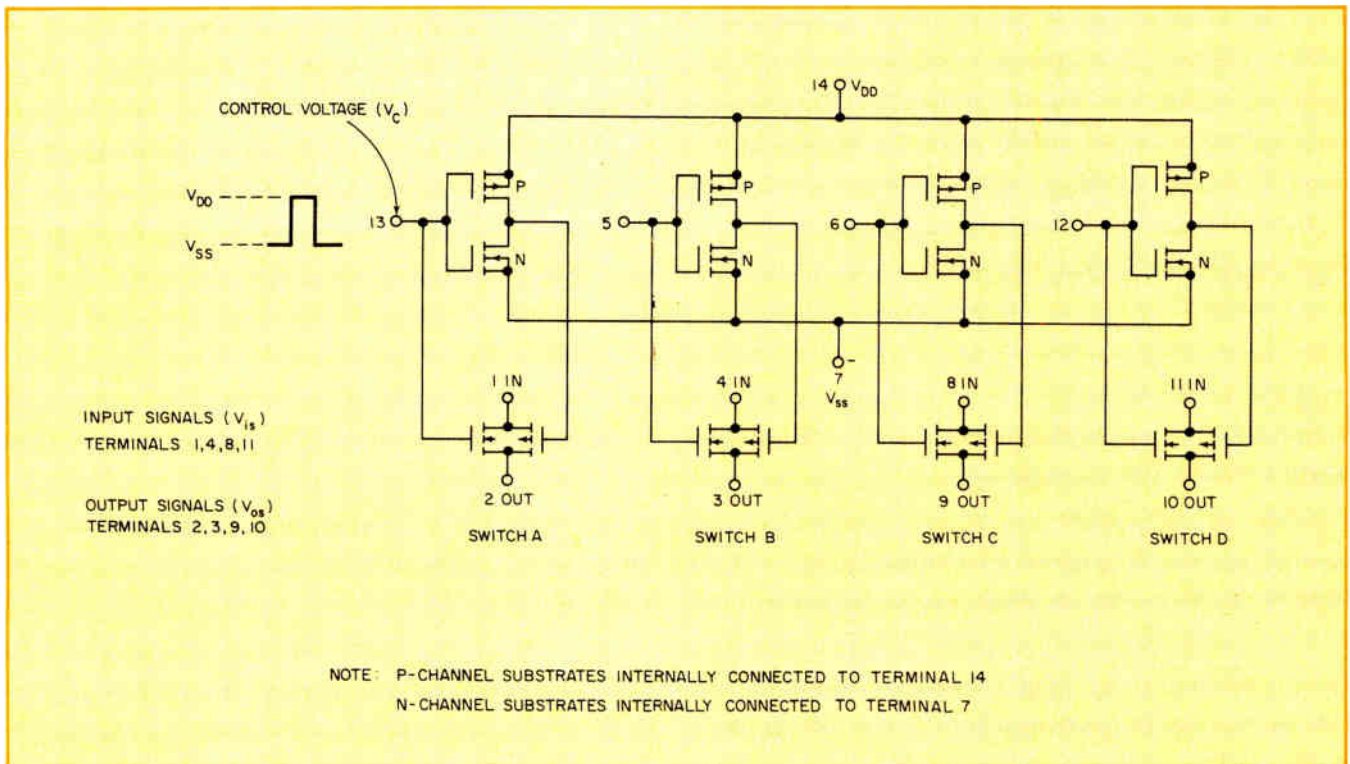

3. The CD4016A quad bilateral switch consists of four independent bilateral switches on a single monolithic

chip. Each of the switches can be controlled by a single logic signal.

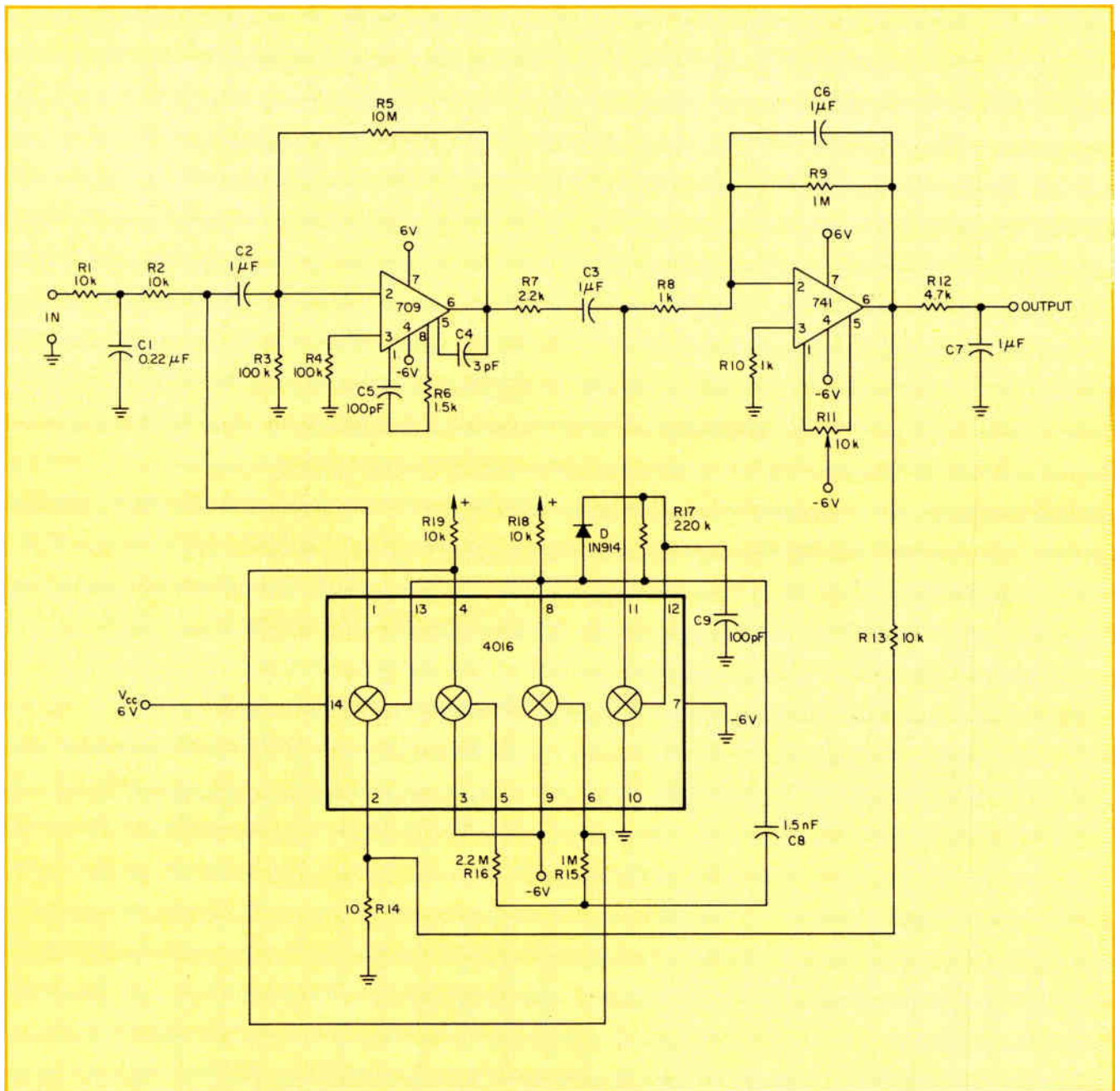

4. The final chopper amplifier design includes a 709 op amp for the ac amplifier, a CD4016AE CMOS switch, and

a 741 op amp as the integrating amplifier. Two switches act as choppers, the others form an oscillator.

plished if you convert each of the extra switches to an inverter (Fig. 2) and then connect these to form a conventional oscillator.

The CD4016A (Fig. 3) contains four independent bilateral signal switches, each consisting of an n-channel and a p-channel device. The source of the p-channel device is connected to the drain of the n-channel device and vice versa. Only one control signal is required for each switch and it is applied to the n-channel unit. The p channel is controlled by the control signal, which is reversed in polarity by an inverter (included on the CD4016A chip).

The final chopper amplifier design is shown in

Fig. 4. The ac amplifier uses a 709 type op amp, which provides sufficient bandwidth at the nominal closed-loop gain of approximately 500. The integrating amplifier is built around a 741 and has a dc gain of 1000. The feedback network, R₁₃ and R₁₄, fixes the over-all closed-loop gain of the amplifier at about 1000. The analog switches are driven by the square-wave oscillator at a frequency of about 600 Hz. The network R₁₇, C₀ and D, provides a slight delay to the demodulating switch so it remains closed longer than the chopping switch. This prevents some of the switching transients from being transmitted to the integrating amplifier, A₂. ■■

How to tell a Super-VOM from just the everyday garden-variety Brand X.

ONLY THE SUPER-VOM (Triplet's New 60) HAS ALL THESE FEATURES:

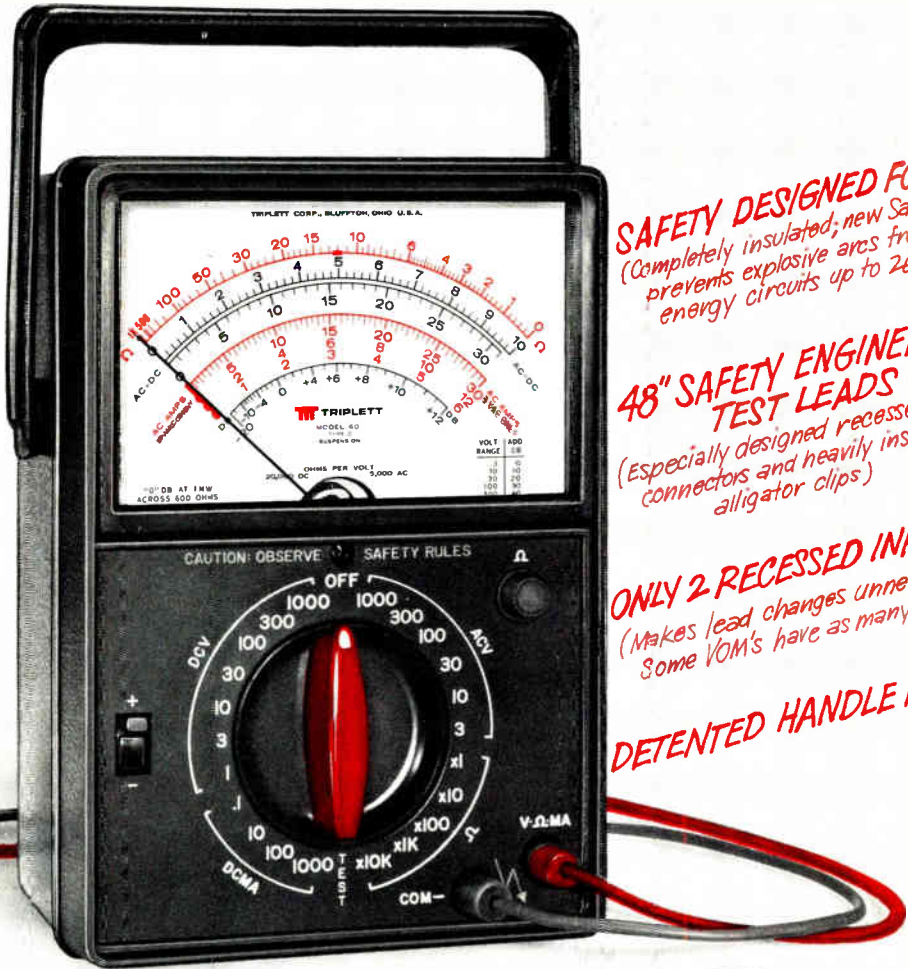

DROP-PROOF CONSTRUCTION
(Virtually indestructible for an accidental drop up to a five-foot height)

BUILT-IN "CONFIDENCE-TEST"
for periodic meter reassurance checks after overload/drops.

BURNOUT-PROOF
3-fuse arrangement, including diodes and 2 Amp/1000V protection fuse)

ANGLE-RANGE SELECTOR SWITCH
Most VOM's have 2 or more. Single switch minimizes range selection errors)

SAFETY DESIGNED FOR YOU
(Completely insulated; new Safety Leads; prevents explosive arcs from high energy circuits up to 20 KW)

48" SAFETY ENGINEERED TEST LEADS
(Especially designed recessed safety connectors and heavily insulated alligator clips)

ONLY 2 RECESSED INPUT JACKS
(Makes lead changes unnecessary - some VOM's have as many as seven)

DETTENTED HANDLE POSITION

only \$96

Nobody else offers these features in a VOM at any price. So for only \$96, the Model 60 is the safest, most versatile, most honestly priced quality VOM you can buy. And, for just \$10 more, you can have the Model 60-A that has 1½% DC accuracy, plus a mirrored scale.

That's the kind of Triplet one-upmanship appreciated the world over by value conscious users in industrial production and maintenance, TV - Radio - Hi-Fi shops, vocational training and hobbyists, airconditioning, appliance and automotive service, R & D, and application engineering . . . anyone who wants to be more productive with the latest in VOM technology.

Drop in on your nearest Triplet distributor or Mod Center and drop the new Model 60. Ask for a no-obligation demonstration of every feature. Compare it with any other VOM. You'll know why Triplet Models 60 and 60-A eliminate over 90% of the costly repairs from VOM misuses. Cultivate a profitable habit for selecting Triplet design-firsts.



TRIPLETT
BLUFFTON, OHIO 45817

CIRCLE NUMBER 184

Super-Safe
Triplet. The easy readers

HIGH RELIABILITY

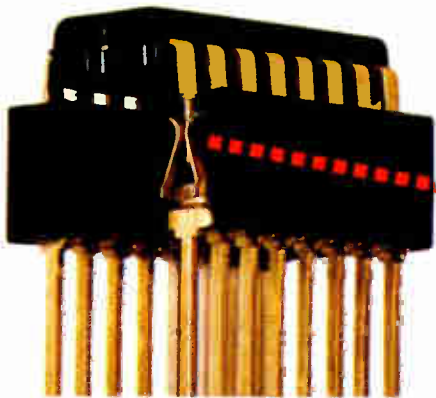

Get the **high reliability** that eliminates trouble. RNDIP sockets make contact with the wide, flat sides of your IC leads. This provides **100% greater surface contact** for positive electrical connection.



DIP SOCKETS **for the price you're paying for junk!**

Robinson Nugent "side-wipe" DIP sockets make 100% greater contact than any edge-bearing socket on the market.

This 100% greater contact with the wide, flat surface of your IC leads is your guarantee of unmatched reliability. This RN "side-wipe" contact provides constant low contact resistance. No edge-bearing contact can possibly deliver this long term dependability. This designed-in reliability of RN DIP sockets is your assurance of trouble-free IC interconnects — yet they cost no more than ordinary sockets.

Put an end to troublesome junk sockets! Write today for catalog and informative book, "What to Look for in IC Interconnects." It's free from RN — the people who make more kinds of high reliability IC sockets than anyone.



They're even packaged for high reliability.

"Protecto-pak"™ packaging delivers consistently perfect RN sockets to your production line — for automated or manual assembly.



RN ROBINSON NUGENT, INC.

800 East Eighth Street • New Albany, Indiana 47150 • Phone: (812) 945-0211

CIRCLE NUMBER 185



High reliability IC sockets . . . we've got 'em all!

WorldRadioHistory

CAN THE ANALOG SWITCHES SYSTEM PASS THE HARRIS

The Harris Personality Test asks important questions about the behavior pattern of your system. In doing so, it'll help you determine whether your analog switches and multiplexers are as trouble-free as they should be. Of course, our own popular pin-for-pin compatible CMOS switches and multiplexers will be used as the standard of comparison. Why not see how your system measures up (Test results on opposite page).

1. Does your system have a latch-up problem that it can't cope with? With the Harris devices, you have

nothing to worry about. They're problem-free. That's because each MOS transistor on the chip is surrounded by an insulating layer, so no four-layer parasitic SCR's could ever be created.

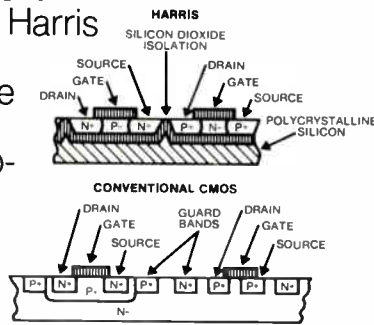

2. Does your system ever feel restricted on the sequence of power? If it does, your system may have a slight disorder. The Harris analog switches and multiplexers never feel any restriction on sequence of power. And that goes for signal application or removal as well.

3. Does your system compromise its performance to achieve latch-free operation? Harris has no such maladjustment. Leakage currents, capacitances, AC crosstalk

are equal or better than the best of the other brands. And switch parameters are essentially independent of analog level.

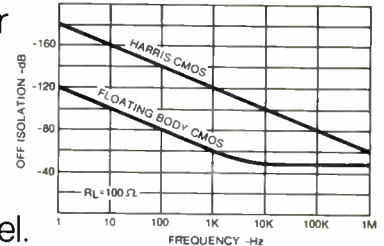

4. Does your system need extra support in order to give you on-board resistor-diode protection in all digital address inputs?

(In order to prevent failures during the handling of loose PC cards.) Harris doesn't need any. We have all the support we need on the same device.

5. Do your systems' digital address inputs have severe negative resistance characteristics in their personality?

Many times this can cause double triggering or oscillations with TTL drive. Harris is free of this personality defect.

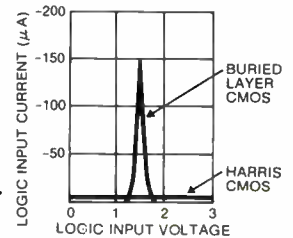

6. Do your systems' supply currents sometimes get very high when they shouldn't? You can count on Harris supply currents to remain low, even when switching at 100 KHz rates!

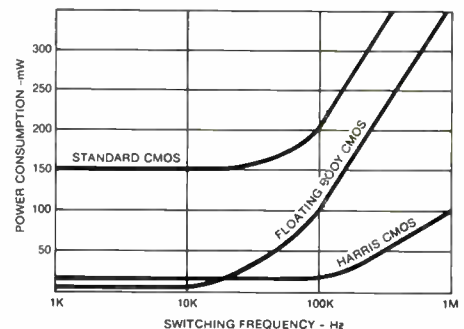

WHERE TO BUY THEM: OEM SALES OFFICES: CALIFORNIA: Long Beach, (213) 426-7687; Palo Alto, (415) 964-6443 **FLORIDA:** Melbourne, (305) 724-7430 **ILLINOIS:** Hinsdale, (312) 325-4242 **MASSACHUSETTS:** Wellesley Hills, (617) 237-5430 **MINNESOTA:** Minneapolis, (612) 835-2505 **NEW YORK:** Endwell, (607) 754-5464; Melville, L.I., (516) 249-4500 **OHIO:** Dayton, (513) 226-0636 **PENNSYLVANIA:** Wayne, (215) 687-6680 **TEXAS:** Richardson, (214) 9031.

SALES REPRESENTATIVES: ARIZONA: Scottsdale, (602) 948-5590 **CALIFORNIA:** Los Angeles, (213) 870-9191; Mountain View, (415) 961-8121; San Diego, (714) 565-9444 **COLORADO:** Denver, (303) 773-0666 **FLORIDA:** Boca Raton, (305) 395-6108; Oviedo, (305) 365-3283; Tampa, (813) 933-3183 **ILLINOIS:** Elk Grove Village, (312) 640-1850 **KANSAS:** Wichita, (316) 943-6221 **MARYLAND:** Randallstown, (301) 922-1248 **MASSACHUSETTS:** Lawrence, (617) 685-7973 **MICHIGAN:** Farmington (313) 476-2446 **MISSOURI:** Hazelwood, (314) 731-5799;

AND MULTIPLEXERS IN YOUR PERSONALITY TEST?

7.

Do you find that your system has more burnouts from voltage transients than it should for its age?

Harris devices are much more immune to those kind of things.

In fact, we invite you to test our devices side-by-side with yours in the usual bread-board environment, and you'll see what we mean.

8.

Does your system feel insecure because it can't offer you extra protection in critical situations?

For example, in a system where multiplexer input signals come from outside the equipment and the signal lines could pick up induced voltage spikes, static electricity, or have signals present when the MUX power is off. Well Harris feels very secure with its HI-506A/507A/508A/509A Overvoltage Protected Multiplexers which can withstand up to ± 35 volts continuously or over 1000 volts momentarily on an analog input. The internal protection networks not only prevent system damage, but prevent the

with inherent low error, but without additional cost. If protection is not your problem, then you can choose from the industry's largest selection of switches and multiplexers, which retain all the other personality traits.

ANALOG CMOS DEVICES AND MULTIPLEXERS					FOR MORE INFORMATION CIRCLE NO. ON REPLY CARD
Data based on information available 1/1/76					
PRODUCT DESCRIPTION	HARRIS	SILICONIX	INTERSIL	ANALOG DEVICES	
MULTIPLEXERS:					
Over voltage protected					
16 Channel	HI-506A				601
8x2	HI-507A				602
8	HI-508A	DG-508			603
4x2	HI-509A	DG-509 non-protected			604
Non-protected, low ron					
16 Channel	HI-506	DG-506	IH-5060	AD 7506	605
8x2	HI-507	DG-507	IH-5070	AD 7507	606
8	HI-1818A			AD 7501* /7503	607
4x2	HI-1828A			AD 7502*	608
SWITCHES					
Dual DPST	HI-1800A				609
Quad-SPST-(600 Ω)				AD 7516 AD 7519	
75 Ω :					
Dual SPST	HI-200	DG-200	DG-200	AD 7513	610
Quad SPST	HI-201	DG-201 (150 Ω)		AD 7501* /7511*	611
SPST	HI-5040		IH 5040		612
Dual SPST	HI-5041		IH 5041		613
SPDT	HI-5042		IH 5042		614
Dual SPDT	HI-5043		IH 5043	AD 7512*	615
Dual DPST	HI-5044		IH 5044		616
Dual DPST	HI-5045		IH 5045		617
DPDT	HI-5046		IH 5046		618
4PST	HI-5047		IH 5047		619
30 Ω :					
Dual SPST	HI-5048		IH 5048		620
Dual DPST	HI-5049		IH 5049		621
SPDT	HI-5050		IH 5050		622
Dual SPDT	HI-5051		IH 5051	*not pin for pin interchangeable	623
DPDT	HI-5046A				624
4PST	HI-5047A				625

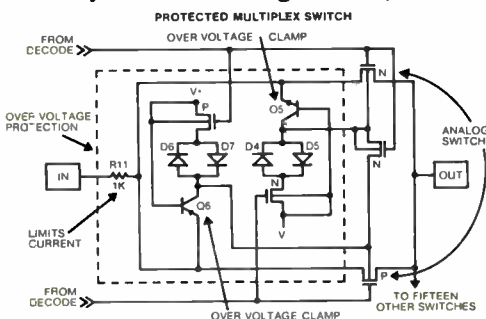

overvoltage spikes from appearing at the MUX output. As a result, the only tradeoff is added ON resistance, which you'd have to create externally to protect any other MUX. So, if you need overvoltage protection, Harris can give it to you. On the chip, featuring the same low leakage currents

Test score results.

If you've answered "yes" to any of the Harris Personality Test questions about your system, then maybe it's time you talked to a Harris distributor or representative. We offer a complete line of analog multiplexers and CMOS switches. Available now. All with healthy, trouble-free constitutions.



HARRIS SEMICONDUCTOR
A DIVISION OF HARRIS CORPORATION

P.O. Box 883, Melbourne, Florida 32901 (305) 727-5430

Kansas City, (816) 761-6543 **NEW JERSEY:** Keasbey, (516) 567-5900 **NEW YORK:** Albany, (518) 489-7408 or 4777; Huntington Station, (516) 567-5900 **NORTH CAROLINA:** Raleigh, (919) 828-3575 **OHIO:** Cleveland, (216) 831-8292, Dayton, (513) 890-2150 **OREGON:** Beaverton, (503) 643-1644 **PENNSYLVANIA:** Allison Park, (412) 487-4300; King of Prussia, (215) 265-0634 **TENNESSEE:** Shelbyville, (615) 684-4544 **TEXAS:** Dallas, (214) 691-4592; Houston, (713) 661-3007 **VIRGINIA:** Falls Church, (703) 534-1673; Lynchburg, (804) 237-4740 **WASHINGTON:** Bellevue, (206) 454-0300 **CANADA:** Montreal, (514) 626-6723; Ottawa, (613) 749-0740; Toronto, (416) 676-1042

NATIONAL DISTRIBUTORS: Hamilton/Avnet, The Harvey Group, Inc., Schweber Electronics, R.V. Weatherford Company

The new IBM 5100. An ideal personal computer for scientists and engineers.

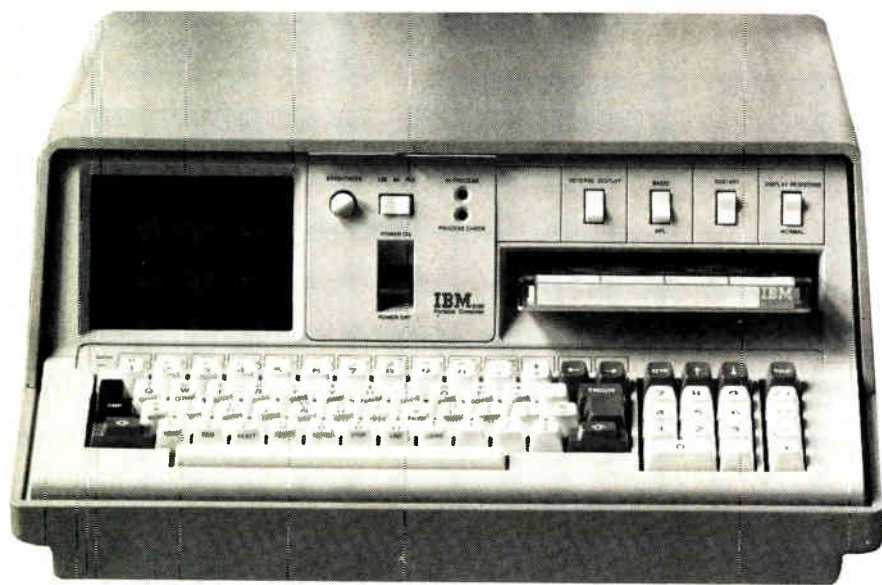

Available with three language options: BASIC, APL or both.

The new IBM 5100 is a sophisticated problem-solving aid incorporating the very latest in semi-conductor technology.

It features an alpha-numeric keyboard, a 15 key calculator pad, 14 interactive command keys and a video display screen that shows 1024 characters in sixteen, 64 char-



The 5100 goes to work wherever you need it to help solve the most complicated problems.

acter lines. In addition, the 5100 display screen has a scrolling capability that allows you to move information up or down for easy editing.

The 5100 uses a tape data cartridge which holds more information than the cassettes used in other small computers.

Still another advantage of the 5100 is its large main storage capacity, up to 64K bytes.

The 5100 also features an optional 80 character per second bi-directional printer, an auxiliary tape unit that reads up to 2850 characters per second and an optional communications adapter that turns the 5100 into a terminal capable of transmitting information to a larger processor.

The most powerful language in small computers

The 5100 is available with three language options: BASIC, APL or both. BASIC is a generally well known, easy-to-use language using English-like commands to solve engineering and scientific problems.

But it is APL that really sets the IBM 5100 Portable Computer apart. APL is the most powerful language in small computers today. It uses concise symbols to solve complex problems, including matrix commands that use a single symbol to solve multiple equations. APL routines are as close to the original mathematics as possible and take



Just flip a switch to go from BASIC to APL, up just a fraction of the space required for the same routines written in other high level languages.

The IBM 5100 Portable Computer is also available with extensive problem-solver libraries. These IBM developed programs are highly interrogative to help you focus on getting answers instead of how to run the program.

Statistical library

The statistical library provides a comprehensive capability covering the most commonly used statistical techniques. It covers such areas as:

Elementary Statistics

- Histogram
- Cross Tabulation
- Transformation, alters columns in matrices
- Tally
- Moment
- Correlation
- t-Test
- Chi-square Test
- Survival Rate
- Probit Analysis

Time Series Analysis

- Moving Average
- Seasonal Analysis
- Cyclical Analysis
- Autocovariance and Autocorrelation
- Triple Exponential Smoothing
- Crosscovariance and Crosscorrelation

Regression and Design Analysis

- Simple Regression
- Multiple Regression
- Polynomial Regression
- Stepwise Regression
- One-way analysis of variance
- Factorial Design

Multivariate Analysis

- Discriminant Analysis
- Canonical Correlation
- Factor Analysis

Non-Parametric Statistics

- Kendall Rank Correlation
- Kendall Coefficient of Concordance
- Sign Test
- Wilcoxon Matched Pairs Signed Rank Test
- Mann-Whitney U-Test
- Friedman Two-way Analysis of Variance
- Cochran Q-Test
- Biserial Correlation
- Point Biserial Correlation
- Tetrachoric Correlation
- Phi Coefficient

Plus there are four data generation routines that provide facilities to enter and display or print data. Or correct, modify, generate or smooth it.



The IBM data cartridge holds up to 204,000 characters on highly-reliable quarter-inch magnetic tape.

Mathematical library

The mathematical library provides pre-programmed routines featuring a conversational interactive capability that allows you to define a problem through a series of questions and answers. The areas covered include the following:

- Solutions to Simultaneous Linear Equations
- Matrix Eigenproblem
- Eigenvalues and Eigenvectors
- Integration
- Differentiation
- Interpolation, Approximation and Smoothing
- Zeros and Extrema of Functions
- Ordinary Differential Equations
- Finite Fourier Transform
- Special Functions
- Linear Programming

Business Analysis Library

There are 30 interactive routines in the business analysis library. They all utilize the BASIC language and can be used to solve problems without the help of specialized data processing personnel. Included in the library are easy-to-use procedures for:

- Spread Sheet Analysis
- Investment Analysis
- Break Even Analysis
- Depreciation Analysis
- Time Series Analysis
- Graphic Presentation

Or, you can program the 5100 yourself. It comes with a self-study training package that makes it easy to learn and easy to use without taking any classes or relying on specially trained experts.

The IBM 5100 Portable Computer. It can help solve complicated problems wherever they happen to be. Because unlike most other so-called small computers the 5100 is truly portable, weighing about 50 lbs.

To arrange for a demonstration, call your local IBM General Systems Division office or fill out this coupon.

IBM

IBM General Systems Division
P.O. Box 2068, Atlanta, Georgia 30302

- I would like more information about IBM's new 5100.
- I would like a demonstration of IBM's new 5100.

My major area of interest is:

- Engineering/Scientific
- Statistical Analysis
- Business/Financial Analysis

Name _____

Title _____

Company _____

Address _____

City _____

State _____

Zip _____

Phone _____

CIRCLE NUMBER 186

connections

find the answers
printed circuit
rack and panel
from
CONTINENTAL

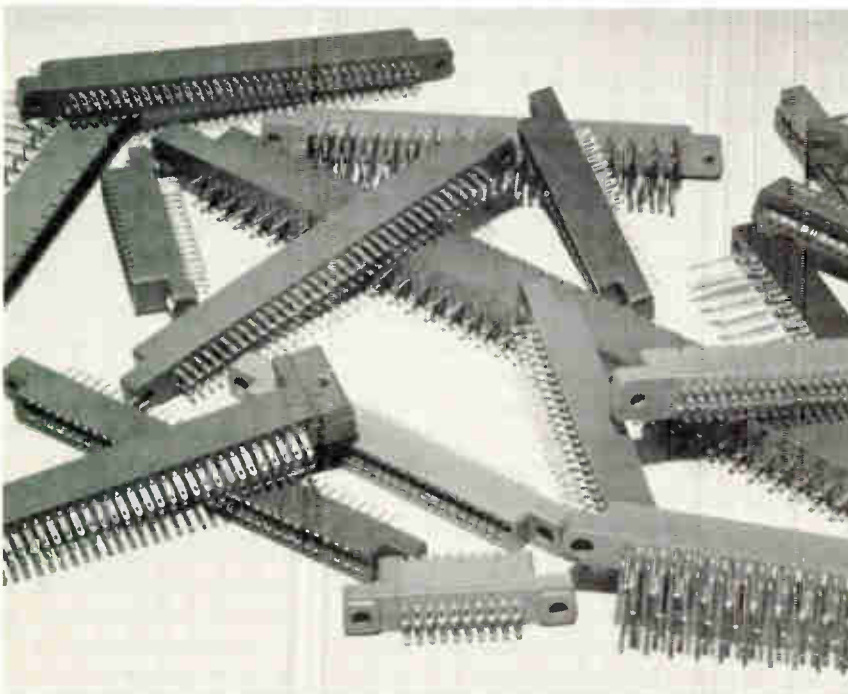
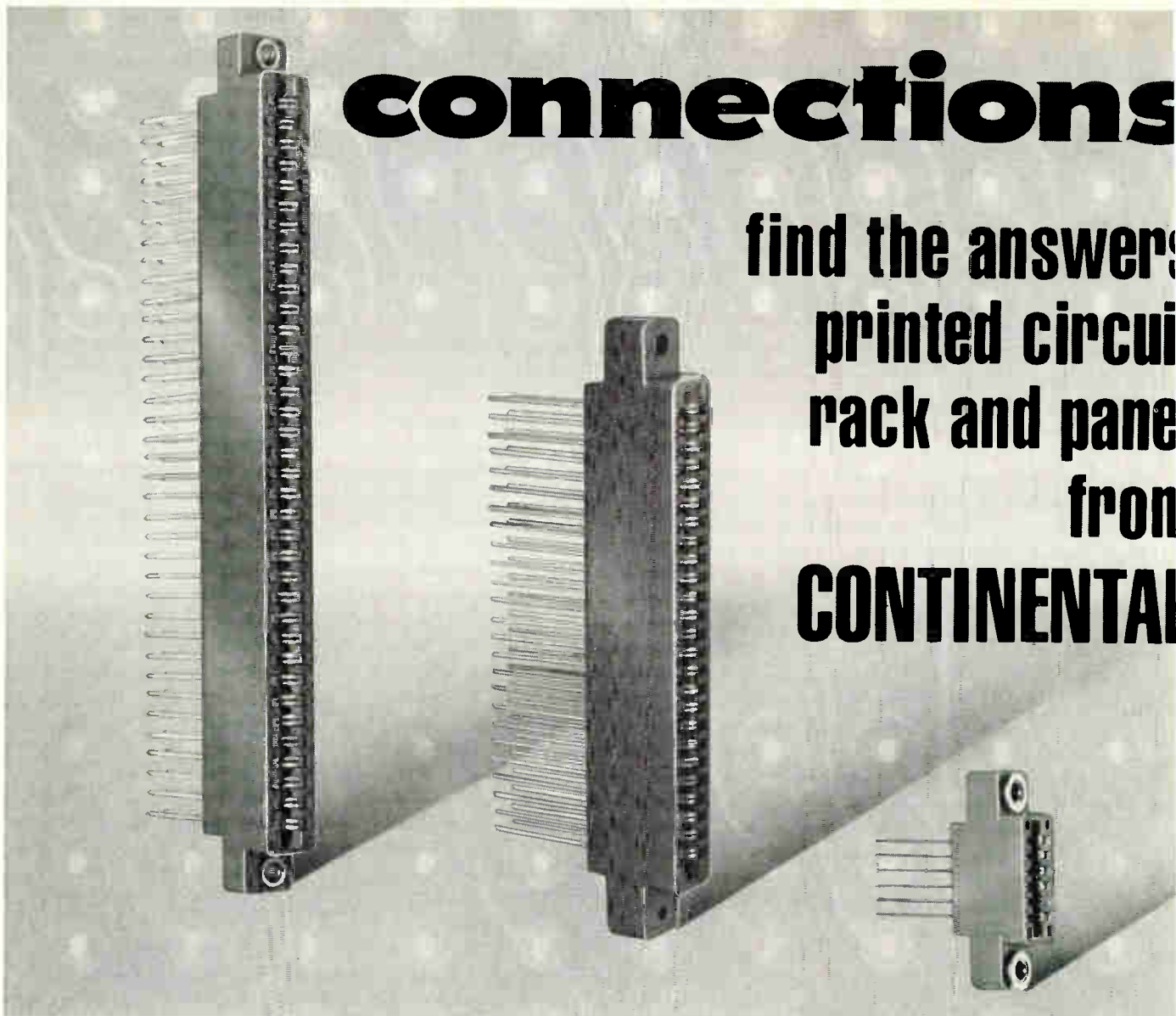

PRINTED CIRCUIT BOARD CONNECTORS

Extensive lines of receptacles, right angle plug and socket and test point provide positive, space-saving connections between printed circuitry and conventional wiring through pc boards, tape cable or "plug" mounted sub-assemblies. Receptacles accommodate 1/32", 3/64", 1/16", 3/32" or 1/8" board thickness with single or dual readouts on .050", .075", .100", .125", .150", .156" and .200" contact centers. Wiring styles include terminations for wire-wrapping (.025" and .045" square terminals), eyelet lug and dip solder.



*For the Sales Representative
Nearest You, See Our Listings
in EEM & Gold Book Directories,
or Phone (212) 899-4422 for
Immediate Action*

are critical...

to your board and connector needs

CONNECTOR



RACK AND PANEL

*Microminiature . . . Subminiature
Miniature . . . Removable Contact*

Choose from a wide variety of rectangular plug and socket connectors that meet or exceed applicable paragraphs of MIL-C-27848 specifications. Available with four to 104 contacts and optional polarizing screwlocks, aluminum hoods, protective shells and guide pins and guide sockets.

CATALOGS AVAILABLE!



CONTINENTAL CONNECTORS

CONTINENTAL CONNECTOR CORPORATION • WOODSIDE, NEW YORK 11377

CIRCLE NUMBER 187

Rookie of the year.

Advanced Micro Devices' new four-bit, high speed ALU: The Am25LS181. A major league version of the TI model. Playing its first full season and already destined for greatness.

How? By increasing speed 20%, improving noise margin by 50mv and doubling fan-out over the military temperature range.

The Am25LS181 does an eight-bit add or subtract in

52ns at only one quarter of the power of standard TTL. Wow! It'll also handle 14 other arithmetic operations and has full look-ahead. And, of course, MIL-STD-883 is yours for free.

A perfect addition to the best low-power Schottky team around.

Check the list for the other Am25LS players. Better still, send for the souvenir book.

Advanced LP/Schottky.



Advanced Micro Devices • 901 Thompson Place, Sunnyvale, California 94086 • Telephone (408) 732-2400 •
Distributed nationally by Hamilton/Avnet, Cramer and Schweber Electronics.

The First Team.	The Bench.	
High Performance Low-Power Schottky Am25LS SERIES	(If you'd like to go with the veterans, we understand. Here's our standard Am54/74LS roster.)	Function
Am25LS07 Am25LS08 Am25LS09 Am25LS14 Am25LS15 Am25LS22 Am25LS23 *Am25LS123 Am25LS138 Am25LS139 *Am25LS148 Am25LS151 Am25LS153 Am25LS157 Am25LS158 Am25LS160 Am25LS161 Am25LS162 Am25LS163 *Am25LS164 *Am25LS170 Am25LS174 Am25LS175 Am25LS181 Am25LS190 Am25LS191 Am25LS192 Am25LS193 Am25LS194A Am25LS195A *Am25LS240 *Am25LS241 Am25LS251 Am25LS253 Am25LS257 Am25LS258 *Am25LS273 *Am25LS281 Am25LS299 *Am25LS374 *Am25LS377 *Am25LS381 *Am25LS670 *Am25LS2517 *Am25LS2518	*Am54LS/74LS123 Am54LS/74LS138 Am54LS/74LS139 Am54LS/74LS148 Am54LS/74LS151 Am54LS/74LS153 Am54LS/74LS157 Am54LS/74LS158 Am54LS/74LS160 Am54LS/74LS161 Am54LS/74LS162 Am54LS/74LS163 Am54LS/74LS164 *Am54LS/74LS170 Am54LS/74LS174 Am54LS/74LS175 Am54LS/74LS181 Am54LS/74LS190 Am54LS/74LS191 Am54LS/74LS192 Am54LS/74LS193 Am54LS/74LS194A Am54LS/74LS195A *Am54LS/74LS240 *Am54LS/74LS241 Am54LS/74LS251 Am54LS/74LS253 Am54LS/74LS257 Am54LS/74LS258 *Am54LS/74LS273 *Am54LS/74LS281 Am54LS/74LS299 *Am54LS/74LS374 *Am54LS/74LS377 Am54LS/74LS378 *Am54LS/74LS379 *Am54LS/74LS381 *Am54LS/74LS398 *Am54LS/74LS670	Six-Bit Register With Clock Enable Four-Bit Register With Clock Enable Four-Bit Register With Two-Input Multiplexer on Inputs Serial/Parallel Two's Complement Multiplier Four-Bit Serial/Parallel Adder Subtractor Eight-Bit Serial/Parallel Register Eight-Bit Universal Shift Register, Synchronous Clear Dual One-Shot One-of-Eight Decoder/Demultiplexer Dual One-of-Four Decoder/Demultiplexer Priority Encoder Eight-Input Multiplexer Dual Four-Input Multiplexer Quad Two-Input Multiplexer; Non-Inverting Quad Two-Input Multiplexer; Inverting Synchronous BCD Decade Counter, Asynchronous Clear Synchronous Four-Bit Binary Counter, Asynchronous Clear Synchronous BCD Decade Counter, Synchronous Clear Synchronous Four-Bit Binary Counter, Synchronous Clear Eight-Bit Serial Shift Register 4 x 4 Register File (O.C.) Six-Bit Register With Clear Quad Register With Clear Four-Bit ALU/Function Generator BCD Decade Up-Down Counter Four-Bit Binary Up-Down Counter Synchronous BCD Decade Up-Down Counter Synchronous Four-Bit Binary Up-Down Counter Four-Bit Register; Shift Right, Left or Parallel Load Four-Bit Register; Shift Right or Parallel Load Octal Bus Driver, Inverting Octal Bus Driver, Non-Inverting Three-State Eight-Input Multiplexer Three-State Dual Four-Input Multiplexer Three-State Quad Two-Input Multiplexer; Non-Inverting Three-State Quad Two-Input Multiplexer; Inverting Octal D-Type Flip-Flop Four-Bit Parallel Accumulator Eight-Bit Universal Shift Register, Asynchronous Clear Octal D-Type Flip-Flop (3-state) Octal D-Type Flip-Flop, Common Enable See Am25LS07 See Am25LS08 Four-Bit ALU/Function Generator See Am25LS09 4 x 4 Register File (3-state) Four-Bit ALU/Function Generator Four-Bit Register With Standard and Three-State Outputs
*in development		

Everything you need in ferrites

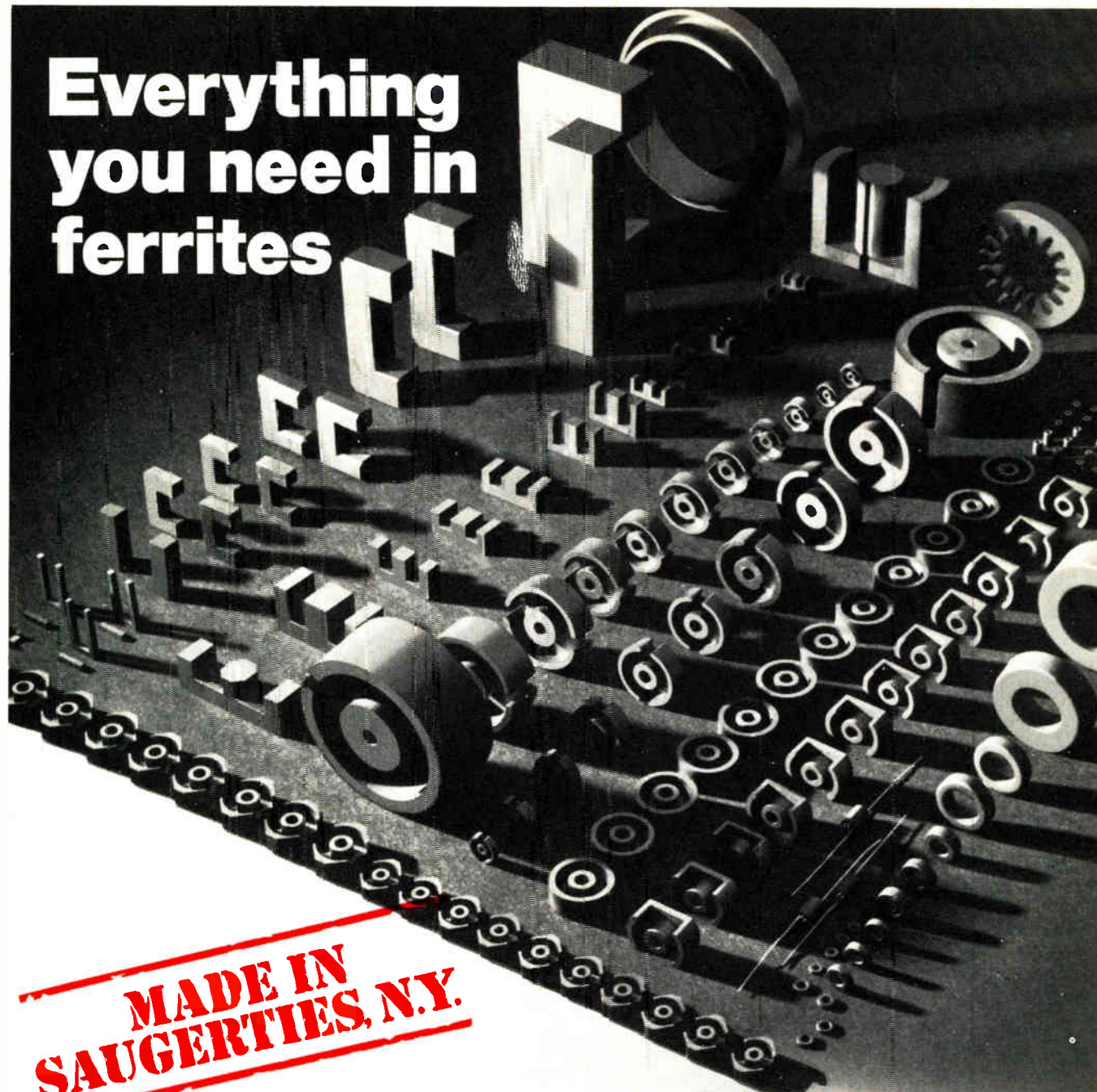

**MADE IN
SAUGERTIES, N.Y.**

Broad Product Line: Ferroxcube offers a complete array of sizes and shapes of ferrite cores. They're made in Saugerties, N.Y. and stocked throughout the U.S.A. Toroids for pulse transformers, pot cores or square cores for precision filters, transformer cores in all sizes and shapes—E, U, I, specials and read-only memory cores—you can trust Ferroxcube to provide the optimum core for your inductors.

Unsurpassed Materials Technology: Ferroxcube, the acknowledged U.S. leader in ferrite technology, offers a wide range of standard materials for your cores. Chances are that one of them has exactly the *right combination of characteristics* for your application. And, you can depend on Ferroxcube to deliver the same uniform,

product characteristics year after year for consistent, optimum circuit performance in your designs.

24-hour Availability: Standard components are available for 24-hour delivery from any of six warehouses conveniently located in Boston, New York, Saugerties, Philadelphia, Chicago, and San Diego.

If you're up on the advantages of ferrites, discover the added values of dealing with Ferroxcube. Ask for the latest catalog. If you're new to ferrites and the design possibilities they open up, talk to one of our applications engineers. Call 914 • 246-2811, TWX 510-247-5410 or write Ferroxcube, Saugerties, N.Y. 12477.

Ferroxcube linear ferrites—made in Saugerties, N.Y. and stocked in six U.S. locations.



FERROXCUBE CORPORATION, SAUGERTIES, N.Y. 12477

A NORTH AMERICAN PHILIPS COMPANY

Distributed through North American Philips Electronic Components Corp.—warehouses in Boston, 617-899-7100; New York, 516-538-2300; Saugerties, 914-246-5861; Philadelphia, 215-836-1616; Chicago, 312-593-8220; San Diego, 714-453-5440

Microprocessor concepts at your fingertips...

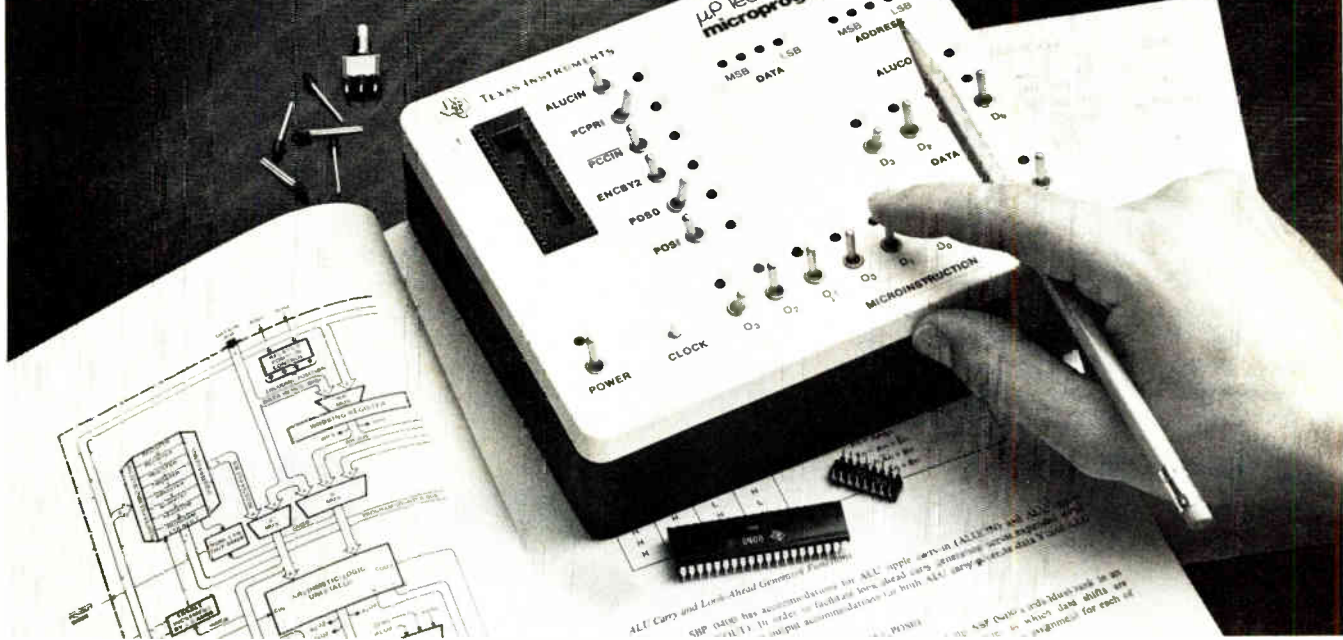

Introducing Texas Instruments Microprocessor Learning Modules

Now there's a quicker, easier way to provide basic "hands on" experience with microprocessors—the TI μ P Learning Module Microprogrammer (LCM-1001). There's nothing to build, no kit to assemble. Just open the comprehensive instruction manual, turn on the module, and you are in the learning mode quickly and easily. From the basics to advanced learning, you set the pace.

Learn hardware/software relationships

By following the manual and applying the module you will become thoroughly familiar with fundamental hardware/software relationships that are essential to successful microprocessor utilization. In addition, the unit will:

- Teach microprogramming
- Enable you to develop simple algorithms
- Help you to develop fixed instructions
- Establish foundation for controller design techniques
- Build insight into microprocessor evaluation techniques

- Better prepare you to effectively employ applications "kits" on specific microprocessors.

Economical self-contained system

The TI Microprogrammer Learning Module consists of a 4-bit static parallel processor, is manually programmed, has VLED bus monitors, push-button manual clock, and offers a 40-pin socket for expansion. Operated from a rechargeable battery, the hand-held module can be used at home or office, or on-the-go. The microprogrammer instruction manual covers the basic and advanced concepts of microprocessor design and suggests follow-on applications to demonstrate further microprocessor advantages.

The complete Microprogrammer Learning Module is economically priced. Only \$149.95 (1-9 units), including manual and battery charger. That's about what you would pay for a do-it-yourself kit, and considerably less than the nearest comparable assembled machine.

More to come

Your learning won't stop with

mastery of the first module. More are coming:

Controller Module—allows conversion to PROM controller and operation from a programmable clock.

Memory Module—adds memory for program and data storage and allows for additional expansion if desired.

Input/Output Module—expands I/O buses to four ports of four bits each

A unique expansion method enables you to eventually link all modules together to achieve elementary prototyping system capability.

Order now

The TI Microprogrammer Learning Module is now available from your authorized TI distributor. Or, for more information, write Texas Instruments Incorporated, P.O. Box 5012, M/S 54, Dallas, Texas 75222.



**TEXAS INSTRUMENTS
INCORPORATED**

© 1976 Texas Instruments Incorporated

CIRCLE NUMBER 69

All the people who bought our DUMB TERMINAL (the ADM-3) because of its low \$995* unit price didn't really expect a lot. But they hadn't counted on the 32 switches. Switches that let you turn the DUMB TERMINAL into a pretty clever animal.

Take the 20 switches under the LSI name plate, for example. Among them, 11 communication rate positive action switches that let you select bauds from 19200 to 75. Also an RS232 interface extension port switch. It allows you to connect the DUMB TERMINAL to all kinds of clever devices — to recorders, printers and smarter terminals. And switches for odd-even parity. Optional upper and lower case (the complete set of 128 USASCII characters) — plus a lot more.

Inside on the PC board, 12 more switches. More positive action types that instruct the DUMB TERMINAL how to behave. And for all those who bought the 24-line optional display, there's a switch to change over from the standard 12-line format. So instead of showing 960 standard characters in 12 rows, you have the option of displaying 1920

The 32 Switches

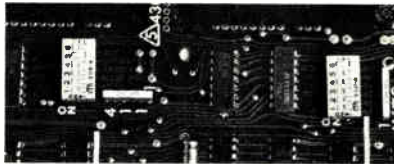

The 12 switches in the rear, on the PC board.

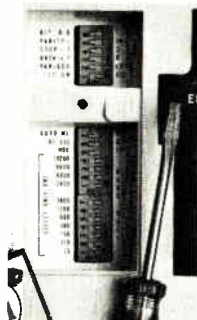

The 20 switches under the front name plate.

characters in 24 rows of 80 letters. And there are still more switches that make your terminal a cinch to operate.

Now people aren't sure what turns them on: the low price, the 32 switches, or the DUMB TERMINAL's standard features. Features like a full 12" diagonal screen. 59 data entry keys, arranged like on a typewriter. Compatibility with all popular computers. Simple, quiet operation. An optional numeric key pad. And fast data throughput. All features that make this terminal a perfect video replacement for the old teletypewriter.

The fact is, people keep finding more and more jobs for our DUMB TERMINAL. Because they can do anything within reason — with just a little switching and training. And that's why the DUMB TERMINAL really turns out to be a smart buy. Which may be the biggest switch of them all.

For full information, write: Lear Siegler, Inc., E. I. D. / Data Products, 714 N. Brookhurst St., Anaheim, CA 92803; Tel. (714) 774-1010.



INTERFACE '76

See you in booth 105.

**DUMB TERMINAL.
SMART BUY.**

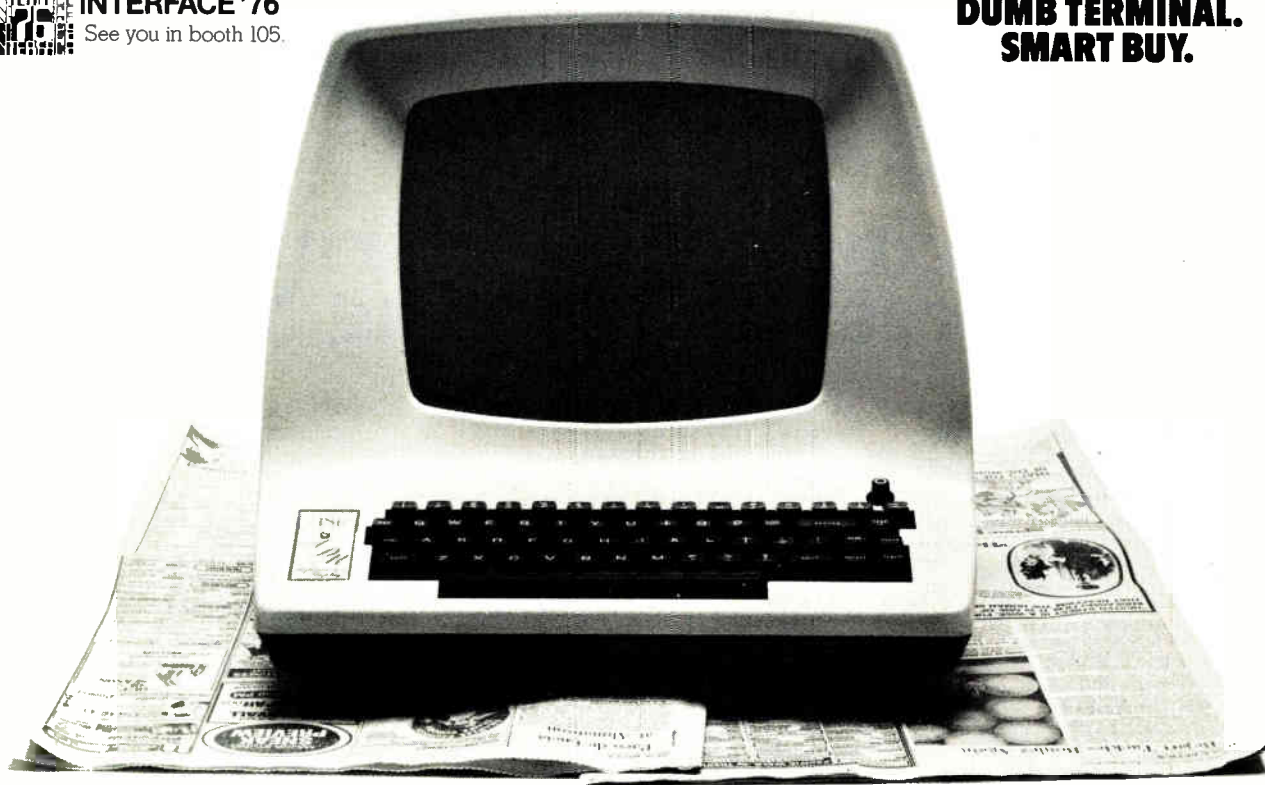

*U.S. domestic price

**THE \$995 DUMB
TERMINAL CAN BE TRAINED
TO DO PRACTICALLY
ANYTHING.**

CIRCLE NUMBER 70

Wescon/76

One of a kind-Again

When Wescon holds its 25th birthday party in Los Angeles for 35,000 close friends, it will be a brand-new show all over again.

That's because the electronics industry cannot tolerate the *status quo*. (You keep up, or you slip out.) This Silver Celebration Year will be another large-scale, full-house WESCON, right up-to-date in a dozen timely and tangible ways.

These are the features you'll find at Wescon/76. And *only* at Wescon/76:

The Red Carpet Treatment,
rolled down every show aisle.

Computerized Registration at two Convention Center entrances.

Freight Service, in and out from the dock, at no charge. (Ditto daily janitorial services.)

Professional Program, keyed to design, specifying and production technologists (no extra charges).

The Great Pink Card guest registration plan for qualified visitors (by the thousands).

The VIV Program for your most-wanted Very Important Visitors.

Product Categories — a floorplan by design, not by chance.

Famous Wescon "Packages": all-inclusive, turnkey display rentals (brand-new again this year).

New Advance Registration system (down with time-in-line!).

Shuttle bus system from major hotels and terminals (no charge, of course).

Industry-wide communications: Nobody won't know there's a Wescon!

Formal certified audit of attendance.

Right Time and Place: A great convention hall, in a great electronics center, in September.

For your copy of the Wescon/76 exhibit prospectus, use the coupon, or telephone directly to Tom O'Gorman (800) 421-6816. (In California, call collect: 213-772-2965)

Wescon/76 Silver Celebration

Sept. 14-17 / Los Angeles Convention Center

CIRCLE NUMBER 71

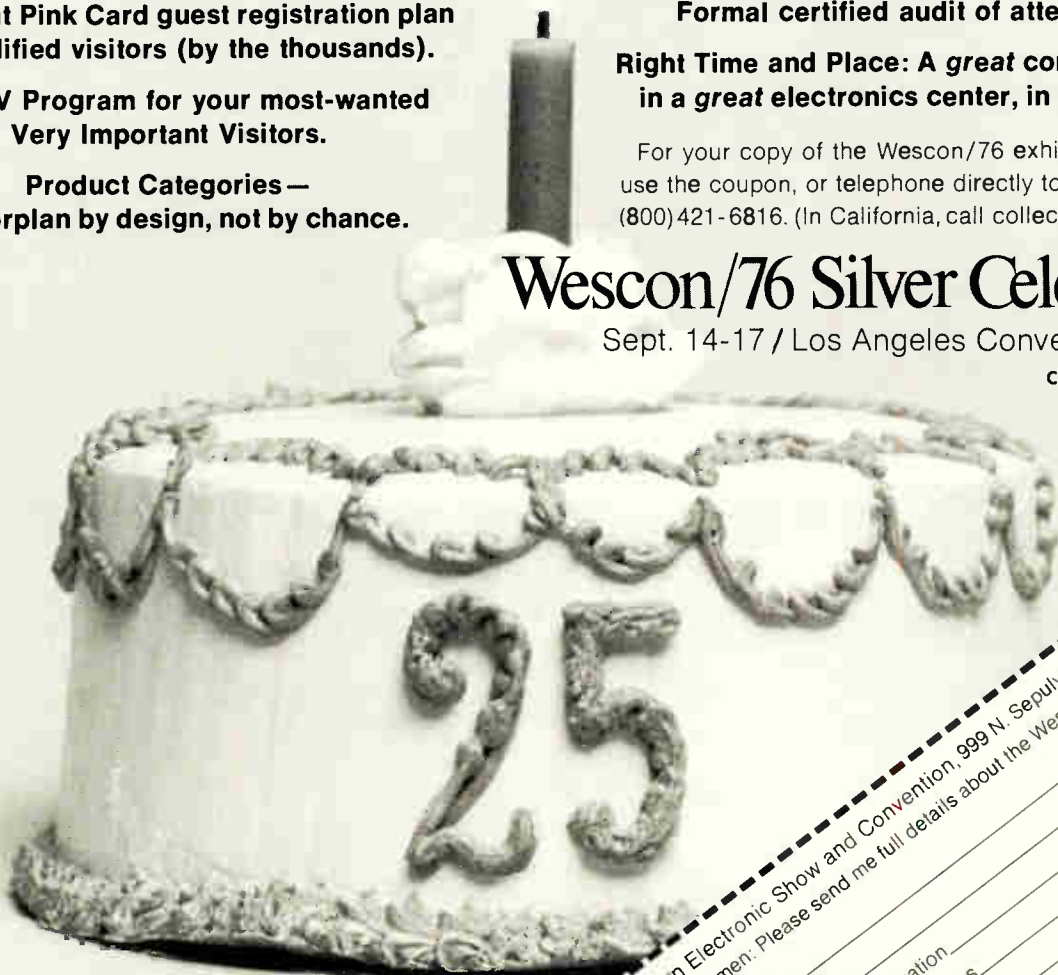

Western Electronic Show and Convention, 999 N. Sepulveda Blvd., El Segundo, CA 90245
Gentlemen: Please send me full details about the Wescon/76 Silver Celebration.

Name _____
Title _____
Organization _____
Address _____
City _____
State _____ Zip _____

Co-Sponsors: San Francisco Bay Area
and Los Angeles Councils, IEEE,
Northern and Southern
California Chapters,
ERA

Measure small capacitance at the end of a long cable

Here's a circuit that can measure capacitance as low as 1 to 10 pF, even when the capacitor is connected to the end of a long cable and when the capacitance of the cable is as much as 100 pF. The circuit is linear and accurate to better than 1% over 25 to 55 C.

In the figure, the quiescent frequency of the oscillator is determined by the adjustable capacitor C_1 , the cable capacitance and any stray capacitances. The output of the J-K flip-flop is half the frequency of the oscillator, and it has a 50% duty cycle. And the center frequency of the phase-locked loop (PLL) is adjusted to the quiescent output frequency of the flip-flop.

When the unknown capacitance at the end of the cable is "chopped" at a power-line frequency of 50 to 60 Hz, the oscillator is frequency-modu-

lated and the PLL tracks the frequency shift, to give an output swing that is proportional to the chopped capacitance.

This output is amplified and fed to a peak detector, which eliminates any uncertainties introduced by contact bounce of the mechanical chopper. The output of the peak detector can then be read by a digital meter.

With the values shown, the oscillator frequency is 1.2 MHz, and the PLL provides an output of about 20 mV/pF. After amplification and rectification, the final output is about 80 mV/pF.

Madhav Kamat, Chief Engineer, Electronic Measurements, 1210-V Block, Rajajinager, Bangalore-560010, India.

CIRCLE No. 311

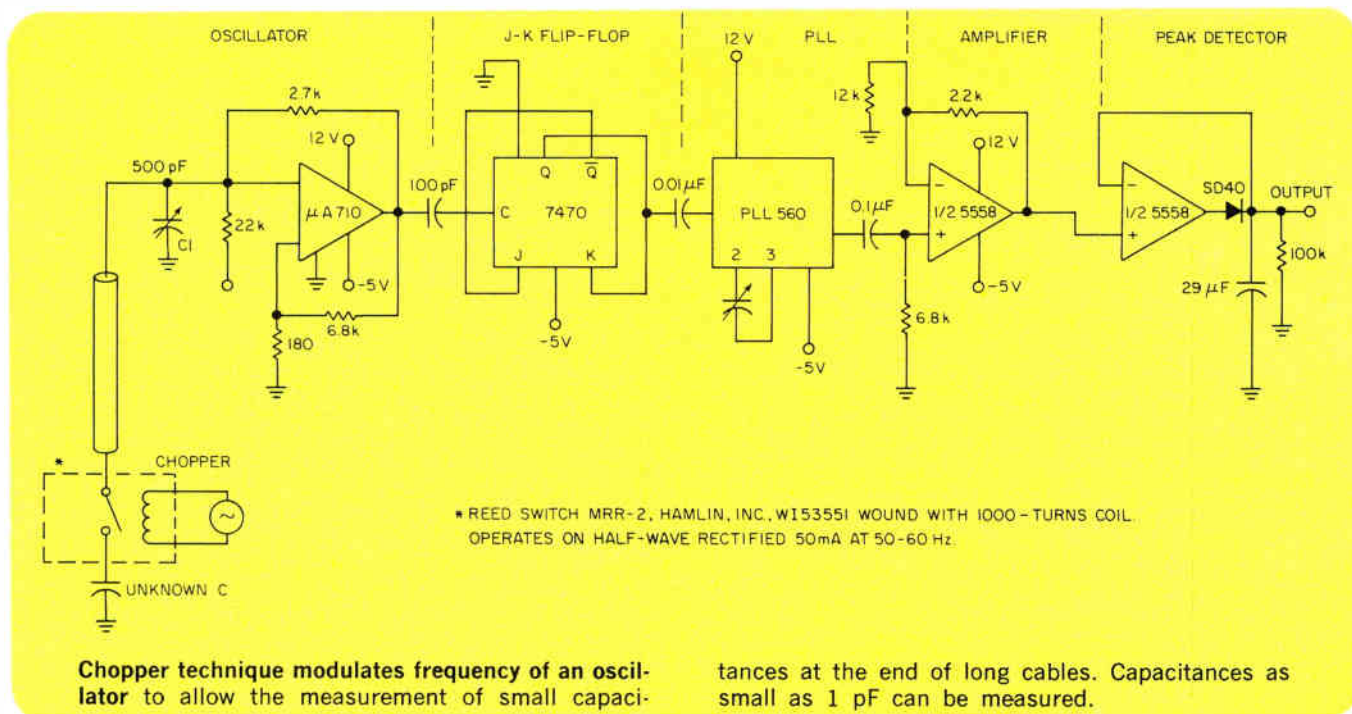

Bypass the middleman!

**Save more than 55%
with unsurpassed quality
and performance!**

Delivery from stock!

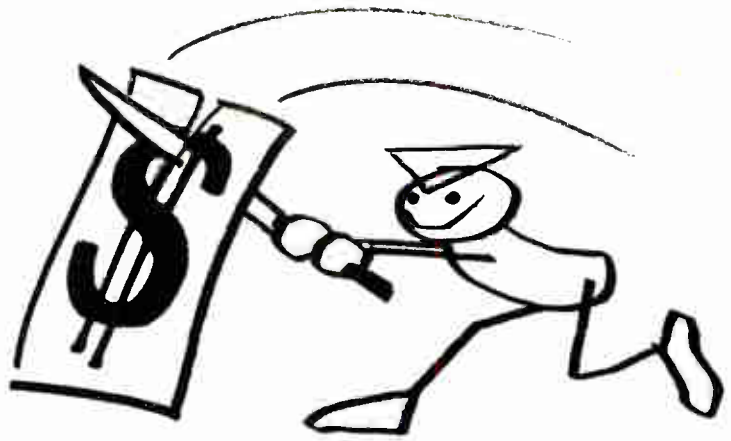

Deltron Slashes the Price of μ Processor Power Supplies

MPS-1: \$77 MPS-2: \$88

In any quantity!

Full one year guarantee. Designed for U.L.



MPS-1

Automatic overload and adjustable overvoltage protection. Dual input voltage, 0.1% regulation, 1.5 mV ripple and noise.



MPS-2

Why buy brand λ ? Deltron's got them spec for spec with same mounting centers at half the price.



The MPS-1 or MPS-2 powers virtually any Microprocessor available. For that rare exception, talk to us about a custom unit.



MODEL	VOLTS	AMPS			PRICE ANY QUANTITY
		40°C	50°C	60°C	
MPS-1 7 x 4 7/8 x 2 3/4	5 \pm 5% Adj.	3.0	2.5	2.0	\$77
	12 \pm 5% Adj.	0.6	0.5	0.4	
	9 to 12V Adj.	0.6	0.5	0.4	
	or 5V	0.38	0.38	0.38	
MPS-2 9 x 4 7/8 x 2 3/4	5 \pm 5% Adj.	7.0	6.0	5.0	\$88
	12 \pm 5% Adj.	1.0	0.9	0.8	
	9V	1.2	1.1	1.0	
	or 5V	0.75	0.65	0.55	

**Next time get the best
for a lot less . . .
write or call collect to:**



Wissahickon Avenue, North Wales, Pa. 19454
215-699-9261, TWX 510-661-8061

CIRCLE NUMBER 72

Sonar transmit-receive switch is compatible with most logic levels

A transmit-receive (T-R) switch is used in active sonar systems to enable a single transducer to both transmit and receive. For generalized use, such a switch must be compatible with the commonly used logic levels: Discrete-component logic families that use +12 to 0 V and +10 to 0 V, TTL levels of +5 to 0 V and MOS levels of +6 to -6 V. The T-R switch design in Fig. 1 is compatible with each.

A mercury-wetted contact relay, Clare HGM-1058, selected for minimum contact bounce and large power capability, operates reliably at 26 V and 60 mA. The Motorola 2N4401 npn transistor, with a collector-emitter breakdown of 40 V and a collector-base breakdown of 60 V dc, is safe for the voltage-level requirements of this circuit. And switch S_1 can invert the sense of the circuit so the relay is energized by either high or low logic levels.

A three-stage circuit is necessary. Two transistor stages, Q_1 and Q_2 , establish a consistent input trigger level and provide sufficient gain to drive the third stage, Q_3 . Transistor Q_3 then drives the relay coil. Diode D_1 protects Q_3 from relay-coil inductive surges.

The design of configuration R_1 , R_2 and Q_1 is

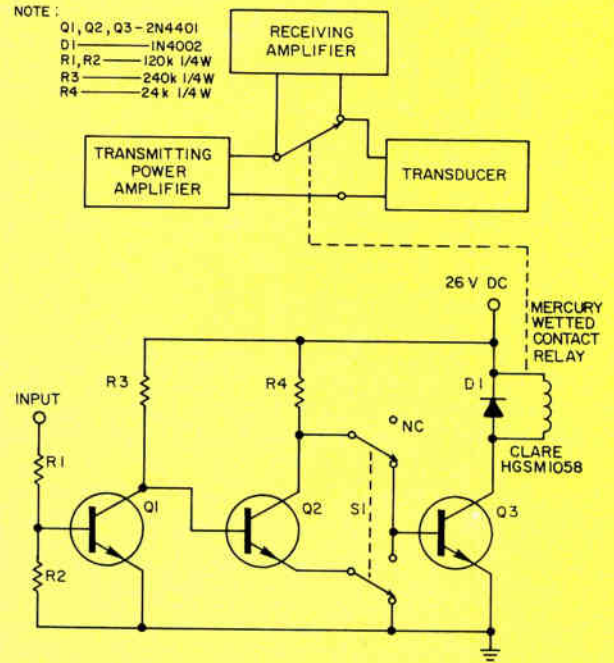

1. Transmit-receive switch for general use must be operable with the most commonly used logic levels.

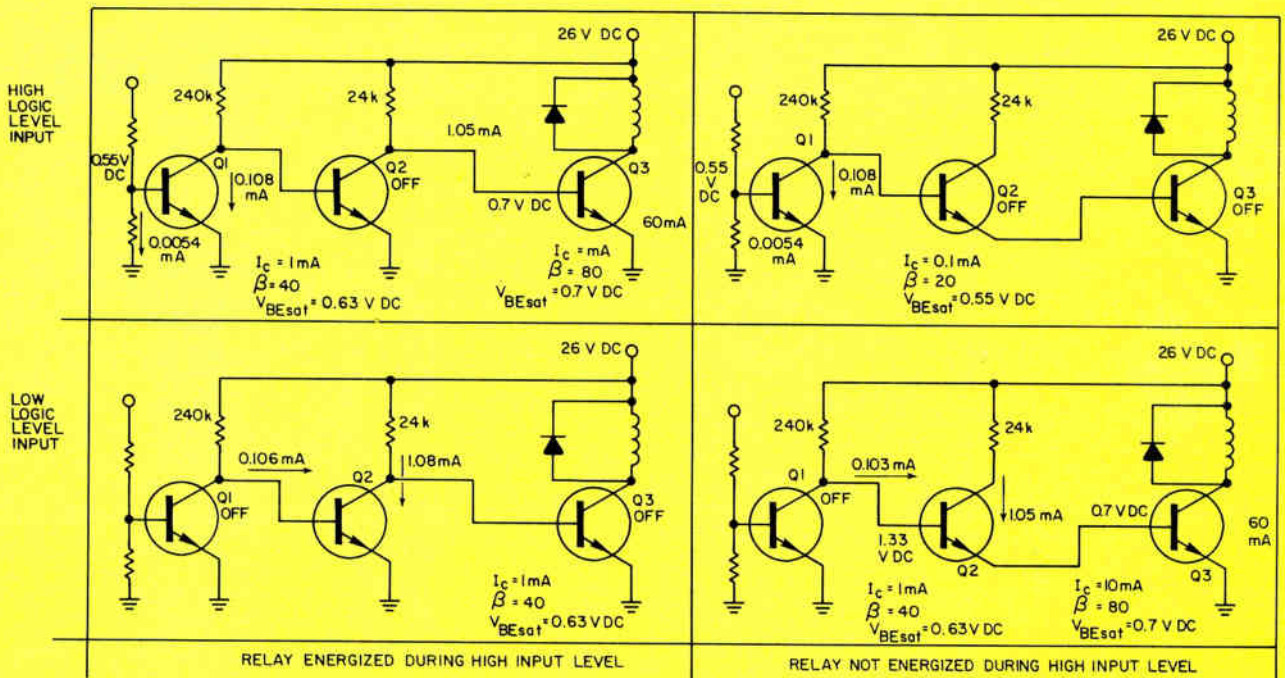

2. All four possible operating states of the T-R switch are analyzed for proper performance.

When battery life is critical, there's nothing even close to a TRW LVA zener

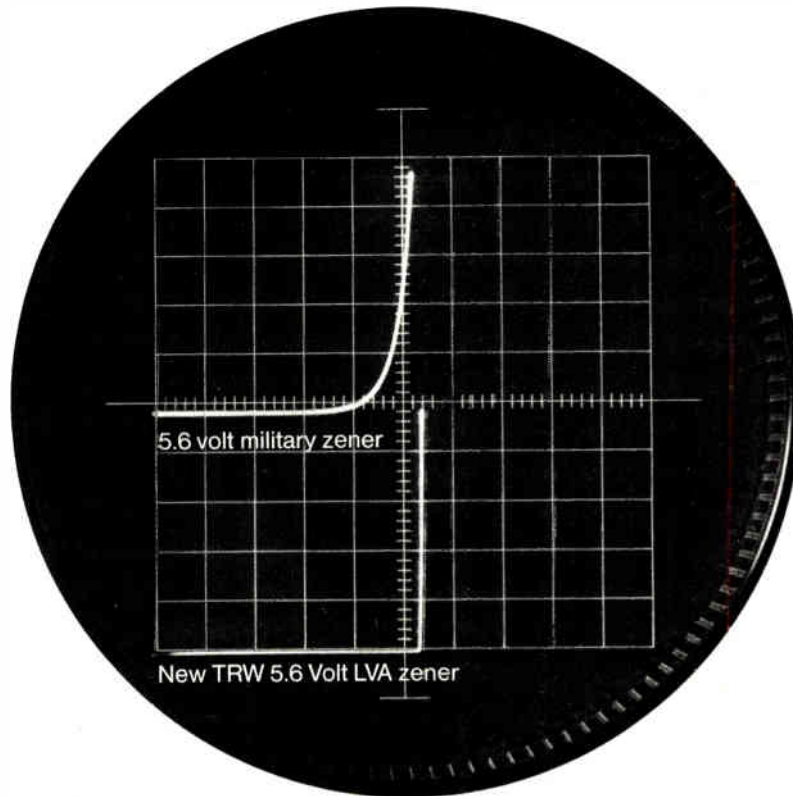

**The sharpest knee below 10 volts
for up to 10 times the battery life.**

In medical equipment, testing devices, watches, pocket pagers—wherever battery life is critical—no other zener can approach a TRW LVA.

TRW's Low Voltage Avalanche zeners are also ideal for instrumentation and logic circuitry where as highly stable zeners they provide extremely constant reference voltage yet draw as little as 50 microamps. True, they cost more. But where battery life is more important than a dollar or so, or when you have to load in transistors and resistors to minimize battery drain, it pays to use TRW LVA's. For your convenience, they're available in several package configurations and chips.

For immediate action and applications assistance, call John Power (213) 679-4561.

TRW Power Semiconductors.

An Electronic Components Division of TRW, Inc.,
*4520 Aviation Boulevard, Lawndale, California 90260

- Please send me data sheets on TRW's LVA zeners.
- I would like a quote on _____ of _____ volt devices.
(Quantity) (Voltage)
- Please have representative call _____
(Phone Number)

Name _____

Company Name _____

Address _____

City _____

State _____

Zip _____

TRW POWER SEMICONDUCTORS

IDEAS FOR DESIGN

especially critical, to permit operation with all of the logic systems. The four possible current-flow diagrams for the two positions of switch S_1 , and the two input sense conditions show all possible operating conditions (Fig. 2). A minimum voltage level of 0.55 V and a minimum current of 0.0054 mA into the base of Q_1 are sufficient to saturate Q_1 .

Obviously, if the circuit triggers for the lowest voltage of the four HIGH logic levels, it will trigger for all of them. TTL logic, with its guaranteed minimum HIGH of 2.4 V, is the worst case. Details of the input circuit and equations for a turned-on condition are shown in Fig. 3. The three equations, with four unknowns, appear to leave an arbitrary choice for resistors R_1 and R_2 , but there are limits on the choices.

If x is the ratio R_1/R_2 , then

$$R_2 = \frac{1}{I_{BE}} \left(\frac{1.85}{x} - 0.55 \right).$$

For minimum turn-on current, $I_{BE} = 0.0054$ mA and for R_2 to be > 0 , $R_1/R_2 < 3.36$. In addition the combination of a -6-V CMOS logic level and a 6-V reverse emitter-base breakdown on the 2N4401 suggests that the resistor ratio be at least 0.5. The low-output current capability of the CMOS logic requires that R_1 be large. Thus the choice of R_1 and R_2 is dictated by the follow-

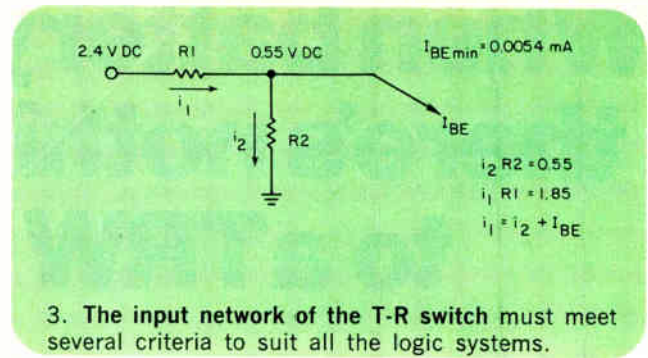

ing criteria:

1. $0.5 < R_1/R_2 < 3.36$.
2. R_1 must be large—above $10^5 \Omega$.
3. For a constant R_1/R_2 ratio, a decrease in R_2 must increase I_{BE} .

Based on these criteria, a ratio of one for R_1/R_2 is a good choice. This permits R_1 to be as high as 120 k Ω and the circuit will still provide double the minimum I_{BE} , a Q_1 reverse emitter-base breakdown with a safety factor of two, and a good level of noise immunity—a 1.1-V trigger level.

Clarence W. Dittman, Research Scientist Associate, Applied Research Laboratories, The University of Texas at Austin, P.O. Box 8029, Austin, TX 78712.

CIRCLE No. 312

Power-supply voltage changed 2:1 with SPDT switch arrangement

An almost obvious arrangement of a SPDT switch, a full-wave bridge rectifier and a center-tapped transformer provide a very useful dual-voltage power supply.

With the switch in the position shown, the supply-voltage output is the full-wave output that the transformer can deliver. With the switch in the lower position, the circuit becomes a full-wave, center-tapped transformer that gives about half the voltage provided by the bridge circuit.

Of course, the filter capacitor must withstand the higher of the two voltages. The two unused diodes in the second configuration are reverse-biased, and the leakage current that flows is negligible.

Charles R. Winchester, Leupold & Stevens Inc., Beaverton, OR 97005.

CIRCLE No. 313

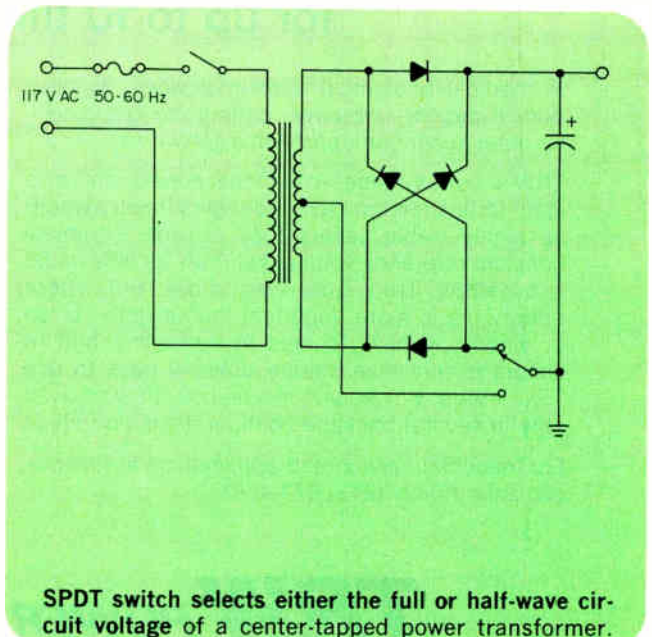

CANNON® COST CUTTERS: ADAPTA-CON INTERCONNECTION SYSTEM

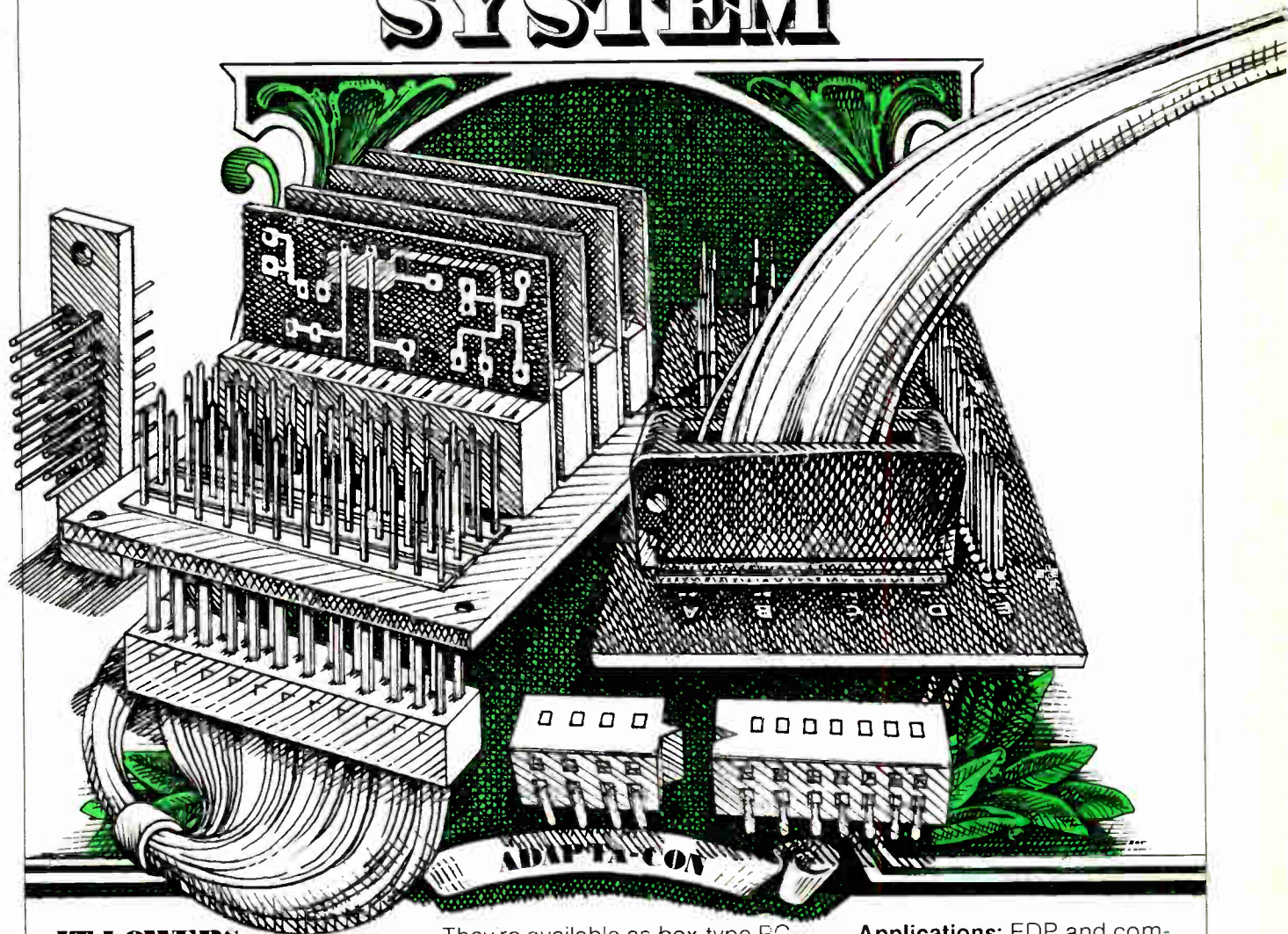

IT LOWERS YOUR TOTAL INSTALLED COST.

Adapta-Con solves one big problem: it meets the ever increasing demand for more versatile, high- or low-force, post-and-receptacle interconnections at less cost per termination. Now you can design your product around the Adapta-Con system and lower your total installed cost—your *real* cost.

Description: Adapta-Con is a versatile approach to printed circuit board, backplane, and I/O interconnection systems.

They're available as box-type PC connectors (single and double row UBS) with 0.100, 0.125, and 0.150 centers. Other styles are box-type, crimp insertable contacts (UBC bulk and reel types) for use in UBC receptacles (single and double row) that mate with 0.025 square posts in UBP assemblies (metal plates and PC boards). There is also a broad line of special assemblies, as well as hand tools and semi-automatic machines. Material is copper alloy, finished in gold over nickel or 90/10 electro-deposited tin lead.

Applications: EDP and computer peripheral equipment; commercial, military, and consumer electronics; indeed, it's so universal, it's used wherever electronic packaging is required.

For the first time, Adapta-Con is available locally from the Cannon nationwide distributor network. Send for the "Cannon Cost Cutters" brochure, ITT Cannon Electric, 666 E. Dyer Rd., Santa Ana, CA 92702, (714) 557-4700, and find out how

**CANNON
ENGINEERING
LOWERS YOUR COSTS.**

CANNON ITT

CIRCLE NUMBER 74

Circuit detects narrow spikes of either polarity, provides 150-ns output

Pulse stretchers are generally designed to expand a pulse of known polarity. However, it is sometimes necessary to flag the occurrence of a level change, no matter what its polarity is and even though the change lasts only a very short period of time. The circuit in the figure can stretch almost any tiny glitch and make it last at least 150 ns for either direction of level change.

Single shots OS₁ and OS₂ provide the 150-ns delay, and the circuit's output signal stays down or up to correspond with the polarity of the input

glitch. The output of each single shot gates the input of the other to prevent mutual interference. Throughput delay for the circuit is about 35 ns. Of course, the minimum duration of the up or down stretched level and be varied if the RC networks of the single shots are changed.

John Shakib, Advisory Engineer, IBM General Systems Div., Boca Raton, FL 33432.

CIRCLE NO. 314

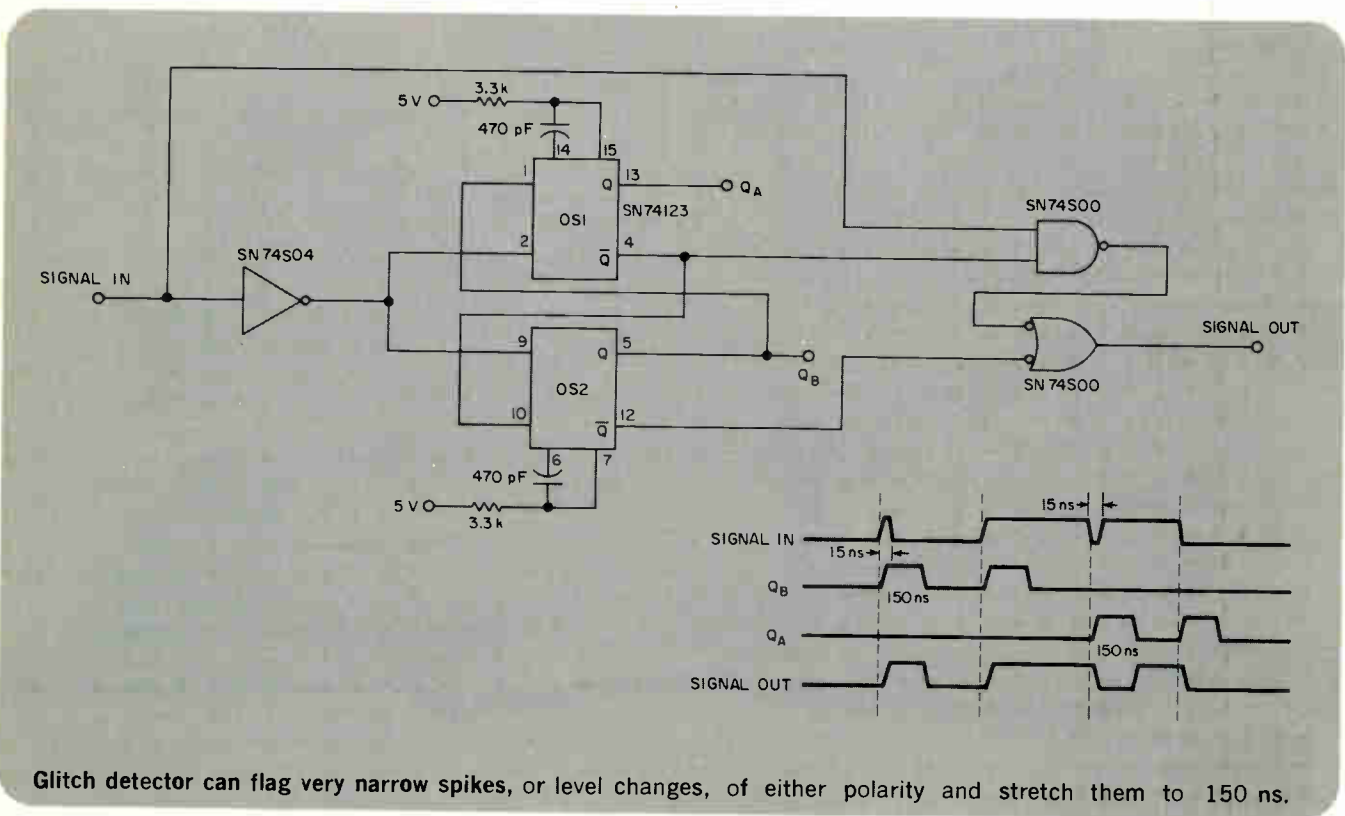

IFD Winner of October 11, 1975

Ralph Tenny, Engineer, Texas Instruments, Inc., P.O. Box 5936, Dallas, TX 75222. His idea "Linear VCO Made from a 555 Timer" has been voted the Most Valuable of Issue Award.

Vote for the best Idea in this issue by circling the number for your selection on the Information Retrieval Card at the back of this issue.

SEND US YOUR IDEAS FOR DESIGN. You may win a grand total of \$1050 (cash)! Here's how. Submit your IFD describing a new or important circuit or design technique, the clever use of a new component or test equipment, packaging tips, cost-saving ideas to our Ideas for Design editor. Ideas can only be considered for publication if they are submitted exclusively to ELECTRONIC DESIGN. You will receive \$20 for each published idea, \$30 more if it is voted best of issue by our readers. The best-of-issue winners become eligible for the Idea of the Year award of \$1000.

ELECTRONIC DESIGN cannot assume responsibility for circuits shown nor represent freedom from patent infringement.

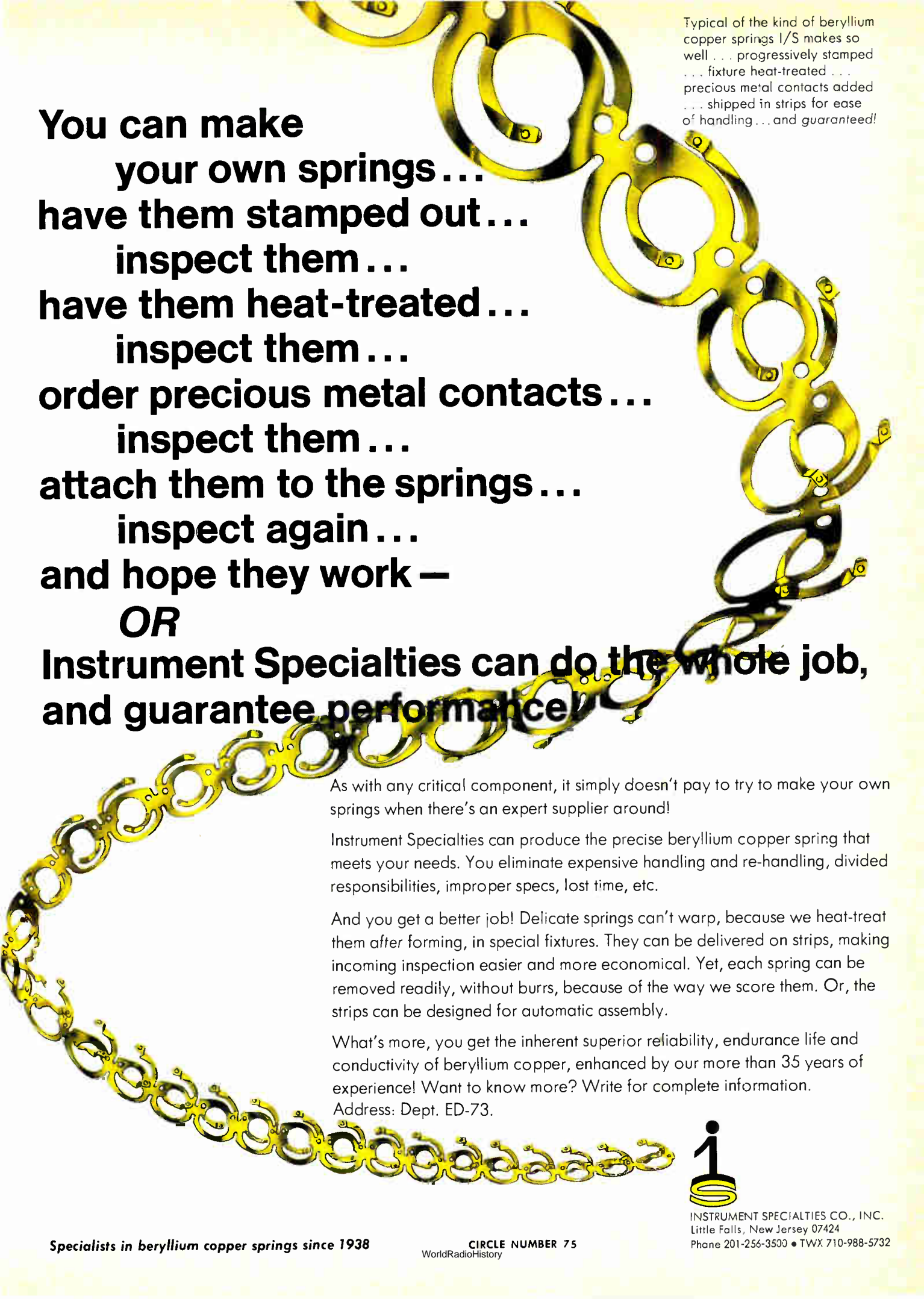

**You can make
your own springs...
have them stamped out...
inspect them...
have them heat-treated...
inspect them...
order precious metal contacts...
inspect them...
attach them to the springs...
inspect again...
and hope they work —**

OR

**Instrument Specialties can do the whole job,
and guarantee performance!**

Typical of the kind of beryllium copper springs I/S makes so well... progressively stamped... fixture heat-treated... precious metal contacts added... shipped in strips for ease of handling... and guaranteed!

As with any critical component, it simply doesn't pay to try to make your own springs when there's an expert supplier around!

Instrument Specialties can produce the precise beryllium copper spring that meets your needs. You eliminate expensive handling and re-handling, divided responsibilities, improper specs, lost time, etc.

And you get a better job! Delicate springs can't warp, because we heat-treat them *after* forming, in special fixtures. They can be delivered on strips, making incoming inspection easier and more economical. Yet, each spring can be removed readily, without burrs, because of the way we score them. Or, the strips can be designed for automatic assembly.

What's more, you get the inherent superior reliability, endurance life and conductivity of beryllium copper, enhanced by our more than 35 years of experience! Want to know more? Write for complete information.

Address: Dept. ED-73.



INSTRUMENT SPECIALTIES CO., INC.
Little Falls, New Jersey 07424
Phone 201-256-3500 • TWX 710-988-5732

Arrow-M Amber Relays eliminate costly hand soldering.

Only Arrow-M manufactures gas-filled plastic sealed relays, proven to have top reliability over a long life. They're applicable from very low level to high capacity contact loads and maintain highly stable contact resistance, even after long use.

Now here's the really big news: by using Arrow-M Amber Relays on your PC board and using automatic wave soldering, you can substantially reduce your labor costs. And since Arrow-M Amber Relays cost less than sealed metal can relays, the savings are even greater.

Arrow-M Amber Relays. When you want maximum reliability *and* maximum savings. And only Arrow-M makes them.

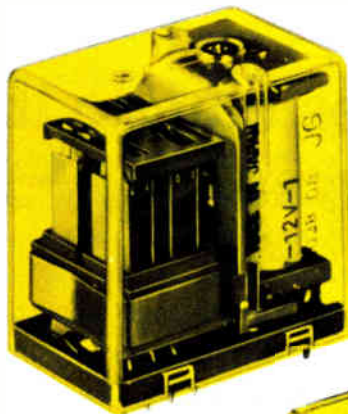

Type KE



Type NFE

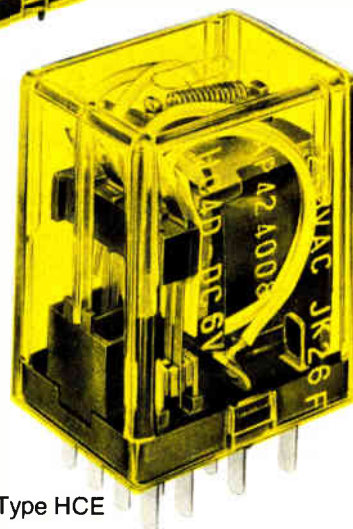

Type HCE

**Relays for
advanced technology.**

For more information
on exact specifications of
our Amber Relays,
write or call your
nearest Arrow-M office.

Arrow-M Corporation
250 Sheffield St.
Mountainside, N.J. 07092
(201) 232-4260

Western Office:
22010 South Wilmington Ave.
Suites 300 & 301
Carson, California 90745
(213) 775-3512



CIRCLE NUMBER 76

New Products

Linear supply rivals switchers in efficiency

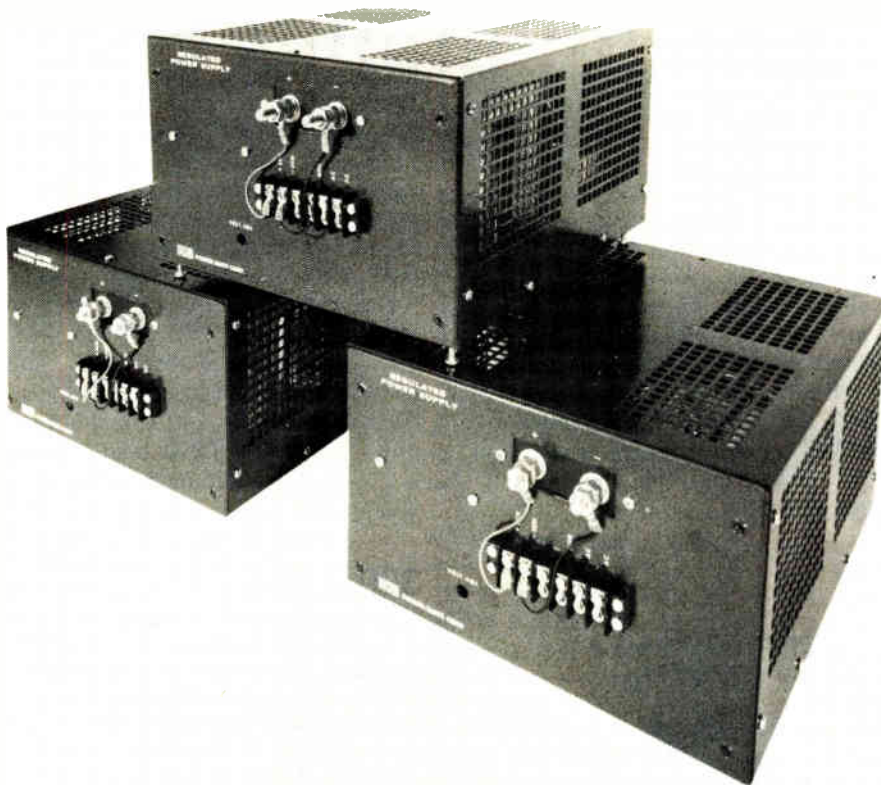

Power/Mate, 514 S. River St., Hackensack, NJ 07601. (201) 343-6294. See text.

Though the search for high efficiency in power supplies now centers on the switching regulator, don't give up on the linear unit just yet.

Power/Mate's "Unswitcher" delivers 5 V at 50 or 100 A and works at 65% to 70% efficiency. This kind of effectiveness in a low-voltage source—and at a price that rings up at less than \$0.80/W—is unusual in any supply, much less a linear one.

Based on a proprietary technique, the Unswitcher uses far fewer parts than conventional sources. Simplicity usually implies reliability and, indeed, the Power/Mate unit claims a calculated MTBF "considerably" greater

than 100,000 h with a 95% confidence factor.

Two models now comprise the Unswitcher series. The CF-5-G delivers 50 A, and the CF-5-J can provide up to 100 A. The output voltage of both units is adjustable over the range of 4.5 to 5.5 V. Input levels can vary from 90 to 130 V ac at 57 to 63 Hz.

Aside from current rating, price, size and weight, both models carry identical specs. Load and line regulation are 0.2% and 0.15% respectively, for a no load to full load change and a 10% line excursion. Ripple stays under 10 mV rms, with a pk-pk noise level of 25 mV max.

The Power/Mate units are cooled by convection, deliver full load from -20 to 50 C (derate to 70% at 71 C) and keep drift to

0.05%/°C. Storage temperature runs a wider -40-to-85-C span. Stability is listed as better than 1% for a period of 8 h.

Protection for overvoltage condition is standard, as is that for current limiting and short circuits. Also standard is provision for remote sensing to improve regulation at distant loads.

Cost of the 50-A unit, which weighs 46 lb and measures 12 × 5.38 × 5.38 in., is \$345. The 100-A model is priced at \$395 and weighs in at 81 lb. Its dimensions are 16 × 6.25 × 8.50 in. Delivery of either unit is from stock.

CIRCLE NO. 301

Freq changer delivers 15 kVA of 400-Hz power

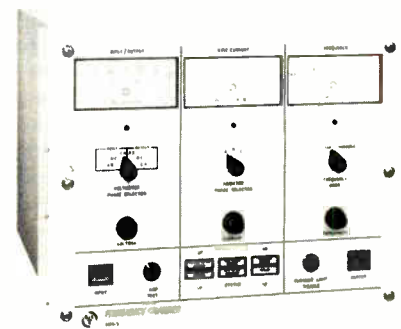

A-L-S Electronics, 733 E. Edna Pl., Covina, CA 91723. (213) 966-7431. \$11,200; stock to 4 wks.

The SMG-15-40 60-to-400-Hz, 15-kVA solid-state frequency changer offers total protection from overloads, short-circuits or input power transients. Any number of units can be paralleled to increase capacity or obtain redundancy. SMG-15-40 has less than 1% THD, 1% voltage regulation, less than 400-W no-load loss, 92% full-load efficiency and a 63-dB sound level.

CIRCLE NO. 302

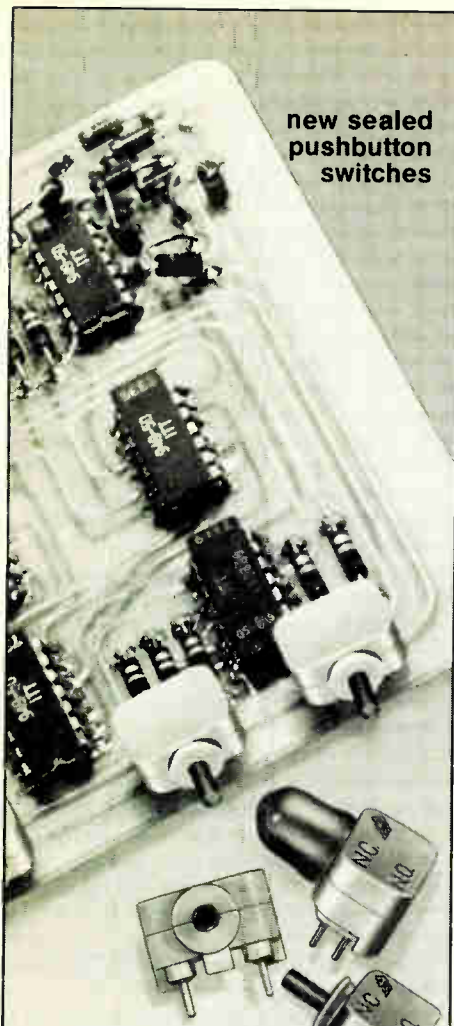

**new sealed
pushbutton
switches**

Grayhill ends contact contamination

**complete protection during
wave soldering and
PC board cleaning**

- terminals welded ultrasonically into switch body
- reusable protective cap seals switch plunger
- tripod stand-offs provide solvent flow area under switch

These economical pushbutton switches are ideal for 'on board' press-to-test or front panel applications. Occupying under 1/2" square, they provide momentary action, long life with low contact bounce and trifurcated gold plated contacts. Terminals are on .100" centers for easy prototype breadboarding and accommodation of board drilling equipment. Circuitry is SPDT (two circuit); operation from logic levels up to 1/4 amp.

The new switches (Series 39-251) are available from stock in prototype quantities and 5-7 weeks for production requirements. For complete information, write Grayhill for Bulletin 248 at 561 Hillgrove Avenue, La Grange, Illinois 60525, or phone (312) 354-1040.



CIRCLE NUMBER 77

POWER SOURCES

Lab supplies come in 23 models



Power/Mate, 514 S. River St., Hackensack, NJ 07601. Start at \$129; stock.

A new line of instrument and system power supplies, called the BPA, consists of 23 models arranged in six case sizes. Each series offers a different case size with optional rack mounting available from a complete assortment of BPA mounting kits. A selection of four voltage ranges in each series provides output voltages from 0 to 60 V with current ranging up to 90 A. Each model offers front-panel precision voltmeters and ammeters as well as controls for coarse and fine voltage adjustments and current limiting.

CIRCLE NO. 303

Power modules deliver 40 W/lb

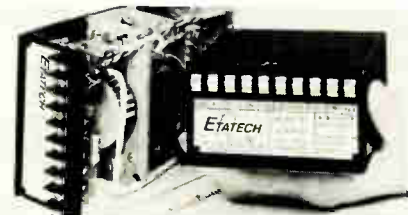

Etatech, Inc., 187-M W. Orange-thorpe, Placentia, CA 92670. (714) 996-0981. Start at \$295; stock to 8 wks.

Series "A" power modules feature output voltages of 5 to 60 V dc with minimum efficiencies of 75% to 82%. Units provide 2 W/in³ (40 W/lb) power density with combined line/load regulation of $\pm 0.2\%$ max and ripple of 100 mV max pk-pk from all sources. MTBF is 70,000 h. Input voltages of 100-to-130-V rms and 47-to-440-Hz frequency range are required by the compact 4 x 6 x 2-1/4-in. modules, which provide output currents from 20 A at 5 V dc to 2 A at 60 V dc.

CIRCLE NO. 304

Potted modules trade regulation for cost



Intronics, 57 Chapel St., Newton, MA 02158. (617) 332-7350. \$36 to \$82; stock-4 wks.

SME Series of modular power supplies features single, dual and triple-output voltages in a compact 2.5 x 3.5 x 0.875-in. (up to 1.56 in.) encapsulated module. Current capabilities range from 5 V dc at 500 mA up to 2000 mA and ± 12 or ± 15 V dc at 100 mA up to 300 mA. All units offer output voltage tolerance of $\pm 1.0\%$ max., voltage tempo of 0.02%/°C typical, output ripple of 1.0 mV rms max., and isolation of 50 M Ω min. Line/load regulation for 5-V-dc single-output units is 0.1%/0.2% and 0.1%/0.1% for all other models.

CIRCLE NO. 305

300-W switcher cools itself with forced air



Hewlett-Packard, 1501 Page Mill Rd., Palo Alto, CA 94304. (415) 493-1501. \$450 (25); 6 wks.

Model 62605L switching-regulated power supply has a single output of 60 A at 5 V and achieves an efficiency of 68% with 20-kHz transistor switching. The unit's efficiency combined with integral forced-air cooling makes for a cool-operating supply. Thus the unit does not need conventional heat sinks and can be packaged into half-rack-width cases (5 x 8 x 11-1/2 in.). The supply is regulated to 0.1% with ripple and noise of 15 mV rms, 50 mV pk-pk (20 Hz to 20 MHz). It will supply a continuous output of 60 A at 5 V from 0 to 40 C, with linear derating to 30 A at 70 C.

CIRCLE NO. 306

JOIN OUR BME-KAPTM SAVINGS PLAN

SAVE 30% TO 50% ON THE COST OF MONOLITHIC CERAMIC CAPACITORS

This major cost saving is the result of our new BMETM capacitor technology. We've eliminated precious metals entirely from the electrodes and terminations of our BMETM capacitors. No precious metals means lower cost. So now we offer you our complete line of monolithic ceramic capacitors — BME ChipsTM, BME RadialsTM and BME AxialsTM — at a genuine savings of 30% to 50%.

This significant reduction is not based on a momentary drop in precious metal prices. This is a long-term solution due to the replacement of precious metals by non-noble metals which are not subject to the same dramatic cost spirals.

SAVE WITH RELIABILITY

Our BMETM capacitors have not sacrificed the inherent electrical and mechanical Ceramolitic[®] quality. Their reliability can be demonstrated by the extensive test procedures to which they have been subjected. Write to our Applications Engineering Department for complete test reports.

SAVE WITH DESIGN FLEXIBILITY

Now you can seriously consider monolithics to replace micas and tantalums. Our BMETM capacitors feature non-polarity, a wide range of capacitance value, low leakage, high volumetric efficiency, availability in chip, radial and axial packages at prices competitive with mica below 1000pF and tantalum up to 2.2 μ F.



TYPICAL SELLING PRICES PER UNIT QUANTITIES OF 5000 OR MORE

BME TM "J" DIELECTRIC (COG)	BME-Chip TM	BME-Axial TM	BME-Radial TM
1 thru 100 pF, 5%, 50WVDC	5.1¢	6.8¢	7.5¢
1000 pF, 5%, 50WVDC	12¢	16¢	16¢
BME TM "S" DIELECTRIC (X7R)	BME-Chip TM	BME-Axial TM	BME-Radial TM
.01 μ F, 20%, 50WVDC	3.5¢	5.8¢	5.8¢
.1 μ F, 20%, 25WVDC	9¢	16¢	14¢
1.0 μ F, 20%, 25WVDC	52¢	—	73¢
BME TM "R" DIELECTRIC (Z5U)	BME-Chip TM	BME-Axial TM	BME-Radial TM
.1 μ F, +80 -20%, 25WVDC	5.7¢	8.8¢	8.8¢
.47 μ F, +80 -20%, 25WVDC	13¢	16.5¢	16.5¢
1.0 μ F, +80 -20%, 25WVDC	19¢	27¢	25¢
2.2 μ F, +80 -20%, 25WVDC	35¢	—	49¢

JOIN THE USCC/CENTRALAB BMETM CAPACITOR SAVINGS PLAN

Get all the details today. Write on your company letterhead for your concise Savings Plan Price list — your pass book to the lowest monolithic ceramic capacitor prices available. Compare it with anyone else's price list and see.

Remember, USCC/Centralab— Quality, Volume, Savings.

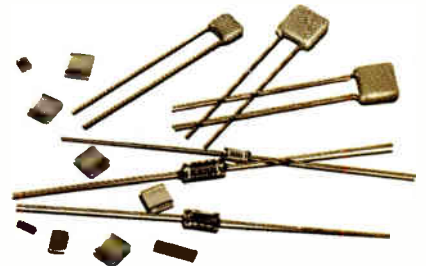

USCC/Centralab

Electronics Division • Globe-Union Inc.

4561 Colorado Boulevard ■ Los Angeles, Ca. 90039

(213) 240-4880



CIRCLE NUMBER 78

TMI CLADS CLICK WITH POLAROID

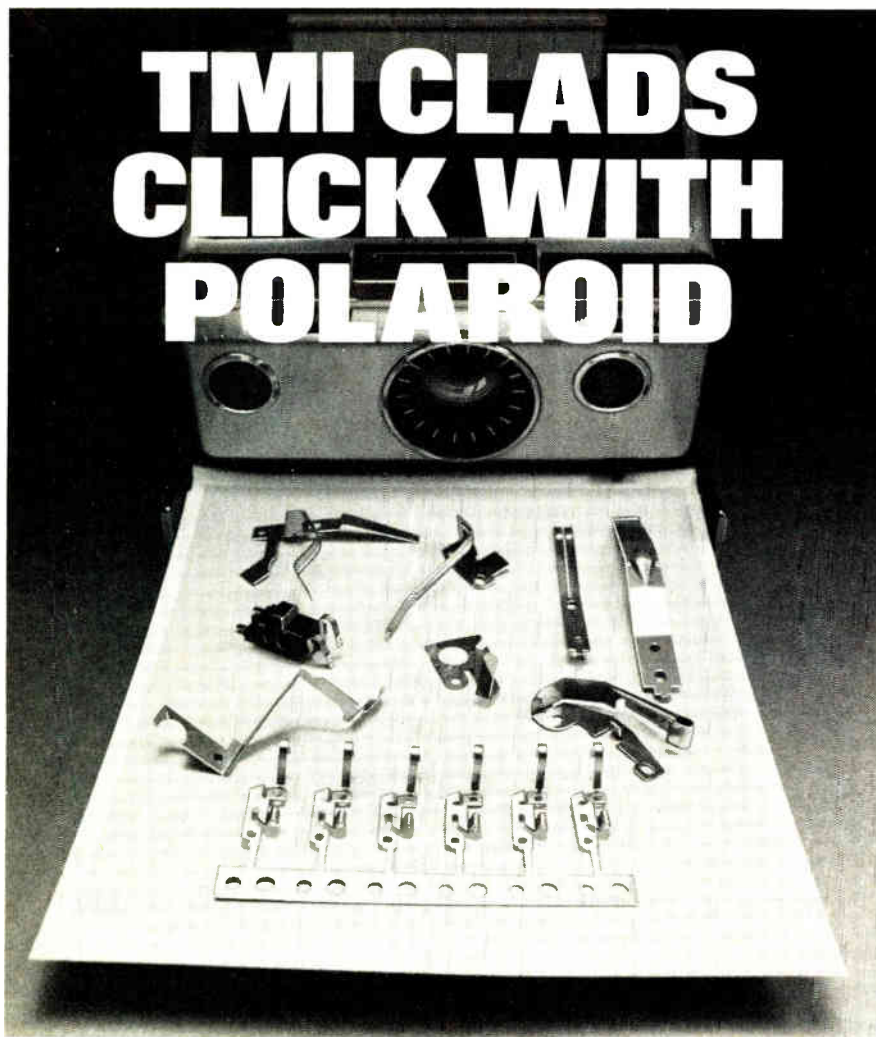

Polaroid uses TMI clad contact springs in both their Square Shooter and their SX 70 cameras for the best of reasons. Economy. Ease of Manufacturing. Reliability.

ECONOMY. Where sliding friction makes the use of silver alloy possible (such as the battery clip), TMI provides Polaroid with a coin silver contact. And where gold contacts are required (low voltage passing through the electronic shutter), Polaroid has found that TMI's 14 karat gold alloy inlay meets their performance requirements at a 50% gold savings over 24 karat gold.

EASE OF MANUFACTURING. When Polaroid selected clad contacts, a prime consideration was that cladding would allow the stamper to provide a one-step, completed assembly rather than having to rely on multiple sources inherent with either plating or welded contacts. A second consideration was the different stresses each of the springs would be subjected to. Here, Polaroid engineers were able to utilize base spring metals that included stainless steel, nickel silver, phosphor bronze, and beryllium copper.

RELIABILITY. Polaroid cameras are in use from the tropics to the Antarctic and continue to function time after time with exceptional reliability. If you're beginning to get the picture, why not write to TMI and see what we can develop for you.



TECHNICAL MATERIALS, INC.

5 Wellington Road, Lincoln, Rhode Island 02865
Telephone 401-728-7200

CIRCLE NUMBER 79

POWER SOURCES

Open-frame units aim at μ P applications

Scarpa Laboratories, 46 Liberty St., Braintree Station, Metuchen, NJ 08840. (201) 549-4260. \$45 to \$75; stock to 2 wks.

These power supplies are specifically designed for the more popular microprocessor chip sets such as the Intel 8008 or 8080, the Motorola M6800 or the Fairchild F-8. The open-frame modules feature short-circuit-proof operation as well as overvoltage crowbar protection. This latter feature protects the costly microprocessor and memory chips from being wiped out if a regulator fails. A husky 6 or 10 A at 5 V is provided.

CIRCLE NO. 307

Compact modules offer efficiency of 75%

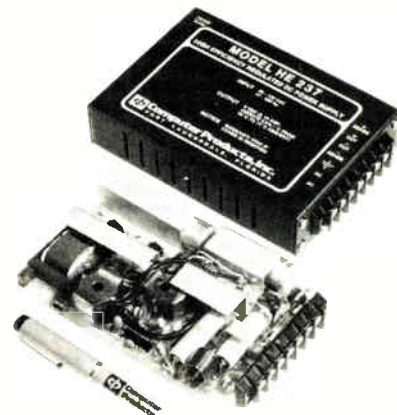

Computer Products, 1400 N.W. 70th St., P.O. Box 23849, Fort Lauderdale, FL 33307. (305) 974-5500. \$195; stock-45 days.

Model HE237 5-V, 10-A unit is the first of a new line of high-efficiency power supplies. It achieves 75% efficiency in a $6.5 \times 4.5 \times 1.5$ -in. package. CMOS logic and switching techniques are combined to produce a volumetric efficiency of 1.2 W per cubic inch. The 25-kHz unit is designed with the "footprint" and mounting hole configuration of Lambda's "B" package size supplies. The HE237 is overvoltage protected, short-circuit proof and carries a two-year warranty. Line and load regulation are $\pm 0.1\%$ max or a 10% change in line and from no load to full load.

CIRCLE NO. 308

Fail-Proof Miniature BITE Indicators

BUILT-IN TEST
EQUIPMENT

- Complete selection from one source!
- Mil-spec or commercial quality
- Ball or Flag Indicators and Annunciators
- Magnetic Latching, Self-Restoring and Manual-Reset models
- Micro-miniature sizes
- Positive indication
- Excellent visibility
- Fast reliable response
- Negligible power drain
- Standard voltages 1.5, 3, 6, 12, 24, 28 VDC
- Off-shelf delivery
- Write or phone for catalog



**Sudden
Service
on Small
Quantities!**

PROTOTYPES

available on phone or letterhead request

MINELCO Div. General Time

135 South Main St., Thomaston, Conn. 06787

Phone 203-283-8261

A  **TALLEY INDUSTRIES COMPANY**

...from **Minelco**

CIRCLE NUMBER 81

INTEGRATED CIRCUITS

Chip controls temperature

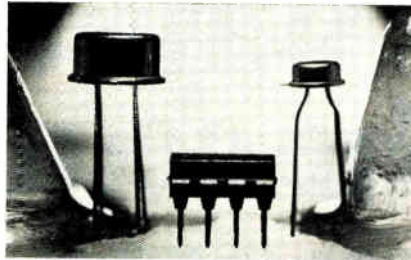

National Semiconductor, 2900 Semiconductor Dr., Santa Clara, CA 95051. (408) 732-5000. 75¢ (100); stock.

With the LM3911, temperatures can be controlled over the -25 -to- 85 -C temperature range with better than $1/10$ of a degree stability. The chip includes calibrated temperature sensor, voltage reference and op amp, and it requires only set-point resistors and a power control device. The sensor is calibrated directly in degrees Kelvin at 10 mV/ $^{\circ}$ K and is linear with temperature. Initial accuracy as delivered is ± 10 K, which can be improved by external means. The internal op amp can be used to obtain a wide range of output scale factors, including 5 V/ $^{\circ}$ C.

CIRCLE NO. 309

See the Microprocessor Design section for microprocessors and related products.

Convert voltage to frequency with IC

Raytheon Semiconductor, 350 Ellis St., Mountain View, CA 94040. (415) 968-9211. \$5 (100-999); stock.

The first monolithic IC voltage-to-frequency converter—the 4151—outputs frequencies in the range of 0 to 10 kHz, with an operating bandwidth of 10 to 100 kHz. Pulsed output signals are compatible with all logic forms, and the circuit operates from a single 8 -to- 22 -V supply. The converter comes in a MIL temperature-range version (prefix RM), commercial temperature-range version (prefix RC) and in a -40 -to- 85 -C version (prefix RV).

CIRCLE NO. 310

18-pin DIP holds complete 10-bit DAC

Precision Monolithics, 1500 Space Park Dr., Santa Clara, CA 95050. (408) 246-9222. \$12 to \$20 (100-999).

The DAC-03, a series of complete 8 or 10-bit d/a converters, includes all the elements of a complete DAC on a single monolithic chip. Packaged in an 18-pin DIP, the unit has a settling time of 1.5 μ s and maximum power consumption of 350 mW. The DAC operates from ± 12 to ± 18 -V supplies. FS temp-co is 60 ppm/ $^{\circ}$ C typical and maximum differential nonlinearity is ± 0.1 to $\pm 0.2\%$.

CIRCLE NO. 320

6-bit hex register operates at 65 MHz

Advanced Micro Devices, 901 Thompson Pl., Sunnyvale, CA 94086. (408) 732-2400. \$1.91 to \$12.84 (100).

A Schottky-TTL 6-bit register, the Am25LS07, features typical operation at 65 MHz. The parallel input, positive edge-triggered D-type register comes with buffered common clock and register-enable functions. This device is similar to the Am25LS174 and Am74LS174 hex registers, but features the common register enable in place of a common clear. The Am25LS07 is being second sourced by Texas Instruments.

CIRCLE NO. 321

2-k ROM can be erased electrically

NEC Microcomputers, 5 Militia Dr., Lexington, MA 02173. (617) 862-6410. Stock.

Fast enough for use with 2-MHz microprocessors, the uPD454D 2-k-bit read-only memory can be erased and programmed electrically. The silicon-gate NMOS memory has a maximum access time of 800 ns. Program write time is typically 7.5 s, and erase time is typically 30 s, with a maximum of 60 s. Other features of the device are nonvolatile storage, TTL-compatible inputs and outputs, 256×8 -bit organization, three-state output, and power supply voltages of 12 and ± 5 V in the ROM mode.

CIRCLE NO. 322

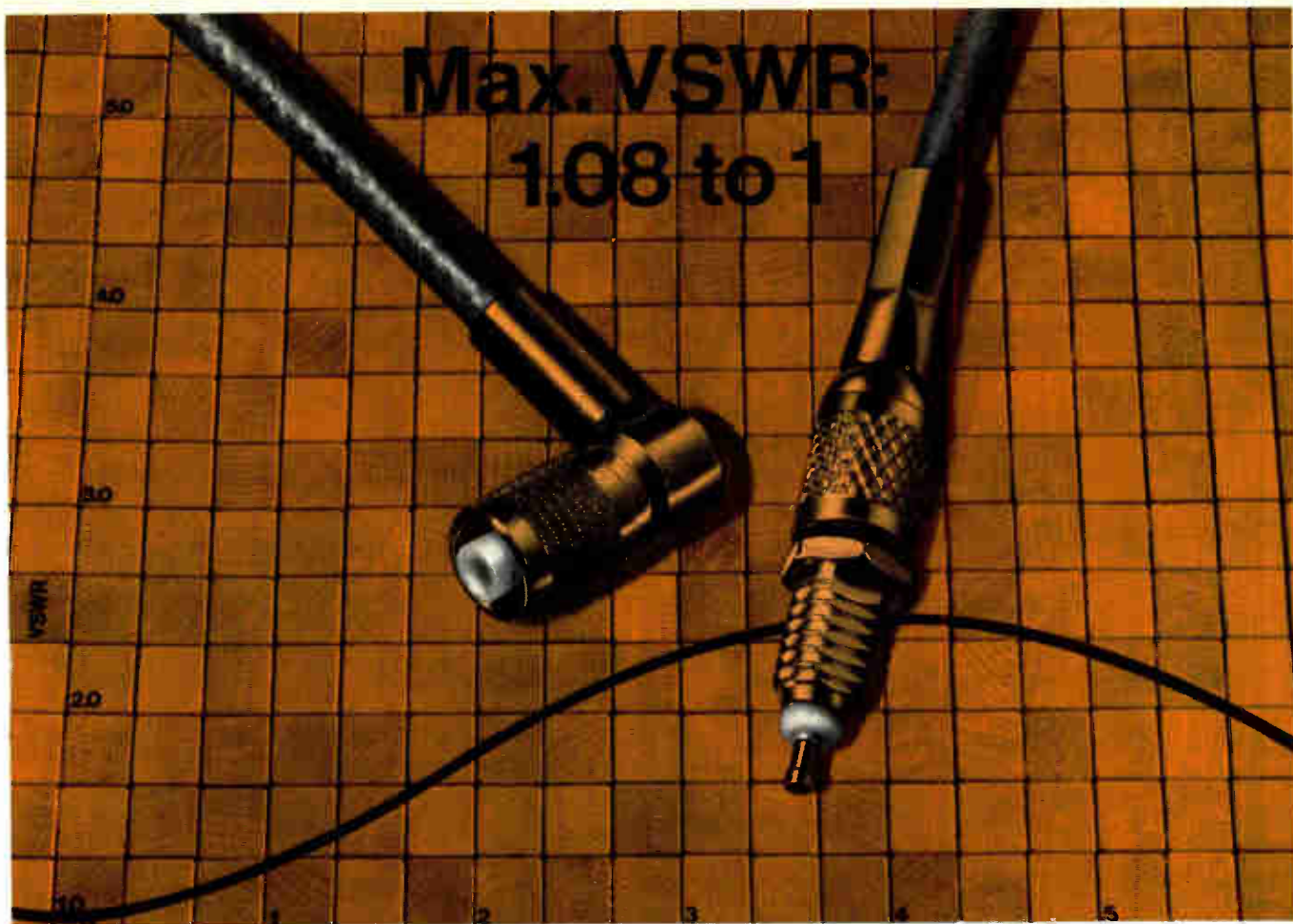

FREQUENCY GHz

Malco's LEPRA/CON Coax connectors provide new lows in VSWR to set new highs in performance.

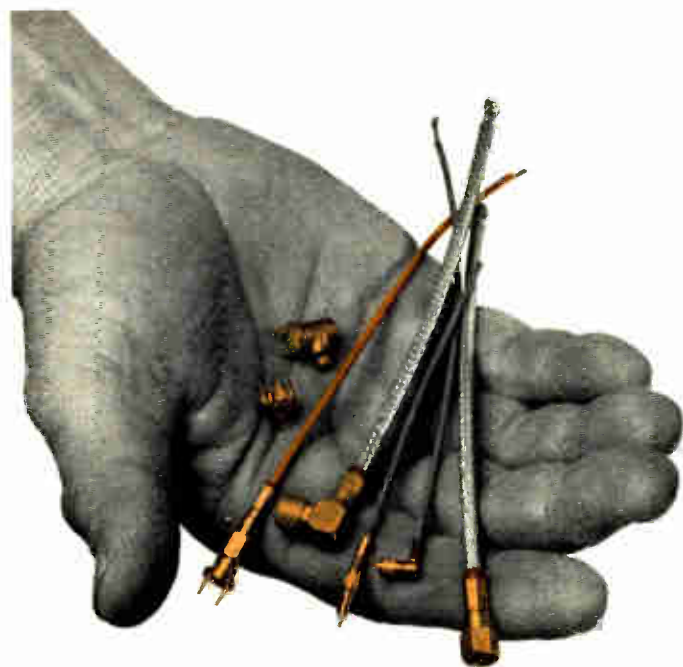

That's right, a VSWR of only 1.08 to 1 on Malco's microminiature LEPRA/CON™ coax connectors. How's that for engineering capability? It's the kind of capability that gives you quality coax connectors in three standard lines . . . LEPRA/CON, GOLDEN CRIMP™, and the intermatable non-crimp. Three styles are available—slide-on, threaded and quick-connect. All for impedance values of 50 to 95 ohms. In severe environments our GOLDEN CRIMP gives peak performance even at temperatures as high as 200°C. Naturally, all Malco coax connectors meet MIL Spec. performance requirements. Select Malco's LEPRA/CON coax connectors and you'll be taking a giant step up in quality, performance and reliability. Write Malco, 12 Progress Drive, Montgomeryville, Pennsylvania 18936 . . . or call our South Pasadena facility (213) 682-3351 for price and delivery.



MALCO
A Microdot Company
Helping industry put things together.

CIRCLE NUMBER 82

You'll like what printer designers like about the 82900 logic stepper motor.

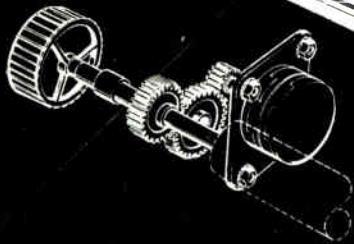

Schematic showing motor drive arrangement. A pinion mounted on the motor shaft engages a spur gear that drives the carriage platen.

Take low price...top quality...compactness and 23 oz-in torque as starters.

The new 82900 stepper motor is built to do yeoman's service not only in impact and non-impact printers, but in small X-Y plotters, chart drives and computer peripherals. Yes, even medical instrumentation, where its reliability really pays off. Compact size, efficiency, low cost and 23 oz-in torque @ 200 PPS all combine to offer design advantages unobtainable in larger, bulkier and more expensive steppers.

A case in point. A high-speed impact terminal printer. Initially a mechanical linkage, actuated by a solenoid, was used to advance the carriage platen and paper automatically on command. This design proved to be somewhat cumbersome in making adjustments during assembly and required excessive downtime during servicing. After careful investigation, the 82900 stepper was adopted as a more vi-

able alternative. In addition to meeting the load requirements of the application, the 82900 proved capable of providing the necessary torque output, the required step angle and a minimum of 5000 hours operating time. Equally important, the motor met price parameters.

Consider the 82900 stepper in your own design. It's bidirectional. It has a nominal power rating of 12.38 w @ 5 vdc. And it is efficient, operating at lower than average temperatures. Standard construction provides 2-phase operation (requiring simplified drive circuitry) a 7.5° step angle and roller bearings. A 15° step angle, 4-phase operation or sleeve bearings in any combination desired can also be provided as options.

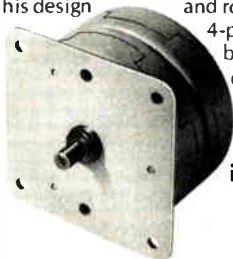

Send for information now!

A. W. HAYDON CO. PRODUCTS

NORTH AMERICAN PHILIPS CONTROLS CORP.

Cheshire, Conn. 06410 • (203) 272-0301

CIRCLE NUMBER 83

INTEGRATED CIRCUITS

4-k static RAM has 100-ns access

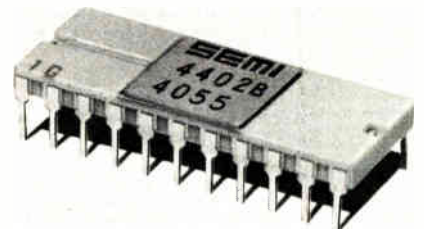
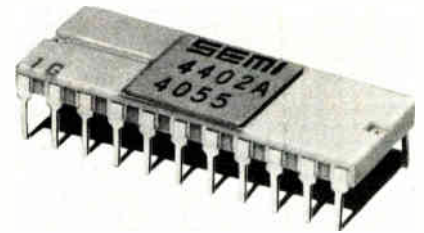

EMM Semi, Inc., 3883 N. 28th Ave., Phoenix, AZ 85036. (213) 644-9881. \$15.25 to \$22.

The 4402B, a 4096 × 1-bit static MOS RAM, has an access time of 100 ns and a 300-ns cycle time. It comes in a 22-pin DIP package with pinouts compatible with that of dynamic 4-k RAMs. A slower speed version, the 4402A, has access and cycle times of 150 and 350 ns, respectively.

CIRCLE NO. 323

8-k, 16-k ROMs boost speeds

Advanced Micro Devices, 901 Thompson Pl., Sunnyvale, CA 94086. (408) 732-2400. See text.

An 8-k and 16-k pair of interchangeable factory-programmable NMOS ROMs sets the pace for speed. The Am9208 is a 512 × 8-bit memory with access times as low as 300 ns. The Am9216 is a 2048 × 8-bit memory with access times as low as 400 ns. The two units also can be interchanged with 8192-bit erasable PROMs. Both ROMs operate from 5 and 12-V power supplies and both circuits have two fully programmable chip selects. Current sinking capability for each unit is two TTL loads. In quantities of 100, the ROMs cost \$18 to \$27. The mask charge is \$1000. Delivery for prototypes is 6 to 8 weeks.

CIRCLE NO. 324

THE COMPANY THAT DIDN'T WRITE THE BOOK ON MICROCOMPUTERS IS OFFERING IT ANYWAY.

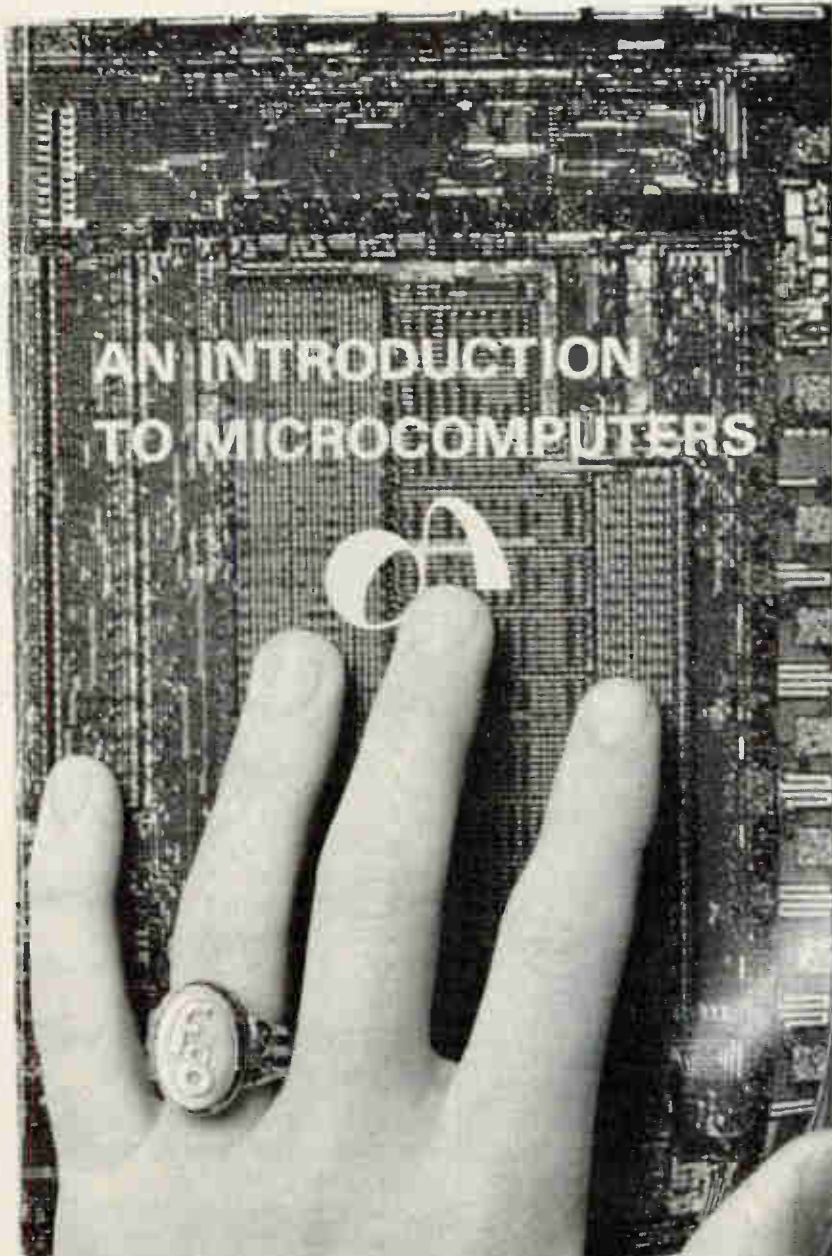

Why would Fairchild offer anyone a book we didn't even write? Because we're into micro-computers in a big, big way, and this is probably the best darned introduction to the industry we've seen to date. We think everyone should have one.

We're not making any money on the book. Just enough to cover inventory and shipping costs and no more. But we'll send it to you *at our cost* just to make sure you get one.

Who *did* write it? Adam Osborne and Associates, a company doing consulting work for many of today's microprocessor manufacturers.

AN INTRODUCTION TO MICRO-COMPUTERS includes just about everything you'll ever want or need to know. Origins of the microprocessor, its evolution, memory organization, microprogramming. And a completely unbiased comparison of the industry's top six microcomputer manufacturers. You'll find facts and figures for National, Intel, Motorola, Rockwell, Signetics and of course Fairchild.

There's a chapter dedicated solely to the *selection* of your microcomputer. Fixed costs, variable costs, engineering costs. Designing the logic, accompanying hardware and software, and after-sales-service.

Altogether, it's nearly 400 pages thick, packed with information, tables, and illustrations you really can't afford to pass up for only \$7.50. Not if you're truly into microprocessors (or would like to be) or still have a lot of questions about them.

And all you have to do is return the coupon today.

Fairchild may not have written the book on microcomputers, but we've got a great sequel on the way. It's the full story on the F8. And although we can't guarantee "a completely unbiased" approach, we can guarantee its price—free!

FAIRCHILD
MICRO SYSTEMS

FAIRCHILD MICRO SYSTEMS
1725 Technology Drive, San Jose, Calif. 95110

AN INTRODUCTION TO MICROCOMPUTERS sounds like just what I've been looking for. Please send me _____ copies at \$7.50 each (in Calif. add 6% sales tax) for a total of _____.

Check BankAmericard No. _____
 Master Charge No. _____

Name _____

Company _____

Address _____

City _____ State _____ Zip _____

UL-LISTED charger/inverter systems?

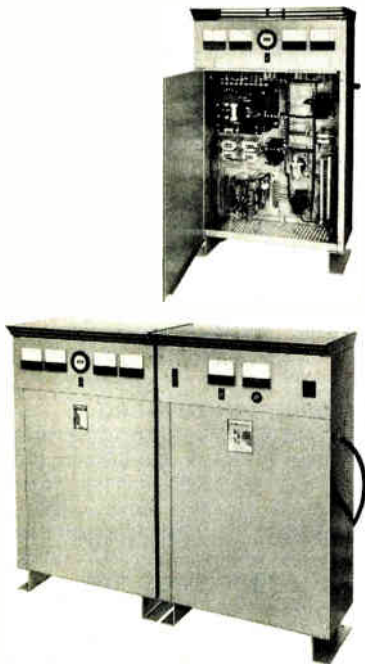

LaMarche stocks 100w-to- 10kw units.

LaMarche charger/inverter systems are UL listed and offered in a full range of types and sizes to provide reliable, uniform and continuous 120- or 240-volt ac power from a dc power source.

LaMarche, one of the originators of dc-to-ac inverters, has produced reliable, utility-grade, float-charging equipment for the past 28 years.

For full information contact your local LaMarche Sales Office or contact factory on special applications.



LAMARCHE
Manufacturing Company

106 Bradrock Drive
Des Plaines, Illinois 60018
PHONE: 312/299-1188

CIRCLE NUMBER 85

INTEGRATED CIRCUITS

SCR array operates at 20 V



Texas Instruments, P.O. Box 5012, MS 308, Dallas, TX 75222. (214) 238-2481. \$2.95 (100-999); 2 wks.

The TCP 2410 eight-SCR array can be used in LED or display latching, analog switching, or as a crosspoint switch. The device uses dielectric isolation, and it has crosstalk rejection of greater than 90 dB when measured at 1 kHz and with 600- Ω load and source. Crosstalk rejection is greater than 80 dB when measured at 3 kHz with the same loads. The array has an operating voltage of 20 V, and an absolute maximum rating of 50 V. Holding current is typically 350 μ A, with maximum rating of 100 mA. The device is available with or without cathode-to-gate diode protection.

CIRCLE NO. 325

CMOS reference generates 60 Hz

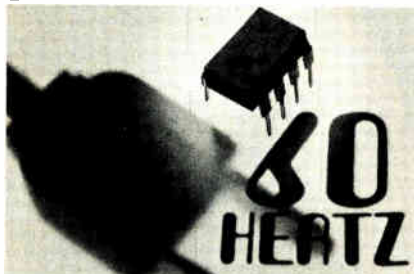

National Semiconductor, 2900 Semiconductor Dr., Santa Clara, CA 95051. (408) 732-5000. \$2 (100).

The MM5369, a crystal-controlled CMOS IC, generates a 60-Hz reference for digital clocks. The IC is a 17-stage programmable oscillator/divider that comes in an 8-pin package. The number by which the circuit will divide can be factory programmed for any point between 10,000 and 98,000. Also the device can be mask programmed to operate with any of several crystals having frequencies of 2.09 to 4.19 MHz.

CIRCLE NO. 326

Single chip performs scientific functions

Rockwell International, 3310 Miraloma Ave., P.O. Box 3669, Anaheim, CA 92803. (714) 632-1650. \$7 (production qty).

One chip provides all common scientific functions with exponential notation, two levels of parentheses, store/recall memory, and direct drive for displays. The P/N A6500 is pin compatible with Rockwell's families of five and six-function calculator circuits and with its basic slide-rule chip. The MOS chip interfaces with up to 36 keys in single or double-function arrangements. Both keyboard decoding and key debouncing are provided internally on the chip.

CIRCLE NO. 327

Obtain stable sine waves up to 150 MHz

Plessey Semiconductors, 1674 McGaw Ave., Santa Ana, CA 92705. (714) 540-9979. \$6.55 (100); stock.

The SL680A crystal-oscillator maintaining circuit, which operates over the range from 100 kHz to 150 MHz, has typical frequency variations of only 0.001 ppm/ $^{\circ}$ C over the temperature range of -10 to $+80$ C. Also, the unit specs 0.1 ppm/V over a power-supply range of 6 to 10 V. The SP680A outputs a sine wave with distortion down 40 dB. Crystals may be used in their fundamental or overtone modes.

CIRCLE NO. 328

3-terminal regulators output -3 to -24 V

Motorola, P.O. Box 20924, Phoenix, AZ 85036. (602) 968-6211. 60¢ to \$1.25 (100); stock.

A series of three-terminal IC voltage regulators, the series MC-79L00C/AC, provides low-current (100 mA) negative-voltage regulation. Each device has a fixed voltage output within the -3 to -24 V range. The suffix-C models offer $\pm 10\%$ regulation, while suffix-AC have $\pm 5\%$. Available in TO-92 plastic and TO-39 metal packages, the regulators require no external components and are protected against internal short-circuits and thermal overloads.

CIRCLE NO. 329

New Honeywell portable packs 28 channels, meter monitoring and solid ferrite heads all into one small, superb unit.



If you've been waiting for better features and more capability in a portable tape recorder — you've got it. The Model 5600E from Honeywell!

Our new portable gives you up to 28 tracks, 7 speeds, field-convertible intermediate or wideband, solid ferrite wideband heads and 10 1/2-inch reel capacity. There's also a variety of rack and shock mount configurations and an integral dc power supply option.

Our meter monitoring isn't typical either. Not with simultaneous monitoring of record input and reproduce output on any channel, plus track monitoring with rms or peak ac or dc meter coupling, and there's more . . .

Like electronics and parts commonality with other Honeywell portables; a 3,000-hour ferrite head warranty and a proven transport all in a lightweight compact package.

Get complete technical specifications by calling Darrell Petersen, (303) 771-4700, or write Honeywell Test Instruments Division, P. O. Box 5227E, Denver, Colorado 80217.

Honeywell

INTEGRATED CIRCUITS

Divide by 10 or 11 up to 250 MHz

Plessey Semiconductors, 1674 McGaw Ave., Santa Ana, CA 92705. (714) 540-9979. \$14.96 (100).

The SP8647B, a 250-MHz divider, can be logically programmed with sine-wave inputs to divide by 10 or 11 over the frequency range of 50 to 250 MHz. When square-

wave inputs are used, the frequency range is 0 to 250 MHz. Rise and fall times are 5 ns, and propagation delays are typically 7 ns or less. An open-collector output simplifies interfacing to TTL or CMOS, and an ECL output is also available. The device can work off a -5.2 or +5.0-V supply, depending on the required interface.

CIRCLE NO. 330

CMOS decade counter drives LEDs or LCDs

Hughes, 500 Superior Ave., Newport Beach, CA 92663. (714) 548-0671. \$6.50 (1000); stock.

A CMOS one-decade counter/latch/decoder can drive seven-segment LEDs, liquid-crystal displays, incandescent displays, or provide bipolar transistor-base currents. A TTL-compatible circuit, the new up/down presettable decade counter contains storage latches that hold the BCD state of the counter on command. The stored information appears at BCD and seven-segment outputs. Inputs are available to change the polarity and provide three states on the seven-segment outputs.

CIRCLE NO. 331

16-pin 4-k RAM accesses in 250 ns

Motorola, 3501 Ed Bluestein Blvd., Austin, TX 78721. (512) 928-2600. \$16.75 to \$23.60 (100-999); stock.

A 4096-bit MOS dynamic RAM, the MCM6604, comes in a 16-pin package. The n-channel, silicon-gate RAM has TTL-compatible inputs and a three-state output, and it is organized as 4096 one-bit words. Only six address lines are needed since row and column address inputs are multiplexed. Three speed ranges are available: 250 ns for the MCM6604L2, 300 ns for the MCM6604L4, and 350 ns for the MCM6604L.

CIRCLE NO. 332

Quad transceivers have high noise margin

Silicon General, 7382 Bolsa Ave., Westminster, CA 92683. (714) 892-5531. \$4.70 to \$5.95; stock.

The SG75138/55138 pair of quad bus transceivers features a receiver threshold of 2.3 V and high input impedance. The receiver draws less than 50 μ A from the transmission line with a low-level signal and less than 1.6 mA with a high-level signal. The four open-collector drivers may be controlled by a common-strobe input, and each will drive TTL or DTL loads up to 100 mA. Nominal propagation delay from the driver input is 15 ns and receiver delay is 8 ns, nominal.

CIRCLE NO. 333

12-bit a/d, clock, comparator and reference are all in here...

and it now costs only \$47.50

With all four functions contained within its 32 pin ceramic package, you'll find ADC80 to be ideal for those designs where space is critical.

Designed especially for data-acquisition systems, this successive approximation, hybrid IC offers you a price-performance combination that's tough to beat. Especially now. We've reduced the price of our 12 bit ADC80 to just \$47.50 (100's), yet it offers 0.01% maximum non-linearity, 25 μ sec conversion speed, and a gain-drift error of only ± 30 ppm/ $^{\circ}$ C.

We've got a 10-bit version, too. It now sells for only \$45.00 (100's) and gives you 0.048% maximum nonlinearity, 21 μ sec conversion time and a gain-drift error of ± 30 ppm/ $^{\circ}$ C.

Both operate over -25 $^{\circ}$ C to +85 $^{\circ}$ C and offer a mode that gives you 5 μ sec conversion time.

For full details on this low-cost, top performer, contact Burr-Brown, International Airport Industrial Park, Tucson, Arizona 85734; (602) 294-1431.



CIRCLE NUMBER 86

MINIATURIZED POWER ROTARY SWITCHES



- Ratings from 12A-300V to 20A-600V
- Mount on 3" centers!
- Lighted packages on NAMEPLATE for further space savings
- Standard options include key-operated, spring-return, color-coded indicator lamps, etc.

Request Catalog AMC for complete specs

 **ELECTRO SWITCH**

Weymouth, Massachusetts 02188

Telephone: 617/335/5200 • TWX: 710/388/0377

CIRCLE NUMBER 87

Noise sensitivity problems go away- we guarantee it!

Topaz Ultra-Isolation Transformers provide an inexpensive and reliable way to supply clean, noise-free AC power to sensitive equipment such as computers, instrumentation, communication and process control equipment.

Ultra-Isolation Transformers offer the industry's best noise attenuation:

- Common-mode noise rejection greater than 145 dB.
- Transverse-mode noise rejection greater than 125 dB at 1 kHz.
- Standard models 125 VA to 45 kVA.
- Priced from \$64.



Our guarantee: A Topaz Ultra-Isolation Transformer will solve your noise sensitivity problems to your complete satisfaction or we'll take it back—no questions asked.

TOPAZ SOLUTIONS TO
ELECTRONICS POWER PROBLEMS

3855 RUFFIN ROAD, SAN DIEGO, CA. 92123 • (714)279-0831

CIRCLE NUMBER 88

ELECTRONIC DESIGN 4, February 16, 1976



Inside Story

Beat the "bends". EMC's Nurl-Loc® Terminals spread the stress evenly throughout the panel, eliminating warp (and the need for stiffeners) . . . even on $\frac{1}{16}$ " boards. The straight male splined cylinder guides the terminal securely into a more accurate true position than a barbed ring. And the internal burr-free, four-finger contact grabs any IC lead firmly, even as small as .011 dia. Prototypes or production, call Allan Klepper (401) 769-3800 for a copy of our new, interesting "Inside Story" . . . or write Electronic Molding Corp., 96 Mill Street, Woonsocket, R. I. 02895.

**EMC's Wire-Wrap® Panels
with Nurl-Loc® Terminals
... better performance
by design!**



 **EMC**
Interconnection Specialists

Wire-Wrap® Gardner-Denver Co.

CIRCLE NUMBER 89

What makes GENERAL SCANNING OEM RECORDER MODULES

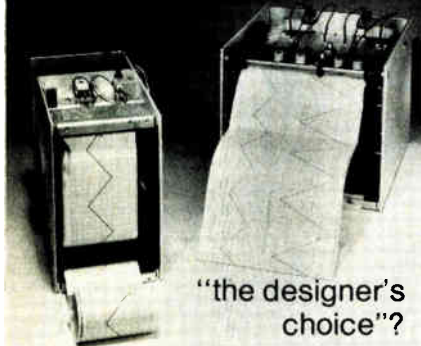

A better selection of standard 'specs' to easily fit particular applications. We developed our complete line of strip chart recorder modules — with OEM needs in mind. Needs like reliability, accuracy, compactness, flexibility and, of course, low cost.

Chances are General Scanning has a standard off-the-shelf recorder module just right for your application. If we don't, our modular construction method makes it simple to fill the most unique requirements. A sample of 'specs' to choose from:

- **Number of Channels**
single through eight
- **Channel Widths**
20, 40, 50, 80 & 100 mm
- **Paper Feed**
roll
fan fold
- **Chart Speeds**
multi-speed, electrically selectable
- **Pen Motor Operation**
open loop
velocity feedback
closed loop
- **Inkless Thermal Writing**

We offer packaged recorders for your lab, portable DC recorders and precision pen motors, too. Make "the designer's choice", call or write for full details. The general awaits your orders.



GENERAL SCANNING INC.
150 Coolidge Avenue
Watertown, MA. 02172
TEL: (617) 924-1010

CIRCLE NUMBER 90

COMPONENTS

Thermal printhead has 4-character matrix

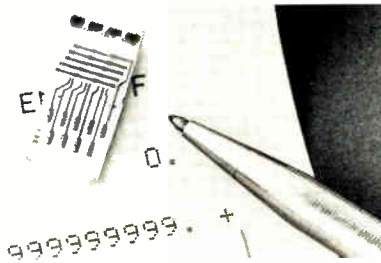

Texas Instruments, P.O. Box 5012, MS 308, Dallas, TX 75222. (214) 238-2481. \$15.76 (1-24); 2 wks.

A new thermal line printhead with a four-character, 5 × 7 alphanumeric matrix, the EPN3100, uses beam leads for high reliability. Electrical interconnections and blocking diodes allow electrical strobing, which reduce the number of external connections and minimize peak power consumption. Four silicon chips each contain five dot mesas. The matrix is produced by a series of horizontal dot-lines sequenced with a seven-step vertical paper movement to produce a character-line. With 14.5 V, print pulse time is 8 ms. Time to print one dot line ranges from 25 to 50 ms. Steady-state current per dot ranges from 170 to 250 mA. Reliability is in excess of 40-million character-lines with 90% confidence.

CIRCLE NO. 334

Ceramic varistors give transient protection



International Components Corp., 105 Maxess Rd., Melville, NY 11746. (516) 293-1500. \$0.35 to \$0.95 (OEM qty); 4 to 8 wks.

The TNR series of ceramic varistors has steep (<50) nonlinearity coefficients and high discharge-current capabilities for transient protection. Available in 100, 300, 500 and 800-mW configurations, these varistors provide characteristics similar to back-to-back zener diodes.

CIRCLE NO. 335

Wirewound resistors come with 3% tolerance

Dale Electronics, Inc., Dept. 860, P.O. Box 609, Columbus, OH 68601. (402) 564-3131. Typical \$0.25: 4 W (1000 up); 2 to 3 wks.

CW resistors, a low-cost wirewound series, are now available in 3% tolerance. The line includes 11 models rated from 4 to 10 W at 275 C in a range from 1 Ω to 100 kΩ with a TC of ±50 ppm/°C. The resistors are all-welded construction and protected by a multilayer silicone coating. All models meet MIL-R-26 requirements.

CIRCLE NO. 336

Two-digit display forms letters and numbers



Beckman, 2500 Harbor Blvd., Fullerton, CA 92634. (714) 871-4848. \$22.50 (1 to 24); stock.

Series SP-252 gas-discharge displays are two-digit, 0.55-in.-high, 14-segment display packages capable of forming the letters of the alphabet, numbers 0 to 9 and some special symbols and signs. The SP-252 displays can be stacked horizontally and they are compatible with the numeric SP-350 Series. Brightness is 210 foot-lamberts, viewing angle 120 degrees and viewing distance 40 ft in a bright orange-neon color. Life expectancy is 10 years under normal service conditions. Minimum voltage required to ionize the display is 160 V dc. After the display ionizes, the voltage drop is approximately 135 V and typical cathode current is 330 μA. Lowest current for an even glow on the largest segment is 130 μA. For multiplexed operation segment currents may be increased to 1.25 mA with 25% or smaller duty cycles.

CIRCLE NO. 337

for the BEST in... FREQUENCY SYNTHESIZERS

Programmable
Multi-Channel
Frequency Synthesizer
System

51
SYSTEM

- Up to 48 Channels
- DC to 3 MHz Range
- 1 Hz Resolution throughout Range
- Direct Digital Synthesis
- Sine and Square Wave Outputs
- High Stability
- High Spectral Purity
- High Reliability
- High Speed Programming
- No Switching Transients—Amplitude and Phase Continuity maintained.

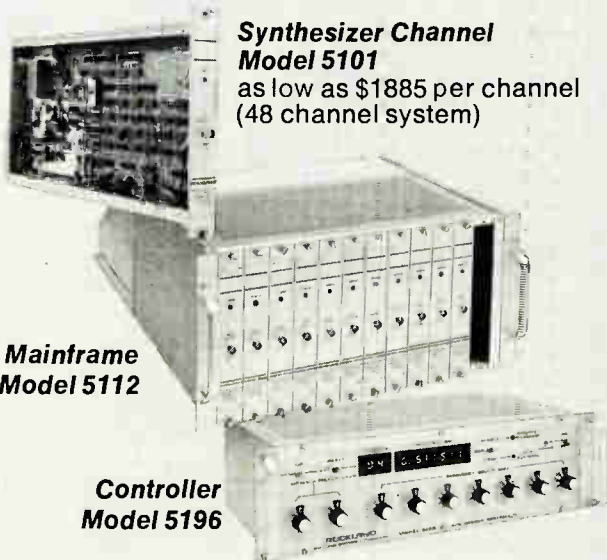
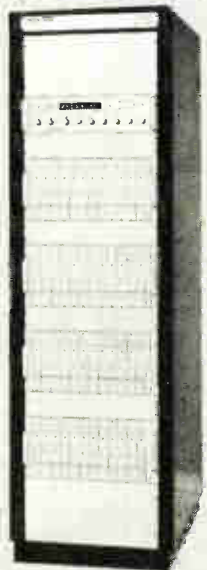

Synthesizer Channel
Model 5101
as low as \$1885 per channel
(48 channel system)

Mainframe
Model 5112

Controller
Model 5196

DC to 2 MHz Range

DC to 3 MHz (Option 13)



Model 5100:
Local and remote programming
for laboratory and systems application



Model 5110:
Remote programming only.
(for O.E.M. and other "hands-off" applications)

- 0.001 Hz Resolution throughout range
- 1.5 Microsecond Programming Speed
- Full Programmability BINARY OR BCD
- No Switching Transients
- Direct Digital Synthesis
NO MIXING OR PHASE LOCKING
- High Spectral Purity -70dB SPURIOUS
-55dB HARMONIC
- High Stability

Model 5100 \$2950

Model 5110 from \$2450 (unit quantities)

Option 13 \$350 additional

U.S. Pat. No. 3,735,269

Prices U.S.A. Domestic subject to change without notice

ROCKLAND

Rockland Systems Corporation 230 W. Nyack Road, West Nyack, N.Y. 10994 • (914) 623-6666 • TWX 710-575-2631

CIRCLE NUMBER 91

COMPONENTS

Capacitor chips cover wide range of properties

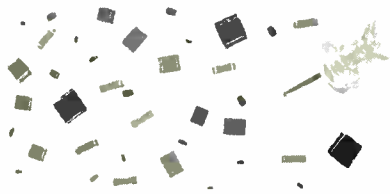

American Components Inc., Eighth Ave. at Harry Street, Conshohocken, PA 19428. (215) 825-6200.

A family of uncased capacitor chips is now available in seven standard sizes, with other sizes available on request. Sizes range from $0.059 \times 0.031 \times 0.020$ in. to $0.220 \times 0.197 \times 0.020$ in. Capacitance values to $0.22 \mu\text{F}$ are available in characteristic AE, with lower values available in NPO, SL, BX, AF, RH, SH and UJ characteristics. Standard working voltage is 50 V dc. Standard tolerances are 5%, 10% and 20%. However, wider tolerances such as +80%, -20% for AE characteristics also are available.

CIRCLE NO. 338

Lighted PB switches feature low cost

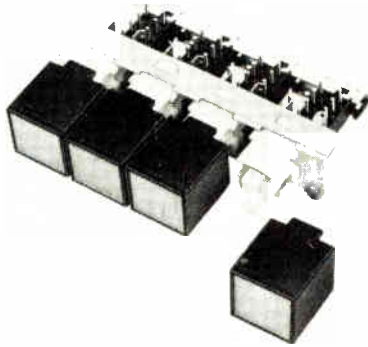

Centralab Electronics Devices, Globe-Union Inc., 5757 N. Green Bay Ave., Milwaukee, WI 53201. (414) 228-2751. \$1.36: DPDT (1000 up).

Centralab's new lighted pushbutton switches offer harmonizing front panel graphics at low cost. Other features include T-1-3/4 wedge-base lamp; PC terminated independent lamp circuit; 15, 17.5 and 20-mm spacing options; flat, concave or recessed lenses; and eight lens colors.

CIRCLE NO. 339

Thin-film networks accurate to $\pm 1/2$ LSB

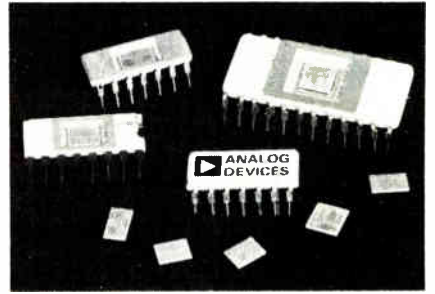

Analog Devices, Route 1 Industrial Park, Box 280, Norwood, MA 02062. (617) 329-4700. \$7.80: DIP, \$6.79: chip (OEM qty).

The AD 1850-1856/N thin-film resistor ladder networks are offered at the industry's lowest prices, according to Analog Devices. The ladder networks are guaranteed to have full scale errors within $\pm 1/2$ LSB from 0 to 70 C for 12, 10 and 8-bit versions. Each model is available in either an industrial DIP configuration (N) or in chip form (C). The DIP versions are specified from 0 to 70 C, the chip versions from -55 to 125 C.

CIRCLE NO. 340

PANCAKE SYNCHROS AND RESOLVERS PROVIDE...

... Lower cost and higher accuracy in position sensing systems. Gimbal mounted synchros, resolvers and linear transformers are available in various configurations . . . single speed accuracies to 10 seconds . . . dual and multi-speed units with accuracies to 3 seconds. Other provisions include wide ranges of frequency, voltage, and temperature. Vernitron Control Components, A Division of Vernitron Corp., 2440 W. Carson St., Torrance, Ca. 90501, (213) 328-2504. Write or phone for new 20 page catalog.

VERNITRON CONTROL COMPONENTS



CIRCLE NUMBER 92

The ties that bind.

Nytyes by Heyco.

Choose from the widest line of Self-Locking Nylon Cable Ties.

Heyco NYTYES provide a secure method for bundling cables, wires, and hoses from 1/16" to 8-1/8" in diameter. They're easily assembled by hand or tool and available for regular, heavy duty and mountable applications. Most NYTYES come with bent tips for easy insertion. U.L. recognized.

Tie one on. Write for free samples.

HEYMAN MANUFACTURING COMPANY
 KENILWORTH, NEW JERSEY 07033 WAUKESHA, WISCONSIN 53186
 (201) 245-2345 • TWX: 710-996-5986 (414) 542-7155 • TWX: 910-265-3668
 CALL TOLL-FREE (800) 558-0917 • IN WISCONSIN CALL (800) 242-0985



160A

CIRCLE NUMBER 93

ELECTRONIC DESIGN 4, February 16, 1976

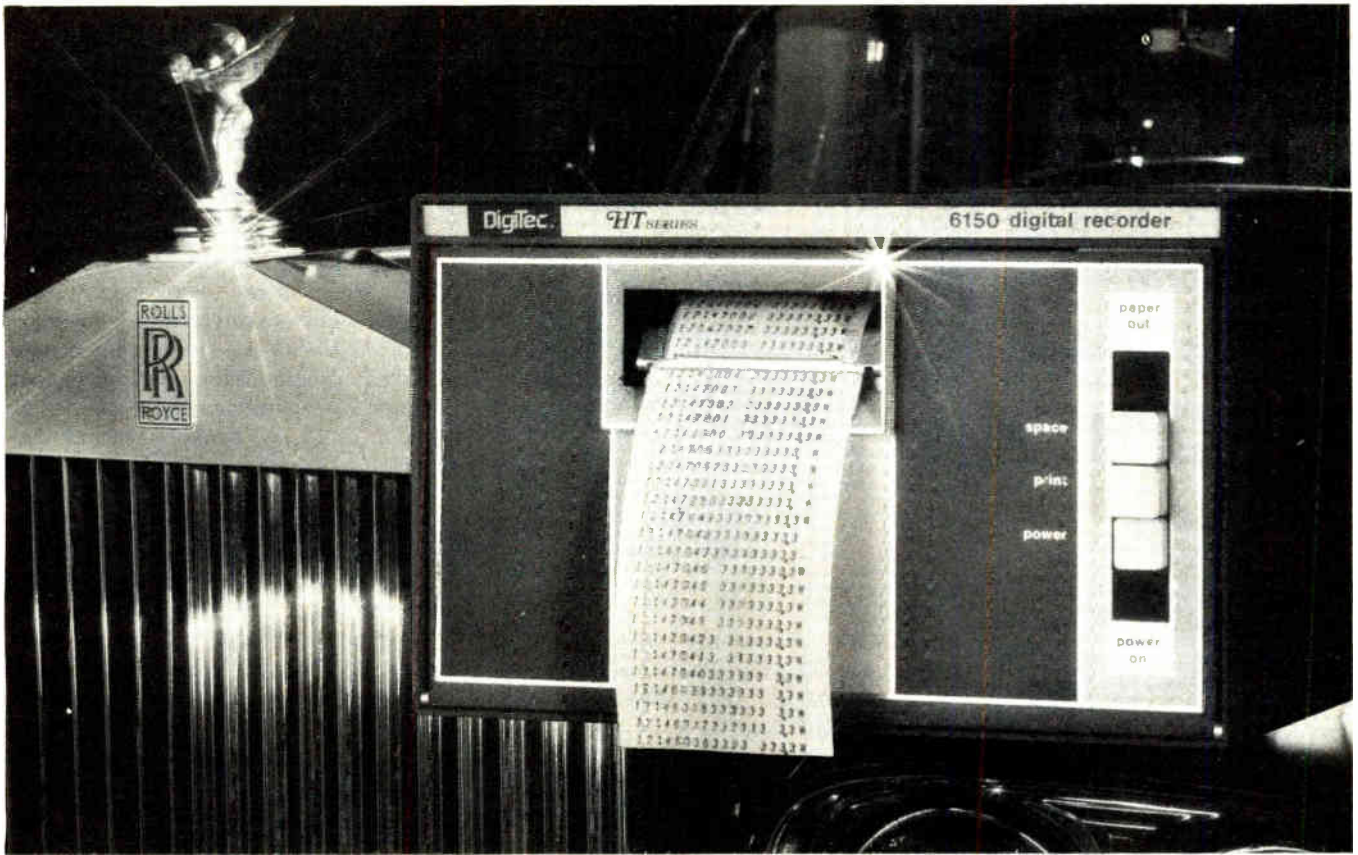

Synonymous with 'excellence and unsurpassed workmanship.'

Most digital printers, like automobiles, offer the same basic benefits; data recording. DigiTec printers provide the luxury appointments and classic cabinet quality that set them apart. One touch of our attractive diecast and extruded aluminum case relates rugged protection with lightweight convenience. Front-panel paper loading is achieved with a swing up print head that also facilitates ribbon replacements. Even when rack mounted, replenishments can be accomplished safely by non-technical personnel, as electronic components are not exposed.

Functionally, DigiTec printers offer many standard features, making them ideal for OEM applications. Floating decimals, selective data blanking, systems interface, red or black print and easy grouping of data for simple visual analysis, are standard on all models. Selected options include up to 21 columns capability, an integral crystal clock, an integral events counter and negative input logic. DigiTec's recognized reliability is guaranteed by a 7-day, fault free burn-in and complete electronic inspection of every unit.

Select a dependable DigiTec printer to match your bench top, systems or OEM application. All models available from stock.

6100 Series,
5 models. Start at

\$549.

(Generous OEM discounts offered.)

Contact your local United Systems representative for complete specifications.

DigiTec

UNITED SYSTEMS CORPORATION

918 Woodlwy Road • Dayton, Ohio 45403 • Ph: (513) 254-6251 • TWX: (810) 459-1728

These instruments available under GSA contract GS-OOS-27741.

For Information only Circle 245 on Reader Service Card

For Demonstration only Circle 246 on Reader Service Card

DUAL OUTPUT REGULATED

15v DC power sources

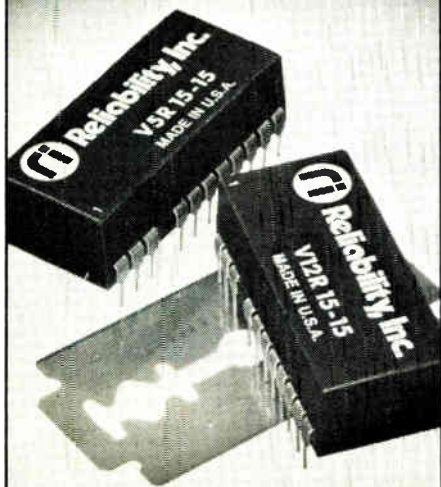

For ...

- Operational amplifiers
- Comparators
- D-A Converters

**ONE WATT OUTPUT · COMPACT
DIP PACKAGE · LOW NOISE
ISOLATED · LOW PRICE**

Ultra compact "V-PAC" *DC-DC power sources use 5v or 12v input, provide $\pm 15v$ regulated low noise output, which can be balanced.

Output Voltage _____ $\pm 15v$
 Output tolerance _____ $\pm 5\%$
 Output ripple _____ 30 mv, P-P max.
 Line regulation _____ .3%
 Load regulation _____ .3%
 Operating temp _____ 0° to $70^\circ C$
 Isolation _____ 10 M Ω @ 50v
 Price _____ \$25.25 (100 pcs)



Reliability, Inc.

5325 Glenmont/Houston, Texas 77036
 713-666-3261/TWX: 910-881-1739

International: Reliability Nederland B. V.
 Summerhill, Nenagh, Co. Tipperary, Ireland

*Trademark, Reliability, Inc.
 Price subject to change without notice

CIRCLE NUMBER 101

COMPONENTS

Bidirectional switch offers large characters

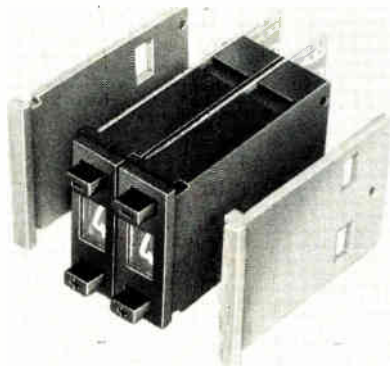

Alco Electronic Products Inc.,
 1551 Osgood St., North Andover,
 MA 01845. (617) 685-4371. \$7.50:
 decimal (unit qty).

MICO, a new series of bidirectional code switches though considered miniature in size, contain a relatively large character size (0.315 in.) to allow greater viewing distance. They are available from stock as decimal or coded versions with 8-4-2-1 BCD and BCD with complement. Gold contacts ensure low contact resistance and long life. Terminals are card edge tabs for use with sockets but have holes for soldering if necessary. Extended PC-tab versions are also available for component mounting. Available from stock in matte-black finish with white numerals. Other colors, custom wheels or codes are available on special order.

CIRCLE NO. 341

Cermet trimmer offers top or side adjustment

Beckman, 2500 Harbor Blvd., Fullerton, CA 92634. (714) 871-4848.
 \$1.12 (1000 up); stock.

The Beckman Model 68 is a 3/8-in. square multiturn cermet trimmer available in three-pin configurations with top-adjust or side-adjust models. The trimmer features a 30-fingered brush contact for low contact-resistance variation, and it is a sealed unit. The resistance range is 10 Ω to 2 M Ω ; power rating, 0.5 W at 70 C; and the maximum operating temperature, 125 C.

CIRCLE NO. 342

Piezo accelerometer has built-in amplifier

Bolt Beranek and Newman, Inc.,
 50 Moulton St., Cambridge, MA
 02138. (617) 491-0091. \$100 (OEM
 qty); stock.

The Model 508 piezoelectric accelerometer has a frequency response of 3 Hz to 15 kHz within $\pm 5\%$ and a standardized sensitivity of 10 mV/g. It includes an internal preamplifier with an output impedance under 1200 Ω . Noise floor is 10- μ V broadband and amplitude linearity is $\pm 1\%$ to 150 g. Transverse sensitivity is less than 5%. A screw-type coaxial receptacle is provided for the output. Mounting is by a 10-32 tapped hole in the base. A mating power supply with a 100-h battery, battery test and BNC output connector is available.

CIRCLE NO. 343

Photoelectric scanner uses acrylic lens



Micro Switch, 11 W. Spring St.,
 Freeport, IL 61032. (815) 232-1122.
 Typical \$52 (OEM qty).

The low-cost MLS7A photoelectric scanner offers a solid acrylic lens system, which eliminates optical dead spots, condensate on the inside lens surface and optical maintenance. Other features include flexible printed wire for electrical connections, and a monolithic-chip receiver circuit. The scanner is a retroreflective dc control that interfaces directly with minicomputers, programmable controllers and other logic-level devices. Models are available in 12 or 24-V-dc versions with NO or NC solid-state outputs. Use of a LED permits the MLS7A to operate in sunlight or in a variety of indoor light conditions. Maximum scanning range is 10 ft; speed of response is 4 ms; and the maximum rate of operation is 125 times per second.

CIRCLE NO. 344

If anybody can hand you the ready-made P/C connector you need,

we can.

That's because we have more of them on the shelf than anybody else we know. We have them from .050 contact centers through .156, from 6 to 210 contacts, with full bellows, semi-bellows and cantilever designs, with gold saving AuTAc™ plating, low insertion force contacts, in micro miniatures, dual and single read-outs . . . and on and on and on.

We've been at this 23 years. And — because we don't compromise on quality

when we make our connectors — we don't like to see your P/C designs compromised by a make-do connector. So, we have a lot of them.

They're all cataloged in our latest 44-page brochure. Send for your free copy so you'll have it when you need it.

Or, if you need help right now, just pick up your phone and call Customer Service. (213) 341-4330.

Ok. Send me: Details on your line of P/C connectors.
 and, come to think of it, your low cost circular connectors, too.

Name _____

Title _____

Company _____

Address _____

City _____

State _____

Zip _____

 **Viking**
CONNECTORS

Viking Industries, Inc./21001 Nordhoff St./Chatsworth, Calif. 91311



CIRCLE NUMBER 102

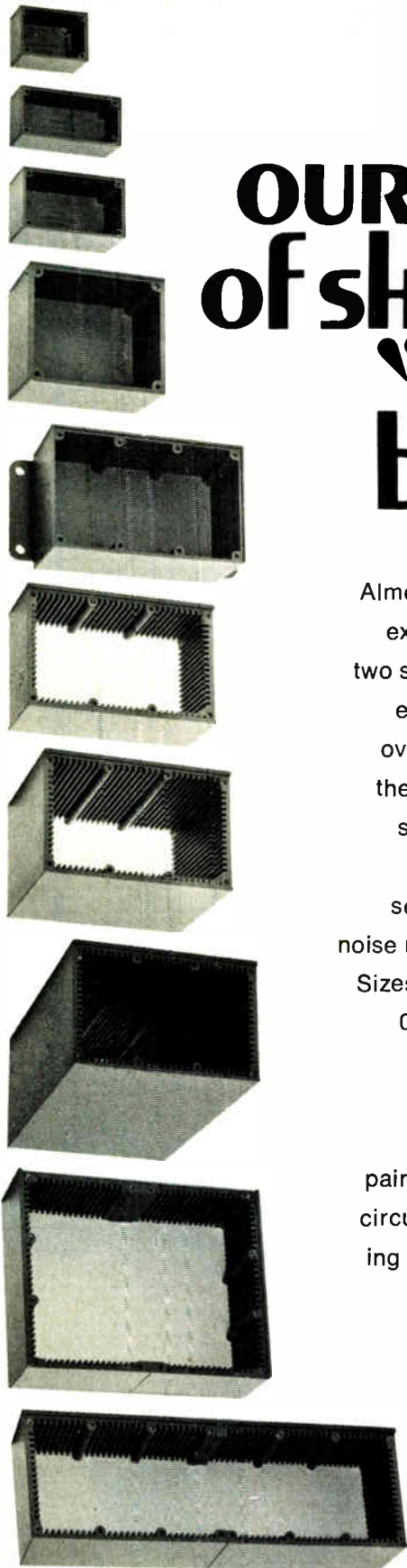

MEET OUR family of shielded "black BOXES"

Almost 10 years ago (1966 to be exact) we introduced our first two series of shielded electronic enclosures. They became an overnight success. Since then the demand for different sizes, shapes and applications has increased our family to ten series of models, each with a noise rejection greater than 70db. Sizes range from 1.50" x 1.13" x 0.88" to 4.13" x 2.68" x 6.0"; in blank versions or with a complete choice of coaxial connectors; painted or unpainted; with or without printed circuit card guides; with mounting flanges or bottom mounting plates. All models supplied with aluminum covers and mounting screws.

AVAILABLE THROUGH YOUR
FAVORITE ELECTRONIC
PARTS DISTRIBUTOR

ITT POMONA ELECTRONICS

1500 East Ninth St., Pomona, Calif. 91766
Telephone (714) 623-3463, TWX: 910-581-3822



CIRCLE NUMBER 103

COMPONENTS

Chip capacitors in three thicknesses

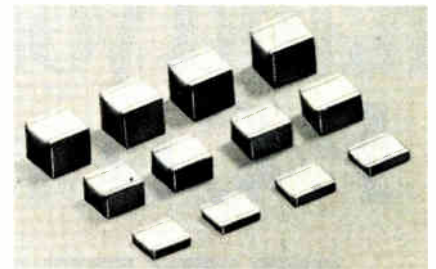

Dielectric Laboratories Inc., 64 Clinton Rd., Fairfield, NJ 07006. (201) 575-8922. Stock.

For low-profile applications in rf and microwave circuits, 50 and 100-mil-square porcelain capacitors are each available in three thicknesses with capacitance values from 0.1 to 1200 pF. A minimum Q of 10,000 at 1 MHz is guaranteed. Typical Q values are in the range of 40,000. Working temperature ranges from -55 to 125 C with no measurable drift and complete retrace. Insertion loss is less than 0.1 dB. Working voltages are as high as 500 V dc for a 100-mil-cube unit and up to 50 V dc for a 50-mil cube.

CIRCLE NO. 345

Thin-film resistor nets for custom designs

Analog Devices, Route 1 Industrial Park, P.O. Box 280, Norwood, MA 02062. (617) 329-4700. \$10 to \$30 (500 up); 8 wks for first 25.

A custom service for user-designed thin-film resistor networks in Flatpak packages is being offered by the Resistor Products Div. of Analog Devices. The nichrome thin-film-on-ceramic networks are packaged in 10, 14, 16 or 24-pin ceramic Flatpaks. DIP and chip configurations are also available. For high-reliability avionic requirements, the networks may be screened to MIL-STD-883 Method 5004.2, and can be qualified to MIL-STD-883 Method 5005.2. Tracking tolerances are as close as 0.001% with absolute accuracy to 0.005%; low temperature coefficients track to 0.5 ppm/°C; noise is as low as -50 dB; drift doesn't exceed 50 ppm/°C at 25 C; and a voltage coefficient of about 0.007 ppm/V is negligible.

CIRCLE NO. 346

Get more for your money!

Use This New 3/8" Square Cermet Trimmer From Allen-Bradley

Our new TYPE E trimmer is a high performer with a realistic price. It has some important advantages: • Immersion seal is tested in 85°C water (not 50° or 70°). • Temperature characteristic is 100 PPM/°C for stability. • Multifingered contact for excellent adjustability. • \$0.49 each—1000 piece price. For more information call your A-B distributor or write for Publication 5219.

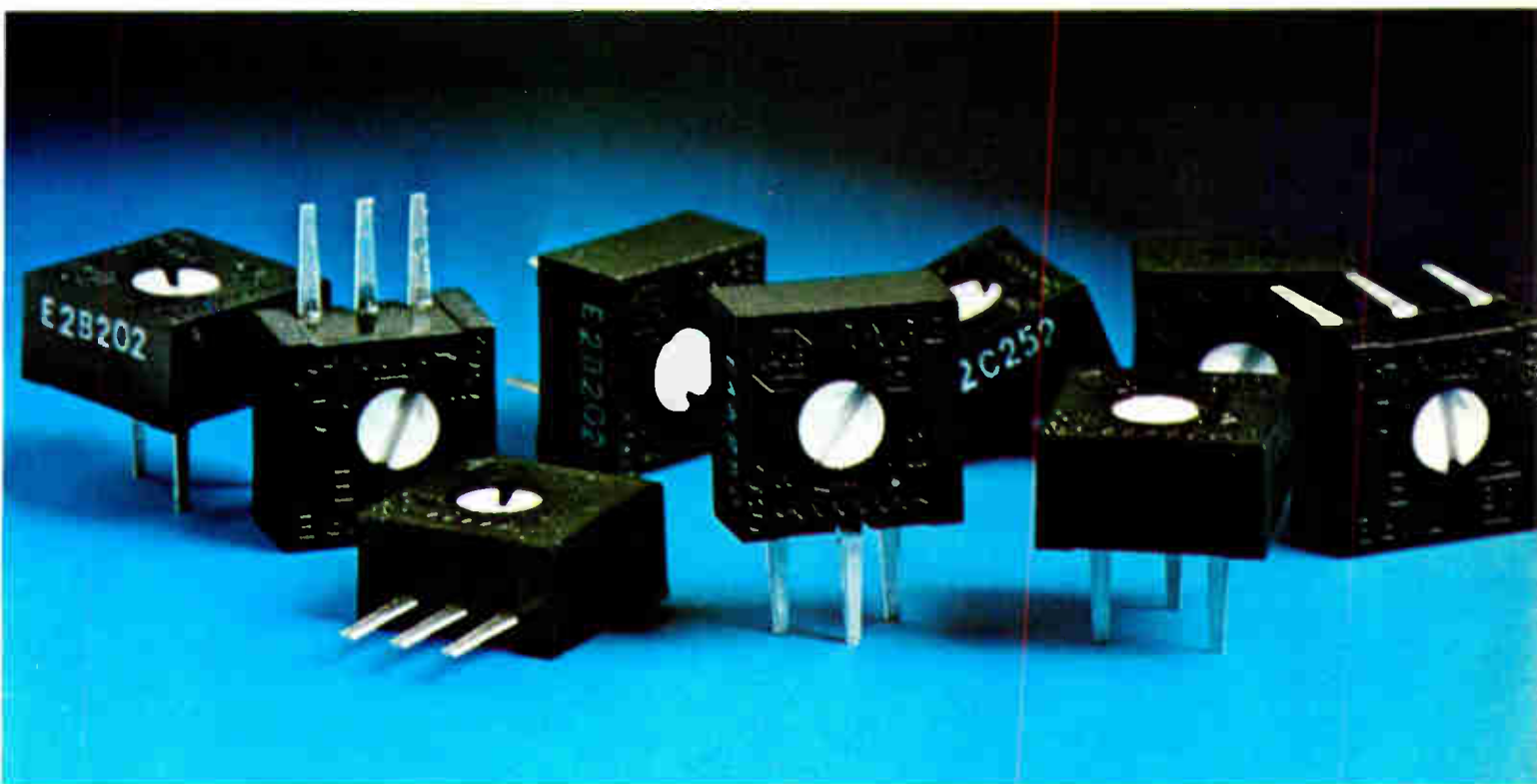
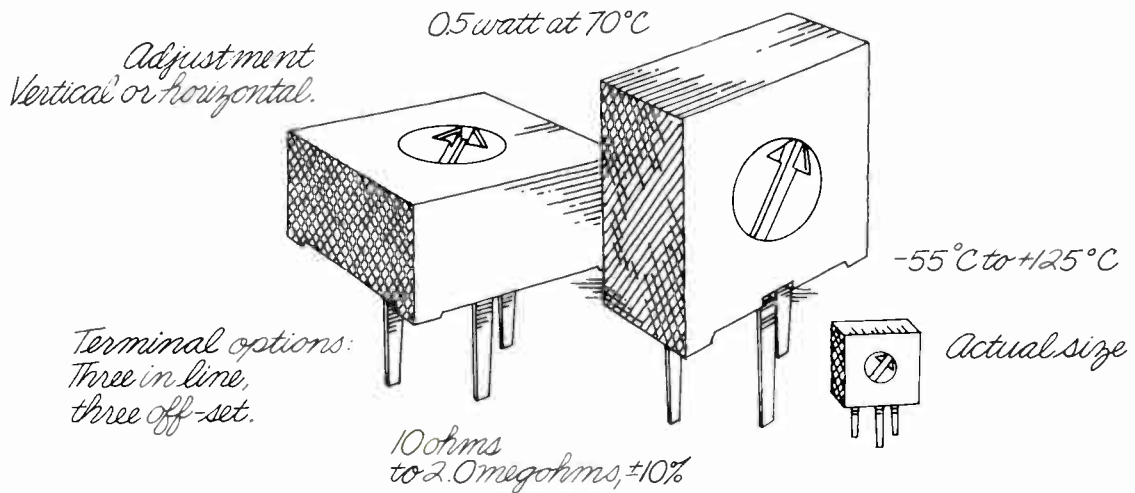

Quality in the best tradition.



ALLEN-BRADLEY
Electronics Division
Milwaukee, Wisconsin 53204

Through Omron's 43-year history, each product has been designed and built as we have seen needs and filled them. One by one, year after year, as your needs grew, so did our family. And our family continues to grow—so that today Omron offers some of the broadest lines of control components available.

Omron enjoys a worldwide position of leadership—a position built on excellence in engineering, manufacturing, and marketing. And Omron's

commitment to quality products and service means you'll get *what* you need, *when* you need it.

So welcome Omron as your component supplier. Tell us your needs. Our applications engineering department will respond to your phone inquiries for key performance data within 48 hours.

Omron will prove—you're not alone anymore!



**Welcome
to the family,
little fella**



Omron Corporation of America
Corporate Headquarters
Sears Tower, Chicago, Illinois
Sales and Service
1051 State Parkway
Schaumburg, Illinois 60172
Phone: (312) 885-9500

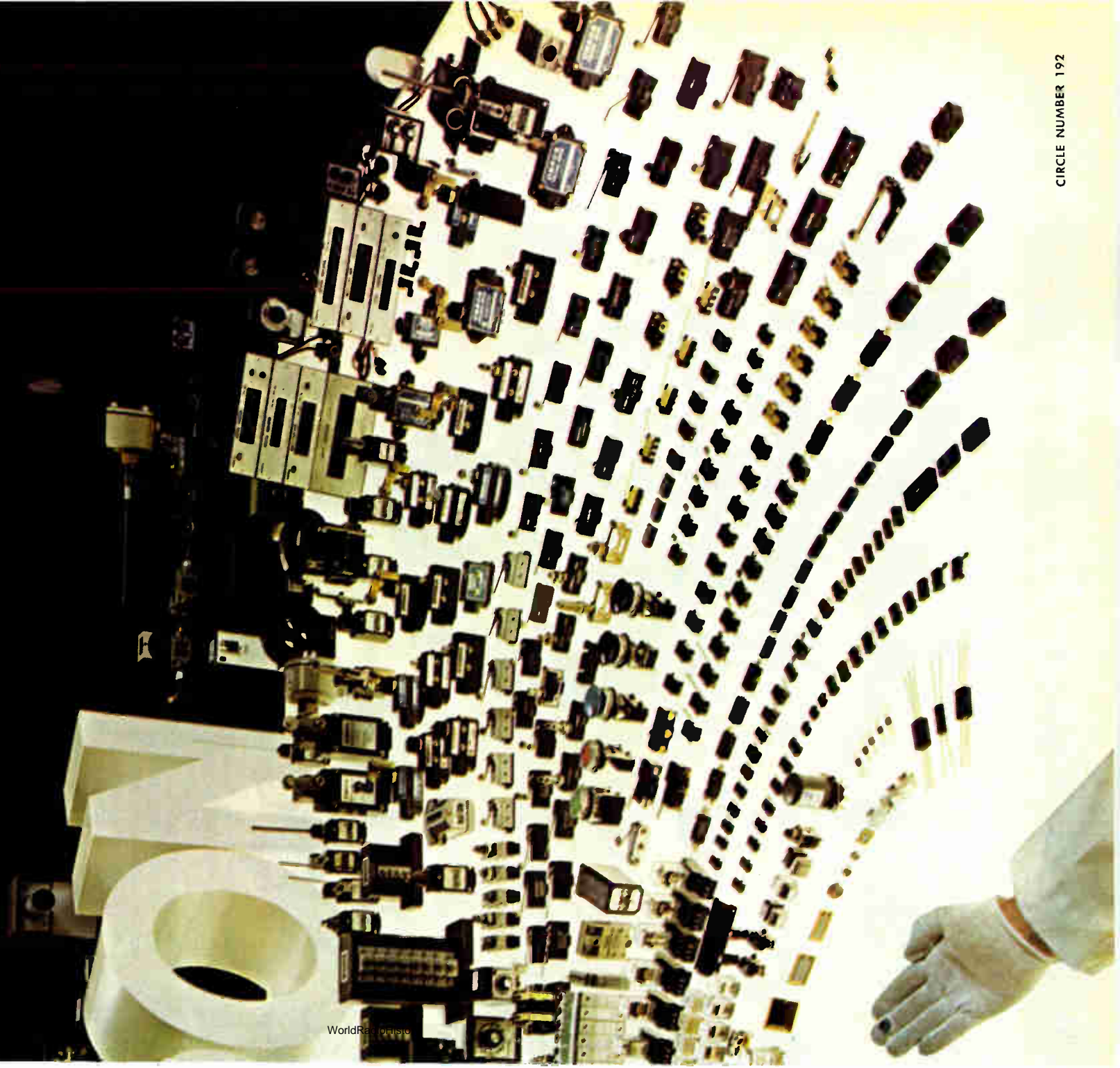

WorldRadioiside

Design with the complete flat cable/connector system.

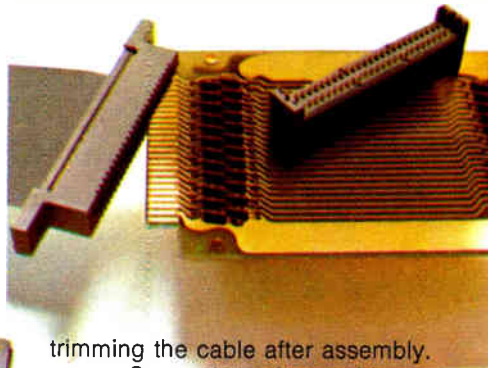

trimming the cable after assembly. Connector units provide positive alignment with precisely spaced conductors in 3M's flat, flexible PVC cable. The connector contacts strip through the insulation, capture the conductor, and provide a gas-tight pressure connection.

Assembly-cost savings are built in when you design a package with "Scotchflex" flat cable and connectors. But more important, 3M Company offers you the full reliability of a one-source system: cable *plus* connectors *plus* the inexpensive assembly aids that crimp the connections quickly and securely (with no special operator training required).

The fast, simple "Scotchflex" assembly sequence makes as many as 50 simultaneous multiple connections in seconds, without stripping, soldering or

With cable, connectors and assembly tools from one design and manufacturing source, you have added assurance the connection will be made surely, with no shorts or "opens."

And "Scotchflex" now offers you more design freedom than ever. From stock you can choose shielded and non-shielded 24-30 AWG cable with 10 to 50 conductors, and an ever-increasing variety of more than

The 3M DELTA pin and socket connector.



100 connectors to interface with standard DIP sockets, wrap posts on standard grid patterns, printed circuit boards, or headers for de-pluggable applications. 3M's DELTA "D" type pin and socket connectors are now also available. For full information, write Dept. EAH-1, 3M Center, St. Paul, MN 55101.

3M
COMPANY

3M's "Scotchflex" line.

"Scotchflex" is a registered trademark of 3M Co.

CIRCLE NUMBER 193

MORE PULL in a smaller package?

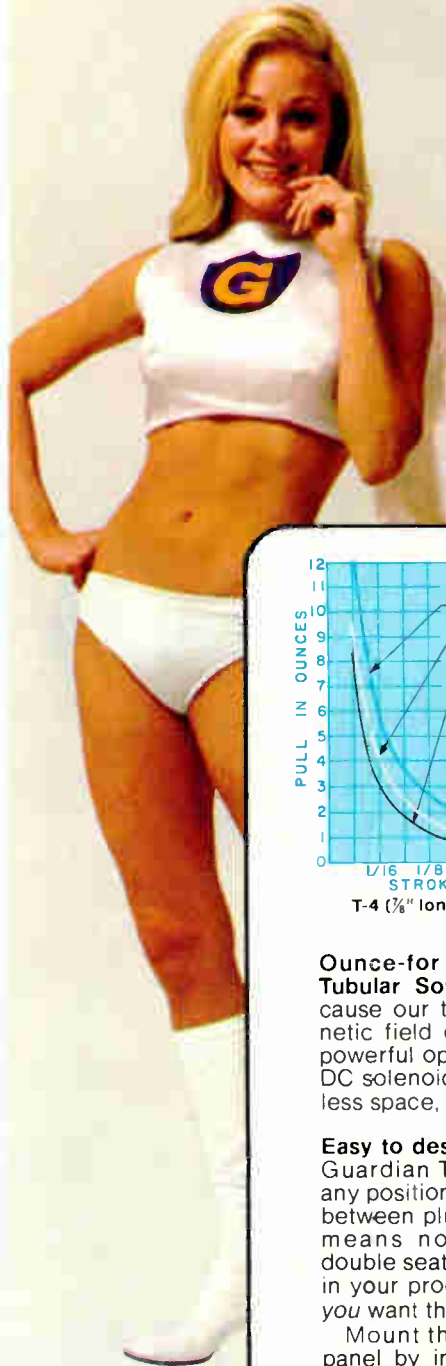

Check these curves.

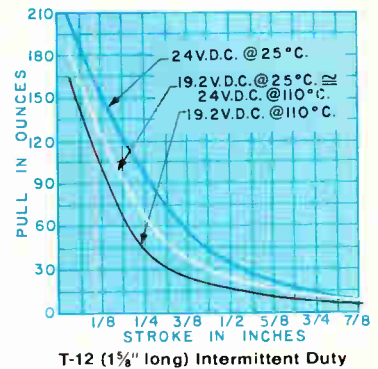
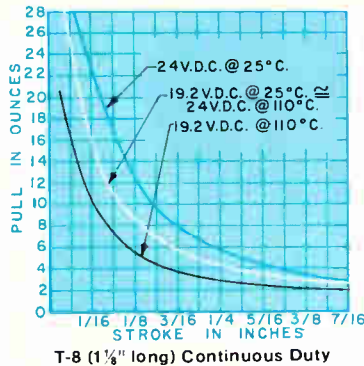
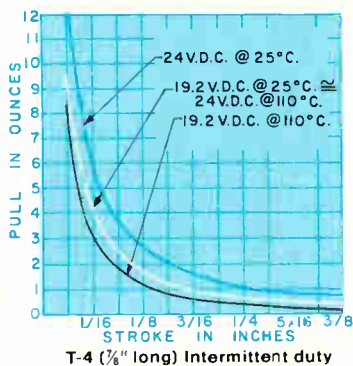

Ounce-for ounce, inch-for-inch Guardian Tubular Solenoids pack more power... because our tubular designs assure total magnetic field enclosure and result in efficient, powerful operation. More efficient than other DC solenoids. They give you more power in less space, plus UL and CSA recognition.

Easy to design-in. Easy to install. By design. Guardian Tubulars work in any position. Close tolerance between plunger and bobbin means no possibility of double seating. So they work in your product just the way you want them to work.

Mount them directly into panel by inserting threaded bushing thru installation hole and tightening nut on lock washer. Or, mount with standard bracket.

Either way, Guardian Tubulars install without damage to the solenoid. Look how the

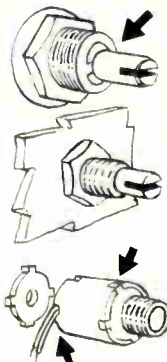

notched tube-steel shell mates with notched end plate. Result? A stronger assembly that takes more torque when installing...with no chance of damage. The leads emerge thru a notch in the steel shell, so they *will* not, *can* not be sheared by rotation during installation.

Once you put a Guardian Tubular in your product...forget it. Typical mechanical life is 20 million. That's probably longer than your product's life expectancy...due primarily to the unique Valox® 420 molded bobbin.

Variations and specials? Guardian's got 'em. Any DC voltage from 6 to 240. Push type or pull type operation. Return springs, silencers, termination variations, special mountings... you name it and we'll deliver it with the high quality craftsmanship and low prices that have made Guardian Number 1 in Solenoids—and that keeps us here on top.

Let the Guardian Angel reveal all the pull charts and curves in full size. Send for your free copy of this 72 page catalog.



GUARDIAN®

GUARDIAN ELECTRIC MANUFACTURING CO. 1572 West Carroll Avenue—Chicago, Illinois 60607 • 312/243-1100

CIRCLE NUMBER 194

WorldRadioHistory

asking about INDICATORS?

Our answers come in any size or configuration you're likely to need. They're CM and Drake LED, incandescent or neon indicators. Backed by more than 65 years experience in lamp and lighting technology, plus on-site help in solving your tough application problems. Give us a call at (312) 784-1020, or write us at 4433 N. Ravenswood Avenue, Chicago, Illinois 60640.



CHICAGO MINIATURE HAS THE ANSWER!

CHICAGO MINIATURE/DRAKE

SUBSIDIARIES OF
GENERAL INSTRUMENT CORPORATION 

CIRCLE NUMBER 195

You asked for an IC socket that
 installs easily, maximizes "real estate,"
 and delivers highest contact reliability.
 Yet costs less than 1¢* a line.

Well, you're looking at it.

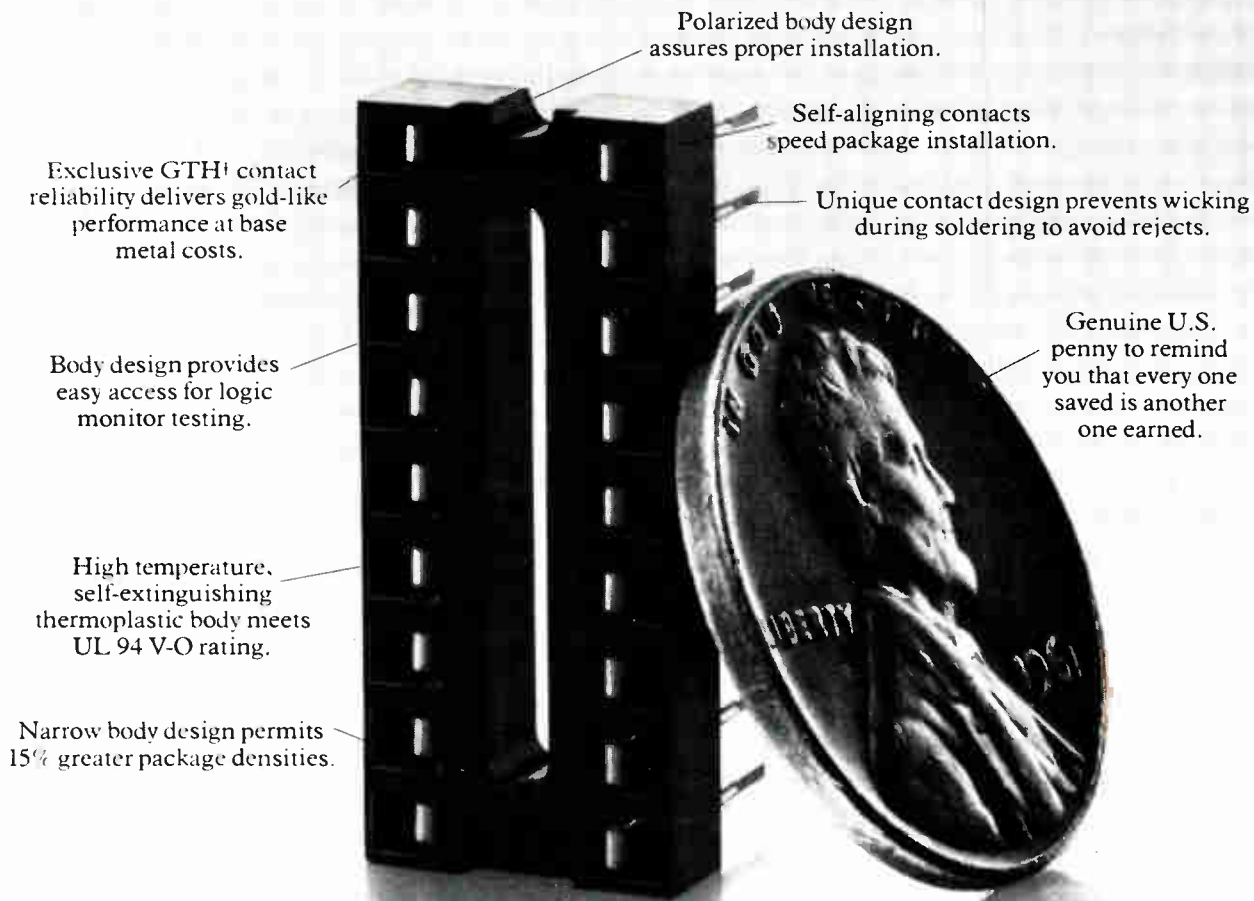

Polarized body design
 assures proper installation.

Self-aligning contacts
 speed package installation.

Exclusive GTH[†] contact
 reliability delivers gold-like
 performance at base
 metal costs.

Unique contact design prevents wicking
 during soldering to avoid rejects.

Body design provides
 easy access for logic
 monitor testing.

Genuine U.S.
 penny to remind
 you that every one
 saved is another
 one earned.

High temperature,
 self-extinguishing
 thermoplastic body meets
 UL 94 V-O rating.

Narrow body design permits
 15% greater package densities.

Burndy's all new DILB-P8.

In short, it's the most reliable, most economical IC socket on the market today.
 And it's available only from Burndy — in sizes from 8 to 40 positions
 on .100" centers. For complete details, contact Burndy or your local authorized
 Burndy Distributor. We'll also supply fully-loaded PC boards
 to your specifications. Call or write W. R. Matthias, Burndy Corporation,
 Norwalk, Connecticut 06856. Telephone 203-838-4444.

*In volume
 †Patented

BURNDY
 Offices in principal cities throughout the United States
 WorldRadioHistory
 CIRCLE NUMBER 196

INTERNATIONAL SALES AND MANUFACTURING: BRUSSELS, BARCELONA, PARIS, ROTTERDAM, STOCKHOLM, STUTTGART, TURIN, ZURICH, ST. HELENS (ENG.), TORONTO, SYDNEY, TOKYO, MEXICO CITY, SAO PAULO

BURNDY CONNECTS

When it's your move ...check Centralab

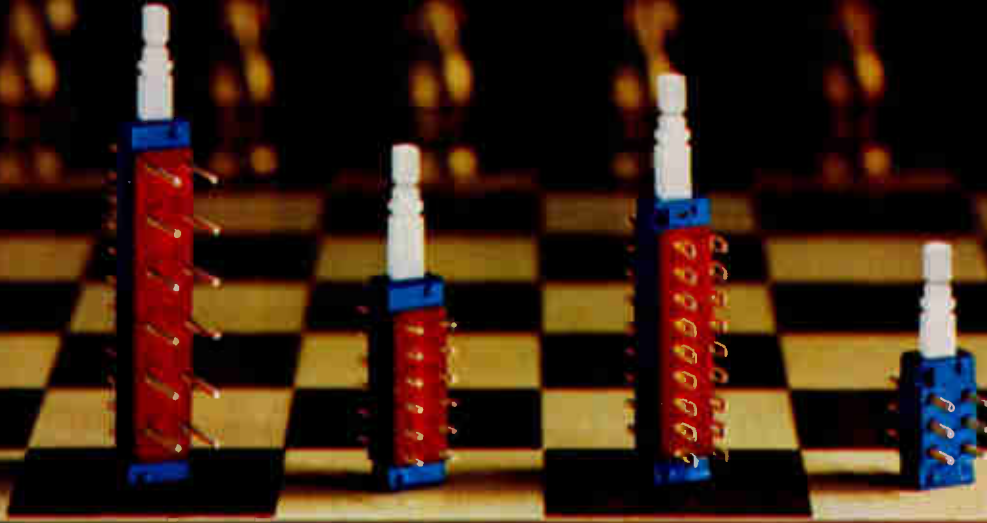

Best pushbutton switch for your board

Don't be checkmated. Only Centralab offers you the best low-cost switch module, plus so many extra-quality options.

THE BEST SWITCH—The basic Centralab pushbutton switch module is unique because of its inherently simple and rugged construction. High speed machinery produces the parts and performs assembly operations simultaneously, ensuring that the parts always fit the assembly perfectly. Stationary and movable contacts are enclosed in a high-dielectric thermoset housing to protect the smooth, positive wiping

action of the slider bar and contacts. And Centralab switches are 100% tested.

Centralab pushbutton switches meet these demanding specifications:

Insulation Resistance: Up to 10^{12} ohms.

Dielectric strength: 1,500 volts.

Contact resistance: .004 ohms.

Life and reliability: Up to 250,000 MTBF in ganged assemblies. Over 500,000 operations on contact systems.

Shock and Vibration: 100g's and 10g's low frequency.

Electrical rating: Covers range from dry circuits to 1 ampere, and low millivolts to 120 volts.

If your requirements go beyond the basic Centralab module, consider these optional moves:

HIGHEST INSULATION RESISTANCE—Centralab offers diallyl phthalate housing material, in addition to phenolic.

BEST CONTACT RESISTANCE—Gold contacts and terminals are standard options. Best for dry circuit applications and contaminating environments.

NO INTERNAL CONTAMINATION—Epoxy sealed terminals prevent

failure from solder flux and other contaminants.

Proven in use by more quality-conscious users, Centralab 2, 4, 6 and 8 pole pushbutton switches are available in four types of lockout for momentary, push-push or interlocking action. Both PC and solder lug terminals are available. PC terminals can be selectively cut to your desired lengths.

PLUS THESE NEWEST ADDITIONS

—A new 5 amp line switch, a new low-cost lighted switch and a new visual display for non-lighted switches.

Get all the technical help you need from our 19 assembly distributors or network of experienced sales engineers. They'll help you select the best pushbutton switch for your board. Now it's your move!

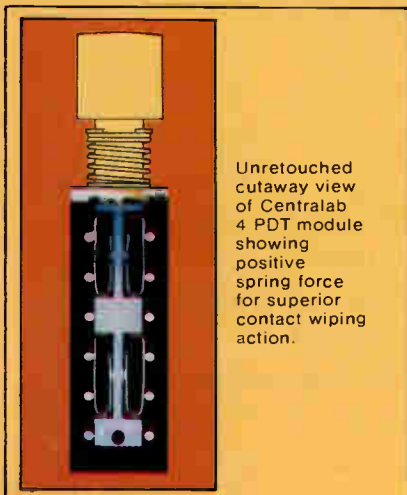

Unretouched cutaway view of Centralab 4 PDT module showing positive spring force for superior contact wiping action.

Isostat Licensed



CENTRALAB

Electronics Division

GLD&E-UNION INC.

P.O. BOX 858

FORT DODGE, IOWA 50501

Lens cap snaps off indicator lamp housing

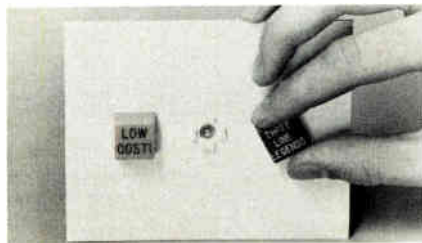

Compu-Lite Corp., 17795 Sky Park Circle, Irvine, CA 92707. (714) 546-9045. \$0.30 (100 up); stock to 4 wks.

A low-cost series of computer-grade front-panel indicators, featuring 3/4-in. square lens caps, offers twist-lock or snap-on/off access to T-1-3/4 bi-pin lamps. Designated the Series 826, the compact indicator includes a polycarbonate lens cap, a 30% glass-filled nylon housing and a single Tinnerman nut that secures the housing in a standard D-shaped hole. The lens caps, offered in orange, white, red, green, yellow and blue, may be engraved with legends having up to three lines and up to seven characters per line.

CIRCLE NO. 347

Mica capacitors take high voltage and current



Custom Electronics Inc., Broune St., Oneonta, NY 13820. (607) 432-3880.

A line of reconstituted-mica capacitors for high current and high-voltage applications, type CMR, is impregnated with a polyester compound and finished in a wrap-and-fill style to provide maximum energy density within minimum volume. Both single and multiple-section assemblies are available in a variety of terminations such as wire leads, threaded studs and heavy ribbon tabs for high current. CMR types are suitable where large amounts of heat must be dissipated. The capacitance range is 40 pF to 10 μ F with voltages from 250 V to 40 kV.

CIRCLE NO. 348

Window bug gives broken-glass alarm

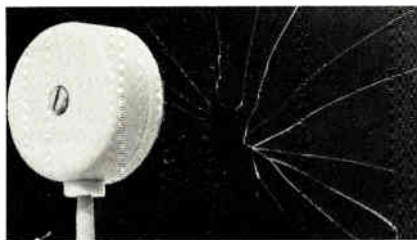

Mountain West Alarm Supply Co., 4215 N. 16th St., Phoenix, AZ 85016. (602) 263-8831. \$11.20 (unit qty).

Guard your windows with the M11 window bug without the usual foil tape. Glass breakage is detected by a tuned fork and cavity. A shock wave travels across the glass when its surface is broken. The window bug resonates and operates a switch for 1/2 s to trigger a burglar alarm. The M11 easily installs on glass with self-adhesive or screw mounting. The bug's contacts can be set to act either NO or NC. The switch is rated at 1 A and no input power is needed to operate the unit.

CIRCLE NO. 349

Mercury reed switches operate in any position

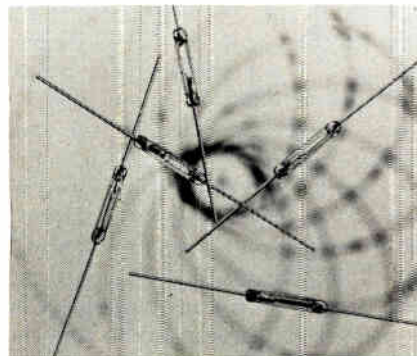

Hamlin Inc., Lake & Grove Sts., Lake Mills, WI 53551. (414) 648-2361. \$2.33 (1000 up); 1 wk.

A new mercury-wetted reed switch, the MTHG-2, offers the advantages of conventional mercury switches plus the capability of being operable in any position. Many other mercury-wetted reed switches are limited to variations of only 15 degrees from perpendicular. Electrical characteristics include a typical 1.2-ms operate and 1.8-ms release time, a contact resistance of 0.080- Ω maximum and a breakdown voltage of 1000-V-dc maximum.

CIRCLE NO. 350

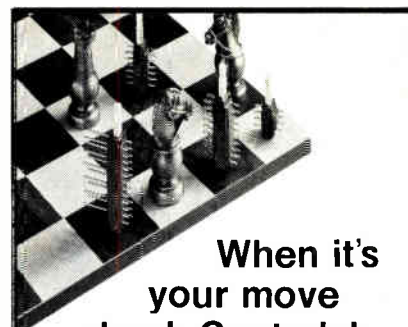

When it's your move check Centralab

High quality pushbutton switches at a low cost



Centralab switches are engineered for quality. Then they're produced on high-speed automated machines to keep your cost down. This means...

Low Price: A Centralab 2-pole lighted switch, for example, costs only \$1.36 including lamp, in 1,000 quantities.

Quality: Up to 250,000 MTBF in ganged assemblies. Over 500,000 operations on contact systems.

Plus Options: Diallyl phthalate housings • gold contacts • epoxy-sealed terminals • 2, 4, 6 and 8 poles • four types of lockouts • and much more for *only pennies more*.

Newest Additions: Non-lighted status indicator • low-cost lighted switch • 5 amp line switch.

When you can have quality *and* low price from Centralab, why settle for less? For full information, call your Centralab Pushbutton Distributor or send reader service card, or write...

Isostat Licensed



CENTRALAB

Electronics Division
GLOBE-UNION INC.

P.O. BOX 858
FORT DODGE, IOWA 50501

CIRCLE NUMBER 104

Rms-to-dc converters get tenfold accuracy boost

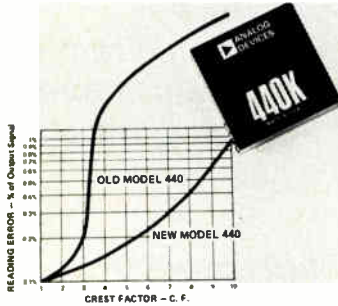

Analog Devices, Rte. 1 Industrial Park, Norwood, MA 02062. (617) 329-4700. From \$62 (1 to 9); stock.

The Model 440 true rms-to-dc converter module has had its accuracy improved by more than a factor of 10, with no increase in cost. Complex waveforms with crest factors of up to five may now be measured with $\pm 0.15\%$ error, compared with $\pm 2.5\%$ error for the original Model 440. With a ± 4 -to- ± 18 -V-dc power-supply range and 10-mA quiescent current dissipation, the Model 440 is useful for battery-powered applications. The 3-dB bandwidth of 500 kHz and accuracy of $\pm 1\%$ of reading (maintained to above 50 kHz) ensures that the Model 440 has a response greater than the entire audio range. The converter's specs hold for the 0-to-70-C range, and it is packaged in a $1.5 \times 1.5 \times 0.4$ -in. ($38.1 \times 38.1 \times 10.2$ -mm) module. Two accuracy grades are available: Model 440J with ± 15 mV $\pm 0.2\%$ maximum total error and Model 440K with ± 5 mV $\pm 0.1\%$ maximum total error.

CIRCLE NO. 351

PDP-11 interface module has do-it-yourself space

MDB Systems, 981 N. Main St., Orange, CA 92667. (714) 639-7238. \$250 (unit qty); 14 days.

The MDB-1710 general-purpose interface module provides an interface between a PDP-11 Unibus and the user's peripheral. Essential and universal Unibus logic interface elements are premounted and wired for address selection and interrupt vectoring. Wire-wrappable posts make it easy to connect Unibus driver inputs and receiver outputs for multiple-controller applications. The module provides space for up to 40 IC devices with wire-wrappable sockets or directly mounted 14, 16, 22 or 40-pin ICs. With the wiring posts on the component's side of the board, the module fits DEC's 0.5-in. spacing without interference.

CIRCLE NO. 352

Predetermining counter uses photoelectrics

Autotron Inc., Danville, IL 61832. (217) 446-0650. From \$99.50; stock.

A high-speed (1500 counts/s) photoelectric control is designed primarily for predetermined batch counting or shaft rotation applications. Predetermining counter and photoelectrics are in a single compact unit. The control uses retro-reflective optics and has thumb-wheel switches to set the desired count, up to 9999. Connect line voltage and load, and it's ready for operation. The count reset time is 400 μ s.

CIRCLE NO. 353

Semiconductor memory replaces core modules



Intel Memory Systems, 1302 N. Mathilda Ave., Sunnyvale, CA 94086. (408) 734-8102. \$1985 (unit qty); 30 to 45 days.

An "add-in" 4-k MOS RAM semiconductor memory for the Interdata Model 7/16 Basic mini-computer, the in-4716 system, stores up to 16,384, 17-bit words on a single card. It provides a completely compatible replacement for the core memories previously used with Interdata's OEM computer. Two major advantages are high speed and low power dissipation—an access time of 300 ns, cycle time of 1 μ s and a worst-case power dissipation of 36 W—less than half the power consumption of core memories.

CIRCLE NO. 354

Hybrid vhf amplifier delivers 1 W class C

Quanta Systems Corp., 979 Rollins Ave., Rockville, MD 20852. (301) 881-2050. \$400 (100-up); stock.

The Model 1105 vhf hybrid power amplifier can deliver 1 W class C at frequencies between 145 and 175 MHz. The amplifier will operate from a dc supply that can range from 9.5 to 15 V. Both its input and output impedances are 50 Ω . Input drive is 1.5 mW minimum and amplifier efficiency is 40%, minimum. The amplifier measures $0.995 \times 0.995 \times 0.2$ in.

CIRCLE NO. 355

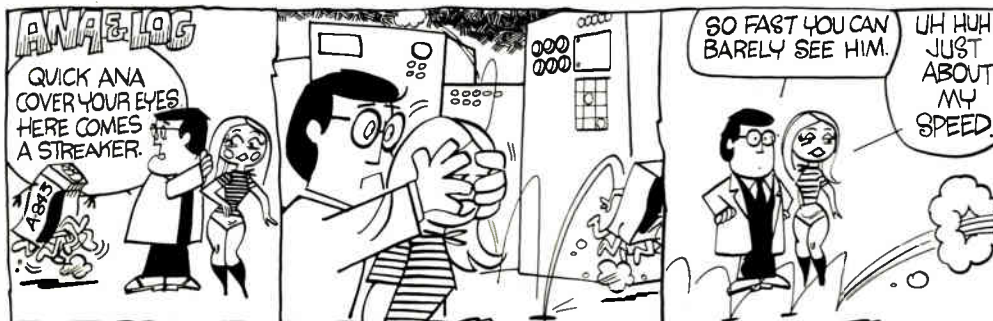

ANALOGY
GET THE BARE FACTS ON THE A-843 VOLTAGE TO FREQUENCY CONVERTER. STREAKS YOUR SYSTEM AT 0.1MHZ IN A STRAIGHT LINE, $\pm 0.01\%$. NEAT LITTLE $1 \times 1 \frac{1}{2} \times 3$ PACKAGE. RUN OUT AND GET ONE.

intech INCORPORATED
(408) 244-0500
1720 COLEMAN, SANTA CLARA CA 95050

INTRODUCING THE EXACT MODEL 605-145 ASCII PROGRAMMER

YOU CAN ASCII NOW...

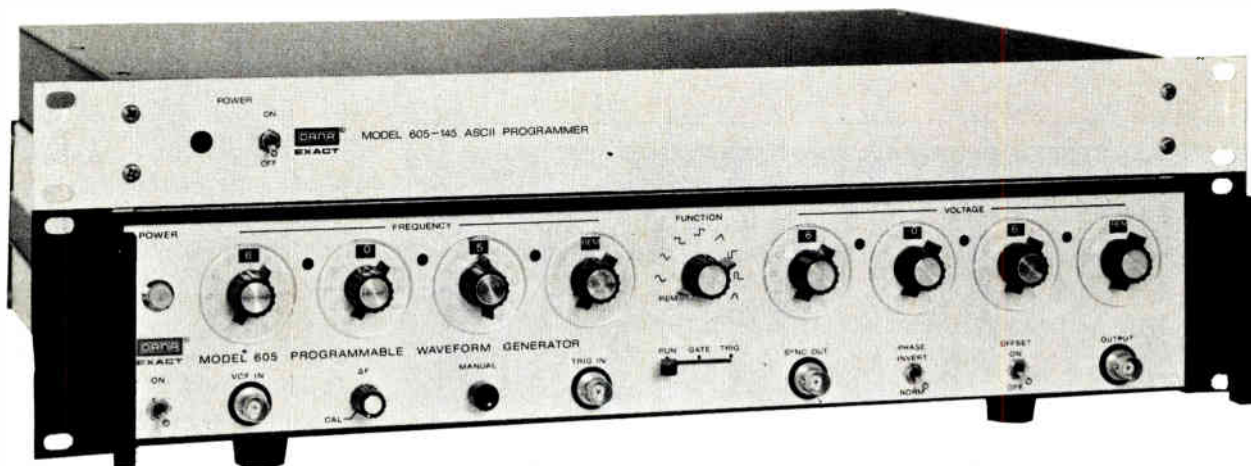

OR ASCII LATER

Fully compatible with the IEEE STD 488-1975, the 605-145 provides for ASCII remote programming of all functions of the standard Exact Model 605 and 606 Programmable Waveform Generators. The 605-145 is equipped with a cable and connector assembly which mates directly with the remote BCD programming connector on the 605/606.

Perhaps your current system is designed around a BCD interface but your future plans call for instruments compatible with the IEEE STD 488. You can order the Model 605 Programmable Waveform Generator now which has BCD remote programming as a standard feature. Later, when you wish to convert to ASCII, the Model 605-145 can be added with no modifications or added circuitry to the Model 605.

The Exact Model 605 is a 1 millihertz to 1 Megahertz (1.66MHz in remote) programmable VCF function Generator. All functions, i.e.; frequency, amplitude, waveform, mode, offset, and phase are remotely programmable in the standard generator or by using the 605-145 ASCII Programmer.

Sixty percent (60%) overrange capability for both frequency and amplitude is provided when operating remotely. This gives a maximum of 1.66MHz and 16.6V P-P into 50 ohms.

Exact's Model 801 and 802 20MHz Frequency Synthesizers are also available with remote ASCII or BCD programming options.

For additional program information about the Exact Model 605-145, you can ASCME now by circling the lower left number.

For more information on Programmable Frequency Synthesizers, circle the lower right number.

DANA [®] **EXACT**
electronics, inc.

Subsidiary of Dana Electronics, Inc.

BOX 160, HILLSBORO, OREGON 97123
(503) 648-6661 TWX 910-460-8811

CIRCLE NUMBER 253

ELECTRONIC DESIGN 4, February 16, 1976

CIRCLE NUMBER 254

MODULES & SUBASSEMBLIES

True-rms-to-dc converter accurate to within 0.2%

Analog Devices, P.O. Box 280, Rte. 1 Industrial Park, Norwood, MA 02062. (617) 329-4700. From \$45 (1 to 9); stock.

The Model 441 precision, true-rms-to-dc converter has an accuracy of within $\pm 0.2\%$. Noninteractive optional external trims for

scale factor and output offset can be used to further increase the accuracy of the converter to $\pm 0.1\%$. The 3-dB bandwidth is 75 kHz and the converter has a wide ± 4 to ± 18 -V-dc power-supply range. The 441 operates over a -25 -to- 85 -C range and is packaged in a $2 \times 2 \times 0.4$ in. ($51 \times 51 \times 10$ mm) module. The Model 441J has a ± 10 mV $\pm 0.4\%$ maximum total untrimmed error and the 441K, a ± 5 mV $\pm 0.2\%$ error.

CIRCLE NO. 356

Hybrid d/a and a/d's designed for low cost

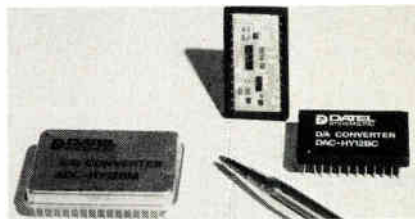

Datel Systems, 1020 Turnpike St., Canton, MA 02021. (617) 828-8000. See text.

The DAC-HY12BC and ADC-HY12BC series of hybrid d/a and a/d converters are completely self-contained units. The 12-bit d/a's are available in either binary or BCD-input versions and start at only \$29 in unit quantities. They can be used in either a current or voltage output mode.

The current mode provides outputs of either 0 to -2 mA or ± 1 mA and output compliance voltage is a useful ± 2.5 V max. In the voltage mode the converter outputs either 0 to $+5$, 0 to $+10$, ± 2.5 , ± 5 or ± 10 V—all with a maximum output current of ± 5 mA and an output impedance of 0.05Ω . The temperature coefficients of gain, differential linearity and unipolar offset relative to full-scale are ± 30 ppm/ $^{\circ}\text{C}$, ± 2 ppm/ $^{\circ}\text{C}$ and ± 5 ppm/ $^{\circ}\text{C}$, respectively.

The DAC-HY12 circuitry is encased in a $1.3 \times 0.8 \times 1.5$ -in. glass, hermetically sealed package.

The 12-bit a/d converter has a conversion time of $8 \mu\text{s}$ max. and a unit price of \$79. Unipolar inputs of 0 to $+5$ or 0 to $+10$ V as well as bipolar inputs of ± 2.5 , $+5$, or ± 10 V are available with parallel complementary straight binary coding for unipolar operation and either complementary offset binary or complementary two's complement for bipolar operation.

The internal buffer amplifier provides a $100\text{-M}\Omega$ input impedance. Monotonicity is guaranteed over the full operating temperature range of 0 to 70 C. the gain tempo is 30 ppm/ $^{\circ}\text{C}$ and the unipolar zero tempo is 5 ppm/ $^{\circ}\text{C}$ relative to full scale. Quantization error, linearity error, and differential linearity error are each $\pm 1/2$ LSB or 0.0125% of full scale at 25 C. The converter is housed in a $1.7 \times 1.1 \times 0.2$ in. hermetically sealed package.

CIRCLE NO. 357

IMPULSE TEST SURGE PROTECTORS AND CIRCUITS

INCLUDING GAS TUBES - VARISTORS - ZENERS - NETWORKS



1500V
8 x 20
1.2 x 50

500A
10 x 1000
10 x 50

and
0.5 to 10kV/usec

The Keytek Model 424 Surge Generator/Monitor surges components and the circuits they're protecting; simultaneously measures resulting peak voltage and current for all generated waveshapes. Digital displays and GO/NO-GO indicators allow Engineering, QC and Production use.

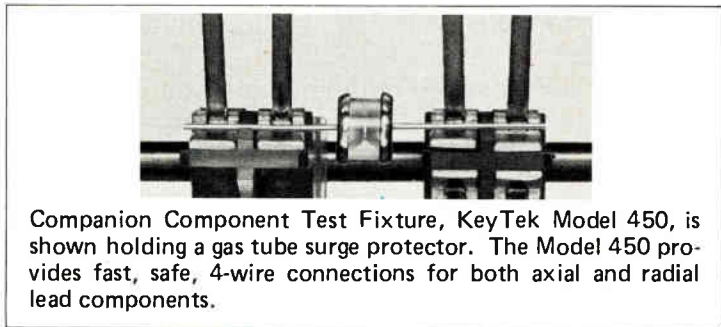

Companion Component Test Fixture, KeyTek Model 450, is shown holding a gas tube surge protector. The Model 450 provides fast, safe, 4-wire connections for both axial and radial lead components.

KeyTek
INSTRUMENT CORP.

40 GUINAN STREET, BOX 109, WALTHAM, MASS. 02154 — TEL. 617-899-6200

CIRCLE NUMBER 107

Big, fast and low-power news on the latest static NMOS RAMs.

If you use RAMs, have we got news.

Three terrific state-of-the-art devices to handle almost any NMOS RAM need.

All with N-channel, Isoplanar fabrication for high yields, low cost.

And all with a super-low speed-power product.

BIG NEWS.

Our 3539 NMOS RAM.

- 256 x 8 Organization
- Bus-structured
- Separate bus-control pin
- Static — no clocks
- TTL compatible
- +5-volt power supply
- 2 Chip Selects
- 22-pin package

FAST NEWS.

Our 3542-2 NMOS RAM.

- 120ns max access time
- Static — no clocks
- 270mW max power
- +5-volt power supply
- 16-pin DIP with 2102 pin-outs
- Industry's best price/performance ratio
- \$2.50 @ 10K piece level

Take our big 2K 3539. It's the first 256 x 8-bit static RAM available anywhere. With just 22-pins, because we've multiplexed the I/Os. Note the list of other outstanding features below. It's available in quantity from Fairchild today.

Then, check our speedy low cost 3542-2. With just 120ns max access time, no competitively priced MOS device is faster. And power dissipation is only 270mW max.

And don't overlook our low-power 2102L. At operational voltage, it beats the power requirement of other devices by almost a factor of two — without sacrificing performance.

LOW-POWER NEWS.

Our 2102L NMOS RAM.

- 132mW max power
- Static — no clocks
- 2102 pin-outs
- Fast Access (350ns max: 2102L)
- No price premium

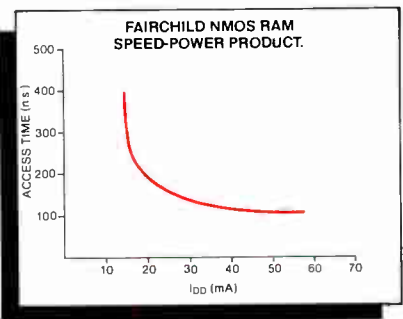

So whatever you need in MOS RAMs, call your Fairchild Distributor, Sales Office or Representative today.

And tell him you got the news.

Semiconductor Components Group, Fairchild Camera & Instrument Corp., 464 Ellis St., Mountain View, CA 94040. Phone (415) 962-3941. TWX: 910-379-6435.

FAIRCHILD
No.1 for logic and memory.

CIRCLE NUMBER 108

AMPERITE

Thermostatic RELAYS

- LONG DELAY -



240 & 300 Seconds

New! For applications requiring long delays. Hermetically sealed — not affected by altitude, moisture, or climate changes... SPST only — normally open or normally closed... Compensated for ambient

temperature changes from -55° to $+80^{\circ}$ C... Rugged, explosion-proof, long-lived... Standard radio octal base only.

Price, under \$6.00 ea.

Write for Bulletin No. LD-73.

DELAYS:

2 to 180 SECONDS*

Same rugged construction, hermetic sealing and stability as the long Delay Relays described above... For standard radio octal and 9-pin miniatures.

Price, standard or min., under \$4.00 ea.

*Miniatures delays: 2 to 120 seconds.

PROBLEM? Send for Bulletin No. TR-81.

All Amperite Delay Relays are recognized under component program of Underwriters' Laboratories, Inc. for all voltages up to and including 115V.



DIFFERENTIAL RELAYS

For automatic overload, over-voltage or under-voltage protection... Made only to specifications for 70V, 80V, 90V and 100V.

Price, under \$6.00 ea.

AMPERITE BALLAST REGULATORS

Automatically keeps current and voltage at a definite value. For AC or DC... Hermetically sealed, rugged, vibration-resistant, compact, most inexpensive.

Price, under \$3.00 ea.

Write for 4-p. Bulletin No. AB-51.



AMPERITE

600 PALISADE AVE., UNION CITY, N.J. 07087

Telephone: 201 UNion 4-9503

In Canada: Atlas Electronics, Ltd.,
50 Wingold Ave., Toronto 19

OUR COMPLETE PRODUCT LINE CAN BE FOUND IN ELECTRONIC DESIGN'S GOLD BOOK.

CIRCLE NUMBER 109

MODULES & SUBASSEMBLIES

Dedicated divider has accuracy to 0.25%

Burr-Brown, Box 11400, Tucson, AZ 85734. (602) 294-1431. From \$34 (1 to 9); stock.

The 4291 dedicated divider maintains its accuracy to within 0.25% with input voltages as low as 100 mV. The 0.25% accuracy with a denominator voltage of 100 mV is achieved with no external components. And by adding several external trimming resistors, accuracy of 0.1% with a 10-mV denominator voltage can be achieved. Input limits of the 4291 are 0 to +10 V on the denominator and ± 10 V on the numerator. Divider output voltage is ± 10 V minimum and output current is ± 5 mA. The small-signal bandwidth is 400 kHz at $D = +10$ V. The multiplier requires ± 15 -V supplies. The 4291 is housed in a 14-pin DIP and is available in three versions: 4291H (1% initial accuracy), 4291J (0.5%) and 4291K (0.25%).

CIRCLE NO. 358

Synchro converters have accuracies of ± 6 min

Computer Conversion Corp., 6 Dunton Ct., East Northport, NY 11731. (516) 261-3300. \$350 (prod. qty.); 4 wk.

The SCT series of synchro control transformer modules provides digital control to existing analog servo systems. The modules measure $2.6 \times 3.1 \times 0.82$ in. and have standard accuracies of ± 6 , 15 or 30 min of arc. They simultaneously accept synchro or resolver inputs of 11.8 or 90 V, 400 Hz or 90 V, 60 Hz, and 14, 12, or 10-bit binary digital data. Their output voltage is the sine of the difference between the two input angles. Gradients are 0.4 V rms/ $^{\circ}$ or 1 V rms/ $^{\circ}$. Output angle range is ± 7 or $\pm 12.5^{\circ}$. This series of converters is insensitive to $\pm 10\%$ amplitude and frequency variations, $\pm 5\%$ power-supply variations. The SCT-40 requires a 26 or 115-V, 400-Hz ac reference and +15 V at 60 mA, -15 V at 25 mA and +5 V at 75 mA. Two operating temperature ranges are available: 0 to 70 C or -55 to $+85$ C.

CIRCLE NO. 359

Hybrid V regulators handle currents to 3 A

Solitron Devices, 1177 Blue Heron Blvd., Riviera Beach, FL 33404. (305) 848-4311. From under \$25 (1 to 99); 4 wk.

Three series of three-terminal hybrid voltage regulators are designed for high-reliability applications. Each series has a 3-A current rating and output voltage ranges from ± 6 to ± 20 V. These regulators include current fold-back and short-circuit protection and are packaged in a two-lead TO-3 case. The ± 6 -V series are identified as the CJSE 017 through CJSE 022; the ± 15 V as CJSE 001 to CJSE 006; and the ± 20 V as CJSE 009 to CJSE 014. At each voltage rating, the devices are offered with line and load regulation of $\pm 1\%$, $\pm 2\%$ or $\pm 3\%$ guaranteed from -55 to 125 C.

CIRCLE NO. 360

Isolation amplifier has 3000 V I/O separation

Analog Devices, Rte. 1 Industrial Park, P.O. Box 280, Norwood, MA 02062. (617) 329-4700. From \$89 (1 to 9); stock.

The Model 285 industrial isolation amplifier allows low-level signals to be processed on top of high common-mode voltages. With its high, 3000 V rms (for 1 s), input/output isolation (2500 V rms, 60 s), the Model 285 allows small signal variations to be measured on high voltage lines. The isolator's 115 dB minimum CMRR at a 1 k Ω source imbalance and a frequency of 60 Hz assures the accuracy of any measurements. The gain of the Model 285 may be varied between 1 and 1000 by adjusting a single external resistor. The isolator delivers ± 5 mA minimum for loads up to 2 k Ω , to provide a full ± 10 V input/output range. The Model 285 is available in three linearity versions (J/K/L) with $\pm 0.05\%$, $\pm 0.04\%$, and $\pm 0.03\%$ maximum nonlinearity, respectively. The three versions also offer selections in temperature performance: Models 285J/K/L have input offset voltage drifts of 15, 10 and 5 μ V/ $^{\circ}$ C maximum, respectively, for an output gain of 100 V/V.

CIRCLE NO. 361

Power to the μ P



Sola offers **DUAL** and **TRIPLE OUTPUT POWER SUPPLIES** for **MICROPROCESSORS** and accessories: **RAM's, PROM's, ROM's, FEPROM's, CLOCKS** and **IO devices**.

All available from your local electronic distributor. At competitive pricing. From a name you can count on—Sola.

Our versatile power supplies offer fully isolated independent outputs for either positive or negative operation. Series or parallel operation. Plus, remote sensing/programming, and complete serviceability. Just call or write for Catalog 647.

For added protection, consider our minicomputer regulators, UPS, and Standby units. Everything you need for MPU power and protection.

Sola Electric, 1717 Busse Road, Elk Grove Village, Ill. 60007 (312) 439-2800.



Think of us as your supply line.

CIRCLE NUMBER 110

PROM PROGRAMMERS

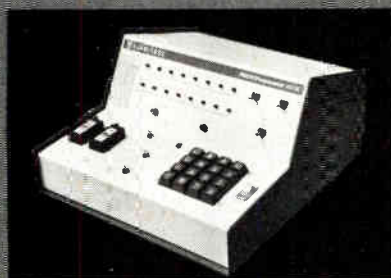

Economical

Technitrol
Model **107K**

Featuring hexadecimal keyboard entry of data and address

- Functions: program, copy, display data and address, verify.
- Auto-copy between selectable min and max addresses.
- Program or list addresses sequentially or randomly.
- Verify master to copy while reading or writing.
- Stop on error detect.
- Display copy data and address in read.
- Display keyboard data and address in write.

Option: general-purpose interface.

Price: \$850. Stock to 3 weeks delivery.

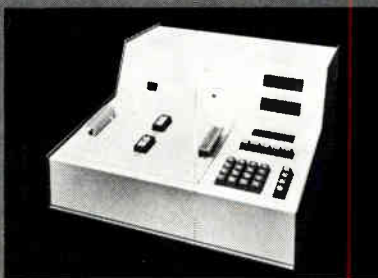

Versatile

Technitrol
Model **501**

Featuring hexadecimal display and keyboard

- Functions: zero field test, program, copy, list, verify.
- Personality cards to accommodate each PROM type.
- 8-bit microprocessor for versatility, expandability, ease of operation.
- Simultaneous display of master and copy data and address.
- Capable of programming up to 65K words.

Options: paper tape reader, TTY interface, general-purpose interface.

Price: \$2150 plus personality modules and options.

PLUS...
UV Erase Light,
Model 2537.
Only \$128.50.
Stock to three weeks.



Technitrol, Inc.
1952 E. Allegheny Avenue,
Philadelphia, PA 19134

CIRCLE NUMBER 111

DIP headers let you mount tiny components

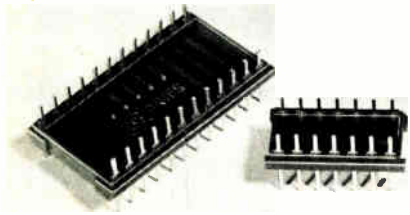

Aries Electronics, P.O. Box 231, Frenchtown, NJ 08825. (201) 996-4096. From \$0.21 to \$1.90; stock.

Headers with solid 0.02 in. square \times 0.1 in. high posts are available with 8 to 24 pins on 0.1-in. centers. The 8, 14, 16-pin headers have dual post rows spaced 0.3 in. apart; 24-pin units with posts 0.6 in. apart. Both tin and gold-plating are available, as are various height snap-on covers. Body and cover are molded of glass filled thermoplastic.

CIRCLE NO. 362

Circuit board connectors have up to 22 contacts

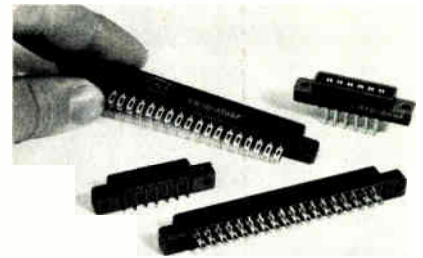

Dale Electronics, East Highway 50, Yankton, SD 57078. (605) 665-9301. See text; 2 to 4 wk.

Series EB 7, a 0.156-in., edge-board connector, is available in both single and dual contact row versions. It is also available with between-contact polarization which can be installed at the factory or in the field. Both single and dual-contact row models provide a choice of 6, 10, 15, 18, or 22-contact positions. Reliable bifurcated bellows contacts of phosphor bronze assure positive contact while accepting variations in PC-board thickness from 0.054 to 0.071 in. The connectors are available with a choice of eyelet or dip solder terminations. Contact plating choices include gold plate (per MIL-G-45204), gold flash or electro-tin plate (per MIL-T-10727). An EB 7 S (single row) model with 10-contact positions and tin-plated eyelet contacts costs \$0.57 each when purchased in 1000-piece lots.

CIRCLE NO. 363

yes Standard Grigsby's rotary switches have printed circuit and solderless terminals that will not bend or twist

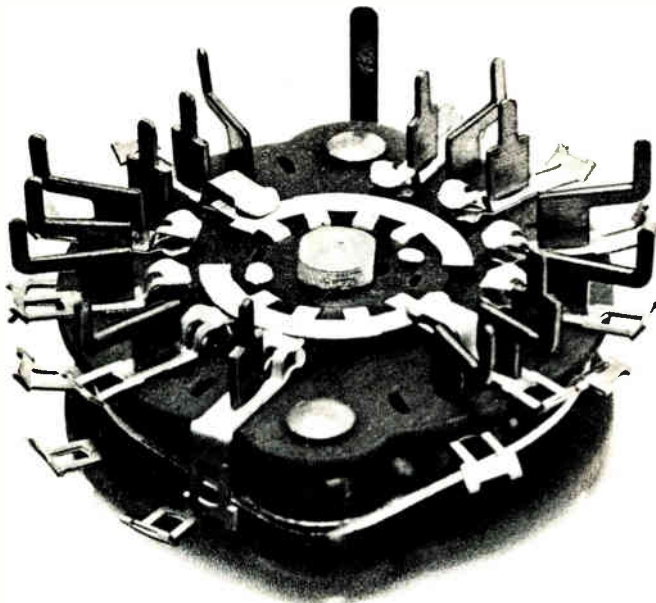

our exclusive rigid construction provides you with savings by eliminating costly assembly operations

"YES" - Save the valuable time wasted on straightening the P.C. terminals of rotary switches!

Our exclusive printed circuit "T" terminals are ruggedly designed to allow EASY insertion of our rotary switches into any P.C. board pattern.

If you wire your rotary switches with wire-wrap or other solderless techniques, try a terminal that won't bend or twist... Standard Grigsby's NEW solderless "T" terminal.

Send for Free "Yes" button and literature.



standard grigsby, inc.

920 Rathbone Avenue • Aurora, Illinois 60507
(312) 897-8417

CIRCLE NUMBER 112

Mica filled material can be used up to 750 F

Mykroy Ceramics, Orben Dr., Ledgewood, NJ 07852. (201) 398-7000. See text.

A commercial grade of glass-bonded-mica, Mykroy 740, is a natural mica filled material suited for continuous use at operating temperatures of 750 F (399 C). The material can be cut, drilled, tapped, milled and lathe-turned with standard tooling. Mykroy 740 is available in standard sheet sizes—19.5 \times 26.75 in. and 13 \times 19.5 in., and in thicknesses of 3/16, 1/4, 3/8 and 1/2 in. Other thicknesses and sizes are available for special applications. A 3/16 in. thick \times 19.5 \times 26.75 in. sheet costs \$27.47.

CIRCLE NO. 364

Line drawing digitizer offers many features

Melco Industries, 7100 Broadway, Denver, CO 80221. (303) 426-1515. \$4450; 30 day.

A microprocessor-controlled digitizer, besides converting a line drawing to X and Y coordinates, automatically converts to and from polar coordinates and computes areas and perimeters. The digitizer has a built-in scale-factor conversion, grid round-off and can also be used as an English-metric converter. Dual six-digit coordinates are displayed by LEDs with sign and decimal point. Digitrac is a totally self-contained portable digitizer, small and light enough to be easily moved from one drafting table to another by one man. It has a built-in power supply and operates from 110 to 220 V, 50 to 60 Hz. The digitizer has a resolution of 0.001 in. and a repeatability of 0.005 in.

CIRCLE NO. 468

Parts marking machine handles any shape part

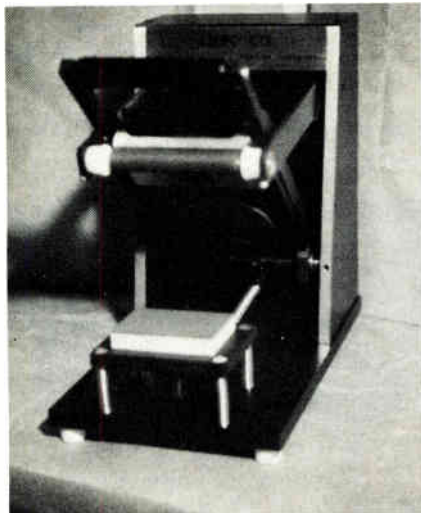

Mech-Tron, Box 67 Blvd. Sta., Andover, MA 01810. (617) 475-3531. \$465; 4 to 5 wk.

The Model 23 offset marking machine is a manually operated portable unit. It does direct and offset marking of flat, cylindrical or irregular shaped objects. The machine accepts a variety of printing elements such as metal type, cuts or rubber dies. The maximum area that could be imprinted measures 2 x 3 in. and the machine weighs just 11 lb.

CIRCLE NO. 469

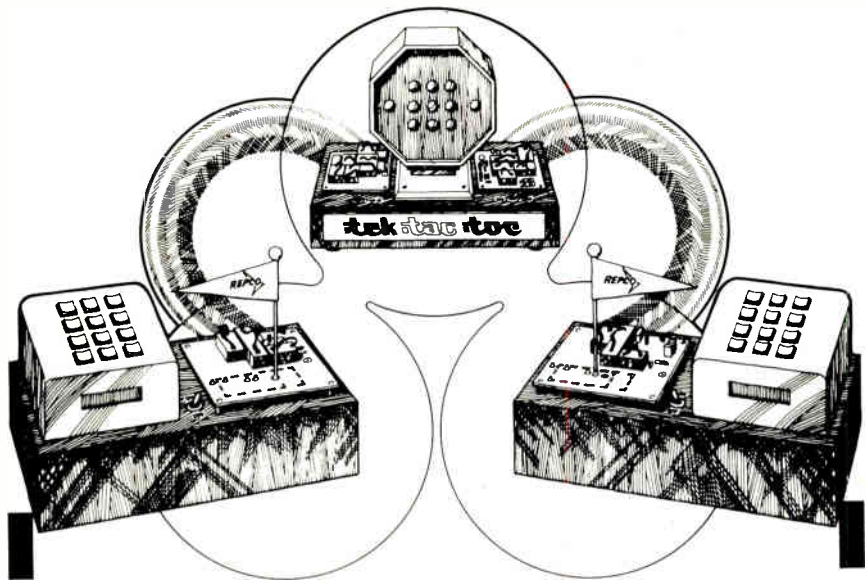

Undiscovered genius contest.

The slightly zany, yet fully workable idea illustrated is an RF link-controlled tic-tac-toe game using Repco's modular RF links. It was developed by our engineers to demonstrate the potential and versatility of our RF links. We figured, since creativity is widespread, other design engineers could come up with even more clever ideas.

And the Undiscovered Genius Contest was born.

Sure, there are limitless practical applications for Repco's RF links. But one of the characteristics of creative engineers is to develop commercial applications while jiving around with off-the-wall ideas.

We'd like you to enter our Undiscovered Genius Contest. The payoff is 12 fantastic prizes for our 6 winners and 6 runners-up.

If you're one of the six winners, you'll receive a Texas Instruments SR51 calculator — retail value \$149.95. Six runners-up win Texas Instruments SR50 calculators — retail value \$99.95.

But just for entering, we'll send you a bright button which identifies you as an Undiscovered Genius. It also makes a neat, semi-deadly frisbee on days there's nothing much doing around the lab.

Just draw a quick sketch or diagram illustrating your clever (but workable) idea incorporating Repco's RF links on an 8½" x 11" sheet of paper and sign it. We **absolutely** will not appropriate or use your idea in any way except for advertising purposes. Your entry constitutes permission for us to use your drawing in our advertising.

Please send your entry directly to Repco, and for further information and contest details pull reply card in this magazine. Contest expires April 30, 1976.

• decision of judges is final • limit one entry per person • void where prohibited by law, or where taxed • all entrants will be notified of winners • employees of Repco, Scope, Inc., or their advertising agency are not eligible (darn!) • and all prizes will be awarded.

Don't delay . . . enter now, and become an undiscovered genius!

REPCO Incorporated

A subsidiary of SCOPE Incorporated

P.O. Box 7065, Orlando, Florida 32804 • (305) 843-8484

CIRCLE NUMBER 113

"off the shelf"

a rugged, well constructed, high quality switch from Capitol it has the same solid reputation as our custom ordered switches

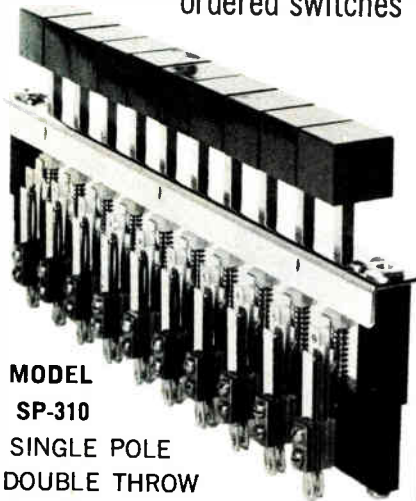

MODEL SP-310

SINGLE POLE DOUBLE THROW CONTACT

SQUARE BUTTON, NON-ILLUMINATED

Contacts: Palladium rated at 3 amp, 110VAC, non-inductive

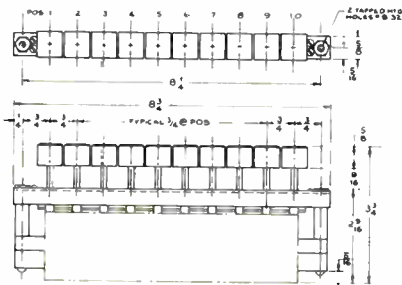

NOTES: 1 CONTACTS 1 FORM C EACH POS SEC 1
2 MECHANICAL ACTION INTERLOCKING WITH POSITIVE LOCKOUT BETWEEN POS
3 BUTTONS 22 32 56

We manufacture top quality push button and lever circuit selector switches single switches or banked assemblies. Write for our catalog.

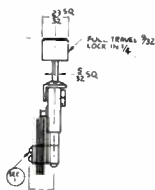

Representatives in principal cities.

CAPITOL SWITCHES

THE CAPITOL MACHINE & SWITCH CO.
87 NEWTOWN RD. DANBURY, CONN. 06810
(203) 744-3300

CIRCLE NUMBER 114

PACKAGING & MATERIALS

PC board laminate can withstand 400 C

Mica Corp., 10900 Washington Blvd., Culver City, CA 90230. (213) 559-4223. From \$9.32/sq. ft.; 10 day.

Type PG-450 high-performance PC board laminate contains a blend of polyimide and epoxy resins. It can tolerate environmental temperatures up to 400 C instead of a maximum of 125 C for pure epoxy laminates and 500 C for polyimides. It is available in thicknesses of 0.031 in. and above, in sheet sizes of 18 x 24 in. or 18 x 36 in.

CIRCLE NO. 365

Silver epoxy paste has R of $1 \times 10^{-4} \Omega\text{-cm}$

Transene Co., Rte. 1, Rowley, MA 01969. (617) 948-2501. \$12.50/oz.; stock.

A silver epoxy paste, a thermo-setting silver, is designed for ohmic bonding. The paste is a one-part system generally applied by screen-printing. It has a cure temperature of 150 C (minimum), an electrical resistivity of $1 \times 10^{-4} \Omega\text{-cm}$, a thermal conductivity of 100 btu/ft²/hr/°F/in., a bond shear strength of 1500 psi, an outgassing of 0.097% at 100 C (1250 hr.) and a temperature stability range of -65 to +250 C.

CIRCLE NO. 366

Solder pastes made for thin & thick-film use

Electro Materials, 605 Center Ave., Mamaroneck, NY 10543. (914) 698-8434. \$5 to \$10/oz.; stock.

A line of solder pastes specifically for thick and thin-film applications meet the latest federal specification QQ-S-571e for 300 mesh material. Four basic alloys are available: a 60/40 tin/lead for general-purpose applications; a 62/36 tin/lead with 2% silver and 354 F eutectic melting point for noble-metal applications; and a lead-free 96% tin and 4% silver alloy with a 430-F eutectic melting point for high temperature, shear and tensile strength applications.

CIRCLE NO. 367

DIP test clips handle up to 24-pin packages



Continental Specialties, 44 Kendall St., P.O. Box 1942, New Haven, CT 06509. (203) 624-3103. \$8.50 (unit qty.); stock.

A 24-pin IC test clip, the Proto-Clip 24, is patterned after the company's other popular DIP clips. This troubleshooting tool offers a narrow throat, which is ideal for bringing IC leads up from high density printed-circuit boards. Scope probes and test leads lock onto gripping contact teeth. Non-corrosive nickel/silver contacts provide simultaneous wiping action and make low resistance connections to IC leads. Over-all plastic construction eliminates springs and pivots, while the molded spring ensures thousands of operations.

CIRCLE NO. 368

Snap together card file assemblies in minutes

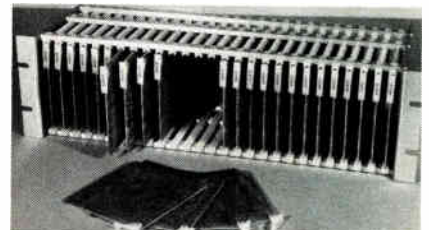

Stanford Applied Engineering, Inc., 340 Martin Ave., Santa Clara, CA 95050. (408) 243-9200. \$25; stock.

The snap-together kit, Varifiles, allows you to assemble a card file in just minutes. Designed on a modular basis, the kit contains only five basic parts: end plates; support bars; card guides; nylon snap locking tabs; and connector mounting feet. Also available is a complete line of accessories including identification tabs, card pullers, circuit-card ejectors, circuit-card ejector/retainers, printed-circuit-board edge connectors and cable connector heads.

CIRCLE NO. 369

STAR PERFORMERS

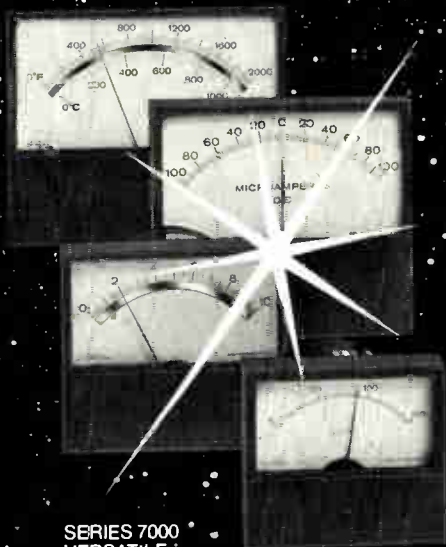

SERIES 7000
VERSATILE

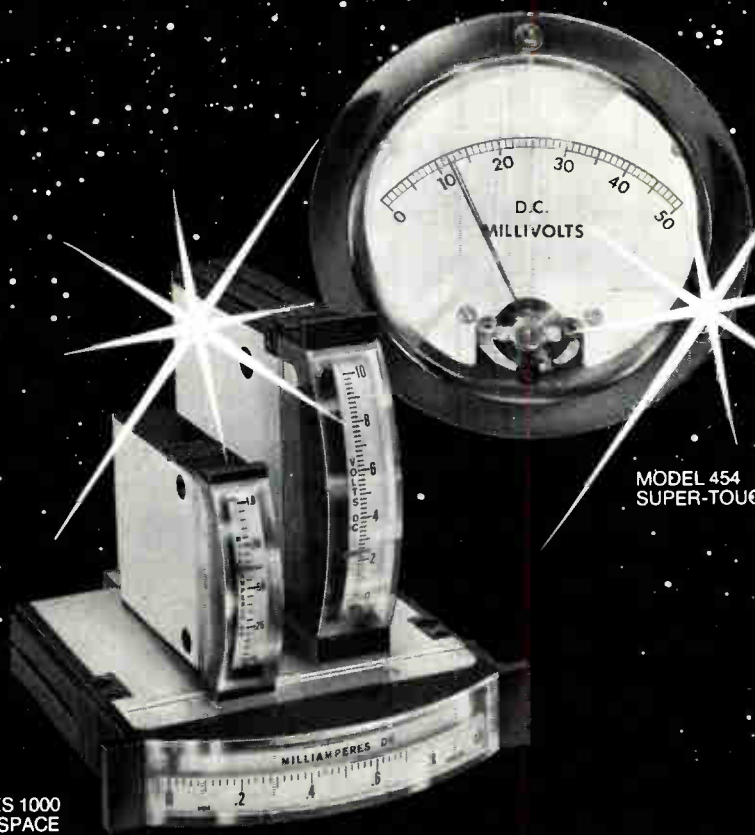

MODEL 454
SUPER-TOUGH

SERIES 1000
SAVES SPACE

api Panel Meters

Get the performance you need — with API panel instruments. Need economy? Small package? Tough case? $\frac{1}{2}\%$ accuracy? LFE has them all.

VERSATILE: Series 7000 can be panel, lens, or bezel mounted. Slide-out scales facilitate modification.

SAVES SPACE: Series 1000 in $1\frac{1}{2}$ ", $2\frac{1}{2}$ " and $3\frac{1}{2}$ " sizes feature rugged polycarbonate case, quick stackable mounting, and famous API quality and styling. Surprisingly economical too.

SUPER-TOUGH: Our new $4\frac{1}{2}$ " round Model 454 is an ideal replacement for glass-window instruments in portable, industrial, and plant uses. Its wrap-around polycarbonate case tosses off blows that would destroy lesser meters. Large clear dial for great visibility.

ACCURATE: Nobody makes more precise panel instruments. We start at a standard 2% rating, with 1% tracking for taut-band ranges. We stop at $\frac{1}{2}\%$ accuracy. You can have anything in between.

There's a LFE distributor or authorized modification center near you to provide quick service on standard or special ranges. Call him. Or call us. We perform. LFE Corporation, Process Control Division, 1601 Trapelo Road, Waltham, Mass., 02154, (617) 890-2000

LFE
CORPORATION

Process Control Division

PACKAGING & MATERIALS

Magnetic foil made for shielding applications

Metallurgical Consultants, 8100 E. Stauson Ave., Montebello, CA 90640. (213) 724-1440. See text.

The Series 80 and 800 materials are shielding grade magnetic foil made from iron-nickel molybdenum alloys. They have a high initial

magnetic permeability and a low core loss. All sheets are annealed for maximum permeability and can be ordered in widths up to 8 in. and lengths up to 20 in. Thicknesses range from 0.001 to 0.006 in. and prices are as follows: 0.001-in. thick is \$0.07 per linear inch; 0.002-in. thick is \$0.09 per linear inch; 0.004-in. thick is \$0.11 per linear inch; and 0.006-in. thick is \$0.13 per linear inch.

CIRCLE NO. 370

DANA INTRODUCES THE SMART COUNTER.

Series 9000: World's First Microprocessing Timer/Counter.

The Dana Series 9000 is smart enough to make your work a lot easier. Microprocessing controls provide all the features of a premium timer/counter, a reciprocating counter and a calculator. Plus interfacing options and operating capabilities never before available in one instrument.

The Dana Series 9000 Microprocessing Timer/Counter goes so far beyond all other counters it takes a whole brochure just to explain its capabilities. Ask for it. It's the smart thing to do.

Dana Laboratories, Inc., 2401 Campus Drive, Irvine, California 92664, 714/833-1234.



DANA
Others measure by us.®

FOR PRODUCT DEMONSTRATION CIRCLE #255

FOR LITERATURE ONLY CIRCLE #256

Optical fiber waveguides lose less than 20 dB/km

Fiber Communications, 391 Lakeside Ave., Orange, NJ 07050. (201) 678-8143. See text.

The S20 series of multimode glass fibers is available in continuous lengths from 100 to 1000 meters. Its transmission losses are less than 20 dB/km at a wavelength of 0.8 micron. A jacketing of EVA or PFA Teflon is available at no extra charge. Cost of the Fiberguide is \$2.75 per meter in lengths of 500 to 1000 meters.

CIRCLE NO. 371

Universal IC packaging panels hold any DIP

Excel Products, 401 Joyce Kilmer Ave., New Brunswick, NJ 08903. (201) 249-6600. From \$23.75; stock to 3 wks.

Pluggable wrapped-wire packaging panels hold a mixture of IC packages that have rows of pin-sockets on 0.3, 0.4 or 0.6-in. centers. The centers of pin-sockets in the rows are 0.1 in. The 3654 series panels can hold 20, 16-pin DIPs, or 24, 14-pin or 16, 22-pin DIPs. The 4620 series panels can hold 50, 16-pin DIPs or various combinations of 14, 16 and 22-pin DIPs. Smaller panels are also available as well as some that will accept up to 96, 22-pin DIPs. All boards are available in various sizes with one, two or three-level wrapped-wire pins.

CIRCLE NO. 372

Liquid ceramic coating handles heat to 4400 F

Aremco Products, P.O. Box 429, Ossining, NY 10562. (914) 762-0685. \$110/quart; stock.

Ultra-Temp 516, a single component zirconia base ceramic coating, can be used at temperatures as high as 4400 F. It can be applied to a wide range of materials including ceramics, glass, quartz, graphite and metals and used as an adhesive coating. The material comes in a premixed paste which will form a hard, dense coating after curing at 500 F for two hours. Ultra-Temp 516 is a good dielectric with resistivity of 10^{14} Ω /cm and dielectric strength of 250 V/mil.

CIRCLE NO. 373

Get CUSTOM MOS in any quantity

7
YEARS
OF SUPPLYING QUALITY PRODUCTS

ALL APPLICATIONS

★ Industrial ★ Commercial ★ Consumer ★ Military

FOR IMMEDIATE ACTION, CALL 516-293-3850

LSI computer systems, inc. • 22 Cain Drive, Plainview, N.Y. 11803

CIRCLE NUMBER 117

Electrodeposited bellows contacts



Servometer's gold plated contact springs are actually tiny bellows with one closed end. They can be:

- Mated to diode packages ● Used in blind connections ● Leak tested for use in instruments ● Used to protect fragile crystals from probe damage ● Used to absorb vibration, temperature expansion, or tolerance build-ups.

Available in nine sizes, .037" to 0.245" OD and varying contact pressures from .02 to .3 oz./,001 in. Special designs can be made to your specifications or standard items can be modified.

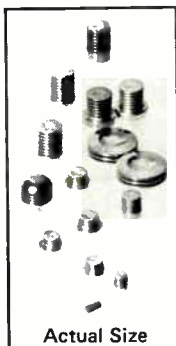

Actual Size

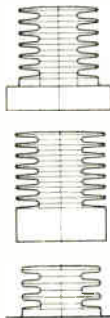

FREE SAMPLE and DESIGN CATALOG write:
Servometer Corporation
501 Little Falls Road
Cedar Grove, New Jersey 07009
(201) 785-4630

MINIATURE METAL BELLOWS
SERVOMETER

CIRCLE NUMBER 118

ELECTRONIC DESIGN 4, February 16, 1976

WorldRadioHistory

NEW PANDUIT® FLAT CABLE MOUNT

Economical, versatile method of mounting or bundling flat cable

- Secures stacked cables, folds and breakouts
- Maintains flat cable's inherently uniform transmission characteristics
- Mount to any surface using screws or commercial adhesive
- Low profile
- Removable and reusable
- Stacking up to 5¼" high; cable widths to 3"

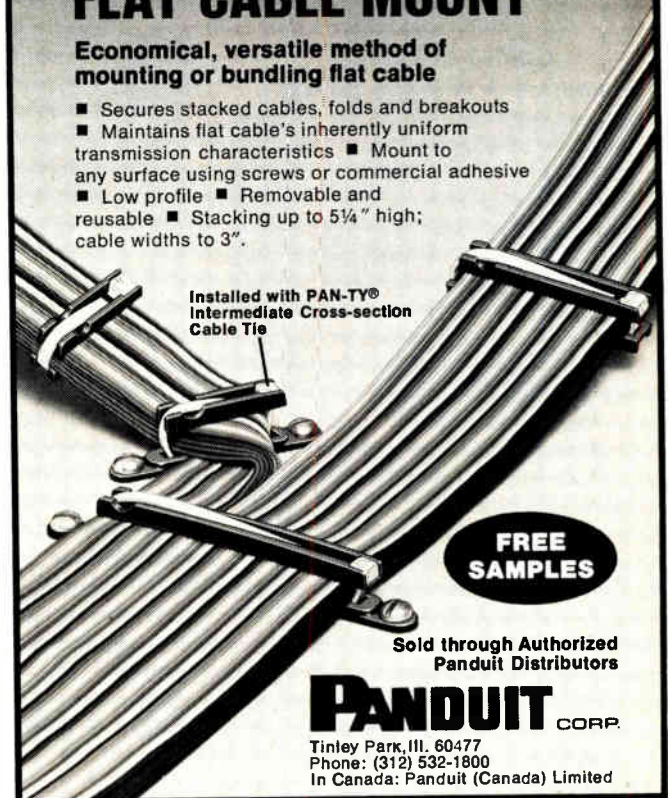

FREE SAMPLES

Sold through Authorized Panduit Distributors

PANDUIT CORP.

Tinley Park, Ill. 60477
Phone: (312) 532-1800
In Canada: Panduit (Canada) Limited

Visit PANDUIT at NEPCON WEST, Booth No. 4063

CIRCLE NUMBER 119

211

**GET PRODUCT DATA FAST
BE AHEAD OF COMPETITION**

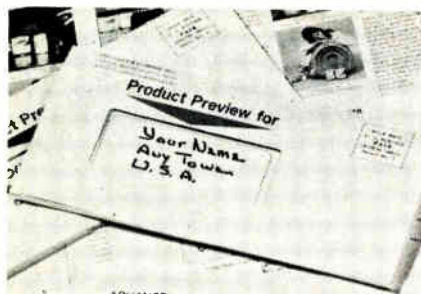

"Product Preview", Emerson & Cuming, Inc.'s free news publication is rushed each month to more than 35,000 eager readers. Tells what's new in plastics/ceramics for electronics; makes profitable reading for design & production engineers & managers.

CIRCLE NUMBER 285

**MICROWAVE PRODUCTS
SHORT-FORM CATALOG**

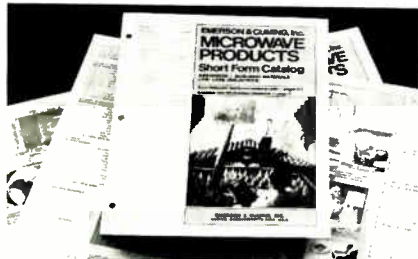

Presents a wide selection of materials, components and facilities of special significance to the microwave industry: high-performance microwave absorbers; EMI/RFI gaskets and shielding materials; radar reflectors and lenses; anechoic and shielded chambers; and more.

CIRCLE NUMBER 286

**CRYSTAL CLEAR
EPOXY CASTING RESIN**



Several transparent Stycast® resins are offered for making display embeddings or castings. A convenient chart is available to aid in selection of the most appropriate system. It is yours for the asking.

CIRCLE NUMBER 287

Emerson & Cuming, Inc.



**CANTON, MASS.
GARDENA, CALIF.
NORTHBROOK, ILL.**
Sales Offices
in Principal Cities

EMERSON & CUMING EUROPE N.V., Oevel, Belgium

PACKAGING & MATERIALS

**E-beam welder has
life increase of 30 times**

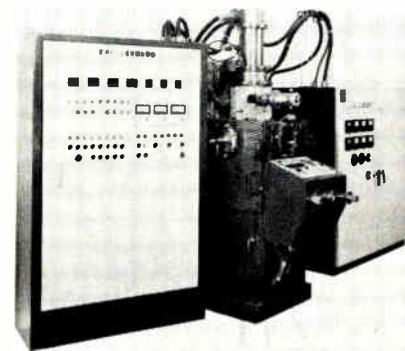

*Matsushita Electric Industrial Co.,
Kadoma, Osaka 571, Japan.*

A high-performance electron beam welding machine features a long-life electron beam gun (approx. 260 hours). The gun has an estimated useful life 30 times as long as the conventional gun. The new gun uses a large diameter (5-mm) cathode, which is uniformly heated by a bombard gun. The electron beam has a power output of 0 to 2.5 kW, a maximum acceleration voltage of 50 kV and a current of 50 mA.

CIRCLE NO. 374

**Epoxy encapsulant
allows heat to escape**

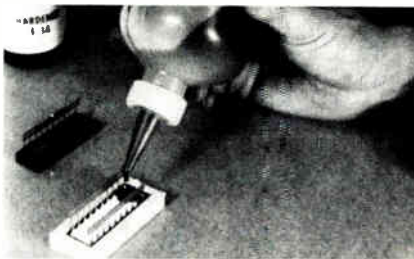

*Castall Inc., Weymouth Industrial
Park, East Weymouth, MA 02189.
(617) 337-6075. See text.*

Type 301AD low-viscosity epoxy encapsulant has high fluidity and good air release. Its thermal conductivity of 31 cal/sec/cm²/°C/cm × 10⁻⁴, dielectric constant at 25 C and 100 kHz of 5.6, and dimensional stability over a wide temperature range make the material particularly useful for encapsulating electronic circuitry. The epoxy is available in quarts, gallons and handy one-use, pre-measured Cast-Paks, and is priced at about \$32.70/gallon plus hardener.

CIRCLE NO. 375

**High density DIP boards
have 3 voltage planes**

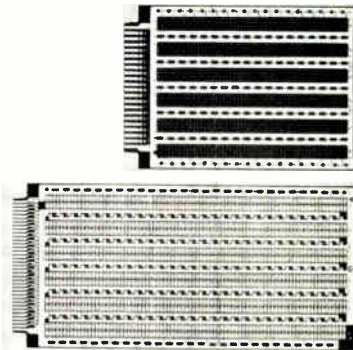

*Vero Electronics, 171 Bridge Rd.,
Hauppauge, NY 11787. (516) 234-
0400. Under \$11 (4.5 × 6.5 in.);
stock.*

A series of high-density DIP boards has three separate planes on a standard double-sided board. The wiring side contains two voltage planes, and the component side contains a ground plane to reduce noise. All boards are made of G10FR4 epoxy glass. Three board sizes are available: 4.5 × 6.5 in. with 22/22 connector contacts on 0.156 centers; 4.5 × 9.6 in. and 4.5 × 6.5 in. with 36/36 contacts on 0.1 in. centers. The 4.5 × 6.5 in. versions will accept a maximum of 34, 14 or 16 pin DIPs.

CIRCLE NO. 376

**Right angle connector
exceeds MIL-C-39012**



*Connecting Devices, 125 Lomita
Ave., El Segundo, CA 90245. (213)
772-6341. Approx. \$25; less than
30 day.*

A precision TNC radius connector is available with a right angle bend. The connector is made from cast stainless steel and exceeds the specification requirements of MIL-C-39012. The center conductor of the connector is beryllium copper and the connector can be supplied with a passivated or plated finish.

CIRCLE NO. 377

*The inside story
on a 42¢* 3/8"
single-turn trimmer.*

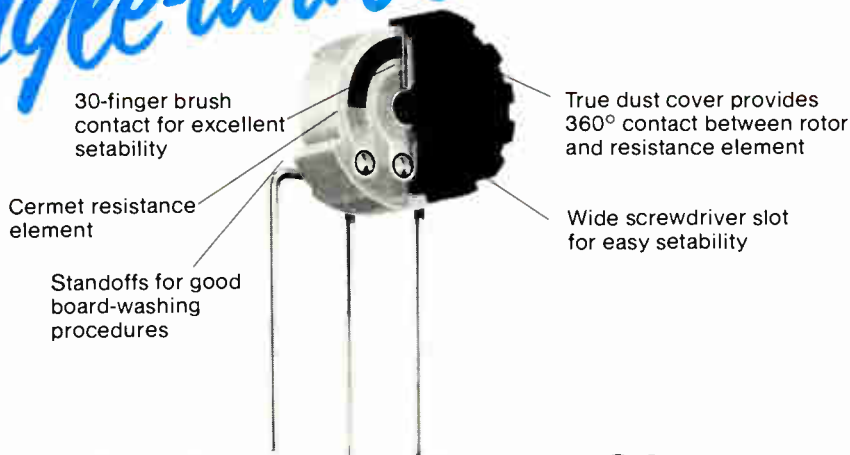

The Beckman Model 91

Take a close look at these features:

- Standoffs on all models
- Unique brush contact design
- True dust cover
- Top or side adjust
- 12 pin configurations
- 10 ohms to 2 megohms resistance range
- Low contact resistance variation: 3 ohms or 2% of terminal resistance, whichever is greater
- 100ppm/°C tempco

Immediate delivery from your local Beckman distributor. Backed by factory stock.

*42¢ each in 1,000-piece quantity.

Call your nearest Beckman Helipot distributor today or (714) 871-4848, extension 1776, for evaluation samples.

Beckman[®]

HELIPOT DIVISION

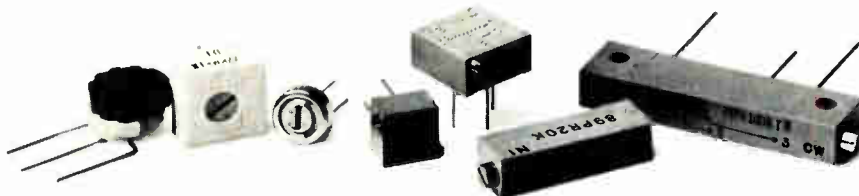

One of Beckman's Cermet Seven That Handle 95% of Your Applications.

CIRCLE NUMBER 120

New case styles!

Bezel, window and surface mounting styles are now included in the expanded line of Beede QA panel meters. There's a variety of meter styles, colors and options to give you complete design flexibility.

Now you can have the best of both... sophisticated appearance *and* high reliability when you specify Beede panel meters. Select from three styles in 1½", 2½", 3½" and 4½" cases. Meter movements available are shielded bar taut-band, Mag B taut-band or pivot-and-jewel, and AC iron vane. Wide choice of options including multi-colored scales, special resistances, different calibration points, tracking accuracies to ±½% and many more.

Each meter has the smart, clean design look. And behind the handsome face of the QA case is the reliable, ruggedized Beede meter you can depend on for long, trouble-free service. Think of Beede as your prime source of reliable, accurate, contemporary-styled panel meters at economical prices.

Write or call for complete information on Beede panel meters, meter relays and pyrometers in the QA case line.

Beede QA panel meters.
Where appearance is as important as reliability.



BEEDE
 BEEDE ELECTRICAL INSTRUMENT CO., INC.
 Penacook, New Hampshire 03301
 (603) 753-6362

CIRCLE NUMBER 121

PACKAGING & MATERIALS

Flat cable splitter handles 2.5-in. cables

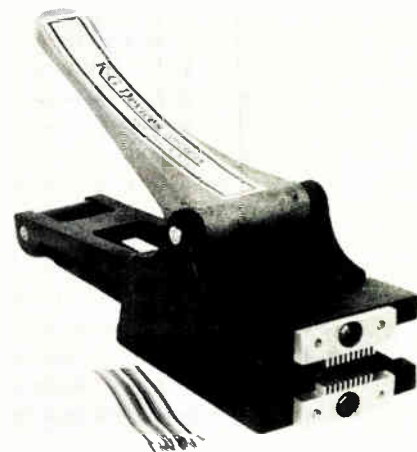

K-G Devices, Box 81, Dewitt, NY 13214. (315) 683-5666. \$185; \$35 (additional set of jaws); 30 day.

The Model 1250S flat cable splitter and separator processes flat ribbon cable in one simple operation. The unit handles cables with a maximum width of 2.5 in. and a minimum wire size of AWG 30. Mixed wire sizes or special spacings are possible and splitting is adjustable from 0 to 1 in. from the end of the cable. The machine has interchangeable jaws and is suited for hand or bench operation.

CIRCLE NO. 378

Component insertion unit handles 20 types

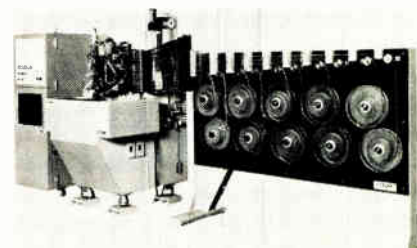

TDK Electronics, 14-6 2-Chome, Uchikanda, Chiyoda-Ku, Tokyo 101, Japan.

An automatic component insertion machine, called Avi-Sert, can insert radial lead components without preforming the leads. Avi-Sert can handle up to 20 types of components, inserts them at a 1 pc/s rate and can position components on a 500-mm × 350-mm PC board. The machine measures 1.3 × 1.4 × 1.8 m and its controller 1.2 × 0.45 × 0.48 m.

CIRCLE NO. 379

NEW BENCHTOP POWER ...FROM \$99



SEPARATE METERS FOR VOLTAGE AND CURRENT

These reliable, yet low-cost power supplies have the performance and features ideally suited for circuit development, component evaluation and other laboratory applications. Line and load regulation, $\pm 0.01\%$ or 2 mv. Ripple, 0.25 mv rms. All models have coarse and fine output voltage controls, and adjustable current limiting. Models K7S200 and K7S500 also have adjustable overvoltage protection. Dual and triple output models also available. Shipment from stock. Write for brochure.

OUTPUT VOLTAGE RANGE	OUTPUT CURRENT AMPS.	PRICE	MODEL
0-7	1.0	\$99	K7S100
0-7	2.0	135	K7S200
0-7	5.0	190	K7S500
0-18	0.6	99	K18S60
0-18	1.0	120	K18S100
0-32	0.35	99	K32S35
0-32	0.6	120	K32S60
0-50	0.35	120	K50S35



Corp., Easton, Pa. 18042. Telephone: (215) 258-5441.

CIRCLE NUMBER 122

**Now we can
tell three
million
more people
that you're
a good guy.
(If you are)**

With your help we can tell millions more next year.

At your Better Business Bureau, we're doing more than ever to encourage good relations between you and consumers.

Our capacity to handle phone calls has increased by over three million a year. So we can tell three million more consumers about a company's reputation or help them when they call with complaints.

That's three million more consumers who will have a better chance of getting their money's worth. And a better opinion of business. Because business itself is the force behind the Better Business Bureau.

If we can keep growing like this, we'll be able to increase our service by three million more next year. But our growth is more than telephone calls.

We've expanded our consumer education programs.

We've established eighty arbitration panels across the country.

We've started to computerize.

And we have a public service advertising campaign to tell millions of Americans that the Better Business Bureau is their place to "speak up" to get their money's worth.

The more we grow, the more we can let consumers know that we—and you—care about them.

Would you like to help? To learn how, write the Council of Better Business Bureaus, 845 Third Avenue, New York, New York 10022.

**Council of
Better
Business
Bureaus**



PACKAGING & MATERIALS

Concentrated flame jets remove defective chips



Semiconductor Equipment Corp., 1520 Lawrence Dr., Newbury Park, CA 91320. (805) 498-6727. \$1400; 2 to 4 wk.

Reject epoxy bonded devices can be removed from hybrid circuits with the Model 4400 Hot Shot. The machine uses a nitrogen hot gas jet with temperatures adjustable to 800 C. The jet is concentrated in a small area and thus allows a reject device to be removed without the heat affecting nearby good units. A heated substrate-holder is provided to eliminate the thermal shock of the hot gas jet and prevent substrate cracking. The machine weighs only 8 lb and measures 8 × 8 × 12 in.

CIRCLE NO. 380

Electric wastebasket shreds classified papers

Mountain West Alarm Supply, 4215 N. 16th St., Phoenix, AZ 85016. (602) 263-8831. \$195; stock.

The E9 electric wastebasket can shred your papers, correspondence, memos, estimates, bids, etc., to prevent any accidental disclosure of information. The shredder starts and stops automatically—just place the paper into the opening. Papers, up to four sheets at a time, are shredded into unreadable strips 0.125-in. wide. The electric wastebasket plugs into any 110-V outlet and has a separate spring-door storage compartment for ordinary waste, which need not be shredded.

CIRCLE NO. 381

Direct etch circuit patterns resist etchant

Theta, P.O. Box 10, Martock, Somerset TA12 6LT, England. See text.

Specially formulated vinyl adhesive circuit patterns permit prototype production of printed-circuit boards. Symbols can be placed directly onto the copper board and used as a resist in acid etching baths. A wide range of symbols and interconnecting tracks is available. The symbols are supplied in packages of five 100 × 100-mm sheets and cost £0.90 per pack. A special "Starter Pack" of 10 sheets of assorted symbols and track is also available for £1.80. These prices do not include postage or VAT. The symbols are also available to ×2 format for 2:1 ratio positive screen masters.

CIRCLE NO. 382

IC probe cards handle up to 100 probes



Probe-Rite, 2725 Lafayette St., Santa Clara, CA 95050. (408) 249-1255. See text; stock.

The P100 series of probe cards can hold 100 probe points. The cards are made from FR4 white-graded thickness laminate, include a die stepping plate, serialization plate, 100% lead programming, proprietary "Little Prune" tungsten probes and trace-to-trace leakage protection. The P100-I can accept 100 probes, of which 70 can be wired to the edgeboard connector, the P100-II also accepts 100 probes, but has a 110-pin edgeboard connector, the P100-III replaces the 60-pin, round, high-frequency probe card with the 100 probe capability and the P100-IV, designed for hybrid probing, has a 110-pin edgeboard connector. Pricing depends upon the number of probes and options but is typically \$200 to \$300.

CIRCLE NO. 383

FREE CARD FRAME DESIGNS

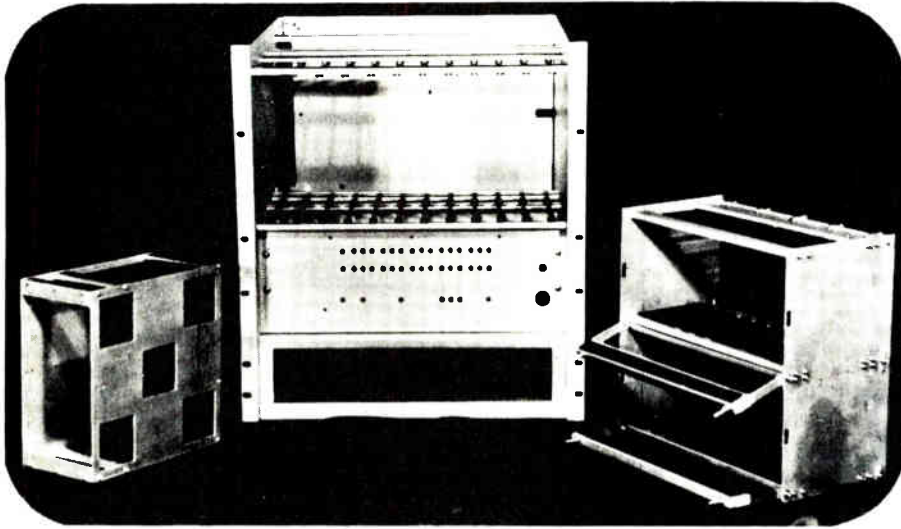

We make your job easier...

Call or write today for more information:

vero

Vero Electronics, Inc.

171 Bridge Road, Hauppauge, N.Y. 11787

Tel.: 516-234-0400 800-645-5110

In Canada Call: EPS, 613-549-5152

Let us design card frames to meet your packaging requirements.

Call and tell us what your needs are and we'll do the rest . . . at no cost to you!

VERO has a complete design and fabrication capability to meet all of your packaging needs.

Our fused quartz makes great tubes, tanks and trays.

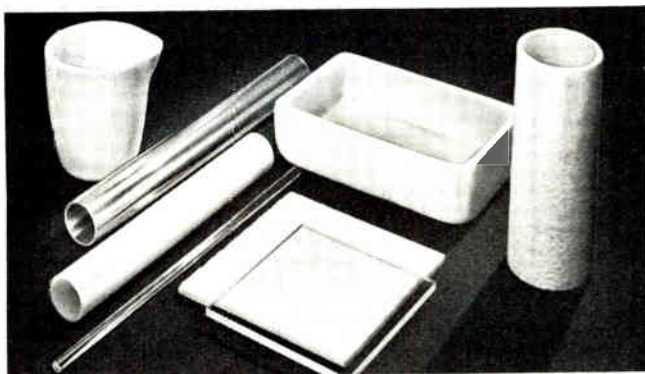

We offer a variety of high quality fused quartz products for high temperature, high purity applications in industry. Tubes, rods, tanks, pipes crucibles, etc. Transparent, translucent, or opaque. Both off-the-shelf and custom-designed. All for prompt delivery. Find out all about it. Call or write today.

Thermal American Fused Quartz Company

Route 202 and Change Bridge Road
Montville, NJ 07045 • (201) 334-7770

CIRCLE NUMBER 129

ELECTRONIC DESIGN 4, February 16, 1976

CONCORDE NEEDED THE FINEST ...THEY CHOSE JANCO!

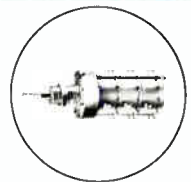
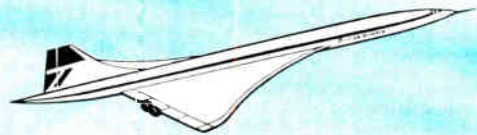

JANCO ROTARY SWITCHES

The reliability, performance, and long life of Janco Rotary Switches has been demonstrated over and over again since 1947. Today, as Janco continues to extend the frontiers of its technology around the world and beyond... we are prepared to offer a down-to-earth solution to your switching problem, too!

Janco
CORPORATION

3111 Winona Ave., Burbank, California 91504
Phone 213-845-7473 • TWX 910-498-2701

CIRCLE NUMBER 130

MONOLITHIC CRYSTAL FILTERS



SPEAKING TO THE DEAF

Our monolithics find their way into some fascinating and unusual applications. For instance — a narrow-band FM system which allows children with severely impaired hearing to participate in normal classroom activities. One of the requirements of the system was that both the students' receivers and the teacher's transmitter allow unhindered movement by the wearer. Another was freedom from interference, including interference from other systems in nearby classrooms. Cost was also an important factor. One of our standard 10.7 MHz tandem monolithic crystal filters in each receiver takes care of the interference. Its size is consistent with the needs of the wearer. Its cost is consistent with educational budgets.

HAVE IT YOUR WAY

As regular readers of this column know by now, we offer the broadest line going of standard monolithic crystal filters. It may be worth mentioning that we're just as interested in helping you with a custom monolithic as we are in showing you new ways to use our regular models. We've done hundreds of production "specials" from 5 to 180 MHz. May we do one for you?

What's your production application? Talk with us about it. We may be able to help. And if your interests include teaching the deaf, we'd be happy to put you in touch with the manufacturer of this equipment.

Pi

Piezo Technology Inc.

2400 Diversified Way Orlando, Florida 32804
305-425-1574

The Standard in monolithic crystal filters.

CIRCLE NUMBER 131

DATA PROCESSING

Cassette cleans, demags tape head in single pass

Robins Industries Corp., 75 Austin Blvd., Commack, NY 11725. (516) 543-5200. \$6.50 (unit qty).

A new cordless tape-head demagnetizer and cleaner, R36008, for cassette-tape recorder/players comes in cassette form. Insert the cassette into the tape machine and run it through until the tape stops to clean the tape head and simultaneously demagnetizes it. A non-abrasive head-cleaning tape polishes and cleans, and a rotating circular permanent magnet within the cassette produces a magnetic field that demagnetizes the tape head.

CIRCLE NO. 384

Programmer stores data on standard cassettes



Data Test Corp., 2450 Whitman Rd., Concord, CA 94518. (415) 689-3583. \$5545 (unit qty); 30 to 60 days.

A read/write program-development station, Model 8010, operates without auxiliary computer equipment or software. Features include: a low-cost cassette tape for bulk storage of test programs; an on-line, high-speed memory; full keyboard facilities for program entry, modification and unit control; and complete parity check on all data transmissions. The unit provides a standard 1 k × 16-bit memory, and it is expandable to 4-k words. A simple test language requires minimum programming skills. Standard audio cassettes allow verbal instruction and provide low-cost operation for transmission, storage and copying of test programs. Tolerant of speed changes, the tone system used will quickly and easily transmit through standard telephone lines, according to the company. Internal logic accepts data from serial or parallel input devices.

CIRCLE NO. 385

Control unit interfaces plotter and computer

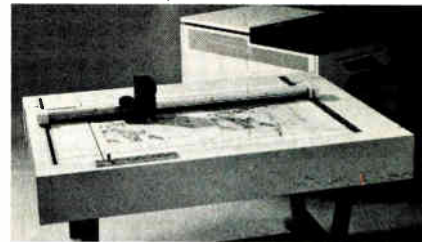

Broomall Industries, Inc., 682 Parkway, Broomall, PA 19008. (215) 353-4610. \$7500; 90 to 120 days.

A plotter control unit puts the 930 Series Flatbed Dataplotter under the control of IBM System 360 or 370 operating in either a burst or multiplex mode. Designated Model 430/560, the control unit operates either with or without an optional core buffer memory expansion. The memory expansion, which consists of two 1024-character core buffers, provides interleaved operation to allow the dataplotter to read from one buffer unit while the computer I/O channel writes into the other.

CIRCLE NO. 386

Cassette tape drive features variable speed

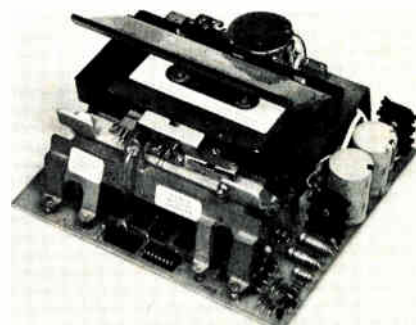

Triple I, a Div. of the Economy Co., 1901 N. Walnut, P.O. Box 25308, Oklahoma City, OK 73125. (405) 528-8444. Under \$100 (unit qty).

A line of cassette tape transports, designated Phi-Deck, features variable speed (0.4 to 10 ips), four motor control, remote control, fast start/stop, less than 30-s rewind and ac or battery operation. Power requirements are only 7 V dc at 600 mA, average. Options such as EOT/BOT sensing, record/play, read/write, electronics, cassette in-place sensing and others are available.

CIRCLE NO. 387

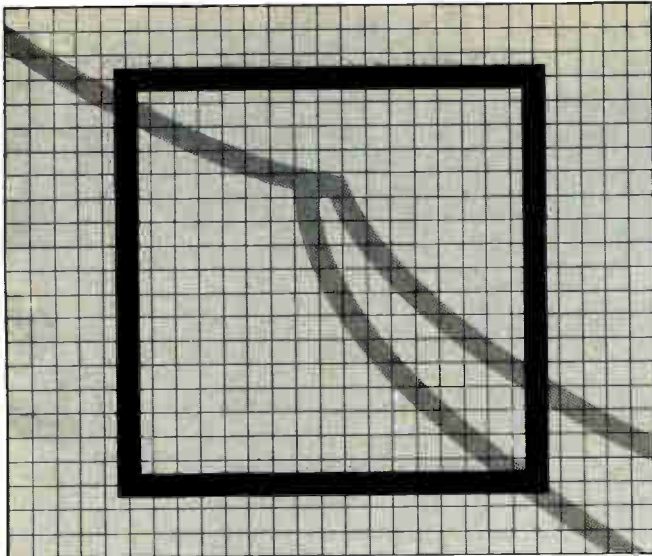

New From Micro Devices A Unique Slow-Blow Current Limiter.

It's the new MICROTEMP 5P Series MultiProtector. A versatile, yet extremely accurate slow-blow current limiter that lets you design-in protection for a specific current requirement within a precise time and current window.

No other commercially available slow-blow fuse even comes close to matching the 5P's ability to handle high current surges without being derated.

5P's unique opening mechanism design guarantees life time rating stability and excellent surge absorption. Conventional slow-blow fuses operate through a metallic, current carrying element making them extremely susceptible to surging and derating. Thanks to its patented non-current carrying temperature sensitive opening mechanism, the MICROTEMP® thermal cutoff reacts only when current put through the heater element generates temperatures capable of

triggering the exclusive pellet-type opening mechanism.

When properly applied, 5P will not nuisance trip reducing costly and annoying "in warranty" service calls.

Here's more:

- current values — 600 milliamps to 3.25 amps.
- ambient temperature range—25 to 100° C.
- can be designed to withstand surges up to 100 amps for 30 milliseconds
- operates within 130% of rated current

Recognized under the Component Program of Underwriters' Laboratories, Inc. UL File #E591B7.



For more information, check the reader service card, or call or write:



MICRO DEVICES CORP.

1881 Southtown Blvd., Dayton, Ohio 45439
Ph: (513) 294-0581 Telex: 28-8087

Penril Modems offer the OEM and End User advantages in . . .

CUSTOM DESIGN

Our facilities and capabilities enable us to provide both OEM and End Users with low, medium and high-speed modems tailored to meet their specific system requirements and cost objectives.

RELIABILITY

Our modems use hermetically sealed semiconductors and ceramic integrated circuits exclusively. Vibration, burn-in, and complete electrical and mechanical testing is performed on every unit prior to shipment. Perhaps these are the reasons our modems are experiencing MTBF's ranging from 35,000 hours to 200,000 hours.

DIAGNOSTICS

No special tools or equipment are required to install, operate or maintain our modems. Built-in diagnostics obviate the need for test equipment and minimize the time and labor involved in performing system fault isolation. Many of our units feature a unique telemetric test capability whereby non-technical personnel can test the entire link and isolate faults therein all from one site.

PERFORMANCE

The bit error rate probability of our modems is 1×10^{-6} or better over leased lines or the dial network. Our units are virtually unaffected by the major line impairments affecting data transmission.

AND MUCH MUCH MORE

If you'd like to know more of what Penril modems have to offer, ask for our modem brochure, or let us know of your specific requirements.

Penril
Corp. 
Data
Communications
Division

5520 Randolph Road • Rockville, Maryland 20852
301/881-8151

DATA PROCESSING

Loop-current regulator covers wide variations

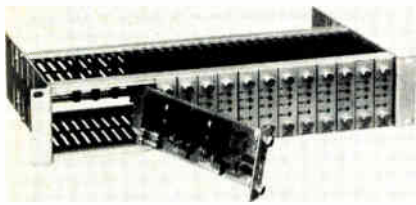

Dataprobe Inc., 290th Huyler St., Hackensack, NJ 07606. (201) 489-5588. \$60 (25 up); stock.

A dual loop-current regulator module, Model 2-LCR-150A, for data-communications can control loop currents over wide variations in loop resistance and battery voltage. Each module contains two independent regulators that are adjustable from 13 to 75 mA over a voltage range of from 15 to 150 V, polar or neutral. LED indicators display circuit conditions. Maximum power dissipation is 8.5 W at 55 C. Sixteen modules (32 circuits) may be housed in a rack-mounted enclosure available from Dataprobe.

CIRCLE NO. 388

Terminal offered with editing option



Ann Arbor Terminals Inc., 6107 Jackson Rd., Ann Arbor, MI 48103. (313) 769-0926. \$1795 (unit qty); 90 days.

A major feature of the new Edit-Option K2480 terminal is the ability to insert or delete not only a complete line of text, but also a line fragment from cursor position to end of line. This characteristic allows more rapid text editing with a minimum of keystrokes. A text wrap-around feature allows the operator to open the text at any point and insert an arbitrary amount of additional data. A 79-key, alphanumeric keyboard is supplied. Keyboard codes are uppercase ASCII with 7-bit-parallel TTL input.

CIRCLE NO. 389

Voice annunciator uses digitized speech



Federal Screw Works, 500 Stephenson Hwy., Suite 102, Troy, MI 48084. (313) 588-2050. \$975: 10-word unit (unit qty); 60 to 90 days.

The Votrax LV-50 voice annunciator uses digitally stored human speech made up of a customer designated vocabulary in any language. Users specify the vocabulary by submitting a tape recording. Reproduction is natural, so actual speaker identification is possible. The basic unit is available with one-to-16 words with a word duration of 0.66 s each, and the unit can contain a total message length of 10.56 s. Multiple units may be clustered to produce a voice annunciator system with as many words as desired.

CIRCLE NO. 390

REED RELAYS TO FIT YOUR SPECS... AND BUDGET

Our **Open-Line** reed relays will give you high performance at remarkably low cost if you have no critical environmental factors to worry about.

Our **Encased-Line** is epoxy sealed to meet extreme environmental and handling conditions.

Both offer top performance; choice of Form A, B, or C dry reed contacts; Form A mercury wetted reed contacts; up to 6 poles; coil voltages 5 to 48 Vdc; either .1" or .15" terminal spacing; optional electrostatic or magnetic shielding.

Available from distributors. Or contact us today.

26477 North Golden Valley Road • Saugus, Calif. 91350
(805) 252-8330 • (213) 788-7292 • TWX 910-336-1556

ELEC-TROL, INC.

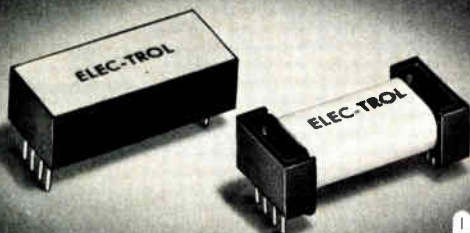

eem

CIRCLE NUMBER 134

SOLID STATE RELAYS WITH SOMETHING EXTRA

From Elec-Trol, a complete line of 3 to 45 Amp, 120 to 480 VAC output, AC or DC input Solid State Relays and custom designs to meet your needs. All feature: **Zero Crossover Switching** to eliminate RF noise and load current or voltage surges. **Photo Isolation between Input & Output.** **Input Current Limiter** on all DC models prevents relay closure by input transients & increases LED life. **Built-in Snubber Network in Output** prevents uncontrolled operation due to load-line transients. **IC Compatibility and Reverse Polarity Protection** on all DC models. Call or write for complete information today.

26477 N. Golden Valley Road • Saugus, Calif. 91350
(805) 252-8330 • (213) 788-7292 • TWX 910-336-1556

ELEC-TROL, INC.

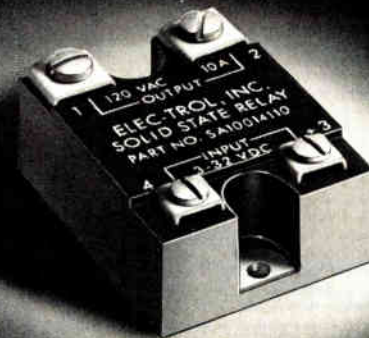

CIRCLE NUMBER 135

ELECTRONIC DESIGN 4, February 16, 1976

Tape copier writes header labels

Recortec, 777 Palomar Ave., Sunnyvale, CA 94086. (408) 735-8821. \$24,750; 90 days.

Recortec's computer-tape copier is used for writing ANSI standard header labels on 1600 bpi magnetic tapes. The equipment is designed for use off-line by semi-skilled personnel and can be easily incorporated as a tape-library function. Also, the unit can perform four other off-line tasks, which are of value to the large, tape-oriented, data-processing facility: copy and verify any 1600 bpi tape; clean and verify 1600 bpi data tapes from archival files or from outside tape sources; clean and evaluate new or scratched tapes; and clean and rewind tapes with or without data.

CIRCLE NO. 391

See the Microprocessor Design section for microprocessors and related products.

'Universal' interface for serial/parallel data

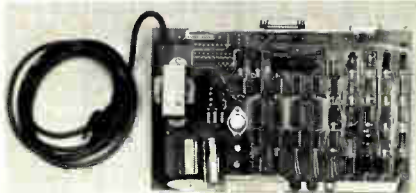

Victor Associates, 1400 Worcester Rd., Framingham, MA 01701. (617) 879-5710. \$500 to \$1100; 6 wks.

Serial data interface, Model VAI 101, can receive serial information over communication lines and directly store the information or transmit it serially on or off-line. The unit interfaces serial data sources with papertape punches or compatible parallel-data storage equipment, and also between paper tape readers or compatible parallel-stored data transmission equipment and serial-data receivers. Transmission rates are 110, 150, 300, 1200, 2400, 4800 and 9600 baud for incremental tape readers. Receive rates are 110, 300, 600 and 1200 baud for tape punches. An internal clock allows individually selectable rates for receive and transmit.

CIRCLE NO. 392



MINIATURE PRECISION MOTORS

featuring

economy simplicity
volume production
low power input
efficient



integral gear reduction
extremely fast response

For more information and application data send for HSI catalog on Precision Motors.



HAYDON SWITCH & INSTRUMENT, INC.
1500 Meriden Road, Waterbury, Conn. 06705
(203) 756-7441

CIRCLE NUMBER 136

THE SOURCE FOR POWER SUPPLIES!

New 66 page Technipower design data catalog #731.

YOURS FREE!



Technipower presents the widest range of commercial, industrial, and mil-qualified power supplies ever compiled - all backed by a comprehensive 5-year warranty.

Complete engineering specifications are provided. Special sections are devoted to extensive thermal data tables, a glossary of the new NEMA terminology, a metric guide, and other technical information.

Write or call today for your free copy.

TECHNIPOWER, INC.
A BENRUS DIVISION

Benrus Center, Ridgefield, Connecticut 06877
Telephone (203) 431-1300 • TWX 710-467-0666

CIRCLE NUMBER 137

Electronic Design

FREE SUBSCRIPTION APPLICATION

Do you wish to receive (continue to receive) ELECTRONIC DESIGN?

Yes No

Date: _____
Signature: Does not obligate me or my company

Subscriptions cannot be entered without complete qualifying information.

FOR CHANGE OF ADDRESS . . .
Attach Old Address Label to Insure
Uninterrupted Service.

Area Code _____ Office Telephone _____

FIRST MIDDLE
INITIAL INITIAL LAST NAME

TITLE

COMPANY NAME IN FULL														
DIVISION/DEPARTMENT/MAIL STOP														
STREET ADDRESS														
CITY										STATE		ZIP CODE		

This questionnaire conforms to the guide lines of the Business Publications Audit of Circulation for eliciting comparable data. The publisher reserves the right to serve only those individuals who qualify for a free subscription. **ELECTRONIC DESIGN is sent free to qualified engineers and engineering managers doing design work, supervising design or setting the standards in the UNITED STATES and WESTERN EUROPE only.**

1 Title: (Insert letter)

A President	J Project Engineer
B Vice President	K Senior Engineer
C Vice President of Engineering	L Group Leader
D Technical Director	M Dept. Head
E Chief Engineer	N MTS
F Principal Engineer	O Engineer
G Research Director	P Consultant
H Section Head	R Scientist
	S Physicist

2 Your principal job function: (Insert code)

- General and Corporate Management
- Design and Development Engineering (circuits, components, equipment systems)
- Engineering Services (evaluation, quality control, reliability, standards, test)
- Basic Research
- Manufacturing and Production
- Engineering Assistants (draftsman, lab assistant, technician)
- Purchasing and Procurement
- Marketing including Sales
- Other Personnel (explain)

3 Plant Your own work

The primary end product (or service performed) at your plant, and the product (or service) that is your own work. (Insert code in each box even if the same)

A Large Computers	A Large Computers
B Mini-Computers	B Mini-Computers
C Computer Peripheral Equipment	C Computer Peripheral Equipment
D Data Processing Systems (Systems Integration)	D Data Processing Systems (Systems Integration)
T Office and Business Machines	T Office and Business Machines
E Test, Measurement and Instrumentation Equipment	E Test, Measurement and Instrumentation Equipment
F Communications Systems and Equipment	F Communications Systems and Equipment
H Navigation and Guidance Systems and Equipment	H Navigation and Guidance Systems and Equipment
J Consumer Entertainment Electronic Equipment	J Consumer Entertainment Electronic Equipment
G Consumer Electronic Appliances	G Consumer Electronic Appliances
N Other Consumer Electronics	N Other Consumer Electronics
K Industrial Controls, Systems and Equipment	K Industrial Controls, Systems and Equipment
L Components and Sub Assemblies	L Components and Sub Assemblies
M Materials and Hardware	M Materials and Hardware
Q Aircraft, Missiles, Space and Ground Support Equipment	Q Aircraft, Missiles, Space and Ground Support Equipment
P Oceanography and Support Equipment	P Oceanography and Support Equipment
R Medical Electronics	R Medical Electronics
U Industrial Companies within the OEM incorporating Electronic Equipment in their end product, not elsewhere classified	U Industrial Companies within the OEM incorporating Electronic Equipment in their end product, not elsewhere classified
V Independent Research, Test and Design Laboratory and Consultant. (Only if you are not connected with a manufacturing company.)	V Independent Research, Test and Design Laboratory and Consultant. (Only if you are not connected with a manufacturing company.)
X Government Agency and Military	X Government Agency and Military
2 Industrial Companies using and/or incorporating any Electronic products in their manufacturing, research or development activities.	2 Industrial Companies using and/or incorporating any Electronic products in their manufacturing, research or development activities.
1 Commercial Users of Electronic Equipment	1 Commercial Users of Electronic Equipment
3 Distributor	3 Distributor
4 School, University or Library	4 School, University or Library
5 Other (explain)	5 Other (explain)

4 Your design function: (Insert each letter that applies)

A I do electronic design or development engineering work
B I supervise electronic design or development engineering work
C I set standards for, or evaluate electronic design components, systems and materials

5 Your principal responsibility: (Insert code)

1 Management other than Engineering	3 Engineering
2 Engineering Management	

6 Please estimate: (Insert letter)

The number of electronic engineers at this address:
(A) 1 (B) 2-5 (C) 6-19 (D) 20-49 (E) 50-99
(F) 100-249 (G) 250-499 (H) 500-999 (J) Over 1000

7 Please write in box total number (other than self) to be served by this subscription at this address and list individuals below:

Name (Please Print)	Title

8 Products you specify or authorize purchase of: (Check all codes that apply.)

- 1 Resistors and Capacitors
- 2 Connectors
- 3 Switches and Relays
- 4 Function Modules: Op Amps, Converters, etc.
- 5 Potentiometers
- 6 Test and Measurement Equipment
- 7 Computers, Medium and Large
- 8 Electronic Power Supplies
- 9 ICs and Semiconductors
- 10 Microwave Devices
- 11 Minicomputers
- 12 Computer Peripherals
- 13 Computer Components
- 14 Cabinets and Enclosures
- 15 Panel Meters, Analog or Digital
- 16 Readout and Display Devices
- 17 Rotating Components
- 18 Cooling Products
- 19 Printed Circuits
- 20 Calculators
- 21 Indicators including LEDs
- 22 Materials, Potting and Stripping
- 23 Communications Equipment

9 Do you specify or buy through distributors?
 YES NO

10 Minicomputers at this address:

	Model	Qty.	Model	Qty.
3 Cincinnati Milacron				
C Computer Automation				
D Control Data				
E Data General				
F Digital Equipment				
I General Automation				
K Hewlett Packard				
M Honeywell				
O IBM				
N Interdata				
7 Microdata				
Modular Computer				
ROLM				
V Systems Engineering Labs				
9 Texas Instruments				
x Varian				
Other				

meet CISPR and VDE interference specifications...

If you export electronic or data processing or electrical equipment, then "CISPR/VDE" standards for RFI and EMI *must be met**

- The only test equipment that will guarantee your compliance and give full frequency coverage are the Rohde & Schwarz and Schwarzbeck Receivers, Line Impedance Stabilization Networks and Absorbing Clamps.
- You can *only* get this equipment in the USA from Rohde & Schwarz.
- Call or write for an immediate response — specifications, pricing and assistance.

*The importing authorities can reject and return equipment to the country of origin if the CISPR/VDE standards are not met.

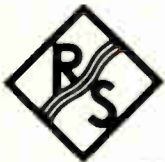

ROHDE & SCHWARZ

14 Gloria Lane, Fairfield, N.J. 07006 ■ (201) 575-0750 ■ Telex 133310

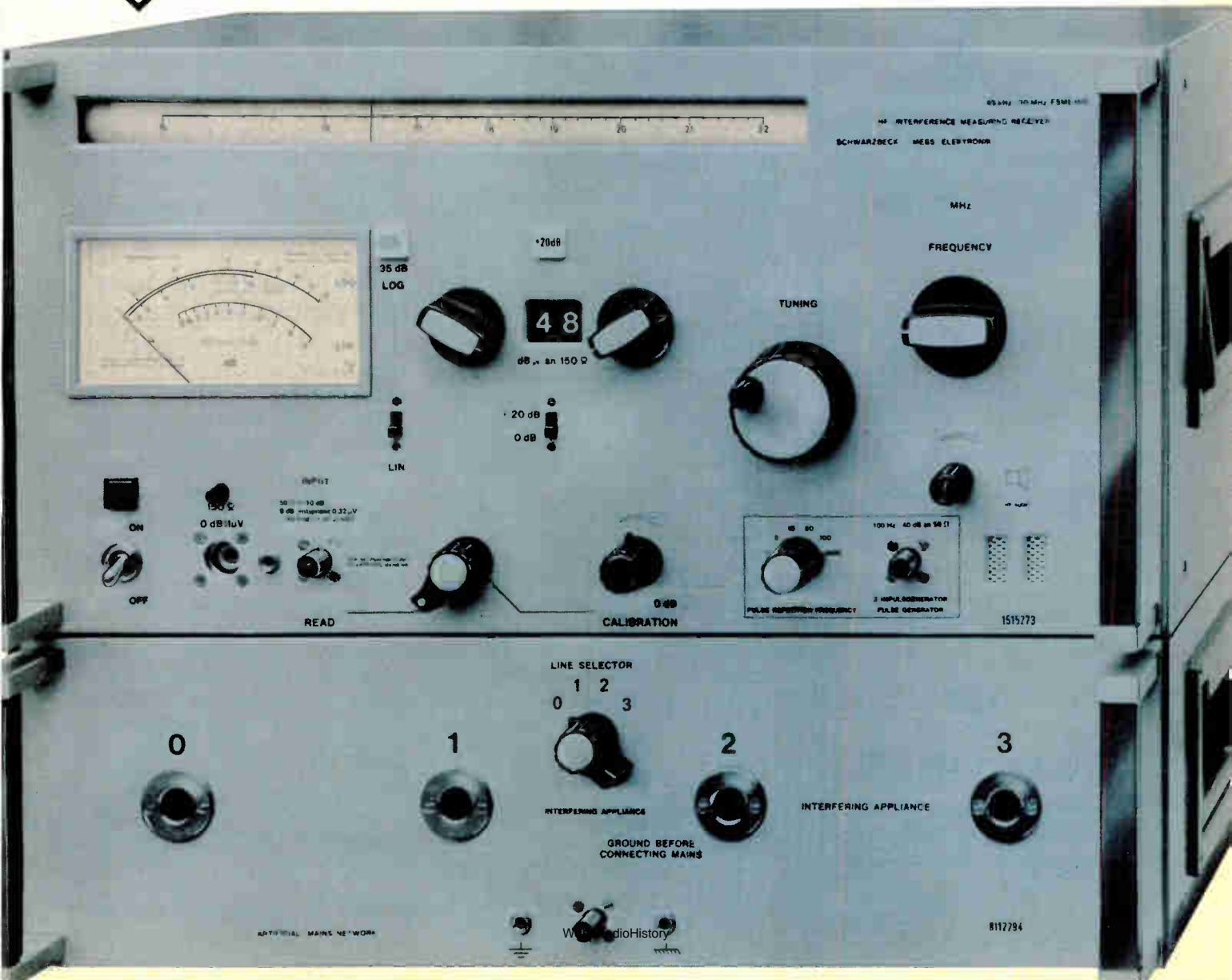

NEW and EXCLUSIVE A/D Converter

features

HIGH SPEED: 4 μ sec.
(220,000 conversions per sec.)

HIGH RESOLUTION: 15 bits

HIGH ACCURACY:
0.0065% of FSR

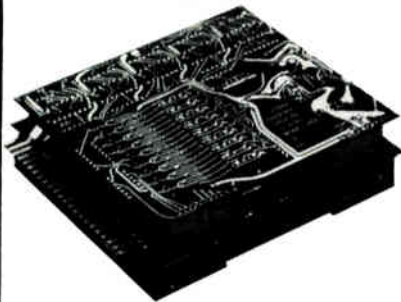

New Model ADC1215F converter from Phoenix Data is available in two basic models: Single-ended and differential.

Phoenix Data's new Model ADC1215F A/D converter has a resolution of 15 binary bits and a total conversion time of 4 microseconds (220,000 conversions per sec). Accuracy of 0.0065% of FSR is **guaranteed** in addition to complete monotonicity. Analog dynamic range is in excess of 86 db.

If it's stability, accuracy, speed, or all-around quality you need in Data Conversion, contact Phoenix Data now!



PHOENIX DATA, INC.

3384 W. Osborn Rd. Phoenix, AZ 85017
Ph. (602) 278-8528, TWX 910-951-1364

CIRCLE NUMBER 138

DATA PROCESSING

Tape preparation system operates on-or-off line

International Computer Products, Inc., 2925 Merrell Rd., Dallas, TX 75229. (214) 350-6951.

The NC-9, numerical-control tape-preparation and communication system, stores all typewritten material on punched Mylar tape, allows the correction of errors electronically and reads back the tape to produce perfect finished copy at speeds in excess of 30 char/s. The system uses the TI Silent 700 or the DecWriter II printer. The editing controls are on the keyboard. Other features include switchable ASCII/BCD/ASCII communications up to 300 baud with any time-sharing service, check-sum verifier, even/odd or no parity, electronic tap settings, automatic block numbering, four-digit-forward-and-reverse search, easy error correction, duplicating of tapes at 50 cps without printing and selective punching.

CIRCLE NO. 393

Disc drive accepts soft/hard sectored discs

Remex, 1733 Alton St., Santa Ana, CA 92705. (714) 557-6860. \$650 (unit qty); 60 days.

The new Remex RFD 7400E is a "universal" disc drive. Its standard features make it possible for the user to expand from basic IBM compatibility to enhanced performance without changing drives. The drive accepts IBM-formatted soft-sectored diskettes and 32-hole hard-sectored discs in the same unit. The addition of a sector-generator option allows the user to create his own hard-sectored format using IBM-compatible diskettes. Consequently, the unit offers data storage capacity from 1.9 to 3.2 Mbits. The unit includes its own unit select decoding circuitry. It also allows four drives to be attached to a single interface cable and be controlled by one set of drivers and receivers in the host system. Any of the drives can be addressed by a two-digit binary number.

CIRCLE NO. 394

Single board stores TV image in 4-k RAM

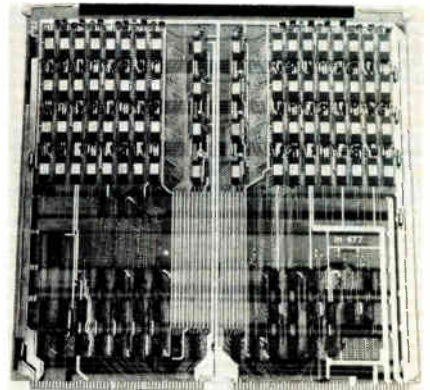

Intel Memory Systems, 1302 N. Mathilda Ave., Sunnyvale, CA 94086. (408) 734-8102. \$1725 (100 up).

A CRT display memory, the Intel in-477, stores an entire video image on a single board built with 4-k RAMs. The memory locations can be accessed both randomly and sequentially at data rates up to almost 20×10^6 b/s. This allows the in-477 to be used in special image processing applications and to refresh CRT displays of virtually any size and image format. The board is 15-in. square, operates on standard power supplies of +5, -5 and 12 V and is completely compatible with TTL. Maximum power dissipation is less than 25 W.

CIRCLE NO. 395

FPLA programmer uses many input sources

Data I/O, P.O. Box 308, 1297 N.W. Mall, Issaquah, WA 98027. (206) 455-3990.

The Model X FPLA programmer can program FPLA devices from input sources such as punched paper tape, mark sense cards, a master PLA or a parallel remote-input interface, in either machine language or ASCII-formatted data. Each FPLA manufacturer's device may be programmed by use of specific personality card sets. The Model X is designed to program up to 63 product terms of 14-to-16 input variables and eight output-term variables. A cathode-ray-tube screen visually displays the data levels and modes of operation that are taking place within the programmer. Errors are clearly displayed on the CRT screen.

CIRCLE NO. 396

bottom line bargain

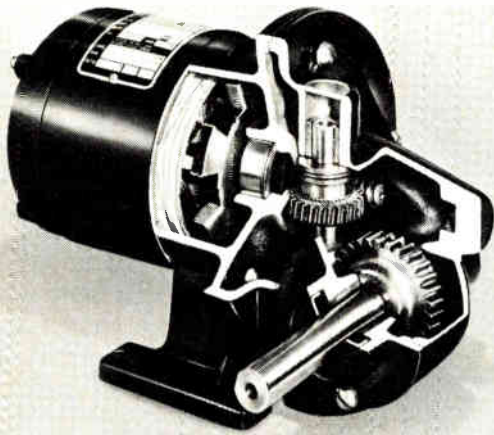

Bodine puts more into its fhp motor and drive system design to give you greater bottom line profit in the long run. We call it ADE (After Delivery Economies). You get fewer rejects from the start and less profit robbing service headaches. Motor to motor, lot to lot, Bodine's consistent quality pays big performance dividends.

If you're concerned about costs, profitability and tomorrow's repeat sales, take a close look at Bodine. You won't find a better fhp buy—1/2000 thru 1/4 Hp.

ADE (After Delivery Economies) make Bodine a better fhp buy



Bodine Electric Company, 2500 W. Bradley Place, Chicago, IL 60618.

CIRCLE NUMBER 139

KNOBS



MACHINED ALUMINUM

Alco's anodized finish protects and enhances the appearance of these totally machined aluminum knobs. 168 types from which to choose in 5 basic sizes and many styles. With 400,000 in stock at all times, we can offer genuine off-the-shelf delivery.

Call (617) 685-4371 for additional information.

MOLDED PHENOLIC

For those who insist on a better than average knob at realistic cost. Our phenolic knobs all have aluminum spin plates, brass inserts and locking set screws. We stock an inventory in excess of 350,000 which comprise 115 types in many styles and sizes.

Write for free literature, samples and pricing.



CIRCLE NUMBER 140

ELECTRONIC DESIGN 4, February 16, 1976



decittrak[®] decit

OPTICAL INCREMENTAL SHAFT ENCODER

**Low,
Low Cost ...
Rugged Industrial
Design ... Wide Ranges
Available Up To 14,400
Counts ...**

The ideal, low cost incremental encoder to digitize rotary motion for display and control...up to 14,400 counts per turn...ultra reliable LED light source...only 5VDC required for operation...Bi-directional outputs in sine wave, square wave or pulse format...heavy duty industrial design...And...if you need additional electronics or a system, you can rely on Theta. Our application engineers are ready to help.

LITERATURE:

Write for descriptive literature and your free copy of Digital Solutions to Automatic Control

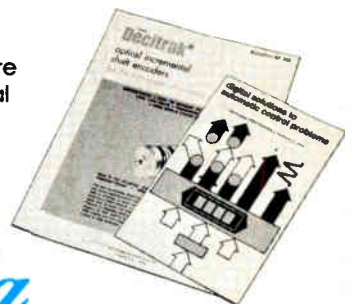

Theta

INSTRUMENT CORPORATION

Fairfield, New Jersey 07006 • Phone: 201-227-1700

CIRCLE NUMBER 142

3000

225

INSTRUMENTATION

Electronic counter fits standard cut out

Kessler-Ellis Products Co., Atlantic Highlands, NJ 07716. (201) 291-0500. \$40 (100); stock.

This miniature electronic counter/timer fits the 25 × 50-mm international panel cut out for electromechanical counters. Other features include a built-in 60-Hz divider that reads out hours, minutes and seconds; silent operation; built-in battery standby is standard; choice of three digit sizes, 0.160, 0.190 or 0.33 in.; and choice of 6, 12, 24 or 110-V-ac models, all with built-in power supply.

CIRCLE NO. 470

Compact DPM filters input signals

Non Linear Systems, P. O. Box N, Del Mar, CA 92014. (714) 755-1134. \$99; stock.

This DPM, the PM-3.5, is said to be the only panel meter with an active filter at the input for high noise rejection. Package size is only 15/16 high × 2-1/2 wide × 3-1/4 in. deep. Weight is less than 4 oz. The display consists of 0.3-in. high LEDs. Zero adjustment is not required and a scaling potentiometer permits calibration in engineering units. Available in four voltage ranges of ±1.999, ±19.99, ±199.9 and ±1200 V fs, accuracy for each is ±0.05% of fs.

CIRCLE NO. 471

3-1/2 digit DMM reads true rms

Systron-Donner, Inc., 10 Systron Dr., Concord, CA 94518. (415) 682-6161. \$295; 5 days or stock.

Model 7003 is said to be the first 3-1/2-digit DMM to include true rms ac capability and circuit-breaker current-overload protection. The unit has five complete functions, 26 ranges, 2000-count capacity, 0.4-in. 7-segment LED display and can be ordered with an internally mounted battery option. Packaging design features an unbreakable case, pushbutton controls and a pop-up stand.

CIRCLE NO. 472

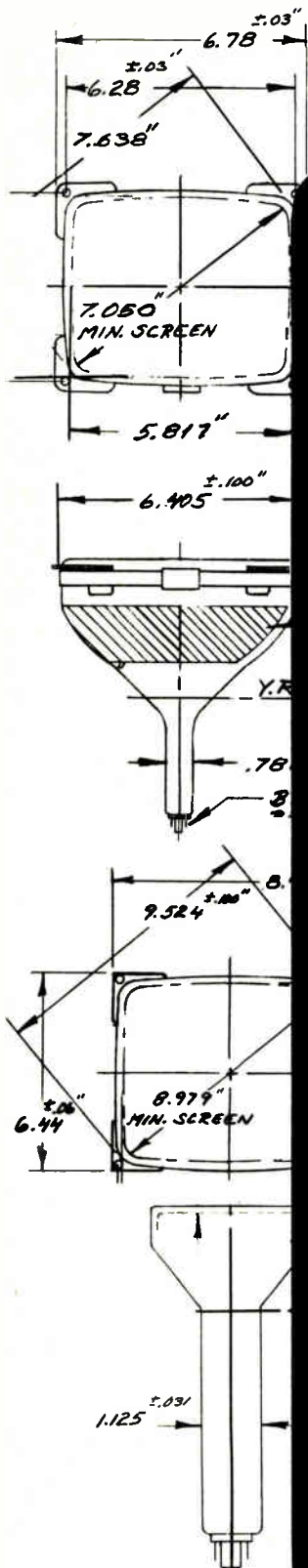

CRT ANSWERS!

Clinton has
177,649
ANSWERS
for CRT
applications.

Many of our customers are faced with unique design and engineering problems. To solve them, we have 177,649 pre-engineered CRT solutions. In addition, Clinton application engineers are experienced in developing Cathode Ray Tubes to fit your specific requirements providing high quality and optimum reliability.

From low profile, high resolution alpha-numeric displays to compact medical monitoring applications in quantities of 1 to 1,000,000, Clinton is a name you can rely on for quality, performance and personal attention.

Let us send you our brochure describing Clinton's facilities and capabilities. Contact our Sales Manager Carl Phillipps.

CLINTON...
the ANSWER people
in CRT'S.



**CLINTON
ELECTRONICS
CORPORATION**

6701 Clinton Rd., Rockford, Ill. 61111 Phone 815-633-1444 Telex 257-484

CIRCLE NUMBER 141

INSTRUMENTATION

Programmable controller is field expandable



Industrial Solid State Controls, 435 W. Philadelphia St., York, PA 17405. (717) 848-1151. Starts at \$1975.

A programmable controller, the IPC-300, can be programmed directly to provide step sequencing and skip functions in addition to relay logic, timing, counting and arithmetic operations. Either a CRT memory loader/monitor or pushbutton loader/monitor is used for programming, real-time on-line monitoring and troubleshooting. The unit is said to be the only programmable controller on the market today that can be field-expanded economically in a modular manner from eight inputs, eight outputs and 2-k solid-state memory to a combined total of 1024 inputs and outputs and either 4-k or 8-k solid-state memory.

CIRCLE NO. 397

Logic analyzer expands to 16 channels

E-H Research Laboratories, 515 11th St., Box 1289, Oakland, CA 94604. (415) 834-3030. \$1250; 60 days.

The company has added the Model 1304 four-channel plug-in module to its AMC Digiscope line of logic analyzers. The 1320 Digiscope with four 1304s is a 16-channel, 50-MHz, dual-threshold analyzer with a 16 x 100-bit video display, 5-ns glitch capture capability, and combinatorial triggering that allows the display of up to 99 words of data before or after the trigger event. The 1304 includes an improved acquisition algorithm for optimum timing resolution and selectable internal or external clocking.

CIRCLE NO. 398

★ ★ ★ Imagine, a low cost, OEM - reliable

★ ★ ★ Panel Mounting Thermal Printer ...

★ ★ ★ Better still, install it!

Mount this little 2.3LB, 7 column printer on your panel right alongside your digital panel meter or any digital instrument. The DPP-7 printer accepts BCD data directly from your TTL source (no extra electronics are needed). Only 2 moving parts are used, assuring OEM reliability. The thermal printhead does away with ink, ribbons, printwheels and hammers. Power the DPP-7 from AC or +5V.

DPP-7 Features

- 6 Digits and sign up to 3 lines/second
- Accepts full parallel BCD TTL levels
- Positive or negative true selectable inputs
- Self-cleaning thermal printing uses no ink or hammers
- \$475 (singles)

COVERED BY GSA CONTRACT NO. GS-00S-27959

Send for your FREE Brochure

1020 TURNPIKE STREET, CANTON, MASSACHUSETTS 02021 TELEPHONE (617) 828-8000
 ● SANTA ANA, CALIF. (714) 835-2751 ● SANTA ANA, CALIF. (LA EXCHANGE) (213) 933-7256
 ● SUNNY VALE, CALIF. (408) 733-2424

CIRCLE NUMBER 143

Compare and save through innovative design

DATA PRECISION®
 ...years ahead

Model 1455

Bench/Portable 4½ DMM \$355.00

Model 1455 — all the virtues of a laboratory bench instrument with the added benefits of complete portability.

A five function multimeter featuring ½" high display, 100% overranging, measures 100 μV to 1000 VDC, 100 μV to 500 VAC; resistance 100 milliohms to 20 Megohms; AC and DC current 1 microamp to 2 amps. AC response, 30 Hz to 50 kHz.

Basic accuracy on DCV is ±0.02% reading ±0.01% f.s., ±1 digit for 6 months. Internal NiCd battery module and recharger.

Model 1450 4½ Digit DMM \$325.00

The same specifications and features as the Model 1455, line operation only.



For complete information on these and other Data Precision instruments or a demonstration, contact your local Data Precision representative or Data Precision Corporation, Audubon Road, Wakefield, MA. 01880 (617) 246-1600. TELEX (0650) 949341.

CIRCLE NUMBER 144

New Low Price

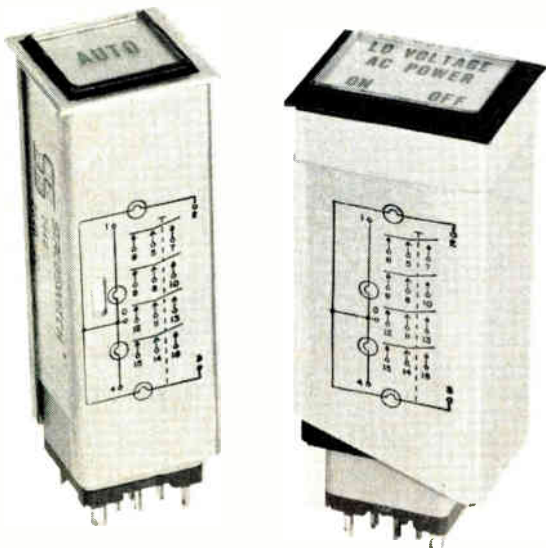

Dependable, proven, Series 2S/2R 4-lamp illuminated pushbutton switches and indicators. The price? \$8.95 for 2PDT and \$9.90 for 4PDT in 1-9 quantities. In larger quantities the price is even lower. Price includes switch and pushbutton with choice of 84 standard display options. At this price you just can't get a better deal on a dependable 4-lamp switch.

Premium grade materials used throughout. Original military design built to industrial/commercial requirements. This rugged switch is inexpensive, but it certainly is not cheap. It will give you long trouble-free service life... 50,000 plus cycle life.

The Series 2S/2R offers wide flexibility with switching capability from 10 micro-amps to 5 amps. Choice of momentary or alternate switch action. Matching 4-lamp indicator at equally low price. Designed for easy installation with relamping from front of panel without use of tools. Write today for General Catalog giving complete description and specifications. When you think switch... think Stacoswitch.

STACOSWITCH
a STACO, INC. company
1139 BAKER STREET, COSTA MESA, CALIF. 92626
(714) 549-3041 TWX: 910/595-1507

Other STACO Company products: Custom Transformers, STACO, INCORPORATED, Richmond, Indiana; Variable Transformers, STACO, INCORPORATED, Dayton, Ohio.

CIRCLE NUMBER 146

FUJI LARGE CAPACITY MEMORIES

STATIC/LOW COST-RAM

NON-ROTATING PARTS·HIGH RELIABILITY
NON-VOLATILITY·RANDOM ACCESS
HIGH DATA TRANSFER·COMPACTNESS

- 256K BYTES MODULE
- 512K BYTES MODULE
- 16K BYTES MODULE FOR MINI DRUM

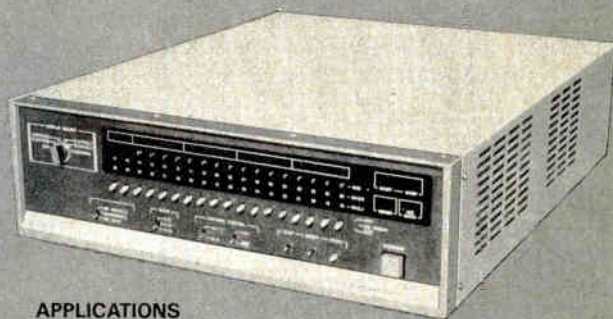

APPLICATIONS

DRUM REPLACEMENT
FIXED HEAD DISK FILE REPLACEMENT
LARGE CAPACITY AUXILIARY MEMORY
BLOCK ORIENTED RAM (BORAM)
BACK UP MEMORY FOR ON-LINE COMPUTER
LARGE CAPACITY INTERNAL MAIN FRAME

The four outstanding features of (1) low cost, low drive current, and a temperature-independent core (TIN core) made by the tape stamping process, (2) development of automatic stringing technology, (3) rationalization of peripheral circuitry, and (4) the use of a switching-regulated power supply have realized successful development of a low-cost (3 to 4 bits per penny), static, large-capacity random access memory system and made possible the direct replacement of a fixed-head drum memory and disc-file memory. Since this system has no rotating parts, no maintenance fees are required and expected to use as a highly reliable data bank system utilizing the non-volatility. Endowed with an access time 1000 times faster than that of a drum and disc-file memory and with a data transfer which rates a high 6 to 10 megabits/second, the opening of new fields is anticipated regarding application to a block-oriented random access memory (BORAM), and or auxiliary RAM. This system is designed to demonstrate an extremely high MTBF reliability of more than 10,000 hours. A standard 19-inch rack mounting type is designed for use as a stand-alone system. Memory system cards possessing storage capacities of 16K bytes and 65K bytes have been standardized for mini-drum replacement use as a sister product. In addition to standard products, special interfaces and other OEM products are available for immediate delivery.

	MODEL	CAPACITY	SPEED		POWER	DIMENSION	NOTE
			CYCLE TIME	ACCESS TIME			
SYSTEM CARD	CMS2163	16KW-8B	3μs	1μs	+5V only	10" x 8" x 1"	MINI DRUM REPLACEMENT
	CMS2804 (Q0)	32KW-18B	1μs	0.4μs	+5V -15V	18.9" x 12.2" x 1"	PLUG COMPATIBLE WITH CMS2551
	CMS2651	65KW-18B	3μs	1μs	+5V -15V	18.9" x 12.2" x 1.4"	CARD FOR MB2200 MB2300
FULL SYSTEM	MB2200 (256KB)	65KW-36B	3μs	1μs	AC 100/115V 50/60Hz	19" RACK	TEMP RANGE 0°C to +50°C HUMIDITY 95% RH max INPUT VARIATION ±15%
		131KW-18B					
	131KW-36B						
	262KW-18B						
MB2300 (512KB)						12" HEIGHT	

FUJI ELECTROCHEMICAL CO., LTD.

Head Office:
No.36-11, 5-chome, Shinbashi, Minato-ku, Tokyo, Japan Tel: 03-434-1271

U.S.A. Head Office:
16921 S. Western Ave. Gardena, Calif. Tel: 213-323-1134

New York Office:
261, Madison Ave., RM. 1102, New York, N.Y. 10016, U.S.A. Tel: 212-532-5630

Düsseldorf Office: c/o Kanematsu-Gosho GmbH
4, Düsseldorf, Karl-Rudolf Strasse 178, West Germany Tel: 211-89031

CIRCLE NUMBER 147

ELECTRONIC DESIGN 4, February 16, 1976

INSTRUMENTATION

Synthesized sig gen sells for \$1595

Comstron/SEG, 120-30 Jamaica Ave., Richmond Hill, NY 11418. (212) 441-3200. \$1595; stock.

Model 1013 is a five-digit synthesized signal source priced below \$1600. The unit, designed for bench and systems applications, covers the 0.1-Hz-to-13-MHz frequency range with 6-digit resolution. It features a LED display, a metered, leveled output up to 3 V rms with a precision output attenuator adjustable in 10-dB steps and continuous level control. Low phase noise (greater than 40 dB in top band and greater than 60 dB from 1 MHz and below) and low harmonic distortion (-50 dB from 0.1 Hz to 1 MHz and -40 dB from 1 MHz to 13 MHz) and spurious (greater than 60 dB down on all ranges) ensures signal purity.

CIRCLE NO. 399

Smart radiometer corrects and computes



Gamma Scientific, 3777 Ruffin Rd., San Diego, CA 92123. (714) 279-8034. \$3900; 90 days.

With an internal μ P, the CR-1 computing radiometer performs both control and processing functions at the same time. The unit completely eliminates zero and dark-current controls by automatic digital subtraction of these components. Its program includes digital signal averaging and digital signal rate sensing. The μ P section also controls the autoranging function and exponent and units display. By keyboard command, the processor can apply correction factors, store readings, perform log conversion, compute ratios, take reciprocals, and multiply by stored constants.

CIRCLE NO. 400

Autoranging DMM costs just \$225



Hewlett-Packard, 1501 Page Mill Rd., Palo Alto, CA 94304. (415) 493-1501. \$225; stock.

This 3-1/2 digit, five-function, fully autoranging DMM, the 3476-A, sells for only \$225. Voltages are measured from $\pm 100 \mu$ V to ± 1000 V dc and from 300μ V to 700 V rms ac. Resistance is measured from 1Ω to 11 M Ω . Current can be measured from 100μ A to 1.1 A dc and 300μ A to 1.1 A ac. Auto-zero and autopolarity are built in. Typical accuracy for dc voltage measurements is 0.5%. Dc current accuracy is 1.0%.

CIRCLE NO. 401

Two scopes weigh-in at less than 10 lb each



Philips Test & Measurement, 400 Crossways Park Dr., Woodbury, NY 11797. (516) 921-8880. PM-3225, \$495; PM3226, \$650; stock.

Two compact, lightweight oscilloscopes with 15-MHz bw and 2-mV sensitivity offer comprehensive triggering facilities, compact dimensions and low weight. The single-trace PM3225 weighs 8 lbs 2 oz. and measures $4.72 \times 9 \times 12.5$ in. The dual-trace PM3226 weighs 9 lbs 10 oz. and measures $4.72 \times 10.8 \times 12.5$ in. Both models offer adjustable level triggering, automatic triggering, line triggering and automatic TV line and frame sync pulse triggering. External triggering is also possible.

CIRCLE NO. 402

Recording hard data?



Analog or digital?
One or sixteen channels?
Short or long term?
The "Instrument Professionals" can help you make the right choice from the thousands of recorder types and sizes in inventory. Delivery is immediate. Performance guaranteed.

Write or call for data on our other specialties: Instrument Leasing • Computer Peripherals • Equipment Sales • Instrument Service.

Call Get our FREE Catalog

Continental Rentals

Div. Continental Leasing Co., Inc.
175 Middlesex Turnpike, Bedford, MA, 01730 (617) 275-0850

Metuchen NJ, (201) 549-8500; Rockville, MD, (301) 881-7997; Dallas, TX, (214) 357-1779; Elk Grove IL, (312) 439-4700; Costa Mesa, CA (714) 540-6566; Santa Clara, CA, (408) 735-8300; Los Angeles, CA, (213) 477-7521

CIRCLE NUMBER 145 ►

WorldRadioHistory

**NEW
AUTOMATIC
IN-CIRCUIT
SEMICONDUCTOR
TESTING
AND LEAD
IDENTIFICATION**



for
all bipolar transistors
(including hard-to-
check Darlington),
FET's, SCR's,
diodes.

**Model 520B
Semiconductor Tester
\$160.00**

New HI/LO power drive circuitry permits accurate testing of even more transistors and other semiconductors in circuits with shunt resistance as low as 10 ohms and shunt capacitance up to 15 μ F. New low power drive automatically identifies base, emitter and collector leads, in or out of circuit.

Test takes 9 seconds or less. Audio tone and LED's indicate GOOD/BAD, NPN-OK or PNP-OK.

Ideal for production line, inspection, and field service applications.

Contact your local distributor for a demonstration or write for detailed brochure.

BK PRECISION
PRODUCTS OF DYNASCAN

1801 West Belle Plaine Avenue
Chicago, Illinois 60613 312/525-3990

In Canada: Atlas Electronics, Toronto

CIRCLE NUMBER 148

DISCRETE SEMICONDUCTOR

**T-1 cased LEDs come in
red, grn, yel and orange**

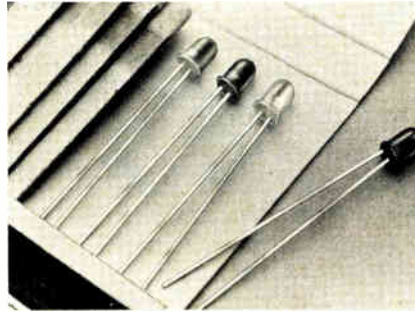

Chicago Miniature Lamp, 4433 N. Ravenswood Ave., Chicago, IL 60640. (312) 784-1020. \$0.52 (1000-up); stock.

Four discrete LEDs, in the CM4-X44B series, are available in red, yellow, orange and green. All LEDs are in T-1 cases and have cylindrical, diffused encapsulations colored to match the color of light output. The diodes provide a 90° half-intensity viewing angle. Both the red and orange have a 5 mcd light output. The yellow delivers 4 mcd, and the green is rated for 1 mcd. Typical peak wavelengths, important for color-consistency matching in all nonred LEDs, are 635 nm for orange, 585 nm for yellow and 565 nm for green.

CIRCLE NO. 403

**Npn switching Xsistors
have BV_{ceo} to 500 V**

Kertron, Inc., 7516 Central Industrial Dr., Riviera Beach, FL 33404. (305) 848-9606. From \$12.50 (100-up); stock.

Three npn high-voltage switching transistors have BV_{ceo} 's of 400 to 500 V. Pulse current ratings reach 10 A and the current gain of 15 is specified at a 3-A collector current. These devices are fast switching, with rise times to 3.5 A of less than 200 ns and fall times of less than 200 ns. Each device can dissipate 35-W, average, with the case maintained at a temperature of 25 C. The thermal resistance junction to case is 5 C/W. The family consists of three devices, the KP3794, with a BV_{ceo} of 300 V; the KP3796, with a BV_{ceo} of 350 V; and the KP3798, with a BV_{ceo} of 400 V.

CIRCLE NO. 404

**Optical switches have
0.125-in. gap spacing**

Sensor Technology Inc., 21012 Lassen St., Chatsworth, CA 91311. (213) 882-4100. From \$2.79; 30 day.

The STIN 135 series of optically coupled switches is electronically and mechanically interchangeable with the General Electric H13 series of switches. The optical switches use a GaAs infrared LED with either a phototransistor or photo-Darlington. The optical elements face each other on opposing walls of a plastic housing with a 0.125-in. sensing gap. Four ratings are offered in the series. Model STIN 135 T2 has a 50- μ A minimum output. The STIN 135 T1 produces 200- μ A output. The STIN 135 D2 delivers a 1- μ A output and the STIN 135 D1 provides 2.5 μ A.

CIRCLE NO. 405

**Rf power transistors
deliver up to 150 W**

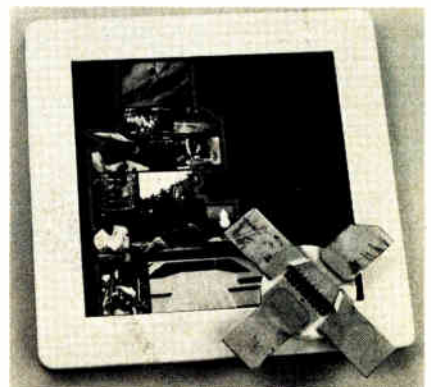

TRW RF Semiconductors, 14520 Aviation Blvd., El Segundo, CA 90260. (213) 679-4561. From \$41.85 (100 up); stock.

The PT9780, 9785 and 9790 series of transistors for single side-band communications applications are rated for operation up to 50 V and 150 W. The transistors are available for 12, 28 and 50-V operation, while ratings of up to 100 W are available for the 12 and 28-V units and up to 150 W for 50-V types. Units have mismatch tolerances up to infinite VSWR and minimum intermodulation distortion of 32 dB. The transistors are rated for a gain of 13 to 15 dB at full rated power.

CIRCLE NO. 406

E-Z-MICRO HOOK ■ E-Z-MINI HOOK X100W AND XL1 ■ E-Z-MACRO HOOK XH AND XHL ■ E-Z-NAILCLIPS

E-Z-PROBES XP AND XPL ■ TEST LEADS AND JUMPERS ■ ADAPTORS

OUR NEW MICRO TROUBLE SHOOTER SOLVES YOUR IC TESTING PROBLEMS

The XM Micro Hook is designed for difficult IC test connections. Light weight (less than 1 gram) and Finger-eze Hypo Action permit direct hookup to delicate wires where weight and leverage may damage component. Fully insulated to a single contact point for true readings.

Construction: One-Piece Beryllium Copper, Gold-Plated Conductor and Hook, made for connections over leads up to .025" diameter. Durable Heat and Chemical Resistant Nylon Body. Stainless Steel Spring. Available preconnected to a wide variety of interface connectors.

Colors Red, Black, Blue, Green, Orange, Yellow, White, Brown, Violet and Gray.

EXCLUSIVE FIELD SERVICING FEATURE

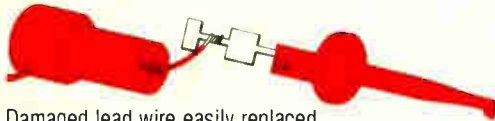

Damaged lead wire easily replaced.

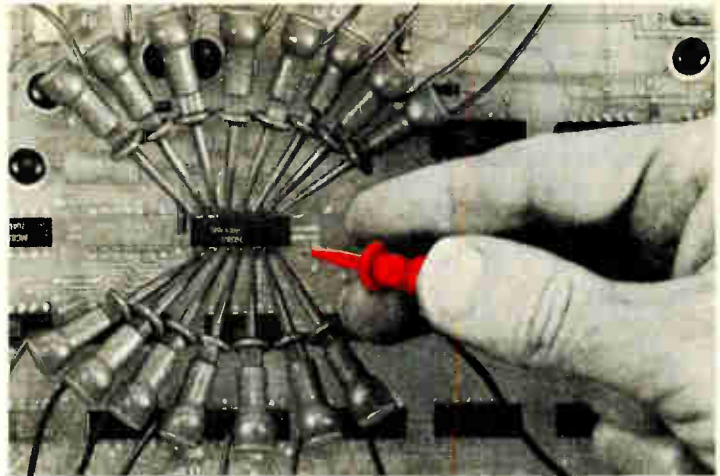

MODEL XM SHOWN ACTUAL SIZE WITH HOOK EXTENDED.

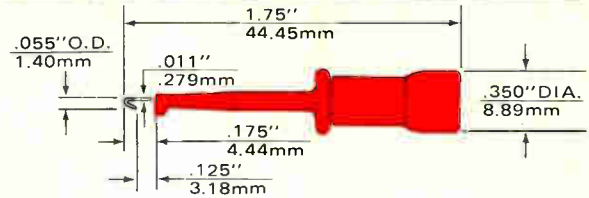

SEND FOR COMPLETE NEW CATALOG AND PRICE LIST

E-Z-HOOK
A DIVISION OF TEKTEST, INC.

114 EAST SAINT JOSEPH STREET
ARCADIA, CALIFORNIA 91006
(213) 446-6175 / TWX 910 582 1614

PATCH CORDS ■ COAXIAL JUMPERS ■ E-Z-HOOK CLIP 61-1 AND 61-2

E-Z-PROBES 52 AND 54-1 ■ BNC, UHF, SMA AND STACKING DOUBLE BANANA COAXIAL TEST CABLES

CIRCLE NUMBER 149

STANDOFFS AND SPACERS

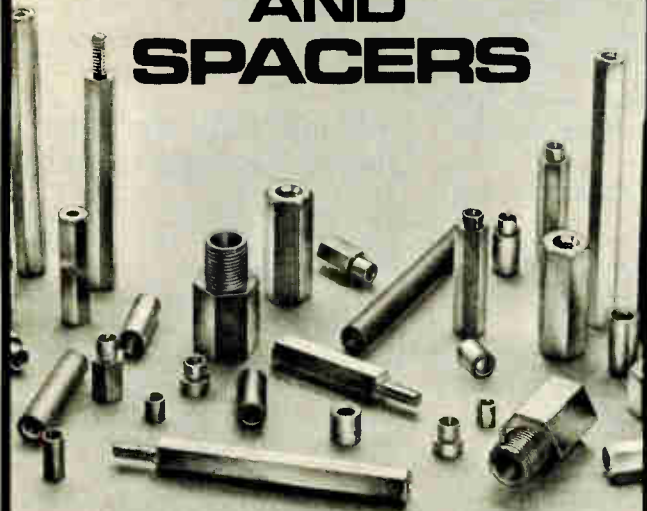

Over 200 assorted sizes and styles cataloged for you to choose from. Available in Aluminum, Brass and Phenolic, tapped or thru-hole. Immediate delivery from stock. Free engineering service for your special requirements.

NEW FREE CATALOG ON REQUEST

Manufacturers of Standardized Hardware for Electronics



KEYSTONE

ELECTRONICS CORP.

49 Bleecker Street · New York, N.Y. 10012

CIRCLE NUMBER 150

FREE TEST



shows you how to save costs
SUPERIOR NO. 30 FLUX
prevents corrosion when soldering
Ideal for printed circuit boards

Why take chances that corrosion from soldering will cause rejects and unnecessary expense? Use the same flux that hundreds of our customers all over the world are using — Superior No. 30 NON CORROSIVE SOFT SOLDER LIQUID FLUX. We'll sample it to you at no cost to prove that it will end corrosion problems! It's positively non corrosive. No zinc, ammonium chloride, resin or gum. Non hygroscopic, non-conductive... no fumes or disagreeable odors. Residue is water soluble. Makes soldering easier and faster!

Send coupon below or check reader service card for free sample now. After you've tested it, you'll be mighty glad you did.

SO SUPERIOR THAT IT IS PATENTED

Meets U.S. Army Sat. Com. Agency Spec. SM-A-571678

send for
FREE
sample
TODAY!

SUPERIOR FLUX COMPANY • Est. 1932
95 Alpha Park, Cleveland, Ohio 44143

Send free sample No. 30 FLUX DEPT. — ED
 Send prices and details

FIRM _____

ATTN OF _____

ADDRESS _____

CITY _____ STATE _____ ZIP _____

CIRCLE NUMBER 151

Little Red Reed Relays

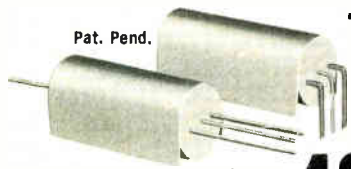

Pat. Pend.

In Quantities as low as **49¢**

- ★ Red Flame Retardant Shell
- ★ Instrument Grade Contacts
- ★ Coto's High Reliability Testing
- ★ Premium Grade Catalogued Switches
- ★ Epoxy Encapsulated
- ★ Low Water Absorption
- ★ ... and Much More!

Write or Call for Bulletin MR 12.1



COTO-COIL COMPANY, INC.
59 Pavilion Ave.
Providence, R. I. 02905
Tel: (401) 467-4777

CIRCLE NUMBER 177

KEEP

Electronic Design's

GOLD BOOK

HANDY

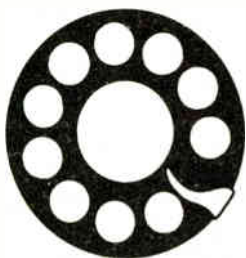

When You Call

Save time when you contact suppliers. Check their catalog pages first in *Electronic Design's* GOLD BOOK. Maybe the information you need is right at your fingertips.

DISCRETE SEMICONDUCTOR

Germanium transistors made for high current

Germanium Power Devices, P. O. Box 65, Shawsheen Village Station, Andover, MA 01810. (617) 475-5982. See text.

Two high current germanium power transistors are available in copper TO-3 and TO-41 packages. The transistors are hermetically sealed and are designated 2N4276 through 2N4283. Prices range from \$4 to \$6, depending on quantities and delivery is 4 to 6 weeks.

CIRCLE NO. 407

Fast switching SCRs handle up to 150 A

International Rectifier, Semiconductor Div., 233 Kansas St., El Segundo, CA 90245. (213) 678-6281. From \$17 (10-up); 4 wk.

Two series of SCRs, the 91RM and 91RL, can handle 150 A rms. The devices offer high di/dt and high dv/dt—maximum turn-off time (t_q) for the 91RM series is 10 μ s and is 20 μ s for 91RL. Both series are available in versions with blocking voltages to 500 V and in flag and flex lead stud-mount cases. Case style A-12 conforms to the JEDEC outline TO-83 and case A-11 to JEDEC outline TO-94. The A-11 case also conforms to JEDEC TO-49 when the auxiliary cathode lead is removed.

CIRCLE NO. 408

LED optoisolators have isolation of 2 kV

Clairex Electronics, 500 S. Third Ave., Mount Vernon, NY 10550. (914) 664-6602. From \$3.25 (1 to 99); stock.

Two LED/photoconductive-cell optoisolators, the CLM-6200 and the CLM-6500, provide 2-kV peak ac isolation. The CLM-6200 has a linear output over a wide input current range. Typical switching speeds include a rise time of 3.5 ms and a decay time of 12 ms. The CLM-6500 features a low output resistance of 300 Ω for a 16-mA input. This isolation has a 10-M Ω off resistance.

CIRCLE NO. 409

Stackable radial-lead LEDs come in 3 colors



Hewlett-Packard, 1501 Page Mill Rd., Palo Alto, CA 94304. (415) 493-1501. From \$0.15 (1000 up); stock.

Four types of LEDs, in radial-lead subminiature epoxy packages, include red, yellow, green and a high-efficiency red. The diodes can be mounted as arrays (stacked) on 2.21 mm (0.087 in.) centers. At a forward current of 10 mA, the red HP 5082-4100 has an axial luminous intensity of 0.7 mcd and the red 4101 has an intensity of 1 mcd. Their forward voltages are 1.6 V. The yellow lamp, Model 4150, has an intensity of 2 mcd at a forward current of 10 mA and a forward voltage of 2.2 V. The green LED, Model 4190, has an intensity of 1.5 mcd at a forward current of 20 mA and a forward voltage of 2.4 V. For high efficiency, the 4160 red LED provides 3 mcd at a forward current of 10 mA and a forward voltage of 2.2 V.

CIRCLE NO. 410

Low-current reference diodes have low tempco

Codi Corp., Pollitt Dr., Fair Lawn, NJ 07410. (201) 797-3900. From \$6 (1 to 24); stock.

The C8000 series of ultra-low current reference diodes includes temperature compensation. These reference diodes operate at currents as low as 100 μ A in a package that has a diameter of only 0.1 in. and a length of 0.3 in. The temperature coefficients of these devices are as low as 5 ppm/ $^{\circ}$ C over an operating temperature range of -55 to 100 C. Shifts in the operating current as large as $\pm 50\%$ cause very small changes in the temperature coefficient. The diodes are hermetically sealed in DO-7 glass packages and can be supplied with long term stabilities as low as 10 ppm/year.

CIRCLE NO. 411

PRECISION LOAD CELLS FOR TESTING, WEIGHING, FORCE MEASUREMENT



Specify Interface...offering industry the most innovative and comprehensive selection of superior load cells available.

Industry standards for accuracy, stability, versatility and cost have been established by Interface...providing a complete line of load cells for electronic weighing, testing or force measurement applications—in any industry! With standard ranges from 5 pounds to 100 tons, these load cells combine extremely high accuracy with low installed cost.

Interface

7401 East Butherus Drive/Scottsdale, Arizona, USA 85260
Telex: 668-394 Telephone: (602) 948-5555

CIRCLE NUMBER 152

CUSTOM-CRAFTED Constant Voltage Transformers

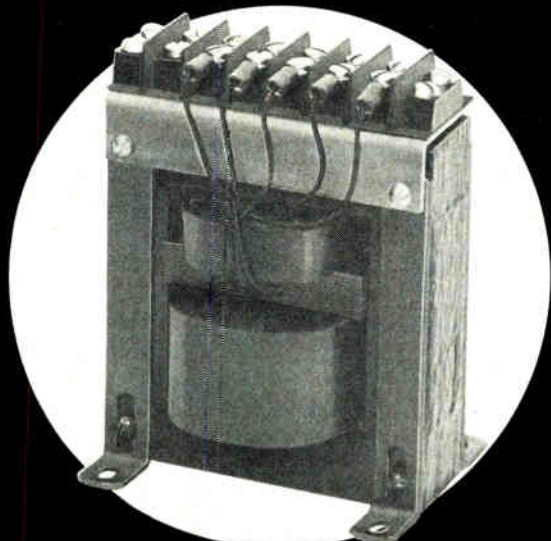

Datatec manufactures a wide range of transformers, inductors, toroids, chokes, matched audio and sub-audio units in many sizes and voltages. For automatic controls, aerospace, computers, biomedicine, and other industrial uses.

DATATEX CORPORATION

TRANSFORMER DIVISION

10935 South Wilcrest Drive □ Houston, Texas 77072 □ (713) 495-1171

CIRCLE NUMBER 153

ELECTRONIC DESIGN 4, February 16, 1976

sealed high density miniature switching

for 12 PDT to 108 PDT
with MIL-R-5757 protection against
humidity... sand... dust... moisture...
splash... explosion... corrosion...
built to withstand shock/vibration!

ENVIRONMENTALLY SEALED

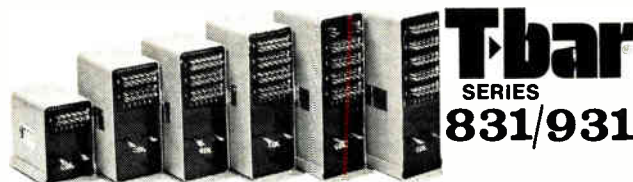

12P,ST,DT 24P,ST,DT 36P,ST,DT 48P,ST,DT 52P,ST,DT 60PST

All contacts epoxy sealed in backfilled metal enclosure for ground support or shipboard applications and other hostile environments. Pulse operated magnetic latching available. Simple crimp snap-in contacts fit into single block connectors for easy wiring. 60 circuits switched in a space as small as 2 3/4" x 1 5/8" x 4 1/2".

HERMETICALLY SEALED



T-bar
SERIES
881/981

12PDT/24PST

24PDT/36PST

34PDT/48PST

Hermetically sealed glass and metal-to-metal enclosures backfilled for ground support and selected airborne applications. Mates with MS connectors. Pulse operated magnetic latching available. 48 circuits switched in a space as small as 1 3/4" x 4 3/8" x 4 7/8".

ENVIRONMENTALLY SEALED



12,24,
36P,ST,DT

48,60,
72P,ST,DT

T-bar
SERIES
832/932

84,96,
108P,ST,DT

Toggle switches with contacts epoxy sealed in backfilled metal enclosures. Lever operates through diaphragm. Dust boot supplied to exclude salt and sand from mechanical actuator. Simple crimp snap-in contacts fit into single block for easy wiring. 108 circuits switched in a space as small as 2 5/8" x 4" x 1 7/8".

Interested? Write or
phone T-Bar today for
complete facts, prices,
quantity discounts.

T-bar INCORPORATED
SWITCHING COMPONENTS DIV.

141 Danbury Road, Wilton, CT 06897
Telephone: 203/762-8351 • TWX: 710/479-3216

CIRCLE NUMBER 154

Now...Eternacell[®] lithium primary batteries in 10 off-the-shelf sizes



There's a lithium primary battery for fast delivery in a cell size for practically every portable-power application — from ½ to 25 ampere-hours capacity. Including "AA", "C", "D" cell sizes and a new 9-volt transistor-size.

Every cell delivers the remarkable performance that has become a new standard for the industry:

- 2.8 volts-per-cell nominal operating voltage, twice that of ordinary cells
- highest energy per unit weight and volume
- greater than 5-year shelf life
- outstanding adaptability to temperature extremes (-65F to +160F)

PCI specializes in the design and manufacture of multi-voltage lithium battery packs for varied industrial, consumer, and military applications.

Write for our catalog or contact our Applications Department to discuss your specific design requirements.



Power Conversion, Inc.

70 MacQuesten Parkway South
Mt. Vernon, N.Y. 10550
Telephone: 914-699-7333

CIRCLE NUMBER 155

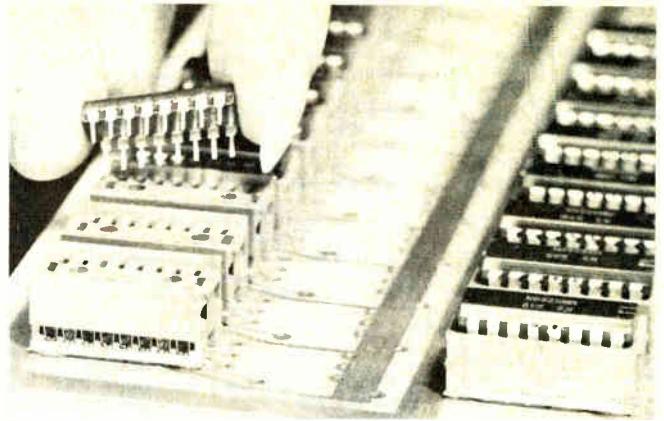

Do Your I/c Burn-In & Test With Our New Dip Sockets

- Patented design requires "zero insertion force" yet holds securely.
- Individual contacts are replaceable.
- Unique 2 piece design makes device removal easy.
- Built for temperatures up to 250°C.
- Use and reuse thousands of times!

Welcon

We make a full line of sockets, contactors and carriers. Send for data.

WELLS ELECTRONICS, INC., 1701 S. Main, So. Bend, Ind.

CIRCLE NUMBER 157

NEW! MICROCOMPUTER DICTIONARY

TITLE: Microcomputer Dictionary & Guide

AUTHOR: Charles J. Sippl and David Kidd

DESCRIPTION: Over 8000 definitions and explanations of terms and concepts (704 pages) relating to microprocessors, microcomputers and microcontrollers. Special sections on programmable calculators; math and statistics; flow chart symbols and techniques; binary numbers systems and other related computer terms. In addition there is a comprehensive electronic/computer abbreviations and acronyms section.

(Also available from technical book stores and selected electronic distributors)

\$17.95

MATRIX PUBLISHERS, INC.

Dept. ED, 207 Kenyon Road, Champaign, IL 61820

Please send me new MICROCOMPUTER DICTIONARY under your 15 day no risk trial guarantee. Remittance enclosed. (Ill. customers add 5% sales tax)

Name _____

Address _____

City _____ State _____ Zip _____

CIRCLE NUMBER 156

Optical switches tailored to fit.

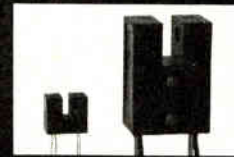

Clairex[®] offers a choice of standard and custom switches with hermetically sealed components.

- Standard widths of .100 in. or .250 in.
- Special sizes and widths to your designs.
- Hermetically sealed components for long life.
- Glass lenses and windows reduce dust pickup.
- Pretested to assure performance.
- No friction wear, contact bounce or switching noise.

Come to the leader in opto-electronics.

Tell us the problem. We'll develop the solution.

CLAIREX ELECTRONICS

560 South Third Ave., Mount Vernon, N.Y. 10550. (914) 664-6602

CIRCLE NUMBER 158

MICROWAVES & LASERS

Compact TWT spans 7 to 17 GHz

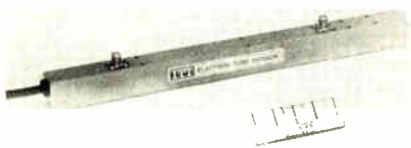

ITT Electron Tube Div., 3100 Charlotte Ave., Box 100, Easton, PA 18042. (215) 252-7331. \$4500; 60 to 90 days.

A compact 25-W cw traveling-wave-tube amplifier—the F-2131—covers the frequency range of 7.0 to 17 GHz with 50-dB small-signal gain. The tube weighs just 0.75 lb. It uses a helix type, slow-wave structure and is PPM focused with samarium-cobalt magnets. The TWT can be mounted in any position, and its isolated collector may be depressed up to 50% of the cathode voltage.

CIRCLE NO. 412

1-to-2-GHz oscillator has 0.005% stability



Microwave Technology, 840 W. Church Rd., Mechanicsburg, PA 17055. (717) 697-4681. \$495 (1-3); 6 wks.

Model EY-243, a high-stability crystal-controlled oscillator, outputs in the 1-to-2-GHz frequency range. The device has a frequency stability of $\pm 0.005\%$ or better over the temperature range of 0 to 50 C, and an output power of 5 mW (50- Ω load and SMA connector). Harmonics and sub-harmonics are 26 dB or more below the carrier and the spurious signals are -65 dB or more.

CIRCLE NO. 413

Protector limiter works at 1.4 GHz

Radiation Devices, P.O. Box 8450, Baltimore, MD 21234. (301) 628-2240. \$50 (1-9); stock to 3 wks.

The Model PLC-1 protector-limiter can be used to reflect 1.5-kW pulse or 25-W cw signals. Full protection is reached within 100 ns after application of power exceeding the limiting threshold of 0 dBm at 2 MHz to -4.5 dBm at 1.4 GHz. Faster operation occurs at higher incident power.

CIRCLE NO. 414

Small He-Ne laser priced at \$70



Coherent Radiation, 3201 Porter Dr., Palo Alto, CA 94304. (415) 493-2111.

The CR 084 helium-neon laser tube, measuring only 28 mm in diameter and 244 mm in length, costs less than \$70 in volume quantities. The laser tube outputs more than 2 mW of power, and it has a 0.51-mm beam diameter and less than 1.6-mrad beam divergence. Tests indicate an operating lifetime of 20,000 hours. Operating voltage is 1400 V at 4 mA.

CIRCLE NO. 415

Octave BW log amps have 10-ns rise

RHG Electronics Laboratory, 161 E. Industry Court, Deer Park, NY 11729. (516) 242-1100. \$1150 to \$1250; 90 days.

Two solid-state logarithmic amplifiers cover the 250-to-600-MHz frequency range. The Models ICLT-375 and ICLT450, operating from 250 to 500 MHz and 300 to 600 MHz, respectively, have rise times of less than 10 ns. Both models also feature 60-dB dynamic range, ± 1.5 -dB linearity and 1.25-V video output into a 93- Ω load.

CIRCLE NO. 416

Meet the First Opto-coupled Linear IC Amplifiers

Starting at \$26.50* each, and less than one cubic inch in volume, our 3650 and 3652 Isolation Amplifiers represent a major breakthrough in linear circuits.

Opto-Isolators have already made a name for themselves in digital designs but until now they weren't suitable for linear circuits. Trouble was, they were inherently non-linear. And the light source tended to degrade with age, which degraded gain accuracy. Temperature drifts, too, were a problem.

But we felt that opto-coupling held too much promise in linear applications to be discarded. Now those problems are solved. Look at the price and size reductions. Look at the splendid isolation they provide (1500V peak, continuous, 4000V peak for 10 seconds) without the cross-talk or EMI problems inherent in transformer isolators. And leakage is less than 0.5 microamp at 240VAC! Our 3650 transconductance amplifier (current-in, voltage-out) and buffered-input 3652 (voltage-in, voltage-out) let you use

isolation where you never could before. We know you will want more information on

the new Burr-Brown Model 3650/3652 amplifiers and on our complete line of instrumentation amplifiers. Contact Burr-Brown, International Airport Industrial Park, Tucson, Arizona 85734. Telephone (602) 294-1431.

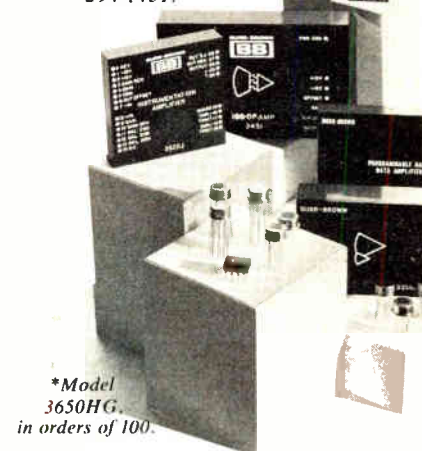

*Model 3650HG, in orders of 100.

BURR-BROWN

BB

A revolution in price and size.

CIRCLE NUMBER 159

AIRPAX™

miniature
toggle, rocker
and lever handle
switches

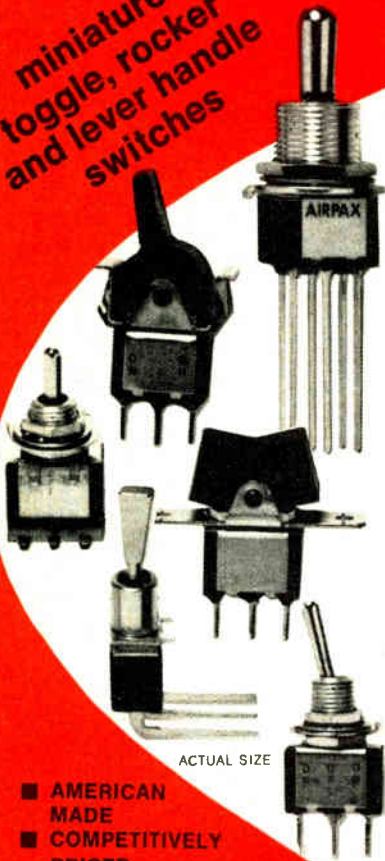

ACTUAL SIZE

- AMERICAN MADE
- COMPETITIVELY PRICED

Single and two pole models. Maintaining or momentary switching actions. A wide range of options for computers, appliances, industrial, military, and consumer applications.

You can choose the exact combination you need from the selection of basic switching functions, contact ratings, terminations, handle types, and hardware.

The product of years of experience in the design and manufacture of electromechanical devices, Airpax miniature switches assure you of the superior quality, performance, and service that has been synonymous with Airpax products throughout the years.

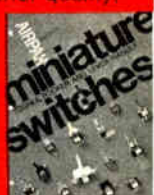

Send for Short Form
Catalog 3001.

AIRPAX™

Airpax Electronics/CAMBRIDGE DIVISION
Cambridge, Maryland 21813
Switches, Circuit Breakers, Glass-Ceramic-to-Metal Seals

Other Airpax Divisions:
CONTROLS DIVISION, Ft. Lauderdale, Fla.
Instruments for Industry
AMERICAN DATA, Huntsville, Alabama
TV Products

CIRCLE NUMBER 160

MICROWAVES & LASERS

Frequency discriminator covers octave BW



Merrimac Industries, 41 Fairfield Pl., West Caldwell, NJ 07006. (201) 228-3890. \$210; 30 to 45 days.

The Model WDS-1-30 frequency discriminator offers an octave bandwidth and 5% linearity. The device provides a linear output voltage proportional to deviation from the center frequency of 30 MHz (positive slope) within the 2-to-40-MHz range. It also provides discrimination at 90 MHz (negative slope), 150 MHz (positive slope), 210 MHz (negative slope), and 270 MHz (positive slope). Other characteristics include input impedance of 93 Ω , rated input level of 10 dBm (maximum level of 23 dBm), output sensitivity of 10 mV/MHz, output bandwidth of dc to 450 kHz, and nominal output impedance of 150 Ω .

CIRCLE NO. 417

System combines up, down converters

Miteq, 100 Ricefield Lane, Hauppauge, NY 11787. (516) 543-8873.

A system intended for small earth-station applications combines one dual conversion down-converter and one dual conversion up-converter in a standard 19 \times 20 \times 5-1/4-in. rack-mounted chassis. The converters are completely independent except for a common power supply. The down-converter specifies an input frequency range of 3.7 to 4.2 GHz, and an output frequency of 70 MHz \pm 20 MHz. The up-converter specifies an input frequency of 70 MHz \pm 20 MHz, and an output frequency range of 5.925 to 6.425 GHz.

CIRCLE NO. 418

MATV amp has 4-way splitter

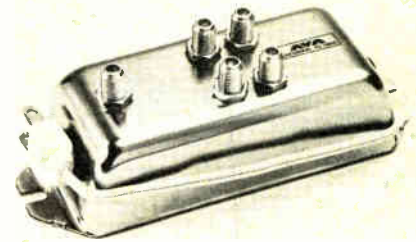

AVA Electronics Corp., 242 Pembroke Ave., Lansdowne, PA 19050. (215) 284-2500. \$18.95 (100 up).

The Model A515-4UV, an MATV amplifier, can be used on up to 16 TV sets. It has a built-in 4-way splitter, and a bandwidth of 50 to 900 MHz. Input and output impedances are 75- Ω per splitter. When powered by a 117-V-ac 60-Hz source, the amplifier has an output capability to 30 dB. The unit also features built-in surge lightning protection and measures only 6-9/16 \times 2-1/8 \times 1-3/4 in.

CIRCLE NO. 419

DB mixer handles 26-dBm LO

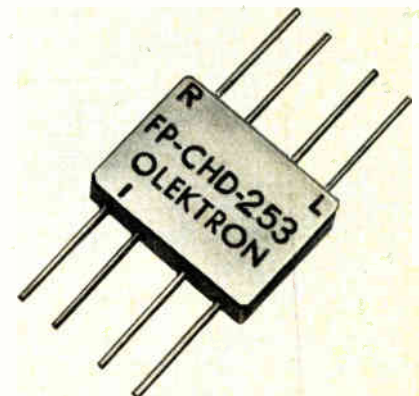

Olektron Corp., 6 Chase Ave., Dudley, MA 01570. (617) 943-7440. \$65 (1 to 24); 2 wks.

A flatpack double-balanced mixer for stripline mounting—the Model FP-CHD-253—can handle LO power levels up to 26 dBm and operate over the frequency range of 10 MHz to 3 GHz. The unit has a conversion loss of 6 dB at 1 GHz, and nominal loss of 10 dB at 3 GHz. The unit can be supplied in other than flatpack configurations.

CIRCLE NO. 420

We've Got a Family of Little CUS's...

CURTIS RELAY SOCKETS



They're unitized, compact, heat-resistant and panel or track-mounted. Just the sockets for most of your relay and plug-in timer needs.

Write for free engineering specs.

CURTIS INDUSTRIES, INC.

8000 West Tower Avenue, Milwaukee, WI. 53223
Call (414) 354-1500 for the name of a representative or distributor near you.
In Canada: A.C. Simmonds & Sons, LTD., Willowdale, Ontario.

CIRCLE NUMBER 161

The fastest, most dependable strip chart recorder anywhere.

There isn't another strip chart recorder on the market today that can match the Gould 110's performance, ruggedness, versatility and writing dependability.

The new hot-tip thermal writing system produces clear, sharp, highly reproducible blue traces with no smudges, no smears, no skips and no puddles.

For complete information, write Gould Inc., Instrument Systems Division, 3631 Perkins Ave., Cleveland, Ohio 44114. Or Gould Allco S.A., 57 rue St. Sauveur, 91160 Ballainvilliers, France.

PHONE FREE (800) 648-4990 FOR BROCHURE.



CIRCLE NUMBER 162

ELECTRONIC DESIGN 4, February 16, 1976

with **MINI/BUS**[®]

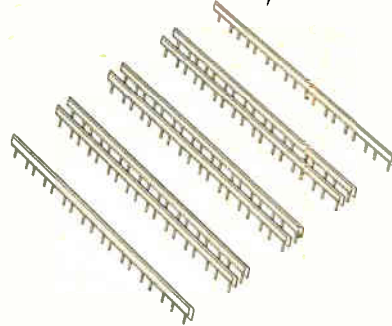

all these **MOSTEK MK 4096** memory packages



go on this 2-layer board



and work as they should!

... and these weren't needed!

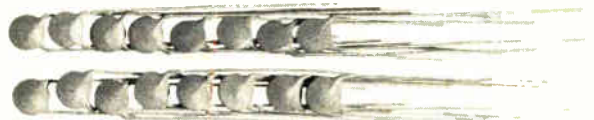

Rogers Application Note No. 1976 tells the full story of how Mini/Bus makes PCB space-saving design easier, eliminates multi-layer PCBs, drastically reduces use of de-coupling capacitors. Write or call for a copy, so you'll know what others know!

© Rogers Corporation 1976

R[®] **ROGERS CORPORATION**
Chandler, AZ 85224 (602) 963-4584

CIRCLE NUMBER 163

BASIC DESIGN — CUSTOM BUILT

Model 90



ROTARY CERAMIC SWITCHES

for RF and Power Applications

R.S.C. switches are available in various models that can be customized to meet your particular requirements.

All switches have heavily silver plated current carrying components for long life and minimum maintenance.

Types include shorting and non-shorting, single and multi-deck, 10 to 100 amp capacity, 20° - 90° detents, and 2,000 to 24,000 volt peak flashover.

Model 88

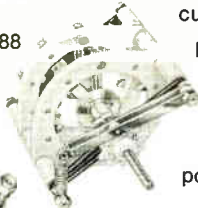

Model 86



Model 80



Write for catalog No. 960



RADIO SWITCH CORPORATION

RT. 79, MARLBORO, N.J. 07746
PHONE: 201-462-6100

CIRCLE NUMBER 164

NEW! OAK SNAP-IN TWO-LAMP PUSHBUTTON SWITCH

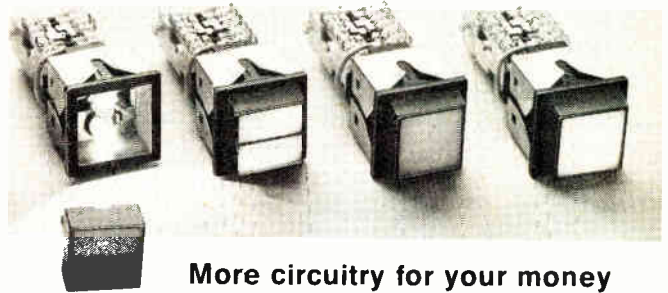

More circuitry for your money

- Up to 4 pole, 2 throw capacity
 - Single or split display
 - 100,000 cycle minimum life
 - Front relampable; T-1 3/4 lamp
- Contact your Oak Distributor for additional information on the Series 300 SL or write for Engineering Bulletin SP-730. For price and delivery quotations, call toll-free 800-435-6106

OAK Industries Inc.
SWITCH DIVISION / CRYSTAL LAKE, ILLINOIS 60014

CIRCLE NUMBER 166

New Low Cost TIME CODE GENERATOR/READER



Time Code Reader \$890.
Generator/Reader \$1265.

The new LOW COST Series 9000 Time Code Units generate and read serial IRIG Time Codes used in analog magnetic tape instrumentation, hard wire transmission and telemetry systems. In addition, they provide buffered parallel BCD outputs, TTL compatible, for digital storage devices and computer inputs. Options include Multi-code units, Day-of-Year Calendars and Millisecond BCD outputs.

Write or call Chrono-log Corporation, 2 West Park Road, Havertown, Pa. 19083. (215) 853-1130



CIRCLE NUMBER 165

Rose enclosures. New. Beautiful. Quality Standards.

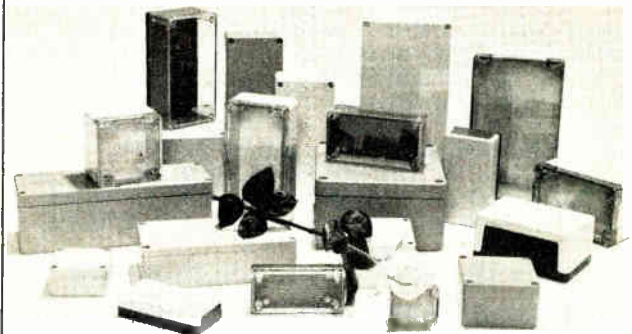

Rose Enclosures, made specifically for electronic use, culminate years of design, engineering and production experience. Extra high quality, precision-finished units provide functional protection, easy access, excellent esthetics. Available materials: Lexan, Aluminum, Polyester and ABS. Clear plastic covers with Lexan and ABS. A competitively-priced stock of Rose Enclosures is maintained in Belding, Mich. for immediate shipment. Contact us at (616) 794-0700.



CIRCLE NUMBER 167

ELECTRONIC DESIGN 4, February 16, 1976

Application Notes

Storage oscilloscopes

When pulses occur at a low rep rate, even most fast writing-rate oscilloscopes do not produce a display visible in normal lighting conditions. An application note illustrates the use of a storage oscilloscope to display these pulses. Tektronix, Beaverton, OR

CIRCLE NO. 421

CMOS Schmitt trigger

Characteristics and typical applications of the CD4093B CMOS quad two-input NAND Schmitt trigger are discussed in a six-page note. Logic and schematic diagrams, tables and performance curves are included. Interfacing of the device is also covered. RCA Solid State Div., Somerville, NJ

CIRCLE NO. 422

Lock-in amplifiers

The theory of operation of the many different types of lock-in amplifiers available today is described and compared in an eight-page technical note. Princeton Applied Research, Princeton, NJ

CIRCLE NO. 423

V/f converters

Theory, operation, calibration and application of v/f converters are covered in a 20-page designer's guide. Diagrams accompany the text and show the circuit connections to actual v/f devices. Datel Systems, Canton, MA

CIRCLE NO. 424

BASIC language

"Learning Timeshare BASIC," a 60-page booklet, is a first course in computer programming—instantly incorporating each new word of BASIC into a useful sample application. The text is kept simple—often colloquial—and is mixed with illustrations. The booklet costs \$3. Hewlett-Packard, 1501 Page Mill Rd., Palo Alto, CA 94304

INQUIRE DIRECT

Viscometers

A 24-page brochure entitled, "Solutions to Sticky Problems," describes the use of the company's viscometer in solving viscosity problems. The relationship of temperature and viscosity is stressed and the differences between Newtonian, non-Newtonian and thixotropic materials are explained. Brookfield Engineering Laboratories, Framingham, MA

CIRCLE NO. 425

Memory systems

"Designing Nonvolatile Memory Systems with Intel's 5101 RAM" covers the use of an ultra-low power 1024-bit static RAM organized as 256 words by 4 bits. The 24-page brochure describes the internal circuitry and operation of the 5101 and outlines circuit techniques for battery-supported non-volatile operation. Intel, Santa Clara, CA

CIRCLE NO. 426

WOULD YOU LIKE A 1/2" DIAMETER PHOTOMULTIPLIER TUBE?

IF YES—

Can you live with CsSb, CsTe, or multialkali cathode?

IF YES—

Is a fused silica, UV glass, or borosilicate window OK?

IF YES—

Then why not ask us to send literature or even better yet, quote to your specifications.

IF NO—

Then maybe you can use one of our 800 larger or smaller detectors, so please ask for our catalog.



SHOWN ACTUAL SIZE

HAMAMATSU CORPORATION
120 Wood Avenue
Middlesex, New Jersey 08846
201-469-6640

YES . . . tell me more about the 1/2" diameter photomultiplier tubes which only you produce.

NO . . . to your 1/2" tubes—send me your complete catalog.

NAME _____

TITLE _____

COMPANY _____

ADDRESS _____

CITY _____ STATE _____ ZIP _____

CIRCLE NUMBER 168

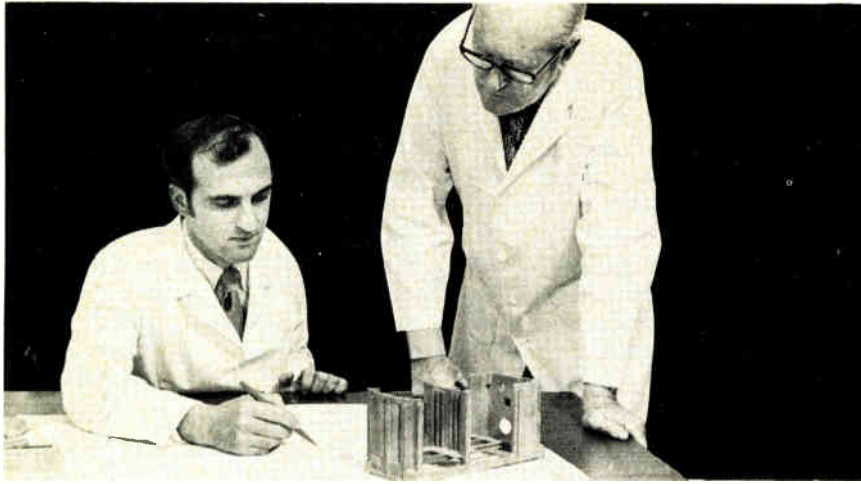

"Check Atlantic for Investment Castings.. they deliver in 3 to 5 weeks"

Atlantic's patented planar investment casting process provides high production rates and true precision control.

The process combines the best features of Plaster Mold and traditional Investment Casting. Almost any shape or

contour is possible.

No order is too big or too small. Delivery in 3 to 5 weeks from Atlantic... the only producer of both investment castings and plaster mold casting serving the industry today.—Literature available.

Atlantic Casting

and Engineering Corporation

EIGHT TEN BLOOMFIELD AVENUE / CLIFTON, NEW JERSEY 07012
201 / 779-2450

CIRCLE NUMBER 169

What's your Mu IQ?

A QUICK QUIZ ON MAGNETIC SHIELDS

1	2	3	4	5	6
Who has the most complete magnetic shield facility in the U.S.?	How many ways can a magnetic shield be fabricated?	Who gives you design help, prototypes, drawings, testing and quality assurance?	How many layers of .004" Hipernom foil will attenuate a 4 oersted field by a factor of 10?	Why are Amuneal magnetic shields cooked 22 hours in 99.9% dry hydrogen?	What is "Mu" anyway?

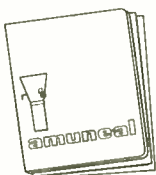

Answers: 1. Amuneal; 2. six; spot welded, heliarc welded, drawn, spun, wrapped or hydroformed; 3. Amuneal; 4. two layers; 5. to restore the optimum magnetic shielding properties of the metal destroyed during fabrication; 6. the Greek letter denoting permeability, the ability of the shield to carry the field.

For all the answers, send for your free Magnetic Shield Source Book today.

amuneal

MANUFACTURING CORP. 4737 Darrach St., Philadelphia, Pa. 19124 Telephone: 215-535-3000

CIRCLE NUMBER 170

Evaluation Samples

Swivel linkage

Swivel linkage for instruments transmits up to 20 lb push or pull, eliminating side thrust caused by rotation and misalignment. The graphitized silicone rubber socket has light interference fit with 1/8-in. brass ball. The 1/16-in. dia. stainless steel connecting rod will rotate 360° and swivel up to 15° around the axis of a 2-64 NFT mounting stud. Airport Corp.

CIRCLE NO. 427

Fasteners

Designed for split-second installation, the HNC-8 Nylatch Catch Series is ideal for fastening access doors. Simply push-in or twist-in the receptacle and stud into rectangular holes. Misalignment of ±0.06 in. is accommodated, and these tough noncorrosive components can withstand up to 100,000 fastening cycles. The Hartwell Corp.

CIRCLE NO. 428

Stud fasteners

One-quarter-turn stud fasteners, initially molded as one piece, turn into a two-piece 1/4-turn panel fastener during the installation process. Only a single mallet tap is required to captivate the latch grommet into the removable panel. The plunger requires only a simple 1/4-turn to unlatch the removable panel. The Hartwell Corp.

CIRCLE NO. 429

Light control film

A thin plastic sheet with built-in "venetian blind" microlouvers which reduce glare, control light, improve contrast and control viewing angle is described and illustrated in a two-page note. Specifications are given for louver material and angles, surface, color filter, materials and thickness. Samples are available. 3M.

CIRCLE NO. 430

New Literature



Data-handling products

A 116-page catalog is divided into the following categories: data-acquisition and μC I/O systems; data conversion products; op amps; instrumentation amps. isolation and data amps; analog circuit functions; active filters and power supplies. Easy-to-read tables allow side-by-side comparison of specifications on similar products. Prices are included. Burr-Brown, Tucson, AZ

CIRCLE NO. 431

Pushbutton switches

Lighted pushbutton switches are described in an eight-page catalog. Grayhill, La Grange, IL

CIRCLE NO. 432

Pots, switches, resistors

Standard potentiometers, switches and trimmer resistors are described in a 40-page catalog. Electrical and mechanical specifications, dimensional drawings and ordering information are included. Centralab, Milwaukee, WI

CIRCLE NO. 433

Calculators

"Pocket Calculator Buyer's Guide," a 32-page brochure, describes and gives specifications for the company's full line of preprogrammed and programmable pocket calculators for science, engineering, business, finance and education. Hewlett-Packard, Palo Alto, CA

CIRCLE NO. 434

Stamped circuits

Design parameters and a description of Mektron stamped circuits are covered in a brochure. Rogers Corp., Rogers, CT

CIRCLE NO. 435

Dynamic braking methods

Evaluation of dynamic braking characteristics of various motors relative to one another is featured in the current issue of *Motorgram*. Bodine Electric, Chicago, IL

CIRCLE NO. 436

Polypropylenes

The case for polypropylene on a cost/performance basis for packaging, electrical, fiber and miscellaneous injection molding applications is presented in a 20-page brochure. Rexene Polymers, Paramus, NJ

CIRCLE NO. 437

Module and controller

A high precision calculator system module and a calculator control instrument, Procal 4, is described in a brochure. Covered is the basic system, theory of operation, options, functional characteristics, typical applications, programming procedures and specifications. Elcom Industries, Burlington, MA

CIRCLE NO. 438

Audio connectors

Model 395P1 audio coupler, which provides ready connections between two different sized audio phone plugs, is featured in a bulletin. Switchcraft, Chicago, IL

CIRCLE NO. 439

Varistors

"Transient Voltage Suppression Manual," 108 pages, incorporates 80 pages of text on transient cause, detection and protection, and it includes a comprehensive selection guide and product specification sheets for selecting the optimum GE-MOV varistor. Copies are available at \$2.50 each plus applicable tax. GE Semiconductor, Electronics Park, Bldg. 7-49, Syracuse, NY 13201

INQUIRE DIRECT



... so I said... OK, show me a switching power supply with the brains to perform reliably in my environment, where others have failed... and **TODD** did.

TODD'S SW SERIES FEATURES:

- High efficiency. Greater than 75%.
- Most reliable.
- Complete range of outputs thru 48V and currents to 120 Amps.
- Lowest price.
- Full 5 year warranty.

Start getting your moneys worth. Write or call for complete information today.

TODD PRODUCTS CORP.

123 Milbar Blvd., Farmingdale, N.Y. 11735. (516) 293-3440.

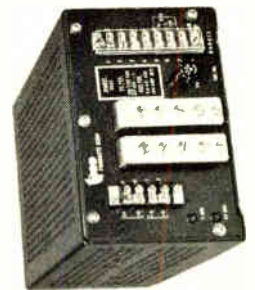

CIRCLE NUMBER 171



A Public Service of
This Magazine &
The Advertising Council



ENERGY MANAGEMENT:

Can your company afford to be without this vital management function?

Frederick B. Dent
Secretary of Commerce

We would like to tell you how Energy Management can help maintain your company's profitability. So we have prepared a free booklet called "How to start an energy management program." It is based on actual company case histories, and it is filled with all the basic information you will need to get your energy savings plan underway. We will also send you another booklet called "33 Money-Saving Ways to Conserve Energy in Your Business," all practical, proven methods based on the real-life experiences of businessmen like yourself.

For both of these useful booklets, just fill in the coupon.

To: U.S. Department
of Commerce
Office of Energy Programs
Washington, D.C. 20230

Please send me your two free booklets on "33 Ways to Conserve Energy" and "How to Start An Energy Management Program."

Name _____

Title _____

Company _____

Address _____

City _____ State _____ ZIP _____

Type of Business _____

NEW LITERATURE

Switching transistors

Glass-passivated power transistors featuring submicrosecond fall time and low leakage and switching losses are described in a four-page data sheet. International Rectifier, Semiconductor Div., El Segundo, CA

CIRCLE NO. 440

Hybrid potentiometers

Details on hybrid potentiometers are presented in a brochure. Duncan Electronics, Costa Mesa, CA

CIRCLE NO. 441

Wire/cable markers

Descriptions, dimensions, specifications and ordering data on wire/cable markers and harness accessories are given in a 16-page catalog. Electrovert, Mount Vernon, NY

CIRCLE NO. 442

Indicators

A 56-page "Lited Devices" catalog presents LED, neon and incandescent indicators. The catalog features an illustrated index arranged by size of indicator from smallest to largest. Complete part numbers are given. Chicago Miniature/Drake, Chicago, IL

CIRCLE NO. 443

Switches & keyboards

A 72-page catalog offers engineering drawings, operating characteristics and technical data on switches and keyboards. Cherry Electrical Products, Waukegan, IL

CIRCLE NO. 444

Ceramic capacitors

Data on a large family of "dipped" radial-lead and axial-lead capacitors in general-purpose Type Z5U, semi-stable Type X7R and NPO-stable Type COG are given in a 12-page brochure. Sprague Electric, North Adams, MA

CIRCLE NO. 445

Components and instruments

High-voltage vacuum components and instruments are featured in a 16-page condensed catalog. ITT Jennings, San Jose, CA

CIRCLE NO. 446

Solenoids

Engineering specifications cover the company's line of solenoids. The 32-page design manual provides graphs, photos and metric conversion data. Regdon/Solenoids, Brookfield, IL

CIRCLE NO. 447

Module library

A 48-page catalog describes the company's module library, a wrapped-wire interconnection system available in numerous configurations compatible with standard electronic enclosures. Teradyne Components, Lowell, MA

CIRCLE NO. 448

Pressure transducers

LVDT and potentiometric pressure transducers are described in a 12-page catalog. Performance specifications, outline drawings, transducer terminology, media compatibility and conversion data are included. Gulton Industries, Servonic/Instrumentation Div., Costa Mesa, CA

CIRCLE NO. 449

Analog, digital instruments

Analog and high-speed digital communications test and measuring instruments are described in a four-page brochure. Tau-Tron, North Billerica, MA

CIRCLE NO. 450

Recorders

Waveform and logic recorder lines are described in a short-form catalog. Biomation, Cupertino, CA

CIRCLE NO. 451

Supervisory control systems

Computer-based data gathering and telemetering equipment is described in a 10-page brochure. Acco, Bridgeport, CT

CIRCLE NO. 452



**Two
C&K Switch Catalogs
for the price of none...**

These two catalogs give you 30 pages of complete specifications including options and ordering information for all switches in the C&K line: *Subminiature toggle, illuminated rocker, and lever handle; subminiature and micro-miniature momentary pushbuttons; and thumbwheel switches.* Call or write for both catalogs now! **C&K Components, Inc.,** 103 Morse Street, Watertown, MA 02172
TEL: (617) 926-0800 TWX: 710 327 0460 TELEX: 92 2546
CIRCLE NUMBER 173

THE COMPLETE PORTABLE DVM

\$198 PATENT PENDING

IT'S PORTABLE FOR BENCH OR FIELD...
 COMPACT & LIGHTWEIGHT. (Only 2½ lbs with batteries.) Fits in any tool box or tube caddy.
 DROP-PROOF with tough Cyclocac® case that will stand up to any field use.
 BURN-OUT-PROOF up to 2000V DC. Saves you from costly downtime.
 VERSATILE 3-WAY POWER: Standard "C" cells, rechargeable "C" cell Nicads or line operation. (No special built-in, recharger pack. Standard "C" cells for the DVM32 for true portability.) And you'll get up to 10 times the battery life with the DVM32, using the patent pending auto-off that turns off the bright L.E.D. displays between measurements. The DVM32 is truly portable.

IT'S COMPLETE FOR ANY JOB...
 Most portable DVM's sacrifice functions, features, or accuracy. Not the DVM32. HIGH ACCURACY Accurate with full 3½ digit readout, .5% of reading accuracy and 15MegΩ input impedance. COMPLETE FUNCTIONS AND RANGES: From 1mV to 1999V DC, 1mV to 1000V AC rms, .1 ohm to 19.99 MegΩ and 1uA to 1.999A, AC, and DC, plus Hi and Lo power ohms. The DVM32... complete and versatile measuring capabilities in a truly portable meter.

IN STOCK NOW AT YOUR LOCAL SENCORE FULL LINE DISTRIBUTOR

DVM32 backed by SENCORE'S 100% MADE RIGHT LIFETIME GUARANTEE

SENCORE 3200 Shiloh Drive, Simu, Fla. 32107 Phone: 1 805 339 0100 TWX 910 660 0300

CIRCLE NUMBER 174

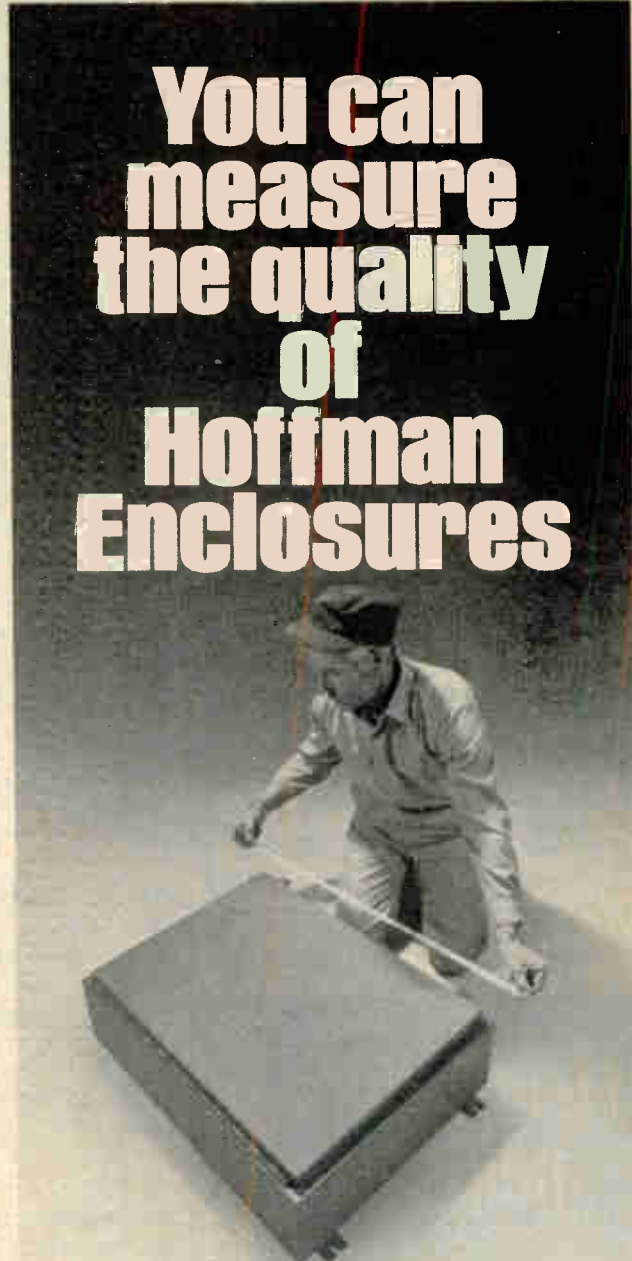

**You can
measure
the quality
of
Hoffman
Enclosures**

Being close isn't good enough in lots of electrical enclosure applications. It either fits or it doesn't. Hoffman quality assures a proper fit. One of our customers put it this way: "What Hoffman says in its catalog is true. Hoffman Electrical Enclosures are consistently well built, and tolerances are what Hoffman says they'll be."

Hoffman is proud of its reputation. We guard it by making numerous checks for dimensional accuracy during our quality control inspections. As one of the country's major manufacturers of electrical enclosures we have a reputation to protect.

We can help you protect your reputation too, with over 1,700 high quality electrical enclosure products. For a copy of our free, problem-solving catalog, call or write:

Hoffman ELECTRICAL ENCLOSURES

HOFFMAN ENGINEERING COMPANY
 Division of Federal Cartridge Corporation
 ANOKA, MN 55303 DEPT. ED543

CIRCLE NUMBER 175

**Send us 2 Bucks*
— Get a sample
Miniature
SOLID STATE
BUZZER**



L'L EARSPLITTER®

with big, rich sound

High reliability in a compact electronic buzzer. 3, 6, 9, 12, 24 volts. Very low current consumption; no arcing contacts, no RF noise.

Write for bulletin ED-276 today!

KOLIN INDUSTRIES, INC.

Manufacturers of Electronic Warning Signals and Alarm Devices

59-B W. Pondfield Rd.
Bronxville, N.Y. 10708
(914) 961-5065 Telex: 137453

*\$1.99 list; lower in quantity

CIRCLE NUMBER 176



**Help college
help you.**

Businesses like yours gave over \$340,000,000 to higher education last year.

It was good business to do so. Half of all college graduates who seek work go into business. The more graduates there are, and the better educated they are, the more college serves the business community.

Your money was vital to colleges. It relieved financial pressures, made planning more flexible, and contributed to the kind of basic and applied research that puts new knowledge and technology at the service of industry.

So that colleges can continue to help you, give to the college of your choice now. For information on ways to do it, please write on your letterhead to Council for Financial Aid to Education, Inc., 6 East 45th Street, New York, N.Y. 10017. Ask for the free booklet, "How Corporations Can Aid Colleges and Universities."

 Council for Financial Aid to Education, Inc.
Advertising contributed for the public good. 

**Vendors
Report**

Annual and interim reports can provide much more than financial-position information. They often include the first public disclosure of new products, new techniques and new directions of our vendors and customers. Further, they often contain superb analyses of segments of industry that a company serves.

Selected companies with recent reports are listed here with their main electronic products or services. For a copy, circle the indicated number.

Honeywell. Instrumentation and automation systems for measurement and control.

CIRCLE NO. 453

Applied Materials. Wafer fabrication.

CIRCLE NO. 454

Warner Electric Brake & Clutch. Step motors, controls, actuators, lead screws, precision ball screws, clutches and brakes, and aluminum and copper coils.

CIRCLE NO. 455

Wavetek. Electronic test instruments.

CIRCLE NO. 456

Burroughs. Business machines, components, computers, minicomputers and peripheral equipment, data processing and terminal products and systems, small application machines and system software and programming aids.

CIRCLE NO. 457

Decision Data Computer Corp. Computers.

CIRCLE NO. 458

RCA. Consumer and commercial electronic products and services, broadcasting, vehicle renting and related services, communications, government electronics and R&D.

CIRCLE NO. 459

The Charles Stark Draper Laboratory. Research and development.

CIRCLE NO. 460

**Bulletin
Board**

Westinghouse Electric's semiconductor division has been granted JAN qualification for its 1N3164 series of high-power rectifiers.

CIRCLE NO. 461

Low-voltage avalanche zeners, 1N6082 through 1N6091, from TRW Power Semiconductors have received JEDEC registration.

CIRCLE NO. 462

ITT Semiconductors has introduced 53 commercial interface circuits, which are pin-to-pin compatible with existing popular circuits.

CIRCLE NO. 463

Siemens has announced a low-cost version of the standard JAN and JANTX 1N821-1N829 series 6.2-V temperature compensated reference diodes. Prices start at \$2.36 (1000 qty).

CIRCLE NO. 464

Hitachi, Ltd., has developed a system model for digital control of electric power systems. This system has the facility to simulate in large scale, and can be combined with computers to verify the over-all performance of various computerized control equipment.

CIRCLE NO. 465

Advanced Micro Devices has licensed Raytheon Semiconductor to build its proprietary 2900 series bipolar μ P IC family. The pact initially transfers technical assistance for production of the Am-2901 microprogrammable processor slice and the Am2909 microprogram sequencer.

CIRCLE NO. 466

Bodine Electric has introduced the 32A and 32D permanent-magnet drives for OEM applications. The drives have standard continuous duty motor ratings of 1/12, 1/10 and 1/8 hp at 2500 rpm; they measure 3.55 in. dia and are totally enclosed, nonventilated, reversible designs.

CIRCLE NO. 467

Electronic Design

Advertising Sales Staff

Tom W. Carr, Sales Director

Rochelle Park, NJ 07662

Robert W. Gascoigne
Daniel J. Rowland
50 Essex Street
(201) 843-0550
TWX: 710-9990-5071

Philadelphia

Thomas P. Barth
50 Essex Street
Rochelle Park, NJ 07662
(201) 843-0550

Boston 02178

Gene Pritchard
P.O. Box 379
Belmont, MA 02178

Chicago 60611

Thomas P. Kavooras
Berry Conner, Jr.
200 East Ontario
(312) 337-5088

Cleveland

Thomas P. Kavooras
(Chicago)
(312) 337-0588

Los Angeles 90045

Stanley I. Ehrenclo
Burt Underwood
8939 Sepulveda Boulevard
Los Angeles, CA
(213) 641-6544

Texas/Oklahoma

Burt Underwood
(Los Angeles)
(213) 641-6544

San Francisco 94040

Robert A. Lukas
3579 Cambridge Lane
Mountain View, CA 94040
(415) 965-2636

London, Amsterdam, Tokyo, Seoul

Malcolm M. Thiele
Wood Cottage, Shurlock Row
Reading RG 10-QE, England
Phone: Shurlock Row 302 &
619
S.T.D. 073 581

Sanders B.V.

Raadhuisstraat 24
Graft-De Ryp, Holland
Phone: 02997-1303
Telegrams: Euradteam-Am-
sterdam

Haruki Hirayama

Electronic Media Service
5th Floor, Lila Bldg.,
4-9-8 Roppongi
Minato-ku, Tokyo, Japan
Phone: 402-4556
Cable: Electronicmedia, Tokyo

Mr. O-kyu Park, President

Dongbo Intl Corp.—
World Marketing
C.P.O. Box 4010
Seoul, Korea
Tel. 76-3910/3911
Cable: DONGBO SEOUL
Telex: EBKOREA K27286

ABP

BPA

WATERS OFFERS the best answer to your servo feedback problem

Designed with computer programmed correction, Waters conductive plastic pots and elements are the answer to your most difficult servo feedback application. They offer long rotational life, low output smoothness, low static noise, and infinite resolution in rotaries from 1/2" to 2" diameters with accuracy to 0.1% terminal linearity. Elements are built to your specifications from 1/2" to 40" in length to almost any resistance value.

Waters customer service team includes an engineering services group which processes every customer inquiry and will consult with you to review existing applications and provide assistance on new ones.

Call Bob Waters at 617-358-2777 or circle reader service card for complete catalog.

We're ready to serve you.

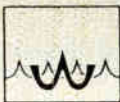

**WATERS
MANUFACTURING,
INC.**

Longfellow Center
Wayland, MA 01778 617-358-2777

CIRCLE NUMBER 178

CUSTOM MICA CAPACITORS for High Current, High Voltage Applications

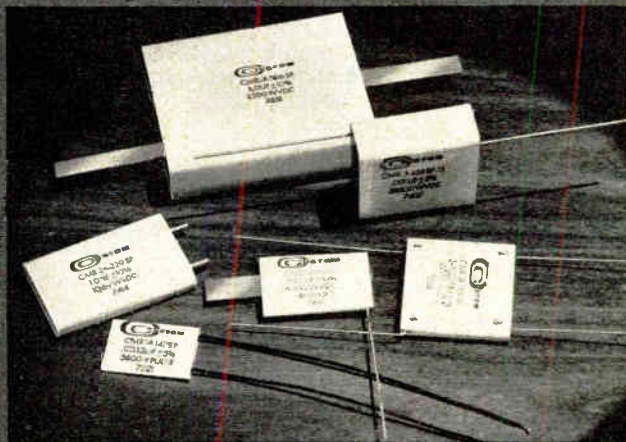

CMR "wrap and fill" mica capacitors offer maximum energy density within minimum volume. CMR types are wrapped in polyester tape, and have an epoxy compound end fill.

CMR types are available in a variety of terminations including wire leads, threaded studs, and heavy ribbon tabs for high current applications. CMR types are ideally suited for encapsulated or hermetically sealed applications.

Designers ... Look:

- No oil to leak
- Unbreakable
- High dielectric strength
- Small Size

To see how Custom Electronics can fill your requirements, write for FREE descriptive CMR Techni Tip, and general Techni Tip including sample of mica dielectric.

Send for FREE Product Brochures



CUSTOM ELECTRONICS, Inc.

4 Browne Street, Oneonta, N.Y. 13826
PH: (607) 432-3880 TWX: 510-241-8292

CIRCLE NUMBER 179

Manufacturers

Advertisements of booklets, brochures, catalogs and data sheets. To order use Reader-ServiceCard (Advertisement)

Electronic Design

ELECTRONIC DESIGN's function is:

- To aid progress in the electronics manufacturing industry by promoting good design.
- To give the electronic design engineer concepts and ideas that make his job easier and more productive.
- To provide a central source of timely electronics information.
- To promote communication among members of the electronics engineering community.

Want a subscription? ELECTRONIC DESIGN is sent free to qualified engineers and engineering managers doing design work, supervising design or setting standards in the United States and Western Europe. For a free subscription, use the application form bound in the magazine. If none is included, write to us direct for an application form.

If you do not qualify, you may take out a paid subscription for \$30 a year in the U.S.A., \$40 a year elsewhere. Single copies are \$1.50 each.

If you change your address, send us an old mailing label and your new address; there is generally a postcard for this bound in the magazine. You will have to requalify to continue receiving ELECTRONIC DESIGN free.

The accuracy policy of ELECTRONIC DESIGN is:

- To make diligent efforts to ensure the accuracy of editorial matter.
- To publish prompt corrections whenever inaccuracies are brought to our attention. Corrections appear in "Across the Desk."
- To encourage our readers as responsible members of our business community to report to us misleading or fraudulent advertising.
- To refuse any advertisement deemed to be misleading or fraudulent.

Microfilm copies are available of complete volumes of ELECTRONIC DESIGN at \$19 per volume, beginning with Volume 1, 1952 through Volume 20. Reprints of individual articles may be obtained for \$3.00 each, prepaid (\$.50 for each additional copy of the same article) no matter how long the article. For further details and to place orders, contact the Customer Services Department, University Microfilms, 300 North Zeeb Road, Ann Arbor, Michigan 48106 telephone (313) 761-4700.

Want to contact us? If you have any comments or wish to submit a manuscript or article outline, address your correspondence to:

Editor
ELECTRONIC DESIGN
50 Essex Street
Rochelle Park, N.J. 07662

GIANT FREE CATALOG

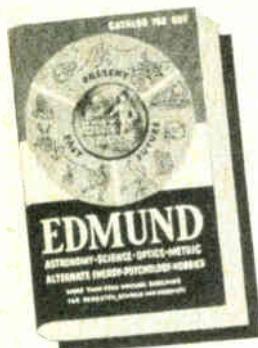

New 172-page catalog! Packed with 1,000's of hard-to-find buys in Optics, Science, Electronics. Loaded with optical, scientific, electronic equipment available from stock. Rare surplus buys. Many "one-of-a-kinds". Ingenious scientific tools. Components galore: lenses, prisms, wedges, mirrors, mounts, accessories. 100's of instruments: pollution test equipment, lasers, comparators, magnifiers, microscopes, projectors, telescopes, binoculars, photo attachments, alternate energy sources. Shop, save by mail! Request free Catalog "DA".

CIRCLE NO. 247

Edmund Scientific Co.

America's Largest Science-Optics-Electronics Mart
300 Edscorp Bldg., Barrington, New Jersey 08007 (609) 547-3488

Share in the nation's top managerial policies, strategies, techniques . . .

MANUFACTURING MANAGEMENT SYSTEMS

New Challenges and Opportunities Edited by Fred Gruenberger



By crystallizing the results of the 1973 Informatics/UCLA Symposium, this book offers a powerful blend of technical and managerial expertise for enhancing the overall success and profitability of today's manufacturing management systems. Some of the nation's top industrial and technical leaders speak freely and in depth of their organization's objectives and specific operations, as well as their personal strategies and methods. You'll find the newest computerized tools available to manufacturers . . . crucial managerial skills for directing progressive systems . . . the tact and care needed for the sensitive human problems of system implementation, and more. #5940-x, 160 pages, \$10.50. Circle the Info Retrieval No. to order a 15-day exam copy. When billed, remit or return book. No obligation.

CIRCLE NO. 248

Hayden Book Company, 50 Essex St., Rochelle Pk, N.J. 07662

Are you using the #1 training courses in electricity & electronics?

BASIC ELECTRICITY and BASIC ELECTRONICS

By Van Valkenburgh, Nooger & Neville, Inc.



Derived from the COMMON-CORE Training Program initially developed for the U.S. Navy, these unique texts are now about to enter their third decade of use in schools, industries, and communication utilities. They continue to be exemplary training texts in their subjects. Carefully integrated illustrations comprise almost half the course material. These perform a remarkable job of visualizing complex theory and applications. Readers are able to grasp essential concepts right away without having to wade through pages of wordy explanation. Thorough, comprehensive coverage. Available in separate paperbacks or one cloth volume. Write for FREE brochure.

CIRCLE NO. 249

Hayden Book Company

50 Essex St. Rochelle Pk, N.J. 07662

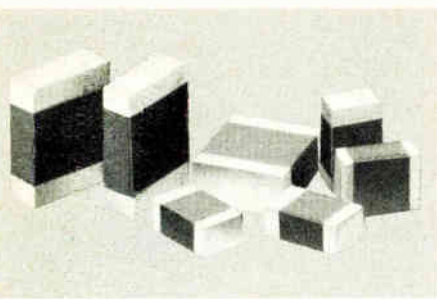

HIGH Q MULTILAYER CAPACITORS feature very high quality factors at microwave frequencies. Offered in three standard sizes: .050 x .040, .080 x .050, .125 x .095. Capacitance values from 0.1 pf to 1000 pF with close tolerance and voltages to 1000 VDCW. Johanson/Monolithic Dielectrics Div., Box 6456, Burbank, Ca. 91510, (213) 848-4465.

MULTILAYER CHIP CAPACITORS 201

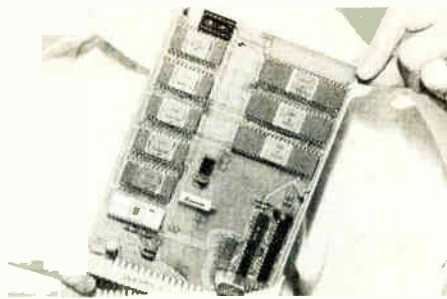

"FREE" MICROCOMPUTER consisting of M6800, RAM, PIA, ACIA, ROM with monitor/debugger to allow stand-alone development of small programs. . . . Fully expandable to 64K bytes . . . included in \$495 tuition for hands-on μ P workshop. Use it at workshop then take it home. March 15-17, San Diego; March 31-Apr 2, St. Petersburg; Apr 5-7, Vienna. WINTEK CORPORATION, 902 N. Ninth St., Lafayette, IN 47904. (317) 742-6802.

MICROPROCESSING COURSE 204

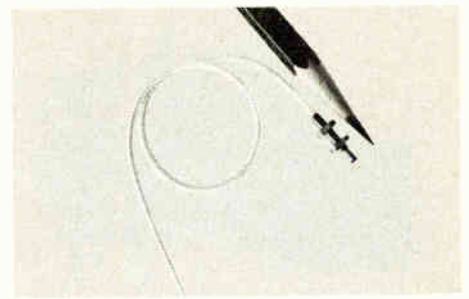

World's Smallest Displacement Transducer. Make precision, noncontacting displacement measurements at points never before possible. This new transducer, 0.080" OD, gives accuracy of $<100 \mu\text{in.}$ in a range up to 0.020". Temperature stable. Repeatability and resolution is better than $10 \mu\text{in.}$ Price \$485, including associated electronics. Kaman Sciences Corporation, P. O. Box 7463, Colorado Springs, CO 80933. (303) 599-1892.

TRANSDUCER 207

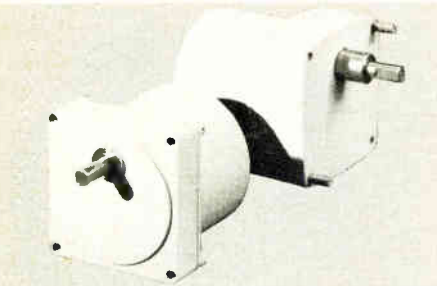

Dual Speed Unidirectional Synchronous Motor (Series 86000) offers advantages for instrument drives, especially strip chart recorders and telecopiers. Available torque to 35 oz-in. Choice of square or NEMA 2-11 gear box gives wide range of dual speed combinations. Fast start/stops eliminate need for clutching and prestarts. Available in 24, 120 or 240 VAC, 60 Hz, with CW or CCW rotation. Weight 30 oz. U/L listed. North American Philips Controls Corp. Cheshire, Conn. 06410 (203) 272-0301.

DUAL SPEED SYNCHRONOUS MOTOR 202

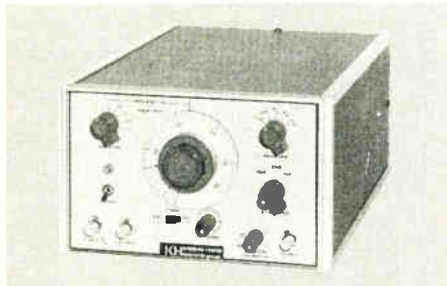

MULTI-PURPOSE FUNCTION GENERATOR Krohn-Hite's Model 5100A offers 8 types of waveforms; sine, square, triangle, pos. & neg. ramps, sawtooth, and pos. & neg. pulses from 0.002Hz to 3MHz. The symmetry control allows a 100:1 range for waveform variation. It has a 1000:1 (VCO) range and features a calibrated (dB) attenuator. Ideal for a broad scope of applications. Only \$495. Krohn-Hite Corp., Avon Industrial Park, Avon, MA 02322 (617) 580-1660

FUNCTION GENERATOR 205

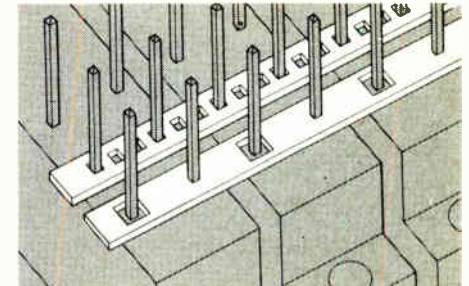

STRIP/BUS BY ROGERS. Low Cost Bussing Systems; easy installation, reliable solder joints; greater pin exposure. Write or call for details. Rogers Corporation, Rogers, CT 06263. Phone (203) 774-9605.

STRIP/BUS 208

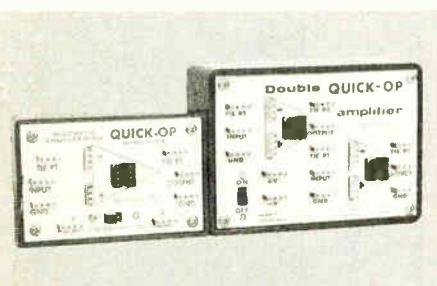

Tool, Teaching-aid, Time-saver, Toy? Quick-Ops are all of these at least. Panels are functional. No clutter of rarely used, unidentified tie-points or trivia obscure circuit function. Just stuff resistors, diodes, capacitors etc. into quad solderless connectors to make hundreds of op-amp circuits. New models 101 at \$14.95 and 201 at \$24.95—which add sockets for 741 pin-outs—are added to the Quick-Op line. Two 9 volt batteries mount inside for $\pm V$. —Hildreth Engineering P.O. Box 3, Sunnyvale, CA 94088 408-245-3279

QUICK-OPS 203

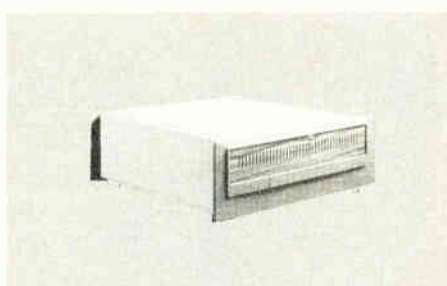

OptimaPAK features molded NORYL[®] side panels with retracting handles. Front and rear panels are part of a chassis that slides out the front for easy access. Available in 17" and 19" panel widths and 4 panel heights. Optima Division, Scientific Atlanta, Inc., 2166 Mtn. Industrial Blvd., Tucker, GA 30084. Ph. 404-939-6340.

ELECTRONIC ENCLOSURES 206

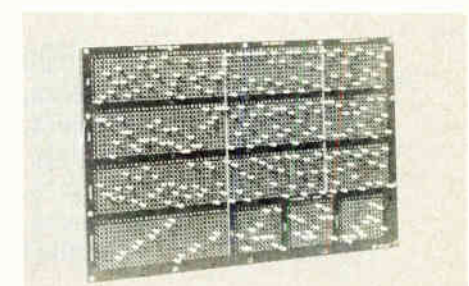

Matrix Program Boards designed to custom specification, provide a reliable and simple method for connecting complex networks while maintaining maximum switching flexibility. Units can be supplied on either .250, .125 or .100 centerlines, with up to 15,000 crosspoints; both Shorting and Diode Pins are available. Pricing for special prototype quantities starts at \$.15 per crosspoint, delivery 4-6 weeks ARO. LVC Industries Inc., 135-25 37th Avenue, Flushing, New York 11354, (212) 939-9777.

MATRIX BOARDS 209

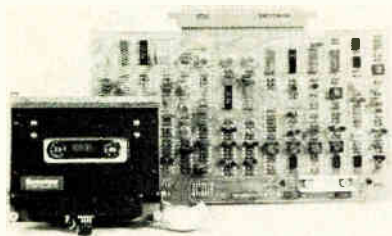

Memodyne Model 763 High Speed Magnetic Tape Cassette Recorder. For Computer or terminal peripheral storage. Records and playsback at 20 IPS. Searches at 120 IPS. Uses patented servo system for constant speed. Has only two moving parts. For literature contact Memodyne Corporation, 385 Elliot Street, Newton, MA 02164.

CASSETTE RECORDER

210



DISPLAY ASSEMBLIES: compact, expandable, easy to install. Utilizing 0.43" high character LED or 0.55" high character gas discharge display. The module contains all plug-in electronic components, including, indicators, decoder/drivers and current limit resistors. Accepts 4 lines BCD input. Available in 1½-, 2-, 2½- and 3 digit modules in two case-styles. CANYON ELECTRONICS, 2001 W. North Lane, Phoenix, AZ 85021 (602) 944-4421

LED DIGITAL DISPLAYS

213



Low-cost tape reader is fast—up to 30 cps—and quality-built. Dual sprocket drive, a state-of-the-art fiber optic light source and photo transistor read head. Simplicity of design is what makes it so reliable, so easy to adapt to specific OEM requirements. Decitek, 250 Chandler Street, Worcester, MA 01602 (617) 798-8731

SAMR TAPE READER

214



Model P203 ultrasonic pulser module drives piezoelectric transducers. Simplify ultrasonic system design. High energy negative spike output pulse typically has 7 nanosecond risetime and 230 volt amplitude into 50 ohms. Pulse repetition rate variable to over 10 kHz. TTL compatible sync output and external positive and negative trigger inputs. Operating temperature -40 to +70°C. Plug-in module measures 2.0 x 1.8 x 0.68 inches. METRO-TEK, INC., P.O. Box 101, Richland, WA. 99352. (509) 946-4778.

ULTRASONIC PULSER MODULE

211



DIGITAL SIGNAL ANALYSIS, S. Stearns. Contains the most recent advances, brand-new design material, and a comparison between continuous and digital systems, making it an ideal master reference to today's signal processing techniques and systems. #5828-4, 288 pages, \$18.95. Circle the Info Retrieval Number to order 15-day exam copy. When billed, remit or return book with no obligation. Hayden Book Co., 50 Essex Street, Rochelle Park, N.J. 07662.

DIGITAL SIGNAL ANALYSIS

214



"Synchro to digital converters - 10, 12 or 14 bit output, errorless tracking up to 4 r.p.s., accuracy ±4 min. of arc ±.9LSE resolution - 1.3 minutes, 60 or 400 Hz input, Module 2.6 x 3.1 x .82" H, Price From \$350 in qty. Computer Conversion Corp., East Northport, N.Y. 11731 (516) 261-3300."

SYNCHRO TO DIGITAL

215



over 500 systems, detectors, controls, sounders, tools, locks, supplies

FREE ALARM catalog. Huge selection of hard-to-find security equipment from stock. Highest quality burglar-fire systems, supplies, to protect home, business, industry: motion detectors, infrared beams, ultrasonics, radar, magnetic contacts, smoke & heat detectors, controls, door switches, bells, sirens in 96 fact-filled pages with technical details, diagrams, notes. (Outside U.S. send \$1). Mountain West Alarm, 4215 N. 16th St., Phoenix, AZ 85016 (602) 263-8831.

SECURITY ALARM CATALOG

212



Basic Electricity & Basic Electronics by Van Valkenburgh, Nooger & Neville, Inc. Derived from the COMMON-CORE Training Program initially developed for the U.S. Navy. Thorough, comprehensive coverage. Available in separate paperbacks or cloth volume. Write for FREE brochure. Hayden Book Co., Inc., 50 Essex St., Rochelle Pk, N.J. 07662 (201) 843-0550.

TRAINING TEXT

215

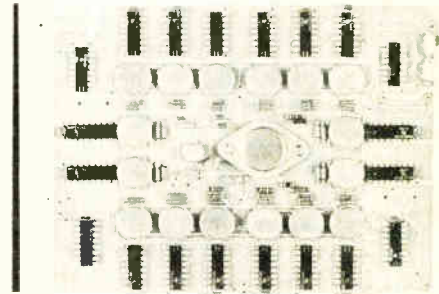

The 5 bit A/D converter constructed on single printed circuit card. Total throughput time 50 n sec, with 20 MHz update rate. Temperature stability over full mil range -55°C to +125°C with drift less than ±1 bit over entire range. For further information contact Ron Seibold. M.S. Kennedy Corp.; Pickard Dr, Syracuse, N.Y. 13211 (315) 455-7077.

CONVERTER

216

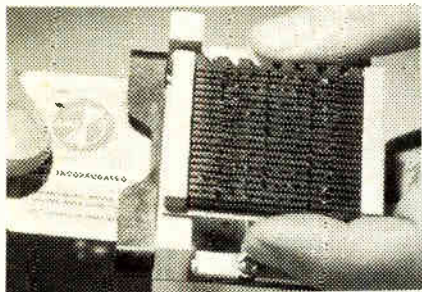

Here new high security starts at low, bank-and-key prices. The AMP 130 Security Card Reader is a high reliability first access control—hotels, motels, offices or time keeping, personnel identification, etc. No external power. No complex mechanisms. Operates with insertion of standard 2 1/8 x 3 3/8" punched card. 1-bit capacity. Never needs adjustment or preventive maintenance. AMP Capatron Division, Elizabethtown, Pa. 17022 (717) 37-1105.

SECURITY CARD READER

219

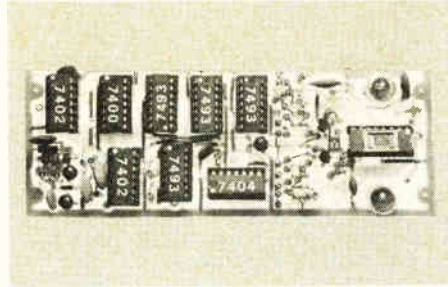

Low Cost Image Sensing Module contains a 1024 element (32-by-32) image sensor and all support circuitry on a single pc board. Digital video output may be displayed directly on an oscilloscope. Complete module (SE1024W) is \$150. Kit (SE1024K) is \$90. Cromemco, 1 First St., Los Altos CA 94022 (415) 941-2967.

MODULE

222

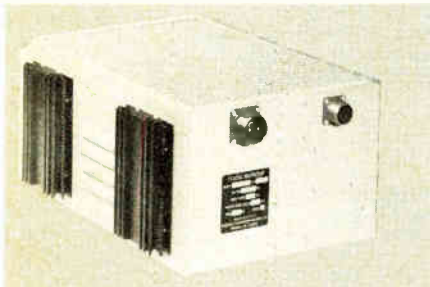

STATIC INVERTERS • SOLID STATE DC
AC Ruggedized Construction for Fixed Use, Marine, Mobile and Remote applications. Standard models operate from 24, 32, 48 or 120VDC source • Special DC inputs • full Sine Wave AC output • Voltage/Amp rated power sizes: 10 models from 36 VA thru 5 KVA • Typical specs include: Regulation-Volts $\pm 2\%$; Hz $\pm 1\%$; 5% RMS Max. Dist'n • Temp -40 to 71°C • Humidity 100% • MTBF 50K. ADVANCE CONVERSION DEVICES CO., 109 Eighth St., Passaic, NJ 07055

SEE OUR PAGES IN GOLD BOOK

220

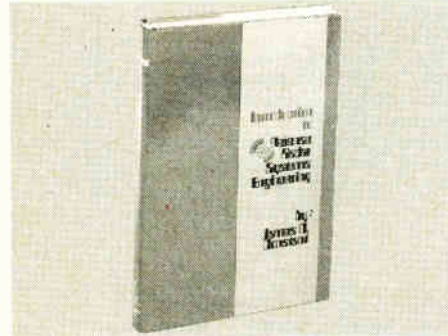

Introduction To Defense Radar Systems Engineering. Excellent introduction and practical reference to radar systems design and applications. #9194, 260 pp., \$22.95. Circle the Info Retrieval No. to order 15-day exam copy. When billed, remit or return book with no obligation. Hayden Book Co., 50 Essex St., Rochelle Park, N.J. 07662

RADAR SYSTEMS

223

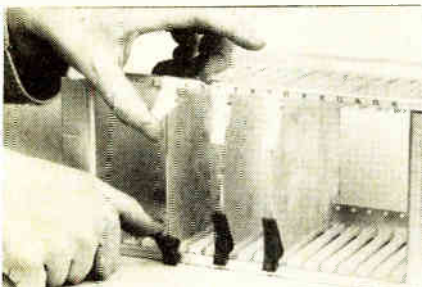

FREE SAMPLES of low-cost Electro-Flex card guides and ejectors. Guides in 4 lengths have built-in bow to aid card retention. Ejectors have longer sure-grip handle for improved leverage and damage-free extraction; stainless roll pins included. Both in UL-approved nylon. Card rack literature also available. Electro-Flex Fabricators, Topton, Pa. 19562. (215) 682-7181.

CARD GUIDES-EJECTORS

221



Free Carlingswitch catalog contains complete specs of electronic, appliance control and special use switches. Included are electrical ratings, circuit variations and basic exterior dimensions for toggle, slide, push, rotary, tippette and new sub-miniature switches. Catalog also illustrates lighted switches (curved rocker, mini-tippette, paddle) plus switch accessories (indicator plates, toggle covers, decorator nuts, etc.) CARLINGSWITCH INC, 505 New Park Ave., West Hartford CT 06110 (203) 233-5551.

FREE SWITCH CATALOG

224

Advertisers wishing to reserve Quick Ad units should note the following mechanical requirements: Specs—Supply glossy photo of product and approximately 40 words which will set no more than 10 lines of 34 characters each. AFTER SUBMISSION NO COPY CHANGES CAN BE ACCEPTED. Quick Ads cost only \$325 per insertion, less for frequency advertisers.

RATES:

1x
\$325

7x
\$300

13x
\$275

19x
\$270

26x
\$265

39x
\$260

52x
\$255

104x
\$250

Advertiser	Page
Molex, Incorporated	254
Monsanto Company	129
Monsanto, United Systems Corporation Subsidiary	195
Mostek Corporation	154, 155
Mountain West Alarm	248

National Semiconductor Corporation	63
Nichicon America Corporation	86
North American Philips Controls Corp.	186, 247

Oak Industries, Inc.	238
Omron Corporation of America	198B-C

Panduit Corporation	211
Penril Corp.	219
*Philips Industries, Electronic Components and Materials Division	215
*Philips Industries, Test and Measuring Dept.	222, 223
Phoenix Data, Inc.	224
Piezo Technology, Inc.	218
Pomona Electronics, A Division of ITT	198
Potter & Brumfield Division AMF, Incorporated	65
Power Conversion, Inc.	234
Power/Mate Corp.	50
Precision Monolithics, Incorporated	18

RCA Solid State	Cover IV
RCL Electronics, Inc.	23
Radio Switch Corporation	238
Reader Service Card	254A-B
Reliability, Inc.	196
Repeco, Incorporated	207
Robinson Nugent, Incorporated	166B-C
Rockland Systems Corporation	193
Rockwell International	16
Rogers Corporation	237, 247
Rohde & Schwarz	17, 223

Scientific Atlanta, Inc., A Division of Optima Division	247
Sencore, Inc.	243
Servometer Corporation	211
Shelly Associates	87
Sola Electric, Division of Sola Basic Industries	205
Solitron Devices, Inc.	139
Sorensen, a Raytheon Company	8, 9
Spectrol Electronics Corporation	97

Advertiser	Page
Sprague Electric Company	10
Stacoswitch, A Staco Inc. Company	228
Stahlin Brothers Inc.	238
Standard Grigsby, Inc.	206
Superior Flux Company	231
Sweda International/OEM Products	253
Synertek	143

T-Bar, Incorporated	233
TRW/IRC Resistors, an Electronic Components Division of TRW, Inc.	76
TRW Capacitors, an Electronic Components Division of TRW, Inc.	96
TRW Power Semiconductors, an Electronic Components Division of TRW, Inc.	173
Technical Materials, Inc.	182
Technipower, Inc., A Benrus Subsidiary	221
Technitrol, Inc.	205
Tektronix, Inc.	4, 5, 47, 49
Teledyne Crystals	141
Texas Instruments, Incorporated	167
Theta Instrument Corp.	225
Thermal American Quartz Company	217
Todd Products Co.	241
Topaz Electronics	191
Triplet Corporation	166A

USCC/Centralab Electronics Division, Globe-Union, Inc.	181
United States Department of Commerce	242
United Systems Corporation, A Subsidiary of Monsanto	195
Universal Data Systems	11

Vactec, Inc.	Cover III
Vernitron Controls Components, A Division of Vernitron Corporation	194
Vero Electronics, Inc.	217
Viking Industries, Inc.	197

Waters Manufacturing, Inc.	245
Wavetek San Diego, Inc.	1
Wells Electronics Inc.	234
Wescon	169
Weston Instruments, Inc.	43
Wintek Corporation	247

*Advertisers in non-U.S. edition

Only with an EMR Real-Time Spectrum Analyzer...

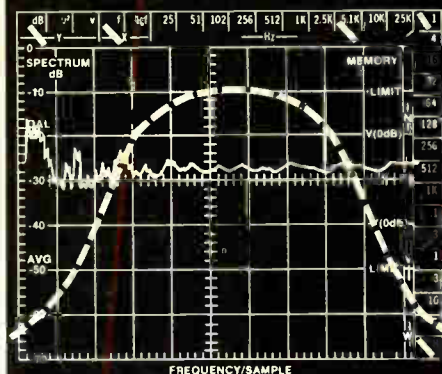

A Rectangular Window for Transient and Order Analysis

EMR Real-Time Spectrum Analyzers are not restricted by a single window function. Our rectangular window allows accurate analysis of transient data type signals . . . without the restriction imposed by arbitrarily shaped windows. Competitive equipments utilize a window function analogous to the dashed line superimposed on the CRT display shown above. All data above the dashed line would have been severely restricted. Why lose vital data!

That's not all . . . other features include 60dB dynamic range, LED readout, computer interface, CRT status display, and much more!

Only From EMR!



EMR EMR
Schlumberger

EMR Telemetry
Weston Instruments, Inc.
Box 3041, Sarasota, Florida 33578
813-371-0811

Product Index

Information Retrieval Service. New Products, Evaluation Samples (ES), Design Aids (DA), Application Notes (AN), and New Literature (NL) in this issue are listed here with page and Information Retrieval numbers. Reader requests will be promptly processed by computer and mailed to the manufacturer within three days.

Category	Page	IRN	Category	Page	IRN	Category	Page	IRN
Components			varistors, ceramic	192	335	VOM	64	36
batteries	234	155	Data Processing			Integrated Circuits		
buzzer, solid-state	244	176	annunciator, voice	220	390	amplifiers, linear IC	228	145
capacitors	6	5	cleaner, demag cassette	218	384	calculator	188	327
capacitors	96	44	computer	136	55	circuit, osc	188	328
capacitors	128	51	digital recorder	195	245	controller	184	309
capacitors	181	78	disc drive	224	394	converter	184	310
capacitors, chip	198	345	generator/reader	238	165	counter	190	331
capacitors, mica	199	348	interface system	221	392	DAC	184	320
capacitors, mica	245	179	large capacity memories	229	146	divider	190	330
circuit breakers	127	50	loop-current regulator	220	388	microprocessor	16	12
components	48	27	memory, TV	224	395	PROM programmers	205	111
display, alphanumeric	192	337	modems	19	15	RAM	186	323
filters, crystal	218	131	plotter control unit	218	386	RAM	190	332
indicators	184	81	portable tape recorder	189	241	RAM, 4-k	63	35
indicators	198G	196	programmer	218	385	RAM, 4-k	158	65
indicators, lamp	199	347	programmer, FPLA	224	396	ROM, erasable	184	322
motors	221	136	reader/punch	227	144	ROMs	186	324
passive components	10	8	recorder/reproducer	152	62	reference	188	326
photodetectors	III	283	strip-chart recorder	237	162	register	184	321
photoelectric scanner	196	344	tape copier	221	391	regulators	188	329
photomultiplier tube	239	168	tape drive, cassette	218	387	SCR arrays	188	325
potentiometers	97	45	tape preparation unit	224	393	transceivers	190	333
printhead, thermal	192	334	terminal	168	70			
relays	65	37	terminal, editing	220	389			
relays	178	76				Microprocessor Design		
relays	204	109	Discrete Semiconductors			computers, mini	142	509
relays, reed	220	135	diodes, reference	232	411	kit, microcomputer	137	502
relays, reed	244	177	isolators, opto	232	409	logger, data	142	508
relays, solid-state	220	134	LEDs	44	25	microcomputer	137	501
resistor networks	194	340	LEDs, multicolor	230	403	module, μ P	140	506
resistors	21	16	LEDs, stackable	232	410	package, software	140	505
resistors	173	73	power transistors	139	57	software, μ P	140	507
resistors, thin-film	198	346	SCRs	IV	284	software, μ P	142	510
resistors, trimmer	196	342	SCRs, high power	232	408	system, data acq.	137	503
resistors, wirewound	192	336	switch, optical	230	405	valve, digitally controlled	138	504
solenoids	198E	194	transistors, power	232	407	μ C dictionary	234	156
stepper motor	186	83	transistors, rf power	230	406	μ C handbook	187	84
switch, PB	198H	197	transistors, switching	230	404	μ P memory	75	38
switch, PB	238	166	zeners	76	39	Microwaves & Lasers		
switch catalog	243	173				amplifier	236	419
switch, coded	196	341	Instrumentation			discriminator	236	417
switch, solid-state	35	231	controller	227	397	laser	235	415
switches	7	6	DMM	228	401	log amps	235	416
switches	59	34	DMM, 3-1/2 digit	15	251	mixer	236	420
switches	180	77	DMM, 4-1/2 digit	253	181	oscillator	235	413
switches	208	114	DVM, portable	243	174	protector limiter	235	414
switches	233	154	frequency synthesizer	153	63	TWT	235	412
switches	236	160	frequency synthesizer	193	91	up/down converter	236	418
switches, PB	199	104	load cells	233	152			
switches, ceramic	238	164	logic analyzer	227	398	Modules & Subassemblies		
switches, mercury reed	199	350	oscilloscope, portable	47	243	a/d converter	190	86
switches, optical	234	157	oscilloscopes	49	271	a/d converter	224	138
switches, rotary	191	87	panel meters	209	115	amplifier, rf	200	355
switches, rotary	206	112	panel meters	214	121	amplifier, isolator	204	361
switches and indicators	229	147	radiometer	228	400	black boxes	198	103
synchros and resolvers	194	92	rental instruments	116	48	converter, syncho	204	359
transformer	191	88	scope	228	402	converters, a/d and d/a	200	357
transformers	233	159	scope, plug-in	5	273	converters, rms-to-dc	200	351
trimmer, cermet	II	282	spectrum analyzer	251	180	converters, rms-to-dc	202	356
trimmers	117	49	synthesizer	1	2	counter, predetermining	200	353
trimmers	213	120	synthesizer	228	399	displays	87	43
trimmers, cermet	198A	191				displays	145	61

Category	Page	IRN
displays	183	80
divider, dedicated	204	358
hybrid circuits	141	58
interface module	200	352
memory, semiconductor	200	354
motor and drive system	225	139
rf links	182	79
recorder modules	192	90
regulators, voltage	204	360
Packaging & Materials		
beryllium springs	177	75
boards, DIP	212	376
bus	237	163
cable ties	194	93
card frames	217	128
cards, circuit	216	383
coating, ceramic	210	373
connector, PC	197	102
connector, right-angle	212	377
connectors	41	22
connectors, circuit board	206	363
digitizer, artwork	207	468
encapsulant, epoxy	212	375
enclosures	243	175
files, card	208	369
flat cable/connector		
sys.	198D	193
flat cable mount	211	119
flux	231	151
foil, metallic	210	370
headers, DIP	206	362
hooks	231	149
IC sockets	198F	195
interconnection system	175	74
investment casting		
process	240	169
knobs	225	140
laminates, PC board	208	365
machine, insertion	214	379
machine, marking	207	469
magnetic shield	240	170
material, mica-filled	206	364
PC boards	22	17
panels, IC	210	372
paste, silver	208	366
pastes, solder	208	367
patterns, PC etch	216	382
remover, chip	216	380
resins	212	287
shredder, paper	216	381
socket contacts	254	182
sockets, DIP	234	158
sockets, relay	237	161
splitter, flat cable	214	378
standoffs and spacers	231	150
terminal blocks	85	41
terminals	191	89
test clip, DIP	208	368
waveguide, optical	210	371
welder, electron beam	212	374
Power Sources		
charger/inverter systems	188	85
frequency changer	179	302
lab supplies	180	303
modular sources	182	308
modular units	180	304
open-frame	182	307
potted modules	180	305
power source	179	301
power sources	196	101
power supplies	9	7
power supplies	50	29
power supplies	205	110
power supplies	215	122
power supply	241	171
power-supply catalog	221	137
switcher	180	306

our quiet one

Our low noise, punched tape I/O desktop unit, is designed to satisfy numerical control, graphic arts, data communications and computer peripheral applications.

It accommodates oiled paper, dry paper, metallized mylar, sandwich paper/mylar/paper and polyester... 5, 6, 7 or 8-level tapes. And, it's TTL/DTL compatible.

Asynchronous punching at up to 60 characters per second. Photoelectric reading at up to 150 characters per second, start/stop. Synchronous reading at up to 250 characters per second. Via a highly reliable stepping motor tape transport. At OEM prices.

For full details, write or call us.

OEM PRODUCTS
SWEDA INTERNATIONAL
 Litton 34 Maple Avenue, Pine Brook, N.J. 07058/(201) 575-8100

IN U.K. — ADLER BUS. SYSTEMS/OEM PRODS., Airport House, Purley Way, Croydon, Surrey, England
 IN FRANCE — SWEDA INTERNATIONAL/OEM, 103-107 Rue de Tocqueville, 75017 Paris, France

CIRCLE NUMBER 181

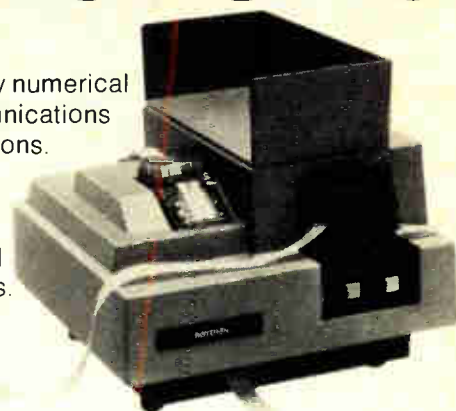

ROYTRON
Model 1560 Reader/Punch

High speed, compact, with integral electronics and power supply self-contained in a quietized housing



When you want more from your mini than data, get motomatic.®

Chances are that if your computer is doing more than producing data, then it is controlling some form of motion. MOTOMATIC is a complete range of computer interfaced motion control systems, such as Digital Contouring and Point to Point positioning systems, phase lock position and velocity controls, and analog position and velocity controls. Let us match your computer and our motion control systems (available off-the-shelf). Call us. Electro-Craft Corporation, 1600 Second St. South, Hopkins, Minnesota 55343. Phone: 612/935-8445.

CIRCLE NUMBER 182

Zipcon
Zipcon
Zipcon
Zipcon

The Designers Answer to Socket Contact Reliability

The new Molex closed entry LSI socket

Molex is proud to have ranked 2nd among socket manufacturers in performance in a 1975 mini-computer manufacturers test study. Why are we proud to be a runner-up? Well, the winner was a screw machine type part at three times the cost, that's why!! Proven reliability, quality features, and the economical price you have wanted in a closed entry socket is now available from . . . Molex, Incorporated.

The 6097 Closed Entry LSI Socket combines the time-tested quality of the Molex Soldercon™ 1938 Dual Beam contact with a new 94V-0 flame retardant polyester housing. This new combination allows insertion and withdrawal of fragile LSI's without damage while maintaining sufficient normal force for a reliable low-level electrical contact.

Key Features:

The Molex Soldercon™ features side bearing contacts. These contacts offer better overall contact reliability, mechanically, and electrically, because we are making contact with the main surface of the lead frame. Contact resistance remains constant after many insertions and withdrawals.

The 94V-0 black housing design incorporates many desirable features such as the closed entry cap . . . a tapered lead-in ramp to insure positive positioning of the LSI in the contact areas, and a closed socket base to prevent solder wicking during wave soldering.

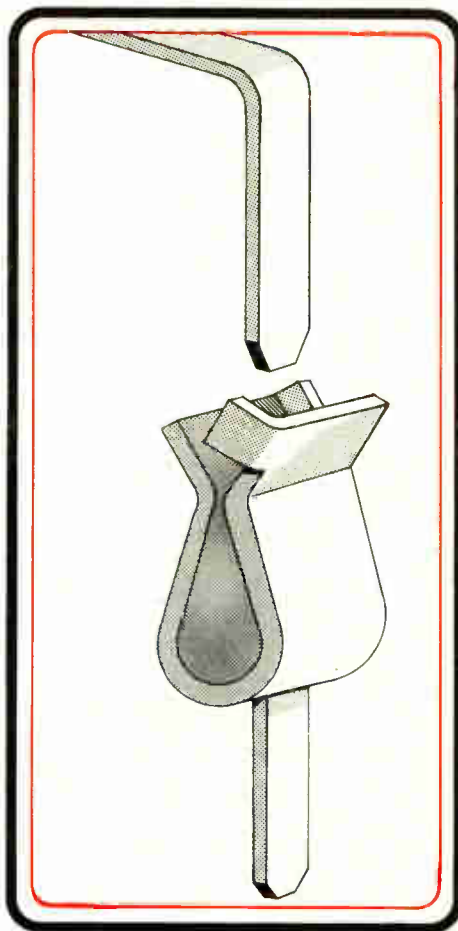
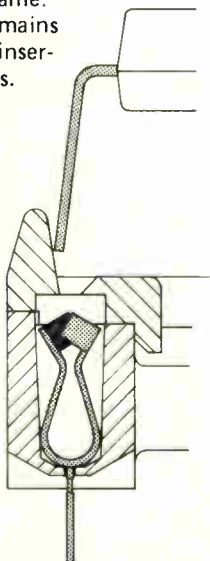

Options:

The 6097 is available in 24, 28, and 40 positions on .100 x .600 spacing. Contact platings and materials are available in tin, selective gold, and overall gold over brass or phos bronze material.

The 6097-N could be the answer to your socketting headaches at a very competitive price. For example, a 24 position socket at the 5,000 piece price level costs 24¢ each in tin.

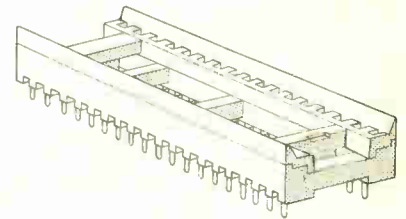

Literature:

For your FREE 6-page Socket flyer including line drawings and specifications of the Molex line, call (312) 969-4550; or write Molex Incorporated, 2222 Wellington Ct., Lisle, IL 60532.

Molex Service:

These sockets are backed by the Molex reputation for excellence in engineering, reflected in the quality and reliability of Molex affordable technology in interconnection and switch products.

Molex has a nationwide network of representatives and franchised distributors to handle your off-the-shelf and large quantity orders. Field engineers are at your service to solve your tooling problems.

molex . . . **Affordable Technology**

CIRCLE NUMBER 183

VACTEC brings you BLUE



Unlike our little Japanese friend, photodetectors have always been insensitive to blue. Until now.

Vactec's latest development is a new Blue Enhanced Silicon (BES) photodiode with exceptionally low dark current for efficient response in the blue region (200 - 400 nm). Made in Missouri, U.S.A., it performs equally well in an expensive Japanese SLR camera or in an American-made colorimetric analyzer as well. And you'll like the price, which could be as big a breakthrough as blue sensitivity. Vactec also introduces a new line of PIN photodiodes that operate at high voltages, low noise levels, and fast rise times, with about half the blue sensitivity of the BES photodiode. For larger areas, Vactec offers a complete range of Blue Enhanced Silicon photovoltaic cells up to 1 1/8" diameter.

Vactec now supplies the broadest line of photodetectors in the industry, including:

- silicon solar cells
- hi-speed/low-leakage silicon cells
- NPN phototransistors
- NPN photodarlingtons
- CdS & CdSe photoconductors
- CMOS & bi-polar custom ICs
- opto-couplers
 - a) LED/photoconductor
 - b) LED/phototransistor or darlington
 - c) lamp/photoconductor
- selenium photovoltaic cells

Call or write today:



Vactec, Inc.

**2423 Northline Industrial Blvd.
Maryland Heights, Mo. 63043
(314) 872-8300**

CIRCLE NUMBER 283



What's new in solid state...

RCA delivers the promise of GTO SCRs in an 8.5A series.

You've heard the GTO promise: a dependable, cost-effective switch that requires only a short negative power pulse to the gate for turn-off. Now RCA makes that promise. And delivers it with product.

Right now, you can choose from 18 RCA 8.5-ampere GTO SCRs available from RCA or through your distributors. At prices ranging from \$4.13 to \$11.47 for 1 to 99 units, from \$2.50 to \$6.95 at 1K.

Marriage of technologies

RCA is in GTOs to stay. We're that confident of the combination that made them possible: high

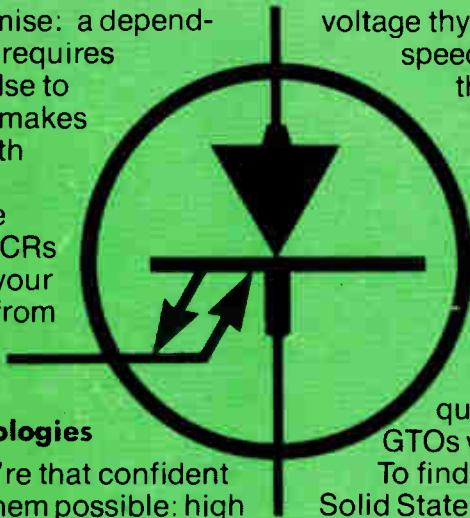

voltage thyristor technology combined with high speed transistor technology. You get everything a conventional 8.5-A SCR offers: normal inrush handling capability, pulse turn-on, operating range to 125°C. Gate turn-off capability is a bonus.

RCA GTOs come in the TO-3 package, in a choice of voltages: 100, 200, 300, 400, 500 and 600 V. They offer high peak-to-average current ratio, 20 kHz operating frequency. For the future, we're working on GTOs with higher current and higher speeds. To find out more, contact your local RCA Solid State distributor. Or RCA.

Write: RCA Solid State, Box 3200, Scmerville, New Jersey 08876; Ste. Anne de Bellevue 810, Canada; Sunbury-on-Thames, U.K.; Fuji Bldg., Tokyo, Japan.

RCA



SWITCHING CHARACTERISTICS For high-, medium- & low-frequency applications.

		G5001	G5002	G5003
		70 V	70 V	50 V
I_{TGOM}		15 A	15 A	15 A
t_{gq}	t_s	1 μ s	1.5 μ s	5 μ s
	t_f	1 μ s	2 μ s	5 μ s
t_{gt}	t_d	1 μ s	1 μ s	1 μ s
	t_r	1 μ s	2 μ s	2 μ s

CIRCLE NUMBER 284

RCA. Powerhouse in Thyristors