

- 96 Applying 16-bit converters effectively
- 104 Automatic testing: modularity assures flexibility
- 112 Fast comparator takes analog lag out of digital systems

# Electronics®

## Metal-oxide varistor halts component burnout

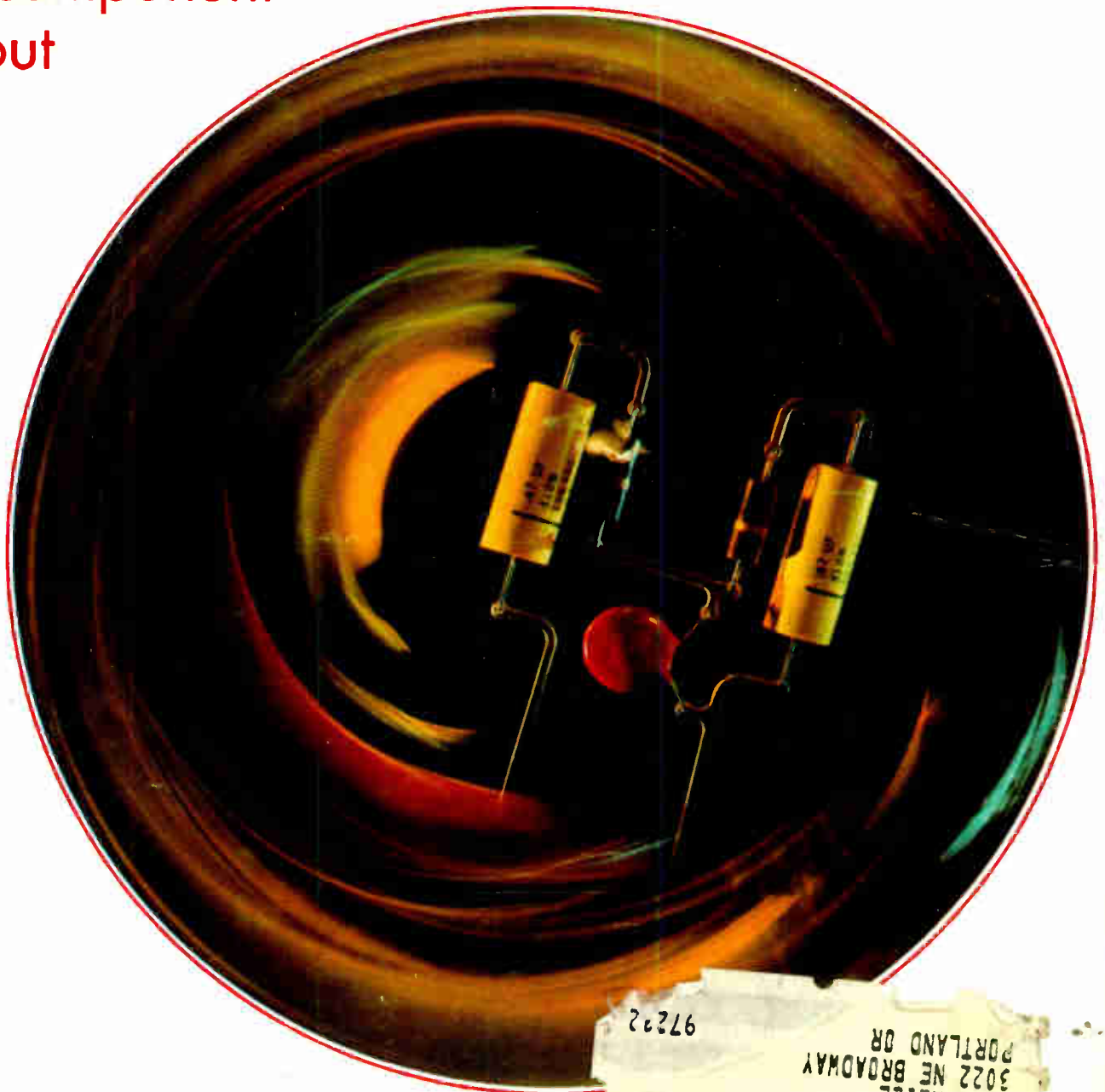

1420 NIL302 BOMAT NOV74  
MATT NEILL  
3022 NE BROADWAY  
PORTLAND OR  
97222

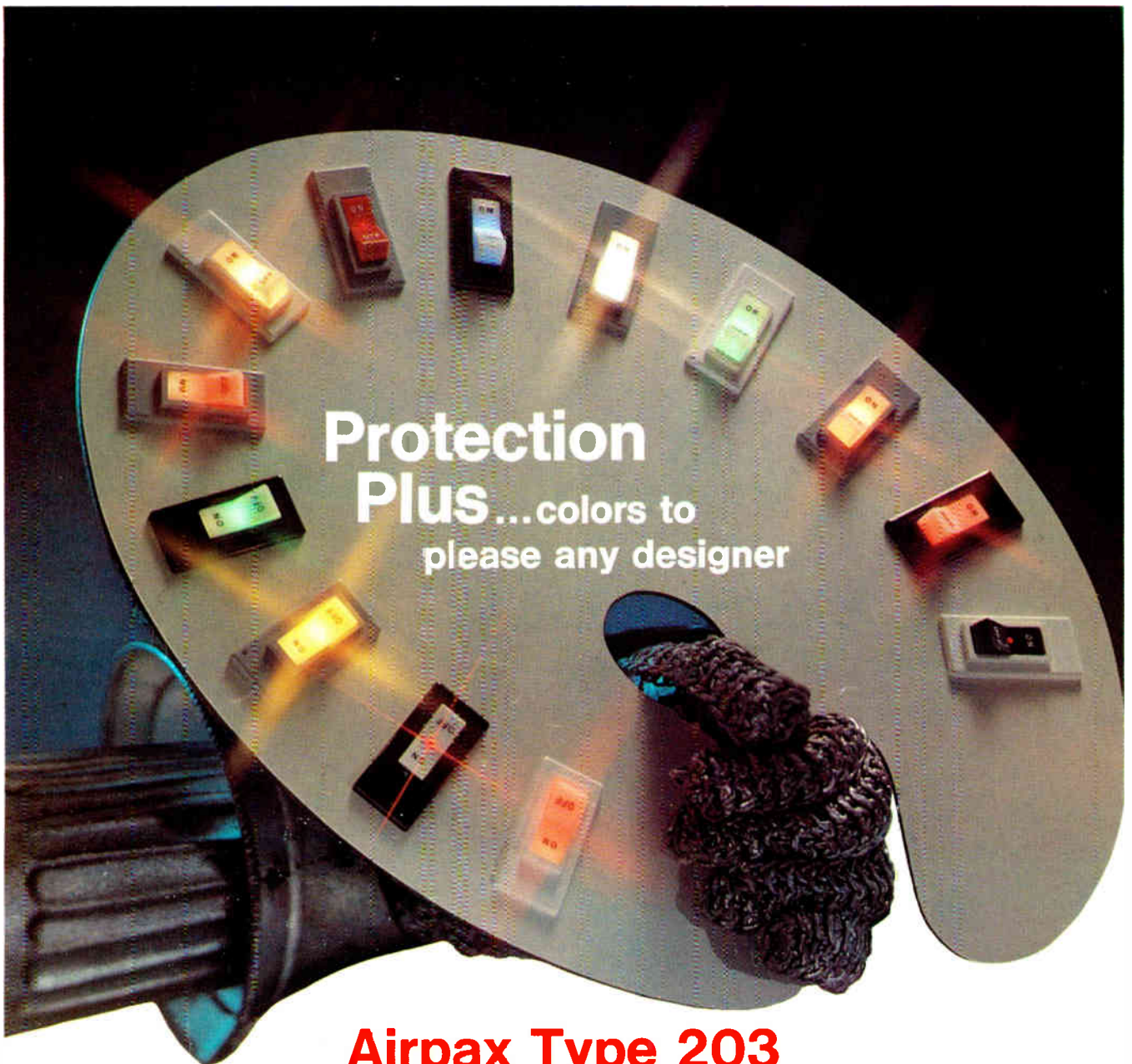

**Protection  
Plus...colors to  
please any designer**

## **Airpax Type 203 Electromagnetic Circuit Protector with Illuminated Rocker Arm**

Airpax circuit protectors have always offered protection, plus. But now there's an added Plus — Type 203 protectors with illuminated rocker handles in a variety of colors that will enhance the appearance (and sales appeal) of any product or panel.

Combining over-current protection with ON-OFF switch and pilot light functions, the 203 is ideal for

use in high quality consumer, commercial, and industrial equipment where accurate, reliable protection and attractive appearance are demanded.

A choice of many mechanical and electrical configurations provide maximum versatility for the designer. Series, shunt, and relay trip internal circuits are available and can be combined in single, two, and

three-pole versions. Current ratings from 0.02 to 20 amperes at 120V AC and 0.02 to 10 amperes at 250V AC. Inverse time delay or instant trip.

Interested? Write for Bulletin 2009. Airpax Electronics, Cambridge Division, Cambridge, Maryland 21613.

# **AIRPAX™**

Protection comes in many colors

Airpax also manufactures many other types of circuit protectors in current ratings up to 100 amperes.

Circle 900 on reader service card



# Carter Semiconductor wants you to know about its reliability...

It's been proven to be  
the best!

Field results of Carter's discrete devices have shown themselves to last  
and last and last... over 20,000 hours in actual tests.

**Our customer service is just as reliable!**

We won't disappoint you on delivery of one device  
for a breadboard or 100,000 for a production run.

Give us a call today and check our competitive prices  
... and our catalog of products.

*You won't be disappointed!*



**CARTER  
SEMICONDUCTOR,  
INC.**

Diode Facility • 361 Arken St., Lowell, Mass. 01853 (617) 454-9141  
Main Office & Eastern Region • 6901 Jericho Turnpike, Syosset, N.Y. 11791 (516) 364-2244  
Western Region • (415) 941-7066 Midwest Region • (312) 297-8416

ASK YOUR DISTRIBUTOR FOR CARTER SEMICONDUCTORS

Circle 1 on reader service card

# MIL-STD-883 MOS OFF-THE-SHELF

General Instrument announces its new TX line of high reliability MOS devices screened in accordance with MIL-STD-883. Each TX device is:  
100% SCREENED TO MIL-STD-883 TEST METHODS  
BURNED-IN FOR 168 HOURS  
SUPPLIED WITH INDIVIDUAL VARIABLES DATA  
INDIVIDUALLY PACKED AND SERIALIZED, WITH ATTRIBUTES DATA TRACEABLE BY LOT  
SUPPLIED WITH CERTIFICATE OF COMPLIANCE

## GENERAL INSTRUMENT'S MOS TX LINE

AY-6-1012 TX	UAR/T™-Universal Asynchronous Receiver/Transmitter
AY-6-4016 TX	16 Channel Multiplexer
AY-6-1011 TX	TTY Transmitter
SS-6-8211 TX	Dual 16 Bit S/R with Recirc.
SS-6-8212 TX	Dual 16 Bit S/R
SL-6-4025 TX	Quad 25 Bit S/R
SL-6-4032 TX	Quad 32 Bit S/R
SL-6-2050 TX	Dual 50 Bit S/R
SL-6-2064 TX	Dual 64 Bit S/R



**YOUR  
TX MAN  
AT GI**



Bernie Rohrbacher is manager of General Instrument's Military and Industrial MOS product line. His group's main responsibility involves product engineering, circuit design, circuit applications, and product marketing. He has in excess of 14 years of semiconductor experience, embracing transistor, bi-polar IC, and MOS IC technology. In 1964 he joined G.I.'s semiconductor division as manager of silicon planar processing. He is now assistant vice president of our microelectronics operations. A graduate of the University of Pennsylvania, he holds a B.S.Ch.E. and an M.B.A. equivalent degree. And he's "your TX man at G.I.". Call him anytime at the toll free number below. He'll be happy to talk to you on his favorite subject . . . Hi-Rel MOS.

**800-645-9247** [TOLL FREE]



GENERAL INSTRUMENT CORPORATION • 600 WEST JOHN STREET, HICKSVILLE, L. I., NEW YORK

The new TX line of MOS devices is immediately available from these authorized General Instrument distributors.

**ALABAMA:** Cramer/E. W., Huntsville (205) 539-5722; **ARIZONA:** Cramer Electronics, Phoenix (602) 263-1112, TWX: 910-951-1382; Liberty Electronics, Phoenix (602) 264-4438; **CALIFORNIA - NORTHERN:** Elmar Electronics, Mountain View (415) 961-3611, TWX: 910-379-6437; Intermark Electronics, Palo Alto (415) 961-6437, TWX: 010-373-1195-910; **CALIFORNIA - SOUTHERN:** Avnet, Culver City (213) 836-7200, TWX: 910-340-6753; Kierulff Electronics, Los Angeles (213) 685-5511; Liberty Electronics, El Segundo (213) 322-8100, TWX: 910-348-7111; **COLORADO:** Cramer Electronics, Denver (303) 758-2100, TWX: 910-431-0440; **FLORIDA:** Cramer/E. W., Orlando (305) 841-1550; Cramer/E. W., Hollywood (305) 923-8181; **ILLINOIS:** Semiconductor Specialists, Elmhurst (312) 279-1000, TWX: 910-254-0169; **INDIANA:** Semiconductor Specialists, Indianapolis (317) 243-8271; **IOWA:** Deeco, Cedar Rapids (319) 365-7551; **KANSAS:** Hall-Mark Electronics, Kansas City (913) 236-4343; **MARYLAND - WASHINGTON, D.C.:** Cramer/E. W., Gaithersburg (301) 948-0110, TWX: 710-828-9745; Milgray/Washington, Hyattsville (301) 864-1111, TWX: 710-826-1127; Radio Electric Service of Baltimore (301) 823-0070; **MASSACHUSETTS:** Greene-Shaw, Newton (617) 969-8900; **MICHIGAN:** Harvey/Michigan, Romulus (313) 729-5500; Semiconductor Specialists, Detroit (313) 255-0300; **MINNESOTA:** Hall-Mark Electronics, Minneapolis (612) 925-2944; Semiconductor Specialists, Minneapolis (612) 854-8841; **MISSOURI:** Semiconductor Specialists, St. Louis (314) 428-6100; **NEW MEXICO:** Cramer Electronics, Albuquerque (505) 265-5767; **NEW YORK (METROPOLITAN AREA):** Milgray Electronics, Freeport (516) 546-6000, TWX: 510-225-3673; Semiconductor Concepts, Hauppauge (516) 273-1234; **NEW YORK STATE:** Summit Distributors, Buffalo (716) 884-3450; **NORTH CAROLINA:** Cramer/E. W., Winston Salem (919) 725-8711; **OHIO:** Newark-Herrlinger, Cincinnati (513) 421-5282, TWX: 810-461-2662; Semiconductor Specialists, Dayton (513) 278-9455; **PENNSYLVANIA - SOUTH JERSEY:** Herbach & Rademan, Philadelphia (215) 426-1700, TWX: 710-670-9760; Milgray Delaware Valley, Cherry Hill (609) 424-1300, (215) 228-2000; Philadelphia Electronics, Philadelphia (215) LO 8-8288, (215) EM 5-6704; Semiconductor Specialists, Pittsburgh (412) 781-8120; **TEXAS:** Computer Components, Addison (214) 239-0271, TWX: 910-860-5006; Lenert Company, Houston (713) 225-1465; Semiconductor Specialists, Dallas (214) 358-5211; **UTAH:** Cramer Electronics, Salt Lake City (801) 487-3681; Alta Electronics, Salt Lake City (801) 486-7227; **WASHINGTON-OREGON:** Liberty Electronics/Northwest, Seattle (206) 763-8200, TWX: 910-444-1379.

# Electronics

The International Magazine of Electronics Technology

## 39 Electronics Review

DISPLAYS: Three models make splash in N.Y., 39  
COMPANIES: 10 days at IBM, 40  
MEETINGS: Wescon considers easing sales ban, 40  
COMPONENTS: Transducer built and priced like IC, 41  
MEMORIES: NR delivers model of bubble system, 42  
AVIONICS: System aims at clean, quiet STOL, 42  
INDEX OF ACTIVITY: 42  
MEDICAL ELECTRONICS: Multiphasic test pares electronics, 44  
MEDICAL ELECTRONICS: Infrared thermometer needs no probe, 44  
OPTOELECTRONICS: SIT tube gives better undersea view, 47  
MARKETING: TI refocuses sales to aim at little man, 48  
COMMERCIAL ELECTRONICS: Systems check in passengers faster, 50  
GOVERNMENT ELECTRONICS: Raytheon unit to prevent stranding, 50  
SPACE ELECTRONICS: Mini helps map Mars and Venus, 52  
FOR THE RECORD: 52

## 63 Electronics International

JAPAN: Electrophoretic display has a memory, 63  
THE NETHERLANDS: Photoplate resolves down to 0.5 micrometer, 63

## 69 Probing the News

COMMERCIAL ELECTRONICS: Electronics guards parked planes, 69  
COMPANIES: DEC's new business is business, 72  
GOVERNMENT: Cocom begins to weaken, 76  
SEMICONDUCTORS: Military studies CCD potential, 81

## 91 Technical Articles

COMPONENTS: Metal-oxide varistor suppressed transients, 91  
CIRCUIT DESIGN: Use 16-bit converters carefully, 96  
DESIGNER'S CASEBOOK: Generator varies pulse rate and width, 100  
Photodetector senses motion in noisy surroundings, 101  
Quasi-matched MOSFETs form filterless squaring circuit, 102  
TESTING: Integrated setup tests intricate assemblies, 104  
SOLID STATE: Accurate comparator keeps pace with ECL, 112  
ENGINEER'S NOTEBOOK: Time measurement finds capacitor R and L, 119  
How to really look at low-drift IC op amps, 120

## 127 New Products

IN THE SPOTLIGHT: C-MOS moves in fast on TTL territory, 127  
Programmable controllers become more versatile, 131  
COMPONENTS: Optical isolator can operate at 20 megahertz, 135  
INSTRUMENTS: Digital panel meter uses only 0.1 watt, 141  
PACKAGING & PRODUCTION: Test system built for low volume, 144  
SEMICONDUCTORS: Chip can drive large core arrays, 151  
MATERIALS: 157

## Departments

Publisher's letter, 4	Washington newsletter, 59
Readers comment, 6	Washington commentary, 60
40 years ago, 8	International newsletter, 65
People, 14	Engineer's newsletter, 123
Meetings, 30	New literature, 158
Electronics newsletter, 35	New books, 161

## Highlights

### Keeping aircraft safe on the ground, 69

Parked aircraft are standing attractions for thieves and vandals. Against the growing threat, electronic security systems are being marketed that keep watch by means of lasers, radars, and other detectors. A low false-alarm rate is essential, to prevent alerts against birds and small mammals.

### A little putdown for large transients, 91

A small metal-oxide addition to the varistor family of circuit-protection devices has several unusual talents. It can handle surges of hundreds of amperes, and it needs hardly any standby power, yet it switches at nanosecond speeds.

### Automated testing of complex assemblies, 104

The second part of *Electronics'* series on automatic test equipment focuses on the requirements of assembled circuits, which may be digital and/or analog and operate at high or low frequencies. The necessary flexibility can be found in a minicomputer-based system with modular software and hardware.

### C-MOS puts pressure on TTL, 127

Dielectric isolation barriers are the latest in a long line of process improvements that are moving C-MOS out of its status as a specialty technology and into the role of TTL competitor. The technology may soon invade even the automobile and appliance markets.

### And in the next issue . . .

Teaching a computer faster pattern recognition . . . a DPM to rival analog meters . . . remote meter-reading.

### The cover

General Electric's metal-oxide varistor (red) protects the circuit components on right from the disaster happening on the left.

Title R registered U.S. Patent Office; Copyright 1972 McGraw-Hill Inc. All rights reserved, including the right to reproduce the contents of this publication in whole or in part. Volume 45, Number 21

EDITOR-IN-CHIEF: Kemp Anderson

EXECUTIVE EDITOR: Samuel Weber

MANAGING EDITORS: Lawrence Curran, *News*;  
Arthur Erikson, *International*

SENIOR EDITORS: John Johnsrud,  
H. Thomas Maguire,

ART DIRECTOR: Fred Sklener

ASSOCIATE EDITORS: Richard Gundlach,  
John N. Kessler, Howard Wolf

### DEPARTMENT EDITORS

*Aerospace*: William F. Arnold  
*Circuit Design*: Lucinda Matterna  
*Communications & Microwave*:  
Lyman J. Hardeman  
*Computers*: Wallace B. Riley  
*Consumer*: Gerald M. Walker  
*Industrial*: Alfred Rosenblatt  
*Instrumentation*: Michael J. Riezenman  
*Military*: Ray Connolly  
*New Products*: H. Thomas Maguire  
*Solid State*: Laurence Altman  
*Special Issues*: Harry R. Rarp

COPY EDITORS: Margaret Eastman,  
Everett C. Terry

ASSISTANT EDITOR: Marilyn Offenheiser

ART: Charles D. Ciatto, *Associate Director*

PRODUCTION EDITORS:  
Patricia Cybulski, Arthur C. Miller

EDITORIAL SECRETARIES: Janet Annunziata,  
Julie Gorgoglione

### FIELD EDITORS

*Boston*: James Brinton (Mgr.), Gail Farrell  
*Dallas*: Larry Armstrong (Mgr.)  
*Los Angeles*: Paul Franson (Mgr.)  
*New York*: Alfred Rosenblatt (Mgr.)  
*San Francisco*: Stephen Wm. Fields (Mgr.),  
Judith Curtis  
*Washington*: Ray Connolly (Mgr.),  
William F. Arnold  
*Frankfurt*: John Gosch  
*London*: Michael Payne  
*Paris*: Arthur Erikson  
*Tokyo*: Charles Cohen

### McGRAW-HILL WORLD NEWS

*Director*: Walter A. Stanbury; *Atlanta*: Stan Fisher; *Chicago*: Mike Sheldrick; *Cleveland*: Arthur Zimmerman; *Detroit*: James Wargo; *Houston*: Robert E. Lee; *Los Angeles*: Michael Murphy; *Gerald Parkinson*; *San Francisco*: Margaret Drossel; *Seattle*: Ray Bloomberg; *Washington*: James Canan, Herbert W. Cheshire, Seth Payne, Warren Burkett, William D. Hickman; *Bonn*: Robert Ingersoll; *Brussels*: James Smith; *London*: Marvin Petal; *Milan*: Peter Hoffmann; *Andrew Heath*; *Moscow*: Axel Krause; *Paris*: Stewart Toy, Michael Johnson; *Stockholm*: Robert Skole; *Tokyo*: Mike Mealey

PUBLISHER: Dan McMillan

ADVERTISING SALES MANAGER: Pierre J. Braude

ADVERTISING SALES SERVICE MANAGER:  
Wallis Clarke

BUSINESS MANAGER: Stephen R. Weiss

CIRCULATION MANAGER: George F. Werner

MARKETING SERVICES MANAGER:  
Tomlinson Howard

While Jim Brinton, our Boston bureau manager, was reporting the Digital Equipment Corp. profile on page 72, a spokesman there loosened up some and in the "now it can be told" tradition unfolded the story behind the mysterious PDP-X minicomputer that preceded the PDP-11.

Before 1968, DEC designed a 16-bit minicomputer, but "it was too good and too complex," the DEC spokesman says. "This was the PDP-X that caused so many industry rumors back then."

"Then came the second development effort," continues the source—who can grin about it now. "By this time guys were beginning to coin money with 16-bit machines and the world was beginning to wonder if DEC would ever pull one off." So was DEC.

"The new machine was designed with specific benchmarks in mind, and within less than a year the new team had it running and passing those benchmarks," says the DEC man. "But the irony was that it wouldn't do much except pass the benchmarks."

So in 1969, a delegation of DEC's top engineers—under growing pressure from DEC vice president Nicholas Mazzaresse to "freeze that machine immediately"—met in Gordon Bell's home near Pittsburgh. A consultant to DEC then, Bell was one of the firm's first two engineers and now is a vice president.

For days, they hashed over the PDP-X and the newer design, and tried to come up with something the firm could sell. The result was the PDP-11—conceived in almost the exact form in which it was to be introduced.

Then came the moment of truth. Bell called to tell Mazzaresse that he now had a third, brand new design

that his top engineers would back "and be damned." There was a stunned pause at the other end of the line, followed by "some explosive questions and some pretty explosive answers."

The PDP-11 survived and prospered. But no one remembers what the second machine was called. "We repressed the name," says the DEC man, "maybe it was the PDP-13."

It happens only rarely that a reporter comes across a story he thinks is about the most satisfying he's done. That's the case with Mike Johnson's report on exporting electronic gear to the East Bloc (see p. 76). Johnson is with McGraw-Hill World News in Paris, headquarters for the Coordinating Committee for Strategic Western Export Controls, the body that rules on exports of high-technology hardware to Communist countries.

But Mike didn't just come across the story; he did some enterprising reporting that made it happen. Aware that the list of items not allowed to be exported to East Bloc nations was up for revision, Mike has been probing to find out if any easing was in the works.

He not only dug out the fact that the list is being chopped greatly, but he also uncovered a document that for the first time reveals some of the inner workings of Cocom—how much of its rulings involve electronic equipment and technology and statistical support that shows a U. S. obstructionist position of 22 years standing. That stance had been known before, but Mike's digging turned up the historical data to document it.



October 9, 1972 Volume 45, Number 21  
89,735 copies of this issue printed

Published every other Monday by McGraw-Hill, Inc. Founder: James H. McGraw 1860-1948. Publication office 1221 Avenue of the Americas, N.Y., N.Y. 10020. Second class postage paid at New York, N.Y. and additional mailing offices.

Executive, editorial, circulation and advertising addresses: Electronics, McGraw-Hill Building, 1221 Avenue of the Americas, New York, N.Y. 10020. Telephone (212) 997-1221. Teletype TWX N.Y. 710-581-5234. Cable address: MCGRAW HILL N.Y.

Subscriptions limited to persons with active, professional, functional responsibility in electronics technology. Publisher reserves the right to reject non-qualified requests. No subscriptions accepted without complete identification of subscriber name, title, or job function, company or organization, including product manufactured or services performed. Subscription rates: qualified subscribers in the United States and possessions and Canada, \$8.00 one year, \$12.00 two years, \$16.00 three years; all other countries \$25.00 one year except Japan \$50.00 per year including air freight. Limited quota of subscriptions available at higher-than-basic rate for persons outside of field served, as follows: U.S. and possessions and Canada, \$25.00 one year; all other countries \$50.00. Single copies: United States and possessions and Canada, \$1.00; all other countries, \$1.75

Officers of the McGraw-Hill Publications Company: John R. Emery, President; J. Elton Tuohig, Senior Vice President—Services; Donald B. Gndley, Group Vice President; Vice Presidents: Ralph Blackburn, Circulation; John R. Callahan, Editorial; John B. Hoglund, Controller; David G. Jensen, Manufacturing; Jerome D. Luntz, Planning & Development; Joseph C. Page, Marketing.  
Officers of the Corporation: Shelton Fisher, President; Wallace F. Traendly, Group President, McGraw-Hill Publications Company; John J. Cooke, Senior Vice President and Secretary, Ralph J. Webb, Treasurer.

Title registered in U.S. Patent Office; Copyright 1972 by McGraw-Hill, Inc. All rights reserved. The contents of this publication may not be reproduced either in whole or in part without the consent of copyright owner.

Subscribers: The publisher, upon written request to our New York office from any subscriber, agrees to refund that part of the subscription price applying to copies not yet mailed. Please send change of address notices or complaints to Fulfillment Manager, subscription orders to Circulation Manager, Electronics, at address below. Change of address notices should provide old as well as new address, including postal zip code number, if possible, attach address label from recent issue. Allow one month for change to become effective.

Postmaster: Please send form 3579 to Fulfillment Manager, Electronics, P.O. Box 430, Hightstown, N.J. 08520

# 4 filters in 1

Model 3202 offers two independent low-pass or high-pass channels or single channel band-pass or band-reject from 20 Hz to 2 MHz.

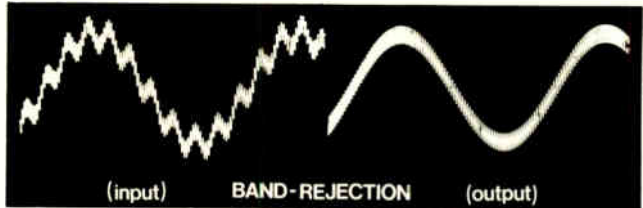
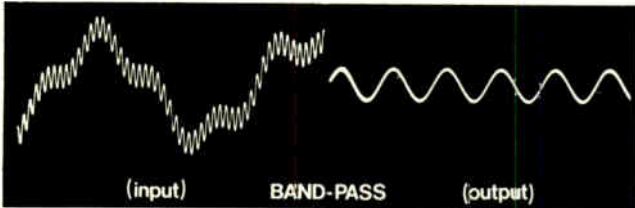
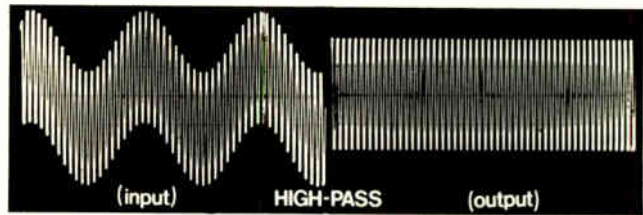
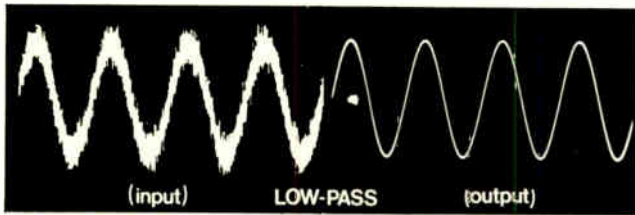

For only \$795, Model 3202 provides the flexibility essential for complex frequency or time domain measurements.

**FUNCTIONS:** Low-pass—direct coupled with low drift.  
High-pass—upper 3 dB at 10 MHz. Band-pass—continuously variable. Band-rejection—variable broad band or sharp null.

**TWO RESPONSE CHARACTERISTICS:** (1) Fourth-order Butterworth or (2) simple R-C (transient free).

**ZERO-dB INSERTION LOSS:** All-silicon amplifiers provide unity gain passband response. 24 dB per octave slopes per channel extend to at least 80 dB.

**90-dB DYNAMIC RANGE:** Low hum and noise (less than 100 microvolts) eliminate costly preamplifiers.

For fast action, call the Wavemakers at: (617) 491-3211  
TWX: 710-320-6583, Krohn-Hite Corporation,  
580 Massachusetts Ave., Cambridge, Mass. 02139, U.S.A.

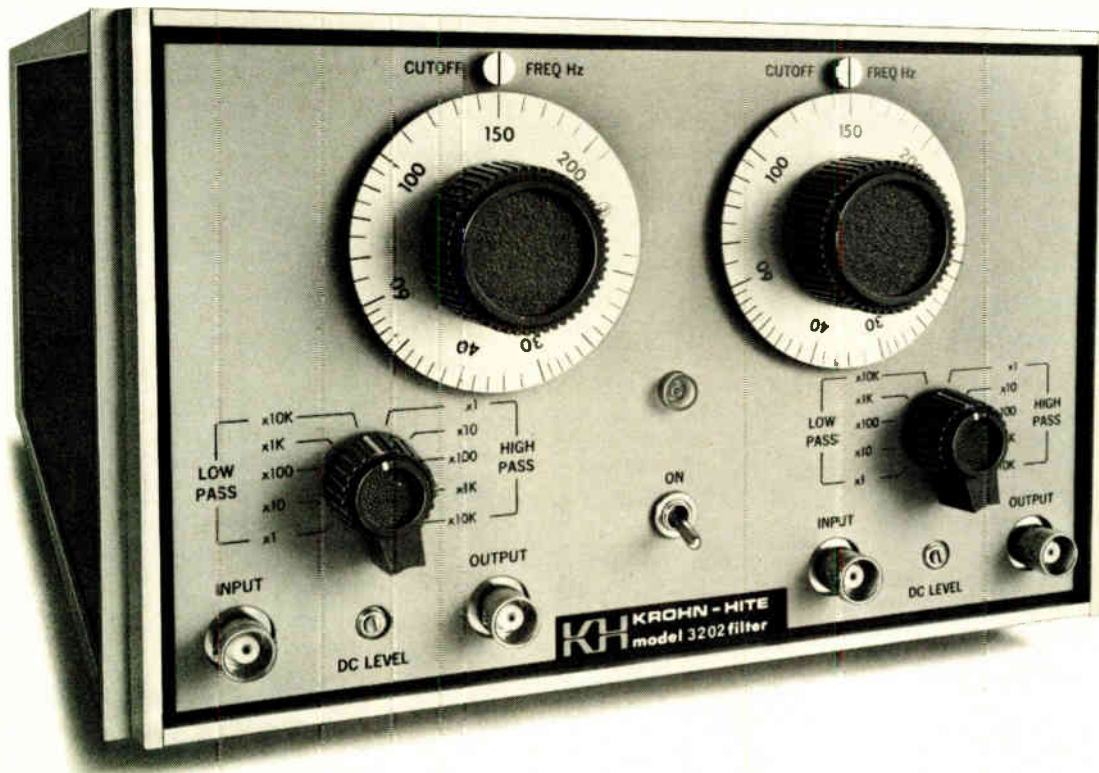

## KH KROHN-HITE CORPORATION

OVERSEAS SALES OFFICES: AUSTRIA, Universal Elektronik Import; AUSTRALIA, Warburton Franki Limited; BELGIUM, C. N. Rood s.a.; DENMARK, SC Metric A/S; ENGLAND, Allied International Limited; FINLAND, Into O/Y; FRANCE, Radio Equipments Antares; GERMANY, Nucletron Vertriebs GmbH; HOLLAND, C. N. Rood n.v.; INDIA, Baij International Agencies; ISRAEL, R. D. T. Electronics Engineering, Ltd.; ITALY, Sistrrel s.p.a.; JAPAN, Shimshin Shoji Kaisha, Ltd.; NEW ZEALAND, Warburton Franki, Ltd.; SOUTH AFRICA, Protea Physical; SPAIN, Rema Leo Haag, S.A.; SWEDEN, Teleinstrument; SWITZERLAND, Megex Zurich GmbH.

**Our  
ultra-bright  
monitor.  
Everything else  
pales  
in comparison.**

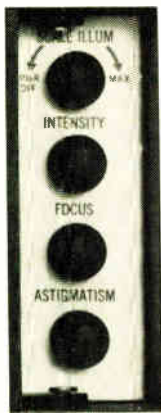

Our model 1000 X,Y,Z monitor features 2 mHz bandwidth, an 8 cm by 10 cm screen, and a display so bright it'll knock your eyes out. All for \$800.

A steal. Especially when you consider that the brighter image gives a higher writing rate. That 2 mHz is one mHz more than our competition. And that you can read faster, easier, without eyestrain.

Our 1000 has one megohm input impedance (so you don't load your driving circuitry). It has its whole electronic works on only two field replaceable plug-in PC cards. It has great linearity and spot size. It even has controls hidden away behind a door.

Why not look into our 1000? Haven't you been looking at pale images long enough? Write for our literature:

DUMONT OSCILLOSCOPE  
LABORATORIES INC.  
40 Fairfield Pl., West Caldwell, N.J. 07006  
(201) 575-8666; TWX (710) 734-4308

**DUMONT**  
OSCILLOSCOPE LABORATORIES INC.

6 Circle 6 on reader service card

## Readers comment

### McGovern's technology 'tilt'

To the Editor: Your Aug. 14 Washington commentary [p.60], "McGovern's 'plan' to reorient technology," calls his program "naive in the extreme." To the contrary—and unlike his detractors—the senator knows the real problem: given the present military tilt of our technology, we cannot create enough internationally viable products to sustain our economy, let alone halt or reverse the deterioration of our mass transportation, housing, medical care, and physical environment—to name only a few of the major problem areas.

Further, to state that Senator McGovern has no advisers who are "heavyweights" in this field is preposterous. Such well-known and respected engineers as Herbert York, Department of Defense director of research & engineering under President Eisenhower, George Kistiakowsky, science adviser to Presidents Eisenhower and Kennedy, and Herbert Scoville, former CIA director of research and Armed Forces Special Weapons Project technical director, among others, have been advising Senator McGovern for many months—even before his carefully formulated conversion proposals were made public.

John E. Ullman  
Professor

Hofstra University  
Hempstead, N.Y.

■ *The Commentary in question made no reference whatsoever to Senator McGovern's "advisers." It did criticize an altogether different body, the McGovern staff, stating accurately that it does not have "a single heavy-weight knowledgeable in the field of defense and aerospace budgeting."*

*As for the McGovern advisers cited by Professor Ullman, they are indeed "heavyweights" in their respective fields. How heavily they have influenced past Administrations is debatable, yet their participation in the McGovern campaign has been on the side of policy formulation—not budget implementation. What's more, there is a vast difference between stating a policy and making it work.*

## 4 Quadrant Magnetic Analog Multiplier DC x AC = AC Output



**Product Accuracy  
is  $\pm 1/2\%$  of all  
readings Over Full  
Temperature Range  
of  $-55^{\circ}\text{C}$  to  $+125^{\circ}\text{C}$**

- Product accuracy is specified in % of reading for all output analog voltage product points over the full military temperature range instead of % of full scale error giving superior results for small values.
- Linearity, product accuracy, and zero point virtually unaffected by temperature changes.
- All units are hermetically sealed and completely shielded from external electric or magnetic fields.

### Specifications Include:

Transfer equation:  $E = XY/3$

X & Y input signal ranges:  
0 to  $\pm 3\text{V}$  Peak

Maximum static and dynamic product error:  $1/2\%$  of point or 2 mVRMS, whichever is greater, over entire temperature range

Input impedance: X = 10K; Y = 10K

Full scale output: 3 VRMS

Minimum load resistance for full scale output: 2000 ohms

Output impedance: Less than 50 ohms

X input bandwidth:  
 $\pm 0.5\text{db}$ , 0 to 200 hertz

Y input bandwidth:  
 $\pm 0.5\text{db}$ , 20 hertz to 1000 hertz

DC power:  $\pm 15\text{V}$  unless otherwise required @ 20 ma

There is No Substitute  
for Reliability



**GENERAL MAGNETICS, INC.**

135 Bloomfield Avenue  
Bloomfield, New Jersey 07003  
(201) 743-2700

Circle 172 on reader service card





# Better system protection against transient voltages

## ... Better than selenium

Both DC and AC models now available.

GE-MOV™ metal oxide varistors make use of a new technology. They provide tight voltage clamping and high energy absorption . . . better than selenium. Present models offer AC voltage ratings from 100 to 1000V. Energy absorption ratings range from 10 to 160 watt-seconds (joules).

Prices are as low as \$.70 in quantity lots. For more information, including a FREE EVALUATION KIT, call your local authorized GE semiconductor distributor . . . or write to General Electric Company, Semiconductor Products Department, Building 7, Mail Drop 49, Electronics Park, Syracuse, N. Y., U.S.A.

### GE-MOV SUPERIOR FEATURES:

- Clamping Ratio
- Size
- Peak Current
- Energy Density

### COMPETING SELENIUM SUPPRESSORS

Mfrs.	Commercial or Trade Names	Device Nomenclature			
		Selenium Suppressors			
		1 inch Square	2 inches Square	4 inches Square	5" x 6"
IR (W)	Klip-Sel Volt-Trap	KSA ----	KSL ----	KSP ----	KSF ----
		SO1, 2AA --	SO3AA ----	SO6AA ----	SO9AA ----
Syntron Sarkes Tarzian	Surge Stop Klip Volt	SD1544 --	SD2650 --	SD2411 --	SD2452 --
		2KV26 ---	5KV26 ---	7KV26 ---	10KV26



OUR NO. 1 GOAL:  
TO MAKE  
GENERAL ELECTRIC  
YOUR BEST BUY

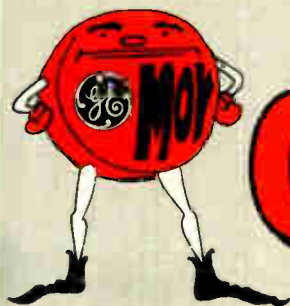

# GE-MOV™ VARISTORS

ASSURE YOUR EQUIPMENT WILL ENDURE

## 40 years ago

From the pages of *Electronics*, October 1932

During 1932 the number of types of thermionic tubes used in the art of communication or for industrial purposes has multiplied at a very rapid rate. Growth has been particularly noticeable in the group of tubes designed primarily for use in home radio receivers, but there are new transmitter tubes and rectifiers as well. At the present time there are over three hundred examples of the tube-makers' art, each with a distinct (but meaningless) code number.

These tubes range in size from the lilliputian "peanut" tube (Western Electric 215-A) which is less than three inches long to the water-cooled giants used in broadcast stations whose plates can dissipate 100 kw of power.

The editors of *Electronics* have collected data on all tubes made in this country and present them in the series of charts to be found in this issue. The information has not been collected and published before and should be useful to anyone interested in using thermionic tubes for any purpose.

Dissatisfaction with the present haphazard method of numbering tubes has led to many attempts to systematize the nomenclature. The most recent, and probably the one having the best chance of ultimate acceptance, has been under consideration of the Vacuum Tube Committee of the RMA and was submitted to member vote late in September. The plan calls for naming tubes according to the following formula. It will be a trinomial system. The first part of the new name will consist of a digit disclosing the filament voltage; the third part will be a digit revealing the number of useable elements having an external connection; the middle part will be a letter arbitrarily chosen.

It remains to be seen whether or not the industry will revamp its clumsy method of giving names and number to tubes according to the system proposed by the RMA Tube committee. At any rate an important step has been taken toward much needed simplification.

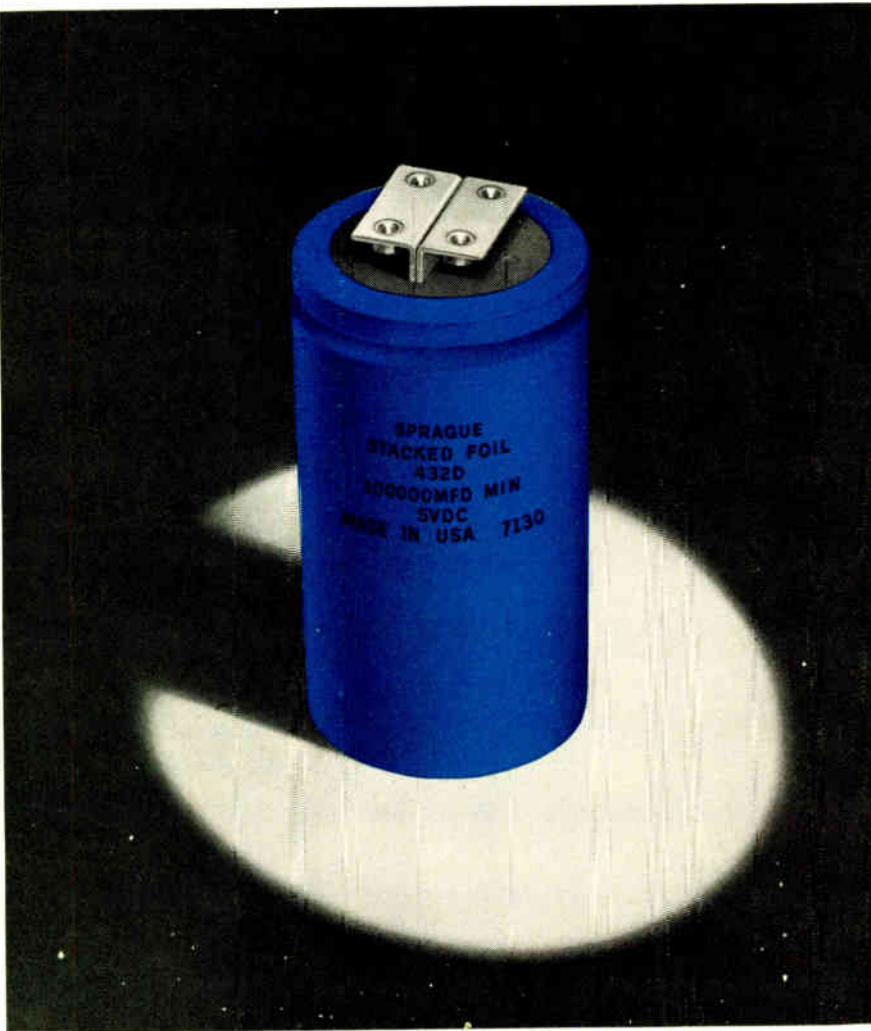

## Stacked...with beautiful curves!

(stacked-foil construction with ultra-low impedance, ultra-low ESR, ultra-low inductance)

Revolutionary new Type 432D COMPULYTIC® Aluminum Electrolytic Capacitors offer capacitance values to 100,000  $\mu$ F with equivalent series resistance of typically less than 0.001 ohm and inductance of only 1 nH in a 3" x 5 $\frac{1}{8}$ " case. This same capacitor will handle 93 amperes of ripple current at 65 C and 1 kHz.

Impedance limits at 10 kHz are as low as 0.001 ohm with typical values of only half of the specified limits.

Terminals are ideal for use with laminated-bus power distribution systems found in modern EDP equipment, where the low ESR and impedance of Compulytic capacitors help insure continued operation of logic circuits even during momentary power outages.

Sprague Type 432D Capacitors are available in nine voltage ratings from 5 to 50 volts d-c, and are designed for operation over the temperature range from -40 to +85 C.

For complete technical data, write for Engineering Bulletin 3443 to: Technical Literature Service, Sprague Electric Co., 35 Marshall St., North Adams, Mass. 01247.



THE BROAD-LINE PRODUCER OF ELECTRONIC PARTS



# NOTORIETY



VOL. 1 No. 1

Santa Clara, California 95051, June, 1972

1 Page

0 Cents

## NATSEM WOWS WINDY CITY CONFAB

### 5 Watt Audio Amp Bows, Car Mfg's say 'Socker'

Raves and kudos continue to be heard about NatSem's new LM383K IC audio amp, the only monolithic 5-watt RMS IC audio amp that's fully short circuit and thermally protected and has a preamp and power amp on the same chip.

Cost effective with discrete designs, the new LM383K also offers adjustable voltage gains from 50 to 500.

### 10-Watt Audio Amp Intros, Hi-Fi Phono Mkt Wowed

National Semiconductor has introduced a 10-watt monolithic power amp designed for use by manufacturers of hi-fi phonographs.

The new LM384 will deliver 10 watts RMS into an 8 ohm load at 28-30V supply voltage. The LM384 is fully short circuit and thermally protected, has both a pre-amp and power amp on the same chip and is cost effective with discrete designs.

### KIDDIE PHONO, PAGING AMP REAL 'LONER'

A new 4-watt IC audio amplifier that requires one external component has been unveiled by National Semiconductor.

Available in a 14-pin DIP package, the new LM380 audio amp was designed specifically for use in kiddie phonographs, paging systems, intercoms and toys which require an amp for their operation.

### CERAMIC PHONO CARTRIDGES FIND FRIEND IN NEW DUAL CHANNEL AUDIO AMP

National Semiconductor has added a dual 2-watt audio amplifier to its expanding line of consumer linear integrated circuits. The new LM377 provides up to two watts of con-

tinuous RMS power into an 8 ohm load on each of its channels with a high impedance equal to 10 megohms, ideal for the ceramic phono cartridges found in most home stereo sets. Gain is 100 dB and distortion is only 0.5 percent at 1 kilohertz, while power bandwidth is 65 kilohertz.

### TV SIGNAL PROCESSOR PACKED WITH POWER

A complete 2-watt TV sound system, utilizing proven circuit techniques, has been incorporated into National's new LM1805. The FM IF portion of the LM1805 uses a three-stage limiting amplifier and a differential peak detector combined with a DC volume control.

Designed for use with a minimum number of external components, the audio power amp section of the new LM1805 may be operated over a wide range of power supply and speaker impedance combinations.

### OPEN LOOP GAIN, HIGH INPUT IMPEDANCE MAKE 4-WATT STEREO AMP 'WINNER'

A new dual 4-watts-per-channel stereo amp, the LM378, has been introduced by National Semiconductor.

An internally-compensated IC stereo amp, the new LM378 features a 100 dB open loop gain, typical 10 megohm input impedance, a dual internal power supply regulator and optimum turn-on, turn-off characteristics to eliminate turn-on delay and speaker pop.

### Possibilities 'Unending' For New NatSem Quad Amp

National's new LM3900 is the first operational amplifier developed to operate from a single +4 to +36V supply and split supplies as well. It consists of four complete amps on a single monolithic silicon chip and is priced at only 75 cents in quantities of 100.

The new LM3900, which is internally frequency compensated for unity gain and completely short circuit proof, has

an open loop gain of 70 dB and a unity gain bandwidth of 2.5 megahertz. Input bias current is only 30 nanoamps.

The combination of four independent amps on a single chip and single power supply operation opens up scores of new applications for op amps in industrial and automotive equipment applications where only one power supply is available.

### Intros IC Preamps, Audio Amps

Chicago—One of the big coups pulled off at the Spring Conference on Broadcast and Television Receivers was the unveiling of a new line of integrated circuits that perform preamp and audio amp functions within recording, stereo, hi-fi, phono and other entertainment and broadcast-oriented systems.

The new IC preamps and audio amps are being manufactured in volume by National Semiconductor Corporation, a company who's no stranger to the integrated circuit business.

"What we've done," says a NatSem spokesman, "is to take the functions which normally require a combination of discrete transistors, IC's,

resistors and put everything on a single chip, with little or no external components required."

In addition to their basic advantages of better systems reliability and lower systems costs, each of NatSem's new IC preamps and audio amps has its own distinct advantages. The LM381, for example, is the lowest noise dual preamp in the business, while the new LM382 is a low noise dual preamp which offers full R.I.A.A. and N.A.B. equalization with a minimum of external components.

Each of NatSem's new consumer IC's, available now at all National Semiconductor distributors, is described in more detail elsewhere on this page.

### Kudos for Super Low Noise Preamp

A growing army of former discrete NPN and PNP transistor users are touting the merits of NatSem's new LM381 IC dual preamp. Designed for extremely critical low noise applications, the new LM381 offers a wideband equivalent input noise of 450 nanovolts with 600 ohms source impedance and 10 kilohertz noise bandwidth.

As a result, the new LM381 offers users a single-chip dual amplifier that's as performance effective as a transistor-resistor combo, with much better reliability in the long run.

### R.I.A.A., N.A.B. EQUALIZED PREAMP PREEMS, USERS HAIL SIMPLICITY

A cost-conscious low noise IC preamp aimed at the auto tape, tape player, recorder and phonograph market is now available from National Semiconductor.

The new LM382 not only offers the advantage of low noise operation, but requires just three additional external components for full R.I.A.A. or N.A.B. equalization.

# NATIONAL

National Semiconductor Corp., 2900 Semiconductor Dr., Santa Clara, California 95051/Telephone (408) 732-5000

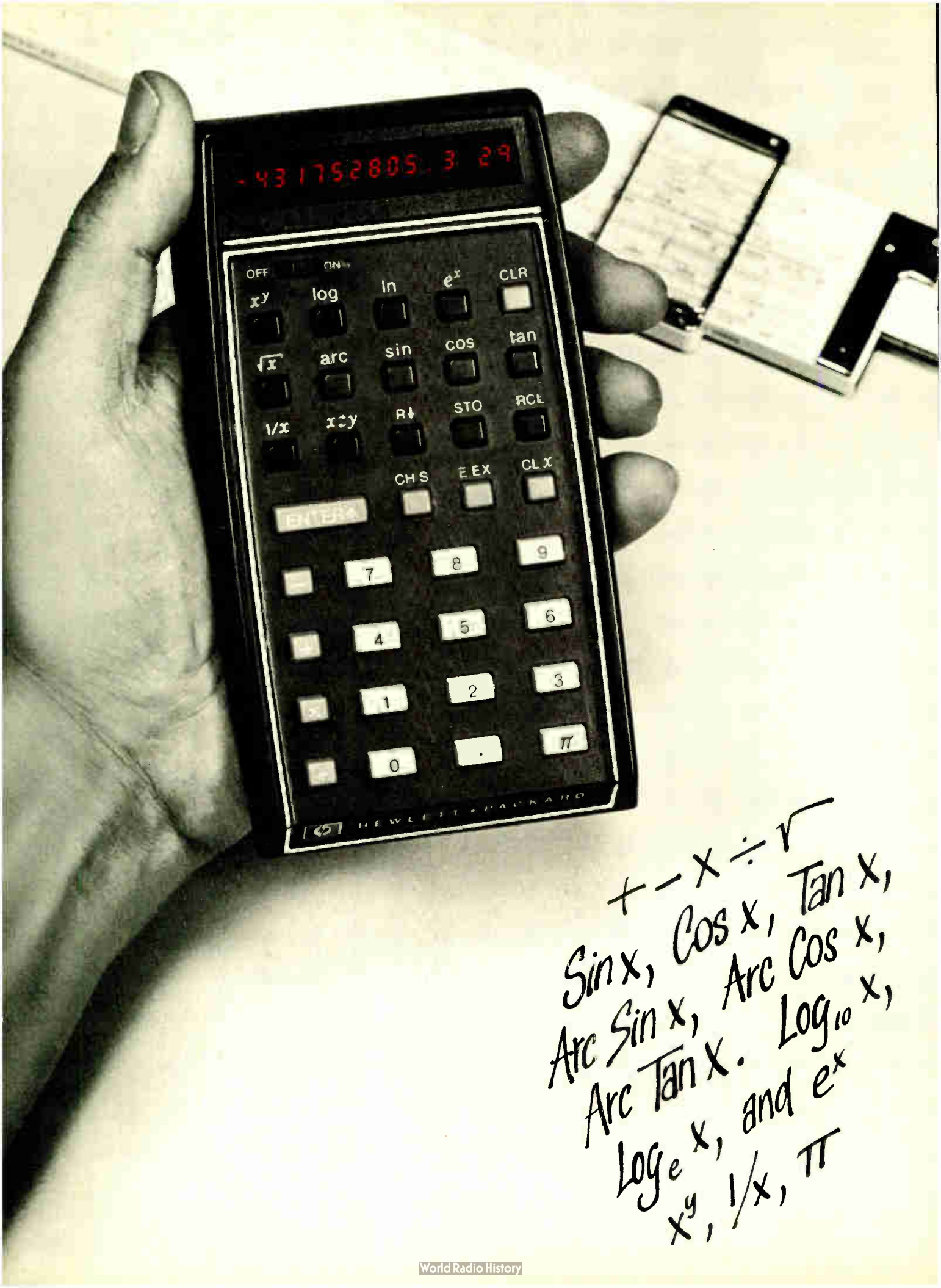

-43.1752805.3 29

OFF	ON	ln	$e^x$	CLR
$x^y$	log	sin	cos	tan
$\sqrt{x}$	arc	R $\leftrightarrow$	STO	RCL
1/x	$x \leftrightarrow y$	CHS	EEX	CLX
ENTER				
	7	8	9	
	4	5	6	
	1	2	3	
	0	.	$\pi$	

$+ - \times \div \sqrt{\quad}$   
 Sin x, Cos x, Tan x,  
 Arc Sin x, Arc Cos x,  
 Arc Tan x. Log<sub>10</sub> x,  
 Log<sub>e</sub> x, and  $e^x$ ,  
 $x^y$ ,  $1/x$ ,  $\pi$

# POCKET COMPUTATION

from Hewlett Packard

## WE'RE ON THE INSIDE!

The HP-35 pocket calculator is available today. A super slide rule, this electronic wonder challenges a computer in its problem-solving capability. People have talked about it for years, but HP made it work . . . a breakthrough product offering an unprecedented combination of size, multifunction capability, accuracy and speed. How is it practical? Through creative, MOS/LSI design, using ion-implanted, depletion-mode technology. A technology pioneered, proven and volume-manufactured by MOSTEK.

What kind of performance does implanted MOS/LSI provide? Here's a summary of the micro-processor developed for the HP-35:

**Low Power:** 90 mw (typical) for the sum of all five complex MOS arrays

**Very Complex Chips:** The arithmetic chip alone contains 3600 transistors

**Immunity to Battery Voltage Variation:** Specifications called for  $\pm 16.6\%$ .

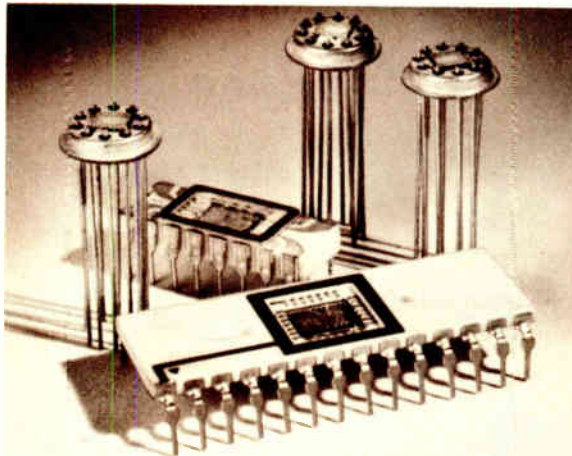

MOSTEK MOS circuits custom designed for Hewlett Packard.

This was exceeded with the micro-program storage chip operating from 3.5 to 30 V, typically.

**Multi-Source Production Capability:**

MOSTEK pioneered the process; other sources are now following our lead.

MOSTEK's design team made implanted MOS work for Hewlett Packard. Can we do the same for you?

For more information, call Marketing Assistance at (214) 242-0444, or contact your nearest MOSTEK sales office listed below.

NOTE: The circuits utilized for the HP-35 are proprietary to Hewlett Packard and not available for general sale. For information on the pocket calculator, write: Advanced Products, Hewlett Packard, 10900 Wolfe Road, Cupertino, Calif. 95014.

# MOSTEK<sup>®</sup>

MOSTEK Corporation, 1215 West Crosby Road  
Carrollton, Texas 75006, (214) 242-0444

Copyright 1972 by MOSTEK Corporation

**REGIONAL SALES OFFICES:** Western: 11222 La Cienega Blvd., Inglewood, Calif. 90304 (213) 649-2888 Eastern: 60 Turner Street, Waltham, Mass. 02154 (617) 899-9107 Central: 515 So. West Avenue, Jackson, Mich. 49203 (517) 787-0508

**INTERNATIONAL:** Europe: Mostek GmbH, 7 Stuttgart 80, Waldburgstrasse 79, West-Germany 0711-731305; Japan: System Marketing Inc., Center News Bldg., 1-3-11 Sotokanda, Chiyoda-ku, Tokyo, Japan; Far East: Imai Marketing Assoc., Inc., 525 W. Remington Dr. # 108, Sunnyvale, Calif. 94087 (408) 245-3511; Hong Kong: Astec Components Ltd., Alpha House, Flat 'F' 13 Floor, 27 Nolan Rd., Kowloon, Hong Kong; Israel: Racom Electronics, 60 Pinkas St., Tel Aviv, Israel.

Circle 11 on reader service card

# Why we think Brush recorders are your best choices.

**CLEANEST TRACES.** When you say hello to your Brush Recorder, you say good-bye to smudging, smearing, skipping and puddling traces. The reason: pressurized inking that forces a crisp, clean trace not just onto, but into the paper. Our pens never need priming, even after long periods of not being used.

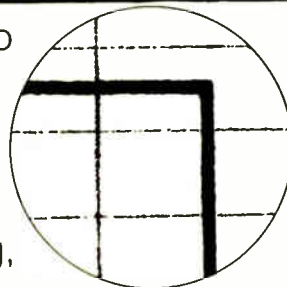

Our traces

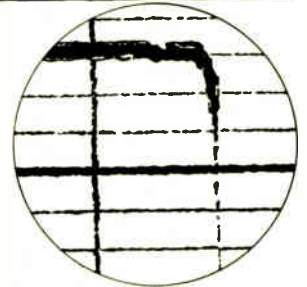

Thermal traces

**ACCURACY.** Another plus for the Brush Recorders is our Metrisite® non-contact servo-loop feedback device. A system so accurate it enforces pen positioning at better than 99½% linearity.

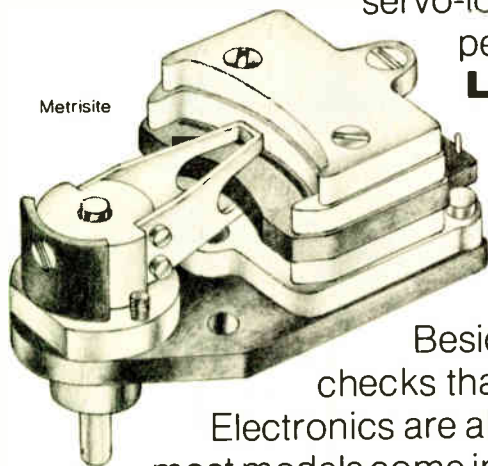

Metrisite

**LOW MAINTENANCE.** We've carefully designed each instrument to require minimal care. For example, our Metrisite system eliminates bothersome maintenance problems. Like dirty pots, wear, cleaning. The Metrisite also eliminates slide wires and all the maintenance problems that go with them.

Besides, we put every instrument through quality control checks that simply don't forgive mistakes.

Electronics are all solid-state in the recorders. And most models come in either portable or rack-mounted versions. All of them are compatible with our wide range of signal conditioners, so you can get the exact signal conditioners to suit your requirements.

If you'd like to know more about Brush Recorders, contact your nearest Gould Sales Engineer or Representative. Or write for detailed performance information and specifications. Gould Inc., Instrument Systems Division, 3631 Perkins Avenue, Cleveland, Ohio 44114 or Rue Van Boeckel 38, Brussels 1140, Belgium.

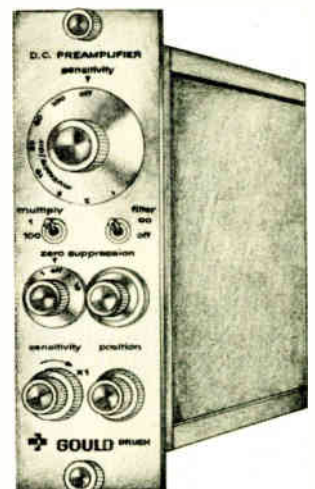

## GENERAL PURPOSE

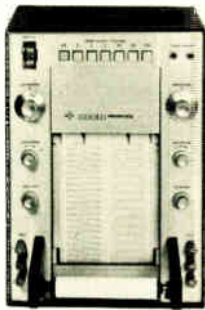

BRUSH 222 • 2-CHANNEL. Portable battery operated version of popular Brush 220 recorder. Internal recharger. 30Hz frequency response. Sensitivity 1mV/div. to 500V f.s.

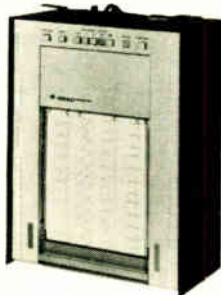

BRUSH 440 • 4-CHANNEL. Designed for maximum versatility at low cost per channel. 40Hz frequency response.



BRUSH 260 • 6-CHANNEL. High precision and maximum operator convenience. Built-in preamps. 1mV/div. to 500V f.s. sensitivity.

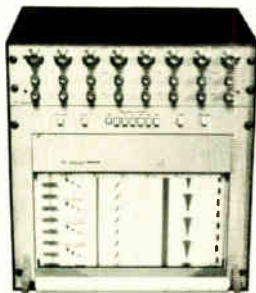

BRUSH 481 • 8-CHANNEL. Our newest 1mV/div. to 500 V f.s. sensitivity. Model 480 available without preamps.

## HIGH PERFORMANCE



BRUSH 250 SINGLE CHANNEL. Fastest, most versatile strip-chart recorder anywhere. Useful response to 100Hz. Detachable chart paper magazine.



BRUSH 240 • 4-CHANNEL. Frequency response to 55Hz on 40mm and 35Hz on 80mm channels.



BRUSH 280 • 2-CHANNEL. Double width 80mm channels. Built-in preamps. 35Hz frequency response.



BRUSH 200 • 8-CHANNEL. The world's standard for high performance recorders. Tailored to your specific requirements.

## SPECIAL PURPOSE



BRUSH 2300 LIGHTBEAM OSCILLOGRAPH. Dual tungsten filament optical oscillograph. From 1 to 16 channels. To 1000Hz response.



BRUSH 816 • 8-CHANNEL HI-SPEED MULTIPPOINT. Scans and displays up to 8 channels. Data is recorded at a rate adjustable from 2 seconds per point to 16 points per second.



BRUSH 511 DIGITAL PLOTTER. Absolute coordinate plotter. Non-cumulative errors. No permanent offsets due to transmission line disturbances. 99.85% linearity.

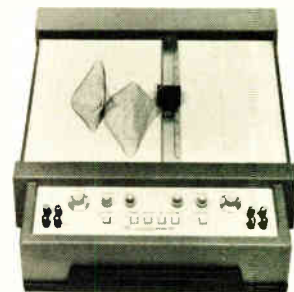

BRUSH 500 X-Y RECORDER. A rugged, low-priced recorder. 99.85% linearity. Pressurized ink writing. Electrostatic hold-down. Built-in preamps.

Give  
your  
sweep  
and  
signal  
generators  
a

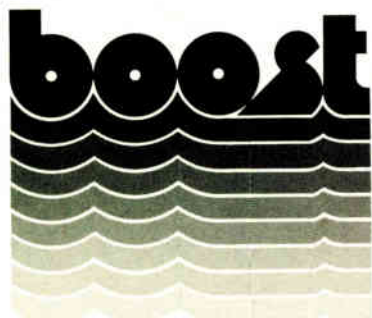

Our boost is a 2-500 MHz RF Power Amplifier, known as the Model 500L. This completely solid-state laboratory instrument will boost the output of any signal source by 27 dB and provide more than 11 volts P-P into 50 ohms. A combination of hybrid integrated circuits and microstrip construction, our state-of-the-art amplifier will operate into any load impedance (from an open to a short circuit) without oscillation or damage.

The boost. Priced at \$295, it's one of the great bargains of our time. Give yourself a boost by writing to Electronic Navigation Industries, Inc., 3000 Winton Road South, Rochester, New York 14623. For an even faster boost, call 716-473-6900, TELEX 97-8283.

**ENI**

ENI . . . The world's leader  
in solid-state power amplifiers.

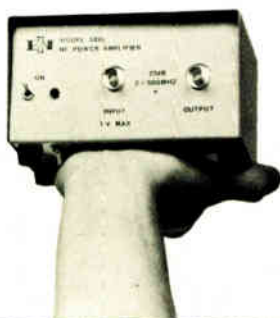

## People

### Schneider's guerrillas take on Navy electronics

It's doubtful that anyone had thought of running the Naval Electronics Systems Command as a guerrilla operation before the advent of its new boss, Rear Adm. Raymond J. Schneider. But that's



**Schneider:** The Admiral is a guerrilla leader.

what Schneider is convinced any commander of a relatively small force must do to survive.

In the hierarchy of an estimated 200,000 persons in the Naval Material Command, of which Navelex is a part, Schneider commands "just 2,600, plus 100 officers;" thus, he expects his subordinates to "think in terms of guerrilla operations—always on the move, and one man must do the work of 10."

Indeed, Schneider's office has almost the look of a jungle encampment—strewn with awards, mementoes, scrolls, plaques, and statuettes attesting to an uncommon string of achievements. Occasional souvenirs are in evidence, too, like the remarkable 2-foot-long and 6-inch-square granite block that dominates his desk. Engraved with the admiral's name, it substitutes for the conventional brass nameplate. Nevertheless, the stone bears a striking resemblance to a military grave marker. Says an aide: "I can't get over it."

Yet Schneider gives every evidence that he will not be buried at

Navelex and that there are a number of other things his staff may not get over as he makes his mark on Navy technology. For the U.S. electronics community that sometimes appears to Schneider as "a world laggard instead of a world leader," the admiral has a simple message: "Stop kidding yourself. Beat the foreign competition before it beats you." To achieve that, he believes, U.S. industry must significantly improve its planning capability. And, like everyone else in the military chain of command, he stresses the need for better cost control.

Of its \$177.6 million RDT&E budget, Schneider's guerrilla force will contract \$118.4 million to industry this fiscal year. Another \$247.4 million is budgeted for communications and electronics procurement. Since Navelex is "the youngest and smallest element" of the Naval Material Command—in existence officially only since May 1966—Schneider concedes that the organizational struggle to attain maturity has necessarily been time-consuming. Now the outspoken 55-year-old admiral expects to change all of that.

Schneider's gruff exterior and colorful surroundings tend to mask his professional qualifications for his new job. Most recently the assistant commander for research and technology at the huge Naval Air Systems Command (Navair), Schneider holds a master's degree in aeronautical engineering from MIT.

### NOAA's Ludwig foresees satellite sensing gains

Like many scientists, George H. Ludwig wanted to see more practical applications of projects he was developing. Now he gets his chance as new director of system integration for the National Oceanic and Atmospheric Administration's National Environmental Satellite Service. "My job is to develop the next generation of operational environmental satellites," he says, "from the sensor to the handover of data," a space-to-ground responsibility that also includes planning and develop-



# Built better. Performs longer. Costs less.

Wire windings are OUT, conductive plastic is IN for high performance audio controls. With its new Series 300 SLIDELINE™, Duncan Electronics replaces noisy, rough and "grainy" wire elements with smooth, noise-free RESOLON® conductive plastic which actually improves with use!

RESOLON elements and precious metal wipers used in all Series 300 controls bring consistent low-noise operation and superior performance to linear motion faders for broadcast and recording. And, the cost is less than many high grade wirewound controls of the past!

Series 300 is offered in 6 different stroke lengths and features longer life of 10 million traverses minimum, infinite resolution and linear, audio and constant impedance outputs for every audio need!

Dual channels can be contained in a standard single housing only 1 3/16" wide — the most compact dual attenuator available to the industry. Two dual units can be coupled and driven by a common knob to create 4 channels for master controls or quadrasonics.

For complete specifications, call or write for our FREE brochure.

## Duncan Series 300 A sound idea.

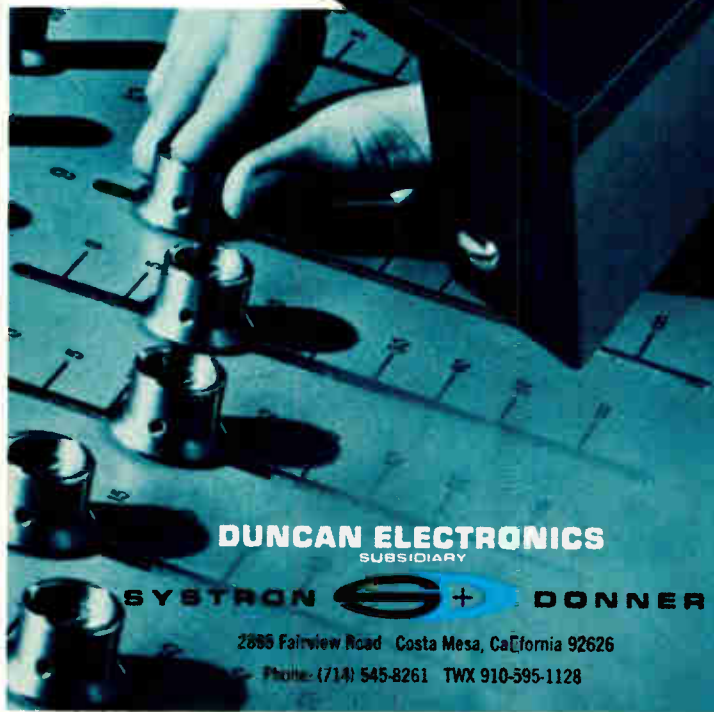

### Series 220 Slideline™

Similar to our Series 200, but internal design and construction are totally new for vastly improved performance. Features the same Resolon element as the professional grade Series 300. This results in far lower noise, longer life (5 million strokes minimum), infinite resolution and smoother "feel."

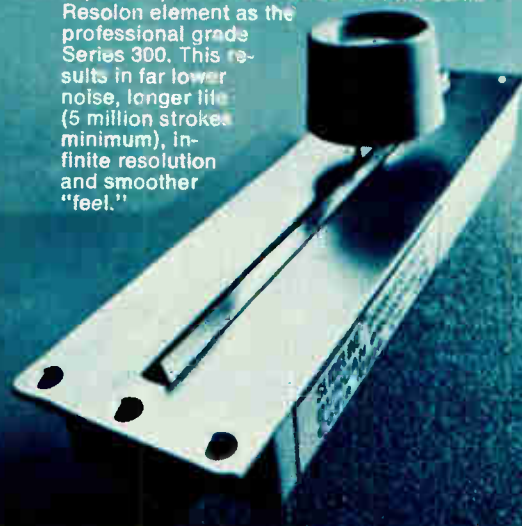

**DUNCAN ELECTRONICS**  
SUBSIDIARY

SYSTRON  DONNER

2685 Fairview Road Costa Mesa, Ca [ornia] 92626

Phone: (714) 545-8261 TWX 910-595-1128

# The Word.

## On A/D and D/A Converters



**Yours FREE with this coupon.**

DDC—today's established leader in the field of advanced, high speed, analog-digital and digital-analog conversion—now brings you the latest word on the subject: our new *1973 Selection and Evaluation Guide on A/D and D/A Converters*.

It covers not only state-of-the-art conversion devices that operate well up into the video frequency range, but also such supplementary modules as multiplexers; sample-and-hold units and signal conditioning devices. All are suitable for use in critical industrial, commercial, shipboard, aerospace and military ground support systems.

Your 1973 Guide comes with detailed technical application notes on Video Conversion Techniques, Fast Settling Amplifiers and Multiplying D-A converters, all prepared by recognized authorities in this field.



**DDC**  
**ILC DATA DEVICE CORPORATION**

ILC Data Device Corporation  
 100 Tec Street  
 Hicksville, N. Y. 11801 • (516) 433-5330

E 10-9

Please send my FREE copy of the Synchro Guide and application notes as mentioned above.

Conversion

Check here if you would also like to receive—FREE—DDC's

- New Synchro Conversion Guide
- New Wideband Amplifier Guide.

NAME \_\_\_\_\_  
 TITLE \_\_\_\_\_  
 COMPANY \_\_\_\_\_  
 ADDRESS \_\_\_\_\_  
 CITY \_\_\_\_\_ STATE \_\_\_\_\_ ZIP \_\_\_\_\_

ing the spacecraft, earth stations, and communications.

Ludwig was associate director for data operations at NASA's Goddard Space Flight Center, where he had an important role in helping to develop new experimental observation satellites. But he took his new job last month because "I wanted to apply the technologies being developed by NASA more directly and more immediately to meet the real needs of people these days." He says that "it's important that NASA continues developing new technologies, but I'm interested in an operational sense with applying existing technology, rather than developing new technology." The bearded engineer foresees big advances in weather prediction, pollution monitoring, and oceanography by satellite.

**ICs ahead.** Ludwig predicts several new electronics trends in observation satellites in the next five years, including "the widespread realization of the advantages of integrated circuits." Another is "reducing the cost and improving the reliability of onboard storage by replacing the tape recorder with some form of all-electronic device.

"We will have to continue to get higher-resolution devices on board spacecraft," he says, noting a trend toward higher frequencies as a way to get larger communications bandwidths. Here, however, "we might be able to trade off some gain in bandwidth if we do some of the data compression on board," an alternative that should be pursued, he says. High data rates also are causing problems with computers on the ground, Ludwig says. New computer approaches will have to be tried because, "as we move to higher-resolution imaging, the present computer facilities are becoming overloaded.

**Reducing problem.** "The basic problem we face is to reduce space observations to a set of measurements of meteorological parameters," he says, which advancing electronic-sensor technology should handle. "Some of the sensors we put on spacecraft could not have been thought of five years ago because of inadequate technology."

# hp MEASUREMENT NEWS

innovations from Hewlett-Packard

OCTOBER edition

## in this issue

A counter for mobile communications  
(page 5)

New security for your pocket calculator  
(page 2)

HP's first two-pen recorder  
(page 3)

## Automatic RF testing without programming

Microwave automatic network analyzers provide speed, accuracy and economy—and you don't need a programmer!

For cost-effective, comprehensive microwave testing, HP offers automatic network analyzers that amplify the design efforts of engineering labs, produce greater efficiency and better yields in production testing, and improve the service and accuracy of calibration facilities. A very comprehensive series of microwave application programs removes the need for a programmer.

The 8542B automatic network analyzer is a highly accurate stand-alone system. Model 8545A is an economy version that can be operated in the same stand-alone mode or linked to a time-sharing facility. The latter mode lets the

*(continued on page 3)*



# New low-cost disc for OEMs

The 7901A packs 24 million bits into only 10½ inches of rack space; and it takes less than a minute to change a disc.



If you are an original equipment manufacturer in search of a low-cost high-quality memory for compact disc operating systems, HP has the answer. The new 7901A is a small, random-access moving-head disc drive with front loading, interchangeable cartridge and high-speed performance. The data capacity is 24 million bits with unlimited off-line storage.

OEMs will appreciate the flexibility of a complete DOS on a single removable cartridge. You get full capability at low cost, yet you can

change the system easily by removing a single disc or by adding up to three more disc drives to the same controller.

If you already use an HP disc operating system, you can add up to three more 7901A disc drives. The result: lots of memory and a system that keeps operating under adverse environmental conditions, such as temperature and humidity extremes.

To learn more, check M on the HP Reply Card.

# New accessories enhance HP-35 pocket calculator

Three new accessories are now available to enhance the versatility of the HP-35, the pocket calculator that challenges a computer in handling complex problems. The HP-35 solves log, trig and exponential functions with a single keystroke.

To protect this 9 ounce wonder, lock it into the security cradles that attaches to your desk, lab table or work surface. Or, chain the cradle to the leg of your desk with a 6-foot flexible stainless steel cable. Only you can open the cradle with a special coded key. It's a practical way to stop pilferage and costs \$24.50.

The new battery holder lets you keep one pack of batteries always on charge while you are using the other pack. Price: \$18.00.

Since you can take the HP-35 anywhere, protect it against dust, dirt and moisture with a sturdy, hard leather field case. Only \$19.50.

For accessory information, check B on the HP Reply Card. To learn more about the HP-35 pocket calculator, check A.

Protect your calculator with a locked security cradle and cable; power it continually with a battery holder and spare pack.



# Now, a two-pen x-y recorder for fast signals

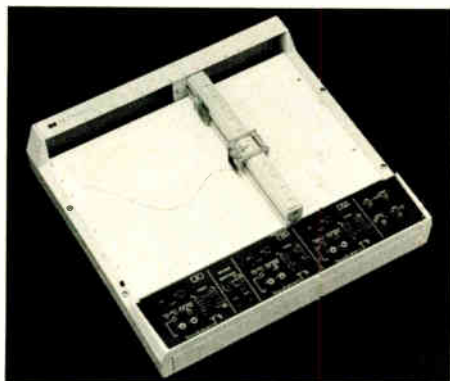

The new 7046A recorder uses standard 11 by 17 in. or European DIN A3 size paper. Metric calibration is available.

Now you can plot gain and phase vs. frequency, horsepower and torque vs. RPM, or temperature gradients and heat flow vs. distance—with HP's first two-pen recorder. The new 7046A is a high-performance x-y recorder that graphs fast changing signals that previously

couldn't be handled by two-pen recorders.

Acceleration on the x axis is 1500 in/sec<sup>2</sup> and on the y axis, 2500 in/sec<sup>2</sup>. This high acceleration mean quick response to small input changes. The high slewing speed (30 in/sec<sup>2</sup>) enables the unit to respond to large, fast input signal changes.

A unique "see-through" capillary disposable pen provides high quality tracing, and the thin-line design lets the pen tips cross over with minimum separation. You don't have to contend with messy refills. When the ink supply is low, you merely detach the whole pen and snap in a new one. For easy identification, use different ink colors for the two traces. Price: \$2650. For more on this fast two-pen recorder, check L on the HP Reply Card.

## Continued from page 1

design engineer transfer measurement data easily to computer-aided design programs for the design of a given circuit.

Both systems measure amplitude and phase parameters under automatic control in single or multiple frequency bands from 100 MHz to 12.4 GHz. (Model 8542B can be extended to 18 GHz.) Test fixtures and adapters let you characterize active and passive components: transistors, amplifiers, antennas, cables, waveguide and strip-line components.

System calibration and error correction techniques provide measurement accuracy and speed impossible to achieve with manual methods. Depending on the device and the actual test performed, a system user realizes 5 to 20 times throughput improvement over the equivalent manual measurement.

A new series of application programs means that microwave engineers and technicians do not have to learn programming. It takes less than 5 minutes for them to fill out a simple form that completely defines how a complex

device is to be tested. ANA BASIC is provided for special measurement cases and further data manipulation capability. You get hardcopy alpha-numeric output at the system console. Or, an optional graphics display shows graphs, charts and data in visual form.

Automatic network analyzers start under \$50K.

For more information, check N or O on the HP Reply Card.

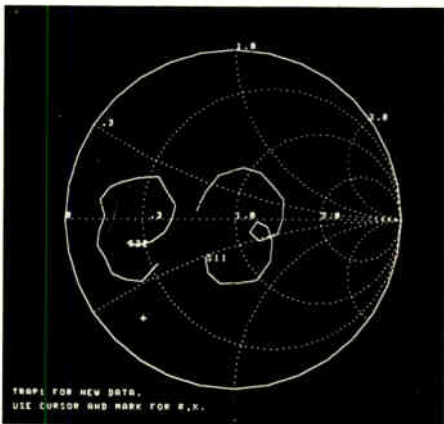

View Smith charts and other visual representations on the analyzer's interactive graphics console.

# Multi-function meter has 12 operating modes



Polarity, function and digital information are shown on the easy-to-read 3450B front panel display.

A high-performance DVM, the 3450B five-digit multi-function meter measures ac, dc, ohms and ratio. All functions include auto-ranging and up to 20% overranging. It has 5 ranges of dc voltage (100 mV to 1000 V) with 4 ranges of 4-terminal ratio. Plug-in options let you add measurement capability for true rms ac, ohms, limit test, digital output and remote control. The 3450B uses a dual-slope integration technique which provides excellent noise immunity at up to 15 readings/second.

The ac option adds 4 ranges of true rms ac (1 V to 1000 V) and 4 ranges of ac ratio. Frequency response extends from 45 Hz to 1 MHz. The optional ohms converter measures 6 resistance ranges (100 Ω to 10,000 kΩ) as well as 4 ratio ranges. Another option—limit test—permits digital comparisons against two preselected limits.

The 3450B DVM costs \$3300; optional ac converter, \$1250; ohms converter, \$425; and limit test, \$375.

Other options are available. For details, check F on the HP Reply Card.

# Fast storage and portable scopes for digital use

A superfast storage scope and a wideband portable display fast infrequent traces common to high-speed computers peripherals, and digital communications.

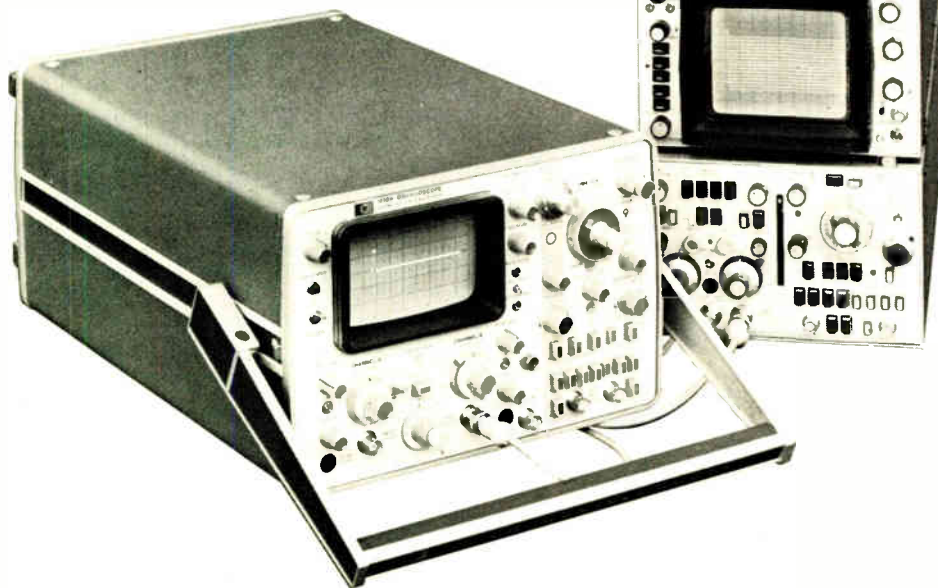

Two new oscilloscopes for digital applications are HP exclusives: the first storage scope capable of super-fast writing, 400 cm/ $\mu$ s; and the first wideband portable with switchable input impedance.

Superspeed writing is achieved by new surface processing that produces a bright display of hard-to-capture signals. Basic writing speed for the 184 scope is 100 cm/ $\mu$ s. With the high-speed option 005, writing speed is greater than 400 cm/ $\mu$ s. Full resolution is maintained in the reduced scan fast mode by increasing the cathode potential which reduces the spot size proportional to the scan area change. Thus, you view fast-rise signals, such as a 16-bit computer word, directly without having to photograph them.

And with storage, you can retain the display for 5 minutes from FAST mode or over 30 minutes from the standard mode. This powerful storage performance is provided in the 184 A/B mainframe which is fully compatible with all 180 series plug-ins to 100 MHz real-time, 18 GHz sampling, and time domain reflectometry.

To view fast digital traces in a portable environment, try the 1710A, a moderately-priced 150-MHz dual-channel portable with fast sweep (2 ns/div). For low duty cycle pulses that are normally encountered in peripherals and I/O equipment, a bright scan mode is available to increase the display brightness by a factor of two. Bright scan restricts the display to a 3 by 5 cm. area and the trace becomes correspondingly sharper, which maintains resolution while increasing brightness.

The 1710A is the first portable to offer switchable input impedance—either 50 ohms or 1 megohm, 12 pF. Signals with < 10 ns rise-time require 50-ohm matching circuitry to avoid waveform degeneration, but high impedance is more suitable for slower waveforms.

The 184 scope costs \$2200 (cabinet style) or \$2275 (rack style). Add \$500 for FAST writing, option 005. The 1710A portable scope costs \$2300.

There's more. Check C or D on the HP Reply Card.

## New low-cost lab quality crystal oscillators

Two new inexpensive quartz oscillators—5 MHz and 10 MHz—match the low aging, high stability and fast warm-up formerly available only in expensive laboratory type designs.

Aging is better than  $5 \times 10^{-10}$ /day or  $1.5 \times 10^{-7}$ /year. With such low aging, a manufacturer of communication and test equipment can offer his customers a real cost saving by reducing the frequency of calibration necessary to stay within FCC accuracy requirements.

Rapid warm-up assures an output within  $< 5 \times 10^{-9}$  of the final stabilized frequency within 15 minutes of turn-on. Excellent short-term stability and low noise make these component quartz oscillators suitable for communication systems where frequency multiplication is required.

The 10543A (5 MHz) costs \$850; 10544A (10 MHz), \$450. Quantity discounts are available.

For more information, check E on the HP Reply Card.

You can use compact HP oscillators in communication and navigation systems, synthesizers, time-code generators, counters and spectrum analyzers.

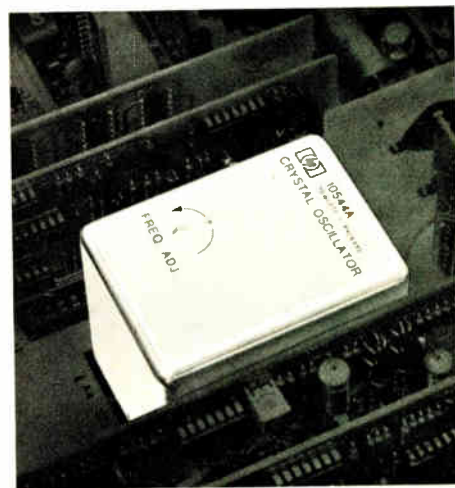

## DC current source has varied applications

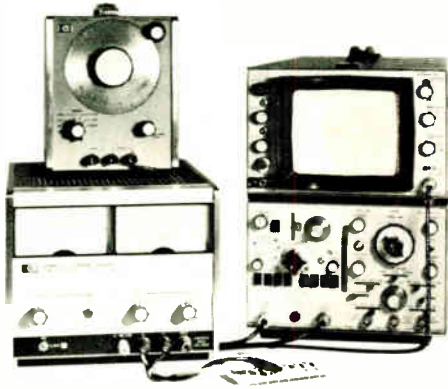

Here a dc current source is used to produce the reverse characteristics of a 6.2 V zener diode.

With a constant current source in the lab, you can:

- Evaluate reverse breakdown and forward V-I characteristics of p-n junctions.
- Measure silicon wafer resistivity and contact resistance.
- Test relays, meters, potentiometers, and electrolytic capacitors.
- Aid in coulometric titration and precision electroplating.
- Determine dynamic and incremental impedance of devices.

HP constant current sources supply precisely-regulated (30 ppm) dc current from 1  $\mu$ A to 0.5A. Current output is selected with high resolution (0.02%) by front panel switches. An external voltage or resistance can program the current source output.

An adjustable voltage limit circuit lets you set the maximum voltage compliance anywhere within the source's output voltage range. Monitoring load voltage with an external meter or the source's own meter won't degrade constant current performance.

Prices: \$475 to \$600.

To learn more, check R on the HP Reply Card.

## Your signal generator now can cover UHF

The all-around capabilities of the HP 8660 series synthesized signal generators catapult into the UHF region with the 86602A RF plug-in unit. Notable features are:

- 1 MHz to 1300 MHz frequency range that you can set in 1 Hz steps. It covers all HF/VHF/UHF communications bands.
- Low phase noise, low spurious, and high stability. The 1300 MHz signal generator is an ideal source for multiplication to microwave communication band frequencies, or for frequency-agile LO uses.
- Wide range (+10 dBm to -146 dBm) calibrated output level.
- Excellent modulation characteristics: AM, FM and pulse.
- All functions are fully programmable for automatic testing, such as receiver tests.

A complete 1300 MHz synthesized signal generator system costs \$8700 to \$12K.

Interested? Check P on the HP Reply Card.

## New low-cost counter for mobile communications

At last there is a long-needed solution to measuring mobile communications—on the ground, in the air, aboard ship. HP's 5300 series of compact, snap-together counters now features a 525-MHz module. It's battery-powered yet meets FCC measuring requirements when you add an optional temperature-compensated crystal oscillator. The new low-cost 5303B combines accuracy with portability, ruggedness with "operate-anywhere" power.

Sensitivity is 25 mV up to 80 MHz and 100 mV to 500 MHz. Input is protected against overload so you don't have expensive repairs for blown input circuits.

The counter has a six-digit display and is powered from ac or

any dc source, 11 to 24 V. For field use, snap a rechargeable battery pack in the middle of the instrument; it will run over four hours continuously before recharge is needed.

Like all the other 5300 counters, the new portable has large-scale MOS integrated circuits and LED readout. The 5300A mainframe and 5303B module cost \$1195. Optional oscillator is \$175 and the battery pack, \$195.

Interested? Check K on the HP Reply Card.

Interested? Check K on the HP Reply Card.

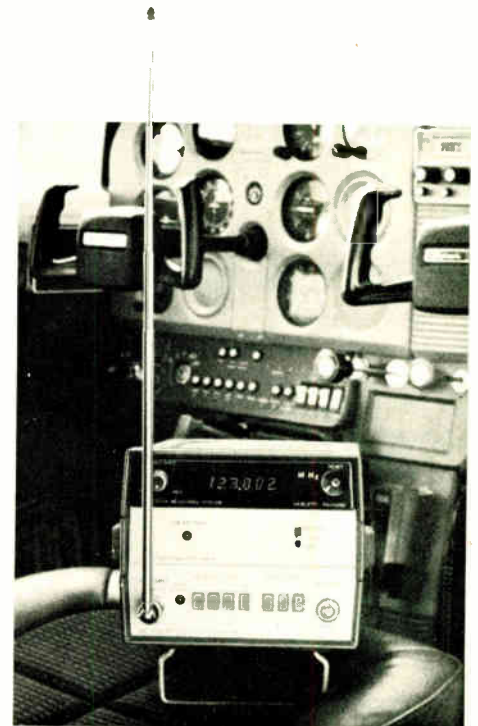

## New booklet on analyzer/ generator applications

Carrier frequency, 60 dB below modulation sidebands, is accurately measured using the tracking generator/spectrum analyzer. Our new application note tells you how.

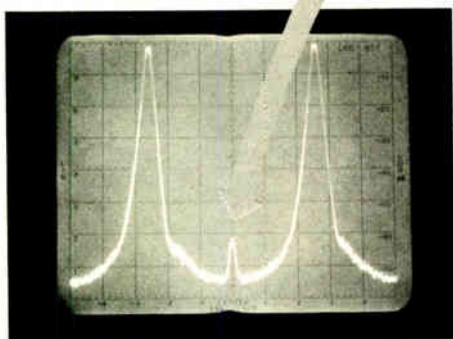

The modern spectrum analyzer—already eminently useful in lab, production and field applications—becomes significantly more powerful when coupled with a tracking generator. The combination can be used for precise frequency measurements of very low level signals and extremely wide dynamic range swept measurements of networks and devices. A new application note on tracking generator/spectrum analyzer applications gives many examples, including specific setups. Check Q on the HP Reply Card for your copy.

## Get microwave switches at low OEM prices

Select the frequency range and performance you need for any switching application—at low OEM prices and without trade-offs. For SPST switches, HP offers the 33200 series optimized for octave bandwidths, and the wideband 33100 series diode switches, from 100 MHz to 18 GHz. Price: \$125 to \$175.

Also in the SPST line are high-performance stripline and coax switching elements that meet MIL-spec environmental conditions. These start at \$60.

If you need SPDT switches, try the 33016A solid-state unit, 0.1 to 18 GHz with >50 dB isolation and 80 ns switching. Price: \$370.

The precision 8761 electromechanical SPDT series covers dc to 18 GHz with exceptionally low insertion loss (<0.8 dB) and SWR (<1.3 at 18 GHz). Price: \$150.

For switching, level control or complex modulation, our absorptive modulators maintain constant match against attenuation to >80 dB. Three overlapping bands cover 1 to 18 GHz. Prices: \$365 to \$575. Quantity discounts are available. For details, check S on the HP Reply Card.

HP high-performance microwave switches fit both your system and your budget.

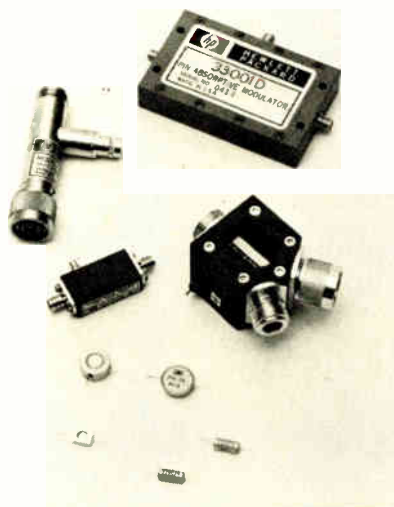

## High-speed isolator breakthrough

Both isolators have isolation voltage greater than 2500 V, and are available in standard eight-pin dual-in-line plastic packages.

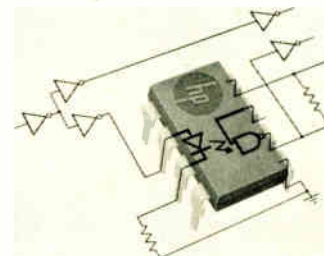
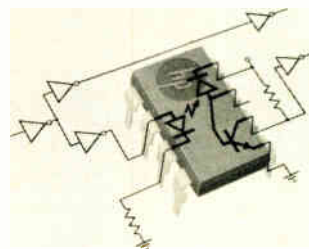

HP offers two new optically coupled isolators that take advantage of our advanced photo IC capability.

The 5082-4350 series isolators operate up to 5 MHz bandwidth. This device consists of a monolithic photo detector with a photo diode and high frequency transistor on the same substrate.

The 5082-4360 series operate up to 20 M bits. This device has a photo detector IC circuit consisting of a photo diode and high-frequency linear amplifier. It is completely TTL compatible at the input and output, capable of feeding eight TTL gate loads.

The 5082-4350 series prices start at \$2.00 in 1K quantity. The 5082-4360 is priced at \$4.50 in 1K quantity. For ratings and other specifications, check G on the HP Reply Card.



## New distributors appointed for HP optoelectronics

Hewlett-Packard announces a network of industrial distributors for its LED displays, LED lamps, detectors and optically-coupled isolators.

Explains Milt Liebhaber, HPA marketing manager, "The number of customer applications for optoelectronic devices is so broad that we wanted to expand our customer interface. New markets include portable calculators, displays for automatic typesetters, or anywhere the display of information is required. Designers for these products are used to ordering from familiar industrial distributors who can provide fast delivery from nearby stocks."

In the U.S., **Schweber Electronics** will stock the HP optoelectronics line in Waltham, Mass.; Westbury and Rochester, N.Y.; Rockville, Maryland; and Hollywood, Florida.

**Hall-Mark Electronics** will cover 11 southern states from offices in Dallas, Houston, Tulsa and Huntsville. The **Wyle Distribution Group** will serve western users from Liberty El Segundo, California; Elmar Electronics, Mt. View, California and Denver, Colorado; Liberty Arizona, Phoenix; Liberty Northwest, Seattle; and Western Radio, San Diego, California.

In Europe, four distributors have been appointed: Celdis Ltd. in the United Kingdom, I.S.C. France, and two in Germany—EBV Elektronik and Ingenieurbüro Dreyer.

"Of course, HP's own offices will continue to give direct technical aid, but our new distributors will make it possible for us to serve many users we might never reach ourselves," says Milt Liebhaber. "We are pleased to be associated with these distribution professionals."

## New large-size LED numeric display

Discrete solid-state lamps in a 5 by 7 dot matrix produce 1.5 inch digits for the new 5082-7500 display.

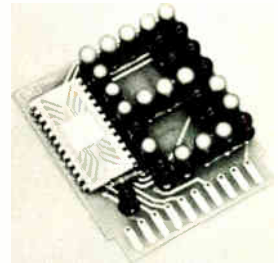

HP's new LED display is easily readable at distances up to 45 feet. The character is 1½ inches high, and average brightness is typically 1.25 millicandelas. Built-in decoder/driver circuitry allows direct addressing using standard BCD code.

The new large-digit LEDs are ideal for process and supervisory control panels, medical equipment, or any application where you have to read numbers at a distance. These displays are available from stock.

Price: \$35 (1-99), \$26 (100-499), or \$23.50 (500-999).

To learn more, check I on the HP Reply Card.

## New low-cost mini-LED

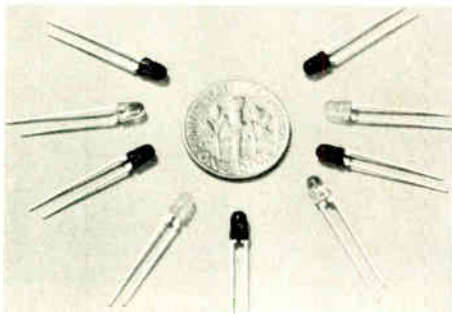

Our new T-1 mini-LED is only 1/8 inch in diameter and is especially suitable for large scale x-y addressable arrays. These devices offer high brightness over a wide viewing angle. And three lens configurations are available—red diffused, clear diffused, and clear.

The price is mini, too—only 45 cents on 1K quantities. Delivery is from stock.

For details, check H on the HP Reply Card.

HP packs long life and high visibility into these 5082-4480 series mini-LEDs.

# New logic troubleshooting kit: the easy way to find bad ICs



The 5011T troubleshooting kit contains everything you need to test in-circuit ICs: a logic comparator, probe, pulser and clip.

With HP's new logic troubleshooting kit, you can repair TTL and DTL logic boards faster than ever before and realize substantial savings in test time and dollars. Each kit component is a handy troubleshooter; but working in various combinations, their value is even greater. The logic com-

The logic comparator is a self-contained functional in-circuit IC tester that borrows power and input signals from the test IC and applies them to a reference IC of the same type inside the comparator. Outputs from the test and reference circuits are compared. Differences in logic state are displayed by one of the 16 LEDs that pinpoints the failing node exactly. Even brief or intermittent failures are captured and stretched for a visible indication. Price: \$375.

Once a failure has been located, the logic probe and pulser provide exacting analysis. For example, the probe indicates if any pulse activity is present or if the suspect node is stuck high or low. The probe detects single pulses as narrow as 10 ns. Using both the probe and pulser on the same node, you can detect shorts to ground or the power supply. (The powerful burst of energy from the pulser won't pulse supply busses.) Price: \$95 each.

parator, probe, pulser, and clip are designed to work together for more effective fault isolation. Increased troubleshooting efficiency at low cost means that the 5011T logic kit pays for itself with just a few weeks of use.

You may purchase the instruments separately; however, you save 10% by buying them in the 5011T kit, only \$625. Quantity discounts are available. For details, check J on the HP Reply Card.

Pulser/probe and pulser/clip combinations provide stimulus-response testing for in-circuit ICs. The pulser injects reset, shift and clock signals directly into flip-flops, counters and decoders while the logic probe and clip monitor the effect. The probe's pulse-stretching is handy for testing gates. The clip is ideal when testing sequential circuits such as counters and shift registers where responses at several outputs are of interest. The clip costs \$125.

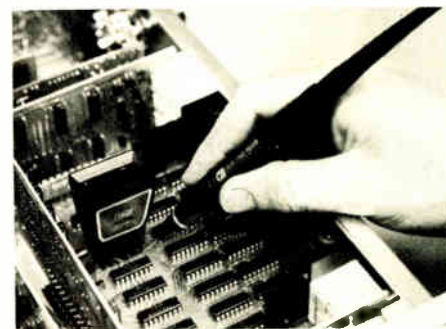
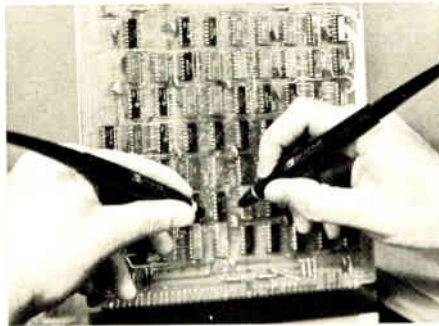

**HEWLETT**  **PACKARD**

Measurement, Analysis, Computation

East—W 120 Century Road, Paramus, N.J. 07652,  
Ph. (201) 265-5000.  
South—P.O. Box 2834, Atlanta, Ga. 30328,  
Ph. (404) 436-6181.  
Midwest—5500 Howard Street, Skokie, Ill. 60076,  
Ph. (312) 677-0400.  
West—3939 Lankershim Boulevard, North  
Hollywood, Calif. 91604, Ph. (213) 877-1282.  
Europe—Post Office Box 85, CH-1217 Meyrin 2,  
Geneva, Switzerland, Ph. (022) 41 54 00.  
Canada—275 Hymus Boulevard, Pointe Claire,  
Quebec, Canada, Ph. (518) 561-6520.  
Japan—Ohashi Building, 59-1, Yoyogi 1-chrome,  
Shibuya-ku, Tokyo 151, Japan,  
Ph. 03-370-2281/92.

- Q.1 Who's got a primerless, non-corrosive adhesive/sealant?
- Q.2 Is there an easy way to improve TV reception?
- Q.3 How can I cut prototype mold costs by 25%?
- Q.4 What's a practical way to protect delicate parts from shock?

**A1** We do. GE's ready-to-use, one-part RTV-162 (White) and RTV-168 (Clear) are odorless, paste-like, room temperature curing adhesive/sealants that bond to most materials without primer. They meet the non-corrosive requirements of MIL-A-46146, and come in tubes, caulking cartridges or bulk-type containers. Circle Reader Service No. 24.



**A3** Use GE RTV-700, the strong, two-part silicone mold-making compound that needs no postbake, cures in 24 hours and has the high tear strength and elongation to reproduce precision parts quickly and accurately. Circle Reader Service No. 26.

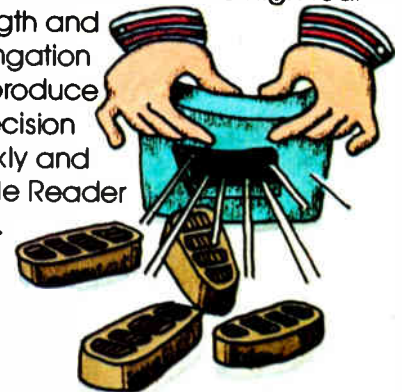

**A2** Definitely. With GE Silicone Rubber. It improves TV set performance because its electrical properties are far superior to those of other elastomers. And because it takes less material to do the job with silicone rubber, you save space and weight. Fire resistance? GE Silicone Rubber meets all the latest TV industry safety requirements. It's perfect for wire insulation, corona rings and anode caps. Circle Reader Service No. 25.

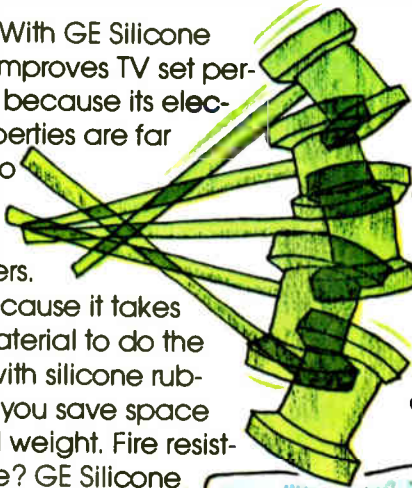
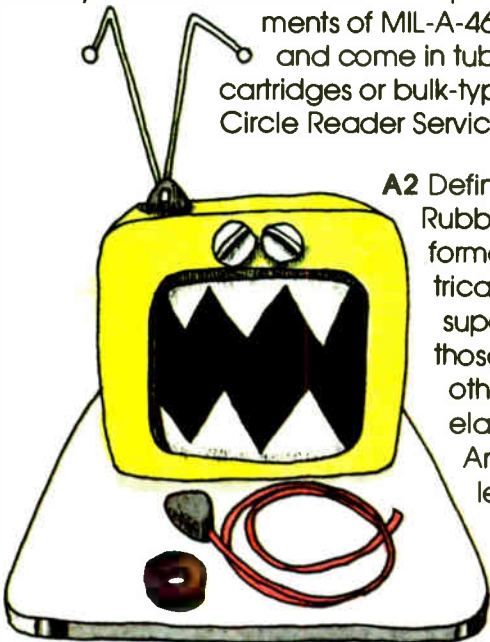

**A4** With GE RTV-619 Silicone Gel. It cures at room temperature into a clear, resilient, dielectric gel cushion for circuitry and for protecting electronic assemblies. RTV-619 cures without exotherm and can withstand temperatures from  $-65^{\circ}\text{C}$  to  $+150^{\circ}\text{C}$ . Circle Reader Service No. 27.



For all the details, write: Section N 10374  
Silicone Products Dept., General Electric Co., Waterford, N.Y. 12188.

GENERAL  ELECTRIC

**GE silicones.**  
**The answer.**

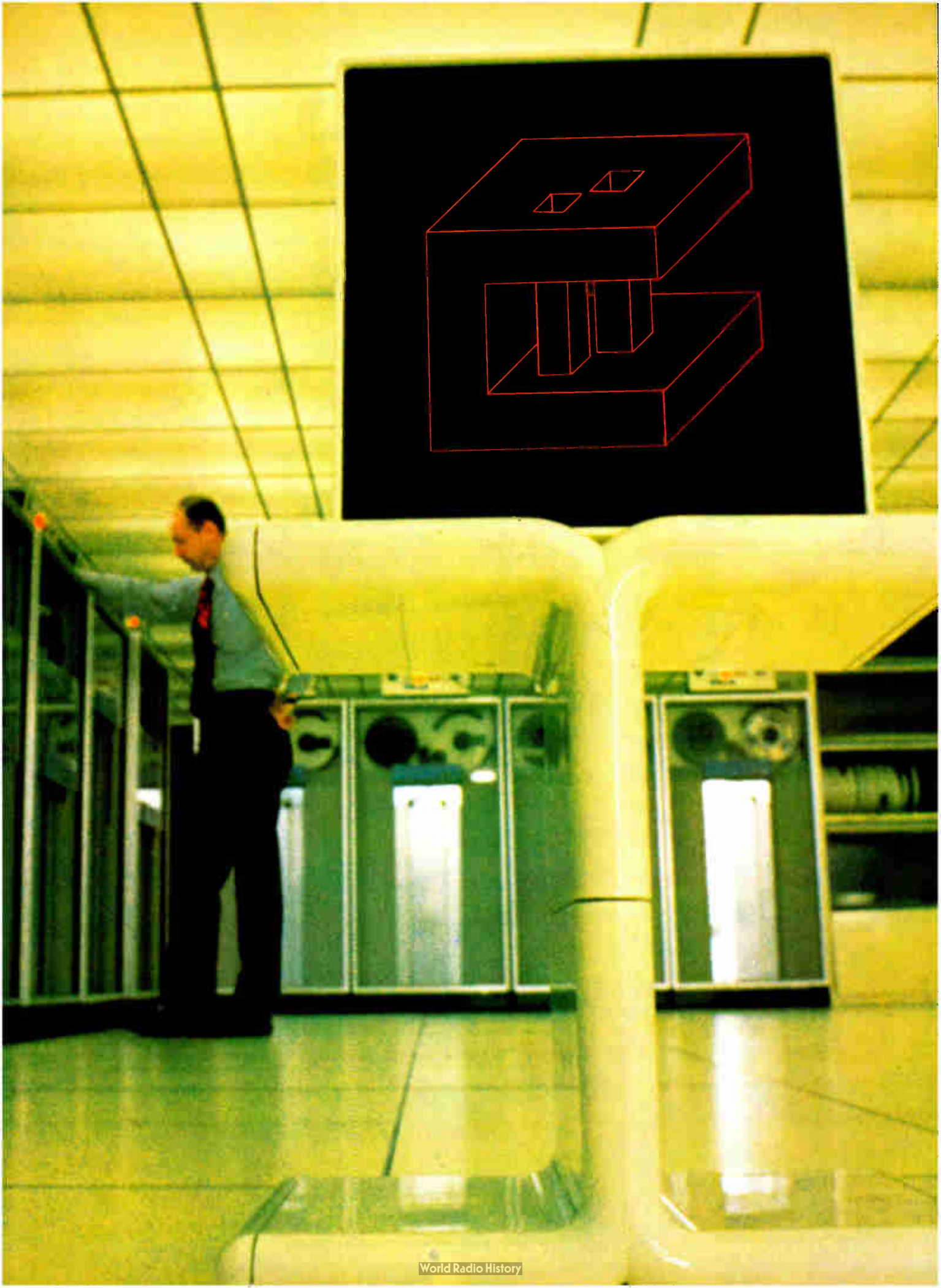

**You've got the kind of an organization that demands instant, high-impact, full spectrum visual communication.**

**We've got Digivue.**

**INVENTORY STATUS**

QUANTITY	PART NO.	QTY.	TYPE	SHIP VIA
09-231	46-200	100	JB	HDR PEIGHT
09-232	46-200	150	JB	HDR PEIGHT
14-223	200-44	2000	Q3	PHIL
20-111	200-44	25	P	REF. IRL
25-29	200-44	50	KD	HDR PEIGHT
40-750	2000	50	T	REP
74-823	10-11	20	PL	HDR PEIGHT
74-824	10-11	5	T	MARK. CHAMP
74-825	10-11	100	P	REF. IRL
74-826	10-11	1000	H8	REP
80-111	10-200	10	J	HDR PEIGHT
80-112	10-200	1	DW	REP
90-75	20-129	50	B2	HDR PEIGHT
90-76	46-200	100	JB	HDR PEIGHT
90-77	2000	50	T	REP

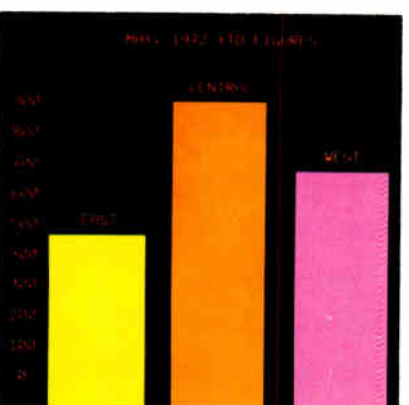
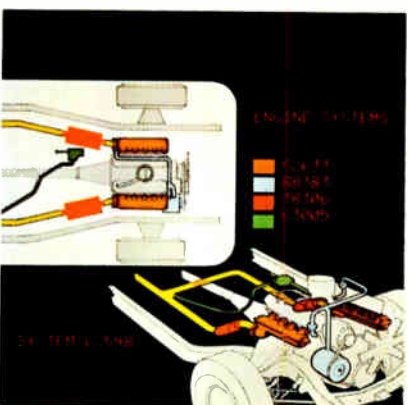

Communicate. That's the watchword for the Seventies. And that's just what Digivue® Display/Memory units do—with impact, immediacy and memorability.

Digivue Display/Memory units deliver computer-generated alphanumeric or graphic information at microsecond speeds. And a Digivue Display/Memory unit is a digital plasma display device—the space age display system that's a technological giant step beyond the cathode ray tube.

Inherent memory, selective write/erase, drift-free images, rear-projection capability, design adaptability, hard copy printout potential—that's Digivue.

Digivue Display/Memory units are now available in three different sizes: A 256 x 80 addressable line panel at a resolution of 33 lines per inch; a 256 x 512 addressable line panel at a resolution of 50 lines per inch; and a 512 x 512 addressable line panel at a resolution of 60 lines per inch that offers an active display area for up to 4,000 characters.

If you need fast, multi-purpose visual communication with impact—in a business, school, hospital, transportation center—we've got what you need. Digivue Display/Memory units.

Call or write: Jon Klotz, Marketing Manager  
Electro/Optical Display  
Business Operations C,  
Owens-Illinois, Inc.,  
P.O. Box 1035, Toledo, Ohio 43601  
(419) 242-6543.

*Communication with Digivue units begins at a data processing center like the one pictured on the opposite page, where computer-generated information is directly addressed to Digivue units at various locations.*

*a/A Digivue unit in a shipping department relays the day's orders by catalog number, type, quantity and method of shipment. Digivue's inherent memory allows instant retrieval of this information without refresh requirements at any time.*

*b/A Digivue unit on the desk of a financial vice president transmits a twelve-month cost projection. Terminal manufacturers note: Digivue's slim panel depth allows for high-styled consoles and attractive, unobtrusive placement in an almost limitless variety of situations and locations.*

*c/Digivue units help a sales training class with assembly techniques for a new product line. Because Digivue panels are transparent, rear-projected graphics in every color of the rainbow deliver high-impact visuals no CRT system can even come close to.*

*d/With the help of a Digivue unit, a busy executive secretary prepares information for an important meeting—utilizing a combination of rear-projected graphics and computer-generated alphanumerics.*

**DIGIVUE**

Display/Memory Units

**Owens-Illinois**

Circle 29 on reader service card

Digivue is a registered trademark of Owens-Illinois, Inc.

# Your custom resistor network is only an idea away!

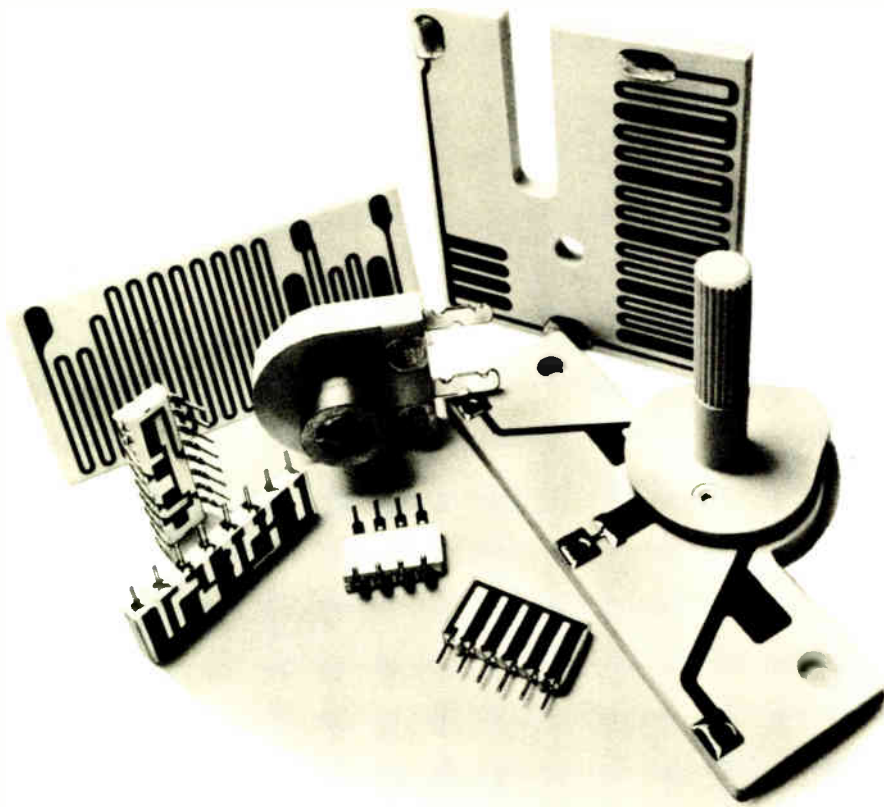

CTS CORPORATION, a pioneer in cermet network packaging, HAS WHAT YOU NEED TO SOLVE "CUSTOM" RESISTOR REQUIREMENTS! Complete thick film facilities save in-house investments: existing tools speed production—cut costs... capabilities you can't afford to overlook. Resistors and resistor networks are our business... not just a sideline.

Whatever your needs, from standard in-line and DIP networks to custom high power/high voltage packages, you can rely on CTS experience and know-how.

Unmatched field reliability, high volume mechanization, and over a decade of cermet thick film-technology make CTS resistors "the engineers' choice". We have what it takes for both standard and custom resistor packages. Call on CTS EXPERIENCE...today! CTS CORPORATION, 905 N. West Boulevard, Elkhart, Indiana 46514, Phone: (219) 293-7511.

**CTS CORPORATION**

Elkhart, Indiana



A world leader in cermet and variable resistor technology.

## Meetings

**Government Microcircuit Applications Conference:** Town and Country, San Diego, Oct. 10-12.

**Business Equipment Show:** McCormick Place, Chicago, Oct. 16-20.

**Eascon:** IEEE, Marriott Twin Bridges, Washington, Oct. 16-18.

**Photo-Optical Instrumentation Engineers Annual Meeting:** SPIE, San Francisco, Oct. 16-18.

**Optical Society of America Annual Meeting:** OSA, Jack Tar Hotel, San Francisco, Oct. 17-20.

**Fifth Annual Connector Symposium:** Electronic Connector Study Group, Cherry Hill Inn, Cherry Hill, N.J., Oct. 18-19.

**International Conference on Computer Communications:** IEEE, ACM, Hilton, Washington, Oct. 24-26.

**International Microelectronics Symposium:** ISHM, Shoreham Hotel, Washington, D.C., Oct. 30-Nov. 1.

**Nerem:** IEEE, John B. Hynes Civic Auditorium, Boston, Nov. 1-3.

**Canadian Conf. on Communications and EHV Power Transmission:** IEEE, Queen Elizabeth Hotel, Montreal, Nov. 9-10.

**Electronica 72:** Munich Fair Grounds, Munich, West Germany, Nov. 23-29.

**Int. Conf. on Digital Satellite Communications:** Intelsat, Unesco Building, Paris, Nov. 28-30.

**International Conference on Magnetism and Magnetic Materials:** AIP, IEEE, et al., Hilton, Denver, Nov. 28-Dec. 1.

**National Telecommunications Conf.:** IEEE, Astroworld, Houston, Dec. 4-6.

**International Electron Devices Meeting:** IEEE, Washington Hilton, Washington, D.C., Dec. 4-6.



# If you'd rather be skiing

Let SAE solve your packaging problems.

Wouldn't you rather be schussing than struggling with component selection, packaging, and systems assembly? Then leave all that to us. You take some extra time to perfect your downhill form.

Only SAE provides a complete packaging service in your choice of three systems: Plug-in, Planer, and Dipstik™.

We manufacture all the hardware for any card cage system, including PC cards, card guides, card files, enclosures, connectors, sockets, mounting and bussing.

Prefer logic panels? We'll provide all the planer system mounting hardware, sockets and all peripheral items.

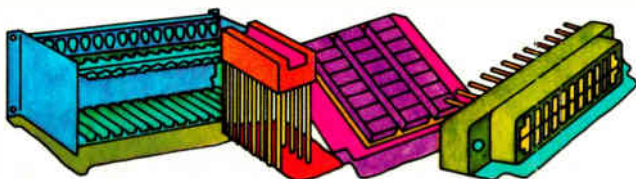

Or investigate our unique Dipstik. It gives twice the IC density as PC methods, and eliminates lots of hardware.

Whichever method you choose, we can supply the components for you to assemble yourself. Or, we'll pick the parts, do the assembly, and let you do the wiring. Or, we'll provide everything: components, assembly, and Wire-Wrap®. So, just call us in... and you go out skiing.

**Free bumper sticker for your desk.** Show you're a downhill racer. Or if apre-ski is more your speed, tell us your favorite sport. We may have a sticker for it. We'll also send you our new brochure describing how we can handle all your packaging problems. Write us:



**I'd rather be  
skiing**

## Stanford Applied Engineering Inc.

340 Martin Avenue, Santa Clara, California 95050 Telephone (408) 243-9200 — (714) 540-9256 — TWX 910-338-0132

**In November, TI announced  
the 960A industrial  
automation computer**

**TI announces  
the leader...**



**Model 960A  
\$2,850**

Quantities 1 to 100  
CPU with 4K memory \$2,850  
CPU with 8K memory \$4,350  
CPU with 16K memory \$7,350

**in minicomputer  
price/performance**

**TEXAS INSTRUMENTS  
CORPORATED**



**Now, TI announces the 980A...  
the price/performance leader  
in general purpose computers**



# Model 980A

# \$3,475

## Quantities 1 to 100 with hardware multiply and divide and many other built-in standard features

TI continues its leadership in price and performance with the new Model 980A general purpose computer.

The 980A, as with the 960A, is a fast, powerful and flexible 16-bit computer at a low unit price with all the features, built-in and *standard*. Consider these many standard features, compare the price and you'll see why the 980A is the most cost-effective general purpose computer available today.

- Hardware, multiply/divide with 16 or 32-bit add and subtract
- 750-nsec add immediate
- 5.25- $\mu$ sec multiply
- 750-nsec, full-memory cycle time
- Bit/byte/word/bytestring data addressing
- Memory parity
- Programmable memory protect and privileged instructions
- Power fail/auto restart
- Power supply to support 65K memory
- Memory biasing (dynamic relocatability)
- I/O bus with 4 ports basic (expandable to 14 in basic chassis, 256 overall)

CPU with 4K memory	\$ 3,475
CPU with 8K memory	\$ 4,975
CPU with 16K memory	\$ 7,975
CPU with 32K memory	\$13,975

(prices are FOB Houston and do not include illustrated tabletop cabinet)

- Main chassis semiconductor memory expandable to 32K. (Up to 65K with memory expansion unit: Two weeks memory protect with optional battery)
- Full, lockable front panel with breakpoint and 4 sense switches
- Switch-initiated ROM bootstrap loader
- Auxiliary processor port
- Direct memory access channel (expandable to 8 ports)
- Four priority interrupts standard (expandable to 64)
- 98 basic instructions (16, 32 or 48 bit)
- 9 addressing modes
- 8 working registers plus status register

A pre-generated standard software system is supplied which allows the user to generate custom system software. Additional soft-

ware for the 980A includes:

- Symbolic assemblers and cross-assemblers for IBM 360/370
- FORTRAN IV
- Link and source editors (object and source)
- Modular executive control routine including disc management
- TI Language Translator (TILT) to extend FORTRAN, assembly, or create special application languages
- Service maintenance, debugging and utility programs.

For applications support, TI offers the resources of its experienced Applications Engineering group. Also, training courses on 980A software and hardware are scheduled regularly, and TI service facilities are located throughout the United States and abroad.

Would you like to know more about the new 980A price/performance leader? Write to Computer Products Marketing Manager, Texas Instruments Incorporated, P.O. Box 1444, Houston, Texas 77001. Or call (713) 494-2168 or any of the sales offices listed below.



Arlington, Va. (703) 525-1444 • Atlanta, Georgia (404) 237-8666 • Boston, Mass. (617) 890-7400 • Chicago, Ill. (312) 593-2340 • Cleveland, Ohio (216) 464-1192 • Dallas, Tex. (214) 238-3881 • Dayton, Ohio (513) 294-0774 • Denver, Colo. (303) 758-5536 • Detroit, Mich. (313) 352-5720 • Los Angeles, Calif. (714) 547-9221 • Minneapolis, Minnesota (612) 831-5094 • Newark, N. J. (201) 467-2670 • New York, N. Y. (212) 233-6890 • Orlando, Fla. (305) 644-3535 • Philadelphia, Pa. (215) 643-6450 • San Francisco, Calif. (408) 732-1840 • St. Louis, Mo. (314) 993-4546 • Bedford, England 58701 • Clamart, France 6450707 • Frankfurt, Germany 726441 • Bad Godesberg, Germany 65534

## TEXAS INSTRUMENTS

INCORPORATED

Circle 33 on reader service card

# Amphenol sets your contacts straight

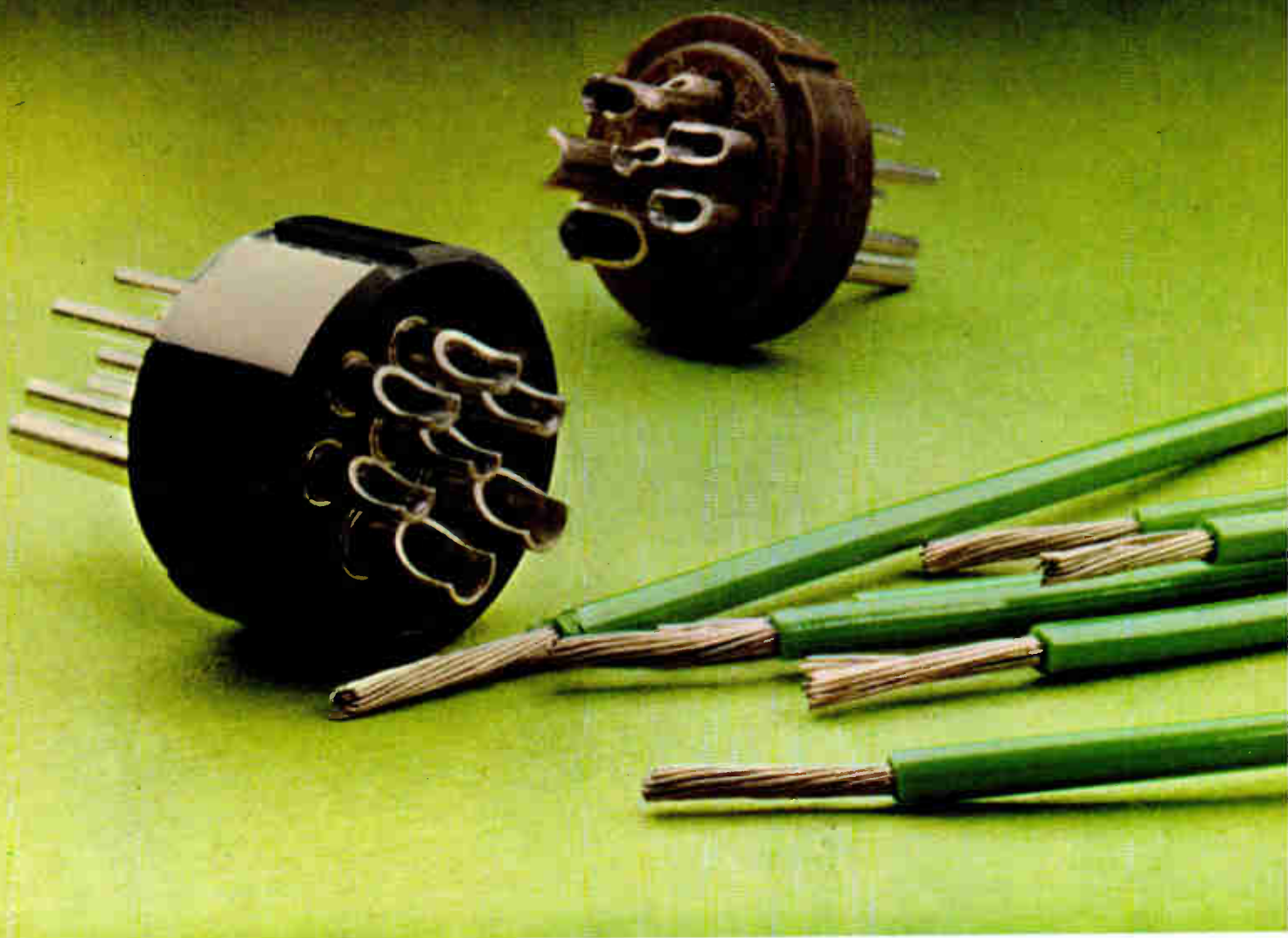

## for 30% faster terminations.

With Amphenol 97 Series connectors, the contacts *don't rotate* within the insert. They're pre-aligned—to stay aligned—so the solder cups are uniformly positioned for quick, easy soldering.

Test ours against the competition's. You'll find the soldering 30% faster, with less wasted motion, giving you lower termination costs. Our inserts are thicker, too. For extra strength and reliability. These benefits mean fewer scrapped parts during assembly, longer product life.

The 97 Series is basically the same connector as our original "Old Vet" AN (MIL-C-5015). In com-

mercial applications such as computers, traffic controls, dynamometers and welding controls, 97 Series connectors are lowering costs.

On-the-shelf inventory at your Amphenol distributor's means fast delivery, less for you to stock. Of all the orders we ship, 90% are straight from stock. Another good reason to specify Amphenol "97 Series" right on your drawings.

Get the "straight" story from our salesman or your Amphenol Industrial Distributor (AID). Amphenol Connector Division, 2801 South 25th Avenue, Broadview, Illinois 60153.

**BUNKER RAMO** **AMPHENOL**

## **Supermarket tests National's p-o-s system**

What is likely to be the first system to bear the name of **National Semiconductor Corp.** is now operating on a trial basis at the El Rancho supermarket in Huntington Beach, Calif. Four checkout point-of-sale terminals have been used for several weeks at the store, which is part of the Certified Grocers Co-op in Southern California. The terminals, called Datacheckers, are specifically designed for supermarkets where the main selling point is to move customers through the lines as fast as possible. **The system also supplies management with up-to-date information on transactions.** Datachecker comes equipped with a journal printer that at 15-minute intervals prints out store totals, department totals, and total taxes collected.

**At the heart of each terminal is National's general-purpose controller/processor MOS chip set,** which processes the keyboard data for the central processor. The test units, however, use a TTL version of the chip set. An optional electronic scale, which makes use of the register display to show weight and item price, will also be available. An industry source says Datachecker will be available in November for about \$2,500 per register.

Meanwhile, National has named **Fred Bialek vice president and general manager of its new System Operations division.** He was director of international operations.

## **Navy's Phalanx antimissile defense uses 20-mm shells**

The Navy has leaked a few details on its Phalanx close-in weapon system, the fleet's last line of defense against cruise missiles, **and it uses a new type of 20-mm shells, not missiles.** General Dynamics/Pomona is prime contractor for the radar-aimed, computer-controlled system, which can fire up to 1,000 rounds per minute from a six-barrel Vulcan gatling gun. The system searches and fires automatically, then returns to the search mode. A unique feature is closed-loop operation that continuously tracks the projectiles as they approach the target, computing the angular error and correcting aim automatically. The system is half-way through development and is scheduled for fleet use in 1974.

## **Line printer promises 20,000 lines per minute**

A new type of line printer may offer the computer industry speeds as fast as 20,000 lines per minute. By comparison, IBM's fastest, the 3211, is rated at 2,500 lines. The new printer, developed by Electroprint Inc., Cupertino, Calif., will initially be offered in an 8,000-line version, **but a company source claims that "speeds of up to 20,000 lines per minute have been reached under experimental conditions."**

Key to the high speed is an electrostatic method of depositing ink from a dot matrix directly onto plain paper. The usual method is to shoot charged ink particles in the desired matrix at the paper; but in the Electroprint system, **charged ions in the desired matrix pass through a cloud of ink and then hit the paper.** The result is higher resolution, as well as higher printing speed.

## **Harris offers op amp with bipolar and MOS on same chip**

Breaking new ground, Harris Semiconductor has developed the industry's first standard-product operational amplifier that uses both bipolar and MOS processing on the same chip—a chopper-stabilized MOSFET input in front of a standard bipolar op amp circuit. **Harris combined**

the technologies to get the input conditions that designers are demanding for precision systems. The offset current is only 1 picoampere/°C, and bias voltage is 0.1 microvolt/°C. Usually, more expensive modules or often-troublesome junction-FET input monolithic devices are used, but J-FETs drift with temperature.

Harris uses chopper stabilization to offset the normally unstable MOSFET operation, thus making it possible to take advantage of the MOSFET's low input current without incurring any loss in stability. Other specifications of the device, which the company plans to announce in about a month: slew rate of 15 volts per microsecond, gain of 500 million, gain bandwidth of 15 MHz, and common-mode rejection of 140 dB.

## **Mostek RAM array does without a single contact**

Look for the great RAM race to get even hotter with Mostek's entry—a 4,096-bit MOS random-access memory. **The company hints that the RAM is built by a new n-channel process that simplifies memory cell design.** Gordon Hoffman, Mostek's marketing director, says that the process, which is self-aligning, results in the "entire matrix of 4k bits not needing one single contact on it anywhere," a prospect that could mean more bits per chip area with greater yields.

Although the company isn't disclosing details at this time, it's known that **the Mostek approach uses a single-transistor cell, instead of the three to four transistors generally used.**

## **Solitron joins calculator club**

The latest MOS producer to jump on the calculator bandwagon is Solitron Devices in San Diego. But for Solitron, the move isn't quite as unexpected as it was for NRMEC and TI because **the company already makes such end-user automotive products as ignition systems.** What's more, the firm is buying the MOS, rather than making it. "Why should I reinvent the wheel when I can get the chips at current prices?" says Kenneth Seybold, vice president and division manager.

Solitron has five models in the works, including **the only 12-digit pocket-size unit on the market, expected to sell for about \$150;** an eight-digit pocket calculator, and three desktop models—one with memory using two Mostek chips. The other four calculators use Cal-Tex chips.

## **Addenda**

Texas Instruments, realizing that its new SN10K ECL series may be incompatible with those of competitors, is going to redesign the parts to match temperature coefficients of competitors. "With the redesign," says Dave Davies, ECL marketing manager, **"we will no longer be limited by circuit design on temperature range—it then becomes a marketing game."** . . . BART, the San Francisco Bay Area Rapid Transit that has experienced a series of electronic malfunctions [*Electronics*, Sept. 25, p. 33] has had its first accident. One of the highly automated cars ran through a station barrier, and five persons were hurt. The state plans two investigations: one into the computerized controls, the other into the car itself. **A spokesman says the failure probably was mechanical because the car was new and in its first day of service.**



# the nutcracker

***This is the "Nutcracker."  
The GRI 99 Minicomputer.***

A Functional Minicomputer\* that's cracking the toughest nuts around.

No idle boast. The GRI 99 begins where the 909 left off. And that was miles and dollars, hours and a heluva lot of manpower ahead of anything the competition was heralding for "ultimate" systems control.

***CYCLE TIMES, INITIAL HARDWARE COST AND AVAILABLE PERIPHERALS ARE NOT ENOUGH TO SELL SYSTEMS ANYMORE! They're important but there are tougher nuts you have to crack:***

cutting costs where they really hurt . . . by reducing software development costs through the use of truly simple, effective software; reducing system engineering costs with a simple but powerful I/O structure; reducing the time it takes to get your real-time system on the air, in short, cutting the costs of *using* your computer — that's what it's all about.

If you can solve these problems and still offer the speed, peripherals and performance at a price less than what everyone else is shouting about, brother you've cracked a hard nut. We have.

And you get twice the memory for your money. An 8K 16-bit model costs just \$2,800 in OEM quantity.

GRI COMPUTER CORPORATION  
320 Needham Street  
Newton, MA 02164  
Phone (617) 969-0800  
Cable: GRICOMP

Go ahead crack a nut.

\*Patented.

**gri**  
GRI Computer  
CORPORATION

## INTRODUCING THE EA 1502 BIPOLAR COMPATIBLE 1024-BIT RAM

The EA 1502 is another new addition to the growing line of N-Channel silicon gate products from EA. The EA 1502 accepts TTL inputs without external level shifting and sinks 1.6 mA on the output. It has an access time of typically 130 nanoseconds and dissipates only 115 mW (typical). In fact, in a systems configuration the EA 1502 outperforms the so-called high performance versions of the 1103, with lower power, bipolar compatibility, automatic refresh and low cost to boot! Oh yes, there's no address cycling requirements either. A single write pulse refreshes all data independent of the state of the address and chip enable inputs. Place your order early, everyone else is. \$27.50 in 100 quantities.

To make it easier for you to evaluate our EA 1500 series RAM's, we have an evaluation P.C. board available which contains all of the necessary interconnections for building a 2K by 4 memory. Ask about it!

# MORE FROM THE VERY SAME FOLKS WHO BROUGHT YOU N-CHANNEL SILICON GATE.

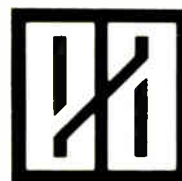

**electronic  
arrays,  
inc.**

501 ELLIS STREET  
MOUNTAIN VIEW, CALIFORNIA 94040  
(415) 964-4321 TWX: 910-379-6985

*Stocking distributors: Burstein-Applebee Company,  
Computer Components,  
Cramer.*



## Three plasma displays cause stir at show

Three-color panel, tubular device, and thick-film line system among developments shown at N.Y. conference

Three plasma display panels, the stars of an IEEE conference on display devices Oct. 11 and 12 in New York, point the way to a brighter future for such displays. The three were an improved three-color plasma panel from Owens-Illinois, a thick-film line display from National Cash Register, and a tubular plasma display from Control Data.

The initial developments in three-color displays at Owens-Illinois Co. [*Electronics*, March 15, 1971, p. 31] have graduated from the research laboratory to advanced development. Engineers in the company's plant at Perrysburg, Ohio, near Toledo, have built three-color displays as large as 17 by 17 inches with 60 lines per in., for a total of 512 by 512 three-color display elements.

Each display element is three selectively addressed phosphor dots

that fluoresce in the three primary colors when excited by the plasma discharge. This size and resolution are impressively better than the original 33-line 4-inch-square color display built in the Okemos, Mich., research lab. The Perrysburg plant is Owens-Illinois' primary facility for commercially producing monochrome plasma panels under the trade name Digivue.

The NCR line display, intended for electronic cash registers and similar equipment, combines a single row of seven-segment numeric displays with one or more of several "canned" alphanumeric messages—such as "grocery," "produce," "meat," "tax," and "total"—in the form of a film strip illuminated from the rear. Thus it differs from the usual dot-matrix pattern that can show alphanumeric or graphic data anywhere on the screen.

**Usual controls.** Eight segment drivers and eight digit drivers control the numeric segments in the usual way—64 segments driven by only 16 circuits. The digit drivers also control eight vertical columns

of canned messages; if the array contains four messages in each column, up to 32 such messages can be driven by only four more driving circuits. This arrangement is much more economical of external connections and circuitry than one in which, for example, a small independent light source is placed behind each message. The panels are assembled from two glass plates that are successively coated with layers of different materials in patterns.

**Glass tubes.** Control Data's tubular display, like the other two, consists of a sandwich of two glass plates with electrodes deposited on their inner surfaces. But instead of NCR's successive thick-film coatings or Owens-Illinois' large continuous gas cavity, CDC lays a series of glass tubes with rectangular cross-section between the plates. These are sealed at one end and connected to a common manifold at the other to equalize the gas pressure.

The tubes now have outside dimensions of 30 by 12 mils and walls 3 mils thick; together they create a rugged structure, which at the same time is easy to build at relatively low

**Light subject.** CDC's tubular plasma display, below, and NCR's plasma line display.

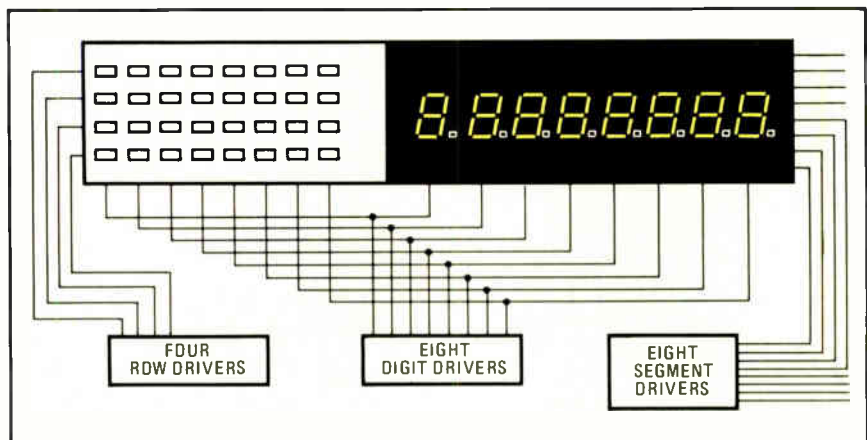
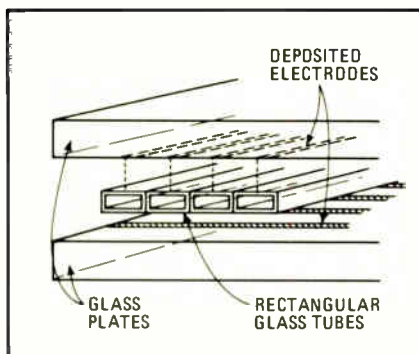

## Electronics review

process temperatures. Several panels of various shapes a few inches wide have been made by this technique, along with one 2-by-51-inch feasibility model. □

## Meetings

### Wescon considers easing sales ban

Spurred by the controversy at last month's Wescon over sales made on the premises by the John Fluke Manufacturing Co., the show's management apparently is trying to relax the ban against selling. A Wescon spokesman admits that Fluke went a bit far in selling its new \$299 digital voltmeter on the premises. In fact, assistant general manager Ted Shields points out that the show's

managers don't want any liberalization of the rules to include handing checks and packages across the counter. One reason for this is the legal problem Wescon would face if retail sales were permitted.

But Fluke's Frank Partin, director of industrial and public relations, emphasizes that sales and deliveries were made from a mezzanine room off the sales floor and that both Wescon management and the exhibits committee were informed before the show. Further, Partin says, "we created a climate for selling at a trade show that should be acceptable. Most of the exhibits committee members I talked with, and our competitors, thought it was a great idea." Close to half the 200 instruments were sold.

Shields does say that the show's paid management, including manager Don Larson, is hoping that Wescon's board will change its pol-

icy to increase the usefulness of the show to exhibitors. "We aren't going to let some companies do it and not allow others to," he says.

Before, during, and after the Fluke sales brouhaha, Wescon's first-ever show in September—it was held at the new Los Angeles Convention Center—chalked up a 20% attendance increase over the 24,500 totaled last year in San Francisco. However, the number of booths was almost identical to last year's figure at around 520, and the new "professional program" was poorly attended. And, as usual, exhibitors gave the show mixed reviews.

One happy exhibitor was William E. Hartman, director of sales and marketing at Industrial Electronic Engineers in Van Nuys, Calif. "We got just short of 1,500 inquiries—50% more than any other show we've attended."

"Quieter." Less enthusiastic was

## IBM's 10 days: some changes in the organization and Learson's retirement

The last 10 days of September were big ones for IBM. First, the company underwent one of the periodic rearrangements of its divisional structure. Then its chairman announced his resignation after having had the job less than 18 months.

The reorganization replaced IBM's Systems Development, Systems Manufacturing, and Components divisions with a new Systems Development division, plus Systems Products and General Products divisions. General Products acquires some of the functions of the former development and manufacturing divisions, while Systems Products apparently takes over functions of

the old Components and Manufacturing divisions and some development functions as well.

The principal significance of the new setup is that it is a return to a structure used some years ago in which both development and manufacturing of particular products were organized within a single division. In those days, IBM had a Data Systems division for computers and a General Products division for card readers, keypunches, and the like. Apparently the new General Products division is structured much like the old one.

The other development is more surprising. T. Vincent Learson,

chairman of the board, announced on his 60th birthday that he would retire at the end of the year. Frank T. Cary, now president, will retain that post and also become chairman upon Learson's departure.

Also, when Learson departs, IBM will initiate a new policy calling for the mandatory retirement of all corporate officers at the age of 60 in the belief that "the best interests of IBM will be best served by . . . upcoming young men and women." This won't have an immediate effect on Cary or on any of the six senior vice-presidents, whose average age as of Jan. 1 will be slightly under 52. IBM also has 17 non-senior vice-presidents and seven other corporate officers, including Thomas J. Watson Jr., son of the company's founder, who was chairman of the board until June of last year and is now chairman of the executive committee.

They'll all be affected by the new retirement policy; Watson himself will retire at the end of 1973, just before his 60th birthday.

**Moving out and up.** Learson, left, retires and Cary becomes IBM chairman.





William C. W. Mow, president of Macrodata Co. of Chatsworth, Calif. "It was quieter than expected for a recovery year. We did have a fair amount of response, mostly from customers who came to see us."

Also having mixed feelings was Leslie E. Hill, manager of advertising and sales promotion at Hughes Electron-Dynamics division in Torrance, Calif. "We consider it strictly an instrument show and are tending to go to more specific vertical shows. However, we did introduce a number of new solid-state microwave instruments and components, and they received good attention." □

---

## Components

---

### Transducer built and priced like IC

The transducer industry includes many companies, each of which makes a few special-purpose, high-priced devices. But that could soon be changed. National Semiconductor Corp. of Santa Clara, Calif., has developed a semiconductor pressure transducer that "is just another component; it's another IC—built like an IC, and priced like an IC," says William Hare, manager of transducer products.

The concept of a low-cost semiconductor transducer has been around for many years, but "all it's needed was the right application to give it a push," says Hare. That market has now arrived in the automotive pollution-control industry, and National is first out with a complete sensor and signal processor that will sell for less than \$10 each in high volume.

**Complex, expensive.** Pressure transducers generally have been complex mechanical and electromechanical assemblies that were built with the precision of a watch. Designed for the aerospace industry, they have been priced at \$200 to \$1,500. The National device, on the other hand, was designed to be built on a standard IC production line.

Another major difference is that all of the National transducers are tested to a single specification as they come off the line, so no system recalibration is needed in the field if a device has to be replaced. With mechanical units, however, a calibration curve is generated for each particular unit—no two are alike—so the complete system has to be recalibrated if replacement is necessary.

Basically, the National transducer consists of a silicon chip, about 115 by 165 mils, on which has been diffused a resistor bridge circuit and a transistor. The back of this chip is then selectively etched to form a tub, and another silicon chip is "glued" to the back, creating a cavity. The cross-section of the completed 25-mil-thick sandwich is thus made of a 1-mil-thick membrane over a 12-mil-thick pocket, with a 12-mil-thick bottom. The bottom is attached in a vacuum so that the cavity is empty; this makes the membrane immune to changes in internal temperature. The vacuum also acts as a reference pressure by which the external pressure is compared. The chip is mounted on a thick-film hybrid substrate, along with several other chips and thick-film resistors.

**Pressure to strain.** The complete transducer system works this way. The input pressure is transmitted to the membrane via a 3/16-in. tube. The membrane converts the pressure to strain, and the strain is measured by the piezoresistive resistor elements diffused on the membrane. This electrical signal is fed to a dual op amp chip (on the same hybrid substrate) which performs some signal discrimination (removes common-mode noise, for one) and provides a single-ended output signal. That signal is then fed to another op amp chip which amplifies the signal.

The complete pressure transducer is a three-terminal device—power supply, output, and ground. The base and emitter of the transistor on the membrane also are brought out, allowing the user to make temperature measurements at the point of the pressure measurement. And while the temperature character-

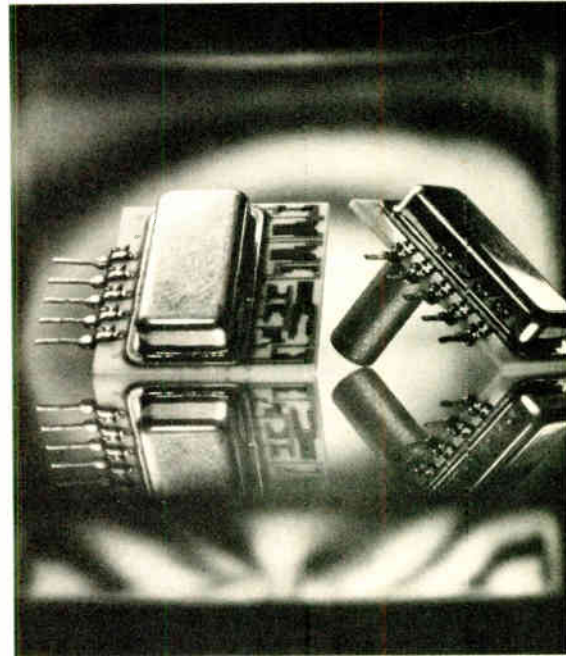

**Transducer.** National's component is built like an IC for \$10. Company expects to sell to auto-pollution-control market.

istics are not supplied with the device, it varies linearly with  $V_{BE}$ , and so it is easy to use.

The calibrated pressure range of the semiconductor transducer is from zero to one standard atmosphere pressure (760 mm of mercury), and the useful range is from zero to 1.9 atmospheres, although the device has an overrange capability of 3 atmospheres. Operating temperature range is from  $-40$  to  $+240^{\circ}\text{F}$ .

Because of this wide operating range, the device is expected to find wide application in markets other than automotive. Hare picks out the utilities, heating, ventilation and air-conditioning industries. □

---

## Memories

---

### NR delivers model of bubble system

Sooner than expected by many observers, North American Rockwell has delivered the first magnetic-domain bubble memories to two military laboratories. The demon-

stration models went from the Research and Technology division of NR's Electronics group, Anaheim, Calif., to the Army and to the Air Force Avionics Lab at Wright-Patterson Air Force Base.

Bubble memories, under development by Bell Labs and IBM, among others, are expected to be used widely as a replacement for medium-capacity disk memories.

**More to come.** What the military got was similar 64-bit memories, complete with exercisers. The units, though small in capacity, demonstrate a capability that NR hopes to follow with as much as 32,768-bit demonstration models to commercial customers next year. The delivered memories, each about 3 inches on a side, plus electronics module, could be expanded to 10,000 bits without enlarging the physical size of either part, says W.J. West, staff member for commercial business, in the office of the president.

West expects to have demonstration models in the hands of customers early next year, with prototypes by the end of the year and production in 1974. The delivered units are organized in serial form, but production units will probably be parallel to improve speed. West says that present units operate at speeds close to what the company is expecting to offer in commercial units, but declines to specify it. Military applications of the units, he says, are further away than commercial ones because of the problems with using unproven devices—even though the small size and prospective high reliability make the bubble memories natural for such applications.

West adds that the technology for making the bubbles seems well in hand, with garnet wafers from Airtron and Union Carbide almost defect-free. NR performs all the deposition and photolithography, and the company makes materials for some

applications. Among the problems remaining are the detectors, but NR claims significant progress. □

Avionics

System aims at clean, quiet STOL

A research system to investigate quieter approach and landing techniques for future short-take-off-and-landing (STOL) aircraft has been installed at NASA's Ames Research Center, Mountain View, Calif.

NASA's STOL transport concept is aimed at reducing aircraft noise and engine exhaust emissions and reducing airport congestion. The new system, called Stoland, is currently installed on a flight simulator for evaluation. Electro-mechanical, cathode-ray-tube, and moving-map

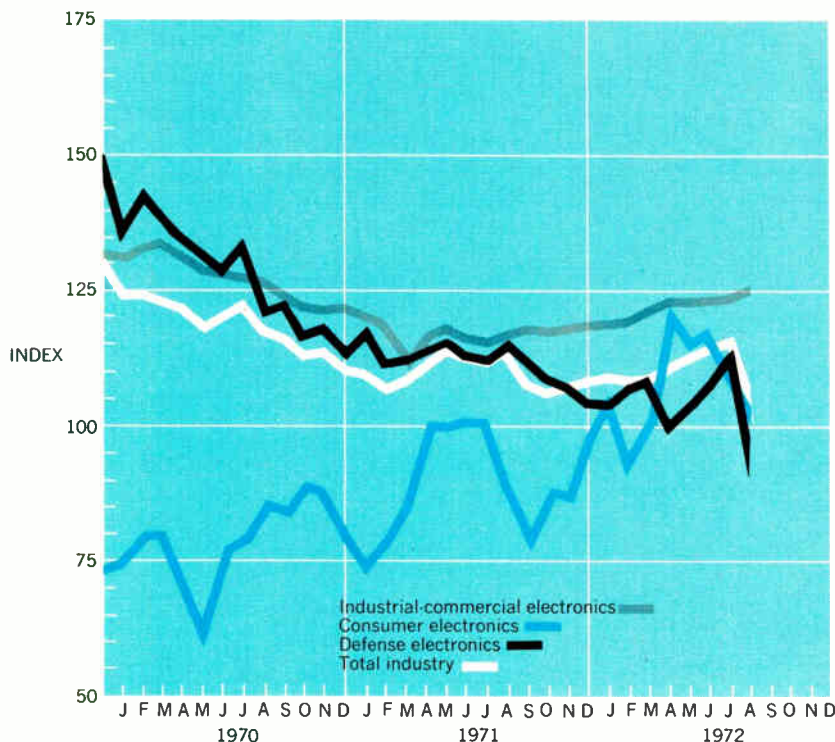

Electronics Index of Activity

Oct. 9, 1972

The index dropped in August for the first time in four months. The 8.3% decline left the index 5% off its year-ago level, the first time since January that it showed a year-to-year decrease. The main reason for the drop was defense electronics, which declined 14.6% to a point 16% below August 1971. Consumer electronics also was down 5%, although it still was 15.8% above last year's level. The only August gainer was the industrial-commercial component, up 1.1%, which was 7.1% over its year-ago result.

Segment of Industry	Aug. '72	July '72*	Aug. '71
Consumer electronics	103.4	109.0	89.3
Defense electronics	97.5	114.2	115.9
Industrial-commercial electronics	125.9	124.5	117.5
Total industry	106.9	116.5	113.0

Indexes chart pace of production volume for total industry and each segment. The base period, equal to 100, is the average of 1965 monthly output for each of the three parts of the industry. Index numbers are expressed as a percentage of the base period. Data is seasonally adjusted.  
\* Revised.

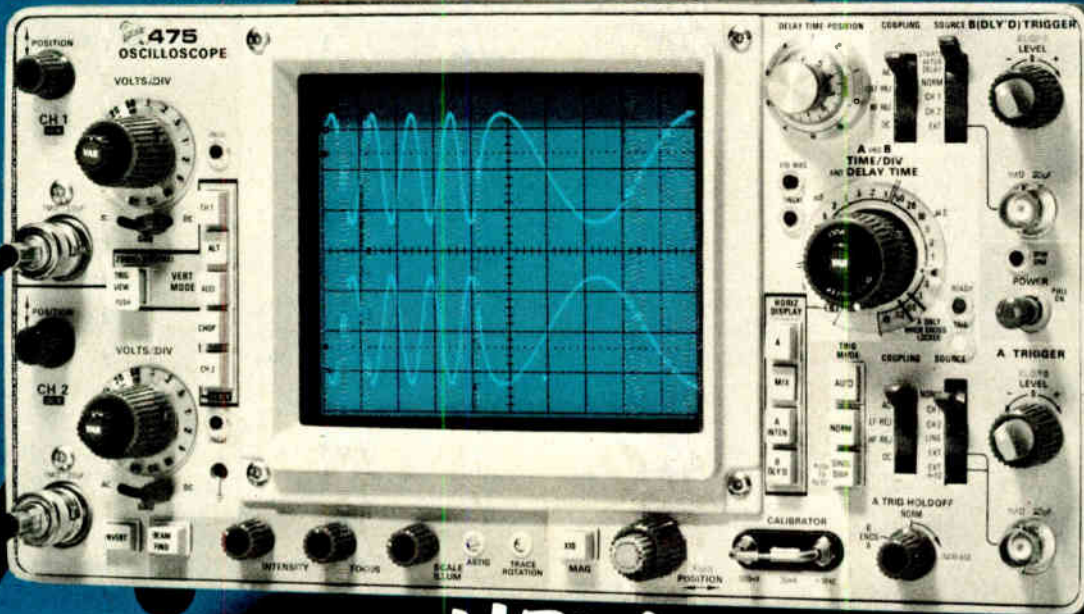

**NEW**

**value leaders =** higher bandwidths + lower prices  
faster sweep speeds + new operation conveniences + better sensitivities

The **NEW** dual-trace **TEKTRONIX 475** and **465 Oscilloscopes** supersede the world's most traveled and widely used general-purpose oscilloscopes . . . the **TEKTRONIX 453A** and **454A**. They have significantly more bandwidth, twice the sweep speed, a bright 25% larger (full 8 x 10 cm) display and additional user conveniences. And all of this in a shorter, thinner, lighter and much lower-priced package.

The **200 MHz TEKTRONIX 475 Oscilloscope** at 2 mV/div and 1 ns/div sweep speed contains the highest gain bandwidth and sweep speed now available in a general-purpose portable oscilloscope and for only \$2500. Add to this many user conveniences including: push-button trigger view, knob-skirt sensitivity readout, ground reference button on the probe tip, simple to interpret vertical and horizontal mode push buttons and many more . . .

The new **TEKTRONIX 465** with 100 MHz at 5 mV/div and 5 ns/div sweep speed has all of the same user conveniences and service features as the 475 and is an outstanding price/performance package for only \$1725.

This outstanding performance and versatility with **TEKTRONIX** quality and laboratory accuracy makes these not only the finest field scopes available but also top contenders for use by development and design engineers. Optional DC or battery operation gives you a portable scope (25 lbs with panel cover and accessories) ready to travel and ready to make measurements at remote locations.

For complete information or to arrange a demonstration, contact any **TEKTRONIX** Field Office. Our offices are located in or near major cities and industrial centers—world wide. If you prefer, write Tektronix, Inc., P.O. Box 500, Beaverton, Oregon 97005.



**value leaders**



U.S. Sales Prices FOB Beaverton, Oregon

## Electronics review

displays in the simulator cockpit provide navigation and control information to the research pilot as he "flies" the simulator. The heart of the system is a Sperry Rand Univac 1819A avionics computer, developed for the supersonic transport, which can simulate various sets of commercial aircraft electronics, including advanced autopilots.

By programing the simulator to reproduce the flying characteristics of various STOL aircraft and by programing Stoland to provide navigation and control information in dif-

ferent ways, NASA investigators will assess the usefulness of various instrument presentations and automatic controls in helping the pilot perform steep, quiet landings safely under all weather conditions.

**Two more due.** The system was designed and built by Sperry Rand's Flight Systems division in Phoenix under a \$3.7 million NASA contract. Two other Stoland systems will be provided under the contract. These will be installed in research aircraft for a joint agency flight-research program. □

## Medical electronics

### Multiphasic test developed at Baylor pares electronics in effort to cut cost

Multiphasic health testing—in which vital functions are checked in a series of tests—has been around for more than 20 years. And electronics firms see it as a respectable market today with huge potential for computer automation, as well as for diagnostic and predictive clinical instrumentation. But a team of engineers and physicians at Baylor College of Medicine in Houston may be poking holes in that picture with a low-cost, nonautomated multiphasic health-screening system that could offer a serious threat to its automated competition. Its proponents claim that it performs most of the tests its rivals do, but for a fraction of the time, capital investment, and operating cost.

The Baylor system, which uses what the group calls "simplicity engineering," relies on the concept of

true screening tests—"go/no-go" procedures, such as throwaway chemical dip-sticks for determining blood chemistries, instead of auto-analyzers, which cost from \$13,000 to \$60,000. The only piece of actual electronic computational equipment, a special-purpose analog computer for spirometry (measurement of lung capacity) was built in the center's lab. The team is also developing an inexpensive, one-lead electrocardiograph computer with a two-light signal to indicate whether or not a comprehensive EKG is needed.

"Frequently, engineers approach health care research with some sophisticated technique or system—which they have previously mastered in their own field—and search for health problems which their expertise can solve," says Dr. Harry S.

Lipscomb. He's director of Baylor's Xerox Center for Health Care Research and was formerly editorial director of the *Journal of the Association for the Advancement of Medical Instrumentation*.

"This approach," he contends, "has led to some monumental mistakes and inefficiencies." In contrast, Lipscomb defines the Baylor approach as moving "away from maximum use of technological sophistication and toward simple, low-cost, effective systems."

Baylor's prototype system was installed in a Houston neighborhood clinic; it was housed in a trailer loaned by NASA. A second system is now being built into a motor home under contract to the Jamaica Blue Cross. The equipment costs around \$5,000, compared to automated systems that run from \$200,000 up to \$5 million, in some instances. The group's health economics analyst, Kenneth A. Verrett, estimates the current screening cost at about \$8 per patient; the time for the battery of some 50 tests is about 30 minutes.

**Cutting down.** "We started out using relatively high technology," Verrett says, "but each modification we make reduces the initial investment." Verrett admits that full-blown, costly multiphasic health test systems have their place—in high-volume industrial, military, or group medical applications, for example. "But they probably won't be able to be produced in large enough quantities to get to the 40 million Americans that don't receive adequate health care. □

### Infrared thermometer needs no probe

Many electronic thermometers have been developed to speed up the temperature-taking process for doctors, and they all have something in common: a probe in the patient's mouth with its attendant sanitation problems. But a new electronic thermometer, dubbed the Ultimate by Infrared Laboratories in Anaheim, Calif., needs no probe. Instead, the

**Less electronics.** Patients receive multiphasic health test that uses little electronics.



# Complete RF Network Analysis in COMMUNICATIONS

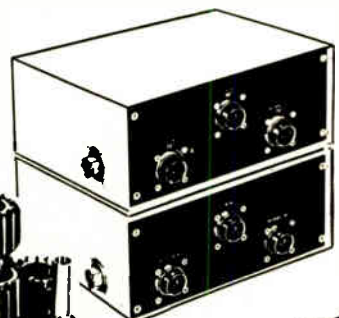
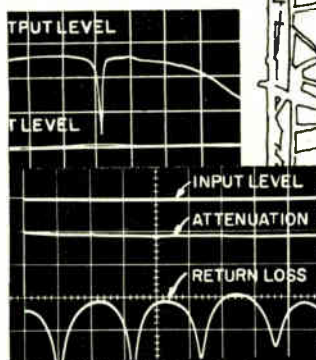
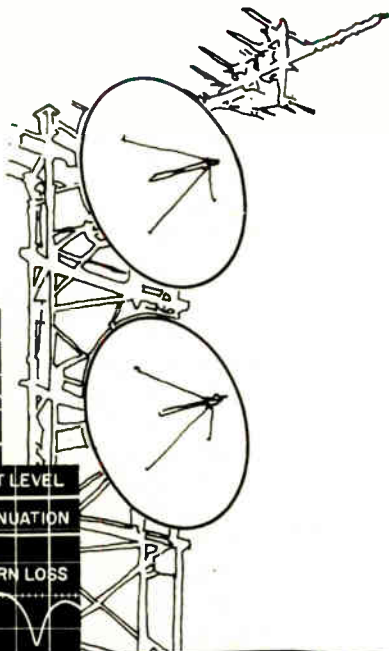

**FOR** cable measurements you need a wide 400 kHz-to-500 MHz sweep range and a simultaneous display of attenuation and return loss.

**FOR** antenna measurements you need a wide 115-dB dynamic range for pattern plotting and a polar display for impedance characterization.

**FOR** narrow-band response measurements you need high 0.005-dB resolution, excellent frequency stability, low residual fm, and low -110-dB crosstalk levels.

**FOR** bandpass characteristics you need a simultaneous display of phase and magnitude.

**FOR** comparison measurements you need a simultaneous display of two unknown channels — invaluable for measuring multiport devices such as duplexers.

**FOR** versatility you need a broad selection of 75-ohm or 50-ohm components, complete programmability for automatic systems, and an expanding line of accessories to adapt to changing requirements.

**FOR** all this you need a GR 1710 RF Network Analyzer completely equipped for communications measurements, including the basic analyzer, polar- and rectilinear-display capabilities, and all the necessary accessories . . .

**FOR** only \$7980.



**General Radio**

NEW YORK (N.Y.) 212-964-2722, (N.J.) 201-791-8990 • BOSTON 617-646-0550  
CHICAGO 312-992-0800 • WASHINGTON, D.C. 301-881-5333 • LOS ANGELES 714-540-9830  
TORONTO 416-252-3395 • ZURICH (01) 55 24 20

GR COMPANIES • GRASON-STADLER • TIME/DATA • TECHWARE COMPUTING CORP.  
GR ASSOCIATE • MICRONETIC SYSTEMS INC.

# SCIENCE / SCOPE

The use of radar to detect oil pollution on the high seas was demonstrated recently with a real-time, digitally-processed, synthetic-aperture radar system, developed by Hughes for the U.S. Navy, during a Coast Guard experiment off Pt. Conception, Calif. The system's advantages over ultraviolet scanner imagery and conventional and infrared photography: it has all-weather, day-and-night capability; its image can be viewed immediately; and it can scan a wide swath with high resolution. It is also a valuable means for locating vessels responsible for oil spillage.

U.S. Air Force Maverick missiles "destroyed" all targets during the Air Force-Army Combat Hunter joint test and evaluation of the Hughes-produced air-to-ground missile at Ft. Riley, Kans. recently. In the war games, a small friendly force with Maverick-equipped F-4 aircraft fought a delaying action against a tank-heavy enemy force. The F-4s carried captive training missiles with units that record data on the attack approach, target acquisition, and launch.

The first firm order for U.S. domestic communications satellites has been awarded to Hughes by Western Union Telegraph Company. Hughes will build three satellites, the first to be delivered in 18 months and the others to follow at three-month intervals. This would permit Western Union to have a satellite in operation before mid-1974. Western Union's satellites will be identical, except for antenna coverage, to the Anik 1 spacecraft Hughes is building for the Canadian Telesat system.

Pilots of the U.S. Air Force's F-15 air superiority fighter will have digitally-controlled electronic eyes to help them track their prey through the radar-blind zones that hamper present systems. The F-15 fire-control radar -- being built by Hughes under contract to McDonnell Douglas -- employs Kalman filtering, a sophisticated approach to extracting accurate information from noisy radar measurements.

A watchful eye on America's natural resources is being kept by a scanning device aboard NASA's Earth Resources Technology Satellite, which is now circling Earth every 103 minutes in a 565-statute-mile-high polar orbit. The scanner, called MSS (for Multispectral Scanner System), detects and records solar energy emitted or reflected from Earth in four bands of the electromagnetic spectrum, including near infrared, to produce photographs that indicate the health of fields, forests, rivers, and lakes. It was developed for NASA's Goddard Space Flight Center by Hughes and its subsidiary, Santa Barbara Research Center.

Hughes has openings for radar engineers in the following specialties: radar systems, microwave components and techniques, receiver/exciter circuits and subsystems, radar signal processing, mechanical design and stress analysis. Requirements: appropriate degree, two to 10 years of applicable experience, U.S. citizenship. Please send your resume to: Engineering Employment, Hughes Aircraft Co., Ground Systems Group, P.O. Box 3310, Fullerton, CA 92634. Equal opportunity M/F employer.

An ultra-lightweight, all-solid-state Manpack transceiver, developed by Hughes for the U.S. Marine Corps under contract to the Naval Electronics Laboratory, features automatic antenna tuning, 2- to 30-MHz coverage, and 280,000 channels. It weighs less than 10 pounds including its 82-watt-hour silver-zinc battery and can operate at least 16 hours before recharging is necessary. Operation is simple: set the frequency by rotating thumbwheel switches, select the mode, then push-to-talk.

*Creating a new world with electronics*



## Electronics review

gun-like instrument is simply pointed at the patient's open mouth and the temperature is displayed digitally in a second.

The instrument looks especially attractive to the military and other organizations with assembly line operations. The company says it's negotiating an R&D contract for final development with the Army.

The thermometer employs a ferroelectric capacity bolometer, made by the company, as the sensor. Its peak efficiency falls at the human wavelength of 0.3 micrometers. The instrument uses a Mostek 5002 digital voltmeter chip, a phase-locked loop, and a LED display for compactness (12 inches long), with a rechargeable internal battery for portability. Accuracy is within  $\pm 0.2^\circ\text{F}$  over the  $95^\circ$ -to- $106^\circ$  range.

The instrument must be held at a constant distance from the patient, and a 3-in. wand is designed to rest on the patient's chin. A disposable tip for the wand costs about 1 cent. The thermometer is priced at \$395, and the company hopes to go into production shortly. □

## Optoelectronics

### SIT tube gives better undersea view

Most deep-water television cameras are either too expensive, too complex, or not sensitive enough in the darker depths for miners, salvagers, and explorers. But, by coupling compact solid-state circuitry with a silicon intensifier-target camera tube, Hydro Products of San Diego, Calif., has developed a low-light-level camera that it says is inexpensive, simple to operate, and 1,000 times more sensitive—with twice the range of previous cameras.

The basic problem, says Arthur E. Vigil, senior staff engineer, "is that water is a mean medium to look through" because even distilled water attenuates light easily, and under water, it's always murky. Hydro's goal was to build a camera with increased viewing range that auto-

matically adjusts video output under the lighting that divers carry.

After considering various types of tubes, Hydro chose an RCA model 7262A silicon intensifier-target (SIT) tube over a secondary electron-conduction tube because it's smaller and more sensitive.

"The circuit is constantly looking at the video output to keep it at a constant level," Vigil explains. If the image darkens, for example, the circuit opens up the iris and image intensifier accordingly. The SIT tube's video output, after being amplified by conventional video amplifiers, drives a buffer amplifier, and then it is rectified and filtered into a signal that varies with the video signal. The signal drives both the programmable high-voltage power supply and the motor-drive amplifier, which, respectively, direct the image-intensifier gain and the iris setting. Both provide negative feedback and maintain the constant output.

**Safety.** The automatic circuit includes an important protective feature. By preventing the iris from opening for 30 seconds after power is on, the camera tube stabilizes before the iris opens to full operating position. The iris also automatically closes when power is turned off. The camera, which is 26 inches long and 7 in. in diameter at the front end, is simple to operate, Vigil says. "You turn it on, and you have a picture."

Resolution is about 500 TV lines, with a lot more horizontal resolution, he says, because "we've maintained a wider video bandwidth than the 4.5 megahertz of commercial units. Typically, we have 6 MHz on long cable and 8 on short." Since repeaters placed along an undersea cable would tend to mess up an armored cable, Hydro uses a long-line amplifier in the camera and in the receiving end to keep the signal up, he says. The camera uses standard scanning, sync, and interlacing for compatibility with any shipboard video monitor and recorder.

Hydro is aiming for a basic price of \$15,000, but this could come down as the cost of SIT tubes falls, he says. The low-light-level camera, which has been operated to depths of 800 feet, is designed to perform

# Hughes is in industrial electronics, too: components, equipment and systems.



Microwave diodes (RS 220)

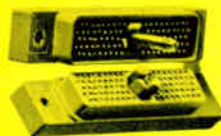

Electrical connectors (RS 223)



Microwave TWTs, TWTAs and solid state products (RS 228)



Direct view and scan converter storage tubes (RS 226)



Wire terminating and harness laying systems (RS 234)

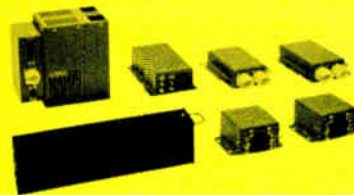

Multiplex systems for remote communications/control (RS 230)

For complete information, write Bldg. 6, Mail Station D 135, Culver City, CA 90230. Or request by Reader Service (RS) numbers.

## HUGHES

HUGHES AIRCRAFT COMPANY

as deep as 20,000 feet. Hydro recently sold 34 earlier model TV camera systems (for ship-hull inspection) to the Navy for more than \$350,000. □

---

**Marketing**

---

## TI refocuses sales to aim at little man

Charles Clough, recently named assistant vice president for semiconductor marketing at Texas Instruments, has turned the firm's marketing organization around—from a company that virtually ignored small customers to one that thrives on them. "We used to be proud of the fact that 80% of our business came from a dozen customers," Clough admits. "Now we're proud that 60% comes from a thousand customers."

**The thousand.** Historically, TI has done very well with large corporate users and very poorly with the small houses. But as national sales manager, Clough focused TI's attention on that "thousand-account" block of smaller customers. "We adopted a segmented approach—we set up a separate marketing organization to penetrate small- and medium-size accounts," he says. Since the category was set up two years ago, TI has increased its number of customers tenfold. And it hasn't sacrificed penetration—in some cases as high as 55%—at those dozen major corporate accounts.

TI started adding sales engineers to handle the thousand-account customers in the midst of the lean years, and with this year's boom in the semiconductor industry, it's beginning to pay off. Now TI has more than 150 sales engineers handling smaller accounts—about 9½ for each one serving the dozen major customers.

Clough prides himself on the grasp his sales force has on details; his market strategy is based on socket-by-socket identification of the total available market for TI devices at each of the thousand-ac-

count customers—in dollars, in units, and by device number.

In addition, Clough has teamed the sales engineer with the distributor—sales to the distributor market are no longer measured. "Instead," he says, "we hold our sales people responsible for all sales, whether direct to the OEM or through the distributor to the OEM." As a result, distributors are no longer competitive with TI field people, and can concentrate on small-quantity operations and opening new accounts. "The largest single factor in improved distributor sales is holding the sales engineer responsible for helping move the product off the distributor's shelf," Clough says.

Of the dozen or so traditionally major corporate accounts, most are handled directly through the Dallas-based government/computer sales segment, headed by Robert F. Spoeneman. His job is principally one of sales and sales support:



**New approach.** TI's Charles Clough is running TI's roundup of the smaller accounts.

"Bob's performance is measured on how he does at these large houses," says Clough. "But he also takes projects successful at one of the large houses and fans them out to the entire sales organization."

A consumer/computer market development segment headed by Wendel Harrison is responsible for the remaining major customers, as well as for smaller accounts in the fast-growing home-entertainment and automotive applications markets clustered in Detroit, Chicago, and Southeast Asia. Although Har-

ison is responsible for product development, "he has sales responsibility so he can take the pulse of industry," Clough says. Added this month to his purview is coordination of product development for semiconductor memory applications.

There's also a difference in the field staff selling to major customers and smaller accounts. "The major customer man," says Clough, "well, he's more well-rounded; he must talk to all levels at the same customer. But the sales engineer at the small and medium accounts must be much better technically, and, in many cases, a better financial manager," he adds. □

---

**Commercial electronics**

---

## Systems check in passengers faster

As airlines add wide-bodied jumbo jets to their fleets, passenger agents will be faced with longer lines of impatient passengers waiting to be processed at the gates. Just about anyone who has had to do any flying on a commercial airline can tell stories guaranteed to draw cocktail-party crowds about how he or she almost managed to miss a flight because of the check-in line. To help ease that crush, General Computing Equipment Corp., a small Dallas firm, has developed a computerized multflight boarding-pass system that allows seat assignment by several agents at different locations for many flights, when passengers check in.

Originally developed as single-flight, dedicated systems for American Airlines, the new terminals are built around Data General's Nova minicomputer with 4,096-words of storage.

An array of lights and corresponding keys represent seat locations, enabling agents to determine seat availability, to select and assign seats, and to issue automatically printed boarding passes with flight number, class, seat number, destina-



# Chip

off the old breadboard.

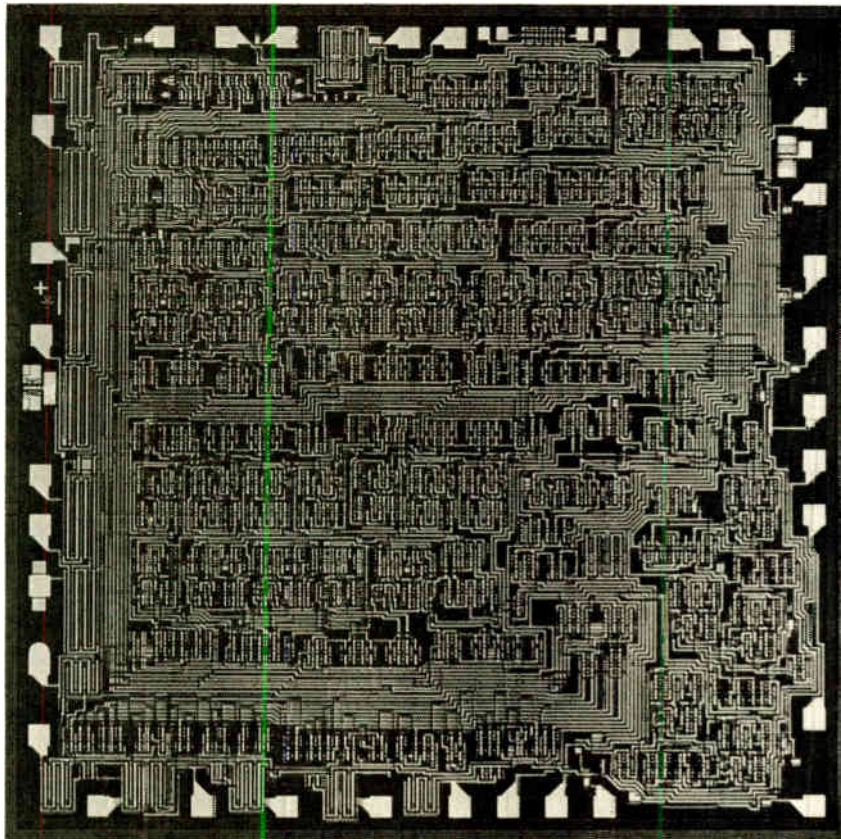

## RCA put 1,238 devices on a 150 mil COS/MOS chip. What are your LSI requirements ?

The move is toward LSI. And RCA is ready now to develop custom COS/MOS circuits to your most demanding requirements.

For example, the 149 x 150 mil timing circuit above was integrated from a breadboard containing 1,238 discrete devices. Just one of many custom chips designed with RCA's unique silicon interconnect process to provide high packaging density.

RCA maintains a staff of systems engineers who are experienced in the

development of complex micropower arrays. They are backed by extensive facilities to speed the process of IC design and development.

These facilities consist of computers for logic simulation, artwork digitizer-plotter systems that can cut turn-around time by 33% in typical circuits, Mann Pattern Generator facilities to speed mask preparation, and Teradyne Model J-283 digital IC systems which functionally evaluate complex arrays.

Put RCA's COS/MOS team to

work to help reduce package count, cut assembly costs, and achieve excellent cost effectiveness in your systems.

When it comes to COS/MOS LSI, come to RCA.

Contact your local RCA Representative or RCA Distributor, or write RCA Solid State Division, Section 70 J-09, Box 3200, Somerville, New Jersey 08876.

**RCA** Solid State  
products that make products pay off

International: RCA, Sunbury-on-Thames, U. K., or Fuji Building, 7-4 Kasumigaseki, 3-Chome, Chiyoda-Ku, Tokyo, Japan. In Canada: RCA Limited, Ste. Anne de Bellevue 810, Canada.



**All aboard.** Computerized boarding-pass system by General Computing Equipment of Dallas is designed to help cut down on the long lines of passengers at airport boarding gates.

tion, date, and boarding gate.

The basic system—a computer with four terminals—sells for around \$30,000, and systems with 16,384-word storage will accommodate up to 16 terminals. Robert Dabbs, director of marketing, says that Air France is installing the system at its gates in Los Angeles and Montreal, and the 45 airlines flying out of Tunis International Airport already use it.

Dabbs estimates the current domestic market at about 150 terminals per year, and the worldwide market at slightly fewer than 500 per year.

General Computing is marketing the system directly to airlines, to airport handling agents, and to multi-host operators, such as the Tunisian government. The firm is expanding the system to handle specific passenger requirements, such as menus, movies, group travel, out-of-terminal ticketing, seat assignments,

credit card and ticket-validation checking, and, eventually, baggage handling. □

## Government electronics

### Raytheon unit to prevent stranding

Shipboard tests are about to begin on a sonar system that promises to keep giant ships from running aground. A joint project of the U.S. Maritime Administration and Raytheon Co., the Fairway Anti-Stranding Sonar goes most depth-sounding sonar systems one better by adding a forward-looking sonar. The two-sonar FASS can warn ship captains to steer clear of a shoal, an iceberg, the mast of a sunken ship, or too-shallow water.

The damaging oil spills from the

strandings of a few tankers have been well publicized, but almost 2,000 ocean-going vessels have been stranded in the past several years. Not only that, but it takes a super-tanker as much as 10 miles to come to a dead stop. Raytheon says FASS could serve many deep-draft vessels and those navigating in poorly charted waters or narrow-channel harbors.

FASS directs narrow acoustic beams from hull-mounted transducers downward and ahead of the ship. The downward-looking doppler beam measures depth and ship speed, as well as predicts the stranding distance based on the average slope of the bottom. It measures depth up to 600 feet with a 2-foot resolution, and speed up to 35 knots within 1% accuracy. The 4° forward-looking conical beam has a range up to 2,500 yards and accuracy within 20 yards.

**Bridge display.** A cathode-ray-tube display on the bridge portrays the sonar readings of ship speed, obstacle range, and predicted stranding range. Also on the bridge are a predicted-stranding-range indicator, critical-range indicator, and a bar graph comparing sonar echoes to their range. As a side benefit, the system also provides the ship's keel depth and a nautical odometer that records travel up to 1,000 nautical miles. Visual and sound alarms are included. An acoustic receiver and transmitter in an unattended equipment rack relays sonar inputs to the bridge display.

A Raytheon spokesman, eyeing the oil-tanker market, forecasts a price between \$30,000 and \$50,000 per unit. Although the company's Navy-oriented Submarine Signal division spearheaded the technology, the basis for the system, which Raytheon calls "nonlinear underwater acoustics," originated in another part of the company and was adopted for FASS. The company is using FASS to develop a Fairway piloting system which it says will give pilots more closely calibrated depth information, as 1 foot of draft equals 1,500 tons of oil aboard a large tanker.

Like General Electric Co.'s ship-

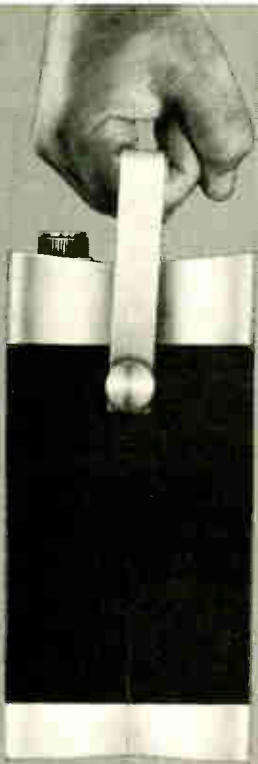

# Take Me Along!

- New** 25 Range DMM
- 3½-Digit **.05%** Accuracy
- Rugged **All Metal** Construction
- 8 Hour **Battery & Line** Operation Standard
- LED** Display



New Model 262C,

**\$345.00**

includes rechargeable batteries. Stock Delivery.  
Model 261C DC & Ohms only, \$289.00

**DIGITEC**  
UNITED SYSTEMS CORPORATION  
subsidiary of **Monsanto**

**United Systems Corp.**, 918 Woodley Rd., Dayton, Ohio 45403  
All Digitec instruments are available for rental or lease through Rental Electronics, Inc.

Phone (513) 254-6251

Circle 51 on reader service card

## Electronics review

board computer contract [*Electronics*, Aug. 14, p. 50], the \$300,000 FASS development costs were split between the Maritime Administration and Raytheon. The company also has a U.S. contract to develop a Watchmaster monitoring control system, based on its 707 computer, that signals when parts of a ship's propulsion system need maintenance or replacement. □

## Space electronics

### Mini helps map Mars and Venus

A few kilohertz out of 2,388 megahertz doesn't sound like much, but when you're charting the topography of Mars or Venus with S-band radar, the small amount of doppler shift caused by the relative motion of the planet and the tracking station makes a significant difference. To compensate for this shift, a team from the Jet Propulsion Laboratory in Pasadena, Calif., has turned to a minicomputer—the Lockheed MAC-16—and developed a programed oscillator that compensates for the shift.

The tracking station is NASA's Goldstone Deep Space Communications complex in the Mohave Desert, where a JPL team has been using radar to examine the surface of Mars for about a year, and it is now also looking at Venus. One station is used for Mars, but the slower-moving Venus requires two, and two programed oscillators have been built.

Need for great precision is apparent in the resolution sought in the experiment: 400 meters in altitude, and a circle diameter of 2 to 100 kilometers on Mars.

The new system with its minicomputer fits in one rack; an earlier system that used a medium-scale second-generation computer required five racks of equipment. The current system includes the MAC-16, a Fluke frequency synthesizer with expanded search oscillator, a digital-logic module, paper-tape

## For the record

### SUE becomes system

The Lockheed Electronics Co. model 1111 SUE minicomputer has been designed into a system—the Servus System 100—to handle accounting and policy rating and writing functions for insurance agents. CNA/systems, Chicago, part of the \$3.6 billion CNA family of insurance and financial concerns, is marketing the turnkey system. And with Paul Sybrandt Inc., a California insurance agency, it helped write the systems software. Lockheed designed the hardware and operating software and will maintain the system in the field.

Included in a base \$1,000 per month rental for the decimal-arithmetic version of the SUE are a dual-disk Caelus drive, a Printec 100-character-per-second printer, and a newly designed Lockheed cathode-ray-tube keyboard terminal. Customer base for the new system is some 16,000 medium and large insurance agencies, says Jerry Sivia, managing director of CNA/systems. Until now, agents have turned to computer service centers or handled their paperwork manually.

### TI expands in Japan

Texas Instruments is planning an expansion of its Semiconductor Japan division, and has purchased a 12.5-acre site within the city limits of Hiji, Oita Prefecture, on the island of Kyushu. The new plant, expected to be in operation the last half of 1973, will be strictly for semiconductor manufacturing, and it will accommodate as many as 1,000 employees at full-shift capability.

### Microwave net OK

Southern Pacific Communications Co. has been granted construction permits by the Federal Communications Commission for the first segment of its proposed 11-state common-carrier microwave network. Construction will begin within the next few months. The permits enable SPCC, a wholly owned subsidiary of the Southern Pacific Co., to construct 19 microwave stations between San Francisco and Los Angeles, at a cost of about \$3.4 million.

The planned 11-state system will stretch along the Pacific coast from Seattle to San Diego and from Los Angeles to East St. Louis, Ill. Service is planned to intermediate points such as Phoenix, Tucson, El Paso, San Antonio, Houston, Dallas-Fort Worth and Pine Bluff. Applications for stations between Los Angeles and East St. Louis are pending before the FCC. John N. Albertson, vice president and general manager, says that applications for the remaining segments will be filed shortly. Construction of the first segment should be complete in about nine months.

### NR acquires Unicom

In separate operations, North American Rockwell has increased its involvement in commercial electronics by acquiring Unicom Systems Inc., the rapidly growing year-old former subsidiary of American Micro-systems Inc., and by appointing NR executives to key positions in subsidiary American Data Systems, maker of MOS modems, multiplexers, and front-end processors.

### Another glass venture

Continuing to press a development that seems neither to reach fruition nor, as was predicted by many, go away quietly, Energy Conversion Devices has entered into another joint venture with another semiconductor maker to build another amorphous memory.

Last time around, it was Intel that supplied the 256-bit chips to the Ann Arbor, Mich.-based Energy Conversion, which then added the glass [*Electronics*, Sept. 28, 1970, p. 56]. This time, it's Advanced Micro Devices of Sunnyvale, Calif., which is doing the silicon work on 3-inch wafers for a decoded 1,024-bit RAM. The attractive feature of any amorphous memory is that it functions like a RAM with its read-write capability. But it's also non-volatile, so that it eliminates card, tape, or disk backup data storage.

# TRON\*



## USE TRON RECTIFIER FUSES TO PROTECT

### VARIABLE SPEED DRIVES

... as used in machine tools and conveyor controls.

### INVERTERS

... wherever it is necessary to produce alternating current from direct current, such as non-interruptible power supplies.

### BATTERY CHARGERS

... used to charge batteries of industrial trucks, forklifts, etc.

### PLATING POWER SUPPLIES

... used to furnish direct current for electro-plating processes.

### POWER CONTROLS

... as used for heating, cooling and temperature control applications.

... or wherever a fast-acting fuse is needed in the protection or isolation of electronic or electrical components.

**TRON fuses offer you a complete line— $\frac{1}{2}$  to 1000 amps.—voltages up to 1500.**

They are designed for the protection of solid state devices such as semi-conductor rectifiers, thyristors, SCR's—wherever extremely fast opening and great limitation of let-through current is needed.

For full information on TRON Rectifier Fuses and time-current characteristic charts, write for BUSS Bulletin TRFS.

\*A member of the "TRON" family of marks, Reg. U.S. Pat. Off.

**Bussmann Mfg. Division,** McGraw-Edison Co., St. Louis, Mo. 63107

*FOR FUSES AND FUSEHOLDERS  
OF UNQUESTIONED HIGH QUALITY  
FOR EVERY PROTECTION NEED...*

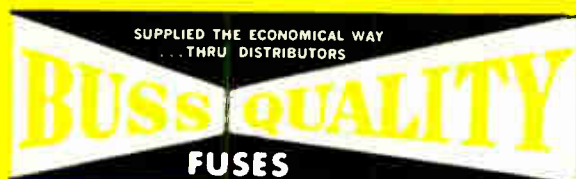

## Model 55 printer in a case with interface and power supply

Add Addmaster's Model 55 to any instrumentation device for hard-copy printing.

12-column capacity

12 characters to each column

Numerals or limited alpha characters

TTL compatible

115V 60-cycle AC driven motor

Uses standard adding machine paper

Prints 3 lines (36 characters) per second

Accepts serial by character or full parallel B. C. D. data inputs

Under \$500.



**\* ADDMASTER**  
Addmaster Corporation

416 Junipero Serra Drive, San Gabriel, California 91776

Circle 54 on reader service card

# Unglue your mind

Eastman 910<sup>®</sup> adhesive invites creativity. Lets you fasten new and old materials in brand-new ways because it's fast, strong, needs only contact pressure.

For details, call or write:



Eastman Chemical  
Products, Inc.  
Kingsport, Tenn. 37662



reader/punch, and the attendant power supplies.

**Daily constants.** The computer program controls the search-oscillator loop in the synthesizer in a stable, low-noise manner. Every 32 seconds, the computer calculates the desired phase by solving a precalculated ephemeris within polynomial at a time accurate to +1 microsecond. The program then reads in the correct day's ephemeris constants from a paper tape containing daily constants for the entire month.

The computer control logic performs the initial solution of the polynomial equations and sets the range center frequency on the frequency synthesizer. The computer program forms error numbers by calculating the difference between the desired phase calculated from the polynomial and the phase obtained from a 0.1-second counter that counts the output of the search oscillator. Every 10th second, the count is dumped into a buffer register and then entered into the computer without disturbing the counting process. Error numbers are digitally filtered by the computer and fed to a digital-to-analog converter that has 15 bits plus sign to make minicomputer words of 16 bits each. Voltage from the converter is fed to the integrator and then to the oscillator, where corrected values enter the phase-locked tracking loop.

The MAC-16 used in the JPL programmed oscillator has 8,000 16-bit words of memory, with the operational program occupying 7,500 words. □

Looking. A Mars-Venus tracking station.



# YOUR SHORTCUT TO FAME AND FORTUNE

Your IC designs might be great, but they're not worth a nickel until they're in saleable products.

And getting your designs to market profitably is where we can really help.

**Fast, flexible, inexpensive.** EECO plug-in IC packaging can cut your production costs by 40%, triple your packing density over PC boards, and cut your production cycle to just 5 weeks from the time your logic diagrams are ready.

With our wire-wrap hardware, prototypes are simpler (ask about our low-cost kits). Production changes are made instantly. And maintenance is faster and less expensive.

**Be picky.** Whether you're designing with standard IC's or LSI (with or without discretes), you can choose from the world's finest and largest selection of plug-in hardware.

For fewer connections, higher reliability and less costly production, use our 2D planes.

For easier maintenance and

lower spares costs, use our EECOLOGIC 2 plug-in cards.

For maximum density, try our newest 3D cards. They pack up to 70 IC's on a card and over a thousand IC's in a 7"H x 9 1/2"D card cage.

**Start selling now.** Standard hardware delivery is 1-2 weeks, but we can save you even more with our automatic wiring service. Send us your logic diagrams and in just 5 weeks we'll send you finished products. Wrapped, debugged, documented and ready to ship to your customers. Far faster and for a great deal less than you could do it yourself.

**How to be an expert.** We've put everything you need to know about IC packaging into a free kit. Besides details on our hardware and software, our IC Packaging Package includes several article reprints and design aids. To get it, just use the coupon or call (714) 547-5651 today.

Opportunity is knocking.



## FREE: THE EECO KIT AND KABOODLE.

EECO, 1441 E. Chestnut Ave., Santa Ana, Calif. 92705

You're right — I've got some great IC designs. Show me how I can turn them into reliable finished products in just 5 weeks while cutting my production costs by as much as 40%.

Name \_\_\_\_\_  
 Company \_\_\_\_\_ Telephone \_\_\_\_\_  
 Address \_\_\_\_\_  
 City \_\_\_\_\_ State \_\_\_\_\_ Zip \_\_\_\_\_

# NEW 650-PAGE TTL BIBLE



**The most usable TTL Data Book for the most usable TTL Family. 250 circuit functions in plastic or ceramic packages.**

Our new TTL data book is like our TTL Family: most comprehensive, practical, easiest to use by far.

The TTL bible is structured to provide the designer with precise data on our TTL family in the most accessible form. He can find what he's looking for quickly and easily, whether he starts with a device number in any well-known series (9300, 5400/7400, etc.) or simply the device functional nomenclature. The indices and selection guides will direct him instantly to those devices suitable for his application, and complete specifications from which he can determine his best choice. A comprehensive industry cross-reference provides an overview of all major sources of TTL devices and their Fairchild equivalents.

The Fairchild TTL Family is a mix of more than 1,000 proprietary and second source device and package combinations selected to give the designer the broadest choice of performance/

cost trade-offs to optimize his system design. Over 100 new devices have been added to the family in the last year alone. There are logic, memory and interface functions in plastic, ceramic or flatpak, commercial or military temperature grade. Together, they provide a comprehensive line of standard off-the-shelf building blocks that can be interfaced directly with each other in the same system for maximum speed/power efficiency.

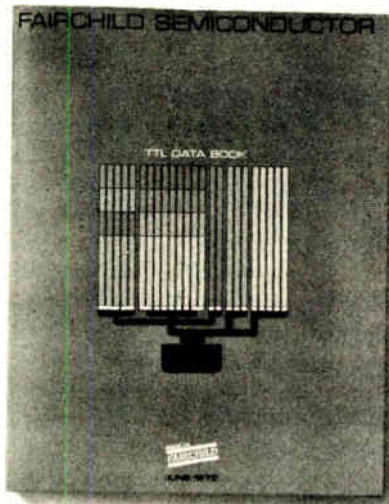

We offer more than 100 MSI devices, both proprietary and second source, that are widely accepted as the keys to optimum TTL system design.

For example: Our proprietary devices include the most complete range of TTL memories available anywhere – from 8-bit scratchpad registers to our new 93415 1024 x 1 bit RAM (made by Isoplanar) that has 60ns access time at 0.5mW/bit.

Our 9344 parallel multiplier eliminates a lot of hardware and software.

For simple solutions for A/D converters, minicomputers and high-speed systems, our 9334 8-bit addressable latch for general purpose storage, our 9338 8-bit multiple port register for high-speed storage in ALUs, and our 93H00 and 93H72 high-speed 4-bit shift registers. Our list of design-time and cost-saving proprietary devices is long and impressive.

**250 proprietary and second source circuit functions:**

- 54/74 & 9000 Standard SSI
- 74H00 High Speed SSI
- 74S00 Schottky SSI
- 9300 and 54/74 Standard MSI
- 9600 Monostable & Interface devices
- 93400 Memory devices

Book and family are designed for practical use. To get a copy of the former, about the latter, please write us on your company letterhead, giving us your name and title.

**MADE IN  
FAIRCHILD**

# Near and far-sighted Spectrum Analyzer.

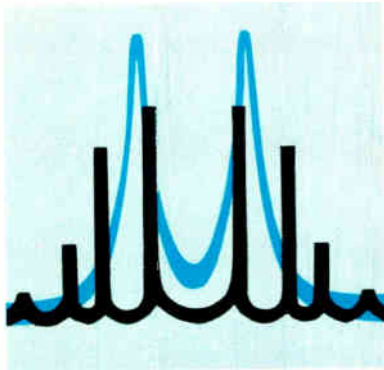

levels down to  $-121$  dBm!

This instrument offers a unique combination of per-

formance, ease of operation, and low cost: Whether you need a bay-window scan or a microscopic display of two very closely spaced signals, the SA-70 series provides near-perfect vision between 500 kHz and 1300 MHz. And it does it over a 141 dB range with signal

formance, ease of operation, and low cost:

- Phase lock for stable displays; indicator light for unambiguous amplitude measurement; 300 Hz resolution for close-in side-by-side signal analysis.
- Internal markers every 100 MHz for precise frequency determination.
- Additional plug-ins for frequency coverage over 20 Hz to 27.5 MHz range.
- Priced to make others seem expensive.

If you need variable persistence and display storage, ask for the SA-71A, otherwise, select the SA-70A. Both are described in our data bulletin. Send for one. It's the far-sighted thing to do.

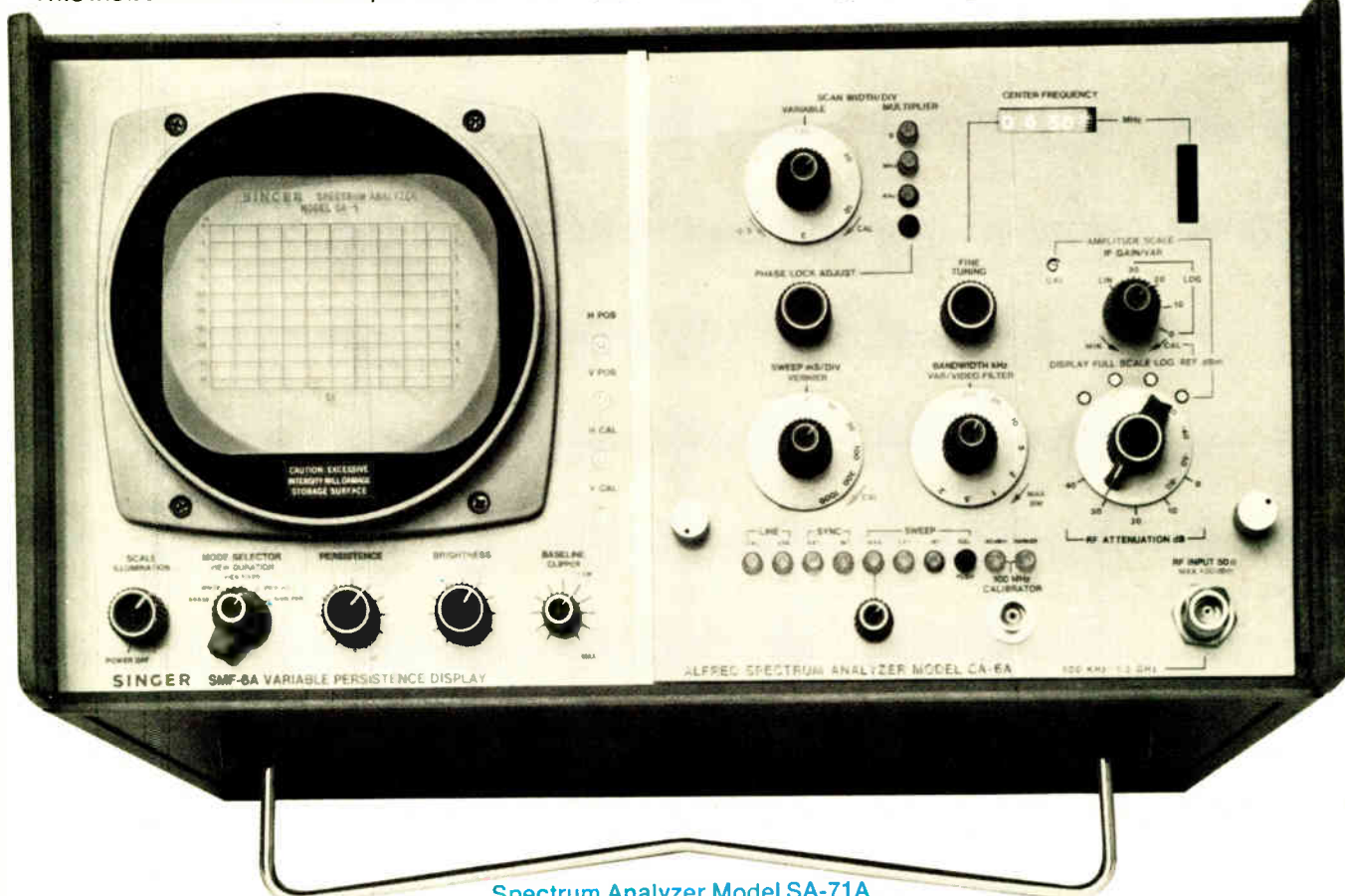

Spectrum Analyzer Model SA-71A

**SINGER**  
INSTRUMENTATION

The Singer Company, Palo Alto Operation • 3176 Porter Drive, Palo Alto, Calif. 94304 • Telephone (415) 493-3231

# Washington newsletter

## U.S. trade deficit soars as Japan woos China . . .

Federal trade officials, forecasting a 20% rise in the 1972 U.S. consumer electronics trade deficit to a \$1.5 billion level, see disturbing signs that **Japan is ready to include trade in general and consumer electronics in particular in its new diplomatic accord** with the People's Republic of China. That would probably spell an end to the hope that China would take some U.S. exports.

**Japan's own rising electronics manufacturing costs, coupled with an apparent readiness to develop the mainland China television market**, are leading to expansion of five subsidiary plants in South Korea previously devoted to production of monochrome receivers and subassemblies. The operations being expanded to color TV production are, with their Japanese affiliation: Dongnam Electrical (Sharp), Goldstar (Hitachi), Taihan Electric Wire (Toshiba), Samsung (Sanyo), and Crown Electronics (Crown Radio).

## . . . but TV from Taiwan continues to flood U.S.

"The reason the Japanese are looking to China," says one Federal official, "is very evident from the first half figures of their TV exports to this country." A Commerce Department analysis shows **Japanese monochrome exports dropping from nearly 1,217,000 sets in the first half of last year to 975,000 in this year's first half** and color receiver exports falling from 577,000 to 506,000. Conversely, **monochrome imports, primarily from U.S.-owned operations on Taiwan, rose 172% to 1,295,000 sets in the first six months of 1972 from 475,000 in the first half of 1971**, while color imports climbed to 69,000 sets from 38,000.

## Government at odds with industry over laser standards

Disagreement between the Government and industry over what are safe laser radiation levels is likely to delay adoption of a Federal standard until next summer at the earliest, say knowledgeable sources. The Federal Bureau of Radiological Health is concerned that **all emissions from lasers could cause biological damage**, while the American National Standards Institute and industry maintain that **certain power levels are relatively harmless**. For example, for one class of lasers in the visible and infrared spectral range, **the bureau declares the ANSI values incorporate no safety factor**, and has raised them a thousandfold.

To settle the dispute, the bureau and ANSI are to set up a panel of outside experts, whose opinions will be used by a small mediating Government-industry panel. The Food and Drug Administration and Department of Health, Education, and Welfare also must okay the results.

## Navy upgrades SASS effort, plans 1973 awards

To upgrade the status of its **largest new antisubmarine warfare project in years**, the suspended array surveillance system [*Electronics*, Aug. 28, p. 37], the Navy is giving its director at the Naval Electronic Systems Command, Capt. Vernon F. Anderson, the title of project manager, electronics, and having him report directly to the chief of naval material, Adm. Isaac Kidd, instead of the commander of Navelex. Department sources say roughly **half of the available funds for advanced ASW sensors and system studies will go to the new SASS effort—an estimated \$45-50 million this fiscal year**—and that first classified studies can be expected not later than the first quarter of 1973.

## Antisubmarine warfare as a growth market

When the Navy came clean not long ago and conceded to Congress that a new nuclear attack carrier would cost \$1 billion and that carriers after that would likely cost more, there was a substantial, if short-lived, uproar on Capitol Hill. The credibility issue was evident in the observation of one committee man when he said, "If they say a billion now, it will probably be a billion-and-a-half before it's done."

There were other reactions, too. The nation's leading nuclear submarine advocate, Adm. Hyman Rickover (USN, Ret.), predictably proposed that the United States scrap the concept of the vulnerable carrier as the capital ship of the fleet and substitute the missile-launching submarine. It is a transition he believes could be made just as the Navy made the transition from the battleship to the carrier. That was not a change that came easily, however, for the Navy does not take easily to change, as a number of military professionals from Billy Mitchell to Hyman Rickover have found. And for the Navy's conservative leadership, Rickover's latest proposal also is unacceptably radical—as was his initial plan for nuclear-powered ships that brought him fame in the first place. Nevertheless, his suggestion has intrigued Congress, which has learned to listen to him carefully, and has some support in that quarter.

### The 'mini-carrier' concept

One Defense Department compromise now under study and proposed for detailed design this fiscal year is the Sea Control Ship, a mini-carrier with a mix of 17 helicopters and V/STOL aircraft. The Navy says it can build eight SCSs for a bit more than \$825 million, or roughly \$103 million a ship, for the mission of antisubmarine warfare escort of underway replenishment vessels, merchant ships, amphibious assault forces and task groups lacking full-fledged carriers. A number of Navy leaders believe SCS is a great idea to supplement its carrier force; none of them, however, is enthused about SCS as a carrier substitute. Nevertheless, it is evident that Congress is still not sold on the future of the billion-dollar carrier as a cost-effective weapon.

Indeed, Congress is proceeding with some caution on the Sea Control Ship concept, too. The Navy's SCS figures are "a class F cost estimate, or ball park estimate, prepared in the absence of minimum design and cost information," asserts the House Appropriations Committee, noting that the service expects to ask for construction money for the lead ship

next fiscal year. The chances are good it will not get it until the service comes up with "a sound cost estimate," has "proven the SCS feasibility concept" through operational tests with the U. S. Guam, using helicopters and AV-8A Harrier aircraft, and has "initiated the V/STOL aircraft development programs for this ship." Though the Navy will get its \$10 million this year for completion of the design, Congress sees "no valid reason to expedite the SCS program."

All of this leaves the Navy leadership unhappy, if not despondent. It would rather have carriers, not mini-carriers, yet it recognizes the big ships' vulnerability and increasingly unacceptable costs.

### The growth in ASW

If, then, the Navy refuses to turn to the submarine as the first ship of the line and Congress refuses to fund billion-dollar carriers, what are the alternatives? For the long term, one is sure to be the Sea Control Ship, or some variation thereof. For the shorter term—and of greater significance to the military electronics engineering community—the choice is to make the carrier less vulnerable by improving the Navy's ASW capability. That decision has already been made.

Calculations of the existing ASW market for military electronics and aerospace manufacturers range from just under \$2 billion annually up to \$2.3 billion, depending on how many elements you factor in. A substantial share of the Government's widely scattered oceanography money, for example, has direct ASW application, and oceanography represents a significant instrumentation market. Within the next three years, outlays on ASW technology can be expected to double, says one senior defense official monitoring the program. His estimate is supported by Navy sources, who cite the old military saw that when hot wars go cold, as in Southeast Asia, money that previously went for operations, ordnance, and other consumables is no longer needed, freeing funds for increased outlays on surveillance, command, and control.

Whether or not these funds should be committed to increased defense expenditures, instead of the nation's peacetime requirements, is not the issue here. Secretary of Defense Melvin Laird has already said the fiscal 1974 defense budget request will be larger than this year's, and all signs indicate that ASW for carriers and other ships of the fleet will get a larger share.

—Ray Connolly

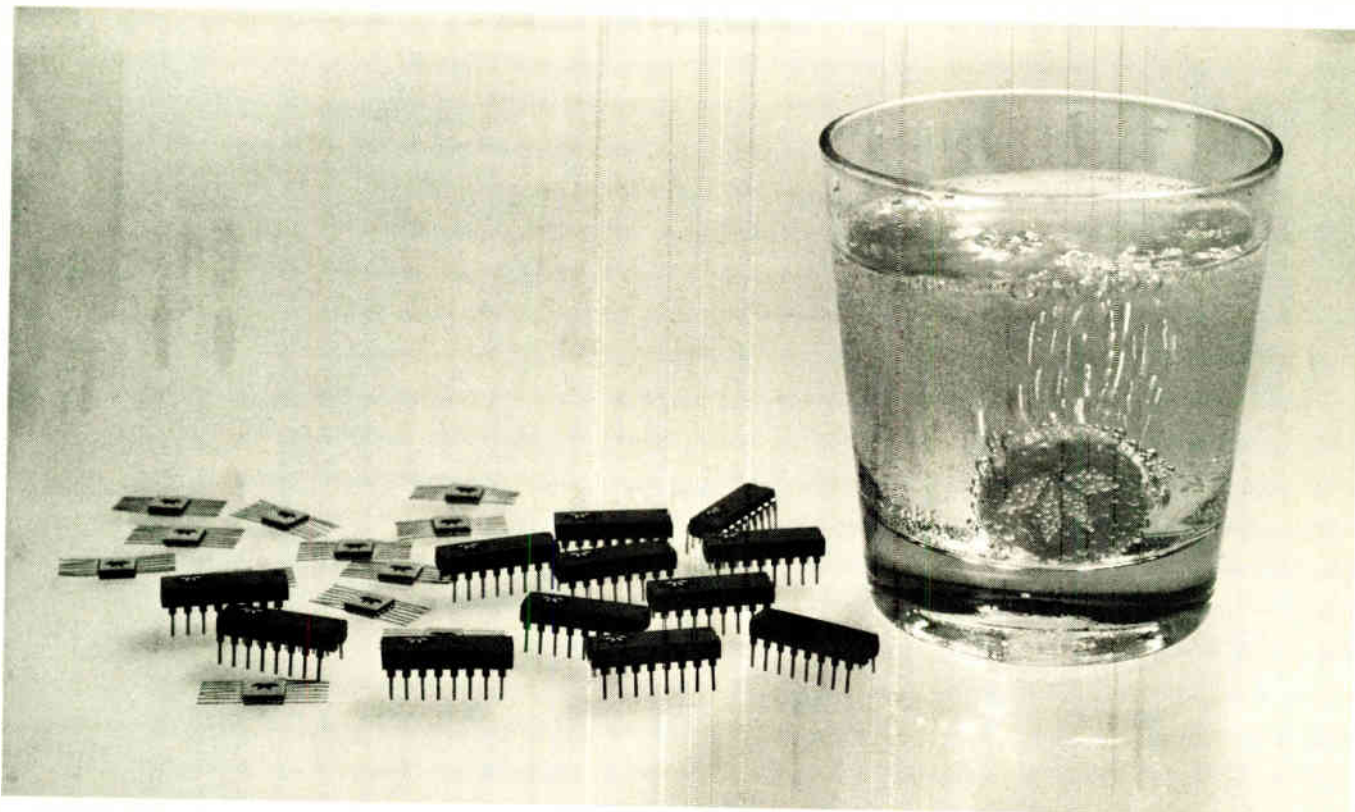

# Try it. You'll like it.

## HiNIL, High Noise Immunity Logic

Nothing can be more upsetting than trying to design sensitive digital equipment that's headed for a noisy industrial application. Try Series 300 HiNIL, Teledyne's high noise immunity logic.

**HiNIL offers MSI.** Included in the Series 300 are such complex functions as BCD to decade decoders and drivers, Nixie<sup>®</sup>\* drivers, decade and hexadecimal counters, a quad latch and a 4-bit comparator.

**HiNIL is slow.** HiNIL is one of the slowest logic families since relays. It has a nice 100-nanosecond propagation delay, so it is unperturbed by high voltage transient noise. HiNIL won't switch falsely when a fork lift rolls by or a lathe turns over.

**HiNIL is easy to use.** There are very few system interfaces that cannot be handled simply with HiNIL devices. The open-collector devices

in the family, including the simple gates, have ample output sink and drive currents to operate a small lamp or relay.

For *output* interfaces to TTL, DTL or MOS—you simply connect an open collector output through a pullup resistor to the desired high logic level.

**HiNIL is versatile.** Every IC in the Series 300 family comes in a 16 pin dual-in-line package, providing better than 10% more functional utility than you get with most standard TTL circuits. Vcc and Ground take up two of the pins, leaving 14 for functional use compared with 12 for TTL. You can do more with HiNIL.

**HiNIL is priced right.** It's priced competitive with TTL. Need we say more?

Write for a free copy of our 64 page HiNIL handbook. Save yourself from those embarrassing noise problems—use Series 300 HiNIL.

 **TELEDYNE SEMICONDUCTOR**

1300 Terra Bella Avenue Mountain View, California 94040 (415) 968-9241 TWX: 910-379-6494 Telex: 34-8416

\*Nixie is a registered trademark of Burroughs Corp.

# A place for everything and everything in its place.

Airco doping gases are predictable. (We

invented doping gases.) They let you lay

down what you want to lay down—where

you want to lay it. Because they're the purest

you can buy: silane, arsine, diborane, phos-

phine. Information? Contact your Airco

rep or Hank Grieco, 575 Mountain Avenue,

Murray Hill, New Jersey 07974. Phone:

201-464-8100. Then let the

chips fall where they may.

**AIRCO**  
Industrial Gases

Circle 62 on reader service card

## Electrophoretic display has a memory and comes in many colors

There's another entry in the low-power display race. Workers at Matsushita Electric Industrial Co. have harnessed electrophoresis to come up with reflective display that not only offers a wide choice of colors, but also has a short-to-medium-term memory that consumes no power.

The heart of the display, developed by Isao Ota, Joichi Ohnishi, and Masami Yoshiyama of the company's Wireless Research Laboratory, is a suspension of charged pigment particles in a liquid of another color. The suspension, a layer typically 50 micrometers thick, is sandwiched between a pair of electrodes, one of which is transparent.

**Attraction.** When direct current of the right polarity is applied to the electrodes, the particles are pulled toward the transparent electrode, thus displacing the contrasting liquid and showing their own coloration. When the polarity is reversed, they move to the other electrode and are hidden by the liquid.

The researchers have already worked up a prototype of the display into a six-digit clock readout. The display, with a contrast ratio of about 40:1 at 70 volts, dissipates only 2 milliwatts when all seven segments of a number measuring 1.8 by 0.98 inches are activated. Contrast can be varied by an ac component. At 1 hertz, the ratio is typically 30:1 and at 200 Hz it is 3:1.

The display has a built-in memory function. The particles drawn to the electrode surface stay there even when the voltage is turned off because of the attraction of the van der Waals force. Memory times ranging from several seconds to one month have been achieved by varying the composition of the suspension.

To avoid any settling of the pigments over time, the team equalizes

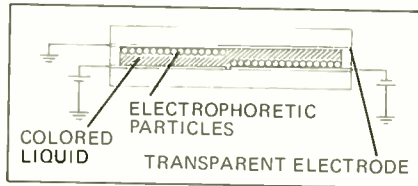

the specific gravity of the pigments and the liquid, which is made by dissolving an oil-based dye in an organic solvent. Inorganic pigments with large specific gravity can be used by encapsulating them in a resin □

### The Netherlands

## Photoplate resolves 0.5 micrometers

In the Lilliputian world of integrated circuits, a micrometer still seems like a Brobdingnagian dimension to many designers. Their ideal is for critical component patterns to be as small as half a micrometer, but with present-day photomasks such resolution is hard to obtain.

But a photomask from Philips Gloeilampenfabrieken in the Netherlands should make the job easier. There, at the company's research laboratories in Eindhoven, a team of scientists has come through with a photographic plate based on the so-called "physical development" process and said to provide half-micrometer line resolution. Under special circumstances, the new Philips PD plate can resolve details down to even 0.3 micrometer.

With conventional photographic plates, the barrier to obtaining such resolution is the light-sensitive material used—tiny silver halide grains dispersed in a gelatine layer about 6 micrometers thick. Both that layer's grainy quality, which causes the

light to scatter, and its thickness, which is larger than the focal depth of the projecting lenses used, limit the sharpness and the resolution of IC patterns on the plates. Even with these high-resolution plates, the best that can be reached in resolving details is about 1 micrometer, according to Philips. Besides, with these plates it is often difficult to meet reproducibility requirements.

The Philips PD plate, developed by L.K.H. Van Beek and his associates, overcome these limitations thanks to a highly absorbing light-sensitive material, which is characterized by a complete absence of grains. The material, called benzenediazo-sulphide and belonging to a class of light-sensitive compounds first synthesized by Philips researchers C.J. Schoot and Jan Boven, is molecularly dispersed in a 1.6-micrometer polymeric and hydrophilic layer deposited on a glass substrate. This layer is made hydrophilic by a treatment in an alkaline bath. The initial problems that the Philips men encountered in getting the layer to adhere to the glass were solved by first applying to the substrate a "subbing" layer about 100 angstroms thick.

In the physical development process, which has already been employed at Philips in small-scale IC fabrication, the mask image formed by illumination is developed in two steps. The first step is a development bath using a very dilute solution of silver salt and mercurous salt. Nuclei of amalgamated silver are formed in the layer at the illuminated spots. The second step is a treatment with a selectively reacting solution of a silver compound. The silver nuclei act as catalysts for the deposition of silver; thus, the nuclei in effect draw out silver from the solution to form a very sharp image in metallic silver. □

# Cincinnati Milacron now offers you the bare minimum

It's called the Strippable CIP. The new CIP/2002 is the minimum hardware framework from which you can build your own minicomputer.

You get only the basic components you need to build your own dedicated system. The CIP/2002 can save OEM users considerable cost because all but the most essential hardware has been stripped away. Only the control board, two data boards, and the frame remain. This allows the system builder to use the power of the minicomputer creatively. Incorporating and adapting the unit to your needs is vastly simplified. Best of all, the variety of options lets you pick just those you need. You don't pay for "frills" you don't need. And the price is very low as a result.



Send today for our free idea booklet entitled "Minicomputers And Their Applications" and get full details on how the Strippable CIP can save you money. Write or call (513) 494-5444, MINICOMPUTERS Cincinnati Milacron, Process Controls Division, Lebanon, Ohio 45036.

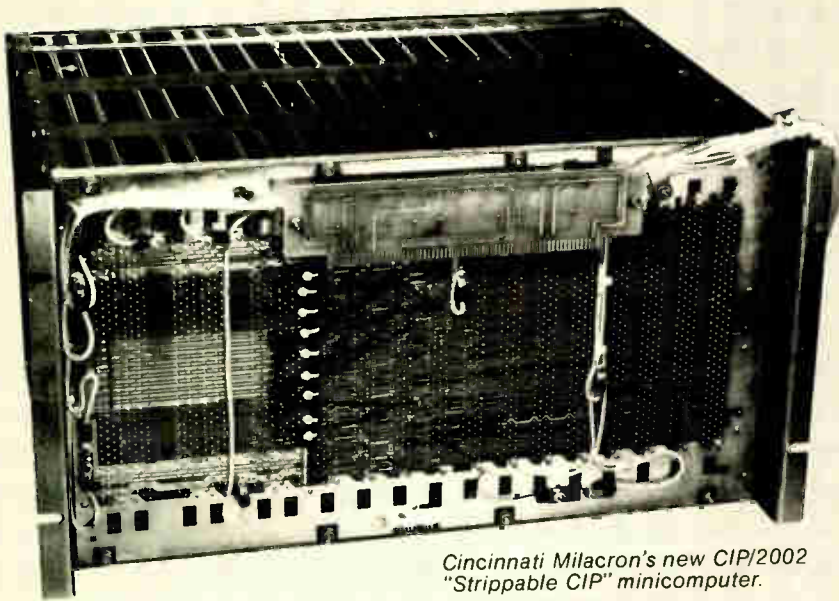

*Cincinnati Milacron's new CIP/2002 "Strippable CIP" minicomputer.*

**minicomputers**



Machine Tools  
Process Controls  
Chemicals  
Plastics  
Plastics Processing Machinery  
Abrasives



# International newsletter

---

## Siemens, Honeywell cooperate in traffic control systems

Honeywell in the U.S. and West Germany's Siemens AG are getting together to promote computer-based traffic control systems. Under the terms of the agreement, **Siemens is making available to Honeywell its systems knowhow and special equipment for use on the American and Canadian markets.** The terms also provide for information exchange and for the manufacture of the equipment by Honeywell under Siemens license.

The equipment in question is control apparatus and vehicle detectors, which will be adapted for use with Honeywell computers. It is possible, a Siemens man says, that the American firm will, under certain circumstances, build the Siemens traffic control computers, too. **Siemens is an old hand in the traffic control business, having supplied 80 of the 128 computer-based systems installed around the world.**

## Saab-IBM battle over computers heats up

Saab-Scania's fight against IBM for Swedish state computer orders [*Electronics*, Aug. 28, p. 47] has evidently forced IBM to launch **an advertising campaign in the daily press stressing that IBM is a Swedish company.** In a series of ads, IBM has been noting how many it directly employs in Sweden—including 300 at its laboratory and 1,100 at a plant outside Stockholm—and the number of subcontractors—500, most of them small companies—it uses. IBM ads note that Svenska IBM's exports of print-out equipment have a value almost equal to IBM's import of computers.

Meanwhile, the Saab-IBM fight for state orders has taken a new twist, with announcement that **Saab is in final negotiations with the Finnish defense department for two Saab D-23 computers.** This is the computer that the Swedish State agency, Statskontoret, rejected as being too costly, compared with the IBM 370/145 and 370/155, to be used for military administration. However, Saab points out that the Finns—who would use the computer for a similar purpose—figured the Saab was cheaper than IBM machines.

## Plessey offers range of MNOS read-mostly memories

Plessey is following the experimental eight-by-eight metal-nitride-oxide semiconductor read-mostly memory demonstrated at Wescon with evaluation samples of single, dual, and quad transistors in TO-5 cans and dual in-line packs. There are five variations in the trade-off between storage permanence and write time: unlimited permanence and a write time greater than 10 milliseconds, ten years and 1 millisecond, one year and 100 microsecond, one month and 10 microseconds, and one day and less than 1 microsecond. Access time for all devices can be down to 1 microsecond using MOS interfaces. **The high-permanence devices are for use where the memory is almost a ROM,** the lower-permanence, faster-writing devices typically for calculating functions where data is rewritten every few hours or days. Samples of the undecoded 64-bit array are scheduled to be available in a few months.

## Another Japanese calculator bows at \$42

A new hand-held calculator shown by Busicom at Japan's business show **has more features than the unit recently introduced by Casio, but will sell at the same bottom-of-the-market price of \$42.67.** Both have a

six-digit display that can show either the left or right six of 12 digits, but the Basicom calculator comes with a decimal point, and the user can specify up to four digits after the point. The Basicom unit also includes an indicator to show when there is need to read more than the six digits normally displayed, and another indicator for negative read-out.

Basicom isn't telling how it is able to provide all these features at such a low cost. **But one industry source says that Basicom uses a standard Mostek 12-digit LSI chip to cut costs.** The six less significant digits are displayed in the usual manner on six-digit display, while an inexpensive external six-digit IC shift register is used to store the other six for display when a button is pressed.

## Germany readies sea/air monitoring net

Several West German electronics and aerospace firms, with Dornier AG leading the pack, are embarking on a **multi-million dollar project aimed at large-scale monitoring of oceanographic and meteorological data in the Baltic and North Sea areas.** The project, which is part of a government-sponsored program, aims at the establishment of a network of sea-based stationary and automatically operating measuring stations. The data collected and sent to shore is to provide a basis for studies of ocean/atmosphere relationships and of the effects of water parameters such as temperature, pressure, and current vectors on atmospheric parameters. **Furthermore, the data will be used in pollution-control, weather-forecasting, and in various sea-related services.**

## Temperature sensor is constant to $\pm 0.5^\circ\text{C}$

West Germany's Siemens AG is tooling up for production a simple low-cost temperature standard that it says is constant to within  $\pm 0.05^\circ\text{C}$  over a temperature range from  $-30^\circ$  to  $+60^\circ\text{C}$ . **As a temperature sensor, the unit employs a vanadium dioxide crystal that is thermally coupled with a transistor serving as a heat source.** Vanadium dioxide has a temperature-dependent conductance behavior. **At a Curie temperature of  $65.5^\circ\text{C}$ , it exhibits a resistance jump of nearly  $10^5$ .** Below that, it has a high resistance and is semiconducting. This effect is exploited to accurately stabilize the transistor at the Curie temperature. The standard is designed for an operating voltage between 8–15 volts. Its power consumption at  $-30^\circ\text{C}$  is 500 milliwatts.

## New ingot capacity overcomes Japanese shortage of LED wafers

**A shortage of gallium arsenide wafers with a gallium arsenide phosphide epitaxial layer is limiting production of light-emitting diodes in Japan.** But the bind should ease now that Sumitomo Electric Industries is beginning large-scale export of gallium arsenide ingots to Monsanto. Sumitomo says that with more ingots **Monsanto, in turn, should be able to up its exports of wafers with the GaAsP layer to Japan.** Monsanto is a main source of wafers in Japan.

Sumitomo has contracted to export 35 kilograms of ingots before yearend, with follow-on orders expected to raise the total to as much as 100 kilograms by yearend. Sumitomo will not reveal the value of its orders but says 100 kilograms of ingots is worth about \$1.67 million to \$2 million dollars.

# Centralab Potentiometers... in line with your design requirements



Write  
Centralab  
for  
Bulletin  
No. 1526P2

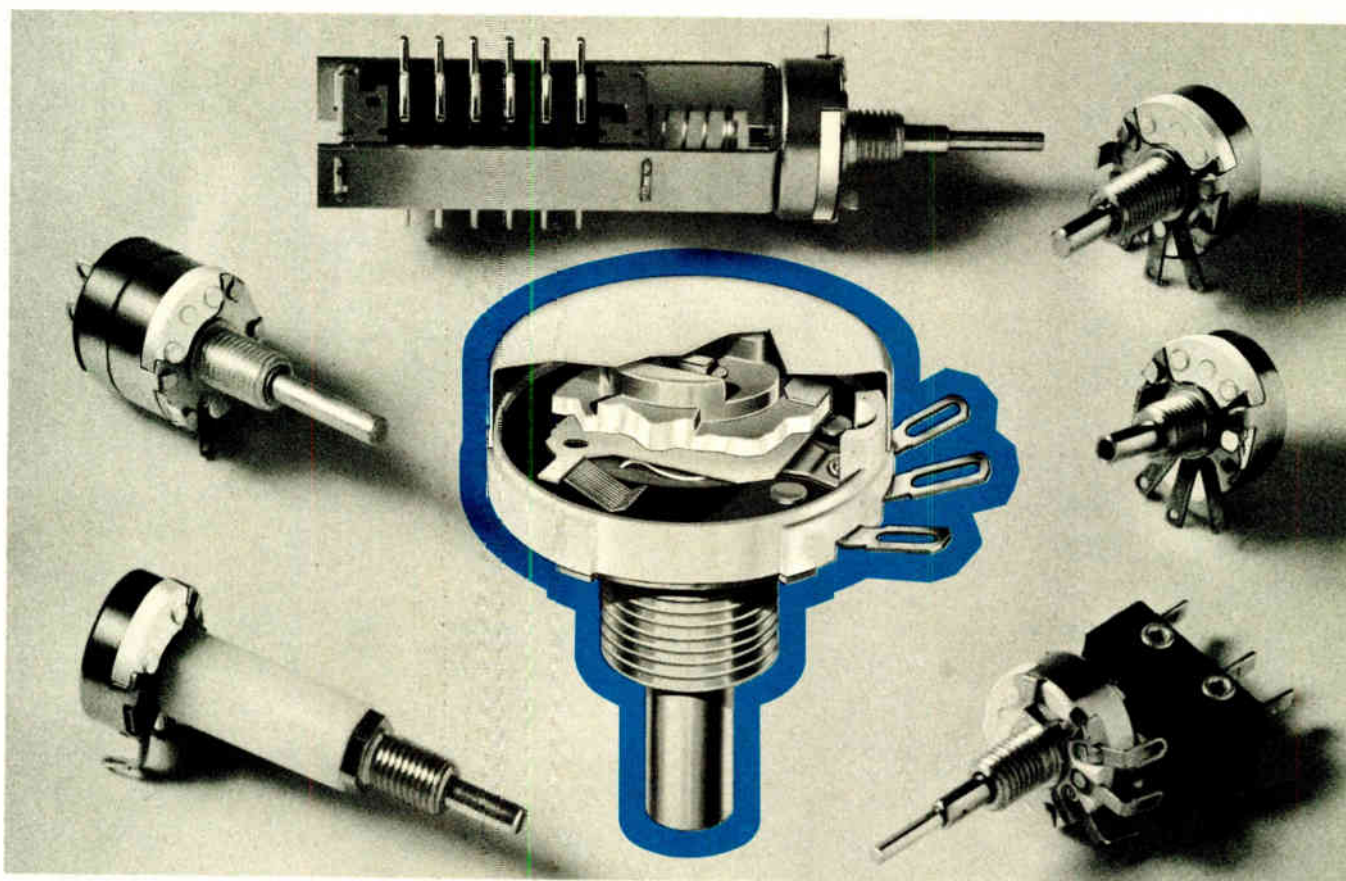

## You can't tell a pot by its cover

You have to look inside to see how a potentiometer is made. Centralab's new ULTRA-ONE™ 5/8-inch potentiometer simply has more quality under its gold finished cover.

The extremely quiet ULTRA-ONE operates within 0.5% maximum CRV (contact resistance variation) for linear tapers—not just initially—but through 100,000 cycles!

We did it by an improved resistor system and by using a new contact. This quiet combination is a smooth conductive plastic element and a ten-fingered contact. The result is that

CRV is almost unmeasurable throughout the life of the potentiometer.

For versatility, the ULTRA-ONE can be coupled with snap-action, line and push button switches. It's available with a high-voltage bushing and shaft—with hollow shaft—and a high-torque feature.

ULTRA-ONE is the industrial potentiometer line that gives you more design flexibility . . . low noise operation, component add-ons, long life, and high-quality . . . in an extremely attractive package.

For complete specs, write Potentiometer Sales Manager, Centralab.

### GET CENTRALAB THE "IN" LINE FOR YOUR DESIGN

Hybrid Microcircuits  
Pushbutton & Rotary Switches  
Capacitors  
Potentiometers  
Technical Ceramics  
Ceramic Packages  
Semiconductor Devices

#### ULTRA-ONE features

- 0.5% maximum noise through 100,000  $\sim$
- Multi-fingered contact
- Conductive plastic element

- $\pm 250$  PPM/ $^{\circ}$ C
- 1/2 watt at 40 $^{\circ}$ C
- 500 volts DC
- $\Delta R < 10\%$  after load life
- $\Delta R < 10\%$  after 100,000  $\sim$



**CENTRALAB**

Electronics Division  
GLOBE-UNION INC.  
5757 NORTH GREEN BAY AVENUE  
MILWAUKEE, WISCONSIN 53201

# 100% ac testing of consumer ICs

Is it really necessary? Is it practical? Is it available?

Sample testing of TV and radio parts is no way to ensure a good night's sleep. Ideally, both makers and users of consumer ICs should test every device for ac characteristics.

But 100% ac testing sounds expensive, so what do people do? They compromise.

They tighten up on AQL specs.

They make dc correlations instead of true ac tests.

If the return rate climbs, or if bad parts show up in the finished product, they shout a little louder at the vendor or the inspector or the QC manager.

There's a better way.

Our J263 will automatically test for every ac spec from stereo channel separation to chroma demodulation angle to video i-f gain. And it will do it so fast that 100% testing is economically practical.

On an IC production line, the J263 will even wafer probe, and it will multiplex to as many as seven stations.

In incoming inspection, the J263 will datalog chapter

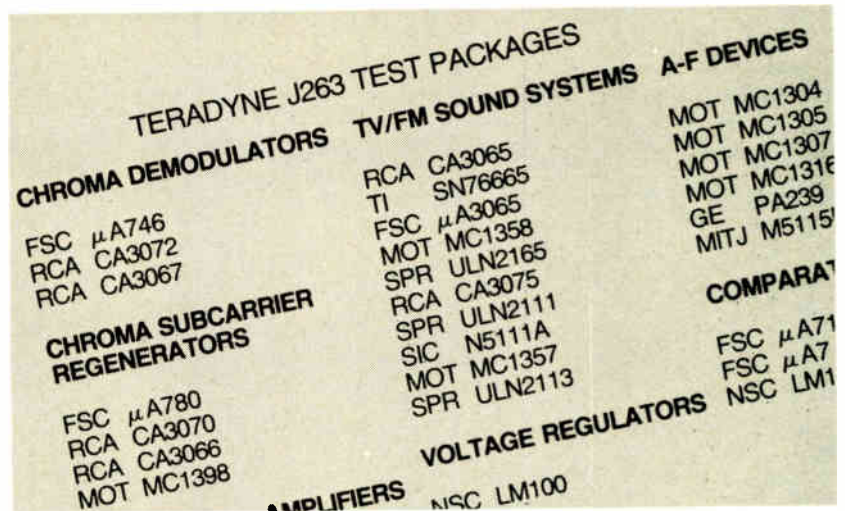
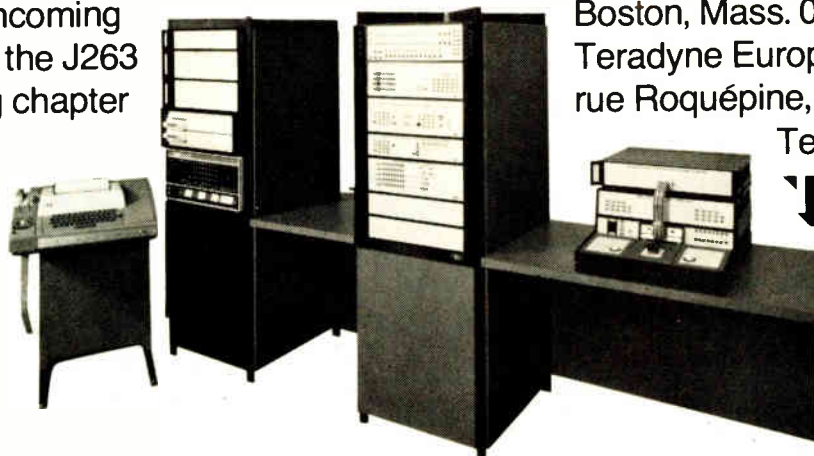

and verse on all your suppliers, so you'll know who's shipping you what.

Backing up the J263 is a long list of test packages. They include the applications hardware and software for just about any consumer IC on the market. All the tests have already been worked out with the key producers and users, so you start off with a thoroughly proven, debugged installation.

If the alternatives to 100% ac testing are getting you down, tell us to rush you a J263 brochure. It illustrates again that in testing, the best solution is always an honest one.

Write: Teradyne, 183 Essex St., Boston, Mass. 02111. In Europe: Teradyne Europe S.A., 11 bis, rue Roquépine, 75 Paris 8<sup>e</sup>, France. Tel. 265 72 62.

**TERADYNE**

## Electronics guards parked planes

Automatic detection systems use various sensors to protect aircraft, and diverse techniques prevent false alarms and enhance reliability

by William F. Arnold, Aerospace Editor

A growing form of terrorism in air travel is being answered by electronic security systems that protect airlines and private plane owners from theft, destruction, or vandalism to parked aircraft. Sensing systems using lasers, doppler radars, infrared, and capacitance detectors, coupled with radio transmitters or computers, are being marketed to stand guard over commercial and private aircraft.

Foreseeing a potentially large market, companies such as Applied Metro Technology Inc., Control Data Corp., GTE Sylvania, Honeywell Inc., and Systron-Donner Corp. have developed various products. Besides neutralizing bomb threats, the systems could prevent the theft of avionics, and tampering.

GTE estimates that it would sell 1,000 of its units to airlines and many more to general aviation customers. American Airlines and Braniff Airways have already tested systems for possible buys. And other airlines are interested.

But "the market isn't taking off as we thought it would," says one executive. He blames the recent economic downturn. Another executive says, "The airlines are dragging their feet until the FAA buys the equipment for them, as it did with magnetometers" [*Electronics*, Sept. 25, p. 51, and July 17, p. 56].

Another factor is dependability. Oscar B. Parker, Eastern Air Lines security director, says he's looked at most systems, and "I'm not convinced of their reliability." He also mentions that hooking them up is

difficult and that perimeter systems can sound false alarms around a busy airplane maintenance ramp. With improvements in the equipment, though, Parker indicates that he'll buy.

"There's a big market there," says Odis W. Kenton, field service manager for Applied Metro Technology, Barrington, N.J., whose company

tem commercially under the name Airalert.

"Hell, yes, we need such systems," declares Eastern's Parker, who says his company is looking at all systems for a potential buy. He recalls an incident this spring, when a Trans World Airlines jet parked at Las Vegas was bombed.

Fred B. McIntosh, director of operational services for the National Business Aircraft Association, says, "there's a constant increase of the use of such (security) equipment in the business fleet every year." Pointing out that his members fly aircraft costing from \$15,000 to \$3.5 million, he says a \$100,000 plane may have \$20,000 to \$30,000 worth of avionics on it, and "the price of the avionics goes up every year." More business planes are flying internationally, McIntosh adds, and "with world conditions being what they are, owners are taking more precautions."

All security system manufacturers say their systems can monitor several planes at once, can be set up in networks to guard aircraft parking areas and be connected to a central security console, where an airport's total security could be watched by a small guard force. This way, they say that electronic security is more effective than guard patrols.

And most manufacturers, aware of the problems of false alarms, have developed detection and error-checking circuits to avoid such problems.

Users are offered a selection of



**Tune in a thief.** To protect aircraft, Honeywell has a system that sounds an alarm when unauthorized persons come near.

makes an infrared unit called Barrier Infra-Red Detection (Bird/Eye). Honeywell Inc., Minneapolis, Minn. recently sold 100 parked aircraft security systems (PASS) to the U.S. Air Force, and the company expects to market this sys-

## Tung-Sol® 3 to 500 Amp Power Rectifiers

Tung-Sol rectifiers are conservatively rated to assure the widest possible margin of safety and reliability. Press-fit rectifiers to 44 Amps. Stud-mounted types to 420 Amps. Ratings to 500 Amps in flat-base construction.



### Modular Bridge Rectifiers 10 to 35 Amps

Highest surge ratings give designers maximum protection against voltage overloads.

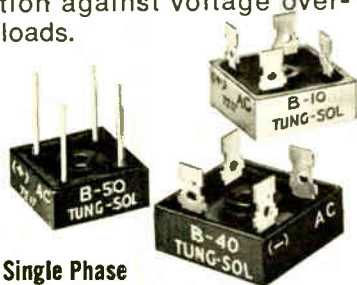

#### Single Phase

**B-50 Series**—To 10 Amps DC.  
50 to 600 PRV. 300 Amps surge.

**B-40 Series**—To 15 Amps DC.  
50 to 1,000 PRV. 300 Amps surge.

**B-10 Series**—To 30 Amps DC.  
50 to 1,000 PRV. 400 Amps surge.



#### Three Phase

**B-20 Series**—To 35 Amps DC.  
50 to 1,000 PRV. 400 Amps surge.

WRITE FOR TECHNICAL INFORMATION  
SPECIFY BRIDGES, OR POWER RECTIFIERS.

SILICON PRODUCTS SECTION  
**WAGNER ELECTRIC CORPORATION**

630 West Mt. Pleasant Ave. Livingston, N.J. 07039  
TWX: 710-994-4865 PHONE: (201) 992-1100  
(212) 732-5426

Trademark TUNG-SOL Reg. U. S. Pat. Off. and  
Marcas Registradas

## Probing the news

different technological approaches. Units by GTE Sylvania and Honeywell, for example, set up a capacitance field on the aircraft's skin. If a person touches the plane, the capacitance changes and an alarm goes off. To prevent lightning strikes from sounding false alarms, both companies use an analog oscillator with a built-in threshold tied to digital logic. Both also claim that the battery-powered units are easy to set up and to ground.

**Oscillating sentries.** GTE's patented Parked Aircraft Intrusion Detector (PAID), developed from a Minuteman 3 missile security system, employs a free-running oscillator having its 30-50-MHz frequency determined by the capacitance from the aircraft to the ground: a DC-8 has from 5,000 to 7,000 picofarads, and a Boeing 747, 10,000 to 12,000 pF, explains Martin H. Daubert, manager of production engineering, Electronic Systems group. A digital counter continuously monitors the capacitive field, and any step increase in capacitance triggers an alarm, he says. A single system costs \$2,950. As an option, two circuit-card assemblies can be inserted in the 18-pound unit to give a radio-alarm link.

Honeywell's Airalert uses two oscillators—one is a reference, and the other detects a phase change caused by an intruder, says Arthur B. Finkelstein, project supervisor at the company's Government and Aeronautical Services division in Minneapolis. In detecting a phase change, "you get the voltage output versus a change in capacitance," he explains. Because the aircraft is part of the dielectric network in Honeywell's system, it will trigger an alarm if someone comes close to a guarded aircraft, even if he doesn't touch it.

Honeywell's unit uses mostly discrete components, whereas GTE's uses integrated circuits. Both systems can broadcast radio alarms from many aircraft, using identification codes to indicate the endangered plane. Both use threshold levels to keep snowflakes, moisture, and birds from triggering alarms.

Applied Metro's Bird/Eye infrared system is built around Texas

Instrument's infrared LEDs. The system erects an invisible fence of interlaced beams around a plane, says Kenton. A nine-beam unit has three transmitters and three detectors. Each detector receives a beam from each transmitter; this forms a cross-hatched fence. If an intruder interrupts the beam, an alarm goes off. Fences 300 feet long for all-weather operations can be built, and two stacked 16-beam units can give a side 10 feet high, he says.

These modular solid-state units use encapsulated IC logic to control time delay, self-checking, and false-alarm functions. To prevent false alarms by birds or small animals, the beams are pulsed every 20 milliseconds for a time reference. Time-delay logic determines when a human is intruding, Kenton says. A nine-beam system costs \$1,980.

Systron-Donner, of Dublin, Calif., offers a "super-photoelectric system" using a pulsed infrared gallium arsenide laser, says Paul I. Corbell, technical director of the Security Devices division. The high-power laser beam spreads out, giving more protection over its 1,000-foot range, he says. A number of units, each costing about \$600, can be stacked to give a multibeam fence, Corbell says.

**Radar sentry.** Sometimes, however, a good idea can't seem to get off the ground. A "radar fence" was marketed by Control Data Corp., Minneapolis, but "no one wanted to spend the money to complete development of it," says its designer, Walter H. Chudleigh, senior consulting engineer in the Military Products division. Chudleigh describes his proprietary unit as a fully coherent doppler bistatic radar system. The system would use antennas 2 inches high and spaced every 15 feet along a 0.25-in. coaxial cable that could be as long as 25 miles. A minicomputer at one end would watch for intrusion signals from the antenna sensors.

Chudleigh ticks off the advantages of his idea: it would be false-alarm-proof from weather and small animals, could not be triggered from vibration or noise interference, could be permanently installed, and even be used for directing taxiing aircraft. A portable unit would cost under \$1,500, he says. □

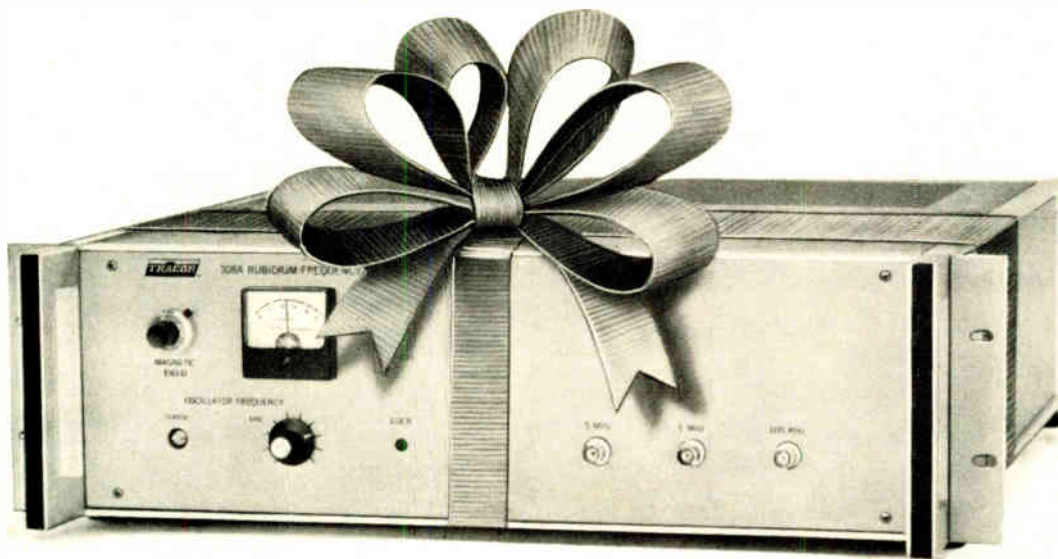

**\$5,900**

## for the new Tracor 308 A Rubidium Frequency Standard.

**A gift for people who want something 100 x  
more accurate than the best crystal oscillator.**

Atomic accuracy at near crystal prices? Stability virtually unaffected by environmental factors? That's what you get with Tracor's new low cost Rubidium Frequency Standard. Utilizing a stable quartz crystal oscillator whose frequency is controlled by the atomic resonance of rubidium 87, the Model 308A offers a long-term stability of better than  $3 \times 10^{-11}$ /month. With a mean time between failures in excess

of 25,000 hours. Options provide additional outputs and standby D.C. powered operation.

Built by Tracor—pioneer in Rubidium Frequency Standard technology.

In astronomy, navigation, in metrology and communications...wherever a precise and stable time base is essential, Tracor's 308A will fill the bill. Cheaper by the dozen, too.

For more information, call 926-2800, or write:

Tracor Inc., Industrial Instruments, 6500 Tracor Lane, Austin, Texas 78721

Companies

# DEC makes business its business

Digital Equipment Corp.'s new computer series, aimed at a larger, less knowledgeable market than present customers, could change company image

by James Brinton, Boston bureau manager

The business systems just introduced by Digital Equipment Corp. could boost that company's prosperity at least as much as its introduction of minicomputers did seven years ago. But that boost will not occur without some changes in DEC's traditional relationships with original-equipment manufacturers and knowledgeable end users—nor without a challenge to IBM.

The Datasystems series, organized around DEC's PDP-8 and -11 mainframes and existing peripherals, will sell for roughly \$30,000 to more than \$100,000 [*Electronics*, Sept. 25, p. 27], and will attract customers from markets new to the Maynard, Mass., firm. But these buyers will often lack the sophistication of present DEC customers, who could be relied on to keep the company's support costs low. Also, many newcomers will be part of markets now serviced by OEMs whose business DEC wants to keep.

The answer, according to Stanley C. Olsen, vice president, group manager, and co-founder of DEC, is

a two-pronged sales approach: "We will sell our data systems to OEMs that can use them. But we'll be active in the areas where our OEMs aren't, selecting the largest and most sophisticated potential end users and customers not already serviced by our OEMs."

DEC also will sell within tightly defined geographical bounds. For example, it will look for customers headquartered in New York City but nationwide in scope that it will be able to service through a single location. Meanwhile, smaller firms and customers in areas where DEC has a low profile will be the preserve of DEC OEMs. "Again we will be able to offer centralized support, while the OEM, with his intimate market knowledge, area knowhow, and acquaintance with his customers, will be able to provide support," says Winston R. Hindle Jr., vice president for large- and medium-scale computers.

Moreover, there are sure to be runoffs between DEC's Datasystems and IBM's smaller systems. The two

companies' names are going to be linked in the minds of data processing managers, and this will change a few competitive ground rules.

**Competing.** "IBM salesmen are trained to be adept at convincing the comptroller of the need for a new computer—but now, data processing managers are facing stiff questions from their management. These men read articles about the under-utilization of computers, and question laying out the kind of money IBM wants for many of its systems," says Hindle.

So DEC is going to compete on a combination of price and performance. It may do well here, because even the least expensive of the Datasystems at \$28,000 includes an 8,000-word PDP-8, DECTape, interactive CRT display, line printer, and operating system software. Presumably, there are discounts if the order is large enough. And DEC salesmen, according to Hindle, are more tightly linked with the engineering side of the house than IBM salesmen, who, he says, often must go through

**Assembly line for PDP-11/40s.** The PDP-11/40 is the basis for all but one of DEC's Datasystems for business customers.





Number 5 in a series

# 7L12 Spectrum Analyzer Facts



Facts like this:

The 7L12 Spectrum Analyzer Plug-in provides simultaneous time and frequency displays when used with other 7000-Series Plug-ins.

Mean

that the 7000-Series mainframes and plug-ins offer the most complete CRT display systems for pulsed RF analysis. You can simultaneously examine the modulating signal, such as the double pulse upper trace at right, while analyzing the resulting spectral distribution, lower trace at right. In addition to this unique display capability, scale factors are displayed by the CRT READOUT, extending your ability to measure and record all factors appropriate to your measurements.

Specifications like this: 3 MHz resolution bandwidth

Mean

a new dimension in time-base display of modulation waveforms. The lower trace (at right) is a modulation waveform as demodulated by the 7L12 and plotted by its calibrated time base. Add a plug-in amplifier to the other mainframe Y-axis compartment and a simultaneous display of the modulating signal can be plotted (upper trace).

Now with Variable-Persistence

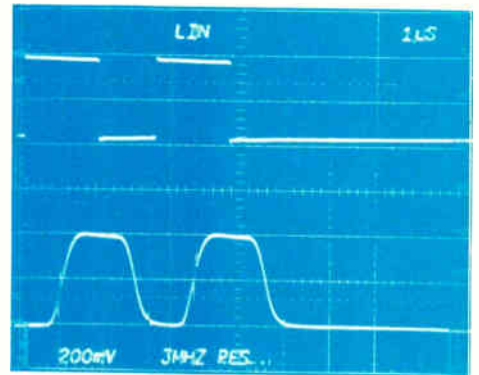
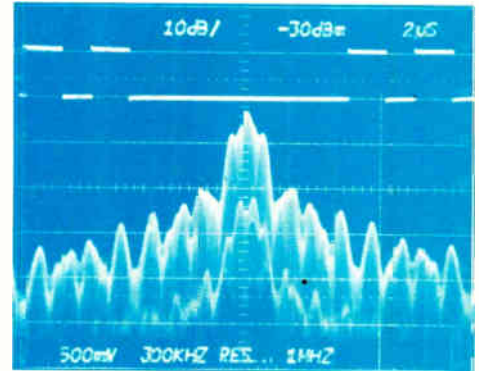

## TEKTRONIX 7L12 Spectrum Analyzer Features

- 0 Hz to 1800 MHz in one display (swept front end)
- Fully calibrated displays
- 70 dB dynamic range
- Intermodulation distortion 70 dB below full screen
- Spurious free operation
- 300 Hz to 3 MHz resolution
- 4:1 resolution bandwidth shape factor
- -110 dBm sensitivity
- Automatic phase lock
- Front panel and CRT readout\* of display factors

### fact

Any 7000-Series Oscilloscope with a 7L12 Spectrum Analyzer Plug-in is an excellent 100 kHz to 1.8 GHz spectrum analyzer. There are 7000-Series mainframes for all your applications including variable persistence (7613 at left) and bistable storage.

### fact

A complete TEKTRONIX 100 kHz to 1.8 GHz Spectrum Analyzer is available at the low price of \$5806. It consists of a 7L12 Spectrum Analyzer Plug-in (\$4850) in a 7403N mainframe (\$950) and a blank panel (\$6) to cover the reserved-for-future-use compartment. Of course you can use it now with one of the many 7000-Series Plug-ins.

\*CRT readout is a feature of many 7000-Series mainframes.

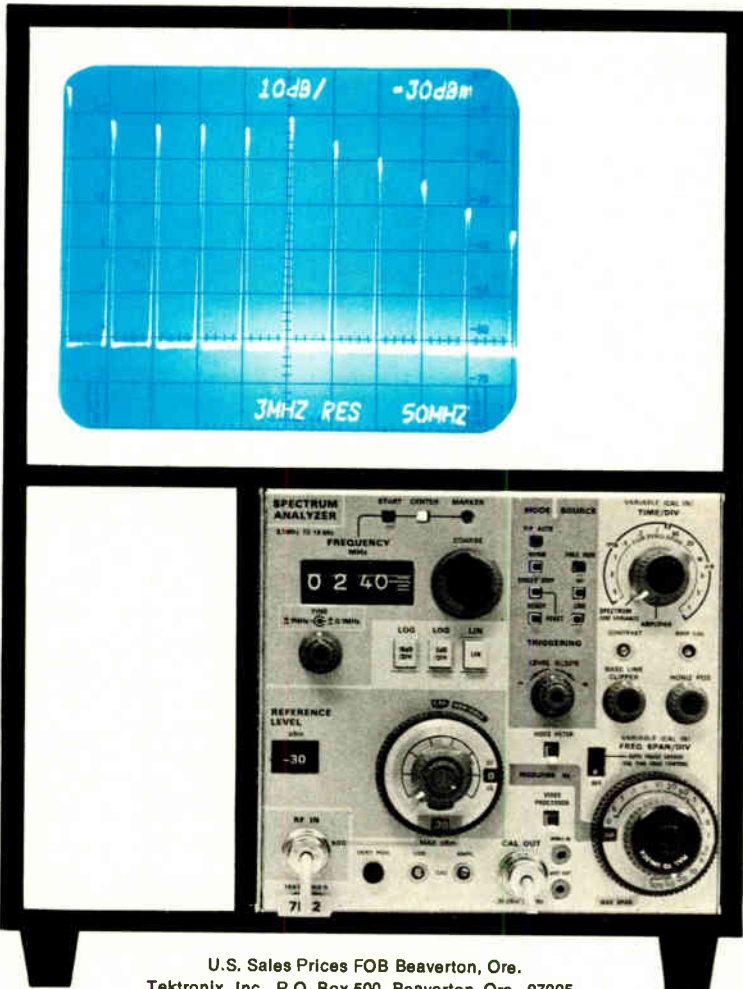

U.S. Sales Prices FOB Beaverton, Ore.  
Tektronix, Inc., P.O. Box 500, Beaverton, Ore. 97005

For a demonstration circle 72 on reader service card

Circle 73 on reader service card

## Probing the news

layers of management before solving a customer's problem.

Assuming the Datasystems are a success, what effect will this have on the future of the company? The Datasystems could act as an opening wedge for other DEC products, such as the recently unveiled data communications equipment. As the data processing needs of small customers grow, there may be a market for DEC's medium-scale computers. Company spokesmen say this is presently a market for the PDP-15, but expect the PDP-11/45 eventually to win any contest for medium-scale computer sales, and even replace the PDP-15 in three to five years.

The PDP-11/45 is also expected to bridge the gap between DEC's smaller computers and systems and its largest, the DECsystem-10 line. In four to seven years, if the Datasystems are as successful as DEC spokesmen hope, their chain-reaction sales effect will have begun to boost sales of DECsystem-10 series computers in business application areas. This is something that would delight DEC managers, since the 10 line has been most popular in the smaller scientific market. Ultimately, the promise is that DEC will surface as a presence in the business data processing field, with the large quantity sales that implies.

**The evolution.** How has DEC—the inventor of the minicomputer—reached this point? When Kenneth H. Olsen, DEC's president, his brother Stan, and Harland Anderson left the MIT-Lincoln Laboratory to form DEC in 1957, they had worked on the TX series of computers—among the first to combine transistor and core memory technology. Thus, DEC's first products were logic modules using transistor technology, from which laboratory-type customers could build more complex digital equipment—hence the name of the firm. DEC still maintains a strong module product line.

Using its own modules for hardware, and its own industry experience and scientific community contacts instead of an expensive marketing program, DEC found the going with its earliest computers rel-

atively easy. Having come from scientific institutions, the founders not only knew the gaps in this market, but also could follow the scientific grapevine to the customer. More often, though, that grapevine alerted the customer to DEC. And where one or two users had specific problems characteristic of larger markets, DEC was able to follow these leads with in-house developed packages targeted at known markets.

But nearly all DEC dedicated systems were announced in or after the mid-1960 period. The firm's first seven to nine years went to servicing the strong markets, which it practically owned in the scientific community, plus such typesetting and clinical applications as the Typeset-5, ancestor of the Typeset-8, and the LINC, or laboratory instrument computer, also a PDP-8 offshoot.

DEC's laboratory products group still produces more different systems—about eight—than any other group in the company. But close behind and still scientifically oriented comes medical products with six computer-based systems. Next, to anyone considering DEC's product line, which ranges from machine controllers to large-scale computers, it was natural that the firm would market equipment for communications between its computers—front ends, message concentrators, and remote job-entry stations. So coming up fast is the newly formed communications group. And one of the first beneficiaries of that communication capability should be the new data systems.

But without the drastic fall in computer prices, and without DEC's efforts in peripheral equipment development, little of this would now be possible.

**Moving in-house.** "Because of IC price cuts, and the advent of ever-larger-scale integration, the mainframe is perhaps the least costly part of many computer systems," says Andrew Knowles, DEC vice president for small computers. "And until almost this year, pricing on nearly all our systems was tied to peripheral equipment, which we were forced to buy outside. It cost us money to repackage and resell these peripherals, and the extra cost had to be passed on to the consumer."

But with the advent of the PDP-

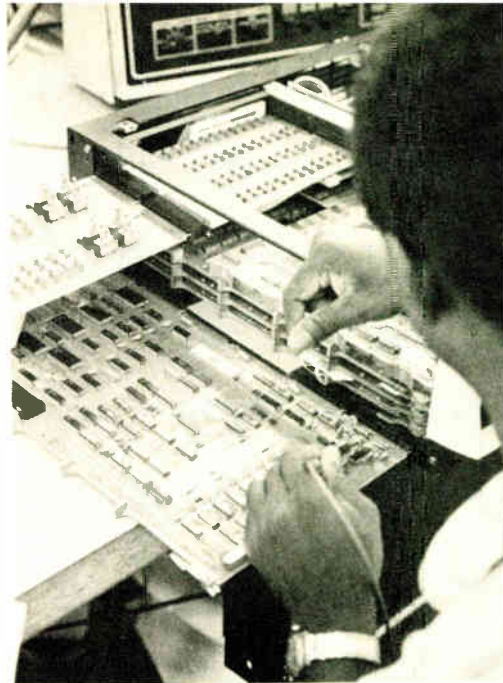

**Checkout before shipment.** DEC's PDP-11/05 is marketed primarily to OEMs, but is also used in DEC's GT-40 graphics terminal.

8/E and PDP-11, the wheels started turning inside DEC. Not only did mainframe redesign take less money than ever before—further decreasing CPU costs—but DEC also began development of new lines of in-house peripheral equipment—peripherals that could not only be priced low, but discounted as well.

The new peripherals are apparent in the Datasystems. DEC's in-house core memory is used in the computers. Its in-house disk is used for bulk storage. Its interactive CRT display is the operator's console. Not only has nearly every subassembly come off the shelf as proven equipment, but it has come off at low cost.

And there should be more of the same in the future. As Knowles says, "This is becoming a terminal-oriented world. In 1972 alone, we have introduced or revamped five important terminals; the GT-40 graphics terminal, the VT-8E low-cost alphanumeric terminal, the RT-01 and RT-02 data entry terminals, and the LA-30 DECwriter hard-copy unit.

"You already need a multitude of terminals, today," he says, "to reach that multitude of less sophisticated users where an ever-increasing part of the market lies." And the Datasystems, though complex, are very intelligent terminals. Thus, industry can expect more complex DEC systems aimed at end users. □



The upsetting problems, the roaring frustrations of defining, specifying and procuring the right printed circuit board connectors are over.

Over, because Winchester Electronics offers one of the world's largest, most varied lines of printed circuit connectors. To this purring thought, we'll add another. That Winchester Electronics has the unmatched capability to custom-design and produce special printed circuit connectors, as well. For you and you alone. Even if your order is relatively small and requires special tooling.

Our standard lines include connectors for single and double sided boards. With contact spacing of .100, .125, .150, .156 and .200. With as few as 6 contacts or as many as 100. And with an array of termination types that include wrap-post, solder-eyelet, dip-solder and crimp.

Add to these our ceramic substrate connectors. And our newest standard connector lines, the HSD and HMD\*. With .156 contact spacing center-to-center plus .140 contact spacing between rows for double sided 1/16" cards. And add our DW

\*The HMD meets performance requirements of MIL-C-21097.



series edgeboard connectors. Featuring .025 square wrappable cantilever contacts on a .125 x .125 grid, 18 to 50 contacts per row.

Yes, add it all up. You'll see why Winchester Electronics has manufactured and delivered more than 15 million printed circuit connectors in the last 10 years. And why Winchester Electronics' record of successful innovations goes back for more than 3 solid decades.

So take the snarls out of your life, tiger.

With the all-inclusive line of printed circuit connectors from Winchester Electronics. You'll get what you need. When you need it. And at very competitive prices. Call the Authorized Distributor near you for details, now. Or, for applications, contact Winchester Electronics Division, Main St. & Hillside Ave., Oakville, Connecticut 06779. Phone(203)274-8891.



**WINCHESTER ELECTRONICS**

Circle 75 on reader service card



---

## Probing the news

---

Government

# Cocom begins to weaken

---

Drastic reduction of list of electronics now prohibited from export to Eastern Bloc is positive move, but U. S. obstruction may die hard

---

by Michael Johnson, *World News, Paris*

Since its inception 22 years ago, the Paris-based Coordinating Committee (Cocom) for Strategic Western Export Controls has been characterized by repeated U. S. objections to its allies' attempts to export electronics equipment to Communist countries.

But the first chinks in the American obstructionist wall have begun to appear. The latest sign is a "drastic pruning" of Cocom's embargo list now being completed. That list has been the chief vehicle the U. S. has used to frustrate such exports by friendly nations. Liberalization of the embargo list is in part an outgrowth of talks earlier this year between President Nixon and the Soviet leaders aimed at relaxation of East-West tensions. Among the stated objectives was the increase of trade between the two blocs.

Some diplomats close to Cocom

say this is the beginning of the end for the committee, although "it may be a year or two before Cocom is disbanded, but only because committees of this nature die hard," says one informant. Government sources in Washington, however, dispute this view, admitting that while Cocom will probably become less important than it has been, it isn't likely to be disbanded. The U. S. Defense Department, these sources say, wouldn't permit its dissolution.

The new embargo list—slashed by more than half—is expected to go into effect this fall, opening for sale to East Bloc nations long-forbidden electronic product categories, principally computers, precision instruments and communications equipment. Importantly, the embargo list has been revised with the active participation of American Cocom members. This is a distinct depart-

ture from earlier attempts to revise the list, in which U. S. participants have made relaxation "very difficult," says a source close to the proceedings.

Since 1950, Cocom members have been honoring the embargo list—revised about every three years—intended to prevent the export to Communist countries of arms, technical know-how that could be used in military systems, and materials deficient in Eastern Bloc countries that could be used in weapons production.

"All we expect to leave under embargo this time around is electronics gear that is clearly military, and obvious stuff like guns and atom bombs," one diplomat says. Cocom

---

**Electronics bound for the USSR.** With Cocom's curtailed embargo list, shipments of electronics from U.S. allies will grow.

# New FET op amp in a can cuts drift to $1\mu\text{V}/^\circ\text{C}$

Long a leader in FET op amp design, Burr-Brown is now the first to combine low drift and low noise performance with all the advantages of quality FET input performance in a hermetically sealed TO-99 package. Pin compatible with 741 types, the 3521 provides guaranteed voltage drift and offset voltage as low as  $1\mu\text{V}/^\circ\text{C}$  and  $250\mu\text{V}$ , respectively. Input noise is just  $1.5\mu\text{V}$  p-p. Bias current is just  $10\text{pA}$ . Thermal response is exceptional, fast warm-up is achieved without heat sinking.

Using a hybrid/thin-film approach and a monolithic FET input stage, the low drift is maintained for source impedances up to  $1\text{M}\Omega$ . With voltage drift and noise equal to the best bipolar IC's the 3521's high performance is obtained by the active laser trimming of high-stability thin-film resistors made right in our own facilities. All units are 100% tested to all min/max specifications.

MODEL NO.	3521 H	3521 J	3521 K	3521 L
Input Offset Voltage vs Temperature, max.	$\pm 10\mu\text{V}/^\circ\text{C}$	$\pm 5\mu\text{V}/^\circ\text{C}$	$\pm 2\mu\text{V}/^\circ\text{C}$	$\pm 1\mu\text{V}/^\circ\text{C}$
Input Bias Current, Max.	$-20\text{pA}$	$-20\text{pA}$	$-15\text{pA}$	$-10\text{pA}$
Price, 100 up	\$18.00	\$23.00	\$28.00	\$36.00

All units have a rated output of  $\pm 10\text{V}$ ,  $\pm 10\text{mA}$ , a unity gain bandwidth of  $1.5\text{MHz}$ , a minimum slew rate of  $0.8\text{V}/\mu\text{sec}$ , an initial offset voltage of  $250\mu\text{V}$ , max. at  $25^\circ\text{C}$  ( $500\mu\text{V}$  for 3521H), and a common mode input impedance of  $10^{11}\Omega$ . Units are also available with Mil temperature and Mil-883 screening.

FOR COMPLETE INFORMATION use this publications reader service card or contact your Burr-Brown Representative.

## BURR-BROWN

RESEARCH CORPORATION  
International Airport Industrial Park • Tucson, Arizona 85706  
TEL: 602-294-1431 • TWX: 910-952-1111 • CABLE: BBRCORP

CHICAGO OFFICE (312) 832-6520

UNITED KINGDOM OFFICE: Watford WD1 8BY PHONE 33080/30336



# Burr-Brown amplifiers deliver what they promise!

Circle 77 on reader service card

# New SOLID-STATE FET-INPUT MULTIMETER

from  
**SIMPSON**  
of course

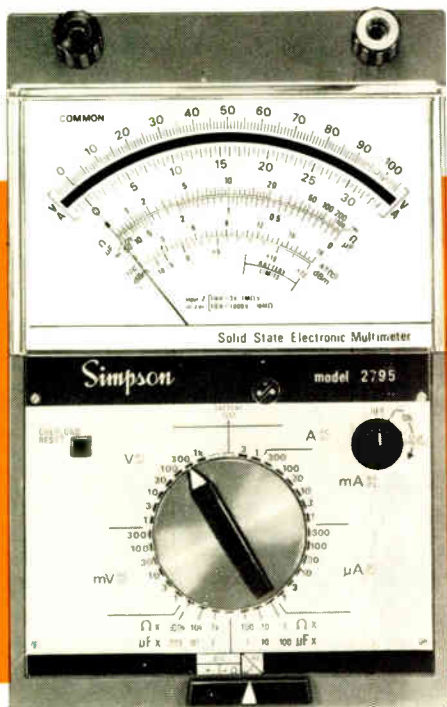

**Model  
2795**  
**PORTABLE,  
LABORATORY  
ACCURACY,  
SOLID-STATE  
ELECTRONIC  
MULTIMETER**

- 68 Switch Selectable Functions:
  - 13 AC and DC Voltage Ranges (as low as 1 MV, full scale)
  - 14 AC and DC Current Ranges (as low as 1  $\mu$ A, full scale)
  - 6 low power (IC compatible) Resistance Ranges
  - 6 completely self-contained Capacitance Ranges
- Plus 12 Output Ranges
- Circuit Breaker Overload Protection
- High FET-Input Impedance
- $\pm 1\%$  Accuracy for AC and DC
- Negligible Voltage Drop
- Simple, Straight-Forward Operation
- Size: 8.07" High, 5.04" Wide, 3.94" Deep. Only 3.3 lbs.

**2795 MULTIMETER** supplied complete with batteries, test leads and operator's manual. Complete accessories available.

**\$250.00**

WRITE FOR BULLETIN L-1010 . . . OR CONTACT YOUR SIMPSON INSTRUMENTATION PRODUCTS DISTRIBUTOR FOR OFF-THE-SHELF DELIVERY

**Simpson**  
INSTRUMENTS THAT STAY ACCURATE

**SIMPSON ELECTRIC COMPANY**

5200 W. Kinzie Street, Chicago, Illinois 60644

Phone (312) 379-1121

EXPORT DEPT.: 400 W. Madison St., Chicago, Ill 60606. Cable Simelco

IN CANADA: Bach-Simpson Ltd., London, Ontario

IN INDIA: Ruttonsha-Simpson Private Ltd., International House, Bombay-Agra Road, Vikhroli, Bombay



## Probing the news

itself broke new ground earlier this year, approving an RCA satellite terminal transaction with Red China (*Electronics*, Feb. 28, p. 44) and Ferranti's unprecedented contract with Poland to share integrated-circuit knowhow. Ranking U. S. officials point out that while State and Commerce are supposedly the dominant U. S. forces in Cocom, DOD exercises an effective veto on requests, occasionally taking vetoes disputed by Commerce as unnecessary to the White House for support, which it gets.

With Cocom's diminished role each Western country would be relatively free to decide what expertise and high-technology products to sell to Communist countries. Last year, the committee ruled on \$100 million worth of requests for exceptions to the embargo list—80% of them in electronics.

**Confidential.** The American clout in Cocom, and the reasons for Western European bitterness about it, surface in previously unpublished data taken from a confidential document prepared annually that summarizes Cocom activity. This report shows that, although each Cocom member country has veto power over every application for an exception to the embargo list, the U. S. has consistently been the biggest objector. Between 1959 and 1969, when Cocom rejected 164 applications, the United States was the only member objecting in 140 of the cases. Last year, the U. S. vetoed 18 applications on its own. The next most-frequent objector was Britain with three vetoes.

Four out of five of the requests that go before Cocom each week involve electronics equipment, and half of those are for the sale of computers or related gear, the Cocom document shows. The main computer applicants in 1971 were from companies in Germany, Britain and the United States, in that order. The major buyers in the Eastern Bloc countries are Czechoslovakia, Hungary, the Soviet Union, and Poland.

Last year Cocom processed about 700 applications, 15% more than in 1970. Britain was the most active applicant with requests totaling \$30

million, Germany was second with \$20 million, and Italy third with \$14 million, the summary reveals. Twenty-four cases were rejected, twice as many as in 1970.

Among those that got through were Honeywell-Bull's big \$6 million computer sale to Leningrad's Gosbank and a \$1.2 million data-switch system sale to Aeroflot by an ITT subsidiary, La Compagnie Générale Des Constructions Téléphonique. Last year, 16 applications from European and Japanese firms were withdrawn because the United States insisted on more technical detail. In addition several from other countries were withdrawn when orders were lost because of U. S. delays in reaching a decision.

**Resentment.** Europeans have grown increasingly bitter over the tough U. S. attitude in Cocom, as East European countries and the Soviet Union have started shopping around for large quantities of Western technology. U. S. firms are less hindered by Cocom than by the U. S. Commerce Department's commodity-control list, which is even stricter than Cocom's. A U. S. firm must clear both hurdles, but Cocom is easy, once the Commerce Department gives the go-ahead.

The European bitterness surfaces fast in any talk about Cocom. "Not only is it useless; it is harmful," complains one French government economist. "Cocom has become an instrument for surveillance of international competition."

Each application for an exception must contain voluminous technical detail, the value of the potential contract, the name of the selling company, and the name of the buyer—an industrial spy's dream.

Cocom insiders say there have been reprisals against firms that have bypassed the committee and violated the embargo list. The most common form has been long, unexplained delays by U.S. Customs in the handling of subsequent shipments to the United States by the offending firms.

But with the much shorter Cocom embargo list and the opportunity to sell high-technology electronics to Eastern Bloc nations, past frustrations should be forgotten as new markets open and sales volume grows. □



## ANNOUNCING THE FIRST PAGE READER ON A CHIP

or two

You can read a standard 8½" wide page at 16 mil resolution with only a single RL-512 self-scanned array. With only two of the 512 element devices aligned you can improve resolution to 8 mil on paper and still read at up to 10 MHz scan rates.

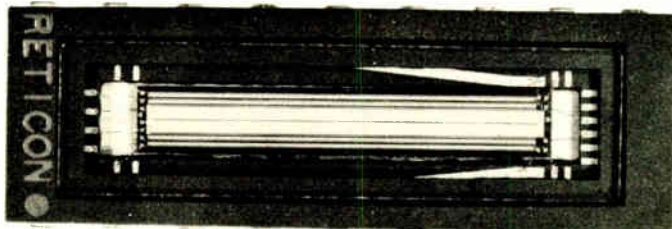

The Reticon RL-512 array offers 512 photodiodes on 1 mil centers self-scanned by on chip shift registers and multiplex switches. The device offers high sensitivity, charge storage mode operation, scan rates from 10 KHz to 10 MHz and operation on 15V supply. Optical quality quartz window seals the 18 pin standard ceramic DIP.

Other applications include OCR, facsimile, surveillance, industrial control, size and edge monitoring, laser detection and many others.

This and other devices of 16, 64, 128, 256 elements are available from inventory.

### RETICON™

365 MIDDLEFIELD ROAD  
MOUNTAIN VIEW, CA 94040  
(415) 964-6800

*up,  
down,  
around,  
back & forth*

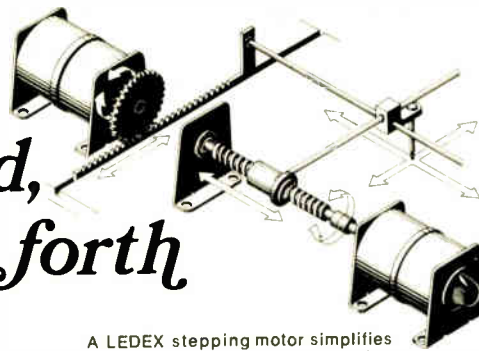

A LEDEX stepping motor simplifies bidirectional positioning

The next time you have a load to move in precise increments . . . consider a Ledex stepping motor

A Ledex stepping motor gives you a simple and economical way to drive a load in precise rotary increments. Its  $\pm 1^\circ$  indexing accuracy assures you of repeatability.

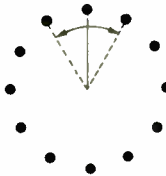

With a bidirectional model, a pulse to one coil gives cw step, to the other, ccw. Standard shelf models move in increments of 10, 15, 20, 30, or 36 degrees.

When your load is rotary, couple directly to the shaft. If it's linear, you can use combinations of lead screws, gear trains, drive belts, or pulleys. Step up or step down, to whatever incremental motion you need.

To drive, all you need is a simple square wave pulse. No expensive logic circuitry. New Ledex Series 50/12S model goes even one better. It has built-in pulsing circuitry, so it self-steps as you apply voltage.

And if it's torque you're after, our 36-position ( $10^\circ$ ) model, for example, gives you up to 246 ounce-inches. Of course, you can always step this up, or down.

The next time you have a load to move . . . up, down, around, back and forth . . . talk to our positioning technology people.



*the total technology people*

**LEDEX INC.**  
123 Webster Street  
Dayton, Ohio 45401  
(513) 224-9891

POSITIONING · SWITCHING · MICROELECTRONICS



Over 400 ways to turn . . . push . . . pull . . . index . . . step . . . and switch, plus new microelectronic interface circuits. All from the shelf.

Ask for Catalog A-9500

*new things  
keep  
happening  
at Ledex*

**. . . push solenoids**

Push action quick, with three new Ledex shelf model solenoids.

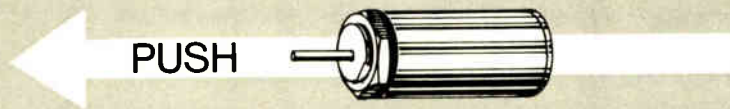

	1/2" dia x 1"	3/4" dia x 1 1/2"	1" dia x 2"
force, .050" stroke	15 ounces	3 pounds	7 pounds
force, .750" stroke		0.6 pounds	2 pounds
weight	24 grams	3 ounces	6 ounces

**Standard features:**

- 1—Electroless nickel plated plungers, for smooth performance
- 2—Built-in impact cushions, for pole face protection
- 3—Flatted bushings, for positive alignment and ease of assembly



Semiconductors

# Military studies CCD potential

Navelex contracts to develop charge-coupled devices for all three armed services emphasize fabrication methods for imaging devices

by Ray Connolly, Washington bureau manager, and Alfred Rosenblatt, New York bureau manager

**Research efforts** in charge-coupled devices have been focused mainly on their application to commercial products, such as television cameras. But interest is mounting now in several applications of this technology for military customers.

The award last month of three contracts totaling \$780,000 by the Naval Electronics Systems Command (Navelex) for development of charge-coupled devices for imaging, rather than the two contracts for \$600,000 that it had planned in the spring [*Electronics*, April 10, p. 39], indicates the military's growing interest in CCDs.

The winners of the six-month-long phase-one contracts, who are to look at basic processes for fabricating CCD devices, are RCA's David Sarnoff Research Center, Princeton, N.J., which received a \$200,000 contract, and Texas Instruments, Dallas, and Fairchild Camera & Instruments' Space and Defense Systems division, Syosset, N. Y., which divide the remaining \$580,000.

But applications are also being pursued by all three branches of the military, with Navelex named by the Department of Defense to lead the military CCD effort. Navelex officials say they are considering CCDs for infrared imaging and such uses as radar signal processors and computer memories.

In addition to signal processing and computer applications, the U. S. Army Electronics Command, Fort Monmouth, N.J. considers CCDs potential devices for analog data stores, tunable band-pass filters, time-compression multiplexers, and delay equalizers. The Air Force Aeronautical Systems division, Wright-Patterson AFB, Ohio, is look-

ing into shift-register applications for a radar processor, and "a small-scale effort" is underway there to investigate CCDs for mass memories. At Rome Air Development Center, Rome, N. Y., a "paper study" is looking into the impact of CCDs on filtering and analog storage.

The Naval Research Laboratory, Washington, D. C., has an in-house effort going on, as well as a small contract program being carried out at Fairchild's Syosset facility. In addition, NRL plans to solicit quotes in about a month for another study. David F. Barbe, technical director for the Navelex CCD program, says that this new program will examine "signal processing" by CCD technology, particularly to "determine where CCDs are going to be most beneficial."

NRL's own efforts include a study "to determine the effects of radiation on silicon CCDs," Barbe says, and another on the feasibility of charge coupling in narrow-band-gap semiconductors for infrared applications. While NRL's first efforts will be to extend CCD technology to large-area arrays, the NRL program is also comparing buried-channel and surface-channel approaches with regard to over-all CCD performance, he says. The laboratory is also midway through a 10-month, \$85,000 contract with Fairchild to design and build a "small unique floating-gate amplifier" based on CCD technology. And Fairchild also has a \$50,000 contract from the Army Electronics Command Electronic Devices and Technology Laboratory for a battlefield page reader [*Electronics*, May 22, p. 25].

Under the Navelex contracts RCA and TI will be pursuing surface-

transfer designs, with RCA incorporating a bias charge. Fairchild is tackling a buried-channel approach. The first phase is also expected to produce two types of devices—a 100-by-100-element array, and a 500-by-1-element linear array, together with their test data for evaluation by the services. However, by next June, Fairchild, using the buried-channel approach, is to deliver to the Army's Electronics Command two linear imaging sensors, together with optics. One will contain a 1,600-element CCD chip, and the other is to have two 1,000-element chips butted together.

The fact that these chips are larger than those being fabricated under the Navelex award may be indicative of the fast pace at which CCDs are being pursued by industry. The original requirements were prepared by Navelex about a year ago, when the goal of a 500-element linear array appeared to be difficult to achieve.

Navelex was named to coordinate all military CCD work, and to eliminate redundant and wasteful R&D efforts within the services and the not-invented-here factor, says George Heilmeyer of the Directorate of Defense Research and Engineering. Accordingly, Navelex is setting up an evaluation team with representatives from the Army's Night Vision Laboratory, Ft. Belvoir, Va., and the Air Force's Avionics Laboratory at Wright-Patterson, says Nathan Butler, Navelex project manager for electronic devices. For the Navy, Navelex is relying on Barbe's group, which performed some early CCD work in-house and under contract to RCA in Princeton.

The Navelex program is envi-



**...one component liquid potting materials from Hysol cast large or small parts quickly and economically.**

The new generation of Hysol epoxy casting systems reduces waste and provides proprietary flame retardancy without sacrificing physical or electrical properties. Meets requirements of UL Standard 492.

- Thermo Shock Resistant • Full Rigid.
- Pre-Catalyzed • No Mixing Errors.
- Uniform • Less Equipment needed.
- Machinable • Long Shelf Life.
- With or Without Filler.

For one component casting compounds with all the best features, call Hysol.



**HYSOL DIVISION • THE DEXTER CORPORATION**  
OLEAN, NEW YORK / LOS ANGELES and PITTSBURG, CALIFORNIA  
TORONTO / LONDON / MUNICH / TOKYO / MEXICO CITY

sioned as a 30-month, three-phase effort. Phase two is expected to produce one or two 12-month contracts to develop a 500-by-500-element chip, followed by a phase three, a 12-month effort to develop camera systems and perhaps other hardware.

The key to the successful development of the imaging arrays, which offer solid-state reliability and low-voltage operation, is their manufacturability, points out Brown Williams, manager of RCA's Electro-Optics Laboratory at the Sarnoff Laboratories. Given the high level of technical ability of the companies in the field, "any design will probably work," Williams says. "But the question is, can reliable devices be turned out with high yields?"

Severe requirements are placed on photolithographic capabilities because of the large silicon chips required for the arrays, he explains. "Conventional LSI technology today produces about a 200-mil-square chip," he says. "Even the first CCD devices will require a chip in the 300-mil-square range, and a 500-by-500-element array means a chip bigger than a half-inch on a side."

Another necessity, Williams points out, is maintaining uniform surface-state densities at less than  $10^{10}$  per square centimeter over the entire chip. This ensures that the high resolution of the image is maintained as it is shifted out of the CCD device.

Clare Thornton of the Army's Electronics Command, emphasizes the ability of CCDs to store information in both analog and digital form. Because of this, he thinks, it should be possible to store and process analog data while controlling information flow digitally. Thus, future applications may also include a new form of a-d converter or random-access memories containing trains of serial registers.

It is this potential versatility that has fostered research programs, begun originally at Bell Laboratories, Murray Hill, N.J., by at least a dozen companies, including Westinghouse and General Electric, unsuccessful bidders for the Navelex contracts. □

# Everything you need to know about power supplies is right here in this little box.



## Only \$94.00 complete

**The equivalent of 25 cubic feet of catalogs sits right on your desk in this little 4" x 6" box.**

The most complete Power Supply Catalog File available anywhere... 6667 current catalog pages have been collected and organized on microfiche cards — 98 pages per card. Every major source of power is listed, indexed and easy to find.

*This little box costs only \$94.00 and can save you hundreds of dollars in space, time and effort.*

**Never before available:** This is the first microfiche series from the Electronics Catalog Retrieval System. The microfiche cards fit any

standard reader and there is space in the box for up-dated information.

**Special introductory offer:** If you don't already have a standard microfiche reader, you can order the new Kodak Ektalite 120 *with your*

*purchase of the Power Supply Catalog File at the special low introductory price of \$85.00 (delivery included).*

The Ektalite 120 is a desktop reader weighing less than five pounds. It's compact, noiseless, easy-to-use. All you do is feed in the microfiche from left to right, and manipulate the control knob to locate the image you want.

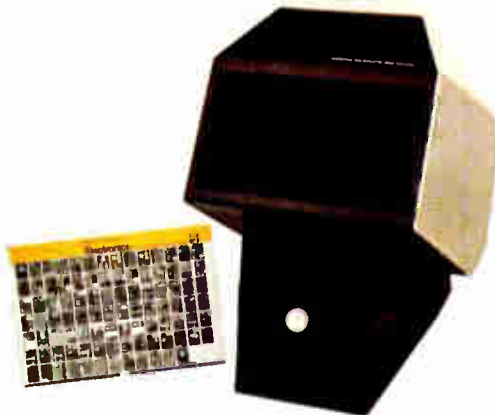

**McGraw-Hill** **Electronics**  
**Catalog Retrieval**  
**System**

1221 Ave. of the Americas/New York, N.Y. 10020

# The world didn't need another darned-good-and-expensive rack and panel connector.

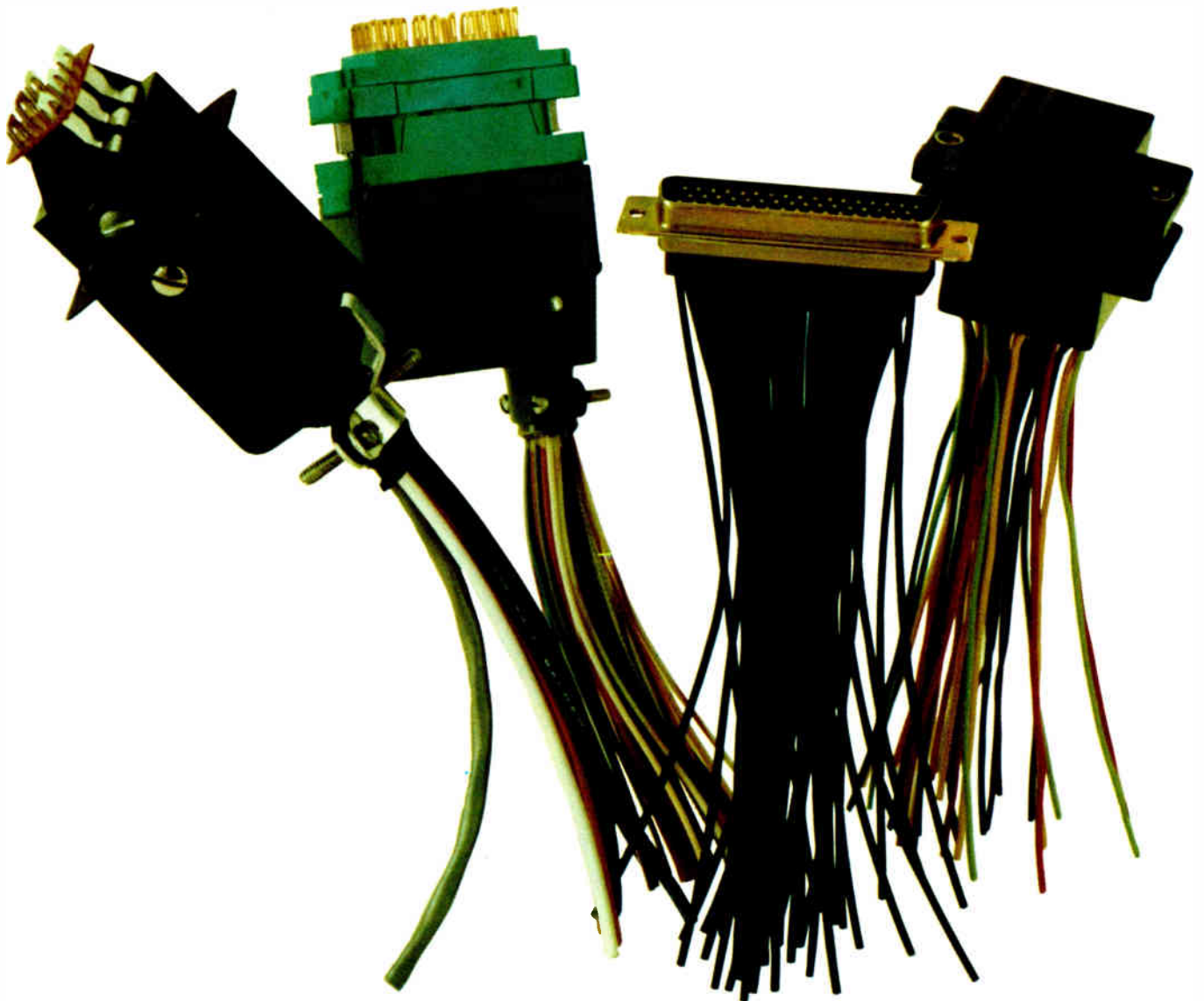

# So we came up with a darned good one that costs you about 25% less.

If you still live in a "let's-go-first-class-and-hang-the-expense" kind of world, you may not need us. But if you live in today's world, read on, rejoice and return the coupon below. For several good reasons:

## WE'VE GOT A DARNED GOOD NEW CONNECTOR

It's UL recognized. The glass-filled nylon insulator block is moisture resistant. Contacts are recessed, both in the male and female contact housings. It provides positive cable strain relief.

Our Tuning-Fork type contact has two important things going for it: low electrical resistance and little change in contact pressure over the specified contact life.



## WE'VE GOT PROOF

Excellent contact alignment was maintained through 500 insertion-withdrawal cycles and no "scooping" action took place. The forces show a gradual increase over 500 cycles caused by plating abrasion.

Take a look at these results computed from more than 100 hours on our Instron testing machine:

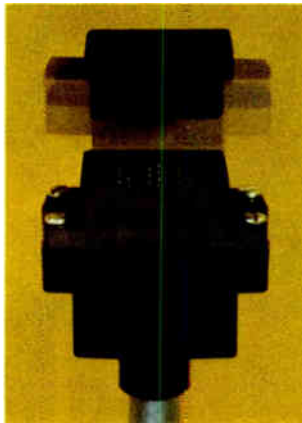

### CONTACT INSERTION AND WITHDRAWAL (Cadmium Plating)

Contact No.	First Cycle		100 Cycles		500 Cycles	
	Insertion (oz.)	Withdrawal (oz.)	Insertion (oz.)	Withdrawal (oz.)	Insertion (oz.)	Withdrawal (oz.)
1	6.9	5.3	8.1	6.4	9.2	6.5
2	7.2	4.5	7.8	6.0	8.9	6.6
3	7.1	5.1	8.0	5.4	9.2	6.0
4	6.5	4.7	7.8	5.4	8.6	5.3
5	7.4	5.4	7.9	5.9	8.9	6.5
Averages	7.0	5.0	7.9	5.8	9.0	6.2

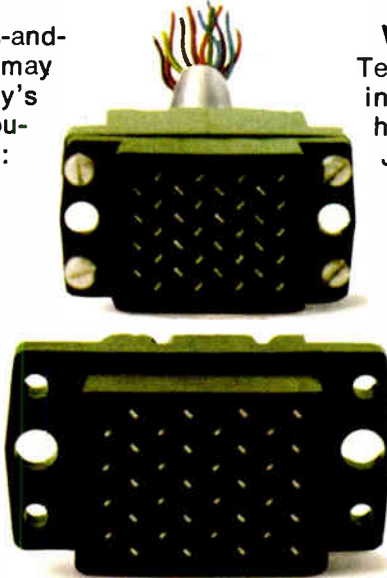

## WE'VE GOT WHAT IT TAKES

Technical experience. True, we're new in multi-pin connectors. But we're old hat at making other types. We make JCM miniature coaxial connectors, for example — which are a lot more demanding and sophisticated from both an engineering and production point of view.

## WE'RE AS GOOD BUT LESS EXPENSIVE

Of course, we want you to check it all out for yourself. So ask us about a free sample along with all its specifications.

### Specs such as:

Voltage Rating (adjacent contacts) . . . . .250 VRMS  
Flashover Voltage . . . . .1000 VDC  
Current Rating (con't max/ckt) . . . . .3 amp  
Contact Resistance (typical) . . . . .0.003 ohms  
Insulation Resistance . . . . .5000 megohms  
Insertion Force\* . . . . .6 oz. min./12 oz. max.  
Withdrawal Force\* . . . . .5 oz. min./10 oz. max.  
Cycle Life . . . . .500 min.

\*Per contact



**E. F. JOHNSON COMPANY**  
WASECA, MINNESOTA 56093

- Please send literature, price and test data.  
 Yes, I'm interested in evaluating a test sample.  
Call me at: \_\_\_\_\_

Name \_\_\_\_\_ Phone \_\_\_\_\_  
Title \_\_\_\_\_  
Firm \_\_\_\_\_  
Address \_\_\_\_\_  
City \_\_\_\_\_ State \_\_\_\_\_ Zip \_\_\_\_\_

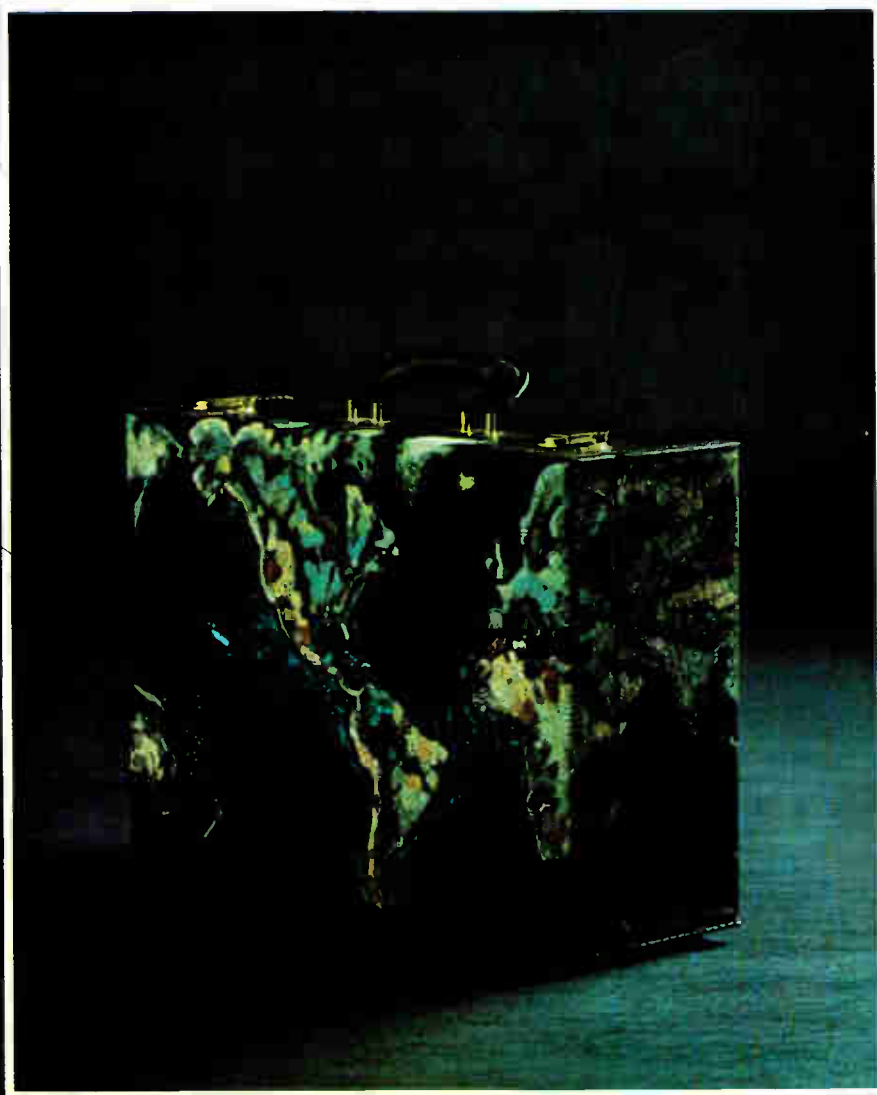

**We have  
over 1500 sales/service  
engineers at 86 offices  
in 20 countries  
all over the world.**

That's more people in more places than anyone else  
in the minicomputer business.

To find out how we've come to be wherever you are,  
write Digital Equipment Corporation, Maynard,  
Mass. 01754. (617) 897-5111. European headquarters:  
81, route de l'Aire, 1211 Geneva 26. Tel. 42 79 50.

If you're not buying from Digital, you're paying  
too much for too little.

**digital**

Circle 87 on reader service card

# New from Amphenol's Spectrum

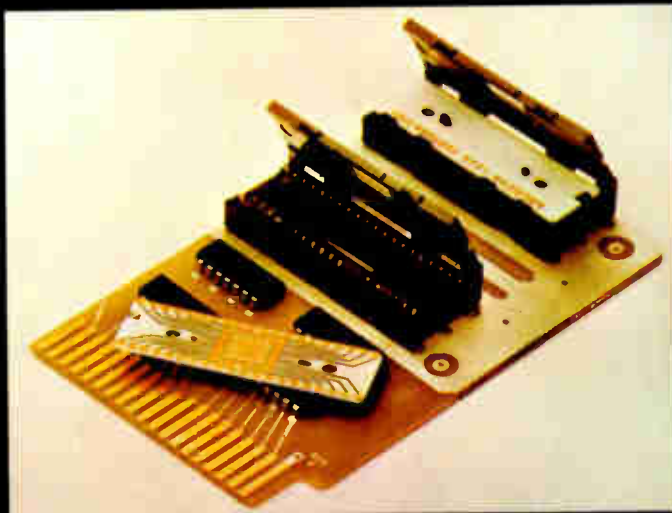

**level 1** MOS/LSI Planar Plug-In connectors (above) for leadless, flat mount ceramic substrates. Permits fast, easy replacement of IC package, no screws, has snap-down lid. ■ Free-standing terminal (below) terminates IC's to PC boards for lowest total systems cost.

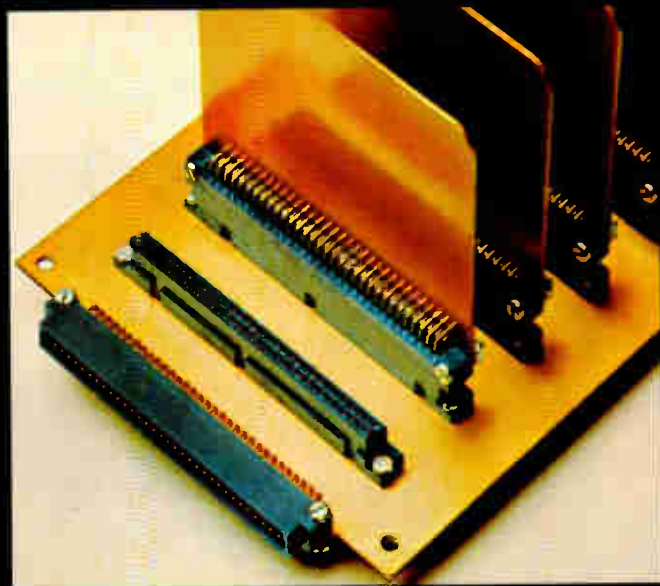

**level 2** Box contact connectors (above) intermate with .025" square or round contacts. Low insertion force. Terminations for crimp, wire wrapping or wave solder. ■ Zero insertion force connectors (below) improve PC board and connector life by eliminating strain and wear.

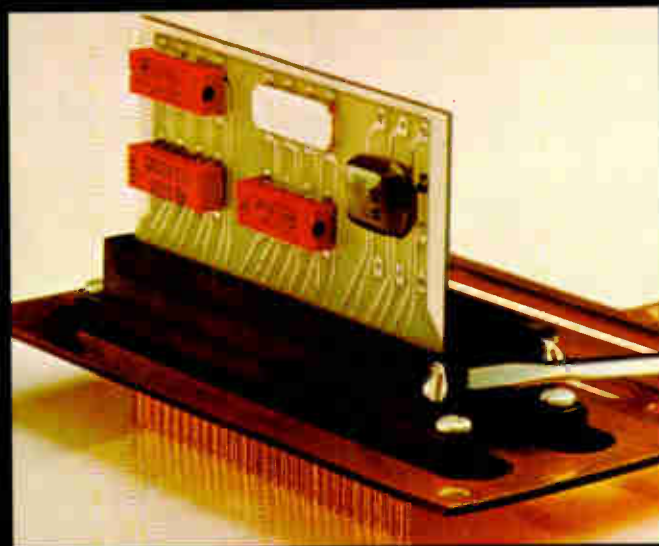
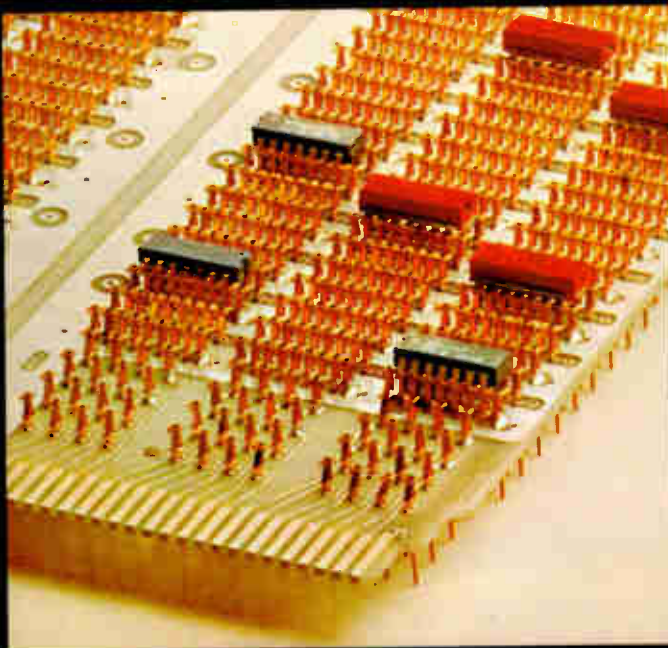

Above are seven new ideas from Amphenol Industrial Division's Spectrum of interconnection capability.

Amphenol's SPECTRUM offers you *all four* levels of interconnections from our unmatched breadth of product line:

**Level 1 . . . DEVICE TO BOARD OR CHASSIS.** We offer interconnections for components such as tubes, relays, transistors, IC packages, trimmers, resistors or capacitors to a PC board or chassis.

**Level 2 . . . BOARD TO MOTHERBOARD OR BACK PLANE.** We offer interconnections for PC boards or

other sub-circuit modules to a motherboard or to a back plane.

**Level 3 . . . MOTHERBOARD OR BACK PLANE WIRING.** We offer interconnections for levels to each other and to other sub-circuits with multi-layer circuit boards, wire wrapping, clip terminations, jumper techniques and dip-soldering.

**Level 4 . . . INPUT/OUTPUT CONNECTIONS.** We offer interconnections for power and signals to and from a system. This interface may be between sub-assemblies within the same enclosure or between individual units.



# of interconnections.

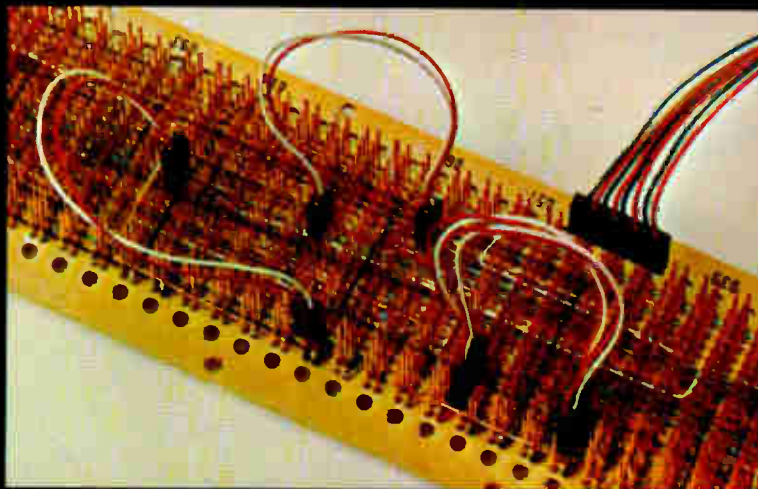

level **3**

Low cost strip connectors (above) are used as jumpers in back plane wiring. Intermates with .025" square or round posts. ■ Circuit Concentration Bay (below) consists of wire wrappable panels that are five times as compact as the telephone distribution frames they replace.

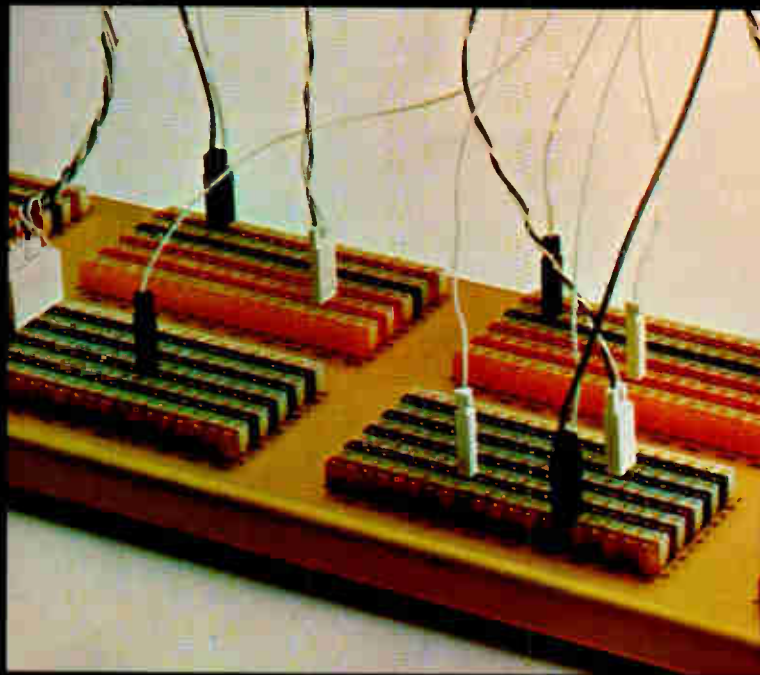

level **4**

Modular Integral Connector concept lets you make your own pin & socket connector to fit your needs. Five contact sizes, thousands of combinations. Sufficient components for six connectors in handy MIC-KIT. Design and assemble your own prototypes.

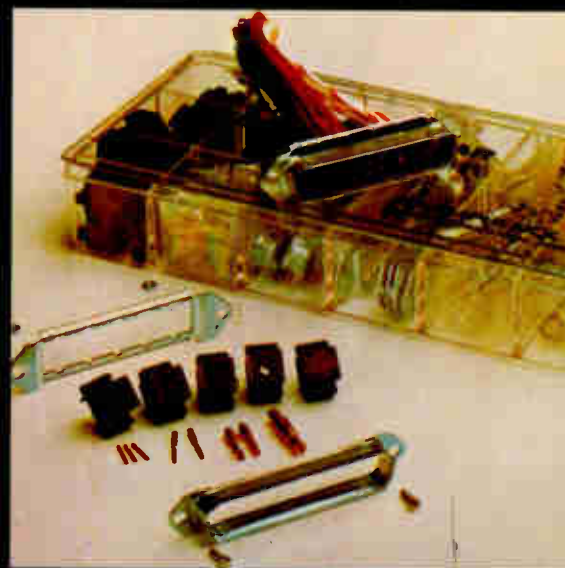

From the simple tube socket—to a myriad of electrical/electronic connectors—to complete and complex termination systems . . . SPECTRUM.

But SPECTRUM is far more than products. It is a depth of capability in engineering, manufacturing and quality control. Amphenol's SPECTRUM is a new height of service, availability and distribution backed by seven Amphenol interconnection-oriented divisions.

Amphenol can fulfill your total interconnection requirements because we are not limited to specifics such as one or two product lines, one or two levels.

Therefore we approach your interconnection needs with complete open-mindedness.

For more new ideas and specific information, write for your copy of "SPECTRUM." Amphenol Industrial Division, Bunker Ramo Corp., 1830 South 54th Ave., Chicago, Illinois 60650.

**BUNKER RAMO** **AMPHENOL**

Circle 89 on reader service card

**Quality  
resistor networks  
now available  
off-the-shelf.**

**Pull ups or  
terminators,  
in popular  
values.**



**If you're really  
serious about cost,  
be serious about quality.**

Now our most popular thick-film resistor networks are ready and waiting, in quantity, at your A-B electronics distributor. Pull-up networks and terminator networks with tolerances of  $\pm 2\%$  in popular values from 68 ohms to 22K ohms. All in compatible 14 lead .300 series DIP's. Or if

you need something special we'll quickly custom design any circuit that'll fit into a 14 or 16 lead DIP. And we mean quickly. Overall specs include: absolute tolerances to  $\pm .5\%$ . Tracking  $\pm 50$  ppm/ $^{\circ}\text{C}$  (and lower). TCR to  $\pm 100$  ppm/ $^{\circ}\text{C}$ . Write for free technical publications 5850 and

5851. Allen-Bradley Electronics Division, 1201 South Second Street, Milwaukee, Wisconsin 53204. Export: Bloomfield, New Jersey 07003. Canada: Allen-Bradley Canada Limited, Galt, Ontario. United Kingdom: Morganite Resistors Limited, Jarrow, Durham.



Actual Size



**Allen-Bradley**  
Milwaukee, Wisconsin 53204

# Metal-oxide varistor: a new way to suppress transients

Able to withstand peak currents of hundreds of amperes, the small disk-shaped metal-oxide type of varistor dissipates negligible standby power while guarding against power-line surges and turn-on transients

by J.D. Harnden Jr.\* and F.D. Martzloff,\* *Corporate Research and Development,*  
and W.G. Morris\* and F.G. Golden,\*\* *Semiconductor Products Department, General Electric Co.*

□ Although it belongs to the established family of reliable varistor protection devices, the recently introduced metal-oxide type of varistor is adding a new dimension to the technology of protecting circuits and components. Trademarked as the GE-MOV and MOV varistor by General Electric Co., the metal-oxide-type varistor offers the advantages of nanosecond switching speeds and small size, while being able to handle current surges on the order of hundreds of amperes.

Like other varistor transient suppressors, the new varistor has a nonlinear voltage-current characteristic that makes it useful in voltage-regulation applications. And because its nonlinear V-I curve is very steep—steeper than that of most other varistors—it can pass widely varying currents over a narrow voltage range. In some applications, using the device allows a circuit to be redesigned with fewer components.

At low applied voltages, the metal-oxide-type varistor looks like an open circuit because its unique two-phase material assumes the properties of an insulator. When applied voltage exceeds rated clamping voltage, the device effectively becomes a short circuit, protecting the component that it shunts.

The unit, moreover, requires very little standby power, making it useful for guarding semiconductors. Steady-state power dissipation is typically a fraction of a milliwatt, as compared to the hundreds of watts dissipated by some other varistor devices.

At present, clamping voltage ratings for MOV-brand series VP varistors range from 140 to 1,400 volts peak, watt-second ratings from 10 to 160 joules, and continuous power ratings range from 0.5 watt to 1.3 w. Units are priced from less than \$1 to \$14 in 1,000-unit lots.

### An inside look

The metal-oxide-type varistor (Fig. 1) has an encapsulated polycrystalline ceramic body, with metal contacts and wire leads. Zinc oxide and bismuth oxide, the essential ingredients, are mixed with proprietary powdered additives, and then pressed into disks and sintered at a temperature greater than 1,200°C.

Because the bismuth oxide is molten above 825°C, it assists in the formation of a dense polycrystalline ceramic through liquid-phase sintering. During cooling,

the liquid phase forms a rigid amorphous coating around each zinc oxide grain, yielding a microstructure of zinc oxide grains that are isolated from each other by a thin continuous intergranular phase. It is this complex two-phase microstructure that is responsible for the nonlinear characteristic.

The voltage across a metal-oxide-type varistor and the current through it are related by the power law,  $I = kV^n$ , where  $k$  is a constant. Exponent  $n$ , which is

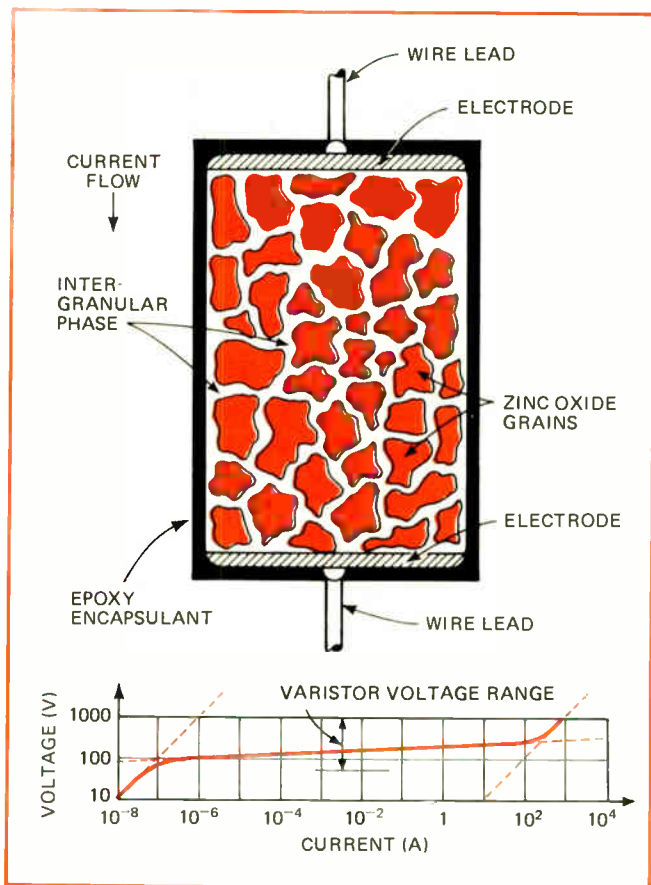

**1. Properties.** Two-phase material in body of metal-oxide-type varistor acts as insulator for low applied voltages and as conductor for transients that exceed device's clamping voltage. Bistable intergranular phase containing bismuth oxide surrounds each conductive zinc oxide grain. Idealized V-I curve illustrates unit's nonlinear behavior in varistor voltage range.

\* Schenectady, N.Y.  
\*\* Auburn, N.Y.

also referred to as alpha ( $\alpha$ ), typically has a value between 25 and 50 or more, leading to the idealized V-I curve of Fig. 1. Over a wide current range, the voltage remains within a narrow band that is commonly called the varistor voltage.

Many properties of the varistor can be directly related to the microstructure and the properties of the two phases. As shown in Fig. 1, the unit's idealized V-I curve consists of two linear segments for extremely low and extremely high currents, and a nonlinear segment in the varistor voltage range.

At low applied voltages, the device's linear characteristic can be attributed primarily to leakage current through the intergranular phase. Device behavior is roughly that of an insulator, indicating that low applied voltages cause a high electric field across the intergranular phase and a low field within the zinc oxide grains.

In the varistor voltage range, the intergranular phase becomes nonlinear, and current through it increases rapidly as the voltage is raised slowly. The conduction mechanism that affects the nonlinear characteristic is now under investigation and is thought to be space-charge-limiting or tunneling phenomena. For extremely high currents, the resistance of the intergranular layer becomes less than that of the zinc oxide grains, causing the V-I curve to tend towards linearity again.

### Comparing transient suppressors

A comparison of the volt-ampere characteristic of the metal-oxide-type varistor to that of other voltage suppressors yields the graph shown in Fig. 2. A number of varistor devices are represented, including silicon, selenium, silicon-carbide, and metal-oxide types. A point-of-reference curve for a linear ohmic resistor is also

**2. Suppressor comparison.** V-I curves of various varistor transient suppressors and linear ohmic resistor show that characteristic for metal-oxide-type varistor is nearly horizontal because of its high alpha ( $\alpha$ ) value. (All varistors obey power law,  $I = kV^\alpha$ .) Table compares some key specifications for several popular surge protectors. Shortly, clamping-voltage range will be broader for 9MOV varistors.

shown. The higher a device's alpha is, the better is its voltage suppression capability.

The parameters of some of the most widely used transient voltage suppressors are summarized in the table of Fig. 2. (The commercial voltage ratings reflect peak values; they must be divided by 1.41 to obtain root-mean-square values.) It should be noted that selenium suppressors are normally supplied as a single package of several series-connected plates, so that the selenium voltage rating is not that of a single plate. The other varistor data, however, reflects single-unit ratings.

Metal-oxide-type varistors can also be connected in series to increase clamping-voltage rating. Moreover, they can serve in a structural mode as well as an electrical one, for instance, by replacing the spacer between switch contacts to allow approaching arcless switching commutation, especially in dc applications.

One of the most important considerations when choosing a protection device is its steady-state power dissipation. In the case of varistors, the higher the alpha or exponent, the lower will be the standby loss. For example, if a varistor is shunted across a load, protecting it at a 300-v level in the presence of a 2,000-v transient with a surge impedance of 10 ohms, a steady-state power dissipation is required of the varistor, since it is connected continuously to the 117-v rms line. For the silicon-carbide varistor, which has a typical alpha of 3,

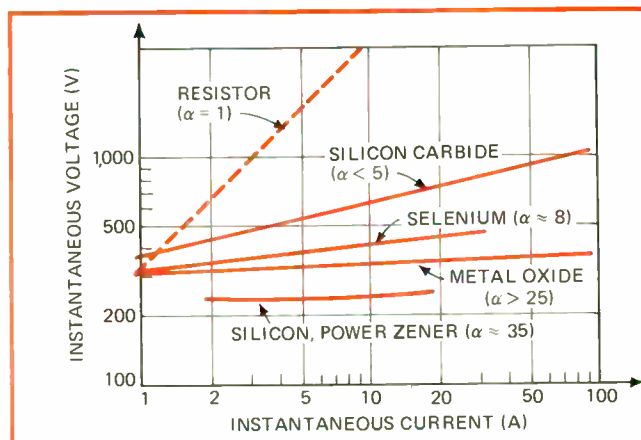

TYPICAL SURGE SUPPRESSOR PARAMETERS

TRANSIENT SUPPRESSOR	PEAK IDLE CURRENT (mA)	MAX CURRENT 1 ms (A)	PEAK POWER 1 ms (kW)	PEAK ENERGY 1 ms (joules)	EFFECTIVE CLAMPING RATIO AT 10 A	WEIGHT (grams)	VOLUME (cm <sup>3</sup> )	COMMERCIAL PER-DEVICE VOLTAGE RANGE (V)
MOV-brand varistors (26.21 mm OD)	1	65	18	18	2.0	5	4.4	140 - 1,400
Selenium (25.4 mm sq)	12	30	9	9	2.3	35	20	35-700
Zener, 6-cell cluster (38 mm sq)	0.05	20	7.7	7.7	1.50	30	24.5	14-165
Zener, single (DO-13 case)	0.005	5.7	1.65	1.65	1.65	1.5	0.5	1.8-300
Spark gap (8 mm OD)	-	<100	50	50	2.55 (100 V/ $\mu$ s)	1.5	0.6	150 MIN

the necessary steady-state dissipation will be 660 w. On the other hand, a metal-oxide-type varistor with an exponent of 30 will dissipate only 0.1 milliwatt.

### Examining device behavior

Fig. 3a shows the simplified equivalent circuit for the metal-oxide-type varistor, as well as its schematic symbol; representative capacitance and resistance values are used. The low-current-level resistance,  $R_{off}$ , is due primarily to the resistivity of the intergranular phase. Capacitance  $C$  can be attributed to the very thin dielectric of the intergranular phase; it becomes a fairly significant factor for the varistor's dynamic characteristic. The high-current-level resistance,  $R_{on}$ , is due to the intrinsic resistivity of the zinc oxide grains; it represents

the unit's limiting resistance. The component values in the figure are for a typical MOV-brand series VP device.

As indicated in Fig. 3b, the device's V-I curve ordinarily exhibits a slightly negative voltage temperature coefficient, in the order of 0.05%/°C to 0.1%/°C for the series VP varistors. At very low current levels, this coefficient is substantially larger but does not affect the normal operating range. Maximum steady-state power dissipation for a disk with 3 square centimeters of total surface area is usually 1 w in a 70°C free-convection ambient environment.

Typical capacitance curves are depicted in Fig. 3c for units with differing diameters. Device capacitance influences high-frequency impedance properties, as shown by the plots of Fig. 3d for two production units—

**3. Electrical behavior.** Equivalent circuit (a) of metal-oxide-type varistor contains high-resistance element to model device's insulator state and low-resistance element for conductor state. Temperature rise from 25°C to 100°C produces only small negative voltage shift in V-I curve (b). Device capacitance (c), which is due to dielectric/conductor intergranular phase, depends on varistor size and voltage rating. Above frequencies of about 10 megahertz, varistor impedance (d) becomes nonlinear because device capacitance increases.

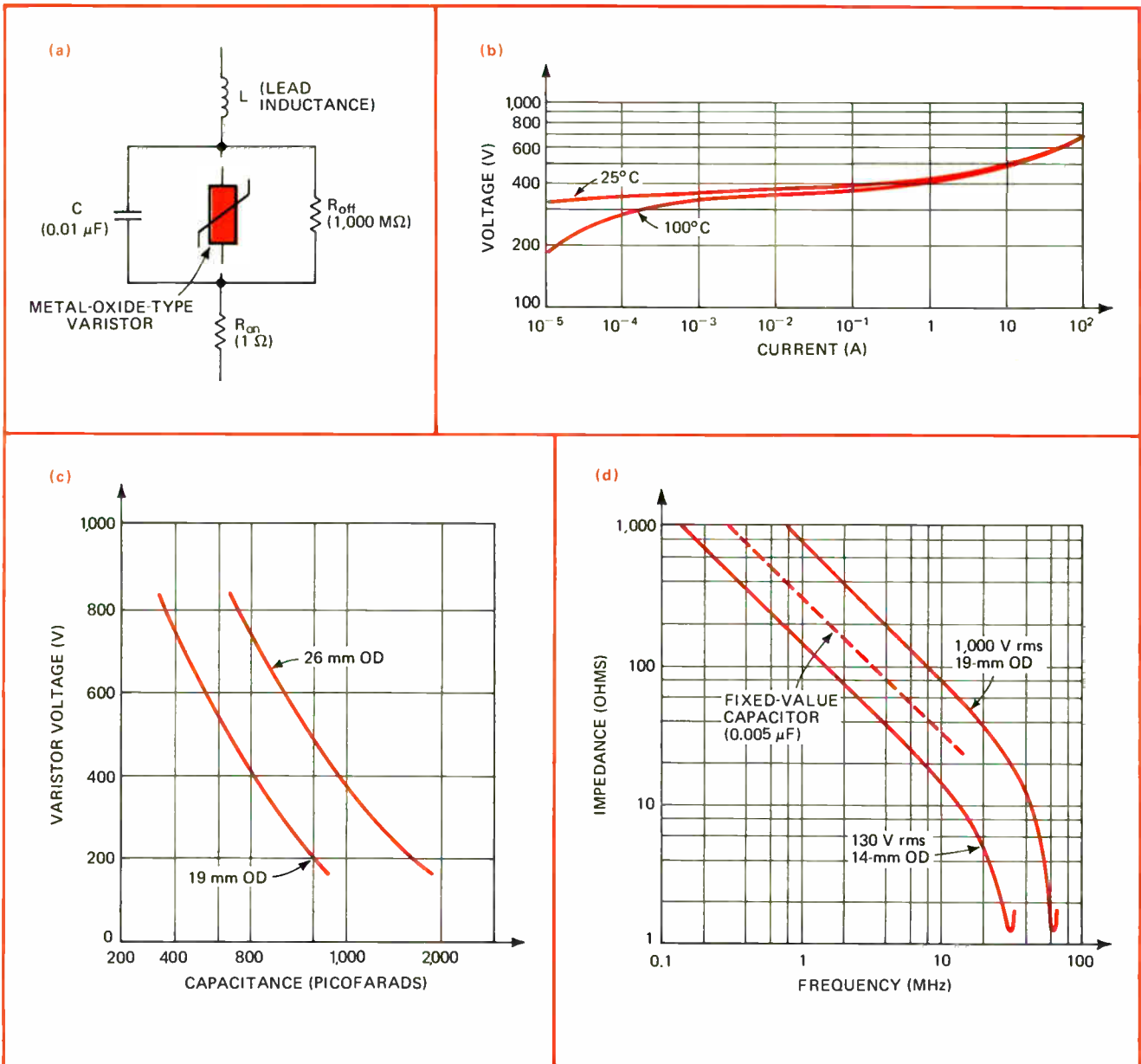

one with a 130-v rms rating, and the other with a 1,000-v rms rating. A point-of-reference curve for a fixed 0.005-microfarad capacitor is also included.

When a fast-rising surge is applied to a metal-oxide-type varistor, its capacitance immediately makes it appear as a low impedance. After the capacitance becomes fully charged, the unit simply operates at the point predicted by its V-I characteristic.

### Tracing the origin of transients

Transient surges originate from a variety of sources. Regardless of whether electrical circuits operate from ac or dc sources, they are often plagued by voltage transients that are either generated within the circuit itself or transmitted into the circuit from external sources.

One of the most common sources of transients in power distribution systems is the  $L(di/dt)$  voltage caused by transformer magnetizing currents as the transformers are switched within either a feeder utility system or an industrial plant's own distribution system. Residual lightning surges are another source of concern. These surges can be thought of as an overflow on the main lightning arrestors with which most consumer, commercial, and industrial distribution systems are protected at the interface between the utility and the user's distribution systems. Still other sources can be found in homes themselves, resulting from equipment that is connected to the utility system.

Even a small synchronous line clock in the home can be subjected to a number of surges within just a 24-hour period. In fact, with the introduction of more automatic switching functions and complex electrical equipment into the home, line surges are becoming more frequent. And oddly, the better and newer the wiring and installation, the less inherent protection is provided by spillover occurring in poorly wired outlets, switches, and fixtures, and the greater the resulting impressed voltage level on connected equipment.

### Using metal-oxide-type varistors

When a stepdown transformer is switched on, it can impress severe transients on any components connected to its secondary winding due to its interwinding capacitance. Installing a metal-oxide-type varistor, as shown in Fig. 4a, can eliminate this startup transient.

Another source of component failure, which is sometimes overlooked, can occur in the conventional transistor series-pass voltage regulator (Fig. 4b). When the circuit is turned on, the capacitor appears to be a short circuit, and the transistor is exposed to the full unregulated bus voltage. Placing a metal-oxide-type varistor across the transistor allows a soft current rise to pass through the regulator without the usual voltage surge.

Semiconductors can be protected with the new varistor, resulting in a design with fewer components, because the device can improve the electrical properties of the circuit in which it is installed. As an example, consider the output stage of small line-operated radio (Fig. 4c) that requires high-voltage transistors and an associated RC network to withstand the voltage spikes generated by distortion during overload.

The oscilloscope traces of transistor stress show the voltage transient that occurs with normal RC suppression

but is dramatically reduced with varistor suppression. Because of this significant transient reduction, the circuit can be redesigned with fewer parts. (The third scope trace displays varistor current.)

### Choosing the right varistor

Selecting the correct metal-oxide-type varistor is a simple, logical procedure. First, find the device with a peak operating voltage rating that is close to, yet higher than, the normal peak ac-line voltage. Next, determine or estimate the energy level of the transient to be suppressed. This energy level is usually determined by the energy term,  $LI^2/2$ , where  $I$  is the peak magnetizing current flowing in inductance  $L$ , which stores the transient energy in its field. In the case of transformers,  $I$  may be considered the peak existing current.

The expected transient current level must be found next. (Peak feeder transformer magnetizing current, reflected to the secondary, is often used to estimate the peak transient current.) Then, the varistor unit can be selected that has the proper ratings for recurrent voltage, clamping voltage, and energy level.

In the case of dc applications, varistor steady-state

## Turning the tables

Traditionally, Japan has taken U.S. technology and run with it—adapting and shaping it to enable that country to run up a remarkable record in the world marketplace, particularly in electronics. But the metal-oxide type of varistor described in this article is an unusual example of role-swapping. The zinc-oxide ceramic, mainly doped with bismuth oxide, which forms the basis of this varistor device, was developed by Matsushita Electric Industrial Co. and is being produced by General Electric Co. in the U.S. under a five-year license granted in 1971 by Matsushita.

Matsushita, which calls its ceramic devices zinc-oxide nonlinear resistors (ZNRs), is producing units only for installation in its own consumer electronic equipment. But since the company is one of Japan's largest electronics firms, it manufactures hundreds of thousands of these protectors every month.

Matsushita is also doing additional materials research, experimenting with such doping materials as lead oxide, strontium oxide, barium oxide, manganese oxide, uranium oxide, and some metallic fluorides. When certain metallic fluorides are used as dopants for the zinc oxide, the material no longer behaves as a simple nonlinear resistor, but exhibits negative resistance characteristics.

Several versions of the varistor device are being used. One version, intended for protecting transistors in audio power amplifiers and in color television receivers, has a clamping-voltage range of 100 to 1,000 volts. Another group provides ratings of 8 to 25 kilovolts for color TV high-voltage power supplies, while a third version can absorb current surges of 500 to 20,000 amperes at clamping voltages between 200 and 1,000 V. This last group was developed for railroad signal control applications and thyristor power-supply protection.

Although Matsushita would like to sell its devices in the American market, the company has no plans to do so at this time.

—Charles Cohen, Tokyo Bureau

power dissipation should be checked. Be sure to derate the device's energy rating if power dissipation demands will elevate the varistor case temperature above 85°C. For applications where repetitive transients may be encountered, calculate the expected watt-seconds per pulse and multiply this figure by the pulse repetition rate to determine the additional steady-state power dissipation required. And finally, make certain that the unit can comply with such ambient environmental factors as operating and storage temperatures.

### Looking ahead

The next major developments for MOV-brand varistors will revolve around package changes to enhance applications versatility and improve heat transfer. Future packages will be available in a variety of mounting schemes—for example, a bolt-down version with or one without heat-transfer capability that could be directly

fastened to chassis, brackets, bus bars, and heat exchangers. Low-inductance pill-shaped packages that are compatible with pressure-mounted thyristors are also being considered. Another possibility is a finned package for direct air convection and forced cooling.

Since metal-oxide-type varistors can be made rather thick, they should be available in the near future with kilovolt ratings. MOV-brand series VP units are currently being developed to cover the clamping voltage range of 30 v to 10 kv. □

### BIBLIOGRAPHY

- R.A. Delaney and H.D. Kaiser, *Journal of Electrochemical Society, Solid State Sciences*, Vol. 114, pp. 883-842, 1967.
- M. Matsuoka, T. Masyama, and Y. Iida, *Supplementary Journal of Japanese Society of Applied Physics*, Vol. 39, 94-101, 1970.
- M. Matsuoka, *Japanese Journal of Applied Physics*, Vol. 10, 736-746, 1971.
- W.G. Morris, "The Electrical Properties of ZnO-Bi<sub>2</sub>O<sub>3</sub> Ceramics," General Electric Co., Corporate Research and Development Report 72CRD069.
- F. B. Golden, R.W. Fox, "GE-MOV Varistor Voltage Transient Suppressors," General Electric Co., Semiconductor Products Dept., Application Note 200.60.
- F.B. Golden, "A New Voltage Transient Suppressor," *IEEE International Semiconductor Power Converter Conference Record*, Publication 72CHO 602-3-1A, pp. 2-6-1 to 2-6-9.

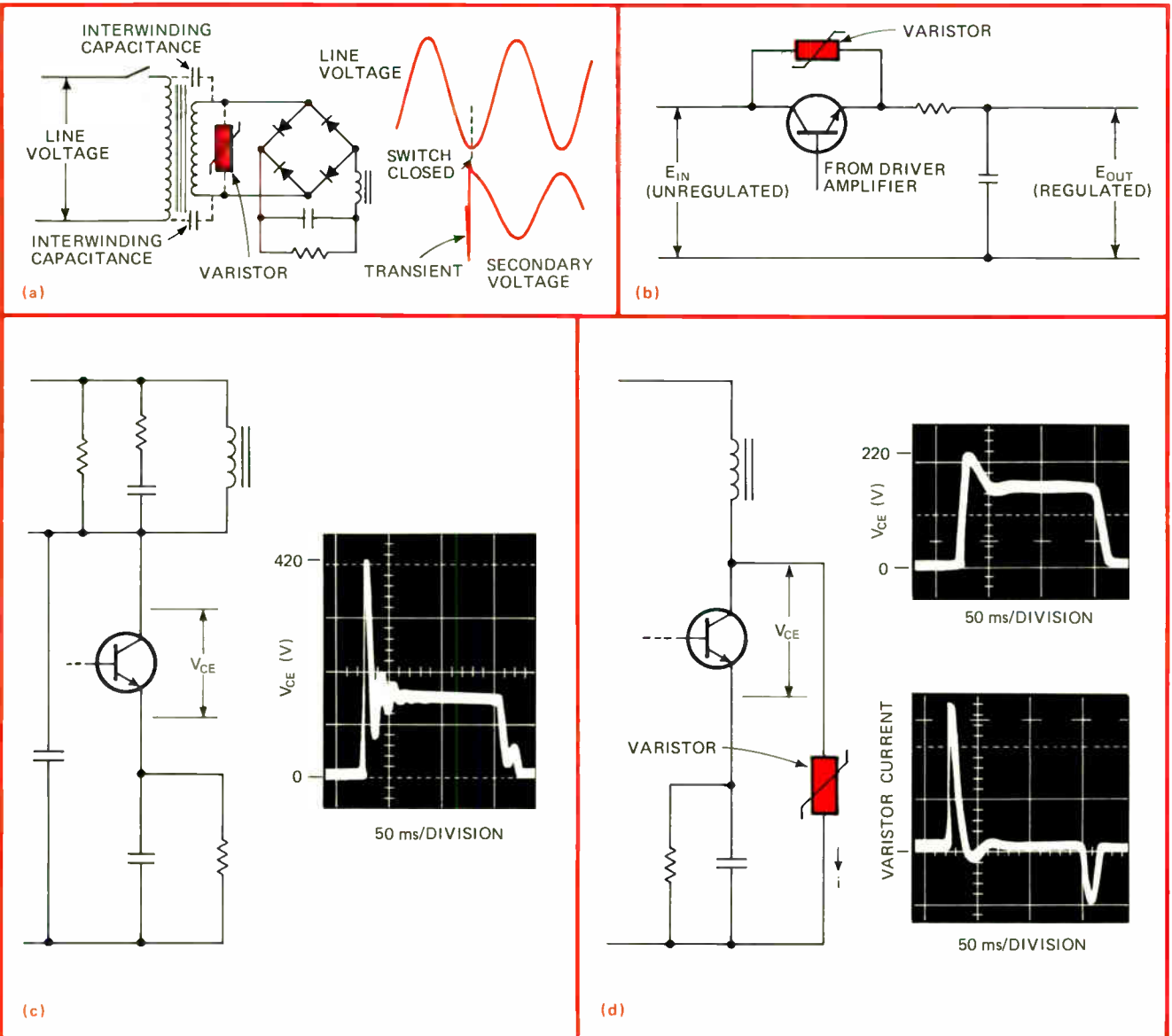

**4. Applications.** Switching transient on step-down transformer (a) can be prevented from damaging components by placing varistor across secondary winding. In (b), varistor protects transistor in series-pass regulator circuit from possible turn-on transient. Guarding transistor in radio output stage (c) with varistor permits circuit on left to be redesigned with fewer components, as shown on right. Scope traces depict voltage across unprotected transistor (left) and protected transistor (right), as well as varistor current (right).

# Take a bit of advice: use 16-bit converters carefully

Their wide dynamic range and extremely fine resolution allow design simplification, while improving performance and cutting costs. But take care in applying them, or their performance will be wasted.

by Wayne Marshall and Cyril Brown, *Analog Devices Inc., Norwood, Mass.*

□ A 16-bit analog-to-digital or digital-to-analog converter that actually works is something of a modern technological marvel (See Part I of this two-part article in the last issue of *Electronics*). True 16-bit devices are now available off-the-shelf, but at prices on the order of \$1,000. The extremely fine resolution, monotonicity, high accuracy, linearity, and broad dynamic range that characterize these converters make them ideal for a wide variety of applications—from nuclear research to precision function generation.

However, the unsophisticated user may waste the advantages of the converter's tight performance specifications unless he exercises extreme care in circuit design. Potential perils that must be considered include thermocouple effects, voltage drops in short lengths of wire, low-level noise, radio-frequency interference, and even

millivolt common-mode signals. In short, factors of only secondary concern in the design and use of a 12-bit converter can have an overwhelmingly adverse impact on the operation of a 16-bit unit.

To understand how and where these precision converters can be most effectively applied, it is helpful to begin by studying their key characteristics, then examining applications that these characteristics suggest, and finally discussing methods to ensure that the devices will operate properly in a real-world environment.

## Would you believe 65,536:1?

The most outstanding characteristic of a 16-bit converter is its extremely wide dynamic range—that is, the ratio of full-scale value to the value of the least-significant bit (LSB) it can handle. For a 16-bit converter, the

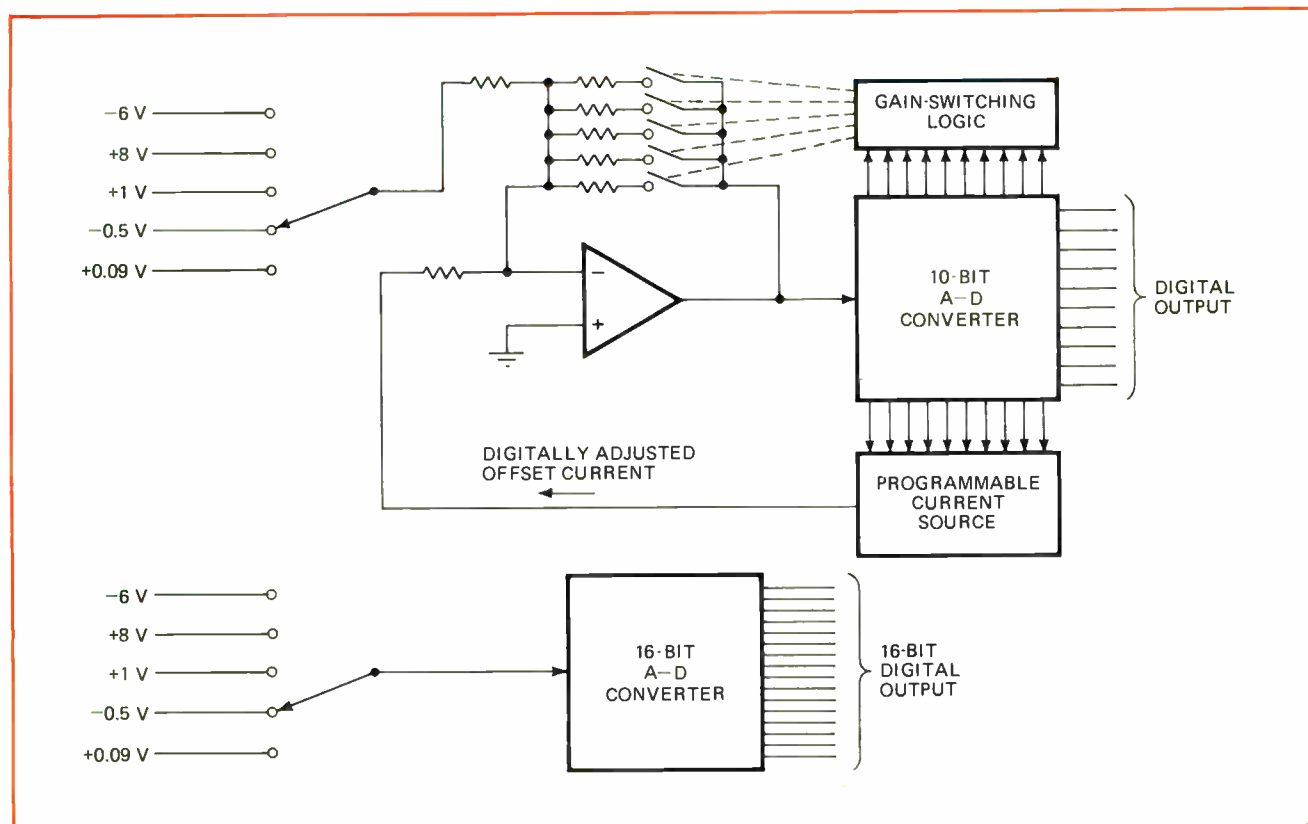

**1. Simplicity.** Complexity of conventional gain-changing data-acquisition circuitry (top) is reduced by exploiting wide dynamic range of 16-bit converter (bottom). Bottom circuit is not only simpler, it's also more accurate, faster, and less expensive.



dynamic range is  $2^{16}:1$ , or 65,536:1, or slightly more than 96 dB. Thus a d-a converter with a full-scale output voltage of 10 v can change its output in steps as small as  $150 \mu\text{V}$ , approximately.

This wide dynamic range means that many naturally occurring variables—like light and sound levels—can be handled by these converters without range-switching or variable-gain amplifiers. The high resolution implied by a wide dynamic range means that accurate ratio measurements can be made between two large-amplitude signals that differ by only a small amount.

A true 16-bit converter must have a linearity specification commensurate with its resolution. For 16 bits, this means that the maximum deviation from perfect linearity should never exceed 0.0015% of full scale. Some applications that only need, say, 12 bits of resolution are better served by a 16-bit converter because of its superior linearity.

Scintillation counters, ion chambers, and other nuclear instruments, for example, are frequently used to separate energy levels, charge levels, or particle momenta into well defined categories. The number of categories that can be obtained is determined by the resolution of the converter, but the uniformity of the category “widths” is determined by its linearity.

### Monotonicity is the tough one

Monotonicity is the toughest single specification that a converter must meet, because it imposes a maximum limit of  $\pm\frac{1}{2}$  LSB on the converter’s step-to-step non-linearity. What is most difficult is preserving the converter’s monotonicity over a useful temperature range. Monotonicity is particularly important in digital servo systems. If such a system is trying to find a null, and the converter is non-monotonic around the balance point, the null balance will never be attained.

Speed is a converter parameter that can be all-important in one application and insignificant in another. Automatic testing systems and CRT displays obviously demand fast converters. However, many slower systems can benefit from using high-speed a-d converters to fight noise. The trick: take several readings of the same input signal in quick succession and average them. Noise will be reduced proportionally to the square root of the number of readings.

### Accuracy’s true meaning

The definition of accuracy is a semantic problem that tends to separate the purists—who think in terms of National Bureau of Standards certification—from the engineers and scientists with data to acquire or distribute. Since the best zener reference sources drift at some 5 ppm/°C, it is difficult to see how a converter can claim any reference to NBS certified standards. The reality is that 16-bit converters don’t claim absolute accuracy to 0.0015%, but offer 15 ppm resolution, linearity to 15 ppm, and excellent stability, which can be exploited for valuable results.

Absolute accuracy is certainly the critical specification for a digital voltmeter, which must make error-free readings from a variety of unrelated sources. By contrast, an a-d converter usually takes readings within a given system, where *relative* voltage magnitudes, *not ab-*

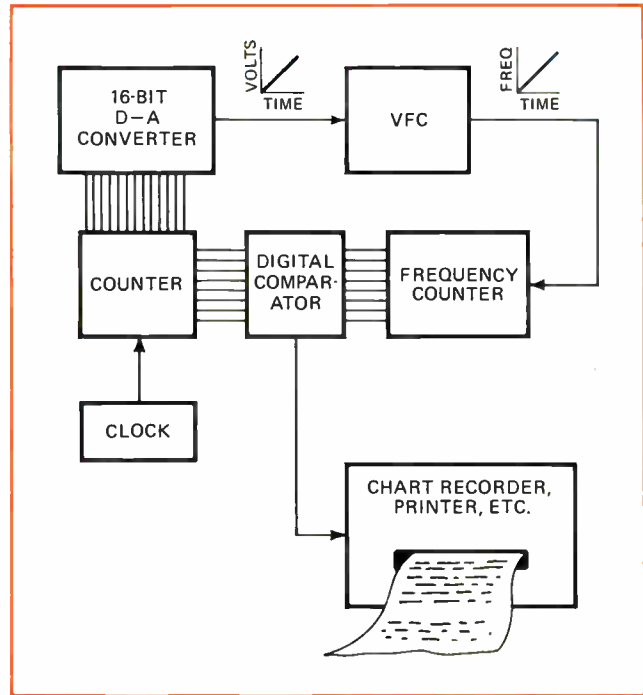

2. **Function generator.** D-a converter is used as ramp generator in setup for testing linearity of voltage-to-frequency converter.

*solute ones*, are required. Nonetheless, of course, the relative magnitudes must be measured with considerably certainty, but this requires high linearity if the converter uses a reference common to all sources, rather than absolute accuracy.

Closely related to a converter’s accuracy is its stability over both time and temperature. This stability must be commensurate with the need for repeating measurements day after day without introducing discrepancies between one day’s results and the next. This is often a relative accuracy factor, since the absolute values of readings may be unimportant so long as they can be repeated with precision. An example occurs in computer-output microfilming, where it may be necessary to update data on a piece of film that was originally recorded days, or even months, earlier.

### Eliminating range switching

What applications do the preceding characteristics suggest? One obvious one is the elimination of range-switching and variable-gain amplifiers. An example of such an application is in a multichannel data acquisition system that must digitize analog signals developed by thermocouples, strain gauges, and other transducers (Fig. 1). The upper diagram of Fig. 1 shows the rather elaborate arrangement required to switch amplifier gain automatically from channel to channel to bring the low-level signals up to the converter’s full-scale input range. The bottom illustration shows the dramatic reduction in complexity provided by a 16-bit converter.

But the 16-bit machine does more than simply eliminate a few extra components. It can improve performance and cut costs at the same time. To understand how, suppose that the system of Fig. 1 requires the nominally 8-v input to be resolved within 1 millivolt over the range of 8 to 9 v. Since a 10-bit converter with

a 10-v reference provides only slightly more than 100 increments between 8 v and 9 v, preamplification by 10 is needed to obtain the desired resolution.

How can a voltage between 8 v and 9 v be multiplied by 10 and still fit into the converter's 10-v amplitude range? The answer is to use an op amp and apply to its summing junction a stable bias current having a magnitude that is exactly sufficient to make the amplifier output zero when the 8-v input is applied. This will allow the 1-v difference signal between 8 v and 9 v to be expanded to fill the converter's full 10-v span. In this way, the 10-bit converter can resolve the amplified signal variation to 1 part in 1,024, or slightly better than 1 mv. However, in addition to a programmable-gain amplifier, the auxiliary equipment now requires a bias source output to be fed into the amplifier's summing junction.

If the system involves many suppressed-zero readings like the foregoing, the circuitry for generating the precise biasing currents adds significantly to the complexity of the over-all conversion equipment; it also adds error sources at the 10-bit level, even though 1-mv resolution of the expanded 1-v signal swing requires performance at roughly the 13-bit level.

Although a 16-bit a-d converter costs appreciably more than any 10-bit counterpart, over-all cost of equipment is considerably reduced, and performance is improved: the 1-v interval between 8 v and 9 v is resolved into more than 6,000 150- $\mu$ v steps, with 16-bit, rather than 10-bit, operation. Further, because it takes an automatically switched amplifier roughly 500 microseconds for each range change, the digitizing rate is greatly enhanced by use of the 16-bit converter, since range switching is eliminated.

A 16-bit converter can be surprisingly useful in precision function generation. Because the LSB is such a tiny fraction of the full-scale output of a 16-bit d-a converter, the converter can be programmed to produce a

**3. Precise positioning.** To approach the quality of a real photograph while using a TV-type raster-scanning approach, this CBS Laboratories electron-beam recording system uses a 16-bit d-a converter to set the beam's vertical position. Computer-enhanced photo of earth was taken from an orbiting satellite.

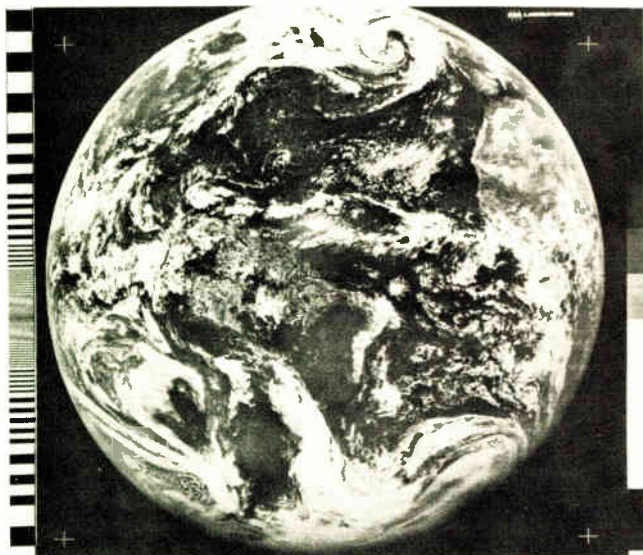

wide variety of output functions with a quantizing noise level approximately 96 dB below full scale.

The usefulness of such a function generator is illustrated in Fig. 2. A setup is shown for testing the linearity of precision voltage-to-frequency converters (VFCs). The automatic testing setup makes use of the d-a converter's excellent linearity as a ramp generator. Clock pulses accumulated in the up-down counter continually update the d-a converter, feeding an analog voltage ramp to the VFC undergoing the linearity test. By holding the quantizing noise of the converter's ramp waveform down to the -96-dB level, while simultaneously ensuring linearity at least tenfold better than the voltage-to-frequency converter's own performance specification, highly accurate calibration curves can be plotted.

The technique can also be applied to digital frequency synthesizers to produce output waveforms in which harmonically related noise is some 96 dB below the full-scale signal level. In such an application the converter's output would be arranged for bipolar signal swings.

### An undistorted view

Although CRT displays are widely used for presenting data to human operators—in aircraft flight controls, interactive computer terminals, newsprint preparation, and so on—there are many additional applications for the basic idea of using a deflected electron beam as a tool for generating and displaying data that have not yet been fully developed.

For example, "photographs" of Mars and other planets could be transmitted to earth by satellite-borne cameras, but they would have to undergo a considerable amount of digital massaging before emerging in conventional photographic format. Similarly, in geological and mineral explorations, where sonar and explosive reverberations are echoed from inner-earth strata and recorded for later transformation into pictures of the

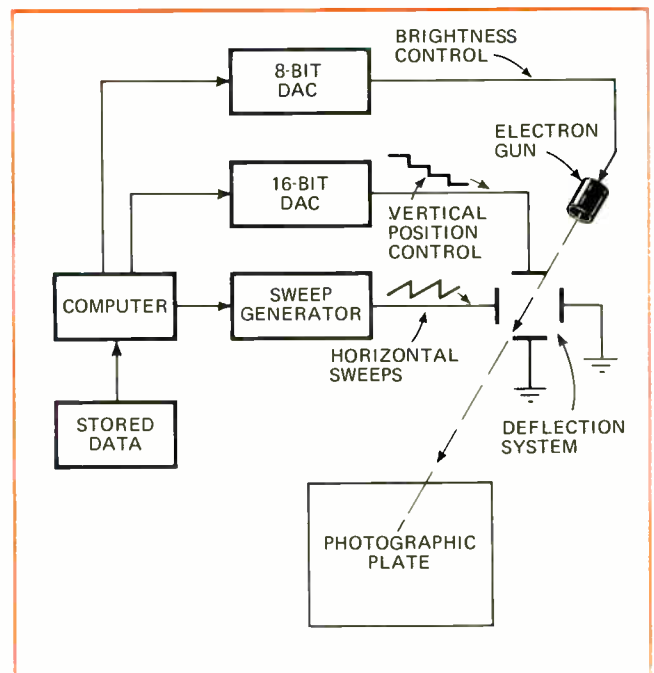

earth's geological cross-section, the raw data is processed by a computer before being converted into an image.

In both these instances, the final picture is produced by exposing a piece of photographic film inside a vacuum system to a digitally positioned electron beam. And it is often wise to use a 16-bit d-a converter to position the beam, even if 16 bits of positioning are not needed. The reason is a need for the 16-bit converter's linearity.

To see why this is so, consider the electron-beam recording system marketed by CBS Laboratories (Fig. 3). This system uses a raster-scanning process not unlike that of conventional television, but with eight bits of bright-to-dark-gray shading, and digital control of the vertical position. To avoid visible distortion in the pictures it produces, the CBS system imposes tight tolerances on the spacing between its horizontal scan lines.

Because a d-a converter's specifications allow an error of up to  $\pm 1/2$  LSB on its output amplitude, it would be possible for successive horizontal scan lines to vary by as much as half a line width in their vertical positioning if the d-a converter's resolution were the same as the vertical resolution of the system. By using a 16-bit converter in a system that requires only 12 bits of vertical resolution, CBS has cut the sloppiness with which its 4,096 scan lines are positioned from  $\pm 1/2$  line width to  $\pm 1/32$  line width. The quality of the picture that results is evident in Fig. 3.

### Preserving the performance

For the user to get all of the performance of which a 16-bit converter is capable, he must avoid the inadvertent introduction of errors on the order of 1 LSB. This is not as easy as it sounds. For example, just 15 mA—the full-scale output of some d-a converters—flowing through 2 feet of 18-gauge wire will drop approximately 165  $\mu$ V, the equivalent of slightly more than 1 LSB.

To combat this problem, converter manufacturers have introduced four-terminal output-connection techniques (Fig. 4) that allow the user to include the impedance of the connecting circuit inside the amplifier's feedback loop. In short, feedback signals are derived from the load, ensuring that the converter's output amplifier places the desired voltage at the actual load terminals, and not merely at the converter's output pins.

In some applications—CRT displays and certain automatic test systems, for example—the output-voltage transients produced by the d-a converter cannot be tolerated. Deflection amplifiers tend to integrate these glitch spikes, creating dc offsets that may persist for many microseconds, creating a noticeable distortion in any smooth CRT trace.

Similarly, semiconductor testers that use d-a converters to control applied voltages and currents cannot tolerate glitches either. When these converters try to creep up slowly on critical threshold voltages, large glitch spikes can burst through the critical region, trigger erroneous responses, and even damage sensitive devices. In such applications, the use of a sample-and-hold deglitch module becomes mandatory.

The problem of getting data into a 16-bit a-d converter is analogous to the difficulties in transmitting

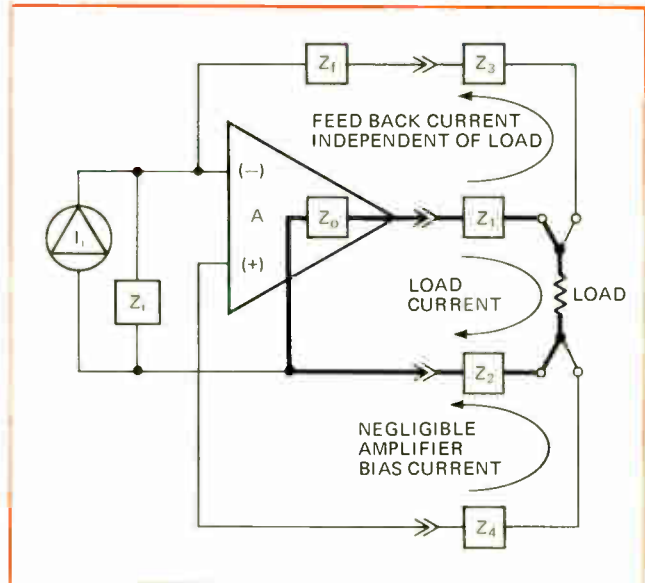

**4. Error reduction.** Four-wire output connection eliminates errors caused by voltage drop between converter output and load.

data from a 16-bit d-a converter to a remote load. Because the dc power for the a-d converter must travel a finite distance from the power supply, and perhaps pass through printed-circuit board interconnections with relatively high resistances, there is likely to be a voltage drop across the power cable and connectors that will raise the entire converter to some finite common-mode voltage. This voltage may easily exceed a few 150  $\mu$ V least-significant bits. In the absence of some subtle precautions in feeding analog data into the measuring circuitry, the digital conversion is therefore likely to be in error by many least-significant bits, because of this common-mode effect alone. The solution is to use a high-performance differential input circuit, or buffer, at the a-d converter's front end. The common-mode rejection of such a circuit then scales the common-mode voltage down to negligible proportions.

Shot noise, 1/f noise, and thermal noise can only be held to an irreducible minimum by careful circuit design and component selection. To keep the noise down, extreme care must be taken with the wiring associated with the converter. In particular, analog and digital grounds should be kept separate to prevent the leakage of large digital pulses onto the analog lines.

Because of high source impedances and other constraints imposed by various signal sources, it is much more difficult to minimize noise effects when measuring, instead of generating, precise analog values. In fact, the 16-bit a-d converter is vulnerable to radio-frequency interference, 60-Hz pickup, feedthrough from digital power-supply transients, and even magnetic coupling from nearby motors and transformers. Therefore, even if all possible care has been taken to minimize circuit noise, it still may be necessary to use the data-averaging technique mentioned earlier. This technique exploits the converter's high speed by taking several readings of the same input data. In this way, averaging techniques will yield a reading that approximates more closely the true analog input. (Noise is reduced in proportion to the square root of the number of readings.)  $\square$

## Generator independently varies pulse rate and width

by Mahendra Shah  
Univ. of Wisconsin, Space Science and Engineering Center, Madison, Wis.

Capacitor charging current can be used to change the output frequency of a voltage-controlled pulse generator that also offers an independent control over output pulse width. The generator's output-pulse frequency can range from 1 to 75 kilohertz and output pulse width from 100 nanoseconds to 18 seconds. A dual retriggerable one-shot performs the actual pulse generation, while an operational amplifier and a couple of transistors convert the control voltage into a proportional charging current for the frequency timing capacitor.

The voltage divider created by resistors  $R_1$  and  $R_2$  determines the voltage level at the noninverting input of the op amp. Since the op amp and emitter-follower  $Q_1$  form a unity-gain buffer having a high input impedance, the large open-loop gain of the op amp keeps the noninverting input voltage ( $V_1$ ) equal to the inverting input voltage ( $V_2$ ):

$$V_1 = V_2 = [R_2 / (R_1 + R_2)] V_i$$

**Voltage-variable rep rate.** Input control voltage determines output frequency of pulse generator. Collector currents developed by transistors  $Q_1$  and  $Q_2$  are directly proportional to control voltage  $V_i$ . Constant current  $I_{C2}$  charges timing capacitor  $C_1$ , controlling pulse frequency of one-shot  $OS_1$ , which is retriggered by its own  $\bar{Q}$  output.  $OS_1$ 's Q output triggers one-shot  $OS_2$ , which controls output pulse width.

and  $Q_1$ 's emitter current becomes:

$$I_{E1} = V_2 / R_3$$

Both  $V_1$  and  $V_2$  can range between 0 and 2 volts.

Transistor  $Q_1$  has a minimum  $h_{FE}$  of 250, making its base current much smaller than its collector current so that constant current  $I_{C1}$  is maintained nearly equal to constant current  $I_{E1}$ . Because transistor  $Q_2$  is also a large- $h_{FE}$  device, it draws very little base current and almost all of  $I_{C1}$  passes through resistor  $R_4$  and diode  $D_1$ .

Furthermore, the base-emitter voltage of  $Q_2$  and the forward voltage drop of  $D_1$  are about the same, permitting voltage  $V_3$  to be written as:

$$V_3 = R_4 I_{C1}$$

And the constant charging current,  $I_{C2}$ , for timing capacitor  $C_1$  can be expressed in terms of voltage  $V_1$ :

$$I_{C2} = R_4 V_1 / R_3 R_5$$

One-shot  $OS_1$  can be retriggered during its on state within 100 nanoseconds of the end of the timing period, fixed by its timing components. The positive trigger input of  $OS_1$  is connected to its  $\bar{Q}$  terminal, and a small capacitive load ( $C_2$ ) is added at the  $\bar{Q}$  terminal to increase the retriggering delay by about 20 ns.

At the end of  $OS_1$ 's timing cycle, its Q output makes a high-to-low transition, and its  $\bar{Q}$  output makes a slightly delayed low-to-high transition, retriggering  $OS_1$  back into its on state for another timing period. This cycle repeats at frequency  $f$ :

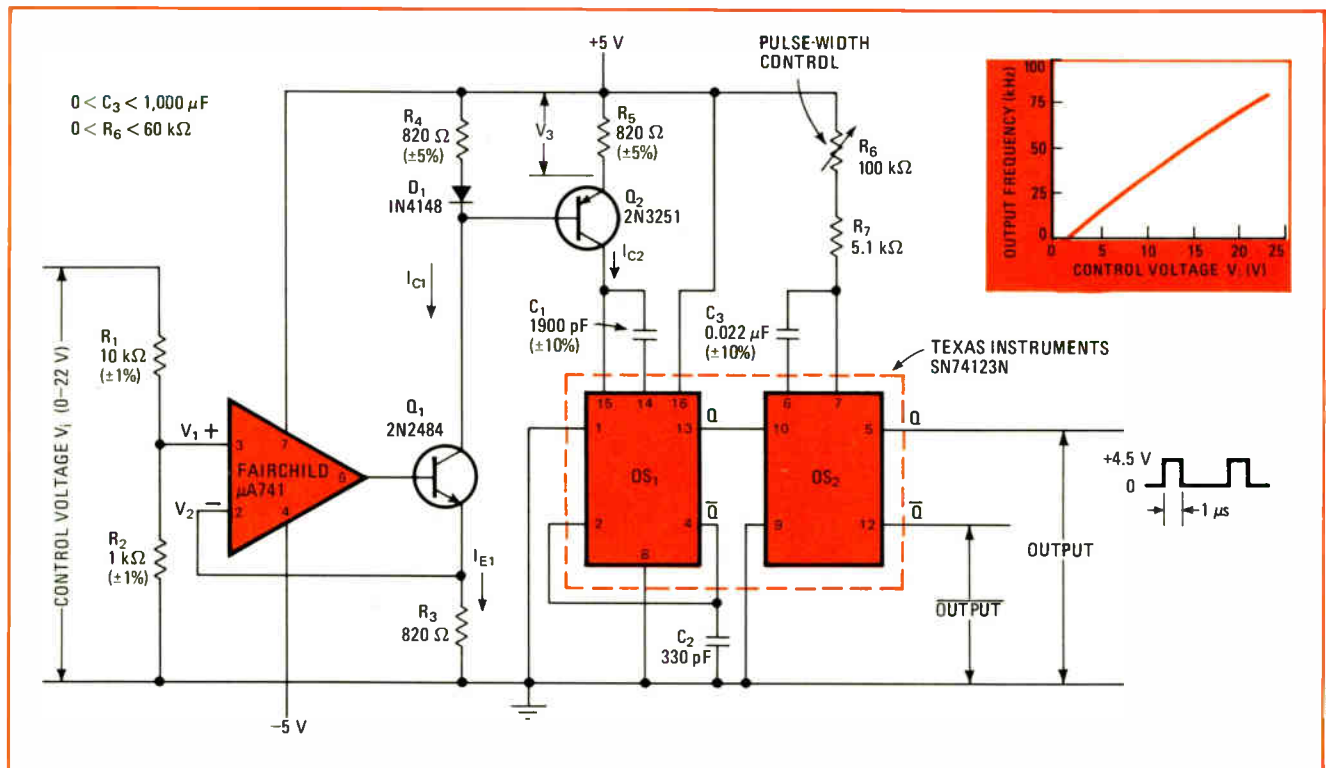

$$f = 1/(T_1 + 60 \text{ ns})$$

where  $T_1$  is  $OS_1$ 's on-time. One-shot  $OS_2$  is triggered by the low-to-high transitions of  $OS_1$ 's Q output; these transitions generate positive-going pulses at  $OS_2$ 's Q output. The width of  $OS_2$ 's output pulses is controlled independently by resistors  $R_6$  and  $R_7$  and capacitor  $C_3$ .

Timing period  $T_1$ , which is usually much greater than 60 ns, is inversely proportional to voltage  $V_1$ . The circuit's output pulse frequency is almost linearly proportional to voltage  $V_1$  and, therefore, to control voltage

$V_i$ . The graph shows that the pulse generator's frequency is practically linear over the control voltage range of 5 to 22 v (0.45 to 2 v for  $V_1$ ).

Generator frequency range can be extended to higher or lower frequencies by scaling the value of capacitor  $C_1$ , but this capacitor's charging current,  $I_{C2}$ , should not be made greater than a few milliamperes. Voltage control of output pulse width can be obtained by replacing resistors  $R_6$  and  $R_7$  with a voltage-controlled constant-current source. □

## Photodetector senses motion in noisy surroundings

by Richard T. Laubach  
National Cash Register Co., Cambridge, Ohio

A digital phototransistor amplifier, consisting of a few readily available inexpensive components, can detect slowly moving objects in an electrically noisy environment. The circuit works reliably, even if long cables link its optical sensing section to its amplifying section.

The circuit detects objects that break the light beam between the light-emitting diode and the phototransistor. When the light beam is interrupted, transistor-output voltage  $V_1$  increases, causing the potential at point A to rise until the threshold voltage (about 8 volts) of inverter  $I_1$  is reached.

Both inverters  $I_1$  and  $I_2$  then switch, and voltage  $V_2$  jumps from 0 to 12 v. This voltage jump supplies additional current at point A through feedback resistor  $R_f$ , reducing the pull-up resistance seen by the phototransistor so that voltage  $V_1$  jumps from 8.5 to 11 v when

voltage  $V_2$  makes its low-to-high transition.

Besides protecting the input of inverter  $I_1$ , diode  $D_1$  isolates point A, allowing the potential at this point to rise to 12 v. Without the diode, point A would be clamped at  $I_1$ 's threshold voltage of 8 v and voltage  $V_1$  would never reach 12 v.

Once the circuit is in its high state, transistor voltage  $V_1$  must drop below 4 v to pull point A below  $I_1$ 's threshold and to switch  $V_2$  back to ground. When  $V_1$  becomes less than 4 v, the phototransistor's pull-up resistance increases and speeds up the rate of decline of  $V_1$ . Feedback resistance  $R_f$  causes  $V_1$ 's switching voltage levels to be different—first 11 v, then 4v—thereby providing 7 v of hysteresis and noise immunity.

Inverter  $I_3$  and diode  $D_2$  buffer voltage  $V_2$ , converting it to a 5-v transistor-transistor-logic signal. If desired, the 12-v output of  $V_2$  can be used directly as the logic input voltage.

The circuit is operating successfully in an electromechanical printer where the cable from the phototransistor to the amplifier input is a twisted pair of wires 10 feet long that run near solenoid driver cables. Moving printed matter is detected by an existing circuit without any output-signal bounce, even though the edge of the matter momentarily stops as it breaks the light beam. □

**Optical detector.** When object breaks LED light beam, phototransistor output voltage  $V_1$  increases, switching on inverters  $I_1$  and  $I_2$ . Voltage  $V_1$  then jumps up because additional current through resistor  $R_f$  to point A decreases phototransistor pullup resistance. Voltage  $V_2$  stays high until  $V_1$  drops to 4 V, increasing pullup resistance and causing  $V_2$  to return to ground. Inverter  $I_3$  converts  $V_2$  to TTL-compatible output.

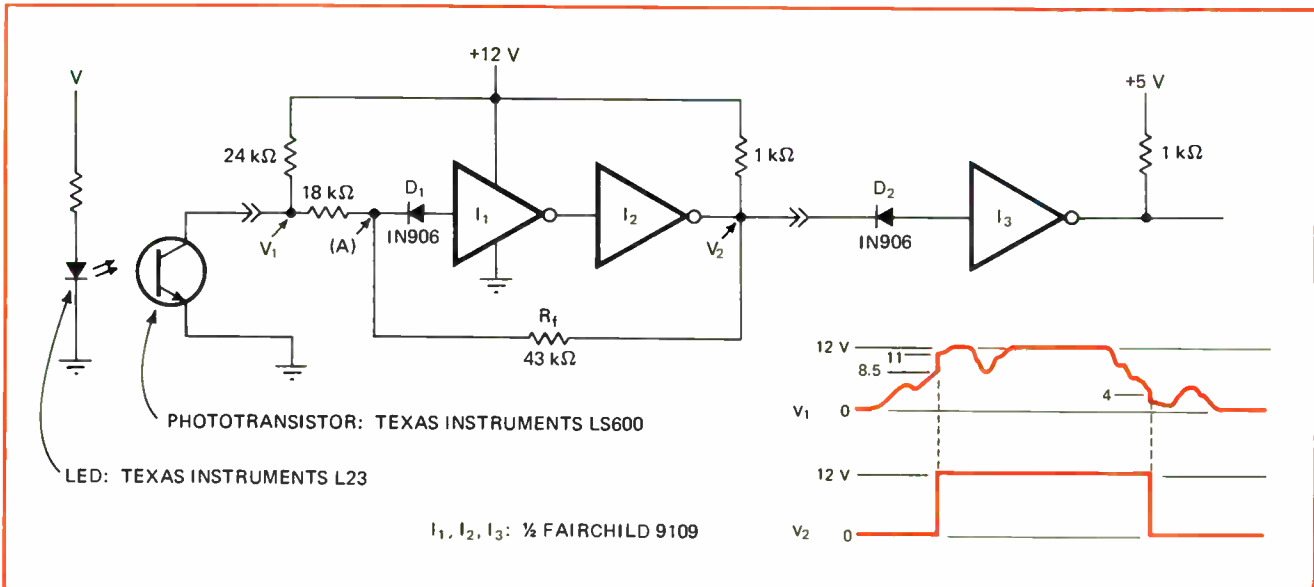

# Quasi-matched MOSFETs form filterless squaring circuit

by W.V. Subbarao  
North Dakota State University, Fargo, N.D.

By compensating inexpensive dual-gate MOSFETs so that they appear matched, a squaring and frequency-doubling circuit can be made to function reliably over a broad frequency range without the aid of a filter. Conventional filterless squaring circuits require costly high-quality matched components.

Biasing MOSFETs  $Q_1$  and  $Q_2$  to operate in their depletion region causes MOSFET behavior to resemble that of the junction field-effect transistor. The drain current ( $I_D$ ) of either  $Q_1$  or  $Q_2$  is given by:

$$I_D = I_{DSS}(1 - V_{GS}/V_P)^2$$

where  $I_{DSS}$  is the drain current with both gates shorted to the source terminal,  $V_{GS}$  is the voltage between shorted gates and the source terminal, and  $V_P$  is the pinchoff voltage (the  $V_{GS}$  value when  $I_D = 0$ ).

Since  $Q_1$  and  $Q_2$  are not matched, they may, however have about the same  $V_P$  value (approximately -1.5 volts) but exhibit different  $I_{DSS}$  values. If  $Q_2$ 's  $I_{DSS}$  current is lower than that of  $Q_1$ , say 3 milliamperes as compared to 4 mA, the control gate ( $G_2$ ) of  $Q_2$  can be driven positive, making  $Q_2$  more conductive so that its  $I_{DSS}$  current is compensated to equal that of  $Q_1$ . In this way,  $Q_1$  and  $Q_2$  can be made to look matched with the same  $I_{DSS}$  and  $V_P$  values. The transfer curves show how  $Q_2$ 's characteristic tracks  $Q_1$ 's characteristic.

Transistor  $Q_3$  functions as a unity-gain stage, transferring input voltage  $V_i$  to produce voltages  $V_1$  and  $V_2$ , which are equal in magnitude to  $V_i$  but  $180^\circ$  out of phase with each other:

$$V_1 = -V_2 = V_i$$

Effectively, the input to the main gate ( $G_1$ ) of transistor  $Q_1$  is  $V_i$ , and the input to the main gate of transistor  $Q_2$  is  $-V_i$ . Input voltage  $V_i$  can then be considered as the  $V_{GS}$  voltage for both  $Q_1$  and  $Q_2$ .

The MOSFET transfer characteristic can now be used to solve for the drain current that flows in resistor  $R_D$ :

$$I_{D1,2} = I_{D1} + I_{D2} = 2I_{DSS} + 2I_{DSS}(V_i/V_P)^2$$

The output signal voltage contribution can be separated from the output dc offset voltage of  $2R_D I_{DSS}$ :

$$V_o = 2R_D I_{DSS}(V_i/V_P)^2$$

Letting  $K = 2R_D I_{DSS}/V_P^2$  allows the output voltage to be written as:

$$V_o = KV_i^2,$$

which is a squaring function.

The value of resistor  $R_D$  is held to 1 kilohm to prevent the dc offset current of  $2I_{DSS}$  from saturating the MOSFETs when the circuit is operating. Also, peak output voltage swing is restricted to about 1 volt to keep from driving the MOSFETs away from their optimum mid-point bias condition.

For a sinusoidal input,  $V_o$  is also a sinusoid at double the input frequency and with a voltage gain of approximately 3.5. Resistors  $R_1$  and  $R_2$  are adjustable so that the  $Q_1$ - $Q_2$  match can be preserved for changing input signal conditions. This permits the circuit to operate from 200 hertz to 1 megahertz without any distortion. □

Designer's casebook is a regular feature in Electronics. We invite readers to submit original and unpublished circuit ideas and solutions to design problems. Explain briefly but thoroughly the circuit's operating principle and purpose. We'll pay \$50 for each item published.

**Compensated MOSFETs double frequency.** Filterless squaring circuit works from 200 hertz to 1 megahertz. MOSFETs  $Q_1$  and  $Q_2$  are operated in their depletion mode, causing them to square voltages applied to their main gates ( $G_1$ ). Adjusting control gate ( $G_2$ ) voltage forces MOSFETs to simulate a matched pair. Unity-gain transistor  $Q_3$  drives  $Q_1$  and  $Q_2$  with equal voltages of opposite polarity ( $V_1 = -V_2 = V_i$ ).

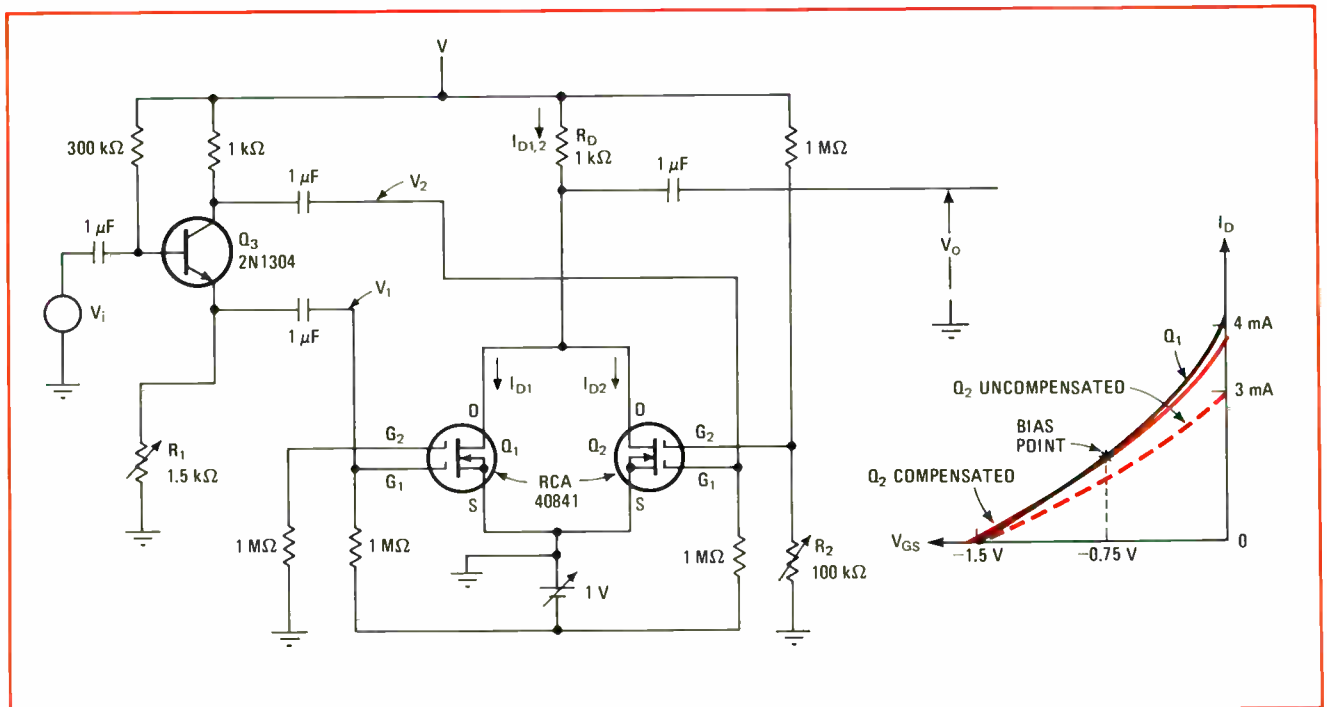



P-channel  
J FET



N-channel  
J FET

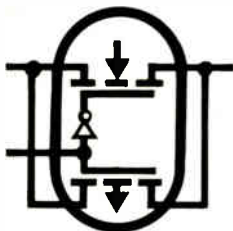

CMOS  
FETs



P-channel  
MOS FET

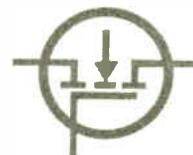

N-channel  
MOS FET

Since 1962, Siliconix has evolved FET technology and applied it to a complete line of singles, duals, arrays, and IC's. So what's new?

# Switch 16 channels with CMOS DG506.

Here is a single-pole 16-channel multiplexer using paired CMOS FETs, with drivers controlled by a 4-bit binary word input plus an Enable-Inhibit input — all on one chip! Check the functional diagram and then refer to the decode truth table to see what binary word input selects which switch.

### The DG506 features:

- $\pm 15$  V Analog signal range
- Break-before-make switches
- ON resistance < 500 ohms
- TTL, DTL, and CMOS direct control interface
- 36 mW standby power

DG506 Function Diagram

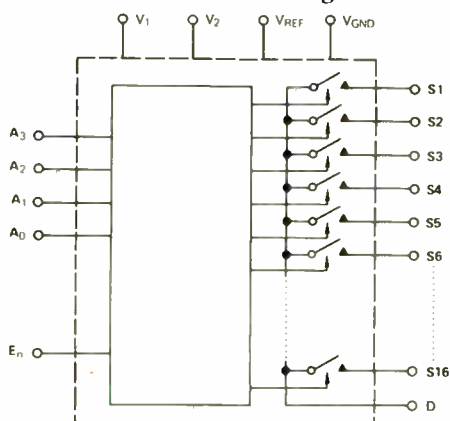

Decode Truth Table

A <sub>3</sub>	A <sub>2</sub>	A <sub>1</sub>	A <sub>0</sub>	E <sub>n</sub>	ON SWITCH
X	X	X	X	0	NONE
0	0	0	0	1	1
0	0	0	1	1	2
0	0	1	0	1	3
0	0	1	1	1	4
0	1	0	0	1	5
0	1	0	1	1	6
0	1	1	0	1	7
0	1	1	1	1	8
1	0	0	0	1	9
1	0	0	1	1	10
1	0	1	0	1	11
1	0	1	1	1	12
1	1	0	0	1	13
1	1	0	1	1	14
1	1	1	0	1	15
1	1	1	1	1	16

Our catalog line of drivers and switches will cover most applications. If your switching problems are unique — and whose aren't — call our applications people. They're eager to help. For complete information,

## write for data

Applications Engineering: (408) 246-8905



### Siliconix incorporated

2201 Laurelwood Road, Santa Clara, California 95054

# Integrated instrument setup tests intricate assemblies

Modular hardware and software of minicomputer-based system provide the flexibility needed to test and isolate faults in both digital and analog components and complex circuitry at high and low frequencies

by Wilbur L. Allain, *Industrial Products division, Texas Instruments, Houston, Texas\**

□ To achieve cost-effectiveness on the assembly line, manufacturers must employ automatic testing for electronic components, modules, and assemblies of both discrete components and integrated circuits. These products differ so radically from semiconductors that experience gained in the automatic testing of semiconductors is difficult to adapt to the purpose.

In addition to being programable, the commercial assembly tester must be able to test from a single station digital assemblies and analog assemblies at both high and low frequencies. For more complex printed-circuit boards, the tester must be able to locate faults, as well as to isolate them. In addition to controlling a wide variety of programable test instruments, the tester should

operate without special controllers for various tasks. The automatic system must let the operator intervene when deviation from a routine program is necessary and provide the advantages of manual probing when needed.

For the flexibility to accommodate nonstandard testing equipment or adapt certain test stations to specialized assemblies, the tester should be modular, both in hardware and software.<sup>1</sup> Modularity also provides insurance against obsolescence.

The software should be written in any easy language that is structured as similarly to English as possible so that those who must write test programs will require a minimum of preliminary training. The software should also be able to control more than one test station at the same time and to multiplex test instruments to more

This is the second in a series of articles on automatic test equipment. Part 1 appeared in the August 14 issue.

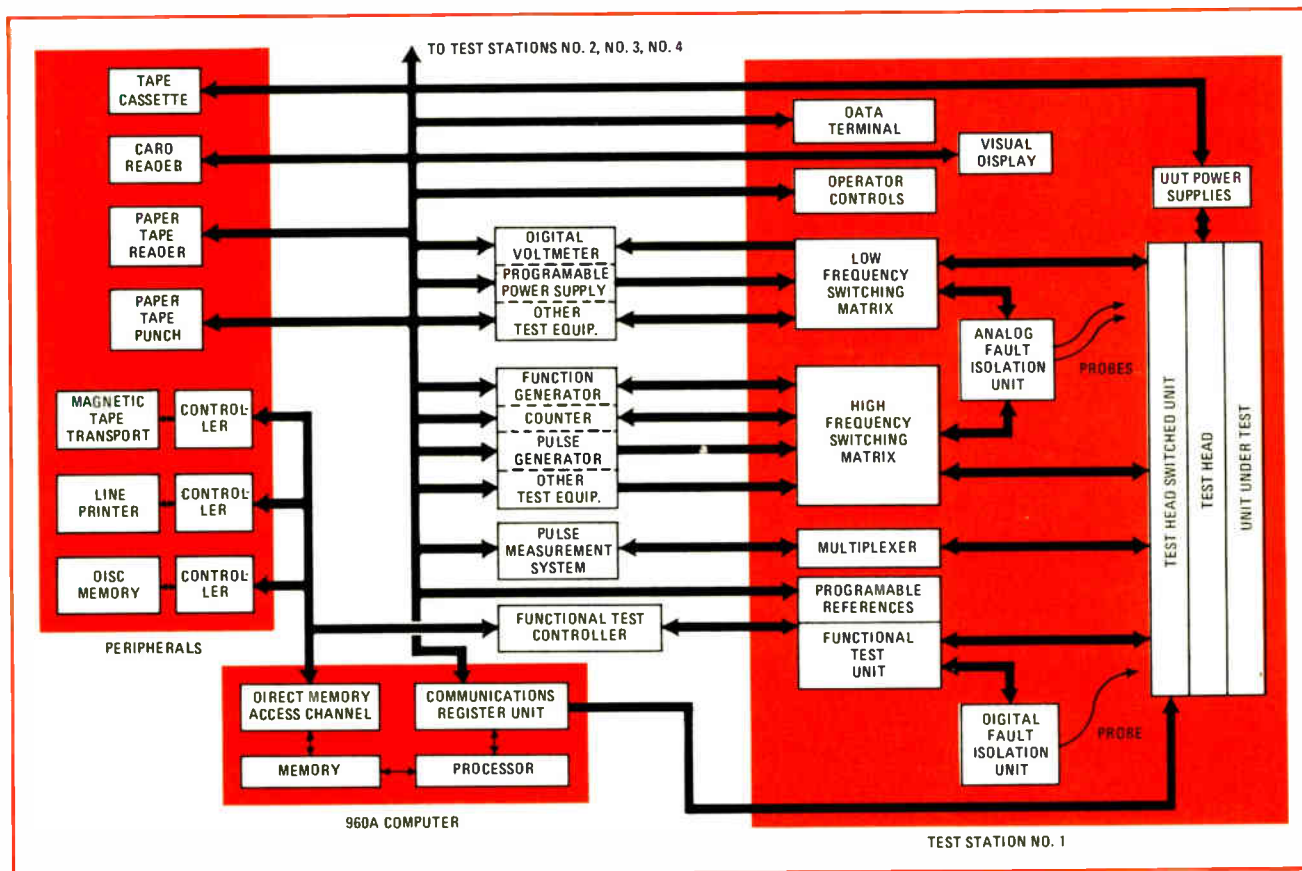

**1. Automatic tester.** Built around Texas Instruments' 960A computer, this ATS-960 tests printed-circuit boards and digital and analog subassemblies requiring up to 256 input and output connections. As many as four test stations can operate simultaneously.

\* Now with Petroleum Pipe Inspectors, Lafayette, La.



than one test station so that some instruments can serve on a time-shared basis. Finally, all instruments must be available to the computer in a programmed rotation.

Among the requirements for component and assembly test systems—none of which apply to semiconductor testers—are:

- Assemblies, such as printed-circuit boards and circuit modules, that fail the test cost too much to be discarded, and they are usually repairable.
- The number of leads to the unit under test is likely to be large.
- The number of separate tests to be run is also likely to be large.
- Some test procedures on large assemblies may be highly complex.
- The time required to run a series of tests is not very important because it's likely to be much less than the time required to set up the unit for testing.
- Users require an integrated system—one comprising separable functional elements joined to form a system, as opposed to a dedicated system specifically designed for a given task or class of tasks.<sup>2</sup>

### TI's tester

One system designed to meet commercial testing needs is the Texas Instruments ATS (for Automatic Test System) 960 (Fig. 1). This system, which can perform tests on as many as 256 leads to the unit under test with a variety of both high- and low-frequency commercial test instruments, can also isolate digital faults. Built around the TI 960A minicomputer<sup>3</sup> [see panel, p. 107], the ATS-960 includes a Tektronix automated measurement system for dynamic testing and can accommodate a wide variety of peripherals, including the TI 730 data terminal for test stations.

A communications register unit, which is standard on the 960A computer, enables the computer to interface through as many as 512 lines (expandable externally to a capacity of 8,192) to all but the fastest test instruments. The CRU enables interface of the 16-bit computer word to the word length of the instrument to be controlled. The software is an adaptation of Atlas (Abbreviated Test Language for Avionic Systems), a fluent test language that minimizes the chore of writing test programs and permits existing programs to be modified on line. Test patterns for the functional tester may be stored in the main memory of the minicomputer or a disk storage unit connected to it.

The ATS-960, which can test assemblies requiring up to 256 leads, performs dc, ac, functional, and dynamic tests on these assemblies. Dc and ac tests, of course, simply check the response of the unit under test (UUT) to steady or sinusoidal signals. Functional tests provide the UUT with inputs similar to those it would receive in actual use and look for the proper outputs. Dynamic tests measure amplitudes and time intervals of complex waveforms. The tester can perform tests simultaneously at as many as four test stations.

One of these test stations appears at the right in the photograph (Fig. 2). It is the desk-like console containing status indicators, control switches, an optional visual display, a TI 730 data terminal, and a magnetic tape-cassette drive. If interactive test programs are used, they



**2. Typical system.** This example of ATS-960 is in use at TI to test electronic assemblies for radar and other equipment. Test station (console at right) contains test head, indicators, switches, and a data terminal; other equipment is below station and in three racks at left.

print out messages for the operator on the terminal's thermal printer or present them on the visual display and require him to enter information through the keyboard. This interactive operation facilitates manual adjustments in automatic test sequences and, when needed, fault isolation with manual probes, which are included at the test stations. The lower part of the station contains switching relays, a functional test subsystem, the test-head switching unit, and several programmable test instruments.

Digital faults are isolated either through software or by a manual probe. When the probe is used, the probing sequence can be displayed on the printer or on the visual display.

### Programed rotation

Because all four test stations may be operating simultaneously, their functional test units may be competing for access to the memory in the 960A. Ordinarily they all have equal priority, and a controller in the central tester simply rotates memory access among all four. But if a particular test station requires high-speed operation, it may be programmed for high priority and obtain every memory cycle during the execution of its test. The other three stations then have access to the memory in rotation while the high-priority station is between tests—for example, while the UUT is being changed.

While a test program is running, the operator can select one of several modes: normal test mode, single-step mode, or recycle mode. Ordinarily a test program is executed once when the operator pushes the start button on the test station. After the test is completed, he removes the UUT, tags it with the necessary pass or fail information, inserts another unit for test, and pushes the start button again. But if the operator runs into trouble with the program, he can execute it in single-step mode, one statement at a time, or in recycle mode, which causes the entire program to run over and over again without stopping until the operator presses a reset button. Recycling is useful when intermittent faults are suspected in a UUT.

Since software in the ATS-960 is modular, various test instruments, peripheral devices, and utility functions can be easily added or deleted (Fig. 3). Thus the

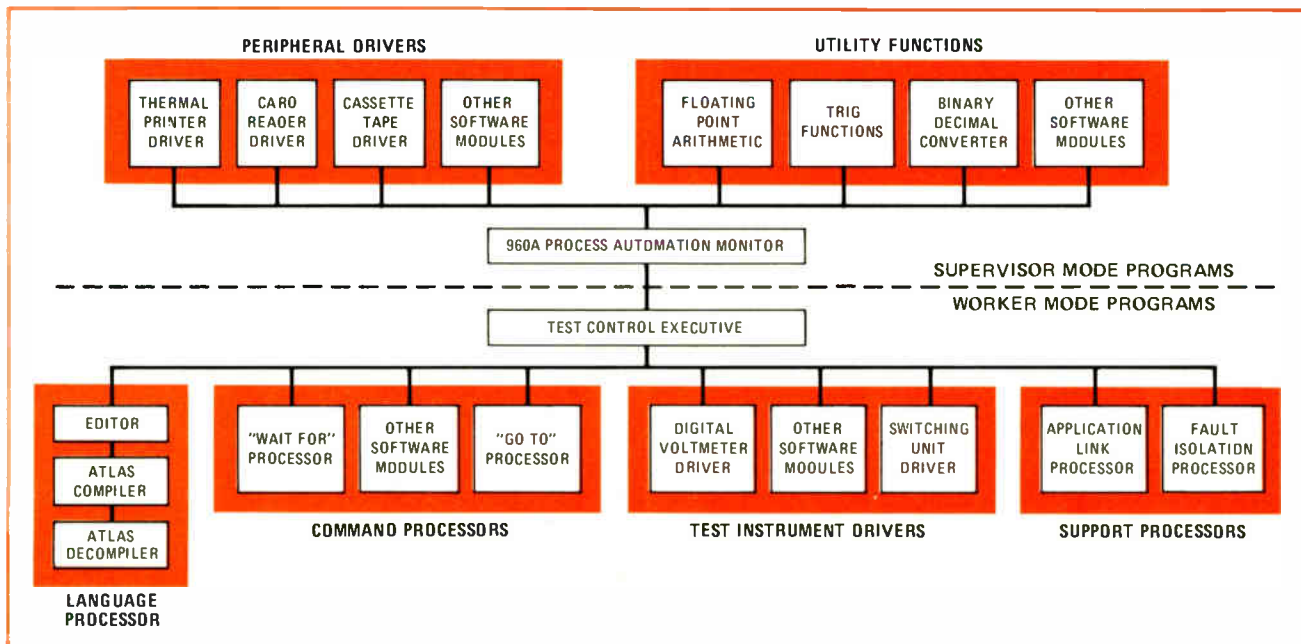

3. **Modular software.** Routines for various functions of the ATS-960 can be added or deleted at the same time as easily as test instruments are added and deleted. Program language is Atlas. (Abbreviated Test Language for Abbreviated Systems).

user is not penalized by having to provide memory for unused software routines.

### Language for testing

The program language used with ATS-960 is an adaptation of Atlas, one of a family of improved general-purpose test languages now being recognized.<sup>4</sup> In Atlas, test programs are written as a series of English statements in two groups—the preamble section, which contains reference information, and the procedure section, in which each statement is a specific step in the execution of a test. Comments, not executed as part of the program, may be interspersed among the procedural statements as a key for users who must work with the program.

After a program is written, it is stored in source-language (Atlas) form on magnetic or paper tape. It is compiled into machine-language code only when read from tape into main memory. Then, when being debugged, it is decompiled back into source language form from display at the test station.

This capability, plus the availability of an editor program, permits the user to modify the test program online in source language—an important advantage, because the cost of debugging and modifying test programs is often substantially more than writing them in the first place. Changes made to a program during debugging are again decompiled when the program is stored permanently on tape.

### Software supervision

The 960A process-automation monitor (PAM) supervises the software system. It includes a test-control executive that directs the editor, compiler, and decompiler mentioned above, as well as command processors, test-instrument drivers, an application-link processor, and a fault-isolation processor.

When special-purpose or nonstandard instruments

are included in the ATS-960, command processors are added to the software package. They interact with the language processor under the test-control executive to generate the specific commands for the nonstandard instrument.

Test-instrument drivers are software routines that control standard instruments and subsystems connected to the CRU. These drivers take the place of hardware controllers for such instruments, and, like the command processors, operate under the test-control executive program. Many of these driver routines have already been written, but new ones can be added to the ATS-960 software at any time.

The application-link processor responds to commands and requests from the keyboard of the data terminal. These requests call for such things as program listings, memory maps, data logs, and test-program editings. For each such request, the processor calls for an appropriate routine that executes the necessary command. This processor also handles interactive operator messages by which the operator “converses” through the data terminal with the ATS-960.

The fault-isolation processor operates with the functional-test subsystem driver, again under the test-control executive. If necessary, the test programmer can write analog fault-isolation programs for the ATS-960.

Of major importance in testing digital assemblies, the functional-test subsystem provides the assembly being tested with inputs similar to those it would receive in actual use and checks to be sure that the proper outputs are generated. This subsystem eliminates dependence on the “standard unit” used in comparison-type testing<sup>5</sup>. The logic patterns that exercise the UUT are programmable, so that minor variations between tested assemblies are easily accommodated, and no comparison unit known to be good is required for a test.

As many as 256 UUT leads may be connected to the functional tester. For each of these leads, the tester con-

tains one driver and two comparators. Four driver/comparator (D/C) circuits are packaged on a single printed-circuit card; four cards and one module logic buffer are used for each group of 16 UUT leads (Fig. 4). The module-logic buffer contains flip-flops that are the source of control signals to the D/C cards.

#### Four out of eight

Since eight programmable reference levels are available but only four are used at any one time on any card—one 1 and one 0 going out, and one 1 and one 0 coming in—the module buffer also selects one of the two sets of four to be used at any given time. With these two levels available, printed-circuit boards containing two types of circuitry—for example, TTL and MOS—can be completely tested in one pass—that is, without removing the UUT from the test head or reprogramming the reference voltages.

For each of the maximum of 256 leads from the functional tester to the UUT, the tester contains one D/C circuit (Fig. 5) which generates the signals going to the UUT and accepts the outputs generated by the UUT. Because only one lead is involved, no D/C can perform both functions at the same time. However, the D/C contains a program-controlled mask flip-flop that can prevent particular incoming signals from the UUT from setting the test flip-flop. This mask also can either prevent outgoing signals to the UUT from causing a failure indication or accept those signals and perform a self-check.

#### Functional testing

To use the functional-test subsystem, the computer loads 16 bits into the first pattern flip-flop of 16 D/C circuits. Each bit represents either the data to be sent to the UUT or its expected response. Up to 16 words are loaded into the maximum of 256 D/C circuits. When they are all loaded, they are simultaneously transferred by a common clock pulse into the second set of pattern flip-flops. In each D/C, the second pattern flip-flop controls a switch that routes either a reference 1 or a reference 0 to the driver, and hence to the UUT. The flip-flop is also connected to two AND gates that match its contents with the responses from the two comparators. The driver and comparators are chosen for their accuracy so as to impose as little degradation as possible on signals sent to or received from the UUT.

A failure in a digital assembly may be indicated by an output of unsatisfactory amplitude, as well as by the mere presence or absence of an output. Therefore, the comparators are actually differential amplifiers, which compare incoming signals from the UUT with reference 1 and 0 voltages. A satisfactory response produces no output from the corresponding amplifier, which has a rather steep transfer characteristic, so that if the UUT response shows only a slight departure from the proper amplitude, compared to the reference, it produces a full output.

The amplifier outputs are compared with the on and off outputs of the second pattern flip-flop. Any departure from a proper response sets a test flip-flop, indicating that an unfavorable response was received. The programmable reference can be set at any level in the range

of  $\pm 15.36$  volts; within this range, 240 increments of 128 millivolts each are available.

#### Test command

The test station logic buffer also formulates the test signal, which sets the test flip-flop in the D/C circuit. If purely synchronous logic is being tested in the UUT, the functional-test controller (common to all four test stations) issues the test command at an appropriate interval after supplying a test pattern to the UUT. The interval, which is programed, is based on the length of time the UUT should take to respond. For asynchronous logic, a synchronizer must be designed especially for the assembly being tested, either by the user or by TI to the user's specifications. This synchronizer monitors the UUT leads, which are buffered and routed to it, measures out an interval of time after the test pattern has been applied, and generates the test signal at the proper time.

The maximum repetition rate for successive test patterns applied to the functional-test subsystem is 160 kilohertz, or one pattern every  $6\frac{1}{4}$  microseconds. Because the CRU can't keep up with this rate, the functional tester is connected to the computer through the direct-memory access (DMA) channel, along with conventional high-speed peripherals. As many as seven more DMA channels may be added to the basic 960A computer if needed. This rate, incidentally, is attained

### Computer for automation

The Texas Instruments 960A minicomputer, aimed at process-control and factory automation, has a 16-bit word length and a metal-oxide semiconductor memory of 4,096 words, expandable to 65,536. Half of them fit in the computer's mainframe, and half can go in an external rack. If primary power fails, the memory's contents can be retained for as long as two weeks by a battery pack.

The computer operates with a set of 76 double-word instructions, including a few optional items, such as hardware multiply and divide. It can respond to any of several simultaneous and independent external operations with its priority interrupt system.

A process-automation monitor (PAM) supervises the software. The multiprogrammed operating system controls program execution through an executive/worker method—that is, it scans the tasks, that make up the application program and permits them to be executed in accordance with their preassigned priorities—switching, if necessary, from one program stream to another.

To keep track of these various streams, and of the various input-output and control devices associated with them, PAM also has a multilevel priority scheme. Another version of PAM, called PAM/D, also supports the use of a disk-storage unit containing applications programs and data files.

Control routines for peripheral equipment and a number of utility functions are included in both PAM and PAM/D. The utility functions are software routines for such tasks as floating-point arithmetic, trigonometric calculations, and binary-to-decimal and decimal-to-binary conversions.

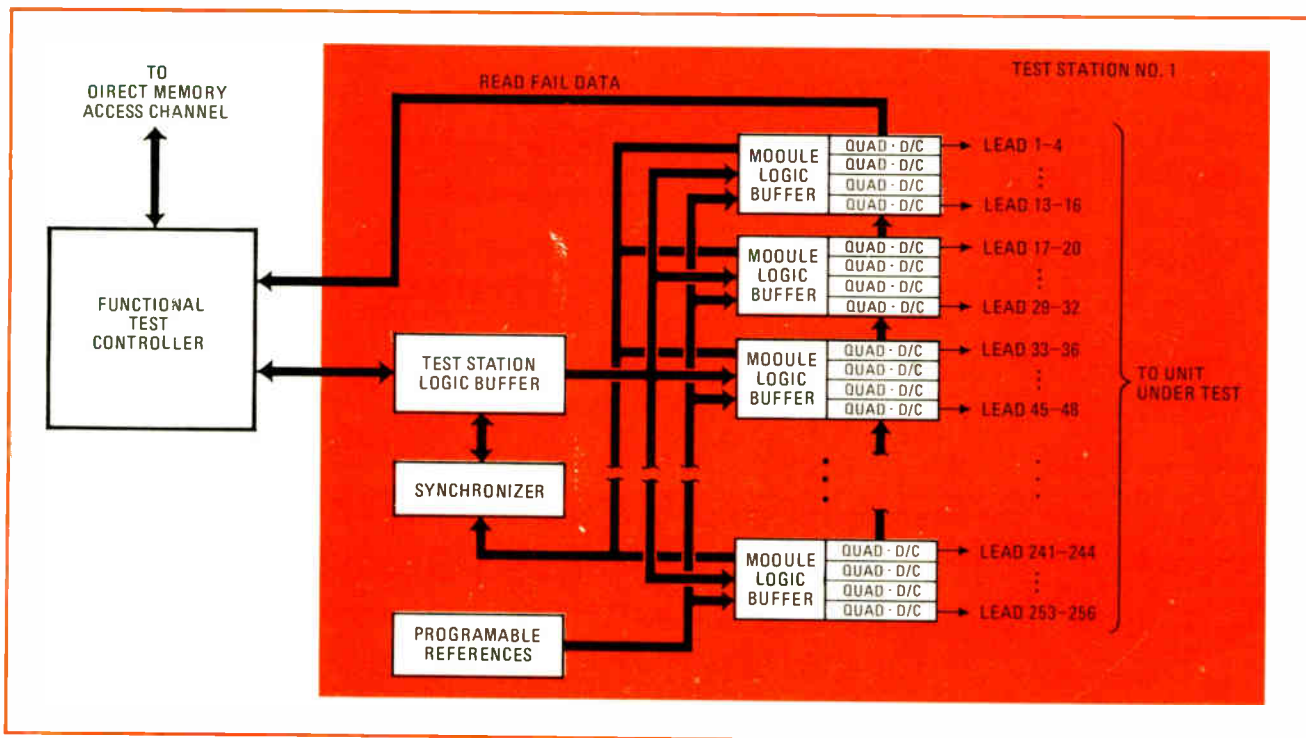

**4. Functional tester package.** The test leads are grouped in fours because four of the driver/comparator (D/C) circuits are packaged on a single card. One module-logic buffer controls 16 lines. The functional test controller coordinates the operation of subsystems in the four test stations, while the test station logic buffer and synchronizer control testing for response.

only when 16 or fewer test leads are used with the UUT. For more than 16, two or more computer cycles are required to load the patterns into the functional tester, thus cutting back on the repetition rate the tester can maintain.

### Communications register unit

The CRU, basically an input/output register, interfaces the 960A with all but the very fastest test instruments. This unit, a major component of all 960A computers, connects peripheral equipment and other digitally controlled hardware to the computer. The basic computer provides 512 lines out of the CRU, but the capacity can be expanded through one or more external chassis to a maximum of 8,192 lines.

In a CRU chassis, any combination of the 512 input and output lines may be used; but in the maximum configuration of 8,192 lines, half must provide input and half provide output because the 960A can address no more than 4,096 lines directly.

The CRU enables the fixed word-length of the 960A to interface with the word length of the system to be controlled. Conventionally, this interface includes a digital controller, which is expensive to design and build, as well as difficult to modify or to expand. But with the CRU, sensing and control functions are performed directly with any number of bits. A single instruction can send out or test a single bit or any field of bits up to and including the full 16-bit word length.

Computer instructions address the register's input and output lines singly or in groups of up to 16. These lines, in turn, are connected to all high- and low-frequency test equipment in the ATS-960 except the functional tester, and to all low-speed conventional I/O

equipment (excluding the disk unit, the magnetic tape unit, and the line printer). One instrument is furnished as many lines as it may require. Incorporating a new instrument into a system requires only the addition of a software module for that instrument, a CRU module, and a cable.

Each CRU module is a printed-circuit card with connectors on both ends. One connector plugs into the computer or into a CRU expansion chassis, and the other plugs into a cable to an instrument.

### Varieties of CRU modules

Various CRU modules are available. The simplest is the data module, which comes with 32 input lines, or 32 output lines, or 16 of each. All three kinds carry 32 flip-flops. For output signals, the flip-flops are set and reset under program control, and they drive the appropriate lines through buffer transistors with open collectors; the necessary collector resistors may be in the instrument at the far end of the cable. Input signals pass through line terminator circuits and set their corresponding flip-flops, which can be tested by the computer program.

Other modules include a contactor module, an interval timer module, an interrupt module, and digital-to-analog and analog-to-digital converter modules. The contactor module contains relays that isolate the computer from instruments operating at a different voltage level or a different ground, while still transmitting signals back and forth.

The interval-timer module can measure out a time delay of 1 millisecond to more than two minutes. The exact time delay is set under program control, within one of four ranges established by a jumper connection on the module. The interrupt module receives signals

sent by the test stations under exceptional conditions and holds the signals so that the computer can respond to them. The computer can also disable these signals if it sees fit.

The digital-to-analog and analog-to-digital converter modules work between a 12-bit two's-complement binary number and one of three scales:  $\pm 5$  volts,  $\pm 10$  volts, and 0 to 10 volts, established by a jumper connection. They are used with instruments that do not themselves accept or produce digital signals.

### Test Instruments

For dynamic testing, the ATS-960 includes a Tektronix automated measurement system. This system includes two sampling channels, and it can service two test stations, which time-share it, provided that the stations are close together. In a four-station tester, either two Tektronix systems would be required, or two of the four stations would be unable to perform dynamic testing, since four stations cannot be grouped close enough to provide sufficiently short cable connections to the Tektronix unit.

Programable commercial test instruments used with the ATS-960 are divided into two categories—high-frequency and low-frequency. Low-frequency instruments include digital voltmeters and power supplies for checking a UUT under marginal conditions. High-frequency instruments include pulse generators, counters, and function generators.

Both classes of instruments are connected to the UUT through a matrix of reed relays. The low-frequency matrix is put together from modules of 4-by-16 (four test instruments connected simultaneously to any four of 16 leads to the UUT) in a cross-point arrangement. This is the most economical kind of connection where the frequency of measurement permits it. However, the electrical characteristics of a cross-point matrix—imped-

ance, attenuation, and the like—prohibit its use with high-frequency instruments, which connect to the UUT through a binary tree. Up to 64 test leads may be connected to any high- or low-frequency instrument; the remainder, up to a total of 256, are limited to low-frequency operation.

The UUT is plugged into the test-head connector bringing all the necessary leads from the two switching matrixes and the functional tester through a switching unit to the UUT. The test head also provides power supply connections to the UUT. The switching unit connects only one of the four units—matrixes, tester and Tektronix system—to the test heads.

### Add-ons

A wide variety of computer peripherals is available for use with the ATS-960. Among these are the data terminals and displays at the four test stations and the tape-cassette drives, if used. A magnetic-tape transport for standard 10½-inch reels of ½-inch-wide tape can also be connected to store software and to log test data. Functional-test patterns can be stored, as mentioned previously, in a disk unit, along with more software, if the system requires it. Also available are a high-speed paper-tape reader and punch, a card reader, a card punch, and a line printer. The standard magnetic tape drive, the disk unit, and the line printer are connected to the computer through a DMA channel. □

### REFERENCES

1. Philip A. Hogan and Aerial E. Nelson, "A Time-Shared Computer Data System for Automated Test Stations," Western Electronic Show and Convention, 1970, paper 16/4.
2. A.M. Greenspan, "Automatic Test Systems, Dedicated or Integrated?" IEEE Transactions on Instrumentation and Measurement, November 1971, p. 191.
3. Paul Franson, "TI elbows way into low-price minicomputer race," *Electronics*, Nov. 8, 1971, p. 111.
4. Gene Kierce, "Programs in Getel speak test engineer's language," *Electronics*, Aug. 2, 1971, p. 53.
5. William R. Johnson, "Proving out large pc boards: which system is best for you?" *Electronics*, Mar. 15, 1971, p. 68.

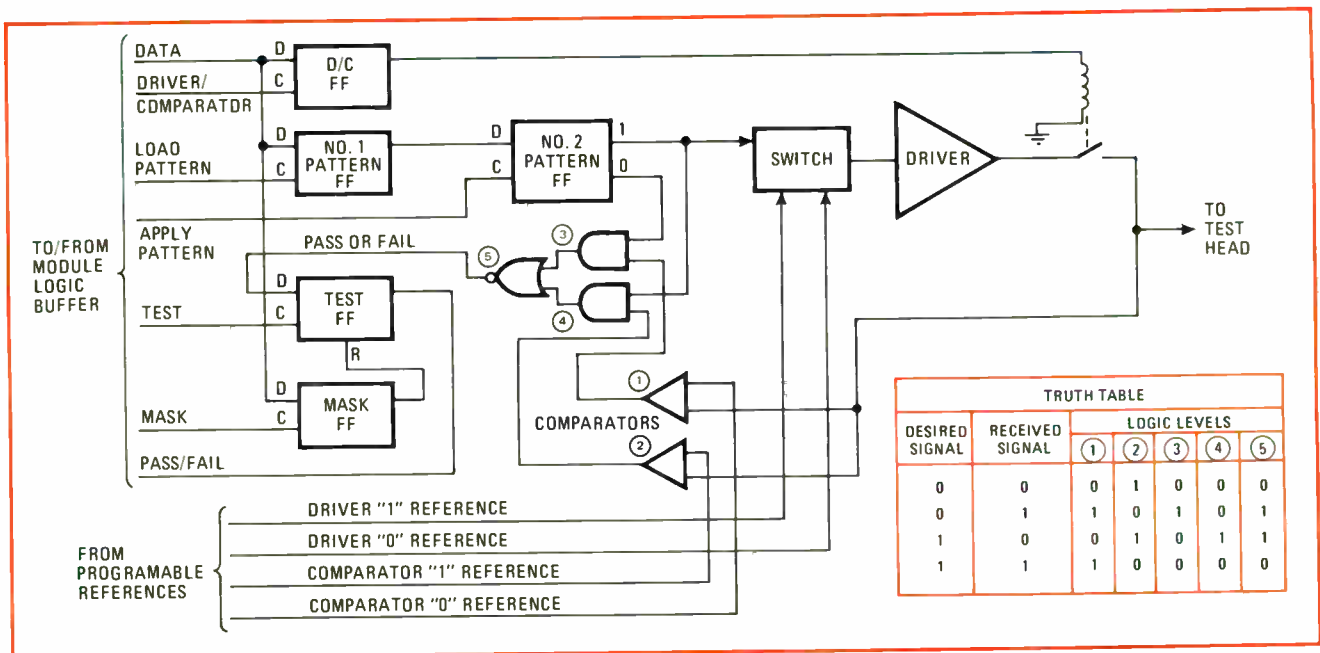

5. Driver/comparator. One of these circuits is used for each of the 256 lines between the functional tester and a digital assembly. The latter is tested by sending actual data to it and checking its response. The truth table shows how the logic levels at various points for combinations of desired and actual signals set the test flip-flop, which then shows "pass" or "fail."

If he's not one of our computer salesmen, that's the one thing he probably won't bring up.

Because he probably can't bring anybody over to do it for you.

But we can.  
And we will.

And we'll bring over all the modules (including special modules), labs, wire wrap service, cabinets, hardware, assembled logic arrays, terminals and technicians it takes to

do the job.

For us it's easy, because our Logic Products Group makes it all themselves, or gets what they need from one of our other groups, so it all fits together when it gets there.

## When you buy a computer the hooker in the deal can be "Who's going to hook it up?"

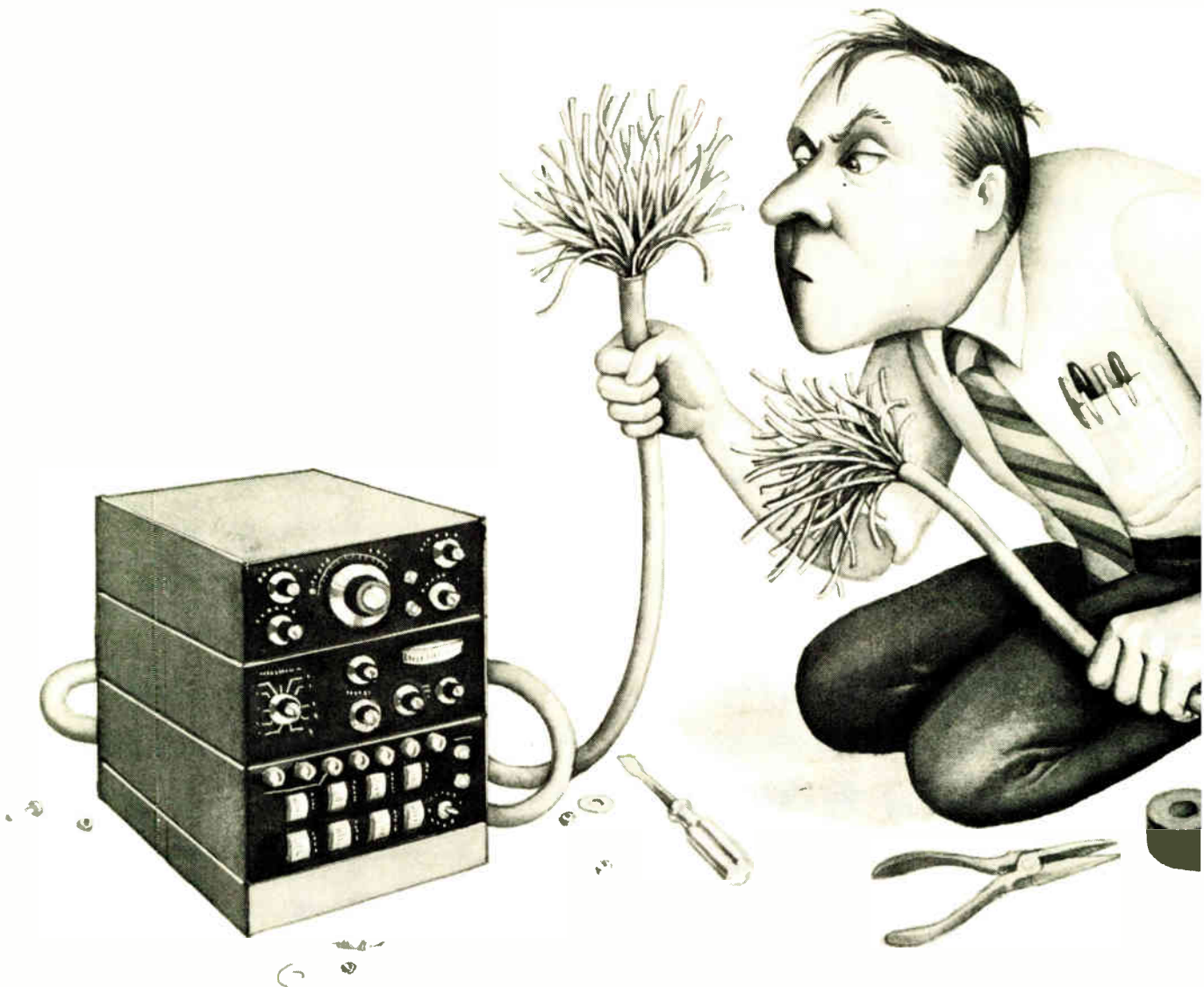

We can do it because we've had, we've got, and we keep getting the kind of designers, engineers and logic people it takes to make and market more kinds of computers, and everything it takes to make a com-

puter work right, right from the start, than any other computer company in the world.

We're the Logic Products Group, Digital Equipment Corporation, Maynard, Massachusetts 01754/(617) 897-5111 (Ext: 2785) in the U.S.

81 route de l'Aire, 1211 Geneva 26/(022) 42 79 50 in Europe.

**digital**

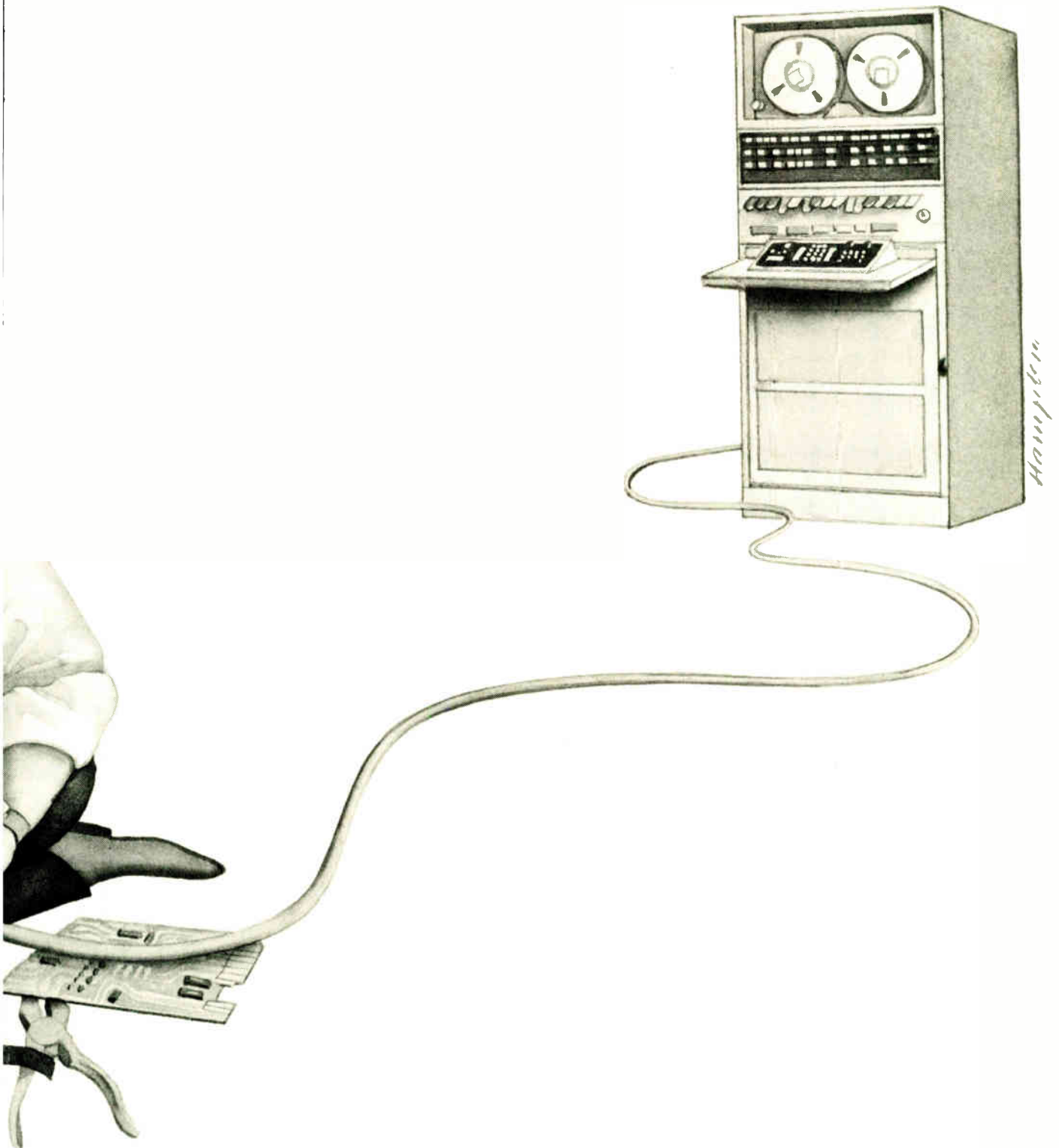

# Accurate comparator keeps pace with ECL

The speed of a system is generally limited if it contains analog elements; but the 10-nanosecond propagation delay of this new comparator is no drag on even the fastest digital circuitry

by James N. Giles and Alan Seales, *Advanced Micro Devices Inc., Sunnyvale, Calif.*

□ No matter how fast designers make the digital part of a complex system, the analog components often kill the over-all system speed. But that need no longer be the case with comparators.

A throughput delay of less than 10 nanoseconds makes a recent circuit the fastest single-chip comparator in operation today. Such a response time matches that of the newest emitter-coupled logic systems, and enables the designer to exploit digital performance to the full.

The chip can be used in any system as an interface between the analog world and the input of a fast logic system. Alternatively, with its high sensitivity and good noise immunity, it can detect low-level logic signals in noisy environments.

To name a few specific applications, it will replace the costly and complex discrete circuitry that designers are presently forced to use in very fast analog-to-digital converters, data acquisition systems, and fast optical isolator systems. And it can also function as a sensitive line receiver or sense amplifier in 100-megahertz sample-and-hold circuits, and in very-high-frequency voltage-controlled oscillators.

## What has been lacking

Essentially, a comparator is an amplifier that measures the difference between a reference voltage and some input voltage. When the difference is zero, the output of the comparator, which is bistable, changes logic states. When the difference is not zero, the output stage stays at either logic 1 or logic 0, depending on the polarity of the difference signal. This capacity to distinguish between two voltage levels is obviously useful in, for example, analog-to-digital conversion, since that process involves balancing an unknown input voltage against some internally produced reference.

The basic requirements for a high-speed precision comparator are easy to state. Good resolution (dependent on high gain) and high common-mode and differential-voltage ranges are of course essential. Equally necessary are outputs compatible with standard logic levels, and, above all, very fast response to a wide range of signal levels.

A survey of presently available monolithic IC comparators (Table 1) reveals none that is wholly satisfactory. The industry workhorse, the 710, comes close, except that its 40-ns propagation delay is too slow for the

most demanding applications. The newer TTL-output circuits offer only marginal improvement over the 710 when measured under identical conditions of large input pulse and small overdrive. The ECL-output comparator, although fast enough, has such poor resolution that it can be used only for large input signals.

## ECL outputs plus latch input

To squeeze the last possible nanosecond out of the over-all delay, system designers are now using emitter-coupled logic in critical circuit areas. Fortunately, building a comparator with ECL output gates requires only one-third the gain of an equivalent TTL circuit for the same resolution, thanks to ECL's smaller output logic swing. This means that lower impedances can be used, and hence a larger bandwidth realized, for the same power dissipation.

Also, interfacing the linear input stages with the digital output gate presents no problems, since an ECL gate is basically a nonsaturating, overdriven differential amplifier. On the other hand, to drive a TTL gate properly from a linear amplifier is more difficult. It requires a large voltage swing suitably biased to track the input logic threshold with temperature, plus a large peak negative current capability to turn off the gate with minimum delay.

A comparator becomes even more useful if it includes a strobe or better yet a latch function. A strobe simply forces the output of the comparator to one fixed state, independent of input signal conditions, whereas a latch locks the output in the logical state it was in at the in-

TABLE 1: PROPAGATION DELAYS OF AVAILABLE MONOLITHIC IC COMPARATORS (100-mV INPUT STEP, 5-mV OVERDRIVE)

Type No.	Logic family	Propagation delay	Resolution
AM 111	TTL	200 ns	0.012 mV
$\mu$ A710	TTL	40 ns	1.4 mV
AM 106	TTL	40 ns	0.06 mV
$\mu$ A760	TTL	25 ns	0.5 mV
NE527/529	TTL	25 ns	0.5 mV
MC1650	ECL	12 ns	30 mV



stant the latch was enabled. The latch can thus perform a sample-and-hold function, allowing short input signals to be detected and held for further processing. Further, if it is designed to operate directly upon the input stage, the signal does not suffer any additional delay through the comparator, and can be acquired and held even if only a few nanoseconds wide.

### Come large, come small

The ability to accommodate a wide range of input signals is another mark of a comparator's utility. A comparator responds with most difficulty to a large-amplitude pulse that barely exceeds the input threshold. This forces the input stage of the comparator to swing from a full off state to a point somewhere near the center of its linear range, thus exercising both the large- and small-signal responses of the stage. Worse, if the comparator must have a 10-ns delay under these stringent conditions, then its need to reach its full rise-time value in very short time poses a real problem in design.

To obtain satisfactory speed for all input signals, and particularly for the worst-case condition, the input stage of the comparator must have a large bandwidth for small signals, a high slew rate for large signals, minimal voltage swings, and high gain. Large bandwidth can be realized by using low-value load resistors, by using processing and geometries that minimize parasitic capacitances, and by using transistors with the highest possible  $f_T$  (the frequency at which  $\beta$  is 1). High slew rates can be attained by keeping operating current high and capacitance low.

Minimum voltage swings and high gain, however, are

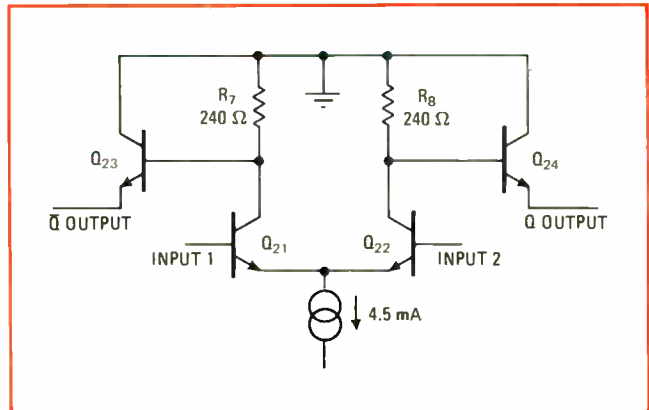

2. **The output.** Like the standard ECL output, the comparator's output has emitter followers ( $Q_{23}$  and  $Q_{24}$ ) that must present a geometry large enough to handle 50-ohm transmission loads yet also small enough not to slow down the outputs.

tough to get simultaneously. Obtaining high gain normally requires a large voltage swing, which therefore must be clamped. But the means of clamping must be one that does not degrade the propagation delay.

The over-all gain of the complete comparator must also be high, since the propagation delay is less if each stage is well overdriven. To ensure that most of the input overdrive signal is actually used for overdriving, and not consumed in just moving the output from one state to the other, the gain error should be no more than about 10% of the input overdrive. Therefore, for a typical 5-mV overdrive and ECL output swing of 800 mV, the minimum gain must be 1,600.

With an actual figure in hand, it is now possible to decide on the number of stages required as well as the gain per stage. Since the output stage must be ECL-compatible, its design is fixed, giving a differential-input to single-ended-output gain of about 6. This leaves a differential gain of 270 to be provided by the remainder of the comparator. The most efficient way is to divide it between two stages, each with a gain somewhat over 16. (Minimum over-all delay time is obtained when identical stages are cascaded.)

### Accuracy and the offset

In comparators, the lower the input offset voltage, the better the accuracy. Unless offset is trimmed out initially, it must be added to the overdrive, worsening the worst-case value of input signal for which the propagation delay specifications will be met. Even with trimming, the temperature drift of high offset units is typically much greater than that of low offset units. Therefore, it is desirable to have as low an initial offset as possible.

Also affecting the offset voltage, and its drift at higher source resistances, are the input currents. To keep this contribution to the total offset low requires input transistors with high current gains. In short, obtaining offsets in the desirable 1-2-mV range requires close attention to circuit design, mask layout, and very tight process control—the equivalent of that needed for high-performance, low-frequency operational amplifier, but with the kicker of  $f_T$  values greater than 1 gigahertz.

The trick in designing wideband circuits is to achieve

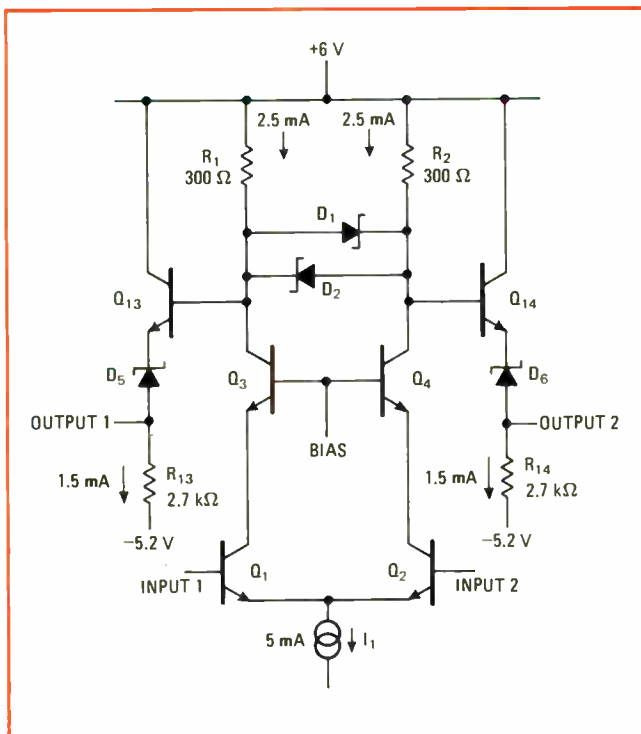

1. **The basic stage.** Innovative circuit design teams up with state-of-the-art processing to boost comparator's speed. The basic circuit is a differential cascode gain stage with Schottky clamps ( $D_1$  and  $D_2$ ) across the collectors of the cascode. Zeners ( $D_5$  and  $D_6$ ) are used to shift down cascode outputs for second stage.

the required gain with the minimum number of stages that have minimal impedance levels and minimal capacitance. The simple, common emitter differential amplifier would do, except for one major problem. When magnified by the Miller effect, the collector-to-base capacitance causes unwanted feedback that worsens as the frequency increases. Such a condition cannot be tolerated if maximum speed is to be achieved, even though the impedance levels will be only a few hundred ohms at most.

### Circuit design tradeoffs

The solution is to form a differential cascode amplifier by adding a pair of common-base transistors (Fig. 1). The circuit shown has been designed for a minimum differential gain of 16 and a minimum negative-going slew rate of 1,000 volts per microsecond, and has all the performance features of a common emitter amplifier minus the feedback capacitance.

The only complications are the need for the bias circuit for the cascode transistors, and a means of shifting the signal at the output of the cascode, which is very near the positive supply voltage, down to a lower voltage to drive the inputs of the second stage. In high-frequency applications, the voltage shift is best accomplished with a zener diode: its shunt capacitance to ground is low, being equal to the collector-to-base capacitance of a transistor; it has no capacitance to substrate; and its dynamic resistance is quite low.

In Fig. 1, zeners  $D_5$  and  $D_6$  are buffered from the cascode collectors,  $Q_3$  and  $Q_4$ , by emitter followers. The pulldown current through the zener-follower combination must be made large enough to discharge the node capacitance when the follower swings in the negative direction. The minimum value necessary is determined by the node capacitance, the amount of delay that can be tolerated, and the signal swing.

The signal swing can be reduced by adding Schottky-diode clamps across the collectors of the cascode as in the schematic of Fig. 1. Schottky diodes have the advantage of being fast and taking up little chip area—though their use does mean the process engineer has to control yet another set of characteristics without affecting other parameters.

The design of the output stage (Fig. 2), on the other hand, offers few tradeoffs, since it can vary little from that of a standard ECL gate. The geometry of the output emitter followers has to be large enough to handle 50-ohm (25-milliampere) transmission lines, yet small enough not to add much capacitance and slow down the response. Since the input common mode level varies with changes in the power supplies and resistor tolerance, a current source is used to supply the emitters of the gate, rather than the usual resistor to the negative supply. The source must provide the correct logic 1 and 0 levels at the output as well as the proper variation with temperature and power supply changes.

### Latching on

The simplest method of adding a latch to a differential amplifier is shown in Fig. 3a. A pair of transistors,  $Q_5$  and  $Q_6$ , is cross-coupled at the collectors of the input transistors,  $Q_1$  and  $Q_2$ . The current source,  $I_2$ , is

switched on when it is desired to enable the latch. If  $I_2$  is greater than  $I_1$ , the positive feedback via  $Q_5$  and  $Q_6$  will hold the circuit in whatever state it was in when the latch was turned on.

But the simple circuit in Fig. 3a won't do for very fast operation because transistors  $Q_5$  and  $Q_6$  add capacitance to the load resistors. They also saturate at high signal levels.

But the scheme fits quite neatly into a differential cascode stage (Fig. 3b). Here, drive for the positive feedback transistors is taken from the level shifters, and the collectors go to the emitters of the cascode. With such an arrangement there is no significant capacitive loading on the gain stage. The current source is switched by

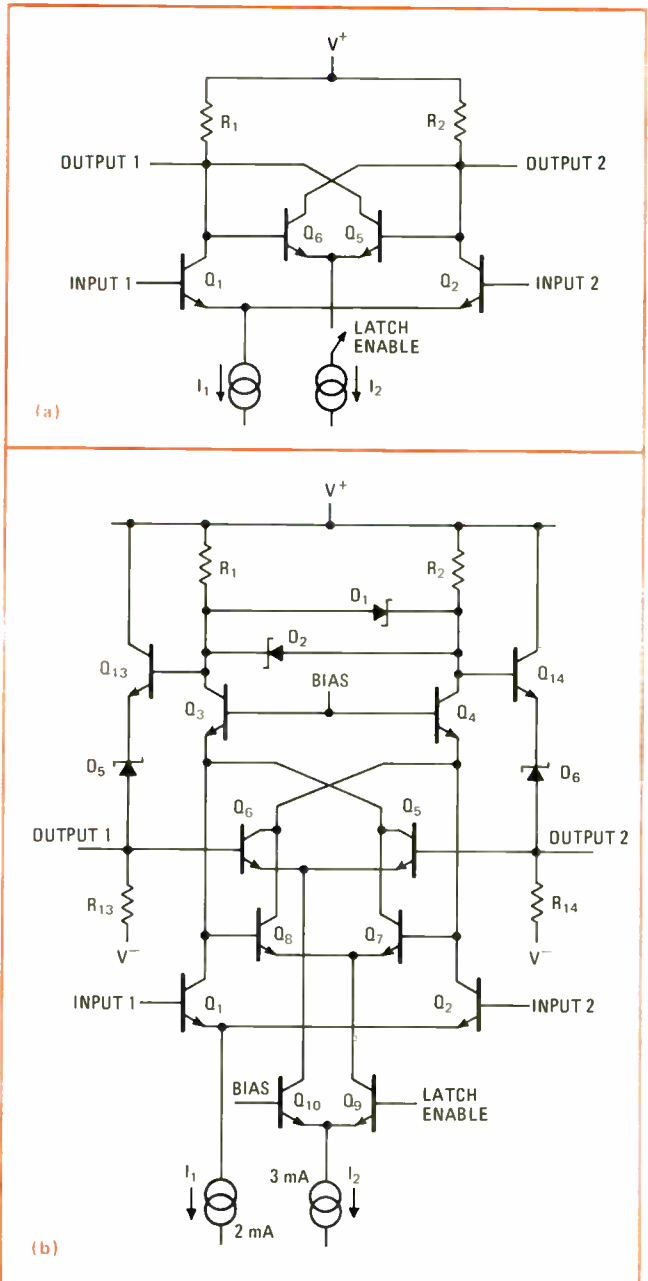

3. Hold It. Simple latch shown in (a) is not fast because the parasitic capacitance of  $Q_5$  and  $Q_6$  slows down the output. When the extra cascode stage shown in (b) is added, as was done in the output design of Fig. 2, no significant capacitance loading results.

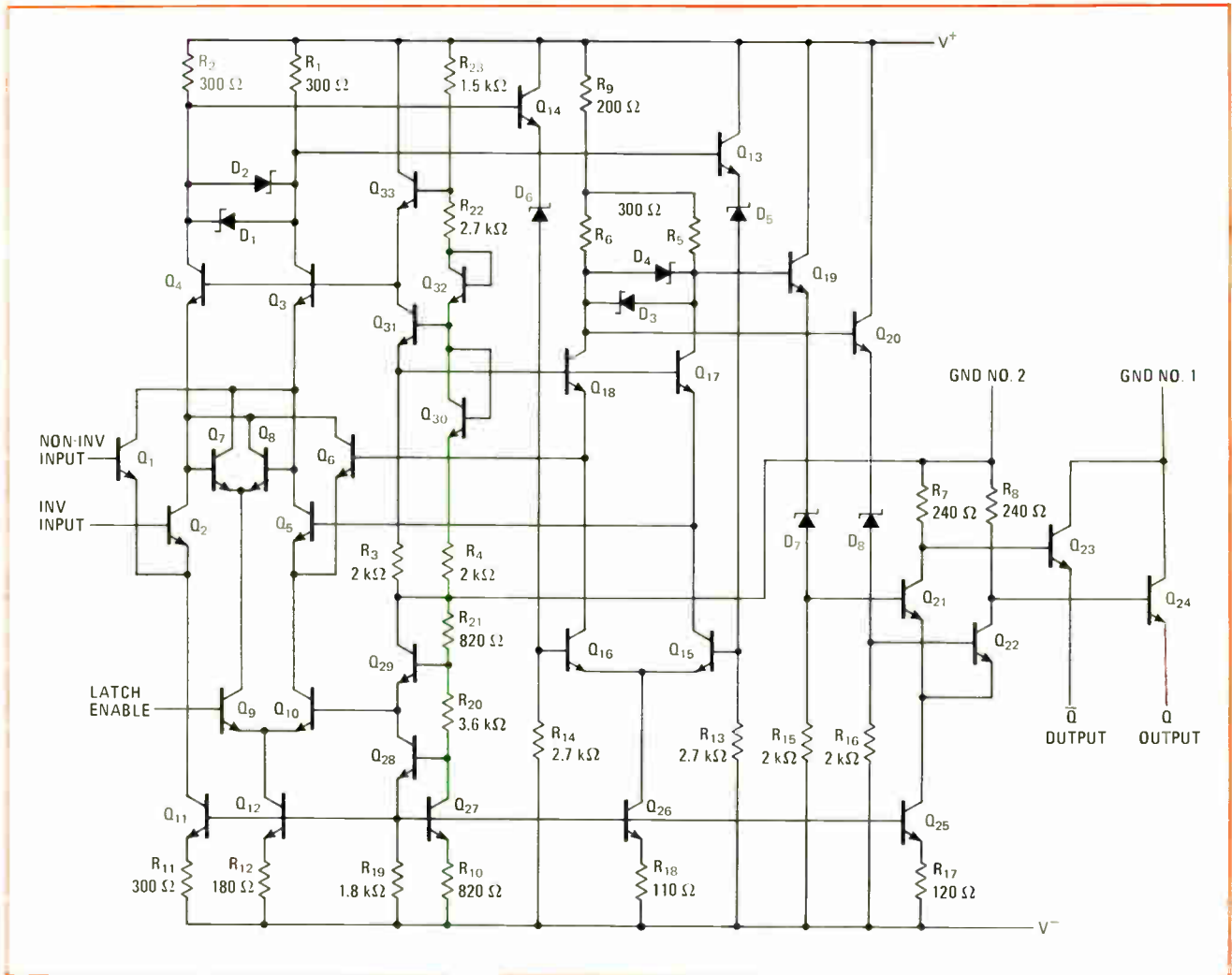

**4. The complete works.** The circuit values given in the schematic of the entire comparator provide the gain of 1,600 and the delay of less than 10 ns. Aiding in maintaining the good propagation delay are current sources that remain constant as temperature rises, and keep the open loop gain at 1,000 even at +125°C. For better matching, the latch drive is taken from the cascode emitters instead of zeners.

another differential amplifier, Q<sub>9</sub>-Q<sub>10</sub>, referenced to the ECL threshold voltage. This provides the correct input levels for the latch enable, since it is being driven from a standard ECL gate, and is also very fast, since only currents are being switched.

The latch current source, I<sub>2</sub>, must be about 1 mA greater than the 5-mA input current source, I<sub>1</sub>, to ensure positive latching for any condition of input signal. This requires that at least 6 mA be used to operate the latch. With the addition of two more transistors, however, (Q<sub>7</sub> and Q<sub>8</sub> in Fig. 3b), the latch standby power can be reduced to zero. When the latch enable is high, Q<sub>9</sub> is on and current source I<sub>2</sub> is supplied to these transistors. Since there is unity voltage gain from the input terminals to the emitters of the cascode, transistors Q<sub>7</sub> and Q<sub>8</sub> function as if they were simply connected in parallel with Q<sub>1</sub> and Q<sub>2</sub>, as far as the net effect at the collector load-resistor is concerned. To obtain the desired total stage gain, the current I<sub>1</sub> can be 2 mA and I<sub>2</sub> can be 3 mA.

Now when the latch enable goes low, I<sub>2</sub> is switched through Q<sub>10</sub> to the positive feedback transistors, stealing 3 mA from the gain stage and giving it to the latch. The

latch current is now 1 mA greater than the input stage current, but the total current required is still only 5 mA.

The parallel transistors have the added bonus of decreasing bias current by more than a factor of two, thus reducing its influence on the offset voltage. But a penalty is paid, too. All three pairs of junctions (Q<sub>1</sub>-Q<sub>2</sub>, Q<sub>3</sub>-Q<sub>4</sub>, and Q<sub>7</sub>-Q<sub>8</sub>) add equally to the input offset.

### The whole thing

The complete schematic of the comparator, AM685, is shown in Fig. 4. Notice that the drive for the latching transistors is taken from the emitters of the second cascode rather than from the level-shifting zeners. Thus their input capacitance is removed from the level shifter, and Q<sub>10</sub> is also prevented from saturating. A resistor, R<sub>9</sub>, is included to center the common mode voltage at the input to the gate within its dynamic range. Thus no saturation of the gate or its current source occurs over the expected range of signal swing, temperature drift, and supply voltage variations.

A separate ground is used for the output emitter followers so that heavy loading at the output will not couple back into the remainder of the circuit. The dc

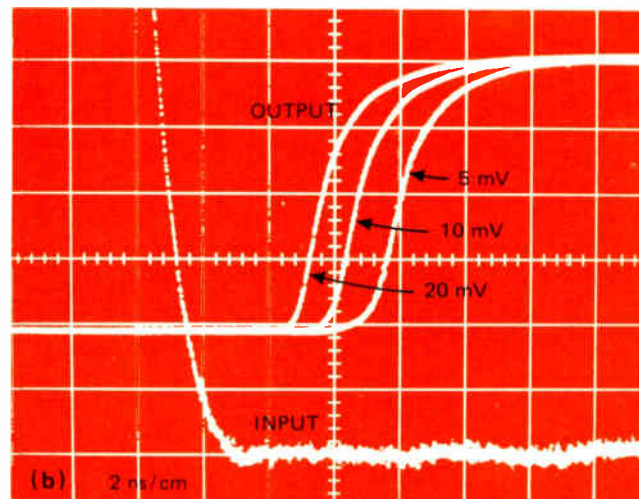
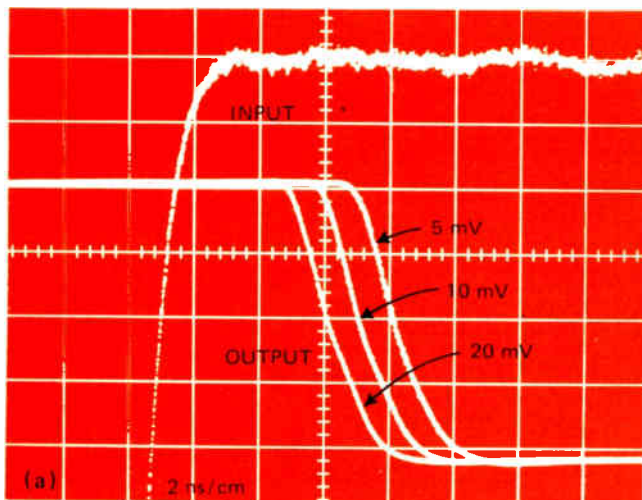

**5. Virtually no waiting.** For both kinds of logic swing, delays are reduced to a minimum. In (a), a 100-milliwatt logic 0 produces a 6.3-ns delay, while in (b) a logic 1 produces a delay that is about 300 picoseconds shorter. The delays are well within the design goal of 10 ns.

bias chain for the current sources is referenced to ground and to the negative supply, so the output logic levels will track those of other ECL circuits connected to the same negative supply. The current sources are designed to stay constant with temperature, which keeps the open-loop gain high at elevated temperatures (1,000 at +125°C), and so helps to maintain good propagation delay.

#### And now for the delay

The primary design objective for the comparator is to obtain under 10-ns propagation delay for large input signals for small overdrive. The performance of the comparator for a 100-mV step input at various overdrives is delineated in Fig. 5 for the output switching to both logic 0 and logic 1 levels. The propagation delay is measured from the time the input step crosses the input threshold (or offset) voltage to the time the output crosses the logic threshold voltage. For the traces shown, the offset voltage was adjusted so that the delay can be measured simply by counting up 5, 10, or 20 mV from the bottom of the input pulse. The input pulse, therefore, is displayed on a magnified scale to facilitate this measurement and also to illustrate the purity of input signal required to make accurate measurements at millivolt overdrives.

The traces show that, in general, the comparator attains its design goal of propagation delays of less than 10 ns. For a 100-mV input step and 5-mV overdrive, the propagation delay for a logical 0 (Fig. 5a) is 6.3 ns, and for a logical 1 (Fig. 5b) is about 300 picoseconds less.

The usefulness of the latch is directly related to how quickly it can be enabled following a change in the input signal. The input signal must last long enough to pass through the first stage of the comparator before the latching transistors can act upon it. The minimum time that the input must be present before the latch can be turned on is defined as the latch enable time. This is measured from the point when the input step crosses the input threshold voltage to the point when the latch enable input crosses the logic threshold voltage.

The performance of the latch function bears out the logic of the design. The latch enable time measured

with a 100-mV step input with 5-mV overdrive is 1.8 ns. The difference between the latch timing for which the output just switches and just does not switch is the latch aperture time; this is about 500 ps for 5-mV overdrive. Latch performance with input overdrive and temperature generally follows that of the propagation delays.

As for the effects of increased temperature on the propagation delay of the comparator, some degradation in speed does result at elevated temperatures, but the over-all speed is well within the design goals. The changes in resistor and gain values at high temperatures increase delay from 6.3 ns at 25°C to 8.4 ns at 85°C and 10.4 ns at 125°C. (All of the above data were taken with output loads of 50Ω connected to -2 v. For lighter loading, such as 500Ω to -5.2v, the output rise and fall times and propagation delays are all slightly faster.) The over-all performance of the comparator is summarized in Table 2. In terms of speed, sensitivity and accuracy, the AM685 is capable of interfacing the fastest ECL systems.

#### The a-d application

Very fast, precision, analog-to-digital conversion stands to benefit considerably from the availability of a fast comparator. As the block diagram of a fast 10-bit converter in Fig. 6 shows, a typical rapid conversion technique may resemble the use of feedforward compensation in an operational amplifier.

The analog input signal is sampled at the beginning of a conversion period and fed to a fast five-bit a-d converter, which provides the first five most significant bits of the output. These five bits also drive a companion d-a converter, which must be accurate to better than 10 bits. The output of the d-a converter is a replica of the input signal, quantized to five bits. This is compared with the actual input signal stored in the sample-and-hold amplifier. The difference between the two analog levels is the remaining part of the input signal that must be quantized. This difference is amplified and applied to another five-bit a-d converter to provide the five least-significant-bits of the final output.

Typical five-bit a-d converters may consist of 31 106-type comparators connected to the signal source and referenced to the full-scale input in steps of 1/32. The

**TABLE 2: COMPARATOR PERFORMANCE CHARACTERISTICS**

Propagation delay (100-mV step, 5-mV overdrive)	7.5 ns max
Input offset voltage	2.0 mV max
Average temperature coefficient of input offset voltage	10 $\mu\text{V}/^\circ\text{C}$ max
Input offset current	1.0 $\mu\text{A}$ max
Input bias current	10 $\mu\text{A}$ max
Common mode voltage range	$\pm 3.3$ V min
Common mode rejection ratio	80 dB min
Supply voltage rejection ratio	70 dB min
Positive supply current	22 mA max
Negative supply current	26 mA max

output of each comparator goes into a latch, and the latch outputs are decoded by three stages of TTL gates to develop the five-bit digital output.

Typical propagation delays are 40 ns for the comparators, 22 ns for the latches, and 10 ns for the decoding, resulting in a total delay of 80 ns. Average settling time for the five-bit d-a converter and the difference amplifier together comes to about 200 ns, and the settl-

ing time for the input sample-and-hold amplifier is 70 ns. Thus, the over-all conversion time for this 10-bit converter amounts to 430 ns.

Substitution of the high-speed ECL comparator for the 106 type in each of the five-bit converters leads to a significant improvement in propagation delay. The typical delay of the comparator is about 6.5 ns, and no external latch is required. With ECL it is possible to wire-OR outputs, so only one level of decoding gates is required. Allowing 1.5 ns for the gates, the total five-bit conversion time is only 8 ns—a tenfold improvement over the existing circuit.

If the latch function of the comparators is used as the sample-and-hold for the first five-bit converter, the sample-and-hold can be put in parallel with the first quantization step, as shown by the dotted lines in Fig. 6. This eliminates its settling time from the over-all delay of the system. With the new comparator, the total 10-bit conversion time drops to 216 ns, with over 90% of the delay attributable to the d-a converter and the difference amplifier. Moreover, the availability of an 8-ns five-bit converter should provide the impetus to improve the slower sections of the system. A 10-bit a-d converter with a delay under 100 ns is not an extravagant prediction.  $\square$

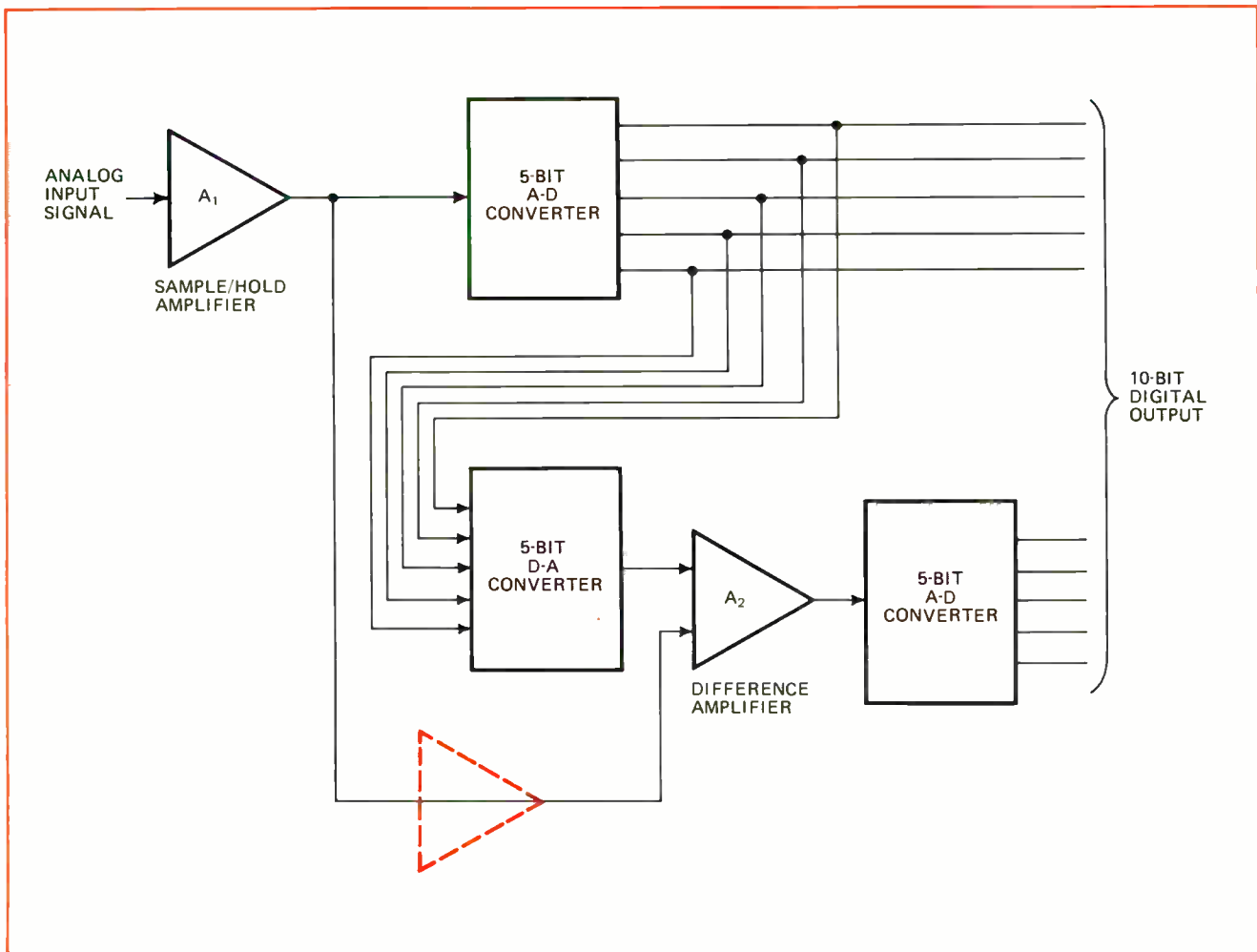

**6. Analog to digital.** If the standard 106-type comparator in this a-d converter is replaced by the 10-ns device, a tenfold improvement in speed is possible. What is more, the ECL makes possible both wired-OR outputs and a single level of decoding for gates.

**Here's something  
even more reliable  
than your old  
Scout knife.**

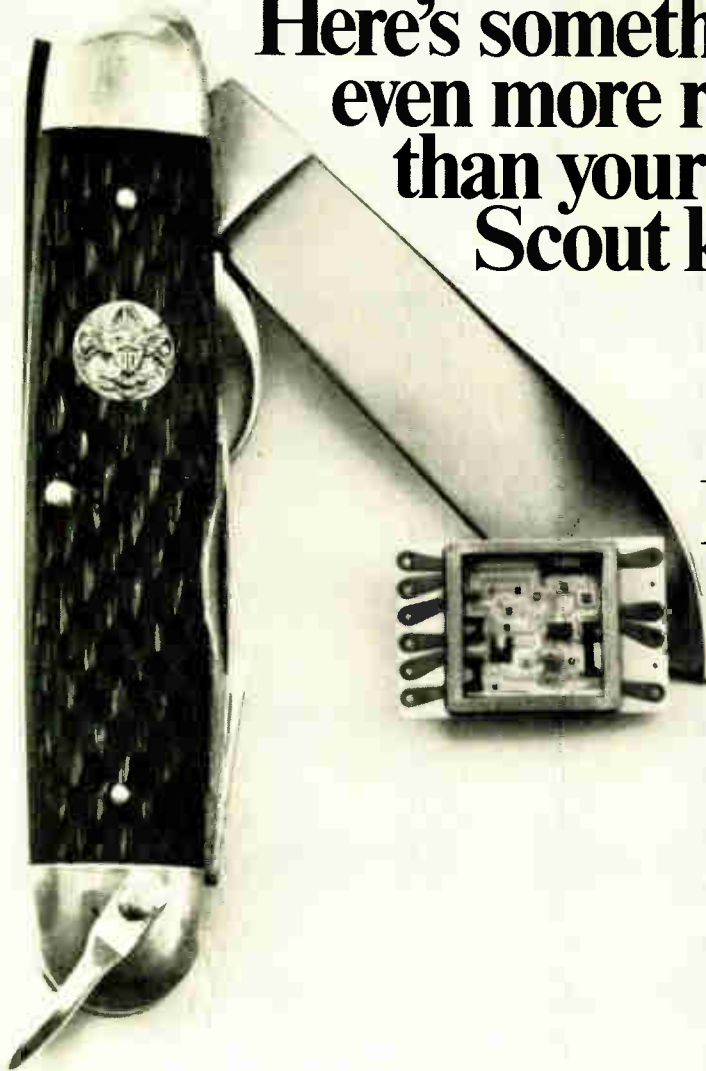

**Raytheon  
microelectronic  
circuits.**

Remember when you slipped that knife out of your pocket? You never had a doubt you could tackle anything. From cutting down a tree — eventually — to opening up a can of beans. You knew it wouldn't fail — ever.

That's the kind of feeling Raytheon builds into microelectronics. Custom hybrid circuitry that may use discrete components, monolithic chips or beam lead IC's. Very specialized circuits that aren't available off anyone's shelf.

**We specialize in reliability.**

Quality assurance to satisfy virtually every NASA / military / commercial requirement. Unmatched engineering and packaging. Plus a production capability proven by thousands of successful circuits. And delivery to specification, on time.

Cut through all your microelectronic circuit problems. Contact Raytheon Company, Industrial Components Operation, 465 Centre Street, Quincy, Mass. 02169.



## Single time measurement determines capacitor R and L

by Carlo Venditti  
Charles Stack Draper Laboratory, MIT, Cambridge, Mass.

The quality of a practical capacitor can usually be judged from its dissipation factor figure, unless the capacitor is to be used at frequencies above 1 megahertz. Then the capacitor's internal inductance must be taken into consideration, and a measurement that complements the dissipation factor test must be made.

A time measurement technique that employs two commonly available laboratory instruments—the pulse generator and the oscilloscope—permits internal capacitor inductance, as well as internal capacitor resistance, to be evaluated directly from scope voltage readings. Both polarized and nonpolarized units can be tested.

The equivalent circuit of a capacitor is shown in Fig. 1. Conductance  $G$ , which represents the losses in the dielectric, and resistance  $R$  can be found by measuring the dissipation factor at a specific frequency:

$$D.F. = \omega CR + G/\omega C$$

where  $C$  is the capacitance, and  $\omega$  the radian frequency. To determine both effective capacitor resistance  $R$  and inductance  $L$  with a single time measurement, the associated test circuit of Fig. 1 is used.

Capacitor voltage response to an excitation pulse is monitored with the scope. The dc offset of this response allows the effective capacitor resistance to be computed, while the overshoot above the dc offset, which is due to the turn-on transient excursion, allows the effective inductance to be computed. The transient excursion occurs during the rise time of the input pulse because of the inductance. Input-pulse rise time must be at least as

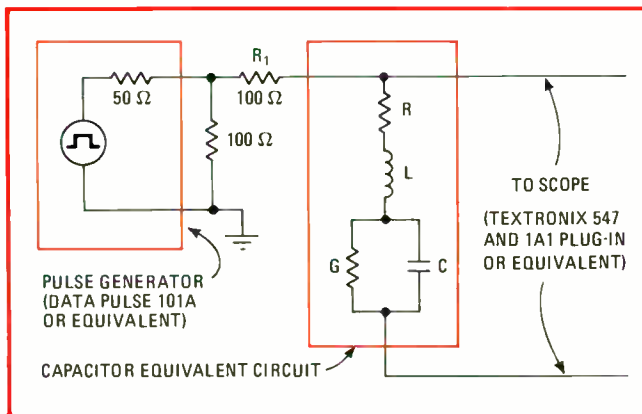

**1. Testing capacitor quality.** Internal inductance and resistance of capacitor are measured by applying fast-rise-time pulse to voltage divider network and displaying capacitor transient voltage response on scope. Conductance  $G$  in capacitor-equivalent circuit represents losses in the capacitor dielectric.

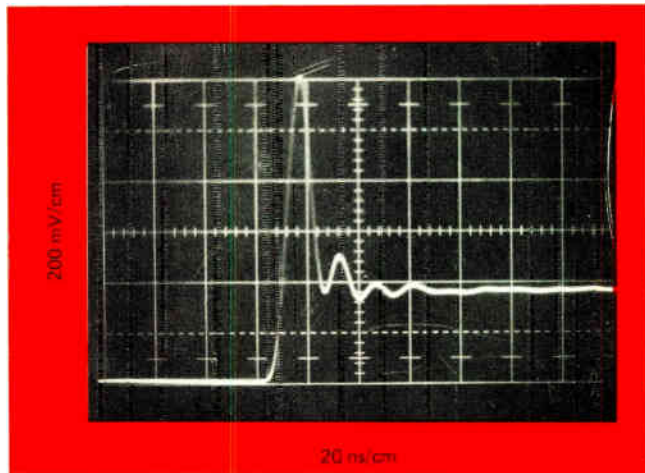

**2. Evaluating the response.** Capacitor transient response registers effective capacitor resistance by amount of dc offset voltage and effective inductance by height of peak overshoot above dc offset level.

fast as 15 to 30 nanoseconds to produce a measurable transient response.

Input-pulse voltage  $V_i$  can be approximated by two ramp functions: one is a positive-going ramp that starts at  $t_0+$  and rises to amplitude  $A$  in  $\alpha$  seconds; the second is a ramp with the same, but negative, slope that begins at  $t - \alpha$  seconds and has an amplitude of  $A$ . The slope of the ramps can be labeled  $K$  ( $K = A/\alpha$ ), allowing the Laplace transform of  $V_i$  to be written as:

$$V_i(s) = K/s^2 - K \exp(-\alpha s)/s^2$$

And the Laplace transform of capacitor voltage is:

$$V_o(s) = [(R + sL)/(R_1 + R + sL)]V_i(s)$$

By using partial-fraction expansion and then taking the inverse Laplace transform of the terms, the capacitor voltage can be written as:

$$V_o(t) = K(R/R_1)tU(t) + KL[(R_1 - R)/R_1^2]U(t) - K(R/R_1)(t - \alpha)U(t - \alpha) - KL[(R_1 - R)/R_1^2]U(t - \alpha) - KL[(R_1 - R)/R_1^2]\exp(-R_1 t/L) + KL[(R_1 - R)/R_1^2]\exp[-R_1(t - \alpha)/L]$$

This equation can be considerably simplified to compute the effective  $R$  and  $L$  from the voltage information on the scope display. For example, Fig. 2 shows the response of a 4.7-microfarad capacitor. The input pulse has an amplitude of 5 volts ( $A = 5$ ) and a rise time of 16 nanoseconds ( $\alpha = 16 \times 10^{-9}$ ). Thus, the positive ramp approximation has a slope of:

$$K = A/\alpha = 5/(16 \times 10^{-9}) = 3.12 \times 10^8$$

The dc offset voltage of 0.36 v can be read from the scope face, and resistance  $R$  computed from the first term of the equation for  $V_o(t)$ :

$$R = 0.36R_1Kt = 0.36(100)/(3.12 \times 10^8)(16 \times 10^{-9})$$

$$R = 7.2 \text{ ohms}$$

To find inductance  $L$ , the other five terms that make up the  $V_o(t)$  expression can be factored and equated to the peak voltage excursion of 1.2 v:

$$KL(R_1 - R)/R_1^2 + K(R/R_1)t = 1.2 \text{ v}$$

Subtracting the dc offset contribution from the total

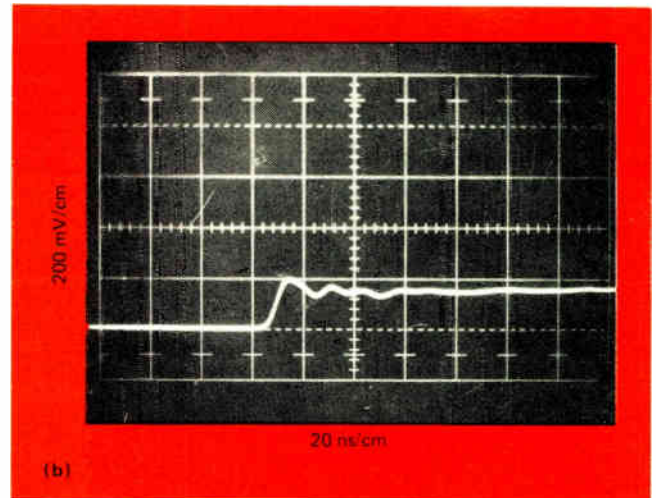
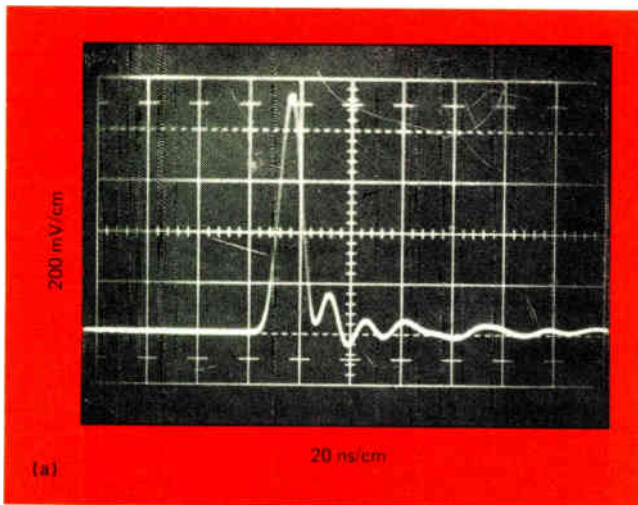

**3. Dissipation factor is not enough.** Capacitor with low dissipation factor (a) exhibits low effective resistance, but has high effective inductance. Although dissipation factor of another capacitor (b) is higher because of higher resistance, its inductance is almost negligible.

voltage leaves the voltage contribution due to L:

$$KL(R_1 - R)/R_1^2 = 1.2 - 0.36 = 0.84 \text{ v}$$

Solving for L yields:

$$L = 0.84R_1^2/K(R_1 - R) = 0.84(100)^2 / (3.12 \times 10^8)(100 - 7.2)$$

$$L = 0.29 \text{ microhenries}$$

These simplified computations for R and L are valid because the RC time constant of the test circuit is extremely long, while the L-R<sub>1</sub> time constant is short, compared to the duration of the transient condition.

In addition to quantitative evaluations, the test circuit can be used to make qualitative judgements as to what capacitor is best for a given application. The responses of two different 1-μF capacitors illustrate this point.

Figure 3a shows the scope display for a capacitor that has a dissipation factor of only 0.005 because its effective resistance is low. Its effective inductance, however, is quite high. On the other hand, the display (Fig. 3b) for a second capacitor, one that has a dissipation factor of 0.05, indicates that its effective resistance is higher than that of the first capacitor, but its effective inductance is considerably lower. If a low dissipation factor were the criterion for determining a capacitor's high-frequency (above 1 MHz) performance, the capacitor with the higher effective inductance—a detriment at high frequencies—would be chosen.

As with most critical measurements, care must be taken to minimize extraneous signal pickup within the test circuit. Every lead must be shielded, and the circuit must be calibrated with noninductive resistors.

Caution must also be observed when capacitance values are 0.01 μF or less, because the test circuit's time constant becomes too small for meaningful results to be obtained. A small RC time constant allows the capacitor to begin charging too soon. By increasing the value of test-circuit resistor R<sub>1</sub> to about 1 kilohm and speeding up the rise time of the excitation pulse to around 10 ns, the response of a 500-pF capacitor can be measured.

Minimum width for the excitation pulse is 0.2 microseconds, and its period should be at least 10 times larger than the test circuit's RC time constant. As already mentioned, nominal pulse amplitude is 5 v, and pulse rise time can generally vary between 15 and 30 ns. The pulse generator itself must be properly terminated.

Since transient conditions are being observed, the response time of the scope should be good. The one used here has a 7-ns rise time capability. If only qualitative testing is to be done, the rise time of the scope and the excitation pulse can be equal to each other. However, for quantitative measurements, the rise time of the scope must be two to three times faster than that of the excitation pulse. □

## How to really look at low-drift IC op amps

by Stan Harris  
Analog Devices, Inc., Norwood, Mass.

There's more to high accuracy in an integrated-circuit operational amplifier than low drift with temperature. Total output error accumulates from a number of

sources, all of which should be considered when choosing an op amp. An error budget analysis that accounts for worst-case error voltages attributable to gain, offset voltage and bias currents, CMRR, as well as other parameters, will give a much more significant measure of accuracy than simply comparing microvolts/°C specifications.

To make the analysis, first assume a circuit configuration—either the actual circuit or some arbitrary circuit. Then list the specifications that are meaningful for accurate circuit operation, noting the minimum or maximum value of each parameter over the required tem-



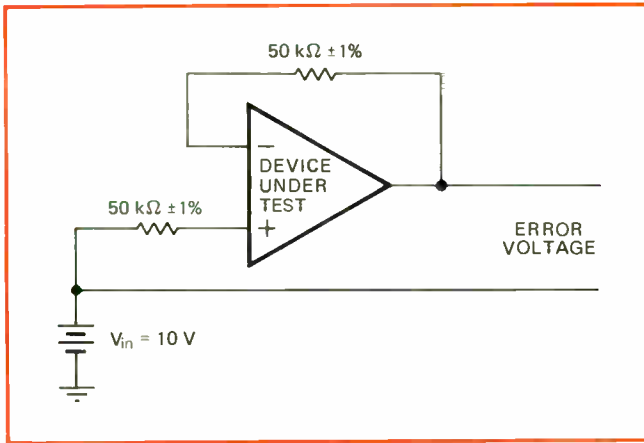

perature range. Such min and max values are usually available from the spec sheets, but if they are not, then either use experience to assign the value from the given typical value, or get in touch with the op amp makers to ascertain a proper value. It may take some spec sheet interpretation to be reasonably sure that all the parameters of concern are specified in the same way by the various manufacturers (e.g., warmed-up versus initial values, CMRR at what  $V_{in}$ ?).

Now go down the list and compute the value of each input error by considering how the specifications contribute to error in the operating configuration. If, for example, an amplifier is intended for accurate dc operation, the following specs are important and should be considered: gain, input bias and offset currents, offset voltage, input offset voltage drift, common-mode and power supply rejection ratios—and their changes (or values) over the temperature range. In the non-inverting circuit shown, the source resistance,  $R_S$ , is assumed to

be 50 kilohms,  $R_S$  mismatch is 2%, input is 10 volts, and power supply variation is assumed to be  $\pm 5\%$ .

Several IC op amps, each of which provides excellent performance in one or more of the characteristics that comprise the error budget analysis, are compared. The error parameters of six different op amp types are detailed for two temperature ranges.

Choosing op amp A from those listed, the errors are defined and calculated as follows:

- Gain: with a minimum gain of  $10^6$ , 10  $\mu\text{V}$  are required across the amplifier inputs to generate a 10-v output voltage. This 10  $\mu\text{V}$  is the gain-error voltage.
- Bias current: a 1% resistor tolerance gives a total resistor mismatch of 1 kilohm. This results in a 10- $\mu\text{V}$  input voltage error, due to the 10-nanoampere maximum  $I_b$  spec.
- Offset current: the offset current of 1 nA through the 50-kilohm source resistance gives a 50- $\mu\text{V}$  error voltage.
- Offset voltage: most high-accuracy op amps can be easily offset-voltage-nulled (one op amp used in the analysis could not be), thus effectively eliminating this parameter as an error source.
- Offset-voltage drift: the maximum spec sheet number multiplied by the appropriate temperature range produces this error voltage. (In general, a linear interpolation will not introduce significant variations from reality—but it might.)
- CMRR: given a 10-v common-mode signal, the 110-decibel minimum spec results in 32  $\mu\text{V}$  of common-mode error voltage.
- PSRR: with a  $\pm 5\%$  power-supply tolerance, a worst-case change of 1.5 V, multiplied by a maximum PSRR of 10  $\mu\text{V}/\text{V}$ , gives an error voltage of 15  $\mu\text{V}$ . □

Engineer's Notebook is a regular feature in Electronics. We invite readers to submit original design, applications, and measurement ideas. We'll pay \$50 for each item published.

OP AMP ERROR BUDGET ANALYSIS										
Error parameter (min or max)	$T_A = +25^\circ\text{C to } +45^\circ\text{C}$					$T_A = 0^\circ\text{C to } +70^\circ\text{C}$				
	A	B	C	D	E	A	B	C	D	E
Gain	( $1 \times 10^6$ ) 10 $\mu\text{V}$	( $8 \times 10^4$ ) 125 $\mu\text{V}$	( $1 \times 10^5$ ) 10 $\mu\text{V}$	( $10 \times 10^4$ ) 100 $\mu\text{V}$	( $5 \times 10^4$ ) 200 $\mu\text{V}$	( $50 \times 10^4$ ) 20 $\mu\text{V}$	(est. $6 \times 10^4$ ) 167 $\mu\text{V}$	( $80 \times 10^4$ ) 12.5 $\mu\text{V}$	(est. $7 \times 10^4$ ) 143 $\mu\text{V}$	( $2.5 \times 10^4$ ) 400 $\mu\text{V}$
Bias current ( $I_b$ )	(10 nA) 10 $\mu\text{V}$	(2 nA) 2 $\mu\text{V}$	(80 nA) 80 $\mu\text{V}$	(50 nA) 50 $\mu\text{V}$	(75 nA) 75 $\mu\text{V}$	(15 nA) 15 $\mu\text{V}$	(est. 2.5 nA) 2.5 $\mu\text{V}$	(100 nA) 100 $\mu\text{V}$	(est. 75 nA) 75 $\mu\text{V}$	(120 nA) 120 $\mu\text{V}$
Offset current ( $I_{os}$ )	(1 nA) 50 $\mu\text{V}$	(0.2 nA) 10 $\mu\text{V}$	(5 nA) 250 $\mu\text{V}$	(30 nA) 1500 $\mu\text{V}$	(10 nA) 500 $\mu\text{V}$	(1.6 nA) 80 $\mu\text{V}$	(est. 0.3 nA) 15 $\mu\text{V}$	(7 nA) 350 $\mu\text{V}$	(est. 45 nA) 2250 $\mu\text{V}$	(15 nA) 750 $\mu\text{V}$
Offset voltage ( $V_{os}$ )	(trim to 0) 0	(500 $\mu\text{V}$ ) 500 $\mu\text{V}$	(trim to 0) 0	(trim to 0) 0	(trim to 0) 0	(trim to 0) 0	(est. 730 $\mu\text{V}$ ) 730 $\mu\text{V}$	(trim to 0) 0	(trim to 0) 0	(trim to 0) 0
Offset voltage drift ( $\Delta V_{os}/\Delta T$ )	(0.5 $\mu\text{V}/^\circ\text{C}$ ) 10 $\mu\text{V}$	(5.0 $\mu\text{V}/^\circ\text{C}$ ) 100 $\mu\text{V}$	(0.6 $\mu\text{V}/^\circ\text{C}$ ) 12 $\mu\text{V}$	(1.0 $\mu\text{V}/^\circ\text{C}$ ) 20 $\mu\text{V}$	(15 $\mu\text{V}/^\circ\text{C}$ ) 300 $\mu\text{V}$	(0.5 $\mu\text{V}/^\circ\text{C}$ ) 35 $\mu\text{V}$	(5.0 $\mu\text{V}/^\circ\text{C}$ ) 350 $\mu\text{V}$	(0.6 $\mu\text{V}/^\circ\text{C}$ ) 42 $\mu\text{V}$	(1.0 $\mu\text{V}/^\circ\text{C}$ ) 70 $\mu\text{V}$	(15 $\mu\text{V}/^\circ\text{C}$ ) 1050 $\mu\text{V}$
CMRR	(110 dB) 32 $\mu\text{V}$	(96 dB) 160 $\mu\text{V}$	(120 dB) 10 $\mu\text{V}$	(est. 96 dB) 160 $\mu\text{V}$	(90 dB) 320 $\mu\text{V}$	(100 dB) 100 $\mu\text{V}$	(96 dB) 160 $\mu\text{V}$	(115 dB) 18 $\mu\text{V}$	(est. 90 dB) 320 $\mu\text{V}$	(90 dB) 320 $\mu\text{V}$
PSRR	(10 $\mu\text{V}/\text{V}$ ) 15 $\mu\text{V}$	(16 $\mu\text{V}/\text{V}$ ) 24 $\mu\text{V}$	(5 $\mu\text{V}/\text{V}$ ) 7.5 $\mu\text{V}$	(est. 50 $\mu\text{V}/\text{V}$ ) 75 $\mu\text{V}$	(15 $\mu\text{V}/\text{V}$ ) 22.5 $\mu\text{V}$	(15 $\mu\text{V}/\text{V}$ ) 22.5 $\mu\text{V}$	(16 $\mu\text{V}/\text{V}$ ) 24 $\mu\text{V}$	(7 $\mu\text{V}/\text{V}$ ) 10.5 $\mu\text{V}$	(est. 60 $\mu\text{V}/\text{V}$ ) 90 $\mu\text{V}$	(15 $\mu\text{V}/\text{V}$ ) 22.5 $\mu\text{V}$
Noise	Difficult to estimate because of non-uniform specifications. Range approximately from 2 $\mu\text{V}$ to 10 $\mu\text{V}$ , not a significant % of the total.									
Total	127 $\mu\text{V}$	921 $\mu\text{V}$	369.5 $\mu\text{V}$	1905 $\mu\text{V}$	1417.5 $\mu\text{V}$	272.5 $\mu\text{V}$	1448.5 $\mu\text{V}$	533 $\mu\text{V}$	2948 $\mu\text{V}$	2662.5 $\mu\text{V}$
Price (100-lot)	\$20.00	\$14.95	\$16.30	\$20.00	\$2.25					

# Dash-8

Now for immediate, off-the-shelf delivery of any of these hi-rel linears just add this suffix (-8) to their part numbers.

Harris' Dash-8 Program. It's our new, short order way to give off-the-shelf delivery of hi-rel devices (Mil Spec 883, Class "B"). Right now the program is limited to linears but will be expanding soon to include other devices. To facilitate ordering we now have available a new product description and specification manual covering linear devices in the program. To



obtain a copy, call your Harris distributor or representative. Dash-8: a service innovation from Harris. How about dashing out an order? Now.

Dash-8 linears available now:

#### OP AMPS

HA-909-8  
HA-2101-8  
HA-2101A-8  
HA-2741-8  
HA-2107-8  
HA-2400-8  
HA-2500/2502-8  
HA-2510/2512-8  
HA-2520/2522-8  
HA-2600/2602-8  
HA-2620/2622-8  
HA-2700-8

#### COMPARATOR

HA-2111-8

#### D/A CONVERTER

HI-1080-8

#### MULTIPLEXERS

HI-1800/1800A-8  
HI-1818/1828/1818A/1828A-8

#### DASH-8 FLOW

MIL-STD-883, Method 5004, Class B, 100% Screening Procedure

SCREEN	METHOD
1. Internal Visual (Precap)	2010.1 Condition B
2. Stabilization Bake	1008, Condition C, 24 hours minimum
3. Temperature Cycling	1010, Condition C
4. Centrifuge	2001, Condition E Y, Plane, 30K G's minimum
5. Hermeticity, Fine Leak	1014, Condition A
6. Hermeticity, Gross Leak	1014, Condition C Omit Step 1. No vacuum Preconditioning Step 2
7. Burn-In	Method 1015, 168 hours @ 125°C (Burn-in circuit enclosed). Cooled to 25°C before removal of bias
8. Final Electrical 8.1 D C Tests at 25°C, Maximum and minimum operating temperatures 8.2 A C Tests at 25°C	Per appropriate Harris DASH-8 Data Sheet
9. External Visual	Method 2009
10. Lot Acceptance	MIL-STD-883, Method 5005, Class B Group A, Table 1

# Harris



**HARRIS**  
**SEMICONDUCTOR**  
A DIVISION OF HARRIS-INTERTYPE CORPORATION

P.O. Box 883, Melbourne, Florida 32901  
(305) 727-5430

**WHERE TO BUY THEM:** ARIZONA: Phoenix—Liberty, Weatherford; Scottsdale—HAR (602) 946-3556 CALIFORNIA: Anaheim—Weatherford, El Segundo—Liberty, Glendale—Weatherford; Long Beach—HAR (213) 426-7687; Mountain View—Elmar; Palo Alto—Weatherford, HAR (415) 321-2280; Pomona—Weatherford; San Diego—Weatherford, Western COLORADO: Denver—Elmar, Weatherford WASHINGTON, D.C.: HAR (202) 337-3170 FLORIDA: Hollywood—Schweber; Melbourne—HAR (305) 727-5430 ILLINOIS: Chicago—Semi-Specs, Schweber; Palos Heights—HAR (312) 597-7510 INDIANA: Indianapolis—Semi-Specs MARYLAND: Rockville—Schweber MASSACHUSETTS: Lexington—R&D, Waltham—Schweber; Wellesley—HAR (617) 237-5430 MICHIGAN: Detroit—Semi-Specs MINNESOTA: Minneapolis—Semi-Specs MISSOURI: Kansas City—Semi-Specs; St. Louis—Semi-Specs NEW MEXICO: Albuquerque—Weatherford NEW YORK: Melville—HAR (516) 249-4500; Syracuse—HAR (315) 463-3373; Rochester—Schweber; Westbury—Schweber OHIO: Beachwood—Schweber; Dayton—Semi-Specs PENNSYLVANIA: Pittsburgh—Semi-Specs; Wayne—HAR (215) 687-6680 TEXAS: Dallas—Weatherford, Semi-Specs, HAR (214) 231-9031 WASHINGTON: Seattle—Liberty, Weatherford.

**LEGEND FOR HARRIS SALES OFFICES & DISTRIBUTORS:** Harris Semiconductor (HAR); Elmar Electronics (Elmar); Harven/R&D Electronics (R&D); Liberty Electronics (Liberty); Schweber Electronics (Schweber); Semiconductor Specialists, Inc. (Semi-Specs); R. V. Weatherford Co. (Weatherford); Western Radio (Western).

## Keep your HP-35 from wandering

If you've shelled out \$395 for Hewlett-Packard's HP-35 scientific pocket calculator, you may be willing to part with another \$24.50 to help you hold on to the 9-ounce machine. That will buy you an accessory consisting of a security cradle that can be attached to a desktop or table; the calculator itself locks into the cradle. There's also an option: a 6-foot stainless steel cable, fastened to the desk or table and the security cradle to permit greater mobility for the HP-35. And the calculator can be removed from the cradle if you want to use it outside the office.

Inquiries about this and other accessories (an \$18 holder to charge an extra set of batteries, or a heavy leather field case for \$19.50) should be sent to Inquiries Manager, Hewlett-Packard Co., 1501 Page Mill Rd., Palo Alto, Calif. 94304.

## Will C-MOS become next logic family?

Put Motorola Semiconductor's name near the top of the list of manufacturers that believe complementary MOS is going to occupy a place as a logic family of the future. The Phoenix, Ariz., company, developing MSI and LSI functions in C-MOS at the rate of 40 circuits a year, says it will continue that pace at least through 1973. The current crop of off-the-shelf devices is described in a recently updated brochure, "McMOS," that's available from Motorola's Technical Information Center, 5005 McDowell Rd., P.O. Box 20912, Phoenix, Ariz., 85036.

But Motorola isn't neglecting another lucrative segment of its business—communications. Recently published is a 64-page book, "Semiconductors for Communication Systems." It covers solid-state devices suggested for both radio and wire systems. The book is available from the Phoenix address above, but the box number is 20924.

## Symposium to list triservice needs for manuals

If you're involved in preparation of manuals for either or all of the military services, a meeting scheduled in Washington later this month should be extra valuable. Sponsored by the National Security Industrial Association, the two-and-a-half-day symposium, Oct. 25 to 27, is entitled "Equipment Manuals for the New Decade."

The symposium will get under way with a keynote address by Assistant Secretary of Defense Barry J. Shillito. Then, senior Pentagon officials will discuss the user needs, budget guidelines, future hardware design, and engineering, maintainability, and support requirements affecting technical manuals. The NSIA is at the Union Trust Building, 15th and H Streets N.W., Washington, D.C. 20005.

## Addenda

Cherry Electrical Products Corp. is offering a "Design Engineer's Switch and Keyboard Selector's Guide" to more than 200 switches and keyboards. The 14-page brochure is available from Cherry at Box 718, Waukegan, Ill. 60085. . . . If you need a handy reference for the spectral-response characteristics of typical photocathode materials, RCA has a dandy wall chart. Write RCA Electronic Components, 415 South Fifth St., Harrison, N.J. 07029.

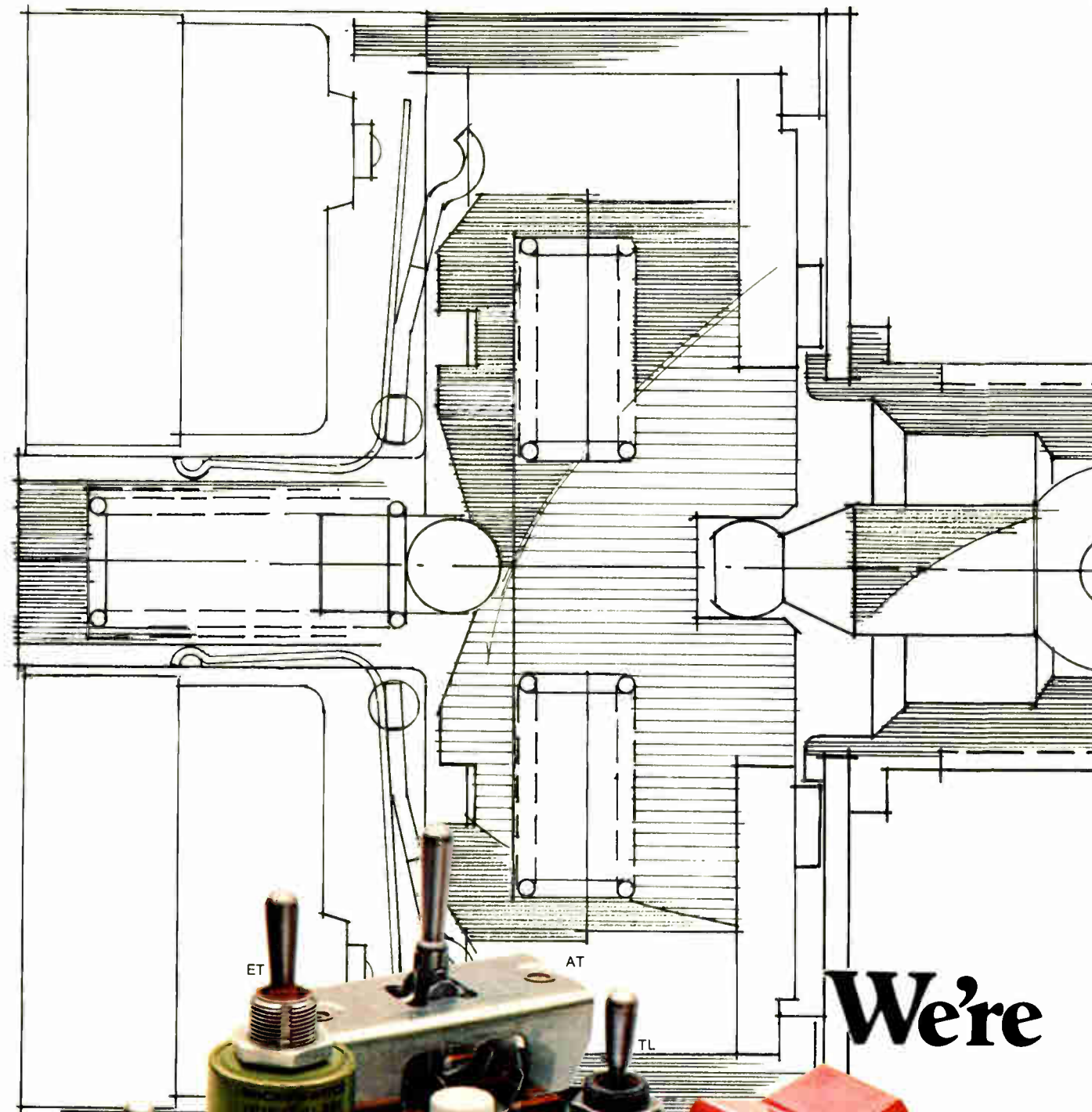

# We're



MICRO SWITCH products are available worldwide through Honeywell International.

**T**hink MICRO SWITCH when you're in the market for toggle switches. Because we offer one of the biggest selections in the world. With an almost limitless choice of size, circuitry, capacity and toggle action.

#### CHOICE NOT CHANCE.

If space is a problem, miniature TW's can provide versatility comparable to many larger switches. When cost is a problem, the new Series 8 features quality construction at a low cost. Standard-size TS toggles are excellent, moderately-priced switches available for both military and commercial use.

For environmental sealing, consider either the magnetically held ET (MIL-E-5272 and MIL-S-3950A) or the tough TL (MIL-S-3950A).

If you're looking for the versatility and styling of pushbuttons, but require toggle circuitry, take a long look at the TP or our new Series 8 rocker switches.

#### A CHOICE OF ASSEMBLIES, TOO.

AT toggle assemblies use snap-action switches to perform the switching operation. Up to twelve switches can be operated by one toggle. Choose from subminiature, high capacity, as well as sealed types.

There are plenty more. For information on any or all of them, see your MICRO SWITCH Branch Office or Authorized Distributor (Yellow Pages, "Switches, Electric"). Or write for our literature.

*MICRO SWITCH makes your ideas work.*

## **MICRO SWITCH**

FREEPORT, ILLINOIS 61032  
A DIVISION OF HONEYWELL

Circle 125 on reader service card

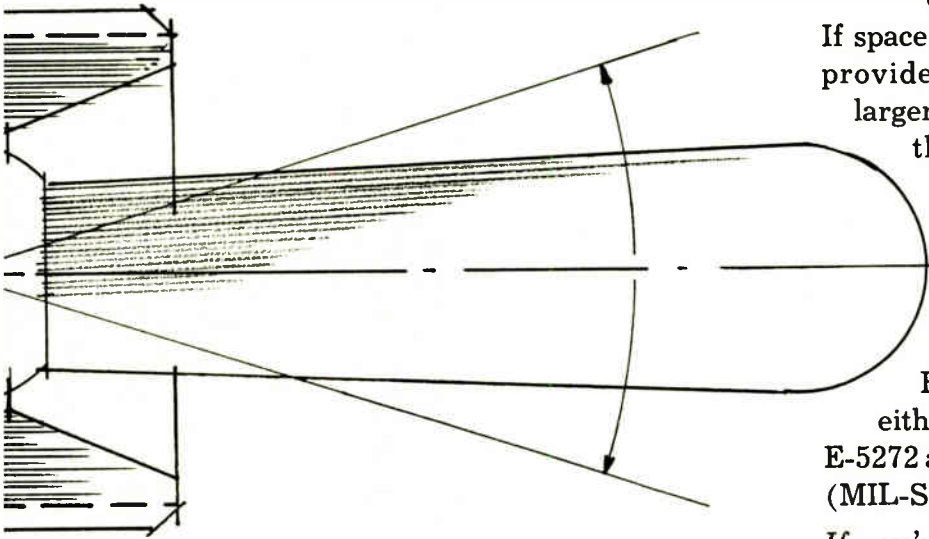

# big in toggle switches.

# Quiet!

## That's the word for selected linears from Microsystems International

Quiet means virtual elimination of popcorn noise and 1/f noise—typically less than 1 db increase at 10Hz over the 1KHz value.

Add low drift rates of between  $1 \mu\text{V}/^\circ\text{C}$  and  $3 \mu\text{V}/^\circ\text{C}$ ; and long term stability to the built-in characteristics of our op amps and quiet becomes synonymous with quality—the highest quality.

Selected means a broad range of products carefully chosen to meet most of the needs of the design engineer—op amps, both single and dual—many with internal frequency compensation; voltage regulators and comparators; line drivers and receivers; reference diodes and transistor arrays. All manufactured with Microsystems unique QL process, the quiet, high quality process. All fully tested to commercial, industrial or military specifications, including MIL std. 883 class B. All backed-up by world-wide applications engineering support.

When considering your next linear order remember the selected linears from Microsystems International, they're available now in most popular packages, or as chips.

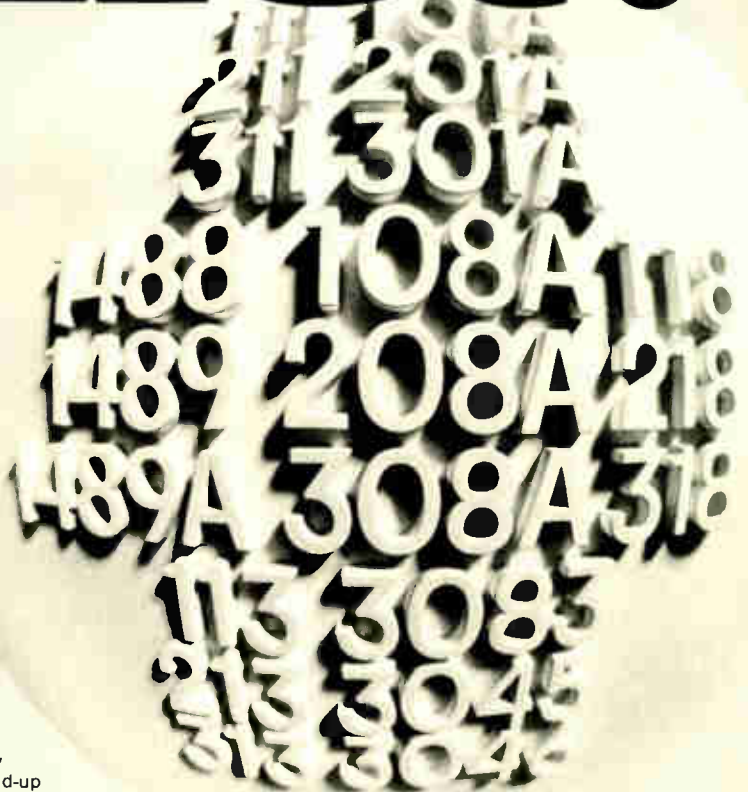

## selected linears from the performance leader



microsystems international limited, box 3529 station c, ottawa, canada — montreal, ottawa, toronto, brussels, stuttgart, london, palo alto, philadelphia.

For further information—call or write your nearest Microsystems sales office or distributor.

**U.S.A. MICROSYSTEMS INTERNATIONAL SALES OFFICES:** CALIFORNIA — Orange, Phone 714-637-2330 Palo Alto, Phone 415-493-0848 ILLINOIS — Schaumburg, Phone 312-894-7660 MINNESOTA — New Hope, Phone 612-544-1802 NEW HAMPSHIRE — Nashua, Phone 617-762-8298 PENNSYLVANIA — Philadelphia, Huntingdon Valley, Phone 215-WI 7-5641 '2  
**SALES REPRESENTATIVES:** ARIZONA — Scottsdale, Erskine Associates, Phone 602-263-7654 CALIFORNIA — Los Altos, W W Posey, Phone 415-948-7771 Santa Ana, Rical Associates, Phone 714-557-6543 CONNECTICUT — New Canaan, Stan Pierce Inc., Phone 203-966-4630 FLORIDA — Indialantic, Tech-Rep Associates, Phone 305-723-9140 Largo, Tech-Rep Associates, Phone 813-595-2834 GEORGIA — Chamblee, Tech-Rep Associates, Phone 404-939-8339 ILLINOIS — Itasca, Lou Bacher & Associates, Phone 312-773-1810 INDIANA — Indianapolis, R E Marguart & Associates, Phone 317-253-3997 MARYLAND — Baltimore, L H Kolman Co., Phone 301-752-8756 MASSACHUSETTS — Norwood, Stan Pierce Inc., Phone 617-762-1114 MISSOURI — St. Louis, Perm Sales Co., Phone 314-427-7200 NEW YORK — Cicero, Advanced Components Inc., Phone 315-699-2671 New York, ABC Electronics Sales, Phone 516-747-6816 OHIO — Columbus, Tom Mulligan & Associates, Phone 614-457-1242 PENNSYLVANIA — Philadelphia, ABC Electronics Sales, Phone 215-464-2275 TEXAS — Addison, Camion Sales, Phone 214-739-9196 WASHINGTON — Seattle, Carlyle Technical Sales, Phone 206-632-4290

**DISTRIBUTORS:** ARIZONA — Phoenix, Kierulf Electronics, Phone 602-273-7331 CALIFORNIA — Gardena, Santa Monica Bell, Phone 213-321-5802 Los Angeles, Wesco, Phone 213-685-9525 Menlo Park, Bell Electronics, Phone 415-323-9431 San Carlos, Sterling Electronics, Phone 415-592-2353 San Diego, Kierulf Electronics, Phone 714-278-2112 COLORADO — Denver, Kierulf Electronics, Phone 303-343-7090 FLORIDA — Clearwater, Switland Electric, Phone 813-443-4514 LONG ISLAND — Freeport, Milgray Electronics Inc., Phone 516-546-6000 MARYLAND — Baltimore, Arrow Electronics Inc., Phone 301-247-5200 MASSACHUSETTS — Dedham, Gerber Electronics, Phone 617-329-2400 Watertown, Sterling Electronics, Phone 617-926-9720 NEW JERSEY — Haddonville, Mid-Atlantic, Phone 609-428-8288 NEW YORK — Rochester, Simcona Electronics, Phone 716-328-3230 NEW MEXICO — Albuquerque, Kierulf Electronics, Phone 505-247-1055 TEXAS — Dallas, Semiconductor Specialists Inc., Phone 214-358-5211 WASHINGTON — Seattle, Kierulf Electronics, Phone 206-763-1550

**CANADA — MICROSYSTEMS INTERNATIONAL SALES OFFICES:** ONTARIO — Ottawa, Phone 613-828-9191 Toronto, Phone 416-279-1358 QUEBEC — Montreal, Phone 514-875-2814  
**SALES REPRESENTATIVES:** BRITISH COLUMBIA — Vancouver, A W Bleue, Phone 604-685-7914 DISTRIBUTORS: BRITISH COLUMBIA — Vancouver, R A E Industrial Electronics Ltd., Phone 604-687-2621 ONTARIO — Milton, Semiconductor Specialists (Canada) Ltd., Phone 416-678-1444 QUEBEC — Montreal, Cesco Electronics Limited, Phone 514-735-5511

## C-MOS moves in fast on TTL territory

New logic types, pin replacements point to \$25 million total in '73; process advance by Harris Semiconductor improves speed-power product

**Process innovations** and an expanding range of logic circuits are combining to change the face of complementary metal-oxide semiconductor technology. At one time considered a specialty technology implemented primarily for very-low-power or electrically noisy applications, C-MOS has emerged as a heavy-duty logic family that promises to rival transistor-transistor logic, not only in the data-processing world but in such equipment as automobiles and appliances, where digital electronics has scarcely been applied.

The latest technology advance comes from Harris Semiconductor, Melbourne, Fla., which uses dielectric-isolation in its new family of circuits, the HD-4000 series. The result is greatly reduced gate capacitance that allows speeds comparable to those of TTL gates. At the same time, devices can be placed closer together.

James Dykes, product marketing manager, says that Harris is planning to add 11 more C-MOS circuits to the eight it has already announced [*Electronics*, Sept. 25, p. 41]. These new parts will also be dielectrically isolated, and Harris is planning to expand still further its C-MOS line with polysilicon isolated devices, which the company feels will result in a truly LSI logic family.

Concurrently, the number of logic types available in standard C-MOS—both in the new families developed by RCA and Motorola, and as “replacements” for TTL circuits, developed by National Semiconductor Corp., Mountain View, Calif.—is also at an all-time high and growing. RCA is already stocking nearly 50 logic parts in its CD 4000A COS/MOS series, and it is sampling

10 more. Second-source suppliers in both areas are busy, too.

Solid State Scientific Inc., Montgomeryville, Pa., for example, has in its SCL-4000 series about 30 of the RCA parts, plus about a half-dozen offshoots in its SCL-4400 line.

Motorola Semiconductor Products Inc., Phoenix, says it is adding about 40 C-MOS products this year to the seven it had last year, splitting them between the MC14000 line (second source to RCA) and its own MC14500 line. Even National, the first to announce C-MOS units geared to replace Texas Instruments' 7400-series TTL [*Electronics*, Nov. 22, 1971, p. 26]—it now has about a dozen—is second-sourcing RCA with approximately 10 parts. Also going both ways is Solitron, which says its RCA parts are its biggest sellers. And, like most C-MOS manufacturers, Solitron has its own designs—its 4100 series.

The impact of C-MOS is only beginning to be felt. The world market is projected to range between \$125 million and \$200 million by 1975. This year, the market will hit \$15 million, according to RCA, and next year it's projected at \$25 million.

“C-MOS circuits will have the same impact as 5400/7400 TTL,” declares Jack Handen, market planner for the COS/MOS product line at RCA. He says this, even though the typical gate-propagation delays in the standard RCA line are slower than 5400/7400 TTL.

But Handen sees “literally thousands” of digital applications not

tied to the speed of a mainframe computer. Beyond the initial applications in clocks and watches, he looks forward to uses in portable measuring instruments, seat-belt sensors, and other electronic circuitry in automobiles, as well as telephone repertory dialers. Even peripheral-equipment makers are looking to COS/MOS, he says.

Right now, a C-MOS gate is more

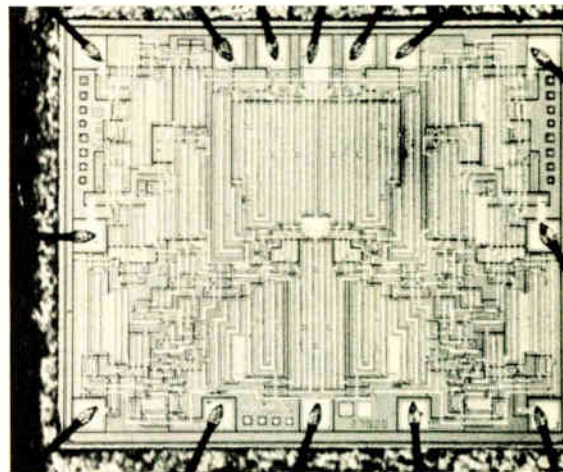
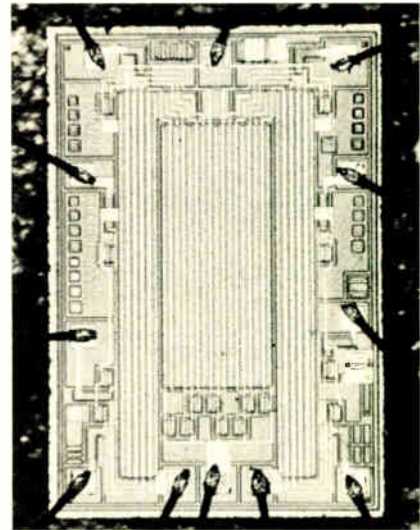

**Challengers.** Family of eight dielectric-isolated C-MOS circuits introduced by Harris Semiconductor includes a dual 4-input NAND gate (top) and a dual D flip-flop.

# NEW 2800 SERIES DC TO DC CONVERTERS

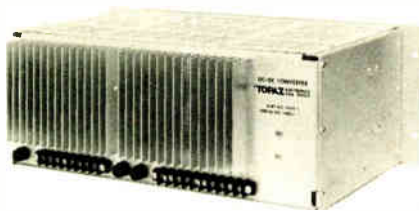

## STANDARD RATINGS:

Input: 48, 125VDC  
Output: +5VDC,  $\pm 15$ VDC,  
+24VDC and 115VAC

## SPECIFICATIONS:

Output Voltage Regulation—  
line and load

+5VDC and  $\pm 15$ VDC:  
 $\pm 1\%$  max.  
24VDC and 115VAC:  
 $\pm 5\%$  max.

Ripple

+5VDC and  $\pm 15$ VDC:  
50 mv p-p max.  
24VDC

1.0 volt p-p max.

Efficiency: 65% at full load.

## BENEFITS:

Reverse polarity protection  
Line transient protection  
Output current limiting  
Overvoltage protection, remote  
sense on +5VDC output  
100VA power capability at  
115VAC output

	OUTPUT +5VDC	$\pm 15$ VDC	+24VDC	PRICE	DELIVERY
Current	15A	1A	2A	\$ 825	Stock
	30A	2A	2A	\$ 925	Stock
	50A	3A	2A	\$1075	4 weeks

# TOPAZ

**ELECTRONICS**

3855 Ruffin Road, San Diego, CA. 92123  
Phone (714) 279-0111 TWX: (910) 335-1526

## New products

expensive—by a factor of about two—than a TTL gate. But prices will, of course, come down as volume picks up. Motorola's Ronald P. Komatz, manager of MOS product development and planning, predicts complex functions will be competitive with TTL by the end of the year.

And even more bullish on increased complexity is Dykes, who feels that with new Harris isolation techniques, circuit-gate complexities at the 100- to 200-level will soon be forthcoming, greatly reducing TTL package counts and significantly lowering system costs.

**Power advantage.** But manufacturers emphasize that a complete C-MOS system will turn out cheaper because of other savings, too. For example, the lower-power C-MOS requires smaller, and hence less expensive, power supplies, points out Robert H. Mason, sales manager at Solid State Scientific. Consequently, blowers and other cooling contrivances may be reduced or eliminated. Also, since C-MOS can operate with a much greater range of usable supply and signal voltages, regulation of supplies is less of a problem, Mason continues. And the greater noise immunity of C-MOS means far less need for careful thermal design or critical attention to ringing and ground planes. Consequently, printed-circuit boards can be simpler and cheaper.

Right now, the industry is concerned over which logic types will become the most popular—National's TTL replacements, or RCA's new family. Most digital designers are already familiar with the 7400-series TTL logic functions and pin-outs, points out Gene Carter, product marketing manager at National. Thus it is very easy to design with National's 74C family. Nomenclature is also similar to make things easy. For example, the replacement for RCA's 7474 TTL, a dual-D flip-flop, is National's 74C74.

But easy replacement of TTL with C-MOS may not be the ultimate answer for designers. For maximum savings, each whole system should be redesigned, and if this is the case, designers might as well learn the design constraints and circuitry of the

new C-MOS family, say suppliers of the devices.

As for speed, however, Harris certainly has taken the lead, exhibiting a 2:1 improvement over existing C-MOS devices, says Donald Sorchych, vice president and general manager. For a supply voltage of 3 volts, a typical gate in the HD-4000 series (again those RCA numbers) operates at a 50-nanosecond delay. But at a  $V_{DD}$  supply of 10 volts, the same gate operates at a propagation delay of only 10 ns, comparable to any TTL gates. Overall, the Harris devices exhibit toggle rates of better than 6 MHz with a supply voltage of 5 v, a 50% increase in frequency over existing C-MOS products. And what's more, with a 10-v supply, the Harris circuits can operate at toggle rates in excess of 15 MHz. In addition, they have a quiescent power dissipation 1/10th that of standard C-MOS and several orders of magnitude less than TTL.

Probably all companies are working on higher-speed versions of their devices. RCA, for example is relying on silicon-gate technology, and devices should become available early next year, says Harry Weisberg, manager for MOS IC and liquid-crystal products. Motorola also is looking into its VIP process, originally developed for high-density bipolar parts. Other techniques include ion implantation and silicon on sapphire and other substrates.

So far, eight parts, including NOR and NAND gates, inverter, buffer, and flip-flop, have been announced in the Harris HD-4000 series. Seven are pin-for-pin replacements for their RCA counterparts, while exhibiting "greatly improved speed and power characteristics over any competitive devices." The eighth, the HD-4809, a triple true-complement buffer, is an original Harris device. More than 30 will be announced by next summer. All units are available in dual in-line packages and most come in 14-pin packages. Both commercial and military types are available.

Reporters on this story were Laurence Altman, Solid State Editor; Paul Franson, Los Angeles bureau manager; and Stephen Wm. Fields, San Francisco bureau manager. The story was written by Alfred Rosenblatt, New York bureau manager.



# Variety comes to ARINC connectors.



Variety in standard types, and in not-so-standard types. From environmentally sealed, unsealed, and filter types, to those designed to accept flat flexible conductor cable, flat etched circuitry, and for use directly with PC boards. AMP has them all.

Standard or special, all our connectors are intermateable and intermountable with other ARINC connectors. All feature rear insertion and release for better contact loading and stability.

And all meet ARINC Specification 404 and MIL-C-81659 requirements. Precision screw-machined contacts can be terminated with hand crimping tools—or with our high-speed, automatic stripper/crimper machine. Now it's easy to specify ARINC connectors for any application. Just talk to AMP. Write for data on the most complete line of ARINC connectors. **AMP Incorporated, Industrial Division, Harrisburg, Pa. 17105.**

**AMP**  
INCORPORATED

Manufacturing and direct sales facilities worldwide: Barcelona, Brussels, Buenos Aires, Frankfurt, London, Mexico City, Paris, Puerto Rico, Sao Paulo, s'Hertogenbosch (Holland), Sydney, Stockholm, Tokyo, Toronto, Turin, Vienna

Circle reader service number  
129 Please send literature—immediate interest.  
173 Please send literature—possible future interest.

The amplifier-per-channel  
Neff system 620

# Like marrying Miss America and finding out that she can cook too!



You marry a ravishing beauty. Then, after the honeymoon, find out she can cook up a storm, and balance the budget too. That's getting more than you bargained for.

Our good looking Neff System 620 also gives you more than you bargained for. Both in performance and economy.

Behind that handsome 7-inch high front panel is a *complete* data acquisition system. 64 field-proven Neff differential amplifiers and active filters — one for each channel. *Plus* a high level FET multiplexer, a gain programmable amplifier, a high speed 14 bit ADC, and TTL control logic. All you supply are the transducers and the computer.

Everyone agrees that for performance, the amplifier-per-channel approach is the way to go. With complete isolation right at the signal source, higher CMR, less crosstalk, lower noise, higher speed, greater accuracy, continuous analog outputs, protection against loss of data on other channels, and filtering *after* amplification, where it belongs.

The price is a happy surprise, too. Less than \$150 a channel. And expandable. Just add 3 more boxes for a 256 channel system which prices out at under \$40K. Or order the *big* configuration. Up to 2,048 channels!

We're getting orders for System 620 from all over the world. For applications we never knew existed. So send for the complete story on this thrifty beauty that's cooking up a storm in data acquisition circles.



1088 East Hamilton Rd., Duarte, California 91010  
Telephone (213) 357-2281 TWX 910-585-1833

Circle 130 on reader service card

# Controllers become more versatile

Increased use of read-write memories, other innovations tailor programable units to changing control functions; economic upturn raises market goals

by Alfred Rosenblatt, New York bureau manager

In the more than two years since programable controllers were introduced, sales—held back by the general economic downturn—have fallen below expectations. But manufacturers of these units, whose solid-state logic processors and memories replace banks of hard-wired electromechanical relays in controlling repetitive production operations, have not been idle. And when the convention of the National Machine Tool Builders Association opened in Chicago last month, manufacturers had a variety of hardware and software innovations to show.

The companies also had new sales predictions for programable controllers. These ranged from \$5 to \$6 million for 1972 sales, projected by Allen-Bradley Co. and General Electric Co. (up from \$3.5 million in 1971, says Allen-Bradley) to a healthy \$15 million predicted by Allan R. Devault, manager of the recently organized industrial products group at Digital Equipment Corp. In 1971, Devault maintains, the market total hit \$8 million, and he expects it to grow to about \$100 million by 1975. Allen-Bradley, on the other hand, forecasts a 1976 total sales of \$25 to \$30 million.

One of the newest companies to enter the programable controller field is the Eagle Signal division of Gulf & Western Industries Inc., Davenport, Iowa. In its new Controlpac 600, a 256-bit metal-oxide semiconductor random-access memory can store interim logic conditions that occur during a control cycle. Ordinarily such states may be stored in a controller's output registers. These are basically transistorized flip-flops with added pulse trans-

formers for isolation and Triacs to drive the output load. Such registers may cost anywhere from \$20 to \$30, points out sales engineer Arnold R. Miller, and one is needed for each logic condition. However, the 256-bit RAM, with one bit devoted to each logic condition, can cost as little as 20 cents per bit, he continues. And each Controlpac may have two RAMs.

Another Eagle innovation is a special one-bit solid-state register, which, in conjunction with processor logic, allows the controller to skip parts of the program stored in the unit's read-only memory. With this SEIPP—for Skip-Enable In Program Processing—register, it's possible, for example, to simulate the time-delay action of a shift register, using but 18 initial program statements and an additional two statements per register stage, says Miller. Ordinarily, about 18 statements are needed for each stage, or a separate hard-wired shift register must be used.

Using SEIPP and the RAM, Eagle asserts, its controller needs only 1/10th the memory capacity of other units applied in typical transfer-machine or material-handling functions. The unit costs \$2,070 for a logic processor, 256-word programable ROM, 256-bit RAM, 16 inputs and 16 outputs, power supply, and cabinetry. The PROM is expandable to 4,096 12-bit words, and the I/O is expandable in blocks of 16 to a maximum of 512 inputs and outputs. Also available is a \$1,500 portable panel for programing the PROM and which can also be used to diagnose faults. As with all such programmers, relay symbology, familiar to control-system operators, is used.

After several years of marketing someone else's programable controller, which it called the PC-45, General Electric Co.'s General Purpose Control Products department in Bloomington, Ill., now has its own—the Logitrol. And unlike most other

**On display.** GE engineer Murray Jones keys in a relay ladder diagram on Logitrol's portable programmer's panel. The diagram is outlined in a matrix of 450 light-emitting diodes.

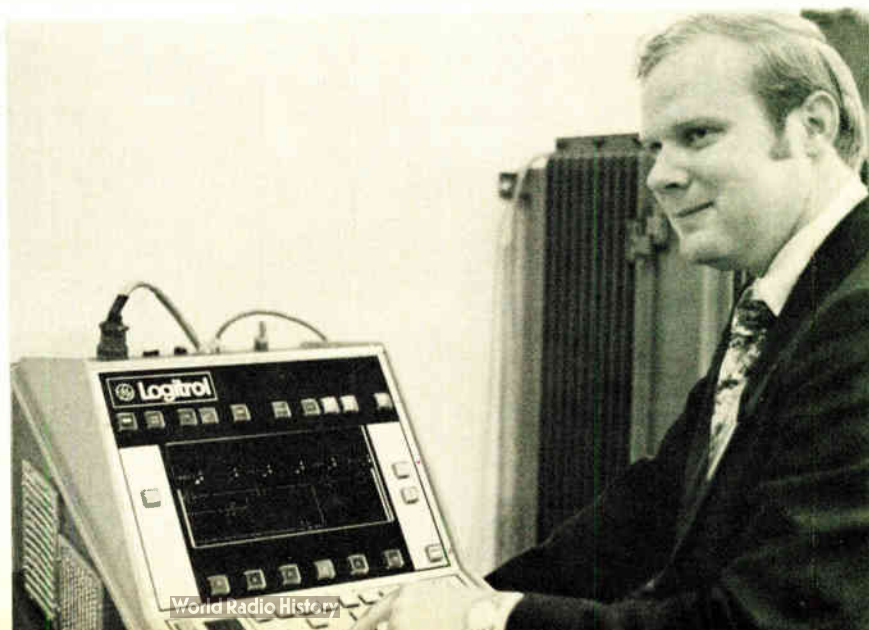



**The hole story.**

## **The stuff our superior cores and memory products are made of.**

We create strips of plastic tape which contain precise amounts of ferrite. This way, the density of magnetic material can be controlled and the material itself easily shaped. We run the tapes through a "cookie cutter" roll-cut press which punches out cores. The plastic is vaporized by firing. What's left are superior cores with exceptionally uniform electrical and mechanical characteristics. We can roll-cut cores to your exact specifications. From 14-mil to 30-mil. Including new wide-temperature ones.

We make stacks of all types, sizes and configurations, too. We can supply sizes from 4K x 18 to 131K x 80 off the shelf. Organizations include 2-wire/2D, 2-wire/2.5D, and 3-wire/3D. If we haven't got what you need, we'll custom-make it for you.

Nothing equals our core memory systems for speed, reliability, and low cost. Certainly not semiconductors. We wrote the book on core quality. From cores to stacks to systems. Call us today for the whole story. And for whatever you need.

**DATA**  
  
**PRODUCTS**

OEM National Marketing: Boston (617) 237-1950; Dallas (214) 231-2240; Detroit (313) 354-5858; Los Angeles (213) 474-1596; Minneapolis (612) 927-8747; Philadelphia (609) 667-7555; San Francisco (415) 941-5485; Washington, D.C. (301) 652-8120. U.S. Representatives: Albuquerque, W. J. Purdy Co. (505) 266-7959; Chicago, L-Fac, Inc. (312) 286-1500; Denver, W. J. Purdy Co. (303) 794-4225; Orlando, Fla., Gentry Assoc., Inc. (305) 894-4401. OEM Int'l Marketing: Amsterdam 020-452-457; London 01-579-2917; Munich 08-106-5766; Paris 686 0691; Tokyo 493-6451; Vienna 34 53 61, 34 44 16. Int'l Representative: Tokyo, Marubeni 501-7421. Home Office: 6219 De Soto Avenue, Woodland Hills, California 91364 (213) 887-8000.

## New products

**NEW!**

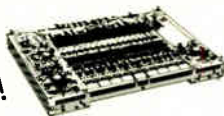

**Store/225.** This one's brand new. It's a large capacity, economy memory (32K x 18) with a 2-wire/2.5D organization. It features an access time of 475 nanoseconds, and a cycle time of 900 nanoseconds.

**NEW!**



**Store/333-M.** Full mil-spec memory system meeting MIL-E-16400.

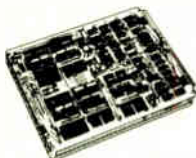

**Store/336.** Access time is 250 nanoseconds. Capacity is 8K x 18, and you can order compact configurations all the way up to 65K x 18.



**Store/333.** A basic 8K x 18 memory that's expandable to 32K x 18 in a 5½-in. chassis. It's the industry's standard for quality, with access time of 300 nanoseconds, and cycle time of 750 nanoseconds. 18-mil cores, 3-wire/3D organization.



**Store/235.** A 4K x 18 planar memory that's expandable to 16K x 18 in 4K increments. It's a high-speed wonder, too: access time is 235 nanoseconds, and cycle time is 500 nanoseconds. 14-mil cores, 3-wire/3D organization.

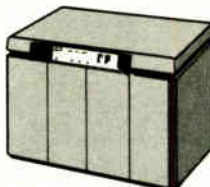

**System/6000 Large Core Store.** A real System/360 saver that offers a faster cycle time than the IBM 2361 (1.8 microsec. vs. 8 microsec.). Rent it or buy it for much less than the 2361, and get more than four times the performance. Fully compatible.

**The  
memory systems  
our uniformly  
superior cores  
make up.**

**DATA PRODUCTS**

manufacturers, who rely on either core or semiconductor memories, GE claims to be the first to use an electrically alterable plated-wire memory. Sales engineer Murray B. Jones says it's more reliable and less susceptible than other types of memory to noise hazards of an industrial environment.

Another design difference is in Logitrol's portable programmable panel, which, like some others, displays the typical relay ladder from which the controller is programmed. Instead of using a cathode-ray tube, GE uses a rectangular array of some 450 red-light-emitting diodes over a 7- by 11-inch area. "They're more rugged than a CRT, Jones asserts. A horizontal "row" on the display may contain as many as five contacts, and up to four rows of the ladder diagram can be seen at one time.

**Modules.** Other features include plug-in memory modules of 1,024, 2,048, or 4,096 14-bit words, and the ability to expand the system to accommodate more than 2,000 inputs and outputs. In addition, I/O racks may be located at a remote machine or process as far as 200 feet from the central processor.

Price of the Logitrol, including the processor, a 1,024-word memory and power supply, is \$3,950. A 16-input card costs an additional \$250, and an eight-output card, \$235. The programmer's panel sells for \$5,300; a more limited panel costs \$4,000.

Hoping to make setting up controllers still easier is the systems division of Allen-Bradley Co., Highland Heights, Ohio. In its new programmable matrix controller (PMC), the company offers a plug-in read/write core memory and logic processor, called Bulletin 1750-W, to allow "unlimited program changes." (Oddly, Allen-Bradley often refers to its products by the word "Bulletin.") The read/write memory is most useful, the company points out, when the controller is first being installed and debugged. Then, once the program is set, the read/write memory and processor may be replaced by a somewhat less expensive and more noise-resistant hardwired programmable ROM module.

And the read/write module can be used to program other controllers. Two portable PMC program panels are also available. The Bulletin 1750-G offers program-edit capabilities and an optional teletypewriter interface; the Bulletin 1750-F is designed only for programming the PROM unit.

Price of the 1750-W PMC processor chassis with 1,000 eight-bit words of core memory, plus 16 inputs and 16 outputs, power supply, and mounting frame is about \$2,600. A similar unit containing the Bulletin 1750-B PROM and its processor is about \$300 less. However, the PROM unit is available with memory increments starting from 64 words.

Allen-Bradley also has a new computer-based system for monitoring manufacturing operations. It's called the Bulletin 1795 computer control system, costs \$30,000 and up, and relies on an Interdata Model 70, 74, or 80 minicomputer, "depending on the sophistication of the application." It can handle as many as 64 programmable controllers.

The system provides a broad range of monitoring and control functions for manufacturing.

And it provides communications capability with data-processing computers and hierarchical management-information systems.

**Option.** Also introducing a read/write memory option for its programmable controller—the PDP-14—is Digital Equipment Corp. Until now, the unit had only been furnished with a ROM. The new memory, priced at \$2,750, comes in a single 4,000-word package. In addition, DEC has a new software package—the CRT-14 (for control-relay translator). It provides hard-or soft-copy documentation in ladder-diagram form, using either a teletypewriter, DEC's VT05 graphics terminal, or the LA30 DECwriter. With the CRT-14, the operator can edit his program, debug it and display the results. Then, either a tape is made, from which the PDP-14's ROM is fabricated, or the program can be fed directly into the programmable controller with the core memory option.

# Big problems

with size and weight in high-performance  
microwave amplifiers?

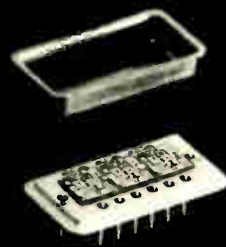

**Small solution.**

(shown actual size)

Avantek's leadership in microwave transistor development and thin-film technology has made possible the UDP Series of high-performance amplifiers in miniature dual in-line packages.



These amplifiers, occupying only 0.1 cu. in. and weighing a mere 0.15 oz., set a new standard of miniaturization, a critical consideration in airborne applications.

Now you can connect amplifiers directly to mixers or detectors with no cables or connectors to degrade reliability. The UDP Series offers this unique advantage to designers of pod-mounted ECM equipment, collision avoidance and beacon sets as well as telemetry and

communications systems for aircraft and space vehicles.

Initially, Avantek is offering three models, covering the 1 to 4 GHz frequency range. Representative specifications include:

	Freq. (GHz)	Gain (dB)	N.F. (dB)	P <sub>out</sub> (dBm)
UDP-2032	1-2	24	5.5	+8
UDP-2332	2.2-2.3	22	5.5	+8
UDP-4003	2-4	6	9.0	+11

Models covering additional frequencies will be introduced later this year.

**Avantek...years ahead today.**

Avantek, Inc., 2981 Copper Road, Santa Clara, California 95051. Phone (408) 739-6170. TWX 910-339-9274. Cable: AVANTEK

Components

## Optical isolator goes to 20 MHz

Fast photon coupler has monolithic NAND gate output for true TTL compatibility

Optically coupled isolators are becoming steadily more attractive as everyday circuit components. The latest is also the fastest, having a 20-megahertz bandwidth that allows

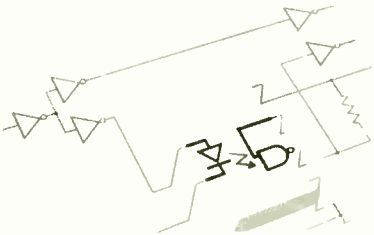

it to process signals at data rates of up to 20 megabits.

Such performance makes the new isolator, Hewlett-Packard's model 5082-4360, truly compatible at both input and output with transistor-transistor logic, as well as diode-transistor logic and complementary-transistor logic. Earlier optical isolators offered bandwidths of only a few megahertz, which are not truly compatible with the normal operating speed of TTL circuits. Also, these isolators usually required additional buffering transistors between the output of the isolator and the input to the logic circuitry.

Another distinction of the 5082-4360 is its monolithic NAND gate output circuit, complete with a photodiode detector and multistage pulse amplifier that has a Schottky-clamped output transistor. The Schottky clamp provides the device with an open-collector output, allowing it to be wired-OR with other model 5082-4360 units.

The device is expected to be used primarily as an interface circuit between digital systems, particularly in line receiver and parallel-to-serial data transmission applications, where its high speed is needed. An-

other use for the device is in the digital programming of power supplies when common-mode signals must be rejected.

A built-in enable circuit, accessible at one of the package pins, permits the interconnection of a string of model 5082-4360s and the strobing of their outputs. This allows data to be read out on a selective basis by, say, a clock signal.

The isolator operates from a standard 5-volt IC supply and remains within its data sheet specifications from 0° to 70°C. It requires an input current of only 5 milliamperes, but can sink an eight-gate fanout (13 mA) at its output, so that additional buffers or triggers are not needed.

Minimum dc isolation for the unit is 2,500 v, and common-mode rejection is 10 v at 10 MHz to assure reliable data transmission in high-noise environments. The unit employs a gallium-arsenide-phosphide light-emitting diode as its photon emitter.

The 5082-4360 is housed in an eight-pin dual in-line plastic package. Units are priced at \$7.00 for 1 to 99, \$5.40 for 100-unit quantities, and \$4.50 for 1,000-unit quantities.

Hewlett-Packard Co., 1501 Page Mill Rd., Palo Alto, Calif. 94304 [341]

## Packages hold combinations of capacitance values

Multi-Cap packages are devices containing various combinations of either metalized polyester or metalized polycarbonate capacitors. Sizes range from 0.385-inch wide by 0.225-in. high in lengths from 0.300 in. (with two capacitance values) to

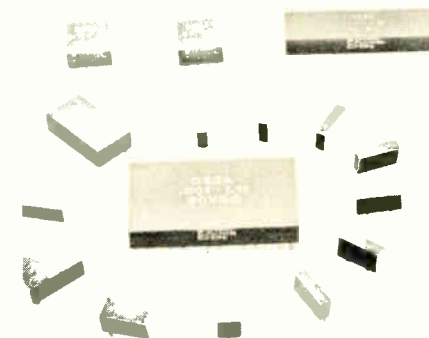

1.40 in. (in 0.100-inch increments) which will accommodate as many as 13 capacitance values. The units are also available in a double-width case 0.800 in. wide by 0.225 in. high by 1.400 in. long, which can accommodate a maximum of 26 capacitance values. The packaging concept reduces the board space required for components and the number of parts that must be handled. Special configurations can be supplied to customer specifications.

Engineered Components Co., 2134 West Rosecrans Ave., Gardena, Calif. 90249 [344]

## Switch can be actuated by a breath of air

Rated at 3 amperes, 125 volts ac, a miniature snap-action switch has an operating force so low that a breath of air will actuate it. The E22-85HX provides an external aluminum actuator 2 3/8 inches long to deliver an

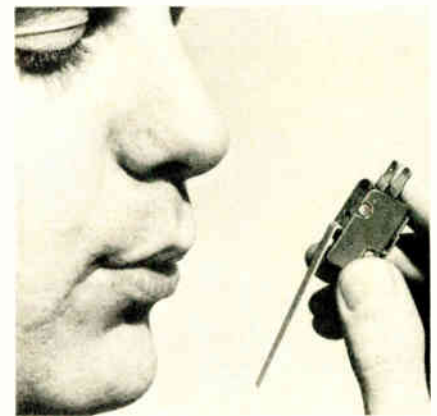

operating force of less than 2 grams at the end of the actuator. An extra internal actuator also aids in reducing operating force while maintaining solid contact-mating pressure.

Cherry Electrical Products Corp., 3600 Sunset Ave., Waukegan, Ill. 60085 [345]

## Pots built for soldering, automatic-insertion systems

A series of dual in-line trimming potentiometers are designed for automatic-insertion and production-sol-

**Finally!  
A filter so precise,  
filter characteristics  
for every setting  
are printed  
on top.**



We've built a variable electronic filter that's so precise, it has enabled us to print the cutoff frequencies, center frequency, bandwidth, noise bandwidth and filter gain, for every setting, *on top of the instrument*. Besides being the easiest-to-use filters on the market, our 4200 series filters are twice as accurate, have less than half the self-noise, and provide 10 dB greater outband rejection than any other filters. Frequency coverage is .01 Hz to 1 MHz. Built-in selectable post-filter gain and remote preamplifiers are optional. A Butterworth response is used in the NORMAL mode and a Bessel response in the PULSE mode (transient response is superior to conventional "RC" or "Low Q" modes of other filters).

The price? \$695.

For complete specifications and your free copies of our variable electronic filter application notes, write to: Ithaco, Inc., Box 818-7R, Ithaca, New York 14850. For immediate response, call Don Chandler at 607-272-7640 or TWX 510-255-9307.

**ITHACO**

**New products**

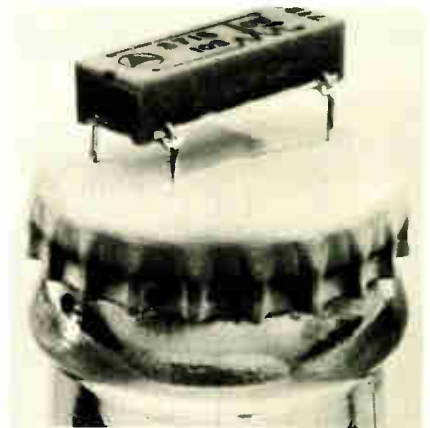

dering systems. The 3715 series features compression and eutectic seal to the substrate of all terminal pins for strength and reliability. A metallic multifinger wiper helps reduce contact resistance variation to a minimum, and ambient temperature range is up to 125°C. Temperature coefficient is 100 ppm/°C. Size is 0.78 by 0.265 by 0.185 inch.

Amphenol Connector Division, Controls Operations, 2801 South 25th Ave., Broadview, Ill. [346]

**Acceleration transducer has built-in calibration signal**

A linear acceleration transducer designed for shock, vibration, and impact testing provides a built-in calibration signal for in-place checking. In units with the internal calibration option, a 6-volt dc excitation voltage applied to the calibration lead produces a dc calibration signal on the output terminals. The model 114 has full-scale ranges from  $\pm 1$  g to  $\pm 10,000$  g and a frequency response to 10,000 hertz. The capacitance-type sensors withstand high over-





# We pack more performance into less space

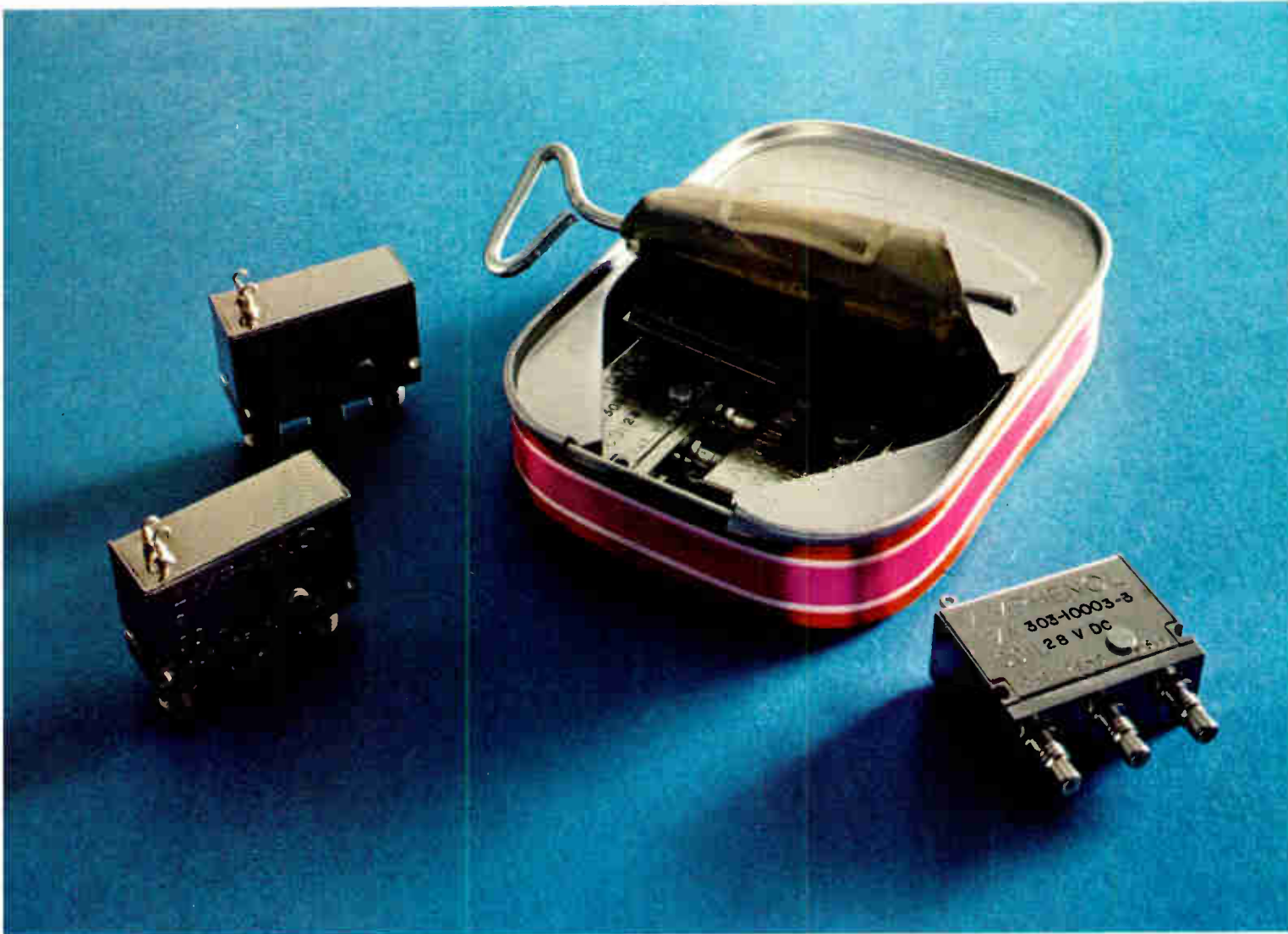

## and save you up to 50¢ on your dollar.

Amphenol's new 303 Series MINIform coaxial switch line is the answer to today's biggest component problem: Getting higher performance, using less space at the lowest possible cost.

High performance we have. From 0 to 1.0 GHz, the MINIform switches handle up to 150 watts CW, maintain maximum VSWR of only 1.1:1, 80 dB minimum crosstalk attenuation and 0.1 dB insertion loss. Maximum VSWR over the 1.1 through 3.0 GHz range is only 1.2:1 with power handling capabilities up to 70 watts CW.

True to their name, MINIform switches weigh only 1.2 ounces and occupy less than ½ cubic inch of precious space.

Three popular termination styles are available: SMA connectors, Amphenol SUB-Minax 27 Series connectors and pc contacts for solder or solderless wrap terminations.

To find out more about MINIform and how it can cut your switch costs in half, write to Amphenol RF Division, Bunker Ramo Corporation, 33 East Franklin Street, Danbury, Connecticut 06810.

**BUNKER  
RAMO** **AMPHENOL**

# Which of these General Electric lamps can help you most?

## New Green Glow Lamp!

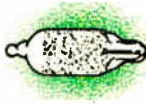

Actual Size

Finally, a broad spectrum bright green glow lamp from General Electric, that gives you greater design flexibility than ever before. It emits green and blue light with suitable color filters. It is called G2B.

What's more, the G2B is directly interchangeable electrically and physically with our high-brightness C2A red/orange/yellow glow lamp.

So you can use the G2B alone for 120 volt green indicator service. Or together with the C2A to emphasize multiple functions with color. For example: for safe/unsafe functions, dual state indications and to show multiple operations in up to 5 colors.

And remember. Both the G2B and C2A save you money because of their low cost, small size and rugged construction.

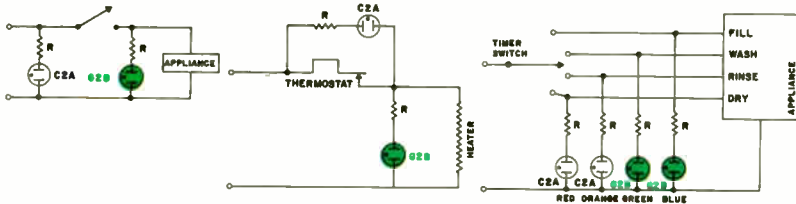

## New Sub-Miniature Wedge Base Lamp.

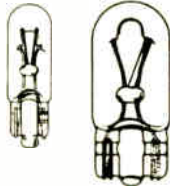

If space for indicator lights is your problem, this new GE T-1 $\frac{1}{4}$  size all-glass wedge-base lamp is your solution. It measures less than  $\frac{1}{4}$ " in diameter.

The filament is always positioned

in the same relation to the base. It won't freeze in the socket, which virtually ends corrosion problems. And like its big brother — the T-3 $\frac{1}{4}$  wedge base lamp — it features a simplified socket design.



Get more than twice the useful output of other GE solid state lamps with GE SSL-54, SSL-55B and SSL-55C.

The increased energy concentrated in a narrow 20° cone allows you to use less sensitive detectors. Or to operate the lamps at lower current. Or to space lamps and detectors

farther apart.

All are excellent matches for GE photodetectors and can be used in many photoelectric applications. They're also particularly useful in applications demanding an infrared source capable of withstanding severe shock and vibration.

To get free technical information on any or all of these lamps, just write: General Electric Company, Miniature Lamp Products Department, Inquiry Bureau, Nela Park, Cleveland, Ohio 44112.

**GENERAL**  **ELECTRIC**

## New products

loads without damage. Temperature-insensitive squeeze-film gas damping provides constant amplitude response. Price is as low as \$345 for models without built-in signal calibration.

Setra Systems Inc., 12 Huron Dr., Natick, Mass. 01760 [348]

## Wirewound resistors handle 5 watts per inch

Power ratings of up to 5 watts per inch are available from the type CA wirewound resistor. The unit, designed for consumer applications,

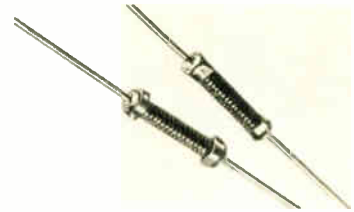

assures power dissipation by using wirewound openwound on an impregnated core of woven fiberglass. The units can operate to temperatures of to 375°C and are available in two models: the 5000, rated at 5 watts per inch, and the type 4000, at 4 watts per inch. Resistance range of both is from 0.1 ohm to 7 kilohms.

Dale Electronics Inc., Dept. 860, P.O. Box 609, Columbus, Neb. [347]

## Transducer provides logic for up to 5 TTL inputs

A miniaturized digital output transducer provides logic output to feed up to five transistor-transistor-logic inputs. The model 4-0008 is designed for use in computer peripherals and speed-sensing applications. Through hybridization, a signal conditioning network is built in, eliminating the need for additional circuitry. Logic output is independent of power-supply voltage (it operates from 5 to 15 volts dc). Unit price is \$39, and quantity prices are available.

Airpax Electronics/Controls Division, 6801 W. Sunrise Blvd., Fort Lauderdale, Fla. 33313 [349]

# 3M introduces laboratory recorder quality without the cost.

We built the Series 120 Recorder/Reproducer with one objective in mind: to provide laboratory instrument features without laboratory instrument cost. It's a compact, 4-channel recorder that uses 1/4" tape with any combination of direct or FM signal electronics. Its features are exceptional:

- All DC tape transport drive
- Five tape speeds from 15/16 to 15 ips
- Phase-locked capstan drive
- Direct — 70 Hz to 64 KHz at 15 ips
- FM — DC to 5 KHz at 15 ips
- Up to 10 seconds repeat scan
- 4 to 60 ips forward search speed
- + 50% to — 30% vernier variable playback speed
- 10-1/2" reels for up to 12 hours of recording

We placed special emphasis on the recorder's design for ease of operation and maintainability. Controls are located for accessibility and quick viewing. The rear panel of the recorder is used as one large inter-connecting panel with all boards plugged in directly. Assembly is extremely simple allowing rapid and easy access to any component.

The Series 120 Recorder/Reproducer can be the most useful research tool you have, as well as the easiest to use. That's what we had in mind. For more information, contact 3M Mincom Division, 300 South Lewis Road,

Camarillo,  
California  
93010.  
(805)  
482-1911.



INSTRUMENTATION PRODUCTS  
**Mincom Division** **3M**  
COMPANY

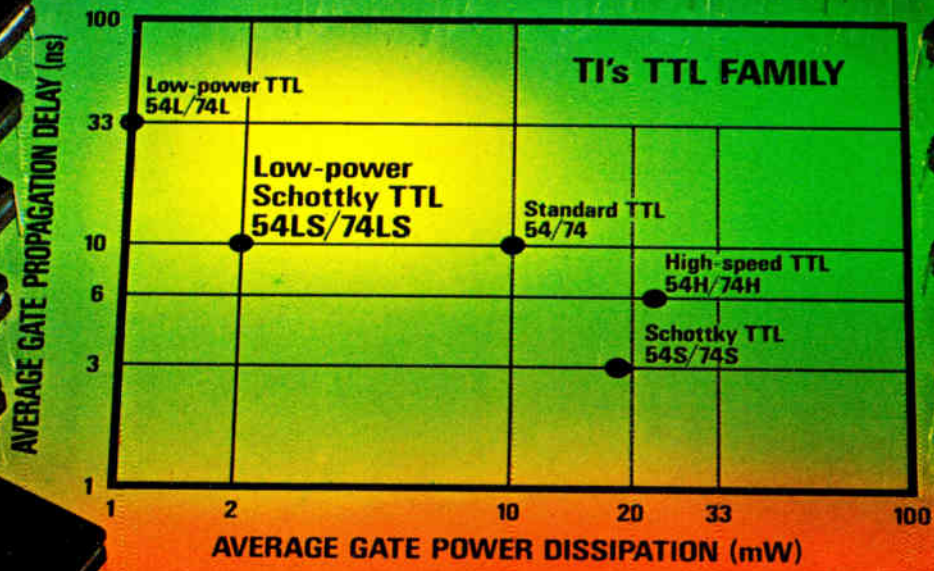
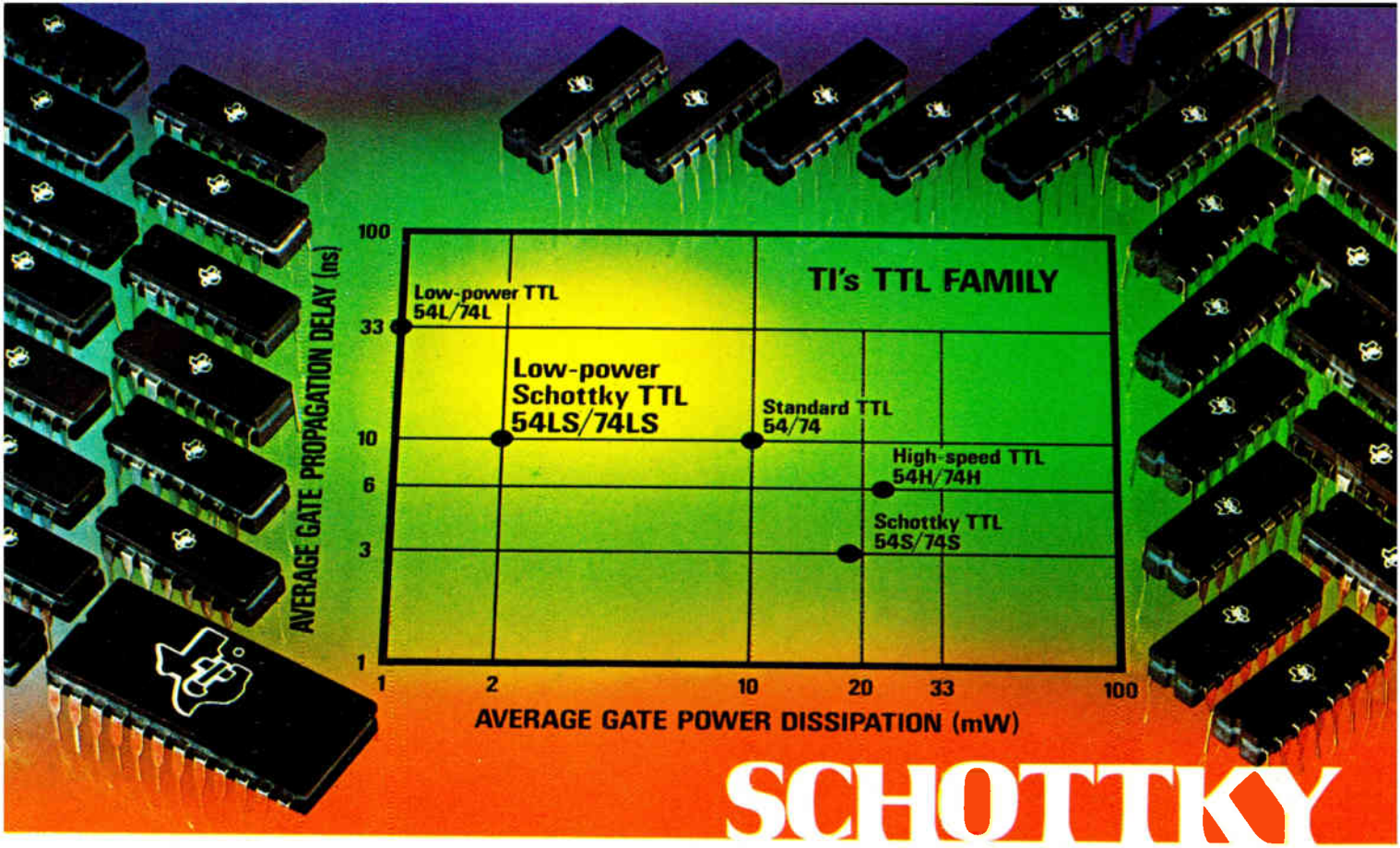

# SCHOTTKY

## Low-power Schottky: 10 ns at <2 mW. Now available in ceramic DIPs.

The 21 SSI and 13 MSI circuits in TI's new low-power Schottky family now come in both plastic and ceramic dual-in-line packages. The new family offers all the performance of low-power TTL (Series 54L/74L) yet provides three times the speed (10 ns) at a power increase of less than 1 mW/gate. This greatly improved speed/power product makes low-power Schottky ideal for portable or remote systems or for any application where minimum power and TTL speeds are prime considerations.

**Fully compatible, readily available**  
This new series is compatible with all TTL—standard, high-speed, low-power and Schottky. Evaluation quantities are immediately available from authorized distributors or factory inventories; production quantities for C-DIP (54LS only) and plastic (74LS only) are available four weeks ARO.  
**For data sheets, circle 215 on Service Card.**  
Or write Texas Instruments Incorporated, P.O. Box 5012, M/S 308, Dallas, Texas 75222.



NEW LOW-POWER SCHOTTKY SSI CIRCUITS	54LS C-DIP	74LS PLASTIC		54LS C-DIP	74LS PLASTIC
SN54LS/74LS00 Quad 2 NAND gate	\$3.28	\$0.96	SN54LS/74LS113 Dual J-K flip-flop, no clear	\$6.56	\$1.91
SN54LS/74LS01 Quad 2 NAND gate, open collector	3.28	0.96	SN54LS/74LS114 Dual J-K flip-flop, common clock and clear	6.56	1.91
SN54LS/74LS02 Quad 2 NOR gate	3.28	0.96	<b>NEW LOW-POWER SCHOTTKY MSI CIRCUITS</b>		
SN54LS/74LS03 Quad 2 NAND gate, open collector	3.28	0.96	SN54LS/74LS83 4-bit full adder	16.39	3.51
SN54LS/74LS04 Hex inverter	3.61	1.14	SN54LS/74LS95A 4-bit left-right shift register	16.39	4.78
SN54LS/74LS05 Hex inverter, open collector	3.61	1.14	SN54LS/74LS138 3-to-8-line decoder/ 1-to-8-line demultiplexer	16.39	4.78
SN54LS/74LS10 Triple 3 NAND gate	3.28	0.96	SN54LS/74LS139 Dual 2-to-4-line decoder/ Dual 1-to-4-line demultiplexer	16.39	4.78
SN54LS/74LS20 Dual 4 NAND gate	3.28	0.96	SN54LS/74LS153 Dual 4-to-1 data selector/multiplexer	16.39	4.78
SN54LS/74LS22 Dual 4 NAND gate, open collector	3.28	0.96	SN54LS/74LS155 Dual 2-to-4-line decoder	16.39	4.78
SN54LS/74LS30 Single 8 NAND gate	3.28	0.96	SN54LS/74LS181 Arithmetic logic unit/function generator	36.35	25.85
SN54LS/74LS51 Dual 2 AOI gate	3.28	0.96	SN54LS/74LS194 4-bit bi-directional universal shift register	16.39	4.78
SN54LS/74LS54 4-wide, 2-input AOI gate	3.28	0.96	SN54LS/74LS195 4-bit parallel-access shift register	16.39	4.78
SN54LS/74LS55 2-wide, 4-input AOI gate	3.28	0.96	SN54LS/74LS196 Presettable decade counter	16.39	4.78
SN54LS/74LS73 Dual J-K edge-triggered flip-flop	6.56	1.91	SN54LS/74LS197 Presettable binary counter	16.39	4.78
SN54LS/74LS74 Dual D-type edge-triggered flip-flop	6.56	1.91	SN54LS/74LS253 3-state version of SN54LS/74LS153	19.67	5.74
SN54LS/74LS76 Dual J-K flip-flop, preset and clear	6.56	1.91	SN54LS/74LS295 3-state version of SN54LS/74LS95A	19.67	5.74
SN54LS/74LS78 Dual J-K flip-flop, common clock	6.56	1.91			
SN54LS/74LS109 Dual J-K edge-triggered flip-flop	6.56	1.91			
SN54LS/74LS112 Dual J-K edge-triggered flip-flop	6.56	1.91			

All prices are 100-999 quantities.

**TEXAS INSTRUMENTS**  
INCORPORATED  
World Radio History

### Instruments

## Digital meter uses only 0.1 W

3½-digit unit employs LED displays, can run for 600 hours on four D cells

Most instrumentation engineers agree that digital panel meters won't replace analog meters in portable equipment until they overcome their power-consumption problems. The consensus is that this will require the use of liquid-crystal displays—devices whose reliability is unacceptable to most DPM manufacturers.

Datascan's latest digital panel meter is noteworthy, therefore, on at least two counts: it dissipates only 100 milliwatts in normal operation (less if the display is operated at reduced brightness), and it achieves this low level of power consumption while using a standard light-emitting diode display.

The 3½-digit (2,000-count) meter has a maximum error of  $\pm(0.1\%$  of reading + 1 digit) and a temperature coefficient of 0.008% of reading per degree centigrade. Its reading rate is five per second. Input bias current is less than 1 nanoampere, and the input impedance is 5,000 megohms.

The model 820, claimed to be the first DPM to employ C-MOS technology, was designed with the battery-powered, portable-instrument market in mind. It will run on any dc voltage from 4.8 to 6.5 volts at a current drain of approximately 20 milliamperes. Consequently, just four D cells can keep the unit running for more than 600 hours at normal brightness.

Operation of the 820 is kept simple by the inclusion of an auto-zero circuit. In fact, the meter has only two adjustments—full-scale gain calibration, and display brightness. Its small size (3.5 in.  $\times$  2.5 in.  $\times$  1.3 in.) further increases its attractiveness as a replacement for

analog meters. Because the meter dissipates very little power, its internal temperature rise is small. Reliability, therefore, is enhanced, and the manufacturer is able to guarantee the meters for a full year. The guarantee covers parts and labor and is unconditional except for damage caused by mishandling.

The meter, which will be in full production by the end of the year, is expected to sell for \$200 in small lots, and for \$150 in OEM quantities. Delivery, at that time, will be stock to 30 days. Prototypes will be available by the end of October.

Datascan Inc., 1111 Paulison Ave., Clifton, N.J. 07013 [351]

## Digital nanovoltmeter provides 4½-digit display

An autoranging digital nanovoltmeter features a 4½-digit readout in which the last digit shows tens of nanovolts on the lowest range. The unit resolves 10 nV with 0.01% resolution and an accuracy to within  $\pm 0.03\%$  of reading,  $\pm 0.02\%$  of full scale. Range is 10 nV per digit (100.00  $\mu$ V full scale) to 1 volt full scale in five decade ranges. There is 100% overranging on all ranges. Normal mode rejection ratio is greater than 90 decibels at line frequency and 75 dB at twice line frequency. Price of the model 180 is \$1,995.

Keithley Instruments Inc., 28775 Aurora Rd., Cleveland, Ohio 44139 [353]

## Panel meter reads up to 39,999 counts full scale

Ideal for applications where accuracy and resolution are important, the series 2000A and 2000B digital panel meters are system-oriented instruments. The units, which offer buffered, isolated, and gated digital BCD outputs, can be integrated into multiplexing and data-acquisition and control systems. The 2000A series features auto-polarity, ratio, and a 39,999-count full scale. A three-pole active filter attenuates

frequencies over 50 Hz by at least 50 dB. The series 2000B, which counts to  $\pm 19,999$ , is priced at \$280 in single quantity, and the series 2000A units at \$385.

Newport Laboratories Inc., 630 East Young St., Santa Ana, Calif. 92705 [355]

## Wave analyzer covers 1 Hz to 5,000 Hz

A 20-pound portable wave analyzer, the model 304-DL, covers the range from 1 hertz to 5,000 Hz with five selectable bandpasses down to 1 Hz. Signal amplitude indication is given



as a linear or logarithmic function. The linear meter has a dynamic range of greater than 70 dB in 10-dB steps. The log meter scale reads -72 dB to 0 dB full scale. Price is \$3,200. Quan-Tech Division, KMS Industries Inc., 43 So. Jefferson Rd., Whippany, N.J. [356]

## Filter achieves roll-off of 24 dB per bandwidth-octave

A filter that has been computer-designed is said to provide a sharpness approximately 33⅓% better than conventional 18-dB-per-bandwidth-octave types. The UA series

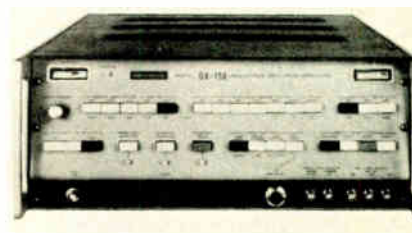

achieves a 24-dB-per-bandwidth-octave roll-off characteristic. Thus the model UA-15A, a 500-line instrument, can perform like a 650-line analyzer. The instrument provides information on vibration, noise and

# the Super- Sensor

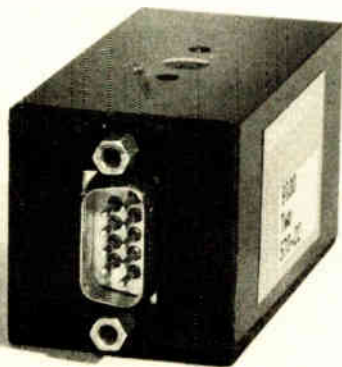

Shown actual size

## DEVELCO'S MINIATURE FLUXGATE MAGNETOMETER

**IN SPACE, UNDERSEA and IN THE LAB,** as an aspect or attitude sensor, as a means of measuring deperming, or in materials research—Develco's multi-axis magnetometers, developed for a wide variety of applications, deliver extremely high performance at low cost. You can count on high sensor stability ( $< 3\%$  sensitivity;  $< 1\%$  zero field) over long periods of time and wide temperature ranges ( $0^\circ$  to  $60^\circ\text{C}$ ). Excellent resolution ( $\pm 1^\circ$ ), low noise (1 gamma) performance over wide dynamic ranges, miniature size ( $< 4.5$  cu. in.), two or three axis capability and low power requirements. Doesn't that combination fit your application? Let us send you the complete specifications. Write or call collect. Develco, Inc., 530 Logue Avenue, Mountain View, Ca. 94040. (415) 969-1600.

**DEVELCO**

Circle 142 on reader service card

### SIR SEIBERLING IS AN IMPECCABLY CLEAN FIGHTER

Yes, when Sir Seiberling is armed with the absolutely dust free, seamless Sensiflex<sup>®</sup> glove, he can do battle in any "white room" in the world.

These comfortable, ambi-fit PVC's from Seiberling Latex Products fit snugly enough, even at the fingertips, for the most intricate of tasks.

Seiberling's Sensiflex gloves are strong enough to be reused, yet inexpensive enough to be thrown away. They come in three models — the dust-free 3004, the powdered 3003, and the 3006 with a little larger gauge.

For a free sample of any or all models, write or call Seiberling Latex Products today.

SEIBERLING LATEX PRODUCTS, 4500 SE 59th Street  
Oklahoma City, Oklahoma 73135 405/672-2301



142 Circle 182 on reader service card

World Radio History

## New products

other low-frequency data in terms of frequency distribution.

Federal Scientific Corp., 615 West 131st St.,  
New York, N.Y. 10027 [357]

Digital clock designed for  
on-line data logging

The series M digital clock is designed for on-line use in data logging, process-control and digital computer systems. The clock provides time of day, elapsed time, or countdown or -up with digital output logic and/or digital display. The time-of-day clock offers a 24-hour range with resolution of minutes or tenths of minutes, seconds, or tenths of seconds. All counting circuits and BCD logic outputs are mounted on a single plug-in printed-circuit card. Display-drive circuitry is on a second card, and a third can be used for additional outputs or special functions. Prices start at \$299.

Thiem Industries Inc., 1918 W. Artesia Blvd.,  
Torrance, Calif. [358]

Power amplifier delivers  
200 W up to 1 MHz

The A7200 series linear power amplifier is unconditionally stable and features complete overload protection. Over 50 dB of gain control is provided on the front panel, and the

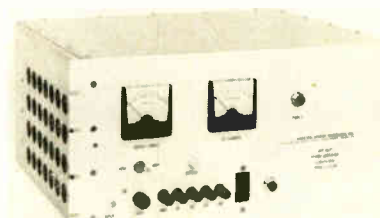

unit has a self-contained power supply drawing 10 amperes from a 110-volt, 60-hertz input. Output power is 200 w  $\pm 0.5$  dB from 10 kHz to 1 MHz; 50 w  $\pm 1.0$  dB from 5 kHz to 2 MHz; and 10 w  $\pm 12.5$  dB from 2.5 kHz to 5 MHz. Useful power is from 2.5 kHz to 30 MHz. Price is \$3,995. Scientific Systems Technology Inc., 3530 Forest Lane, Dallas, Texas [359]

Electronics/October 9, 1972

# Should you be apprehensive about changing jobs in aerospace?

## Yes.

All you have to do is look around you. And you can see all the reasons why *not* to change jobs in an industry as volatile as ours.

So don't do it. Unless you have equally good reasons *for* changing.

Example: Your company's going nowhere fast.

(Hughes last year had \$765 million in sales and a backlog of \$1.35 billion. This year, we expect the figures to be \$880 million and \$1.6 billion.)

Example: You've been stuck in the same spot too long.

(Our Engineering Rotation

Program enables many junior engineers to change job assignments every year or two. Like travel, that broadens you. And it's fun.)

Example: Your company is too vulnerable to cutbacks.

(As one of our senior vice-presidents said, "We have a fantastic diversity of products—hence, security." Specifically, we're in 80 major areas, with over 550 products and services. And we're looking at *others*.)

Example: You're worried about professional obsolescence.

(You can keep it from happening at Hughes. We encourage

you morally and financially to keep technologically current with after-hours, graduate, and on-premises study.)

We never encourage people to change jobs. But we do open our mail. If you're a technically current electro-optical, laser, or radar system engineer, with accredited degree and 3-8 years of experience, we're especially interested. Write: Mr. Robert A. Martin, Head of Employment, Dept. 29, Equipment Engineering Divisions, Hughes Aircraft Co., 11940 W. Jefferson Blvd., Culver City, CA 90230. U.S. Citizenship required. An equal-opportunity M/F employer.



Packaging &amp; production

## Tester designed for low volume

---

System built around controller uses mark-sense cards for programing

---

In high-volume production situations, automatic testing can save the manufacturer both time and money. But for small and medium runs, the economics of such a test setup has been marginal at best—the



fully automatic systems generally start at \$50,000. Thus, on many production lines, it is a common thing to find several instruments and power supplies connected to a switch panel, diode matrix, or a bank of thumbwheel switches in a configuration that allows some test flexibility, but leaves a lot to be desired.

To fill this testing void, Zehntel Inc., Berkeley, Calif., has introduced an automatic system that is aimed at small-to-medium production runs. Called Testpac III, the system is basically a programable controller, containing some built-in decision and comparison electronics, plus interface printed-circuit cards. All communications between the instruments and controller take place over an ASCII data bus, so instruments that already "speak" ASCII don't require an interface card.

Testpac III is a low-cost automatic test system that has simple mark-sense card programing, plus a

built-in LSI memory, and utilizes off-the-shelf measuring instruments. The basic Testpac III-A, which includes LSI memory, sequencer, go/no-go analyzer, command-register housing, console, and connector panel, is priced at approximately \$12,000. Testpac III-B, a complete system with switch drivers, power supplies, function generator, digital multimeter, and electronic counter, is priced at about \$18,000.

"Because the solid-state memory (an MOS-type employing Intel 1103s) can deliver test programs as fast as they can be performed, the system is extremely fast; speed is limited only by the time constants of the instruments and the device being tested," says Philip E. Goodrich, marketing manager at Zehntel. A "stop on fail" or "diagnose on fail" mode makes it simple to identify the test that failed.

The "stop and recycle" mode with continuous display of "high", "low," and "in limit" makes it possible to adjust a device under test until it is within specifications. Says Goodrich, "Correct resistors or capacitors can be selected, oscillators or cavities tuned, pots set, filters optimized, etc. Thus, Testpac III is suited for the testing and adjustment of passive devices such as filters and attenuators; active modules such as amplifiers and a-d or d-a converters; DVMS, counters and other measuring instruments; signal sources, including pulse generators and oscillators, transducers of all kinds, and actuators, motors and other electromechanical devices."

Another feature is the use of mark-sense cards for programing. Programs can be prepared with a pencil, by using the simple Testpac language, and modifications are easily made with an eraser.

Zehntel Inc., 1450 Sixth St., Berkeley, Calif. 94710 [391]

---

IC handler processes

7,000 devices per hour

Stick-to-stick operation of up to 7,000 devices per hour is provided by the model IMS-2203 integrated

circuit handler. The unit accommodates dual in-line packages with eight to 40 leads each, and has replaceable segmented contacts. The handler uses ac line voltage, and is suited for the rapid hardware changes necessary for incoming inspection. Photo-optical sensing allows interfacing to voltages from 3 to 30 v. Price of the IMS-2203 is \$6,500.

Computest Corp., 3 Computer Dr., Cherry Hill, N.J. 08002 [393]

---

Rack and panel connectors are available in five sizes

The 8026 connector series is engineered for applications requiring reliability. These include rack and panel, in-line cable, and input-output connectors for wire-wrapped computer back panels. The units conform to military specification MIL-C-28731. The connectors are available in five sizes: 33, 75 or 117 contacts on 0.100-inch centers and 55 or 79 contacts on 0.125-in. cen-

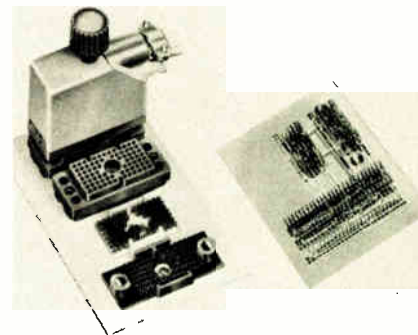

ters. Options include jackscrews, covers, cable clamps and polarizing hardware.

Elco Corp., Maryland Rd. and Computer Ave., Willow Grove, Pa. [395]

---

Machine can produce 1,000 twisted-pairs an hour

A twisted-pair wire preparation unit, the model 14YT1, is designed to eliminate the tedious manual method by automatically feeding, cutting, stripping and twisting the wires. Production rates in excess of





## DIGITAL MEASUREMENT AND DISPLAY



api

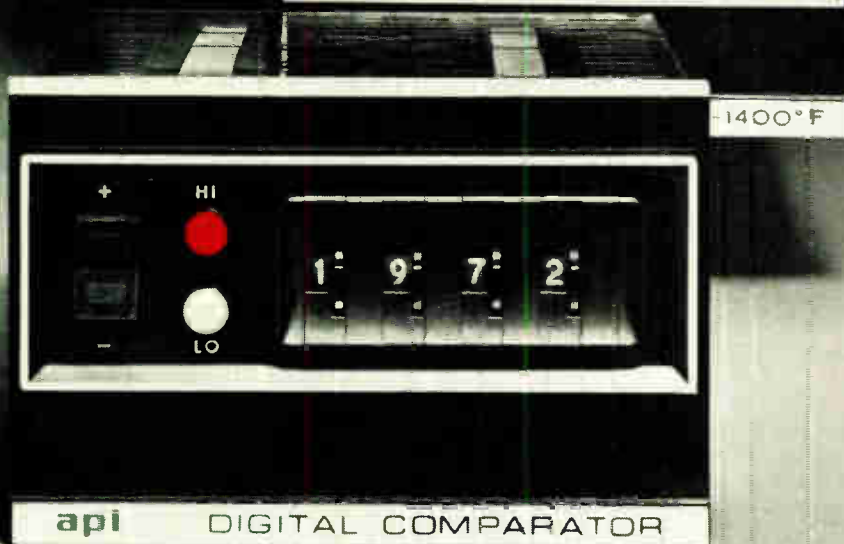

## Best buys Better specs Bigger digits

More than 50 standard models of **api** digital measurement/display devices get your measurements up front with excellent readability, clean styling and the stable, reliable performance of MOS/LSI circuitry. DTL/TTL compatible BCD outputs . . . autopolarity . . . display hold, print command, polarity and overrange outputs . . . programmable decimal points . . . 0.1% accuracy . . . 100 db common mode rejection . . . 1000 meg. input impedance — are features common to most models.

For premium performance in a small size at low cost, the new 2½- and 3½-digit **api** 4350 Series offers remarkable brilliance and clarity in ½" planar 7-segment digits. Rugged, low voltage electrofluorescent tubes rated for 100,000 hours produce intense blue, green or turquoise display. Only 2.1" high x 4" wide.

For readability from 40 feet, the **api** 4300 Series units have ⅞" high, 7-segment planar displays of four digits. Panel space only 3" x 4.5"; separable power supplies save depth behind panel. DPM std. ranges to 19.99 mv and 1000 V, 19.99 ua and 199.9 ma. The **api** 4320 *Digital Temperature Indicator* also features isolated BCD output, 0.15% accuracy, 1°F. resolution. The **api** 4310 *Comparator* algebraically compares BCD input to a preset limit, for indication and on-off control. For complete specs and application help, write LFE, Process Control Division, 1601 Trapelo Road, Waltham, Mass. 02154. Tel. (617) 890-2000.



CORPORATION

Process Control Division

Circle 145 on reader service card

# NEW Low Cost, 12-Bit D/A Converter



- Bipolar — 2's Complement Coding
- Pretrimmed — Ready to Use
- Full Range — 10V Output
- TTL, DTL Compatible
- All Hermetic Components
- 2" x 2" x 0.4"

**\$45**  
in hundreds

Now at a remarkably low OEM price . . . The DAC372-12 is a fine performance, general purpose 12-bit D/A converter featuring 30PPM/°C temperature coefficient, 0-70°C operation, and 5µSec settling. The unit incorporates thin film precision resistors and is complete and ready to use. Price for 1-9 — \$75.

Need ultra fast settling? The DAC372-WB-12, using an extremely fast internal amplifier, settles in under 950nSec for a full 10V output range . . . a remarkable unit at only \$120 (1-9). Contact us for full details.



## HYBRID SYSTEMS CORPORATION

87 Second Ave., Northwest Industrial Park, Burlington, Mass. 01803  
Telephone: 617-272-1522 TWX: 710-332-7584

See us at Electronica '72

Circle 146 on reader service card

## Megohmmeter and Hipot?

**YES!** For true integrity in HV bench-testing of electrical or electronic equipment —you need both! Megohmmeter to test insulation resistance (IR) . . . Hipot to test dielectric strength.

### HIPOTRONICS OFFERS

a full line of high resistance megohmmeters — sixteen models with ranges to 20,000,000 megohms and high current capability for testing insulation resistance to ASTM specification D-257, MIL, and UL standards.

### HIPOTRONICS ALSO OFFERS

a full line of AC/DC hipots — twenty-seven models with ranges to 10KV AC and 25 KV DC for non-destructive measurement of leakage current, corona discharge, AC and DC insulation strength.

### HIPOTRONICS GUARANTEES

complete high voltage — high resistance capability for thorough testing of switches . . . motors . . . coils . . . chokes . . . insulation . . . transformers . . . cables . . . electrical/electronic assemblies . . . harnesses . . . and more.

For more information write or call our marketing department for brochures HP7101 and HP7107.

**HIPOTRONICS**® BREWSTER, N. Y. 10509  
Phone: (914) 279-8091



146 Circle 174 on readerservice card

World Radio History

## New products

1,000 wires per hour can be achieved. Solid and/or stranded conductors in sizes from 22 to 33 gauge and lengths to 50 inches can be accommodated.

Gardner-Denver Co., Gardner Expressway, Quincy, Ill. 62301 [397]

IC sorter adapts to many DIP configurations

An integrated circuit sorter is made to adapt to various dual in-line packages. Adjustment to all packages from eight to 18 leads and to body variations is accomplished without the use of tools. Continuous

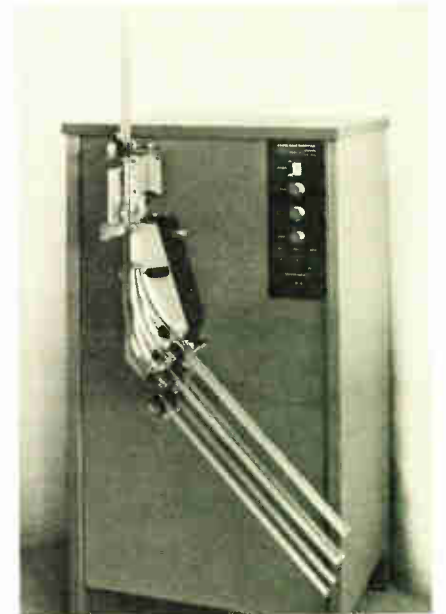

operation is achieved with a tandem stick design. Each station, input and output, carries two similar sticks: one working and one in reserve. Testing continues during stick changes. Operating rate is 5,000 units per hour with a 100-millisecond test time.

Daymarc, 40 Bear Hill Rd., Waltham, Mass. 02154 [398]

Logic tester probe offers 12-MHz response

The LT-1 is a logic tester probe constructed in a pencil-like configuration. The unit operates from the dc

Electronics/October 9, 1972

# WILEY-INTERSCIENCE

## TOPICS IN APPLIED ELECTRONICS

### PRACTICAL APPLICATIONS OF INFRARED TECHNIQUES:

**A New Tool in a New Dimension for Problem Solving**  
By Riccardo Vanzetti, *Vanzetti Infrared and Computer Systems Inc.*

Passive infrared sensing is currently used in such diverse fields as electronics, materials testing and medical diagnosis. This book shows the reader basic infrared techniques, and explains how they can be successfully applied to many of his own technical problems.

1972 384 pages \$19.95

### IEEE STANDARD DICTIONARY OF ELECTRICAL AND ELECTRONICS TERMS

Approved by the Standards Committee of the Institute of Electrical and Electronics Engineers, Inc.

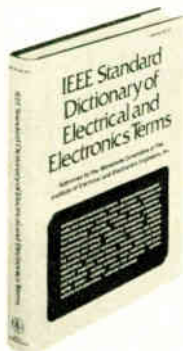

Compiled and authorized by the IEEE, this encyclopedic volume defines over 13,000 technical words from every area of electrical and electronic engineering. More than just a list of definitions, it provides useful supplementary information on every entry, including cross-indexing to related fields and notes on specific applications. Hundreds of new and revised terms have been included, making this dictionary the most complete, up-to-date reference of its kind.

1972 716 pages \$19.95

### MINICOMPUTERS IN DATA PROCESSING AND SIMULATION

By Branko Souček, *University of Zagreb*

Basic digital operations and their applications to actual equipment are clearly presented in this instructive book. The first six chapters deal with programming principles for simple systems and minicomputers; the final four describe detailed techniques of data simulation, measurement, and analysis. Numerous diagrams, examples, references and practice exercises are included.

1972 467 pages \$19.95

### INTRODUCTION TO COMPUTER-AIDED MANUFACTURING IN ELECTRONICS

By Douglas A. Cassell, *Computer Guild Inc.*

Written especially for the electronics manufacturer contemplating automation, this book introduces basic design, application, and economic principles of computer systems, and shows how they can be incorporated into existing production equipment. The effects of computer installation on managerial and procedural operations are also discussed.

1972 248 pages \$12.95

Available at your bookstore or from Dept. 092-A3002-WI

## WILEY-INTERSCIENCE

a division of JOHN WILEY & SONS, Inc., 605 Third Avenue, New York, N.Y. 10016

In Canada: 22 Worcester Road, Rexdale, Ontario

### THEORY AND ANALYSIS OF PHASED ARRAY ANTENNAS

By Noach Amitay, *Bell Telephone Laboratories Inc.*,  
Victor Galindo, *Virginia Polytechnic Institute*,  
and Chen Pang Wu, *Bell Telephone Laboratories Inc.*

This book presents a mathematical approach to the design and analysis of phased array antenna systems, placing particular emphasis on mutual coupling and boundary effects. Additional areas of discussion include various methods of solution, the effects of different dielectrics, and antenna matching techniques.

1972 443 pages \$22.50

### TOPICS IN SOLID STATE AND QUANTUM ELECTRONICS

Edited by W. D. Hershberger, *University of California, Los Angeles*

A Volume in the University of California Engineering and Physical Sciences Extension Series

The twelve chapters in this volume represent the most current developments in solid state research and quantum electronic applications. Topics range from the Gunn effect, superconductivity, and magnetic materials, to avalanche diode oscillators, microwave integrated circuits, display devices and laser systems.

1972 506 pages \$23.50

### FUNDAMENTALS OF NUCLEAR HARDENING OF ELECTRONIC EQUIPMENT

By L. W. Ricketts, *The Magnavox Company*

This book covers every phase of nuclear hardening—from different kinds of radiation environments to the design and construction of hardened equipment. There are extensive discussions of radiation effects on resistors, diodes, transistors and integrated circuits as well as sections dealing with nuclear-hardening costs, computer models, failure mechanisms, and degree of hardening improvement. The text is supplemented with numerous tables and diagrams, reflecting the results of irradiation tests performed by thousands of scientists and engineers throughout the world.

1972 548 pages \$29.95

### ACTIVE INDUCTORLESS FILTERS

Edited by Sanjit K. Mitra, *University of California, Davis*

A volume in the IEEE Press Selected Reprint Series, prepared under the sponsorship of the IEEE Educational Activities Board

Solid state technology has greatly facilitated the development of low-frequency filters that do not require heavy, low quality inductors. The 26 papers in this book cover the current state of the art, stressing theory, design, and the considerations of microelectronic production.

1971 224 pages \$9.95

wiley

# The only argument for punched tape is full of holes.

Because mag tape for your minicomputer costs less to buy. And a great deal less to use.

For less than the "high-speed" punched tape system priced on the right (from one of the major mini makers), you can get the Cipher Mini-Cette 2000, fully interfaced to any of the popular mini's and with two cassette drives.

Even with a single drive, the Cipher 2000 loads a 40-minute, 12k punched tape program in 10 seconds.

Conveniently stores up to 720,000 characters (5.76 megabits) on a single ECMA/ANSI-compatible cassette.

And has an error rate of less than 1 in  $10^9$  bits even after a thousand passes. (We use read-after-write error correction, just like in the large tape drives we make.)

With the Cipher 2000, you'll get a lot more out of your mini for a lot less. Use it for industrial control, test instrumentation and data acquisition systems. For file storage, program overlays, sort/merge or other I/O operations. It's a complete miniature magnetic tape system.

And it's yours for less than the price of punched tape. For more details or a demo, call or use the bingo card today.

We've got some convincing arguments for mag tape.

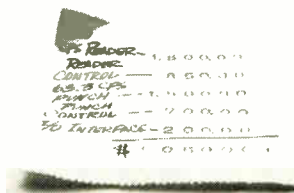

Circle 148 on reader service card

**Cipher**  
Data Products  
(714) 277-8070

## FIGHT THEM ALL...

Heart Attack  
Stroke  
High Blood Pressure  
Rheumatic Fever

GIVE ... SO MORE WILL LIVE HEART FUND



## New products

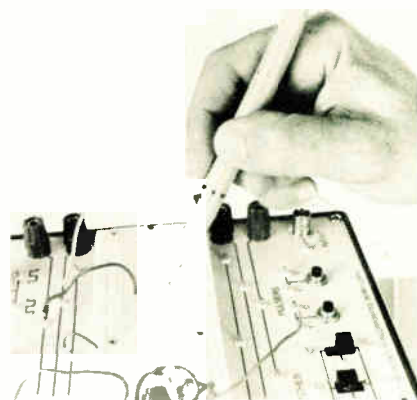

supply of the system under test, and responds to logic levels in the dc to 12-megahertz range. The levels are detected by an LED that acts as an indicator light; the LED is on at the logic 1 level and off at the 0 level. Because the LT-1 is a high-impedance device, there is a minimum of circuit loading. Price is \$11.95.

EL Instruments Inc., 61 First St., Derby, Conn. 06418 [394]

Computer interface board accepts up to 18 DIPs

A breadboard is designed primarily for use with Digital Equipment Corp. computers but may be used as an interface for other applications.

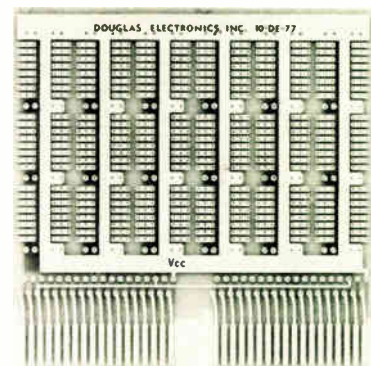

The 10-DE-77 has double-sided 36-contact connector fingers and accepts eighteen 14- or 16-pin dual in-line packages. It is etched in two-ounce copper on flame-retardant glass epoxy. In addition to the standard configuration, priced at \$9, modified versions are available.

Douglas Electronics, 718 Marina Blvd., San Leandro, Calif. 94577 [399]



## Deionized Water Essential To Texas Semiconductor Manufacturer



Typical silicon rectifiers made by Varo Incorporated.

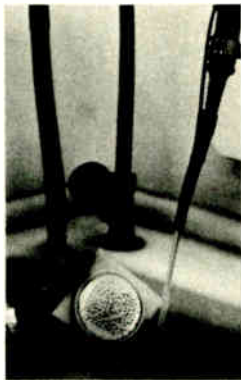

Close-up view of cleaning booth, where assembly is being rinsed with deionized water.

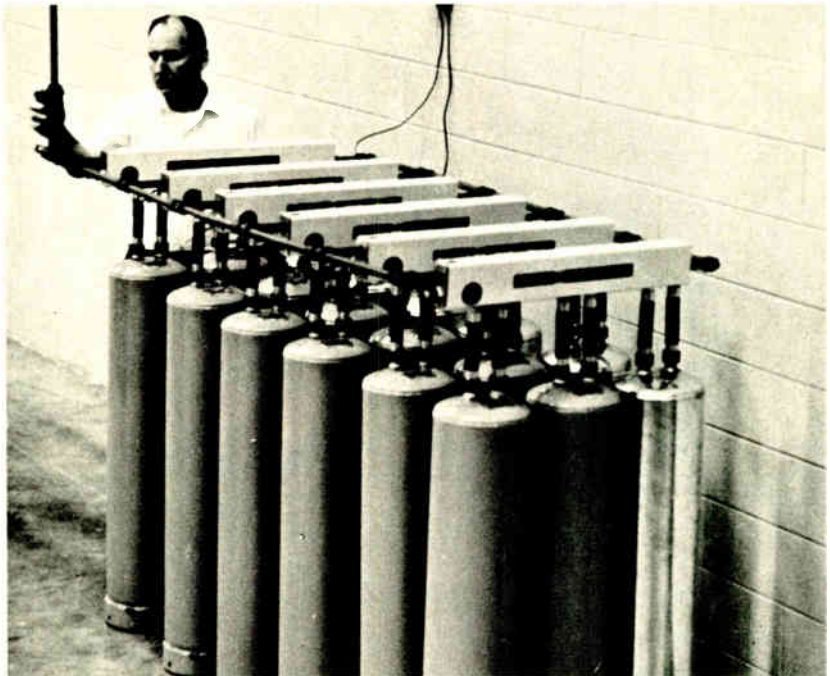

Eighteen-tank Culligan system in use at Varo. System supplies deionized water for use in manufacture of semiconductors.

□ If a manufacturer of semiconductor devices can't get high quality water, then it isn't a matter of product quality—it's a matter of product life or death. "And by very high quality," says Jan Collmer, General Manager of Varo, "we're talking far beyond one or two parts per million; we mean water quality in the 15 to 18 megohm range."

To meet Varo's exacting standards, the local Culligan Man supplied a deionizer system, utilizing 9-inch exchange service tanks. The decision to use portable exchange rather than automatic packaged

deionizers was made for two reasons: economics and convenience.

The Culligan Man put the economics reason this way: "When the flow volume demand is low, you use portable exchange. Naturally, you reach a point in gallonage where you must balance the cost of purchase against the cost of leasing equipment. But you can't make a universal rule about it; each customer's demands are different."

As for convenience, Collmer adds, "We're not interested in becoming water experts. Our main concern is having high quality water available at all times,

and we want to limit our involvement to paying the invoice each month.

We pay only for the water we use. If we have a plant shutdown or if production drops for any reason, we can reduce or cut off the supply of deionized water immediately."

For detailed information and additional case histories, write to Will Sanders for our 4-page Job Reports 103, 119 and 120—or call your local Culligan Man for a consultation. □

Culligan USA, One Culligan Parkway, Northbrook, Illinois 60062.

**CUSTOMER:** Varo Incorporated

**PROBLEM:** Need for high quality water for manufacture of semiconductors

**SOLUTION:** 15-megohm water with exchangeable tanks

**EQUIPMENT:** Culligan deionizer tanks and carbon filters

# HOW MANY SPECIALTY GAS MANUFACTURERS DO YOU KNOW THAT HAVE SEVEN DISTRIBUTION POINTS IN WYOMING?

Just one, right? Linde. And we've got 526 others located throughout the rest of the country. Plus five plants in key geographic locations. One near you, so you'll always save on delivery charges. To find out a lot more about Linde Specialty Gases and services, write us for a free copy of the 108-page "Linde Specialty Gas" catalog. Union Carbide Corporation, Linde Division, Dept. LJB, 270 Park Ave., N.Y., N.Y. 10017.

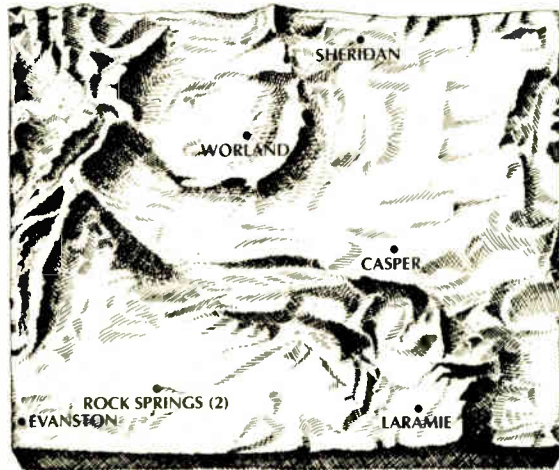

Linde is a registered trademark of the Union Carbide Corporation.

Semiconductors

## Chip can drive big core arrays

IC combining high-power transistor outputs, MSI logic replaces about 20 discretes

An MSI eight-bit memory driver, for use with magnetic core memory systems, heads up a new group of bit drivers and sense amplifiers for core and MOS memories from Texas Instruments. The company hopes the items will make TI's the broadest line in the industry [*Electronics*, June 5, p. 96].

TI put it all together by incorporating power control, polarity select and timing, decoder, and 16 high-reliability transistors on a single 124-by-178-mil chip—the most complex monolithic driver now in production. Developed for a major computer manufacturer, the model SN55329 is aimed at cutting a significant part of the size and cost out of military linear-select core memory systems, says David A. Rosendahl, manager of systems interface products.

The driver features a power-enable control that reduces package standby power to 30 milliwatts typically. In addition, internal power control does not require power supply sequencing.

With an output driver current spec of 400 milliamperes, the device has a read-and-write cycle time of 1 microsecond and a typical operating power dissipation of about 1 watt. Bipolar output currents are controlled to within  $\pm 5\%$  by four shared external resistors.

"At the component level, the 329 is probably more expensive than the 16 transistors and at least three ICs it replaces," admits Rosendahl, "but in military use, the device's small size and low power operation give economies of weight, space, and power supply."

The core memory driver is packaged in a 24-lead metalized ceramic

flatpack, with pins at 35-mil centers. A screened pattern of lead interconnects on the bottom of the package reduces 37 bonds to 24 pins. Price in 100-piece quantities is \$50.50. A commercial version, planned for next year, probably will be packaged in ceramic or plastic.

Other new core drivers include a quad sink, the SN75326, and a quad source, the SN5327, with outputs rated at 24 v and 600 mA.

TI is also adding a dual sense amp, the SN55236, with built-in data register for each channel featuring a threshold sensitivity of  $\pm 2$  millivolts over the full military temperature range. "This is the first sense amp with this sensitivity to be announced as a standard product by the industry," says Dale Pippenger, linear applications engineer at TI. "It allows you to operate in systems where the signal levels are lower, such as is the case with high-speed systems." Threshold sensitivity is at least a twofold improvement over TI's earlier 7520 series. The SN55236 is offered in a 24-pin ceramic flatpack at \$23.17 in 100-piece quantities.

For semiconductor memory interfacing, TI developed a dual-bit driver/sense amplifier/converter that combines these functions on a single chip for the first time. With development paid for by Advanced Memory Systems Inc., the device, called the SN75370, is designed to work with the AMS6002 1,024-bit RAM (TI's 4602), and provides the simplicity of interface that has made the 1103 so popular. "We expect the 370 will help swing the memory market to the 6002," says Pippenger.

The new part has propagation delays of about 30 nanoseconds for the bit driver, and 40 ns for the sense amp/converter. It dissipates 550 mw with both channels in the read mode, 700 mw in the write mode, and around 350 mw in standby. Because the output current from its companion RAMS approximates a ramp function, the interface will respond within 10 ns, as compared to a typical delay of 40 ns for a step input. In a 16-pin plastic DIP, the 370 sells for \$5.40 each in 100-

piece quantities. In a ceramic package, the price is \$5.99.

Texas Instruments Incorporated, Inquiry Answering Service, P.O. Box 5012, M/S 308, Dallas, Texas 75222 [411]

---

IC for data transmission contains four transceivers

For use in half-duplex transmission, a Schottky TTL quad bus driver-receiver is in the form of a monolithic integrated circuit. Other applications include routing data in bus-oriented systems, circuitry that interfaces MOS and TTL devices, and any application requiring a high-current driver. Propagation delay is less than 17 nanoseconds. The

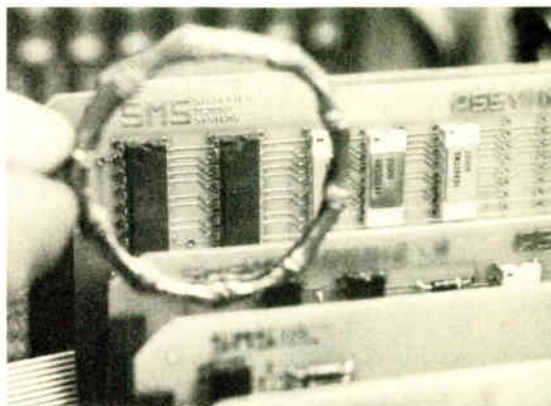

model 8T26 contains four pairs of inverting logic gates and two buffered common-enable lines. Pnp inputs are used, providing an input loading of less than 200 microamperes.

Signetics, 811 East Arques Ave., Sunnyvale, Calif. 94086 [415]

---

Interrupter module can do 10,000 operations a second

A module that can be used in limit-switch applications, an optoelectronic interrupter, requires no contact pressure and is capable of up to 10,000 operations per second. Each plastic module contains a solid-state lamp source and a sensor separated by a throat width of 0.125 inch. Leads are parallel for printed-circuit-board mounting. The unit comes in four models: the H13A1

# electronic delay relayability

Reliability is built into 300 different configurations offered by Hoagland in its electronic time-delay relays.

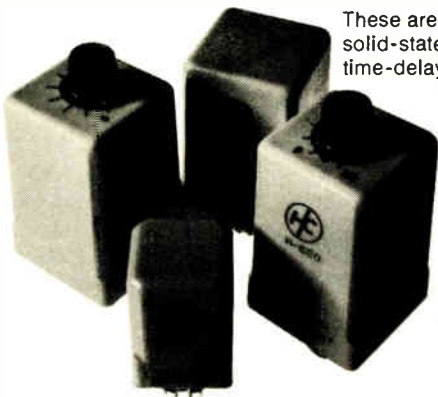

These are solid solid-state-controlled time-delay relays

So we coined a word for the reliability in our relays... relayability.

Your choice of: time from .1 up to 300 seconds, AC or DC operating voltages in seven voltages, SPDT or DPDT, transient and polarity protection. Prices to fit all applications from economic to high reliability.

Write or call for our new descriptive catalog on electronic and thermal time delay relays. Hoagland Instruments, 65 Chestnut Street, Red Bank, New Jersey 07701. Phone: (201) 741-7319. **HOAGLAND**

Circle 152 on reader service card

# ENGINEERS WHO KNOW ZENER DIODES SPEC DICKSON

That's because Dickson has earned a reputation for excellence in voltage regulating (Zener) and reference (TC) diodes. Since Dickson has always been a specialist in Zeners, engineers expect the best and they get it... from a hi-rel military unit to low-cost industrial devices. Give us a try! Write, today, for our 6-page Zener Selection Guide.

"The Specialists"



"Where Quality Makes The Difference"



**DICKSON**  
ELECTRONICS CORPORATION

PHONE (602) 947-2231 TWX 910-950-1292 TELEX 667-406  
P. O. BOX 1390 • SCCOTTSDALE, ARIZONA 85252

## New products

and H13A2 are high-speed types with operational stability to within 20% between -20° and +100°C, and

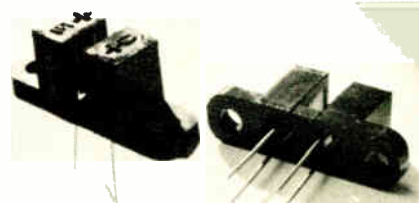

the H13B1 and H13B2 feature speed plus high gain. Prices start at \$1.35 each.

General Electric Co., Semiconductor Products Dept., Electronics Park, Bldg. 7, Mail Drop 49, Syracuse, N.Y. [417]

DIP reed relays handle up to 20 watts

Available in single- or dual-coil versions, a Form A magnetic latching reed relay is housed in a 14-pin dual in-line package. The units are com-

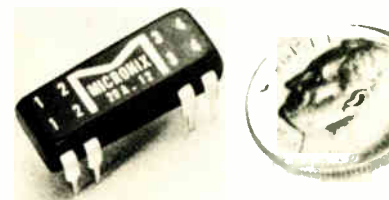

patible with ICs and have contacts capable of handling up to 20 watts with resistive loads of 1 ampere and 200 volts. At 20 W, life is in excess of a million cycles; and at 10 watts, life is rated at 10 million cycles. Coil voltages offered are 5, 6, and 12 V, with 500 ohms impedance; a 24-V coil has 1,400 ohms.

Micronix, 24248 Crenshaw Blvd., Torrance, Calif. 90505 [418]

Capacitor diodes are radiation-resistant

Microminiature silicon voltage-variable capacitor diodes are available in capacitances of 3.3, 12, 15, 18, and 22 pF, and with Qs of 50 to 300. The units are packaged in hermet-



# Avoid professional obsolescence—stay on top of your field with these new books from McGraw-Hill

## BASIC ELECTRONIC INSTRUMENT HANDBOOK

Clyde F. Coombs, Jr., Editor-in-Chief.  
800 pp., \$28.50

This guide to the operation and use of electronic instruments is written specifically to provide information to those at all levels of electronic sophistication. It bridges the gap between beginner's level understanding of electronic test equipment and the technical content of the instruction manuals which assumes a knowledge of the subject that may not yet have been developed. At the same time, it provides the practicing professional with a general reference on all equipment he may use and about which he may wish to refresh himself concerning fundamentals of operation and use.

## ELECTRONIC ANALOG AND HYBRID COMPUTERS, 2nd Ed.

By Granino A. Korn and Theresa M. Korn.  
480 pp., 250 illus., \$21.50

This completely revised edition, which includes much previously unpublished material, is unique in its emphasis on the latest in hardware information for designers of hybrid analog-digital equipment. It also introduces improved computing techniques made possible by the new, ultra-fast hybrid computers, especially in connection with optimization. Ideal for designers, research workers, electronic engineers, computer programmers, and systems analysts.

## PRACTICES AND PROCEDURES OF INDUSTRIAL ELECTRICAL DESIGN

By Lionel B. Roe. 320 pp., 135 illus., \$14.50

This utterly practical volume is the result of 20 years experience in making decisions and answering questions about electrical design work, electrical construction, and electrical trouble-shooting. Created as an engineering reference which will help readers find solutions to electrical design problems quickly and accurately, it is a gold mine of material unavailable in any other source. It offers fast, uncomplicated answers to 99 per cent of day-to-day questions, and is not only an ideal guide, but perfect for self-study or retraining.



## MAGNETIC RECORDING

By Charles E. Lowman. 285 pp., \$14.50

Just published—an authoritative and practical guide to the technology of magnetic recorders. The most up-to-date circuitry, the newest techniques, and the latest innovations are covered clearly and comprehensively. The author, a Senior Instructor in the Ampex Training Dept., discusses applications, advantages, and limitations of magnetic recording; its basic principles and theory of operation; as well as its practical operating and maintenance procedures.

## HANDBOOK OF WIRING, CABLING, AND INTERCONNECTING FOR ELECTRONICS

By Charles A. Harper, Editor-in-Chief.  
1136 pp., \$29.50

This work is designed to provide in a single volume the guidance information and data on all of the important forms of wiring, cabling and electrical interconnecting which are useful to those engaged in all the electronic and electrical industries. It is a highly useful on-the-job guide, a text for training programs in industry or in graduate schools, and a thoroughly reliable reference for engineering students and/or professionals.

## PRACTICAL VACUUM SYSTEMS

By Rolland R. LaPelle. 238 pp., \$14.50

For those scientists, engineers, technicians, and supervisors who use vacuum systems in their work in research, development, or manufacturing, this is the first fully practical work on the selection, application, use, and maintenance of these systems. It is dedicated to the man who is an expert in the laboratory or production work he is doing, but not on the vacuum systems that serve that work.

And, in case you missed this classic best seller on small motors . . .

## FRACTIONAL- & SUBFRACTIONAL-HORSEPOWER ELECTRIC MOTORS, 3 Ed. What Kinds Are Available—How They Work & What They Will Do—How to Select, Apply, Connect & Service Them

By C. G. Veinott. 500 pp., illus., \$16.50

This up-to-the-minute, fully illustrated instruction manual gives authoritative, completely detailed answers to just about any question on today's small electric motors. Concentrating on important recent developments in the industry, changes in standards, and the vastly increased applications of the motors, it covers an amazing number and variety of motors in how-to-do-it terms that make it easy to use on the job.

### 10-DAY FREE EXAMINATION OFFER

McGraw-Hill Book Company  
1221 Avenue of the Americas, N.Y., N.Y. 10020

Please send me the book(s) checked here on a 10-day free examination basis, after which time, I will remit the full price, plus local tax, postage, and handling for the book(s) I keep, and return any other book(s) postpaid. I understand that if I remit in full with this order, plus local tax, McGraw-Hill pays all postage and handling, and that return privileges still apply. **This offer good only in U.S., and is subject to acceptance by McGraw-Hill.**

- (126151) Basic Electronic Instrument Handbook
- (353638) Electronic Analog and Hybrid Computers, 2 Ed.
- (533903) Practices and Procedures of Industrial Electrical Design
- (388458) Magnetic Recording
- (266743) Handbook of Wiring, Cabling, and Interconnecting for Electronics
- (363552) Practical Vacuum Systems
- (67390X) Fractional- & Subfractional-Horsepower Electric Motors, 3 Ed.

Name

Address

City  State  Zip

Please Initial

23-11092

## TEC LED LITE

### TRANSISTOR CONTROLLED LED INDICATOR SAVES PC BOARD SPACE

If you're driving LED's directly from IC outputs you're wasting valuable PC board space! TEC's new L-1017 Series LED Indicator requires 1/10th the current (only 1.6ma) of ordinary LED's (using 15ma) — lets you drive one L-1017, plus nine other loads from one IC logic circuit. Transistor driver and LED are housed in a .284 dia. x 1" long body that mounts in a 1/8" panel hole on 1/2" centers. Wire-wrap terminals standard. L-1017 Series turns on with "high" input, logic "1" (IC driven LED's indicate logic "0"). L-1017 signals: ON, +2.5 to +5VDC; OFF, 0 to +0.8VDC. Supply: +5VDC @ 15ma, maximum. Special lens design increases LED brilliance and side viewing — available in red or clear, spherical or flat top lens style.



2 X SIZE

Immediate Del. \$2.30 ea., 100-499 qty.



ACTUAL SIZE

### DIRECT DRIVE LED INDICATOR

L-1015 Series LED Indicator is identical to L-1017 Series above in all mechanical details. Internal resistors allow operation directly from 5.0, 6.3, 10 and 24 VDC supplies — permit LED indicator substitution for incandescents.



ACTUAL SIZE

Immediate Del. Price, \$1.30 ea., 100-499.

### TEC LED LITE INDICATOR PACKAGES



Select a rugged, long life LED indicator or switch/indicator from more than 20 TEC designs. More brilliance, easier mounting, attractive appearance are added to the various LED's packaged by TEC.

See TEC-LITE for the complete line of readouts, indicators, switches, display panels, keyboards, CRT terminals.

TEC, Incorporated; 9800 North Oracle Road, Tucson, Arizona 85704; or phone (602) 297-1111



## New products

ically sealed glass DO-7 or DO-20 cases. The ion-implanted devices are radiation-resistant and have a

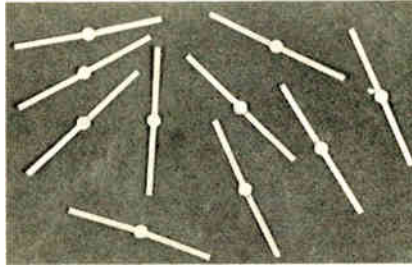

reverse voltage of 50/100 v. The units are suitable for the replacement of mechanically tunable capacitors, tunable rf circuitry, tunable oscillators, and video switches. Typical price is \$4 in 100-lots.

Solid State Devices Inc., 12741 Los Nietos Rd., Santa Fe Springs, Calif. [419]

Schottky barrier diode has low forward-voltage drop

A 50-ampere, 20-volt hot-carrier Schottky barrier diode, designated the 50HQ020, has a maximum peak forward voltage drop of 0.87 volt at 157 amperes and 25°C (0.65 v at 100 A). The low reverse recovery losses of the unit make it suitable for use in high-frequency (over 20 kHz) rectifier circuits. The diode, fabricated with epitaxial construction and oxide nitride passivation, is packaged in a DO-5 case.

International Rectifier Corp., Semiconductor Division, 233 Kansas St., El Segundo, Calif. [420]

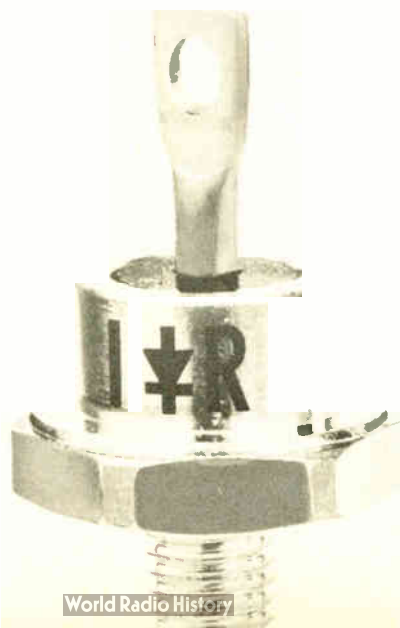

World Radio History

# TEMP-R-TAPE: GREAT ELECTRICAL PROPERTIES PLUS MOST ANYTHING ELSE YOU MIGHT WANT IN A TAPE.

Like high tensile or tear strength; excellent abrasion, thermal, and chemical resistance; exceptional dimensional stability; excellent conformability; and a low-friction, easy-release surface. Because Temp-R-Tape® is a complete tape "family" available in a variety of materials like polyester, polyester/rope paper laminate, Teflon\*, Kapton\*, and fiberglass. Supplied with thermosetting, silicone, or acrylic pressure-sensitive adhesive.

Find your CHR distributor in the Yellow Pages under "Tapes, Industrial" or in industrial directories. Or write for details and sample. The Connecticut Hard Rubber Company, New Haven, Connecticut 06509.

\*T.M. of DuPont

a HITCO company

# CHR

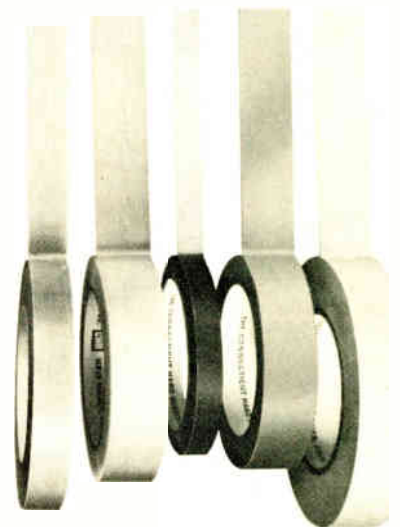

Circle 176 on reader service card

# NO ONE

Customizes Switches Like CDI  
Nor Has a More Complete Line

## THUMBWHEEL SWITCHES



Completely sealed against hostile environments.



Mounts on 1/2" centers, retrofits most panel openings for miniature thumbwheel switches.

## ROTARY SWITCHES

Snap-in, snap-out modules in seconds, eliminating downtime.

Tabet Pat.  
2841660,  
2971066,  
3015000,  
2956131,  
2988607.



## PUSHBUTTON SWITCHES



Miniature add/subtract units retrofit most minithumbwheel switch panel openings.

CDI earns its reputation every day for Consistently High Quality, Consistently Good Delivery.



**CHICAGO DYNAMIC INDUSTRIES, INC.**

PRECISION PRODUCTS DIVISION  
1725 Diversey Blvd., Chicago, Illinois 60614  
Phone: 312. 935-4600

Circle 177 on reader service card

## Catch-up reading. CAMBION'S new Integrated Packaging Catalog.



Its 48 pages cover our whole line of high density IC Sockets, Cambi-Card® circuit boards, bread boards, card files, power planes and Wire-Wrap\* products and services. Send for Catalog 99. Cambridge Thermionic Corporation, 445ED Concord Avenue, Cambridge, Massachusetts 02138.

\*Registered Mark of Gardner-Denver Co.

Standardize on

# CAMBION®

The Guaranteed Electronic Components

Circle 178 on reader service card

## New Multi-Octave Double Balanced Mixers

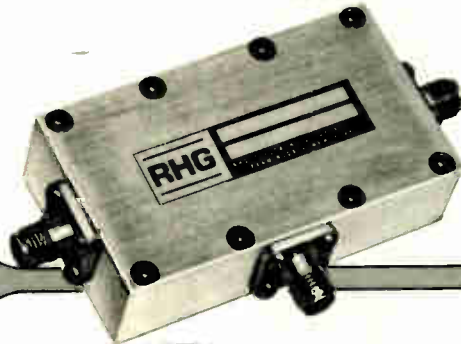

Now Available  
RF to 18 GHz  
IF to 2.3 GHz

0.5 to 12 GHz  
COVERAGE

IN A SINGLE MIXER  
UNIQUE DOUBLE  
BALANCED MICROWAVE  
CONFIGURATION\*

Excellent noise performance is maintained over several octaves along with low IM distortion and high isolation.

### MULTI-OCTAVE • OCTAVE MODELS

Model No.	Freq. (GHz)	NF (db)	Price
DM 1-4	1.0 to 4.0	7.5	\$325
DM 1-8	1.0 to 8.0	8.5	345
DM 1-12	1.0 to 12.0	10.0	425
DM 5-12	0.5 to 12.0	10.0	450
DM 1-18	1.0 to 18.0	10.0	595
DM 1-2	0.8 to 2.2	7.2	295
DM 2-4	1.8 to 4.2	7.5	295
DM 4-8	3.7 to 8.2	8.2	325
DM 8-12	7.8 to 12.2	10.0	345
DM 12-18	11.8 to 18.2	10.0	495

#### NOTES:

1. LO-RF isolation 20 db.
2. Based on 1.5 db IF N.F.
3. RF & LO VSWR: 2.0:1.
4. LO injection: +5 to +10 dbm.

Mixers are available with or without built-in low noise preamplifiers — one group of hundreds of standard RHG waveguide and coaxial mixer-preamplifiers.

Write for technical performance curves and detailed data sheets.

\*U.S. Pat. #3,652,941

# RHG

**RHG ELECTRONICS  
LABORATORY • INC**

94 MILBAR BOULEVARD • FARMINGDALE  
NEW YORK 11735 • (516) 694-3100 • TWX 510-224-6493

for Reliability, Innovation and Service

Circle 155 on reader service card 155

**Radiation Devices Co.**

**BROADBAND AMPLIFIERS**

Our Economical Line of Broadband RF Amplifiers Covers The Frequency Region From 3 MHz. to 800 MHz. With Noise Figures As Low As 3.0 dB. Remotely Powered Versions Are Available. Brochures and Application Notes Are Available Upon Your Request.

RADIATION DEVICES CO., BOX B450, BALTO., MD. 21234

CIRCLE 952 ON READER SERVICE CARD

**FREE CATALOG**

**HARD-TO-FIND PRECISION TOOLS**

Lists more than 1700 items—pliers, tweezers, wire strippers, vacuum systems, relay tools, optical equipment, tool kits and cases. Also includes four pages of useful "Tool Tips" to aid in tool selection.

**JENSEN TOOLS**  
4117 N. 44th Street, Phoenix, Ariz. 85018

CIRCLE 953 ON READER SERVICE CARD

**New**

for picking up miniature parts

**VACUUM PENCIL**

**PHILIP FISHMAN COMPANY**  
7 CAMERON ST. WELLESLEY, MASSACHUSETTS

CIRCLE 954 ON READER SERVICE CARD

**EMPLOYMENT**

**Personnel Recruiters, Inc.**  
1703 Spring Arbor Road  
Jackson, Michigan 49203

We need qualified men for the following positions:

**Data Processing Mgr. ....\$20,000**  
**Logic Design Eng. ....18,000**  
**Systems Development Eng. ....16,000**  
**Systems Analyst .....16,000**  
**Hybrid Programmer .....15,000**  
**Programmer/Analyst .....14,000**

Call or Send Resume  
Fred Nagelson 517-782-0541

**HELP!**

**Q. How do I reply to a box number ad?**  
**A.** Address an envelope with the box number indicated in the ad, c/o Electronics, Class. Adv. Dept., P.O. Box 900, NY, NY 10020

**Q. Whom do I contact or call to renew my classified ad or make corrections?**  
**A.** Write Electronics, Class. Adv. Dept., P.O. Box 900, NY, NY 10020 or call: (212) 997-6585 or 6586. Give full company name, size of ad, & date or dates it is scheduled to appear.

**AUTOTRACK MOUNT**

**AUTOTRACK SCR-584 RADARS**  
360 degree azimuth, 210 degree elevation sweep with better than 1 mil. accuracy. Missile velocity acceleration and slewing rates. Amplify and servo control. Will handle up to 20 ft. dish. Supplied complete with control chassis. ALSO in stock - 10 cm. van mounted radar system. Conical scan. PPI. 6 ft. dish. Ideal for S band telemetry, weather, balloon trk, missile trk, rocket trk, ECM range. Write for complete data. 600 pg. instr. bk. avail. at \$25 ea.

**PATH LOSS MEAS. FACILITY**  
Mfg. REL For establishing max. xmsn paths for tropo and microwave links. 2 heli-hut vans. Covers 1-2.5ghz bands. 20 to 120 watts CW output

**PHOENIX MISSILE SYSTEM**  
10" PPI, 5" B and C displays, and complete digital computer consoles.

**IBM 704 SCIENTIFIC COMPUTER**  
w / peripherals & programs. Cost \$2,000,000. Our price \$10,000.

**MIT MODEL 9 PULSER 1 MW—HARD TUBE**  
Output 30 kv at 70 amp. Duty cycle .001. Rep. rates. 1 microsec. 600 pps. 1 or 2 msec. 300 pps. Uses 5948 hydrogen thyatron. Input 120/208 VAC 60 cycle. Mfr. GE. Complete with high voltage power supply.

**2 MEGAWATT PULSER**  
Output 25kv 40 amp., 30kv 40 amp. max. Duty cy. .002. .25 to 2 microsec. Also 5 to 5 microsec. and .1 to .5 microsec. Uses 6C21. Input 115v 60 cycle AC. Mfg. GE. Complete with driver and high voltage power supply. Ref: MIT Rad. Lab. Series, Vol 5, p. 152.

**2 MEGAWATT HARD TUBE PULSER**  
Output 40kv at 50 Amps. Duty cy. .0038. Var. pulse width. Compl. with driver and HV power supply. Input 208V 60 Hz.

**HV POWER SUPPLIES**  
5KV @ 1 Amp; 20KV @ 1.3 Amps; 35KV @ 1.5 Amps; 28KV, 70MA; 12KV @ 800MA; 18KV @ 2.25 Amps; 17.5KV @ 1.8 Amps.

**RECON DRONE CONTROL RADARS**  
X Band systems autotrack and search complete with plotting boards. Fully mobile van mounted. Gives PPI, slant range, altitude data. Ground to air control links and beacons also in stock. AN / MPQ-29 & AN / UPW-1

**PARAMETRIC AMPLIFIER**  
Collins type. 2.3 Ghz. 30 Mhz band width. 1.7 DB noise figure. 20 DB gain. 5-way power splitter output.

**SPARE PARTS IN STOCK**  
Nike Ajax, Nike Hercules, M-33, MPS-19, TPS-ID, TPS-10D, FPS-6, SPS8, SCR-584, HIPAR.

**RADAR & RF PKGS.**  
34ghz 40kw Pulse RF pkg  
24ghz 40kw Pulse bomb toss system  
16ghz 130 kw Pulse B-38 search radar system

**X BAND AUTOTRACK 250KW PULSE M-33**  
compl w / plot boards

**X BAND AUTOTRACK 50KW PULSE B-47**  
fire control complete

**C BAND HEIGHT FINDER**  
AN / FPS-26 5 megawatt output  
AN / TPS-37, 1 megawatt output.

**C BAND 1 MEGAWATT AUTOTRACK**  
10ft dish mortar locator MPQ-21

**C BAND 285KW PULSE Search AN / SPS-5 / 10**

**S BAND 1 MEGAWATT COHERENT AN / FPS-18**

**S BAND 1 MEGAWATT PULSE NIKE ACQ.**

**I. BAND 1 MEGAWATT PULSE AN / UPS-1**

**I. BAND 500KW PULSE AN / TPS-ID / E**

**I. BAND 5 to 20K W PULSE**  
400mhz 1KW CW AN / FPS-23  
225mhz 1 MEGAWATT PULSE AN / TPS 28  
2-30mhz 100K W PULSE  
CW 950-5ghz 150 WATTS  
CW 1.5mhz-10.5ghz 5 WATTS

**AN / GPG-1 SKYSWEEP TRACKER**  
3 cm. auto. tracking radar system. Comp. pkg. w / indicator sys. Full target acquisition & auto. tracking. Input 115v 60 cy. new. In stock for immed. del. Entire sys. 6' x 3' x 10' Ideal for infrared tracker, drone tracker, missile tracker. R & D

**CATV-COLOR MICROWAVE LINKS**  
Ratheon type KTR-1000. Fullcolor bandwidth as well as studio audio. Rack mounted. Complete trans-recv racks in stock.

**HUNDREDS MORE IN STOCK LARGEST RADAR INVENTORY IN WORLD. WRITE FOR CATALOG ON YOUR LETTERHEAD**

**Radio-Research Instrument Co. INC.**  
3 Quincy St., Norwalk, Conn. 06850 • 203-853-2600

CIRCLE 951 ON READER SERVICE CARD

**Job-seekers... be the first to know with McGraw-Hill's Advance Job Listings**

Beginning October 2nd (and every Monday after that), by having our new weekly ADVANCE JOB LISTINGS sent to your home, you can be the first to know about nationwide openings you qualify for both in and out of your field.

This preprint of scheduled employment ads will enable you to contact anxious domestic and overseas recruitment managers BEFORE their advertisements appear in upcoming issues of 22 McGraw-Hill publications.

To receive a free sample copy, plus information about our low subscription rates (from one month to 12), fill out and return the coupon below.

---

**ADVANCE JOB LISTINGS / P.O. BOX 900 / NEW YORK NY 10020**

PLEASE SEND A SAMPLE COPY OF ADVANCE JOB LISTINGS TO:

NAME \_\_\_\_\_ ADDRESS \_\_\_\_\_

CITY \_\_\_\_\_ STATE \_\_\_\_\_ ZIP \_\_\_\_\_

E 10/9/72

## Wide dynamic range flatpack amplifier

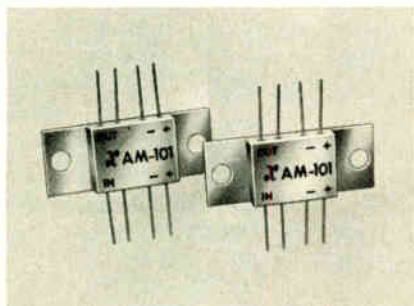

Operating from 5-500 MHz, the AM-101 Flatpack Amplifier provides 10 db gain and high output power (up to 100 mw at 1 db compression point) with one-third normal DC power requirement (900mw). High gain stability, low noise figure (4.5 db) and very low intermodulation distortion (+ 40 dbm 3rd order intercept) are provided by the AM-101 Amplifier.

Gold plated mounting tabs provide good heat sinking. ANZAC Electronics, 39 Green Street, Waltham, Mass. 02154 Tel. (617) 899-1900 Circle 179 on reader service card

# Save 50 %

On printed circuit layouts

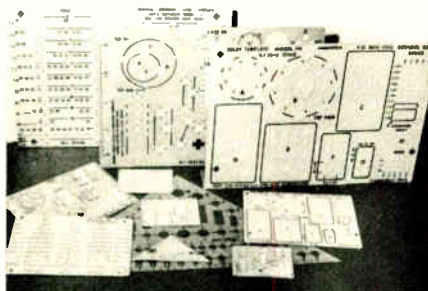

## With the HAPCO Designer's Template Set

12 templates in 3 different scales and 4 different configurations

Free Printed Circuit Design and Documentation Booklet and Wall Chart with order for complete set.

Templates sold individually Write for details.

The complete set \$70.70 FOB  
Over \$100 if purchased separately.

Order From:

**HAPCO, POB 1205  
Boulder, Colo. 80302**

Circle 180 on reader service card

## New products/materials

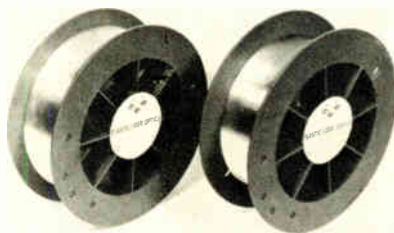

Plastic optical monofibers are available in five diameters in spool lengths ranging from 1,000 to 100,000 feet. Diameters offered are: 0.005 inch, 0.010 in., 0.020 in., 0.040 in. and 0.060 in. Maximum continuous operating temperature is 170°F and acceptance angle is 67°. Price per spool is \$95; price per foot ranges from 0.095 cent to 0.00095 cent. A sampling kit is available.

Dolan Jenner Industries Inc., 200 Ingalls Court, Melrose, Mass. [476]

Alumina substrates with polished edges are intended for use in critical microwave and thin-film applications, mainly to facilitate front-to-back connections. Length and width tolerances can be held to 0.001 inch/in. The 99.5% alumina substrates are also available with beveled edges. Price for 1-by-1-by-0.025-inch blanks is \$1.50 in 100-lots.

Electronic Slicing and Dicing Inc., 45 Osgood St., Methuen, Mass. 01844 [478]

Type EE1018 epoxy compound is a fire-resistant casting resin for use in potting modules where high impact strength must be met with a room-temperature cure. Moisture absorption is 0.21% immersed for 24 hours, and flexural strength is 11,370 pounds per square inch.

Hysol Div., The Dexter Corp., 211 Franklin St., Olean, N.Y. 14760 [479]

Solder paste for use in thick- and thin-film microelectronic circuits provides a bonding alloy for discrete components, leads and cover seals. Several compositions are offered, varying in alloy content and melting range. All contain a particle size of -325 mesh with a viscosity range of from 450,000 to 550,000 centipoise.

Sel-Rex Co., 75 River Road, Nutley, N.J. 07110 [480]



# CARD FILES

from the originator of card packaging systems

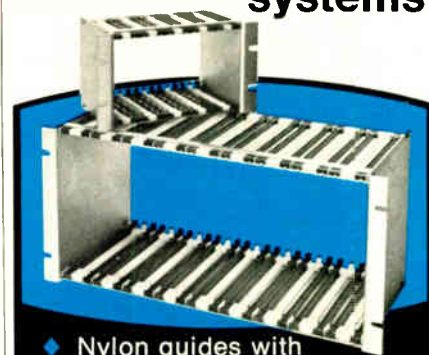

- ◆ Nylon guides with integral mounting feet
- ◆ Precision card/connector alignment
- ◆ Easy assembly — snap-on card guides
- ◆ Extruded aluminum mounting bars
- ◆ Rugged, lightweight construction



Configurations are virtually unlimited — files, kits, drawers — both vertical and horizontal, as well as fully wired systems. Also, Scanbe P.C. card file systems provide for any card/connector combination and any card spacing with single and multi row designs. Contact Scanbe for quality card file systems.



**SCANBE MANUFACTURING CORP.**  
"The Packaging People"  
3445 Fletcher Avenue  
El Monte, California 91731  
Telephone (213) 579-2300

Circle 157 on reader service card 157

# NEW HUTSON CERMA-CEL\* TRIAC's & SCR's



- 8 Amp ( $I_{T(RMS)}$ )
- 200V, 300V, 400V ( $V_{DRM}$ )
- Miniature size — requires only slightly more space than direct chip mounting
- Thyristor die bonded to ceramic cell and secured within nickel-plated steel housing
- Can be reflow soldered. Correct amount of solder on housing head.
- Void-free-glass passivated, hermetically sealed chip
- Di-Mesa\* construction for maximum operational reliability
- Extremely low-cost



Hutson's complete thyristor line includes 3A sensitive gates to 40A ( $I_{T(RMS)}$ ) • 50V to 600V ( $V_{DRM}$ ). All popular packages & chip form



WRITE FOR FREE CATALOG

\*T.M. HUTSON INDUSTRIES

## HUTSON INDUSTRIES

BOX 34235 • 2019 W. VALLEY VIEW, DALLAS, TEX. 75234 (214) 241-3511 TWX 910-860-5537

Distributed by:

ALTA-LAND ELECTRONICS, INC. Salt Lake City, Utah. 801/486-7227 ■ BODELLE CO., INC., Chicago, Ill. 312/468-1016, Detroit, Mi. 313/273-6920 ■ THOR ELECTRONICS, Elizabeth, N. J., 201/354-2420 ■ In Canada: WEBER-SEMAD ELECTRONICS, Downsview, Ont. 416/635-9880.

European Marketing Director:

30 Rue Pierre Semard, Yerres, 91 France Tel: Paris 925-8258 • TELEX 21-311

Distributed in Europe by:

Belgium: C. N. ROOD S.A. Brussels 02-352135 ■ Denmark: E. V. JOHANSEN A/S, Copenhagen (01)\* 295622 ■ Holland: RODELCO, Den Haag 647808 ■ Spain: BELPORT, Madrid 234.62.62 ■ Sweden: ELEKTROFLEX, Sundyberg 08-29 50 40 ■ Switzerland: D. LEITGEB, Dubendorf 051 85 2201 ■ UK, CLAUDE LYONS, LTD, Hoddeston, Hertfordshire (09924) 67161

Circle 158 on reader service card

## ELECTRONIC ENGINEERS:

### CAREER OPPORTUNITIES WITH A FLORIDA COMPANY SPECIALIZING IN ADVANCED COMMUNICATIONS SYSTEMS AND HIGH TECHNOLOGY UHF RADIO EQUIPMENT

Electronic Communications, Inc., a subsidiary of NCR, has openings at all levels for electronic engineers experienced in the design and development of communication systems, RF, digital and audio equipment. You will be working with major UHF command and control systems, satellite relay and telemetry systems, and a variety of other challenging long-term programs. At ECI, you (like all of our pros) will function with a minimum of supervision and a maximum of opportunity for advancement. ECI is small enough to give your accomplishments high visibility, yet big enough to provide the facilities and benefits of the largest companies. ECI is on Florida's West Coast — the BEST COAST — in comfortable, sunny cosmopolitan St. Petersburg.

If you are tops in your field, and if you are interested in a career opportunity on long-term programs in an intriguing location, write in confidence today to Paul E. Jordan, Supervisor of Professional Placement, Electronic Communications, Inc., Box 12248, St. Petersburg, Fla. 33733.

A Subsidiary of NCR  
An Equal Opportunity Employer — Male and Female



## New literature

**Potentiometers.** A series of plastic rectilinear potentiometers for military and industrial applications is described in a technical bulletin available from Amphenol Connector Division, Controls Operations, 2801 South 25th Ave., Broadview, Ill. 60153. Circle 421 on reader service card.

**Resistors.** Technical bulletin R-700, offered by Vishay Resistor Products, P.O. Box 925, Malvern, Pa., describes the V and M series of low-priced precision resistors that are direct replacements for wirewounds. The bulletin shows the design and construction of the radial- and axial-lead products and provides specifications. [423]

**Liquid crystals.** Eastman Kodak Co., Dept. 412-L, 343 State St., Rochester, N.Y. 14650, has published bulletin JJ-14 describing liquid-crystal compounds and their classifications—nematic, smectic, and cholesteric. [424]

**Multi-element semiconductors.** A multiple-semiconductor catalog is being offered by Texas Instruments Incorporated, P.O. Box 5012, Dallas, Texas, and highlights in 96 pages new products in the company's line of small-signal transistors. Catalog CC-406 covers devices with more than one chip in a package including duals, quad transistors, Darlington pairs, and diode matrices. [425]

**Gas laser products.** A gas laser product guide, PWR-551D, provides information on helium neon tubes, heads, and exciters. It is available from RCA Electronic Components, 415 S. 5th St., Harrison, N.J. 07029. [426]

**Impulse generators.** Singer Instrumentation, 3211 S. LaCienega Blvd., Los Angeles, Calif. Two data sheets describe three impulse generators with ranges from 50 Hz to 5 MHz, 60 kHz to 1 GHz, and 500 Hz to 35 MHz. [427]

**Soldering system.** A 12-page brochure from ITT Industrial and Au-

# We sell more magazines than most of our competition can give away free.

When you can sell something that everyone else gives away free, you must have something special. And that's how it is with Electronics.

Our readers find Electronics so valuable, they'd rather pay for it than take a chance on something for nothing.

With every other electronics magazine giving subscriptions away, Electronics, at \$8.00 to \$25.00 a year, has a higher circulation than all but one. And that one doesn't beat us by much.

Ours is the most controlled circulation in the field. Controlled first, because subscribers must qualify to receive Electronics. Controlled again, because our readers have to be willing to pay the price.

Not only is our audience select, it's loyal. In fact, 25,000 of our subscribers never read any of the next six electronics journals.

And that's the kind of audience you have to reach.

58,000 (67%) have management responsibility.

48,000 (56%) are responsible for company profits.

74,000 (86%) do or supervise design work.

73,000 (85%) select vendors.

These important customers believe in Electronics. And they'll believe in you when you advertise in Electronics.

With our kind of reader loyalty, you can't afford not to go to **The Source.**

**Electronics**  
**THE SOURCE.**

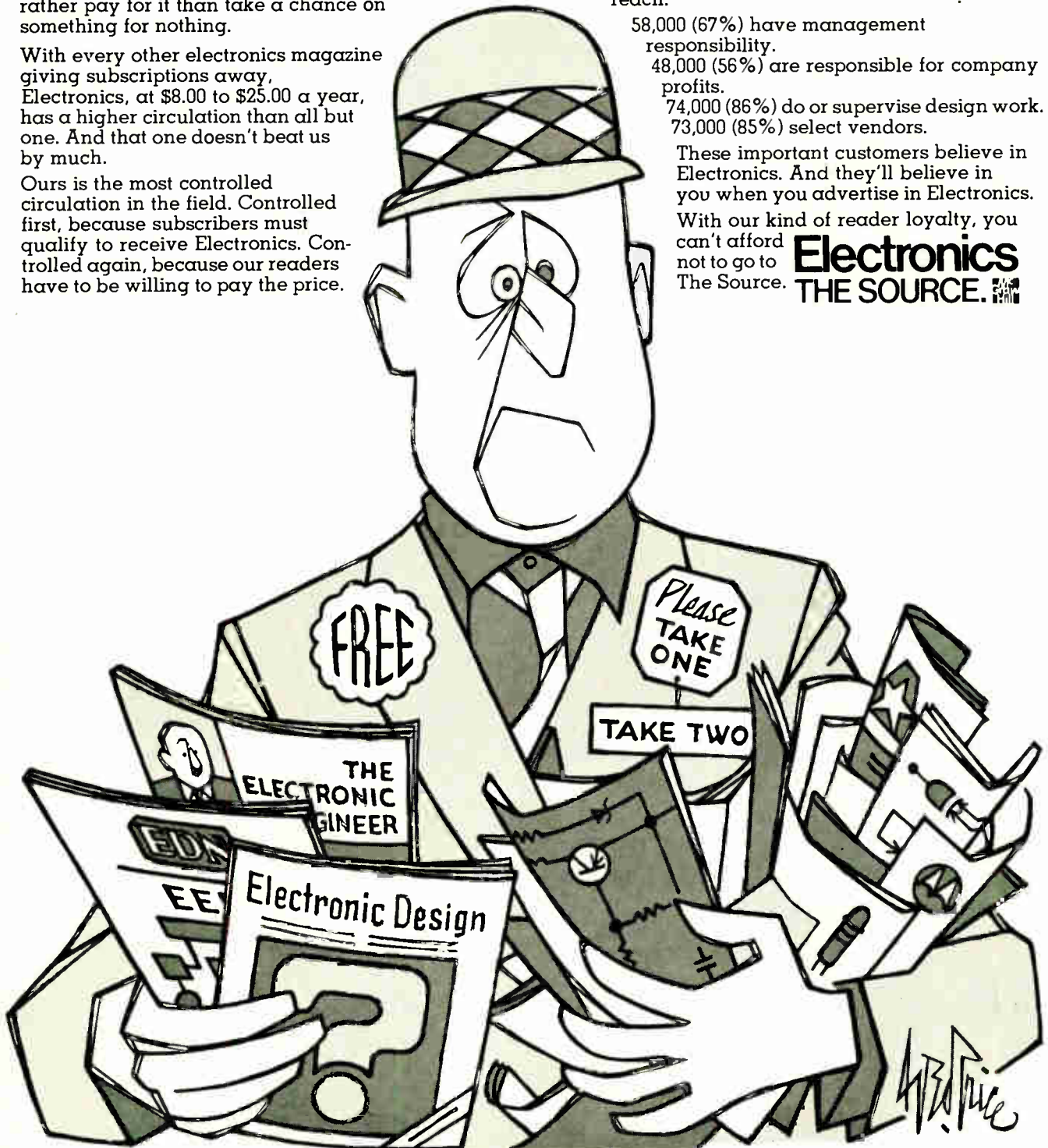

# HIGH VOLTAGE DIFFUSED SILICON RECTIFIERS

- Six versatile series include PRV ratings from 1 KV to 40 KV in a wide range of minimum-sized packages.
- 5 mA to 100 mA, average forward current ( $I_o$ ) ratings.
- All series available with fast recovery characteristics
- Designed for high reliability at economical cost
- Cataloged in EEM and REM
- Typical applications include CRT power supplies, television receivers, electrostatic copiers, electrostatic precipitators, RF transmitters, and microwave ovens.
- For complete information and applications assistance, call or write Sales Dept., Varo Semiconductor, Inc.

*Design us in . . . we'll stay there*

(ACTUAL SIZE) SERIES VG20  
20 KV PRV \$1.49 ea. (1000 qty)



**VARO**

**VARO SEMICONDUCTOR, INC.**

P.O. BOX 676, 1000 N. SHILOH, GARLAND, TEX. 75040 (214) 272-4551 TWX 910-860-5178

*Distributed by:*

ALLIED ELECTRONICS, Chicago, Ill. 312/421-2400. THE ALTAIR CO., Richardson, Tex. 214/231-5166. BELL ELECTRONICS, Menlo Park, Cal. 415/323-9431. BLUFF CITY DIST. CO., Memphis, Tenn. 901/725-9500. BRIDGEFIELD SUPPLY, Twinsburg, Ohio 216/425-4209. CRAMER ELECTRONICS, Nationwide; Newton, Mass. 617/969-7700; Rochester, N. Y. 716/275-0300. ELECTRONIC PARTS CO., Denver, Colo. 303/266-3755. FARWEST, INC., Bellevue, Wash. 206/747-1515. MERQUIP ELECTRONICS, Skokie, Ill. 312/965-7500. MERRILL ELECTRONICS, Chicago, Ill. 312/286-2525. MILGRAY ELECTRONICS, Freeport, N. Y. 516/546-6000.

*In Canada:*

ELECTRO SONIC, Toronto, Ont. 416/924-9301. R.A.E. IND. ELECTRONICS, Vancouver, B. C. 604/687-2621. WESTERN RADIO SUPPLY, Hamilton, Ont. 416/528-0151.

Circle 160 on reader service card

## New literature

tomation Systems, 41225 Plymouth Rd., Plymouth, Mich., describes modules of automatic soldering systems available for individual system work-up and a cascade-wave soldering method. [428]

**Dual processor.** Microdata Corp., 644 East Young St., Santa Ana, Calif. A four-page bulletin explains the Micro 1600D digital computer system, consisting of two micro-programable central processors capable of simultaneously executing independent programs while sharing a common main memory. The bulletin contains a general description, application information, and a list of specifications. [429]

**Power supplies.** Catalog 72-1 from Dynage Inc., 1331 Blue Hills Ave., Bloomfield, Conn., describes six series of power supplies for systems applications. [430]

**Recorder.** A data sheet describing the model 600 hard-copy recorder is being offered by Alden Electronic & Impulse Recording Equipment Co., Alden Research Center, Westboro, Mass. [431]

**Computers.** Computer Automation Inc., 18651 Von Karman, Irvine, Calif. 92664. The biography of a minicomputer developed for use as an OEM component is documented in a 16-page brochure. The bulletin describes the development features and applications of the company's 16-bit Naked Mini and Alpha 16 computers. [432]

**I/O interface.** A six-page brochure being offered by Computer Products, P.O. Box 23849, Fort Lauderdale, Fla. 33307, explains the company's concept of a plug-compatible process I/O interface for mini-computer users. [433]

**Noise analysis.** A brochure from General Radio Company, 300 Baker Ave. Concord, Mass. 01742, describes real-time analysis of noise. Common applications are discussed, along with technical features, custom systems, and peripheral equipment. [434]

## Specify



## Mica Capacitors

# this week

use them

# next week

**CMR**  
**CER**  
**GEM**

... Within hours after receiving your application requirements by phone, we're back to you with the design and cost quote. Your order can be in production the next day.

This is just standard procedure at Custom's short run department with the wrap and fill CMR's and the epoxy housed CER's. The epoxy molded GEM's take a little longer, like one more week due to tooling requirements.

*Try us, we're sure you'll like the service.*



**CUSTOM ELECTRONICS, Inc.**

Browne St., Oneonta, N. Y. 13820

PH: 607-432-3880 TWX 510-241-8292



THIS IS A VERY LOW COST  
FREQUENCY RESPONSE  
ANALYZER WITH AUTO-  
MATIC HIGH NOISE AND  
HARMONIC REJECTION.

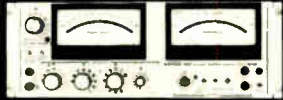

Single Units : \$2875.  
In Quantities: \$2450.

READS AMPLITUDE AND PHASE  
vs FREQUENCY 0.1 TO 20,000 Hz.  
■ FAST OPERATION ■

WRITE FOR BULLETIN 7172 ON  
OUR COMPLETE LINE OF FRE-  
QUENCY RESPONSE ANALYZERS.

**BAFCO, INC.** 717 Mearns Road  
Warminster, Pa. 18974  
Telephone (215) 674-1700

Circle 183 on reader service card

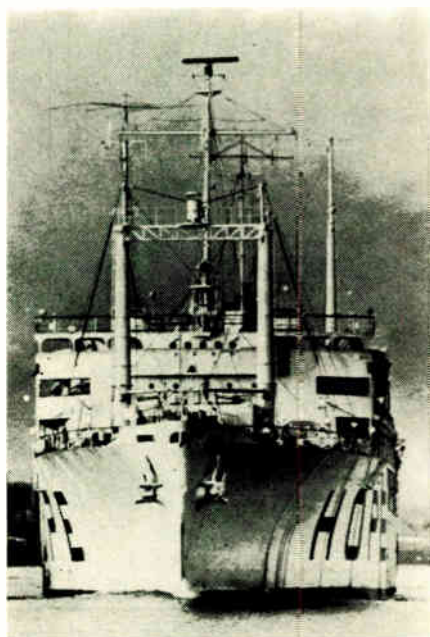

## S.S. HOPE, M.D.

Doctor . . . teacher . . . friend to  
millions on four continents—  
this floating hospital is a  
symbol of America's concern  
for the world's disadvantaged.  
Keep HOPE sailing.

**PROJECT  
HOPE**

Dept. A, Washington, D.C. 20007

## New books

**MOS Integrated Circuits: Theory, Fabrication, Design and Systems Applications of MOS LSI**, The engineering staff of American Microsystems Inc., Van Nostrand Reinhold Co., 458 pp., \$18.00.

This book on MOS integrated circuits should prove to be a good reference text for the practicing engineer. But, like most books with many authors, it tends to vary in its depth of treatment of the subject.

The evolution and advantages of MOS LSI, along with the problems and limitations of the new technology, are well stated in the opening chapter. And of the eight other chapters, three middle chapters—MOS circuit design theory, logic design with MOS, and system design with MOS arrays—are very good. The relationship between static and dynamic logic and the various clocked logic designs are well covered after a thorough treatment of MOS inverters from both a dc and a transient viewpoint. The treatment of logic design is excellent, but the portion on testing does not add very much to the major content.

However, the chapter on memory elements is quite inadequate, as is the discussion on the interface between MOS and other circuitry. The processing and device characteristics discussed are heavily weighted to p-channel processing, with only limited attention paid to silicon gate. And, while there is some coverage of n-channel MOS, the authors perhaps could have extended the longevity of the book by speculating a bit more on future processing and new devices.

Much of the material in the book comes from an engineering course in MOS technology developed originally in 1966 by American Microsystems Inc. for engineers and designers in the U. S., Europe, and Japan. The book contains updated material from the course and reflects the comments of the attendees, as well.

The overview chapter, the topology chapter, and the reliability chapter provide somewhat standard material. Overall, it is a book to be recommended to the designers of custom systems that can be imple-

# NEW SHORTER CASE! SCHAUER 1-WATT ZENERS

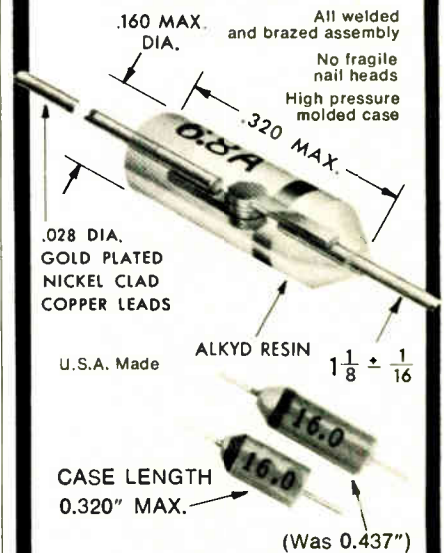

**SAME LOW PRICES FOR  
1% TOLERANCE ZENERS**

**ANY VOLTAGE  
FROM 2.0 TO 18.0**

Quantity	Price Each
1-99	\$1.07
100-499	.97
500-999	.91
1000-4999	.86
5000 up	.82

**IMMEDIATE SHIPMENT**

Send for rating data and  
20%, 10%, 5% and 2%  
tolerance prices.

Semiconductor Division

**SCHAUER**

MANUFACTURING CORP.

4514 Alpine Ave., Cincinnati, Ohio 45242  
Telephone 513/791-3030

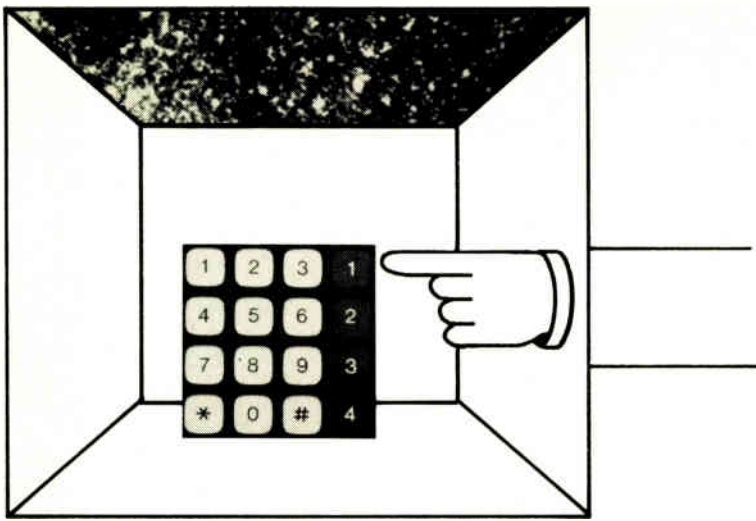

## The Chomerics EF Keyboard

(It's the keyboard of tomorrow.)

And most of the key parts are missing. All the moving parts, and most of the expensive ones. Instead, the EF switches with a single piece of highly conductive rubber. It's fail-proof, less than 3/16" thick, and comes in any configuration you want to dream up. For a price you won't believe.

Pretty soon everybody will be trying to make keyboards like the EF. Meanwhile you'll have to come to us.

CHOMERICS 77 Dragon Court, Woburn, MA 01801 (617) 935-4850  
Circle 162 on reader service card



**Now there are 3  
Breadboarding Systems!  
Design, layout, test build any  
combination of components FREE for 5 days!**

**Elite 1** features built-in wide range pulse generator, variable power supply, independent circuit monitor logic lights, isolated push-buttons and toggle switch arrays. Plus universal component acceptance with SK-10 socket, unlimited fan in / fan out capability and common hook up wire interconnections. **Only \$850.**

**Elite 2**, advanced design concept, features function generator, dual output pulse generator, 3 independent power supplies, 12 buffered monitor lamps, 4 SK-10 universal component sockets, isolated switch, pushbutton arrays and a variety of I/O connectors. Over 3,503 interconnection contacts simulating hi-density p.c. card layouts. **\$1,300.**

**Elite 3**, the basic economy package breadboard, including built-in independent circuit monitor logic lights, isolated pushbuttons and toggle switches, plus universal component acceptance with SK-10 socket, common hook-up wire interconnections and unlimited fan in / fan out capability. **Only \$350.**

Send purchase order now. Try FREE for 5 days! If not completely satisfied, just return! Write for literature.



**EL INSTRUMENTS, INCORPORATED**  
61 First Street, Derby, Conn. 06418  
Telephone: 203/735-8774

## New books

mented with MOS. The material reads well and is edited well.

Jerry Luecke  
Texas Instruments Learning Center

### Recently published

**Synchronization Systems in Communication and Control**, William C. Lindsey, Prentice-Hall Inc., pp. 695, \$35.00

**Data Communications and Business Systems**, Edward Webster, International Business Forms Industries, pp. 186, \$12.00.

**Digital Simulation of Physical Systems**, Joseph S. Rosko, Addison-Wesley Publishing Co., pp. 427, \$15.00.

**Electronics Data Handbook**, Martin Clifford, Tab Books, pp. 255, \$7.95.

**Graph Theory**, Wataru Mayeda, Wiley-Interscience, pp. 588, \$24.95.

**An Introduction to Engineering Systems**, Samuel Seely, Pergamon Press Inc., pp. 531, \$17.50.

**New IC FET Principles and Projects**, Ken W. Sessions and Don Tuite, Tab Books, pp. 160, \$6.95.

**Handbook of Microwave Techniques and Equipment**, Harry E. Thomas, Prentice-Hall Inc., pp. 319, \$16.50.

**Electric Power Systems**, B. M. Weedy, John Wiley & Sons, pp. 501, \$16.50.

**Modern Sound Reproduction**, Harry F. Olson, Van Nostrand Reinhold Co, pp. 328, \$17.50.

### SUBSCRIPTION SERVICE

Please include an Electronics Magazine address label to insure prompt service whenever you write us about your subscription.

Mail to: Subscription Manager  
Electronics  
P.O. Box 514  
Hightstown, N.J. 08520

To subscribe, send us your address with your payment and indicate whether it is a new subscription or a renewal. Subscription rates: qualified subscribers in the U.S.: 1 year, \$8; three years, \$16. Non-qualified: 1 year, \$25. Subscription rates for foreign countries available on request.

# Another introductory offer to new members of the ELECTRONICS AND CONTROL ENGINEERS' BOOK CLUB

	404/445 <b>ELECTRONIC CIRCUITS MANUAL</b> by J. Markus Pub. price, \$19.75 Club price, \$15.75		286/515 <b>INTEGRATED CIRCUITS: A Basic Course for Engineers and Technicians</b> by R. G. Hibberd Pub. price, \$9.95 Club price, \$8.45
	637/458 <b>DESIGNING WITH TTL INTEGRATED CIRCUITS</b> by Texas Instruments Inc. Pub. price, \$18.50 Club price, \$13.50		162/212 <b>INTEGRATED CIRCUITS &amp; SEMI-CONDUCTOR DEVICES</b> by Deboo & Burrous Pub. price, \$13.95 Club price, \$10.50
	404/437 <b>SOURCEBOOK OF ELECTRONIC CIRCUITS</b> by J. Markus Pub. price, \$19.75 Club price, \$14.75		313/059 <b>HANDBOOK OF SEMI-CONDUCTOR ELECTRONICS, 3/e</b> by P. Hunter Pub. price, \$27.50 Club price, \$21.50
	259/607 <b>COMMUNICATION SYSTEM ENGINEERING HANDBOOK</b> by D. H. Hamsher Pub. price, \$29.50 Club price, \$22.50		558/140 <b>ELECTRONIC COMPUTER TECHNOLOGY 2/e</b> by N. R. Scott Pub. price, \$18.00 Club price, \$13.75
	139/296 <b>AMERICAN ELECTRICIANS HANDBOOK</b> by Croft, Carr & Watt Pub. price, \$22.50 Club price, \$18.25		124/035 <b>HANDBOOK OF PHYSICS, 2/e</b> by Condon and Odishaw Pub. price, \$34.75 Club price, \$14.95
			109/32X <b>ELECTRONICS IN INDUSTRY 4/e</b> by Chute & Chute Pub. price, \$13.95 Club price, \$10.75
			649/170 <b>OPERATIONAL AMPLIFIERS</b> by Tobey, Graeme & Huelsman Pub. price, \$15.00 Club price, \$11.50
			209/731 <b>STANDARD HANDBOOK FOR ELECTRICAL ENGINEERS, 10/e</b> by Fink and Carroll Pub. price, \$32.50 Club price, \$24.95

**ANY ONE**  
of these great professional books  
for only **\$1.00**  
VALUES FROM \$9.95 to \$34.75  
Special \$1.00 bonus book comes to you with your first club selection

## Save time and money by joining the Electronics and Control Engineers' Book Club

HERE is a professional club designed specifically to meet your day-to-day engineering needs by providing practical books in your field on a regular basis at below publisher prices.

How the Club operates: Basic to the Club's service is its publication, the *Electronics and Control Engineers' Book Club Bulletin*, which brings you news of books in your field. Sent to members without cost, it announces and describes in detail the Club's featured book of the month as well as alternate selections which are available at special members' prices.

When you want to examine the Club's feature of the month, you do nothing. The book will be mailed to you as a regular part of your Club service. If you prefer one of the alternate selections—or if you want no book at all for that month—you notify the Club by returning the convenient card enclosed with each *Bulletin*.

As a Club member, you agree only to the purchase of four books over a two-year period. Considering the many books published annually in your field, there will surely be at least four that you would want to own anyway. By joining the Club, you save both money and the trouble of searching for the best books.



### MAIL ATTACHED POSTPAID CARD (If card removed, send coupon below)

**ELECTRONICS AND CONTROL ENGINEERS' BOOK CLUB**  
582 Princeton Road, Hightstown, N.J. 08520

Please enroll me as a member of the Electronics and Control Engineers' Book Club and send me the two books indicated below. I am to receive the bonus for just \$1.00, and my first selection at the special Club price shown. These books are to be shipped on approval, and I may return them both without cost or further obligation. If I decide to keep the books, I agree to purchase as few as four books during the next two years at special Club prices (at least 15% below list).

Write Code No. of  
bonus book  
here

Write Code No. of  
first selection  
here



Name \_\_\_\_\_

Address \_\_\_\_\_

City \_\_\_\_\_

State \_\_\_\_\_ Zip \_\_\_\_\_

E33199

## MONOLITHIC CRYSTAL FILTERS

# THE STATE OF THE ART

### The Truth About Monolithics . . .



Truth is stronger than fiction. It's also said to be the greatest gimmick in advertising. That's what this series of ads is about — the truth about monolithic crystal filters. If you want the truth about the best filter for your application, talk to us. We've been making monolithic crystal filters longer than anyone else — and we've made more of them. We know what can't be done as well as what can.

### Standard Substitute . . .



When is a conventional crystal filter unconventional? When it's a monolithic designed to be completely interchangeable with its conventional counterpart — and to be 10 to 50% less expensive. If you're still using conventional crystal filters and aren't ready to redesign your equipment check with us. The next best thing to designing your new radio around a monolithic crystal filter is plugging a monolithic into your old one. It may be just what the doctor ordered to keep the patient alive and well a little longer.

### Short Course . . .



Whether you're now using integrated crystal filters or just thinking about it, you'd probably like to know more about them. We're offering a limited number of reprints of an up-to-date survey article including specification guidelines. A copy is yours for the asking. Just drop us a note on your letterhead.

Like more information on monolithics? Drop us a line or call us.

# Pi

**Piezo Technology Inc.**

2400 Diversified Way  
Orlando, Florida 32804  
305-425-1574

The Standard in monolithic  
crystal filters.

### Advertising Sales Staff

**Pierre J. Braudé** [212] 997-3485  
Advertising Sales Manager

**Atlanta, Ga. 30309:** Joseph Lane  
100 Colony Square, 1175 Peachtree St., N.E.  
[404] 892-2868

**Boston, Mass. 02116:** James R. Pierce  
607 Boylston St. [617] 262-1160

**Chicago, Ill. 60611:**  
645 North Michigan Avenue  
Robert W. Bartlett (312) 751-3739  
Paul L. Reiss (312) 751-3738

**Cleveland, Ohio 44113:** William J. Boyle  
[716] 586-5040

**Denver, Colo. 80202:** Harry B. Doyle, Jr.  
Tower Bldg., 1700 Broadway  
[303] 266-3863

**Detroit, Michigan 48226:** Robert W. Bartlett  
2600 Penobscot Building  
[313] 962-1793

**Houston, Texas 77002:** Charles G. Hubbard  
2270 Humble Bldg. [713] CA 4-8381

**Los Angeles, Calif. 90010:** Robert J. Rielly  
Bradley K. Jones, 3200 Wilshire Blvd., South Tower  
[213] 487-1160

**New York, N.Y. 10020**  
1221 Avenue of the Americas  
Warren H. Gardner [212] 997-3617  
Michael J. Stoller [212] 997-3616

**Philadelphia, Pa. 19103:** Warren H. Gardner  
6 Penn Center Plaza  
[212] 971-3617

**Pittsburgh, Pa. 15222:** Warren H. Gardner  
4 Gateway Center, [212] 971-3617

**Rochester, N.Y. 14534:** William J. Boyle  
9 Greylock Ridge, Pittsford, N.Y.  
[716] 586-5040

**San Francisco, Calif. 94111:** Don Farris  
Robert J. Rielly, 425 Battery Street,  
[415] 362-4600

**Paris:** Alain Offergeld  
17 Rue-Georges Brizel 75 Paris 16, France  
Tel 720-73-01

**Geneva:** Alain Offergeld  
1 rue du Temple, Geneva, Switzerland  
Tel 32-35-63

**United Kingdom:** Keith Mantle  
Tel: 01-493-1451, 34 Dover Street, London W1

**Milan:** Robert Saidel  
1 via Baracchini, Phone 86-90-656

**Brussels:** Alain Offergeld  
23 Chaussee de Wavre  
Brussels 1040, Belgium  
Tel 13-65-03

**Stockholm:** Brian Bowes  
Office 17 Kontor-Center AB, Hagagarten 29,  
113 47 Stockholm, Tel 24 72 00

**Frankfurt/Main:** Fritz Krusebecker  
Liebigstrasse 27c  
Phone 72 01 81

**Tokyo:** Masaru Wakeshima, McGraw-Hill  
Publications Overseas Corporation  
Kasumigaseki Building 2-5, 3-chome,  
Kasumigaseki, Chiyoda-Ku, Tokyo, Japan  
[581] 9811

**Osaka:** Ryji Kobayashi, McGraw-Hill  
Publications Overseas Corporation, Kondo  
Bldg., 163, Umegae-cho Kita-ku [362] 8771

**Australasia:** Warren E. Ball, IPO Box 5106,  
Tokyo, Japan

### Business Department

**Stephen R. Weiss, Manager**  
[212] 997-2044

**Thomas M. Egan,**  
Production Manager [212] 997-3140

**Carol Gallagher**  
Assistant Production Manager [212] 997-2045

**Dorothy Carter,** Contracts and Billings  
[212] 997-2908

**Frances Vallone,** Reader Service Manager  
[212] 997-6057

### Electronics Buyers' Guide

**George F. Werner,** Associate Publisher  
[212] 997-3139

**Regina Hera,** Directory Manager  
[212] 997-2544

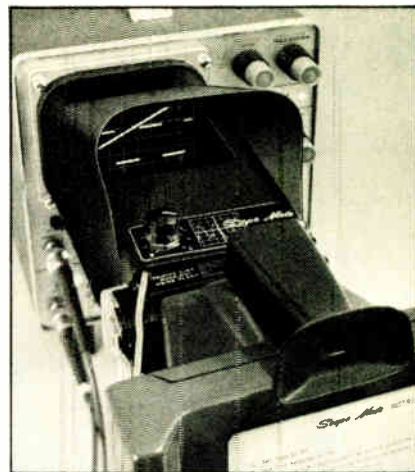

## A Scope-Mate® Hood and any Polaroid Camera\* can produce B/W or color photos of CRT data.

- Versatile, low-cost, lightweight, easy to use.
- Standard hood fits 90% of all scopes.
- Models available for latest Tektronix and H-P scopes.
- Special hoods for large CRT displays.
- Shutter speeds from 1/100 to 3 sec. and bulb.
- Graticule illuminators, incandescent and U.V.
- Hoods from \$90.

Contact:

## INTEGRATED CONTROLS, INC.

3045 Moore Street  
San Diego, Calif. 92110  
Phone: 714/295-5807

\*Except Swinger and Square Shooter. Polaroid is a registered trademark of Polaroid Corp.

Circle 185 on reader service card

## High performance double balanced mixer

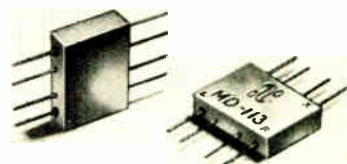

This flatpack double-balanced mixer with bandwidth of 10 to 1000 MHz has typical mixer noise figure less than 7 db and LO-RF Isolation better than 30 db at 1 GHz. Third order intercept is typically +20 dbm. Used as frequency converter, phase detector, pulse modulator and as voltage/current variable attenuator. Price \$29. ANZAC Electronics, 39 Green Street, Waltham, Mass. 02154 Tel. (617) 899-1900.

Circle 186 on reader service card

# Electronics advertisers

October 9, 1972

<b>Addmaster Corporation</b> Mich Associates	54	<b>EL Instruments, Inc.</b> The Robert A. Paul Advertising Agency, Inc.	163	<b>Phillips Gad Elcoma</b> Tag-Intermarco de la Mar	44E, 6E, 20E, 50E, 64
<b>Aeroflex Laboratories, Inc.</b> Caroe Marketing	18E	<b>English Electric Valve Co. Ltd.</b> C.R. Casson Ltd.	28E-29E	<b>Phillips N. V. PR/T &amp; M Division</b> Marsteller International S. A.	31E
<b>Airco Industrial Products, Division of Airco, Inc.</b> Gimbel, Hammond, Farrell & Walsh, Inc.	62	<b>Fairchild GmbH</b> Evan Steadman Services Ltd.	25E	<b>Plezo Technology, Inc.</b> Shattuck/Roether Advertising, Inc.	166
<b>Airpax Electronics</b> Welch, Mirabile & Co., Inc.	2nd Cover	<b>Fairchild Semiconductor, Inc.</b> Carson/Roberts, Inc. Adv., Division of Ogilvy & Mather, Inc.	56-57	<b>Portescap</b> IVA	24E
<b>Atco Electronics Products, Inc.</b> Marketronics Advertising	16E	<b>Ferranti Ltd. - Dundee</b> Rowlinson Broughton Ltd.	44E	<b>Raytheon Company, Industrial Components Operation</b> Provandie Eastwood & Lombardi, Inc.	118
<b>Allen-Bradley Company</b> Hoffman, York, Baker & Johnson, Inc.	90	<b>General Electric Co., Miniature Lamp Div.</b> Carr Liggett Advertising, Inc.	138	<b>RCA Electronic Components</b> Al Paul Lefton Company, Inc.	5E
<b>AMP, Incorporated</b> Aitkin-Kynett Co., Inc.	129	<b>General Electric Co., Semiconductor Products Department</b> Advertising & Sales Promotion Syracuse Operation	7	<b>RCA Solid State Division</b> Al Paul Lefton Company, Inc.	49
<b>AMP-Italia</b> Studio Dolci	43E	<b>General Electric Co., Instrument Corporation, Semiconductor Products Div.</b> Norman Allen Associates	2	<b>Reticon Corporation</b> Kassler Noble Advertising	79
<b>Amphenol Connector Division, Bunker Ramo Corporation</b> Marsteller, Inc.	34	<b>General Magnetics</b> McCarthy/Scelba/DeBiasi Adv. Agcy. Inc.	6	<b>RHG Electronics Laboratory, Inc.</b> Samuel H. Goldstein	155
<b>Amphenol Industrial Division, Bunker Ramo Corporation</b> Marsteller, Inc.	88-89	<b>General Radio Co.</b> GRAD Associates	45	<b>Rohde &amp; Schwarz</b> Scanbe Manufacturing Corp. Warren C. Wilson & Associates	1E, 9E 157
<b>Amphenol RF Division, Bunker Ramo Corporation</b> Marsteller, Inc.	137	<b>Genelee</b> Logos	48E	<b>Schauer Manufacturing Corp.</b> Nolan, Keelor & Stiles	161
<b>Anzac Electronics</b> Robert J. Allen Marketing & Public Relations	157, 166	<b>Gould, Inc./Instrument Systems Div.</b> Carr Liggett Adv., Inc.	12-13	<b>Schneider R. T.</b> Intermedia	21E
<b>Avantek, Inc.</b> Witmer & Berridge Adv./Design Associates	134	<b>Grayhill, Incorporated</b> Carr Liggett Advertising, Inc.	168	<b>S. E. Laboratories Ltd.</b> Graphic Publicity Ltd.	22E-23E
<b>BAFCO, INC.</b> Designex Company	161	<b>GRI Computer</b> Allied Advertising Agency, Inc.	37	<b>Selberling Latex Products</b> KENRAY Advertising, Inc.	161
<b>Bayer AG.</b> Roston, Kremer and Slawter	2E-3E	<b>Hapco</b> W. Winfield Stark Advertising	157	<b>Secosem</b> Perez Publicite	35E
<b>Burr-Brown Research Corp.</b> N. A. Winter Advertising Agency	77	<b>Harris Semiconductor</b> Tucker Wayne & Company	122	<b>Siliconx Incorporated</b> Paul Pease Advertising	103
<b>Bussmann Mfg. Division of McGraw Edison Co.</b> Henderson Advertising Company	53	<b>Hewlett-Packard, Electronics Products Group</b> Corporate Marketing Communications	17-26	<b>Simpson Electric Co.</b> Amerad Advertising Services, Inc.	78
<b>Cambridge Thermionic Corporation</b> Chirurg & Cairns, Inc.	155	<b>Hewlett-Packard</b> Dorland Advertising Ltd.	11E-14E	<b>Singer Instrumentation - Alfred</b> N. W. Ayer/Jorgensen/MacDonald, Inc.	58
<b>Carter Semiconductor</b> RAMA Advertising	1	<b>Hipotronics Inc.</b> Kenmarc Advertising Inc.	146	<b>SPI/ITT</b> Akila Marais	40E-41E
<b>Centralab Electronics, Div. of Globe Union, Inc.</b> The Brady Co.	67	<b>Hoagland Instruments</b> Ophlode Advertising	152	<b>Sprague Electric Company</b> Harry P. Bridge Company	8
<b>Chicago Dynamic Industries, Inc.</b> Burton Browne Advertising	155	<b>Hughes Aircraft Company</b> Foote, Cone & Belding	46-47, 143	<b>Stanford Applied Engineering</b> Rose Associates Advertising & Public Relations	31
<b>Chomerics, Inc.</b> Van Christo Associates, Inc.	162	<b>Hutson Industries</b> Warren-Guild	158	<b>TEC, Inc.</b> TEC-AD	154
<b>C.I.I.</b> Interplans-Publi Action	49E	<b>Hybrid Systems Corp.</b> Susan E. Schur	146	<b>Tektronix, Inc.</b> Dawson, Inc.	43, 73
<b>Cincinnati Milacron, Process Controls Division</b> David K. Burnap Advertising	64	<b>Hysol Div., The Dexter Corp.</b> Stahlka, Falter & Klenk, Inc.	82	<b>Teledyne Relays</b> S. Michelson Advertising	17E
<b>Cipher Data Products</b> R & H Marketing Communications	148	<b>ICI Mond Division-Arkon K</b> Trans World Media Ltd.	19E	<b>Teledyne Semiconductor</b> Regis McKenna, Inc.	61
<b>Colorado Video, Inc.</b> O'Connell-Colum, Inc. Creative Business Communications	168	<b>ILC Data Device Corporation</b> Marchin Weltman Advertising, Inc.	16	<b>Teradyne, Inc.</b> Quinn & Johnson, Inc.	68
<b>The Connecticut Hard Rubber Company</b> Cohar Associates	154	<b>Integrated Controls</b> The Phillips Agency of California, Inc.	166	<b>Texas Instruments, Incorporated, Components Group</b> Albert Frank Guenther Law, Inc.	140
<b>CTS Corporation</b> Reincke, Meyer & Finn, Inc.	30	<b>Ithaco Inc.</b> Hart Conway Co. Inc.	136	<b>Texas Instruments, Incorporated, Digital Systems Division</b> Albert Frank Guenther Law, Inc.	32-33
<b>Culligan U S A</b> Alex T. Franz, Inc.	149	<b>Johnson Company, E. F.</b> Martin Williams Advertising	86-87	<b>Thomson CSF</b> Bazaine Publicite	47E
<b>Custom Electronics, Inc.</b> Laux Advertising, Inc.	160	<b>Krohn-Hite Corporation</b> Impact Advertising Inc.	5	<b>Topaz Electronics</b> Chapman Michetti Advertising	128
<b>D. Olivetti - C. Spa</b> Studio ECO	26E	<b>Lambda Electronics Corporation</b> Michei Cather Inc.	3rd Cover	<b>Tracor, Inc.</b> William Chollick Associates, Inc.	71
<b>Dale Electronics, Inc., A Sub. of The Lionel Corporation</b> Swanson, Sinkey, Ellis, Inc. Advertising	4th Cover	<b>Ledex Inc.</b> Advertising/Mervar	80	<b>Tung Sol Division, Wagner Electric Corp.</b> Winius Brandon Company	70
<b>Data Products</b> Farrell-Bregmann Advertising	132-133	<b>LFE Corporation Process Control Division</b> Culver Advertising Inc.	145	<b>Union Carbide Corp. Linde Division</b> Young & Rubicam Inc.	150
<b>Develco, Inc.</b> Wank, Williams & Neyland, Inc.	142	<b>LTT</b> Publibel	16E	<b>United Systems Corp., A sub. of Monsanto Co.</b> Advertising & Merchandising, Inc.	51
<b>Dickson Electronics Corporation</b> N. A. Winter Advertising Agency	152	<b>McGraw-Hill Book Company</b>	153	<b>Varo Semiconductor, Inc.</b> Warren-Guild	160
<b>Digital Corporation</b> Creamer, Trowbridge, Case & Basford, Inc.	84-85	<b>Micro</b> DP Industrie	33E-34E	<b>Victoreen Instrument Division</b> Dix & Eaton, Inc.	45E
<b>Digital Equipment Corporation</b> Schneider Parker Guy, Inc.	110-111	<b>Microfiche</b>	82A-B, 83	<b>John Wiley &amp; Sons</b> Ed McLean & Co., Inc.	147
<b>Dumont Oscilloscope Laboratories, Inc.</b> Barbett Miller Advertising, Inc.	6	<b>Microsystems International Ltd.</b> Media Advertising Ltd.	126	<b>Winchester Electronics</b> Renaccio Advertising & Marketing, Inc.	75
<b>Duncan Electronics, Inc., Sub. of Syston Donner Corp.</b> Enyart & Ross Advertising, Inc.	15	<b>Micro Switch Division of Honeywell</b> N. W. Ayer & Son Inc.	124-125		
<b>Eastman Chemical Products, Inc., Industrial Chemicals</b> J. Walter Thompson Company	54	<b>3M Company - Mincom Division</b> D'Arcy-MacManus-Intermarco, Inc.	139		
<b>Electronic Arrays Inc.</b> Regis McKenna, Inc.	38	<b>Mostek Corporation</b> Continental Communications Incorporated	10-11		
<b>Electronic Communications, Inc.</b> W. M. Zemp & Associates, Inc.	158	<b>National Semiconductor Corp.</b> Chiat/Day, Inc. Advertising	9		
<b>Electronic Navigation Industries</b> Hart Conway Co. Inc.	14	<b>Neft Instruments Corp.</b> Larry Courney Company	130		
<b>Electronics &amp; Control Engineers Book Club</b>	163-165	<b>Ohmic</b>	37E		
<b>Electronics Engineering Company of California, Electronics Products Div.</b> R & H Marketing Communications	55	<b>Owens-Illinois Inc. - Digivue</b> Howard Swink Advertising	28-29		
		<b>Phillips Electrologica</b> Tag Intermarco	39E		

## Classified & Employment Advertising

F. J. Eberle, Manager 212-971-2557

<b>Equipment (Used or Surplus New) For Sale</b>	
Jensen Tools	156
Phillip Fishman Co.	156
Radiation Devices	156
Radio-Research Instrument Co., Inc.	156

■ For more information on complete product line see advertisement in the latest Electronics Buyer's Guide  
 \* Advertisers in Electronics International  
 † Advertisers in Electronics domestic edition

# COMPRESSED VIDEO

- Starts with a standard CCTV camera
- Ends on the screen of a standard CCTV monitor
- Uses "dial up" voice grade telephone circuits in the middle
- Is a highly flexible alternative to facsimile or the Picture Phone

The CVI 200 series Video Converters provide for single frame TV picture transmission over audio bandwidth circuits. Options include multiple image storage, hard copy, computer I/O, and color.

Video instruments for data acquisition, processing, transmission, and display.

Colorado Video, Inc.  
Box 928 Boulder, Colorado 80302  
(303) 444-3972

## cvl

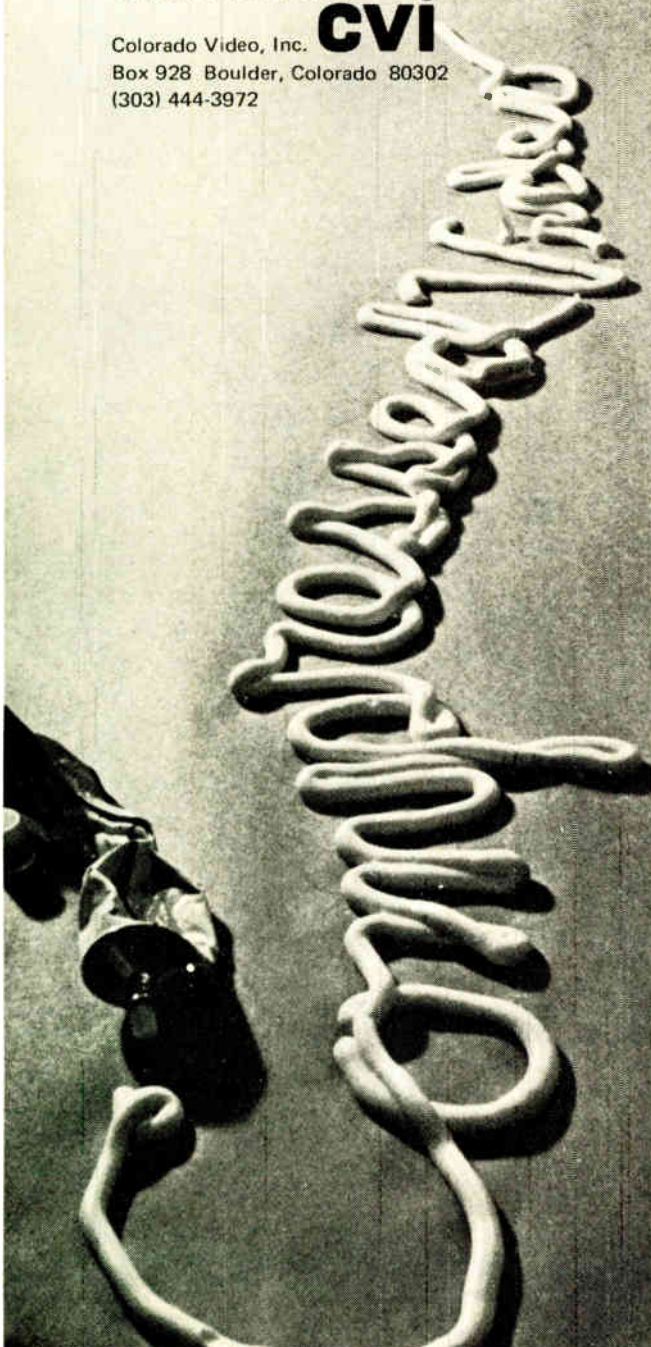

## MULTIPLE POSITION SLIDE SWITCH



First in a series of PC Slide Switches with "ELEVEN" positions for greater versatility in design. Useful in a variety of matrix designs or singularly as 0-10 positions and OFF.

SS Series

### ALCOSWITCH®

DIV. OF ALCO ELECTRONIC PRODUCTS, INC. NORTH ANDOVER, MASS. 01845

Circle 188 on reader service card

## ECONOMY PRICED

# KEYBOARD

Gold clad contacts offer long operational life. N.O. momentary rated 100 ma @ 24 VDC. Basic models include 1x4 & 3x4 matrix. Also available with 2-shot molded 0-9 & 1-12 keytops. Low contact bounce. Write for further details.



"CR" SERIES

### ALCOSWITCH

DIV. OF ALCO ELECTRONIC PRODUCTS, INC. NORTH ANDOVER, MASS. 01845

Circle 189 on reader service card

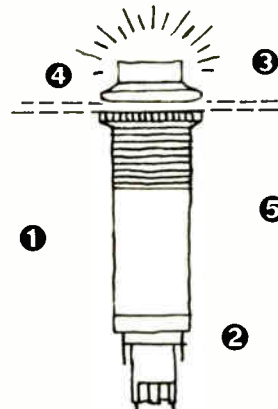

## Push button—and lighted too!

Of course. The push button Series 80 lighted decorator line of switches from Grayhill. Your choice of:

- 1 **Actuation**—Momentary or alternate action.
- 2 **Circuitry**—Single pole, single throw; single pole, double throw; double pole, double throw.
- 3 **Styling**—Square, round, bezel, colors, lighted.
- 4 **Mounting**—Front panel, sub-panel or bushing. Lamps replaceable from front.
- 5 **Five designer colors . . . and lighted too!**

And if what you want isn't covered in the variations above, we can design one that is. We also have a companion line of indicator lights—Series 81.

For our latest Engineering Catalog write or phone:  
Grayhill, Inc., 523 Hillgrove Ave.,  
La Grange, Illinois 60525  
(312) 354-1040



Do you face  
a make or buy decision  
on power supplies?

## How to use power hybrid voltage regulators to build your own power supplies.

There's another choice now in power-supply design. You're no longer restricted to a supply designed by others, nor to one you have to design from scratch. You can buy the heart of the supply—the voltage regulator—in a hybrid form that offers much more power output than monolithic regulators. Then you can design the rest of the supply and the heat sink, if necessary, using a straightforward procedure.

Hybrid regulators are now available in many models with outputs to 28 V dc and to 5 A. Dissipation at 25°C can reach 85 W—a far cry from the watt or so available in monolithic regulators.

Though there are differences in circuitry, specifications and packaging among regulators available from companies like Lambda, Melville, N. Y.; Micropac, Garland, Texas; Melville, N.J.; and Tecnetics, Boulder, Colo., designing with them are

A typical unit

This article in Lambda's new hybrid regulator brochure tells you how to use these devices to build your own power supplies. . . . Send for your free copy.

**Announcing:  
NEW POWER HYBRID  
VOLTAGE REGULATORS**

**62W 5V 3A**

**\$25 ea.**  
(in quantity  
of 1)

**\$14 ea.**  
(in quantity  
of 100)

**\$11 ea.**  
(in quantity  
of 1000)

**NEW  
LOW PRICES ON  
85W 5V 5A**

**\$30 ea.**  
(in quantity  
of 1)

**\$18 ea.**  
(in quantity  
of 100)

**\$15 ea.**  
(in quantity  
of 1000)

**100,000 hours MTBF  
demonstrated**

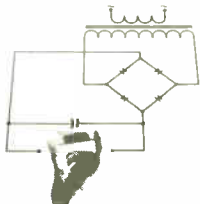

**WHETHER  
YOU MAKE  
OR BUY...**

**LAMBDA  
ELECTRONICS CORP.**  
A Veeva Company

**MELVILLE, NEW YORK 11746** 515 Broad Hollow Road Tel. 516-694-4200 **ARLINGTON HEIGHTS, (CHICAGO) ILL. 60005** 2420 East Oakton St., Unit Q Tel. 312-593-2550  
**NORTH HOLLYWOOD, CALIF. 91605** 7316 Varna Ave. Tel. 213-875-2744 **MONTREAL, QUEBEC** 100C Hymus Blvd., Pointe-Claire, Quebec-730 Tel. 514-697-6520

Circle 901 on reader service card

# Think big



50,000 Volts

For long-term continuous loading, Dale Type F film resistors provide working voltages to 14 KV, pulse voltages to 50 KV with less than 1% change after 2,000 hours. Lead and/or threaded cap terminations. Write for Bulletin M7C.



1,000,000,000 Ohms

Fill ultra-high resistance requirements with Dale Type M and MH film resistors. Miniature sleeved or glass enclosed models with values from 60 Meg. to 1,000KM. Excellent stability (0.5%/yr.). Tolerances as low as 1%. Write for Bulletin HV8C.



1,000,000 pieces  
RL20...3¢

RL07 and RL20 needs can be swiftly met with a choice of two materials—metal film (Type CM) and metal oxide (Type F). Fast delivery in quantity. Call for details.

# Think Dale



Save selection time... send for and use Dale's helpful and complete **Guide to Film Resistors**. Circle Reply Number for your free copy.

DALE ELECTRONICS, INC., 1300 28th Ave., Columbus, NE 68601  
A subsidiary of The Lionel Corporation • In Canada Dale Electronics Canada, Ltd.

Circle 902 on reader service card