

JUNE 9, 1977

HIGHLIGHTS OF THE NATIONAL COMPUTER CONFERENCE/164

Wider test set for cellular mobile communications/75

Microprocessors in action: a radio navigation system/ 147

97232

1720 N.W. 231 CANAL NOV77
MATT NEILL
2516 NE CLACKAMAS
PORTLAND OR

FOUR DOLLARS A MCGRAW-HILL PUBLICATION

Electronics®

SPECIAL REPORT

THE
GATHERING
WAVE
OF JAPANESE
TECHNOLOGY

Piazza

World Radio History

A New Dial Design...

... beautiful
from any angle.

Any way you look at it, there's beauty and reliability at a low cost in our new Model H-1400 turns-counting dial. From the smooth, high impact tapered plastic design ... to the big, bold legible numbers ... this dial will add to the aesthetics of any control panel.

But, with beauty being only skin deep, we've put durable long-lasting metal inside where it counts — including the gears and set-screw thread insert. And, the price is just as attractive — only \$4.26* in production quantities!

Send today for complete technical data and discover a beautiful new angle in turns-counting dials — from Bourns, naturally!
Direct or through your local distributor.

TRIMPOT PRODUCTS DIVISION, BOURNS, INC., 1200 Columbia Ave.,
Riverside, CA 92507 Phone: 714 781-5123. TWX: 910 332-1252

*Domestic U.S.A. price only, H1411, without brake.



International Marketing Offices: European Headquarters — Switzerland 042/23 22 42 • Belgium 02/214 3058 • France 01/2039633 • Germany 0711/24 29 36 • Italy 02/32 56 88 • Netherlands 70/87 44 00 • United Kingdom 01/572 3831 • Norway 2/71 18 72 • Sweden 764/20 110 • Japan 075/921 9111 • Australia 02/55-0411 03/95-9566 • Korea 37 21 13427

For immediate action
or for further information

World Radio History



power supplies off our shelf

- DIGITAL/ATE ■ LAB/BENCH ■ OEM MODULES ■ LINEAR
- SWITCHING ■ FERRORESONANT ■ BIPOLAR OPERATIONAL

KEPCO®

For complete specifications, write Dept. CBF-14

131-38 SANFORD AVENUE • FLUSHING, N.Y. 11352 U.S.A. • (212) 461-7000 • TWX =710-582-2631 • Cable: KEPCOPOWER NEWYORK

Circle 1 on reader service card

World Radio History

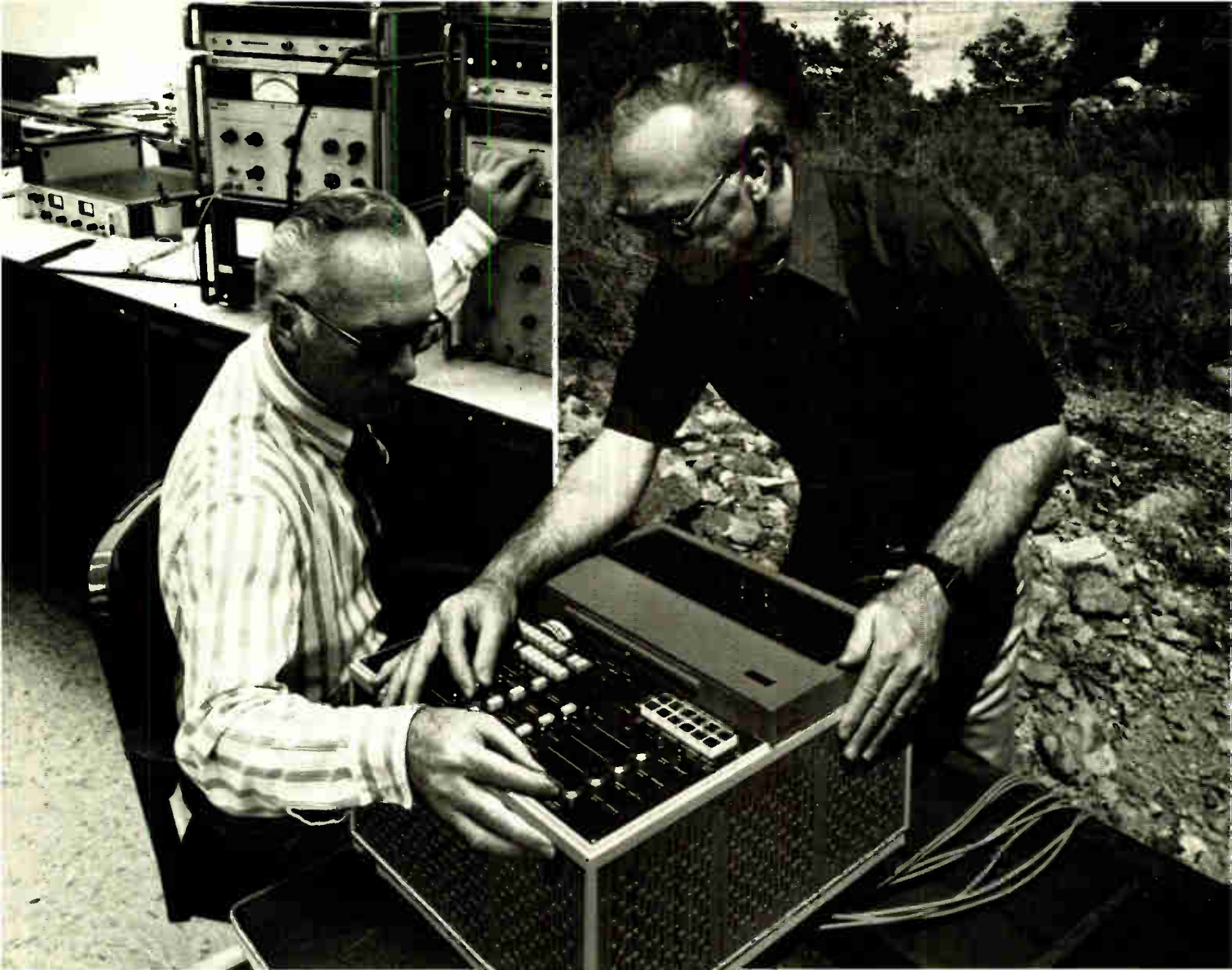

AC in the lab. DC in the field. HP recorders do it with the flip of a switch.

Hewlett-Packard's instrumentation tape recorders have a simple switch that lets you change from AC to DC operation. That means the same high performance four channel or eight channel HP recorder used in the laboratory can also be used in a rugged field environment. Out there your HP recorder will operate from either a 12 or 28 volt DC power

source without an external inverter.

Recording is economical because you use inexpensive 1/4-inch tape. And these compact machines are designed to meet Hewlett-Packard's own tough environmental specifications.

Both machines have the same features including six tape speeds from 15/32 ips to 15 ips which give

you a 32:1 time base compression or expansion for flexibility and easy data analysis. Select direct recording from 50 Hz to 64 KHz with SNR up to 38 dB, FM recording from DC to 5 KHz with SNR up to 48 dB. Standard features include TTL remote control, a pushbutton built-in calibration source, tape/tach servo, flutter compensation and voice channel.

Start using one high performance recorder both in the lab and in the field. Make the switch to Hewlett-Packard. (3964A, four channels, priced from \$6300; * 3868A, eight channels, priced from \$9200. * OEM discounts available.)

*Domestic USA price only.

HEWLETT-PACKARD, 16399 West Bernardo Drive, San Diego, CA 92127
Please send me complete details on Hewlett-Packard
Instrumentation Tape Recorders.

Name _____
Company _____
Address _____
City _____
State _____ Zip _____
Application _____
Telephone Number _____

World Radio History

HEWLETT  PACKARD

For assistance call Washington (301) 948-6370 Chicago (312) 255-9900 Atlanta (404) 465-1500 Los Angeles (213) 877-1282

Circle 2 on reader service card

- 31 Electronics Review**
MILITARY: Interactive system speeds in-field repairs, 31
CITIZENS' BAND: Kit has all parts for 40-channel radio, 32
INSTRUMENTS: Fluke widens line with digital DMM, 32
PACKAGING & PRODUCTION: Electron beams speed fabrication, 33
MILITARY: Terminal radar upgrades Pershing missile, 34
MICROPROCESSORS: Portable unit diagnoses many 8-bit devices, 34
STANDARDS: Microprocessors hurt military standards work, 36
COMPONENTS: Current mirror ups bi-FET performance, 38
CALCULATORS: National readies belated programmable unit, 41
PACKAGING & PRODUCTION: Plasma processors handle aluminum, 42
NEWS BRIEFS: 42
- 53 Electronics International**
WEST GERMANY: Fluorescent plexiglass brightens LCD, 55
GREAT BRITAIN: Hughes C-MOS family heads for clocks, 55
FRANCE: Government unveils components plan, 56
- 75 Probing the News**
COMMUNICATIONS: Cellular concept gets test, 75
COMPONENTS: Monolithic converters pick up strength, 78
NAVIGATION: Civilians to get Loran-C, 80
COMPANIES: Rockwell hopes shake-up is recipe, 83
HP Components shatters mold of tradition, 88
- 99 Technical Articles**
SPECIAL REPORT: The gathering wave of Japanese technology, 99
DESIGNER'S CASEBOOK: Sample-and-hold controls oscillator, 132
Full address simplify design of majority-vote logic, 134
Glitchless TTL arbiter selects first of two inputs, 136
MICROPROCESSORS: IMP-16 helps small planes fly a direct course, 147
ENGINEER'S NOTEBOOK: PIA multiplexes many d-a converters, 151
CALCULATOR NOTES: SR-52 program eases number conversion, 152
NATIONAL COMPUTER CONFERENCE: Architecture, data bases, 164
- 171 New Products**
NCC PRODUCT PREVIEW:
Memories expand computer systems, 171
8-bit operating system bows, 172
Printer runs at 2,000 lines per minute, 174
Computer has more memory, 176
Board controls floppy disk, 178
One-board computer simulator offered, 180
CRT terminal works to 19,200 bauds, 182
Intelligent printer offers firmware updating, 187
Terminal mixes data-entry jobs, 188
Disks hold 70 megabytes, 190
SEMICONDUCTORS: Power Darlingtons finds TV niche, 192
SUBASSEMBLIES: Instrumentation amplifier has good stability, 196
COMPONENTS: Transformer aims at medical uses, 205
INDUSTRIAL: S-d converter consumes only 0.25 watt, 215
MATERIALS: 222
- Departments**
Publisher's letter, 4
Readers' comments, 6
News update, 8
Editorial, 12
People, 14
Meetings, 20
- Services**
Employment opportunities, 240
Reprints available, 254
Reader service card, 255
- Electronics newsletter, 25
Washington newsletter, 49
International newsletter, 53
Engineer's newsletter, 154
New literature, 228
New books, 236

Highlights

Cover: Japan pushes digital development, 99

Intensive development has produced Japanese state-of-the-art memories and microprocessors that their makers hope will win them a major position in export markets. Electronics firms in Japan also are mounting a cooperative development effort of very large-scale-integrated technology.

■ Part 1 of this special report reviews the current position of the Japanese and outlines their development plans.

■ Part 2, which begins on page 106, gives an overview of the semiconductor industry and introduces a number of the country's leading electronics researchers.

■ Starting on page 110, part 3 goes into detail on the directions taken by Japanese VLSI development.

■ Part 4, which begins on page 118, focuses on the memories and microprocessors that Japan is using for its near-term assault on the world markets.

Cover illustrated by Assistant Art Director Paula Piazza.

Mobile-phone market heats up, 75

Even as AT&T is getting tests of its cellular mobile-telephone system under way in Chicago, the FCC is weighing whether to approve two rival systems, one of them noncellular.

NCC to look at data organizing, 164

This year's National Computer Conference will devote a number of program sessions to the architecture and data-base management of computer systems that process all kinds of information. This preview of the sessions is followed on page 171 by a report on some of the products to be introduced at the conference.

And in the next issue . . .

A product development profile of a low-cost digital multimeter . . . a pair of articles on a pair of 16-bit microprocessors.

EDITOR-IN-CHIEF: Kemp Anderson

EXECUTIVE EDITOR: Samuel Weber

MANAGING EDITOR: Arthur Erikson,
International

SENIOR EDITORS: Laurence Altman,
Ray Connolly, Lawrence Curran,
John Johnsrud, H. Thomas Maguire,
Stephen E. Scrupski, Gerald M. Walker

ART DIRECTOR: Fred Sklenar

ASSOCIATE EDITORS: Howard Wolff,
Alfred Rosenblatt

DEPARTMENT EDITORS

Aerospace/Military: Ray Connolly
Circuit Design: Vincent Biancomano
Communications & Microwave:

Richard Gundlach

Components: Lucinda Mattera
Computers: Raymond P. Capece

Consumer: Gerald M. Walker

Instrumentation: Stephen E. Scrupski
New Products: H. Thomas Maguire,

Michael J. Riezenman

Packaging & Production: Jerry Lyman
Solid State: Laurence Altman

CHIEF COPY EDITOR: Margaret Eastman

COPY EDITOR: Ben Mason

ART: Charles D. Ciatto, *Associate Director*
Paula Piazza, *Assistant Director*

EDITORIAL SECRETARIES: Janet Noto,
Penny Rothman

EDITORIAL ASSISTANT: Marilyn B. Rosoff

FIELD EDITORS

Boston: Lawrence Curran (Mgr.), Pamela Leven

Los Angeles: Larry Waller (Mgr.)

Midwest: Larry Armstrong (Mgr.)

New York: Bruce LeBoss (Mgr.)

San Francisco: Bernard Cole (Mgr.)

Judith Curtis

Washington: Ray Connolly (Mgr.)

Frankfurt: John Gosch

London: William F. Arnold

Paris: Arthur Erikson

Tokyo: Charles Cohen

McGRAW-HILL WORLD NEWS

Editor: Michael Johnson

Brussels: James Smith

Milan: Andrew Heath

Moscow: Peter Hann

Paris: Andrew Lloyd

Stockholm: Robert Skole

Tokyo: Robert E. Lee

PUBLISHER: Dan McMillan

ADVERTISING SALES MANAGER:

Paul W. Reiss

MARKETING ADMINISTRATION MANAGER:

Wallis Clarke

CIRCULATION MANAGER: Karl Peterson

MARKETING SERVICES MANAGER:

Tomlinson Howland

RESEARCH MANAGER: Margery D. Sholes

For some time now, a growing number of people concerned about the world's electronics industries have been watching the progress that is being made in Japan at the leading edge of electronics technology. Although to some, the Japanese strides may seem to threaten a potential takeover of world markets, a more realistic assessment is simply that a new and important competitor has arrived—and it will have to be reckoned with in the already volatile semiconductor world.

On page 99 of this issue, you'll find a major 24-page special report on technology in Japan. Put together by our Solid State Editor, Larry Altman, and our Tokyo bureau manager, Charlie Cohen, it is based on extensive reporting and interviewing in Japan by them and Editor-in-Chief Kemp Anderson.

The major conclusion of the weeks of reporting, and of the special report itself, is that Japan's government-sponsored as well as privately supported research programs are putting Japanese producers among the leaders in digital technology. As Altman and Cohen say in the report: "Their goal is nothing less than a major position in the worldwide digital electronics market."

And speaking of our cover story, that eye-catching painting on the cover is the work of our Assistant Art Director, Paula Piazza. Paula is a graduate of the School of Visual Arts in New York City, where her major specialty was advertising. Before joining us last August, she had been art director for an industrial magazine. Before that, she had worked in illustration, graphics, package design, and advertising and

public-relations campaigns. As for the cover assignment, she says it fit in quite well with her taste for things Japanese, from Japanese design to Japanese food.

Once again, the National Computer Conference is set to open its doors, and once again the fast pace of technology is reflected in the wide range of topics covered in the technical sessions, as well as in the new hardware and software packages being shown at the Dallas convention center.

While nothing quite equals being at such a show, the next best thing is to read the preview that we are publishing in this issue. First, on page 164, we are presenting a detailed look at what you expect to see and hear at the show's technical sessions. As you would expect, microprocessors are the one single item having the biggest impact. From their effect on architecture and data-base setups to their boosting of the personal computer toward calculator-like prominence, microcomputers come in for a lot of discussion.

Then, on page 171 begins a special section describing some of the more significant new products that will have their market debut at the National Computer Conference. From high-speed printers to interactive terminals, some of latest computer and peripheral gear is previewed. We hope you don't miss the show, but if you can't make it, don't miss our show coverage.



June 9, 1977 Volume 50, Number 12 96,336 copies of this issue printed

Published every other Thursday by McGraw-Hill, Inc. Founder: James H. McGraw 1860-1948. Publication office 1221 Avenue of the Americas, N.Y., N.Y. 10020; second class postage paid at New York, N.Y. and additional mailing offices.

Executive, editorial, circulation and advertising addresses: Electronics, McGraw-Hill Building, 1221 Avenue of the Americas, New York, N.Y. 10020. Telephone (212) 997-1221. Teletype 12-7960 TWX 710-581-4879. Cable address: MCGRAW HILL NEW YORK.

Subscriptions limited to professional persons with active responsibility in electronics technology. No subscriptions accepted without complete identification of subscriber name, title or job function, company or organization, and product manufactured or services performed. Based on information supplied, the publisher reserves the right to reject non-qualified requests. Subscription rates: in the United States and possessions \$14.00 one year, \$35.00 three years; company addressed and company libraries \$20.00 one year, \$50.00 three years; APC/FFO addressed \$35.00 one year only; Canada and Mexico \$16.00 one year, \$40.00 three years; Europe \$40.00 one year, \$100.00 three years; Japan, Israel and Brazil \$65.00 one year, \$165 three years; Australia and New Zealand \$90.00 one year, \$240 three years; including air freight; all other countries \$45.00 one year, \$112.00 three years. Limited quota of subscriptions available at higher-than-basic rate for persons asked to hold served. Check with publisher for these rates. Single copies: \$4.00. Please allow four to eight weeks for shipment.

Officers of McGraw-Hill Publications Company: Gordon L. Jones, President; Paul F. McPherson, Executive Vice-President; Group Vice-President, Gene W. Simpson; Senior Vice-Presidents: David G. Jensen, Manufacturing; Ralph R. Schulz, Editorial; Vice-Presidents: James E. Boddorf, Planning & Development; James E. Hackett, Controller; Robert L. Leyburn, Circulation; Edward E. Schirmer, Sales.

Officers of the Corporation: Harold W. McGraw, Jr., President, Chief Executive Officer, and Chairman of the Board; Robert N. Landes, Senior Vice President and Secretary; Ralph J. Webb, Treasurer.

Title registered in U.S. Patent Office. Copyright © 1977 by McGraw-Hill, Inc. All rights reserved. The contents of this publication may not be reproduced in whole or in part without the consent of copyright owner. Subscribers: The publisher, upon written request to our New York office from any subscriber, agrees to refund that part of the subscription price applying to copies not yet mailed. Please send change-of-address notices or complaints to Fulfillment Manager; subscription orders to Circulation Manager, Electronics, at address below. Change-of-address notices should provide old as well as new address, including postal zip code number. If possible, attach address label from recent issue. Allow one month for change to become effective.

Postmaster: Please send form 3579 to Fulfillment Manager, Electronics, P.O. Box 430, Hightstown, N.J. 08520.

NEW 1978 PROMS!



IF YOU CHANGE TO A NEW TYPE OF PROM TODAY, WILL YOUR PROM PROGRAMMER BE OBSOLETE TOMORROW?

When you program your PROMs on a Data I/O programmer you don't have to worry about obsolescence.

Data I/O programmers are universal. They program all 200 plus commercially available PROMs. This gives you maximum design and production flexibility.

With one Data I/O generic program card set you can program an entire PROM family simply by changing socket adapters. **You'll always have current PROM programming specifications.** Data I/O program

card sets are tested and certified by the PROM manufacturers themselves before we approve them for manufacturing and distribution to our customers.

If manufacturers change PROM programming specifications, we provide you with all the information you need to update your card sets. And, by making periodic tests with the Data I/O Universal Calibrator, you have the guarantee that you're always programming within exacting PROM and programmer specifications to help you reach maximum PROM yields.



Programmers from \$1095.00

HOW TO SELECT THE RIGHT PROM PROGRAMMER FOR YOUR NEEDS.

We'd like to tell you more.

This fact filled tabloid gives you valuable information about PROM programming technology. To get your copy, circle reader service number or contact Data I/O Corporation, P.O. Box 308, Issaquah, WA 98027. Phone 206/455-3990.

DATA I/O

THE PROM PROGRAMMER PEOPLE.

**There are
big reasons
these little
EMC sockets
are molded
of Plenco
phenolics:**

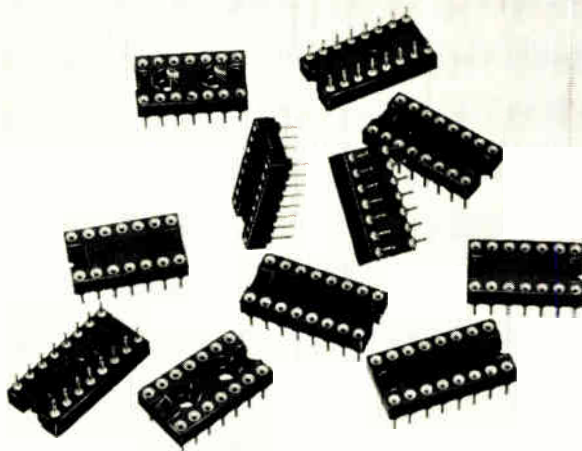

"Positive anti-wicking of solder during wave soldering," reports Electronic Molding Corporation, Woonsocket, RI, "and the withstanding of individual pin soldering temperatures without softening and allowing pins to loosen. Those are the chief benefits of the phenolic materials supplied us by Plenco."

EMC, manufacturer of a large variety of precision sockets, features new Dual-In-Line integrated circuit and LED sockets. Specified as insulation for their molded bodies are our Plenco 317 Red and Plenco 320 Green phenolic compounds.

More than likely we can provide a Plenco thermoset compound to suit your particular application or molding problem. Just dial (414) 458-2121 and "socket to us."

PLENCO
THERMOSET PLASTICS

PLASTICS ENGINEERING COMPANY
Sheboygan, WI 53081

Through Plenco research, a wide range of ready-made or custom-formulated phenolic, melamine-phenolic and alkyd thermoset molding compounds, and industrial resins.

Readers' comments

What's lacking is cooperation

To the Editor: I believe that the mismanagement situation at American manufacturers is more serious than you suggested in the last sentence of "On Fukuda, Carter, trade, and mismanagement" (Washington Commentary, March 31, p. 48). One very important reason for the success of the Japanese is not discussed in our journals. I mean the cooperation between management and employees in working toward a common goal.

In 50 years as an employee or other associate with 14 companies with activities ranging from steel manufacturing, paint making, chemical production, pharmaceuticals, medical electronics to printing, I have not found one in which management respected and trusted the lower-level employees, accepted their advice, and cooperated with them fully. Technically incompetent managers second-guessed the competent workers and, thereby, made first-class work impossible.

I noticed that the same managements were suckers for the con men on their staffs who promised the world on a platter if given just a few more months to work on a project. Productivity of the competent was reduced because they spent so much time trying to repair damage done by others.

Management spends its time extinguishing small fires and does not take steps to prevent fires—small or large. The talents needed to climb the corporate ladder are not necessarily those required for proper operation of the corporation.

A mechanical engineer has said that his experiences matched mine.

Our society is characterized by antagonisms. These dominate our law, media, corporate organizations, and social relations, and they are destructive of quality of product and life. First-class products are unlikely from large, unionized U. S. companies. A series of articles could be written on the reasons the Japanese can compete with our manufacturers—and not necessarily on price.

Frederick Kavanagh
Indianapolis, Ind.

Need a 2-digit BCD DAC?

Our DAC-20 is the world's first monolithic 2-digit BCD-coded DAC. Gives you very high speed performance (85nsec settling, typ.) with very low power consumption (37mW), terrific nonlinearity ($\pm 1/4$ LSB Max. over temp.)—all for very low cost.

It's simple to use. Provides a universal logic interface for TTL, CMOS, ECL, or any other logic. Full noise immunity is provided by high swing adjustable threshold logic inputs. And dual complementary current outputs with $-10V$ to $+18V$ compliance give you a voltage output with only a resistive termination. No speed-limiting output op amp needed.

Just ask . . .

Applications for our DAC-20 series range from audio attenuators and analog meters to modems and microprocessors. We'll be glad to send you a data sheet full of these and other application ideas

using the DAC-20 in such things as reference amplifiers, logic threshold controls, and multiplying circuits with bipolar or pulsed references.

Just circle the reader service number for a copy. And if you would like a free sample DAC-20, write us on your letterhead and tell us what application you're thinking about. We'll be glad to help you get going. Write DAC-20 at the address below. Thank you.



Precision Monolithics, Inc.,
1500 Space Park Drive,
Santa Clara, CA 95050
(408) 246-9222. TWX 910-
338-0528.

Circle 7 on reader service card



You finally have a choice:

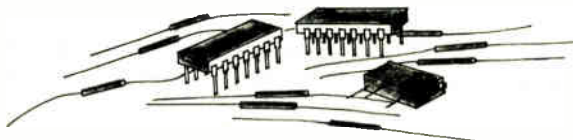

Make

Buy

Get the scope you need-Now!



Our "Instrument Professionals" will tell you which scope will do the job best, at the lowest cost, make immediate delivery and guarantee performance.

Write or call for data on our other specialties: Instrument Leasing • Computer Peripherals • Equipment Sales • Instrument Service.

Circle 8 on reader service card

Call Continental Rentals

Get our FREE Catalog

Div. Continental Leasing Co., Inc.
175 Middlesex Turnpike, Bedford,
MA 01730 (617) 275-0850

FOR IMMEDIATE RESPONSE CALL:
N.E. (617) 275-0850; L.I. (516) 752-1622;
NY, NJ (201) 654-6900;
Gtr. Phila. (609) 234-5100;
Wash., D.C. area (301) 948-4310;
Mid West (312) 439-4700;
So. Central (214) 690-1706;
Costa Mesa, CA (714) 540-6566;
L.A., CA (213) 477-7521;
Santa Clara, CA (408) 335-8389

News update

■ Last spring, in the best tradition of the season of renewal, rebirth, and hope, a new electronics trade association was born on the West Coast. Its ambition was to provide lobbying power to manufacturers of consumer electronics products; its name was the Association for Contemporary Electronics [*Electronics*, May 13, 1976, p. 26]. The association's first president was Don C. Hoefler, publisher of a newsletter, *Microelectronics News*, that chronicles the action in and around California's semiconductor-manufacturing locus known as Silicon Valley. Among the initial directors of the association were American Microsystems Inc. chairman Howard Bobb, Atari Inc. chairman Nolan Bushnell, and Inter-sil chairman and venture capitalist Fred Adler.

The association's rise and fall was quick. The group managed to sign up only eight members. President Hoefler resigned last November because of his concern over possible conflict of interest between that role and his job as newsletter publisher, he says. Frank Burge, an account executive at an advertising agency, became president and resigned in January—presumably to himself, because by then there were no members left.

The group initially had found it difficult to attract members, so Hoefler decided to offer a trade show to create interest and revenue. Eight companies put up about \$10,000 in deposits for booths for the show, scheduled for March in Long Beach, Calif. The money has been spent, says Burge, and the companies that planned to exhibit are upset. So ACE, although defunct, may have to seek protection under the bankruptcy laws to avoid litigation over the \$10,000. But Burge says that he does not know at this point what will happen to those bad debts.

Burge says ACE failed because it did not get a broad base of support. He adds that soon after he came to the group he told the agency promoting the projected trade show to stop all spending and not to accept any more exhibitors' deposits. ■



MODEL LVA-110

- INTEGRATING AC V/F CONVERTER Pat. pend.
- ON-LINE MONITOR and ANALYZER
- THREE MEMORIES: MAX. HIGH LINE MIN. LOW LINE POWER FAIL
- THREE TIME BASES: HALF CYCLE ONE CYCLE TWO CYCLES
- MULTIPLEXED MIN./MAX. OUTPUT
- DYNAMIC INPUT RANGE: 0-199V rms, 60Hz
- CONTINUOUS OPERATION: 50-160V rms, 60Hz

Power-Science, Inc.

8076 ENGINEER RD., SAN DIEGO, CA 92111
(714) 292-4422 TWX 910-335-1207

Circle 259 on reader service card

from ovenaire



Crystal Controlled DIP Oscillators designed especially for digital clock applications

Low-cost Models DT1-121 & DT1-221 feature...

Frequency Range: 20KHz to 25 MHz

Overall Stability: $\pm 0.010\%$ —Model DT1-121

$\pm 0.005\%$ —Model DT1-221

Temperature Range: 0°C to $+70^{\circ}\text{C}$

Output Waveform: Squarewave 50/50 = 20% to drive 10TTL loads. 0.4V max. "0" and 2.4V min. "1" level.

Input Power: Voltage $+5\text{V} \pm 5\%$. Current 30 to 120mA depending on frequency.

Package: 14 pin DIP, glass-filled nylon. Fits into standard 14 pin socket.

Size: (WxLxH) Approx. 0.50" x 0.80" x 0.37"

Other Ovenaire Highlights...

State of the Art High Stability Crystal Oscillators
Ovenized Crystal Oscillators • TCXO • VCXO
Crystal and Component Ovens • Thick Film Hybrid
Circuit Custom Services

for additional information contact...

ovenaire

Division of Walter Kidde & Company, Inc.
706 Forrest St.—P.O. Box 1528, Charlottesville,
Virginia 22902 • 804-977-8050—TWX 510-587-5461

Circle 260 on reader service card

The complete \$655 line printer.

It's ready to plug in, has an 80-column format, a remarkable MTBF and is 14 times faster than a teletype!



Breaking the hardcopy barrier

It's finally happened! The Axiom EX-800 provides full performance hardcopy at a price compatible with today's low cost micros. This little 80-column machine zips along at 160 characters per second (14 times faster than a teletype) — at a breakthrough single quantity price of \$655 for a complete printer.

When we say complete we mean it

The EX-800 is a stand-alone unit with case, power supply, 96 character ASCII-generator and interface, paper roll holder, infra-red low paper detector, bell, and multi-line asynchronous input buffer. You won't find these standard features on any other printer, regardless of price!

Our only option

Our printer is so complete, that we offer only one option. A serial interface (RS 232C or current loop) good for 16 baud rates from 50 to 19,200 and thoughtfully provided with a switch for either Centronics or Tally compatibility. Might we call it a Tally-whacker? At \$85.00 it certainly should be!

Built-in LSI microprocessor

The heart of the EX-800 is a printed circuit card, containing a custom LSI chip made by Intel to Axiom specifications, which controls all printer functions. Microprocessor power means flexibility. Such as the built-in self test routine and variable



character size. It also means reliability. Several industry surveys have shown LSI to be many times more reliable than equivalent conventional circuitry.

THIS LIFE-SIZE SAMPLE SHOWS THE 80-COLUMN PRINTOUT FROM AXIOM'S EX-800 PRINTER

There are 3 character sizes (upper and lower case) which can be MIXED.

This can have the same effect as UNDERLINING or changing COLOR.

The advantages of electrosensitive printing

The EX-800 can print 80, 40, or 20 characters across the five inch wide electrosensitive paper. Under software control, single characters or words may be printed larger for emphasis. The permanence of the hardcopy is archival, because once the aluminum coating has been removed, there is no way to put it back. It's unaffected by sunlight, moisture or heat. Although the printer doesn't provide multiple copies, excellent quality photocopies can be made from the high contrast printout. Also,

the paper is inexpensive and readily available, costing about 1¢ for an 8½ x 11" equivalent.

Light, small, quiet, reliable, and versatile

Our EX-800 weighs in at 12 pounds, is just 9½ inches wide, 4 inches high, and 11 inches deep, and is delightfully quiet which makes it ideal for office and other low noise environments. The simple print mechanism is virtually maintenance free. In fact, tests show an incredible MTBF, many times greater than impact printers. This versatile printer is the ideal mate for micros, minis, CRTs, instruments and systems.

Just unbox and plug it in

That's all you have to do to the Axiom EX-800 — apart from pay for it, and at \$655 that's almost a pleasure.

Send to: **AXIOM**
5932 San Fernando Rd.
Glendale, CA 91202

- Urgent. Please phone me at ext _____
- Have rep contact me
- I'd like to have a demonstration
- Send lit including sample of printout

Name _____

Company _____

Dept _____

Address _____

City _____ State _____

Zip _____ Telephone _____

AXIOM

AXIOM CORPORATION

5932 San Fernando Rd., Glendale, CA 91202 • (213) 245-9244 • TWX 910-497-2283

See Axiom at NCC, Booth 104, Personal Computing Section

World Radio History

Circle 9 on reader service card

**How
to do three
things at the
same part:**

Advanced Micro Devices, Inc. • 901 Thompson Place, Sunnyvale, California 94086 • Telephone (408) 732-2400 •
Distributed nationally by Hamilton/Avnet, Cramer and Schweber Electronics and regionally by Arrow, Bell,
Century Electronics, Future Electronics and RAE Electronics.

If you want a great 8-bit D-type register with common clear, get our Am25LS273. If you want one with three-state outputs, get our terrific Am25LS374. If you're looking for a sensational common enable, you want our Am25LS377. However, if you'd be willing to settle for all three, read on.

Advanced Micro Devices announces the Am25LS2520 8-bit D-type register. With common clock enable. With common asynchronous clear. With three-state outputs. With MIL-STD-883 for free. And all in a super-convenient 22-pin DIP. Look:

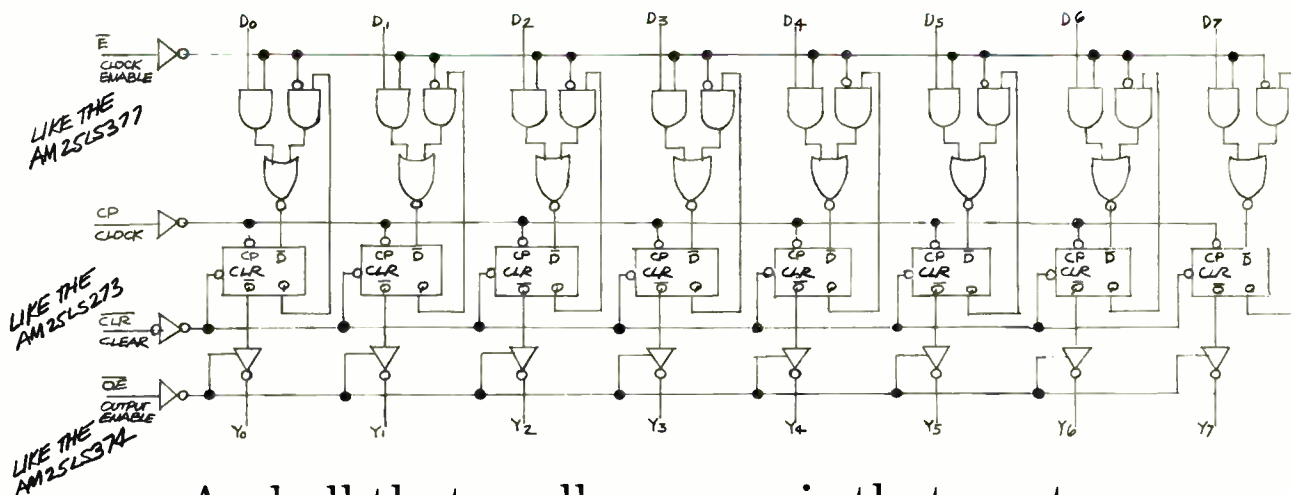

And all that really means is that next time you're thinking about registers, low-power Schottky and TI, you should also be thinking about AMD. Or calling. Or writing.

(After all, where else can you do three things at the same part?)

Advanced Micro Devices

Bipolar LSI. N-channel, silicon gate MOS. Low-power Schottky.
Multiple technologies. One product: excellence.



Circle 253 on reader service card

Countering Japan's cooperative technology

With an impressive single-mindedness of purpose, the Japanese have focused their sights on the rapidly developing data-processing markets, both in Japan and abroad. Witness the Japanese government's decision to sponsor a well-financed cooperative effort among major computer companies, the goal of which is an advanced computer technology based on very large-scale-integrated circuitry.

In addition to this, individual firms have in-house crash programs of their own in VLSI and are putting increasingly larger fractions of their revenues into advanced semiconductor design and production technology. The aim is the same: deep penetration of the world's high-technology markets by 1981.

Their program is certainly in keeping with the postwar tradition of Japanese industrialization. Starting from scratch in 1945, Japan has joined the world's premier manufacturing nations, and its industrial companies bring to their job some qualities that are found nowhere else in the world. For one, they are organized toward a common end: exporting. Then, too, they have strong government backing, and the country is behind them. Their workers, from boardroom executives to the lowest assembly-line technicians, rank among the most dedicated.

They have been brilliantly successful, dominating ship building, becoming No. 3 in the world's steel production, flooding the world's markets with the output of an automobile industry that is the fastest-growing of any, and supplying 70% of the world's consumer electronics gear.

As the Japanese turn their proven abilities to the design of data-processing components and equipment, some American firms are reacting in a way that could have a corrosive effect on the industry. Since the most advanced technology and the biggest EDP markets are

in the U. S., these voices are counseling defensive measures, such as increased tariff barriers, buy-American campaigns, Government-subsidized programs, cooperative development and technology exchanges — in short, all the things they themselves criticize in the Japanese programs.

We think this represents a short-sighted view. While the Japanese move in digital technology encompasses some aspects that cannot be countered directly by American companies — such as joint technology programs that go against antitrust laws and increased tariff barriers that are complex political questions largely beyond the spheres of individual companies — the best course for American companies is to continue doing what they do best, which is pursuing innovation in a free-enterprise environment.

If anything has put American digital technology in the lead, it is independence and innovation, and not government support, defense programs, tariff barriers, or fear of foreign competition. Rather it has been the fiercely independent semiconductor and computer industries and their employees who have first piled innovation on innovation in staggering progression and then applied these innovations quickly to new opportunities in calculators, watches, computers, and so on.

While the Japanese are bound to score some solid successes through their cooperative programs and government support, the best defense against a technology assault is an aggressive technology offense — new microelectronic structures and materials, submicrometer-pattern generation, automatic production equipment, and innovative chip and computer-system design. That is what the best American semiconductor and computer manufacturers have always done, and that is what the best of them are doing now.

Portable Weather Station

Rain or shine, arctic or desert,
-20°C to +70°C



Geophysical Monitor

Event-triggered recording to save tape,
batteries and for fast computer data-spotting

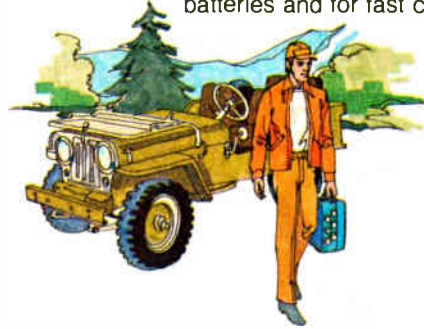

Traffic or Noise Level Logger

Accepts analog or digital
(event counter) inputs



Oceanographer's Probe

No outside power needed,
runs on internal batteries



Log your Analog Data on Digital Tape Cassettes . . .



Biomedical Data Recorder

Optional 5 mV
differential amplifier
for low level detectors.



Pollution and Environmental Logger

Crystal CMOS clock
can command different
scan periods

DATEL'S DL-2 DATA LOGGER

An Important New Tool- Choose Datel's DL-2 Cassette Data Logger for unattended standby recording of multi-channel, slowly-varying analog samples. The DL-2 samples up to 64 high level or low level analog channels, digitizes them to 12-bit binary coding and records them on a cassette at 5 samples per second. Also recorded are a one year calendar clock with one second resolution produced by an internal CMOS crystal oscillator. And external digital samples (up to 36 bits) may be recorded at any time. Analog scans are started automatically from a preset front panel scan timer with intervals from one second up to 30 hours.

The all-CMOS electronics of the DL-2 and stepper-motor transport consume only one watt while recording and microwatts while powered-down between scans. A set of batteries in the front cover will power the DL-2 for a year or longer, recording up to 120,000 samples.

Or external +12VDC or AC power may be used.

The DL-2 features a high-quality instrumentation amplifier (down to $\pm 5\text{mV}$ full scale input) and weather-proof housing and connectors suitable for -40°C to $+70^\circ\text{C}$ environments.

A companion DL-2R Cassette Reader offers a convenient playback front end to a minicomputer, microprocessor, TTY, CRT terminal or modem telephone coupler.



1020 Turnpike St., Canton, Ma 02021
• Phone (617) 828-8000 • Santa Ana,
Calif. (714) 835-2751 • Santa Ana (L.A.
Exchange) (213) 933-7256 • Sunnyvale,
Calif. (408) 733-2424 • Gaithersburg, Md.
(301) 840-9490

Circle 13 on reader service card



NEW!

300°C TEST SOCKETS

TEXTTOOL's new line of 300°C test sockets offers single source, fast delivery and high temperature test capabilities for almost all industry standard devices.

New TEXTTOOL standard high temperature test sockets in a wide range of models are immediately available to meet applications requiring device testing or burn-in at 300°C.



The extensive line includes TEXTTOOL's proven 300°C ZIP DIP (zero insertion pressure) sockets and others capable of high temperature testing of TO-5 packages (3

leads up), flat-packs and DIPs, power devices, as well as axial lead packages and miscellaneous hybrid devices.

In short, with one of the widest lines of 300°C sockets available, TEXTTOOL offers a high temperature test capability for virtually all industry standard devices.

All new TEXTTOOL high temperature sockets feature the option of either chassis or P.C. board mounting as required by the application. The socket line is available with Nickel Boron plated BeNi contacts for extended use at highly elevated temperatures.



Detailed information on this new high temperature socket line and other products in a wide choice of materials from TEXTTOOL . . . IC, MSI and LSI sockets and carriers, power semiconductor test sockets, and custom versions . . . is available from your nearest TEXTTOOL sales representative or the factory direct.

Ask today for your copy of the new 1977 TEXTTOOL CONDENSED CATALOG!



PRODUCTS, INC.

1410 W. Pioneer Drive • Irving, Texas 75061
214/259-2676

People

Computer Automation means high volume for Marshall

Frank Marshall had a good reason for switching jobs three years ago from a secure post in the aerospace industry to a small company in the minicomputer business. "My life ambition was to work on a product commercially producible in high volume," something not possible for the military, he explains.

Computer Automation offered him the chance because it was, "in the mainstream of the commercial marketplace." Within a year, his move paid off and Marshall, as computer development manager, was in the middle of developing a brand-new three-machine line of minicomputers, introduced last month [*Electronics*, May 26, p. 139]. Eventually he directed a 16-person task force.

The big difference in building the new minicomputers was that "cost and producibility, not technology were the main considerations" Marshall says. "Management set cost and performance goals and we had to meet them. Such constraints represent a far cry from new computer lines developed by most companies, which seek to incorpo-

rate all the latest semiconductor technology.

Marshall, however, shudders when asked why did he not consider such exotic semiconductor approaches as silicon-on-sapphire, very large-scale integration, and the like. "We had to have an industry standard process, second-sourced all the way," he says. This means n-channel metal-oxide-semiconductor technology, which the design team used in two processor chips built for the company's low-end minicomputer, the 4/10. The medium-level 4/30 has conventional medium-scale-integration logic and the top 4/30 employs transistor-transistor-logic circuitry.

As perhaps the riskiest part of the early design process, Marshall singles out commitment to a chip size of less than 200 mils, without knowing at that time exactly what was needed. "We came within 2% since the final size ended up in the 190-mil-square range."

For a project so important to the Irvine, Calif., company's fortunes, the 30-year-old Marshall says it was a "well-controlled orderly process. Although we worked some weekends and nights, there was none of the crash-program stuff." While he says top management didn't ride herd on the project on an hourly basis, its



Differences. For Frank Marshall, the move to commercial work from aerospace brought a shift in emphasis away from technology.

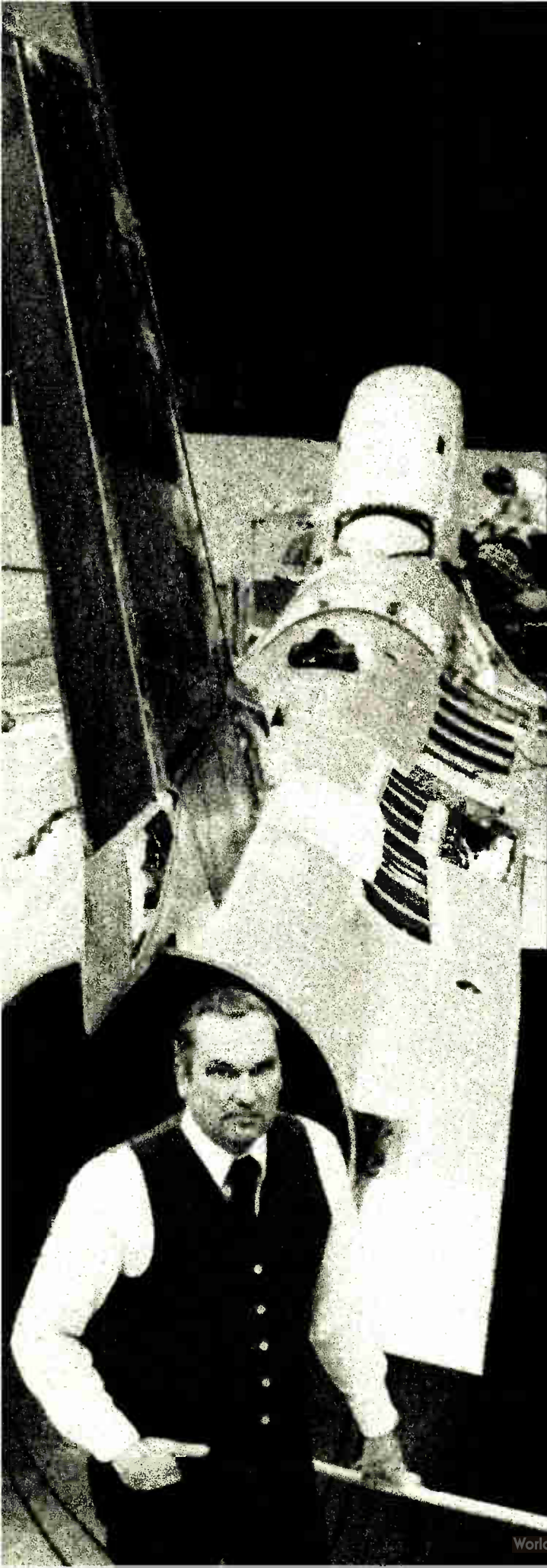

**"We've cut up to 80%
of our negative costs and
reduced our lab labor
time by half thanks to
reprographic techniques."**

**Bill Williams, Manager,
Still Photo Services Lab,
General Dynamics Corporation,
Fort Worth, Texas.**

"The F-16 Air Combat Fighter that General Dynamics is manufacturing for the U.S. Air Force and five allied nations is based upon thousands of engineering drawings—many eight-foot J size. And most of them have funneled through our Still Photo Services Lab for reproduction.

"When you're creating a new airplane, designs and specifications are often changed—until you're sure you're producing the finest aircraft for the mission defined by the Air Force. So, new drawings are needed. It's much easier to use reprographic techniques and make small changes photographically than it is to redraw everything.

"Before we installed our new Kodak Supermatic processor and process camera, we shot everything same-size and tray-processed. We'd shoot our J-size drawings in sections and then splice the whole thing together. I claimed my technician used a four-inch brush to opaque pinholes in negatives.

"Now we shoot the drawings down five to seven times, opaque the reduced-size negative, and come back to a full-size second original with absolute accuracy. All the Kodagraph products go through the processor—so do a lot of our publicity photos. One person processes the same number of line drawings that two technicians did when we were using a wet line. And our savings on negative material alone run between 50 and 80 percent."

Reprographics can help you, too.

Send for more details about General Dynamics' use of reprographic techniques, plus, a complete listing of Kodak products and other applications. Write: Eastman Kodak Company, Graphics Markets Division, Dept. R04805, Rochester, N.Y. 14650.

**VERSATILITY IN
REPROGRAPHICS**



Circle 15 on reader service card

Pulse withstand capacitors for colour T.V.

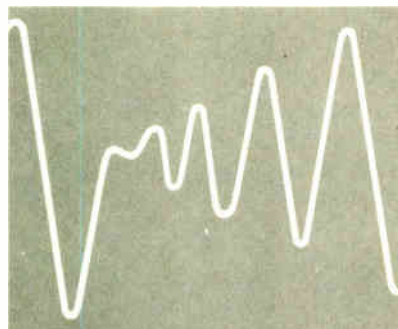
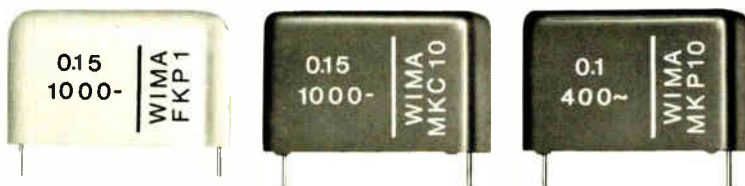

WIMA FKP 1

Polypropylene film and extended foil electrode capacitors encapsulated in cast resin. Self-healing properties. Suitable for sharp-edged or short rise time pulses in thyristor deflection circuits.

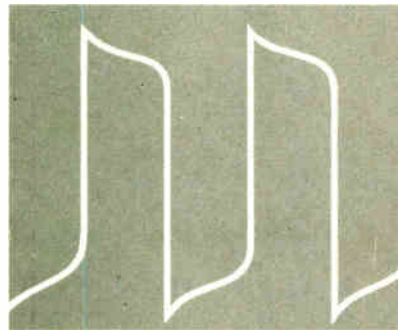

WIMA MKC 10

Metallized polycarbonate capacitors. Particularly suitable for stringent pulse and surge conditions. Low power factor at high frequencies. Self-healing properties. Plastic case design.

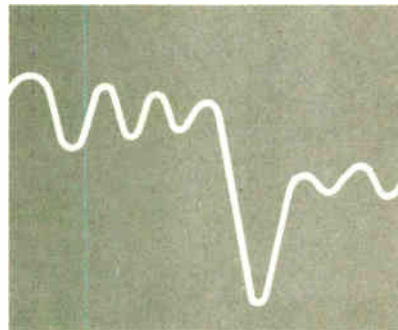

WIMA MKP 10

Metallized polypropylene capacitors in plastic cases. Self-healing properties. Suitable for both high current and pulse circuits owing to low dielectric losses.

- Other special capacitors in metal cases.
- One year successful field experience in equipment by leading manufacturers.
- Suitable for advanced solid-state equipment.
- For professional electronics.



WILHELM WESTERMANN

Spezialvertrieb Elektronischer Bauelemente
D-68 Mannheim 1
Fed. Rep. of Germany
Augusta-Anlage 56
P. O. Box 2345
Tel.: (621) 40 80 12

Write for our new catalogue.

People

interest was intense. "Dave Methvin, the president, for instance, would walk into the lab and intently watch us probing wafers."

Jacobson's route to success lies in European subsidiaries

Many U.S. computer firms have decided the way to boost sales faster is to cross the Atlantic and sell to the Europeans. Not many executives of companies turning over only \$13 million a year, though, have taken the plunge of setting up their own subsidiaries in Europe.

But Roy Jacobson, 55-year old president and cofounder of Anderson Jacobson, based in Sunnyvale, Calif., did just that three years ago. About to post 1976-77 revenues of more than \$20 million, the company is the world's largest independent supplier of printer-keyboard terminals, he reckons.

Jacobson, who majored in engineering at Yale University, is a Harvard Business School graduate and read economics and political science at Oxford. He insists that the way to go is to set up wholly owned subsidiaries wherever viable.

Sitting in the Paris suburb offices rapidly being outgrown by the company, Jacobson says: "I don't know any data-processing companies our size—or even a good deal larger—that have set up their own independent operations in Europe. Why do it? It's part of our philosophy."

He notes, too, that "it gives better control of the total operation. We also get better feedback on what users need and can put this information into designing products and improving services. It's also a basis for larger growth."

For relatively small companies, this is an expensive approach to adopt. But its two European subsidiaries, in France and England, made profits last year, and it was the second profitable year in France. So far, European sales reach only 11% of total company turnover, but Jacobson is expecting this to grow rapidly to 25%.

MIL-SSR UPDATE

Ready for military service: Our new AC power SSR.

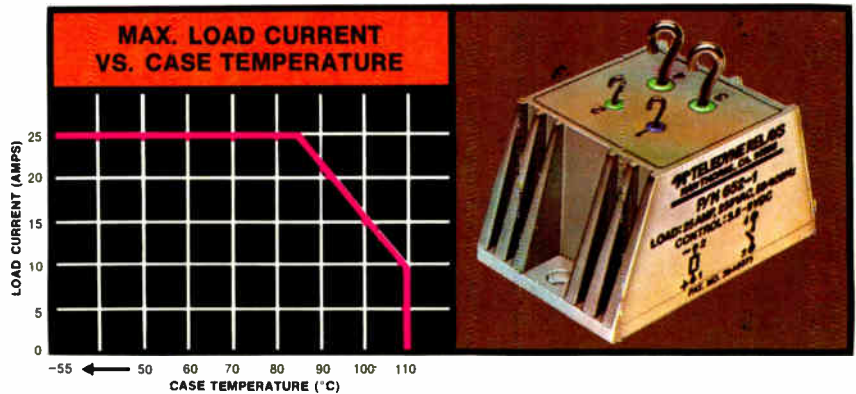

Commercial relays are no match for severe military or aerospace environments. But there's no doubt about our new 652 Series. Designed expressly for military and aerospace applications, this new AC SSR is packaged in a rugged, hermetically sealed aluminum case with the internal circuit assembly encapsulated to resist shock and vibration. What's more, all circuit components are military grade including the inverse parallel SCRs that provide reliable output switching — up to 25 Amps — over the frequency range of 45-440Hz.

Other features include logic compatible input drive

circuitry, optical isolation, and zero voltage turn-on to reduce EMI.

To top it all off, our 652 Series is designed to meet MIL-R-28750 and all categories of MIL-STD-704A, with an operating ambient temperature range of -55°C to +110°C.

For complete specification data, contact your nearest Teledyne Relays sales office listed in EEM, Gold Book and Electronics Buyers' Guide. You'll find we have the experience, products, and technical support to meet all your SSR needs — including a quick reaction capability to design SSRs specifically for your application.

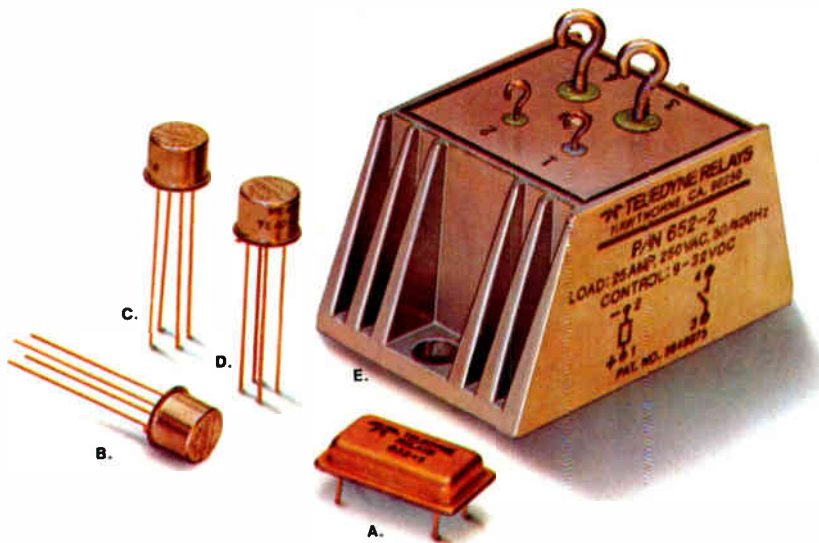

TELEDYNE'S MILITARY SSRs

- A. P/N 683-1 DC SSR
DIP package, with output rated at 600mA/50VDC
- B. P/N JM640-1 Bi-polar SSR
Mil P/N M28750/5, TO-5 package, with bi-polar (AC/DC) output rated at 60mA/40V
- C. P/N JM643-1 DC SSR
Mil P/N M28750/6, TO-5 package, with output rated at 300mA/40VDC
- D. P/N JM643-2 DC SSR
Mil P/N M28750/7, TO-5 package, with output rated at 100mA/250VDC
- E. 652 Series AC Power SSR
Output rated at 25A/250VRMS

TELEDYNE RELAYS

3155 West El Segundo Boulevard, Hawthorne, California 90250
Telephone (213) 973-4545

**Designers say we have the lead
in edge connector design.
And the performance to keep it.**





The reason why is clear. The contacts for AMP wrap-type edge connectors have unique strength and stress relaxation characteristics that assure long-term top performance. And they come in either leaf spring or cantilever types. Each incorporates full bifurcated design to achieve effective contact redundancy. A choice of contact alloys and selective gold platings is available too. The result is premium reliability and performance at a cost as low as 2 cents a line in quantity.

There's another reason you're ahead with AMP edge connectors, or any other AMP product for that matter. It's called technical support. It means you can call on us for assistance in research, product design, and production. We feel the professional engineer is entitled to it. After all, when he puts his confidence in us, we can do no less than back him fully.

There are other advantages, too, with these AMP edge connectors. You can select from types for either rack or solder-to-board mounting. And if you're a panel maker, we've got ECONOMATE I connectors with outstanding insertion speeds and space savings.

For more information on these wrap-type printed circuit edge connectors, just call AMP Customer Service at (717) 564-0100. Or write AMP Incorporated, Harrisburg, PA 17105.

AMP has a better way.

AMP
INCORPORATED

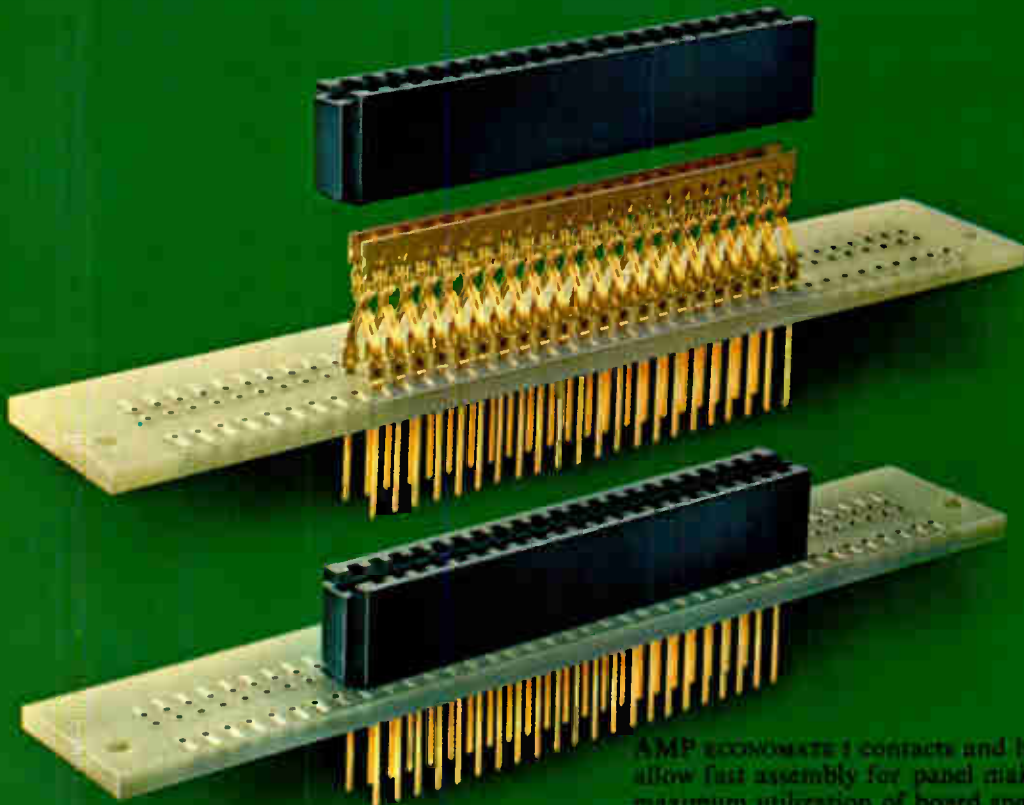

AMP economate I contacts and housings allow fast assembly for panel makers and maximum utilization of board space.



TAKE THE GAMBLE OUT OF SPECIFYING POWER SUPPLIES

When you specify power supplies manufactured by Abbott Transistor Laboratories, you minimize your risks and maximize your return.

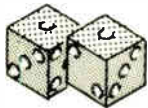

No "SNAKE EYES" with Abbott, only winning performance

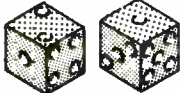

Abbott power supplies are reliable, they won't "CRAP OUT" on you



No "LITTLE JOE'S," Abbott units are big on performance



No "BOX CARS" either — Abbott units are compact

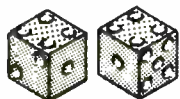

Don't go the "HARD WAY," specify Abbott, the easy way to solve your power supply requirements

Abbott makes a wide variety of industrial/commercial, OEM, military and aerospace power supplies. Each and every unit is subjected to rigorous quality control and electrical testing before shipment to insure that when you put it on the line, it will pass every time.

So when you want a reliable power supply, come to Abbott, the winner for price and performance.

Please see pages 1836-1848 of your 1976-77 EEM (ELECTRONIC ENGINEERS MASTER Catalog) or pages 672-682 Volume 2 of your 1976-77 GOLD BOOK for information on Abbott Modules.

Send for our new 60 page FREE catalog.

abbott transistor
LABORATORIES, INCORPORATED

GENERAL OFFICES
5200 W. Jefferson Blvd.
Los Angeles, CA 90016
(213) 936-8185
Telex 69-1398

EASTERN OFFICES
1224 Anderson Ave.
Fort Lee, NJ 07024
(201) 224-6900
Telex 13-5332

Meetings

Joint Automatic Control Conference, IEEE *et al.*, Hyatt Regency Hotel, San Francisco, June 22 - 24.

35th Annual Device Research Conference, IEEE, Cornell University, Ithaca, N. Y., June 27 - 29.

International Symposium on Fault-Tolerant Computing, IEEE, University Hilton Hotel, Los Angeles, June 28 - 30.

1977 Electronic Materials Conference, AIME, Cornell University, Ithaca, N. Y., June 29 - July 1.

Computer-Aided Design of Electronic and Microwave Circuits and Systems, IEEE, University of Hull, Hull, England, July 12 - 14.

International Conference on Nuclear and Space Radiation Effects, IEEE, College of William and Mary, Williamsburg, Va., July 12 - 15.

IEEE Power Engineering Society Summer Meeting, IEEE, Maria Isabel Sheraton and Camino Real Hotels, Mexico City, Mexico, July 17 - 22.

Summer Computer Simulation Conference, ISA, IEEE, *et al.*, Hyatt Regency O'Hare Hotel, Chicago, July 18 - 20.

International Conference on Integrated Optics and Optical Fiber Communication, IEEE *et al.*, Tosho Building, Tokyo, Japan, July 18 - 20. (Post-conference meeting on fabrication technologies at Senri-Hankyu Hotel, Toyonaka, Osaka, Japan, July 22.)

1977 International Conference on Crime Countermeasure Science and Engineering, IEEE *et al.*, Oxford University, Oxford, England, July 26 - 29.

ACM-Pacific 77—Exploring the Small Computer, ACM, LeBaron Hotel, San Jose, Calif., July 28 - 29.

Electromagnetic Compatibility Symposium, IEEE, Olympic Hotel, Seattle, Wash., Aug. 2 - 4.

WAFERTRAC. STILL STEAMING AHEAD!

Since GCA introduced the revolutionary WAFERTRAC™ a few months ago—the completely automatic, microprocessor-controlled wafer processing system, 9 out of 10 of the world's largest manufacturers of semiconductors have purchased their WAFERTRAC systems. Why?

WAFERTRAC provides higher yields in less facility space.

WAFERTRAC improves up-time and reliability to higher levels than ever before possible.

WAFERTRAC eliminates traditional 25-wafer group processing limits.

WAFERTRAC lets you design your own specific configuration, according to your firm's unique requirements.

WAFERTRAC.
The first practical application of the microprocessor to semiconductor processing, requiring only a single person in your processing loop ... and *then* only to load and unload carriers.

Don't be the last to get on board. WAFERTRAC's still steaming ahead ... destination: greater profits!

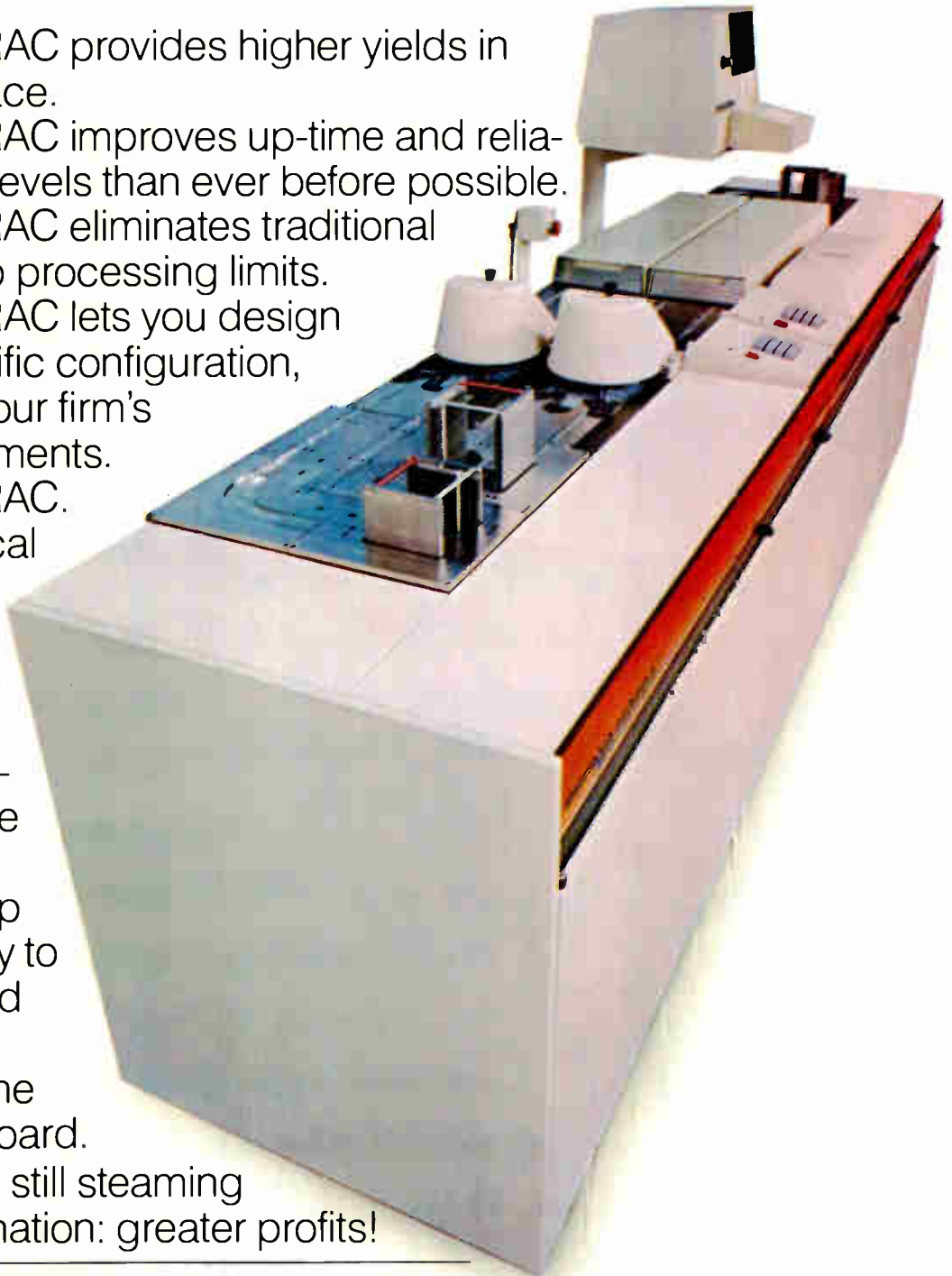

GCA/SUNNYVALE DIVISION ●●▲

PART OF THE GCA/IC SYSTEMS GROUP
1050 Kifer Road, Sunnyvale, Calif. 94068 TWX: 910-339-9211 (408) 732-5330

Mostek SDB-80. Z80 Power and

The solution for OEM applications.

For OEM applications the SDB-80 is one of the most powerful, yet low cost microcomputers available in the industry today. For \$995 (single unit quantities) the SDB-80 single board microcomputer includes Mostek's Z80 CPU (MK 3880), eight MK 4116 16K RAM memories, two PIO's (MK 3881), one CTC

(MK3882), serial ASCII interface (110—9600 baud) sockets for up to 5K bytes of PROM or 20K bytes of ROM, plus a fully buffered and highly sophisticated system bus for complete expandability (including multi-processor applications).

These features are not only important in the user's final system, but also permit the SDB-80 to be used as an extremely powerful software development station, providing even greater savings.

High level languages such as BASIC are also easily supported with the SDB-80 by loading either Z80 or 68080A based interpreters/compiler into the 16K bytes of on-board RAM

The solution for software development.

For software development, the SDB-80 is available with a complete package of software development aids in ROM. This optional 10K byte firmware package may be located in sockets on the board to provide the ability to generate, edit, assemble, execute, and debug programs for all types of Z80 applications. Other features include channelled I/O for user-defined peripheral

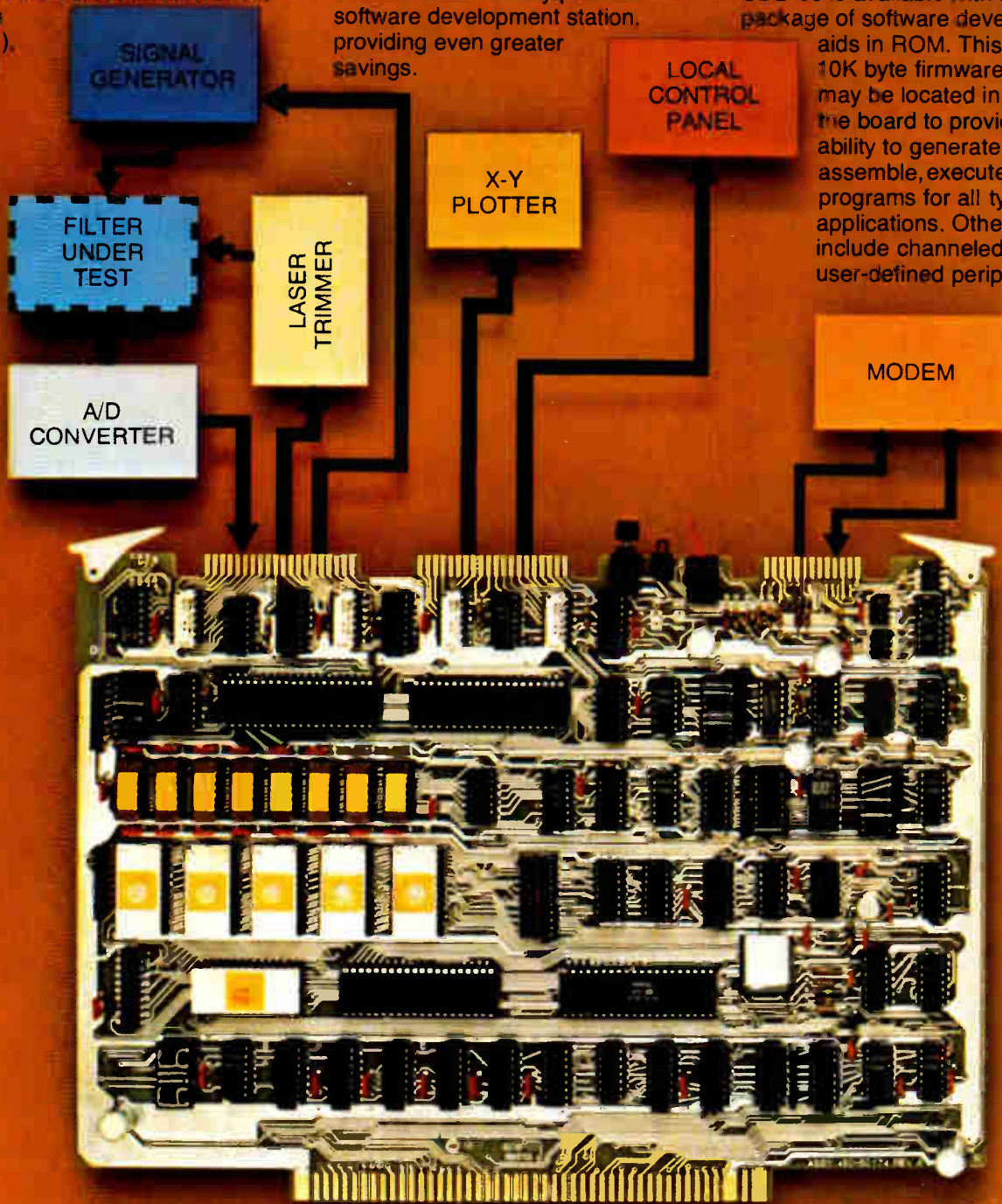

The \$995* solution. 16K Bytes of RAM.

drivers, relocatable object module generation with a corresponding linking loader, a complete set of console routines for examining and/or modifying memory and port locations, and a set of driver routines for various standard peripheral devices.

For users requiring even greater system capabilities, the SDB-80 is fully expandable through the use of optional add-on boards. In this way the user may configure his system to include whatever amount of PROM, ROM, RAM or I/O desired, plus add

such features as in-circuit emulation, floppy disk interfaces, and PROM programming capability.

Non-resident software development is also supported through the use of Z80 Cross Assemblers which are available for both Fortran IV and 8080A systems. The resultant object code can then

be loaded into the SDB-80 for execution and debug

For more information on the SDB-80 and the complete range of optional support boards, software, and boxes, contact your local Mostek sales office or representative.

MOSTEK

1215 West Crosby Road
Carrington, Texas 75005
(714) 242-0444

In Europe, contact
MOSTEK GmbH W. Germany
Telephone: (0711) 701066
MOSTEK ASIA
Hong Kong
Telex: 85148MKA H X

PAPER TAPE
READER/
PUNCH

CARD
READER

LINE
PRINTER

ASCII
TERMINAL

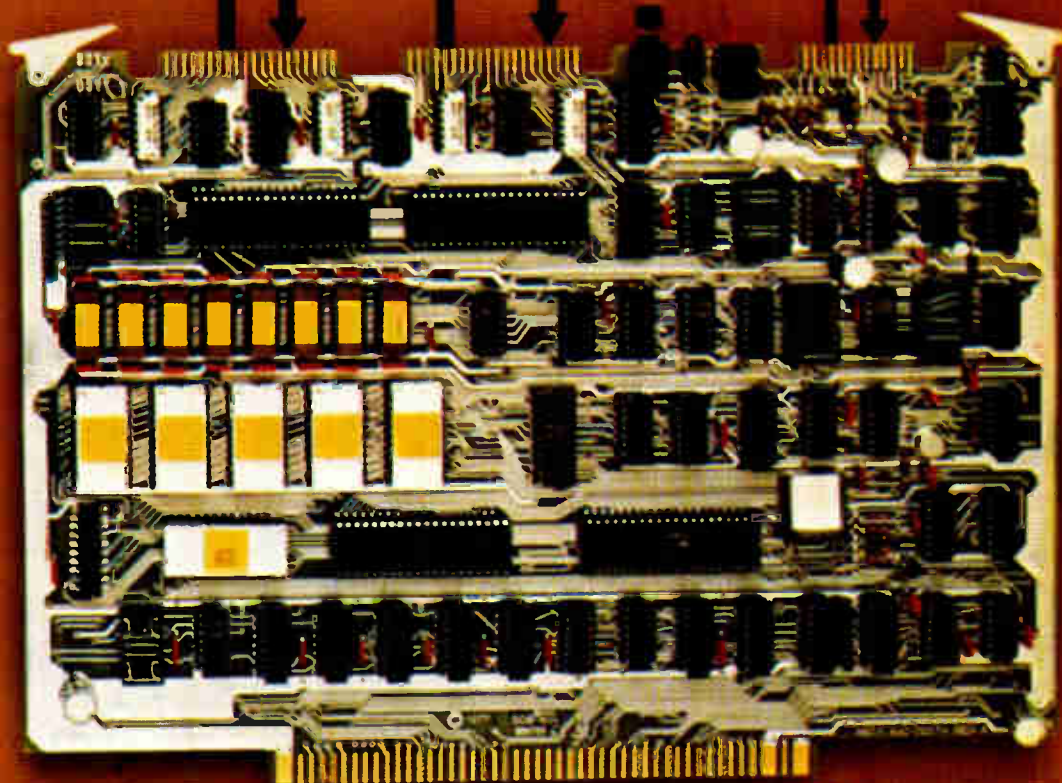

DEVELOPMENT SYSTEM

World Radio History

*One piece quantities.
Prices apply within the U.S.
and Canada. Eurocard
version available.
Contact Mostek GmbH.

Circle 23 on reader service card

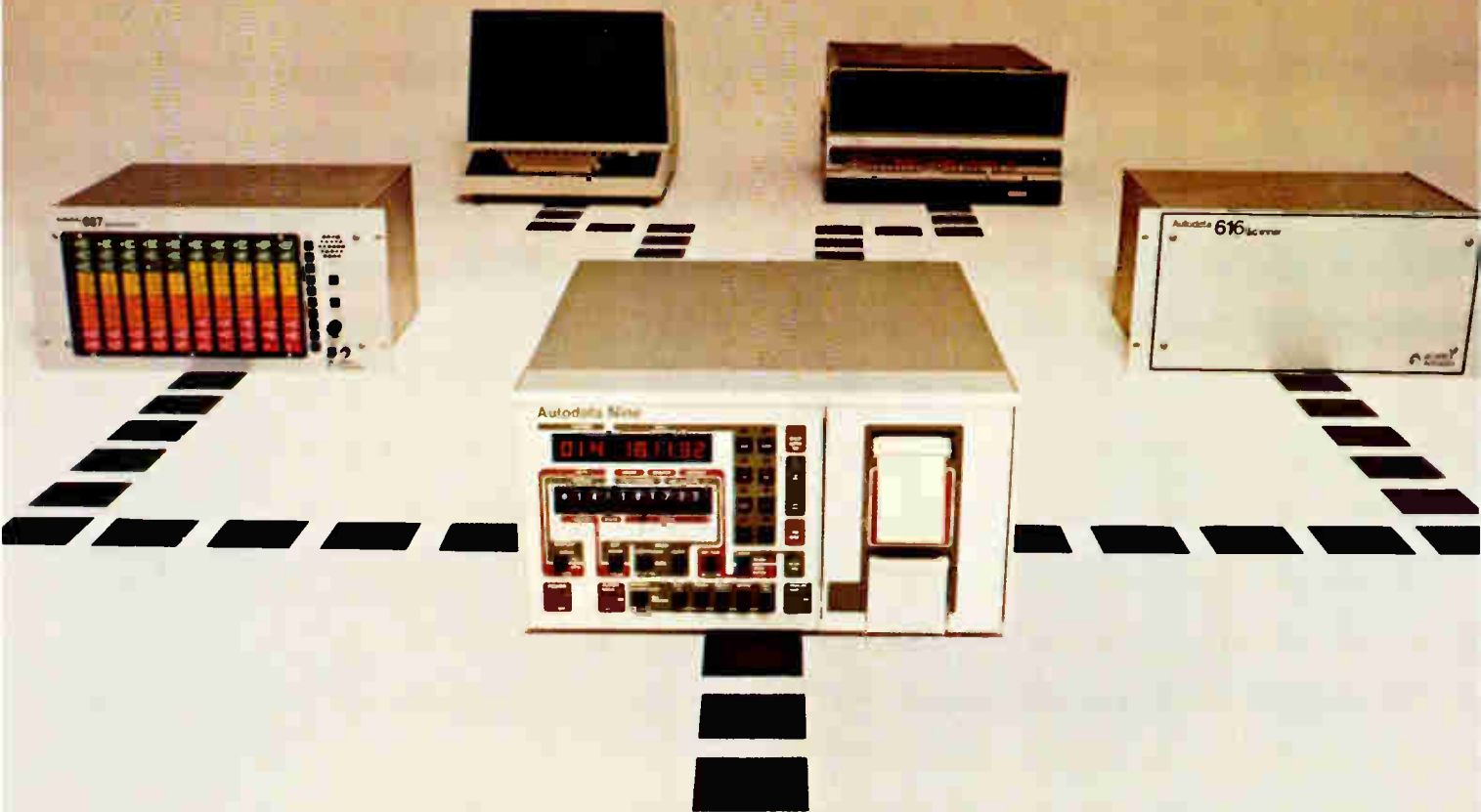

YOU DRAW THE LINE.

Monitor/alarm/control applications simplified: The Autodata Nine flexibility allows you to tailor a system to your needs by selecting the right options - just draw a line. Almost any line — from the Autodata Nine to computers, to CRTs, to Annunciator Panels, to Remote Scanners and to what you require. Here's how some of our customers draw their lines:

A major government agency needed a line on agricultural **data acquisition**. By plugging in an Autodata Nine they now measure (and record on paper tape) such diverse input as solar activity, soil moisture levels and weather data — over several hundred channels.

The engineers at a West Coast power plant are concerned about preventing excessive motor bearing, winding and boiler tube temperatures. **Process monitoring** is a natural for the Nine. And at this installation, it performs two-out-of-three logic for alarming and automatic shutdown, and informs the operator of problems through annunciator panels, and data printout.

We lined up another Nine for a marine biology study. The intent was to determine the effects of heat on marine life by varying water temperature in 30 tanks using cost effective **supervisory control**. Again, through a single Autodata Nine, temperatures were sampled, read and — when required — corrected by the incremental control of valve positioning.

We placed Autodata Nines at each of several engine test stands for one customer. He then drew a line from each to his central computer. Now they serve as **smart front ends** acquiring and manipulating data on temperature, pressure and flow under computer control (or manually if the computer is down). And since less software was required in the computer, the system was on line fast at the lowest cost.

These examples only begin to indicate the Nine's versatility. Get the Autodata Nine into your diagram — just draw a line around our number on the bingo card.

 **ACUREX**
Autodata Formerly Vidar Autodata

485 CLYDE AVE., MOUNTAIN VIEW, CA 94042 (415) 964-3200 (TWX) 910-379-6593

Circle 24 on reader service card

World Radio History

Mostek to show its first entries in memory system field

Mostek Corp. is using the edge it has in 16,384-bit random-access memories to wedge its way into the memory systems business. Its first four products, to be unveiled at next week's National Computer Conference in Dallas, will include **the largest memory board to date**, a 15.4-by-11.75-inch printed-circuit card populated with 192 16-k RAMs. Aimed primarily at large computer systems, the MK8000, as it's called, can be configured to yield 131,072 words of 24-bit memory on a single board.

Other boards that the firm will announce are a 64,536-by-18-bit board for DEC's LSI-11 and a 131,072-by-17-bit system that will take Data General's Nova 3 to its maximum storage capacity with a single memory card.

Sandia decides to buy several concentrator models

The process of selecting a prime contractor to build Sandia Corp.'s 10-kilowatt photovoltaic optical concentrator array has taken a new turn. Instead of naming a single winner from among nine bidders [*Electronics*, Feb. 3, p. 44], **Sandia picked two firms to come up with evaluation prototypes and likely will add one more.**

Both Martin Marietta Aerospace of Denver and Spectrolab Inc. in Sylmar, Calif., received contracts to deliver prototype arrays, in the 100-to-300-watt range, by Oct. 31. Negotiations are continuing with a third firm, a spokesman says. Martin Marietta got a \$256,000 contract, and Spectrolab, a subsidiary of Hughes Aircraft Co., is working under a \$277,000 award.

Rockwell sees megabit bubble chip within 2 years

An experimental million-bit bubble-domain memory chip could be in production within two years. John L. Archer, manager of the applied magnetics branch at Rockwell International's Electronics Research Center, says the megabit bubble chip, while "not fully speeded yet," **already has proven the necessary technology.** Its density of 1.6×10^6 bits per square centimeter on a 10-by-9.5-millimeter chip gives a capacity 10 times that of any solid-state memory device reported to date, he says.

Fast, powerful multiplier coming from Monolithic

Monolithic Memories Inc. is gearing up to produce **an 8-by-8-bit multiplier with what is probably the industry's best speed-power product.** Designated the MMI 67558, the 40-pin combinational device has a typical speed of about 100 nanoseconds and a power consumption of only 1 watt. By comparison, Advanced Micro Devices' 8-by-1-bit multiplier is specified at 450 ns and 1.2 w, its 8-by-8 at 400 ns and 1 w. TRW Semiconductor has an 8-by-8 on the market that is specified at 130 ns and 1.8 w.

HP takes wraps off watch-calculator

Hewlett-Packard Co. executives have just announced what they call an entirely new product area for the Palo Alto, Calif., originator of the hand-held calculator—the HP 01, a sophisticated wristwatch-cum-calculator based on improved versions of the integrated circuits that run the HP-35. **Containing two calculator ICs, a watch chip, and new memory chips,** The 6-ounce HP 01 will be sold as a high-fashion piece of jewelry, at about \$650 to \$750 retail. It will have more than 30 to 40 computing and timing functions.

**TI develops
\$3.90 monolithic
a-d converter**

Texas Instruments has developed a low-cost, monolithic analog-to-digital converter **designed specifically for use with microprocessors**. The part, the TL505, will be in production at the end of this month, priced at \$3.90 each in lots of 100.

Designed to interface directly with TI's TMS1000 family of 4-bit p-MOS microcomputer chips, the part integrates an operational amplifier, comparator, voltage reference, analog switches, and switch drivers onto a single bi-MOS chip that runs from a 9-volt power supply. The 8-to-10-bit part (0.1% accuracy) is aimed at a wide range of low-speed conversion applications, such as process controls, microwave ovens, and automotive systems. It will handle up to 20 conversions each second.

**Intel producing
\$600 "math board"**

Looking to take advantage of another market created by its line of single-board SBC microcomputers, Intel Corp. is going into production with the SBC 310, a \$600 high-speed bipolar "math board" based on its Schottky bipolar 3,000 bit-slice family. Acting as a slave unit to any SBC 80 microcomputer, the SBC 310 extends the mathematical number-crunching capability **an order of magnitude beyond what is now possible with the 8080 alone**. On command it performs fixed-point-integer and floating-point arithmetic. An SBC 80/20 with an SBC 310 can perform a fixed-point multiply in 70 microseconds, roughly equivalent to the performance of an LSI-11.

**Xerox bases
printing system
on mini, laser**

Xerox Corp. has announced an all-electronic printing system intended as a high-style alternative to the inelegant fan-fold computer printout. Dubbed the 9700, the printer uses a Digital Equipment Corp. PDP-11 minicomputer and a laser to produce letter-quality 8½-by-11 sheets, putting out two pages a second. At \$295,000, the 11-ft-long 9700 is actually a printing factory using xerographic principles to print on mixed weights of paper. Aimed at the data-processing industry, the printer eliminates all the steps between the computer and the high-quality printed page.

**Mass storage
system for minis
uses video disk idea**

Optical videodisk technology is being applied to a mass storage system for minicomputers at Philips Laboratories, Briarcliff Manor, N.Y. According to Philips consulting scientist Frits Zernike, confidence is growing that **in another year Philips will have a prototype demonstrating actual transfer of data** to and from a minicomputer system. "I could not have said that six months ago," he notes, but continuing developments on the system now make him "reasonably confident that an error rate of 1 in 10 billion is attainable."

Basically, the system works with a helium-neon laser delivering about 10 milliwatts of optical power to the disk, which is coated with a thin tellurium film. The laser creates a micrometer-sized hole to record the presence of a data bit. The disk measures 30 centimeters in diameter and, in its 40,000 tracks, can hold 10 billion bits. Thus, the expected error rate is equivalent to one error per disk. Once written, the data cannot be erased, so the system is intended for archival storage or where a great volume of data is accumulated and must be played back on-site.

Specify the panel meter you'd be proud to have designed yourself

Panel meters from General Electric can add a lot to the overall quality of your product. Accuracy. Reliability. Attractiveness.

How do you design this kind of quality?

Start with the *suspension system*. The moving parts. You'll want one of two kinds (depending on what kinds of physical abuse your panel meter may be exposed to). In a *taut band suspen-*

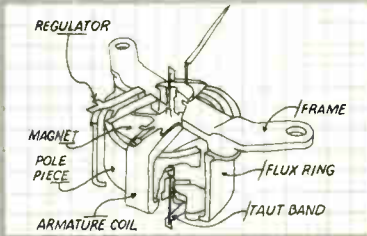

sion system, the moving mechanism is suspended between two ribbons of platinum-nickel alloy welded securely to a resilient, shock-resistant anchor. This suspension system design keeps friction to an absolute minimum.

The aluminum pointer is attached to an oversized, high-torque armature coil of fine copper wire, for fast response and accuracy you can count on.

Pivot-&-jewel suspension maintains high performance and reliability in high vibration environments. The armature assembly is supported by highly polished, hardened-steel pivots selected

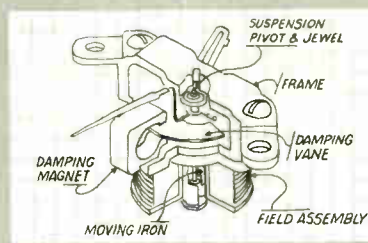

for wearability. The pivots are designed with a radius that will minimize friction level to give maximum performance. The 1/10-carat jewel bearings are of ceramic material that is stronger than glass jewels and has greater scratch and impact abrasion resistance.

Pointers are tapered to a radius point as small as .38 mm, combining high readability with superior reading accuracy. Scales on the meter face are available with mirror backing that will align the reader's eye perpendicular to the face, eliminating parallax error.

Self-protecting features are important, too. All GE panel meters are housed in a tough, *molded case* of high-impact styrene. Special gaskets are available for assembly in *BIG LOOK®* type panel meters between the window and case to keep out contaminants. Ultrasonically placed mounting studs assure that the meter will fit your panel exactly. Choice of meter styling (*BIG LOOK®* or *HORIZON LINE®*) lets you

pick the shape and appearance that will best enhance your product. (Color masks are also available for *HORIZON LINE®* in red, blue, green, black, yellow and white.)

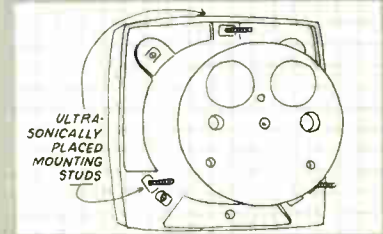

Hundreds of GE panel meters are available for almost any conceivable monitoring or measurement task.

And when you buy a GE panel meter, you also get more than 80 years of meter manufacturing experience and a sales network that is literally worldwide. For a free guide entitled, "Pick the Right Panel Meter," write to General Electric Co., Section 592-82, Schenectady, N.Y. 12345.

**Specify General Electric...
Just for good measure.**

GENERAL ELECTRIC
Circle 27 on reader service card

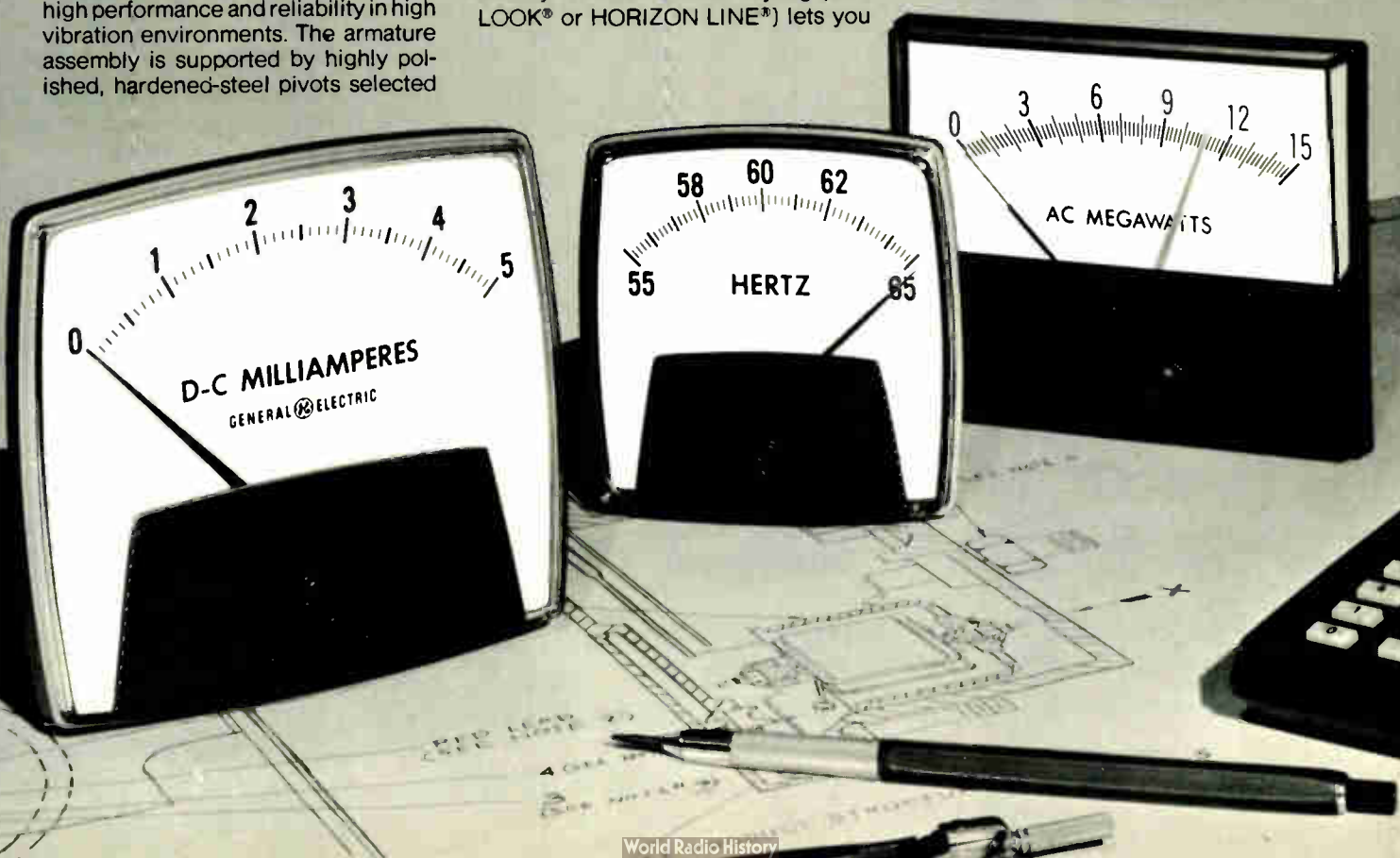

HP's Terminals: smart, but simple.

With 10,000 sold in just two years, Hewlett-Packard's CRT line has made a considerable impact on the terminal market. The secret? Human engineering.

By designing our smart terminals around a microprocessor, we've managed to uncomplicate difficult jobs and make simple tasks a piece of cake.

But that was just the beginning. We wanted to make our terminals easy to maintain and expand. And we wanted to make them easy on the eyes, both from the operator's point of view and as pieces of office furniture.

We did it all. Our terminals won design awards for their appearance. And our exceptionally clear, high-resolution displays have won the hearts

(and eyes) of everyone who has to spend long hours in front of a CRT.

Reducing operator fatigue.

For our screens, we use a 9x15 character cell, with dot shifting to provide exceptionally clear definition. You don't have to peer at tall, skinny letters. Ours look like the best typewriter printing, with the right spacing and descenders below the line.

By using white characters rather than green, we've made the display brighter and easier to read. (Have you ever tried

watching black and green television?)

Several other screen features simplify an operator's life. Inverse video, optional half-brightness, underline or blinking characters can be used to stress important information, and reduce mistakes in transmission.

Plug-in modules for quick changes.

That's the simplest way of adapting a terminal to your job. So we offer a variety of components that pop in and out.

All our terminals have plug-in character sets to cover a wide range of computer languages. And a plug-in Forms Drawing option lets you generate almost any form your company uses.

Our smartest terminals let you plug in fully integrated mass storage. This takes the form of twin cartridges, each able to store up to 110,000 bytes of data or programs.

You can use this information locally (the terminal's "soft keys" save a lot of time and effort on off-line jobs) or transmit it to your central computer.

Another new terminal, the ultimate "have-it-your-way" design, should be extremely popular with OEMs. You can pick and choose from a variety of hardware modules, and write your own firmware. Everything plugs together for a virtually custom display station.

Some intelligent ideas for smart terminals:

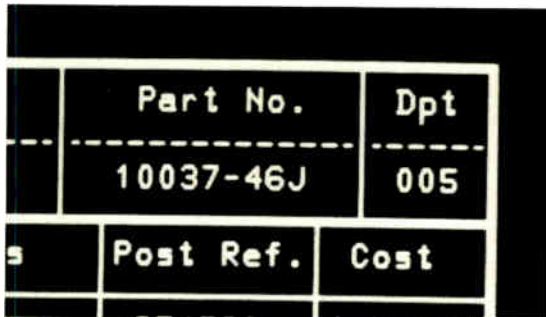

An exceptionally clear display eases long sessions at the CRT. A Forms Mode aids accurate data entry.



Plug-in mass storage: you can get up to 110,000 bytes per cartridge.



The "soft keys" on our smartest terminals let you execute complex operations with a single keystroke and eliminate many repetitive jobs.

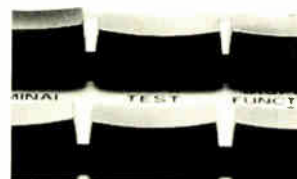

Problems? The self-test key helps pinpoint them for you.

Maintenance is a snap.

Unsnap a couple of catches and our terminal is wide open. The plug-in PC boards are right there. What could be easier for changing options or speeding up repairs by our servicemen?

Not that downtime is a problem. Our terminals have such a good MTBF that we've lowered our maintenance price twice in the past 18 months.

And when you do need service, you've come to the right company. We have more than 700 Customer Engineers ready to



give you support, documentation and training.

So when you're choosing a terminal, think of your people first. Then think of the terminals that are smart enough to be almost human. Your local Hewlett-Packard sales office can give you complete information. Or mail us the coupon and we'll send you the facts.



Smart doesn't have to mean complicated: eight HP terminals that prove the point.

The HP 2640B Interactive Display Terminal. Even our simplest terminal has many intelligent features, including an enhanced high-resolution display, plug-in character sets, dynamically allocated memory, microprocessor control, full editing, self-test, forms mode and more. It's a lot of terminal for the money.

The HP 2640C Cyrillic Display Terminal. This has everything you like about the B version, but it speaks Russian too.

The HP 2640N is fluent in Danish or Norwegian.

The HP 2645S completes our Scandinavian coverage with Swedish or Finnish.

The HP 2645R. Designed for an application in Iraq, this model enters Arabic characters from

right to left. It also works from left to right for standard computer languages.

The HP 2645A Display Station. Our smartest terminal, it can transmit at rates up to 9600 baud, has a forms mode, user definable "soft keys," and optional fully integrated mass storage. A very intelligent choice.



Cyrillic Swedish Arabic

The HP 2641A APL Display Station. This is modeled after the 2645A, but also includes a full 128 character APL set, plus an APL 64 character overstrike set.

The HP 2649A Mainframe Terminal. This data station is ideal for OEMs. It lets you design custom firmware for your special application and pick the hardware modules your system demands. Available with all of the 2645A's advanced features.



I want to know more about HP's terminals.

- Contact me to arrange a demonstration in my office.
- Let me know dates of the HP Terminals Seminar to be held in my area.
- Send me complete information about the following terminals:

Name _____

Company _____

City/State/Zip _____ Phone _____

Mail to: Ed Hayes, Hewlett-Packard, 11000 Wolfe Road, Dept. 603, Cupertino CA 95014

42702HPT3

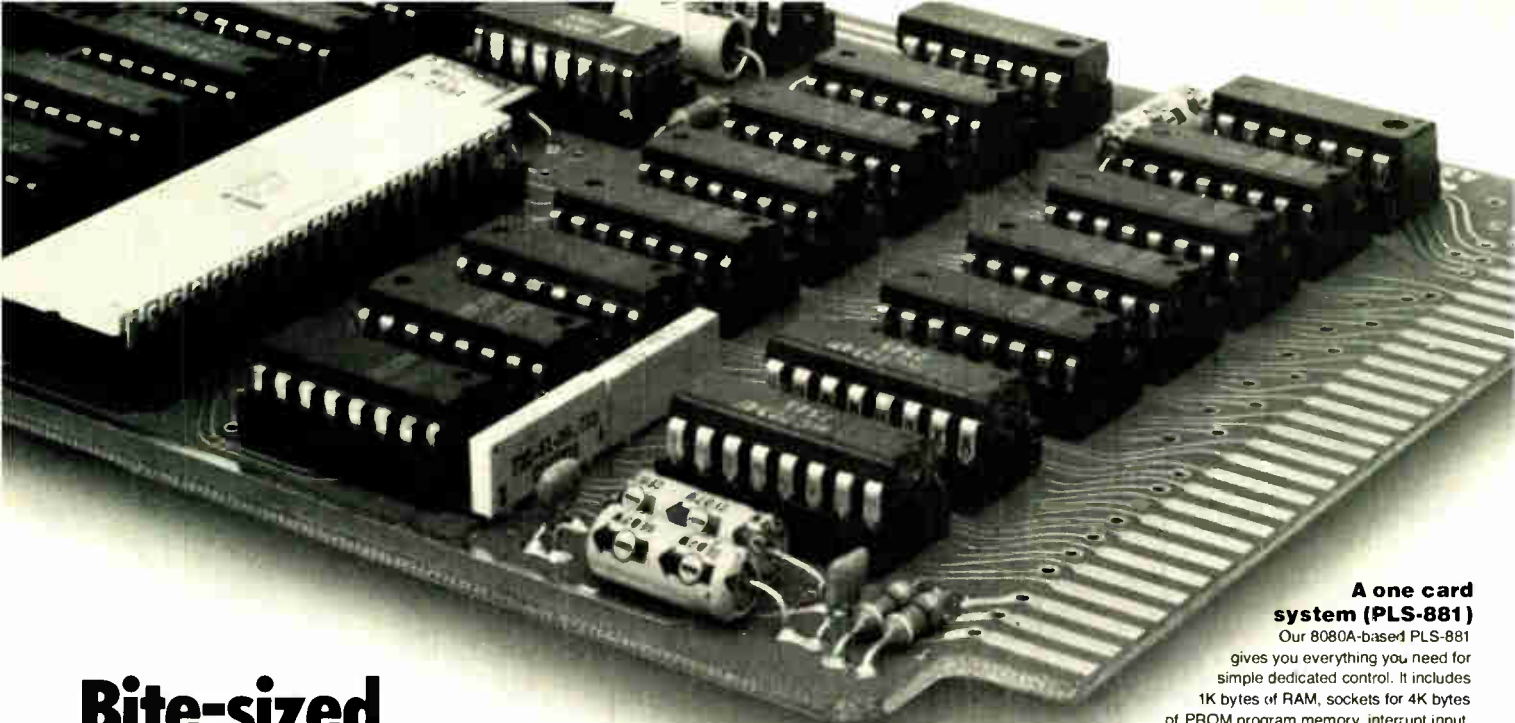

Bite-sized 8080A systems make big boards hard to swallow.

A one card system (PLS-881)

Our 8080A-based PLS-881 gives you everything you need for simple dedicated control. It includes 1K bytes of RAM, sockets for 4K bytes of PROM program memory, interrupt input, crystal clock, power-on and external reset, three 9-bit output ports, and two 8-bit input ports. It costs only \$195 in 100 piece quantities.

Simple, flexible, standardized Pro-Log 8-bit microprocessor systems a best buy for OEM's.

We sell 8080A and 6800 microprocessor cards two ways; as single and multicard systems, or as individual CPU and support cards so you can build a system of your own.

Our cards are all standard 4.5" by 6.5" with 56 pin edge connectors. They fit into standard card racks. To keep you from being tied to a specific semiconductor manufacturer for parts, delivery and pricing, our 8080A and 6800-based systems use only second-sourced parts.

Buy 250 of any particular card and we throw in free its manufacturing and assembly plans and non-exclusive rights to manufacture it, allowing you to build your own hardware, relying on us as an established and dependable second source.

We've got 4-bit systems, instruments, education and literature, too.

4-bit 4040 and 4004 systems; 4- and 8-bit microprocessor system analyzers; PROM programmers; a half-day economics seminar for decision makers; a three-day hands on design course for engineers; manuals and support documentation.

Call or write for data sheets or a free copy of The Microprocessor User's Guide.

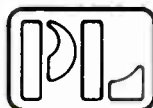

PRO-LOG CORPORATION
2411 Garden Road
Monterey, CA 93940
Telephone (408) 372-4593
TWX 910-360-7082

An expandable plug-in CPU card (8821)

Our "buffered bus" 8821 processor card implements the 8080A as a fully TTL buffered microprocessor. Add one I/O card and it becomes a complete two-card system. Or expand it to use full 8080A memory and I/O capability—it's compatible with all the Pro-Log ROM, RAM and I/O modules shown here plus many more. The 8821 costs only \$190 in 100-piece quantities. We also have equivalent cards implementing the 6800 microprocessor.

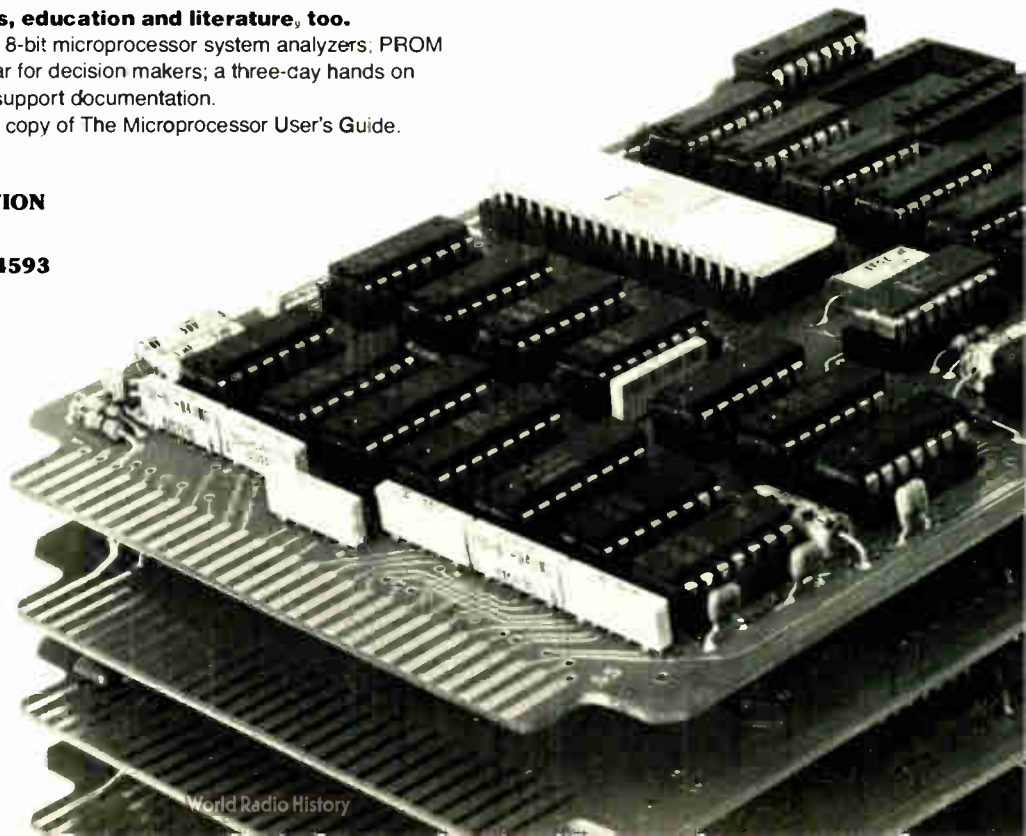

Microprocessor runs military repair system

Interactive display console, floppy-disk mass memories are the key elements in transportable package

From any viewpoint, maintaining complex military electronics systems poses a headache. The contractor has to write and update costly manuals running to thousands of pages, and the services constantly have to train technicians—many reading at sixth-grade level—to fight rapid turnover. Attacking this problem from a new angle, Hughes Aircraft Co.'s Ground Systems group has built a microprocessor-based troubleshooting and repair system that it claims almost anyone can operate with little training.

Called the Technician's Maintenance Information System, it consists of an interactive display console, a 6800 microprocessor, two 256-kilobyte floppy-disk mass memories, and a programmable read-only memory.

"What the system does is replace a trained, experienced technician," says Arthur Harris, head of the development project at the Hughes group, Fullerton, Calif. As he describes it, the system works by storing maintenance data about a specific piece of equipment on the floppy disks, then displaying the proper action when an operator enters a malfunction's symptoms as an English language statement via the keyboard. Depending on the trouble, the console might respond with further queries. In any case, it would narrow down the list of

possible causes to one corrective action.

"Not only can the system pinpoint the failure from answers the technician provides, but it tells him which part needs replacing and pictorially depicts where it is located and how to change it," Harris says. If necessary, the transportable unit will indicate what are the proper tools and test equipment for the job and explain how to use them.

Language. Heart of the system is a hybrid computer language, combining elements of cobol and IBM Assembly Language. It was developed by Hughes to allow managing a large data base with microprocessor architecture. With English as the input language, operators do not have to be trained in programming.

"We tailored it to the lowest possible reading level," Harris says, which is the sixth-grade range. To guard against imprecise phasing and even misspellings of trouble descriptions, the system has algorithms that pick out key words. "It would recognize the word 'transmitter,' even if nothing else were understandable, and give the right response," Harris claims.

The prototype system is built to troubleshoot one of the Hughes radars being evaluated by the Navy for target acquisition on destroyers. The prototype troubleshooter has been demonstrated to all the services and has sparked lively interest, Harris says. "It's not just aimed at replacing maintenance people in the field, but also at simplifying techni-



On the go. With Hughes-built microprocessor-based repair system, faults in complex electronic gear can be diagnosed in the field by relatively unskilled technicians.

Electronics review

cian training and improving parts inventory control."

Although other firms have talked about such a microprocessor-based system, the Hughes unit has reached the hardware stage. The company has had a five-person team working on it for 18 months in the system engineering group of its support equipment section. In large production runs, the system could sell for \$5,000 each, Harris estimates, and would be flexible enough for any kind of electronic equipment. □

Citizens' band

Kit has all parts for 40-channel radio

A 40-channel amplitude-modulated citizens' band radio using a complete kit of parts supplied by a semiconductor maker is going to the Federal Communications Commission this month for type acceptance. The radio, manufactured by Palomar Electronics Corp., Escondido, Calif., was built entirely from a Plessey Semiconductor kit that included all the components—from printed-circuit board to switches—needed to put together the radio, which was also designed by Plessey.

Plessey does not plan to supply the entire kit, which includes non-Plessey parts, to all potential customers. But it is gearing up to give CB makers a kit containing a lot more material—complete details on pc-board layout and detailed lists of actual components needed—than many other vendors supply.

The complete kit will cost \$38 if purchased in 100,000-lot quantities, according to Bill Bradford, manager of CB Radio systems applications at Plessey in Irvine, Calif. "We have done the total design from the ground up," says Bradford. "All the manufacturer has to do is buy the parts we've specified."

His firm's main interest, of course, is getting its integrated circuits into CB sets. Its IC package for the a-m radio includes a SL1610 radio-frequency voltage amplifiers, two

Fluke widens line with digital meter

In a major move to broaden its product line and customer base, John Fluke Manufacturing Co. is going after the service technician and home experimenter with a \$169 portable digital multimeter.

Putting the company for the first time in competition with such multimeter manufacturers as Simpson, Triplet, and Weston, the model 8020A is a 3½-digit meter that uses a liquid-crystal display and is based on a custom complementary metal-oxide-semiconductor chip made for the Mountlake Terrace, Ore., company by Intersil Inc. Because of the lower power consumption possible with the LCDs and C-MOS, the meter runs off an alkaline battery, which will give 200 hours of operation, according to Fluke.

"We hope to get a much broader recognition of the company among customers who may not have heard of us—opening doors for the future," says Fluke president John Zevenbergen. "This is the first time we have had a meter that can be almost totally supported by the person who owns it. Although we specify the calibration period as one year, we feel it will more typically go for three years before it needs recalibration. And with about 100 service locations around the world, we hope to be able to service the meter on the spot if the user brings it



in or to turn it around in 48 hours if he sends it in."

Zevenbergen says that he hopes to sell considerably more 8020As than his most popular DMM, the \$299 8000A bench-top model, which is selling at about 20,000 units a year. "We expect to at least double that," he says.

The new hand-held meter is in a case measuring 7 inches long, 3½ in. wide, and 1½ in. high and weighs 13 ounces. It measures dc voltage to 1,100 volts, ac voltage to 750 V, ac and dc current to 2 amperes, and resistance to 20 megohms. A new feature to the field is its ability to measure conductance directly, allowing resistance measurements up to 10,000 megohms.

SL1641 chips for first and second mixers, three SL1612 intermediate-frequency voltage amplifiers, a SL1624 a-m detector and automatic-gain-control amplifier, a two-chip bipolar synthesizer using a SP8921 and either a SP8922 for binary-channel entry or a SP8923 for binary-coded-decimal channel entry, a SL1626 audio amplifier with over-modulation protection, and a SP1648 voltage-controller oscillator or a SL1610 plus a discrete field-effect-transistor oscillator.

Plessey claims that the a-m radio's performance exceeds all FCC requirements, with a sensitivity of 0.5

microvolts for a 10-decibel signal-to-noise ratio in a 6-kilohertz bandwidth. Adjacent channel selectivity is greater than 65 dB, 10 kHz away, and agc action is excellent over at least a 30-dB change in received transmission, the firm says.

In the works. The company is planning some new ICs for the fourth quarter of this year. Its designers are combining the rf amplifier and first mixer into a single-chip and are putting two of the i-f amplifiers onto another. Other ICs will provide either double- or single-conversion capability, as well as i-f amplification at 455 kHz and audio-derived agc for feed-

forward operation, adjustable squelch and s-meter output drive, and a noise-blanker chip that uses rf or i-f sensing for blanking and has shaped-switching response to eliminate i-f ringing.

Other semiconductor companies are offering ICs for CB radios. But they have not gone as far as Plessey in putting it all together. National Semiconductor Corp., for instance, has a four-chip set but does not include the modulator, rf transmitter chain, and the first mixer and rf amplifier. Toshiba has a similar lineup, and other companies offer selected chips.

Another view. Although these companies pose competition to Plessey's aim of becoming a market leader in supplying all the needed ICs, Texas Instruments Inc.'s recent entry into the CB market [*Electronics*, May 12, p. 31] could change its complexion. Bradford thinks that the automatic clarifier feature of TI's microprocessor-controlled combination a-m and single-sideband radio, which does away with the bothersome task of having to tune in each transmission to achieve intelligible speech, could revolutionize the market.

SSB radios effectively triple the number of talking channels over a-m only. Bradford says that Plessey is busily putting the final touches on their own SSB radio kit and is developing an automatic clarifier circuit that could end up using charge-coupled-device technology.

Industry observers think that TI could crank their sets through its calculator production lines and sell them for \$49.95 if they wanted to. Even at twice that price, the set would be cheaper than most others now on the market, and it offers many extra features to boot. As a result, many CB manufacturers are rushing for help to ready their own IC-implemented SSB radios, which Plessey feels it can supply for about \$55 for the complete radio. □

On target. Aimed to up both resolution and the speed of wafer processing, \$1.5-million electron-beam machine from Japan is due on market next year.

Packaging & production

Electron beam ups wafer throughput

Researchers at Japan's Cooperative Laboratory have come up with an electron-beam fabrication system that completes a pattern in a tenth of the time needed by conventional equipment. The system is one result of Japan's push in VLSI (see report, p. 99).

Compared to other electron-beam systems, says the lab, it is about twice as fast as Bell Laboratories' MEBES and about as fast as IBM's EL-1—based on line widths of 2 micrometers. But, Japanese spokesmen add, the time required by the American units increases as the reciprocal of the resolution squared. Because the Japanese unit has much higher resolution to begin with, it does not incur a time penalty when submicrometer line spacing is required. The new system, using a variable-area rectangular technique that can be used to make integrated-circuit masks or to expose patterns directly on wafers, has fabricated 3-

inch wafers in the lab in 30 minutes to an hour.

It can expose rectangular areas with sides ranging from 1 micrometer to 25 μm , meaning that most features in a cell of an LSI circuit can be fabricated in a single exposure, rather than with many overlapping circles or squares. In one experiment, the mask for a memory cell was completed in 12 exposures rather than the 4,400 dots necessary in conventional systems. Although each individual exposure takes longer with the new system, the overall time is still reduced.

The electron gun in the new system produces a broad beam that a flood lens focuses into uniform density over an area larger than the aperture in the beam-shaping plate. Below this plate, which is perpendicular to the beam, are pairs of beam-shaping deflection plates perpendicular to each other. Below them is the projection lens and then another beam-shaping plate with a square aperture. All lenses in the system are magnetic electron lenses.

The first beam-shaping plate gives the beam a square cross section; the projection lens focuses it so that its area just corresponds to the aperture

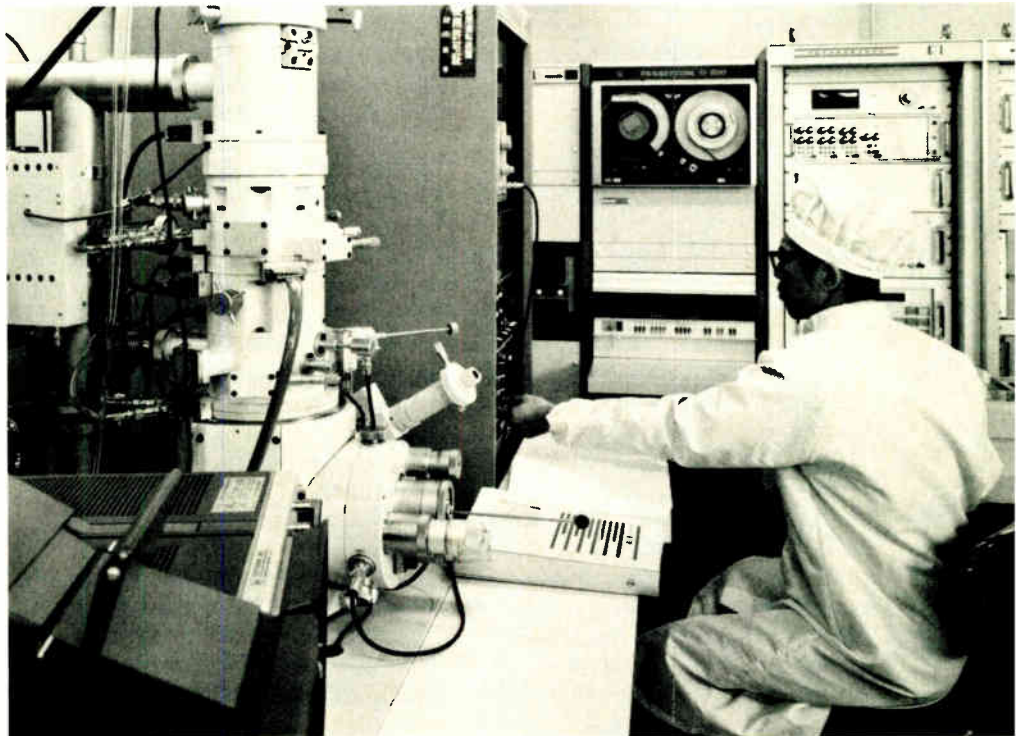

in the second beam-shaping plate. If it is not deflected, the beam merely passes through the second plate unaltered. If it is deflected in only one direction, the square beam becomes a rectangle with the length of its short side decreasing as deflection is increased. Deflection by the other set of beam-shaping plates can shorten the rectangle in the other direction, too.

The shaped beam then passes through a reduction lens, which focuses it on the wafer or mask, and through beam-positioning deflection plates, which position the rectangle on target. The reduction lens serves to make the beam edge sharper than with raster-scan or vector-scan systems.

The initial proposal for the unit was developed by the Institute of Physical and Chemical Research and Fujitsu Ltd. Fabrication was undertaken by JEOL and Fujitsu. Final assembly, adjustment, and experimental operation were done at the Cooperative Laboratory.

The machine, dubbed model JBX-6A, is due on the market in September 1978. Price will be about \$1.5 million. A factory prototype of the system will be ready in three months, according to JEOL. □

Military

Terminal radar upgrades Pershing

The U.S. Army wants to improve the accuracy of its Pershing tactical missile so that it can use nuclear warheads with greatly reduced yields. These would destroy their assigned targets, while doing minimum damage to adjacent areas and civilians.

Toward that end, Martin Marietta Aerospace's Orlando, Fla., division is well along in advanced development of Pershing II, which would replace the aging Ia version of the 400-mile-range missile now deployed in Europe. The chief improvement of Pershing II is a reentry vehicle that uses a newly developed radar for

terminal guidance. The Pershing Ia, has a purely ballistic reentry vehicle.

Martin Marietta's Orlando division is prime contractor for Pershing and has received more than \$65 million for advanced development of the new version. Goodyear Aerospace Corp., Akron, Ohio, is building the radar area correlator, which is being tested in a prototype warhead carried under the wing of an aircraft that simulates the missile's reentry trajectory.

The converted jet fighter has made more than 150 flights, diving at angles between 45° and 90° from altitudes as high as 40,000 feet. While the accuracy improvement over the Pershing Ia achieved in those tests is classified, Martin Marietta's James Bogard is convinced that six flight tests set for this fall aboard a real missile will be successful. Bogard has been manager of the Pershing II captive flight tests, and he says they have met or exceeded the Army's accuracy specifications.

Those tests aboard the fighter are continuing at Huntsville, Ala., after earlier flights at Orlando and at White Sands Missile Range, N. M., where this fall's missile flights will take place. The reentry vehicle is a prototype, but Bogard expects only minor alterations before the missile flights commence.

So far, so good. In the captive tests, an image of the target area is stored in the radar's correlator unit on 35-millimeter film. As the aircraft dives, the Goodyear mapping radar scans about an inertially derived nadir axis to derive video data stored in a flashlight-sized tube called a Correlatron. The radar scans at a mapping rate of 0.5 second, with another 0.5 s required to correlate the radar-derived image in the Correlatron with the stored film image.

The 35-mm film target image is back-lighted and projected to the Correlatron tube, generating an electron image on the photocathode. The two are correlated through electron multiplication, which results in the best match in terms of the X-Y position from the target. Any dis-

agreement between the inertially derived reentry-vehicle position and the correlator-derived position is sent to the reentry vehicle's on-board computer in a digital format.

The computer aboard the Pershing II in actual missile flight tests would then correct any detected navigation errors and generate commands for the vehicle's fin-control system. The control hardware is not used in the captive tests because the reentry vehicle is never launched. But a portable distance-measuring system is being used to determine the accuracy of the combined inertial/correlator subsystem to calculate their position to within 6 meters. □

Microprocessors

Unit diagnoses many 8-bit devices

As a multitude of 8-bit n-channel metal-oxide-semiconductor microcomputer-based systems enters high-volume production, there is a growing need for a powerful, portable diagnostic and maintenance tool designed especially for field servicing of microprocessors.

Intel Corp. is introducing just such a system, designated the model 820 μ -Scope, at the National Computer Conference. The new microprocessor console is portable enough to fit into a large brief case but powerful and adaptable enough for use with any 8-bit microcomputer-based system, says Thomas Jones, product line manager for instrumentation and test systems at Intel.

To date, logic analyzers or microcomputer development systems, such as the Intellec MDS, fitted with special diagnostic modules have frequently been used for field servicing and maintenance of microprocessors. "But the major drawbacks to these partial solutions are expense and lack of portability," Jones says. In addition, many such diagnostic aids do not test in real time or at the normal operating speed of the system under scrutiny. Then, too,

PROVEN PERFORMANCE CRYSTAL CLOCK OSCILLATORS



Motorola's K1100A leads the industry with a crystal clock oscillator that has a proven track record of more than two million units. That's right... over two million oscillators are in use by satisfied, repeat customers.

How versatile is the K1100A? With over 1200 frequencies already designed, and same-day shipment for standard stock frequencies of 4, 4.9152, 5, 10, and 20 MHz, you make the decision.

Oscillators are available from 250 kHz to 70 MHz, $\pm 0.01\%$ stability from 0°C to 70°C , TTL-compatible, and standard +5V dc input.

For full specifications and prices on the oscillator that design engineers trust, write Motorola, Component Products Department, 2553 N. Edgington, Franklin Park, Illinois 60131.
Or call (312) 451-1000, ext. 4183.

It's simple!
Motorola wants to be
your clock company.



MOTOROLA
Communications and Electronics Inc.



Speed. To use μ -Scope to test any microcomputer-based system, service personnel need only remove the microprocessor from its socket and insert the μ -Probe connector in its place.

such systems are designed for specific microcomputers and are not easily adaptable for use with other types.

The Intel 820 μ -Scope is small enough to fit in a 19-by-15.5-by-7-inch carrying case. What's more, when it becomes available in September, it will be priced in single-unit evaluation quantities at under \$2,500, economical even for small-volume users, says Jones.

Outside control. The μ -Scope provides complete real-time control over the microprocessor in the system under test. The user's central processing unit can be forced to halt, single-step, reset, run real time, or run real time with periodic display-data collection, without loading the system or changing its speed while being tested. All tests are conducted at the microcomputer's normal clock rate. Thus, unlike many existing diagnostic aids, the 820 tests the CPU as a part of the total system.

Most important, says Jones, the μ -Scope is intended to work with many of the microprocessors available today through the use of a variety of hand-held μ -Probes. Able to drive a 6-foot cable, each probe plugs directly into the μ -Scope and comes complete with a personality read-only memory, which defines and

interprets control signals specific to each type of microprocessor.

First of the 820 aids will come with a μ -Probe designed for the Intel 8080A CPU. Probes for most of the other microcomputer types now on the market will follow in the next few months.

New board. Key to the power and portability of the Intel 820 is the use of a newly developed single-board maintenance processor built around Intel's new n-channel microcomputer system, the MCS-85 [*Electronics*, May 12, p. 109]. The 8085 CPU and its peripheral circuitry fit on a single 18 $\frac{7}{8}$ -by-15.5-in. board that fits in the bottom of the 820 carrying case.

Also contained on the board are 256 by 32 bits of trace memory, 128 by 8 bits of overlay random-access memory, breakpoint logic that allows execution of a number of different diagnostic operations, and a fully regulated dc power supply.

A front-panel zero-insertion-force socket is provided for mounting 2,048-bit ROMs or programmable ROMs that serve as storage for preprogrammed test subroutines. The actual usable program space of the ROM/PROM is 1,920 bytes. The remaining 128 bytes of storage are

used by the μ -Scope to identify as many as 16 separate subroutines and to define the specific instrument states and conditions under which the subroutine can be called. These 16 subroutines can be used by a particular customer to tailor the 820 for a specific application. □

Standards

Microprocessors hurt Army standardization

The desire in military circles for standardization is running into an unexpected obstacle: the microprocessor. Devices that can emulate 16-bit and 32-bit computers are posing a formidable challenge to the need for standards as the semiconductor industry enhances distributed processing by cramming more capacity onto a chip, including memory, and slashing the cost per bit.

Army-Navy standards advocates are finding their position increasingly difficult as they realize that large-volume commercial and industrial markets—not low-volume military users—now call the shots in microprocessor technology.

These conclusions emerged after two days of intense discussion and disagreement among 132 government and industry participants in the IEEE Computer Society's microprocessor workshop at the end of May. The meeting was cosponsored by the Naval Air Development Center, Johnsville, Pa., and Johns Hopkins University's Applied Physics Laboratory, Laurel, Md.

It was the Control Data Corp.'s 480 family of microprogrammable computers that sparked much of the argument. A subset of the 480 has been chosen as the Navy's first standard airborne computer, the AN/AYK-14 (V), for use on the F-18 air combat fighter now in development at McDonnell Douglas Corp., St. Louis, and the Mark III version of the helicopter called Lamps (for Light Airborne Multipurpose System).

The CDC 480 is using pluggable

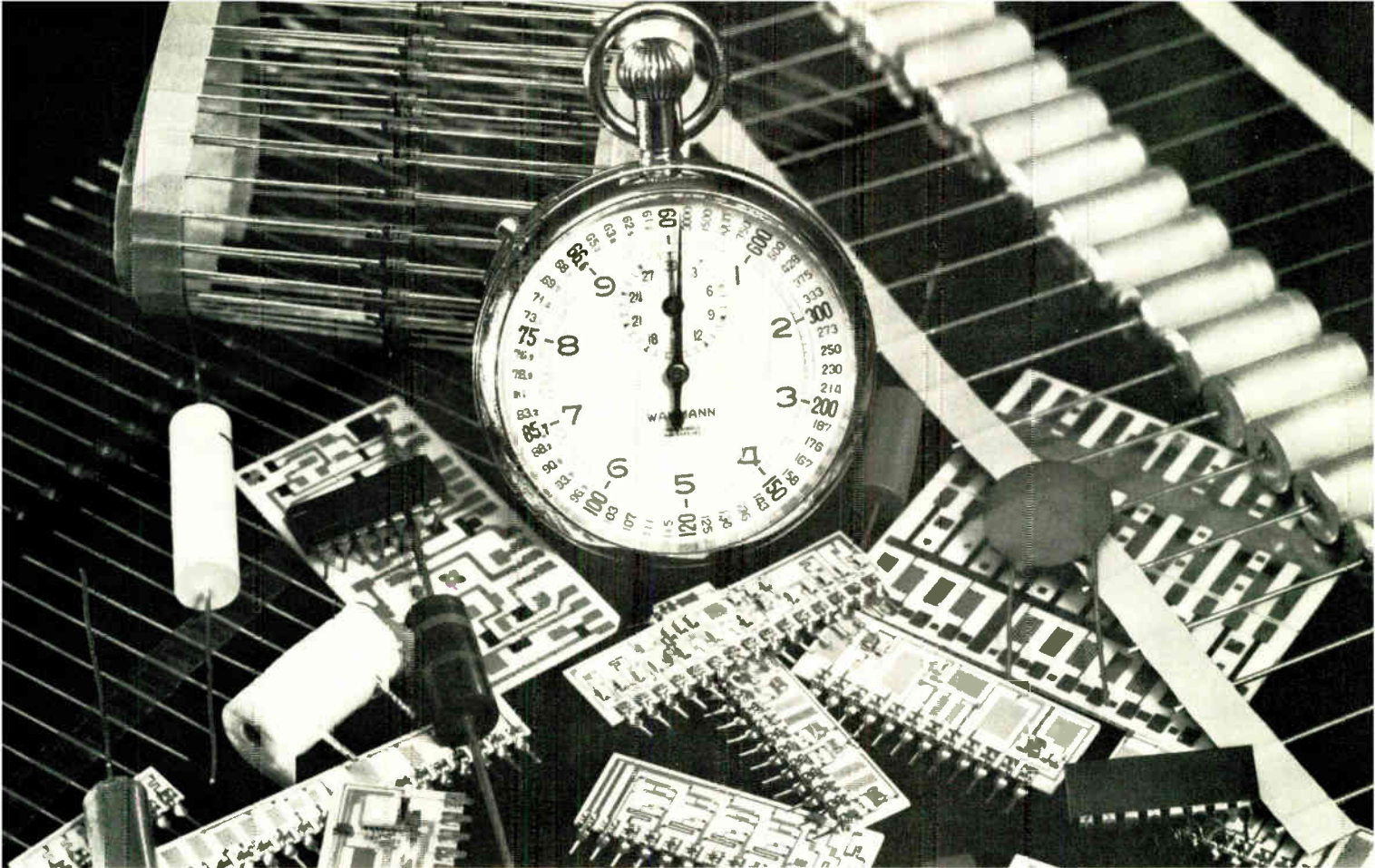

80 tests per second with GenRad's 2230

The GR 2230 is the first computer-controlled network and module tester for under \$20,000. This extremely flexible multifunctional circuit tester increases productivity in both manufacturing and incoming inspection areas. It has total programming flexibility and readily interfaces with handlers and other instrumentation.

The 2230 provides:

- mixed R, L, C and dc measurements with individualized test limits
- point to any other point scanning with Kelvin connections
- simple programming with macro-instruction keyboard
- both Go/No-Go and parameter read-out modes of operation
- quick-disconnect device adaptors for various package styles
- data-logging and data-reduction capabilities with hard-copy output
- ease of interface to automatic device handlers
- computer-controlled speed and accuracy at low cost

The 2230 will test:

- thick- and thin-film hybrid circuits
- discrete components on reels
- sequenced components
- diodes and transistors
- small functional modules/circuits
- D/A and A/D converters
- integrated circuits

Contact us now on your specific application requirements.

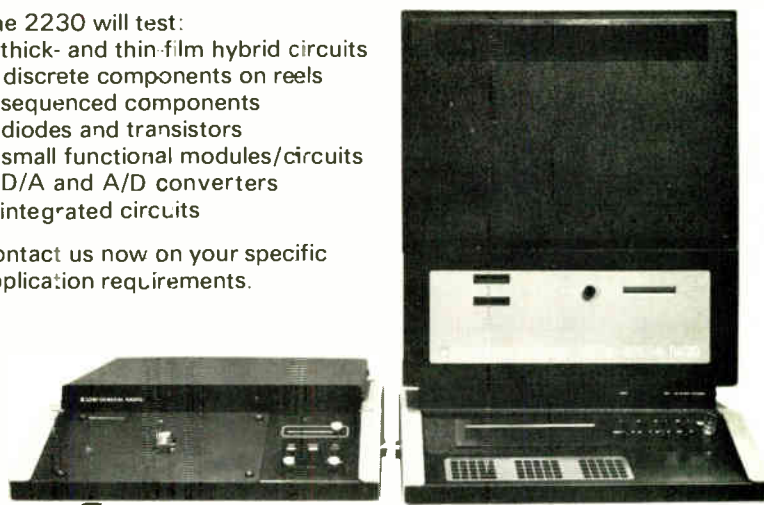

GenRad

6-by-9-inch cards and "can emulate any 16- or 32-bit computer," according to the firm's Will Kenney, with the latter configuration achieved by using two modules in parallel. Configurations range from a two-module dedicated processor to 32-bit, high-speed multiprocessors with 16 modules and as much as 512,000 words of memory, and extensive input-output capability with 256 ports available for each function.

Opposition. The Naval Air Systems Command is pushing hard for microprocessor standardization and expects to develop newer systems for the family of vertical/short take-off and landing aircraft that it wants a decade from now. Yet Navair's standardization concepts are being challenged even within the service.

"All standards become passé in three to five years," observed NADC's William Norr, program chairman. System designers "don't care what is on a chip. They only care about its function" and such physical characteristics as its power requirements and the number of pins, he argued. "A standard interface is okay until it begins to get in the way."

Countering Norr's view was Navair's Bernard Zempolich, who also chairs the Computer Sciences Resources Council, formed last fall by the Naval Material Command. "Standards can be beneficial," Zempolich contended, but only if definitions of terms can be established first. "What is a microprocessor? What is firmware?" Answers to these questions that can be accepted by government and industry need to come first, he said.

Languages. Zempolich, also an advocate of a standard high-order language for Navy computers, disclosed that his council has indicated a preference for the SPL-1 language and has moved it into advanced development for the Navy's interim high-order language over the other candidates: CMS-2M used in the AN/UYSK-20 shipboard tactical system and compatible with an AYK/14, the SMS-2Y in the Navy tactical data system's AN/UYSK-7, Cobol, and Fortran.

But the military's need for a stan-

dard high-order language was also challenged from the floor by questioners who cited the rapid development of small bubble memories. Their ability to permit more distributed processing in subsystems eliminates the need for constant central-processor control and thereby high-order language, they said. A registrant from National Semiconductor Corp. said a high-order language "takes us back to minicomputer dark ages."

Economics. The fact that major semiconductor circuit makers have written off many low-volume military users as a principal influence on design is a matter of economics, according to Joseph Kraeger of Advanced Microdevices Inc., Sunnyvale, Calif. To arouse industry interest in designing circuits with high-order arithmetic functions, a military customer would have to have at least \$50,000 and be ready to order 100,000 devices.

But Raytheon Co.'s Frank Langley advanced the argument that semiconductor makers should not overlook the high-volume market for expendable, air-launched tactical missiles, as he detailed a company study on possible standardization of missile microprocessors. Missiles, like Raytheon's air-to-air Sparrow are bought by the "tens of thousands compared to buys of 400 to 500 planes," he said. □

Components

Current mirror ups bi-FET performance

Look for some strong competition for National Semiconductor Corp. in high-precision bi-FET operational amplifiers from Precision Monolithics Inc., which has primarily been a high-precision linear bipolar house specializing in op amps, comparators, and data converters.

The Santa Clara, Calif., firm is moving aggressively into the mixed-process marketplace by using a new ion-implantation process, by second-sourcing National's LF155/156/157

series of bipolar-field-effect-transistor op amps, and by producing a new, improved second-generation series called the OP-15/16/17. All these bi-FET devices are mixed-process chips, having junction field-effect transistors up front and a bipolar output stage.

Compared with even National's higher-precision A series, the new family, says George Erdi, design engineering manager at Precision Monolithics, has lower bias currents at high temperature—0.9 nanoamperes versus 5 nA at an ambient temperature of 70°C and a fourfold improvement in offset voltage—0.5 millivolt. What's more, it has higher slew rates—16 vs 12 volts per microsecond, typical for the OP-15—and a lower maximum supply current—4 vs 7 milliamperes. Moreover, the die area of 64 by 45 square mils is 20% smaller than comparable standard bi-FET parts, he says.

Cancellation scheme. A significant contributor to the improved performance of PMI's family, particularly in regard to bias currents, says Shelby Givens, staff applications engineer, is a proprietary gate-leakage-current-cancellation scheme used in the FET input stage of these mixed-process devices.

"As a common rule, the input current on most bi-FET-type devices is the leakage current of a FET gate, typically an isolation pocket in which an epi layer extends down to the substrate and vertically to the isolation walls," says Erdi. Approximately 90% of the leakage is from the epitaxial layer to the substrate, and the other 10% is from the gate to the drain of the device. The bias current that results is about 50 mA at a junction temperature of 25°C, doubling every 10°C.

Erdi and his engineers have reduced the amount of leakage by the use of a current-mirroring technique, in which another isolation pocket is fabricated next to the FET gate, with a leakage that is approximately equal in magnitude but opposite in charge. The result is a bias current that increases less than one third as fast with increasing temperature to 150°C. Bias current on the

Making your own Triac switching circuits?

Save time, space and dollars with a switch to IR Crydom solid-state relays.

Your "brainy" logic circuits probably require a "brawny" output power switch. It will pay you to devote your talents to the "brains" and leave the "brawn" to the Crydom power specialists.

When you consider the design time, parts procurement and inventory, assembly costs, quality control, and test procedures needed to build your own circuits, it can become a costly business. Especially when you can buy U.L. Recognized, CSA Certified, high-performance alternatives ready to wire into your system, for the same or less cost from Crydom.

Crydom's solid-state relays are "packaged" answers for microprocessors, minicomputers, instrumentation, machine controls . . . anywhere you need highly reliable logic level switching of power loads from 100 mA to 40 Amps. They are the industry pacesetters, with the advantages



**Series 2 for Heat Sink
or Panel Mount.**
Rated to 8 Amps,
120 Vac or 240 Vac.
Occupies less than
1.0 cubic inch.



Series 3 for PC Board Mount.
Rated to 2 Amps,
120 Vac or 240 Vac
Occupies less than
0.4 cubic inch.



of photo-isolated, zero voltage, RFI-Free switching and complete electrical isolation.

Solid-state power switching is our only business. We're the leaders in the industry with field proven devices in thousands of applications. We produce our relays from the power chip to the finished device. You can count on consistent quality . . . on time . . . everytime. And, we are the only SSR company that provides complete technical data, including specifications for repetitive surge service.

Our power switches are cost-competitive with in-house design and production. Why not contact our rep or send for data to review? It could make your job a lot easier!

International Rectifier Crydom, 1521 East Grand Avenue, El Segundo, California 90245. Phone: (213) 322-4987. TWX 910-348-6283

INTERNATIONAL RECTIFIER



CRYDOM
SOLID-STATE RELAYS

Contact the Crydom Representative near you: Alabama: Birmingham, (205) 823-0897 California: Los Angeles, (213) 387-8283 Santa Clara, (408) 247-1252 Tustin, (714) 832-7282 Colorado: Denver, (303) 751-2600 Connecticut: Ridgefield, (203) 438-3351 Florida: Ft. Lauderdale, (305) 771-6501 Maitland, Altamonte Springs, (305) 831-2097 Illinois: Elk Grove Village, (312) 956-8240 Indiana: Indianapolis, (317) 253-5610 Kansas: Prairie Village, (913) 649-4000 Massachusetts: Burlington, (617) 273-1520 Michigan: Bloomfield Hills, (313) 628-3171 Minnesota: Minneapolis, (612) 884-7471 Missouri: St. Louis, (314) 997-1515 New Jersey: Middletown, (516) 567-5900 New York: Buffalo, (716) 633-7970 Long Island, (516) 567-5900 North Carolina: Raleigh, (919) 828-0575 Ohio: Cleveland, (216) 461-8333 Dayton, (513) 293-3145 Oregon: Portland, (503) 245-2342 Pennsylvania: Ardmore, (215) 649-6300 Tennessee: Shelbyville, (615) 684-4544 Texas: Ft. Worth, (817) 640-9101 Houston, (713) 772-1572 Utah: Salt Lake City, (801) 261-1058 Wisconsin: Milwaukee, (414) 476-2790; OR CALL YOUR IR DISTRIBUTOR.

SCIENCE/SCOPE

Meteorologists will be able to paint a three-dimensional picture of the earth's cloud cover -- and improve long-range weather forecasting -- when a new instrument, aboard geostationary meteorological satellites, is launched around 1980. The instrument, to be built by Santa Barbara Research Center, a Hughes subsidiary, is called VAS (Visible Infrared Spin-Scan Radiometer Atmospheric Sounder).

The VAS will take vertical soundings of the earth's atmosphere, examining the water vapor and carbon dioxide absorption bands, in order to obtain data on temperature and humidity at various altitudes. This vertical profile is then compared to the measured temperature of adjacent cloud tops to determine the altitude of the clouds. By observing the direction and speed of these clouds, meteorologists can determine wind movement at various heights, adding this information to the two-dimensional picture obtained by the earlier VISSRs.

This will be the first time that vertical soundings will be made from a geostationary satellite, so the VAS will provide previously unattainable information on atmospheric circulation patterns, a vital part of weather forecasting.

The invisible fabric that weaves diverse and complex hardware into today's major weapon systems is software, which is the programming of computers within these systems. More than 25 years ago -- that's even before software was called software -- the Hughes initial entry into the specialized technology of software was an airborne, digital, fire-control system for the "Century" series of interceptor aircraft. As systems became more sophisticated to meet growing threats, Hughes software teams were formed with specialists in programming the fire-control systems.

Today, the nearly one thousand team members provide software for such diverse programs as the Navy's AWG-9 fire-control system, the Air Force's F-15 airborne radar, the Army's AN/TPQ-36 and -37 mortar and artillery-locating radars, SURTASS antisubmarine-warfare program, the NATO NADGE air-defense systems, and JTIDS (AN/ARC 191), a joint service program to provide a secure, real-time communication network.

Hughes needs communications-satellite engineers, at all levels of experience, to design and develop advanced digital-communications hardware. There are opportunities in circuit, logic, and unit design for phase-lock loop demodulators and bit synchronizers; spread-spectrum and PSK demodulators; DFT- and FET-hardware design; and microprocessor control design, primarily below 100 MHz. Also openings for micro-electronic design engineers in logic and circuit design and layout of custom CMOS/SOS microcircuits, for high-reliability space applications, advanced CCD memories, signal-processing devices, and tradeoffs of CMOS/SOS, ECL, I²L, PMOS, TTL, CCD, and GaAs technologies. US citizenship and a degree from an accredited institution are required. Please send resume to Don H. Haycock, Hughes Aircraft Company, PO Box 92919, Los Angeles, California 90009. An equal opportunity M/F/HC employer.

Reduced energy consumption and extended equipment life will result from a new facility-management system being developed by Hughes for installation at the Air Force's Arnold Engineering Development Center. The system will monitor and control most of the heating, ventilating, and air-conditioning equipment in the Center's 42 buildings. The system can be programmed to shut down nonessential operations automatically during periods of peak-power requirements.

Data is transferred between remote terminals and a computer-controlled central station via time-division multiplexing. Other functions, such as closed-circuit TV, can be added. It is estimated the system will result in savings of \$200,000 annually in energy and labor costs and will pay for itself in four years.

Creating a new world with electronics

HUGHES

HUGHES AIRCRAFT COMPANY

Electronics review

OP-16, for example, is 11 nA, more than a thirteenfold improvement over present devices, says Erdi.

According to Erdi, if traditional thermal-balancing techniques of circuit design had been used, the additional circuits needed would have resulted in a chip that measured some 10% larger than the present die, and on-chip zeners for trimming to reduce offset voltage by a factor of 4 to 16 would have resulted in an even larger one, says Givens.

In thermal balancing, circuit elements are placed symmetrically around a center line on the die, so that the heat flow from one side balances the other. However, thermal balancing has been used with little thought given to the actual thermal contribution, Erdi says. "As a result, present circuit designs are loosely laid out, with much wasted space."

What PMI engineers have done, he says, is analyze each element in detail. If there is a significant thermal contribution, it is balanced. If not, more consideration is given to saving chip area.

National Semiconductor, not to be outdone, is reportedly redesigning its higher-precision parts to improve the specifications in the same areas PMI has. "But we've got the jump on them as far as the high end of the market is concerned," says Erdi, "and we've still got a few tricks up our sleeves." □

Calculators

National's belated programmable ready

After a half-year slippage, National Semiconductor Corp.'s programmable calculator is about to make its debut. Originally scheduled for Christmas 1976 release [*Electronics*, June 10, 1976, p. 29], the all-semiconductor-memory 7100 has undergone a massive software overhaul. Only awaiting the completion of software programs and documentation it should hit the market within a few weeks.

"Essentially, the hardware was all done. We had a working calculator a year ago," explains Robert Johnson, director of advanced calculator development at the Santa Clara, Calif., firm. "But after much study and playing with the machine we found that the way we had done it really wasn't the best way."

Before the software changes, the 7100 had operated in algebraic-type mode, like the machines of Texas Instruments Inc., but had no hierarchical structure for the operations. Moreover, the method of addressing memories was criticized by potential users as too cumbersome, Johnson says.

Thus, the microprogramming was restructured, and what was supposed to have taken six weeks took six months. Explains Johnson: "The microcoding was a bear—but we think now we've got a really smooth calculator. It handles nicely, it's fully merged, it has algebraic hierarchy, and you can access all the registers easily."

Since the initial description of the 7100 at the Electro76 convention in Boston, little has been changed in the calculator hardware itself. According to Johnson, some additional read-only memory has been added—three 16,384-bit ROMs were replaced by two 32,768-bit units. Aside from slight changes in cosmetics and keys, the calculator is virtually the one announced last year at this time: 240 merged program steps, 32 addressable data-storage registers, and a line of factory-programmed plug-in library cartridges.

Johnson credits the increased smoothness and useability of the machine to a special series of test sessions that National arranged. During them, the calculator was extensively tested by typical users. "In the last stages of microcoding the ROMs, we brought in experts in calculator use to get their reactions and to see if there were things they would like any different," says Johnson. "We took action on nearly every comment that came in."

The calculator boasts some features not found on competitive programmables, such as an in-

For microelectronic circuits and systems

Call Hughes (714) 548-0671

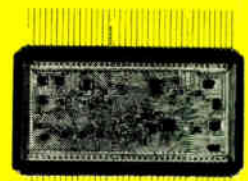

Hybrid Microcircuits—both thick film and thin film



Communications Products: crystal filters and crystal oscillators



B-polar LSI Cell Arrays—interconnection of MSI functions



Microelectronic System: for remote communications/control

We've been solving tough problems in microelectronic circuits and systems for years. Designing, manufacturing, testing—all within one organization specializing in microelectronics technology. That's why you can call on us for answers you need in a hurry—on specs, specials, prices and delivery. For product literature, write 500 Superior Ave., Newport Beach, CA 92663.

HUGHES

HUGHES AIRCRAFT COMPANY

put/output port for which National has big plans—for tying in peripheral equipment and even interfacing to the SC/MP microcomputer line also manufactured by the firm.

With a scheduled price of around \$400—\$100 more than the newest programmable from Texas Instruments, the SR-59 [*Electronics*, May 26, p. 42]—National may be at a price disadvantage. Johnson explains, however, that marketing of the 7100 will follow a whole new strategy. The programmable calculator will be kept apart from National's other consumer products, which include watches, calculators, and other digital items. "Being a semiconductor company, we normally go after the products that are only high volume," he says, "but the 7100 is not a low-end calculator." □

Packaging & production

Plasma processors handle aluminum

Plasma technology is rapidly becoming an important factor in integrated-circuit processing at major U. S. firms, and it was taken a step further last month at Semicon/West 77 with the introduction of the first two machines capable of dry-etching aluminum. With this new capability for dry etching, most of the operations of the "wet room" that processes ICs could be eliminated, thus streamlining production.

A plasma is a highly ionized gas with a nearly equal number of positive and negative ions, plus free radicals. The free radicals are electrically neutral atoms or molecules that can form chemical bonds. These free radicals do the actual etching on the surface of a processed wafer.

Plasma etching was first introduced in the microelectronics industry about five years ago. By now it is commonly used in forming patterns in silicon, silicon oxide, and silicon nitride on wafer surfaces because, unlike acid-based wet etching, plasma etching is dry and safe. Also, it can achieve the finer resolution

News briefs

Arizona highway signs to get solar electric power

The Arizona department of transportation plans to use silicon solar-cell arrays to provide battery-recharging power for 40 signs warning of dust storms on two state highways. The decision follows a successful system demonstration supported by the Energy Research and Development Administration. The solar energy systems used to recharge each sign's batteries will replace propane-fueled, 60-watt generators. While the initial outlay for the system will be high, the agency says that annual operating costs of the signs will be cut nearly in half to \$12,400 by reduced fuel costs and maintenance.

Upgraded Mostek RAM is faster

Even before competitors were able to sample second-source versions of its original 16,384-bit random-access memory, Mostek Corp. began shipping samples of a newer, higher-speed part. Unveiled late last month at the firm's annual users' forum in Dallas, the MK4116-1 is essentially an optical shrink—die size has been reduced from 27,700 square mils to 23,000—but minor design changes make requalification by users necessary. Maximum access time has been cut to 120 nanoseconds from 150 ns, and cycle time is down to 320 ns from 375 ns.

TI to require engineers to use calculators?

Acting on its claim that programmable calculators will enhance productivity, Texas Instruments Inc. is reportedly requiring that all its salaried engineers learn to use them. To carry out the mass training, the firm's Learning Center is setting up a six-hour videotape-and-seminar course. Billed to the employee's profit center, the course comes with a Programmable 59 calculator that the students keep. The recently announced calculator [*Electronics*, May 26, p. 42] accepts 3-inch magnetic program strips as well as plug-in read-only-memory cartridges.

Better polarizers coming for LCDs

The iodine-based polarizers that have been available for use with field-effect liquid-crystal displays have been the major limitation in extending the use of such LCDs to outdoor applications involving extremes of temperature and humidity. After extended exposure to such environments, the H-type iodine-based polarizers have severely darkened as they absorbed moisture. Now, Polaroid Corp., Cambridge, Mass., says it is ready to reintroduce a polarizing material that was withdrawn a couple of years ago for lack of a market. Polaroid is resuming production of its K-type polarizer, which is based on dehydrated polyvinyl alcohol.

Control Data, Yugoslavia sign computer deal

Control Data Corp. of Minneapolis and Iskra ZP, an association of automation and telecommunications equipment producers and marketers in Yugoslavia, have agreed to a 10-year program of business and technical cooperation in the fields of computer-related technology and marketing. The initial agreement calls for cooperative efforts involving the design, development, production, and marketing of minicomputer systems and the purchase of computer peripheral equipment.

Digital Equipment Corp. unveils its lowest-priced computer

A new generation of the PDP-8 minicomputer, this time a large-scale-integrated version with 16,384 words of random-access memory, was introduced late last month by Digital Equipment Corp. The new diskette-based system, named the DECstation 78, is priced at less than \$8,000 for the PDP-8 CPU, a video terminal, and dual floppy disks. Included as standard in the VT78 video data processor are a real-time clock, disk interfaces, and high-speed input-output—features that ordinarily are options on PDP-8s. The Maynard, Mass. minicomputer maker calls the DECstation 78 its lowest-priced computer system.

For that "impossible" crystal filter or oscillator, call the specialist:

Hughes.

If you have one of those "impossible" frequency control device requirements, don't give up. Maybe we can help. Our engineers are used to tough specs. If we can't meet yours as-is, we'll at least give you some interesting alternatives. Or work out some trade-offs that just may not have occurred to you.

Our general operating characteristics (right) will give you an idea of the parameters we work with. They're not inflexible, though. We've bent more than one on different occasions.

We think it will pay you to take advantage of our experience. Maybe you'll find your requirement isn't so "impossible" after all.

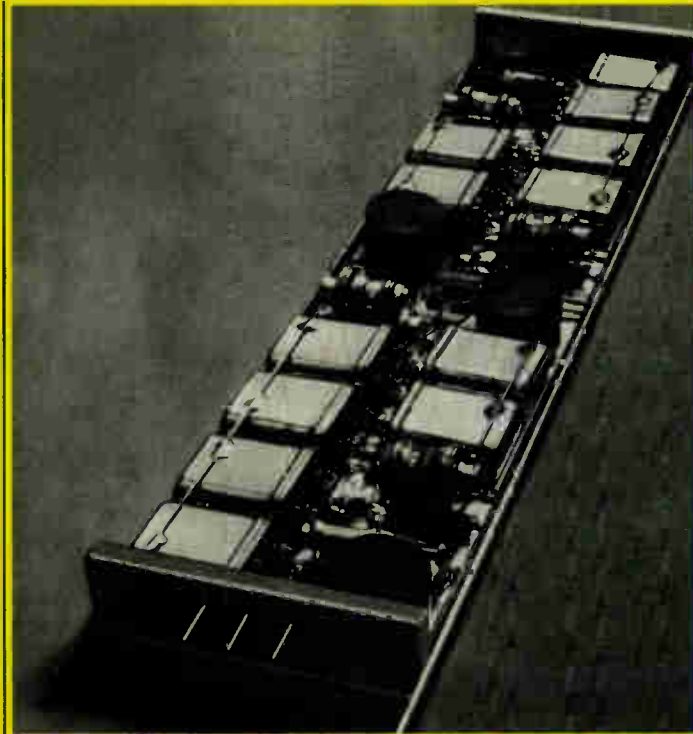

Complex crystal filter shown with typical attenuation and time response characteristics.

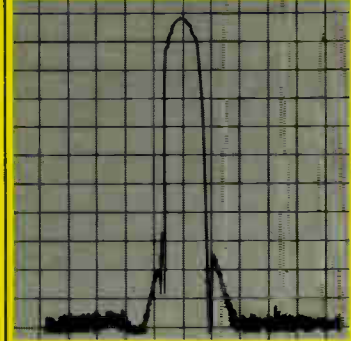

Frequency response

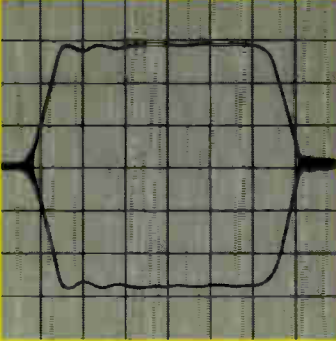

Time response

Crystal Filters

- Bandpass filters—shape factors to 1.15:1 (60 to 3dB)
- Band reject filters—shape factors to 1.5:1 (60 to 3dB)
- Upper sideband filters—shape factors to 1.11:1 (60 to 3dB)
- Lower sideband filters—shape factors to 1.11:1 (60 to 3dB)
- Gaussian (linear phase) filters—shape factors to 5:1 (60 to 3dB)
- Phase (or delay) compensated filters (to ± 1%)—shape factors to 1.15:1 (60 to 3dB)
- Frequency selection: 20 kHz to 125 MHz
- Percent bandwidth range: .005 to 5.0

Discriminators—Frequencies/bandwidths similar to filters

TCXOs

- Computer synthesized selection of components
- Small size, light weight, low power drain, instant warmup
- Frequency range: 1 Hz to 200 MHz
- Frequency stability: ± 1 ppm over -55° to +85°C or ± .1 ppm over 0° to +70°C

TC/VCXOs

- Frequency range to 200 MHz
- Frequency deviation to ± 3000 ppm
- Deviation sensitivity to ± 250 ppm/volt, or as desired
- Linearity to ± 1% of best straight line
- Short term stability to ± 1 ppm/sec.
- Frequency stability: ± 1 ppm over -55° to 85°C or ± .1 ppm over 0° to +70°C

Hybrid Oscillators

- TO-5, TO-8, E-7, DIP configurations
- TTL, CMOS compatible
- Frequency range: 1 Hz to 40 MHz
- Frequency stability: ± 40 ppm over -55° to +125°C
- Capable of meeting MIL-STD-883

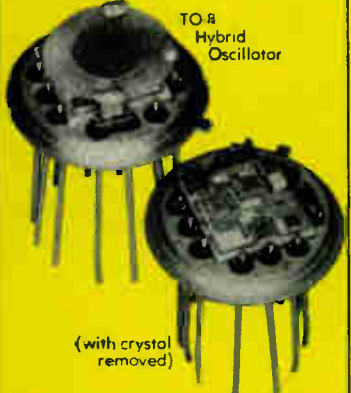

Note: Input voltages from ± 5 VDC to ± 50 VDC are acceptable for all oscillators. Input power, dependent on application, can be as low as 10 mW.

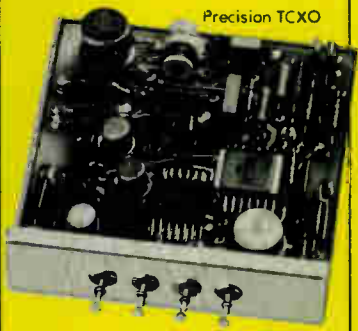

All Hughes' filters, discriminators and oscillators are capable of meeting military, commercial or space-qualified environments. For more information, send for six-page frequency control device brochure describing Hughes' custom and standard product capabilities.

Hughes Aircraft Company, Communication Products Department, Microelectronic Products Division, 500 Superior Avenue, Newport Beach, California 92663. Telephone (714) 548-0671.



In Program After Program, Designers Choose Micro Networks A/D's and D/A's

| | | | | | |
|-----|---------|--------|-------------|---------------|----------|
| F14 | APOLLO | SAS-C | PERSHING II | TRIDENT | AWG10 |
| F15 | MRCA | A6 | SAM D | APOLLO/SOYUZ | ALQ 119 |
| F16 | MARK 30 | A10 | NIMBUS | SPACE SHUTTLE | AQ 98 |
| F18 | CRUISE | DC10 | STD-MISSILE | HARM | GLLB |
| B1 | T38 | AWACS | CONDOR | STD-ARM | LAMPS |
| S3A | PRIDE | ROLAND | PATRIOT | ITADS | TOMAHAWK |



Micro Networks offers more military grade A/D and D/A converters than anyone else in the business. Converters with low calculated failure rates per MIL-HDBK-217B. Converters processed to the rigid requirements of MIL-STD 883 Class B. Converters that are laser trimmed to completely eliminate the need for external components and adjustments. Converters that combine the performance of thin-film hybrid construction with the compactness of dual-in-line packaging. Converters that have been chosen for more than 70 military programs, including every one on this page.

Whatever your requirements, chances are that one of our more than 150 program-proven converters will do the job. Here's just a sample.

| PART # | DESCRIPTION | UNIT PRICE | SPEED | LINEARITY | FAILURE RATE/10 ⁶ HOURS | | PACKAGE |
|-----------|------------------------|------------|---------------|---------------|------------------------------------|--------|------------|
| | | | | | @25°C | @125°C | |
| MN3014H/B | 8 Bit D/A | \$ 58.80 | 1.5 μ Sec | $\pm 1/2$ LSB | 0.323 | 5.51 | 16 PIN DIP |
| MN3850H/B | 12 Bit D/A | \$273.00 | 5 μ Sec | $\pm 1/2$ LSB | 0.517 | 6.43 | 24 PIN DIP |
| MN5120H/B | 8 Bit A/D | \$165.20 | 6 μ Sec | $\pm 1/2$ LSB | 0.823 | 11.61 | 18 PIN DIP |
| MN5210H/B | 12 Bit A/D | \$462.00 | 13 μ Sec | $\pm 1/2$ LSB | 1.183 | 15.99 | 24 PIN DIP |
| MN343H/B | Sample/Hold | \$137.20 | 10 μ Sec | $\pm 0.01\%$ | 0.131 | 2.47 | 14 PIN DIP |
| MN7100H/B | 8 Channel 8 Bit DAS | \$504.00 | 13 μ Sec | $\pm 1/2$ LSB | 1.03 | 17.48 | 32 PIN DIP |

Like what you see? Call or write today for our broad line catalog.



Micro Networks Corporation

324 Clark Street, Worcester, MA 01606, (617) 852-5400 TWX 710-340-0067

Electronics review

needed for upcoming large-scale-integrated designs. Finally, plasma processing creates no pollution problems with its by-products.

Up to now, though, dry etching could not handle the forming of the aluminum interconnects of a processed silicon wafer. But the two new plasma etchers from International Plasma Corp., Hayward, Calif., and D. W. Industries, Sunnyvale, Calif., can dry-etch aluminum as well as silicon oxide and nitride.

IPC's series 5000 costs about \$39,500 and can etch 2,000 angstroms per hour into aluminum on 10 3-inch wafers at a time. The D. W. Industries model 335, priced at \$49,500, etches at the same rate but can process 35 3-in. wafers at once.

Planar reactors. Both of the units use parallel-plate plasma reactors, a departure from the concentric-cylinder, or barrel, reactors used in older equipment. The parallel-plate, also called planar, reactor generates its plasma, and therefore its free radicals, right at the wafer, while the plasma generated in a barrel reactor is generated at the reactor wall. The planar reactor's free radicals thus have a longer lifetime, the key to successful etching of aluminum.

Planar reactors have a number of other benefits, so that other companies are turning to them even without adding aluminum-etching capabilities. For example, planar reactors for depositing silicon nitride were shown at Semicon/West by Applied Materials Inc., Santa Clara, Calif., and Tegall Corp., Richmond, Calif. For one thing, the uniform field of the planar reactor gives much more even etching, and the etching rate versus time is constant rather than increasing, as is typical of barrel reactors. Also, the plates of the planar reactor can easily be water-cooled to provide the stable temperature necessary for uniform etching.

In the future, says Richard Reichelderfer, senior scientist at IPC, planar reactors will have much larger wafer capacities and cassette rather than the present manual wafer loading. □

AIRPAX MAGNETIC CIRCUIT BREAKERS

meet U.L., C.S.A., and
military requirements.



The choice of a protective device for any application involves voltage, current, trip time delay, and short circuit ratings. Such mechanical variables as number of poles, termination, mounting, size, and type of actuation are also involved. Before final selection is made, however, be sure to consider applicable U.L., C.S.A., and military requirements. Chances are that Airpax has the magnetic breaker you need . . .

qualified, recognized, or listed for your specific requirements. **Other Advantages.** Airpax magnetic circuit breakers have accurate trip currents. They are not sensitive to ambient temperatures, can be used as ON-OFF switches, and come in single or multipole packages. Some even have a pilot light in the handle and snap-in mounting.

Full Details Available. For further information on the full line of Airpax circuit breakers, plus U.L., C.S.A., and military listings, request

Short Form Catalog 2013 from your local Airpax representative, or contact Airpax Electronics, Cambridge Division, Cambridge, Maryland 21613.

Phone (301) 228-4600. Telex: 8-7715. TWX: (710) 865-9655. Other factories in Europe and Japan. European Sales Headquarters: Airpax S.A.R.L., 3 Rue de la Haise, 78370 Plaisir, France.

AIRPAX™

THE PRO IN PROTECTION

Circle 45 on reader service card

MOS MEMORY

A 16K RAM BY ANY OTHER NAME WOULD NOT BE A FAIRCHILD.

We understand there's already an industry standard 16K RAM—the 4116.

Okay. We're all for standardization.

You have to start someplace.

But, before you start designing it in, as if there were no other source, we'd like to offer a suggestion: Compare it against our new F16K RAM.

Form, fit and function, you'll find there's no difference.

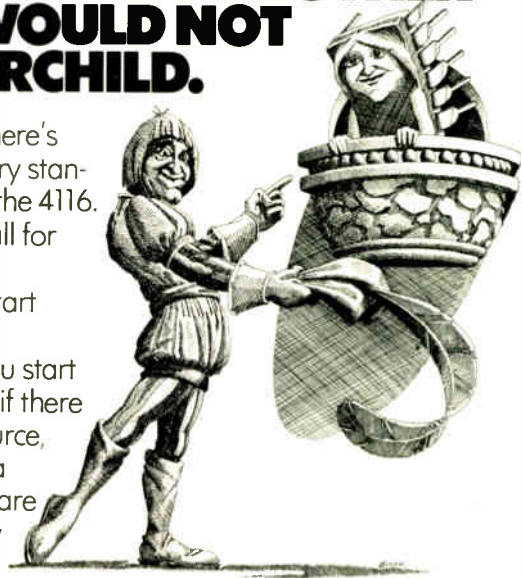

TO THINE OWN SPECS BE TRUE.

We know. You'll need a little proof. So, here's a sample.

The F16K is a 16,384-word by 1-bit MOS RAM.

Random access speed ranges from 150-350ns, with faster access times available in page mode.

Power requirements are low — less than 600 mW. Of course, the outputs are in the standard unlatched configuration. All inputs are

low capacitance and TTL-compatible. The device provides input latches for addresses and data-in, common I/O capability, two-dimensional selection using RAS and CAS, plus flexible timing with Read-Modify-Write, RAS-only Refresh and Page-Mode capability. The F16K also provides 3-state TTL-compatible output data valid to end of cycle. And, it features ± 10 tolerance on all power supplies (+ 12V, + 5V, - 5V). The F16K comes in a standard 16-pin DIP with pinouts and timing suitable for easy upgrade of 4096 on 4027 based systems.

There's more. But we think these specs give you a pretty good idea of the potential cost-effectiveness of our new 16K RAM.

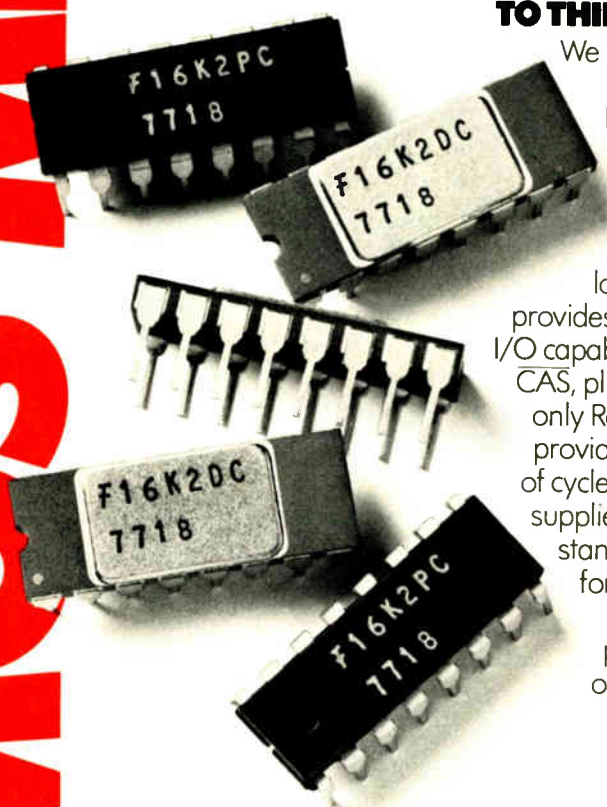

WHAT'S OURS IS YOURS.

At the very moment you are reading this ad, Fairchild is shipping prototype quantities of F16K to eager recipients throughout the industry. (The phone number or address at the bottom of this page will get you prototypes of your very own.) Once you try our new 16K RAM in your system, we know you'll want more. Which gets us to our next point:

When you're ready to order F16Ks in quantity, we'll be ready to ship them in quantity.

MUCH ADO ABOUT SOMETHING.

There are two very good reasons we're confident about our delivery capabilities.

First, we've got a three-year jump on the industry using the Fairchild double poly Isoplanar™ process. The remarkable manufacturing process gives us higher yields resulting in better delivery at lower cost.

Second, we've built another new domestic production plant. It is already turning out devices and is devoted 100% to MOS. Which tells you something about the importance we place on little numbers like our new F16K.

THE NOBLEST RAM OF THEM ALL.

Complete information on our new 16K RAM awaits your request. Use the direct line to our MOS Division at the bottom of this ad. Or call your favorite Fairchild distributor, sales office or office representative today. Fairchild Camera and Instrument Corporation, 464 Ellis Street, Mountain View, California 94042. Tel: (415) 962-3941. TWX: 910-379-6435.

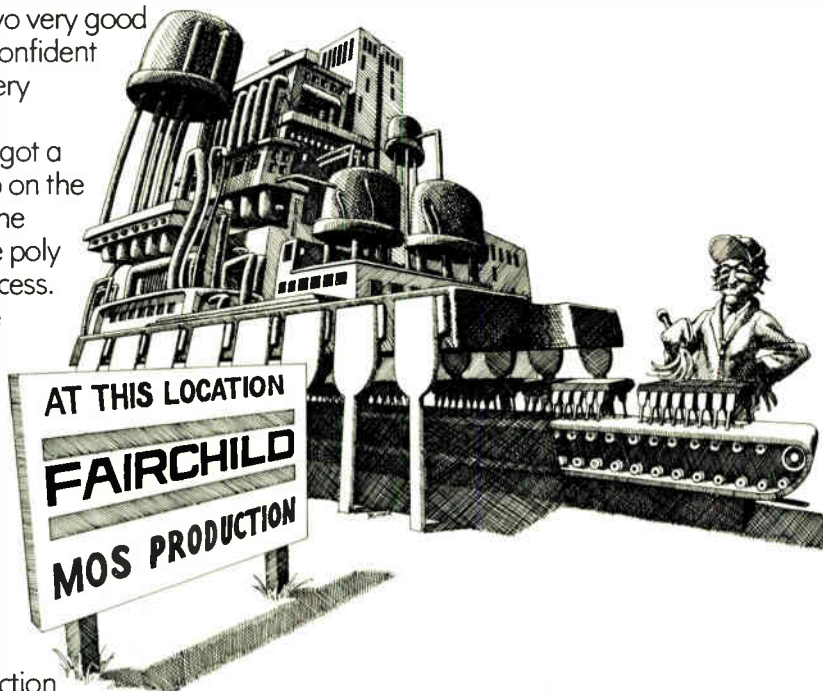

FAIRCHILD

**CALL US ON IT.
(415) 962-3941**

INTERFACE POWER*

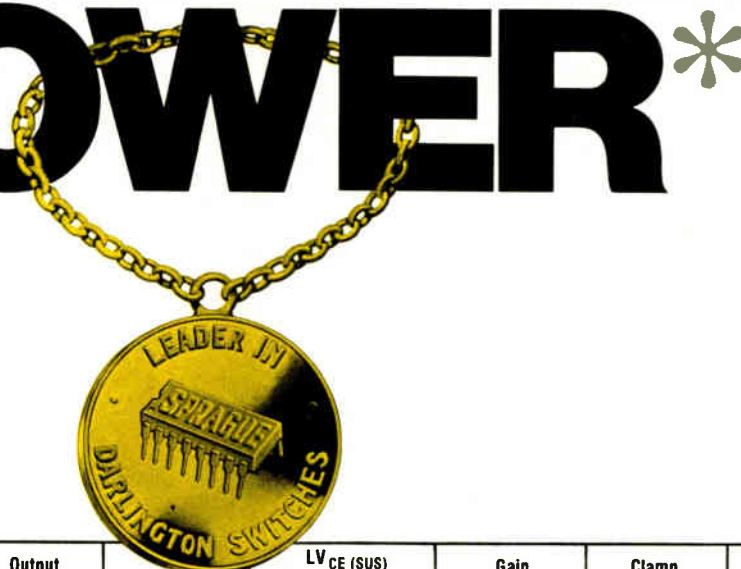

| Device | Input | Drivers per package | Output Current | BV CEX | LV _{CE(SUS)} @ 100 mA | Gain Stages | Clamp Diodes | Package |
|-----------|---------|---------------------|----------------|--------|--------------------------------|-------------|--------------|------------|
| ULN-2061M | TTL | 2 | 1.75A | 50V | 35V | 2 | Yes | 8-pin DIP† |
| ULN-2062M | TTL | 2 | 1.75A | 80V | 50V | 2 | Yes | 8-pin DIP† |
| ULN-2064B | TTL | 4 | 1.75A | 50V | 35V | 2 | Yes | 16-pin DIP |
| ULN-2065B | TTL | 4 | 1.75A | 80V | 50V | 2 | Yes | 16-pin DIP |
| ULN-2066B | MOS | 4 | 1.75A | 50V | 35V | 2 | Yes | 16-pin DIP |
| ULN-2067B | MOS | 4 | 1.75A | 80V | 50V | 2 | Yes | 16-pin DIP |
| ULN-2068B | TTL/MOS | 4 | 1.75A | 50V | 35V | 3 | Yes | 16-pin DIP |
| ULN-2069B | TTL/MOS | 4 | 1.75A | 80V | 50V | 3 | Yes | 16-pin DIP |
| ULN-2070B | MOS | 4 | 1.75A | 50V | 35V | 3 | Yes | 16-pin DIP |
| ULN-2071B | MOS | 4 | 1.75A | 80V | 50V | 3 | Yes | 16-pin DIP |
| ULN-2074B | TTL/MOS | 4 | 1.75A | 50V | 35V | 2 | No | 16-pin DIP |
| ULN-2075B | TTL/MOS | 4 | 1.75A | 80V | 50V | 2 | No | 16-pin DIP |

† Mini-DIP, .375" long

*Only Sprague can supply dual and quad 1.75A, 50/80V Darlington Switches

Sprague Series ULN-2060 and ULN-2070 offer the highest power ratings available. They are 1.75 amp 50/80 volt Darlington switches and have guaranteed LV_{CE(SUS)} minimums of 35/50 volts. No other IC manufacturer offers voltage-current combinations of this magnitude.

A pioneer in both high-current interface and copper alloy DIP lead frames, Sprague possesses extensive experience with plastic DIPs which offer greatly improved thermal characteristics. All quad switches in this series utilize the webbed-pin "B" DIP package. Lower thermal resistance ratings offer

increased device limits, reduced junction temperatures, and improved reliability.

Many high-power interface problems are simplified and solved with Sprague Darlington Switches. Typical uses include interface with solenoids, relays, motors (dc and stepping), LEDs (MUXed numeric or matrix), lamps, and other applications in search of 1.5 A IC hardware.

For complete data, write for Engineering Bulletin 29305A and WR-172 'Quick Guide to Interface Circuits' to: Technical Literature Service, Sprague Electric Co., 35 Marshall St., North Adams, Ma. 01247.

FOR FAST INFORMATION, CALL YOUR NEAREST SPRAGUE SALES OFFICE:

ALABAMA, Sprague Electric Co. 205/883-0520 • ARIZONA, Sprague Electric Co. 602/279-5435 • CALIFORNIA, Sprague Electric Co. 213/649-2600, Wm J. Purdy Co. 415/347-7701, KCE Corp. 714/278-7640 • COLORADO, Wm J. Purdy Co. 303/777-1411 • CONNECTICUT, Sprague Electric Co. 203/261-2551 • DIST. OF COLUMBIA, Sprague Electric Co. (Govt. sales only) 202/244-6006 • FLORIDA, Sprague Electric Co. 305/831-3636 • ILLINOIS, Sprague Electric Co. 312/678-2262 • INDIANA, Sprague Electric Co. 317/253-4247 • MASSACHUSETTS, Sprague Electric Co. 617/899-9100, Sprague Electric Co. 413/664-4411 • MICHIGAN, Sprague Electric Co. 517/787-3934 • MINNESOTA, HMR Inc. 612/920-8200 • MISSOURI, Sprague Electric Co. 314/781-2420 • NEW JERSEY, Sprague Electric Co. 201/696-8200, Sprague Electric Co. 609/795-2299, Trinkle Sales Inc. 609/795-4200 • NEW MEXICO, Wm J. Purdy Co. 505/266-7959 • NEW YORK, Sprague Electric Co. 516/549-4141, Wm. Rutt Inc. 914/698-8600, Sprague Electric Co. 315/437-7311, Mar-Com Associates. 315/437-2843 • NORTH CAROLINA, Electronic Marketing Associates. 919/722-5151 • OHIO, Electronic Salesmasters Inc. 800/362-2616, Sprague Electric Co. 513/278-0781 • PENNSYLVANIA, Sprague Electric Co. 215/467-5252, Trinkle Sales Inc. 215/922-2080 • TEXAS, Sprague Electric Co. 214/235-1256 • VERMONT, Ray Perron & Co. Inc. 617/762-8114 • VIRGINIA, Sprague Electric Co. 703/463-9161 • WASHINGTON, Sprague Electric Co. 206/632-7761 • CANADA (Ontario), Sprague Electric of Canada Ltd. 416/766-6123 • CANADA (Quebec), Sprague Electric of Canada Ltd. 514/683-9220



... and you thought we
only make great capacitors.

Circle 49 on reader service card

Washington newsletter

AT&T plans subsidiary to buy equipment from Independents

Independent telecommunications equipment producers got a boost with the American Telephone & Telegraph Co.'s disclosure to the Federal Communications Commission that it will set up a separate subsidiary for central procurement of products from "non-Bell System manufacturers." The AT&T action was in response to an FCC March 1 order that the company file a plan to insure that its operating companies have autonomy to buy equipment from independent suppliers as well as from Western Electric Co.—AT&T's manufacturing arm.

Thomas E. Bolger, AT&T executive vice president, said the as-yet-unnamed subsidiary will be headed by a chief executive of equal rank to Bell operating company presidents and will take over functions now assigned to Western Electric and to Bell's Purchased Products division. But Bolger said that Bell System companies may still buy equipment separately and that Western "will still be the primary source of telecommunications products" for Bell affiliates because of the cost, performance, and high quality of its products. The subsidiary's size and location are still being determined, but preliminary estimates call for a staff of about 1,300 when the company becomes operational, 12 to 24 months after FCC approval.

Justice Investigates possible antitrust actions by SBS . . .

The Justice Department has hit Satellite Business Systems and its three partners in its domestic digital satellite venture—Comsat General Corp., International Business Machines Corp., and Aetna Life and Casualty Co.—with investigative demands that could be the precursor to an antitrust suit. SBS confirms receipt of the demands for documents to find if there may have been, or may be, antitrust violations in connection with the establishment of SBS and the acquisition of the assets of its predecessors, CML Satellite Corp. and MCI Lockheed Satellite Corp.

Sources say the action reflects the Justice Department's concern with the combination of Comsat General and IBM, two of the potentially largest competitors in the digital communications satellite field. But the inquiry is separate from the antitrust suit against IBM's data-processing activities.

The investigative demand came a week before a Federal appeals court rejected a request by the Justice Department and prospective SBS competitors—including AT&T, Western Electric Co., and American Satellite Corp.—to review the FCC's refusal to reconsider its Feb. 8 approval of the SBS system. The commission ruled that public-interest benefits from rapid establishment of the system outweighed any potential anticompetitive concerns.

. . . but company sees no delay, asks for bids by Aug. 8

Satellite Business Systems says it doesn't expect the Justice Department investigation to obstruct progress on its domestic digital satellite system, and has asked U. S. satellite makers for bids on three 12-to-14-gigahertz spacecraft by Aug. 8 "in order to permit a contract award as soon thereafter as possible." Two of the three satellites are scheduled for launch in the last half of 1980 to begin operation on Jan. 1, 1981. The third will be a spare. The system will operate in a time-division-multiple-access mode linking small customer rooftop terminals for voice, high-speed data, facsimile, and teleconferencing service.

Proposal requests call for satellites with 10 transponder channels each, with each channel having a 42-megahertz bandwidth and an output in excess of 20 watts. The spacecraft may be either spin-stabilized or three-

axis-stabilized, but must carry solar arrays able to generate 1 kilowatt of direct current. Lifetimes must be several years. A request for proposals for the large number of rf ground terminals for the operational system will be issued soon, SBS says.

Airlines digital data, avionics specs coming in July

Watch for new standards defining future avionics packaging and aircraft racking plus a specification for digital data buses to emerge from the July 20–21 session of the Airlines Electronic Engineering Committee in San Francisco. The AEEC will act on the **two proposals for standards to be adopted by Aeronautical Radio Inc.**, Annapolis, Md., the engineering and telecommunications operation of the nation's airlines.

While the avionics packaging proposal will represent an evolutionary improvement of Arinc characteristics 404A, the specification for the system for digital-information transfer will be new. It will cover systems used for inertial reference, attitude and heading, vhf omnidirectional-radio range, instrument landing, air data, vhf communication, and Omega navigation plus radio altimeters, distance-measuring equipment, automatic direction finders, weather radar, and air-traffic-control transponders.

Solar electric craft is sought for 1985 Halley's Comet event

When Halley's Comet approaches the earth around Christmas Day 1985 for its 31st reported sighting since 467 B. C., NASA wants to meet it with a spacecraft using ion engines and powered by the first solar electric propulsion system. The propulsion system proposed by NASA's Marshall Space Flight Center in Huntsville, Ala., would use **reflectors to concentrate solar energy onto silicon solar cells and provide electric power to operate eight ion engines.**

The engines and power processors have been under development and test for several years at NASA's Lewis Research Center in Cleveland. The spacecraft being defined by the Jet Propulsion Laboratory, Pasadena, Calif., would carry a variety of instruments to study the comet's composition, an understanding of which is considered critical to unraveling theories on the origin of the solar system. Included would be an imaging system to transmit pictures to earth and possibly a separate probe to penetrate the comet's tail and approach the nucleus to determine its characteristics. Launch from an orbiting Space Shuttle between March and June 1982 is proposed for the 3½-year journey to the rendezvous point more than 600 million miles from earth. A headquarters decision on the effort is expected by August.

Addenda

Ruth M. Davis, director of the National Bureau of Standards' Institute for Computer Sciences and Technology, is being nominated to become deputy undersecretary of defense for research and advanced technology, **a new post in the Directorate of Defense Research and Engineering.** She will report to William J. Perry, recently confirmed as the new undersecretary for research, engineering, and system acquisitions. He is former president and a founder of ESL Inc. of Sunnyvale, Calif., specialists in reconnaissance and information systems . . . Robert A. Frosch, 49-year-old oceanographer and the Woods Hole Oceanographic Institution's oceanography applications chief, **has been nominated to head NASA,** confirming earlier reports. Frosch was assistant Navy secretary for R&D between 1966 and 1973.

There are two places in Wabash, Indiana with economical, high volume production capability.

Knee's Rabbitry is one. Wabash Transformers is the other. And it's a generally held local opinion that Wabash has got the edge. Not just in sheer numbers—but in variety. While Knee's Rabbitry can produce only two genders of rabbits, Wabash produces literally thousands of different types of transformers.

Not only that—Wabash custom designs their product to precisely suit the application—any type of transformer or high voltage power

supply application. A few where Wabash is a leader are air cleaners, photocopying and VRT equipment.

With their engineering expertise, sophisticated products, automated winding and high volume production capability, Wabash is a standout among the hundreds of transformer manufacturers. But, in turning out sheer numbers, Knee's Rabbitry is pretty stiff competition.

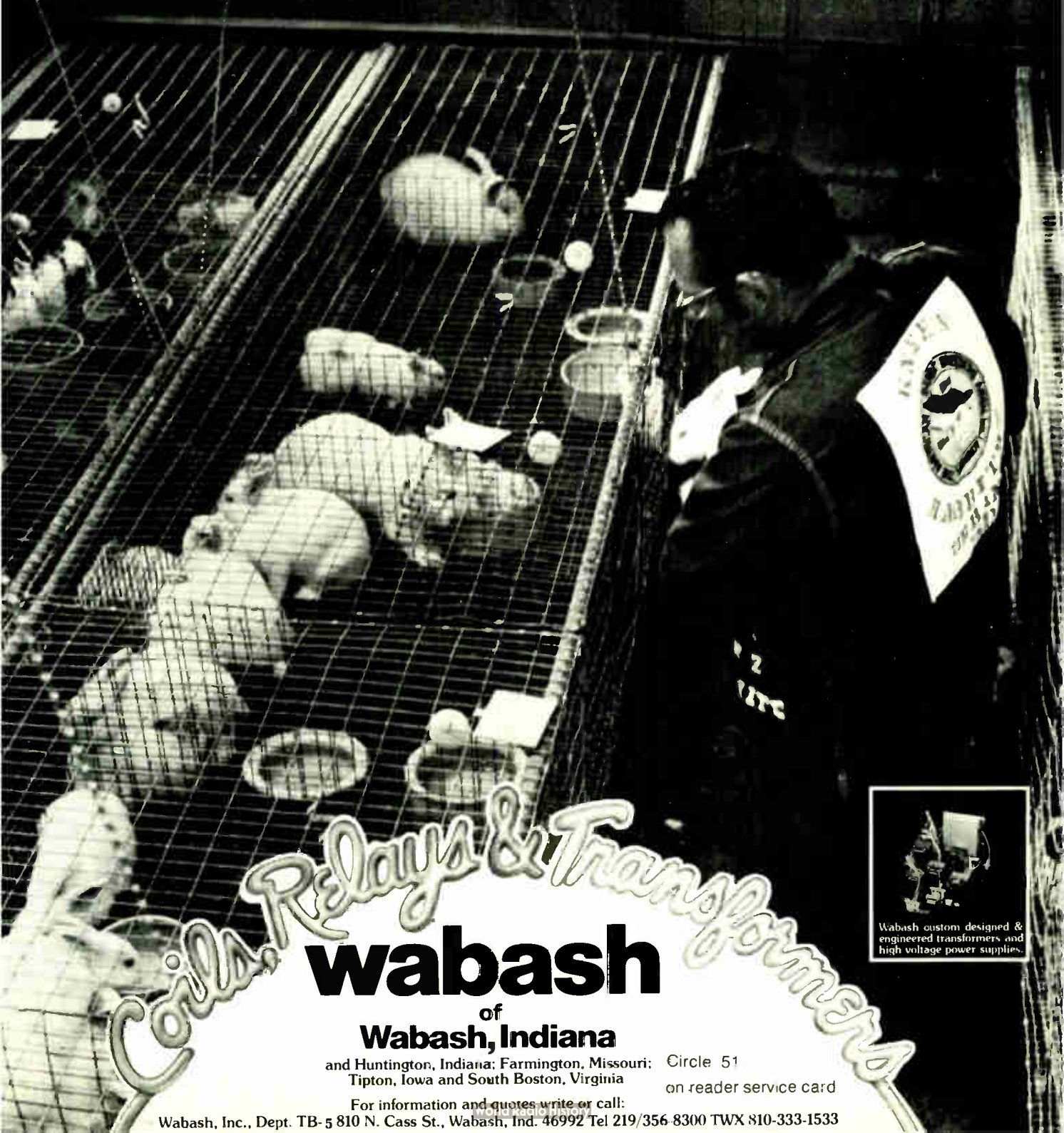

Coils, Relays & Transformers
wabash
of
Wabash, Indiana

and Huntington, Indiana; Farmington, Missouri; Tipton, Iowa and South Boston, Virginia

Circle 51
on reader service card

For information and quotes write or call:

Wabash, Inc., Dept. TB-5 810 N. Cass St., Wabash, Ind. 46992 Tel 219/356-8300 TWX 810-333-1533

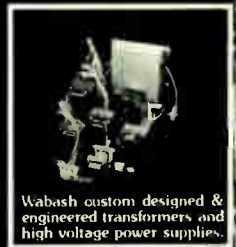

Wabash custom designed & engineered transformers, and high voltage power supplies.

From the people who brought you IDIOM* United States Instrument Rentals introduces...

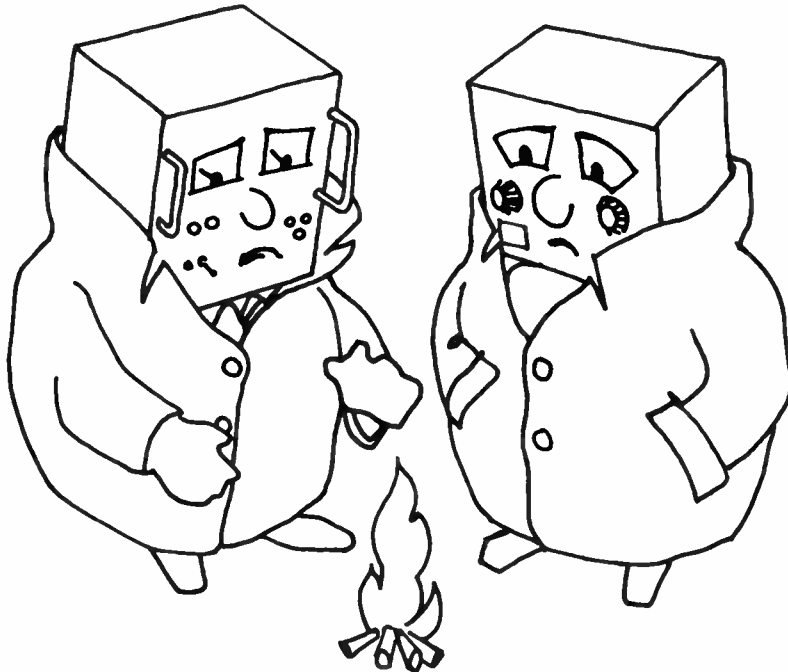

*Inventory Delivery Information in One Minute.

Unemployment Insurance (FOR TEST INSTRUMENTS)

Does it break your heart to see your test instruments just standing around idle while you're kept busy paying for them? Look around on your shelves . . . Are your test instruments not working to their full capacity because you don't need them all the time?

Well, U.S. Instrument Rentals believes that you shouldn't have to worry about paying *or* caring for instruments that are not working for you all the time. USIR feels that your valuable capital should be spent for equipment that can be employed all the time.

So, U.S. Instrument Rentals offers you Unemployment Insurance.

Unemployment Insurance means that by renting your test instruments from USIR only when you need them, you're protected against paying for idle equipment. You pay for our instruments *only* when they are working full-time for you. And when the job

is finished, you simply return the equipment to USIR until you need it again.

In addition, by renting from USIR, you're protected against those expensive calibration, maintenance and repair cost worries. We take care of all our instruments' needs.

And to insure that you get the equipment you need, USIR has thousands and thousands of instruments that are seeking gainful employment, giving you a better chance of finding the instrument that is just right for your needs.

So for a list of instruments you might like to employ and suggestions for solving your test equipment unemployment problems, send for our Unemployment Insurance Booklet . . . The USIR Rental Catalog. It's your best guide to full employment for test instruments.



Headquarters 951 Industrial Road San Carlos, CA 94070 (415) 592-9225



International newsletter _____

Brain scanner with 20-second speed developed in France

The leading French medical-electronics firm, Compagnie Générale de Radiologie, has developed a brain scanner capable of doing an examination in 20 seconds. CGR, a subsidiary of Thomson Brandt, claims its ND 8000 provides flexible treatment of density and size though there is a tradeoff between the two. Objects as small as 1.5 cubic millimeters may be examined; contrasts as fine as 0.2% of the density difference between X rays taken through air and water can be shown. The kit includes a specially developed X-ray tube that CGR says is twice as efficient as current fixed-anode tubes.

British approve Viewdata for market trial

The British Post Office plans to push Viewdata, the interactive data display system, closer to regular service with a \$6.9 million market trial beginning June 19, 1978. For the trial, which will include 1,000 terminals in London, Birmingham, and Norwich, the post office will create a London center using twin GEC 4080 computers and enlarge the present data base at its Martlesham Heath research labs. The trial will let users select from 60,000 "pages" of alphanumeric information for display on decoder-equipped TV sets via their telephones. Meanwhile, this August the West German Post Office plans to exhibit its version of Viewdata at the Berlin International Radio and Television Show using a newly acquired GEC 4080 computer system.

Siliconix challenges Hughes with C-MOS driver chip for LCDs

Hughes Microelectronics Ltd. of Britain won't have the growing European market in C-MOS LSI driver chips for liquid-crystal displays to itself now that Siliconix Ltd. is entering the fray (see Electronics International). Siliconix is shipping small quantities of its DF411 that, like Hughes HLCD 0012, contains all the circuitry needed to drive four LCD digits. Market targets for both low-power chips are large displays for higher-priced clocks, portable instruments, and lower-priced clocks—though Siliconix is concentrating on instruments, medical thermometers, automotive applications, and marine instrumentation.

Japanese printer delivers 10,000 lines per minute

An experimental nonimpact laser system is being developed at Fujitsu Laboratories in Kawasaki, Japan, to print 10,000 lines a minute, at six lines per inch, with a resolution of 10 dots per millimeter. The system uses a helium-cadmium laser with a wavelength that is compatible with the response of the selenium-tellurium coating of the photosensitive drum. A 12-faced polygonal mirror rotates and scans the beam across a parabolic mirror, which reflects the line onto the drum.

IBA shows all-digital TV studio

The coming digital revolution in color television studio techniques is being advanced by Britain's Independent Broadcasting Authority, which recently demonstrated the major components of an experimental all-digital studio to European broadcasting organizations. Claimed to be the world's first, the demonstration studio converted a camera's analog signals for digital vision coding and decoding, vision mixing and switching, video-tape recording, and the generation of the color-bar test signal. However, although the digital tape recording produced faultless half-width color pictures, further work is needed to produce full-width pictures, says IBA.

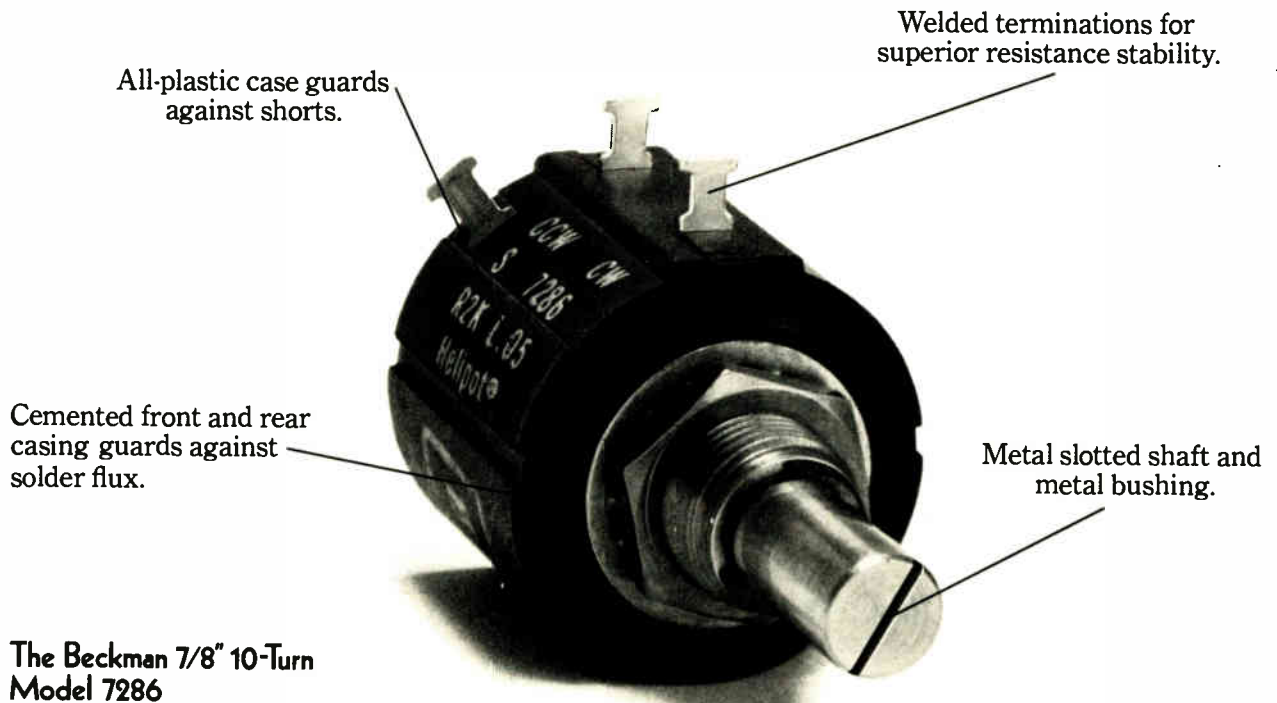

All-plastic case guards against shorts.

Welded terminations for superior resistance stability.

Cemented front and rear casing guards against solder flux.

Metal slotted shaft and metal bushing.

The Beckman 7/8" 10-Turn Model 7286

Pay less for a better-quality precision potentiometer.

Look at more of the specific features of the 100%-inspected Model 7286:

- Operating temperature of 125°C (max).
- Independent linearity well within 0.25%.
- Separate contact position guide to decrease coil wear.
- Power rating: 2 watts at 70°C.
- Resistance range: 11 standard wirewound versions from 100 ohms to 100K ohms.
- Excellent setting stability.

One of the fine Beckman Helipot® family of standard pots, in sizes from 7/8" to 3-5/16". All available in wirewound; many available with conductive plastic, cermet, or hybrid resistance elements.

Available for delivery now. To order, or for more information, call your nearest Beckman Helipot distributor, or call (714) 871-4848, Extension 1776.

And the price: just \$4.68*



BECKMAN®

Doped clear-plastic display collects enough light even when it's dim outside

Liquid-crystal displays passively reflect or transmit the light around them, which may be dim and is generally white. But neither limitation affects a new liquid-crystal display from West Germany that uses fluorescent plexiglass as its light source.

The plexiglass can make the liquid crystal glow as bright as any light-emitting diode, in any color in the green to red part of the spectrum, without adding to the new display's low power requirements, say its developers at the Institute for Applied Solid State Physics, which is in Freiburg.

Called FLAD (for fluorescence-activated display), the display is in a prototype phase at Siemens AG in Munich and could go into production during the fourth quarter if customers like it, says Hans Krüger, project manager for liquid-crystal displays.

Start with time. Initially, FLAD will be made for digital timepieces like tabletop, wall, and alarm clocks, which could then be driven by battery instead of needing line voltage, Krüger points out. Other applications being considered for the new display include portable test and measuring instruments, pocket calculators, scales, and gasoline pumps.

FLAD's brightness depends on the ambient light that strikes it. This light enters the plexiglass, which has been doped during its manufacture with fluorescent organic molecules that belong to the fluorescein class and are similar to those used in liquid-dye lasers.

The color of the light produced by the display depends upon the dopant's composition. However, the light can only leave the display through the segments that make up the display's symbols, as shown in the figure.

Sandwich of brightness. Siemens uses a twisted nematic type of liquid

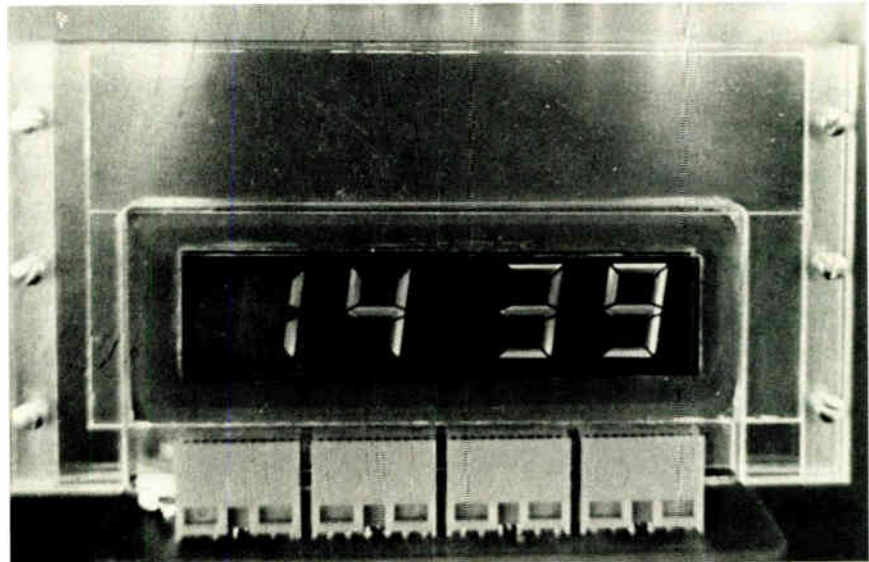

Doing its job. The Siemens FLAD can glow in any color in the red to green part of the spectrum without using more power.

crystal that is sandwiched between two polarization foils. As in an ordinary liquid-crystal display, light is transmitted through the display when a voltage is applied to the number segments.

The back of the fluorescent plate has V-shaped grooves, placed directly in line with the electrode segments of the display. The grooves' walls are covered with a metallic reflective coating, and a similar coating covers the plate's two ends. On the front of the plate, directly opposite the grooves, are layers of light-scattering material.

In operation, ambient light absorbed in the plate excites the organic molecules. The resulting fluorescent light is trapped within the plate, for the most part, but some of it does emerge directly through the display segments.

This is augmented by ambient light striking the grooves and bouncing back from their shiny walls toward the plate's front, and then through the light-scattering layers. From that point, the light passes

through the electrode segments to the observer's eye.

The symbols appear bright against a dark background. The light-scattering layers serve to increase the angle of observation.

The FLAD, Krüger says, collects enough outside light for operation even under dim ambient light conditions. For operation in complete darkness—as alarm clocks need to—a small light-emitting diode would be used to couple light into the fluorescent plate. The diode would connect to the same voltage supply employed for the LCD's electrode segments. □

Great Britain

Hughes plans C-MOS for LCDs

As European demand for liquid-crystal displays in clocks and instruments begins to pick up, Hughes Microelectronics Ltd. thinks it is time to turn to low-power complementary-metal-oxide-semiconductor, large-scale-integrated cir-

cuits, The company is introducing a four-digit decoder-display chip, completing an alarm clock chip, and planning to unveil a comparator chip with memory later this year to replace mechanical timers.

Next year's European market for LSI display chips alone could reach 50,000, depending on how soon the decorator clock market takes off, estimates Derrick Harding, marketing manager. If that stimulates further LCD business in instruments and low-cost alarm clocks, then he has a crack at 150,000 sets with two or three of the chips apiece, depending on the application.

Harding could be right, according to David Turner, optical-product marketing manager, Optical Equipment division, ITT Components Group Europe. Turner expects to be producing 1,000 LCDs a week by the end of the year, many of them 0.5-inch, four-digit units. That figure should rise to 5,000 a week when a new production line cranks up early next year, he declares.

Other firms are eyeing the market. Rank Optics in Britain plans to convert from pilot to volume production, according to Roy Lewis, a Rank research manager.

So far, the only other company active in the European market, which should total "hundreds of thousands" of displays next year, is Hamlin in the U.S., says Turner. But he acknowledges that other LCD module makers, such as American Microsystems Inc., Beckman Instruments, Motorola Semiconductor, and Siemens AG, could move in. Both Turner and Lewis admit, however, that the market is a classic chicken-and-egg situation among clock and instrument manufacturers, display suppliers, and chip makers like Hughes.

Meanwhile, Hughes is poised to exploit its versatile C-MOS chips not only for battery-powered instruments and clocks but also for other low-powered timing functions, such as domestic heating controls, Harding says.

In the display circuit, for example, besides drawing many times less current, "C-MOS produces better

waveforms for LCDs than p-MOS," explains Richard Morcom, senior electronics engineer. Also, "no other chip takes the BCD input and actually decodes it on chip," he says. This means that it is "the only chip that can drive the whole display—all four digits—from only one driver."

Called the HLCD 0012, the versatile circuit can handle inputs from either a timer or a digital voltmeter. Basically a series of latches and a decoder, the chip also has three extra drivers for a.m., p.m., and decimal point, an on-chip oscillator providing

the ac signal for direct drive to the LCD—important for long life—and zero detection and blanking of the first digit of the display.

To boost the market, Harding says, the display chip could be sold separately for about \$1.50 versus about \$4 in its 40-pin package. Further, he figures that that chip, the alarm clock chip, quartz crystal, and trimming capacitor could be mounted on a printed-circuit board at low cost. Eventually, such chips could be bonded into the back of the display as well, he says. □

France

Components makers to get \$120 million in French government's 5-year plan

The French government has finally disclosed its \$120 million, 5-year plan to bolster its electronics components industry. The state will pump the money into integrated-circuit research and development, which it hopes will spin off benefits for other sectors of the French electronics industries.

But the cash is only part of the total package. French policy is also clearly shifting toward collaboration with foreign firms—at least if they are willing to come to terms with French wishes to have development and production on home soil.

Government aid for components makers is not a new idea in France. In fact, there was a components plan as long ago as the mid-sixties. However, the present plan adds two newly important areas.

First, government and industry have seen the growing danger of foreign firms' grabbing bigger and bigger pieces from French electronics firms. Those firms traditionally have made a lot of their money from the discrete components in their finished products. But, with increasing integration, that source of revenue has been slipping away. The other potential problem is that French firms may not satisfy the growing demand for custom-built circuits; rather, they may be inter-

ested only in high-volume standard circuits.

The government admits that it would be "unrealistic to hope to set up over the next few years a French group which could compete with the world leaders." It believes that the best it can hope for is that most circuits bought by French companies will be produced on French soil.

It expects to achieve this by encouraging research centers in France. These, says the government, may be French- or foreign-financed, "as long as their work is directed toward production on national territory." Also, the government believes that one of the major directions might be toward very large-scale integration.

User companies will be encouraged to develop in-house capabilities for circuit design, and the government hopes to see agreements between users and suppliers of custom-built circuits for the study, development, and supply of special-purpose ICs.

While the government's new plans will be a welcome boost for the components industries, the proposed \$120 million, at \$24 million a year, will only be doubling the present state spending. And it is less than provided in a German plan to spend \$30 million a year. □

NEW

FROM LAMBDA

**7 low cost power supplies for OEM,
Industrial and Military applications**

LN-P Pkg.
up to 22A
up to 28V

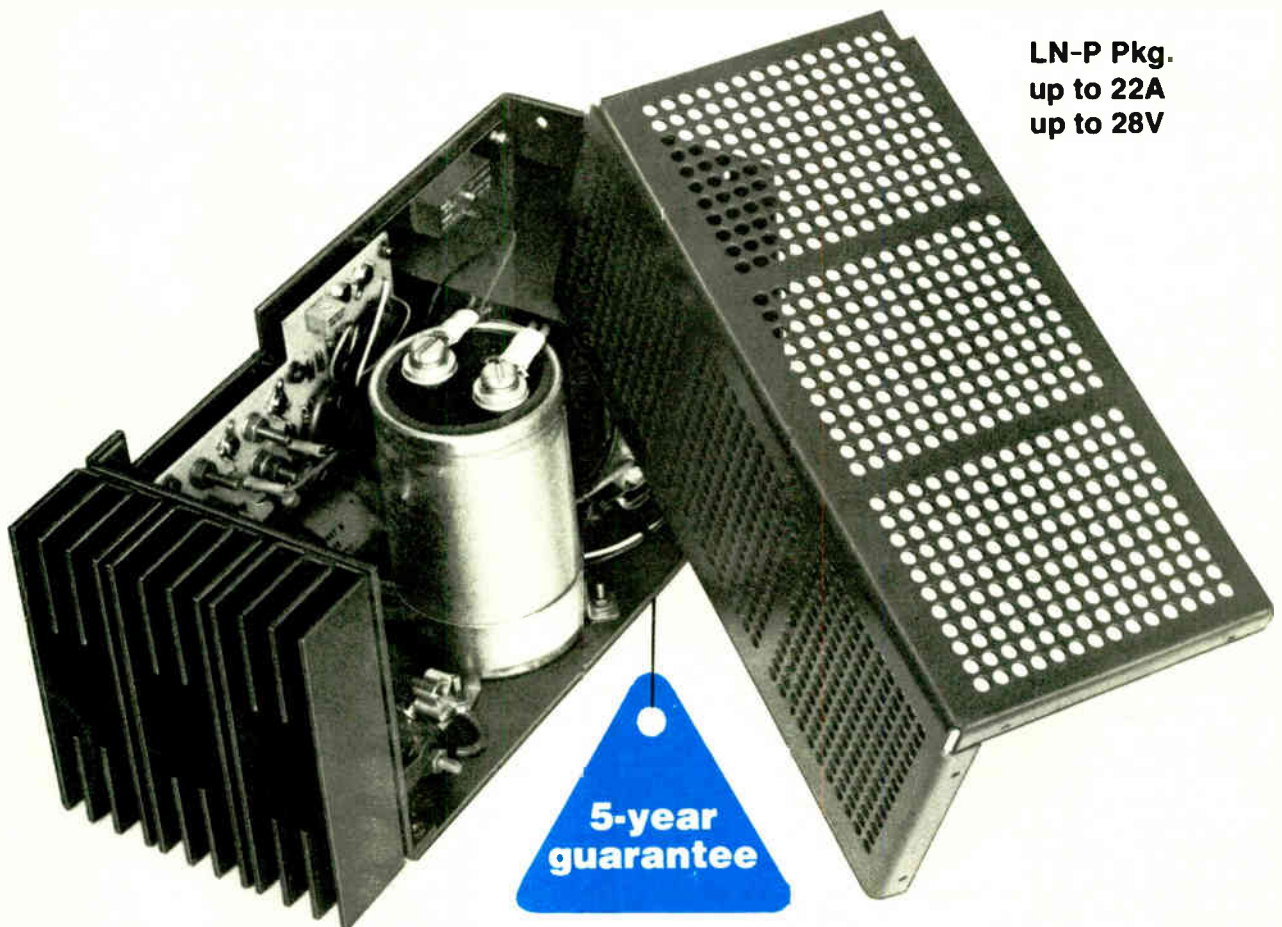

**Lambda LN Series Power Supplies
have been tested and meet
all these MIL STD-810C Requirements**

- | | |
|---|--|
| • Low Temperature . . . Method 502.1 Procedure I | • Vibration Method 514.2 Procedure X, XI |
| • High Temperature . . . Method 501.1 Procedure I & II | • Shock Method 516.2 Procedure I |
| • Low Pressure Method 500.1 Procedure I | • Temperature Shock . Method 503.0 Procedure I |
| • Humidity Method 507.1 Procedure I & II | • Fungus Method 508.1 Procedure I |
| • Temperature - Altitude Method 502.1 Procedure I Class 2 (0°C operating) | |

LN series power su OEM, industrial and

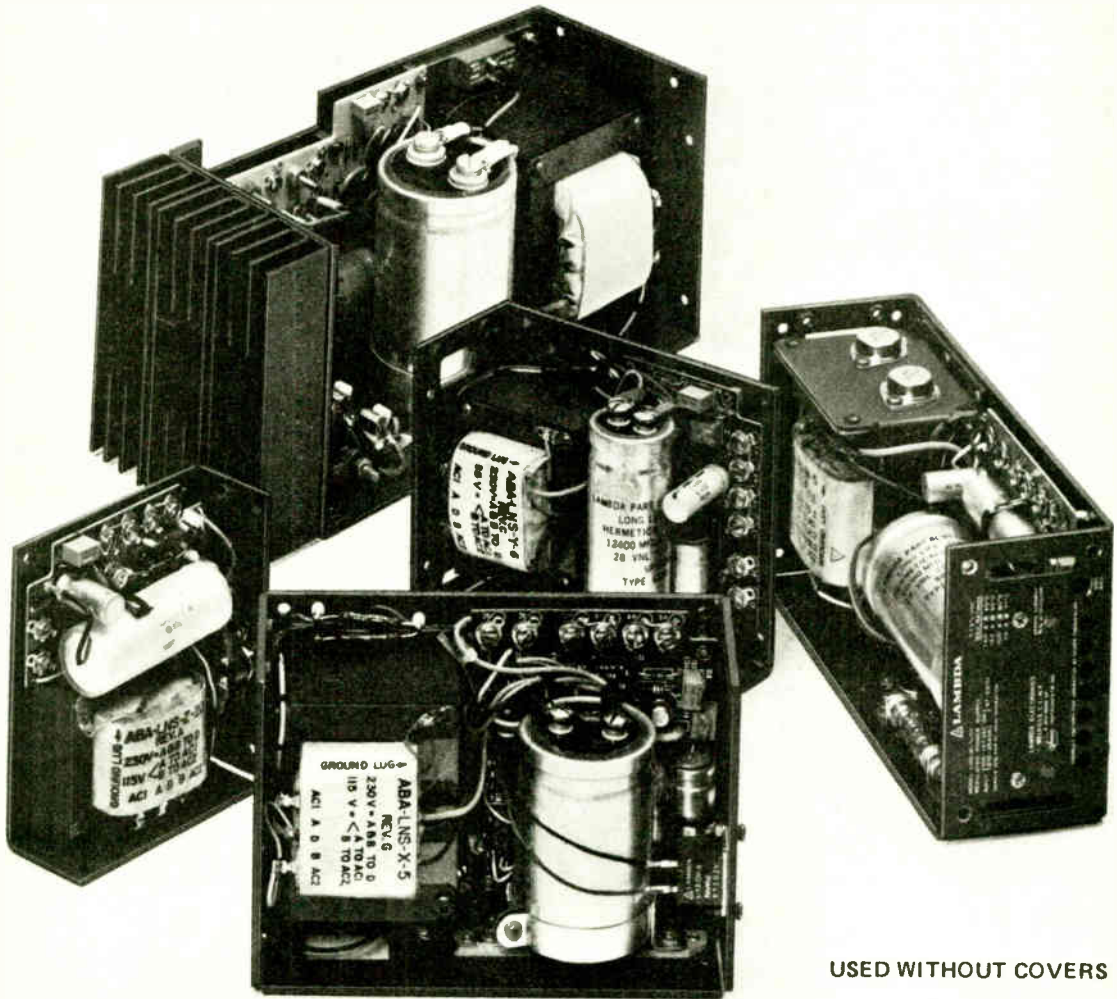

USED WITHOUT COVERS

5 Package Sizes, 40 Models

Single, Dual, — mpu compatible models
up to 28 volts
up to 22 amps

Dual Input

105-127 VAC, 47-440 Hz,
210-254 VAC, 47-440 Hz

Regulation

line and load — 0.1%

Ripple and Noise

1.5 mV rms, 5mV pk-pk

Tested and Meets Mil Environmental Spec.

MIL-STD-810B
MIL-I-6181D

Fungus Proof

No fungus nutrient material used

New Monolithic and Hybrid OV

overvoltage protection standard
on 5V models — available as
an option on other models

and guaran

plies designed for military applications

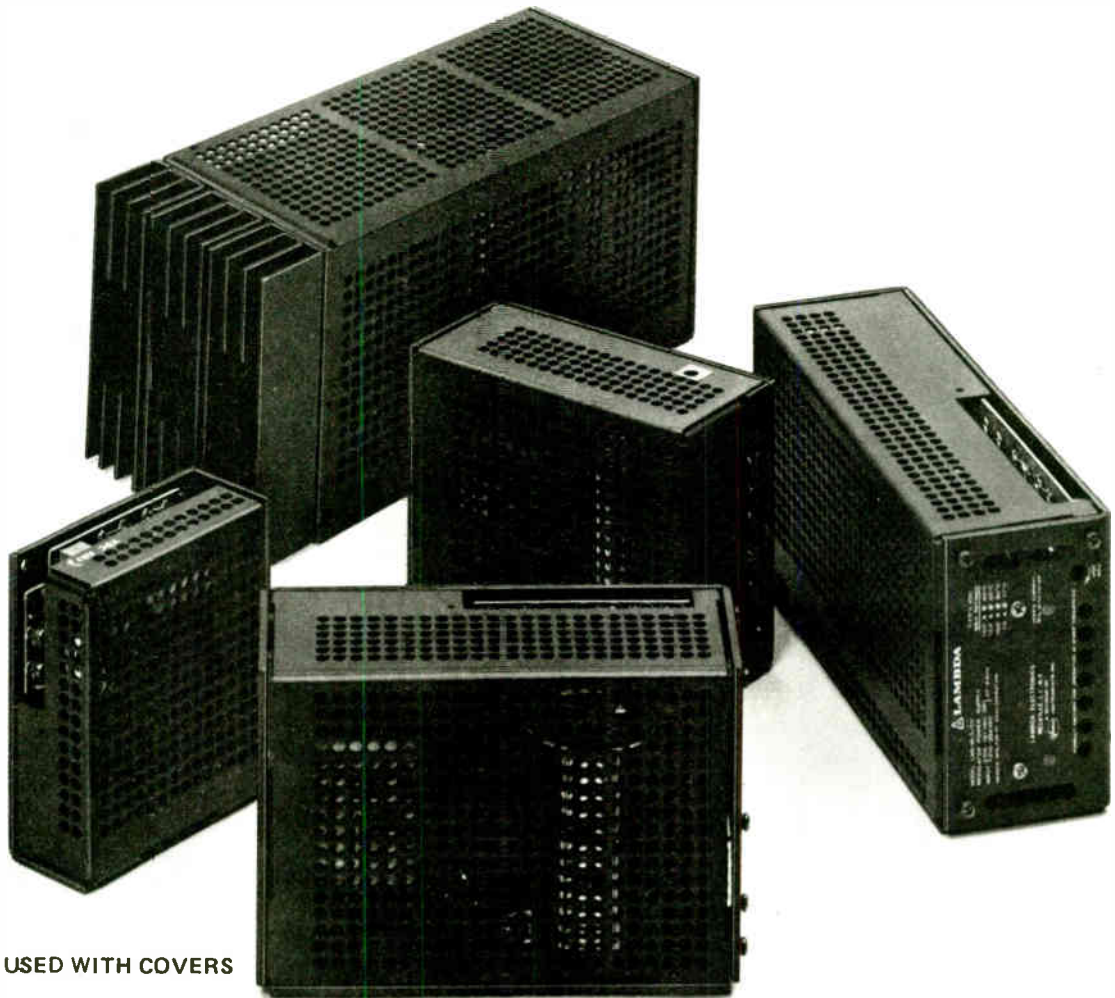

USED WITH COVERS

**Designed for Listing in
UL Recognized Component
Index**

**Designed to Meet
VDE Specs.**

Isolation Resistance
10 Meg ohms

Isolation Voltage
input to output — 4000V

**Thermally Engineered
Ventilation Holes**

Convection Cooled
no external heatsinks or
blowers necessary

Mounting
3 positions
3 surfaces

Shipped Complete with Cover
can be used with and
without cover, depending
on your application

teed 5 years

Lambda I designed for min

△ LAMBDA

MIL-T-27C

Grade 6 Transformer

layer-wound with electrostatic shield

MIL-W-16878 Wire

△ LAMBDA

**Perforated 0.075 inch
Thick Steel Cover**

Thermostat - automatically
resets when overtemperature
condition is eliminated

Sprague 602D high temperature,
premium computer grade hermetically
sealed electrolytic capacitor

△ LAMBDA

LAS-1100

monolithic voltage
regulator (TO-96)

Sprague 601D, 672D

high temperature, long life
electrolytic capacitors

△ LAMBDA

CC4®* Printed Circuit Board

plated thru-holes
fungus inert, flame retardant

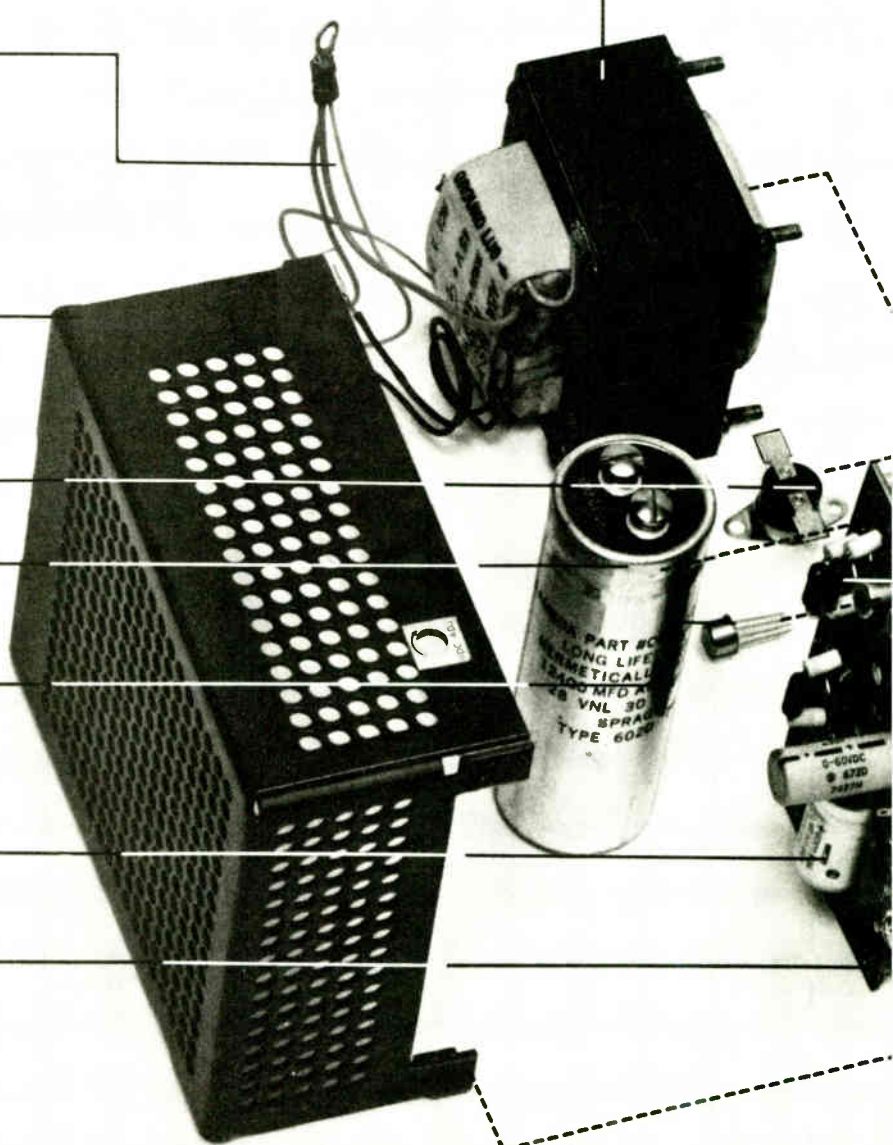

.N Series Minimum repair time

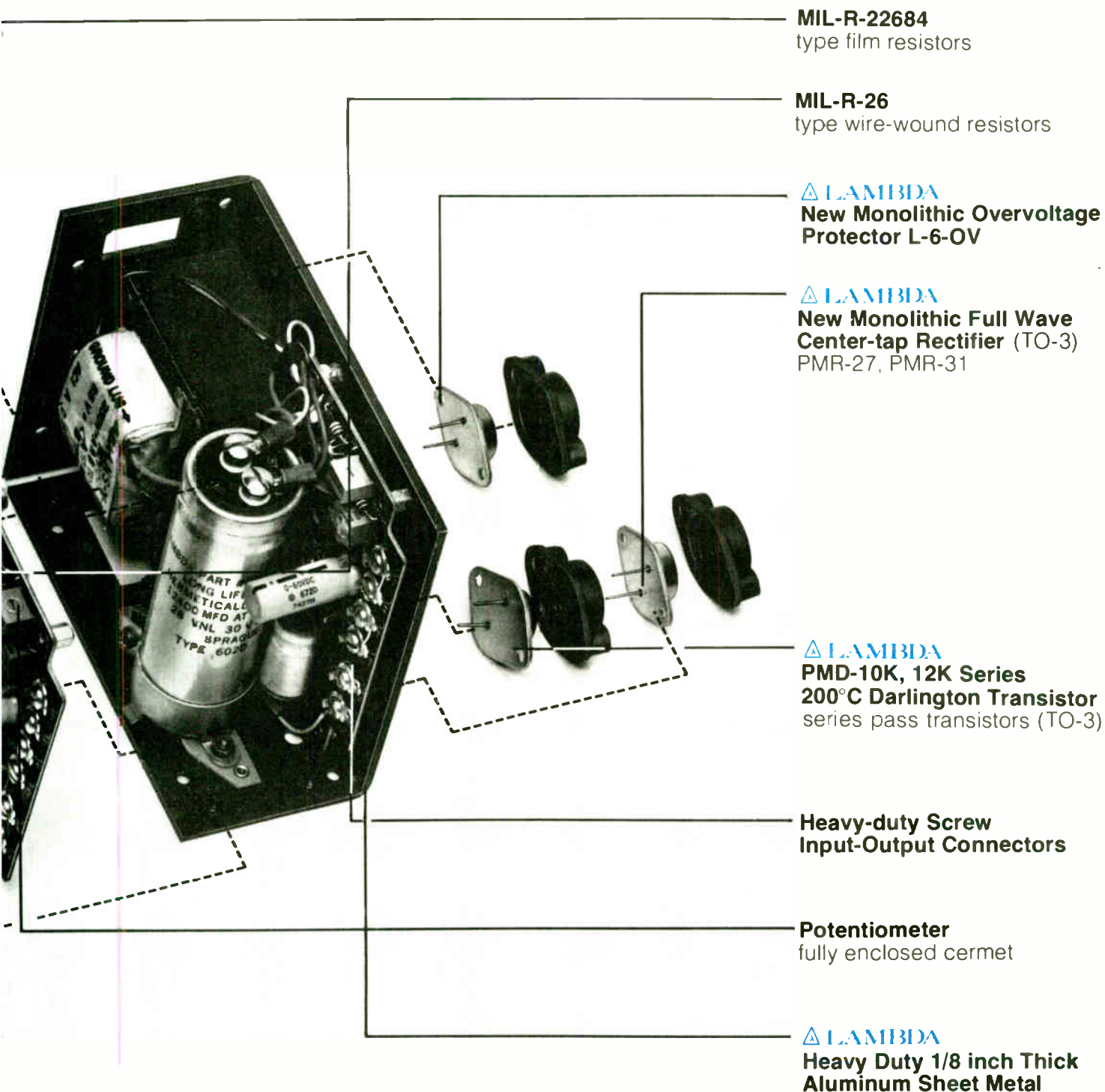

VOLTAGE AND CURRENT RATINGS

DUAL OUTPUT

5 VOLTS ± 5% ADJ, 9V-12V ADJ

| MODEL | REGULATION (LINE OR LOAD) | RIPPLE (RMS) | VOLT. VDC. | ⁽¹⁾ MAX CURRENT AMPS AT | | | | PKG SIZE | DIMENSIONS ⁽²⁾ (INCHES) | PRICE |
|---------------|------------------------------|-----------------|---------------|------------------------------------|------------------------|-----------------------|------------------------|-------------|---------------------------------------|-------|
| | | | | 40°C | 50°C | 60°C | 71°C | | | |
| LND-X-MPU (3) | 0.1% | 1.5 | 5±5% 9-12 | 7.0(5.95) 1.2(1.02) | 6.0(5.11) 1.1(0.94) | 4.7(4.0) 1.0(0.85) | 3.2(2.72) 0.8(0.68) | X | 7 x 4 7/8 x 2 7/8 | \$172 |

± 15 VOLTS TO ± 12 VOLTS ADJ

| | | | | | | | | | | |
|-----------|-------|-----|---------------|------------------------|------------------------|--------------------------|------------------------|---|-----------------------|-------|
| LND-Z-152 | 0.15% | 1.5 | ±15 to ±12 | 0.6(0.54) 0.6(0.54) | 0.55(0.5) 0.55(0.5) | 0.45(0.41) 0.45(0.41) | 0.3(0.27) 0.3(0.27) | Z | 4 7/8 x 4 x 1 3/4 | \$ 85 |
| LND-Y-152 | 0.1% | 1.5 | ±15 to ±12 | 1.4(1.20) 1.2(1.02) | 1.2(1.02) 1.1(0.94) | 0.9(0.77) 0.8(0.68) | 0.6(0.51) 0.5(0.43) | Y | 5 5/8 x 4 7/8 x 2 5/8 | 120 |
| LND-X-152 | 0.1% | 1.5 | ±15 to ±12 | 2.5(2.13) 2.3(1.96) | 2.1(1.79) 1.9(1.62) | 1.6(1.37) 1.4(1.2) | 1.1(0.94) 0.9(0.77) | X | 7 x 4 7/8 x 2 7/8 | 150 |
| LND-W-152 | 0.1% | 1.5 | ±15 to ±12 | 3.3(3.0) 3.1(2.8) | 3.1(2.8) 2.8(2.52) | 2.6(2.34) 2.3(2.07) | 2.0(1.8) 1.6(1.44) | W | 9 x 5 x 2 7/8 | 170 |

SINGLE OUTPUT

5 VOLTS ± 5% ADJ

| MODEL | REGULATION (LINE OR LOAD) | RIPPLE (RMS) | 40°C | ⁽¹⁾ MAX CURRENT AMPS AT | | | | PKG SIZE | DIMENSIONS ⁽²⁾ (INCHES) | PRICE |
|------------|------------------------------|-----------------|------------|------------------------------------|-------------|-------------|---|-----------------------|---------------------------------------|-------|
| | | | | 50°C | 60°C | 71°C | | | | |
| LNS-Z-5-OV | 0.15% | 1.5 | 3.0(2.7) | 2.7(2.4) | 2.3(2.1) | 1.7(1.5) | Z | 4-7/8 x 4 x 1-3/4 | \$ 80 | |
| LNS-Y-5-OV | 0.1% | 1.5 | 6.0(5.4) | 5.1(4.6) | 4.2(3.8) | 3.1(2.8) | Y | 5-5/8 x 4-7/8 x 2-5/8 | 115 | |
| LNS-X-5-OV | 0.1% | 1.5 | 10.0(8.5) | 8.9(7.6) | 7.3(6.2) | 5.3(4.5) | X | 7 x 4-7/8 x 2-7/8 | 140 | |
| LNS-W-5-OV | 0.1% | 1.5 | 14.0(11.9) | 12.2(10.4) | 10.0(8.5) | 7.5(6.4) | W | 9 x 5 x 2-7/8 | 175 | |
| LNS-P-5-OV | 0.1% | 1.5 | 22.0(20.9) | 19.5(18.53) | 16.5(15.68) | 13.0(12.35) | P | 11 x 4-7/8 x 4-13/32 | 220 | |

6 VOLTS ± 5% ADJ

| | | | | | | | | | |
|---------|-------|-----|-------------|------------|-------------|------------|---|-----------------------|-------|
| LNS-Z-6 | 0.15% | 1.5 | 2.5(2.25) | 2.2(2.0) | 1.9(1.7) | 1.4(1.3) | Z | 4-7/8 x 4 x 1-3/4 | \$ 75 |
| LNS-Y-6 | 0.1% | 1.5 | 5.6(5.0) | 4.9(4.4) | 4.0(3.6) | 2.9(2.61) | Y | 5-5/8 x 4-7/8 x 2-5/8 | 110 |
| LNS-X-6 | 0.1% | 1.5 | 9.5(8.1) | 8.4(7.15) | 7.1(6.0) | 5.0(4.25) | X | 7 x 4-7/8 x 2-7/8 | 130 |
| LNS-W-6 | 0.1% | 1.5 | 13.0(11.0) | 11.2(9.5) | 9.3(7.9) | 6.8(5.9) | W | 9 x 5 x 2-7/8 | 165 |
| LNS-P-6 | 0.1% | 1.5 | 20.5(19.48) | 18.1(17.2) | 15.3(14.54) | 12.0(11.4) | P | 11 x 4-7/8 x 4-13/32 | 200 |

12 VOLTS ± 5% ADJ

| | | | | | | | | | |
|----------|-------|-----|------------|------------|-----------|-----------|---|-----------------------|-------|
| LNS-Z-12 | 0.15% | 1.5 | 1.7(1.55) | 1.6(1.45) | 1.5(1.4) | 1.3(1.2) | Z | 4-7/8 x 4 x 1-3/4 | \$ 75 |
| LNS-Y-12 | 0.1% | 1.5 | 4.0(3.6) | 3.5(3.15) | 2.9(2.6) | 2.2(2.0) | Y | 5-5/8 x 4-7/8 x 2-5/8 | 110 |
| LNS-X-12 | 0.1% | 1.5 | 6.5(5.5) | 5.5(4.7) | 4.5(3.8) | 3.3(2.8) | X | 7 x 4-7/8 x 2-7/8 | 130 |
| LNS-W-12 | 0.1% | 1.5 | 8.5(7.2) | 7.2(6.1) | 5.9(5.0) | 4.2(3.6) | W | 9 x 5 x 2-7/8 | 165 |
| LNS-P-12 | 0.1% | 1.5 | 14.0(13.3) | 12.4(11.8) | 10.0(9.5) | 7.3(6.94) | P | 11 x 4-7/8 x 4-13/32 | 200 |

15 VOLTS ± 5% ADJ

| | | | | | | | | | |
|----------|-------|-----|------------|------------|-----------|-----------|---|-----------------------|-------|
| LNS-Z-15 | 0.15% | 1.5 | 1.4(1.3) | 1.3(1.62) | 1.2(1.1) | 1.0(0.9) | Z | 4-7/8 x 4 x 1-3/4 | \$ 75 |
| LNS-Y-15 | 0.1% | 1.5 | 3.4(3.1) | 3.1(2.8) | 2.6(2.35) | 2.0(1.8) | Y | 5-5/8 x 4-7/8 x 2-5/8 | 110 |
| LNS-X-15 | 0.1% | 1.5 | 5.5(4.7) | 4.8(4.1) | 3.9(3.35) | 2.8(2.4) | X | 7 x 4-7/8 x 2-7/8 | 130 |
| LNS-W-15 | 0.1% | 1.5 | 7.7(6.55) | 6.7(5.7) | 5.5(4.7) | 3.8(3.15) | W | 9 x 5 x 2-7/8 | 165 |
| LNS-P-15 | 0.1% | 1.5 | 12.0(11.4) | 10.6(10.1) | 8.5(8.1) | 6.3(6.0) | P | 11 x 4-7/8 x 4-13/32 | 200 |

20 VOLTS ± 5% ADJ

| | | | | | | | | | |
|----------|-------|-----|-----------|------------|------------|------------|---|-----------------------|-------|
| LNS-Z-20 | 0.15% | 1.5 | 1.0(0.69) | 0.85(0.77) | 0.65(0.59) | 0.45(0.41) | Z | 4-7/8 x 4 x 1-3/4 | \$ 75 |
| LNS-Y-20 | 0.1% | 1.5 | 2.7(2.45) | 2.5(2.25) | 2.0(1.08) | 1.3(1.2) | Y | 5-5/8 x 4-7/8 x 2-5/8 | 110 |
| LNS-X-20 | 0.1% | 1.5 | 4.4(3.75) | 3.6(3.1) | 2.6(2.2) | 1.6(1.4) | X | 7 x 4-7/8 x 2-7/8 | 130 |
| LNS-W-20 | 0.1% | 1.5 | 6.1(5.2) | 5.2(4.4) | 4.2(3.6) | 3.0(2.6) | W | 9 x 5 x 2-7/8 | 165 |
| LNS-P-20 | 0.1% | 1.5 | 10.0(9.5) | 8.9(8.46) | 7.5(7.13) | 5.5(5.23) | P | 11 x 4-7/8 x 4-13/32 | 200 |

24 VOLTS ± 5% ADJ

| | | | | | | | | | |
|----------|-------|-----|-----------|------------|-----------|-----------|---|-----------------------|-------|
| LNX-Z-24 | 0.15% | 1.5 | 0.9(0.81) | 0.75(0.68) | 0.6(0.55) | 0.4(0.36) | Z | 4-7/8 x 4 x 1-3/4 | \$ 75 |
| LNS-Y-24 | 0.1% | 1.5 | 2.3(2.1) | 2.1(1.9) | 1.7(1.5) | 1.1(1.0) | Y | 5-5/8 x 4-7/8 x 2-5/8 | 110 |
| LNS-X-24 | 0.1% | 1.5 | 3.8(3.25) | 3.2(2.75) | 2.4(2.0) | 1.4(1.62) | X | 7 x 4-7/8 x 2-7/8 | 130 |
| LNS-W-24 | 0.1% | 1.5 | 5.4(4.6) | 4.6(3.9) | 3.7(3.1) | 2.5(2.1) | W | 9 x 5 x 2-7/8 | 165 |
| LNS-P-24 | 0.1% | 1.5 | 9.0(8.55) | 8.0(7.6) | 6.7(6.37) | 5.0(4.75) | P | 11 x 4-7/8 x 4-13/32 | 200 |

28 VOLTS ± 5% ADJ

| | | | | | | | | | |
|----------|-------|-----|-----------|-----------|-----------|------------|---|-----------------------|-------|
| LNS-Z-28 | 0.15% | 1.5 | 0.8(0.75) | 0.65(0.6) | 0.5(0.45) | 0.35(0.32) | Z | 4-7/8 x 4 x 1-3/4 | \$ 75 |
| LNS-Y-28 | 0.1% | 1.5 | 2.0(1.8) | 1.8(1.65) | 1.5(1.35) | 1.0(0.9) | Y | 5-5/8 x 4-7/8 x 2-5/8 | 110 |
| LNS-X-28 | 0.1% | 1.5 | 3.4(2.9) | 2.9(2.5) | 2.2(1.5) | 1.2(1.0) | X | 7 x 4-7/8 x 2-7/8 | 130 |
| LNS-W-28 | 0.1% | 1.5 | 4.7(4.0) | 4.0(3.4) | 3.2(2.75) | 2.2(1.9) | W | 9 x 5 x 2-7/8 | 165 |
| LNS-P-28 | 0.1% | 1.5 | 8.0(7.6) | 7.1(6.75) | 6.0(5.7) | 4.5(4.28) | P | 11 x 4-7/8 x 4-13/32 | 200 |

- Note: 1. Rating in Parenthesis for LN Series when cover is used
 2. Dimensions include cover
 3. Includes OV protection on both outputs (5V OV trip point is 6.6 ± .2V fixed; 9-12V OV trip point is 13.7 ± .4V fixed)

SPECIFICATIONS OF LN SERIES

DC Output

Voltage range shown in tables

Regulated Voltage

regulation, line 0.1% (0.15% for LN-Z)
 regulation, load 0.1% (0.15% for LN-Z)
 ripple and noise 1.5mV RMS, 5mV pk-pk with
 either positive or negative terminal grounded.

temperature

coefficient 0.03% /°C
 remote programming
 resistance 200 ohms per volt nominal
 remote programming
 voltage volt per volt

AC Input

line 105-127 VAC, 210-254 VAC
 (by transformer tap change)
 47-440 Hz. Consult factory for
 operation at frequencies other
 than 57-63 Hz.
 Efficiency (Typical) 30%-5V and 6V models, 42%
 12V and 15V models, 49%-20V,
 24V and 28V models. 42% for
 LN duals except LND-X-MPU
 which is 34%.

Ambient Operating Temperature Range

Continuous duty from 0° to +71°C with corresponding
 load current ratings for all modes of operation.

Storage Temperature Range

-55°C to 85°C

Overload Protection

Electrical

External overload protection, automatic electronic
 current limiting circuit limits the output current to a
 preset value, thereby providing protection for the load as
 well as the power supply.

Thermal

Thermostat — automatically reset when overtemperature
 condition is eliminated.

Overshoot

No overshoot on turn-on, turn-off or power failure.

Overvoltage Protection

Overvoltage protection module crowbars output when
 trip level is exceeded — standard on all 5V models and
 both outputs of model LND-X-MPU. For other models
 see back cover.

Input and Output Connections

Heavy-duty screw terminals on printed circuit board.

DC Output Controls

Simple screwdriver adjustment over the entire voltage
 range.

Tracking Accuracy (Dual Tracking Models Only)

3% absolute voltage difference, 0.2% change for all con-
 ditions of line, load and temperature.

Remote Sensing

Provision is made for remote sensing to eliminate effect
 of power output load resistance on DC regulation.

Mounting

Three Mounting surfaces, three mounting position.
 One mounting position for LN-P.

Convection Cooled

No external heat sinking or forced air required.

Transformer

MIL-T-27C, Grade 6; Electrostatic shield; 4000 VAC
 input/output isolation.

Isolation Rating

Minimum 10 meg-ohm isolation from DC to ground at
 1000 VDC.

Fungus Proof

No fungi nutrient material used.

Military Specifications

The LNS series has passed the following tests in accor-
 dance with MIL-STD-810C:

- 1) Low Pressure — Method 500.1, Procedure I.
- 2) High Temperature — Method 501.1, Procedure I & II.
- 3) Low Temperature — Method 502.1, Procedure I.
- 4) Temperature Shock — Method 503.0, Procedure I.
- 5) Temperature — Altitude — Method 504.1, Procedure I.
 Class 2 (0°C operating)
- 6) Humidity — Method 507.1, Procedures I & II.
- 7) Fungus — Method 508.1, Procedure I.
- 8) Vibration — Method 514.2, Procedures X & XI.
- 9) Shock — Method 516.2, Procedures I & III.

MIL-I-6181D — Conducted and radiated EMI with one
 output terminal grounded.

Physical Data

| Package Model | Weight | | Size Inches |
|---------------|----------|-----------|--------------------------------------|
| | Lbs. Net | Lbs. Ship | |
| LN-Z | 3 | 3-1/4 | 4-7/8 x 4 x 1-3/4 (w/cover) |
| | | | 4-7/8 x 4 x 1-5/8 (w/o cover) |
| LN-Y | 5 | 5-1/2 | 5-5/8 x 4-7/8 x 2-5/8 (w/cover) |
| | | | 5-5/8 x 4-7/8 x 2-1/2 (w/o cover) |
| LN-X | 7 3/4 | 8-1/4 | 7 x 4-7/8 x 2-7/8 (w/cover) |
| | | | 7 x 4-7/8 x 2-3/4 (w/o cover) |
| LN-W | 9 | 9-1/2 | 9 x 5 x 2-7/8 (w/cover) |
| | | | 9 x 4-7/8 x 2-3/4 (w/o cover) |
| LN-P | 14 | 15-1/2 | 11 x 4-7/8 x 4-13/32 (w & w/o cover) |

Finish

Gray, Fed. Std. 595 No. 26081.

UL/VDE

Designed for listing in UL Recognized Components
 Index.

Designed for listing in VDE Index.

Accessories

Overvoltage protectors (standard on 5V models and
 model LND-X-MPU).

Guaranteed for 5 Years

5-year guarantee includes labor as well as parts.
 Guarantee applies to operation at full published
 specifications at end of 5 years.

6 Amp Monolithic OV Protectors

\$5.00 Qty 1 \$3.40 Qty 1000

TO-3 PACKAGE, NO EXTERNAL COMPONENTS NEEDED

LAMBDA OVERVOLTAGE PROTECTORS L-6-OV, L-12-OV, L-20-OV, L-35-OV Series

General Description

The Lambda overvoltage protector prevents damage to the load caused by excessive power supply output voltage due to improper adjustment, improper connection, or failure of the power supply. Load protection is accomplished automatically by effectively short circuiting the output terminals of the power supply when a preset limit voltage has been exceeded. The trip-point limit voltage cannot be adjusted. To reset overvoltage protector, remove AC input to power supply allow overvoltage protector to cool, and reapply power.

Overvoltage Protector Performance Specifications

| PARAMETER | SYMBOL | L-6-OV SERIES | | L-12-OV SERIES | | L-20-OV SERIES | | L-35-OV SERIES | |
|---|-----------------|---------------|-----------|----------------|--------|----------------|--------|----------------|--------|
| | | MIN | MAX | MIN | MAX | MIN | MAX | MIN | MAX |
| On State Current | I_{DC} | - | 6A | - | 12A | - | 20A | - | 35A |
| On State Voltage | V_{DC} | - | 2.5V | - | 1.3V | - | 1.4V | - | 1.6V |
| Non-Repetitive Peak Surge Current* | I_p | - | 150A | - | 200A | - | 260A | - | 350A |
| Standby Current | I_s | - | 25mA | - | 5mA | - | 5mA | - | 5mA |
| Operating Temperature (Blocking)** | T_{CB} | -40°C | +100°C | -40°C | +100°C | -40°C | +100°C | -40°C | +100°C |
| Operating Temperature (Conducting)*** | T_{CC} | -40°C | +150°C | -40°C | +140°C | -40°C | +140°C | -40°C | +140°C |
| Storage Temperature | T_s | -40°C | +150°C | -40°C | +125°C | -40°C | +125°C | -40°C | +125°C |
| Power Dissipation @ 25°C Derate @ 1.5W/°C above 50°C | P_D | | 150 Watts | | | | | | |
| Thermal Resistance | $R_{\theta JC}$ | | 1.0°C/W | | | | | | |

*For sinusoidal current duration of 8.3 milliseconds max.

**Case temperature for overvoltage protector in non-conducting or "OFF" state.

***Case temperature for overvoltage protector in conducting or "ON" state. Power must be removed and case temperature allowed to drop to 100°C before application of output voltage.

The overvoltage protector must be mounted on external heat sink to maintain case temperature below rated limit. When the overvoltage protector is used with a Lambda power supply, the power supply chassis acts as the heat sink. The L-12-OV, L-20-OV, L-35-OV, overvoltage protector is supplied with mating connectors for pins on overvoltage protector (+V and -V engraved on unit).

OVERVOLTAGE PROTECTORS

| NOM SUPPLY VOLTAGE (VOLTS) | TRIP POINT VOLTAGE ^A (VOLTS) | 6 AMP MODELS | QTY 1 | PRICE | | | 12 AMP MODELS | QTY 1 | PRICE | | | 20 AMP MODELS | QTY 1 | PRICE | | | 35 AMP MODELS | QTY 1 | PRICE | | |
|----------------------------|---|--------------|-------|---------|---------|----------|---------------|-------|---------|---------|----------|---------------|-------|---------|---------|----------|---------------|-------|---------|---------|---------|
| | | | | QTY 100 | QTY 250 | QTY 1000 | | | QTY 100 | QTY 250 | QTY 1000 | | | QTY 100 | QTY 250 | QTY 1000 | | | | | |
| 5 | 6.6 ± .2 (6.8 ± .2) ^B | L-6-OV-5 | 36 | \$4 | \$3.75 | \$3.40 | L-12-OV-5 | 10 | \$8 | \$7.50 | \$8.80 | L-20-OV-5 | 14 | \$11.20 | \$10.50 | \$9.50 | L-35-OV-5 | 18 | \$14.40 | \$13.80 | \$12.30 |
| 6 | 7.3 ± .2 | L-6-OV-6 | 5 | 4 | 3.75 | 3.40 | L-12-OV-6 | 10 | 8 | 7.50 | 8.80 | L-20-OV-6 | 14 | 11.20 | 10.50 | 9.50 | L-35-OV-6 | 18 | 14.40 | 13.80 | 12.30 |
| 9 | 10.5 ± .4 | L-6-OV-9 | 5 | 4 | 3.75 | 3.40 | L-12-OV-9 | 10 | 8 | 7.50 | 8.80 | L-20-OV-9 | 14 | 11.20 | 10.50 | 9.50 | L-35-OV-9 | 18 | 14.40 | 13.80 | 12.30 |
| 12 | 13.7 ± .4 | L-6-OV-12 | 5 | 4 | 3.75 | 3.40 | L-12-OV-12 | 10 | 8 | 7.50 | 8.80 | L-20-OV-12 | 14 | 11.20 | 10.50 | 9.50 | L-35-OV-12 | 18 | 14.40 | 13.80 | 12.30 |
| 15 | 17.0 ± .5 | L-6-OV-15 | 5 | 4 | 3.75 | 3.40 | L-12-OV-15 | 10 | 8 | 7.50 | 8.80 | L-20-OV-15 | 14 | 11.20 | 10.50 | 9.50 | L-35-OV-15 | 18 | 14.40 | 13.80 | 12.30 |
| 20 | 22.8 ± .7 | L-6-OV-20 | 5 | 4 | 3.75 | 3.40 | L-12-OV-20 | 10 | 8 | 7.50 | 8.80 | L-20-OV-20 | 14 | 11.20 | 10.50 | 9.50 | L-35-OV-20 | 18 | 14.40 | 13.80 | 12.30 |
| 24 | 27.3 ± .8 | L-6-OV-24 | 5 | 4 | 3.75 | 3.40 | L-12-OV-24 | 10 | 8 | 7.50 | 8.80 | L-20-OV-24 | 14 | 11.20 | 10.50 | 9.50 | L-35-OV-24 | 18 | 14.40 | 13.80 | 12.30 |
| 28 | 31.9 ± 1.0 | L-6-OV-28 | 5 | 4 | 3.75 | 3.40 | L-12-OV-28 | 10 | 8 | 7.50 | 8.80 | L-20-OV-28 | 14 | 11.20 | 10.50 | 9.50 | L-35-OV-28 | 18 | 14.40 | 13.80 | 12.30 |
| 30 | 33.5 ± 1.0 | L-6-OV-30 | 5 | 4 | 3.75 | 3.40 | L-12-OV-30 | 10 | 8 | 7.50 | 8.80 | L-20-OV-30 | 14 | 11.20 | 10.50 | 9.50 | L-35-OV-30 | 18 | 14.40 | 13.80 | 12.30 |

^A VOLTAGE TOLERANCE MAINTAINED OVER 0.71°C DUE TO POWER DESIGN ^B FOR L-6-OV-5 ONLY

Outline Drawings

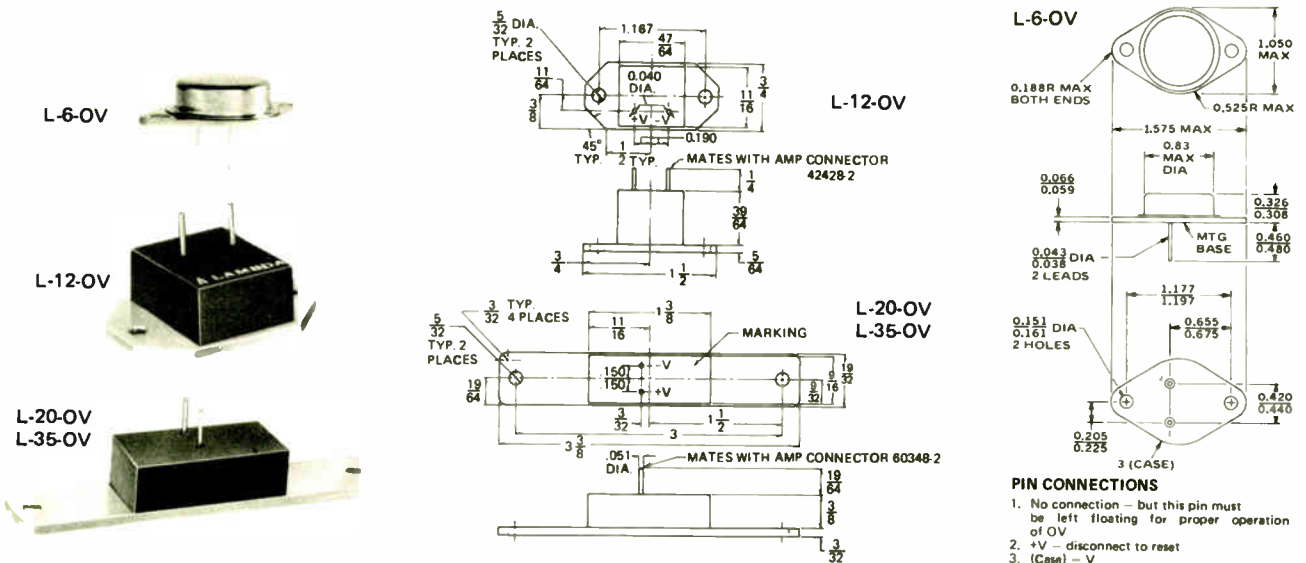

LAMBDA ELECTRONICS

515 BROAD HOLLOW ROAD, MELVILLE, L.I., NEW YORK 11746 (516) 694-4200

DIVISION of **Veeco** INSTRUMENTS INC

The Electronics Book Series offers you:

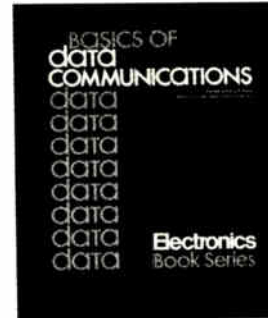
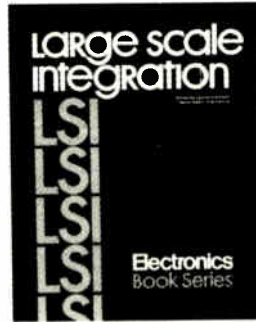
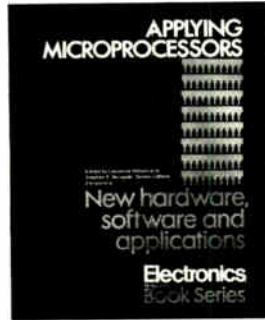
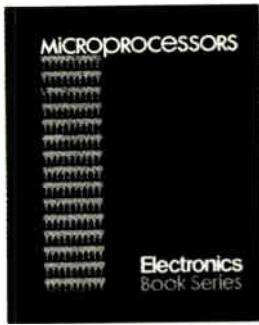

1

MICROPROCESSORS

This book cuts through the confusion, presenting the design and application potential of this exciting technology in a manner that will appeal to the design engineer who needs to know how to use microprocessors as well as the system analyst who must assess the tradeoffs between microprocessors and other techniques to accomplish his system goals.

2

APPLYING MICROPROCESSORS

This new book completes the engineer's transition from the old methods of electronic design to the new world of microprocessor engineering. The book contains the up-to-date and ready-to-use information that every designer needs to know about the new technology.

3

LARGE SCALE INTEGRATION

"Large Scale Integration" deals with the entire range of design applications main memory systems, peripheral memories, memory controllers, on-line industrial controllers, data acquisition boards, communication systems, calculators, watches, etc.

4

BASICS OF DATA COMMUNICATIONS

Chances are you are going to be a part of the data communications market. There's no better place to start than getting a copy of "Basics of Data Communications"—a 316-page compilation of essential articles which have appeared in Data Communications magazine.

Use form below to order your copy. Prices on 10 copies or more, available upon request.

Electronics Book Series

P.O. Box 669, Hightstown, N.J. 08520



- 1** Send me _____ copies of "Microprocessors" at \$8.95 per copy.
2 Send me _____ copies of "Applying Microprocessors" at \$9.95 per copy.
3 Send me _____ copies of "LSI" at \$9.95 per copy.
4 Send me _____ copies of "Basics of Data Communications" at \$12.50 per copy.

Full payment must accompany my order.

I must be fully satisfied or you will refund full payment if the books are returned after ten-day trial examination.

Name _____ Title _____

Company _____

Address _____

City _____ Country _____

Signature _____

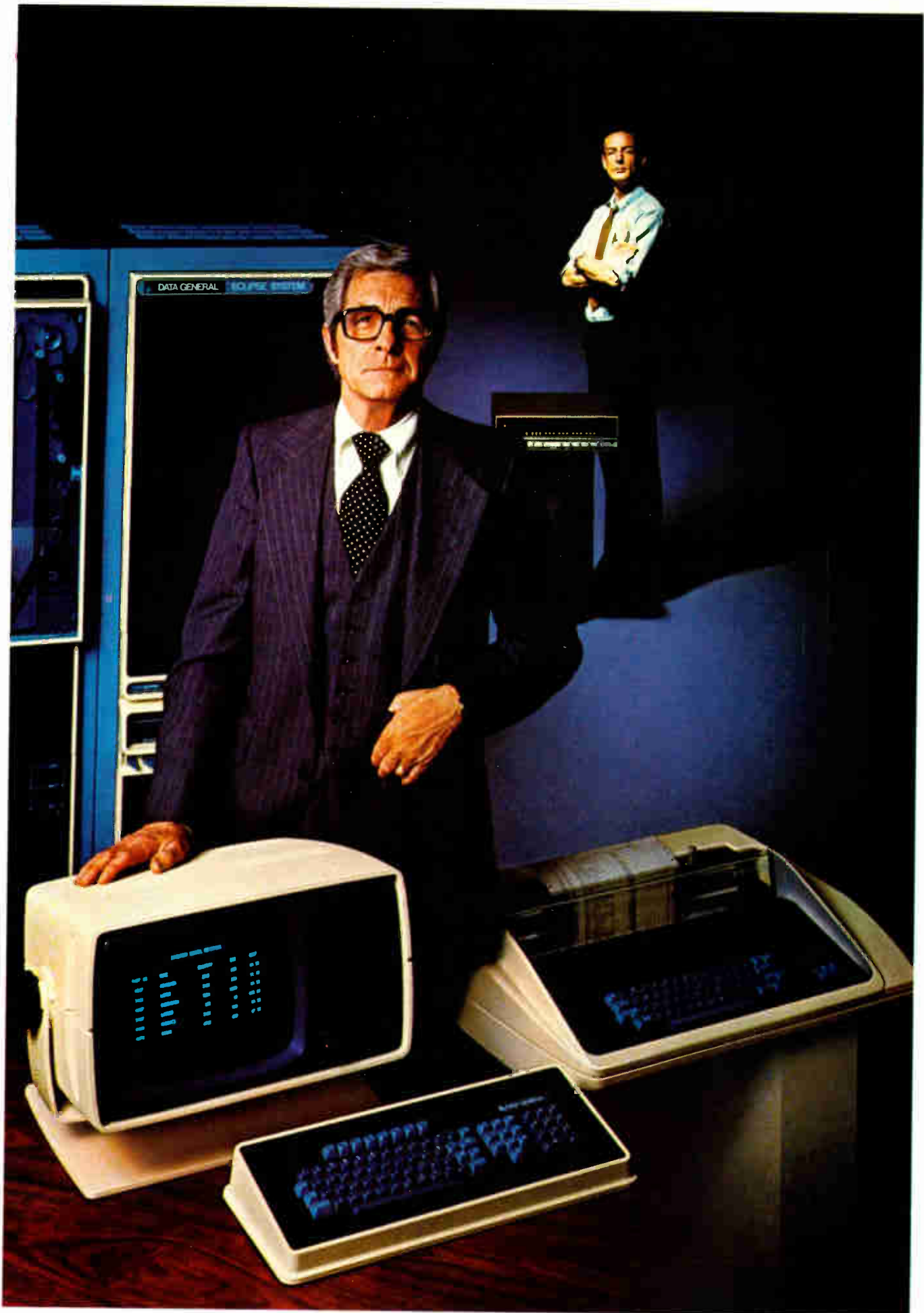

Once it was considered daring to select Data General. Today it's smart business.

A few years ago, some far-sighted computer users had guts enough to take a chance on an aggressive, young minicomputer company called Data General. As the word got around, more smart businessmen found out

the first to offer high-speed semiconductor memories. All of which increased performance and lowered costs.

And we're the only company to design, manufacture and market such a wide-ranging compatible product line.

Including everything from microNOVA chips to 16-bit NOVA minis and full-blown ECLIPSE computer systems. As well as a complete line of high performance peripherals and communication devices. All supported worldwide.

We're not saying that we

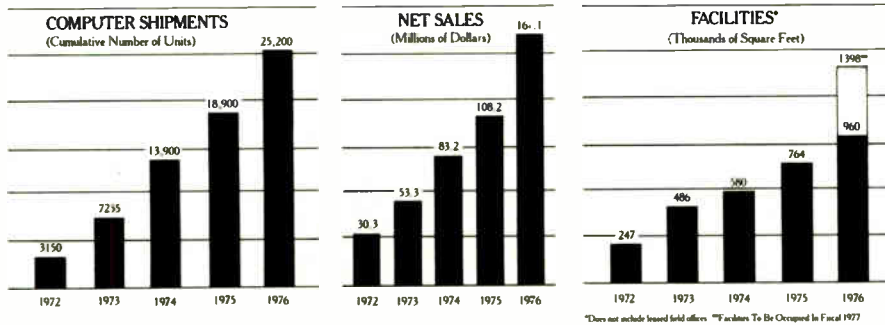

that we had the best answers for applying computer technology to their needs. In just nine years, they've made us one of the fastest growing, most profitable computer companies around. With over 26,000 systems in 33 countries, we are third largest in systems shipped.

Last year we increased sales by 49% to \$161 million. At the same time we also increased facilities by 80% and number of employees by 76%. And we put a higher percentage of revenues into research and development than any other computer company. Which enabled us to introduce a new product every 15 working days. Products that supply more useful technology to more users.

Unlike many other computer companies, Data General's only business is computers. We were the first small computer company to design and manufacture a 16-bit computer-on-a-chip. The first to provide high-level ANSI '74 COBOL, essential for business users. And

have a computer system for everyone. But if you like a computer system you can grow with, one that can provide you with instant information for faster, more accurate day-to-day business decisions, and one that, we firmly believe, offers the best price/performance ratio on the market, then you should talk to Data General.

We tell you all this because you're not just buying a computer system, you're buying a whole computer company. You should know as much about the company as you do about the system. Today it's no longer daring to select Data General. It's smart business. And we can prove it. Send for our booklet.

Data General, Dept. EE69, Westboro, MA 01581
I'm interested in smart business. Send me your booklet.

NAME _____
 TITLE _____
 COMPANY _____
 ADDRESS _____ TEL. _____
 CITY _____ STATE _____ ZIP _____



© Data General Corporation, 1977

Data General
It's smart business.

Data General, Westboro, MA 01581, (617) 485-9100. Data General (Canada) Ltd., Ontario. Data General Europe, 15 Rue Le Sueur, Paris 75116, France. Data General Australia, Melbourne (03) 82-1361.
NOVA and ECLIPSE are registered trademarks of Data General Corporation.

Going into business sale.

National Semiconductor is going into the microcomputer business.

And to celebrate, we're having a "sale."

10% off the Intel 80/10.

To get 10% off Intel's 80/10, don't buy Intel's 80/10. Buy National's 80/10.

We're able to sell the 80/10 for less because of our improved board layout which permits automated assembly (such as using axial leaded components)...the fact that we make not only the 8080, but also—unlike Intel—most of the rest of the ICs on the board...and, of course, National's

legendary competence in efficient manufacturing doesn't hurt either.

The industry standard.

Our second-sourcing of the 80/10 clears the way for the 80/10 to be the clear-cut standard of the microcomputer industry.

You can't effectively have an industry-standard without a second-source. Having two suppliers is a healthier competitive situation for you, the customer, and you have the security—and abuse-protection—of an alternate source.

What we make and how we make it.

What we're making is this:

Series/80 Cards:

BLC 80/10 BLC 104*
BLC 016 BLC 508*
BLC 406 BLC 416*
BLC 905

*Available 3rd quarter '77

Series/80 Systems:

BLC 80P BLC 614 BLC 604

Series/80 Firmware:

BLC 910

(With more, much more, to come
in the future.)

And how we're making them is this:

We're putting out the finest
quality available. A cleaner board—
better layout, all axial components,
plug selectable options rather
than wire wrap.

We "burn in" every board at
elevated temperature, and run
computer diagnostics during burn-in.

Think we're kidding about quality?
We're offering a one year warranty.
Which is just about four times longer
than Intel's warranty period.

A microcomputer company small enough to do business with.

We're not dummies.

We know that to break into a field
that somebody else has a lock on, we've
got to offer something extra.

And extra quality for less money
ain't a bad start.

But we're offering something else
extra, too.

Desire.

As the little guy we can't afford
a fat cat attitude.

We'll do our best to meet
impossible deadlines.

Our phone won't be busy. Etc.

In the microcomputer arena we're
young, small, and hungry.

So if you'd like to see what
you've been missing in 80/10's, see your

local distributor or use this coupon to
get our literature.

Help us celebrate our going into
business sale by helping us *stay* in
business.

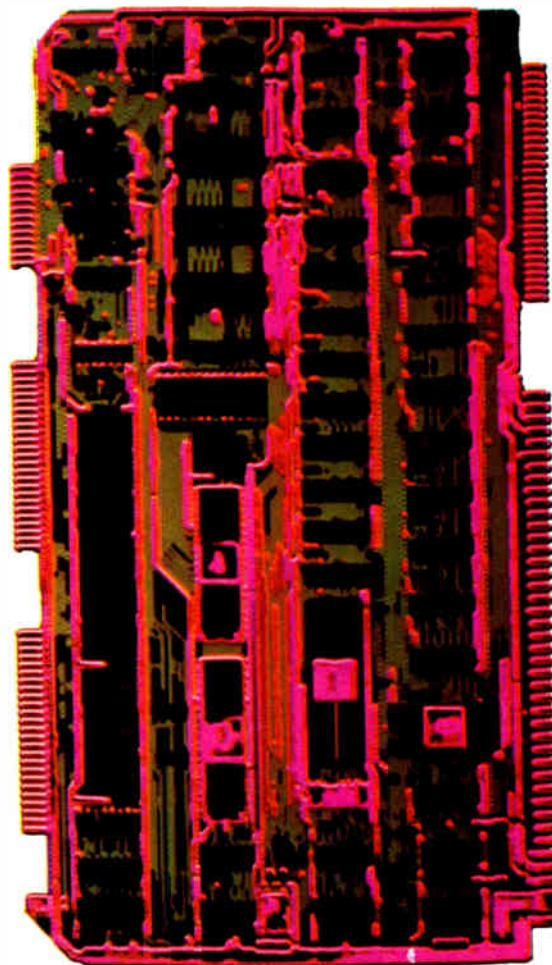

See us at NCC Booth 1565.

National Semiconductor Corporation
2900 Semiconductor Drive, Santa Clara, CA 95051

E6-9

Gentlemen: You've got my interest. Please send me more
information on National's SERIES/80.
 I'm so turned on, I can't wait. Please have a
salesman call me immediately.

Name _____ Title _____

Company _____

Address _____

City _____ State _____ Zip _____

Telephone _____

My application is _____

- I'm presently using the other guy's 80/10.
 I'm not up to the 80/10 yet but I'm using the 8080.
 I have an 8080 software development system.
 Your BLC 80/10 will be used in house.
 I'm an OEM. Your BLC 80/10 will be shipped out as part of
my equipment.

 **National Semiconductor**

Intel delivers MOS RAM's

Convert to the Intel® 2115A and 2125A and enjoy MOS economy, bipolar speed and power savings up to 50%. These new NMOS RAMs offer 45 nsec worst case access time and a 100 quantity price of only \$6.90. And that's just the beginning of the cost/performance advantages you can expect from Intel's new +5 volt, silicon gate static MOS RAMs.

The new 2115A and 2125A RAMs are pin for pin, plug-in replacements for the popular 93415 and 93425 bipolar RAMs. They offer all the same advantages. No need for external clocks or refresh circuits, fully TTL compatible, 16mA output sink current and operation from a single +5 volt supply.



In addition, the 2115A/2125A dissipate 20% less power and the 2115AL/2125AL 50% less power than the 93415/93425. This

saves power supply and cooling costs which all adds up to additional savings in the cost of your system. And there's more. Unlike bipolar RAMs, the 2115A/2125A use only a single layer of metalization which means lower manufacturing cost and a more reliable process. So you can look for continued improvement in cost/performance. To put the cost potential in proper perspective, consider this: The 2115A/2125A chip is 35% smaller than Intel's industry standard 2102A. And the

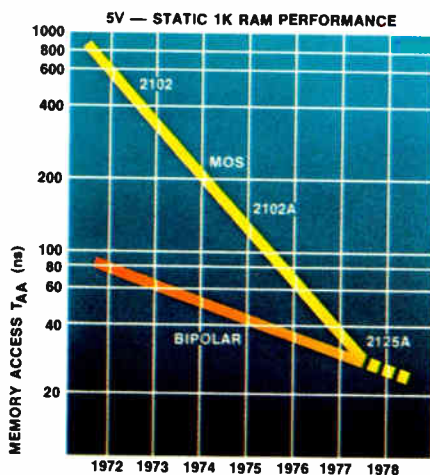

to match bipolar speeds.

2115A/2125A are made on the same manufacturing line and with a process similar to the 2102A. If you've been following the 2102A price curve you'll understand the significance.

Today Intel technology delivers MOS RAMs to match bipolar speed. Tomorrow look for greater speed, higher densities, and even lower cost. Order 2115A's and 2125A's from your local Intel distributor and take advantage of MOS economy and bipolar speed. They're in stock.

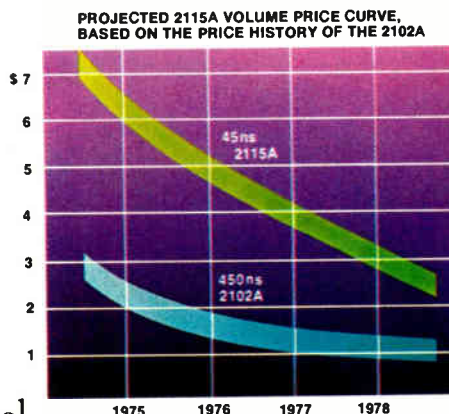

Contact: Almac/Stroum, Component Specialties, Cramer, Elmar, Hamilton/Avnet, Harvey Electronics, Industrial Components, Liberty, Pioneer, Sheridan, L. A. Varah or Zentronics.

For your copy of our new 2115A/2125A brochure, write: Intel Corporation, Literature Department, 3065 Bowers Avenue, Santa Clara, California 95051. In Europe, contact Intel International Corp. S.A., Rue du Moulin à Papier, 51-Boite 1, B-1160, Brussels, Belgium. Telex 24814. In Japan, contact Intel Japan Corporation, Flower Hill-Shinmachi East Bldg. 1-23-9, Shinmachi, Setagaya-ku, Tokyo 154.

intel® delivers.



The keyboard switch with a heart of gold

...keeps your product WORKING year after year...after year.

In your keyboard or ours, Cherry key switches just don't fail. The knife-edge contact area is so small (9 millionths of a square inch) ... the contact pressure so great (about 5,000 psi) ... the gold alloy so pure and film-free ... that you are assured of positive contact every time. For 50 million operations and beyond. (Which is probably beyond the life expectancy of your product!)

Cherry "heart of gold" keyboard switches are available individually or with two-shot molded keycaps. Hopefully, you want keycaps. Because, *we have keycaps* ... in more legends, sizes, type faces than you're likely to find anywhere else. Sculptured keycaps? We've got 'em. Gloss or matte finish? We've got *both*. Colors? Lighted? Specials? Sure! Some "off the shelf" ... all at prices that make it obvious why the *Cherry* way is the *economical* way to put a heart of gold in any keyboard.

See Us At
National
Computer Conference
June 13-16
Booths 1768-1774

For free test sample switch and catalog, just
TWX 910-235-1572 ...
or PHONE 312-689-7700.



CHERRY ELECTRICAL PRODUCTS CORP., 3608 Sunset Avenue, Waukegan, IL 60085

Circle 74 on reader service card

World Radio History

Cherry switches now available locally from distributors.

AT&T starts tests of cellular mobile telephone system

by Richard Gundlach,
Communications & Microwave Editor

The fight for shares in the mobile-telephone market will start in Chicago, where AT&T and Illinois Bell are setting up a developmental high-capacity cellular system (where low-power antennas cover small areas, called cells, that are packed together so that a channel used in one can be reused in another). At the same time, the Federal Communications Commission is weighing approval of two potential competitors: a system being built by Motorola Inc.'s Communications Systems division for the American Radio Telephone Service Inc. [*Electronics*, March 3, p. 38] and a noncellular setup from Harris Corp.'s RF Communications Systems division for ARCH, a joint venture of several radio common carriers [*Electronics*, May 12, p. 49].

But the American Telephone & Telegraph Co. is well ahead. The giant utility gained FCC approval three months ago, and it is moving quickly to solidify its lead. For the Chicago test, Western Electric Co. shipped the first production equipment on June 1 to Illinois Bell. When installed in the Canal Street facility, that equipment will handle the traffic in the first and largest of 10 operational cell sites for the technical trial of the system, which is scheduled to go into operation in 1978 with a 48-channel capacity serving up to 1,000 units.

Meanwhile, with the FCC holding that a wireline common carrier could not also make radio equipment for the cellular system, Bell was permitted to build only the switching, testing, and computer-control equipment. Major vendors involved in the total system are:

- E.F. Johnson Co., Waseca, Minn., for the cell-site channel transmitter and receiver modules, each usable on any one of 667 channels.
- Motorola Communications Systems division, Schaumburg, Ill., for the cell-site 40-watt channel power amplifiers
- Microwave Associates Inc., Burlington, Mass., for rf power distribution equipment for the cell site.
- Oki Electric Co. of Japan, for the handset and control unit that mounts in the automobile as well as the transceiver (including the audio processing and logic circuits) that is carried in the trunk.

Planning ahead, AT&T is ready to award contracts to three vendors to equip some 2,000 mobile units for the second test, the market trial, scheduled to begin in the first quarter of 1979. It is expected that Oki, E.F. Johnson, and Motorola will receive contracts for this equipment this month.

Then, if all goes well with the



Chicago market trial, Bell is shooting to have a similar service operating in more than 25 cities by 1985. By 1990, about 100 cities and some 1 million subscribers will be using Bell's mobile telephone service. In the year 2000, Bell planners envision all major urban areas covered.

The start. The technical trial will include 10 cell sites and cover about 2,000 square miles in the Chicago area. Initially, 100 mobile units will be installed in Bell-owned vehicles. The startup system will use a cell radius of 8 miles, instead of the originally proposed 4 miles, with three omnidirectional antennas placed at alternate corners of each hexagonal cell. Then, as use grows, cell size can be halved and halved again down to a 1-mile radius.

But Bell is not alone. ARTS, a Baltimore common carrier, petitioned the FCC early this year for permission to establish a cellular mobile radiotelephone service in the

Probing the news

Baltimore-Washington, D. C., area using Motorola's system. Later, ARCH, a joint venture of several radio common carriers, petitioned the FCC to establish a mobile radio service in the same area using Harris equipment. Their concept, however, differs radically from Bell's cellular approach. They proposed a centralized approach, which uses a single high-power TV transmitter and requires no switching. The Bell concept is a distributed approach using lower-power base stations and switching offices.

The Motorola system is compatible with Bell's. In fact, the meaningful differences are few. For one, Motorola uses a single antenna in the center of a cell. Each cell is divided into 60° sectors, which in effect, creates six independent cells. The cells are grouped in fours, and this pattern is repeated. Motorola uses both hexagonal and triangular shaped cells that vary in size; Bell uses only hexagonal cells of the same size in clusters of seven calls.

Another difference is in switching. Bell uses a single mobile telephone switching office equipped with its No. 1 ESS; Motorola uses a distributed switching approach because it wants lower startup costs. Finally, since Motorola expects to accommodate portable telephone units immediately, it is using antennas as high as 500 feet, taller than Bell's.

Another idea. The Harris system concept (no equipment has been built yet), has one high-power base station instead of the distributed approach of the cellular system, and requires no special multiple switching centers since there is no need to "hand off" a mobile unit leaving one cell and entering another. "It's a kind of brute-force approach," admits Lee Blanchowicz, director of engineering, short-range radio, for Harris's RF Communications division in Rochester, N.Y., "but it's simple to implement and very cost-effective. What's more, it doesn't require wireline interconnections except at a single point—which pleases the carriers since it doesn't require multiple leased lines from the telephone companies."

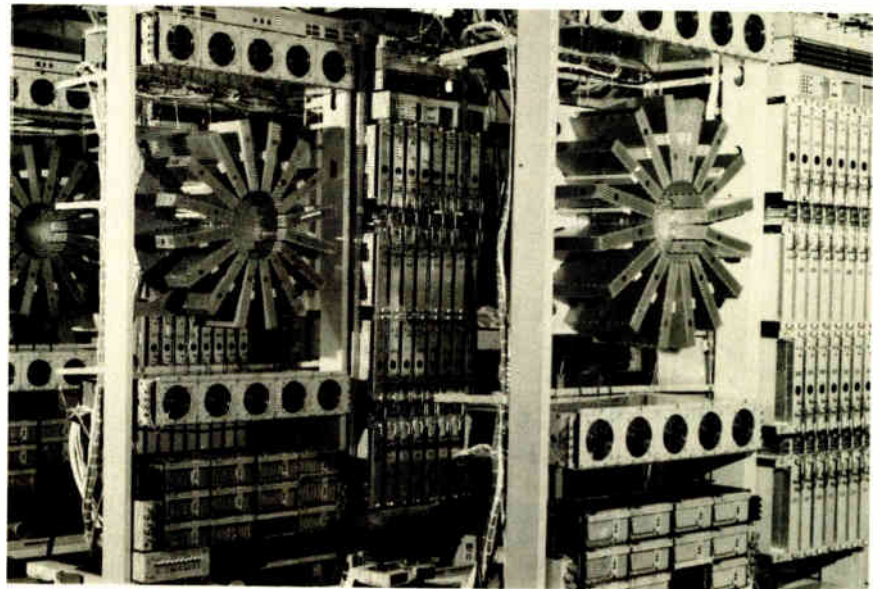

Cell block. Three frames of cell site equipment are shown. They give the Chicago test site a capacity of 48 channels. The fan-like objects combine outputs of channel amplifiers.

Harris plans to use a single 10-kilowatt TV transmitter in the base station and an antenna having a gain of 16 db. This combination produces an effective radiated power of 367 kilowatts when feedline losses are considered. Transmission from base station would be wideband digital with some form of time-division, multilevel modulation techniques to minimize multipath problems (similar to the ghosts that show up on TV sets when signals bounce off tall buildings in all directions).

Although the mobile units will receive wideband digital transmissions, they will use conventional narrow-band fm to transmit back to the base station. Mobile transmissions on individual channels (the system will ultimately have 96 channels that Blanchowicz feels will handle upwards of 10,000 subscribers) will be picked up by remote receivers that translate the mobile channel frequencies to higher microwave frequencies and then retransmit to the base station using microwave techniques.

Conflict. Responses to the Harris/ARCH proposal were submitted to the FCC on June 1. Motorola/ARTS petitioned the FCC to dismiss the Harris proposal, according to Motorola's Martin Cooper, vice president and general manager of the Communications Systems division. He claims it conflicts with the intent of FCC Docket 18262 that calls for a

cellular, frequency-reuse, high-capacity system. Also, says Cooper, Harris is planning to try out technologies that are uncertain, and a high-power approach that will pollute the spectrum.

Cooper says he is angered by the Harris plan, but what he fears most is that the FCC will hold meetings—to decide which system should be used in Washington—that could delay for years the onset of the cellular system. However, his biggest concern is the great advances the Japanese have made in cellular technology: "With the world accommodating mobile radio, the country that develops the technology will have a worldwide market," maintains the Motorola executive.

Bell personnel also question the technical viability of the Harris approach. According to Bell Labs engineers, it is difficult to provide reliable service at a 3-Mb/s transmission rate in an urban environment. "Bell Labs has done extensive testing in this area," says F. R. Blecher, director of the Mobile Telephone Laboratories in Whippany, N.J., "and has found out from tests conducted in Philadelphia and New York City that transmitting at greater than a 300-kilobit-per-second rate causes problems. Bell used a signaling rate of only 10 kb/s with a sophisticated coding scheme, employing quite a bit of redundancy to achieve reliable operation." □

New from Centralab...

IMPS PUSHBUTTON SWITCHES

A new miniature modular building block system that offers microprocessor control designers more of what they need.

To meet the special digital and analog needs of today's μ P-based controls, Centralab offers design engineers a whole new system of modular pushbutton switch building blocks. We call it IMPS — Integrated Modular Panel System. IMPS saves PC board and panel area and simplifies front panel design, cuts assembly costs, reduces back-panel space requirements, and meets the digital-analog needs of μ P-based controls. Check these space saving, cost-cutting features.

Simplify front panel interface.

All IMPS switches regardless of function, are uniform in size, simplifying design and selection of front panel hardware. They have high volumetric efficiency, occupying .505" x .388" PC board area and require only .608" of space between PC board and front panel.



Cut assembly costs.

IMPS switches may be mounted on the front panel, and are designed for automatic wave soldering installation and PC board cleaning. Insert molded terminals prevent flux and solder wicking and contact contamination. Integral PC board stand-offs provide for efficient board cleaning.

Meet analog and digital needs.

IMPS switches are available with momentary, push-push and interlocking actions, with a long-life contact system that switches both digital and analog signals. To accommodate critical signal requirements, housings are high-insulation molded plastic with UL 94V-0 rating.

Available options.

Optional installations include ganged assemblies, front-panel mounting and wire-wrapping.



All IMPS pushbutton switches are built to Centralab's highest quality standards (see specifications at right). They're priced as low as 41 cents in 1,000 quantity. For full technical details, samples and quotation, call (515) 955-3770, or write to the address below.



CENTRALAB

Electronics Division

GLOBE-UNION INC.

P.O. BOX 858

FORT ODOOGE, IOWA 50501

World Radio History

Built To Centralab Quality Specs.

IMPS Pushbutton Switches combine compact size, low cost and highest quality throughout.

- Silver or gold inlay wiping contacts for long-life and low-contact resistance.
- Less than 2 milliseconds contact bounce.
- SPST, SPDT, DPST, and DPDT switch contacts.
- Printed circuit, DIL socket or wire-wrap terminations available.
- 2.5 to 3.5 oz. actuation force (momentary).
- Choice of button interface — square or blade shaft (shown) — permits use of a variety of Centralab and industry standard buttons and keycaps.
- 10, 15, 20 or 25mm center-to-center spacing.

Circle 77 on reader service card

Components

Monolithic converters gain strength

With the advent of 12-bit d-a chips a year ahead of schedule, the performance lead enjoyed by hybrid devices shrinks still further

by Lucinda Mattera, Components Editor

Competition among producers of data converters is heated and getting hotter all the time, with the sharpest battle lines being drawn between monolithic and hybrid devices. Although monolithics still do not perform on a par with hybrids all along the line, the amazing recent advances of chips cannot be denied, and the coming year promises more startling developments.

High-accuracy, fast, 8- and 10-bit digital-to-analog chips are already here, and the 12-bit area is at last beginning to take form. That's a surprise, because 12-bit devices were not expected to arrive for another year or so. Yet, within the next six months, a number of 12-bit d-a chips will be on the market. Because speed is essential to many 12-bit applications, most of the devices will be bipolar rather than MOS.

The action in monolithic data converters is in two technologies—bipolar and MOS—with some firms doing both. The company with probably the most diverse capability is National Semiconductor Corp., which is making low-end bipolar, complementary-MOS, and p-channel MOS chips but will begin to concentrate on high-quality C-MOS designs. The only other firms currently producing both bipolar and C-MOS converters are Analog Devices Inc. and Motorola Inc. However, Analog tends to specialize in high-quality products, whereas Motorola serves principally the low-end markets. High-performance bipolar devices are the specialty of Precision Monolithics Inc. and Harris Semiconductor, a newcomer to the converter marketplace.

Texas Instruments Inc. and Sig-

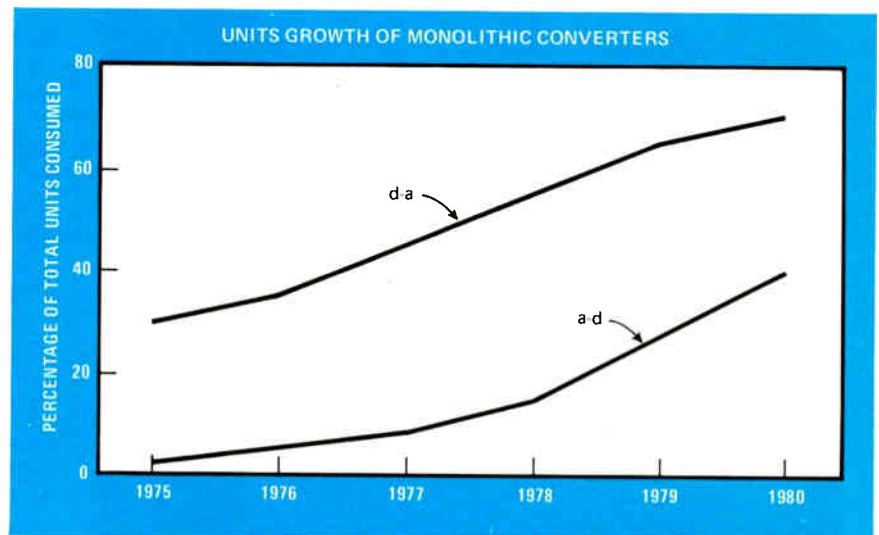

netics are just beginning to get their converter efforts under way, choosing high-quality products as their initial vehicles. Signetics, though, is leaning on its bipolar capability, while TI is going first with bi-MOS and I²L integrating converters. Burr-Brown, a leader in hybrid converters, is also in the initial phases of its monolithic program. At Siliconix Inc. and Intersil Inc., the commitment is to charge-balancing integrating converters in C-MOS.

The major drawback of most monolithic d-a converters is that they require either an external voltage reference or an output amplifier, and sometimes both. Hybrid d-a converters, on the other hand, are almost always self-contained, which makes the engineering easier but the price tag higher. Rallying to remedy this situation, semiconductor producers are adding at least the voltage reference to their designs.

In certain respects, the monolithic

challenge to hybrids is actually stronger as regards a-d converters. To assess the challenge properly, the a-d area should be divided into successive-approximation devices and integrating devices. Essentially, monolithics are on top in the latter category and running a commendable second in the former.

A successive-approximation a-d is nothing more than a d-a converter, a comparator, a logic register, and other trappings like a clock and a voltage reference. At this time, the only completely self-contained monolithic successive-approximation converters are 8-bit devices that are fairly slow, taking about 20 microseconds to complete a conversion. Some bipolar 10-bit units offer reasonably short conversion times, but none is self-contained. However, within the next few months, complete 10-bit bipolar chips will emerge that combine high speed and low power.

However, a 12-bit successive-

approximation a-d chip still eludes the semiconductor makers. Some are content to let the hybrid people have the 12-bit a-d market for now, while others are producing sets of two or three chips, partitioning the converter into its analog and digital sections. Only one or two companies are hard at work on a direct approach. By year's end, though, there should be at least one full-fledged 12-bit bipolar a-d chip on the market and even a low-cost C-MOS device.

More important, perhaps, is the ability of the semiconductor industry to take a different tack altogether and turn to building low-cost converter subsystems for microprocessors. This direction is already in evidence, as a number of converter chips, both d-a and a-d devices, include on-chip three-state buffers for direct connection to a microprocessor bus.

In contrast, the upcoming converter subsystems would resemble the front end of a data-acquisition system, including a multiplexer, a d-a converter, a comparator, and perhaps a sample-and-hold circuit on the same chip. They would be designed to work with the microprocessor, using its logic for the control functions and for the successive-approximation register. Initial devices will probably have a six-channel capacity and a resolution of 8 bits.

Since monolithics are beginning to dominate 8-bit applications, some hybrids are starting to move up to the systems level at this low end. Complete eight-channel 8-bit data-acquisition systems, as well as self-contained 8-bit analog input/output systems for microprocessors, are appearing. Prices, however, are fairly steep, running about \$150 to \$200 for single-unit purchases. This systems approach will undoubtedly be the future direction for hybrids, especially as converter chips take over most 10- and 12-bit applications for single devices.

Integrating a-d converters is another story. Monolithics easily satisfy the moderate conversion speeds needed, and there is no troublesome resistor network to trim as there is with successive-approximation devices. Also, the external circuitry is

minimal—only an outboarded capacitor and perhaps a voltage reference. Integrating converters are particularly suitable for instrument applications where speed is not critical.

Uses. Monolithic dual-slope and charge-balancing integrating converters are quickly finding their way into digital panel meters for 3- and 3½-digit applications. Some of these chips even incorporate decoder/drivers for seven-segment light-emitting-diode displays. Higher-resolution units for 4½-digit applications are appearing, and several newer devices include three-state output buffers for microprocessor hookup. Moreover, in the near future, chips made with an MOS process will likely bring the integrator capacitor inside the package.

The real key to the improving performance of monolithic converters is simply the fabrication and trimming of the thin-film resistors needed for d-a and successive-approximation a-d converters. Semiconductor manufacturers have now learned how to adapt existing thin-film resistor technology to their needs, although opinions differ as to which trimming technique is best for their purposes.

Most producers are doing straightforward active laser trimming—that is, they directly laser trim the resistors for ratiometric accuracy with power applied. Several others are using a method popularly dubbed zener or diode zapping, where zener diodes connecting the resistors are selectively short-circuited under reverse bias.

All these methods work well for the companies using them. Probably the major difference between them is the continuous nature of the direct laser trimming versus the discrete, or step, nature of the zener-zap and metal-link trimming. Also, as its proponents point out, direct trimming permits simultaneous adjustment of both offset and drift.

Interestingly, a passive-component technology has largely been the stumbling block of monolithic converters. Most, if not all, semiconductor manufacturers would like to get rid of the network altogether, so the search continues for conversion techniques that better lend themselves to semiconductor technology. □

RF Power Amplifiers?

One unit may be all you'll ever need.

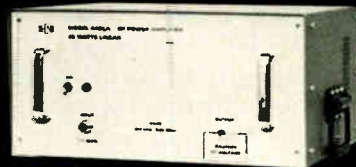

If you have the ENI Model 440LA ultra-wideband solid state power amplifier, all you need is a laboratory signal generator and you've got the ultimate in linear power for such applications as RF/EMI testing, NMR/ENDOR, RF transmission, ultrasonics and more.

Capable of supplying more than 40 watts of RF power into any load impedance, the 440LA covers the frequency range of 150 kHz to 300 MHz.

We could mention unconditional stability, instantaneous failsafe provisions and absolute protection from overloads and transients, but that's what you expect from any ENI power amplifier, and the 440LA is no exception!

Our catalog contains complete specifications on the 440LA as well as the entire line of ENI amplifiers, and is available without obligation, of course.

For further information or a demonstration, contact ENI, 3000 Winton Road South, Rochester, New York 14623. Call 716-473-6900, or Telex 97-8283 ENI ROC.

ENI

The World's Leader
in Power Amplifiers

Navigation

Civilians to get Loran-C

As sea lanes approach saturation, Coast Guard speeds toward implementation—but major benefits may be on land

by Bruce LeBoss, New York bureau manager

As sea lanes approaching U. S. ports near saturation, the risk of vessel collisions and groundings grow. To prevent them, the U. S. Coast Guard is going full speed ahead to set up a precision positioning system for marine navigation. But the major benefits of the long-range navigation system, called Loran-C, may well come ashore.

By the end of this month, the Coast Guard hopes to have finished and in operation along the Canadian west coast and Gulf of Alaska new groups (or chains) of transmitting stations that consist of one master station and at least two secondary stations. Along with a new chain that went into operation along the U. S. west coast in April, this will end the first phase of a major upgrading of radio-navigation service in the zone from 200 miles offshore into the rivers and harbors.

The next phases of the Coast Guard program call for expanding and upgrading an existing Loran-C chain on the east coast and adding a similar chain along the Gulf of Mexico, both of which are to be in place by the summer of 1978. The addition of yet another Loran-C chain in the Great Lakes area, to be operational in early 1980, would complete the nationwide system.

Like its predecessor, Loran-C is a navigation system in which the time difference between hyperbolic pulses is measured to fix a vessel's position. Whereas Loran-A signals are single pulses that give the system a fix accuracy of 0.5 to 2 nautical miles, the Loran-C pulse consists of a carrier that rapidly increases in amplitude in a carefully controlled manner and then decays at a speci-

fied rate. This provides a more accurate means of measuring time differences and a fix accuracy of 0.1 to 0.5 nautical mile, repeatable to 100 feet. Furthermore, Loran-A operating at 2 megahertz has a ground wave range of 700-900 nautical miles, whereas substantially increased ranges (1,200 to 1,500 nautical miles) are achieved with Loran-C, which transmits in the 90-110-kilohertz band. The low frequency of Loran-C also permits propagation of signals over land.

The cost of the new Loran-C stations, including electronic and power equipment and installation and construction, is about \$5 million per station, says Commander Paul Pakos, chief of the Coast Guard's Systems Development branch in Washington, D. C. In addition, the cost of upgrading existing Loran-C stations to provide a signal-to-noise ratio of 1 : 3 or better (compared with 1 : 10 or greater for existing stations), "is \$1 million to \$1.5

million for the new electronics," Pakos adds.

The Coast Guard is in the throes of calibrating five of the eight Loran-C transmitters built by International Telephone & Telegraph Corp.'s Avionics division in Nutley, N. J., for the three chains that cover from the Pacific coastal waters of Mexico up to Canada and the Gulf of Alaska. All but one of the ITT transmitters are new versions of the vacuum-tube FPN-44, a 400-kilowatt peak-power system. But the new transmitters have solid-state, in place of vacuum-tube, power supplies and regulators, Pakos says.

The lone ITT transmitter not of the FPN-44 variety is a 1-megawatt-peak-power system designated the FPN-45. The reason for the 1-MW transmitters, explains Pakos, is that "sometimes, to get a good hyperbolic signal, the stations needs to be located inland where the attenuation is much more severe than over water." Another reason for the

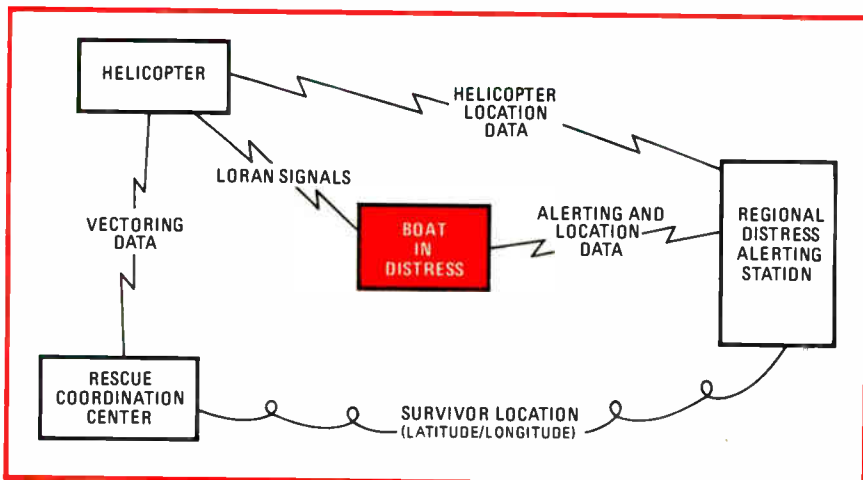

Mayday. The new Loran-C long-range navigation system of "chains" along the U.S. coastline will operate in the manner shown above in a typical search-and-rescue operation at sea.

higher power, he adds, is because "certain stations are optimized for longer-range coverage."

There are no plans yet to replace the vacuum-tube Loran-C transmitters recently installed on the west coast with solid-state units, Pakos reports. But before the Loran-C systems can be effectively implemented, much more needs to be done, says John M. Beukers, president of the Wild Goose Association, an organization of more than 400 industry and government officials with a common interest in Loran systems.

For one thing, in its new navigation safety regulations, expected to be published this fall, the Coast Guard proposes to require Loran-C receivers on all vessels of 1,600 or more gross tons that enter U.S. waters. The receivers would be required to have features available on receivers selling today for \$3,000 to \$5,000.

In addition to the Loran-C receiver market on large vessels, Beukers notes there are an estimated 75,000 Loran-A receivers out among commercial fishing boats, "and they'll all have to convert to Loran-C. But they'll likely do it with the \$1,000 manual receivers and not the \$4,000 automatic ones."

An even larger potential marine market exists among the several million pleasure-boat owners, notes Beukers, "but I don't think the Loran-C receiver market will really open up to the pleasure-boat owner until the price of automatic receivers falls below \$1,500."

But perhaps the biggest potential for Loran-C receivers is on land. When all of the planned chains are operational, the Loran-C signals will propagate over two thirds of the land mass of the continental U.S., covering about 95% of the population, says Commander William B. Mohin, chief of the Coast Guard's Loran-C Applications Project office. "Indeed, there's an enormous bonus to transportation and to other fields by making use of those highly stable signals coming inland," he adds. That's why the Coast Guard plans to request another \$20-25 million to build three stations in Montana, Colorado, and Texas that would make a mid-continent chain. □

the Chip makes the difference in...



NORTH ATLANTIC Angle Position Indicators

with LSI and 48 hour burn-in

- high reliability
- simplified circuitry

the Same Accuracy at One-Half the Cost

Model 8300

.01° Resolution
Lazy Eight Ambiguity
Indicator
Programmable for Synchro
or Resolver and Line-Line
Voltage
2 channel

Model 8800

0.005° accuracy, 5½ digits
Small-size, remotely
programmable
Synchro and/or resolver —
auto line/line select
2 channel
IEEE Interface (optional)
for ATE

CALL OR WRITE FOR
COMPLETE SPECIFICATIONS



NORTH ATLANTIC
industries, inc.

200 TERMINAL DRIVE, PLAINVIEW, NEW YORK 11803
cable: noatlantic / twx: 510-221-1879 / phone: (516) 681-8600

Tally's got your number!

from 40 to 500 lines per minute



40 to 100 lpm



55 to 150 lpm



70 to 200 lpm



125 lpm



200 lpm



300 lpm



375 lpm



500 lpm

Whatever your data volume, Tally can fit a printer to it. Tally's ever expanding family of matrix printers offers top value in price/performance.

With Tally, you'll get cost effectiveness you can measure. The cost effectiveness of selecting a printer tailored to your requirement. A low cost of ownership printer that requires no preventive maintenance, that has no duty cycle limitations. A printer that's priced low to start. There's a lot to like with Tally printers. Easy operation. Superb print quality. Plenty of forms control features. Steadfast reliability. Easy to interface.

So talk to Tally about your printing needs. Call your nearest Tally sales office or contact Tally Corporation, 8301 S. 180th St., Kent, Washington 98031. Phone (206) 251-5524.

OEM Sales Offices:

Los Angeles (213) 378-0805

San Antonio (512) 733-8153

New York (516) 694-8444

Business Systems (415) 254-8350

Boston (617) 272-8070

Chicago (312) 325-9788

Seattle (206) 251-6730

TALLY

Companies

Rockwell hopes shake-up is recipe

Microelectronic Devices is downgraded from division status, gets new management, and signs second-source deal with MOS Technology

by Larry Waller, Los Angeles bureau manager

By any standard, Rockwell International's former Microelectronics Device division has undergone a thorough shaking up this year. Yet with a new status—downgraded from a division—different management, and a changed microprocessor development outlook, the old question remains. After many abortive tries, is it finally on the right track to workable n-channel metal-oxide-semiconductor devices?

"We have it this time, we're sure it's right," answers Malcolm B. Northrup, who was put in charge of the Anaheim, Calif., operation in February. Specifically, he is vice president of the microelectronic devices segment of the Electronic Devices division, created to pull together 10 separate circuit operations formerly scattered throughout the Electronics Operations group.

Northrup pins his plans on a licensing agreement with MOS Technology Inc. Announced without fanfare in April, it allows Rockwell to produce and market the n-channel 6500 family of microprocessors. The contrast between this deal and the much-ballyhooed 1975 exchange pact with National Semiconductor Corp. goes far beyond the difference in decibel levels, as Northrup explains it, for it confirms that the previous agreement is now "dead as a doornail."

"The National deal was an honest agreement," he says, "but we both got to the point where we couldn't figure out why we were second-sourcing each other." In other words, the technology, customer lists, and product lines of Rockwell and National Semiconductor just did not mesh.



The optimist. Malcolm B. Northrup, who is the new man in charge of Rockwell's Microelectronic Devices operation, has a deal with MOS Technology to fuel his ebullience.

When the agreement's unworkability became apparent, Northrup himself was called in last October to lead a "task force to find the solution." At that time he was managing mechanical-filter and MOS large-scale-integration business for Collins Radio Co., another Rockwell group. Several factors impelled Rockwell to make the MOS Technology decision in February. "We figured enough companies already were in the 8080 camp," Northrup says, "and we had the high-volume production and sales organization MOS Tech needed."

Prepared. With this decision, Rockwell prepared the technology transfer properly this time, instead of "grabbing the mask and running," as with National. One result is 98% of the technology and processes are

in place at Anaheim, and the company already is producing in volume to meet the first contract this month. Rockwell's 6500 line initially covers 10 MOS Technology central-processing devices.

For memory devices to go with n-channel, Rockwell also is going outside, since its own program ran into problems. Here, it will build three read-only memories and four static random-access memories under license from Synertek of Santa Clara, Calif.

"We're not stopping p-channel," Northrup insists, "but we are working to make the 6500 a natural bridge to address the 8-bit market, on the way to an integrated product line." Interestingly, Northrup reports that the pressure to get n-channel devices does not come

A MIXED BAG

... that solves a lot of shielding problems. Pick one group or all four.

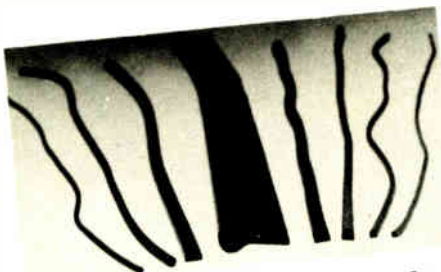

Circle item 83 to receive our conductive elastomer EMI/RFI shielding and sealing products catalog!

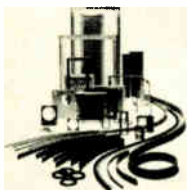

Our new wire mesh-based gaskets, air vents and shielded windows are covered in our new revised Brand-C catalog. This new catalog is a total replacement for the original and contains new part numbers which must be used in placing orders. Circle number 84.

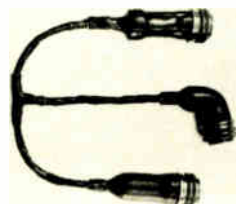

Chomerics heat shrinkable tubing and boots provide light-weight EMI shielding, grounding and strain relief. Circle number 264.



For conductive compounds in such forms as coatings, adhesives, caulks and inks, circle number 265.

Pick one or all - but stay with the leader - CHOMERICS

CHOMERICS

77 Dragon Court
Woburn, MA 01801
(617) 935-4850

Probing the news

from any present p-channel customer demanding it. "Rather, he has to look and see that n-channel is there, if and when he needs it," says the new vice president.

Although yet another reorientation of microprocessor plans gets most of the attention, Northrup thinks some other changes could be more important to the company in the longer run.

In particular, he singles out the move that brought the 300-person Electronic Research Center into the division from the Autonetics group. "Before, together we had so many resources, but organizational barriers kept us apart." Now, Northrup and his managers have stepped up programs aiming at the next generations of device technology. These include advanced n-channel work on very large-scale integration intended to match that of other semiconductor houses, as well as silicon-on-sapphire devices that are close to commercial level and bubble domain memories.

Northrup's ultimate goal, which he puts three to four years away, is a product line of off-the-shelf modules that can be put together in custom configurations at low cost. "These will be customized devices that vary the CPU, ROM, and RAM on the same chip," he foresees.

Collins flavor. Both Microelectronic Devices and the parent division have taken on a distinct Collins Radio flavor. Northrup has brought in colleagues, and division president Howard D. Walrath, a Collins veteran, has liberally staffed other segments of his command with Collins executives.

This infusion of proven Collins managerial talent is seen by many as central to the strategy of Donald R. Beall, Electronics Operations president, to get Microelectronic Devices moving quickly. Employing 1,900 of the more than 3,000 people in the division, it is by far the largest part. Beall himself, who ran Collins before being named to his present job about a year ago, was instrumental in making that company into a highly successful operation after it was acquired by Rockwell. □

WE'RE WARNING YOU™



Series X-20
Actual Size

... panel mounting is made very easy with these new piezo crystal audio indicators. They fit a 1.125" (28.6mm) diameter opening in panels as much as 0.125" (3.2mm) thick. Behind panel depth only .500" (12.7mm)! Can be used for computer terminals ... or remote control warning, fault detection and alarm devices ... or to replace other, larger alarms. Continuous tone 35mm diameter sounding element really gets attention. Rated to 85 dbA at 3.3 kHz; 6 to 16 vdc; current drain just 10 mA. Terminals accept 0.187" (4.76mm) disconnects, screws or solder. Ask for free catalog and a demonstration.

Where to buy an audio indicator for every need:



3680 Wyse Road, Dayton, Ohio 45414
Tel. (513) 890-1918, TWX 810-450-2523

Distributors throughout the world.

CALIFORNIA, COSTA MESA
MarVac Electronics

CALIFORNIA, SUNNYVALE
Pyramid Electronics

COLORADO, DENVER
Waco Electronics Inc.

MASSACHUSETTS, SHARON
Adcour

MICHIGAN, FARMINGTON
CMP Distributor Co.

MISSOURI, ST. LOUIS
Olive Industrial Elec.

NEW JERSEY, WAYNE
Gordon/Horne, Inc.

NEW YORK, ROCHESTER
Ossmann Component Sales

OHIO, CINCINNATI
Hughes Peters Inc.

OHIO, CLEVELAND
CMP Distributor Co.

OHIO, COLUMBUS
Hughes Peters Inc.

OHIO, DAYTON
NASCO

TEXAS, DALLAS
GARLAND

K. A. Electronics

WASHINGTON, SEATTLE
Frank Jackson & Associates

WISCONSIN, MILWAUKEE
Taylor Electric Co.

B. C., VANCOUVER
Deskin Sales Corp.

ONTARIO, TORONTO
Deskin Sales Corp.

ONTARIO, WILLOWDALE
Electro Sonic, Inc.

QUEBEC, MONTREAL
Deskin Sales Corp.

Circle 85 on reader service card

MDB SYSTEMS presents... The LSI-11 Connection

GP Logic Modules · Peripheral
Controllers · Communications
Interfaces · Special Purpose
Modules · Accessory Hardware
Plus: DEC's own LSI-11 Micro-
processor Module.

Here are some MDB Systems
connections to LSI-11
microprocessors:

- General Purpose Interfaces:
Parallel for programmed I/O
and DMA.
Do-it-yourself dual and quad
wire wrap for any DIP design.
- Device Controllers for most
major manufacturer's
Printers
Card equipment
Paper tape equipment
Plotters
- Communications/Terminal
Modules
Asynchronous Serial Line
Synchronous Serial Line

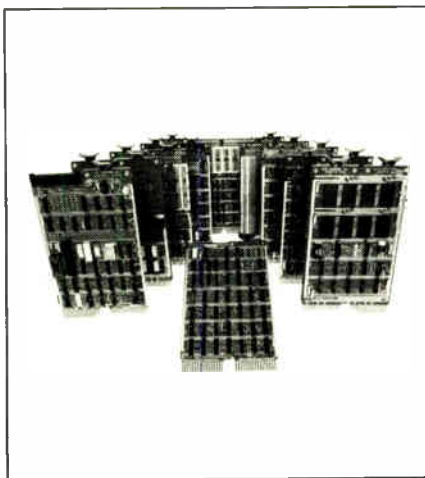

- MDB Backplane/Card Guide
Assembly (8 Quad slots)
Rack mount chassis 5¼"
front panel.
- Special Purpose Modules and
Accessories
System monitoring unit
provides front panel switch
addressing, power on/off
sequencing; line frequency
clock.

- Bus extenders/terminators.
E-PROM and PROM modules.
Bus connectors for backplane
assemblies.

MDB Systems products always
equal and usually exceed the
host manufacturer's specifica-
tions and performance for a
similar interface. MDB interfaces
are software and diagnostic
transparent to the host computer.
MDB products are competitively
priced; delivery is usually within
14 days ARO or sooner.

MDB also supplies interface
modules for DEC PDP-11 Data
General NOVA* and Interdata
minicomputers.

MDB
MDB SYSTEMS, INC.

1995 N. Batavia St., Orange, California 92665
714/998-6900 TWX: 910-593-1339

*TMs Digital Equipment Corp. & Data General Corp.

CIRCLE NO. 267 FOR LSI-11; 268 FOR PDP-11; 269 FOR NOVA; 270 FOR INTERDATA

BENDIX BRISTLE BRUSH BUNCH.

Opens new horizons for PCB design.

Free and easy are now the bywords for board and board support design with the 70% to 90% reduction in mating and unmating forces offered by the new Bristle Brush Bunch connector series from Bendix.

The need for costly board support systems is minimized.

You get extended interconnection contact counts and versatility—up to 400 contacts per connector.

You can choose from a broad product line:

- 2-, 3- and 4-row Mother Board, Daughter Board, PC receptacle and Input/Output body styles.
- Removable crimp, solderless wrap, straight or 90-degree PC stud and willowy tail termination.

For complete information, contact The Bendix Corporation, Electrical Components Division, Sidney, New York 13838.

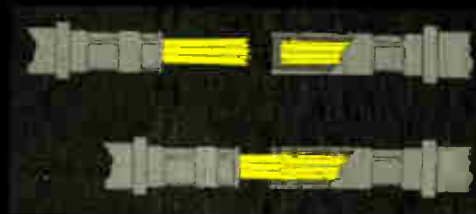

CONTACT INNOVATION

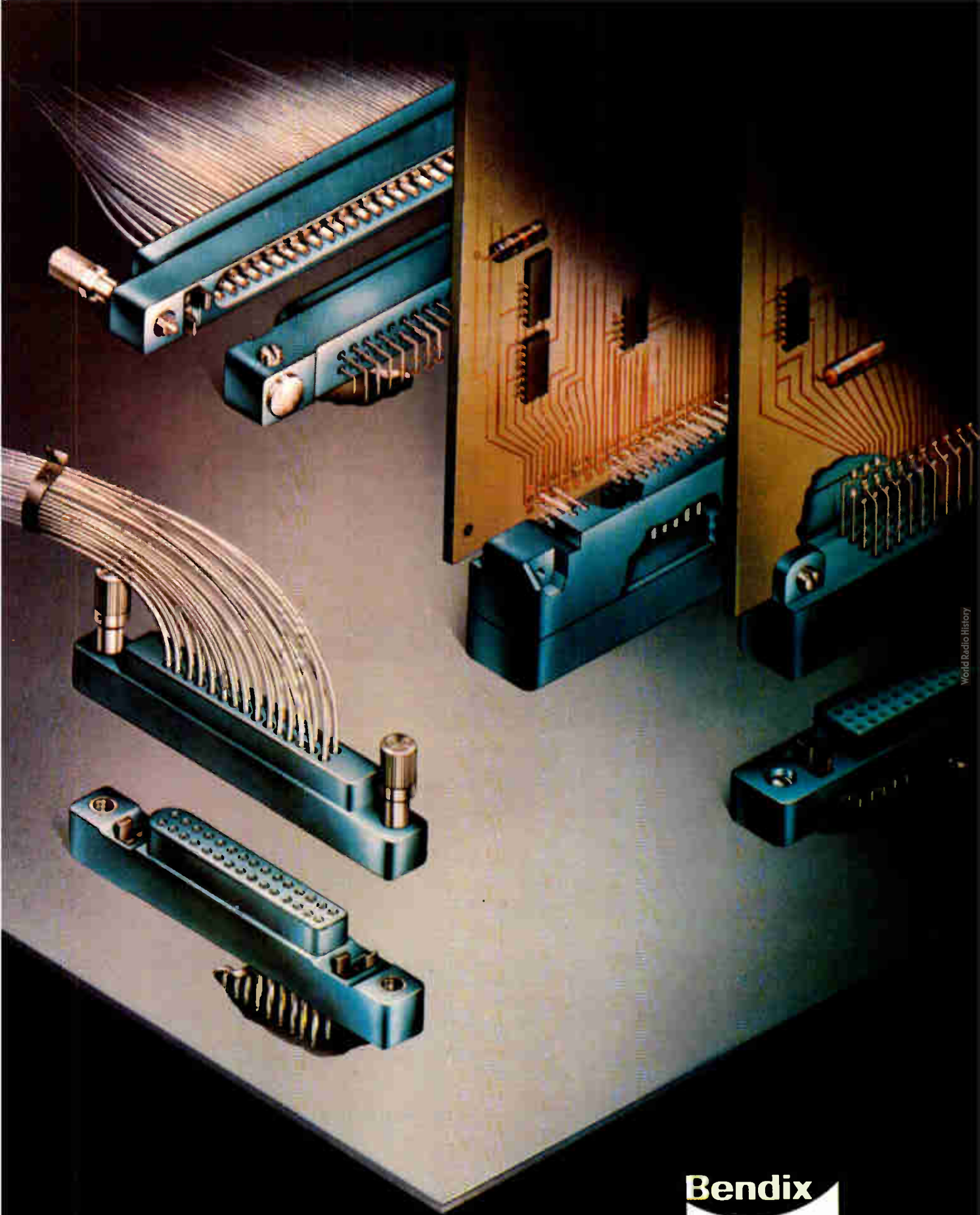

World Radio History

Bendix



Companies

HP Components group breaks the mold

By investing 10% of profits in R&D, selecting its market areas, and selling abroad, the group far outpaces the industry norm

by Bernard Cole, San Francisco bureau manager

According to traditional wisdom, the discrete semiconductor marketplace, which over the years has been losing its share of total semiconductor sales to integrated circuits, is not a place where a company will experience dramatic growth.

It is a market where the company doing \$10 million to \$50 million in sales a year is the norm and where 4% to 5% growth is considered spectacular. It is also a market where companies tend to focus on a particular segment and concentrate all their energies there to the exclusion of others.

But one organization seems to have violated all these rules—and to have done so successfully. With yearly sales now approaching the \$150 million to \$200 million level, it is larger than many traditional IC houses. Over the past five years, it has grown more than 30% in total sales. Moreover, net profit usually ranges from 8% to 10%, about double the profit margin of most IC houses. Finally, it is definitely not a one-product or one-technology company; its line spans the entire discrete market: light-emitting diodes, infrared detectors, optically coupled detectors, solid-state numeric and alphanumeric displays, microwave transistors, microwave diodes, radio-frequency and general-purpose diodes, and hybrids of various types.

The company is Hewlett-Packard Co.'s Components group in Palo Alto, Calif., the successor organization to the former HPA division, which succeeded HP Associates. The obvious explanation for its remarkable growth—internal sales to other HP groups and divisions—is not the answer. "That may have been the



Strong to the outside. Components group manager David Weindorf says that 85% of its sales are outside Hewlett-Packard.

way we started out," says group manager David Weindorf, "but that reaches a steady state after a few years. Most of our sales—85%—are the result of orders from outside."

Components group products, he says, are sold to many major companies for a variety of applications, including space exploration, microwave ovens, cameras, automobiles, communications satellites, radios, radar, heart pacemakers, instrumentation, computers, and calculators. HP Components' customers include IBM, Hughes, Delco, and Chrysler.

The keys to the group's success, says Milton Liebhaber, group marketing manager, are technological leadership, careful selection of market areas, and an emphasis on international sales. "About 10% of our profits each year goes into research and development," he says, "and we apply this technology to market areas in such a way as to ensure a dominant share."

Among the first of its high-quality

products, developed in 1964, was a hot-carrier Schottky diode for use in high-frequency diodes. In 1968, after extensive R&D, HP entered the optoelectronics field with the first commercially available light-emitting-diode technique.

The group's Microwave Semiconductor division has developed a low-cost double-balanced mixer that has high-volume use in such diverse areas as fm stereo and television receivers, cable TV converters, communications systems, high-level receiver front ends, up/down converters, and phase detectors. Late last year, the Microwave division also introduced a high-frequency, high-gain, and low-noise microwave transistor, using ion implantation and a variety of techniques new to discrete-semiconductor technology.

In the works, says Weindorf, are a new series of Schottky diode chips aimed at replacing germanium diodes in numerous applications, as well as a whole range of new products based on the group's newly developed gallium-arsenide field-effect-transistor technology. For the longer term, there is a whole new series of silicon-based microwave transistors.

According to Liebhaber, the group is eyeing a new market area: optical communication. "Fiber-optics technology has advanced to the point that long-range communication via light beams is now possible. What needs to be developed is the means to link the fiber optics more efficiently to existing electronic systems." Liebhaber sees this market as a definite opportunity for the group's gallium-arsenide-based LED and FET technology. □



We figured a way to cut the cost of interface in half.

So what? So OEM's are dancing in the streets, that's so what. At least the pros are.

And what makes it such a big deal is the magnitude of the cost savings—possibly 20% or more per computer system.

One reason is that interfaces are generally long on duplication and short on common sense. Most interfaces, for example, faithfully repeat half or more of the circuitry on all the other interfaces. And with multiple interfaces, that gets to be a pretty expensive proposition.

And once you get by its unorthodox appearance, the logic of it becomes pretty appealing. As do the cost savings.

All the basic circuitry is located on a single half-card I/O

Distributor, which can be shared by as many as eight "Intelligent Cables." Packaged into every cable is an integral PicoProcessor, which handles the functional control for each interface.

This arrangement allows much smaller computer packages, since only one I/O

board is housed inside the computer cabinet.

And along with a smaller package, comes a smaller price.

The I/O cost comparison at left shows the savings on a typical four-interface system (2 CRT's, 1 line printer and 1 card reader). And since our System handles up to eight interfaces, imagine your savings using its full capability.

Consider ComputerAutomation's Distributed I/O System. It's an uncommonly sensible solution to a commonplace problem. From the price/performance people who brought you the NAKED MINI®

| Supplier A | Supplier B | CA |
|------------|------------|-------|
| \$2077 | \$1414 | \$752 |

I/O System cost comparison

So we came up with the solution you see here: The Distributed I/O System. Designed to work specifically with our line of NAKED MINI® computers.

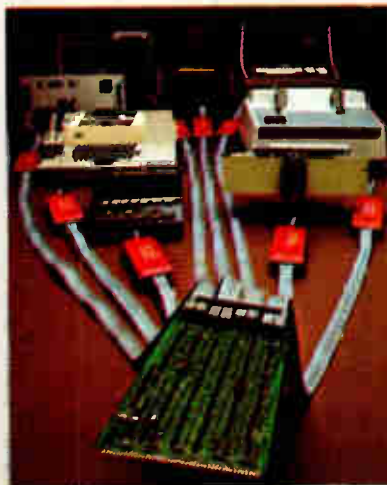

The Distributed I/O System
World Radio History



ComputerAutomation
NAKED MINI® Division
18651 Von Karman, Irvine,
California 92713, (714) 833-8830

Circle 89 on reader service card



The LSI-11 microcomputer is really getting the plastics business rolling.

There's a new computerized extrusion process control system for plastic sheet and film that improves material uniformity by up to 75%. It also decreases usage of expensive resins by up to 10%, while automatically maintaining close produce tolerances. Yet it's one of the most effective extruder control systems you can buy.

It's called the Measurex 2000/25.

And it's run by an LSI-11—the highest performance, most software-supported microcomputer you can buy.

For Measurex Project Manager Dave Stepner, anything less than the LSI-11 simply wouldn't have been enough.

"We were looking to develop the most cost effective, full state-of-the-art system on the market," says Dave. "With the LSI-11, we got the computer power and 16-bit accuracy we needed, plus packaging flexibility."

What Dave Stepner liked most about the LSI-11 compared to other microcomputers, was its full

16-bit accuracy and hardware floating point option. "We have to do a great deal of high speed, accurate calculations to support our sensors and control algorithms. The LSI-11's 16-bit word length and floating point arithmetic let us accomplish this and not sacrifice response or performance."

The people at Measurex were also looking for real flexibility and expandability in their system.

"Thanks to the LSI-11's capability, we were able to design a distributed architecture which links up to eight dedicated Measurex 2000/25 control stations, each with

its own LSI-11, to a central intelligent data terminal for management reporting. And because of the LSI-11's low cost and single-board packaging, we can provide customers with a spare computer on site."

Dave Stepner concludes: "The LSI-11 really has everything going for it. The instruction set allows for very efficient coding—the technology has been tested and proven—and, of course, Digital has a mass production and delivery capability well matched to our needs."

Why not do like Measurex's Dave Stepner and get in touch.

We'll show you how the LSI-11 can get your business rolling too.

(For 600 pages of solid technical information, plus our new brochure of microcomputer case histories, "Why Anything Less than the LSI-11 Wasn't Enough for Me," just call toll free 800-225-9480 (in Mass. 617-481-7400 ext. 5144), or write Digital Equipment Corporation, One Iron Way, Marlborough, Massachusetts 01752.)



Dr. Dave Stepner,
2000/25 Project Manager, Measurex Corp., Cupertino, CA.

digital
COMPONENTS
GROUP

time domain.



data domain.

Biomation's new logic analyzers give you both.

When your job is to interface, integrate and program a complex new digital logic system, you want as much information as you can get.

That's why we're providing a new set of tools which let you display timing information as well as logic word content—in the language of your choice.

Our new 1650-D logic analyzer gives you 16 channels at 50MHz. Our 851-D gives you 8 channels at the same speed.

Accessories can now give you a logic state (1's and 0's) display of any 16 stored words; hex or octal translation; and a vector map of memory contents. The 8 and 16-channel logic analyzers feature:

- Pretrigger and delayed trigger recording
- Trigger point can be easily identified
- Latch record mode for fast pulse capture
- Combinational triggering (true or false)
- Movable display cursor that stays with the data when you switch display modes
- Display expansion, mixed or full, X5, X10 or X20

These are complex instruments and we can't give you all significant details here. But please write, call, or use the reader service card. We want to get this useful information into your hands. Biomation, 10411 Bubb Road, Cupertino, CA 95014, (408) 255-9500. TWX: 910-338-0226.

CURSOR LOCATION

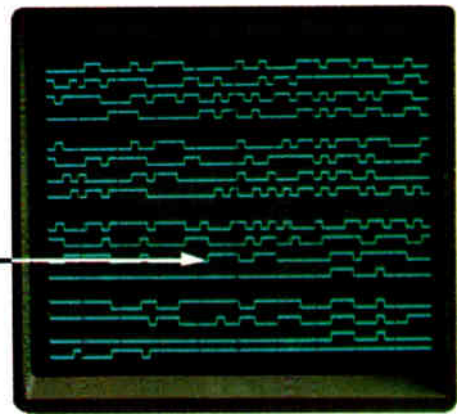

Biomation's new 1650-D produces a repetitive display output reconstructing precisely 500 bits per line for a 16-line timing diagram on a conventional oscilloscope or CRT display. Separate selection of individual channel outputs allows viewing of 1, 2...16 channels at one time with automatic vertical expansion.

CURSOR WORD

CURSOR

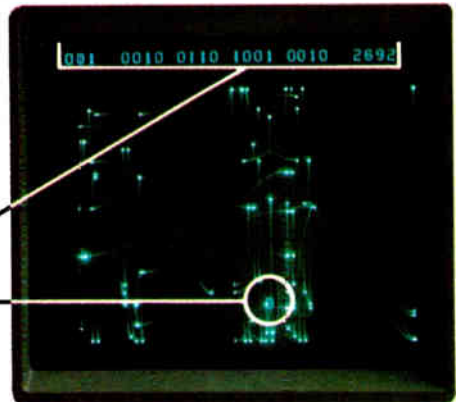

Map—each word in memory is transformed via two DAC's to form a unique dot which characterizes that word. All 512 words of the 1650's memory can be accessed for mapping. The cursor word is circled in the map as well as displayed at the top of the screen in alphanumeric form. The cursor may be moved to any of the points in the map for positive identification of that word. In addition, a map of only 16 words may be selected.

CURSOR WORD

RELATIVE ADDRESS

TRUTH TABLE

HEX OR OCTAL TRANSLATION

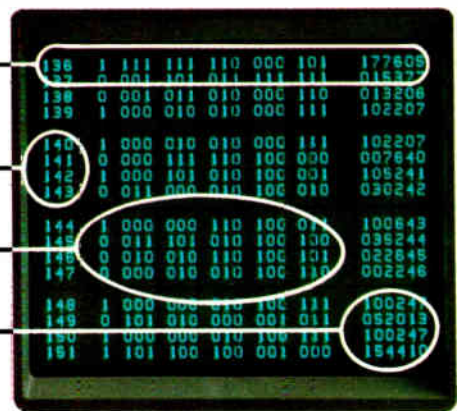

Logic state—provides memory address, location, binary output of the 16 channels and selectable octal or hexadecimal translation. 16 words are displayed at one time with the cursor address location at the top of the screen. Movement of the cursor control allows accessing any 16 words of the entire 512 words stored in the 1650-D. The display control memory can store 16 words while a different set of 16 is selected from the 1650's main memory (or a new recording is made). These two sets of 16 words can then be overlaid on the CRT. Any differences will blink and be easily identified.

biomation
Creating tools for technology

Try this on your old logic analyzer:

```
3F1  bd 7F W 00 E3 1 0 1 FF 1 1 1 1 1 0 1 0
3F2  d  FF R 11 FF 1 1 1 FF 1 1 1 1 1 0 1 0
3F3  a dt 00 R 00 FF 1 0 0 FF 1 1 1 1 1 0 1 0
3F4  d d 00 W 00 E3 1 0 1 FF 1 1 1 1 1 0 1 0
3F5  d d 00 W 00 FF 0 1 0 FF 1 1 1 1 1 0 1 0
3F6  d d 00 W 00 FF 0 1 0 FF 1 1 1 1 1 0 0 0
3F7  d dt 00 R 11 FF 1 0 1 FF 1 1 1 1 1 0 1 0
3F8  FF R 11 FF 1 1 1 FF 1 1 1 1 1 0 1 0
3F9  FF R 11 FF 1 1 1 FF 1 1 1 1 1 0 1 0
3FA  FF R 11 FF 1 1 1 FF 1 1 1 1 1 0 1 0
3FB  FF R 11 FF 1 1 1 FF 1 1 1 1 1 0 1 0
3FC  FF R 11 FF 1 1 1 FF 1 1 1 1 1 0 1 0
3FD  FF R 11 FF 1 1 1 FF 1 1 1 1 1 0 1 0
3FE  FF R 11 FF 1 1 1 FF 1 1 1 1 1 0 1 0
3FF  FF R 11 FF 1 1 1 FF 1 1 1 1 1 0 1 0

Header:  data rs A: P0 cl e2 virq B: P0 cl e2 virq o cs: 0,2,1 +rese
a qual:  00 R 00 FF 1 0 0  XX X X X X 1 0 1 0
b qual:  7F W 00 E3 X X 1  XX X X X X 1 0 1 0
OSC:     XX X XX  XX X X X  XX X X X X 1 0 1 0
TRIG:   XX R XX  XX X 0 X  XX X X X X 1 0 1 0
STATUS:  DELAY=0006 CLX=OSC FORMT=15020 EDIT=15020
Lights:  F1:RUN F2:STOP DELAY: F3:TRC F4:EDIT: F6:WRITE
```

You can't, can you?

Your logic analyzer isn't software controlled. Ours is. As the latest addition to our Microcomputer Development Center, it's the only logic analyzer with computer power to do things your way.

Instead of a few buttons to give you binary, octal, hexadecimal or symbols, you can choose your own layout and format. Even disassembly.

We start you off with a floppy file of 6800 family formats for the MPU, memories and peripheral circuits, such as the PIA on the

screen. You take it from there. Alter them, build your own right on the CRT while you check the captured data, even save new formats on the disk with the help of our analyzer's built-in text editor. And you can do it with any circuit or digital logic family.

What else is new? 40 channels. 1024 traced steps. Delay from 0 to 64K clocks. Four clock types with speeds up to 10 MHz. Two qualifiers to start the delay ticking, a third to define clock cycles and a fourth to trigger external equipment.

The cost of this digital design breakthrough is less than \$4000. Considering our recent price cuts on the MDC (now \$9600) and entire 6800 family, you're really getting a lot for your money.

Have some free BASIC.

We have some new software that comes absolutely free when you buy our Microcomputer Development Center. This includes full BASIC, Macro Assembler, and a display-oriented editor. Put it all together with our very smart CRT terminal, dual floppy disks and full debug firmware—and you have the easiest way of developing the best microprocessor on the market.

You'll find our logic analyzer, MDC and all the 6800 parts you need at your nearest AMI distributor or sales office. Or write us for complete details at AMI, 3800 Homestead Road, Santa Clara CA 95051. Phone: (415) 246-0330. It's the only logical way to go.

AMI
AMERICAN MICROSYSTEMS, INC.

See us at Booth 1051/1053
at the National Computer
Conference in Dallas,
June 13-16.

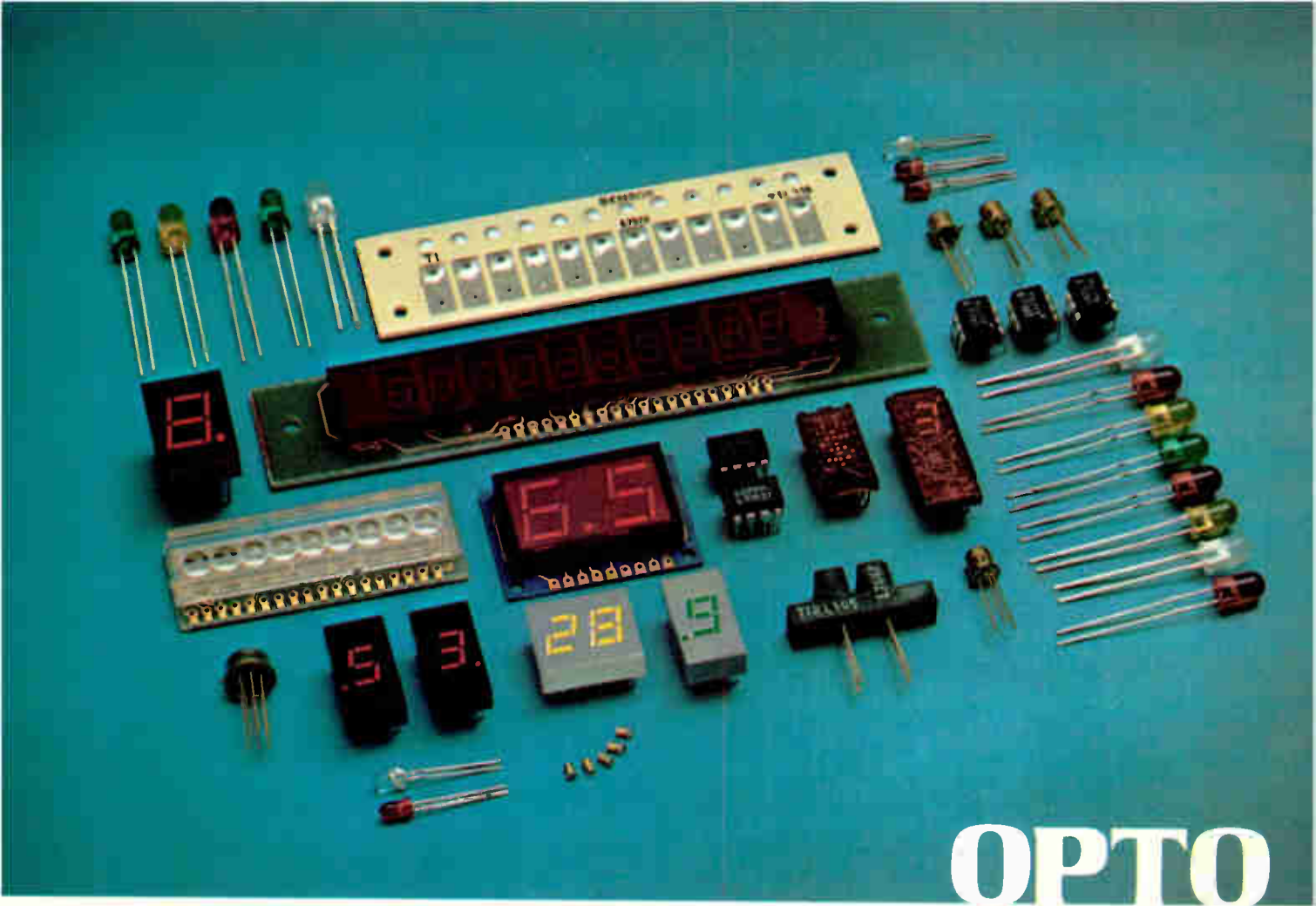

Highest quality at lowest cost. Optoelectronics... from Texas Instruments.

Quality need not be expensive. With TI's optoelectronics family you get both superior technology and the industry's lowest prices.

Compare cost and performance before you buy. Across the complete product spectrum, you can have the best for less from one of the industry's largest opto producers ... Texas Instruments.

Discrete VLEDs.

These reliable solid-state light sources, designed for use in both panel and pc board applications, are available in three colors and two package sizes.

Their solid epoxy bodies with diffused lenses afford maximum viewing angles, except for the TIL221 which has a water-clear epoxy body for pinpoint illumination.

| Visible Light Emitting Diodes | | | | | |
|-------------------------------|--------------|------------|-------------------|----------------------------|-----------------|
| Device | Source Color | Lens Color | Package Outline | Typical Brightness @ 20 mA | 100-Piece Price |
| TIL209A | Red | Red | T-1 | 0.8 mcd | .17 |
| TIL216 | Red | Red | T-1 | 6.0 mcd | .28 |
| TIL220 | Red | Red | T-1 $\frac{3}{4}$ | 1.0 mcd | .20 |
| TIL221 | Red | Clear | T-1 $\frac{3}{4}$ | 1.2 mcd | .20 |
| TIL228 | Red | Red | T-1 $\frac{3}{4}$ | 8.0 mcd | .32 |
| TIL212 | Yellow | Yellow | T-1 | 4.0 mcd | .28 |
| TIL224 | Yellow | Yellow | T-1 $\frac{3}{4}$ | 6.0 mcd | .32 |
| TIL211 | Green | Green | T-1 | 1.5 mcd | .24 |
| TIL222 | Green | Green | T-1 $\frac{3}{4}$ | 1.6 mcd | .26 |
| TIL232 | Green | Green | T-1 | 3.0 mcd | .28 |
| TIL234 | Green | Green | T-1 $\frac{3}{4}$ | 5.0 mcd | .32 |

Low-Cost Displays

| Device | Character Height & Color | Type Characters | Connection | 100-Piece Price |
|--------|--------------------------|-------------------|----------------|-----------------|
| TIL312 | .3" - Red | 7 Segment - r&lhd | Common Anode | 1.36 |
| TIL313 | .3" - Red | 7 Segment - rhd | Common Cathode | 1.36 |
| TIL327 | .3" - Red | ± 1 - lhd | Common Anode | 1.36 |
| TIL314 | .3" - Green | 7 Segment - r&lhd | Common Anode | 2.85 |
| TIL315 | .3" - Green | 7 Segment - rhd | Common Cathode | 2.85 |
| TIL328 | .3" - Green | ± 1 - lhd | Common Anode | 2.85 |
| TIL316 | .3" - Amber | 7 Segment - r&lhd | Common Anode | 2.85 |
| TIL317 | .3" - Amber | 7 Segment - rhd | Common Cathode | 2.85 |
| TIL329 | .3" - Amber | ± 1 - lhd | Common Anode | 2.85 |
| TIL321 | .5" - Red | 7 Segment - r&lhd | Common Anode | 1.47 |
| TIL322 | .5" - Red | 7 Segment - rhd | Common Cathode | 1.47 |
| TIL330 | .5" - Red | ± 1 - lhd | Common Anode | 1.47 |

Circle 97 on reader service card

High-Performance Displays

| Device | Type Characters | Character Height | Package | 100-Piece Price |
|---------------|---|------------------|----------|-----------------|
| TIL302-304 | 7 Segment | .27" | Standard | 4.85 |
| TIL305 | 5x7 Dot Matrix Alphanumeric | .30" | Standard | 4.58 |
| TIL306-309 | 7 Segment with Logic | .27" | Standard | 9.15 |
| TIL311 | 4x7 Hexadecimal with Logic | .27" | Standard | 9.40 |
| 4N41 (TIL501) | 7 Segment | .27" | Hermetic | 47.37 |
| TIL505 | 5x7 Hexadecimal with Logic | .27" | Hermetic | 66.03 |
| TIL506 | 7 Segment with Logic | .30" | Hermetic | 57.41 |
| TIL507 | 5x7 Alphanumeric with Logic | .30" | Hermetic | 69.72 |
| TIL560 | 3-Character 5x7 Alphanumeric with Logic | .50" | Hermetic | 254.26 |

Circle 271 on reader service card

Seven-Segment Display Sticks

| Device | No. of Digits | Character Height & Color | Feature | 100-Piece Price |
|--------|---------------|--------------------------|------------------|-----------------|
| TIL361 | 2 | .50" - Red | PCB - Edge Conn. | 4.05 |
| TIL364 | 4 | .50" - Red | 12-hr Clock | 5.92 |
| TIL370 | 4 | .50" - Red | 24-hr Clock | 6.15 |
| TIL804 | 12 | .27" - Red | PCB - Edge Conn. | 11.65 |
| TIL807 | 2 | .30" - Red | CA - Plug-in Pkg | 2.88 |
| TIL808 | 2 | .30" - Red | CC - Plug-in Pkg | 2.88 |
| TIL809 | 2 | .30" - Amber | CA - Plug-in Pkg | 4.35 |
| TIL810 | 2 | .30" - Amber | CC - Plug-in Pkg | 4.35 |

Circle 272 on reader service card

Opto-Coupled Isolators

| Isolator Family | Part Numbers | Isolation Voltage | Package | 100-Piece Price |
|-----------------|-----------------|-------------------|-----------|-----------------|
| P-DIP | TIL111 - TIL119 | Up to 2.5 KV | 6-Pin DIP | from \$0.74 |
| Dual | MCT6 & MCT66 | Up to 1.5 KV | 8-Pin DIP | from 1.69 |
| JAN, TX, TXV | 4N22 - 4N24 | 1.0 KV | TO-5 MC | from 5.19 |
| Hi-Rel | TIL120, TIL121 | 1.0 KV | TO-72 MC | from 3.75 |
| UL Listed | TIL153 - TIL157 | 3.5 KV | 6-Pin DIP | from 0.93 |
| Hi-Voltage | TIL124 - TIL128 | 5.0 KV | 6-Pin DIP | from 0.99 |

Circle 273 on reader service card

Low-Cost Displays.

Continuous uniform segments, high contrast and brightness make the difference in TI's cost-effective single-digit VLED displays.

Red, green and amber .3" characters are available in 14-pin dual-in-line packages. Large .5" red devices are available in 10-pin DIPs.

High-Performance Displays.

Versatile capabilities for specialized applications. TI has a specialty display to fit the job you're doing.

- Alphanumeric
- Hexadecimal
- Built-in logic
- Hermetic packages
- Combinations

Seven-Segment Display Sticks.

Two-digit combinations for digital indicators including television and CB radio channel readouts. Four-digit sticks for 12 and 24-hour digital clocks. And the 12-digit TIL804 stick (red, .270" characters); the most digits on a single stick.

Opto-Coupled Isolators.

Six complete families for any opto switching need: P-DIP couplers, metal-can devices, duals, high voltage isolators, JAN and UL listed parts. Call TI or your distributor for complete specifications.

IR Emitters/Detectors.

High efficiency, spectrally matched infrared emitters and photodetectors for card and tape readers, encoders, intrusion alarms, level indicators and more.

Also available: nine and 12-channel arrays for precise alignment in card and tape readers and single-package assemblies for counting, flow and weight control, position sensing, timing and speed control.

Take advantage of the savings and convenience you'll find in TI's complete opto capability. For more information write Texas Instruments Incorporated, P.O. Box 5012, M/S 308, Dallas, Texas 75222. Please identify the device you are interested in by giving its TI part number.



TEXAS INSTRUMENTS

INCORPORATED

high voltage ceramic capacitors...

Georgia style.

Our "Georgia style" high voltage ceramic caps provide value and performance that are hard to beat . . . by anyone's standards. Ratings to 60 KVDC. Capacities to 9,300 pF. Epoxy resin encapsulation. Minimum size-capacity-voltage ratios. What's more, every capacitor is backed by Murata's 30 years of experience in the field and our "Georgia style" pride in a job well done.

If you need high voltage capacitors for HV power supplies or distribution systems, TV doubler and tripler supplies or virtually any other application, call Murata. Chances are we have just the "Georgia style" HV ceramic capacitor you need.



First in ceramics

1148 Franklin Road, S.E.
Marietta, Georgia 30067
Tel: 404-422-9777
Telex: 54-2329
TWX: 810-763-4723

Circle 98 on reader service card

THE GATHERING WAVE OF JAPANESE TECHNOLOGY

by Laurence Altman,
Solid-State Editor
and Charles L. Cohen,
Tokyo bureau manager



□ Japan's electronics manufacturers have embarked on massive development programs that are aimed at putting them on the leading edge of digital technology. Their goal is nothing less than a major position in the worldwide digital electronics market.

Today Japan supplies 4% of the world's computer and digital integrated circuits, but by 1980, the country's electronics makers intend to be major exporters of data-processing technology. With their consumer exports running into tougher tariff barriers and enforced quotas, they are looking to the multibillion-dollar data-processing market as their next growth sector.

There are two thrusts to the Japanese move into digital technology. First is an immediate attack on the digital components market now dominated by U.S. semiconductor manufacturers. Using n-channel silicon-gate technology developed over the past two years, individual Japanese companies are now ready to export large quantities of the most advanced 4,096-bit and 16,384-bit random-access memories, 4- and 8-bit microcomputers, and a host of digital large-scale industrial- and communications-control integrated circuits. To penetrate these markets quickly, Japanese suppliers are organizing American-style marketing and applications operations staffed by nationals in U.S. and European markets.

Even more consequential is a concurrent four-year government-sponsored program involving Japan's five major electronics firms: Nippon Electric Corp., Tokyo Shibaura Electric Ltd. (Toshiba), Hitachi Ltd., Fujitsu

Ltd., and Mitsubishi Electric Corp., as well as personnel from Nippon Telegraph and Telephone Public Corp. and the government's Electrotechnical Laboratory. Called the VLSI project, for very large-scale integration, it has the goal of designing a line of computers 100 times more powerful than the technology represented by the IBM 370. The budget through 1980 is at least \$250 million—some observers put it as high as \$1.5 billion. (See "VLSI Japanese style," p. 101, for details of the project).

Ambitious goals

To achieve this goal, engineers are developing an advanced semiconductor technology capable of achieving 10,000- to 50,000-gate logic chips and 1-million-bit memories—an IC capability that dwarfs today's 5,000- to 10,000-gate microprocessor chips and 16-k RAMs. Participating companies will be free to use the resulting digital technology as they see fit, with no planned marketing restriction on either the computers or the ICs in Japan or abroad. If this VLSI capability is achieved and if it filters down through all component and equipment levels, it is bound to make Japanese electronics manufacturers formidable competitors in the world's digital electronics marketplace.

Although money is not everything in gauging success in the semiconductor industry, it is instructive to analyze the VLSI development budgets of the major Japanese manufacturers. For 1975 and 1976, they spent \$150 million internally on IC developments, including salaries

SPECIAL REPORT

TABLE 1: MEMORY TYPES CURRENTLY AVAILABLE FROM U.S. AND JAPANESE MANUFACTURERS

| Application | U.S. | | JAPAN | |
|---|--------------------------------------|------------------|-------------------------|------------------|
| | Device type | Access time (ns) | Device type | Access time (ns) |
| Large mainframes | 4-k n-MOS dynamic | 150 - 350 | 4-k n-MOS dynamic | 100 - 300 |
| | 16-k n-MOS dynamic | 200 - 350 | 16-k n-MOS dynamic | 150 - 300 |
| | 4- and 16-k I ² L dynamic | 50 - 100 | - | - |
| Small mainframes and microprocessor-based systems | 4- and 16-k MOS dynamic | 150 - 350 | 4- and 16-k MOS dynamic | 100 - 300 |
| | 4- and 16-k I ² L dynamic | 50 - 100 | 1-k n-MOS static | 50 - 300 |
| | 1- and 4-k n-MOS static | 75 - 300 | 1- and 4-k C-MOS static | 300 |
| | 1-k C-MOS static | 300 - 500 | - | - |
| | 1-k SOS static | 100 | - | - |
| Buffer and cache, etc. (all static) | 256-bit ECL | 10 - 30 | 256-bit ECL/TTL | 10 - 30 |
| | 1- and 4-k TTL | 40 - 100 | 1-k TTL | 50 |
| | 1- and 4-k n-MOS | 50 - 70 | 1-k n-MOS | 70 |
| | 4-k I ² L | 75 - 150 | - | - |
| Peripheral systems | 1- and 4-k n-MOS static | 75 - 500 | 1-k n-MOS static | 75 - 500 |
| | 1- and 4-k I ² L static | 75 - 150 | 1- and 4-k C-MOS static | 300 |
| | 1-k C-MOS | 300 | - | - |
| | 1-k SOS | 100 | - | - |
| Small storage (1 to 5 megabytes) | CCD | 100 μ s | - | - |
| | bubbles | 100 ms | - | - |
| Large storage | CCD | 1 ms | - | - |
| | bubbles | 10 ms | - | - |

Source: Electronics

market. First they develop parts suitable for internal consumption, and then they redesign them for export.

For example, NEC, the leading supplier of Japanese memories both at home and abroad, began developing a 4-k dynamic RAM for internal consumption early in 1975—its computer and telecommunications divisions required a faster part than was available from U.S. suppliers. Using a proprietary high-speed n-channel process, engineers completed the design in eight months and then immediately turned to the requirements of the American market. Modifying their package to conform to the performance and pin-out of U.S. suppliers, NEC was able to begin shipping 22-pin TI-type 4-k parts by the end of 1975.

By the middle of 1976, the company was exporting both 18- and 22-pin 4-k chips at the rate of 250,000 per month, a production rate exceeding those of all but Intel, TI, and Mostek.

The same kind of activity is taking place in the American market for 16-k RAMs. Three Japanese manufacturers—NEC, Hitachi, and Toshiba—are already shipping 16-k parts to the U.S.

Indeed, Japanese semiconductor manufacturers have pulled even with their American counterparts in memory design (Table 1). For large mainframes, Japanese manufacturers can now compete head on with U.S. suppliers in both high-speed 4-k dynamic RAMs and 16-k dynamic RAMs. The same is true for buffer and cache systems, where the Japanese can match American suppliers in all

but integrated-injection-logic design.

For peripheral equipment, the Japanese are also well represented, with 1,024-bit and 4-k n-channel metal-oxide-semiconductor static RAMs and the various dynamic types. In addition, NEC offers an 8,192-bit electrically alterable read-only memory for peripheral applications. While such parts are in intense development in the U.S., they are not yet available from American manufacturers.

Where Japanese manufacturers appear deficient is in relation to small mainframes and microcomputer-based systems. High-speed static devices dominate this area, with Japanese manufacturers only now beginning to launch 4-k development efforts. The exception is Toshiba, which is manufacturing a 4-k complementary-MOS static part not yet available from an American supplier.

Nor do the Japanese have charge-coupled-device memories for disk and drum replacement beyond the early development stage. At least three American suppliers—TI, Fairchild, and Intel—have already made available 65-k CCD memory chips and are quickly developing CCD memory-board systems. The first Japanese-made charge-transfer memory probably will not be available in this country for 18 months.

Bubble memories are another area where American manufacturers lead. TI, with its bubble chips and systems, has no counterpart in Japan. True, Hitachi, NEC, and Fujitsu are working on bubble memories, but

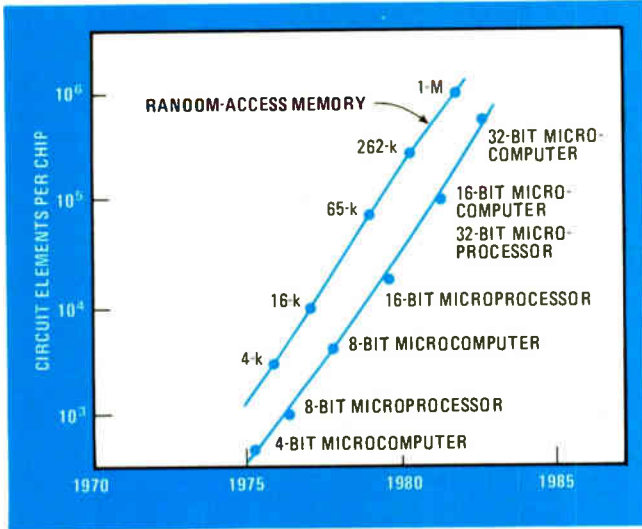

1. Driving hard. Japanese manufacturers have this timetable for developing VLSI components and next-generation computers. Ambitious products, such as 262-k dynamic RAMs and one-chip 32-bit microcomputers, are on the drawing boards for 1981-1983.

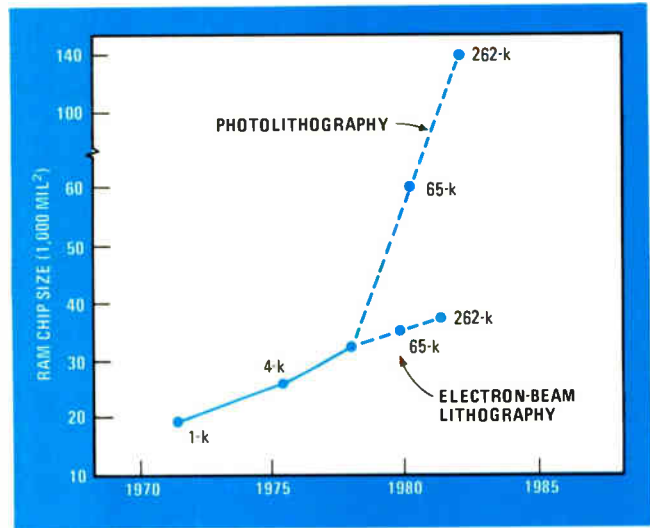

2. Where electron beams fit in. Japanese technologists, factoring in their electron-beam plans for memory development, predict that 65-k and 262-k RAMs are achievable in the 1979-1982 time frame on chips not much larger than today's 16-k chips

these are either for in-house computers or for custom applications supported by Nippon Telegraph and Telephone Public Corp. There seems little prospect of seeing a Japanese bubble memory in the U. S. market for at least two years.

While Japanese memory exports abound, microcomputer shipments are scarce. With the exception of NEC, the Japanese have practically no products in the U. S. or in Europe. While other Japanese firms build American-type microcomputer chips, they have yet to market these products outside of Japan.

Marketing standard LSI

The difference in the availability of memory and microcomputers in the U. S. illustrates a basic Japanese strategy for penetrating foreign markets. While the country's manufacturers can make microcomputer circuits as well as they can make memories, selling them requires a large marketing and applications support staff to work closely with a large number of users. Memories, on the other hand, require practically no sales engineering force since the users are extremely sophisticated about their system requirements. Thus, the Japanese are making their immediate exporting thrusts in memory, both in the U. S. and Europe. They are challenging American technical dominance, as well as testing the political climate for signs of tariff difficulties.

Atsuyoshi Ouchi, who runs the semiconductor division for NEC, may have been talking for the Japanese semiconductor industry when he said, "We intend to be a major memory supplier in the U. S. We think our technology is at least as good as American technology, and we think our reliability is better. Japanese companies can supply 25% of the U. S. RAM market in two years."

There is little doubt that standard-product areas such as memories play to the Japanese ability to react quickly to a well-defined industry standard. Take dynamic RAMs: once it became clear 18 months ago that consensus was forming in the American market around Mostek's 4027 4-k and 4116 16-k RAMs, every major Japanese supplier began working on those parts. Within six months, Japan's leading semiconductor companies were able to export samples of 4027-type 4-k devices—and, within 12 months, 4116-type 16-k devices—beating to the marketplace many American suppliers who were still busy trying to qualify their own high-speed 4,096-bit and 16,384-bit dynamic designs

U.S. viewpoints

Since RCA Corp. is not a major supplier of n-channel MOS RAMs, Bernard Vonderschmitt, vice president and general manager of the Solid State division, can be objective in evaluating the Japanese threat to American mainframe memory suppliers. "I think the Japanese will gobble up U. S. suppliers in standard LSI areas where they can attack a well-established standard," he says. "The Japanese are effective at working together and cooperating on technical developments. Standard memory gives them a perfect opportunity to move in quickly with high-quality, extremely cost-competitive devices."

Gordon Moore, president of Intel Corp., a leading U. S. manufacturer of random-access memories, does not take lightly the Japanese ability to react quickly to industry standards. "We've been impressed with the Japanese rate of progress in digital technology, and we're watching them closely, especially in the VLSI area where they have government support and united goals. They seem to know where the semiconductor industry is

SPECIAL REPORT

TABLE 2: JAPAN'S GOALS IN VERY LARGE SCALE INTEGRATION

| | Random-access memory | | Microprocessor | | Minimum line width (mils) |
|-------------|---------------------------------------|---------------------------|---------------------------------------|--------------------|---------------------------|
| | Chip size (x 1,000 mil ²) | Bit density (x 1,024 bit) | Chip size (x 1,000 mil ²) | Word length (bits) | |
| 1976 | 32 | 16 | 52 | 8 & 16 | 0.2 |
| 1979 - 1980 | 32 | 64 | 50 | 16 | 0.07 |
| | 50 | 256 | 60 | 32 | 0.04 |
| 1981 - 1983 | 45 | 256 | 55 | 32 | 0.03 |
| | 60 | 1,024 | 65 | 32 | 0.02 |

Source: Electronics

heading, and from what we can tell, they'll be there."

While American semiconductor manufacturers eye with trepidation the immediate Japanese threat to today's digital markets, many see an even greater danger in Japanese efforts to leapfrog the industry with powerful new VLSI circuits. Their fears may be well-founded, as illustrated by the projected march of ever more complex Japanese devices up the technology-development scale (Fig. 1). These curves, which represent the composite product goals of major Japanese manufacturers, show their determination to achieve a dominant position in semiconductor and computer technology by the 1980s. With the possible exception of Texas Instruments and Intel, no American manufacturer has displayed as ambitious a program.

Working within the government-sponsored VLSI project and independently in their own VLSI laboratories, Japanese semiconductor manufacturers plan to produce 65-k RAMs by 1979 and 262,144-bit RAMs by 1981. Such a timetable would put Japan's memory technology considerably beyond the reach of many American manufacturers. Moreover, the move into high-performance microcomputers is equally strong, with intentions announced to build 16-bit single-chip microcomputers by 1979 and full 32-bit microcomputer chips—the equivalent of the IBM 370—by 1983.

Although leading Japanese manufacturers will give no details on the exact nature of the technology they plan for this arsenal of VLSI components, it is certain they intend to stretch existing n-channel and bipolar technology. As in America, most Japanese manufacturers are working on modifying the double-level silicon-gate MOS process for 65-k RAMs. Squeezing circuit features down to 2 micrometers from about 5 micrometers will achieve the required 100,000-circuit-element complexity. The same process, equipped with depletion-load transistors, can then be applied to producing 16-bit microcomputers.

For 262-k RAMs and 50,000-gate microprocessors, Japanese designers are betting on a double-diffused



Electron beams. Japanese engineers are in agreement that electron-beam manufacturing systems are essential for making VLSI circuits. The government-sponsored VLSI lab is developing electron-beam equipment for mask and direct-wafer fabrication.

(D-MOS) structure for a fourfold increase in complexity. By going to n-channel technology and by using fully ion-implanted structures, Japan's designers expect to fabricate D-MOS devices with submicrometer channel lengths—just what is needed for 262-k RAMs.

The D-MOS structures will scale down to provide power dissipations in the nanowatt range—keeping total chip power below 1 watt. Moreover, the process is amenable to dynamic logic designs, a circuit type that further reduces power requirements.

In the U. S., manufacturers apparently are only now beginning to develop a D-MOS capability. They are relying instead on shrinking silicon-gate designs (Intel) or on V-channel MOS designs (American Microsystems Inc.) for the move into VLSI.

Electron beams

More important for VLSI circuits than device types is fabrication—the ability to build 1- μ m device patterns—a goal that everyone now agrees will require some form of electron-beam fabrication directly on wafers. (This is not to be confused with the technique of using electron beams to build masks, which are then exposed with conventional photolithographic methods—a process that stops at 2- μ m geometries.)

Significantly, electron-beam wafer fabrication is where the Japanese have put a major portion of their development funds, both in the government VLSI lab and in their internal development labs.

A glimpse of the advanced nature of Japan's electron-



Watching the rising sun

A high regard for Japanese technical ability and an uneasy feeling about its effects characterize the reaction of computer and semiconductor manufacturers in the U. S. and other countries. Frank T. Cary, chairman of the board of International Business Machines Corp., puts it succinctly: "The Japanese manufacturers are extremely competent, especially NEC, Fujitsu, and Hitachi. We are not taking that competition lightly."

But Cary is quick to point out that IBM is not sitting idly by. While he will not say how much IBM is spending in VLSI computer development, others in the industry put the figure at just under \$1 billion over the next three years—or at least as much as the total Japanese combined effort.

The No. 1 semiconductor executive has an equally high regard for Japan's recent digital efforts. "We have a healthy respect for the capabilities of the Japanese industry," says J. Fred Bucy Jr., president of Texas Instruments Inc. "They're backed by their government, and they can focus on selected targets, as they've well demonstrated in the heavy industries. And now they're moving into the high-technology area."

While watchful, Bucy does not feel unduly threatened by the Japanese VLSI effort. "They probably will establish a strong position from time to time in limited product segments," he says. "However, TI has outperformed them in such areas as calculators and digital watches, as well as semiconductors, and we are dedicated to maintaining our leadership in VLSI."

He admits that the Japanese firms are about on par with U. S. firms in MOS random-access memories, but "we are confident that TI is well ahead of the Japanese today in such important areas as electron-beam and dry processes, as well as CCDs, magnetic bubbles, microprocessors, standard bipolar ICs, and I²L. But we always pay attention to any good competitor, and we consider the

Japanese to be good competitors," he says.

More worried is Wilfred J. Corrigan, president of Fairchild Camera and Instrument Corp. "The basic problem is that we're not competing in the normal way here—we're competing with the Japanese government," he says. "We think the Japanese VLSI effort is enormous—something in the neighborhood of \$500 million to \$1.5 billion over a five-year period, spread out over many companies and in government-sponsored programs, but all focused on the same objective: advanced VLSI components and powerful computers. We regard it as a very serious issue."

Corrigan sees the Japanese united effort as the principal reason for the recent formation of the Semiconductor Industry Association, and Bernard T. Marren, its head, agrees. "Since we can't count on Government protection, our strategy is to counter the Japanese threat with a buy-American campaign among our computer makers," says Marren, who was president of American Microsystems Inc. "We'll remind them that component makers in Japan are computer manufacturers too, so buying Japanese components strengthens the competition."

Cooperation between U. S. companies and computer manufacturers, says Charles E. Exley Jr., president of NCR Corp., is impractical "with or without Government support" to combat the Japanese offensive. "I think we individually must continue making substantial expenditures in engineering to keep ahead," he says.

In Europe, however, there appears to be sentiment in favor of forming cooperative efforts to combat the Japanese. Alfred Prommer, vice president of component sales at Siemens, thinks that his government should do its part in helping the industry attain a better competitive position *vis à vis* Japanese products. He opts for computer makers and semiconductor firms in Germany joining forces to develop an advanced LSI technology.

beam program comes from reports of the work at the government's VLSI lab, where several prototype electron-beam stations have been assembled, and at individual semiconductor plants. Details are skimpy, but it is known that the new machines are vector-scanned systems capable at the present time of fabricating a one-mask pass on a fully populated 4-inch wafer in 8 to 15 minutes. This throughput is not far from the 6-minute-per-mask throughput rate that American IC specialists feel is needed to make electron-beam wafer fabrication a production feasibility.

Indeed, the 8-minute 4-in.-wafer throughputs would make Japanese circuits fabricated with electron beams cheaper to build than American ones fabricated with photolithographic methods. By transferring 8-minute machines to production, the Japanese manufacturers could get an immediate two- to four-fold advantage in chip costs.

Another electron-beam cost-reducing factor on which the Japanese are counting is higher yields resulting from smaller chips. Figure 2 shows that an electron-beam-

fabricated 65-k memory would be 32,000 square mils compared to 55,000 mil² for optically fabricated 16-k memories. Even if American manufacturers were able to fabricate 65-k chips with conventional methods, they would not be able to compete with the higher-yielding Japanese electron-beam RAMs. Moreover, a 262-k chip built with photolithography would require approximately 120,000 mil² of silicon, which is simply not producible in high volume.

Table 2 sums up the goals of the VLSI programs now under way in Japan. The milestones are awesome: 65-k RAMs on 32,000 mil² chips by 1979 and 16-bit microcomputer chips with 4 kilobytes of memory on 50,000-mil² slices. By 1980, memory chips would hold 262 kilobits and microcomputer chips would contain 32-bit instructions with 16,000 bytes of random-access memory. Finally, by 1983, 1-megabit memories would be in production, as would 32-bit microcomputer chips containing 32 kilobytes of memory. Computers built with such devices would indeed exceed the performance of today's IBM 370 computer by a factor of 100.

CHIP MAKERS PART OF GIANT FIRMS

Most Japanese semiconductor manufacturers have a clout that goes beyond their position on the cutting edge of industrial technology. They are divisions of corporations that rank among Japan's top twenty corporations. Conservatively managed, extremely well-financed, and highly integrated, these export-minded corporate giants are in sharp contrast to the volatile and fiercely independent American semiconductor manufacturers.

The biggest Japanese company with a stake in electronics is Hitachi Ltd. This \$6.5 billion manufacturer makes semiconductors, computers, and communications equipment. Yet 25% of its sales are in heavy electrical machinery, such as turbines, and almost 20% are in heavy machinery, such as rolling mills.

Hitachi is no slouch in semiconductor production: its 1976 sales of \$220 million would rank among the largest in the U.S. In-house consumption took semiconductor production, and 10% were exported, with 3% landing in the U.S.

Tokyo Shibaura Electric Ltd., often known as Toshiba, is a \$3.5 billion industrial giant with equivalent emphasis on heavy electrical equipment. Its biggest product lines are home-entertainment equipment and consumer appliances, which accounted for almost half of last year's sales. Electronics and communications added another 27%. Toshiba sold \$300 million worth of semiconductors last year and exported about 20%, with half

of this total to manufacturers in the U.S.

Mitsubishi Electric Corp. is another electronics manufacturer that is also a major supplier of heavy electrical equipment, with almost half of last year's \$2.5 billion sales going for such gear. Appliances and home-entertainment products accounted for 28%, while electronics products, including IC and discrete semiconductors, added another 28%.

The company is its semiconductor division's best customer, consuming about 30% of the output. Only about 5% is exported, mostly small-signal and power transistors and mostly to Asiatic and European markets.

Another group of Japan's IC makers are diversified electronics companies that can trace their origins to the field of communications. An interesting case is Nippon Electric Corp., which got its start as an overseas subsidiary of Western Electric in 1899. After passing under the control of ITT, it became an independent supplier. Telecommunications is still its biggest product line. More recently, however, NEC corporate managers have put increased emphasis on its semiconductor division, especially in the big growth areas of digital LSI. Success has been dramatic: the company is now the biggest Japanese supplier of memory and microprocessor chips in both domestic and export sales.

Last year's sales were \$1.8 billion with 20% equipment and components for the NTT. Semiconductor sales were \$357 million, of which 23% were used in house and 10% exported, one fifth to Asia and the rest evenly divided between America and Europe.

Like NEC, Fujitsu Ltd. started as a supplier of communications equipment. Unlike NEC, communications gear (telephone-exchange and wireless transmission equipment) now accounts for only a minor portion of its business. The company is primarily a manufacturer of computers and electronic data-processing equipment, which accounted for almost three-quarters of its \$1.2

TECHNOLOGY LEADERS



Yoshiyuki Takeishi is typical of the leading semiconductor technologists borrowed from private industry for the government's VLSI Cooperative Laboratory. Developing the lab's electron-beam fabricating system is his assignment. He brings valuable experience from his last job at Toshiba, where he headed that firm's electron-beam efforts. Before that, Takeishi, as manager of Toshiba's LSI production technology, developed the 12-bit microprocessor that the company is supplying to Ford in the U.S. for engine controls. Another of Takeishi's achievements is his stacked-gate avalanche MOS structures, which may allow Japanese manufacturers to pass the Americans in reprogrammable read-only memories for computers. His background includes a brief stint at Bell Labs in 1962-63, where he was involved in basic work in silicon materials.



billion 1976 sales. Although the firm does manufacture sizable quantities of ICs—\$112 million last year—80% were consumed in its own computer divisions. But Fujitsu executives see ICs, as well as computer and equipment components, as a major target for exports, especially to the big U. S. and European data-processing markets.

The final member of this group is Oki Electric Industry Ltd. with 1976 sales of \$451 million. Unlike NEC and Fujitsu, it has stayed exclusively in the communications field, with participation in the computer industry only through its data-communications office equipment. (The company does sell high-end computers, made jointly with Univac, but they account for less than 5% of its billings.) Oki Electric's biggest product lines are office equipment, 38%, and electronic exchanges, 30%.

A third group of Japanese manufacturers is known mostly for consumer electronic products, although they manufacture sizeable quantities of semiconductors. Biggest of these is Matsushita Electric Industrial Ltd., Japan's largest electronics manufacturer with home-entertainment products (the National brand in Japan and Panasonic brand in the U. S.) accounting for 45% of its total 1976 sales of \$6.1 billion. Matsushita's discrete and integrated circuit semiconductor production, which totaled \$162 million for 1976, is a joint venture with Philips Gloeilampenfabrieken.

Prominent in this group are the two familiar names outside of Japan. Sony Corp., of course, is known around the world for its TVs, radios, tape recorders, and so on, and Sharp Corp. is known for calculators. While Sharp produces a large quantity of semiconductors for itself (16.2 million in 1976), Sony semiconductor production is concentrated on products that it feels it cannot buy elsewhere or that, if bought openly, will telegraph future product plans.

MAVERICK SEES OBSTACLES

Being under the wing of giant companies may hinder Japanese semiconductor development as much as it helps. The security provided by the corporate umbrella discourages talented engineers from striking out on their own. This, plus the financial community's reluctance to provide venture capital, may ultimately frustrate the ambitious semiconductor goals set by the government.

That is the lonely opinion of Jun-ichi Nishizawa, perhaps the only electronics entrepreneur in Japan. He runs a small laboratory called the Semiconductor Research Institute, in out-of-the-way Sendai in the northeastern part of the country. Adding to the picture of a maverick is the fact that Nishizawa, who also is a professor at Tohoku University, keeps SRI going on a shoestring to keep himself in the forefront of semiconductor research, not for personal gain.

Another inhibiting factor for semiconductor innovation will be finding suitable people, he says. "One reason is that Japanese education and social traits are not oriented towards speculation. While this may lead to the stability of the large companies, it prevents ventures such as ours from blossoming," he asserts.

The backing for his lab illustrates the reluctance of the big companies to invest in research, he says. The institute started in 1961 on a paltry \$140,000, which consisted of royalties to Nishizawa and the professor with whom he studied, Yasushi Watanabe, for their



Takao Nakano, an engineer in Mitsubishi Electric Corp.'s IC research department, is at the hub of that company's VLSI plans. He is working on high-speed 4-k and 16-k MOS and bipolar memories and computer logic chips using double-diffused MOS technology. He is convinced that MOS processes, such as D-MOS, could eventually replace low-power Schottky TTL in high-performance LSI applications. Nakano is best known for his recent work in vertical injection logic, a technique that retains the low-power features of conventional TTL and complementary-MOS approaches while increasing the density and speed characteristics. An example of his VIL technique is the LSI watch circuit that Mitsubishi is building on a chip half the size of C-MOS watches of equivalent performance.



Jun-ichi Nishizawa
Semiconductor Research Institute

keep the lab going. Since then, the income has grown to around \$400,000: \$90,000 for annual membership fees, \$250,000 for contract research, and \$50,000 for license fees and know-how.

A large part of the lab's work centers on the static induction transistor (SIT), the only field-effect transistor with triode-like characteristics. Nishizawa and Watanabe had applied for a patent on the SIT in 1950. When Nishizawa returned to this work many years later to investigate what appeared to be errors in theory derived by Shockley, he discovered the device's useful triode features. This led to two new patents in Japan, with about 40 pending, and one in the United States, with about 20 pending. It has also led to many contracts.

The SIT's triode behavior is being exploited in stereo amplifiers by Nippon Gakki Ltd. (which makes Yamaha stereo equipment). Tohoku Metal Industries Ltd. is developing a kilowatt class of SIT power-transistors for ultrasonic equipment and another class operating at

work on pnp transistors, p-i-n diodes, and ion implantation.

The Japanese companies using these ideas were adverse to paying for them, but agreed to give the inventors contributions to set up a lab. The companies also agreed to pay a small annual membership fee of \$17,000 to

several hundred watts for use in broadcast frequency transmitters. Mitsubishi and Toshiba have received licenses for building SIT audio devices: Mitsubishi for ultrahigh-frequency gear (100 watts at 1 gigahertz and 20 w at 2 GHz), and Toshiba for devices that operate at frequencies above 3 GHz.

Nishizawa plans to use his static induction transistor in LSI logic configurations similar to integrated injection logic. His present designs, which operate at the incredibly low power-dissipation levels of 2 femtojoules, can be built into nonplanar configurations for microwave devices operating at speeds higher than 10 nanoseconds or in planar configurations for digital LSI applications. For example, Yamaha is working on SIT logic that will enable electronic musical instruments to perform with concert reality. Firms eyeing SIT logic devices include Seiko for watches, Toshiba for replacing complementary metal oxide semiconductors, and Sony for consumer ICs.

LAB CHIEF IS RESEARCH STAR

The strengths of the Japanese semiconductor industry are well embodied in Yasuo Tarui, head of the cooperative research laboratory in Japan's four-year VLSI project. His reputation should swell internationally when results start flowing from the lab to the computer-applications groups that will rely on the technology for next-generation computers and computer equipment.

Tarui has that combination of basic scientific curiosity and practical semiconductor knowledge so rare among



Atsuyoshi Ouchi (left), is key to Nippon Electric Corp.'s good fortunes. He was general manager of the IC division from the beginning. A circuit engineer turned manager, he credits the firm's LSI success to "harnessing markets to technology," something he says he has "learned from my American friends."

Toshio Abe (right), another veteran of the IC industry in Japan, now manages Toshiba's principal semiconductor plant (still quaintly called the Toshiba Transistor Works) where LSI production is done. As a technologist, he developed C-MOS LSI for watches and n-MOS for memories and microprocessors.





technical people. Even while working on narrow technology and complex design problems, he never loses sight of their bigger implications for semiconductor production. He sees the concept of very large-scale integration as a method of production as revolutionary as the invention of printing.

"The printing press gave the author a way of arranging the basic elements—characters representing the language—in low-cost mass-reproducible form, at once making his work available to millions," Tarui says. "Similarly, the mask-projection method of building ICs allows the electronics designer as much freedom arranging his elements as the author with his language."

From the very beginning, Tarui was shaping the course of Japanese semiconductor technology. Upon graduating from Waseda University, he joined the government's Electrotechnical Laboratory and spent four years on measurements of semiconductor materials. This was in the early 1960s when very little was known about conduction in materials such as germanium and silicon. From this basic work, he moved rapidly into fabricating germanium point-contact devices and then alloy-diffused transistors.

In 1965, seeing the full potential of semiconductor production, he was the first person in Japan to fabricate an IC—a germanium flip-flop with two transistors, four resistors, and two capacitors. He quickly turned to diffused silicon transistors and was ready to make a real contribution to the art.

For Tarui, 1969 was a vintage year. At the International Solid State Circuits Conference in Philadelphia, he gave a paper on Schottky transistor-transistor logic, the first in the world. Because of his paper, Texas Instruments wound up without a patent in Japan. During the same year his group developed a very fast n-channel MOS 144-bit memory, which was produced by Nippon Electric Co. for large computers. At the same time,

his group developed an electron-beam exposure system for semiconductor applications.

While this system was five or six years ahead of its time, it is what the industry is clamoring for now.

It was in 1970 that Tarui pioneered D-MOS, also a world premier and in the forefront of today's VLSI techniques. In the same year, his group announced their results on preferential etching of gallium arsenide for the fabrication of FETs. Preferential etching was also later used in batch methods of fabricating lasers to replace cleaving, a process that radically reduced the cost of the devices.

Tarui has spent the last six years in n-channel memory and D-MOS and V-notch MOS work. He developed an analog memory and a nonvolatile stacked-gate digital memory that can be both programmed and erased electrically. Although development of the analog memory has been delayed by the press of other work, it could find important applications in display and information processing. It should also provide a very powerful method for studying the effects of time and ambient conditions on programmable memories.

Tarui spent a year in America studying at Stanford University in 1966. There he worked on analog memories and ferroelectric materials.



Yasuo Tarui
VLSI Cooperative Laboratory

Takashi Tokuyama is one of that group of unsung semiconductor specialists whose work forms the underpinning of Japan's impressive process capability. Having spent all his working life (since 1953) in the Central Research Laboratory of Hitachi Ltd., he has to his credit a host of processes now used in the firm's products: low-temperature passivation for silicon transistors, multilayer passivations for integrated circuits, ion implantation for LSI device fabrication, annealing methods to increase IC reliability, and ion-beam deposition techniques for growing crystal lattices. Recently, Tokuyama has turned his talents to making solar cells. The first to propose deposition of polysilicon on aluminum oxide for low-cost devices, he has produced solar cells that achieve 3% efficiency on the first shot. These cells are now in intensive development aimed at increasing their efficiency.



SPECIAL REPORT

JAPAN PRESSES INNOVATIONS TO REACH VLSI GOAL

Japanese semiconductor manufacturers have high hopes for very large-scale integration, and to realize them, they are developing an advanced and powerful semiconductor capability. For the first time, Japan's designers are not just copying but inventing integrated-circuit technology—a step they feel is absolutely essential if they are to overtake the Americans in digital design by 1980. No major technology escapes their attention. Standard and advanced metal-oxide-semiconductor and bipolar VLSI are yielding to attack, and a start is being made on charge-coupled devices and bubble memories—both virtually untapped areas in Japan till now.

The point at which Japan's designers stopped copying America and began innovating can be determined by

examining the process techniques that Japanese manufacturers have used to implement the various LSI device types over the last 10 years (Fig. 1). In 1970, following the Americans, designers in Japan applied the simplest high-threshold p-channel MOS process to their first four-function LSI calculator circuits. In 1972, they moved to silicon-gate p-MOS for more complex 1,024-bit dynamic random-access memories and scientific calculators, and by 1974 and 1975 they were using single-level n-channel MOS processes for high-speed 4,096-bit RAMs and 4-bit microprocessors.

Meanwhile, still following the American lead, they began working on double-level variations of the basic n-channel silicon-gate process, until by the end of last

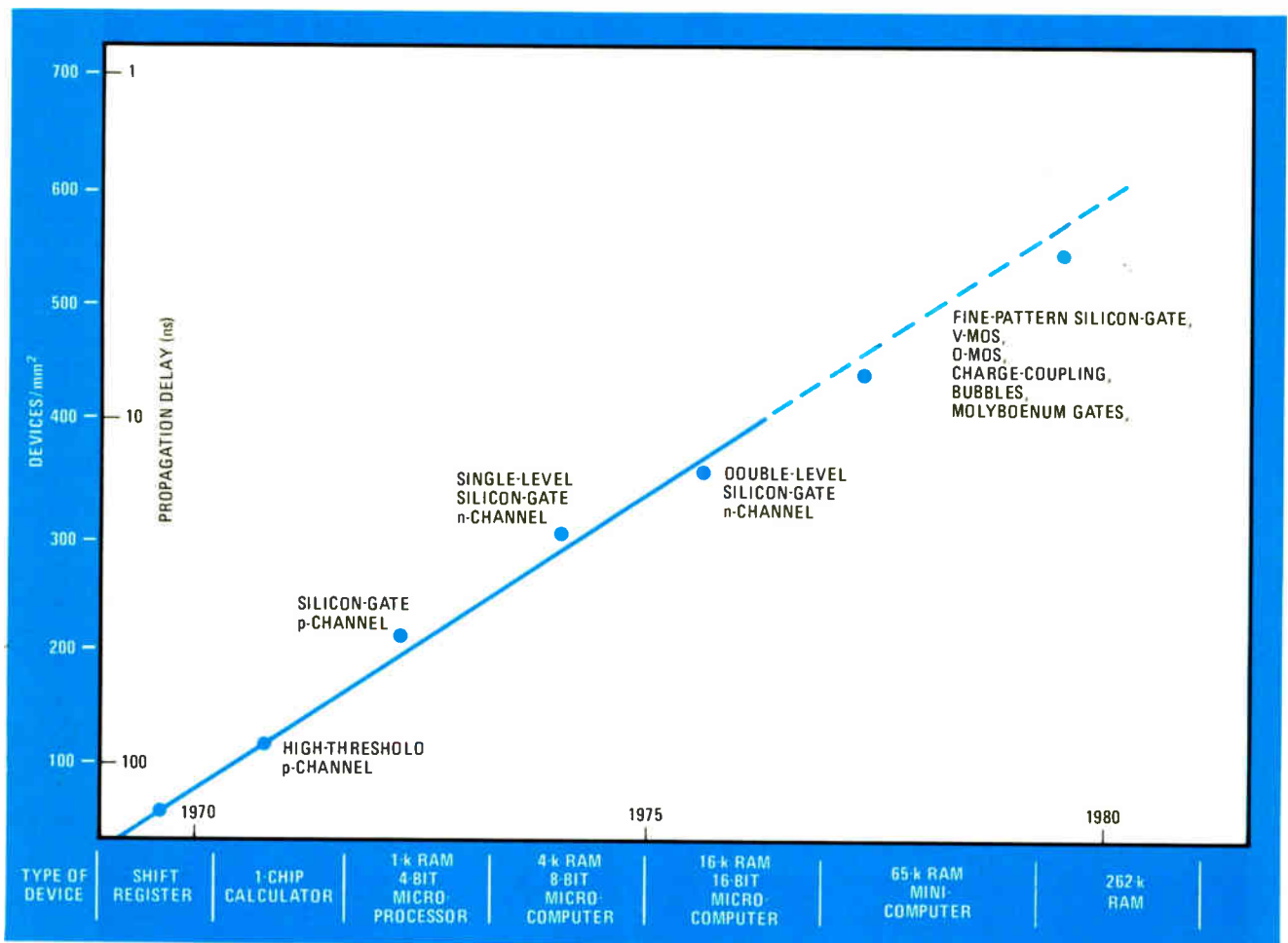

1. Breaking out. The last five years saw Japanese semiconductor manufacturers following the U. S. lead in digital-circuit techniques, but now they are developing proprietary processes based on D-MOS, V-MOS, molybdenum, and magnetic bubbles for memories and computers.



year they were already designing state-of-the-art 16,384-bit dynamic RAMs, 4,096-bit static RAMs, and 8- and 16-bit microprocessors—about the same time that U. S. firms were introducing these products on the market. With this double-level n-MOS capability, the Japanese had caught up with their U. S. rivals in dynamic RAMs.

However, the next level of VLSI product development—the 65,536-bit RAM and 16- and 32-bit microcomputers—demands innovation in both processing and circuit design, as the dotted portion of Fig. 1 shows. Table 1 shows Japan's current process capability. In the next three to five years, the Japanese hope to develop VLSI technology at a rate that equals, and in some cases exceeds, that of American efforts.

Table 2 shows the process types the Japanese plan to use for various stages of memory and microprocessor development through 1980. High on the list are double-diffused MOS, molybdenum-gate MOS with molybdenum bit lines, and integrated injection logic, with charge-coupled devices close behind. Already designers in Japan are far advanced in implementing double-diffused MOS structures for logic circuits and refractory metal structures for memories.

D-MOS coming at the double

Major Japanese manufacturers are working with the double-diffused MOS structures because they feel that these structures can achieve five times the speed and density at a third of the power consumption of today's single-diffused n-MOS structures. D-MOS does all this by in effect reducing the channel lengths in MOS field-effect-transistor structures to 1 micrometer or less without requiring micrometer-sized circuit dimensions.

A selective diffusion gradient under the gate is the key. The process, which is very similar to V-notch MOS (Fig. 2), adds a second lightly-doped p-diffusion, called a pi region, to a heavily doped p-region in the channel, so that its length during conduction appears very short, 1 micrometer and less. Two ion implantations maintain the proper diffusion profiles accurately.

Perhaps the best example of the D-MOS work in progress is the 4,096-bit high-speed dynamic D-MOS RAM built by engineers at Mitsubishi Electric Corp. with help from researchers at MITI's Electrotechnical Laboratory. This design, which has an access time of 60 nanoseconds, combines a basic D-MOS inverter with a depletion-load MOSFET output (Fig. 3). At the same time, an advanced arsenic doping process borrowed from bipolar design increases the stability and efficiency of conduction in the channel. Finally, a selective oxide-isolation process further increases packing density and simplifies fabrication by making it easier to oxidize surface steps. The result: the equivalent of a 0.4- μm channel-length and thresholds controlled within 1.2 ± 0.15 volts. Better yet, the structure's gain is five times that of conventional n-MOS structures.

Impressive as the 4,096-bit D-MOS dynamic RAM is, its developers see no profit in introducing the part into a maturing 4-k market. Rather, they see it as a forerunner of high-speed 16-k and 65-k RAMs. The 4-k design was built with standard 5- μm design rules that, when reduced to 3 μm , say, will yield circuitry two to four times denser with half the power dissipation. Thus, the same 4.33-by-4.9-square-millimeter 4-k chip could accommodate a 16-k RAM. If 2- μm rules were adopted, achieved either through electron-beam masks and photolithographic exposure or through electron-beam wafer fabrication, a 65-k D-MOS RAM would fit a chip only slightly larger than the 4-k design.

While a combination of D-MOS and fine-pattern geometry could eventually squeeze 65 kilobits of RAM onto a chip about the same size as today's 4-k devices, a simple extension of silicon-gate processing is already yielding a 65-k design that is larger but may still be manufacturable. It is a joint development of Nippon Telegraph and Telephone and three commercial suppliers (NEC, Hitachi, and Fujitsu). Such a 65-k RAM combines polysilicon gates in single-level cells with molybdenum bit lines that, thanks to the material's fine-grain structure, can be made into smaller line patterns. Then, to decrease cell size and power dissipation, the project's designers are using 2- μm line widths and oxides only 500 angstroms deep. The result is a 5.8-by-6.1-mm² chip dissipating 150 milliwatts, or less than today's 16-k RAMs. Access time is 200 nanoseconds, or about the same as that of most dynamic RAMs in production today.

While the 65-k RAM project is at full steam in four laboratories, the consensus is that a manufacturable device will not be available for about two years. By that time, Japanese technologists should have the lithographic means to fabricate 2- μm -wide lines in volume production.

Static memory looks lively

While dynamic-memory designers are utilizing Japan-developed D-MOS processing and molybdenum-gate structures for extra density and performance, static-

TABLE 1: JAPAN'S PROCESS CAPABILITY

| Technology | Propagation delay (ns) | Power-delay product (pJ) | Density | | Chip size (mm ²) |
|---------------------------------------|------------------------|--------------------------|----------------------------|--------------------------|------------------------------|
| | | | (devices/mm ²) | (gates/mm ²) | |
| N-channel silicon gate | 15 | 45 | 285 | 95 | 6 x 6 |
| N-channel silicon gate depletion-load | 12 | 38 | 320 | 107 | 6 x 6 |
| N-channel double-polysilicon | 10 | 35 | 525 | 175 | 6 x 6 |
| Silicon-gate C-MOS | 10 | 0.5 | 220 | 45 | 5.5 x 5.5 |
| V-MOS, D-MOS | 5 | 20 | 600 | 225 | — |
| SOS/C-MOS | 2 - 5 | 0.1 | 650 | 275 | 5 x 5 |
| J ² L (double level) | 5 - 50 | 0.01 - 1 | 500 | 150 | 5.5 |

Source: Electronics

SPECIAL REPORT

TABLE 2: A DECADE OF JAPANESE PROCESS CAPABILITIES

| | 1975 | | 1977 | | 1980 | |
|---------------------|-----------------------|---|------------------|------------------------------|--|---|
| Memory type | 1,024-bit static | 4,046-bit dynamic | 4,096-bit static | 16,384-bit dynamic | 16,384-bit static | 65,536-bit dynamic |
| Speed | 150 ns | 250 ns | 150 ns | 200 ns | 100 ns | 200 ns |
| Process | n-channel C-MOS | n-channel single-level C-MOS I ² L | | n-channel double-level | n-channel V-MOS D-MOS C-MOS I ² L | n-channel V-MOS D-MOS CCD |
| Microprocessor type | 8- to 16-bit parallel | 8- to 16-bit parallel | | | 16-bit parallel (active RAM control) | 16- to 32-bit parallel (active RAM control) |
| Cycle time | 2 μ s | 1 μ s | | 200 ns | 100 ns | |
| Process | n-channel C-MOS | I ² L | | V-MOS D-MOS I ² L | | |

Source: Electronics

memory designers are modifying American-style n-channel processes for their next-level, 4-k static parts. Boasting the clocked peripheral circuits and resistive loads that lower power dissipation and pack more static cells onto a chip, these designs are similar to the commercially available Intel 4014 and Mostek 4004 4-k parts.

The Japanese are also adapting the oxide-isolation technique (called OXIM) used by Advanced Micro Devices for its static RAMs, a process that pushes access time below 100 ns. Thus the Japanese, as they did in the early stages of dynamic design, are taking the best of the American world to achieve very competent 4-k static devices for the American market.

While following the American lead in n-MOS static designs, the Japanese are making original contributions in low-power static designs that use complementary-MOS techniques. Their experience with C-MOS dates from their early use of it for calculator circuits, and they have now applied their considerable sophistication in C-MOS processing to memory.

The centerpiece of Japan's C-MOS effort is the work going on at Toshiba's Semiconductor division on clocked C-MOS (or C²MOS). This technique differs from standard C-MOS in being static, in the sense that cell contents are retained statically, yet dynamic, in the sense that peripheral circuits are cycled during each transient time. (To do this, row decoders, sense circuits, and input/output controllers are designed with clocked gates and half-bit inverters.)

The technique yields a fully static 4-k RAM chip that, at only 4.7 square millimeters, is no larger than equivalent n-MOS 4-k RAMs yet dissipates one fifth the power. Moreover, since the standby current of 0.1 microampere is a fraction of that needed by n-MOS RAMs, the device will find immediate application in the American market

wherever battery backup operation is desirable—in point-of-sale gear, calculators, cash registers, and so on.

This C²MOS design is the most advanced in Japan and is a good measure of the ability of Japan designers to push C-MOS into the VLSI area. For very high densities, in fact, it appears quite attractive, since it offers extremely low power dissipation (nanowatts per cell) and high static performance (2- to 3-ns delays) in a compact configuration. For VLSI, Toshiba engineers estimate that by going from the standard 5- μ m geometry, they can pack 8,192 bits onto the same size chip as holds the 4-k design. Then with 2- or 3- μ m rules—the limit of photolithography—they believe they could get to the 16-k level with little increase in area or power dissipation. Those are the VLSI goals that Japanese designers are shooting for in static designs.

Dynamic logic starts up

Toshiba researchers are applying their clocked C-MOS process to microprocessors as well as and have already built a 16-bit C²MOS parallel-processing chip with the performance of most minicomputer central processing units. What they do here is to use dynamic circuitry throughout—dynamic logic for computation and dynamic read-only memories for instruction decoders and control—a technique that, if successful, will usher in a new era in logic design.

To illustrate, the logic equivalent of a dynamic C²MOS NAND gate is shown in Fig. 4. It should be noted that the circuit operates as a NAND gate when the waveform clock pulses are high, as shown, while maintaining the previous logic levels when those pulses are low. By going to fine-pattern geometry and reduced transistor scaling, the Toshiba C-MOS process could implement a full 32-bit parallel-processing configuration on a single chip. Apply C²MOS RAM arrays on the same chip, and the device

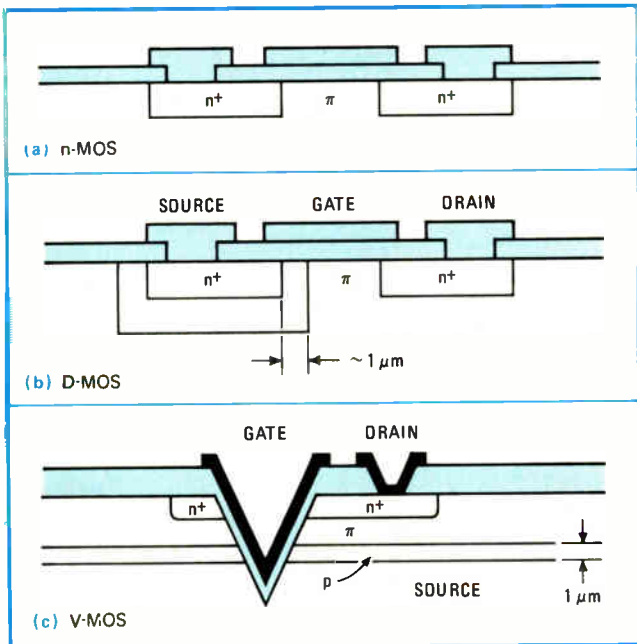

2. Double is shorter. Japanese manufacturers are moving to double-diffused MOS processes for the next generation of large-scale-integrated circuits. Similar to V-MOS, D-MOS reduces the effective channel lengths of MOS transistors with gate diffusions.

becomes a stand-alone 16- or 32-bit microcomputer—another major goal of Japan's VLSI program.

Another promising path to VLSI is the back-gated-MOS or B-MOS structures. Hitachi engineers are currently developing them for use in 10,000-gate logic chips and 65-k RAMs. Clearly, if there is a limiting factor (apart from line width) in packing more digital circuitry onto a chip, power dissipation is it. Finer photolithography may be one way to achieve lower power (smaller devices run on smaller currents), but the Hitachi engineers think the B-MOS method of designing gates could accomplish the same thing without straining present lithographic limits.

Back-gated MOS for LSI

The technique is called B-MOS because a back- or grounded-gate MOSFET serves as the logic input device (Fig. 5). A back-gate transistor can operate with gain current modulation at input voltage levels as low as 0.1 v. That is well below the 1- or 2-v thresholds of the

ordinary insulated-gate MOSFETs that make up the bulk of today's logic circuits. When the back-gate input device drives a normally biased MOS output transistor, logic elements can be built that operate stably yet dissipate mere microwatts.

The B-MOS inverter is constructed out of an n-channel B-MOS driver and a conventional p-MOS current source. In configuration, it resembles a C-MOS inverter, in which an n-channel element acts in conjunction with a p-channel element. But it is much more compact than conventional low-power C-MOS, where n and p transistors lie side by side. The p-type well of the back-gate input terminal slips into the n-type substrate needed for the output transistor (Fig. 5b). Just as in integrated injection logic, the B-MOS transistor pair merges into the space of a single transistor, keeping the level of power consumption low and the level of circuit integration high.

Hitachi workers in fact have demonstrated that a quad-gate B-MOS structure combines the low power and superior load characteristics of C-MOS equivalents with the high packing density of I²L equivalents, while requiring no additional process steps (Table 3). The only drawbacks of B-MOS are its fairly low speed (50-ns gate delays) and its need for an extra power supply to bias the current-source gate.

Bipolar LSI is also on the program

While Hitachi designers are developing MOS structures like B-MOS that rival the present-day performance of such bipolar LSI approaches as integrated injection logic, bipolar researchers are not sitting still. One approach to improving bipolar performance is vertical injection logic or VIL.

Using standard processing, Mitsubishi gets better I²L performance by fabricating the pnp injector transistor vertically instead of laterally. This device, which merges with a multicollector npn transistor to form the basic I²L gate, needs a narrow base for high gain. For conventional I²L structures, this same narrow base also results in poor breakdown voltages, high leakage currents, and other degrading electrical characteristics. But when the transistor is stood on end, the now vertical base can be as narrow as need be, and electrical performance is not affected.

Compared with conventional I²L, vertical injection logic has more than double the gain (0.9, as against 0.4),

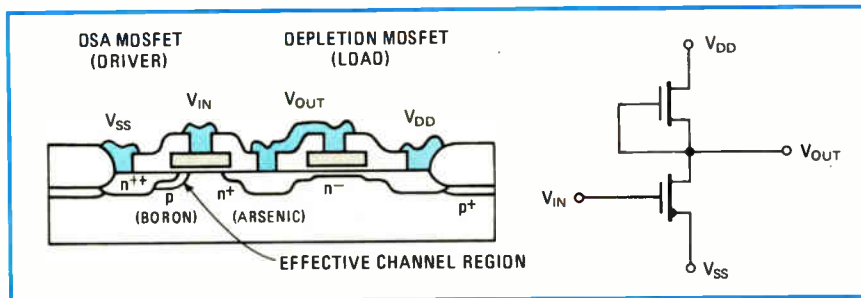

3. D-MOS density. Engineers at various Japanese semiconductor manufacturers, as well as at the VLSI laboratory sponsored by the Japanese government, are working with D-MOS inverters and depletion-load outputs to achieve channel lengths of only 0.4 micrometer. This Mitsubishi technique could lead to 65-k dynamic RAMs and 16-bit microcomputer chips.

SPECIAL REPORT

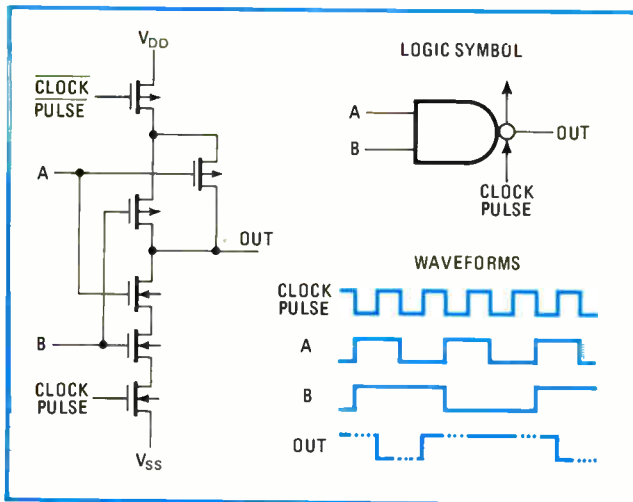

4. Modern C-MOS. Toshiba's clocked C-MOS technique boosts the performance of C-MOS circuits while increasing circuit density by a factor of 10. The circuit operates as a NAND gate when clock pulses are high and retains previous levels when the clock pulses are low.

four times the gate speed (8.8 ns per gate, as against an average 37 ns), and a much lower power dissipation (nanowatts per gate). Its power-delay product of 0.07 picojoule is the lowest reported to date for any I^2L structure.

As for the future, Mitsubishi engineers predict that VIL will prove capable of 1-ns gate delays and contend that this performance will give them an edge in memory and LSI logic. In fact, VIL versions of 4-k and 16-k RAMs and 8- and 16-bit microprocessors are already in development, along with watch chips and linear-to-digital and digital-to-linear interface circuits.

Another approach to bipolar LSI comes from Nippon Electric Co., where workers are employing a single heavy gold diffusion for integrated-circuit fabrication. The outcome is a new LSI family called gold transistor logic (GTL), that sports a packing density, and speed-power product as sensational as those of today's I^2L and in addition operates five times faster (Table 4). Moreover, GTL can be fabricated in a variety of configurations—TTL, diode-transistor logic, emitter-coupled logic and so on—and can therefore, unlike I^2L , interface on chip with other bipolar circuit forms. However, GTL does need six photoresist masking steps as opposed to four masking steps for basic I^2L .

In comparing the Japanese bipolar LSI efforts with American work, however, it is important to bear in mind that while the Japanese programs in I^2L and GTL have produced powerful high-performance LSI circuit elements, the Japanese manufacturers have neither moved the processes into production nor applied them to useful VLSI products. In fact, there is no VIL or GTL device on the market, either in Japan or abroad, and while prototype and developmental chips have been built, these new bipolar techniques remain largely untried in a high-

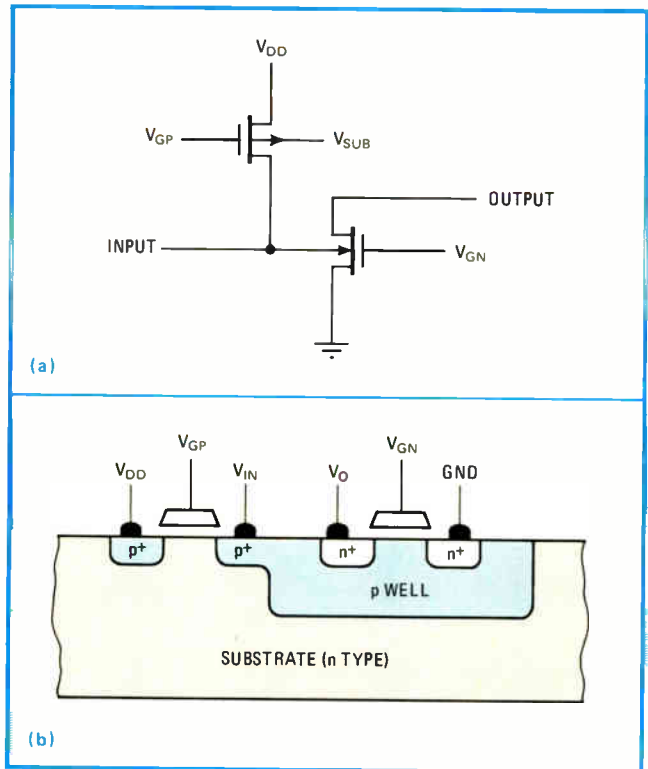

5. Now B-MOS. Hitachi's back-gated MOS technique leads to microwatt power dissipations and low threshold voltages. B-MOS inputs drive a normally biased MOS transistor, in a configuration that resembles a C-MOS inverter but is considerably smaller.

volume commercial environment.

Exactly the opposite is true of the American work in bipolar LSI. Manufacturers like Texas Instruments and Fairchild Semiconductor have been introducing a variety of I^2L memories and microprocessor chips over the last two or three years. These devices, which use various generations of I^2L processing capability, have been steadily improved as process capability grew. TI is already on its third-generation I^2L process—one that achieves 5-ns propagation delay and 1- μ w power dissipation—and plans to upgrade I^2L 16-bit microprocessors and its 4-k and 18-k static RAMs with the technique.

Fairchild Semiconductor, too, has been gathering extensive injection-logic production experience with fast 4-k dynamic RAMs and 16-bit minicomputer CPUs. Moreover, it has already developed a design strategy to achieve a 65-k RAM. Fairchild is using an I^2L circuit design in conjunction with its oxide-isolated fabricating process (I^3L) to achieve performance as good as Japan's VIL and GTL, as has TI with its advanced I^2L . Indeed, this production experience with high-performance LSI memory and microprocessor parts should give American manufacturers a major cost advantage over their Japanese rivals in the next generation of bipolar products.

Performance, on the other hand, is another story. Here Japanese manufacturers may be getting a leg up on their

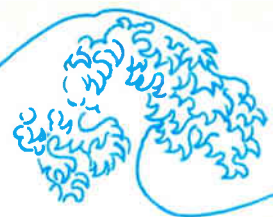

TABLE 3: COMPARISON OF JAPANESE LOW-POWER VLSI TECHNOLOGIES

| | B-MOS | C-MOS | I ² L |
|--------------------------------------|-----------------------------|---------------------------|--------------------|
| Cell area: inverter logic gate | 0.58 0.35 | 1 1 | 0.31 0.14 |
| Power (W/gate) | < 10 ⁻⁶ | | < 10 ⁻³ |
| Delay time (ns/gate) | > 50 | ~ 10 | > 10 |
| Power-delay product (pJ) | 0.01 | | 0.3 |
| Supply voltage (V) | 0.15-0.5 | > 1 | > 0.5 |
| Process masking steps | C-MOS- compatible 5-6 | 5-6 | 5-6 |
| Drawbacks | multiple power supply | low packing density | limited fanouts |

Source: Hitachi

American rivals in high-speed memory and logic circuits by using more traditional emitter-coupled and current-mode logic. This they are doing mainly in cooperation with their own computer divisions, as well as with Nippon Telegraph and Telephone. A good example of the memory work is Fujitsu's 1,024-bit ECL RAM, which NTT will use in its next-generation switching equipment and Fujitsu will use for buffer memories in new high-speed computers.

With its typical access time of 7.5 ns, this part is the fastest 1,024-bit static RAM yet to be developed anywhere. It owes its speed to advances in both circuit design and processing technology. It is laid out with highly efficient washed emitters, Schottky-clamped flip-flop memory cells, and a 2-ns ECL sensing circuit to reduce peripheral delays. Fujitsu designers are also using V-groove isolation (tried and abandoned by American technologists) and a shallow-junction doping process that reduces junction losses and increases speed.

When it comes to speed

In high-speed bipolar logic, Hitachi, Fujitsu, NEC, and Oki Electric Industries have programs to supply 200-gate CML master slices to NTT for the company's upcoming generation of D-10 electronic exchanges. (The technology can of course go for commercial export.)

The 200-gate chips provide one of the fastest and densest logic configuration available for high-speed controllers. Gates operate with 2-ns propagation delays, twice to three times as fast as equivalent LSI chips in the ECL 10,000 series. Yet the power dissipation, at 3 milliwatts per gate, is about the same as the slower ECL versions.

NTT has designed a 4-bit arithmetic/logic unit using

TABLE 4: GOLD TRANSISTOR LOGIC COMPARED WITH INTEGRATED INJECTION LOGIC

| Item | GTL | I ² L |
|--|-----------|------------------|
| Packing density (gates/mm ²) | 100 ~ 200 | 120 ~ 200 |
| Propagation delay time (ns/gate) | 5 ~ 50 | 25 ~ 250 |
| Speed-power product (pJ/gate) | 0.5 ~ 20 | 0.5 ~ 10 |
| Logic swing (V) | 0.4 ~ 0.6 | 0.4 ~ 0.6 |
| Supply voltage (V) | 1.5 ~ 6.0 | 1.0 ~ 15 |
| Photoresist steps | 6 | 4 |
| TTL compatibility | yes | no |

Source: NEC

the master slice technology, with eight such chips making up the 32-bit central processing unit. Included in the design are CML peripheral interface chips as well. What is nice about it is that CML technology is compatible with standard ECL technology, working off the same -5.2-v supply, so that it is possible to mix CML and ECL chips on the same board without suffering interface and buffering penalties.

While the telephone company's influence on LSI component design is considerable, its cooperation with the private sector in VLSI fabricating is even more significant. The focus is, of course, on electron-beam fabrication for pattern definition of lines narrower than 2 μm.

NTT researchers, working with Hitachi, Fujitsu, and NEC engineers, are developing a high-speed electron-beam system for fabricating masks and actual wafers. If successful, it could catapult Japanese VLSI capability well above that of many independently working American and European manufacturers.

Three electron-beam systems now being installed in NTT's Musashino Electrical Communication Laboratory (the equivalent of Bell Laboratories in the U.S.) are vector-scan units purchased from Thompson CSF, Hitachi, and JEOL, a Japan-based production-equipment supplier, and each is being modified to perform system characteristics determined by conference between the partners and executed jointly.

Modification in some cases is extensive. For example, the JEOL unit is being fitted with a high-speed arithmetic control unit built by NEC, a 16-bit digital-to-analog converter designed by NTT, and an output amplifier that can handle the JEOL scanning signals. The result is full 16-bit resolution in positioning in both the X and Y directions and coverage of 2-by-2-mm² field with a clock rate of 5 MHz. The beam spacing—from 0.3 to 0.97 μm—puts the unit well below submicrometer resolution capability.

SPECIAL REPORT

The advanced-technology payoff

All these LSI chips have reached an advanced stage of development at Japanese semiconductor manufacturers. The near-right photograph shows a 200-element current-mode-logic gate array packaged in a low-cost film-carrier strip. A NEC product intended for a new line of big mainframe computers, the package illustrates one of Japan's major strengths: adopting low-cost assembly techniques for high-performance applications. At far right is a frame-transfer chip built by Sony with charge-coupled-device technology. Although Sony has introduced no CCD cameras, whereas Fairchild and RCA in the U.S. have camera products using CCD imagers, the big Japanese manufacturer of consumer products is well advanced in using the techniques for color-imaging devices. Far right at the bottom, is an n-channel MOS memory cell that is used in a NTT-funded 65-k dynamic-RAM project. The complete chip, which was fabricated by Fujitsu, is shown at bottom middle. The cell, a single-level silicon-gate structure, is connected to the sense amplifiers by low-capacitance molybdenum bit lines that can assume much finer patterns than polysilicon or metal lines on today's RAM products. Finally, shown directly below is a five-digit frequency counter using high-density integrated injection logic. The chip, built by Mitsubishi, also contains driver transistors on its periphery for seven-segment displays. The circuit has 845 gates that fit on a chip measuring only 3.43 by 3.2 mm².

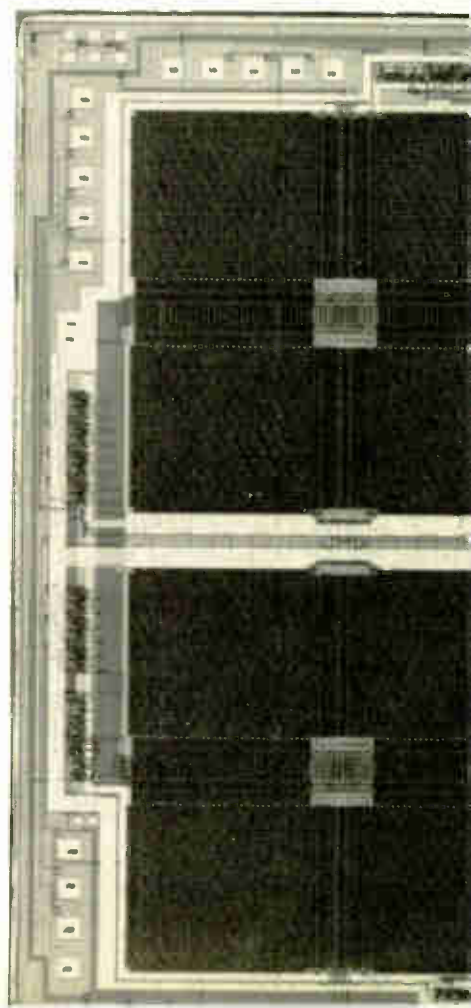
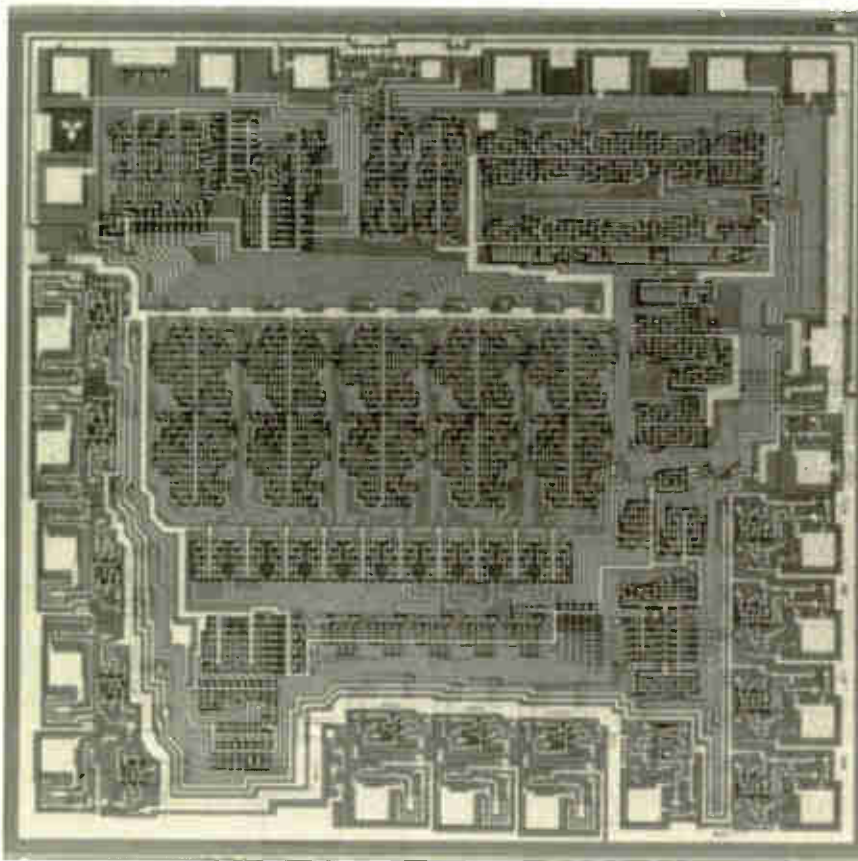
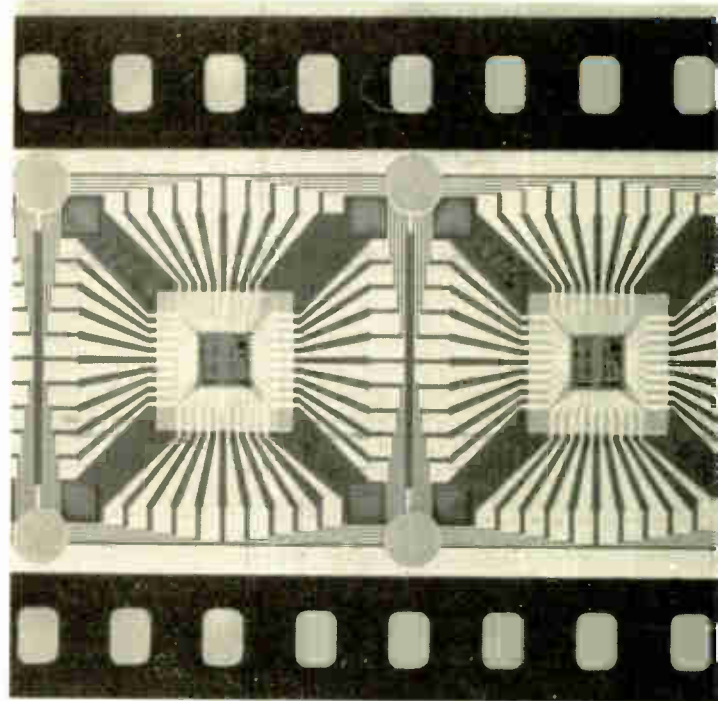

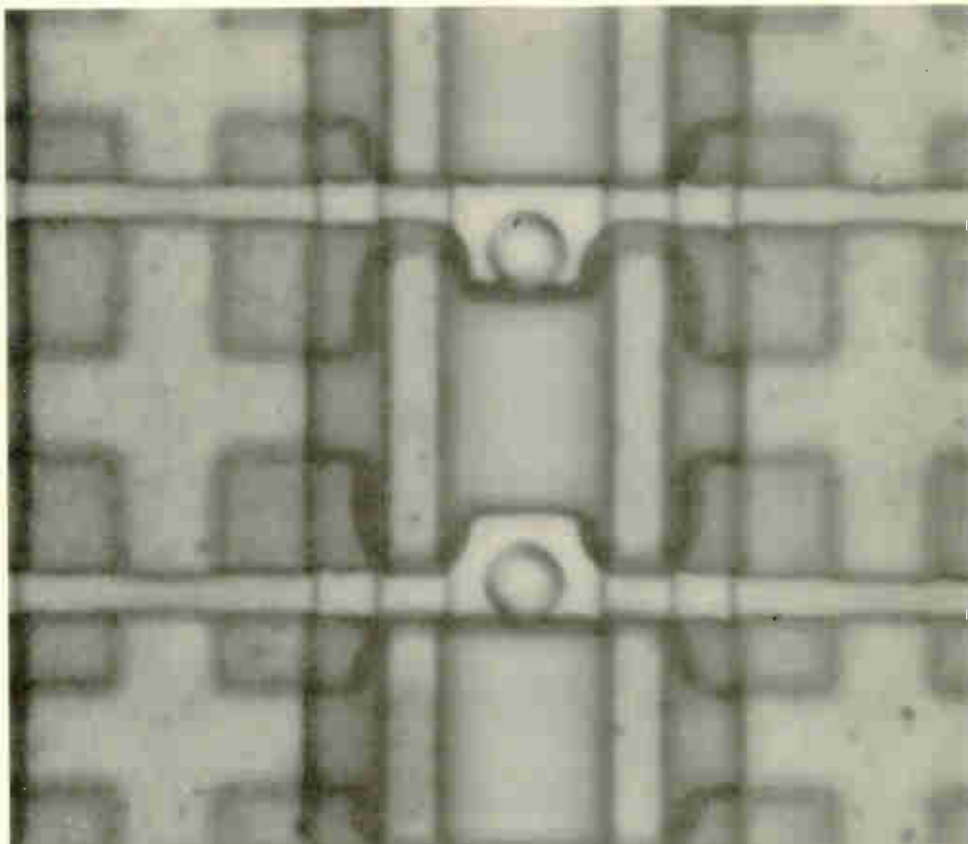
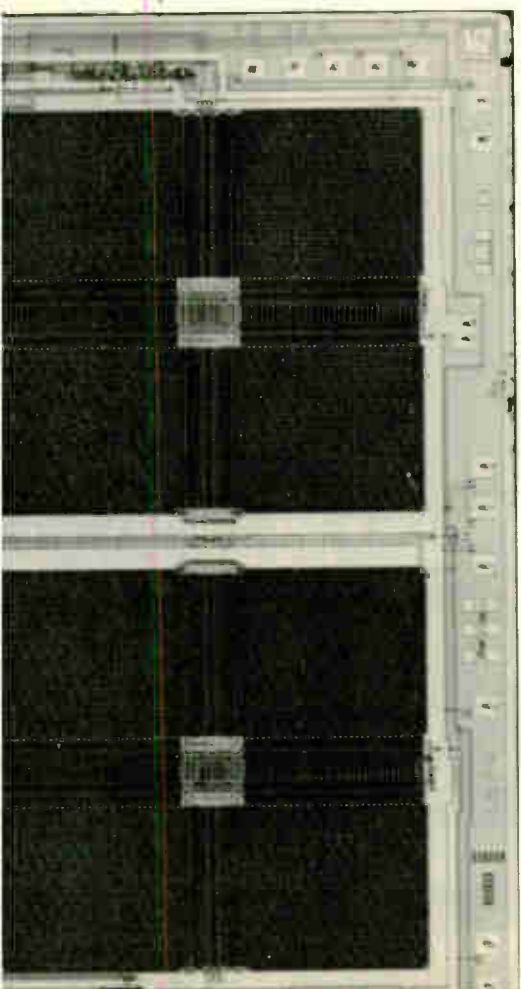
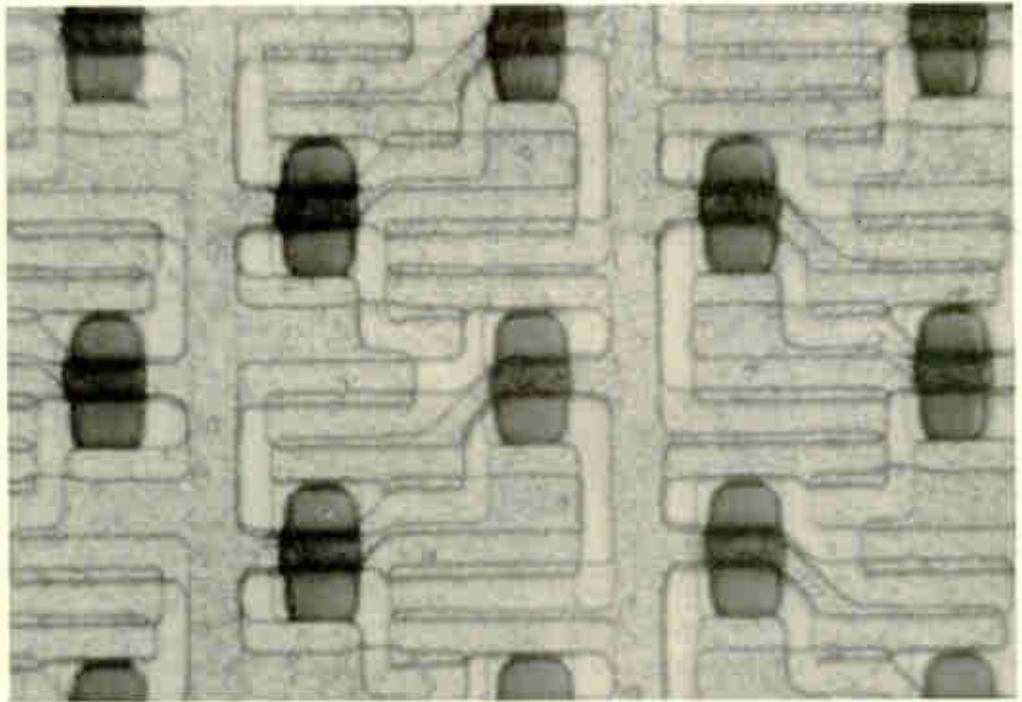
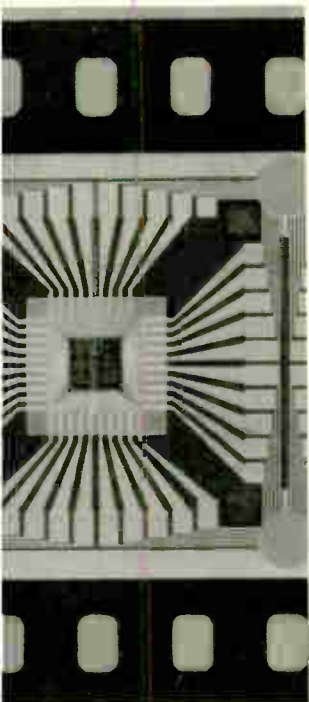

SPECIAL REPORT

JAPAN PREPARES TO SELL THE WORLD ON MEMORY

With single- and double-level n-MOS technology in hand, the Japanese semiconductor makers are ready to storm the world's memory markets. Satisfied that they can meet their domestic computer and data-processing equipment requirements, they are planning major drives on the U.S. and European markets with 4-k and 16-k dynamic random-access memories, 1-k and 4-k static RAMs, and 8-k and 16-k read-only memories for use in both mainframe and peripheral microcomputer systems. Further off, but near enough, are the popular 2708 erasable programmable ROM, which the Japanese are now supplying at home and will soon be exporting as well, and the Intel 2716-type 16-k erasable PROM, which they are tooling up to make.

In charge-coupled memories, some Japanese memory makers are already hitting pay dirt, for they are introducing 65,536-bit CCD serial memories in Japan as replacements for small disks in microcomputer systems. New high-speed metal-oxide-semiconductor and integrated-injection-logic parts still appear to be 18 to 24

months away from serious product entry, although sample flyers will probably appear in Japan this year. Bubble memories are also under investigation in various laboratories.

The dynamic picture

The big dynamic-RAM product in Japan is still the 4,096-bit copy of Intel's 2107B, which all the major Japanese computer manufacturers have adopted. The Japanese suppliers are NEC, Fujitsu, Hitachi, and Mitsubishi, all of whom either are or soon will be exporting to Europe and the U.S. In the lead both in Japan and abroad is NEC, which has been selling 22-pin 4-k devices in the U.S. for two years. But the extra influx should quicken the 2107B's price decline—it is already well below \$4.

The situation is not all roses for Japanese suppliers, though, since major U.S. mainframe makers have already shifted the bulk of their designs to faster 16-pin parts, both to upgrade speeds and in order to anticipate

1. Getting tough in microcomputers. Japanese chip manufacturers are gearing up for a big push in 4- and 8-bit processor systems. This one-chip 4-bit microcomputer from NEC, part of a family covering controller applications, is representative of the trend.

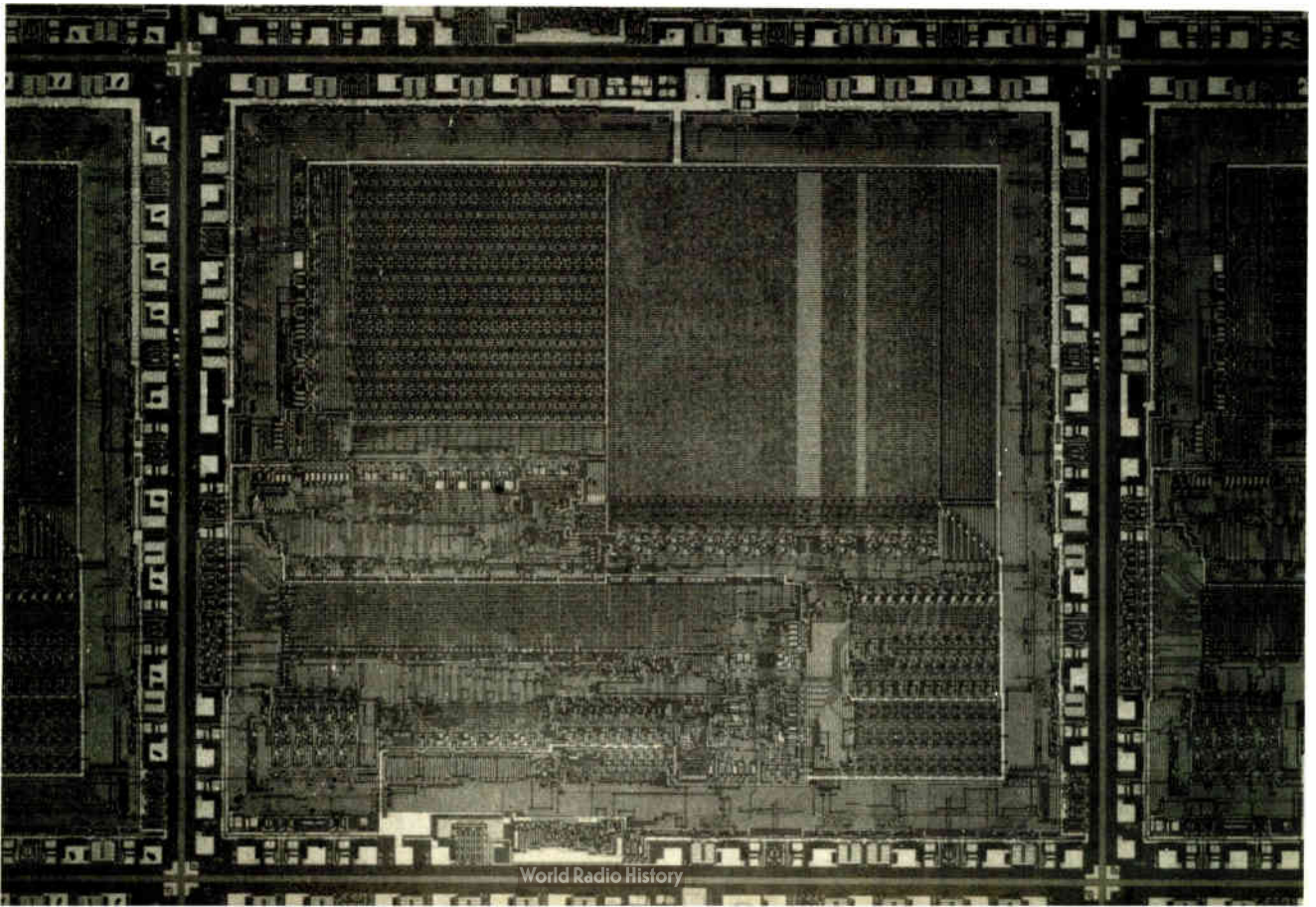

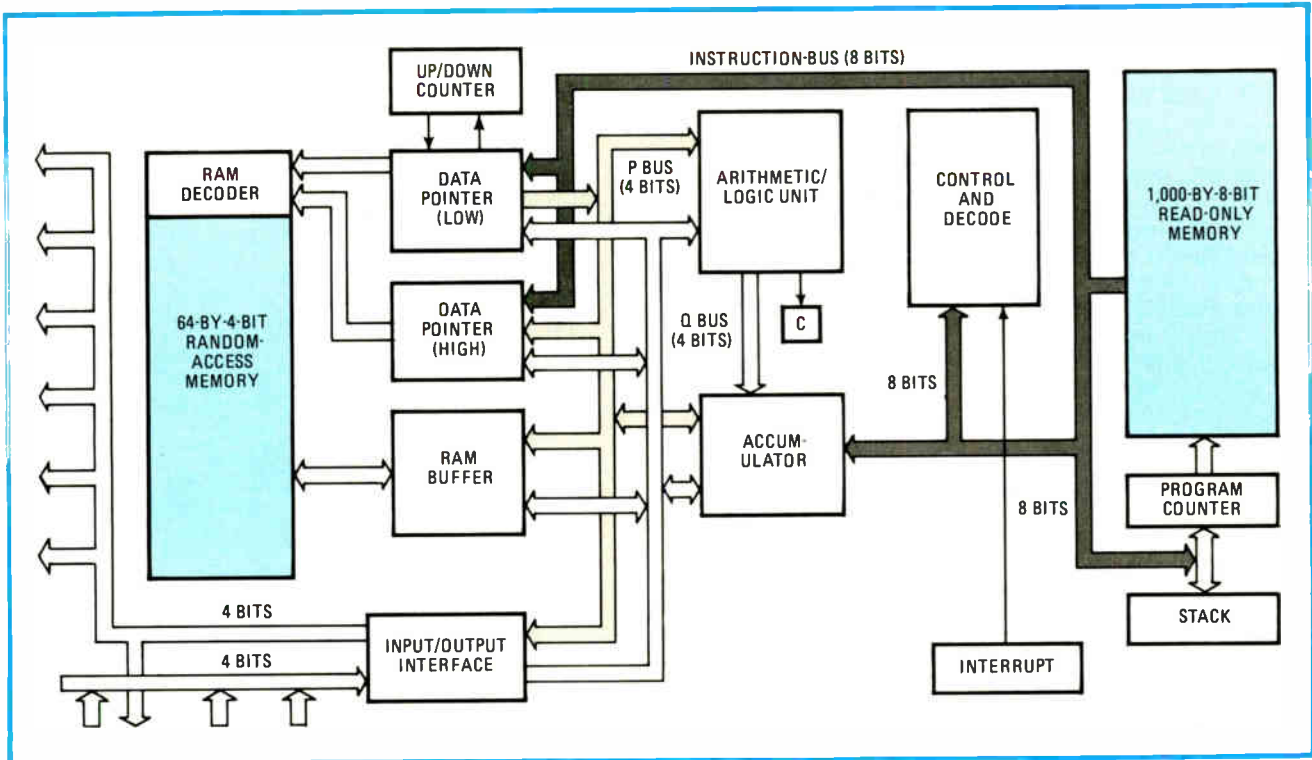

2. One-chipper. NEC's 4-bit microcomputer is a self-contained controller for low-end consumer and industrial equipment. It has 8,192 bits of program ROM, 256 bits of data RAM, and a flexible arrangement of I/O ports for interfacing with the user's peripheral equipment.

the imminent arrival of the 16-pin 16,384-bit devices. In response, NEC, Fujitsu, and Hitachi will start churning out 16-pin 4-k types, copying Mostek or Intel. However, since their computer divisions are not switching to the smaller-package parts, they will be denied a big domestic market for getting production of the 16-pin devices up and their costs down.

If some Japanese memory makers, always excepting NEC, were caught flat-footed by the shifting 4-k market in America, they will not be beat in the rapidly developing 16,384-bit memory market. Neck and neck with American leaders Mostek, Intel, and TI are NEC, Hitachi, and Fujitsu, which are making industry standard 16-pin 4116s in speed ranges of 200 to 300 ns, and soon to arrive are Toshiba and Mitsubishi. NEC is even supplying the 150-ns version and probably will have Hitachi for company as exporters of the premium part this year.

Crowded market place

What will three and possibly five newly qualified contenders do to the already overcrowded U. S. memory market? Chasing the MOS RAM market has long been a strain on many American semiconductor manufacturers—indeed, TI and Intel are probably the only American companies consistently making money in main-frame memory. If these aggressive Japanese exporters arrive early with the right part, they could rapidly rid the U. S. ranks of all but the most powerful American

firms competing in this heavily populated arena.

The Intel 2102 static types are being supplied by all Japanese RAM manufacturers but are exported apparently only by NEC, mainly to fill out its own 8080 microcomputer line. U. S. prices at \$1.50 in volume are just too low to make the Japanese enthusiastic about exporting the 1,024-bit static RAMs.

In 4,096-bit statics, too, the Japanese may have trouble, this time because there is no U. S. industry standard for them to copy. NEC is leaning towards the Intel 2114 part, while other Japanese manufacturers are leaning toward the Mostek 4104 type. Making it worse, static memories are used mostly in small microprocessor systems or in peripheral equipment where volume is low, so that memories often are bought as part of the package that includes the microcomputer.

The Japanese may have better luck with C-MOS devices, especially Toshiba with its line of 1-k and 4-k static RAMs. Its participation in Japan's big electronic cash register industry gives Toshiba a leg up on its U. S. rivals in C-MOS RAMs—Intel, Intersil, and RCA.

Microprocessors come last

Japan lags behind the U. S. in microprocessors, even at home. Two giants split about 25% of the Japanese market between them—Nippon Electric and Intel. But though NEC makes 4- through 16-bit types, 70% of its sales are 4-bit systems, including one-chippers for elec-

SPECIAL REPORT

Worthy competitors

Even as Japan is embarking on a VLSI program to produce integrated circuits for future computers and digital systems, the firms there are already using their considerable large-scale-integration capability to build a formidable array of products for today's markets. The memory card shown directly on the right is using NEC's new high-speed n-MOS dynamic random-access memories, which were designed for use in mainframe buffer systems. Hitachi's 16-k dynamic RAM shown on the far right is another example of production-ready state-of-the-art design. Using advanced IC techniques, such as double-level silicon gates, local-oxide isolation, and 5-micrometer photolithographic rules, it has an access time of 200 nanoseconds while dissipating only 500 milliwatts. Meanwhile, in charge-coupled-device memories, there is Toshiba's 65-k CCD serial chip (lower, far right) developed as a disk replacement in small microcomputer systems. Built with a double-level silicon-gate process similar to the one used in today's 16-k RAMs, it puts Japanese manufacturers on a par with U. S. CCD memory development. An example of a very-high-speed memory for buffer systems is Fujitsu's 7-ns, 1,024-bit random-access memory (lower middle) built with emitter-coupled logic. The part will be used in Fujitsu's upcoming big computers and will also be made available commercially both in Japan and abroad. Finally, Matsushita's linear MOS sensor arrays (directly below) are solid-state replacements for the low-resolution cathode-ray tubes used in industrial imaging applications. A 512-bit linear array is in volume production, and a 1,024-bit linear array and 64-by-64-bit area array are in pilot production.

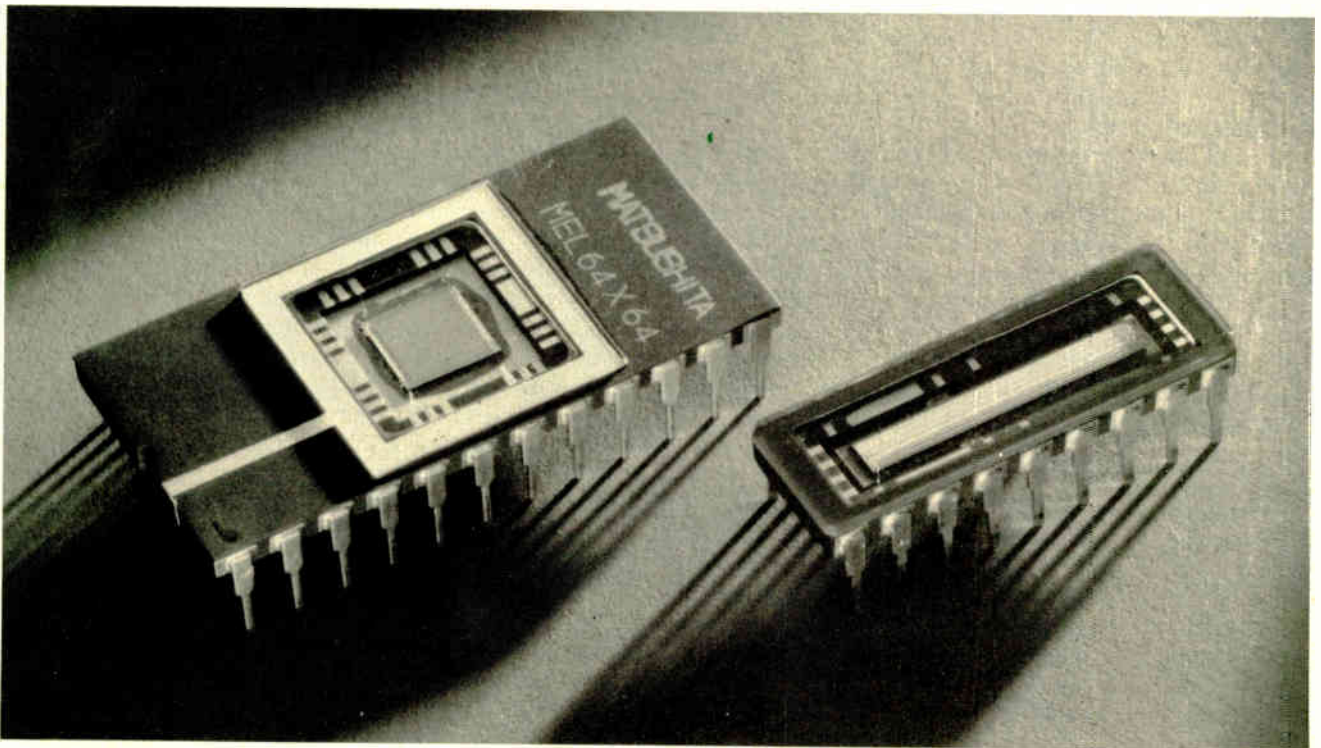
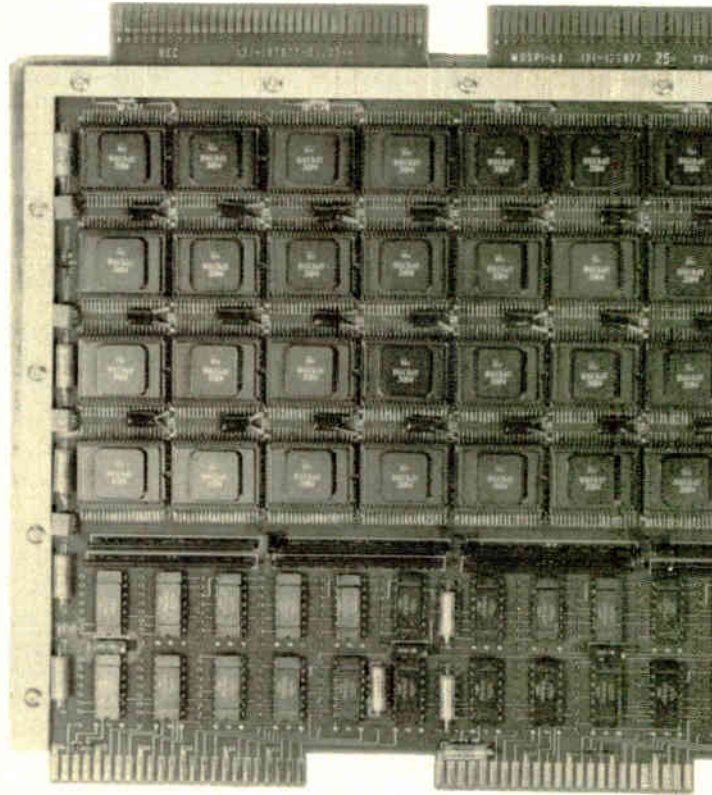

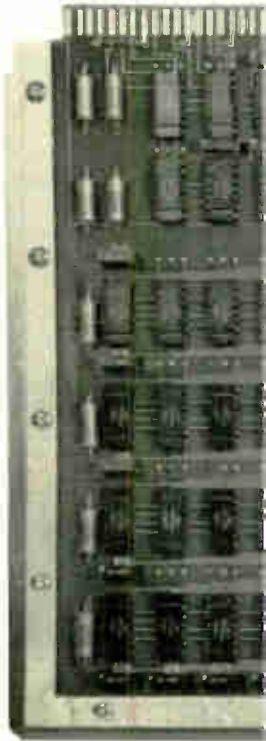
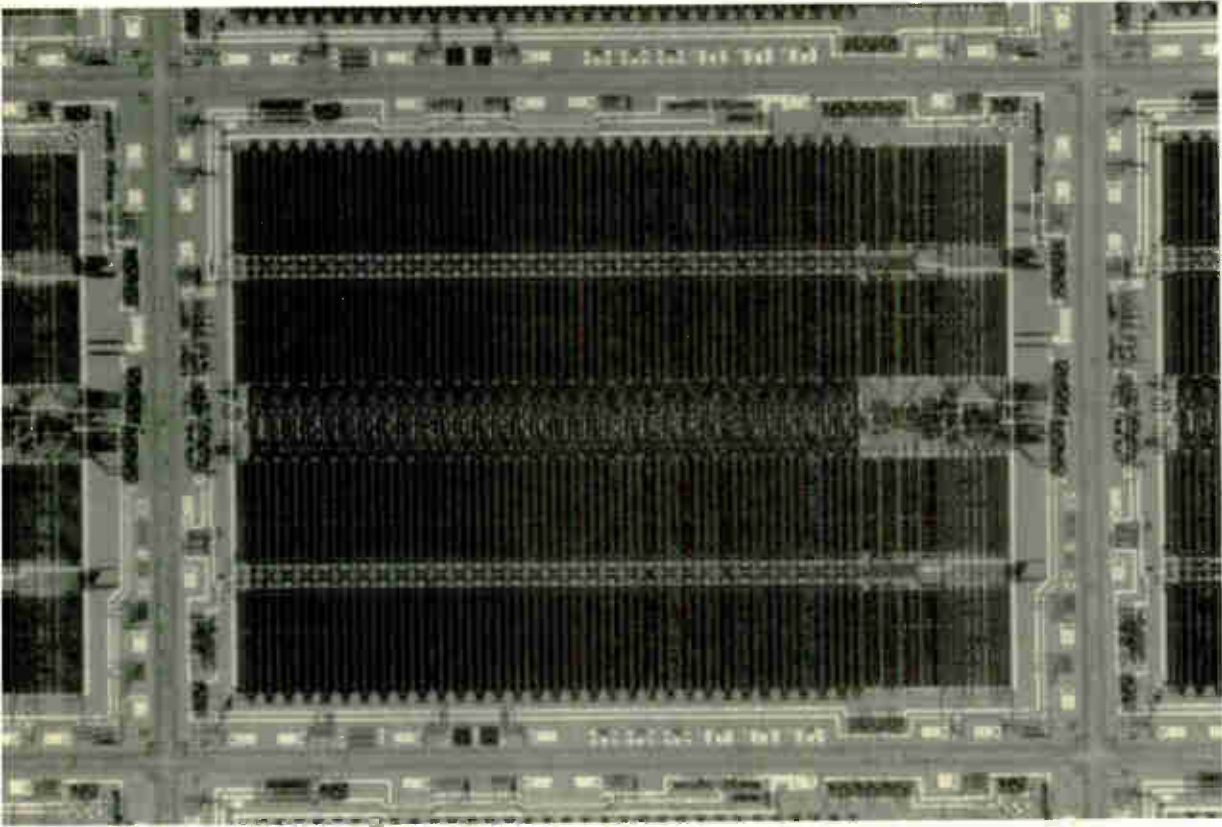
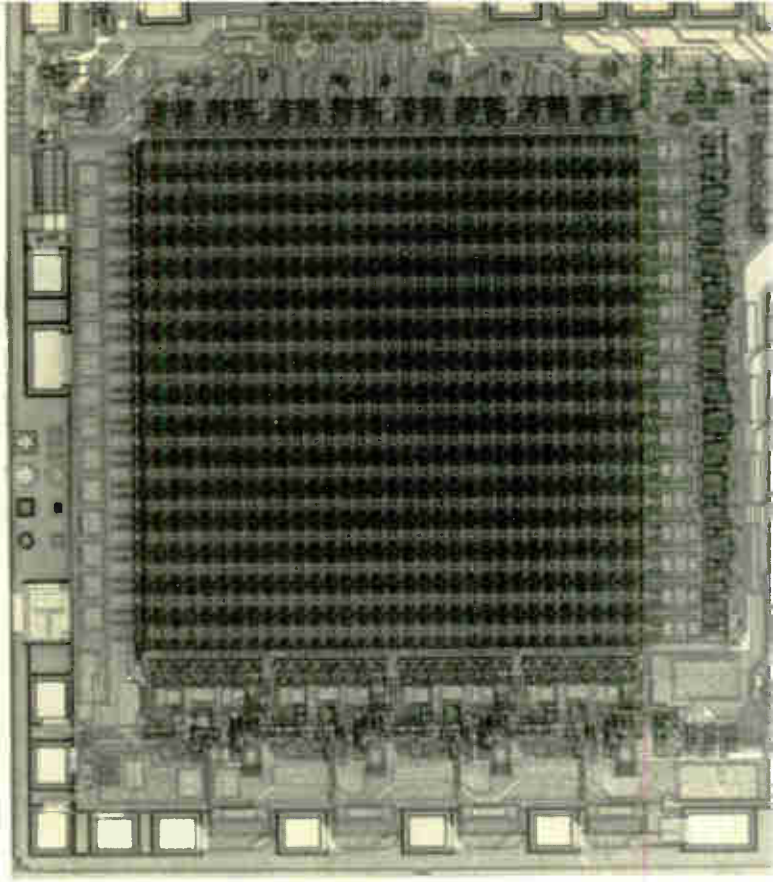
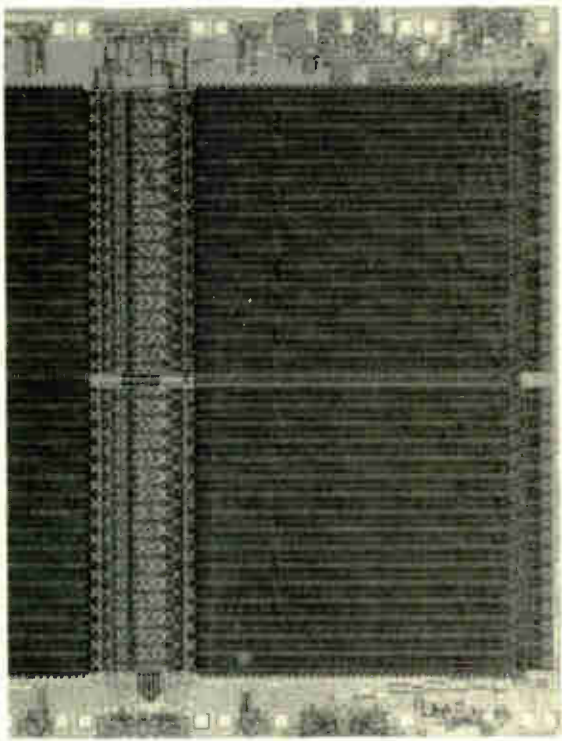



| 4-BIT MICROCOMPUTERS IN THE MN1400 SERIES | | | | | |
|--|------------------------------------|-------------------|-----------------|-------------------|----------------------------------|
| | | MN1400 | MN1402 | MN1498 | MN1499 |
| Dual in-line package | | 40-pin plastic | 28-pin plastic | 40-pin plastic | 64-pin ceramic |
| Power supply (V) | | + 5 | + 5 | + 5 | + 5 |
| Instruction cycle time (μ s) | | 10 | 10 | 10 | 10 |
| Instruction set (number of instructions) | | 75 | 57 | 68 | 75 |
| Subroutine stack | | 2-level | 2-level | 2-level | 2-level |
| Instruction memory | On-chip instruction ROM (bits) | 1,024 x 8 (8,192) | 768 x 8 (6,144) | — | — |
| | External instruction memory (bits) | — | — | 1,024 x 8 (8,192) | 2,048 x 8 (16,384) |
| Total data RAM (bits) | | 64 x 4 (256) | 32 x 4 (128) | 64 x 4 (256) | 64 x 4 (256) |
| directly addressable | | 4 words | 4 words | 4 words | 4 words |
| Counter/timer (bits) | | 8 | — | 8 | 8 |
| Power-on reset | | yes | yes | yes | yes |
| Input | parallel | one 4-bit port | two 4-bit ports | one 4-bit port | two 4-bit ports |
| | sense | 2 | 2 | 1 | 2 |
| Output | discrete | one 12-bit port | one 5-bit port | one 9-bit port | one 12-bit port |
| | parallel | one 4-bit port | two 4-bit ports | one 4-bit port | one 4-bit port one 5-bit port |
| | PLA | one 8-bit port | — | — | — |
| Assembler support | | yes | yes | yes | yes |
| On-chip clock generator (external control) | | yes (yes) | yes (yes) | yes (yes) | yes (yes) |

Source: Matsushita

tronic cash registers, vending machines, and consumer products. Its 4-bit types include both proprietary and general-purpose types, but none is compatible with American-made products.

Nevertheless, NEC soon plans to test the water here with 4-bit originals that cover the spectrum—from the μ PD751 high-end three-chip set that is made with the n-channel process through a low-end single-chip p-channel device, μ PD547 (Fig. 1). In between are several p-channel devices—the two-chip μ PD541/ μ PD542 and the one-chip μ PD548 for arithmetic operation, and the single-chip μ PD546 for sequence control.

The block diagram of the μ PD547C (Fig. 2) is typical of Japan's 4-bit one-chippers. The part contains all the necessary computer functional blocks—arithmetic/logic unit, ROM, RAM, and input/output functions to handle a host of low-end controller jobs. Included on the chip are a 4-bit parallel CPU and control logic, an 8,192-bit ROM for program memory, a 256-bit RAM for data memory, a stack memory, and input/output ports. The part can hook up directly with standard printers and seven-segment-digit displays, with no external parts needed.

Matsushita is another Japanese supplier of a 4-bit one-chip microcomputer family (see table). The parts range in size from 6,144 and 8,192 bits of program memory and 128 to 256 bits of data memory. Two chips in the family, the MN1498 and 1499, are expandable into more powerful systems by the addition of an

external program ROM. Other firms in Japan with one-chippers are Sharp, which makes its own 4-bit unit as well as Rockwell's PPS-4 family, and Hitachi, Fujitsu, and Toshiba, which have one-chip parts on the way.

The word about 8 bits

In 8-bit microprocessors, NEC leads the Japanese semiconductor companies with its version of the 8080A, which it both sells at home and exports. (Others in Japan making the 8080 include Mitsubishi and Oki.) NEC is also well along in developing one-chip 8-bit versions of the one-chip Intel 8048 and 8748 and in addition produces proprietary 8-bit one-chippers, the μ PD767 microcomputer and the μ PD765 peripheral control microcomputer. For its 8-bit systems, NEC produces many LSI peripheral chips, including direct-memory-access, keyboard, and cathode-ray-tube controllers.

Hitachi's 6800, built under Motorola license, is just starting to have some success at home. Moreover, the firm has just developed three LSI peripheral chips for DMA, CRT, and cassette control, which in turn will be second-sourced by Motorola. Fujitsu makes a somewhat enhanced 6800, not under Motorola license, but uses it mostly for in-house designs. Sharp is making Rockwell PPS-8 devices and at year end will start turning out Zilog's Z-80 under license. \square

Reprints of this special report cost \$3.00 each. Write to Electronics Reprint Dept., P.O. Box 669, Hightstown, N.Y. 08520. Copyright 1977, Electronics, a McGraw-Hill publication.



A new line of enclosures styled and designed to house new ideas.

There are scores of applications for Bud's new Contempo Series. And their versatility is equalled by their clean, contemporary design. Four styles come in 22 sizes with either a woodgrain and eggshell or black pebble and smooth gray finish. Whatever the size or finish you choose, the Contempo Series is immediately available from your authorized Bud distributor. For literature, phone Bud toll free: (800) 321-1764; in Ohio, (800) 362-2265.

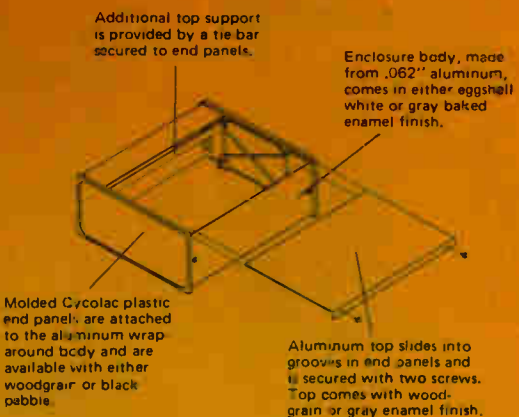

BUD INDUSTRIES, INC.
4605 East 355th Street
Willoughby, Ohio 44094

BUD WEST, INC.
3828 North 36th Avenue
Phoenix, Arizona 85019

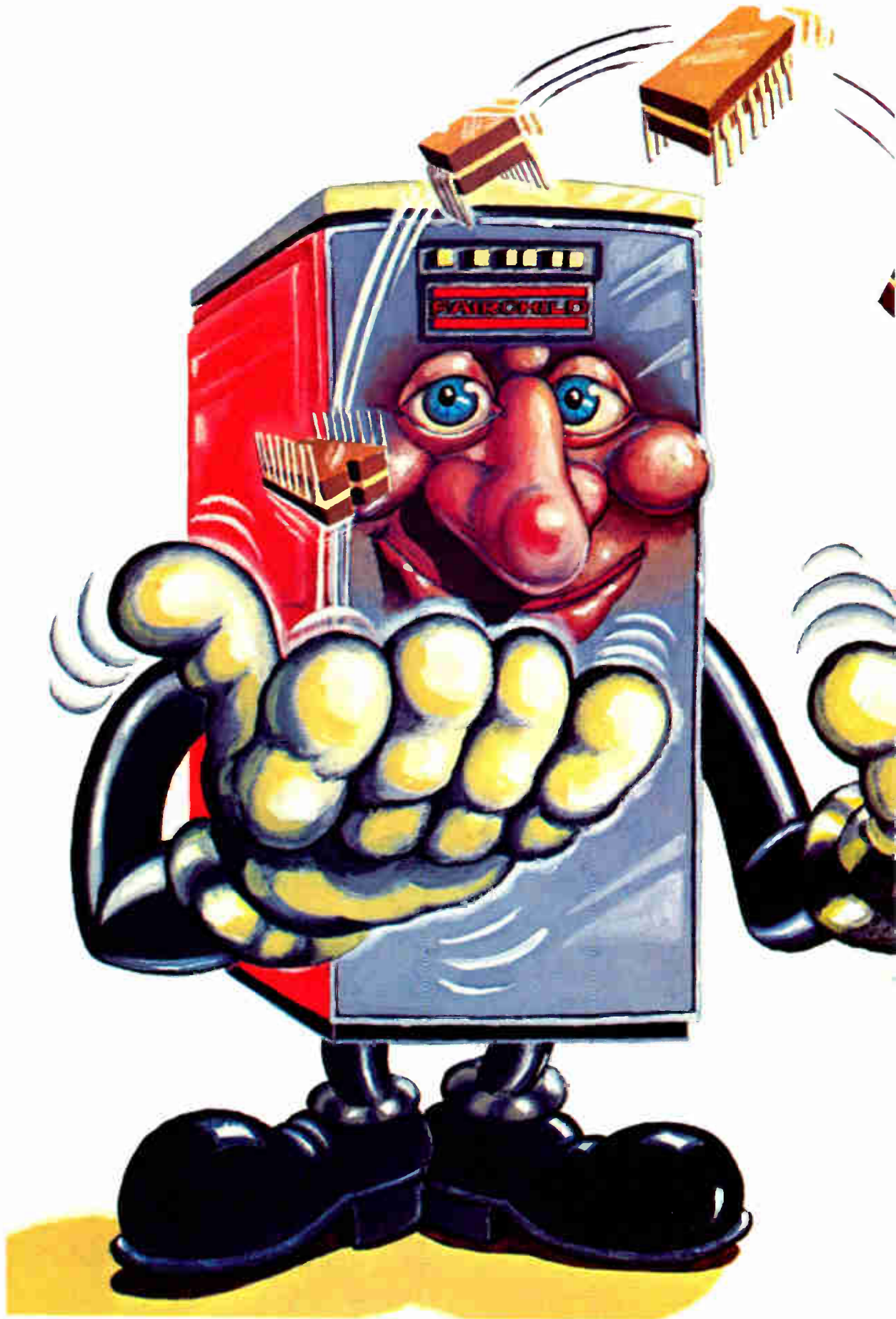

THERE'S ONLY ONE WAY TO TEST 16k RAMS— FOUR AT A TIME.

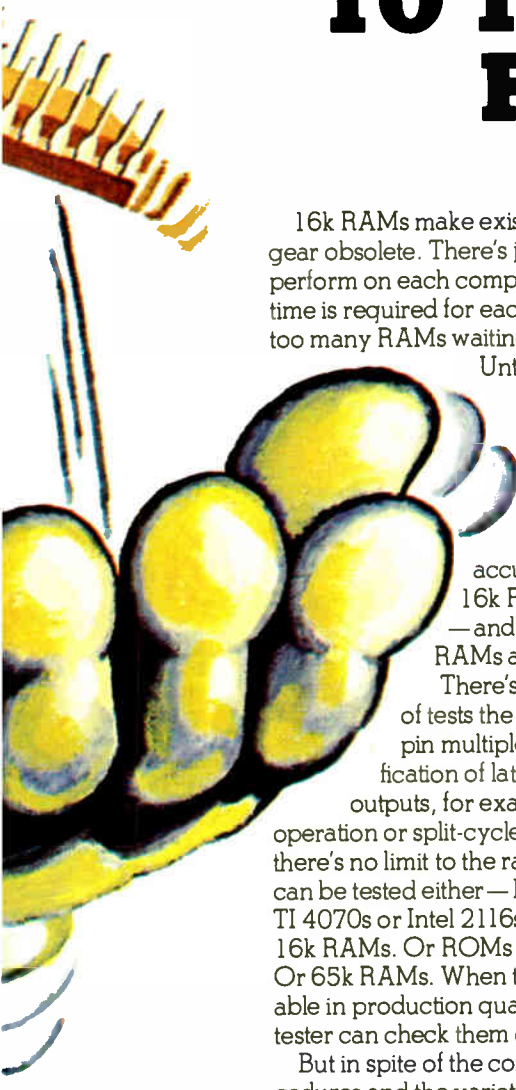

16k RAMs make existing memory test gear obsolete. There's just too many tests to perform on each component, too much time is required for each test, and there are too many RAMs waiting to be checked out.

Until now.

With Xincor's Quad tester you can perform all the complex functional testing needed to thoroughly and accurately check out any 16k RAM on the market—and you can do it four RAMs at a time.

There's no limit to the range of tests the Quad can perform—pin multiplexing checks, verification of latched or unlatched outputs, for example. Or page-mode operation or split-cycle timing tests. And there's no limit to the range of devices that can be tested either—Mostek 4116s, TI 4070s or Intel 2116s to name just a few 16k RAMs. Or ROMs of any size up to 65k. Or 65k RAMs. When these become available in production quantities, the Quad tester can check them out four at a time too.

But in spite of the complex test procedures and the variety of devices that the Quad can handle, throughput rates are comparable to those associated with simpler, 4k-device testers. For large scale applications, up to four Quad testers can

be hooked together in parallel, giving you the power to check out 16 16k devices at one shot.

That's the good news.

Even better news is this. With the Quad's four-up parallel testing capability, per-socket costs come down—under \$35k. As a result, per component test costs come down too.

But the number of extras you get with a Quad tester goes up. As part of the Xincor III distributed automatic test system, the Quad tester can be used to store, analyze and process vast amounts of test data—schmoo plots for example, or wafer maps, or device-by-device, shift-by-shift yield/trend comparisons. You also get compiling and test-program editing capabilities.

And we do it all for you. We'll provide the software, and we'll put the system in. Then we'll assign an on-site team to run the Quad through its paces in conjunction with your engineering and production staffs to insure it does what it's supposed to do even under the most demanding industrial environments.

We'd like to show you a Quad tester, and we'd like to show you what it can do. Call or write us for more information.

The Quad tester: a four-taste of things to come from Xincor. Xincor Systems, Division of Fairchild Camera & Instrument Corp., 8944 Mason Avenue, Chatsworth, California 91311 (213) 341-5040 or TWX 910-494-2769.

FAIRCHILD

Portable 250 MHz Frequency Counter \$345.*



Actual size, front view.

...Goes Anywhere You Need It

Model 585 Meets Your Requirements

- In field service and maintenance
- In the development laboratory
- In quality control
- On the production line

The Model 585 Digital Frequency Counter is another Data Precision design breakthrough: remarkably low in cost, compact and easy to use, yet uncompromised in either reliability or performance.

Completely independent of the power line, the Model 585 is a full 8-digit frequency counter to 250 MHz. It is battery and line operated, fits in your hand, and its performance and value have been optimized, *not* by cutting corners, but by *design innovation*.

Exceptional Reliability

Data Precision proprietary LSI chip contains not only the front end signal conditioning circuitry, but the first counter decade as well. This allows Model 585 to provide exceptional reliability, laboratory performance and field portability – all at the remarkably low price of \$345.!



Features that make the Model 585 something special for you!

- 10Hz to 250MHz – Direct Counting, Direct Reading.** Always reads directly in MHz, with correctly positioned decimal point. No calculations, no interpretations, no heterodyning, and no prescaling.
- High Sensitivity.** 10mVRMS to 50MHz, 50mVRMS to 250MHz! And the signal may be amplitude or frequency modulated, provided that the minimum-signal and frequency ratings are respected.
- 8-Digit Display – with Fully Compatible Stability.** Exceptionally High Resolution. Gate Time: 10 sec., 1 sec., 0.1 sec. Resolution: 0.1Hz, 1Hz, 10Hz.
- Big, Bright Display.** Eight 0.3" LEDs, for optimum readability wherever you use it.
- Dual Input Impedance.** Switch-selected, 1 megohm or 50 ohms.



- Wide-Range Attenuator.** Three position front panel switch, x1, x10, x100, accommodates very wide input-signal range. Input protection circuits prevent damage from extra high signals.
- Big-Chip Reliability, Economy, and Battery Longevity.** A Data-Precision LSI chip provides high performance in a miniature configuration. The 585 has the lowest

cost, the lowest component count, and the lowest battery drain of any comparable design!

Model 585, including rechargeable NiCd batteries, AC line/charger, and a vinyl carrying case is only \$345. This package also includes a full instruction manual, Certificate of Conformance, and final test data.

Optional Accessories available include: telescopic antenna, (TCXO) precision crystal oscillator, leather or fiberglass carrying case, panel mount adaptor, and bench stand.

All specifications guaranteed for a full year. Full-Year warranty for both parts and labor. Service is available from our worldwide service centers.



100 MHz Multifunction Counter/Timer – \$295.

If you need a bench counter/timer consider our Model 5740 which measures: Frequency, Period, Period Average, Total Events and Elapsed Time. Sensitivity to 10mV.

For further information or a demonstration, contact your local Data Precision representative or Data Precision Corporation, Audubon Road, Wakefield, MA. 01880. U.S.A. (617) 246-1600 TELEX (0650) 949341.

*Price USA

| | |
|-----------------------|-----------------------|
| AL (205) 533-5896 | FL (N) (813) 294-5815 |
| AZ (602) 253-6104 | FL (S) (305) 491-7220 |
| CA (N) (408) 733-8690 | GA (404) 945-4222 |
| CA (S) (714) 540-7160 | IL (312) 593-0282 |
| CO (800) 528-4512 | IN (317) 293-9827 |
| CT (203) 525-7647 | MA (617) 245-5940 |

| | |
|-----------------------|-----------------------|
| MD (301) 622-4200 | NJ (S) (215) 674-9600 |
| MI (313) 482-1229 | NM (800) 528-4512 |
| MN (612) 781-1611 | NY (N) (315) 446-0220 |
| MO (816) 358-7272 | NY (S) (516) 482-3500 |
| NC (919) 787-5818 | NY (S) (212) 895-7177 |
| NJ (N) (800) 645-8016 | |

| | |
|-----------------------|-----------------------|
| OH (N) (216) 331-0900 | TX (S) (713) 461-4487 |
| OH (S) (513) 433-8171 | TX (W) (512) 837-3881 |
| OK (918) 936-3631 | UT (800) 528-4512 |
| OR (503) 238-0001 | VA (800) 638-2720 |
| TX (N) (214) 234-4137 | WA (206) 763-2210 |

 **DATA PRECISION** [®] ...years ahead

Circle 126 for Demonstration
Circle 127 for Additional Information

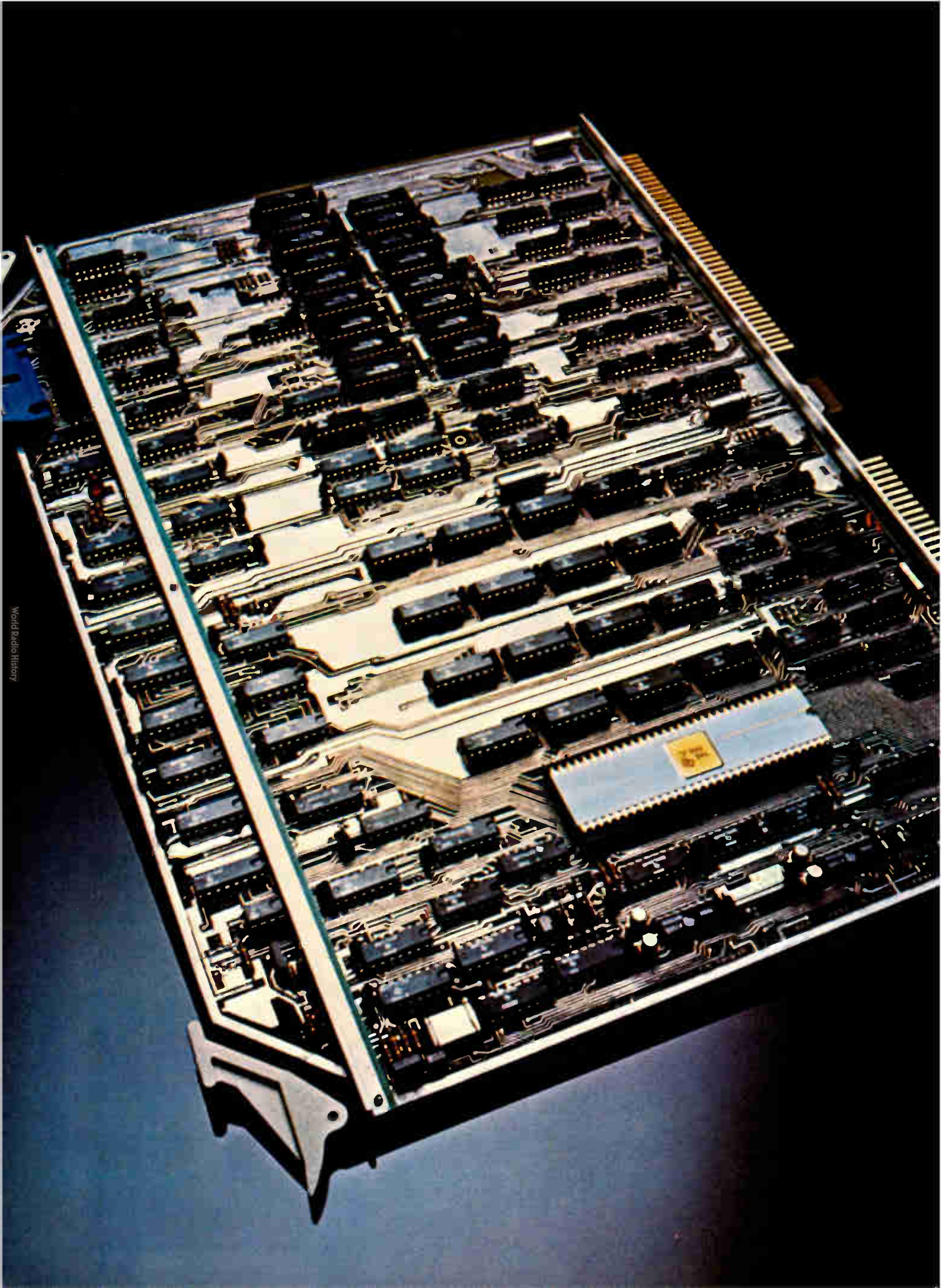

**When you're
designing microprocessors
into your products...
our 990 computer products
can give you a head start.**

TEXAS INSTRUMENTS.

Start with the TMS 9900 microprocessor.

It delivers surprising power, speed and flexibility in a low-cost, single-chip 16-bit package. Its repertoire of versatile instructions and high-speed interrupt capabilities provide computing power usually associated with a 16-bit TTL minicomputer.

Hardware multiply and divide is standard and the software you develop for the TMS 9900 is upward compatible with any other member of the 990 computer family.

When your application calls for a microcomputer—start with the 990/4 microcomputer on a board.

It offers all the advantages of the TMS 9900, plus flexible memory and CPU options ideally suited to manufacturers' applications: up to 8K bytes of dynamic RAM memory, up to 2K bytes of RAM and/or PROM, real-time clock input, eight vectored interrupts, expansion interface and optional ROM utilities. It's our off-the-shelf answer for many production needs.

The 990/4 microcomputer is also available in a low-cost three-slot OEM chassis...or housed in a 6- or 13-slot rack-mount chassis with programmer's panel...or in a 6-slot



tabletop chassis. And, the 990/4 is available as a complete computer system supported by your choice of performance options and peripherals.

For applications requiring greater speed, we offer the most powerful member of the 990 computer family...the 990/10 minicomputer. It uses a TTL implementation of the 990 architecture and features TILINE*, an asynchronous, high-speed 16-bit parallel I/O data bus which links the CPU, memory, and high-speed peripheral devices.



Rack-Mount 990 Computer

And to help you get on line faster and surer, there's a prototyping system using 990 computer hardware and software packages.

In addition, the 990 family is well supported by a substantial library of software development packages.

Whatever your needs...the TMS 9900 microprocessor, the 990/4 microcomputer, or the 990/10 minicomputer...you'll be working with some of the most attractive



990/9900 Prototyping System

computer component values on the OEM market. Price/performance leadership you expect from Texas Instruments.

You can start today by getting more information on the entire 990 computer family. Contact your nearest TI sales office, or phone (512) 258-5121, Computer Equipment Marketing, for your local distributor. Write Texas Instruments Incorporated, P.O. Box 1444, M/S 784, Houston, Texas 77001.



*Trademark of Texas Instruments Incorporated

© Copyright 1977, Texas Instruments Incorporated

See Texas Instruments products at NCC.

TEXAS INSTRUMENTS
INCORPORATED

The new DAC standard. Analog Devices' complete 10-bit monolithic DAC.



Less than a buck a bit.

You can pay at least twice as much for a 10-bit IC D/A converter and still not get the degree of accuracy and stability of our new AD561. Selling for less than \$10, the AD561 sets a new standard of price and performance for the other guys to shoot for.

As for accuracy, the AD561 is guaranteed to $\pm 1/2$ LSB max of 10-bits (or even $\pm 1/4$ LSB — and that's 11-bits). Monotonicity is guaranteed over the full operating temperature range. The excellent stability is made possible by a unique buried zener voltage reference and Analog Devices' proprietary thin film resistor process. And for settling time, there's nothing faster: less than 250ns for the worse case transition; that's fast enough to build a 5 μ sec ADC. Current-to-voltage conversion with an op amp is direct and simple: trimmed application resistors mean no calibration trimmers are needed.

How did we achieve this breakthrough? With the industry's most advanced monolithic processing and our pioneering technique of laser wafer trimming. The kind of advances that have quickly pushed us

to the top and made us the leading supplier of D/A and A/D converter components.

The AD561 joins another group of Analog Devices' pacesetters: a series of monolithic CMOS converters that also set new performance standards. At the same time they set a lot of microprocessor users free of analog interface problems. One is the 10-bit successive approximation AD7570 ADC. Another is the multiplying 10-bit DAC, AD7522, the only device that can be loaded in either parallel or serial modes.

And the AD561 joins the industry's 12-bit IC DAC standard, AD563.

Find out how you can cut in half the cost of your 10-bit IC D/A converters and still get true, 10-bit performance by writing for our data sheet. Contact Analog Devices, the real company in precision measurement and control.

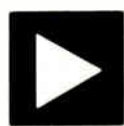

**ANALOG
DEVICES**

The real IC converter company.

Analog Devices, Inc., Box 280, Norwood, Massachusetts 02062. East Coast: (617) 329-4700, Midwest: (312) 894-3300, West Coast: (213) 595-1783, Texas: (214) 231-5094, Belgium: 031 38 27 07, Denmark: 02/84 58 00, England: 01/94 10 46 6, France: 686-77 60, Germany: 089/53 03 19, Japan: 03/26 36 82 6, Netherlands: 076 87 92 51, Switzerland: 022/319704 and representatives around the world.

Self-gating sample-and-hold controls oscillator frequency

by Peter Reintjes
Research and Design Ltd., Morehead City, N.C.

A phase-locked loop in conjunction with a transmission gate serving as a sample-and-hold device can remember the frequency of a short-duration signal by providing a constant feedback voltage to a voltage-controlled oscillator. The circuit is useful for electronic-music synthesis and tuning radio oscillators by remote push button, as well as other applications.

The circuit can sample and hold frequency bursts without the error introduced when the direct conversion of an input frequency to a voltage or digital quantity is attempted. As shown in the figure, a relatively high-level, short-duration alternating-current input signal is amplified, buffered and compared to a user-determined reference by the three operational amplifiers in the LM3900 device. The output of the last stage drives the 555 timer, which serves as a monostable multivibrator (one-shot). The input signal also drives the CD4046 phase-locked loop.

As the one-shot periodically fires in response to the input signal, the transmission gate conducts, completing the feedback loop in the PLL. This permits the output of a selected comparator in the PLL to feed the voltage-controlled oscillator at pin 9. The output of the comparator is a function of the difference between input and VCO output frequencies; the resulting current charges the RC network in the feedback loop consisting of the 10-kilohm resistor and the 0.1-microfarad capacitor. The final dc voltage, across pin 9, controls the VCO frequency and becomes constant when the input and VCO frequency match.

When the amplitude of the input signal fades, thus signalling the end of the burst, the feedback loop is opened because the 555 no longer fires. The voltage across pin 9 remains, however, because the high-input impedance of the VCO terminal prevents negligible leakage by the RC network. Therefore the VCO continues to oscillate at the same frequency indefinitely. The high input impedance provides a good "hold" characteristic.

Comparator 1 in the PLL, an exclusive-OR gate, should be used for high-noise input sources for optimum performance. Comparator 2 is an edge-detecting device and may be used for most other conditions. The LM555 sampling period is adjustable from 10 milliseconds to 1 second. The supply voltage on all devices may range from 5 to 15 volts. □

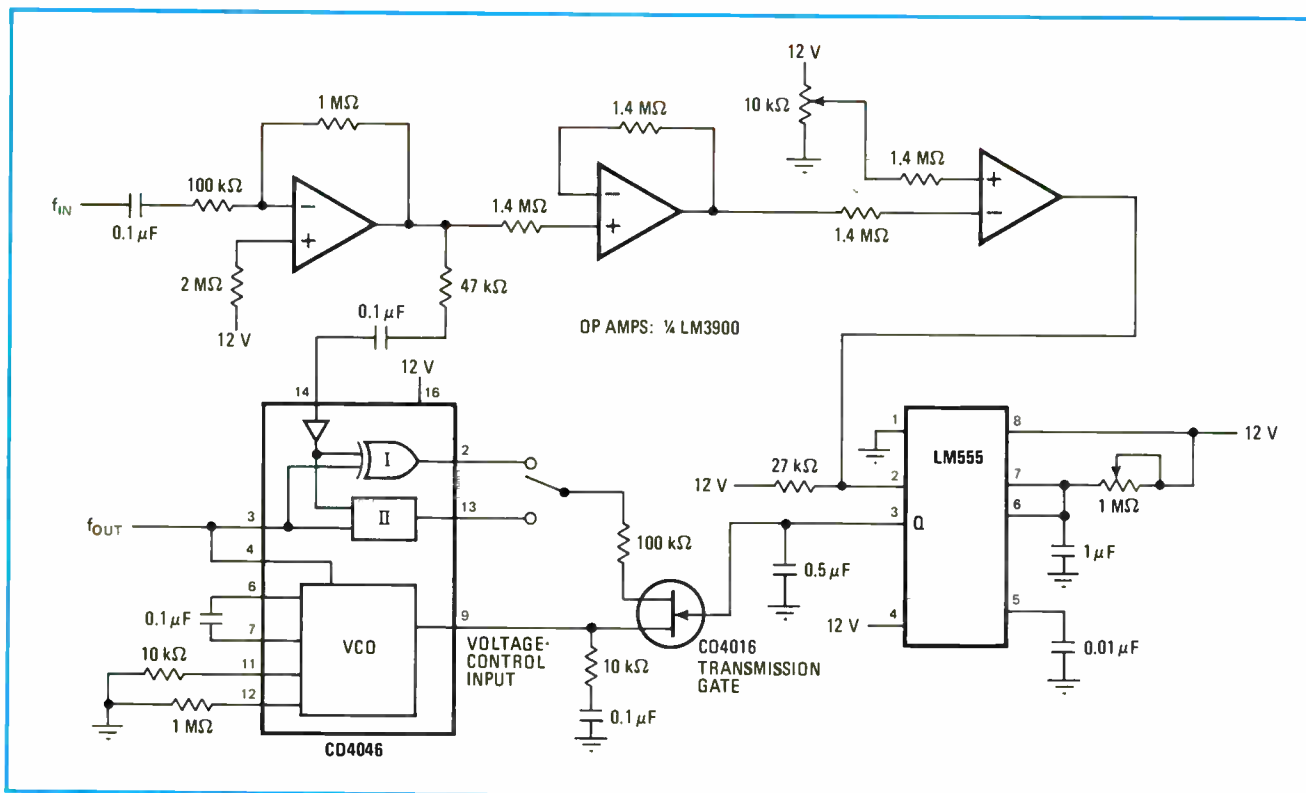

Self-gated sample-and-hold. Input-signal burst closes feedback loop in PLL, locks it to incoming frequency. Removal of input opens loop but causes no change in VCO frequency because of RC network, which stores unchanging voltage to drive oscillator.

Continued on page 134

A BROKEN AXLE COULD BE MORE THAN AN INCONVENIENCE.

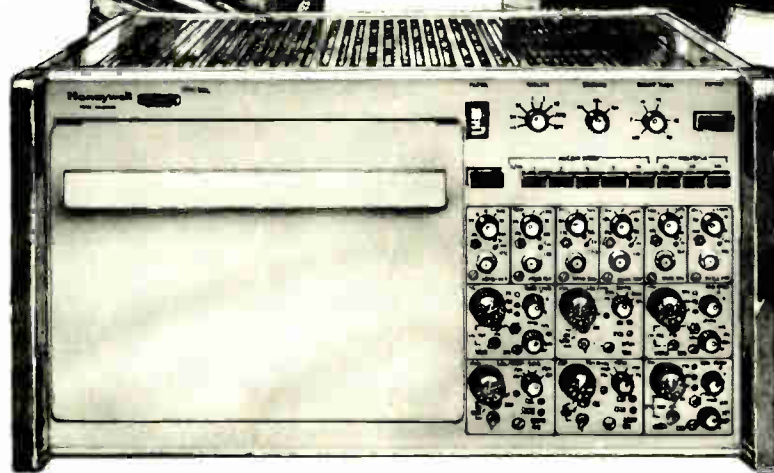

A leading manufacturer of roller coaster cars had a serious problem: defective axles. After futile attempts to pinpoint the cause, engineers installed strain-gages on one of the cars, put a Honeywell 1858 Visicorder and portable power source aboard, and sent the car around the track. Within minutes they had a complete graphic record of the stresses and strains encountered. And this pointed them toward a solution.

For such on-the-spot data acquisition, the 1858 is an obvious choice. It's exceptionally compact; 18 data channels with plug-in signal conditioning in a

package only 8-3/4 inches high. It's light and durable enough for field use, and it gives you the performance you expect from the most advanced lab system: frequency response from dc to 5000 Hz with no trace overshoot, input sensitivity from 100 μ V to 300V. The 1858 can be expanded to 32 channels and offers a complete selection of signal conditioning modules.

For more information on the 1858, or other Honeywell instrumentation recorders, call or write: Lloyd Moyer, Honeywell Test Instruments Division, Box 5227, Denver, CO 80217. (303) 771-4700.

WE'LL SHOW YOU A BETTER WAY.

Honeywell

Circle 133 on reader service card

Full adders simplify design of majority-vote logic

by Zhahai Stewart
Penfield Engineering, Boulder, Colo.

A majority-vote circuit—one with an output state determined by the logic states of the majority of its input variables—can be implemented by 4-bit binary full adders to yield lower chip counts or cost advantages than with standard designs using programmable read-only memories. The adders are easily combined to synthesize circuits used for decision-making or time-and-event-counter applications.

The circuits described use the 7483 full adder, but other adders that provide a similar logic function can be used. Each bit adder in the 7483 (Fig. 1a) has inputs A_i , B_i , and C_i ; the outputs are S_i and C_{i+1} . Each adder is cascaded internally by connecting the C_i ports together.

The characteristics of the device are such that there will be a logic 1 output from the sum (S_i) terminal of each adder if one input is high or all three inputs are high. The carry output (C_{i+1}) of each stage will assume the high state if any two inputs or all inputs are high.

1. Binary-adder majority gate. A single 7483 full adder (a) or similar device can be wired to produce up to a five-input majority-vote circuit. Five-input (b) and seven-input (c) gates are built using adders' truth table as the primary design tool.

This is the basic design tool used in the design of any n-bit majority gate.

Only one adder is needed to form majority gates with as many as five inputs. For example, a three-input device can be built by introducing the input variables to A_3 , A_4 , and B_4 of the 7483, while tying all other inputs high to form the "trivial case" solution. In reality, only one quarter of the adder is used to full advantage. The output, taken from the carry-out port of the adder, will be high if any two of the three inputs are high.

Figure 1b shows an implementation of a more important case, the five-input gate. Output M is high if any three of the five inputs are high. The seven-input circuit (Fig. 1c) is a simple extension of the five-input case using the design rules outlined above, but it cannot be built using a single 7483 because its internal-carry connections are not accessible. While the adders cannot be directly cascaded, a majority gate of any size may be easily built as design experience is gained.

When the number of inputs is small, a PROM can generate the required gate function for slightly greater cost and design effort. However, when the number of input variables is greater than 10 or so, the use of adders will provide clear-cut advantages. An 11-input gate constructed from three adders is easier to design than with a PROM. (Fig. 2a).

When the number of inputs becomes very large, it is

2. No need for PROMs. Implementation with adders offer advantages over PROM designs when number of inputs exceed 10 (a). Tree networks can replace adders for additional ease in wiring when the number of input variables is higher (b).

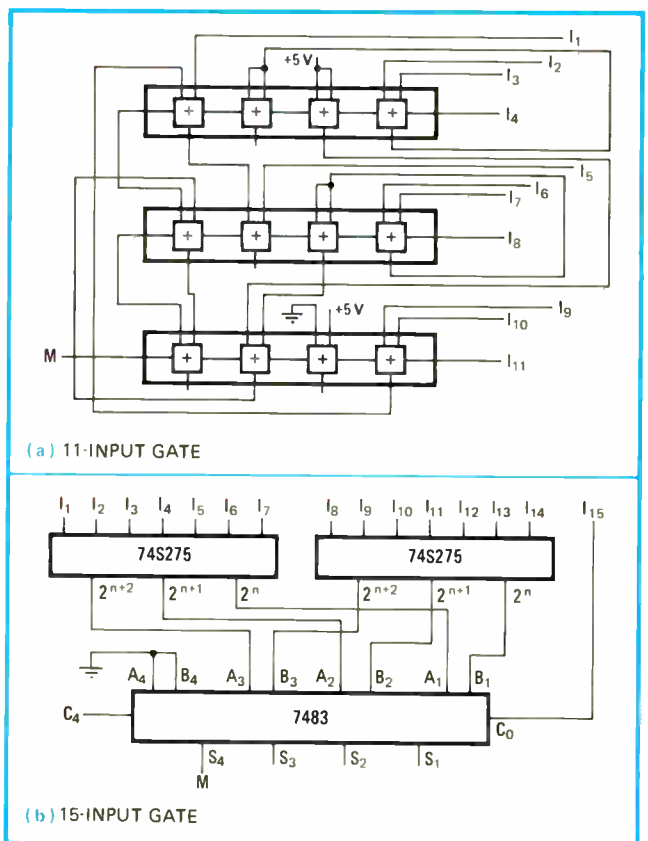
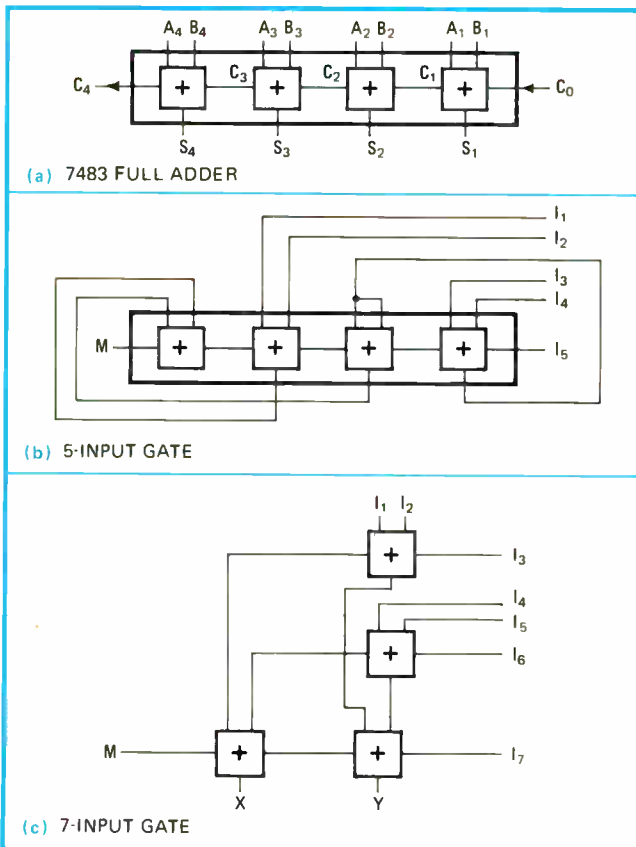

If you spend more than 20 minutes picking a P.C. connector

It's your guide to the broadest line of printed circuit connectors made by any single manufacturer. We have just about everything and in more combinations and more depth than anyone — more types of contact terminations, insulator materials, mounting styles, contact designs, types of plating.

Send for our catalog. Browse through it and you'll discover that picking out the right printed circuit connector for your job is as simple as it should be.

Quick delivery.

And you can get your hands on our connectors, too — in a hurry if need be. We keep a large inventory; so do our distributors.

Our "Whatever-you-need-we've-got" department.

As you can guess, we have a lot of tooling filed away. Our production engineers have a unique talent at taking an existing bit of tooling, fiddling with it, and turning out a "custom" connector that's exactly what you need. Your extra cost is only a modest set-up charge... a long way from a full retooling cost.

Use the coupon.

...you don't have this catalog.

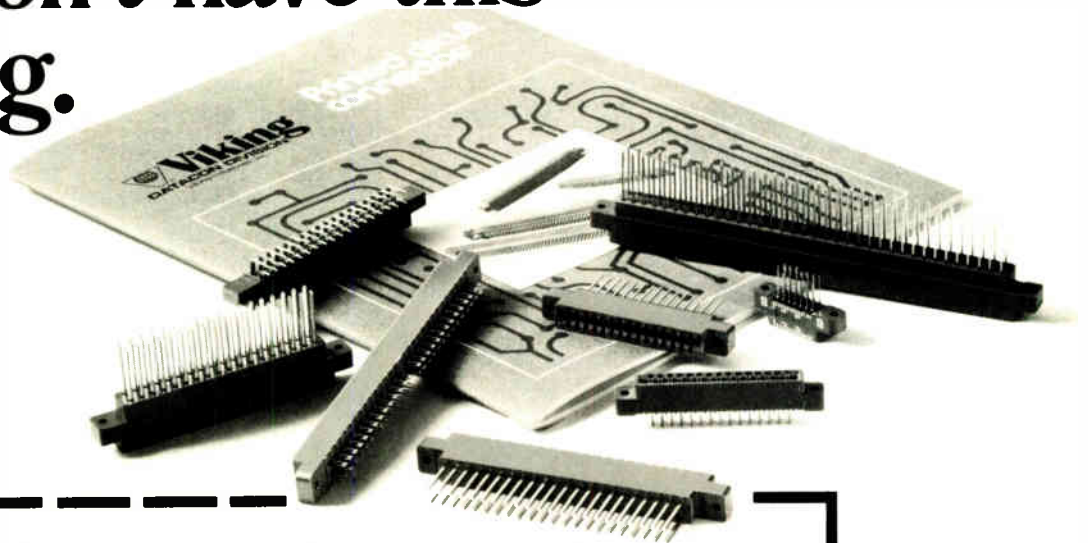

Ok. Send me: Your latest printed circuit connector catalog.
 ...and your nearest rep. I want to talk to him about a particular problem I have.

NAME: _____

TITLE: _____ TELEPHONE: _____

COMPANY: _____

ADDRESS: _____

CITY: _____ STATE: _____ ZIP: _____

 **Viking**
CONNECTORS

Viking Industries, Inc./21001 Nordhoff Street
Chatsworth, CA 91311 U.S.A./ (213) 341-4330/ **DATACON DIVISION**

advantageous to search for devices with characteristics similar to the adder and use them to reduce wiring and design headaches—and, in many cases, to minimize chip count. In Fig. 2b, a 15-input gate is implemented using two 74S275 “Wallace trees” and a full adder; the 74S275 provides the function of four adders without the external wiring. When connected to the external adder, space and cost are minimized.

If the carry bits of the Wallace tree are wired low, each tree output will yield the binary sum of the number of input variables that are high. Alternatively, the X, Y, and M outputs of two 7-bit devices (example in Fig. 1) may provide the binary sum to the external adder, where Y is the least significant bit. The output of both trees are then added directly by the 7483, with the result that M will be high if eight or more inputs are high. □

Glitchless TTL arbiter selects first of two inputs

by Yukihiro Mikami
Ottawa, Canada

Failure to differentiate between independently timed asynchronous signals only a few nanoseconds apart can cause glitches in standard transistor-transistor-logic circuits that spell disaster to system operation. Once the glitch is detected, it must be eliminated, so that an arbiter circuit like the one described here is essential in applications like dynamic memory controllers.

As shown in the figure, the 74S02 cross-coupled NOR latch will respond to a signal on request line A or B. The signal arriving first will appear on the corresponding output line. With simultaneous inputs, however, a single-pulse glitch, a sinusoidal oscillation, a metastable-state response (0.8-to-2.1-volt unassigned or guard-band region), or a combination of such responses may occur at each output for an indefinite period before the gate decides to switch into its desired state.

An RC network and Schmitt-trigger buffer eliminate these undesirable responses from the circuit outputs while minimizing the decision time. The amplitude of the glitch or oscillation is essentially filtered or damped, as the case may be, by the RC combination of the 330-ohm resistors and the 22-picofarad capacitor.

The resistors also combine with the 820-Ω resistor at the input of either Schmitt trigger to form a voltage divider. This divider effectively raises the positive-going switching threshold at this point by 0.6 to 2.1 v. Thus there is no spurious response, even for a 3-v glitch, a 1.5-v peak-to-peak oscillation, or a metastable-state response at the NOR gate output. The circuit responds with an output when the transient dies away, as the latch may then decide which signal came first. In the event of the arrival of two truly simultaneous signals, the gate would render an arbitrary decision.

Nonsimultaneous signals appearing at the appropriate output of the NOR gate will pass through the deglitching circuit relatively unaffected. Typical propagation delay of the arbiter is 20 nanoseconds for nonsimultaneous inputs and 25 ns for simultaneous input signals. □

Designer's casebook is a regular feature in *Electronics*. We invite readers to submit original and unpublished circuit ideas and solutions to design problems. Explain briefly but thoroughly the circuit's operating principle and purpose. We'll pay \$50 for each item published.

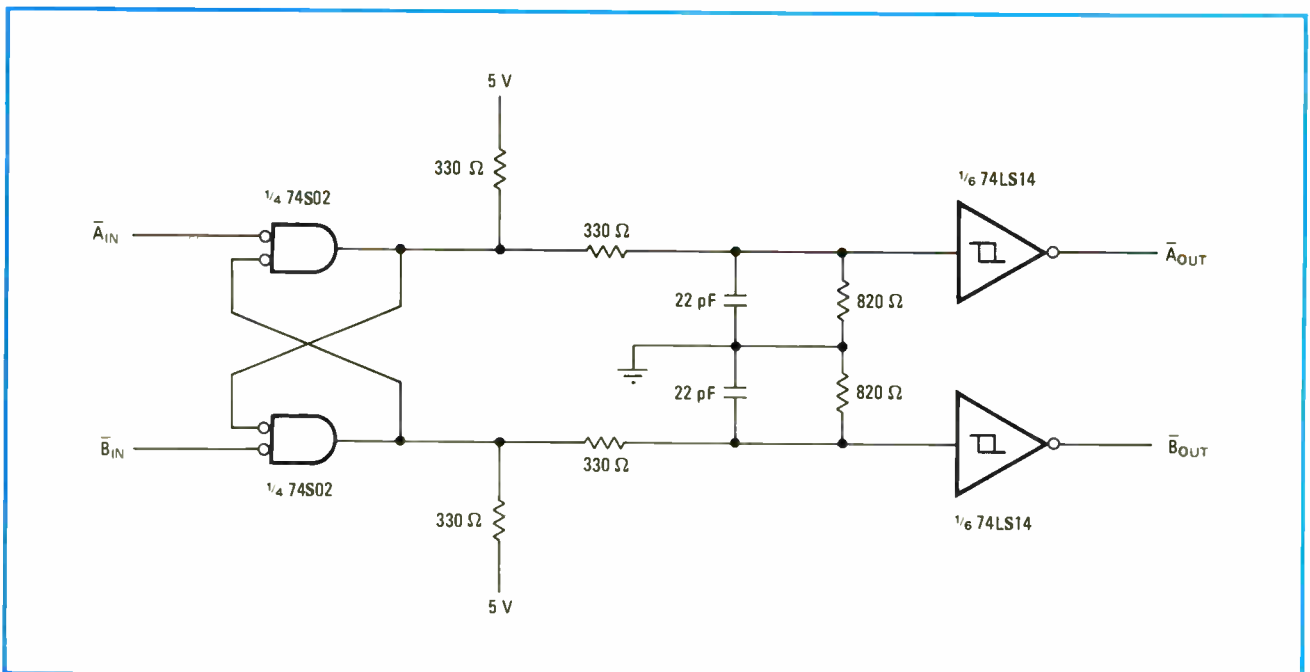

First come, first served. The input signal arriving first passes to an output, while simultaneously arriving signals produce an eventual output but no glitch. The resistor network raises the threshold of the Schmitt trigger, and the RC combination reduces glitch amplitude.

**POLAROID
TYPE 667
COATERLESS
LAND FILM**

Polaroid®

**FOR PROFESSIONAL USE.
PRINTS DO NOT REQUIRE
COATING. 2 PACKS, 16
BLACK & WHITE PRINTS,
3¼ X 4¼ IN. (8.3 X 10.8CM).**

POLAROID

**TYPE 667
COATERLESS LAND FILM**

There's no messing around with this film.

It's coaterless to save time and steps.

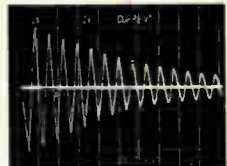

Polaroid Type 667 pack film really simplifies making hard copies of your oscilloscope and CRT displays.

Because it gives you sharp black and white prints in 30 seconds that do not require coating after development.

Pictures are ready immediately for study, filing or attaching to a report.

Type 667 coaterless film can be used for CRT recording in Polaroid Land cameras (such as the CU-5) or in other cameras and instruments equipped with any Polaroid 3¼ x 4¼ inch (8.3 x 10.8 cm) pack film back.

Type 667 is conveniently packaged in boxes with 16 exposures and is now available at participating Polaroid dealers.

For the name of the one nearest you—or for technical or application information on Type 667 or our other

professional films—call Polaroid toll free: 800-225-1618 (in Massachusetts call collect: 617-547-5177).

For your next assignment, don't mess around. Make picture-taking simpler and more convenient. Use Polaroid's Type 667 coaterless film.

Polaroid
Type 667 Coaterless Film

Circle 137 on reader service card

**Rockwell
one-chip computers
give you the right fit
at the right price.**

Right now.



If you're designing a system or subsystem requiring as few as 10 TTL circuits, cost alone is reason enough to consider a Rockwell one-chip computer.

A wide choice of Rockwell one-chip computers is available right now. And the line-up of compatible one-chips is growing fast.

From Rockwell's PPS-4/1 family, you select the most cost-effective computer for your application.

More on-chip I/O eliminates extra interface devices.

All of Rockwell's one-chip computers offer powerful, user-oriented I/O ports that eliminate costly interface circuitry in overall systems.

I/O features, including bidirectional ports, flexibly designed drivers and receivers, and serial input/output ports, provide you with powerful system options.

Many types of displays can be driven directly. Analog-digital conversion is easy. And serial I/O ports offer a new dimension of capability by giving you simple, "no-cost" interfacing for multi-computer systems.

Rockwell flexibility assures cost-effective design.

Rockwell's one-chip computers give you design options you couldn't afford with other logic approaches.

During the design stage you can add or reduce functions, allocate I/O differently and make dozens of other changes by simple reprogramming or by moving to another software-compatible chip within the family.

Powerful instruction sets increase efficiency.

Rockwell's instruction sets provide ROM efficiencies of typically 2 to 1 over other microcomputers. For example, some one-byte multi-function Rockwell instructions perform operations requiring five instructions in other systems.

More than 80% of Rockwell's instruction

types can be executed in one byte and in a single cycle. Special ROM instructions allow many subroutine calls to be handled in one byte. Table look-up instructions for MM77 and MM78 chips provide easy look up of stored data and easy keyboard decoding with minimal programming.

The PPS 4/1 family of one-chip computers.

| Model | MM76 | MM77 | MM78 | MM75 | MM76C | MM76D | MM76E |
|------------------------|-------------|-------------|-------------|-------------|---------------------|----------------------|-------------|
| Description | Basic 76 | Basic 77 | Jumbo 77 | Economy 76 | High speed counter* | 12-bit A/D converter | Expanded 76 |
| ROM (x8) | 640 | 1344 | 2048 | 640 | 640 | 640 | 1024 |
| RAM (x4) | 48 | 96 | 128 | 48 | 48 | 48 | 48 |
| Total I/O lines | 31 | 31 | 31 | 22 | 39 | 37 | 31 |
| Cond. Interrupt | 2 | 2 | 2 | 1 | 2 | 2 | 2 |
| Parallel Input | 8 | 8 | 8 | 4 | 8 | 8 | 8 |
| Bidirectional Parallel | 8 | 8 | 8 | 8 | 8 | 8 | 8 |
| Discrete | 10 | 10 | 10 | 9 | 10 | 10 | 10 |
| Serial | 3 | 3 | 3 | — | 3 | 3 | 3 |
| In-line package | 42 pin quad | 42 pin quad | 42 pin quad | 28 pin dual | 52 pin quad | 52 pin quad | 42 pin quad |
| Availability | Now | Now | Now | 2Q/77 | 2Q/77 | 3Q/77 | 16 wk ARO |

Power supply is 15v except low voltage version of Basic 76 available 3Q/77. Typical power dissipation is 70mw.

*Two 8-bit or one 16-bit presetable up/down counter with 8 control lines.

Rockwell design aids also help lower your system cost.

To help control development costs, Rockwell makes available a universal Assembler that lets you assemble, edit, develop and debug programs, as well as load PROMs. Special development circuits enable prototyping.

Your Assembler can also handle incoming inspection and factory testing. And the same Assembler can be used to develop systems based on all Rockwell one-chip and multi-chip microprocessors.

For the full story on Rockwell one-chip computers, and how quickly they can be a part of your new product, write on your company letterhead to: Marketing Services, D/727-E, Microelectronic Device Division, Rockwell International, P.O. Box 200, Anaheim, CA 92803, U.S.A. or (714) 632-3729.



A new direction in microprocessor design aids.

Introducing a software development system that supports a variety of microprocessors: first the 8080 and 6800, then the Z-80*, with a wide selection to follow. Assembler software for two microprocessors is provided from those available at the time of purchase, and software for each additional microprocessor may be purchased as an option with a minimum of added expense.

This feature alone means that you can *change* direction without having to make a major investment in a new design aid. Choose a component on the basis of its suitability for a particular project, then, if it seems desirable, switch to another for the next project.

* Available late summer 1977.

It also means that you don't have to relearn your software development system each time you use a different microprocessor chip. And that can save valuable time.

The 8002 offers several other time-saving features to ease the task of program creation: a text editor that simplifies software entry and revisions, an assembler with macro capability, and dynamic trace for software debugging.

Since microprocessor-based program creation and prototype design typically go hand in hand, the 8002 also offers three progressive option levels for program emulation and debugging, prototype emulation and debugging, and real-time prototype analysis.

The 8002 Program Emulation and Debugging System, which adds an emulator processor and software for a selected microprocessor, enables the developmental software to be run, tested, changed, traced, and debugged on the desired microprocessor. The

THE TEKTRONIX 8002 MICROPROCESSOR LAB



emulator microprocessor is identical to the microprocessor in the designer's prototype; if the software is to be executed on an 8080 in the prototype, for example, an 8080 microprocessor chip is used in the emulator processor.

The 8002 Interactive Prototype Emulation and Debugging System adds a Prototype Control Probe for a selected microprocessor. With the probe inserted into the prototype, developmental software and hardware may be tested, traced, and debugged together.

The 8002 Real-Time Prototype Analyzer System adds real-time trace and an 8-channel Analyzer Probe. At this level bus transactions and events external to the microprocessor may both be monitored.

One final advantage: the Tektronix name. Tektronix has always been responsive to the instrumentation needs of the design engineer . . . and the 8002 Microprocessor Lab is no exception. Its ability to deal with a

number of different microprocessors, its many convenience features for software development, and its capabilities for software/hardware debugging, make it a unique design tool.

As a leading electronics instrument company, Tektronix offers you a full line of options and peripherals, from the three 8002 option levels . . . to PROM programming facilities for the 1702 or the 2704/2708 MOS PROMs . . . to a line printer and choice of system terminals.

Backed by years of experience, Tektronix also offers you a rare commodity in the field of microprocessor development tools: local Field Engineers and local service. A nation-wide network of Field Offices and Service Centers is ready to help you realize the full benefits of the 8002.

For more information or a demonstration of this new software development tool, write Tektronix, Inc., P.O. Box 500, Beaverton, Oregon 97077.

For availability outside the U.S., please contact the nearest Tektronix Field Office, Distributor, or Representative.

The 8002... with multiple microprocessor support.



Te

HIGH RELIABILITY

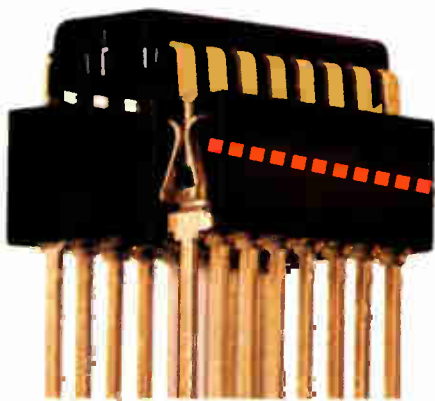

Get the **high reliability** that eliminates trouble. RN DIP sockets make contact with the wide, flat sides of your IC leads. This provides **100% greater surface contact** for positive electrical connection.



DIP SOCKETS for the price you're paying for junk!

Robinson Nugent "side-wipe" DIP sockets make 100% greater contact than any edge-bearing socket on the market.

This 100% greater contact with the wide, flat surface of your IC leads is your guarantee of unmatched reliability. This RN "side-wipe" contact provides constant low contact resistance. No edge-bearing contact can possibly deliver this long term dependability. This designed-in reliability of RN DIP sockets is your assurance of trouble-free IC interconnects—yet they cost no more than ordinary sockets.

Put an end to troublesome junk sockets! Write today for catalog and informative book "What to Look for in IC Interconnects." It's free from RN—the people who make more kinds of high reliability IC sockets than anyone.

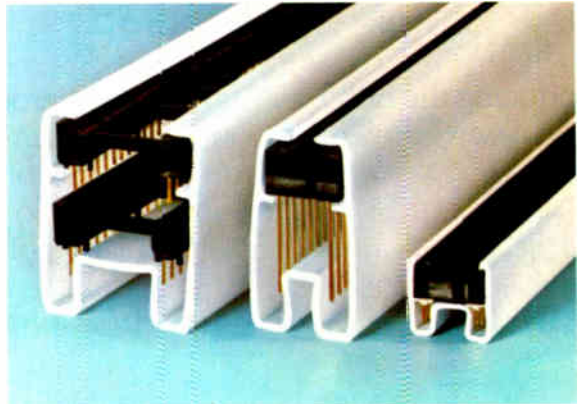

They're even packaged for high reliability.

"Protecto-pak"[®] packaging delivers consistently perfect RN sockets to your production line—for automated or manual assembly.

RN ROBINSON NUGENT, INC.

800 East Eighth Street • New Albany, Indiana 47150 • Phone: (812) 945-0211



High reliability IC sockets... we've got 'em all!

Circle 143 on reader service card

Flat cable connector system ...high reliability in ultra-compact design



In TRW Cinch flat cable connectors, two gold-plated wire contact points for each conductor assure extra reliability. The socket contact also provides two surfaces for electrical contact when mated with feed-thru pins or headers. Integral molded-in locking tabs on the cover increase cable retention, as does the optional cable strain relief assembly.

The ultra-compact design saves valuable space, and the connectors can be positioned on .250-inch centers on a mother board if required. One contact size accepts 24 gauge solid and 26 gauge solid or stranded wire and another gauges 28 and 30 solid and stranded.

The cable supplied by TRW Holyoke Wire & Cable has conductors positioned on .050" centers. The

connector contacts are positioned on two staggered rows of .100" centers.

Fast, positive cable positioning and registration is assured by molded-in guides in the connector cover. Only one fixture is required to accommodate all six connector sizes—10, 20, 26, 34, 40 and 50 positions.

For complete information contact your Local TRW/ECD field sales office or write to TRW Cinch Connectors, an Electronic Components Division of TRW Inc., 1501 Morse Avenue, Elk Grove Village, IL 60007; phone (312) 439-8800.

CC-7711

TRW CINCH CONNECTORS

ANOTHER PRODUCT OF A COMPANY CALLED TRW

IMP-16 helps small planes fly a straight course

by Steve Tsolis,
Advanced Electronics Development, Old Saybrook, Conn.

□ By enabling business aircraft to fly directly to a distant destination, a microprocessor-based radio navigation system can cut up to 22% off their operating costs. At present, their pilots zigzag across country from one station in the very-high-frequency omnirange navigation network to the next, for lack of equipment powerful enough to compute a direct route in real time yet small enough to fit in their general-aviation airplanes.

The microprocessor used in the new R-Nav system is an IMP-16. Mainly because of it, the equipment costs less than \$10,000. The digital equipment built for commercial airliners costs \$48,000 and performs about the same, for all its bulk. Even conventional analog systems are \$12,000 to \$15,000 and also, of course, are much less precise.

To operate the IMP-16 system, the pilot taps out the end point of the flight on the keyboard, along with the bearings and frequencies of as many as 180 VOR stations along the route (see "The VOR network," p. 150). He may also enter other routing details, such as altitude required at a given point. In flight, the VOR receiver and distance-measuring equipment (DME) supply actual data for comparison with the planned flight path, and other

inputs come from the rest of the aircraft's analog instrumentation. Using this data, the IMP-16 performs in real time all the calculations necessary for manual or automatic flight control—in particular the triangulation of the VOR distance and bearing data that makes it possible for the pilot to fly straight to his destination. The output data is shown and continuously updated on the airplane's various cockpit displays.

To derive complete flight control information in real time, with a high degree of accuracy, with minimal hardware, from such a variety of inputs, demands a powerful microprocessor. The National IMP-16/100 appeared suitable because of its 16-bit word size and its programming flexibility.

Advantages of the IMP-16

Included in the six-chip bit-slice processor are not one but two control read-only memory chips. The first contains a basic 43-word instruction set, supplemented by a 17-word extended instruction set on the second. This extended set includes such instructions as multiply, divide, double-precision add, and double-precision subtract, which are essential to much of the data manipulation needed for navigational computation.

To speed triangulation calculations, which form the basis of navigation, the IMP-16 uses trigonometric algorithms found in most pocket calculators. These functions are stored not in its control ROM but in the system's programmable read-only memory.

Also helping the IMP-16 to process data quickly is the fact that it has separate buses for input data, output data, and addresses, as well as 16 general-purpose flag

1. Cockpit console. Flight data is entered manually on the electroluminescent keyboard, which consists of a Mylar layer sandwiched between a conductive polymer and copper contact grid. A seven-segment gas discharge panel displays the navigational data, updating it continuously.



outputs, two interrupts, and four jump-condition inputs. Some microprocessors can be multiplexed by using software subroutines to handle data inputs one at a time, but that would not provide the real-time inputs needed for high-speed jet aircraft.

An R-Nav system must combine high accuracy with speed. For example, directional information must be accurate to tenths of a degree, making 3,600 separate inputs necessary for data covering all 360°. This takes 2×10^{12} bits of information, and to input and process that much data quickly requires a 16-bit word. An 8-bit microprocessor could handle the larger word size, but it would take longer to process the data in that form. Moreover, the 16-bit word allows computation with a resolution of well over four significant digits without using the double-precision mathematics that an 8-bit microprocessor would require.

Between them, the IMP-16's 16-bit word length and powerful instruction set also reduce the overall amount

2. Space saver. In an analog system, synchro data must be resolved to a signal proportional to flight angle. But the microprocessor-based system calculates this angle from dc voltages representing sine and cosine information and needs less signal-processing circuitry.

of system memory needed—only 4,096 16-bit words of programmable read-only memory and 256 16-bit words of random-access memory are used. But as that alone did not shrink the hardware enough for the system to fit into the space allowed, several other space-saving features measures were adopted.

The use of firmware

For instance, many of the functions that would normally require separate circuit modules were implemented in firmware to reduce the amount of interface circuitry. Also, an address-decoding and input/output-control circuit allows single-line control of many input and output devices. Finally, other peripheral devices are controlled with decoded addresses combined with one of the IMP-16's user-available flags, the result being that less PROM is needed. In other words, each bit of the 16-bit word can represent a peripheral decode instruction, so that the microprocessor can be wired directly to the peripheral, rather than requiring room in memory for decoding and encoding for peripheral addressing.

The R-Nav system comprises a navigational computation unit and a control display unit (Fig. 1). A block diagram of the complete system is shown in Fig. 2.

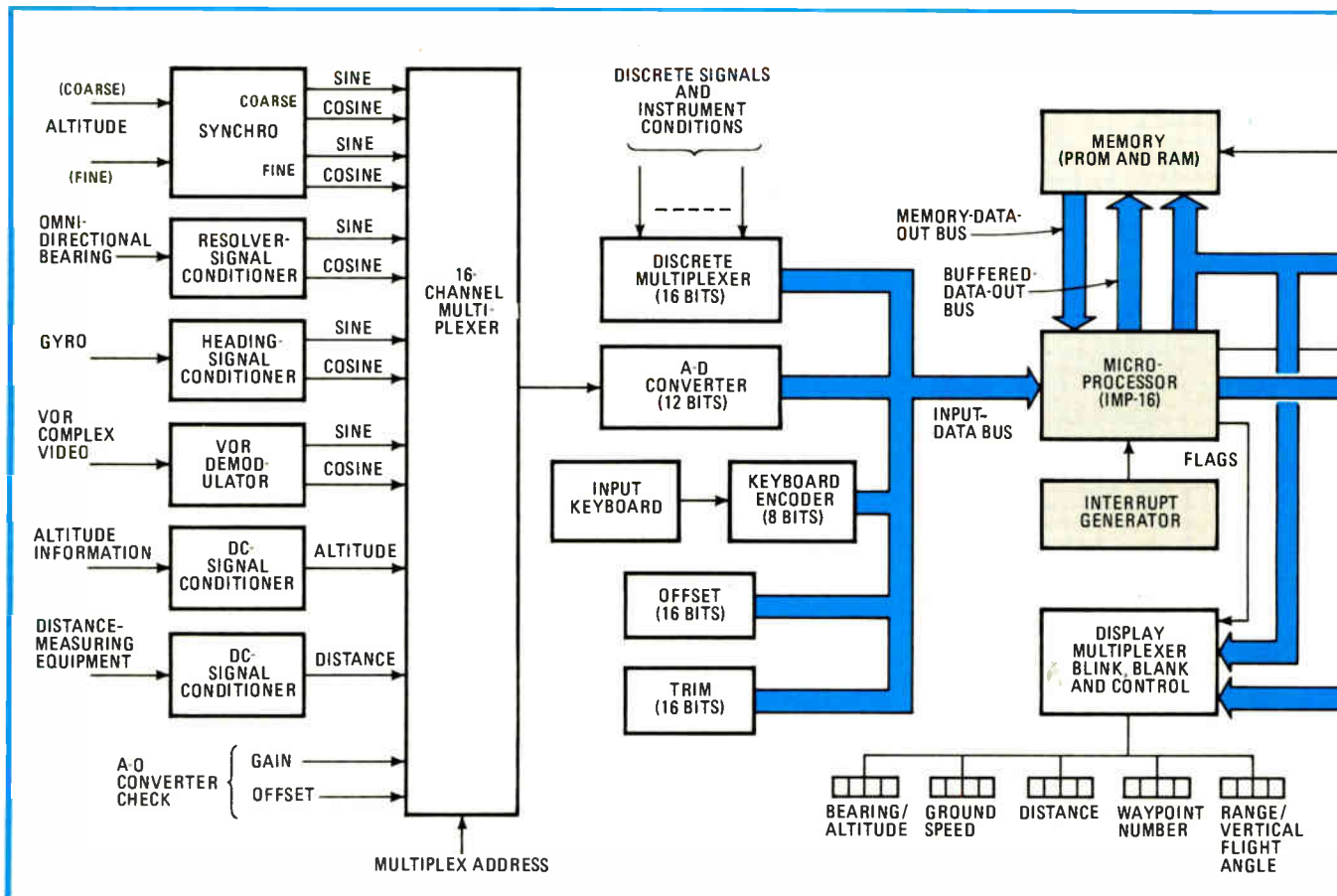

One of the computation unit's jobs is to condition the signal inputs, such as those representing coarse and fine altitude and omnidirectional bearing as well as VOR and DME information. Once conditioned, these analog signals are multiplexed and converted into digital format by a 12-bit analog-to-digital converter. This digital information, along with additional data from the keyboard, other signal inputs, and flags signaling instrument conditions, passes over the input-data bus to the IMP-16.

Two other buses link the microprocessor with memory, decode and control circuitry, and displays. The address bus connects the IMP-16 to the programmable read-only and the random-access memories, the address decode and input/output control circuitry, and the control display unit. The buffered-data-output bus links it with the 8-bit latches to provide data for the radio compass indicator, course-deviation indicator, and instrument flag indicators. That bus also carries data to the control display unit, where it is multiplexed to the various digital visual displays to provide information on bearing and altitude, range and flight angle, way point number, distance, and ground speed.

Since the R-Nav system must interconnect with existing aircraft instruments having slightly different

input/output signal requirements, it appears at first that a particularly large amount of I/O interface circuitry is needed. For example, to maintain altitude or provide controlled ascent or descent, the system must interface with a potentiometer or a two-speed signal from a synchro or a central air data computer, depending on the aircraft configuration. To satisfy all the possible interface conditions, normally accomplished in hardware, would have required many components. With microprocessor control, however, much hardware is replaced with firmware routines, which minimize the amount and complexity of the signal-conditioning circuitry needed. This approach not only keeps size to a minimum, but replaces recurrent manufacturing costs with a single, nonrecurring software development charge.

Simple signal conditioning

All input-signal-conditioning circuits are available in every R-Nav system even if they are not used. However, it only takes eight dual-operational amplifiers to provide complete conditioning. Variations in the connector-pin terminations and cables adapt the system to a specific aircraft equipment configuration. With this concept the R-Nav can accommodate all the different input/output requirements of the numerous aircraft instruments used in general aviation today.

Once the analog signals are conditioned to levels suitable for a microprocessor-based system, they are digitized at a 10-millisecond rate controlled by the interrupt generator and real-time clock. This makes the timing independent of program size and allows each input to be scanned eight times—a good compromise between stability and cost. Since most of the processor's time is used for computation, program control, and output driving, that scanning rate is fast enough to make the system stable enough for smooth autopilot operation.

During each 10-ms interrupt, several events occur. The analog-to-digital converter is read and then reset for the next conversion (better accuracy results when each conversion is made at a precise interval, because this eliminates any jitter that would be present if just software-controlled timing were used). Each interrupt is also used to increment a counter for accumulating time, which is essential in calculating ground speed and other navigational relationships. Also, the flight data entered by the pilot via a keyboard and stored in memory in the keyboard encoder chip is scanned and the resultant data multiplexed onto the input data bus for processing by the microprocessor during the 10-ms interrupts.

Note that the microprocessor-based system also lends itself to self-checking. This is done by multiplexing the analog ground and the reference voltage for the analog-to-digital converter. (Before being fed through the converter, this voltage is attenuated by approximately 90%.) With these two inputs, which represent the gain and offset of the a-d converter, the microprocessor can

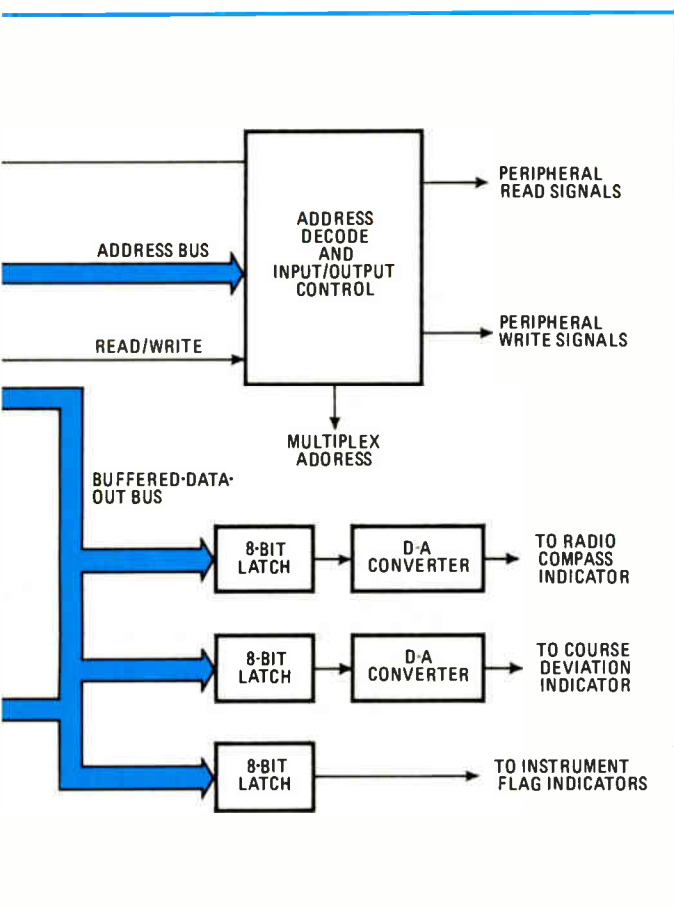

The VOR navigation network

By broadcasting bearing information to aircraft, the very-high-frequency omnirange navigation network creates airways that must be used under instrument flight conditions and are usually used for cross-country navigation whenever a plane's on-board equipment cannot handle direct-flight computations in real time. The network consists of a series of transmitters operating in the 108.2-to-117.9-megahertz band and emitting nondirectional reference modulation as well as bearing information—a signal that varies in phase against a fixed reference through a 360° rotation in the horizontal plane. The VOR receiver in the aircraft picks up these signals and displays the relative bearings of the receiver and transmitter as well as nonambiguous indication of direction.

Most VOR stations are also equipped with Tacan equipment to provide distance information. Such stations are called Vortac. When an aircraft interrogates a Vortac station, the resultant distance information is displayed by its on-board distance-measuring equipment.

check the converter's calibration and to some extent compensate for parameter changes. If either the gain or offset of the a-d converter exceeds an established limit, an internal error signal is generated, and warning flags are set to alert the pilot to the existence of uncompensated errors.

Into the mill

The data is now ready for processing by the microprocessor. By this time, for example, input from synchro systems like the altimeter and compass system has been converted to dc voltages that represent the sine and cosines of the synchro angle and has then been digitized. The microprocessor takes both these values and uses software routines to calculate the arc tangent of the flight angle. This method, besides saving on hardware, provides more accurate and reliable results over an extended temperature range than could be obtained from an all-analog system.

In the same way, the microprocessor takes the conditioned VOR and DME inputs and from them calculates the distance and bearing between aircraft and way point (the point where the flight path intersects the VOR radial at 90°), time to way point, and distance and time to destination. Since it also computes ground speed accurately, regardless of the aircraft's heading, the pilot can fly around busy way points or bad weather and still receive valid ground speed information. The time and destination to way point are appropriately modified by the IMP-16 under these conditions.

The microprocessor determines the relative bearing between the aircraft heading and the VOR station being received, calculating deviation from desired flight path as well as VOR bearing.

Vertical flight paths are automatically determined by comparing the manually or automatically entered altitude at each way point with the aircraft altimeter input. The microprocessor calculates relative position and provides information to display whether the aircraft is below or above the prescribed altitude.

To conserve aircraft panel space, most system outputs drive existing aircraft instruments such as the flight director and the horizontal situation indicator. Computed data from the microprocessor is placed on the buffered-data-out bus to drive the 8-bit latches and then converted to analog format by digital-to-analog converters before being displayed on the appropriate aircraft instruments. Associated with these instruments are visual-instrument-flag indicators also controlled by the IMP-16. It receives information about the status of each instrument via the discrete multiplexer and actuates an 8-bit latch to indicate malfunction or lack of complete information.

Output data for the control display unit, however, stays digital. For instance, all way point data is stored in RAM located in the navigation computation unit and upon pilot command is transferred onto the output bus to latches in the display unit. These latches drive decoders for the seven-segment gas-discharge display elements and also, under microprocessor control, dim, blink, and blank them.

The display unit also has a self-check routine. When activated by a push button, it checks all associated equipment and flags. Should it detect a fault, the distance display shows all number eights.

Trading off hardware for firmware results in a very compact unit. The display portion, located in the aircraft panel, measures 4.5 inches high by 5.75 in. wide by 7.5 in. deep. The navigation computation unit, containing all analog interfaces, power supplies and the like, is located in the body of the plane, remote from the cockpit. It fits into an electronics rack measuring 7.5 in. high by 4.75 in. wide by 12.5 in. deep.

System flexibility

The IMP-16 R-Nav system is contained on five circuit boards with three blank slots for future expansion. With software control the system is easily adaptable to handle any additional features. One of these slots, for instance, could be used for a plug-in, hand-held calculator to determine range to destination and the fuel required as well as other flight factors that normally would have to be looked up in the aircraft flight manual.

In the future, the system could include ground-proximity-warning capabilities and receive automatic flight-data programming from a remote location. Inertial platform, Loran C, Omega or other navigation inputs from satellites or ground stations could be interfaced easily by changing the software and adding a small amount of signal conditioning. □

Interface adapter multiplexes many d-a converters

by Paul Brokaw
Analog Devices, Wilmington, Mass.

Several digital-to-analog converters in a 6800-based data-acquisition system may be multiplexed with only one peripheral interface adapter if sample-and-hold amplifiers are placed at the output of each converter to select one of them. This eliminates latches and control circuits usually needed at the input of each converter to maintain the input data while the microprocessor is otherwise occupied. Chip count and cost are reduced

because the same input data is processed by each converter.

The system in the figure uses the MC6820 PIA with its dual 8-bit ports to drive eight AD561 10-bit d-to-a current-mode converters and eight AD582 sample-and-hold devices. The AD582s function as operational amplifiers in the sample mode, permitting calibration of the converters when the sample-and-hold output is observed. Eight bits from the PIA's port A output are combined with 2 bits from the port B output to supply all 10 bits of

Sample-and-hold multiplexing. Output from the PIA supplies each AD561 with identical data; the AD582 gets the decoded channel number. Clamp diodes ensure that the converter output is zero when the AD582 is in the hold mode, preventing converter currents from degrading the circuit's operation. C_h should range from 100 pF to 0.015 μ F, depending upon refresh interval.

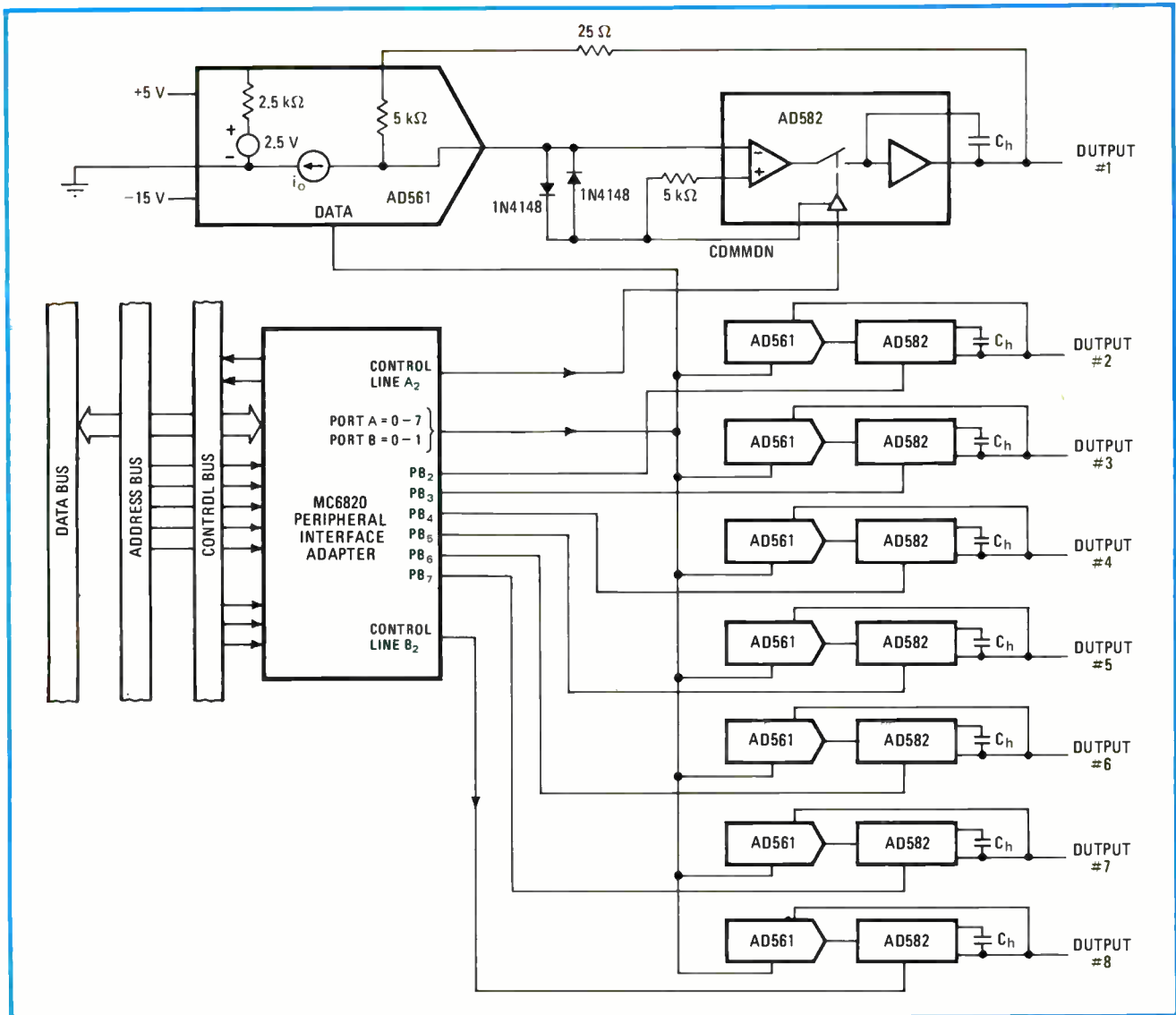

data for each converter. The remaining six lines from port B and two additional control lines select the sample-and-hold units. By appropriate instructions from the microprocessor, the sample-and-hold devices pass the analog output of each converter in turn without requiring any additional gating logic.

Pretrimming each converter with an external 25-ohm resistor gives nominal accuracy, while more precise calibration is possible with a 50- Ω potentiometer. Each converter may be calibrated by generating a 10-volt dc signal from each 561, then adjusting the appropriate potentiometer for a 10-volt output at each 582. The error in calibration will be less than 1 least significant bit.

The AD582s, which are dynamically controlled charge-storage devices, must be refreshed periodically to

restore lost charge on holding capacitors C_h . If the microprocessor is used in synchronous systems where the input data to the converter will not change during a sample period, one AD582 can be held in the sample mode until the program switches to the next converter. This permits a relatively long acquisition time, which allows for a long refresh period and larger hold capacitors. For example, a 0.01-microfarad capacitor will ensure a drift of less than $\frac{1}{2}$ LSB when the refresh interval is 1 second. Most programs with polling routines will update the output more frequently than once per second, of course. \square

Engineer's notebook is a regular feature in *Electronics*. We invite readers to submit original design shortcuts, calculation aids, measurement and test techniques, and other ideas for saving engineering time or cost. We'll pay \$50 for each item published.

Calculator notes

SR-52 program simplifies universal number conversion

by John Bryant
Indianapolis, Ind.

If those persons sweating to manipulate numbers from one exotic base system to another will look up from their labors, they will find cause to rejoice. This program can easily convert a positive number in any system to any other system, from base 2 to 99. The 219-instruction program is a heavily modified version of the less versatile one found in the applications library for the SR-56.

The user has the option of converting numbers containing integers and fractions directly from base p to base q , or (for faster calculations when working directly with decimal quantities) from base 10 to base q , or base p to base 10. As shown in the simplified flow chart, once the option is determined, the number is entered into the display and pressing keys A, B, or C initiates the conversion to the desired base.

In each case, the program determines the p or q relationship to the decimal (base 10) system by executing its base-analysis routine. This routine is needed to express an integer using two decimal digits if p is greater than 10. For instance, numbers in base systems greater than 10 may be expressed in terms of letters. The letters must be converted to two digits using the numbers 0-9.

After the relationship is known, the system flags that enable the program to run the proper subroutine are tested, and number conversion to a decimal equivalent proceeds. If either the original or desired base is 10, a decimal-number conversion will be done once after the program transfers through paths B or C to the arithmetic-conversion subroutine. Otherwise, path A is followed with the user supplying the value of q to the program so that both bases are known before actual conversion begins. Conversions will be performed twice, p to decimal, then decimal to q .

If p and q are not equal to 10, it is necessary to adjust the base locations prior to the second conversion, so that

the same conversion routine can be used to process a decimal number to a nondecimal base using decimal arithmetic. The arithmetic-conversion routine will approximate the input number to the new base through a series of iterations designed to eliminate rounding-off errors when working with integers and to approximate the fractional value within the limits of the calculator readout. Careful examination of the program will provide details of the operation.

When dealing with bases greater than 10, alphanumeric characters frequently represent the given or desired number. The calculator cannot display these characters because it is designed to work in the decimal system. However, it can represent the number with its available digits 0-9 in pairs.

For instance, when converting 26 in base 10 to base 14, the answer should be 1C. The calculator's output will be 1 12, however. Similarly, converting 38 from base 10

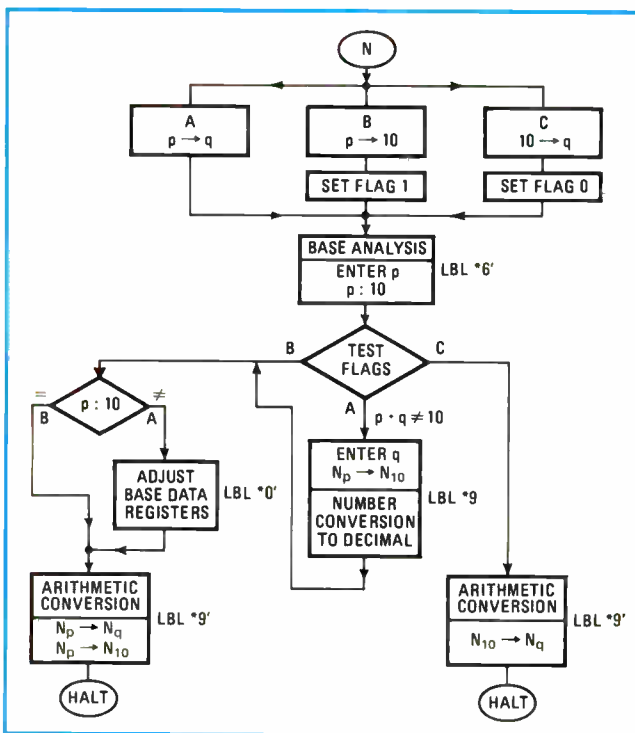

to base 14 yields 2A; the calculator's output is 2 10. Conversely, it is necessary to key in 1 12 for the base 14 number when desiring the base-10 equivalent of 26.

It cannot be emphasized too strongly that in any base system greater than 10, the alphanumeric characters

must be expressed in digit pairs when any given column contains a number equal to or greater than 10. Then A = 10, B = 11, C = 12, etc. For example, the number 468 in base 10 equals 1 13 04 in base 16, or 1D4. With practice, this situation will become well understood. □

SR-52 UNIVERSAL-BASE NUMBER CONVERSION PROGRAM

| LOCATION | CODES | KEYS | COMMENTS |
|-----------|----------------------|---------------------------|---|
| 000 - 003 | 46 12 50 01 | *LBL B *st flg 1 | executive control flags |
| 004 - 007 | 46 13 50 00 | *LBL C *st flg 0 | |
| 008 - 012 | 46 11 42 00 03 | *LBL A STO 03 | |
| 013 - 016 | 01 00 75 81 | 10 - HLT | executive control and routing |
| 017 - 020 | 51 79 60 01 | SBR '6' *if flg 1 | |
| 021 - 025 | 27 60 00 69 81 | *INV' *if flg 0 '9' HLT | |
| 026 - 030 | 42 00 06 51 97 | STO 06 SBR '0' | nondecimal conversion |
| 031 - 035 | 51 69 42 00 03 | SBR '9' STO 03 | |
| 036 - 041 | 01 00 75 43 00 06 | 10 - RCL 06 | |
| 042 - 045 | 51 79 41 69 | SBR '6' GTO '9' | |
| 046 - 049 | 46 27 51 97 | *LBL 'INV' SBR '0' | |
| 050 - 055 | 46 69 25 42 00 00 | *LBL '9' CLR STO 00 | |
| 056 - 058 | 42 00 05 | STO 05 | build new N |
| 059 - 063 | 46 87 43 00 02 | *LBL '1' RCL 02 | |
| 064 - 067 | 22 49 00 03 | INV PROD 03 | |
| 068 - 072 | 43 00 03 75 01 | RCL 03 - 1 | |
| 073 - 076 | 44 00 00 95 | SUM 00 = | |
| 077 - 078 | 80 87 | *if pos '1' | |
| 079 - 083 | 46 88 43 00 02 | *LBL '2' RCL 02 | |
| 084 - 089 | 49 00 03 43 00 03 | *PROD 03 RCL 03 | |
| 090 - 093 | 52 22 52 75 | EE INV EE - | |
| 094 - 100 | 46 68 53 42 75 01 54 | *LBL '8' (STO - 1) | |
| 101 - 105 | 80 68 75 01 95 | *if pos '8' - 1 = | separate integer |
| 106 - 109 | 22 44 00 03 | INV SUM 03 | fraction with guard digits in R ₀₃ |
| 110 - 113 | 48 00 05 65 | *EXC 05 X | integer in R ₀₅ |
| 114 - 117 | 43 00 01 95 | RCL 01 = | |
| 118 - 121 | 44 00 05 01 | SUM 05 1 | decrement R ₀₀ |
| 122 - 125 | 22 44 00 00 | INV SUM 00 | |
| 126 - 131 | 43 00 05 75 01 02 | RCL 05 - 12 | convert fractional portion of number |
| 132 - 136 | 22 28 95 80 89 | INV *log = *if pos '3' | |
| 137 - 142 | 43 00 03 22 90 88 | RCL 03 INV *if zro '2' | |
| 143 - 147 | 46 89 43 00 01 | *LBL '3' RCL 01 | |
| 148 - 151 | 20 42 00 04 | *1/x STO 04 | |
| 152 - 156 | 43 00 00 90 77 | RCL 00 *if zro '4' | |
| 157 - 162 | 94 80 78 43 00 01 | +/- *if pos '5' RCL 01 | |
| 163 - 165 | 42 00 04 | STO 04 | |
| 166 - 170 | 46 78 43 00 04 | *LBL '5' RCL 04 | |
| 171 - 175 | 49 00 05 58 78 | *PROD 05 *dsz 5' | |
| 176 - 180 | 46 77 22 50 00 | LBL '4' INV *st flg 0 | reset executive flags |
| 181 - 187 | 22 50 01 43 00 05 56 | INV *st flg 1 RCL 05 *rtn | set up for decimal arithmetic |
| 188 - 192 | 46 97 43 00 01 | *LBL '0' RCL 01 | |
| 193 - 199 | 48 00 02 42 00 01 56 | *EXC 02 STO 01 *rtn | digit separation constant |
| 200 - 205 | 46 79 42 00 02 95 | *LBL '6' STO 02 = | |
| 206 - 210 | 80 67 01 00 65 | *if pos '7' 10 X | |
| 211 - 215 | 46 67 01 00 95 | *LBL '7' 10 = | |
| 216 - 219 | 42 00 01 56 | STO 01 *rtn | |

INSTRUCTIONS

- Key in program
- For conversion from base p to base q :
Enter desired number (N). Press A. Display reads 10.
Enter base of N (p), press RUN. Display reads 10 or 100.
Enter desired base (q), press RUN.
- For conversion from base p to base 10:
Enter desired number (N). Press B. Display reads 10.
Enter base of N (p), press RUN.
- For conversion from base 10 to base q :
Enter desired number (N). Press C. Display reads 10.
Enter desired base (q), press RUN.

REGISTERS

| | |
|-----------------|--------|
| R ₀₀ | in use |
| R ₀₁ | base C |
| R ₀₂ | p |
| R ₀₃ | N |
| R ₀₄ | in use |
| R ₀₅ | N' |
| R ₀₆ | q |

Lamp shakes in its socket yet shines steadily

When an incandescent indicator lamp must withstand vibration, many engineers prefer the more rugged subminiature 5-volt lamps to the common 28-v lamps, but often run into a problem with the solder spot contact on the bottom of the lamp. According to James Amis, chief engineer at Korry Manufacturing Co., Seattle, Wash., the lamp starts flickering after a few minutes of vibration and continues to do so even after the vibration stops. Cleaning the solder spot stops the flickering—but only until the vibration starts up again. Amis says the problem is “fretting corrosion.” The relative motion of the two contacts constantly breaks old contact areas and establishes new ones, but as the old contact areas quickly oxidize and the motion is not sufficient to clear away the oxides, **eventually the whole surface becomes oxidized and the light goes out.** Oil at the interface will prevent exposure to air, but Amis says an even better solution is to use a special lamp with a nickel-plated brass disk instead of a solder spot, such as the CM 328-297 from Chicago Miniature Lamp Co.

The 555 gives you fingertip switching

If you need an inexpensive and reliable touch-controlled switch, try building one with the 555 integrated-circuit timer, suggests Howard Berlin, a technical consultant in Wilmington, Del. The basic switch is obtained by wiring the 555 in its standard one-shot mode, with the reset line (pin 4) tied to the supply, and then connecting a touchplate to the trigger input (pin 2). **This plate may be of copper or aluminum, and touching it momentarily with a finger** causes the timer's output to go high for a period of 1.1 times the RC time constant. If you hold your finger on the plate, the output will stay high. Usually a time constant of 1 second or so is enough. For latching operation, you remove the timing resistor altogether and connect a normally open push-button switch between the timer's reset pin and ground. Now by touching the plate you will latch the timer on indefinitely—until you push the reset button.

Or—to make a touch-controlled on/off switch, you just add a 7473-type J-K flip-flop at the output of the basic switch circuit. Wire the circuit's output to the flip-flop's clock input, tie both the J and K inputs to a 5-v supply line, and run the Q output to the load. Now, touching the plate once turns the load on, and touching it again turns it off. If you add a solid-state relay, **you can control household appliances.**

Read how to test sample-and-holds . . .

Here's a useful brochure that recently crossed our desk: “**Specifying and Testing Sample-and-Hold Amplifiers,**” from Teledyne Philbrick, Allied Drive at Route 128, Dedham, Mass. 02026. It's only five pages long, but it packs in a lot of information, including a glossary and extended discussions of parameter temperature coefficients and testing. (Although terminology tends to differ among manufacturers, at least you'll know Teledyne's.) Ask for Application Bulletin AN-30.

. . . and measure microwave gear

Hewlett-Packard, too, has another useful catalog and handbook available. This one's on microwave equipment, and it contains a **20-page handbook section summarizing measurements of attenuation, impedance, power, frequency, and noise figure.** Write to the Inquiries Manager at HP, 1501 Page Mill Rd., Palo Alto, Calif. 94304. **Stephen E. Scrupski**



All our memories are worth remembering.

Everybody knows NEC Microcomputers makes the fastest and most reliable 4K MOS RAMs on the market.

But that's just the start of our state-of-the-art memories.

We've got both static and dynamic types. In NMOS, CMOS and bipolar technologies. All made with the same care and quality control we give to our more famous products.

And we can deliver them in the quantity you need, when you need them.

At prices that are very competitive.

So if you are in the market for memory components, remember everything we have.

And remember us.

NEC Microcomputers, Inc., Five Militia Drive, Lexington, MA 02173. 617-862-6410.

| Product | Description | Organization | Access Times (Max) (ns) |
|---------|------------------------|--------------|-------------------------|
| 2101AL | NMOS Static RAM | 256 x 4 | 250-450 |
| 2102AL | NMOS Static RAM | 1K x 1 | 250-450 |
| 2111AL | NMOS Static RAM | 256 x 4 | 250-450 |
| 5101 | CMOS Static RAM | 256 x 4 | 450 |
| 2205 | Bipolar TTL Static RAM | 1K x 1 | 45 |
| 403 | Bipolar PROM (A.I.M.*) | 256 x 4 | 60 |
| 405/25 | Bipolar PROM (A.I.M.) | 512 x 8 | 70 |
| 406/26 | Bipolar PROM (A.I.M.) | 1K x 4 | 80 |
| 2308 | NMOS ROM | 1K x 8 | 450 |
| 2316A | NMOS ROM | 2K x 8 | 450 |

* Avalanche Induced Migration

NEC microcomputers, inc.

REPS: East—C&D Sales 301-296-4306, Contact Sales 617-273-1524, Harry Nash Assoc. 215-657-2213, Tech-Mark 607-748-7473, 716-223-1252, 315-652-6229, Trionic Assoc. 516-466-2300; South—Perrott Assoc. 305-792-2211, 813-585-3327, 305-275-1132, Wolffs Sales Serv. Co. 919-781-0164; Midwest—Electronic Innovators 612-884-7471, W. Pat Fralla Co. 817-640-9101, 817-649-8981, 713-772-1572, K-MAR Eng. & Sales 816-753-5385, R. C. Nordstrom & Co. 313-559-7373, 616-429-8560, Technology Sales 312-438-3300; West—Mike Duffy Assoc. 303-934-7392, Electronic Component Marketing 714-524-9899, 213-649-5374, Spedden Assoc. 714-295-6122, Summit Sales 602-994-4587, Trident Assoc. 408-734-5900, Tri Tronix 206-232-4993, 505-265-8409; Canada—R.F.Q. Ltd. 416-626-1445, 514-626-8324.

DISTRIBUTORS: Century Electronics (Albuquerque, Salt Lake City, Wheatridge CO), Diplomat (Chicopee Falls MA, Clearwater FL, Elk Grove Village IL, Farmington MI, Minneapolis, Mt. Laurel NJ, Salt Lake City, St. Louis, Sunnyvale, Totowa NJ, Woodbury NY), Future Electronics (Montreal, Ottawa, Rexdale, Canada), Harvey Electronics (Fairfield NJ, Lexington MA, Norwalk CT, Woodbury NY), Intermark Electronics (San Diego, Santa Ana, Sunnyvale), Lionex (Burlington MA), G.S. Marshall (Sunnyvale), Mirco Electronics (Phoenix), Resco (Raleigh), R-M Electronic (Kentwood MI, Madison Hgts MI), Semicomp (Newport Beach CA), Semiconductor Specialists (Burlington MA, Chicago, Dallas, Dayton, Farmington MI, Hazelwood MO, Indianapolis, Kansas City, Milwaukee, Minneapolis, Pittsburgh, St. Louis, Malton Canada), Sterling Electronics (Albuquerque, Dallas, Houston, New Orleans, Phoenix, San Diego, Seattle, Sun Valley CA, Watertown MA), Technico (Columbia MD, Roanoke VA), Zeus Components (Elmsford NY).

More and more major companies The future

More than 200
deep discharge
cycles.

Great versatility
in charging methods.

Wide temperature range
from -40°C to
 $+50^{\circ}\text{C}$.

More packaging
flexibility than
you might
have thought possible.

Easy
recharge,
plus a wide
range of
discharge rates

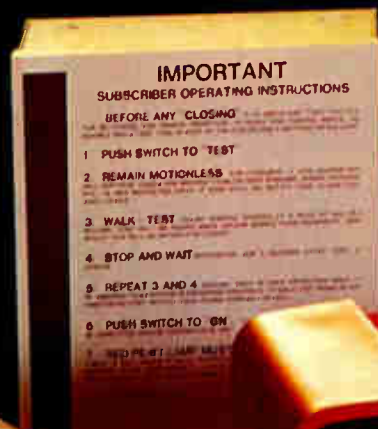

use Gates. in energy cells.

Fewer design problems,
fewer operating problems.

A watt-hour
per dollar value
that would warm
a comptroller's heart.

Thermal
runaway problems
are a memory.

Tough,
sealed construction
for rugged, safe
performance.

E-6
FREE!

I would like to know a
lot more about Gates' energy
cells. Please send your **FREE**,
no-obligation brochure containing
battery features, application information,
ratings and specifications.

Name _____

Title _____

Company _____

Address _____

City/State/Zip _____



Energy Products

Circle 157 on reader service card

Please mail coupon to: Gates Energy Products, Inc.,
1050 S. Broadway, Denver, CO 80217.

World Radio History

**ALL THESE
ZINC AND ALUMINUM PARTS
WERE MADE IN DIE CAST TOOLS.**



**AND HERE'S
HOW YOU CAN
GET A FREE
PROTOTYPE
TOO.**

ALL THESE LEXAN[®] RESIN PROTOTYPES WERE MADE IN DIE CAST TOOLS. FREE.



We say LEXAN resin can give products metal-like strengths plus material, production, assembly, finishing and shipping economies. But actions speak louder than words. Which is why we also produce LEXAN resin prototypes and technical evaluations for prospective customers (who more times than not, become regular customers). So if you'd like our technical people to consider your die-cast part for free prototyping and/or evaluation, simply return the coupon for fast action.

WHAT THE WORLD IS COMING TO: GE PLASTICS
LEXAN[®] NORYL[®] VALOX[®] GENAL[®]

GENERAL  ELECTRIC

LEXAN Products Section, Plastics Division, General Electric Company,
One Plastics Avenue, Pittsfield, Massachusetts 01201

Please consider our die-cast part for:

prototyping evaluation. The part is a
presently cast in

part enclosed detailed drawing enclosed
 die available contact us

Name

Title

Company Telephone

Address

City State Zip

Get a Computer- 6-PAC

The Complete Microcomputer, \$495.

There is no faster way to learn programming 8080A based systems than the ia7301 Computer-in-a-Book™. In one, rugged binder you get a fully operational microcomputer and a comprehensive programming course that work together to make you an expert microcomputer programmer. Almost anyone with an engineering background can follow the "learn-by-doing" text, application by application. Programming exercises include programming switching, timing and counting functions, writing programmable controllers, setting up data search and file maintenance routines, and multibyte arithmetic programs. Then, you'll expand and apply your newly acquired knowledge by programming a digital clock, computerize your check-book, and write a few games of skill like PONG™ and Mastermind™.

The ia7301 computer system comes to you entirely assembled and tested. All you need is a dual voltage power supply (+5V, +12V). As an option, lasis offers a compact supply that fits in a briefcase.

The ia7301 microcomputer features 1K RAM, 1K PROM (containing the monitor program), sockets for an additional 1K PROM, 2 I/O ports, a neat cassette tape interface, a set of eight 7-segment LED digital displays and a handy 24 pad keyboard. Which is to say, the Computer-in-a-Book has the best combination of features and capability at a very affordable price.

And since this system has a special monitor program which allows you to look into all operating parts of the microcomputer, you'll never get bogged down in loading or debugging programs. The monitor can be used anytime through versatile mode keys to display and change data and instructions in memory or in all the 8080A registers. Likewise, programs can either be executed or stepped through, instruction by instruction, so that you can learn your way around the inner workings of the system. Complete is the best word for the Computer-in-a-Book.

The Computer-in-a-Book will also support a large, expensive microcomputer development system. The portable binder containing the ia7301 computer, programming pad and Hex conversion card offers a powerful tool to write and pretest program segments which can then be assembled in the development system. This is very efficient since it allows many engineers to program and debug in rapid succession.

Then, as your company brings microcomputer based products to market, the Computer-in-a-Book becomes an excellent training system and trouble-shooting tool for field service technicians. The on-board cassette interface can play a major role in helping management communicate program changes and new test procedures to field personnel for hardly the cost of commercial cassette tapes.

Computer-in-a-Book is a trademark of lasis, Inc.
PONG is a trademark of Atari, Inc.
Mastermind is a trademark of Invicta Plastics (U.S.A.) Ltd.

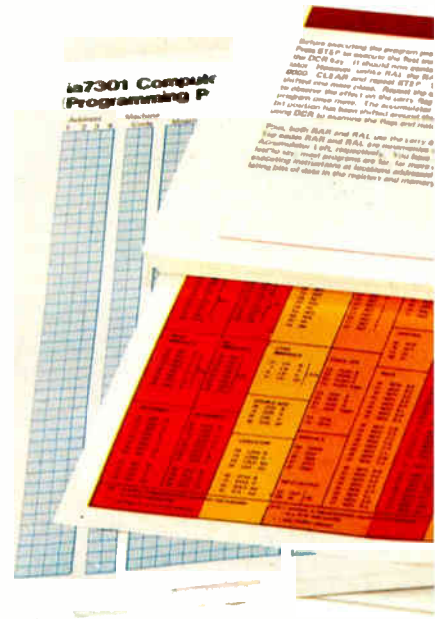

The ia7600 Series Expansion Cube.

As you might expect, lasis has combined a powerful hardware simulator and development system into one low cost package. The 7600 Series Expansion Cube has 12K RAM (expandable in 8K and 16K increments), 8K EROM, a CRT and keyboard interface, and much more.

The 7600 Series Cube can be used both as a Computer-in-a-Book add-on and as an inexpensive development system. It will simulate ROMs, program and test EROMs, and even electrically check out your prototype boards. We didn't make a cheaper development system, we just solved the microcomputer design cycle differently and better. The ia7600 will be available in late July. Watch for it.

The 6-PAC— (Personal Application Cassettes), \$72.

Here is the first sampler of the lasis growing family of preprogrammed cassette tapes. It's our way of getting you into advanced, practical applications using your Computer-in-a-Book quickly and easily; no need to learn a specialized computer language. Use these six canned tapes containing over twelve interesting and varied programs as a spring-board into your own applications. We give you the head



in-a-Book and a to go.



**Save \$24
and get
a free bonus**

If you order the Computer-in-a-Book and the 6-PAC before August 1, 1977, Iasis will discount the \$72 price of the 6-PAC to \$48. That is a \$24 cash savings. As an extra, Iasis will also give you a \$7.95 Microcomputer Applications Handbook as a Free Bonus. It contains over 140 pages of text, diagrams, and charts of

start. You see, we believe computers should work for you doing the things you expect them to do from day one. Look at what we put in this first sampler 6-PAC.

| Tape | Side A | Side B |
|------|------------------------------------|------------------------|
| 1 | A Flexible Micro-Assembler program | Other Programming Aids |
| 2 | Floating Point Arithmetic | Other Math Functions |
| 3 | Challenging Games | More Games of Skill |
| 4 | Checkbook Balancing | Home Budget System |
| 5 | Programmable Controller | Digital Stop Watch |
| 6 | Educational Programs | Metric System Quizzes |

By design each of the programs can be used right off the tapes through your home cassette recorder and the Computer-in-a-Book. Or if you wish, you can change or expand many of the programs to fit your specific application. It's up to you.

We will be announcing a continuing stream of new 6-PACs with such programs as a laboratory data analysis package, more process controller programs, inventory control systems, and much more. Now, you have a 6-PAC to go with the Computer-in-a-Book.

The Prices

The Computer-in-a-Book which contains an operational 8080A System, 250 page programming course, machine code pad, 26 page system service manual, and Hex conversion card are all contained in a sturdy 3-ring binder and offered for only \$495.

The complete set of 6 canned tapes in this first sampler 6-PAC is offered at \$72. It also includes the works on support documentation.

All Iasis products are warranted 90 days. Please allow 30 days for delivery.

microcomputer information. But you must place your order before August 1, 1977 to get in on this \$24 savings and free bonus.

OFFER GOOD ONLY TO AUGUST 1, 1977

Please rush me _____ Computer-in-a-Book(s) at \$495 each and _____ 6-PACs at \$48 each, a \$24 savings.

I also need _____ PS-1 Power Supplies for the Computer-in-a-Book at \$62.50.

I want the Microcomputer Applications Handbook as a Free Bonus.

Here is my check for \$_____ (Calif. residents add 6½% State Tax.)

Put this order on my Credit Card:

BankAmericard No. _____

Master Charge No. _____

For M.C. the 4 digits above my name are _____

My Signature _____

My card expiration date _____

Please print clearly

Name _____

Firm _____

Address _____

City/State/Zip _____



iasis inc.

Iasis Inc., 815 W. Maude Ave., Suite 37,
Sunnyvale, CA 94086 (408) 732-5700

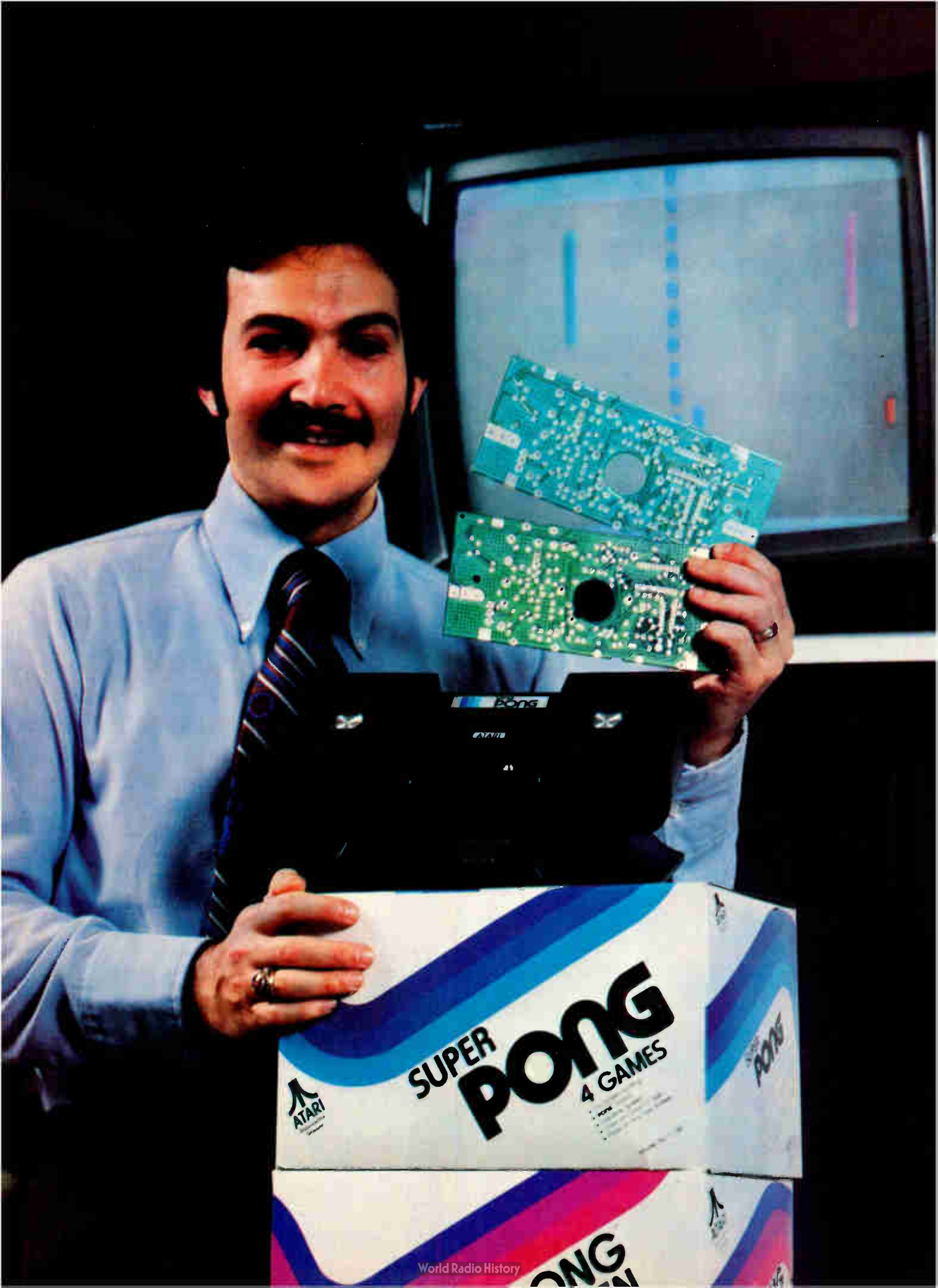

“Photocircuits has two ways to keep us ahead of the game.”

Rick Krieger, Materials Manager, Atari Corporation.

“The game market, like other electronic markets, is not for the faint-hearted. As many have found out, a miscalculation in vendors can cost millions in sales. Photocircuits is one of the very few vendors Atari can trust to handle two-sided plated-through-hole boards in tremendous volume for our short manufacturing season.

“Making the identical board by two separate processes (conventional and additive) Photocircuits not only can deliver higher volume, it is uniquely set up to be a second source to itself. But, as we’ve found out, their additive boards are more than just volume and insurance.

“Our manufacturing manager, Dave Elson, noticed a significant advantage for Photocircuits CC-4 additive boards over conventional boards. He’s saving money in soldering additive. No bridging or soldering problems. But most important, he’s getting 100% yield on additive with 90% at best on conventional. In short, we’re finding additive boards to be much more reliable.”

Are you playing for big stakes, like Rick Krieger and Atari? Remember this: Few suppliers can provide conventional boards in volume like Photocircuits. And no other can help you so quickly to the benefits of CC-4 additive process. In fact, we’re more than delighted to provide you with high quality subtractive boards in large volume while you explore the advantages of our CC-4 additive. Then take your pick for the long run. Just contact your Photocircuits PCB representative about conventional, additive or both. Or call or write Photocircuits, PCK Sales, 31 Sea Cliff Ave., Glen Cove, New York 11542. 516-448-1301. Division of Kollmorgen Corporation.

Photocircuits

Printed circuitry for mass-produced electronics.



Architecture and data bases are the hot topics at this year's NCC

Two fast-growing fields stressed at National Computer Conference

by Lawrence Curran, *Senior Editor*

□ This year's National Computer Conference in Dallas, June 13–16, will be strong on the architecture and data-base management of computer systems that process all kinds of information. Since computer users are processing a wide variety of new information, as well as numerical data, today's computer is far more than a number cruncher, according to the conference program chairman, Robert Korfhage, professor of computer science at Southern Methodist University in Dallas. Moreover, microprocessor developments are increasingly influencing both the data-base setups and the architecture of such systems, he says.

Korfhage expects tomorrow's systems to be far more versatile than today's, and they will significantly enlarge the variety of information maintained in data bases. He envisions the day when pluggable, hand-held personal computers will have access to very large data bases and will tie into printers and other peripheral devices.

This year's conference confers legitimacy on the exploding field of personal computers [*Electronics*, March 31, p. 89] with a total of two days' worth of sessions, a personal-computing exposition, and a national congress of personal-computer clubs. The incorporation of this smaller show into the NCC is evidence, if any more were needed, of the pervasiveness of the microprocessor,

which is the key building block in all of the personal-computer systems.

Conference officials say 317 exhibitors will cram their wares into 1,140 booths in the Dallas convention center. While this tops the 930 booths at last year's New York gathering, attendance probably will drop 5,000 to 10,000 from the 35,000 in 1976. A report on some of the products to be introduced begins on p. 171.

In addition to the regular program sessions, there will be seminars, covered by a separate registration fee, on topics ranging from distributed data-base systems through microprocessors and computer networks. Software design techniques will be covered in day-long courses conducted by authorities on the subject.

Because of the rapidly advancing microcomputer penetration into small systems, a session intended as a forecast of computer technology through 1985 has been focused down to assess the impact of microcomputers through 1980. Being organized by Charles Hornisher, a director of Iasis Inc., Sunnyvale, Calif., it will include an overview paper by Iasis president David Guzeman. He will examine the sociological impact of microcomputers as they mature rapidly from today's primarily commercial/industrial systems to true home computers used by owners who do not want to learn programming.

A forecast of the hardware such home machines will use will be offered by Donald Pezzolo, manager of product development at Cognition Inc., Mountain View, Calif. Pezzolo managed major development programs for automotive and consumer electronics at Fairchild Semiconductor. He will show that a variety of new data-gathering transducers will evolve by 1980. Bubble memories may be readily available to take on the entire storage task, he maintains. A software paper by Timothy Barry, a consultant from Mountain View, Calif., will elaborate on the overview's assumption that home-computer software will have to be greatly simplified and use a simple English language.

A multi-microprocessor system

A further illustration of the utility of today's micro-computer is its role in distributed and multiprocessing systems. A session will be offered that is dedicated entirely to a multi-microprocessor computer system developed at Carnegie-Mellon University in Pittsburgh. Samuel Fuller, associate professor of computer science and electrical engineering, will lead the session and is co-author of one of the three papers. His team is putting together a modular multiprocessor system called Cm*, which eventually could include as many as 100 micro-computers. The prototype system encompasses 10 Digital Equipment Corp. LSI-11 microcomputers.

Fuller says the system has been used to implement a simultaneous set of linear equations, a sorting problem, and an integer programming application. Initial perfor-

mance results from these early applications will be presented at the conference.

The three papers cover the architecture and basic design of the system, its implementation in 1975/1976 technology with the LSI-11, and software systems. "I think the implementation paper will be of particular interest to other engineers who are attempting to integrate microcomputers into large computing systems," Fuller says. "The software paper is essential because it describes how useable the multi-microprocessor will be. It describes how we will manage the multiple central processors, allocate storage in main memory, and communicate between cooperating parallel processors."

The Cm* project is funded by the Defense Department's Advanced Research Projects Agency, which pioneered the highly ambitious Arpanet linking dozens of dissimilar computers at sites called nodes throughout the U.S. Fuller does not think the Cm* concept will evolve into a smaller Arpanet, but he believes it could function as a node when fully implemented. He expects to build it into a system capable of speech recognition. Also, he wants to use it to implement an Algol 68 compiler/run-time system in order to show that multi-processors using microcomputer technology can work with higher-level languages.

Architectural attitudes

A double session on microprocessor architecture runs the gamut from bit-slice, large-scale-integrated processor modules that have been put together in a multiprocessor configuration to a theoretical look at the use of light pipes—optical fibers—as interconnects between LSI circuits to help overcome the problem of pin limitations as circuits become extremely dense. The session chairman is Charles Vick, chief of the data-processing directorate in the Army's Ballistic Missile Defense Advanced Technology Center, which is located in Huntsville, Ala.

Mario Tokora, a member of the engineering facility at Keio University, Yokohama, Japan, will discuss the three-processor system he has implemented using the PM/II complementary-metal-oxide-semiconductor processor made by Matsushita Electric Industrial Ltd. The PM/II (for processor module in its second generation) is designed with multiprocessor-oriented architecture. Tokora's paper, given jointly with the Matsushita Research Institute, Tokyo, will validate multiprocessor design based on bit-slice building blocks. His aim is threefold: to provide maximum architecture flexibility with the smallest possible number of hardware modules; to construct a variety of computers of every size in which the total number of components is held to a minimum, and to demonstrate that the basic architecture need not vary, no matter what semiconductor processor is used.

His system consists of executor, sequence controller,

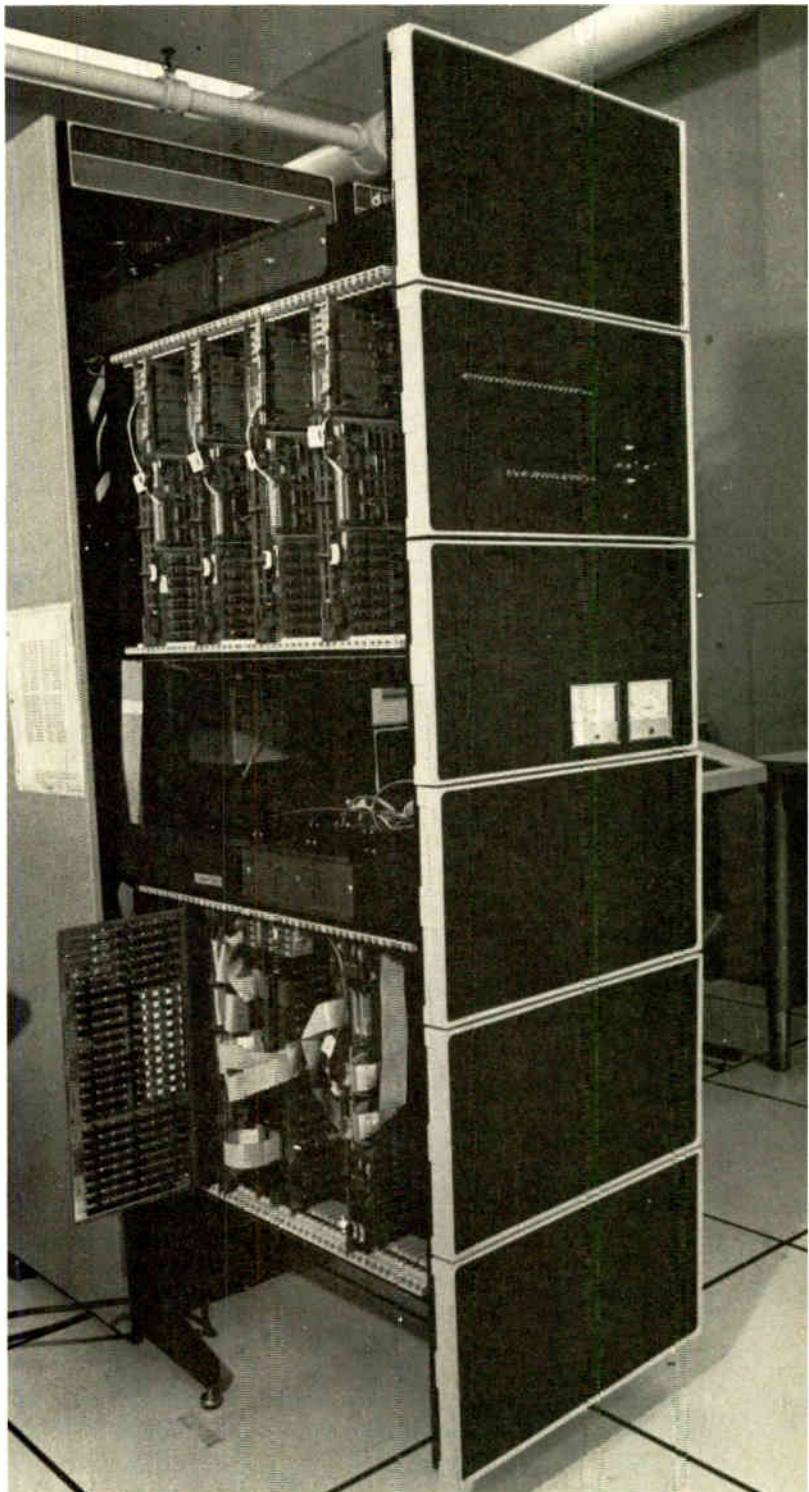

Multiprocessing. Sessions at NCC will assess new, increasingly complex uses of the microprocessor. This cluster of microcomputers is part of the Cm* multiprocessing system, developed at Carnegie-Mellon University, that will be covered in one such session.

The Measure of Excellence Goes On

Ailtech, with manufacturing facilities located in New York and California has become a recognized source for instrumentation of excellence, worldwide. The *Advanced Performance, Ease of Operation and Reliability* built into every AILTECH product give credence to our staff's technical expertise. Ailtech dedication to customer service is best illustrated by an ever growing list of satisfied users. Look to Ailtech for Instruments designed to meet the total needs of Industry today, and in the Future.



RF Power Signal Sources from 10 KHz to 6000 MHz

- CW and Pulse Power up to 70 watts
- Plug-in heads provide broad coverage
- Positive load mismatch protection
- Frequency counter readout
- AM-FM options



System Noise Monitors for field or production use

- Monitor noise performance of operating systems and components
- Synchronous on line Radar monitoring
- Analog or digital readout
- Noise Figure and Gain measured in one instrument
- GPIB option available



Synthesized Signal Generators from 10 KHz to 1800 MHz

- Clean Signals—Spurious 100 dBc
- Quiet Signals—Phase Noise 138 dB/Hz
- Fast Switching—20 μ sec
- Programmable τ GPIB Adapter available
- Modulation—Amplitude, pulse, frequency and phase in ONE plug-in

EAST COAST OPERATION

815 Broadhollow Road • Farmingdale, N.Y. 11735 • Telephone (516) 595-6471 • Telex 510-224-6558

WEST COAST OPERATION

19535 East Walnut Drive • City of Industry, CA 91748 • Telephone (213) 965-4911 • Telex 910-584-1811

INTERNATIONAL OFFICES

FRANCE—La Garenne—Colombes • Telephone (01) 780-73-73 • Telex 62821

GERMANY—Munich • Telephone (089) 5233023 • Telex 529420

UNITED KINGDOM—Crowthorne • Telephone 5777 • Telex 847238

JAPAN—Tokyo • Telephone (404) 8701 • Telex 781-02423320 (Nippon Automatic)

with Precision Instrumentation from **AILTECH**



Precision Automatic Noise Figure Indicator *The Standard around the World*

▪ RF Range from 10 MHz to 40 GHz ▪ Input frequencies from 10 to 1000 MHz ▪ Adjustable ENF calibration ▪ ± 0.15 dB tracking accuracy ▪ Complete selection of noise sources



Broadband Amplifiers all Solid State design

▪ Broadband—from 1 to 200 MHz ▪ Up to 75 watts available ▪ Monitors both forward and reflected power ▪ Linear—Less than 1 dB compression at rated output



Spectrum Analyzers from 1 MHz to 20 GHz

▪ Simple, easy-to-use operation ▪ Absolute Power Measurement ▪ 100 dB Display Range ▪ Digital Frequency Readout ▪ Internal Preselection

WRITE FOR COMPLETE CATALOGS AND TECHNICAL LITERATURE

AILTECH

A CUTLER-HAMMER COMPANY



CONTROL

World Radio History 1969 on reader service card

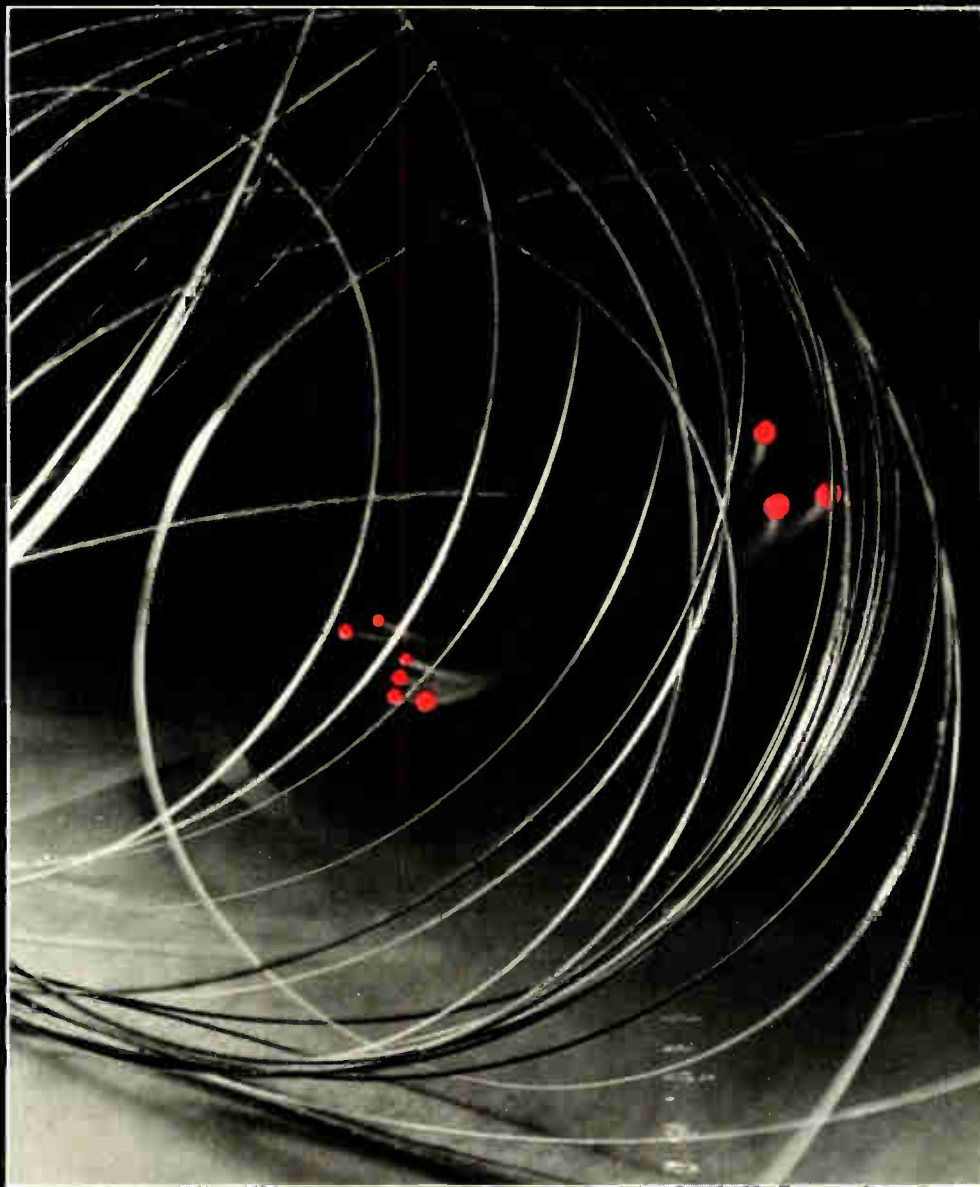

Tomorrow's data link. Optical waveguides. From Corning.

Till now, transmitting megabits of information over reasonable distances required coax cable. Expensive. Subject to EMI. Costly to install.

Now, a superior data link from Corning's glass technology. Low attenuation, high bandwidth optical waveguides. Immune to EMI. Secure. With unequalled data-handling ca-

capacity. Economical, lightweight cables that are easy to install.

Right now, Corning can supply complete systems for development purposes—Corguide™ optical waveguide fibers, connectors, electro-optical converters. Ask us about optical waveguide links for computer applications. Or write for details to

Telecommunications Products Department, Corning Electronics, Corning Glass Works, Corning, New York 14830.

Corning.

The leader in optical waveguide technology.

CORNING



NCC NCC NCC NCC NCC NCC NCC NCC NCC NCC NCC NCC NCC NCC NCC

Some significant new products make their debut at the show

Memories expand computer systems

Calling it the industry's largest mini-computer add-on memory, National Semiconductor Corp. is introducing the NS3-2 bulk-storage memory unit at the National Computer Conference. What's more, the company is also unveiling a "double density" add-in memory card, the NS11, to mesh with the PDP-11 minicomputer family.

According to Chuck Fleming, product marketing manager, the NS3-2 is a self-contained semiconductor random-access memory system with a maximum capacity of up to 512 kilobits by 22 bits—with error correction—or 1 megabyte. Also, while designed primarily as an add-on memory for all minicomputer systems, it adapts easily to a wide range of applications, he says.

The NS3-2 system is housed in a 5.25-inch-high cabinet with standard 19-in. racks and contains its own power supply and fans. The card cage/enclosure houses one timing-and-control card and up to four storage cards, with two additional card slots available for a combination of optional features including error check and correct (ECC), self test, 4-byte interface (44 bits), and custom features.

The memory is configured in four modular cards, each with a maximum of 128 kilobits by 22 bits. The basic system element, is a 16-kilobit dynamic RAM, which provides speed, reliability, and low cost. Memory flexibility is achieved by depopulating the board.

The timing and control card

provides the interface between the host processor and the storage cards and contains address registers, card decode logic, data registers, refresh-related logic, and the timing-and-control circuitry.

A double-word (44-bit) latch card is required whenever the memory-word size exceeds 2 bytes. This card contains the input and output data registers and control logic required for 4-byte systems. The card, says Fleming, may be used with either unidirectional or bidirectional data interface.

The error check and correct

control card contains the logic necessary to correct single-bit and detect double-bit errors for either 16- or 22-bit interfaces. Included on the card are data registers, error timing-and-control logic, bit-correct logic, and the parity circuitry necessary for generating the check bits to be stored in memory.

The NS11 "double density" card is a 32-kilobit-by-18-bit add-in memory card designed to be interchangeable with seven separate cards used in Digital Equipment Corp.'s PDP-11 minicomputer family. The card plugs directly into the

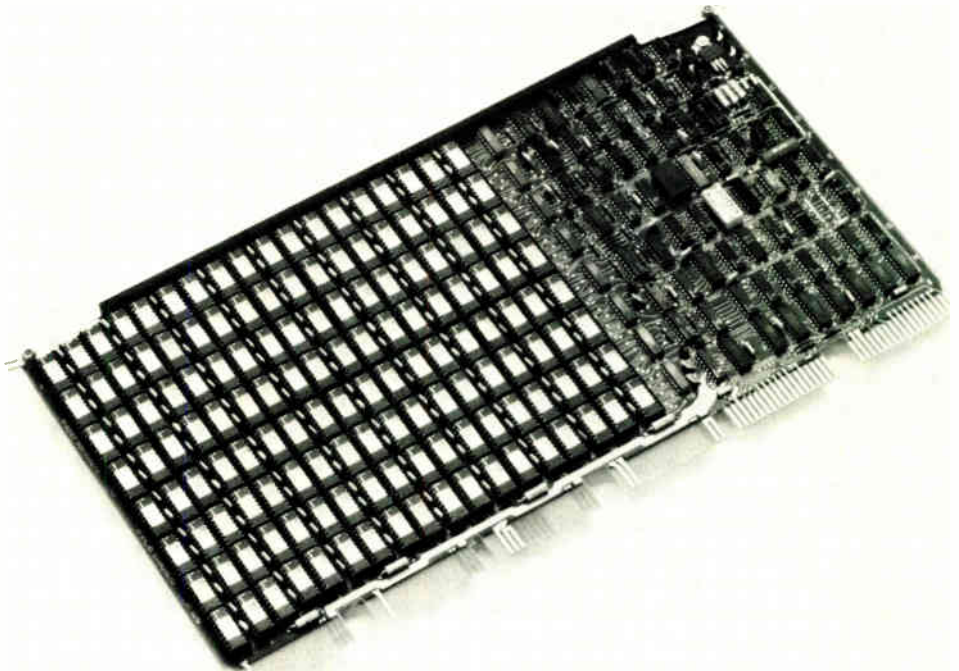

THERMISTORS

OBTAIN STATE-OF-THE-ART PERFORMANCE AT COSTS LOWER THAN YOUR PRESENT COMMERCIAL PRODUCT:

**BEADS
PROBES
FLAKES
RODS
ASSEMBLIES**

FAST RESPONSE ASSEMBLIES (TO 3ms)

HI-TEMP UNITS (TO 450°C)

SPECIAL CURVE MATCHES

0.05% TOLS. AND INTER-CHANGEABILITY

PRECISION CALIBRATIONS

DESIGNED TO MEET MIL-T-23648

QUICK REACTION TO SPECIAL APPLICATIONS AND ASSEMBLIES!

THERMOMETRICS INC.

808 U.S. HIGHWAY #1
Edison, N.J. 08817
(201) 287-2870

New products

PDP 11/04, 05, 34, 40, 45, 55 mini-computers. According to William Leduc, product marketing manager, each NS11 card replaces two 16-kilobit DEC cards in the back-plane assembly with 50% savings in space, lower cost, and increased reliability.

Fully compatible with PDP-11 hardware, software, and standard peripherals, NS11 cards can be intermixed with DEC cards or configured as an all-NS11 memory with increments of 32 or, optionally, 16 kilobits. With either National or DEC management, up to four NS11 cards can replace eight DEC cards for a maximum capacity of 124 kilobits by 16 or 18 bits.

In 18-bit systems, the on-board parity circuits work in conjunction with the PDP-11 parity controller. To insure simple plug-in installation, the NS-11 includes on-board circuits for interfacing with the Unibus or modified Unibus, DIP-switch address block selection in 4-kilobit incre-

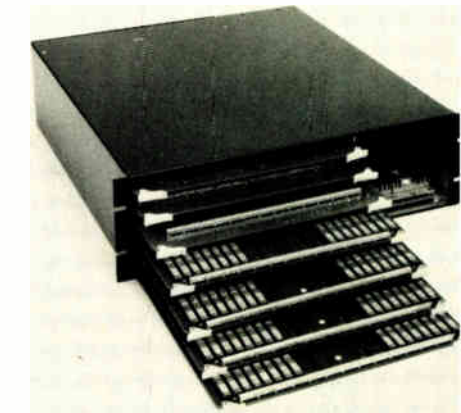

ments, and input power regulation.

It is dimensionally equivalent, says Leduc, to DEC memory cards and capable of operating from 0% to 90% relative humidity and 0-50°C. Compatible back-plane assemblies are provided, if required.

National Semiconductor Corp., 2900 Semiconductor Drive, Santa Clara, Calif. 95051 [351]

NCC NCC NCC NCC NCC NCC NCC NCC NCC NCC NCC NCC NCC NCC NCC

8-bit operating system bows

Look for Intel Corp. to introduce a software operating system designed specifically for an 8-bit microcomputer at the National Computer Conference. Designated the RMX/80 real-time multitasking executive operating system, it is, says Ed O'Neil, software product manager at Intel, an easy-to-use but sophisticated tool that operates on Intel SBC single-board computers and System-80 packaged systems.

RMX/80 consists of a library from which required routines are configured with application tasks to form a full system. Users generate RMX/80 systems by selecting appropriate modules, relocating and linking them with user-generated tasks on an Intel microprocessor development system. According to O'Neil, the RMX system is organized in such a way that code, data, and stack can be placed in separate areas of memory. This means, he says, that peripheral devices are not necessary to load RMX.

Instead, programmable read-only

memories containing nonvolatile code portions of an RMX system can be installed directly into SBC systems. In the case of power failure, program instructions resident in programmable read-only memory are not destroyed, and the system may be restarted when power is restored.

Requiring a minimum of 48 kilobytes of memory, RMX/80 contains all major real-time functions, including resource access based on task priority, inter-task communication, interrupt-driven control for standard devices, real-time clock control, interrupt handling, as well as other optional features. These functions, says O'Neil, eliminate the need to implement detailed real-time coordination for specific applications, greatly simplifying application development, particularly in areas of control, test and measurement, data communications, and specialized data-processing systems.

The nucleus of the RMX operating system, however, including task management, real-time control,

Digital IC testers. Linear IC testers.

GenRad is the source.

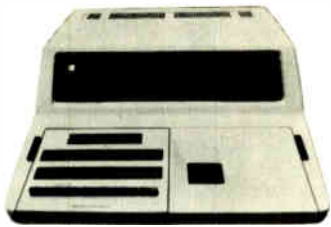

Model 1742



Model 1740

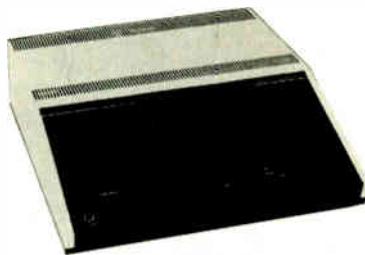

Model 1744

Model 1730

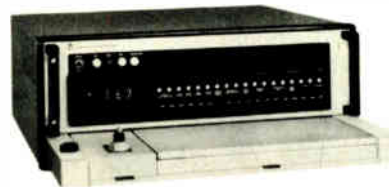

for digital IC's

for linear IC's

Find out how you can increase your testing throughput and decrease your testing costs. Call your GenRad sales engineer today.

 **GenRad**

300 BAKER AVENUE, CONCORD, MASSACHUSETTS 01742 • ATLANTA 404 394-5380 • BOSTON 617 646-0550 • CHICAGO 312 884-6900 • DALLAS 214 234-3357 • DAYTON 513 294-1500 • LOS ANGELES 714 540-9830 • NEW YORK (N.Y.) 212 964-2722, (N.J.) 201 791-8990 • SAN FRANCISCO 408 985-0662 • WASHINGTON, DC 301 948-7071 • TORONTO 416 252-3395 • ZURICH (01) 55 24 20

VAC
VACUUMSCHMELZE

VACUZET®

a semi-hard magnetic alloy with rectangular hysteresis loop for impulse controlled self latching relays.

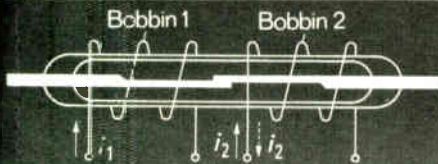

Properties:

- high remanence
- adjustable coercitive force

VACUZET 200 258 655 923

| | | | | | |
|---------------|------|-------|------|------|------|
| H_C | A/cm | 15 | 30 | 50 | 75 |
| B_r | T | 1.5 | 1.45 | 1.45 | 1.25 |
| B_r/B_{10c} | % | ca.90 | | | |

For data sheet and further information apply to

VACUUMSCHMELZE GMBH

6450 HANAU

W.-Germany · POB 109

New products

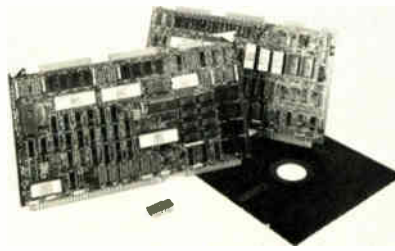

interrupt handling, and inter-task communication facilities, can be contained on 2 kilobytes of memory, such as on a 2716 nonvolatile ultraviolet-erasable ROM. Other features of the RMX/80 include customiza-

tion based on system software requirements, full multitasking operation, priority access to system resources, full inter-task communication and synchronization—allowing tasks to send information to other tasks and to cause other tasks within the system to execute at proper times—and easy addition of special user I/O tasks.

Available in September, the RMX/80 executive operating system will be supplied to customers in the form of a diskette.

Intel Corp., 3065 Bowers Ave., Santa Clara, Calif., 95051 [352]

NCC NCC NCC NCC NCC NCC NCC NCC NCC NCC NCC NCC NCC NCC Printer runs at 2,000 lpm

Aimed directly at original-equipment manufacturers, a high-speed line printer will be among the newest offerings shown by Documation Inc., Melbourne, Fla., at the National Computer Conference. Called the DOC 2000, it prints 2,000 single-spaced lines per minute, using a set of 48 characters and a fully buffered print line of 132 characters.

The printer evolved from the company's earlier DOC 2250. Though it prints 250 lines per minute less than does its predecessor, its circuitry has been greatly redesigned to cut production and materials costs to make it competitive in the OEM market. Gary Fisher, vice president for engineering, says it incorporates an Intel 8080 microcomputer to control the print hardware and communication with the host computer, as well as the decoding of all commands. The microcomputer also handles error detection and system status functions in the DOC 2000.

"There's no wire-wrapping in this unit," Fisher says of the electronics redesign. "We've recabled and re-harnessed the whole system, using quick-connect pressed-on connectors." At the same time, however, the company retained the mechanical design of the 2250, which has been successful with end users.

The DOC 2000 is intended for top-of-the-line computer systems

like the larger Digital Equipment Corp. models, which compete with IBM 370 mainframes. It can handle forms with as many as six parts, ranging from 3 to 24 inches long and 4 to 18¾ in. wide. Paper slew rate is up to 75 inches per second. Vertical line spacing may be either 6 or 8 lines per inch.

Other standard features include a powered forms stacker, an acoustically insulated cover, and interchangeable character arrays. A universal buffer allows any character set on the printer band to be used, and print bands can be changed in 2





Field lab!

Now you can take advanced multi-channel recording technology out of the laboratory and into the field. EMI's proven SE7000 rivals the versatility, fidelity and performance of the most expensive lab recording systems. Yet it's rugged enough, compact enough to travel to the factory floor, the launch pad or any other operation site.

The SE7000 handles the full range of requirements from routine 14-track midband all the way to 42-track recording capability. It offers a choice of eight speeds between 15/16 and 120 ips providing 600 kHz DR or dc to 80 kHz FM at 120 ips. Equalizers and filters for all tape speeds are built in as standard. And it has a built-in

calibration module, eliminating the need for time-consuming cross-patching.

All these features are packed into a transportable unit so rugged that the system is warranted unconditionally for a full year. Complete with its internal AC or DC power supply, the weight is less than 100 pounds.

The SE7000 has gone into the field in automotive, aerospace, petrochemical and transportation applications all over the world. Applications, like yours, that need laboratory precision but can't be brought to the lab.

EMI Technology Inc., Instrumentation Division,
55 Kenosia Avenue, Danbury, CT 06810 (203) 744-3500,
TWX: 710-456-3068



EMI Technology Inc. Instrumentation Division
A member of the EMI Group International leaders in music, electronics and leisure

KEEP THE HORSE BEFORE THE CART!

You've probably known design engineers who are half-way through a project before they realize the power supply that could have come from a standard line must all of a sudden be a customized design. And you also know what that means in the way of extra costs. It's the old cart before the horse theory.

Call us when you are in the embryonic stages of your design and we'll work with you in your primary important stages. And not only will you like the fact that our standard lines will both fit your supply and keep you in budget... you'll like the idea of our already field-tested dependability.

Our power supplies are available for OEM computer, point of sale, EDP, bank telling and telecommunications use:

- Switching regulator and linear designs • 11 models — single/multi-output • Voltage ranges, from 2 to 30V • 50 current levels from .01 to 225 amps • Overcurrent/overvoltage protection
- Filtering to meet world-wide EMI requirements • Designed and built to UL, CSA and European safety requirements.

Dependability. That's a word we define as quality and reliability. It's also what design engineers define as our reputation!

NCR

NCR POWER SYSTEMS DIVISION

formerly Scott Electronics
584 S. Lake Emma Road, P.O. Box 898
Lake Mary, Florida 32746

Telephone (305) 323-9250

176 Circle 176 on reader service card

New products

minutes. Print bands bearing a 64-character set are also available, but then print speed is reduced.

Price for single units is \$36,000,

which drops to \$28,000 each in OEM quantities.

Documation Inc., P.O. Box 1240, Melbourne, Fla. 32901. Phone (305) 724-1111 [353]

NCC NCC NCC NCC NCC NCC NCC NCC NCC NCC NCC NCC NCC NCC

Computer has more memory

Datapoint Corp. is using this year's NCC to highlight its introduction of a powerful new business computer. The model 6600 Advanced Business Processor will offer users 2½ times the memory of the firm's model 5500, its current top-of-the-line product, and memory access and instruction execution times have been speeded up as well. Deliveries will begin next month.

Housed in a cabinet the same size as other Datapoint processors, the 6600 is one of the first computers on the market to take advantage of the 16,394-bit random-access memories now becoming available from semiconductor vendors. And Datapoint, which started stockpiling MK4116 RAMs from Mostek Corp. late last year in the absence of alternate sources, uses 18 RAMs on each of four boards to give its users 122,880 bytes of 8-bit storage with parity. The extra 8,192 bytes, along with a read-only-memory overlay on a fifth board, are assigned to system functions.

Memory cycle time has been reduced from the 5500's 800 nanoseconds to 600 ns, and the 6600's

microprogrammed controller will execute a 16-bit instruction in 150 ns, pared from 200 ns on the earlier version. "In addition, we've speeded up some of the more complex instructions," says Jonathan E. Schmidt, vice president for advanced product development at the San Antonio, Texas, firm. "Some multi-byte instructions, such as block transfers, were literally doubled in speed by the use of more efficient microcoding."

While Datapoint has enhanced its instruction set for the new machine, the 6600 is fully software-compatible with earlier processors. Both 8-bit and 16-bit instructions have been extended, and the firm has added integer multiply and divide as well as exotic doubly linked, list-handling instructions. "But new instructions are primarily utilized by the system," Schmidt says, "and in all cases the user's 5500 programs will run faster and better."

When configured as a host computer using Datapoint's Datashare business time-sharing system, the model 6600 will support up to 24 video display terminals, each of which can direct the execution of the same or different programs concurrently. The earlier 5500 processor is limited to 16 terminals.

The Schottky-TTL processor uses both 8- and 16-bit-wide internal architecture, with two sets of eight 8-bit program-accessible registers and a 16-bit pushdown stack. The 6600 includes dual cassette drives, a standard 55-key typewriter keyboard, an 11-key numeric pad, and a 7-by-3.5-inch video screen that will display up to 960 5-by-7 dot-matrix characters.

Purchase price for a typical system, consisting of the model 6600 processor with 5-megabyte disk drive, multiple-terminal controller,



YOU CHOOSE THE WINNER

| PROCESSOR | 6/16 | NOVA 3/4 | PDP-11/04 |
|---------------------------------|----------|----------|-----------|
| Data Type Lengths (bits) | 4,8,16 | 16 | 1,8,16 |
| Instruction Word Length (bits) | 16,32 | 16 | 16,32,48 |
| General-Purpose Registers | 16 | 4 | 8 |
| Hardware Index Registers | 15 | 2 | 8 |
| Maximum Memory Available (KB) | 64 | 64 | 56 |
| Directly Addressable Memory(KB) | 64 | 2 | 56 |
| Automatic Interrupt Vectoring | Standard | N/A | Standard |
| Parity | Optional | Optional | N/A |
| Cycle Time (nanoseconds) | 600 | 800 | 725 |

| PRICE | 6/16 | NOVA 3/4 | PDP-11/04 |
|--------------------------|--------|----------|-----------|
| 8KB Processor | \$2200 | \$2600 | N/A |
| 16KB Processor | \$2800 | \$3200 | \$3795 |
| 32KB Processor | \$4000 | \$4400 | \$4995 |
| Multiply/Divide Hardware | \$ 950 | \$1400 | \$1820 |

Interdata's 6/16 wins the battle of the specs.

Not only do we cost less than the Nova 3/4 and the PDP-11/04, we have more features. Just compare: 16 general purpose registers on the 6/16 to simplify programming and reduce fetches . . . only 4 in the Nova and 8 in the 11/04; 15 hardware index registers on the 6/16 against 2 for the Nova and 8 for the 11/04; 64 KB of directly addressable memory instead of just 2 KB for the Nova 3/4 and 56 KB for the PDP11/04.

What's more; all these hardware features enhance the nimble 6/16's performance. Its cycle time is only 600 nanoseconds, compared to 800 for the Nova and 725 for the 11/04.

Interdata's comprehensive software drives this powerful hardware full out. You get the field-proven OS/16 MT2, a real-time, multi-tasking operating system providing instantaneous response to events, while allowing the user to minimize memory by storing non-critical functions on disks. And the 6/16 can be programmed in your choice of FORTRAN, BASIC or MACRO CAL.

All this and save money too, as much as one-third less than a PDP-11/04 and substantially less on a Nova 3/4 . . . with OEM discounts saving even more.

Get the whole story. Just fill in the coupon or call (201) 229-4040.

*Visit us at N.C.C.
Booth #1483*

Send me 1977 specs on your Model 6/16 E-6

NAME _____ TITLE _____

COMPANY _____

ADDRESS _____

CITY _____ STATE _____ ZIP _____

PHONE _____

INTERDATA®
A UNIT OF
PERKIN-ELMER DATA SYSTEMS
 Oceanport, New Jersey 07757. U.S.A.

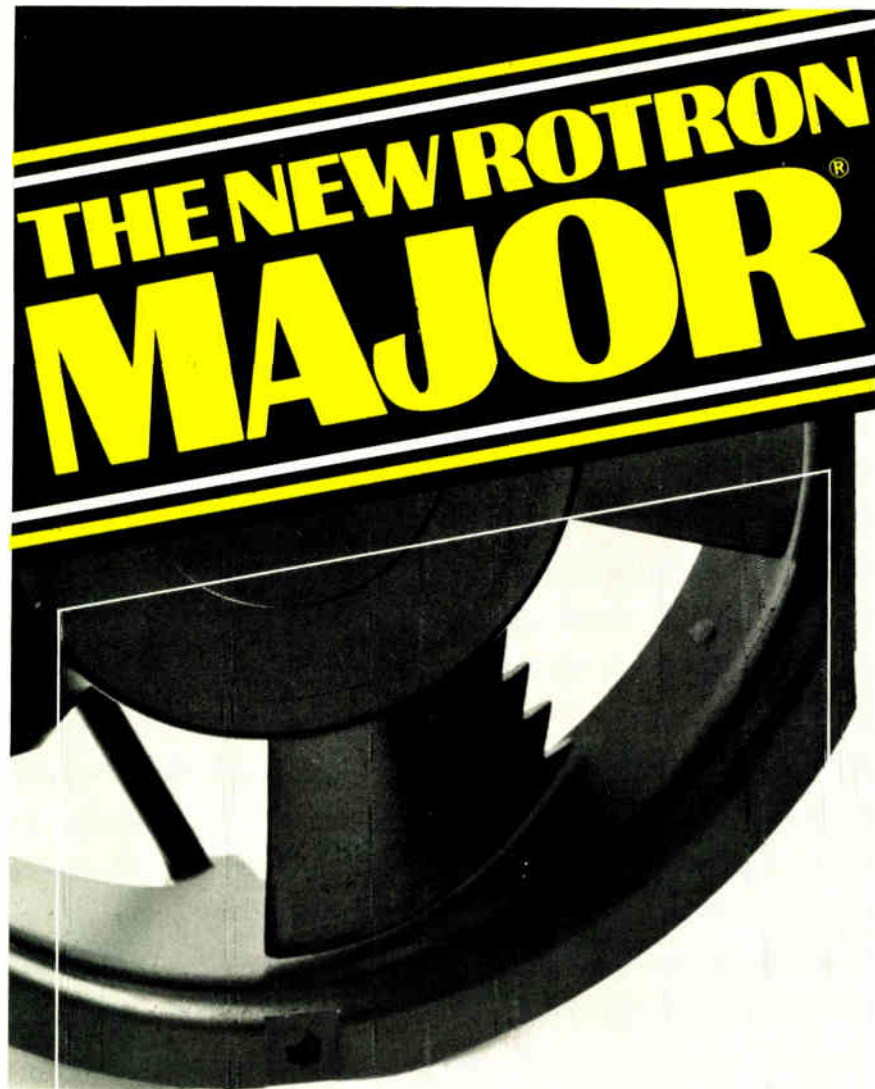

One more proof... Rotron has a way with air.

The news is noise ... the lack of it. Because the *new* Major tubeaxial fan gives the same performance as its popular predecessor, with even less noise than before under typical operating conditions. (150 cfm at .35" H₂O).

- with exclusive Feathered Edge™ blade design—for acoustical ratings as low as NC-53
- compact package—6.75" x 5.9" x 2"—flatted sides permit space saving array
- by the company that has brought you more new developments in precision air moving than all other companies combined.

See if it isn't time for a Major decision on your part. Call or write for the information you need on the new Rotron Major today.



ROTRON INC.
AN **EG&G** COMPANY

Woodstock, N. Y. 12498 □ 914 • 679-2401 □ TWX 510-247-9033

Gardner Grove Cal 92641 • 714•898 564 • Rotron B/V Breda Netherlands Tel 79311 Telex 844-54Q74

New products

and software/documentation package, is \$32,500; the three-year lease price is \$1,240 per month, including maintenance. The firm also has developed a new Cobol compiler that takes advantage of the 6600's full 123-kilobyte memory.

Datapoint Corp., 9725 Datapoint Drive, San Antonio, Texas 78284 [354]

NCC NCC NCC NCC NCC NCC NCC

Board controls floppy disk

A single circuit board mounted inside the cabinet provides a built-in controller/formatter for a floppy-disk drive, doing away with separate hardware, cabling, and interfacing, according to Terry Zimmerman, general sales manager of iCOM division of Pertec Computer Corp.

Heart of the FD5200 board is a special floppy-disk controller chip designed by Western Digital Corp. to iCOM specifications. "The simple formatter circuit board performs an extensive amount of complicated logic needed to lay down a data pattern on a diskette in the IBM 3740 format," Zimmerman explains. The control section accomplishes track, seek, and verify without intervention of the host processor, he says, unlike other formatters. "This makes for simpler programming and more efficient operation." Other advantages are modular replacement of the board, when necessary, and fewer failures because of the reduced component number.

The FD5200 uses a simple 8-bit bidirectional bus that enables an original-equipment manufacturer to mount the drive directly. The drive has an 8-inch diskette and is based on Pertec's FD511 model. The iCOM floppy disk operates with any 8- or 16-bit microprocessor and can interface to a minicomputer. A diskette may be formatted by the unit.

Not only is the FD5200 suitable for stand-alone applications such as intelligent terminals, but it also offers multiprocessing capabilities in some systems, Zimmerman says. "The reduced cost of the FD5200, compared to an external formatter

FREQUENCY SYNTHESIZER AND LEVEL GENERATOR

2400
300 Hz
14 MHz

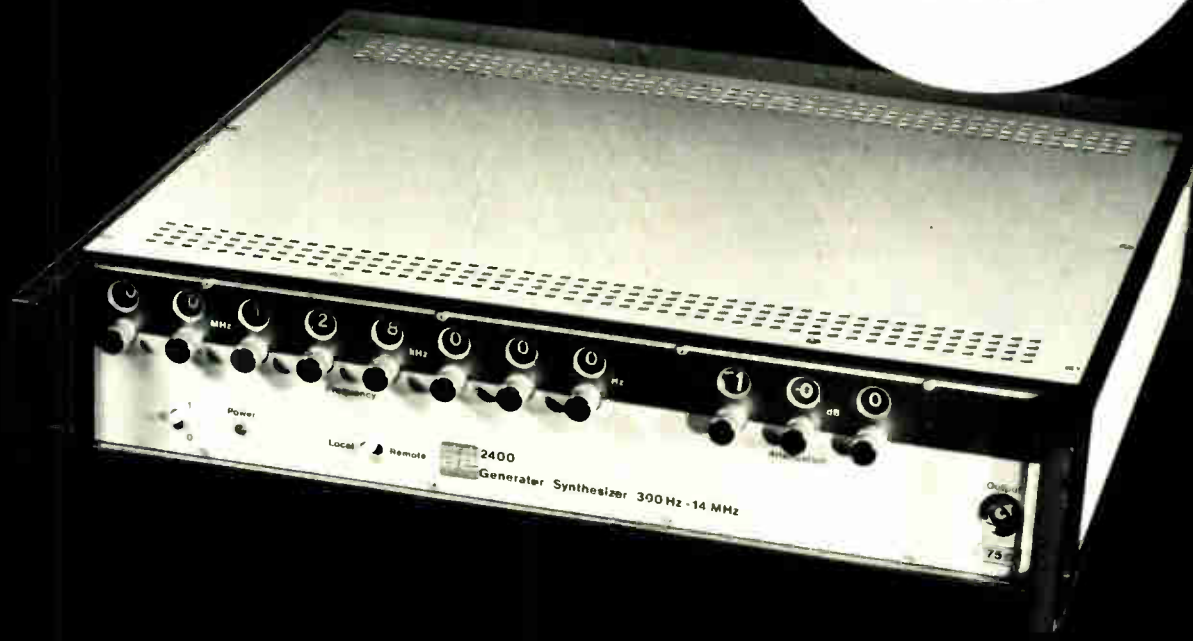

The Frequency Synthesizer and Level Generator model 2400 is particularly well suited for Telecommunication applications in the 300-Hz to 14-MHz band, covered in only one range with 1-Hz resolution.

Adaptable to 19" rack thanks to its 2 U high cabinet, this instrument features a 20-MHz offset tracking frequency for selective decibelmeter monitoring, excellent internal level regulation, together with provision for level regulation through an external detector placed at signal injection point.

The output signal is delivered on a front-panel coaxial connector with 50 Ω or 75 Ω output impedance, depending on selected option. The output frequency is determined by eight rotary switches in Local mode, and programmed in parallel BCD code in Remote mode. The frequency resolution is 1 Hz in both cases, while the acquisition time in Remote mode varies from 1.2 ms to 3 ms depending on the increments affected by the frequency switching.

The output level ranges from + 19.9 dBm to - 79.9 dBm in Local mode, and from + 20 dBm to - 79.9 dBm in Remote mode. This level is determined by eight rotary switches in Local mode, and programmed in parallel BCD code in Remote mode. The level resolution is 0.1 dB in both cases, while the acquisition time in Remote mode is 100 ms.

The internal level regulation provides ± 0.05 dB output level flatness within the entire frequency range, and ± 0.01 dB level flatness can be reached with an external detector. Besides, the attenuator accuracy is better than ± 0.2 dB over the whole dynamic range.

Nonharmonic content lies below - 70 dB, harmonic signals are between - 40 dB and - 50 dB, and phase-noise in a 1-Hz bandwidth lies between - 110 dB and - 130 dB.

A low-impedance ($Z < 3 \Omega$) auxiliary output, providing + 10 dBm to + 20 dBm output level, is also available on the rear-panel of the instrument.

Owing to the oven-controlled Master Oscillator, frequency stability is that of a Frequency Synthesizer, that is $\pm 5 \cdot 10^{-9}$ per day. Besides, this Master Oscillator can be phase-locked to an external reference.

so let ADRET guide you to the

right frequency synthesizer ; circle our number on the reader service card, return the coupon or write us on your letterhead. We'll rush you our new 1977 catalog. It gives you a lot of practical tips about frequency measurements as well as the details on our hardware.



1630 Manheim Pike,
Lancaster,
Pennsylvania 17601,
Telephone (717) 569 7059,
TWX 510-672-0516

Circle 179 on reader service card

World Radio History

Name _____ Title _____
Firm _____ Phone _____
Address _____
City _____ State _____ Country _____

When Clear Displays Count

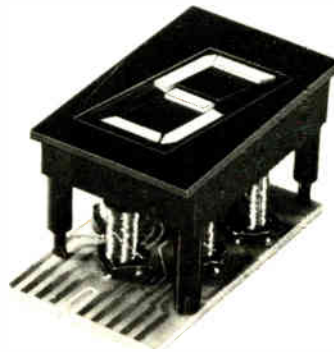

You can count on Ferranti-Packard's electromagnetic 7-Bar display module to give you the electronic compatibility you need plus the reliability and visibility your customers demand.

Only 7 moving parts to each display module — no complex mechanical linkages to wear out, or incandescent lamps and neon tubes to burn out.

Performance-proven for over 5 years, the simple design and construction, backed by Ferranti-Packard research and engineering, gives you the combination of reliability, visibility and flexibility that no other read-out component can match.

When you design an electronic read-out system, Ferranti-Packard display modules will help you do it better. It's clearly the display module you should consider. See the difference for yourself, write or call us and we'll prove it.

When clear displays count — Specify Ferranti-Packard.



Ferranti-Packard Limited

Electronics Division,
121 Industry Street,
Toronto, Ontario, M6M 4M3, Canada
Telephone: (416) 762-3661
Telex: 06-22007

for each unit, permits designers to consider using several drives rather than a single shared formatter." This makes possible performance improvements, including overlapping-head seeks, reads, and writes.

Single-unit price is less than \$1,000 and is under \$700 in small OEM quantities. Sample units will be available by midyear, with volume production in the fourth quarter.

ICOM Division of Pertec Computer Corp.,
6741 Variel Ave., Canoga Park, Calif. 91303
(213) 348-1391. [355]

NCC NCC NCC NCC NCC NCC NCC 1-board computer, simulator offered

Iasis Inc., a three-year-old company whose main business has been home-study courses in microcomputer programming using an 8080-based computer in a book, is moving into the mainstream of the microprocessor marketplace. The Sunnyvale, Calif., firm is introducing two new products aimed at what it perceives as two chinks in Intel Corp.'s marketing armor. One is a an 8080-based single-board computer—the SBC 80/80—that in both price and performance falls between Intel's two single-board computers, the SBC 80/20 and System 80/20 [*Electronics*, March 17, p. 121]. The other, says Iasis president David Guzman, is the Iasimulator, a hardware simulator system for 8080 microcomputers that lowers the cost of development of a microcomputer system to one fourth of that required for more sophisticated systems, such as Intel's MDS.

Iasis' single-board units cost \$650 each and contain 8 kilobytes of programmable read-only memory, 4 kilobytes of random-access memory, eight input/output ports and levels of interrupt, and a real-time clock. "We are aiming the SBC 80/80 at users who have stand-alone applications," says Guzman, "but who require more memory, I/O, and interrupt capability than what's now available." Completely compatible with all of Intel's SBC 80 family of boards, the SBC 80/80 is also

no tradeoffs needed



DAK pushbutton switches have it all.

These Oak switches provide so many standard options, that you won't have to change your designs or your costs.

Consider the Series 300.

- One to 4 pole, single pole, single throw through four pole double throw, N.O. or N.C. or combinations; make before break or break before make.
- Up to 12 switches in one bank, with any combination of momentary, interlock, alternate action and blockout, on the same bank.
- Choice of four contact materials that best suit your application and budget, from silver plated brass for low cost applications, to hard gold inlays for logic circuits.
- Lighting is single display, single lamp; split display, four-lamp and indicators. Unlighted type also available.
- Printed circuit or solder terminations and a power module for line switching.
- Front replaceable lamps, buttons and legend plates.

All this and more in a highly dependable, compact (.750" centers), rugged, reasonably priced switch assembly.

The Snap-in, Single Switch Version, Series 300SL

Has the same features as the Series 300, is priced competitively with similar switches. Dual lamp, dual display, or single display, and indicators.

For fast delivery, Oak distributors stock and assemble Series 300/300SL pushbutton switches to your specifications.

Circle 102 for information
Circle 181 for salesman to call

World Radio History

DAK Industries Inc.

SWITCH DIVISION / CRYSTAL LAKE, ILLINOIS 60014
TELEPHONE: 815-459-5000 • TWX: 910-634-3283 • TELEX: 72-2447

The Noise Loading Test Set

MEV8

The MEV8 consists of the Noise Receiver ML415A and the Noise Generator MG431A. It is best to measure the performance of radio relay and cable systems for frequency division multiplex telephony under conditions closely approaching those of actual operation.



- Meets the latest CCIR and CCITT recommendations.
- Suitable for systems of 24 to 2700 channels or more (10kHz to 18MHz).
- Easy replacement of plug-in filters and accommodation up to 7 measuring frequencies simultaneously.
- Direct reading dial of noise level (absolute or relative) and noise ratio (NPR or S/N) with or without weighting.
- TRANSMISSION LEVEL dial and DIFFERENCE FROM TL dial facilitating measurements.
- Easy operation by remote control from the Noise Receiver to Noise generator.
- Low intrinsic thermal noise minimized at -130 dBm.
- Inband and out-of-band measurements.

Anritsu

ANRITSU ELECTRIC CO., LTD.

MEASURING INSTRUMENTS DIVISION

SALES DEPARTMENT:

12-20, Minamiazabu 4-chome, Minato-ku, Tokyo 106, JAPAN

Phone: (03) 446-1111/Telex: 0-242-2353

Cable: ANRITDENKI TOKYO

U.S.A. Tau-Tron Inc. Tel: (617) 667-3874 • West Germany Knott Elektronik GmbH Tel: (08178) 4085 • England Dymar Electronics Limited Tel: Watford 37321 • France Tekelec Airtronic Tel: (1) 946-96-48 • Italy Vianello S.p.A. Tel: 544041 • Sweden Teleinstrument AB Tel: 08-38 03 70 • Singapore O'Connor's (Pte.) Ltd. Tel: 637944 • Malaysia O'Connor's SDN. BHD. Tel: 51563/5 • Australia NEC Australia Pty. Ltd. Tel: Melbourne 560-5233

New products

compatible with teletypewriter outputs and the RS-232 protocol.

The SBC 80/80 is also an integral part of Iasis' other NCC-shown offering—the Iasimulator. At \$1,895, Guzman says it lowers considerably the entry-level cost of developing a microcomputer-based system and also the level of sophistication needed.

This new hardware-simulator system includes the 7600 expander cube, which contains an SBC 80 board, an 8-k RAM board, an interface board, and a PROM programmer. Completing the system is the 8080-based microcomputer in the 7301 computer in a book, which contains 1 kilobyte of RAM memory, 1 kilobyte of PROM memory, a power-monitor system, 8 seven-segment LED displays, 3 LED indicator lights, and a hexadecimal keyboard that features six special-mode keys.

Iasis Inc., 815 W. Maude Ave., Sunnyvale, Calif. 94086 [356]

NCC NCC NCC NCC NCC NCC NCC CRT terminal attains 19.2 kbauds

Quiet operation, fast transmission, and inherent reliability are among the reasons for the growing popularity of cathode-ray-tube terminals for the common-carrier communications lines. Two such terminals, the Regent 100 and 200 from Applied Digital Data Systems Inc., are teletypewriter-compatible and offer features that are unattainable with printing terminals.

Both the 100 and 200 have a full 128-character ASCII keyboard and separate 14-key numeric pad for data entry, and both provide a page display of 24 lines of 80 characters each. Communications can take place over a standard RS-232 interface or a 20-milliampere current loop, and the transmission rate is switch-selectable to up to 19,200 bauds.

The practical aspects of using a temporary display such as a CRT for common-carrier terminals become more apparent with an appreciation

If the print band doesn't get you, the price will. It's that simple.

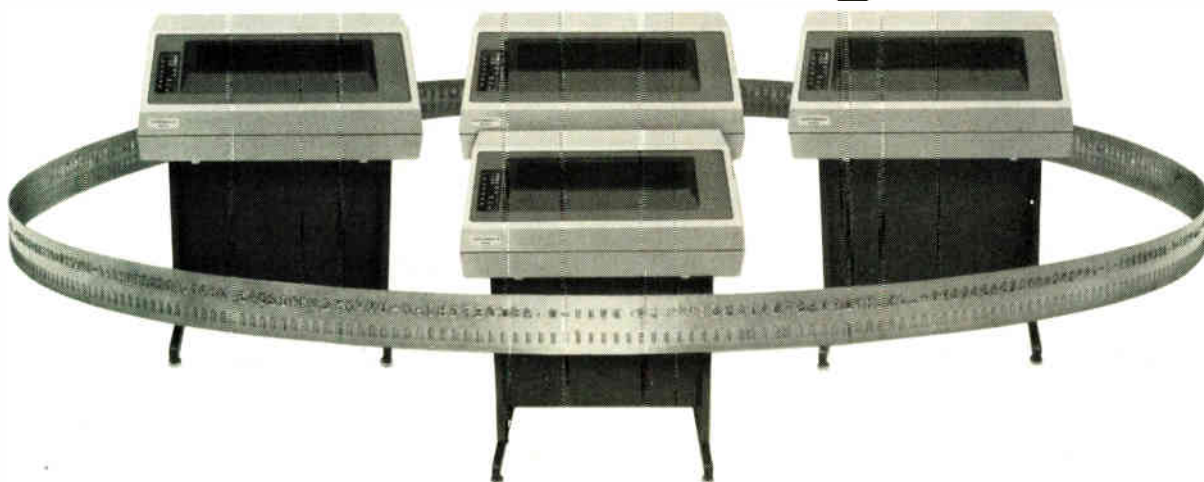

The New Centronics 6000 Series Line Printers.

Centronics now offers you a family of line printers so new in design simplicity, reliability and value that nothing else in the industry today can compare. The outstanding features of the 6000 series only begin with the operator-changeable print band. They also include: the widest choice of speeds—75, 150, 300, and 600 lpm models . . . with 85% parts commonality. And more—like fully-formed characters and superior print quality . . . microprocessor electronics for increased reliability, and full customizing capability . . . all at a price that's up to 40% lower than what you're paying now for line printers.

Like all Centronics printers, the 6000 series printers are even better because they're backed by more than 100 sales and service offices worldwide. And by the Centronics reputation for stability—and for dependability proven by more than 80,000 printers installed.

The new Centronics 6000 series line printers. Simply better. Write or call today for the new 6000 series brochure. Centronics Data Computer Corp., Hudson, N.H. 03051. Tel. (603) 883-0111. Or Centronics Offices in Canada and throughout the world.

CENTRONICS® PRINTERS
Simply Better

BREAKT



OEM SALES OFFICES

CALIFORNIA: Long Beach (213)426-7687, Palo Alto (415)964-6443, FLORIDA: Fort Lauderdale (305)971-3200, Melbourne (305)724-7430, ILLINOIS: Hinsdale (312)325-4242, MASSACHUSETTS: Wellesley Hills (617)237-5430, MINNESOTA: Minneapolis (612)835-2505, NEW YORK: Melville, L.I. (516)249-4500, OHIO: Dayton (513)226-0636, PENNSYLVANIA: Wayne (215)687-6680, TEXAS: Richardson (214)231-9031.

SALES REPRESENTATIVES

ALABAMA: Huntsville (205)533-3620, ARIZONA: Phoenix (602)971-6250, CALIFORNIA: Goleta (805)964-8751, Mountain View (415)961-8121, San Diego (714)565-9444, COLORADO: Denver (303)759-0809, CONNECTICUT: East Norwalk (203)838-1493, FLORIDA: Boca Raton (305)395-6108, Oviedo (305)366-3283, Tampa (813)933-1759, ILLINOIS: Elk Grove Village (312)640-1850, INDIANA: Fort Wayne (219)484-1432, Indianapolis (317)849-6454, IOWA: Cedar Rapids (319)377-8275, MARYLAND: Lanham (301)459-1556, MASSACHUSETTS: Burlington (617)273-1313, MICHIGAN: Farmington (313)476-2446, MISSOURI: Hazelwood (314)731-5799, Independence (816)737-1100, NEW JERSEY: Keasbey (516)567-5900, West Caldwell (516)567-5900, NEW MEXICO: Albuquerque (505)265-5655, NEW YORK: Albany (518)489-7408 or 4777, Huntington Station (516)567-5900, NORTH CAROLINA: Winston-Salem (919)722-5151, OHIO: Cleveland (216)831-8292, Dayton (513)890-2150, Worthington (614)888-0463, OREGON: Beaverton (503)643-1644, PENNSYLVANIA: Allison Park (412)487-4300, King of Prussia (215)265-0634, SOUTH CAROLINA: Greenville (803)268-1125, TEXAS: Dallas (214)691-4592, Houston (713)780-9710, VIRGINIA: Charlottesville (804)973-6672, WASHINGTON: Bellevue (206)454-0300, CANADA: Mississauga (Toronto) (416)676-1042, Montreal (514)626-6723, Ottawa (613)729-1831.

THROUGH!

Announcing the first all-digital CVSD.

The only Encoder/
Decoder available
in a single IC.

Just a few years ago you needed a whole board full of discrete components to design a voice privacy transmission system. Then along came a couple of 16-pin linear-IC Continuously Variable Slope Delta Modulators. But they also required a number of external components, a lot of power, and four IC's ...two at either end of the system. □ Today there's the Harris HC-55516/55532. World's first all-digital CVSD. The only encoder/decoder available in a single IC. Designed for high performance. For example, low power requirements (5mW) — 3 times less than alternate approaches — making them ideal for battery powered mobile operations. Long term drift is entirely eliminated. Board space is reduced by our 14-pin packages and there is no necessity for external components. And, built-in "quieting" feature knocks out noise completely. □ If you're in the business of designing voice privacy communication systems for industry, the military, police, fire, ambulance; voice grade data analysis with computers, or what have you, it'll pay you to look at the Harris HC-55516/55532. □ They'll increase system performance. They'll save money; cut overall system costs appreciably. They'll provide you with a design flexibility you've never enjoyed before. □ They come in a variety of packages, models and temperature ranges: 14-pin DIP or flat pack, or chips. 16K for lower data bandwidth; 32K for improved fidelity. —40°C to +85°C and —55°C to +125°C. □ For complete information, call your nearby Harris sales location, or write Harris Semiconductor, P. O. Box 883, Melbourne, FL 32901.



**HARRIS
SEMICONDUCTOR**

A DIVISION OF HARRIS CORPORATION

You Don't Have To Beg, Borrow Or Buy...



Rent'em From GE

Short or long-term instrument rentals give you flexibility and economy.

GE has over 9,000 instruments available for immediate shipment: □ Tek Scopes □ Biddle Megger Insulation Testers □ H-P Signal Generators □ Honeywell Oscillographs □ Complete Data Systems □ Esterline Angus Recorders □ GE Chart Recorders □ Modems □ Communication Terminals ... all calibrated to the manufacturer's specs.

We have over 100 Sales/Service Centers,

and one of them is near you. In addition to maintaining our Rental Inventory, they can also repair and calibrate your own equipment.

Don't borrow someone else's GE Rental Catalog. **Call collect (518) 372-9900** or your nearest Sales/Service Center.

**Quick-rental[®]
instruments**

GENERAL  **ELECTRIC**

ALA. BIRMINGHAM (215) 925-3104 • **ARIZ.** PHOENIX (602) 278-8515 or 8516, TUCSON (602) 294-3139 • **CAL.** LOS ANGELES (213) 642-5350, SAN FRANCISCO (415) 436-9260 • **COL.** DENVER (303) 371-1260 • **CONN.** SOUTHINGTON (203) 621-4059 • **FLA.** JACKSONVILLE (904) 751-0610 • **GA.** ATLANTA (404) 457-5563 • **ILL.** CHICAGO (219) 933-4500 • **IND.** INDIANAPOLIS (317) 639-1565 • **KY.** LOUISVILLE (502) 452-3311 • **LA.** NEW ORLEANS (504) 367-6528 • **MD.** BALTIMORE (301) 332-4700 • **MASS.** BOSTON (617) 396-9600 Ext. 160, SPRINGFIELD (413) 781-1111 • **MICH.** DETROIT (313) 285-6700 Ext. 208 • **MINN.** MINNEAPOLIS (612) 522-4396 • **MO.** KANSAS CITY (816) 231-4377, ST. LOUIS (314) 965-7115 • **N.J.** CLIFTON (201) 471-6556 • **N.Y.** BUFFALO (716) 876-1200, SCHENECTADY (518) 385-2195 • **N.Y.C.** CLIFTON, N.J. (201) 471-6556 • **N.C.** CHARLOTTE (704) 525-0311 • **OH.** CINCINNATI (513) 874-8512, CLEVELAND (216) 523-6382, TOLEDO (419) 691-3501 • **OR.** PORTLAND (503) 221-5101 • **PA.** PHILADELPHIA (609) 424-4450, PITTSBURGH (412) 462-7400 • **TEX.** DALLAS (214) 357-7341, HOUSTON (713) 672-3570 • **VA.** RICHMOND (804) 232-6733 • **WASH.** SEATTLE (206) 854-0211 • **W.V.** CHARLESTON (304) 345-0920 • **WISC.** MILWAUKEE (414) 744-0110 • **PUERTO RICO** PONCE (809) 843-4225.

New products

of the display flexibility. Aside from upper- and lower-case letters, any part of the display can be highlighted by using reverse video, mixing half- and full-intensity brightness and blinking or underlining characters. This highlighting is especially effective if used with the forms-generating feature on the Regent 200, which allows the user to set up a format on the screen made up of combinations of protected fields for the questions and variable fields for the answers. The protected or variable data in the display can be highlighted for easy identification and retrieval.

The Regent 200 also boasts a buffered memory that permits three modes of data transmission. In the conversational mode, which is the only operating mode of the model 100, data is transmitted one character at a time to allow easy two-way communications and efficient question-and-answer operation.

When the terminal is in the message mode, the user transmits a line at a time, which is useful for message checking. Finally, in the page mode, the operator can transmit at once a full or partial screen of lines. The model 200 has as standard equipment eight user-programmable



function keys, which are an option on the model 100.

In addition, the 200 offers an editing option that allows the operator to clean up text rapidly for transmission or to delete characters or lines of data with simple keystrokes. At the bottom of the screen, both terminals have a status

line that is distinct from the rest of the display. This line shows both the operating mode of the terminal and, when it is first turned on, the results of a self-diagnostic test of the memory and of the interface.

Applied Digital Data Systems Inc., 100 Marcus Blvd., Hauppauge, N. Y. 11787. Phone (516) 231-5400 [357]

NCC NCC

Intelligent printer offers firmware updating

A family of microcomputer-controlled medium-speed printing systems with both processing-power and output-printing capabilities is being unveiled at the National Computer Conference by Dataroyal Inc., of Nashua, N. H. Ronald O. Huch, president, says that the intelligent printers have a flexible configuration that will enable users to keep them up to date by making simple firmware changes.

The first of the systems, the model 7000, combines a 120-character-per-second parallel printer with an 8-bit microcomputer system that has 10,000 words of memory. Other members of the family offer serial interfacing and keyboard send/receive features.

"The new systems can be configured to meet a variety of commercial and industrial printing requirements," then reconfigured through changes in firmware as applications change or as new applications develop," Huch says. A variety of input and storage peripherals such as floppy disks or keyboards can be interfaced to the 7000, allowing the system to function either as a stand-alone printer or as a work station within a distributed network.

As much as 75% of the 7000's processing power can be dedicated to tasks other than the printing applications at hand. For example, report-or label-printing jobs that need 1,000 words of random-access memory and 2,000 words of programmable read-

only memory leave up to 3,000 words of RAM and 4,000 words of programmable read-only memory for other applications.

Huch notes that the electronic sophistication in the back end is matched by mechanical simplicity in the front end that insures system reliability. The printing mechanism consists of a transport with only a lead screw and a servo motor, keeping parts to a minimum while permitting bidirectional printing.

Model 7000 includes a parallel interface as standard and produces an ASCII character set in either standard or extended widths. It is priced competitively with popular medium-speed printers at \$2,871 in single units for end users and at \$1,595 in

New products

tion including four key stations, 10 megabytes of disk storage, a tape drive, and a 600-line-per-minute printer will lease for approximately \$1,950 per month, including maintenance. An entry-level system including two key stations and a 200-line-per-minute printer will lease for about \$1,350 per month.

Inforex Inc., 21 North Avenue, Burlington, Mass. 01803. Phone (617) 272-6470 [359]

NCC NCC NCC NCC NCC NCC NCC

Disks hold 70 megabytes

A line of moving-head disk drives that store up to 70 megabytes of data at rates of 1 megabyte per second is being introduced by Kennedy Co. The series 5300 drives have unformatted capacities ranging from

14 megabytes in the single-disk version up to 70 megabytes in three-disk model. Each surface has two 350-track-per-inch cylinders with a recording density of 600 bits per inch. Moreover, the line features a sealed enclosure, which permits operation in environments previously considered unsuitable for disk drives.

The drives use a dual-head carriage driven in an arc by a d'Arson-

We're
showing
off for
Bendix.

val-type actuator that positions the heads without lead screws or linear motors. Prerecorded servo-tracks on the bottom of one disk control the positioning.

Recording heads fly at 20 micro-inches above the recording surface and land in clear spaces adjacent to tracks, to prevent head damage or lost data. Track-to-track head motion is 10 milliseconds, and average

head movement time is 45 ms, with a worst-case maximum of 80 ms. Disk rotation of 3,000 rpm gives an average latency time of 10 ms.

Another feature, modified frequency modulation recording, is implemented with emitter-coupled logic, both for high-speed maximum frame definition and to eliminate data ambiguities caused by propagation delay.

The drives are 19 in. wide by 7 in. high by 22 in. deep. Weight is 45 pounds. Power supply and all electronics are included in a single assembly.

Drive prices range from \$2,500 to \$4,000, depending on data capacity and quantity.

Kennedy Co., 540 West Woodbury Road, Altadena, Calif. 91001. Phone (213) 798-0953 [360]

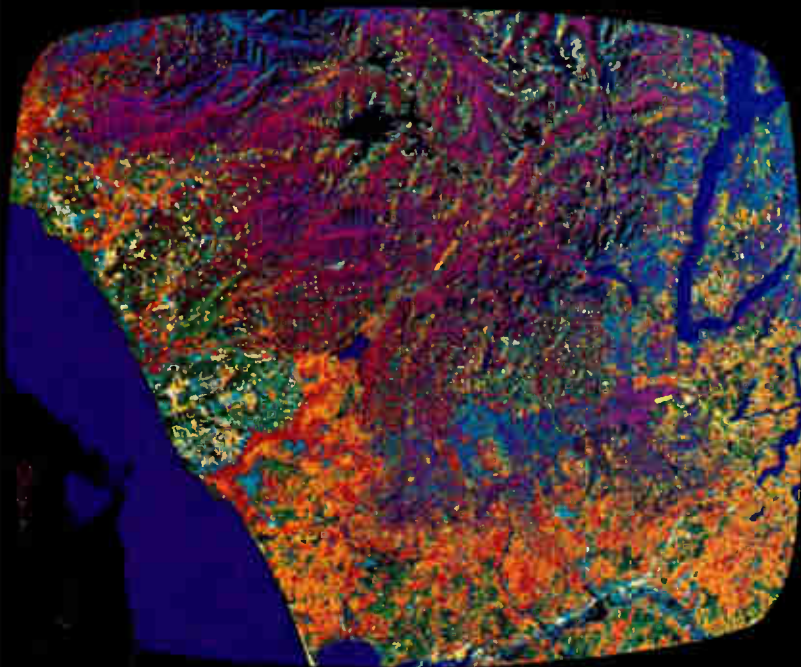

This display shows the Quinault Indian Reservation in Washington state. 16 separate colors have been assigned for such categories as Burn Areas, Forest, Brush and Bare Land.

Bendix Aerospace Systems Division uses a Ramtek display generator to really show its colors. The Bendix Multispectral Data Analysis System (M-DAS) provides a clear, color-coded display for analysis of data from NASA's LANDSAT. And by using Ramtek's moving window display—or scroll—they're able to look at more data at one time than can be displayed on the still screen. Images of the same areas may also be correlated so that changes between past and present can be referenced.

Bendix is but one of a growing number of customers who are finding that Ramtek's modular graphics and imagery systems are giving them the expandability, flexibility and increased productivity they need. Besides the basic alphanumeric and imaging capability, Ramtek offers a wide variety of other functions including graphics — vectors, conics, plots, bar charts — pseudo color and grey scale translation.

Because the Ramtek RM 9000 family is totally controlled by a standard 8080 micro-processor, it is easy to develop and download your own control software.

To find out more about how Ramtek can show off for you, call or write: Ramtek Corporation, 585 North Mary Avenue, Sunnyvale, California 94086; (408) 735-8400.

ramtek
Our Experience Shows

Semiconductors

Darlington finds TV niche

Power transistor, an npn silicon device, handles 8 A at 1,400 V

Inherent high-gain characteristics and the simplicity of Darlington transistors make them naturals for replacing discrete devices in such key jobs as switching in the horizontal-deflection output of color television sets. Here, most sets use combinations of 1,500-volt transistors and damper diodes. What has held back Darlington's, however, is state-of-the-art voltage levels in the 500-V range, far lower than required.

To improve those levels, an engineering effort launched by Motorola Semiconductor's discrete division has paid off with a new high-gain Darlington device, already catching the eye of domestic TV manufacturers. The MJ10011 npn silicon power Darlington transistor, rated at 8 amperes and 1,400 v, attains nominal gain of 40 at 5 A.

"This order-of-magnitude gain increase was a major goal of the program," says Ralph Greenburg, planning manager for power products at the Phoenix division. Other objectives were "to combine the output transistor with the damper diode and equal the performance of discretes in all the critical parameters such as fall time, safe operating area, voltage saturation and thermal stability."

The Motorola design team not only succeeded in replacing the separate damper diode with the monolithic diode, Greenburg explains, but the high gain eliminates the conventional driver transformer because only a 200-milliampere base drive is needed. Other MJ10011 parameters are a forward voltage drop of 2 v maximum, saturation typically less than 2 v at 4 A, and an operating temperature range of -65 de-

grees Celsius to +150°C.

Motorola designers, employing integrated-circuit development technology, started with specially fabricated high-voltage discrete transistors and synthesized them into Darlington configurations. Various combinations of die geometries were coupled with base-to-emitter resistors and tested in a TV set until an optimum design prototype resulted. Finally, the synthesized version was converted into a single monolithic structure.

Another design goal, long-term electrical and thermal stability, required special glass-passivation techniques and a beefed-up TO-3 package to handle high voltage. Passivation of the collector-base junction is accomplished after mesa etching the Darlington's triple-diffused wafers. In this process, each die is isolated for electrical probing, with the cross sections showing a typical mesa outline, on slope of which the junction terminates. This entire slope is then covered with a proprietary Motorola photoglass, Greenburg points out.

The TO-3 package has a special construction to withstand high voltage, with glass insulators surrounding the base designed for maximum creepage path length, to resist arcing. Header thicknesses have a low thermal resistance, typically 0.6°C per watt, without sacrificing mechanical strength.

Eliminating the driver transformer, and its base inductor, also does away with the problems of matching inductance to device output of present switching systems, according to Greenburg. Here, variations in discrete-transistor performance from vendor to vendor require circuit designers to choose the correct base inductor to get optimum fall time, an expensive process.

Greenburg expects that the reduction of parts and the competitive pricing of the MJ10011 will provide significant cost reduction of the total horizontal-deflection system. Also, he says that fewer parts will enhance reliability and streamline the assembly. Major U. S. television manufacturers now have sample quantities of the Motorola device available for

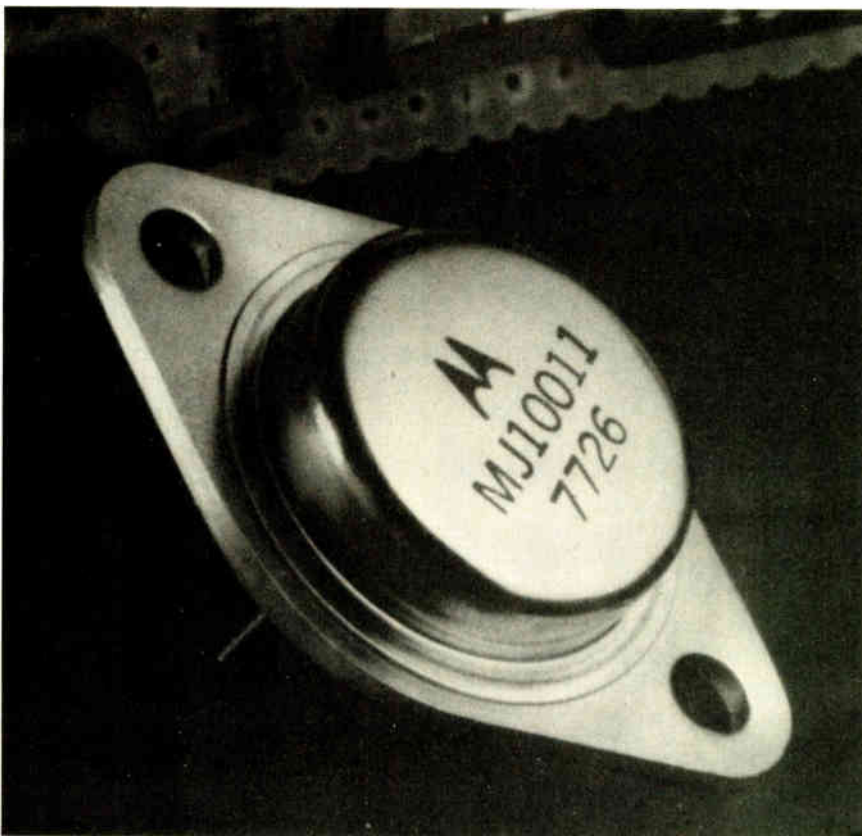

Here are two ways to measure ceramic capacitor reliability

40

Major Hi-Rel Programs

You'll find our ceramic capacitors functioning in some of the toughest environments known to man. Here are just a few of the programs. Space: Surveyor, Mercury, Gemini, Apollo (Command Module, LEM, PLSS). Defense: Minuteman II and III, F-14, F-15 and F-16, Polaris and Poseidon, Sparrow, Hawk and Maverick, F-111 and the B-1 bomber.



15

Years of Hi-Rel Experience

Founded in 1960 to supply ceramic capacitors for Hi-Rel programs, we were a technology leader almost from the start. We were the first to develop precious metal alloy electrode systems; the first to automate chip production to meet a proven failure rate level of .001% per 1000 hours; the first to perfect the use of base metals in electrodes. Latest — the totally redundant fail-safe feed-thru capacitor.

Unlike many companies, we do not have separate chip lines for Hi-Rel military and commercial MonoKap products. You get the same high quality in both. And, you can buy MonoKaps right off our distributor's shelves.



CENTRALAB/USCC

Electronics • GLOBE-UNION INC.

4581 Colorado Blvd., Los Angeles, CA 90039 (213) 240-4880
CERAMIC CAPACITORS • FILTERS • THICK FILM CIRCUITS • SWITCHES
TOUCH SWITCHES • POTENTIOMETERS • TRIMMER RESISTORS

MILITARY APPLICATIONS

DAC CONVERTERS

by
MSK

- Accuracy
- Speed
- Size
- Repairability
- Military
- Temp. Range
-55°C to +125°C

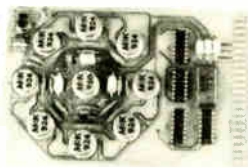

- 4 Bit/50 nSec; Low Cost
- Ideal for Radar Scan Converters
- Holds Absolute Accuracy Over Temperatures
- Tracks a 10 MHz Analog Input



- 9 Bit/200 nSec.
- < 2 Bit Drift Over Temperature
- Insensitive to Clock Frequency

For Further Information Call or Write
M.S. Kennedy Corp.
 Pickard Drive, Syracuse, New York 13211
 Tel. 315-455-7077

New products

testing and evaluation by users.
 Price of the MJ10011 is \$3.50 in 100-999 quantities, compared to \$3.85 for Motorola's present discrete power transistor, which is among those used in the color TV function. Deliveries will start this summer.
 Motorola Semiconductors, Discrete Division, Power Marketing, Box 20912, Phoenix, Ariz., 85036. Phone (602) 244-3912 [411]

Monolithic Darlington transistors can switch 500 volts

A series of monolithic Darlington transistors, which have a power-dissipation rating of 96 watts, can switch up to 500 volts in 400 nanoseconds. The npn devices, designated the SVT6000 series, can withstand a continuous collector current of 15 amperes and a peak current of 20 A. The three transistors in the series have collector-emitter voltage ratings of 400 to 500 v dc and sustained voltage ratings of 300 to 400 v dc. At a collector current of 15 A, the $V_{ce(sat)}$ of the three units is 2.0 v. Key applications of the new transistors are expected to be in automotive ignition systems and in high-power switching regulators. The devices sell for \$6.45 each in quantities of 500.
 TRW Power Semiconductors, 14520 Aviation Blvd., Lawndale, Calif. 90260. Phone John Power at (213) 679-4561 [413]

Monolithic unit generates full ASCII character set

The TMS4710 is an 8,192-bit read-only memory programmed to function as a character generator of the full set of upper- and lower-case ASCII characters. The n-channel silicon-gate device is organized as 1,024 words of 8 bits each. Key operating features include a maximum access time of 450 nanoseconds, a minimum cycle time of 450 ns, a typical power dissipation of 310 milliwatts, and TTL-compatible inputs and outputs. The fully static ROM is housed in a 24-pin dual in-line package—

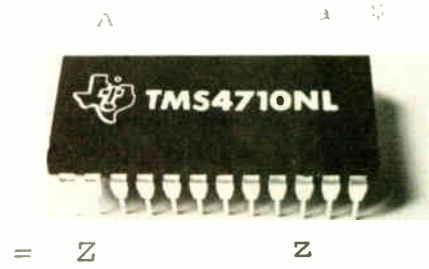

either plastic or ceramic. The former sells for \$10.66 each in hundreds, while the latter goes for \$12.66. The units are available now.
 Texas Instruments Inc., Inquiry Answering Service, P.O. Box 1443, M/S 669 (Attn: TMS4710), Houston, Texas 77001. Phone David Sitrick at (713) 494-5115, ext. 2781 [414]

10-bit d-a converter works from -55°C to 125°C

The DAC-05 family of monolithic digital-to-analog converters includes units that are guaranteed monotonic over the full military temperature range from -55°C to 125°C. The sign-plus-magnitude devices are monolithic circuits that include a precision voltage reference, a logic-controlled polarity switch, and a high-speed (1.5-microsecond settling time) output operational amplifier. Units are available with ±5-volt outputs and ±10-v outputs. A total of 18 converters make up the family. Six of them operate from 0°C to 70°C, a second six operate from -55°C to 125°C, and the third six have the same temperature range as the second six, but are also processed to MIL-STD-883 Level B. Each group of six units consists of units that are monotonic to within 8, 9, and 10 bits in both the ±5 and ±10-v versions. Pricing extremes, for 100 to 999 pieces, are \$15 each for the 8-bit 0°C to 70°C converters and \$162 for the 10-bit devices that have been processed to the military standard.
 Precision Monolithics Inc., 1500 Space Park Drive, Santa Clara, Calif. 95050. Phone Donn Soderquist at (408) 246-9222 [416]

Ready for automatic insertion?

Our Radial Capacitors are

That's right. Our radial leaded ceramic capacitors — both disc and monolithic — are now available in reel packaging for your automatic insertion equipment. That means whichever type you need, you can now use the most efficient production method for lowest installed cost. For price, delivery, and technical information, contact Centralab, El Paso about the discs, and Centralab, Los Angeles about the MonoKaps™.

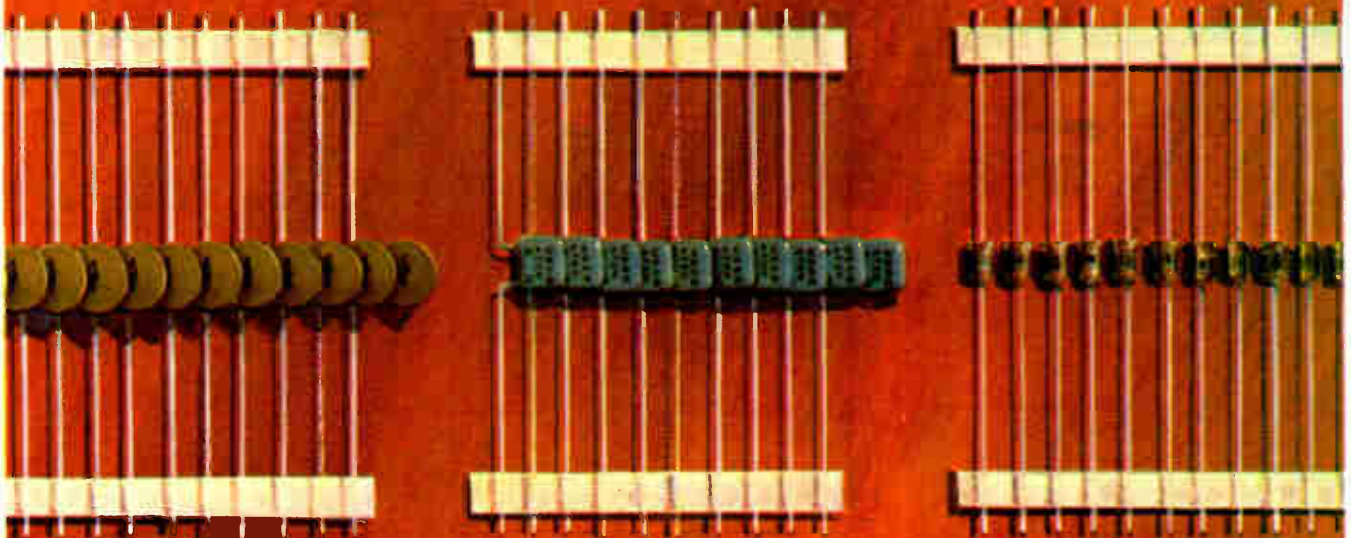

So are our Axial Capacitors

If board space and weight are your critical concerns, consider our miniature Mono-Glass ceramic capacitors. Also reel packaged for automatic insertion, they feature glass encapsulated construction in an axial leaded configuration, and a variety of dielectrics, in both precious and base metal electrodes. Contact Centralab, Los Angeles for complete price and delivery information.



CENTRALAB
Electronics • GLOBE-UNION INC.

4561 Colorado Blvd., Los Angeles, CA 90039 (213) 240-4890
7158 Merchant Ave., El Paso, TX 79915 (915) 779-3961

CERAMIC CAPACITORS • FILTERS • POTENTIOMETERS • SWITCHES
THICK FILM CIRCUITS • TRIMMER RESISTORS

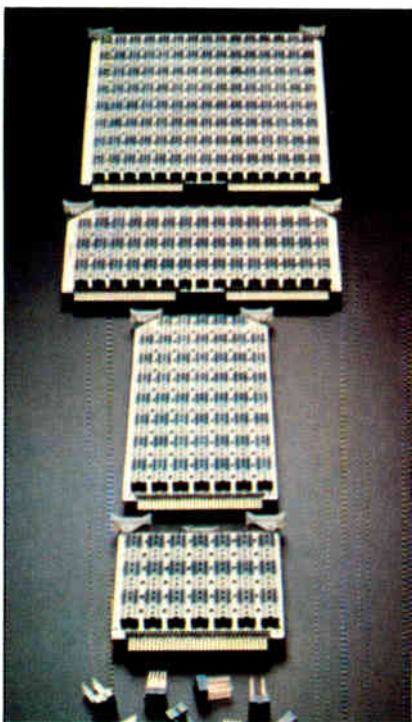

Sockets Unlimited

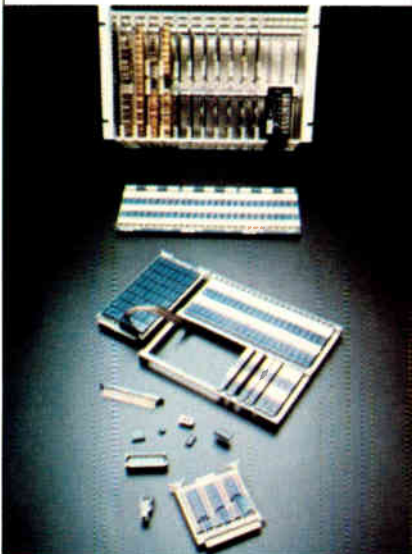

Cambion continuous IC socket systems let you keep on going and going. Interlocking units allow maximum use of boards. Cambion IC sockets also set you free from service problems, pre-mature failure and damage from solder heat. With Cambion the only limits are your imagination. Would you like literature, samples or one of our sales engineers to call? Write: Cambridge Thermionic Corporation, 445 Concord Avenue, Cambridge, MA 02138. Phone: 617-491-5400. In California: 2733 Pacific Coast Hwy., Torrance, CA 90505. Phone: 213-326-7822.

Standardize on

CAMBION
The Guaranteed Electronic Components

New products

Subassemblies

Amplifier has good stability

Instrumentation unit has input-offset drifts of 15 pA/°C and 0.25 μV/°C

For high-performance applications, an instrumentation amplifier should keep offset drifts low for both input voltage and current. Officials at Dynamic Measurements Corp., Winchester, Mass., believe they have the best combination of drift performances available in their new model 1312. The unit's maximum input-offset drifts are 15 picoamperes per degree Celsius for current and 0.25 microvolt/°C for voltage.

That performance is comparable with the closest competitive unit for the voltage specification and superior for current drift. The device is aimed at applications that include load cells in scales and handling signals from temperature and pressure transducers.

To get the good drift specs, says Stephen Connors, engineering manager, the company uses discrete components in the input stage, in combination with "the latest op amps on the output to keep good temperature tracking on the front end." The front end combines field-effect transistors and super-beta transistors in what Connors calls a novel kind of bootstrapping circuit

that reduces input bias current to 15 nanoamperes maximum. It also provides a high common-mode rejection ratio of 114 decibels, specified at 120 hertz.

Other important features of the model 1312 are a maximum output settling time of 50 microseconds, independent of gain, for a 20-volt step; a gain range from 1 to 1,000; a minimum bandwidth of 75 kilohertz with a voltage gain of 2 to 1,000, and shielding against electromagnetic interference on five sides by a metal can.

Connors points out further that internal trimming on the output yields a maximum offset voltage of ±200 millivolts, adjustable to 0. The unit has a power supply range of ±5 v to ±18 v.

A companion unit, the model 1313, with certain specs slightly relaxed, sells for \$69. The 1312 is priced at \$79 in quantities of 1 to 24. Delivery is from stock.

Dynamic Measurements Corp., 6 Lowell Ave., Winchester, Mass. 01890. Phone Stephen Connors at (617) 729-7870 [381]

V-f converters combine low drift with low price

Two voltage-to-frequency converters, the VFC12LD and the VFC15LD, offer designers low drift specifications that are exceeded only by converters costing twice as much. Both units are guaranteed to drift less than 10 ppm/°C, although 8 ppm/°C is regarded as typical. The converters are both linear to within better than 0.005% of full scale.

The devices differ in their input-voltage and output-frequency ranges. The VFC12LD handles inputs from 0 to 10 volts and produces frequencies from dc to 10 kilohertz. The VFC15LD handles 0 to 20 v and produces 0 to 20 khz.

Both of the new converters are of modular design, measuring 1.5 by 1.5 by 0.4 inches. They are self-contained and require only ±15-v power supplies. In hundreds, the VFC12LD sells for \$46, while the VFC15LD is priced at \$47. The unit



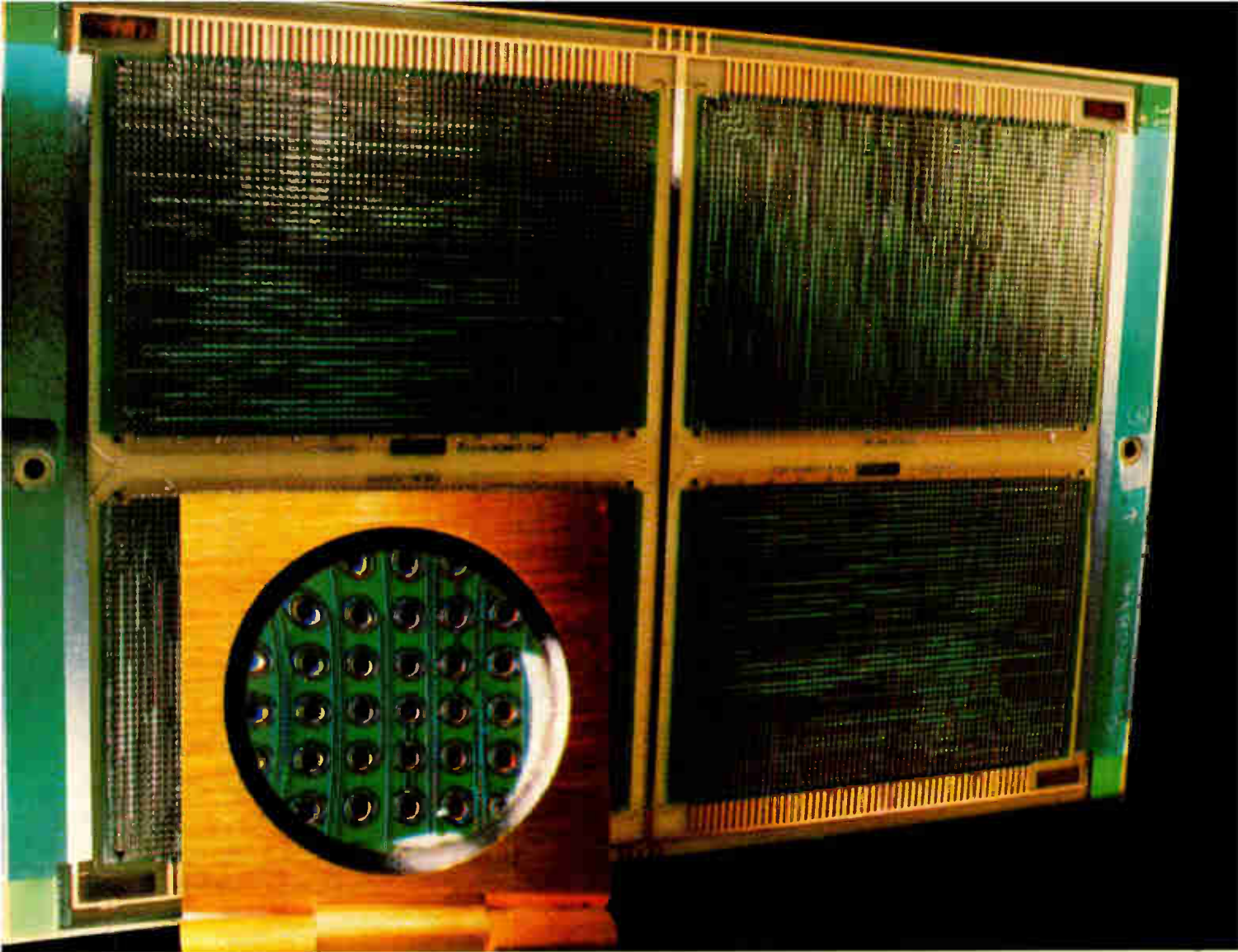

Printed circuit board courtesy of Memorex Corporation

More than a fine line separates RISTON* Dry Film Solder Mask from other masks.

We know fine lines are important to you. That's just one of the reasons why we developed RISTON* Dry Film Solder Mask. Photo-imaging gives precise resolution, even on dense circuitry boards and around critical pad areas. Because there is no bleed-out or solder bridging, inspection is fast, with minimum rework and few rejects. With RISTON Dry Film Solder Mask, application and processing are easy, without specially skilled operators or screen setups and attendant delays. Reliability? You can count on it!

The uniform thickness of RISTON Dry Film Solder Mask permits handling of the highest density circuitry and offers high impedance integrity with outstanding electrical insulation. Long or short runs are a natural, and boards can be produced up to 21" x 24", one after the other, without multiple recoats or skips.

All of these features of the dry film process with RISTON Solder Mask add up to wide flexibility for the designer. What's more, it comes in a variety of film types which enable masked boards to pass UL flame-

retardant standards. RISTON Dry Film Solder Mask adheres to all common metals and performs consistently under a variety of soldering conditions as well as solder flux cleaning. The result for you is a tough, permanent, well-designed board.

Find out how the benefits of RISTON Dry Film Solder Mask fit your needs. Call your Du Pont RISTON Technical Representative, or write Du Pont Company, Room 35619, Wilmington, DE 19898.

*Registered U.S. Pat. & Tm. Off. for Du Pont's processable dry film photoresist system

RISTON Division



Electronics

Fill 'er up.



Once you've got your equipment designed, there's always the problem of what to do for an enclosure. You want to be sure that it gets just the right degree of protection and just the right degree of impressiveness at just the right price.

There are two options. You can shop around at a lot of different enclosure companies and try to find a lot of different alternatives. Or you can come to Zero.

At Zero, you'll find the world's most comprehensive source of enclosure capability. You'll find the Centurion Elite™ case, the premium case that gives you the most impressive look you can get in a case that's practically a portable vault.

You'll find the Centurion Logolite™, an economical, lightweight case that you can personalize with your logo.

And you'll find the Centurion Valuline™, the widest selection of economical top-opening instrumentation cases in the world.

Just about any case you can possibly need is already here, in stock, waiting for you to fill 'er up.

ZERO

We make you look good.

Zero Corporation • Burbank, CA 213/846-4191 • Monson, MA 413/267-5561
 Circle 5 on Reader Service Card for Catalogue Call Me, I'm interested. Circle 198 on Reader Service Card

1977 Answer Book. It makes your job easier. \$25.

Who makes what? Over 4000 products, more than 5000 manufacturers with their local contracts and distributors, directory of trade names and catalogs, post-paid inquiry cards for 5-second ordering of current catalogs.



Electronics Buyers' Guide
 1221 Ave. of the Americas
 New York, N.Y. 10020

Yes, send me a copy of The Answer Book. I've enclosed \$25 (USA and Canada only, elsewhere send \$35). Full money back guarantee if returned within 10 days.

Name _____
 Company _____
 Street _____
 City _____ State _____ Zip _____

New products

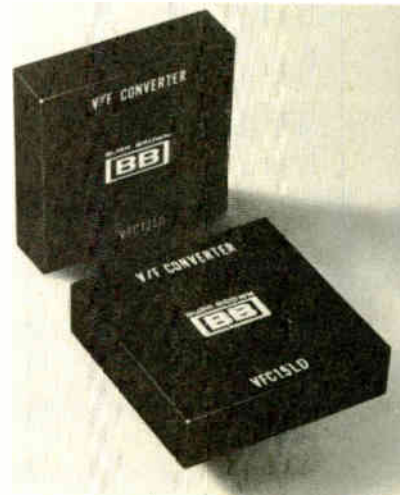

prices are \$57 and \$59 respectively. Burr-Brown Research Corp., P.O. Box 11400, Tucson, Ariz. 85734. Phone (602) 294-1431 [383]

Large-screen CRT display provides 0.5-mm spot

The high-resolution model 1304A cathode-ray-tube display combines a screen area of 20 by 25 centimeters with a spot diameter of only 0.5 millimeter. The unit, which can display 2,000 alphanumeric characters in normal room lighting, uses electrostatic deflection for fast response and low power consumption. It has a writing speed in excess of 25 cm per microsecond and a power consumption of only 60 watts. Dynamic focus keeps the spot sharp at all intensity levels.

Applications for the 1304A include calculator and computer graphics, spectrum analysis, and physiological monitoring. For this last application, a \$50 option can be

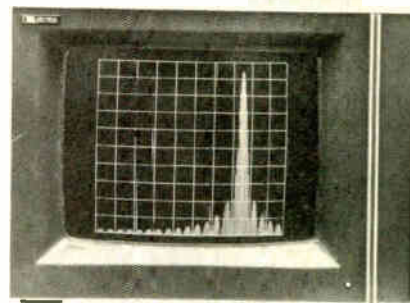



PUSH to initiate automatic in-circuit testing of all of your analog, hybrid and digital boards.



Test *all* of your printed circuit boards and, in many cases, completely eliminate costly functional testing. Faultfinders FF101C and FF303 in-circuit test systems give you the flexibility you need with a broad range of CPU/peripheral compatibility. And you can get full time utilization of the system computer with foreground/background programming to execute automatic program generation, text editing, data analysis or file maintenance *even while you're testing boards.*

You'll be testing more boards, bigger boards and more complex boards, so now is a good time to start checking on what Faultfinder in-circuit test systems can do to make the job more cost-efficient. Call your Faultfinder

representative:

Latham, Tom Coleman, (518) 783-7786;
Irvine, Chuck Hults, (714) 549-4901;
Chicago, Al Roraus, (312) 696-0335;
San Francisco, Bruce Douglas, (408) 432-9020;
Waltham, Thomas McLaughlin, (617) 890-4717
Europe, Marty Liebman, (49) 6196-44008;
England, Mike Cook, (44) 4204-3443.

Or start with the coupon.

FFI **FAULTFINDERS Inc.**
15 AVIS DRIVE, LATHAM, NY 12110

O.K., Start.

Show me how Faultfinder in-circuit test systems can improve our production testing.

NAME _____ TITLE _____
COMPANY _____
ADDRESS _____
CITY _____ ZIP _____
PHONE _____

EL

DATA I/O BY BIT OR BYTE

.... for 15,000 hours.

The MFE 250B cassette tape transport is ideal for program loading, communications terminals and data acquisition systems. *It's 1/3 the size of a minifloppy, has a 1/10⁸ error rate, 366 Kilobyte storage and a 32 Kilobit transfer rate.*

Just 2 moving parts and no mechanical adjustments assure its constant speed, accuracy, speed range and reliability.

Computer and communications interfacing is simplified by your choice of 8 bit parallel or 8 bit serial option boards — which include Bi ϕ level — The ANSI/ECMA Standard.

Call Jim Saret (603) 893-1921 for more data.
Unit price \$525, 100's \$325 plus options.

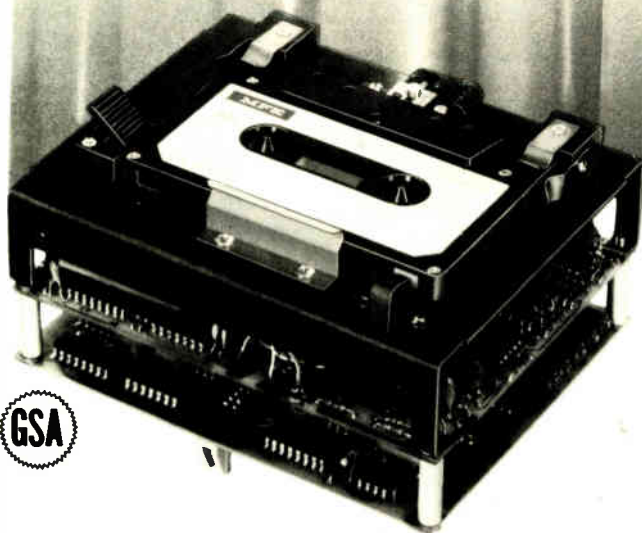

KEEWAYDIN DRIVE, SALEM, N.H. 03079 U.S.A.
See Us At Booths 1753 & 1755 — NCC.

New products

specified to meet the requirements of UL listing 544 for medical and dental electronic equipment. A variety of other options are also available. The basic unit sells for \$2,400. Delivery time varies from about 8 to 12 weeks, depending upon options. Inquiries Manager, Hewlett-Packard Co., 1501 Page Mill Road, Palo Alto, Calif. 94304 [384]

Hybrid rectifier/regulator puts out 2 A at 5 V

The SI3050G hybrid power rectifier and voltage regulator is a compact unit that can put out up to 5 amperes at 5 volts dc. The device, which

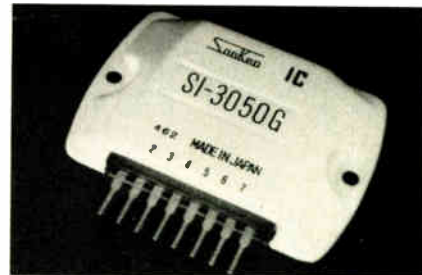

includes circuitry for overload and short-circuit protection, requires few external components and no adjustments. Priced at \$8.50 each in singles, dropping to \$6.10 in hundreds, the unit is available from stock.

Energy Electronic Products Corp., 6060 Manchester Ave., Los Angeles, Calif. 90045. Phone (213) 670-7880 [385]

Power-supply modules deliver up to ± 180 V dc

A new series of dual high-voltage modular power supplies is particularly well-suited for use with such high-voltage equipment as large-swing operational amplifiers and deflection amplifiers. The three supplies in the series offer outputs of ± 120 volts at 25 millamperes (model BPM-120/25), ± 150 v at 20 mA (BPM-150/20), and ± 180 v at 16 mA (BPM-180/16). All three devices offer line regulation to within

A GOOD FUSE CAN'T HOLD ON WITHOUT A GOOD GRIP.

GET BOTH FROM BUSSMANN.

Don't put a good fuse in the grip of a poor fuse holder. If the holder can't hold on right, the best fuse in the world can't, either.

Some clips just don't have the muscle to hold tight. The fuse gets loose. The heat builds up. You know what happens.

There's an easy way to put a stop to it: Put good Buss fuses in good Buss fuse holders. Our holders are made with the muscle it takes to keep a good tight grip on trouble-free electronics protection.

They'll pay off for you a thousand times over in reliability that's for sure, not for maybe.

Your equipment deserves the best. Bussmann has it for you. A great fuse. And a great grip. Get them together now.

Ask for Buss Bulletin SFB.



SUPPLIED THE ECONOMICAL WAY
THRU DISTRIBUTORS
BUSS FUSES
THE QUALITY LINE



BUSSMANN MANUFACTURING
a McGraw-Edison Company Division
Earth City, Missouri 63045

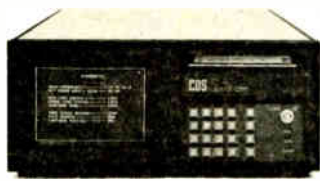

NEW

The d/pad one displays more intelligence than any comparable Decommuration System in the world.



The μ P-smart d/pad one is really 8 instruments in 1. And more.

This new product is an 8080 micro-processor controlled Data Processor Analyzer and Display System (we call it d/pad).

Simply stated, "d/pad one" accepts serial data, and outputs decommuted/demultiplexed parallel information in real time.

The added dimension of a micro-processor allows front panel, ASCII keyboard or computer programming of various PCM formats, with entries instantly fed back from the CRT.

The CRT displays three pages for programming entries. Six pages of diagnostic information includes automatic data limit checking and a bar

graph representation of selected data. Built in test (BITE) includes a PCM simulator.

Need PAM and PCM demultiplexed? We have d/pad II.

Need extended memory and a multiplier? We have d/pad III.

Write or call Cal Brewster for more details. Conic Data Systems, 9020 Balboa Ave., San Diego, CA 92123. Phone (714) 279-0411.

CONIC DATA SYSTEMS

A Division of Conic Corporation

the quiet leaders in communications systems

A subsidiary of Lorain Corporation

Circle 202 on reader service card

1977 Answer Book. It makes your job easier. \$25.

Who makes what? Over 4000 products, more than 5000 manufacturers with their local contracts and distributors, directory of trade names and catalogs, post-paid inquiry cards for 5-second ordering of current catalogs.

Electronics Buyers' Guide

1221 Ave. of the Americas
New York, N.Y. 10020

Yes, send me a copy of The Answer Book. I've enclosed \$25 (USA and Canada only, elsewhere send \$35). Full money back guarantee if returned within 10 days.

Name _____

Company _____

Street _____

City _____

State _____

Zip _____



New products



0.05%, load regulation to within 0.1%, and output ripple of 10 millivolts rms, maximum. Temperature coefficient is no more than 0.02% per degree Celsius.

The supplies feature a minimum isolation resistance of 100 megohms, output current limiting, and an operating temperature range of -25°C to 71°C .

Datel Systems Inc., 1020 Turnpike St., Canton, Mass. 02021. Phone Eugene L. Zuch at (617) 828-8000 [386]

450-cubic-inch power supply puts out 1,000 watts

Operating at 70% to 80% efficiency, a line of high-power switching power supplies puts out 25% more power than did previous models in the same package sizes. The units deliver up to 1,000 watts from a package that measures 5 by 8 by 11 inches and weighs less than 14 pounds.

Available voltages range from 2 to 28 volts dc with currents up to 150 amperes. All units feature dual wide-range inputs of 85 to 132 v ac and 170 to 264 v ac at 47 to 63 hertz. They will maintain regulation down to 78 v ac and 156 v ac for up to 10 minutes, providing brown-out protection. Output regulation is maintained for a minimum of 30 milliseconds after loss of input power—useful in computer systems in which it is important to preserve data integrity. Regulation for both line and load variations is within 0.1% with less than 25 millivolts of peak-to-peak ripple. Prices on the new supplies start at \$750.

Power/Mate Corp., 514 S. River St., Hackensack, N.J. 07601. Phone Joe Geronimo at (201) 343-6294 [387]

Need ROM retention and RAM alterability?



Design in Nitron Non-Volatile Memories.

Our Metal Nitride Oxide Silicon NVM are fully reprogrammable in-circuit. They offer long-duration storage security without battery backup or "power-on" auxiliaries.

HIGH DATA RETENTION

Data is secure for a minimum of 10 000 hours and can be read 10^{10} times between refresh cycles.

PROGRAM VERSATILITY

Nitron NVMs offer entire memory or word alterability. And it can all be done in-circuit a minimum of 10^5 times. Millisecond write times are ideal for applications in the human-response range.

SYSTEM COMPATIBILITY

We built in on-chip decoding, and TTL and CMOS compatibility. Plus, Nitron NVMs can be reprogrammed without additional power supplies or power supply switching.

PRODUCT AVAILABILITY

Nitron NVMs are available off-the-shelf for parallel data applications in 64x4 and 256x4 configurations;

and for serial data applications in 16x16, 16x18 and 1024x1 configurations. If you don't see what you need, tell us about it. We custom design NVMs, too.

Unique Nitron process puts silicon nitride and silicon dioxide

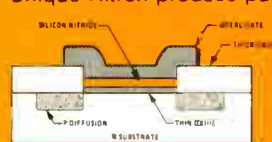

layers between MOS gate and substrate. When voltage is applied, trapped charge offsets threshold voltage. Charge remains after voltage is removed.

Need information fast? Call Nitron NVM Marketing at (408) 255-7550. Or fill in the coupon below for your NVM Fact Kit.

NITRON
A DIVISION OF MCDONNELL DOUGLAS

Mail to:
NITRON NVM Marketing
10420 Bubb Road
Cupertino, CA 95014

TELL ME MORE!

I'm interested in (check box):

- | | |
|---|---|
| <input type="checkbox"/> 64x4 NC7040 | <input type="checkbox"/> 16x16 NC7033 |
| <input type="checkbox"/> 256x4 NC7050 | <input type="checkbox"/> 16x18 NC7035 |
| <input type="checkbox"/> 1024x1 NC7051 | <input type="checkbox"/> Complete NVM Fact Kit |

Send to:

name & title

company

address

city

state

zip

E-6

Inherently rugged, these triple-diffused devices permit circuit operation directly from rectified 117V or 220V line—eliminating transformers. Ideally suited for inverters, convertors, switching regulators, motor controls and wherever there's hi-rel applications. The exploded view demonstrates our single chip design and packaging

concept which makes high-voltage, high-current transistors off-the-shelf availability possible. Pre-rating and pre-testing techniques of chip allows choice of solid copper packages. For further information

| TYPE # | (pk.) I _c | V _{CE} | h _{FE} @ I _c | Switching Speed (Typ.) |
|-----------------------|-------------------------|-----------------|----------------------------------|---------------------------|
| PT-3512 | 70A | 325 | 10 @ 30A | t _r = .5 μs |
| PT-3513 | 70A | 400 | 10 @ 30A | t _s = 1.2 μs |
| PT-3522 | 90A | 325 | 10 @ 50A | t _r = .5 μs |
| PT-3523 | 90A | 400 | 10 @ 50A | |
| 350 Watt Power Rating | | Guaranteed SOAR | | |

and application assistance, call Sales Engineering, PowerTech, Inc., 0-02 Fair Lawn Ave., Fair Lawn, N.J. 07410; Tel. (201) 791-5050.

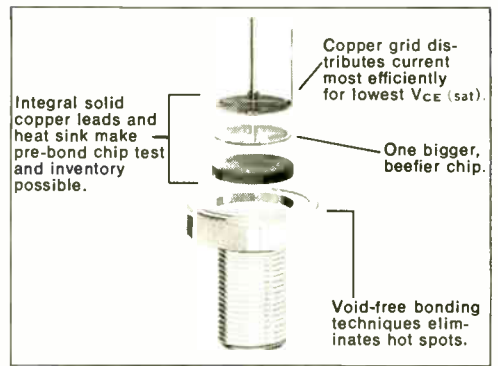

PowerTech, Inc.

"BIG IDEAS IN
BIG POWER"

400v90AMP

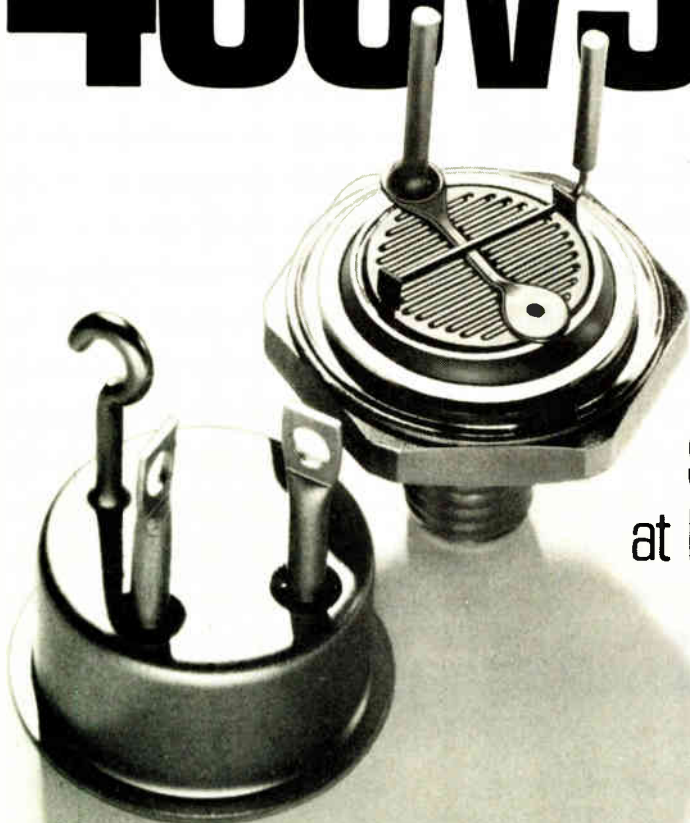

NPN Silicon
Power Transistor
Switch — Highest KVA
at lower cost,
weight & space.

New products

Components

Transformer aims at medical uses

Intended to shield patients from shock, unit is designed to operate at 20 kHz

Switching power supplies, which are beginning to supplant series supplies in new computer installations, may be about to move into medical electronics applications where the patient must be protected from electric shocks. The isolation transformers needed for medical gear have been large, heavy 60-hertz devices. But Stevens-Arnold, a long-established transformer house, has come up with a new 20-kilohertz design that meets the stringent requirements of Underwriters Laboratories UL544 standard for medical and dental equipment. Although it is intended to operate from a 20-kHz square-wave generator, the unit still holds interwinding leakage current to a low 20 microamperes at the standard line frequency of 60 Hz.

Furthermore, the model IT-3573 incorporates thermal protection for each of its secondary windings. Thermal fuses, which are inserted in series with the windings, trip when the transformer overheats to temperatures of 125°C to 150°C. The unit is also available with input protection—fusing against a fault current in the primary protects all the secondaries.

The primary, which is centertapped, can handle voltages of up to 100 volts nominal. The secondary is available with single or multiple windings. Single secondaries provide 200 watts of output power at voltages of 40 to 100 v. Multiple secondaries can have voltages ranging from 20 to 100 v, with an output power of about 150 w for double windings and around 125 w for triple windings.

Designed for mounting on printed-circuit boards and weighing a mere 4

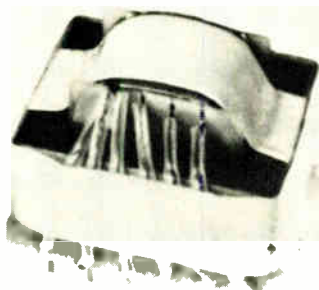

ounces, the transformer measures 1.81 inches long by 1.56 in. wide by 1.375 in. high (when seated). Its power-transfer efficiency is a high 98%, and breakdown voltage between the primary and the secondary is 2,500 v root mean square.

In addition to medical electronics, the unit is suitable for use in industrial process control and scientific instrumentation. Also, it is available with an optional electrostatic shield between the primary and secondary to reduce capacitive coupling and minimize switching transients in critical applications.

In lots of 100, the transformer sells for \$14.50 each. Delivery is within four weeks.

Stevens-Arnold Inc., 7 Elkins St., South Boston, Mass, 02127. Phone (617) 268-1170 [341]

Nonlinear precision pots sell for about \$6

The model 6657 single-turn potentiometer is a low-cost precision unit that is offered with a full line of nonlinear functions. Selling for about \$6 each in production quantities, the potentiometers have a standard independent linearity of 1%. Among the standard nonlinear functions that are available are sine, cosine, sine-cosine, and logarithmic.

Measuring 1 $\frac{1}{16}$ inches in diameter, the pots have a bushing mount and a conductive-plastic element. Molded-in terminals add to reliability. Other specifications include a resistance range of 1 kilohm to 100

POWER μ P

with SCI 

Increase your system reliability...

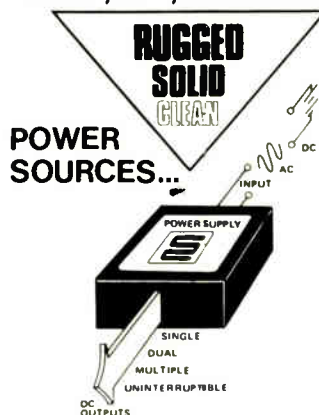

Designed for YOUR application:

- μ P's and Memory
- Logic and Analog—A/D/A
- Peripherals
- Medical

We not only listen — we respond! That's why our product line gives you the widest choice of AC/DC, DC/DC and UNINTERRUPTIBLE POWER SUPPLIES®.

Look What's Available ...

OUTPUTS:

From 3.6 to 1000Vdc;
Singles, Duals, Multiples

INPUTS:

AC ... 12 to 265Vac @
47Hz to 1KHz
DC ... 3.6 to 90Vdc
UPS ... 6 to 24Vdc

PERFORMANCE:

Reg ... 5% to 0.005%

PRICE:

Low Cost/High Value

DELIVERY: Same day shipment for most models

RELIABILITY:

MTBF's > 150,000 Hours

Value-Loaded Products From Your NO. 1 SOURCE. Get Complete Information FAST! Circle the number for our new 1977 FREE CATALOG.



**SEMICONDUCTOR
CIRCUITS, INC.**
POWER SOURCES DIVISION

306 RIVER ST., HAVERHILL, MA 01830
TEL. (617) 373-9104, TWX 710 347 0269

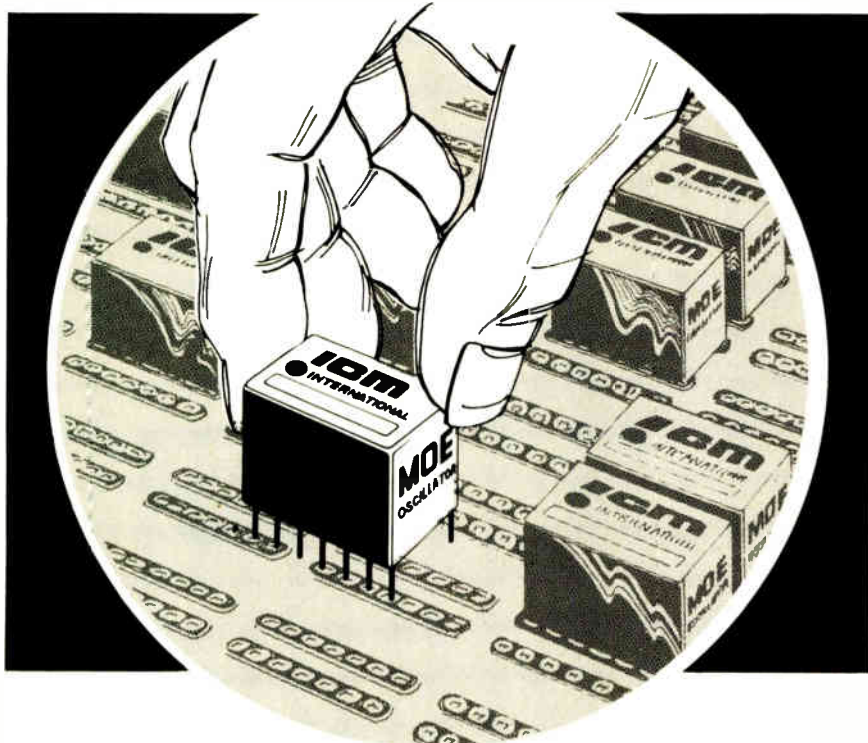

INTERNATIONAL'S
moe
**CRYSTAL OSCILLATOR
 ELEMENTS**

A Complete Controlled Signal Source from 6000 KHz to 60 MHz

The MOE series is designed for direct plug-in to a standard dip socket. The miniature oscillator element is a complete source, crystal controlled, in an integrated circuit 14 pin dual-in-line package with a height of 1/2 inch.

Oscillators are grouped by frequency and temperature stability thus giving the user a selection of the overall accuracy desired. Operating voltage 6 vdc. Output wave shape — non sine.

| TYPE | CRYSTAL RANGE | OVERALL ACCURACY | 25°C TOLERANCE | PRICE |
|--------|------------------|---------------------------|----------------|---------|
| MOE-5 | 6000KHz to 60MHz | + .002% -10° to +60°C | Zero Trimmer | \$35.00 |
| MOE-10 | 6000KHz to 60MHz | + .0005% -10° to +60°C | Zero Trimmer | \$50.00 |

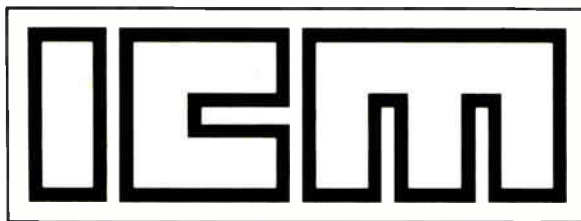

International Crystal Manufacturing Company, Inc.
 10 North Lee, Oklahoma City, Oklahoma 73102

New products

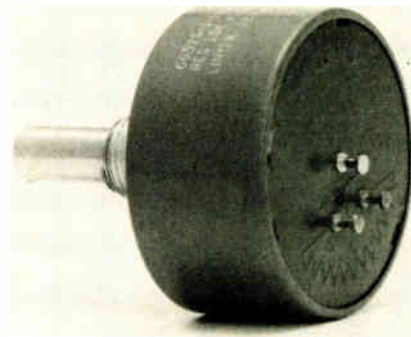

kΩ, a power rating of 1.5 watts at 70°C, and a rotational life of 10 million revolutions.

Trimpot Products Division, Bourns Inc., 1200 Columbia Ave., Riverside, Calif. 92507. Phone (714) 781-5200 [343]

**Shielded power cords
 reduce interference**

Two versions of UL-listed shielded power cords and cord sets are designed to minimize electronic interference in the power supplies of business machines and test equipment. They are expected to greatly reduce the need for filtering devices in sensitive test gear and computers. Two types of shielding are available: Beldfoil with a drain wire, and

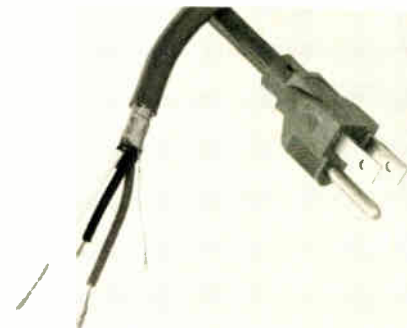

copper-serve shielding. The Beldfoil shielding consists of an aluminum/polyester film wrapped around the conductors. A foldback design ensures continuous metal-to-metal contact and 100% shield coverage.

The copper-serve shielding is formed by spiralling copper wire around the conductors. It provides nearly 100% coverage and acts as a ground wire when terminated. The

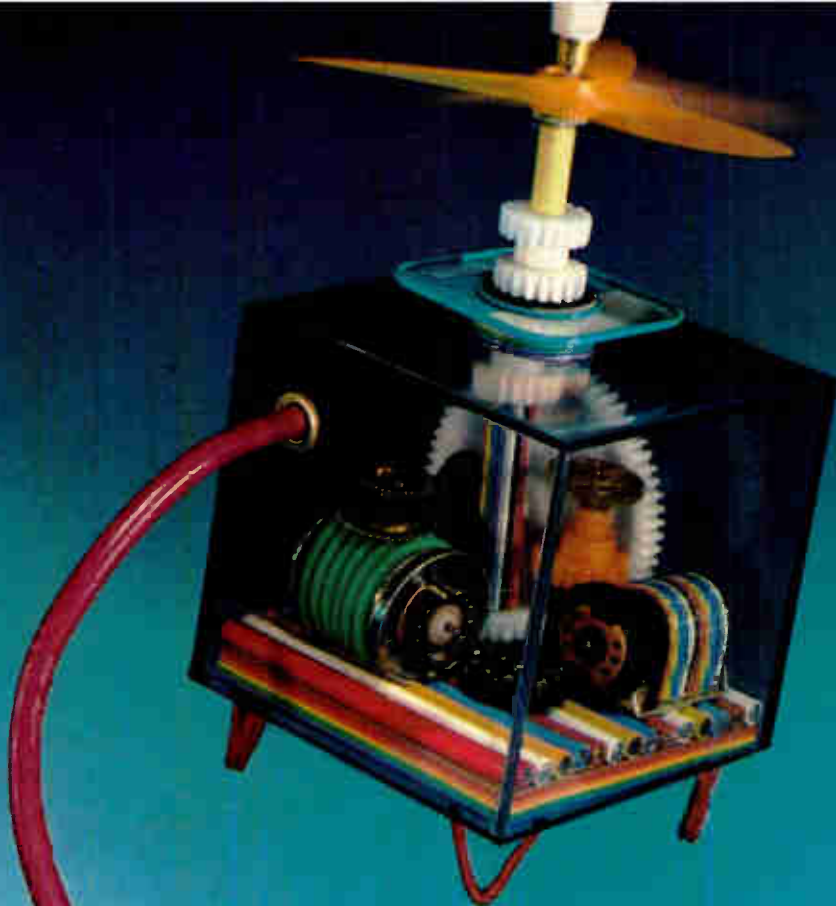

Coming through...

with help getting your ideas off the ground

Whether you're thinking about new "black box" designs or better ways to work with wire, we can help get your ideas off the ground.

Involving Belden in the early stages of a project will almost always pay off in a cleaner, more economical package. It can also keep knotty—and costly—problems in compatibility, workability and availability from arising later.

We're coming through with extensive capabilities in problem solving and custom design. Plus thousands of high-quality wire, cable and cord products to draw from—in twisted pair, coaxial and cable constructions.

Our know-how in the areas of insulation compound-

ing, shielding, innovative packaging, quality control and time motion have resulted in some extraordinary savings for our customers.

Talk to a Belden specialist about your new black box ideas, processing and application problems—all your wiring needs. For fast answers to special problems, call our engineering "hot-line" number, 317-966-6661. You'll like the results.

Whether your needs can best be met through our nationwide team of electronic distributors or through a totally new cable design, we won't let you down. Belden Corporation, Electronic Division, P.O. Box 1327, Richmond, IN 47374; 317-966-6661.

8-4-7



BELDEN

Coming through...

with new ideas for moving electrical energy

Circle 207 on reader service card

© 1977 Belden Corporation

World Radio History

HOW DO YOU GET ANALOG SIGNALS INTO YOUR COMPUTER?

Using the new RAMP/Scanner, you can connect any combination of thermocouples, voltage signals or current transmitter signals directly to the input panel. Use two sets of twisted pair wires to tie the RAMP/Scanner into your computer's standard 20 ma current-loop or RS232 port. You'll now have two-way communication between the RAMP/Scanner and your computer in ASCII code. What could be simpler?



The new RAMP/Scanner features a solid-state scanning breakthrough, providing common mode voltage capability in excess of 250Vrms continuous or 600V peak - an auto-ranging dual-slope integrating DVM for high noise rejection - selectable serial transmission rates from 150 to 19,200 baud - and more!

Write or call Newell Tillman at (617) 275-0300.



15 DeAngelo Drive, Bedford, Massachusetts 01730

Circle 208 on reader service card

MICROPROCESSOR POWER SUPPLIES

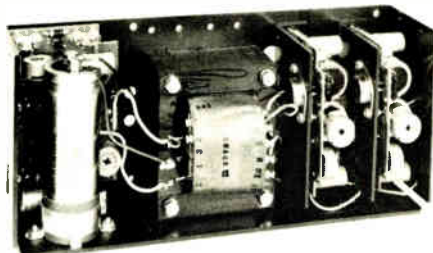

Featuring . . . High Reliability and Low Cost

Now Power/Mate introduces a series of triple output, open frame power supplies designed specifically for microprocessor users.

Based on a rugged, field proven design, the ETR series of microprocessor power supplies features Dual AC Input, remote sensing, adjustable current limiting and plug-in IC regulation throughout the line.

Built to the same rigid quality standards that have made Power/Mate the industry leader, they offer a very impressive 100,000 hour MTBF.

Best of all, the ETR series is economical and in stock. Call or write for our free brochure.



POWER/MATE CORP.

World's largest manufacturer of quality power supplies.

514 South River Street/Hackensack, N.J. 07601 /Phone (201) 343-6294 TWX 710-990-5023

208 Circle 10 on reader service card

New products

ords are SJT-type, 14 to 18 gage, with three-strand copper conductors. Belden Corp., 2000 S. Batavia Ave., Geneva, Ill. 60134 [344]

Solid-state relays offer high noise immunity

A series of miniature solid-state relays with high noise immunity is intended to convert high-voltage ac and dc signals to TTL levels. The low-cost devices in the HL series accept inputs from 5 to 48 v dc or 6.3 to 120 v ac. Using photoisolation, they provide an output capable of switch-

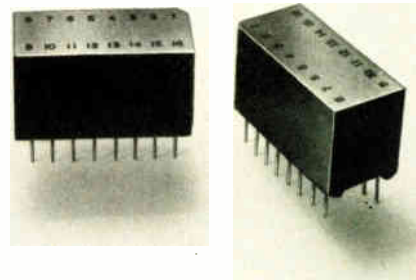

ing 5- or 12-volt logic levels at currents up to 25 milliamperes. All HL relays are packed in a 16-pin dual in-line package about 0.5-inch high. Pricing is \$4.50 each in thousands with a delivery time of three to four weeks for small quantities.

Theta-J Relays Inc., 1 DeAngelo Drive, Bedford, Mass. 01730. Phone (617) 275-2575 [345]

Compact cathode-ray tube has 100-MHz bandwidth

An all-electrostatic cathode-ray tube for instrumentation applications features a 9-inch-diagonal screen, a vertical sensitivity of 6 volts per centimeter, and a bandwidth of 100 megahertz. Designated the DC5106, the tube is only 15.55 inches long and has maximum bulb dimensions of 8.43 by 6.50 inches. Applications for the DC5106, which has a mesh-lens, post-deflection scan-expansion

Electronics / June 9, 1977

Save \$650 on iCOM's New Dual Floppy Disk System.



At the regular price of \$3,300, our new dual floppy is a great buy. It's priced less than competitive models, with features found on no other machine.

At the special \$2,650* single quantity price, it's a super value.

Why the low introductory price?

Quite frankly, to make your buying decision easy. We're betting you'll design the iCOM® dual floppy into your system. Many of the largest companies have. And by the way, our OEM quantity prices are right, too. Even more savings.

Here's what you get

The \$2,650 price includes the iCOM Dual Floppy and your choice of interface to any of these microcomputers: Intellec 8, Intel SBC-80/10 or 80/20, Intellec-800 or Motorola's EXORciser. You also get our powerful FDOS-II development software with macro assembler and string text editor. And for only \$50 more, our new Disk BASIC-M is available for most models.

Another savings

iCOM's software is disk resident, requiring virtually no dedicated computer memory. Most dual floppies require 16K or more of RAM. You could save as much as \$1,000 on computer memory alone.

A comforting thought

iCOM® is the world's largest supplier of peripherals for microcomputers. And, being a division of Pertec Computer Corporation, we'll be around whenever and wherever you need us.

This offer ends July 31, 1977. So don't procrastinate. Phone us, or mail the coupon. Right now!

*U.S. Domestic Price

Mail to: **iCOM® MICROPERIPHERALS®**
a division of Pertec Computer Corp.
6741 Variel Ave.
Canoga Park, CA 91303 U.S.A.

- Phone me Send tech data
 I need a quote on _____ units
 My computer is _____
make/model

NAME _____
 COMPANY _____
 DEPT. _____
 ADDRESS _____
 CITY _____ STATE _____
 PHONE _____ ZIP _____

© 1977, Pertec Computer Corporation

Intel and Intellec are trademarks of Intel Corp. EXORciser is a trademark of Motorola Inc

iCOM® MICROPERIPHERALS®

6741 Variel Ave., Canoga Park, CA 91303 U.S.A.
 Tel. (213) 348-1397 TWX 910-494-2788

a division of Pertec Computer Corporation

See iCOM at NCC - Dallas - Booth 1415

World Radio History

Circle 209 on reader service card

PMOS NMOS DMOS 'P' CHANNEL 'N' CHANNEL

OH!
**what a
 switch
 it is**

**NEW 'N' CHANNEL 'D'MOS
 FROM SOLITRON**

- Switch 1.5 amp in 3 nsec (typical)
- Switch 30ma in 1 nsec (typical)
- Switch $\pm 10V$ analog signals
- CMOS TTL compatible

Try them as your: Digital Switch — Analog Switch — Relay and Clock Driver — Cross-bar Switch — Sample and Hold — Line Drivers — Logic Driver (Fan-out 100 typical)

Call your Solitron Representative
 or call Dick McClain at . . .

THE HOUSE OF FETS

Solitron San Diego

Solitron Devices, Inc. • 8808 Balboa Ave.
 San Diego, CA 92123 • Phone (714) 278-8780

Circle 210 on reader service card

New products



system, include real-time signal analysis, medical equipment, and computer terminals.

DuMont Electronics Corp., 750 Bloomfield Ave., Clifton, N. J. 07015. Phone (201) 773-2000 [346]

Microswitches are highly reliable, extremely thin

Three new snap-action microswitches have been designed for applications in which size, weight, and reliability are critical factors. The precision single-pole/double-throw switches have a mechanical life of 1 million operations and an electrical life of 100,000 operations.

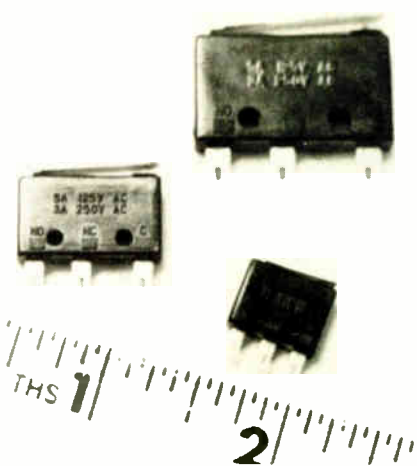

The switches are rated at 5 amperes at 125 v ac or 3 A at 250 v ac. Maximum operating force is 120 grams. Release force is 20 g. Differential travel is only 0.02 millimeter. The smallest of the three switches

**1977 Answer Book.
 It makes your job
 easier. \$25.**

Who makes what? Over 4000 products, more than 5000 manufacturers with their local contracts and distributors, directory of trade names and catalogs, post-paid inquiry cards for 5-second ordering of current catalogs.



Electronics Buyers' Guide
 1221 Ave. of the Americas
 New York, N.Y. 10020

Yes, send me a copy of The Answer Book. I've enclosed \$25 (USA and Canada only, elsewhere send \$35). Full money back guarantee if returned within 10 days.

Name _____
 Company _____
 Street _____
 City _____ State _____ Zip _____

When you need LEDs or more than LEDs...



Dialight is the first place to look. We can help you do more with LEDs... because we've done more with them.

Discrete LEDs come in a variety of sizes, shapes, colors (red, yellow, green in clear or diffused), with or without built-in resistors.

Low cost logic state fault indicators for trouble shooting complex circuits. Designed for close density PC board mounting.

High-brightness bi-color LEDs (red/green) suitable for go/no-go situations. Designed with unique

lenses for the extra visibility you'll want for your most critical applications.

Snap-in mounting LED indicators reduce labor cost. Available in red, yellow or green with or without built-in resistors.

Whatever you need in LEDs, Dialight's probably got it already. For your free 60-page selector guide and listing of our nationwide stocking distributors, contact us today.

DIALIGHT

A North American Philips Company

Dialight meets your needs.

Dialight, 203 Harrison Place, Brooklyn, N.Y. 11237 (212) 497-7600

World Radio History

Circle 211 on reader service card

We've got more going for us than just good looks

Like Quality. Service. Price.

Through years of experience we've put together a quality product line with plenty of sell. A line that's value engineered to meet your specific requirements for either heavy-duty or commercial applications.

If one of our modulares won't do this job we'll modify, redesign, or custom build to your standards. We can provide equipment in just about any color you'd like, and give you on-time delivery as well.

So, if you need a quality enclosure system to compliment your product, give us a try. You'll find our line comprehensive and our price competitive. And by the way, we do look good too!

P.S. Ask about our ENGINEERING EVALUATION PROGRAM.



• Choice of finish and color — no extra charge.

Equipto Electronics Corporation
435 Woodlawn Ave. • Aurora, Illinois 60507
Phone: 312/897-4691

Circle 12 on reader service card

Make the HAL Connection

- 8080A MPU
- 1K Monitor/Debug Software in 2708 EPROM or 2-3624 PROMs
- On board space for: 4K ROM (2708), 2K RAM (2102A-4)

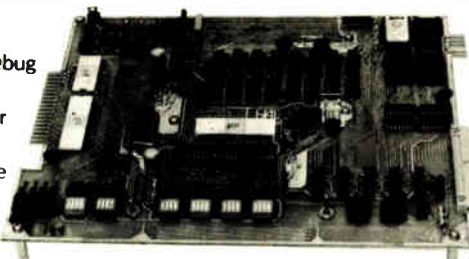

- 24 lines of Parallel I/O (8255)
- Hardware "front panel" on board
- Optional Accessories: CRT Terminal Board, BASIC in EPROM, Audio Cassette Interface, 7K RAM Expansion Board/ EPROM Programmer, Power Supply.

• TTY Current Loop or RS-232C serial I/O (8251)
MCEM-8080 from \$375 (2-3624 ROM/1K RAM) or \$445 as shown (2708 EPROM/2K RAM)

and solve your lab or OEM computer problems

1. Connect to the 24 lines of Parallel I/O and ASCII or Baudot Serial I/O.
2. Connect to processor bus to add memory expansion board/EPROM programmer, I/O devices, or our unique CRT Terminal Board.
3. Connect to our power supply or use your own.

Lab users and OEM's alike will find solutions to their computer problems with the MCEM-8080 computer. All essential com-

puter system elements are incorporated in this fully assembled, tested single-board computer. Some unexpected features of the HAL MCEM-8080 are: hardware "front panel" which allows setting a breakpoint and manual control of the computer; 1K ROM Monitor/Debug Software (with user callable, Intel[®] compatible I/O routines) which greatly simplifies program development; Parallel and Serial I/O on the board; and very reasonable prices.

Call or write for further information on the HAL Connection.

You'll be glad you did!



HAL COMMUNICATIONS CORP.
Box 365BG 807 E. Green Street, Urbana, Ill. 61801
Telephone (217) 367-7373

212 Circle 212 on reader service card

New products

measures 0.5 by 0.41 by 0.21 inch. The units are available from stock. Control Temp Inc., 10930 Grand Ave., Temple City, Calif. 91780 [348]

Ceramic-chip capacitors operate up to 4,000 V dc

High-voltage ceramic-chip capacitors designed for operation at working voltages up to 4,000 v dc are available with NPO/COG and BX/X7R dielectrics. Capable of providing high capacitance values at high

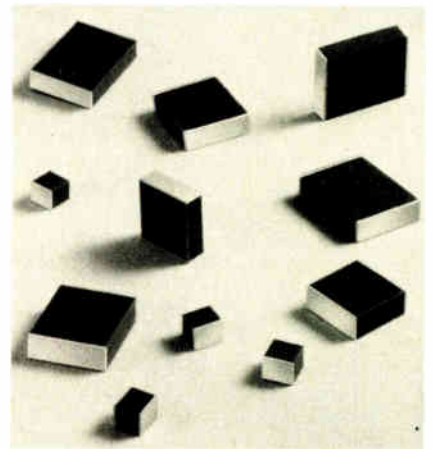

voltages, the units are intended for use in high-voltage power supplies and meter multiplier circuits. Capacitance values range up to 0.82 μ F. Johanson/Monolithic Dielectrics Division, Box 6456, Burbank, Calif. 91505 [347]

TOPICS

Components

Mag-Con Inc., St. Paul, Minn., announces the start-up of a new design and production capability for supplying custom-designed transformers for microprocessing equipment. . . **Grayhill Inc., La Grange, Ill.,** has produced a printed-circuit-board-mountable version of its 16-position rotary switch that measures only 0.562 inch in diameter and extends less than 0.6 in. behind the panel. . . **C.P. Clare & Co., Chicago, Ill.,** reduced the prices of its LA/LB relays by almost 30%.

Electronics / June 9, 1977

Patinal[®] evaporation chemicals: We already know what your results will be.



Patinal chemicals are made specifically for vacuum deposition. And every batch of every chemical is tested under actual deposition conditions. So you can count on top quality results, time after time. Without chemical variations. And without spitting.

Part of what makes Patinal chemicals so reliable is that they are prepared in the "optimum" form for vacuum deposition. Granules, powders, chunks, tablets. Each chemical is in the form which assures you the best results for your application.

Whether you are making thin film electronic components or precision optics, think Patinal chemicals from EM Laboratories.

More than 35 compounds manufactured by E. Merck, Darmstadt, Germany. Each one application-tested, in the right form, at the right price. Off-the-shelf and on-time from EM Laboratories.

Patinal: the perfected chemicals for vacuum deposition.

Pure Consistency...

EM

EM Laboratories, Inc.

associate of
E. Merck, Darmstadt, Germany
500 Executive Boulevard
Elmsford, N.Y. 10523
(914) 592-4660

◆ Chemicals for electro optics ◆ Suprapur[®] ◆ Patinal[®]
◆ Aneron[®] ◆ Licristal[®] ◆ Selectipur[®]

World Radio History

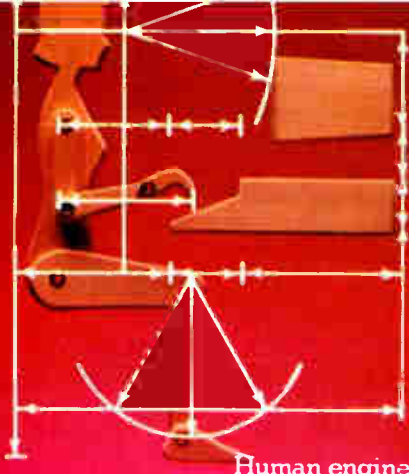

Human engineered
for more throughput



Reduced glare, reduced eyestrain



Typewriter touch for simplified
operation and training



State of the art technology
with a human touch.

Circle 214 on reader service card

THE MOST SOPHISTICATED, COMPLICATED COMPONENT OF ANY DATA TERMINAL SYSTEM IS THE PERSON BEHIND THE CONSOLE.

When we designed the Teletype[®] model 40 product line, we paid as much attention to human engineering as we did to electronic engineering. Simply because we don't think one makes much sense without the other.

After all, throughput is as much a function of operator performance as it is of advanced CMOS technology.

That's why we positioned the tube so it's a comfortable 19" to 21" from the operator. The tube isn't in a fixed position, either, but tilts through 20° to adjust for lighting conditions and individual viewing preferences.

To eliminate eyestrain, a specially darkened and etched glass is used on the screen to diffuse surface reflections and increase contrast by 100%. Even the large 7 x 9 display font is designed for legibility, with a flicker-free refresh rate of 60 times/second. Plus generous spacing between characters and lines increases readability even more.

Keyboard controls aren't just grouped by function so they look right, we made them "feel" right, too. Not only do they fit the fingers, they also duplicate the touch and feel of office typewriters.

As you can see, we think the best way to impress you with our model 40 product line is to make sure your operator is impressed. For more information, write: Teletype, 5555 Touhy Ave., Skokie, IL 60076. Or call: 312/982-2000.



Teletype is a trademark and service mark
registered in the United States Patent and Trademark Office.

New products

Industrial

S-d converter uses 0.25 watt

Low-profile module uses C-MOS circuitry, sells for \$345 in small quantities

As more and more angular-positioning systems come into the realm of computer control, the demand for synchro-to-digital and resolver-to-digital converters continues to increase. But designers do not simply want more converters, they want converters that take up less space, consume less power (so they can be packed tightly without overheating), and, of course, cost less money. Enter the ILC Data Device Corp. model SDC-632.

This is a 12-bit tracking converter that can be configured to handle either resolver or synchro inputs. It uses complementary-MOS circuitry to keep total power consumption down to 225 milliwatts and is housed in a 4-ounce module that measures 3.125 by 2.625 by 0.42 inches.

The SDC-632 is actually a series of 12 products. There is a choice of synchro or resolver input. There are two operating temperature ranges: 0°C to 70°C and -55°C to 105°C; and there are three input voltages: 11.8, 26, and 90 volts. The reference input can vary from 20 to 130 v and from 360 to 1,000 hertz.

The converter will maintain its full 8.5-minute accuracy for input rates that do not exceed five revolutions per second. It exhibits no lag error for inputs that meet this criterion. For a 179° step change, the unit will settle to within one least significant bit within 120 milliseconds (typical) and will settle to a final value within 160 ms (typical) and 240 ms (maximum). At an acceleration of 3,000°/s², the converter will lag by one LSB.

Two power supplies are required: 15 v dc and 4.5 v dc. The lower voltage sees a resistance of at least

10 kilohms, so essentially all of the power is supplied by the 15-v input. Typical current demand is 10 milliamperes, with 15 mA specified as maximum.

A key feature of the SDC-632 is full isolation of the synchro or resolver input and the reference input. Transformer isolation and high input impedances on both reference and signal inputs eliminate loading errors. And a ratiometric conversion technique makes the unit insensitive to voltage and frequency variations. The device has a fanout capability of four TTL loads. For quantities of one to nine pieces, the 0°C to 70°C converters sell for \$345 each, while the extended-range units go for \$395. Delivery is from stock to four weeks.

ILC Data Device Corp., Airport International Plaza, Bohemia, N.Y. 11716. Phone (516) 567-5600 [371]

Thermocouple compensator powers itself for 200 days

A built-in battery allows thermocouple reference-junction compensators in the NC420 series to operate continuously for up to 5,000 hours (more than 200 days) or up to three years with intermittent use. The encapsulated solid-state units replace ice baths and ovens. Standard reference temperature setting is 0°C, but other temperatures are available. The units are typically accurate to within 0.25°C at 25°C and to within 0.75°C over the range from 0°C to 50°C. The standard model has an output impedance of less than 250 ohms. The compensator is cylindrical in shape, with a length of 3 inches and a diameter of 0.625 in. It sells for \$69 each in lots of 1 to 24



THICK FILM MATERIALS IN 2 FORMS.



POURABLE INK OR PARTILOK® PASTES

WHICH ONE DO YOU NEED?

Thick film formulas, resistors, conductors and dielectrics, are available in literally thousands of variations from manufacturers. Most formulas require costly controls in storing, jar rolling, stirring and screen printing.

EXCEPT... THE ONE YOU NEED. NOW AVAILABLE FROM:



SYRINGE

TO SCREEN

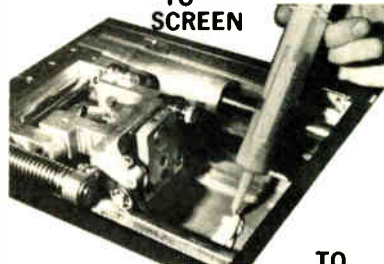

TO SUBSTRATE

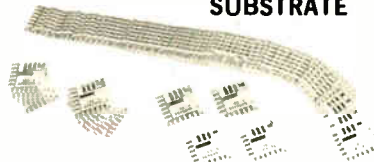

Whether the application is for high volume—consumer products, small run prototypes, opto-electronic displays or medical electronics and other Hi-Rel circuits, consider the advantages of pastes in syringes:

- Ultra Cleanliness—dispense dust free paste onto the screen.
- Indefinite Shelf Life.
- Particles Stay Suspended—no stirring—EVER.
- Minimize Shorts—no dried paste from jar rims and lids to cause printing problems.
- Properties repeat years later; no need to scrap old pastes.

POWEROHM® RESISTORS, CONDUCTROX® Conductors and SILICA-SEAL® and ISO-OHM® Dielectrics—Premium Properties from PARTILOK® PASTE in a SYRINGE.

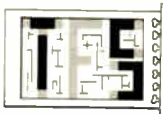

For full information contact THE PASTEMAKER

THICK FILM SYSTEMS, INC.
324 PALM AVE., SANTA BARBARA, CA 93101
TEL.: (805) 963-7757

Maximum cool at minimum cost

Our new third generation of 6½" Pamotor fans are now priced 25% less than previous models. The 7600S (6½" x 2"), and our all-new space saver

7900S (6½" x 1½") are available in either 115V or 220/230V and provide maximum cooling performance in larger electronic consoles.

These new, all-metal 6½" models are more efficient, deliver more cfm with less noise, and will cool longer than any equivalent sized fan on the market today.*

That's why thousands of design engineers trust Pamotor quality exclusively. And, with our new lower prices, Pamotor's 6½" fans are the best cooling value available for immediate delivery anywhere.

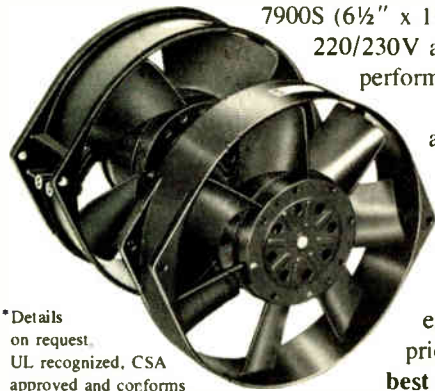

*Details on request. UL recognized, CSA approved and conforms to IEC and VDE standards.

Write for technical assistance, literature, and name of nearest distributor. Pamotor, 770 Airport Blvd., Burlingame CA 94010. Or phone (415) 347-1203.



PAMOTOR

ONE OF THE PURDY GROUP OF COMPANIES

Circle 218 on reader service card

NOW measure AC, DC, and AC on DC CURRENT without breaking the circuit

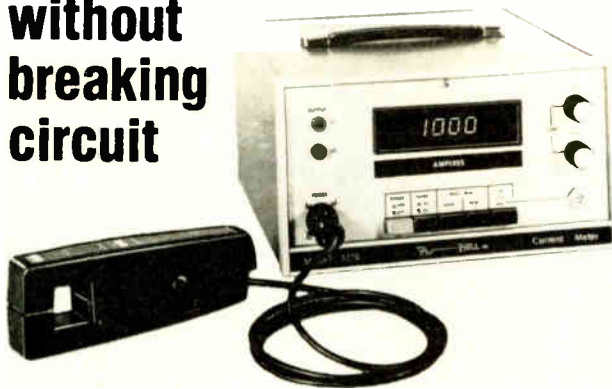

Bell Model 1776 Digital Current Meter with non-contact, clamp-on probe does it!

Current measurements are faster, easier and safer. Utilizing Hall effect probes, the 1776 introduces practically no disturbance into the measured circuit. It can measure currents ranging from DC to 5 kHz.

- 3½-Digit Readout
- Peak—Read—Hold
- Three Current Ranges
1000A, 100A, 10A (Resolution to 10 mA)
- Fully Portable
Operates on 117VAC or rechargeable integral batteries.

Request complete information on this unique instrument for use in troubleshooting, R & D and maintenance.

Bw A Subsidiary of
The Arnold Engineering Company

BELL INC.
4949 Freeway Drive East
Columbus, Ohio 43229
Phone: (614) 888-7501
TWX: 810-337-2851

New products

cable both supplies the device with the power required by its impedance converter and carries away the low-impedance output signal.

Endevco D. I. D., 30700 Rancho Viejo Road, San Juan Capistrano, Calif. 92675. Phone (714) 493-8181 [376]

Enclosed linear transducer is accurate within 100 μin.

The model SST linear transducer is a fully enclosed device that is accurate to within better than 100 microinches. Available with either a 2- or a 4-inch stroke, the SST is designed for use in production environments as either a feedback element or as a primary measurement tool. Its outputs are compatible with transistor-transistor-logic lev-



els for easy control interfacing. Dynamics Research Corp., 60 Concord St., Wilmington, Mass. 01887. Phone (617) 438-3900 [373]

Thermistors measure from 500°C to 1,000°C

A line of ionic conduction thermistors is designed for measurement and control applications in the temperature range from 500°C to 1,000°C. The standard device has a nominal dc resistance of 10 kilohms at 750°C and a temperature coefficient of about -1%/°C. Other units, with 750°C resistances from 3 kΩ to 12 kΩ, are also available.

Because the high-temperature thermistors are ionic devices, their



SEL-REX: An important part in the OMI world of metal finishing.

Sel-Rex has led its industry for more than a generation in advancing the technology of precious metal electroplating. For both decorative and functional plating deposits, Sel-Rex has been the leading innovator, with more processes than any other company in the industry.

The world's first bright gold plating process was an invention of Sel-Rex researchers. Sel-Rex made significant contributions to high-speed gold plating for the electronics industry. Their low-karat, cost-cutting alloy systems are currently changing cost patterns in many markets. And Sel-Rex research led to a complete chemical system for printed circuit board processing, from cleaners and surface conditioners, to electroless copper baths, to final tin/lead gold coatings uniquely suited to the special requirements of printed circuits.

Sel-Rex refineries on the east and west coasts help plants reclaim and reuse precious metals from scrap and solutions. And Sel-Rex's in-depth knowledge of precious metal electroplating has been applied to enable OMI's Equipment

Division to improve its full range of semi-automatic equipment for high-speed, high-volume plating, as well as cost-saving selective strip, stripe, and spot plating equipment.

Today, Sel-Rex's position of leadership has been further strengthened as an integral member of OMI.

With its components, the Sel-Rex Division; the Udylite Division, leader in base metal plating processes; the Parker Division, industry's major supplier of cleaning, treating, and prefinishing chemicals; Recovery Systems Division, a pioneer in designing and engineering environmental and metals recovery systems; and the Equipment Division; OMI represents the most complete source of processes, equipment, supplies, and services, to the world of metal finishing.

For further information, write to Oxy Metal Industries Corporation, 21441 Hoover Rd., Warren, Mi. 48089.



OMI

OXY METAL INDUSTRIES CORPORATION

World Radio History

Circle 219 on reader service card

After you look at the specs, look how long they're guaranteed.

The accuracy specs for the Dana 5100 5½ digit multimeter are guaranteed for a full year. Not 90 days. Not 6 months. That means you only have to calibrate it once a year.

All other multimeters have to be calibrated an average of three times a year. At about \$75 a pop. Which makes their \$995 units a lot more expensive to own than the Dana 5100 at \$1145*.

Instead of sitting in the shop for six weeks over the course of the year, the Dana 5100 will stay right where you are. Measuring AC, DC, Ohms and *frequency* (yes, frequency too) with very high accuracy. Just like the specs say. For a year at a time.

When you look at it that way, one thing becomes obvious. The cost of owning a multimeter is a lot more important than the price.

Write Dana Laboratories, Inc., 2401 Campus Drive, Irvine, CA 92715 for all the specs. And take a good look. With specs that good, you'll be glad you only have to give it up once a year.

DANA®

Others measure by us.

*U.S. domestic prices



Dana 5100.

Ask for a free demonstration before you consider anything less.

For Product Information Circle 25 on Reader Service Card

For Additional Literature Circle 32 on Reader Service Card

New products

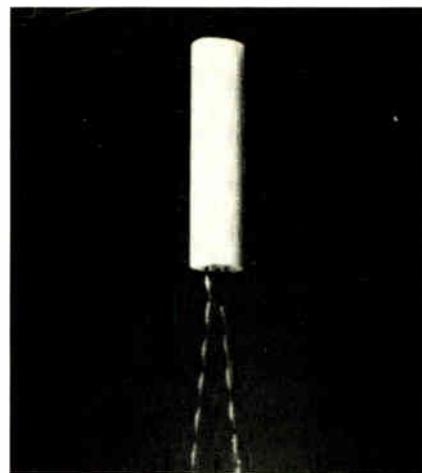

ac behavior is different from their behavior at dc. When operated at 60 hertz, for example, a 10-kΩ unit will exhibit an impedance of 6.3 kΩ. Intended for such demanding applications as measuring automobile exhaust-gas temperatures, the rugged Hi-Temp devices are bead thermistors spot-welded to twisted nickel-chrome leads and encapsulated in alumina. They are available with body lengths from 0.25 to 2 inches.

Fenwal Electronics, 63 Fountain St., Framingham, Mass. 01701. Phone (617) 872-8841 [377]

Pyroelectric IR detector includes signal conditioning

Despite its low 100-piece price of \$29 each, the model 406 pyroelectric infrared detector includes a sensing element and an impedance-converting source follower/voltage amplifier. The detector has a sensing area 2 millimeters in diameter, a 10-hertz voltage responsivity of 275 volts per watt, an optical pass band that extends from 2 micrometers to 15 μm, and a specific detectivity (D*) of 1.8×10^8 cm-Hz^{1/2}/w.

The model 406 uses a lithium tantalate wafer as a sensing element. A special germanium window with an antireflection coating can be supplied at no extra cost. The model 406 is available from stock.

Eltec Instruments Inc., P. O. Box 9610, Daytona Beach, Fla. 32020. Phone Fred H. Oettel at (904) 252-0411 [378]

1977 Answer Book. It makes your job easier. \$25.

Who makes what? Over 4000 products, more than 5000 manufacturers with their local contracts and distributors, directory of trade names and catalogs, post-paid inquiry cards for 5-second ordering of current catalogs.



Electronics Buyers' Guide
1221 Ave. of the Americas
New York, N.Y. 10020

Yes, send me a copy of The Answer Book. I've enclosed \$25 (USA and Canada only, elsewhere send \$35). Full money back guarantee if returned within 10 days.

Name _____
Company _____
Street _____
City _____ State _____ Zip _____

Announcing the first major advance in magnetic shielding in 50 years.



METSHIELD™ Fabric

... the first magnetic shielding product made from METGLAS® alloys. METSHIELD fabric can be handled and shaped without performance degradation.

Now you have such a shielding. It's METSHIELD™ magnetic shielding fabric—a wholly new flexible product made from Allied Chemical's METGLAS® amorphous metal alloys.

Because of its exceptional strength and flexibility, METSHIELD fabric retains its full shielding effectiveness during fabrication and use.

This reliability of performance—plus the ease with which METSHIELD fabric can be handled and shaped—promises you a significant reduction in the overall cost of shielding.

You can use METSHIELD fabric for a variety of applications, including cathode ray, photomultiplier, vidicon, and image tubes.

To find out how METSHIELD fabric can help solve your shielding problems, phone John Dismukes at 201-455-4031 or Jack Thorp at 201-455-3306. Or send in the coupon.

The time is right for a revolutionary concept in magnetic shielding.

Increased sales of electronic equipment, a trend toward miniaturization, and intensified regulatory considerations have put increased emphasis on electromagnetic compatibility.

Consequently, electronics manufacturers need cost-effective magnetic shielding not plagued by fabrication problems and use limitations associated with conventional nickel alloys.

Send me information on METGLAS® alloys and METSHIELD™ fabric

Name/Title _____

Company _____

City/State/Zip _____

Mail to Metglas Products, Allied Chemical Corporation
7 Vreeland Road, Florham Park, NJ 07932



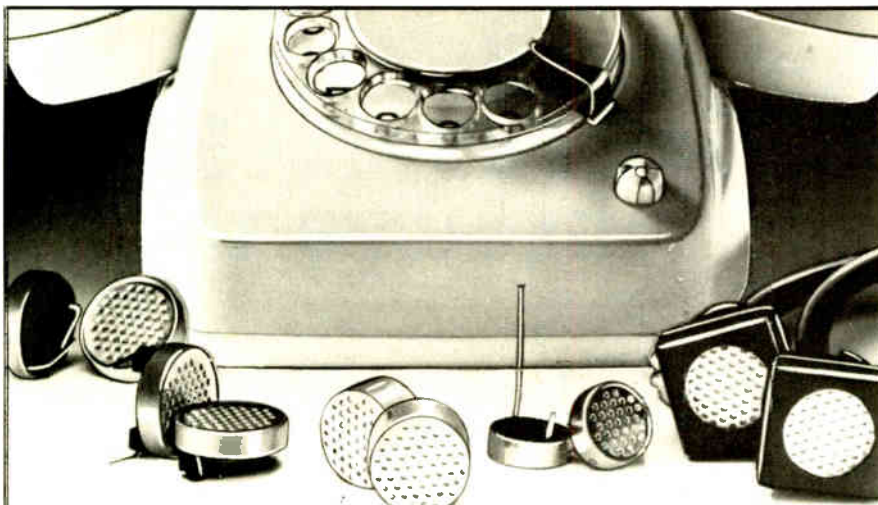

Offer: Free Proposals for Remote Control by Supersonic Transducers

This is a good reason for you to review your product line: Where could remote control become the new and convincing sales argument?

For many years, we have been producing supersonic transducers for remote control. You'll find them in many radio and TV sets manufactured in Europe. But, as we are remote control experts, we know that this little device could become an excellent 'extra' for other products in many markets.

Name us your product and we will show you how remote control can easily become applicable to your product.

SALOTA

Phone West Germany: 0911-32177 Telex 622466 hoco d
Raabstr. 24 · D 8500 Nürnberg/West Germany

Circle 222 on reader service card

THE SUNSHINE STATE OFFERS HIGHER PROFIT POTENTIALS TO ELECTRONIC PRODUCTS MANUFACTURERS THAN ELSEWHERE IN THE COUNTRY!

Florida's substantial labor and operating cost advantages, plus ready access to the markets of the United States, Latin America and the world, combine to offer a unique profit opportunity for a Florida-based manufacturer.

Before you make any decisions regarding your business, this new industry study documenting Florida's position should be reviewed carefully.

To get your copy of *Florida Profit Potentials in Electronic Products Manufacturing*, write or call:

FLORIDA
WE'RE MORE THAN SUNSHINE

Joe Hennessy, Director
Division of Economic Development
Florida Department of Commerce
107 W. Gaines Street, Room 103E
Tallahassee, Florida 32304
(904) 488-5507

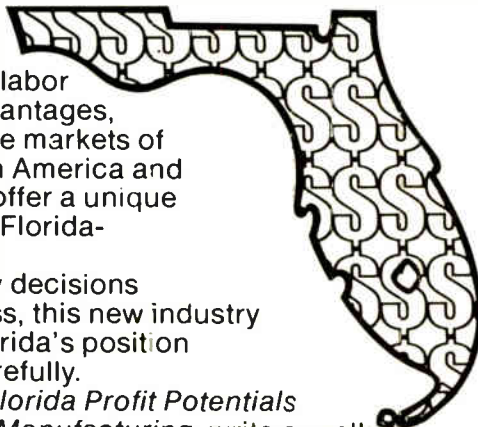

New products/materials

High-stability thick-film resistors, which have been very difficult to produce, have now become a routine matter with duPont's Birox 1700 series of resistor inks. Besides providing temperature coefficients of less than 50 parts per million per degree Celsius, these thick-film compositions give high yields of close-tolerance resistors that change less than 0.1% in value after laser trimming. They are intended for use in such demanding applications as military, aerospace, telecommunications, and medical electronics.

Additionally, the inks offer processing flexibility—they may be fired in cycles of only 30 to 60 minutes at a peak temperature of 850°C. A wide range of sheet resistivities is available, including values from 100 to 100,000 ohms per square. The compositions, which are designed for termination with silver-bearing conductors, exhibit minimal sensitivity to resistor geometry, as well as to modest variations in printing and firing conditions.

E. I. du Pont de Nemours & Co., Photo Products Department, Electronic Materials Division, Wilmington, Del. 19898 [476]

A **nonmetallic conductive coating**, Merix Anti-Static #79 is designed to prevent the build-up of static charges on all kinds of electronic circuit boards and components. After being diluted with its own volume of deionized water, the coating material is wiped onto the surface to be treated. On plastics it provides a surface resistivity of 20 to 100 megohms per square, while on glass it provides more than 100 megohms per square. The nonflammable material sells for \$21.60 per gallon in lots of 60 gallons.

Merix Chemical Co., 2234 East 75th St., Chicago, Ill. 60649. Phone (312) 221-8242 [478]

Gallium-arsenide ingots up to 6 inches in diameter are now commercially available. The circular-cross-section Czochralski-grown boules are expected to provide substantial savings in wafer fabrication, labor, and yield-per-unit area because of lower edge losses. The material can

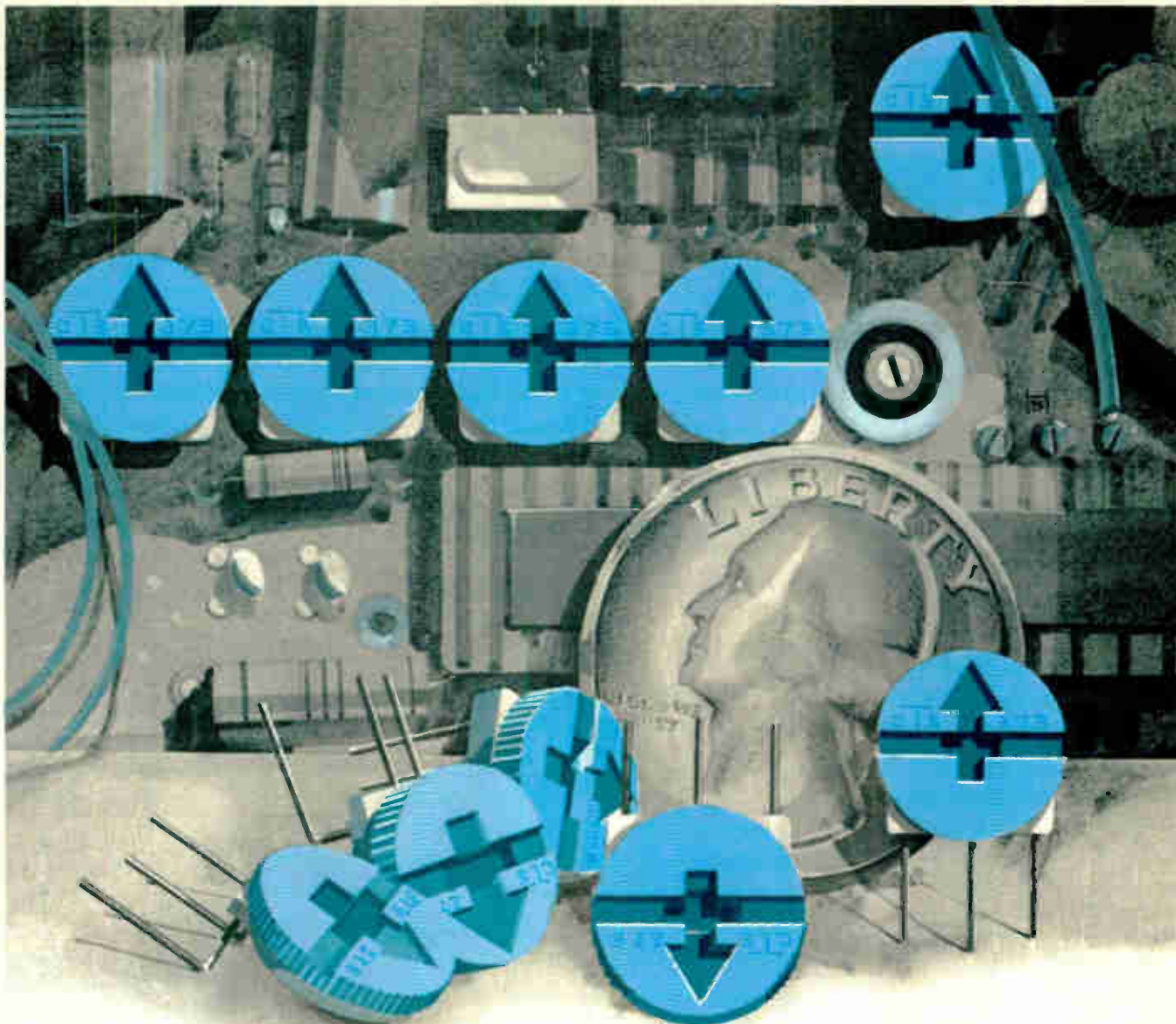

CTS mini cermet trimmers... low in price, high in performance.

Fantastic! Small $\frac{3}{8}$ " dia. (10mm), great performance and CTS reliability are only three reasons you should use our NEW series 375 single turn cermet trimmers. The low 25¢ price tag is still another.

CTS 375's, in six popular terminal styles, feature a low ± 100 ppm/°C standard temperature coefficient—throughout the resistance range. Power rating, 1 watt at 40°C; $\frac{1}{2}$ watt at

70°C. CRV of 2%. Settability of .03%.

And the serrated adjustment knob doubles as a dust cover to protect the element from dirt, oil and other contaminants. It's a lot for so little. But you expect that from a company that's put millions into electronics for industry. For complete information, write **CTS OF WEST LIBERTY, INC.**, 6800 County Road 189, West Liberty, Ohio 43357 or phone (513) 465-3030.

CTS CORPORATION
ELKHART, INDIANA



A world leader in cermet and variable resistor technology.

THE NEW DIT-MCO SERIES 8210 AUTOMATIC WIRE CIRCUIT ANALYSIS SYSTEMS



A CHOICE... FLEXIBLE, EXPANDABLE, POWERFUL SOFTWARE/HARDWARE TEST SYSTEM PACKAGES

Obsolete is Obsolete...

The DIT-MCO Series 8210, comprised of systems 8211, 8212, and 8213, offers the most complete package of automatic wire circuit test capabilities available to serve your present and continuing test needs. In fact, Series 8210 obsoletes the word obsolete. You can select the system to fit your current test requirements with certain knowledge that as your needs expand your DIT-MCO system can be upgraded to deliver!

Powerful Software/Hardware...

Series 8210 are real-time disc operating systems with disc file maintenance in the system.

Series 8210 systems are driven by fully interactive computer systems yet require no specialized operator training. A unique and comprehensive group of programs for testing, maintenance, and diagnostics are standard. Software is the evolutionary culmination of over five years experience and proven field use.

Eeny, Meeny, Miney...

You get a choice...to fit your budget. To fit your test needs. You get versatility, flexibility, the ability to expand and adapt.

And remember, when you choose DIT-MCO you have chosen Number One.

Too New to be Copied...

So new you won't find anything like it available anywhere else.

System 8210 incorporates all the "state of the art" advancements with some new wrinkles only DIT-MCO could provide.

So if you are going to look around for a comparison you will just have to compare the systems within the 8210 Series. None of the others come close.

Hand in Hand...

When you select DIT-MCO equipment you have bought not only the hardware and software you also get the Company...our over 25 years leadership in the field, our just reputation for treating every customer, big or small, with the same respect and dedicated service. With DIT-MCO you get it all!

Call or Write for Full Information...

A DIT-MCO representative can show you how Series 8210 or any of our complete line of interconnect test systems can accommodate your test requirements. Call or write us for full information.

DIT-MCO — The Difference in Testing...

DIT-MCO INTERNATIONAL

5612 Brighton Terrace
Kansas City, Missouri 64130
Telephone (816) 444-9700
Telex Number 42-6149



European Technical
Representative
Radix House
Central Trading Estate
Staines, Middlesex, TW18-4-XA
England
Telephone (0784) 51444
Telex Number 935023

New products/materials



be supplied as ingots, as sliced wafers, or as wafers polished to Epidyne or customer specifications.

Epidyne Inc., 12525 Chadron Ave., Hawthorne, Calif. 90250. Phone (213) 772-4545 [477]

Ceramic adhesives that can be used at temperatures in excess of 2,800°F are offered in convenient kit form. Kit 970 includes four materials: one-component adhesive 918, which can be used up to 2,500°F; high-resistance model 919, for use up to 2,800°F; fast-setting number 940, which has a service temperature of



2,200°F; and high-strength adhesive 944 for use up to 2,000°F. The kit sells for \$24.95. In small quantities, the individual adhesives sell for \$25 per quart; for quantities of 5 to 12 quarts, the price is \$20 a quart.

Cotronics Corp., 3379 Shore Parkway, Brooklyn, N.Y. 11235. Phone (212) 646-7996 [479]

A copper-base adhesive for use at elevated temperatures is intended to compete with silver- and palladium-base adhesives in hybrid-circuit fabrication. Usable up to 2,000°F, Aremco-Coat 543 can be cured at

1702A MANUAL EPROM PROGRAMMER

Features hex keypad, two digit hex address and two digit hex data display. Controls include load, clear, go! (step), key/copy, data in/ data out, and counter up/ down. Profile card includes high voltage pulse regulator, timing, 8 bit address and 8 bit data drivers/receivers. Two 6½" x 9" stacked cards with spacers. Allows programming in 20 minutes - copying in 5 minutes. Requires +5, -9, and +80 volts.

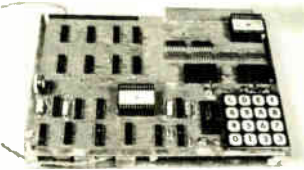

ASSEMBLED \$299.95
KIT \$189.95

NOW

The best of two worlds... use our 1702 EPROM programmer as a manual data/address entry programmer... or connect it to your processor.

IMSAI/ALTAIR computer interface (requires 3 output ports, +1 input port) and software \$49.95

Briefcase unit with power supplies and interface connectors (assembled and tested only) \$599.95

ANNOUNCING

Our NEW 16K Byte Pseudo-Static, IMSAI/ALTAIR compatible RAM. Single card slot. Uses less power than equivalent low power RAM. All memory chips socketed. Uses all prime, factory fresh ICs. High quality, two-sided, through-hole-plated circuit board. Crystal controlled, totally invisible refresh system requires NO software management. Just plug it in and use like STATIC memory.

Complete kit \$349.95
Assembled, tested, and burned in \$549.95

ASSOCIATED ELECTRONICS

12444 Lambert Circle • Garden Grove, CA 92641
(714) 539-0735

Circle 100 on reader service card

16 POSITIONS

INTERSWITCH now offers two new 16-position thumbwheel switches - the Type H front mounting switch and the Type P rear mounting switch.

Each switch module measures only 10-mm wide and is available with a multitude of options which INTERSWITCH offers on all of its thumbwheel switches.

Available from stock and local distribution. Write or call today for complete information.



ONE OF THE PURDY GROUP OF COMPANIES

770 Airport Boulevard
Burlingame, CA 94010

(415) 347-8217 • TWX 910-374-2353

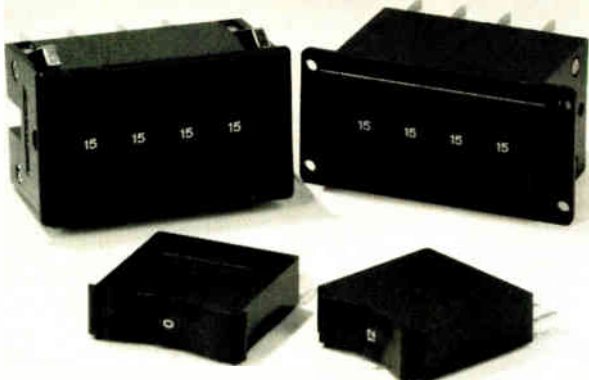

Circle 36 on reader service card

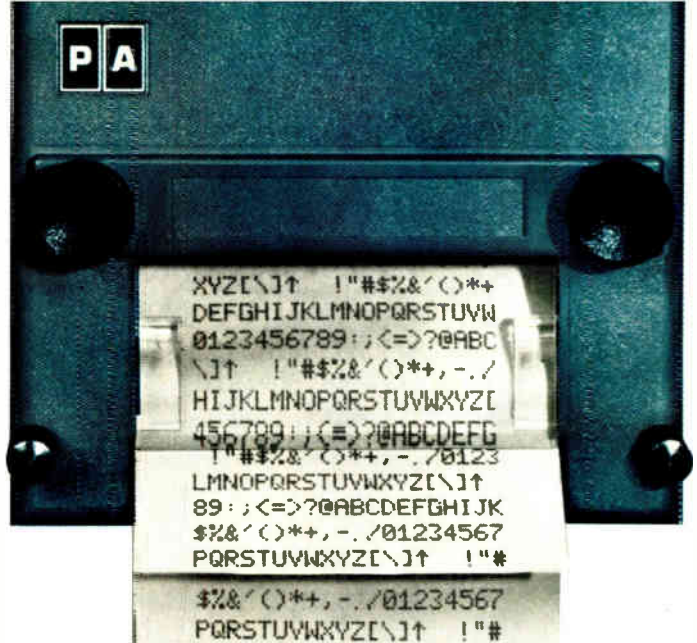

Name one other printer this small that prints multiple copies using standard paper

Don't even bother trying; only our DMPT-3 Miniature Alphanumeric Printer puts it all together like this. Granted, our 20-column workhorse is the industry's smallest alphanumeric impact printer. Granted, it packs the versatility of both "first line up" text and "first line down" print formats. Even so, that's just the beginning for the DMPT-3.

The truth is, you not only get multiple-copy capabilities, but you can use ordinary adding machine rolls instead of the special paper thermal printers require. You not only get a full alphanumeric capability, but enhanced characters and high 120 cps speeds as well. You'll graduate from messy ribbons to a drop-in ink platen with a 75,000-line life. And you can move up to microprocessor compatibility by putting our programmable control option between the DMPT-3 and the outside world. You get it all, but only in the DMPT-3.

For more details, call or write today.

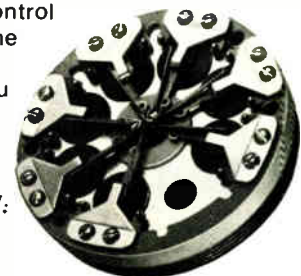

PRACTICAL AUTOMATION, INC.

Trap Falls Road
Shelton, Connecticut 06484
Tel.: (203) 929-5381

Circle 225 on reader service card 225

LARGEST RADAR INVENTORY IN THE WORLD

SYSTEMS & SPARES

AN/ALT-6-7-8
 AN-APG-33
 AN/APG-51
 AN/APN-69
 AN/APN-102
 AN/APN-169
 AN/APQ-50
 AN/APQ-55
 AN/APS-20
 AN/APS-31A
 AN/APS-42-45
 AN/APS-64
 AN/ASB-4-9
 AN/CPG-68
 AN/CPG-9
 AN/DPN-32
 AN/FPS-6-8
 AN/FPS-14-18
 AN/FPS-20-75
 AN/FRC-39
 AN/FRT-15
 AN/GPA-30
 AN/GPA-126
 AN/MPQ-4A-10
 AN/MPQ-29
 AN/MPS-19
 AN/MPX-7
 AN/MSQ-1A
 AN/SPA-4A
 AN/SPA-8
 AN/SPN-5
 AN/SPS-5B
 AN/SPS-6C
 AN/SRW-4C
 AN/TPN-12-17
 AN/TPS-1D, E
 AN/TPS-10D
 AN/TPS-28
 AN/TPS-34B
 AN/TPS-37
 AN/TPX-21
 AN/UPA-25-35
 AN/UPX-4-6
 AN/UPX-14
 HIPAR
 MK-25
 Nike Ajax
 Nike Hercules
 SCR-584

AUTOTRACK ANTENNA SCR-584 RADAR SYSTEM

360 deg AZ 210 deg EL. 1 mil. accuracy. Missile vel. accel. and slew. rates. Amplidyne control. Handle up to 20 ft. dish. Compl. control chassis. ALSO in stock 10 cm. van-mounted rad. system. Conical scan. PPI. 6 ft. dish. 300 gp. instr. bk. on radar. \$50.

RF SOURCES

17-27 KHz 200 W CW
 125-450 KHz 4 KW CW
 2-30 MHz 3 KW CW
 4-21 MHz 40 KW CW
 24-350 MHz 100 W CW
 80-240 MHz 500 W 2.5 uS
 175-225 MHz 300 KW 1, 20 uS
 200-2000 MHz 40 W CW
 210-225 MHz 1 MW 5 uS
 385-575 MHz 1.5 KW CW
 400-700 MHz 1 KW .03 DC
 950-1500 MHz 1 KW .06 DC
 900-1040 MHz 5-10 KW .006 DC
 1.2-1.35 GHz 500 KW 2 uS
 1.5-9.0 GHz 150 W CW
 3.2-3.3 GHz 10 KW .002 DC
 2.7-2.9 GHz 1 MW 1 uS
 3.1-3.5 GHz 1 MW 1.3 uS
 2.7-2.9 GHz 5 MW 2.3 uS
 4.4-5.0 GHz 1 KW CW
 5.4-5.9 GHz 5 MW .001 DC
 6 GHz 1 MW 1 uS
 6.2-5.6 GHz 200 KW 37 uS
 8.5-11 GHz 200 W CW
 9.375 GHz 40 KW 5-1-2 uS
 8.5-9.6 GHz 250 KW .0013 DC
 15.5-17.5 GHz 135 KW 33-1-3 uS
 24 GHz 40 KW 15 uS
 35 GHz 100 KW 1 uS

MODULATORS

25 KW 5.5 KV 4.5 A. .0025 DC
 144 KW 12 KV 12 A. .001 DC
 250 KW 16 KV 16 A. .002 DC
 405 KW 20 KV 20 A. 1 DC
 500 KW 22 KV 28 A. .001 DC
 1 MW 25 KV 40 A. .002 DC
 3 MW 50 KV 60 A. 30 uS
 10 MW 76 KV 135 A. .001 DC
 66 MW 160 KV 400 A. .00

TRACKING SYSTEMS

K BAND MONOPULSE SE 40 KW E-34
 X BAND NIKE AJAX/HERCULES
 X BAND HI-RES MONOPULSE MOD IV
 X BAND GCA PAR II
 X BAND FIRE CONTROL 250 KW M-33
 X BAND AIRBORNE 50 KW APG-32
 X BAND MOBILE 40 KW AN/MPQ-29
 X BAND BEACON 100W AN/DPN-62
 S BAND 10' DISH 500 KW AN/MPQ-18
 S BAND 250 KW AN/MPQ-10A
 S BAND 250 KW AN/MPS-9

SEARCH SYSTEMS

KU BAND AIRBORNE 135 KW B-58
 X BAND WEATHER 250 KW AN/CPG-9
 X BAND WEATHER 40 KW AN/SPN-5
 X BAND 7 KW AN/TPS-21
 X BAND CW DOPPLER AN/PSP-9/12
 C BAND HGT FDR 1 MW TPS-37
 C BAND 285 KW AN/SPS-5B/D
 S BAND HEIGHT FINDER 5 MW AN/FPS-6
 S BAND COHERENT 1 MW AN/FPS-18
 S BAND 1 MW NIKE AJAX/HERC
 L BAND 40' ANTENNA 500 KW AN/FPS-75
 L BAND 500 KW AN/TPS-1D/GSS-1
 UHF 1 MW HELIHUT TPS-28

C BAND TRACKER

Pwr: 1.5 MW Range: 250 miles
 Recv. paramp. Display: 5" "A" scopes.
 10' dish with linear or circ. polarization.

SPARE PARTS IN STOCK

Nike Ajax, Hercules, M-33, MPS-19, TPS-1D, TPS-10D, FPS-6, FPS-8, SCR-584, HIPAR, UPX-6, TPN-12-17, PAR II, UPA-35, GPG-1, MPS-9, FPS-18, FRC-39. Many more, write.

SEND FOR FREE 22 PAGE CATALOG



Radio Research Instrument Co., Inc.

2 Lake Avenue Ext., Danbury, CT. 06810
 (203) 792-6666 • Telex 962444

Circle 149 on reader service card

New products/materials

temperatures as low as 250°F. It is supplied as a viscous paste that can be thinned for spraying; it can also be screen-printed or brushed on. The material has already been used to



attach alumina substrates to gold-plated Kovar packages. The minimum order of Aremco-Coat 543 is a half pint; it sells for \$30.

Aremco Products Inc., P. O. Box 429, Ossining, N. Y. 10562. Phone Herbert Schwartz at (914) 762-0685 [480]

A glass-sealing material developed specifically for joining the two glass surfaces in liquid-crystal displays has the same coefficient of expansion as the soda-lime silicate glass used in LCDs. Called AVX 8800, the material has a proprietary vehicle system that burns out completely during glazing, resulting in a bond that is free of vehicle-related bubbles. The material's glazing and sealing profiles are identical, meaning that the same oven can be used for both processes.

AVX Ceramics Corp., Materials Division, 10441 Roselle St., San Diego, Calif. 92121 [475]

A gold stripper formulated to strip gold from copper, steel, brass, or nickel without using any electric current is especially recommended for printed-circuit boards and other electronics applications where protection of the base metal is important. Supplied as a dust-free, free-flowing, highly soluble powder, Oxytron 620 is capable of removing 0.5 to 1.0 mil of gold per hour without attacking the underlying metal substrate.

Sel-Rex Division, Oxy Metal Industries Corp., 75 River Road, Nutley, N. J. 07110 [474]

FUJI MEMORIES

CONSOLIDATED MEMORY MAKER

SEMICONDUCTOR MEMORY SYSTEM

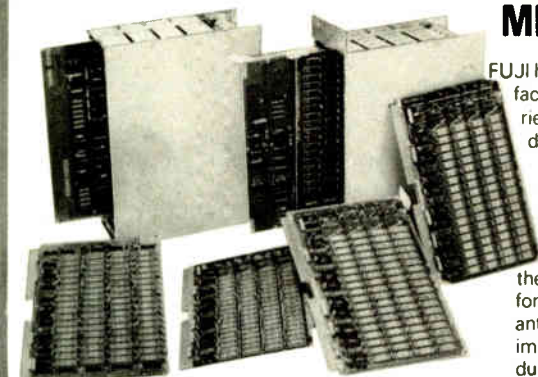

FUJI had entered the field of manufacturing semiconductor memories by utilizing our production, design engineering, and measurement technology developed through many years of experience in manufacturing core memories. As such, we are fully aware of the fact that the reliable design, overall performance as a system and guaranteed reliability are the most important factors in a semiconductor memory system.

FUJI has a history of more than 20 years as a consolidated manufacturer of memory devices, core memory and semiconductor memory, and has gained the trust of a large number of customers for the high reliability and performance of its products such as, hybrid IC, pulse transformers, delay lines, memory cells and peripheral circuits.

These characteristics are being developed to the fullest and are making a large contribution to the manufacture of compact systems.

Our superb technology and production facilities can also quickly meet customer requirements for special designs.

FUJI ELECTROCHEMICAL CO., LTD.

HEAD OFFICE 5-36-11, Shinbashi, Minato-ku, Tokyo 105, Japan TEL 03-434-1271

U.S.A. OFFICE TEL 213-323-1134 EUROPE OFFICE TEL 211-38811 HONG KONG OFFICE TEL 3-691382



The extras make the difference

Extras like variable trigger hold-off (with displayed hold-off time) and external reset/start allow spurious signals to be ignored, multiple pulse period measurement and even measurements on sections picked out of a pulse train.

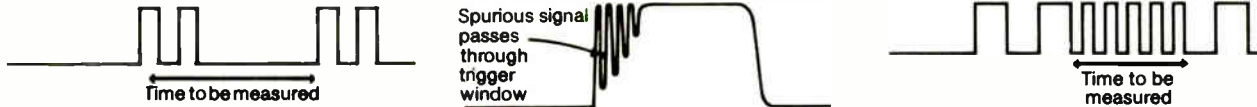

The extras add up to a very versatile 9-digit timer/counter that can make many lab measurements easier--and some even possible for a single instrument setup.

High stability timebases, BCD and analog outputs, IEEE buss, internal battery and rack mounting are some of the options available.

Philips PM6620 series timer/counters from 80 to 1000 MHz; starting at \$965.

Want more information or a demonstration? Call our toll-free Hotline number: 800 631-7172 (New Jersey residents; call collect), or contact: Philips Test & Measuring Instruments, Inc.:

In the U.S.: 85 McKee Drive
Mahwah, New Jersey 07430
Tel.(201) 529-3800

In Canada: 6 Leswyn Road
Toronto, Ontario, Canada M6A 1K2
Tel.(416) 789-7188



PHILIPS

Circle 227 on reader service card

WHO NEEDS A VIDEO OP AMP

**With 1 GHz Gain Bandwidth Product
and
70 Nanosecond Settling to 0.01%?**

Far more people than you would have imagined! People who require the performance of a true differential input op amp at frequencies from DC to beyond 100 MHz, with the ease of using a 741 at 100 kHz. Those who want a ± 5 volt output to reach an accuracy of 0.01% in 70 nanoseconds. Others who require this state-of-the-art performance from -55°C to $+125^{\circ}\text{C}$, and many more who require the high reliability provided by MIL STD 883 processing.

Your application may not need the full temperature range or the hermetically sealed DIP, but for many industrial applications these and other features of the new Video Op Amp offer you vital reliability.

All of this and more is available to you off-the-shelf with the 1435 – The op amp that solves problems you didn't even try to solve before!

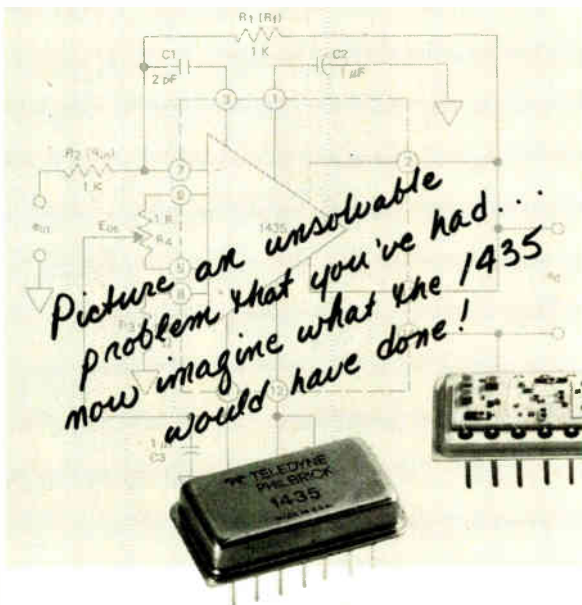

TELEDYNE PHILBRICK

Allied Drive at Route 128
Dedham, Massachusetts 02026
Tel: (617) 329-1600

TWX: (710) 348-6726
Telex: 92-4439
Cable: TELEPHIL

with MINI-BUS[®]

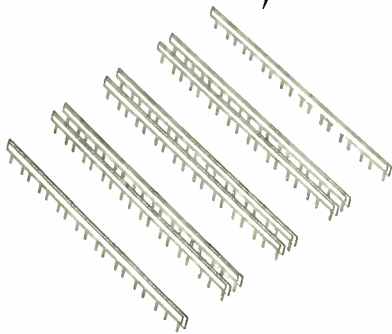

all these MOSTEK MK 4096 memory packages



go on this 2-layer board

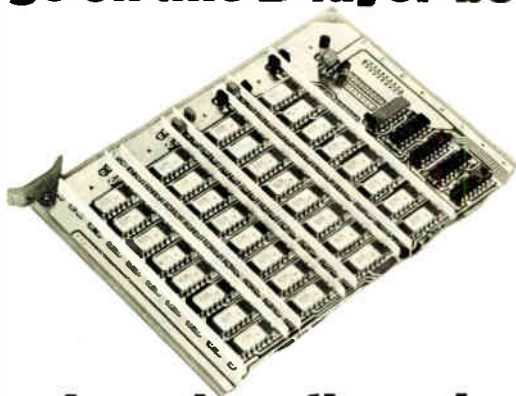

and work as they should!

... and these weren't needed!

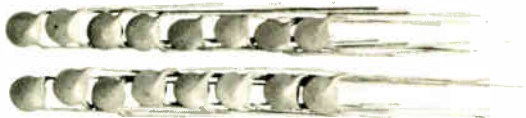

Rogers Application Note No. 1976 tells the full story of how Mini/Bus makes PCB space-saving design easier, eliminates multi-layer PCBs, drastically reduces use of de-coupling capacitors. Write or call for a copy, so you'll know what others know!

© Rogers Corporation 1976

R[®] **ROGERS CORPORATION**
Chandler, AZ 85224 (602) 963-4584

EUROPE: Mektron NV, Ghent, Belgium JAPAN: Nippon Mektron, Tokyo

New literature

Simulator-based logic testing. Application note AN 210-1 is a tutorial text designed to help the digital-circuit designer and test engineer understand the technology of modeling and simulation. Included in this 48-page booklet are the fundamentals of digital testing and logic circuit simulation. Inquiries Manager, Hewlett-Packard Co., 1501 Page Mill Road, Palo Alto, Calif. 94304. Circle reader service number 421.

UL specs. Questions most frequently asked concerning the specifying of products are answered in a new brochure, "How to Specify Products That Meet UL Safety Requirements." It is intended to aid architects, specification writers, insurance underwriters, consultants, and others. Underwriters Laboratories Inc., Public Information Office, 207 E. Ohio St., Chicago, Ill. 60611 [422]

Ion implantation. In a series of technical reports, practical information is provided on the semiconductor production process. Included in the series are the basics of ion-implantation equipment selection (VR-123) and features of high- and medium-current ion-implantation machines (VR-122). Varian, 611 Hansen Way, Palo Alto, Calif. 94303 [423]

Vacuum gauges. A wide variety of gauges are described in this new 23-page catalog. Featured is the new Penthervac GPT-450 continuous reading Penning-Thermistor gauge, which automatically switches pressure scales through 11 decades. Pressure ranges from 1 atmosphere through 10^{-10} torr are covered by various sensing elements and matching controllers. CVC Products, Inc., 525 Lee Road, P. O. Box 1886, Rochester, N. Y. 14603 [424]

Photomultiplier tubes. Besides providing up-to-date information on photomultiplier tubes, a new catalog contains complete information on related sockets, magnetic shields, and power supplies. Specifications for 118 types of photomultipliers and related equipment are included. RCA

THE FASTEST, MOST DEPENDABLE, MOST VERSATILE STRIP CHART RECORDER ANYWHERE.

It's the new GOULD/Brush 110 with a thermal pen unmatched in the quality of its easy-to-read blue traces.

It produces clear, crisp, dry traces at all speeds. With no smudges, no smears, no skips, no puddles.

The pen tip warms up in just milliseconds. So it can produce accurate traces even during a series of short movements. And response time is exceptional. Full-scale response time is 250 milliseconds, which enables it to record fast-changing signals more faithfully than most other strip charts.

When it comes to reliability, we back up our promise with a lifetime pen guarantee. One reason we can make such a strong guarantee is that the special ceramic pen tip is virtually wear-free. No frequent, costly pen replacements. And although other pens are sometimes damaged by excessive off-scale input signals, ours is not because we use hard-electronic limiters and soft mechanical stops.

Then take versatility. The 110 has features that let you tailor it to your exact application. For example, you can choose from ten

chart speeds. A selection of plug-in signal conditioners accommodate a wide range of input signals. Charts may be pulse-driven by an external device. And an optional solid state electronic chart integrator follows positive and negative signals up to 4 times full scale on the analog channel.

We don't believe there's another strip chart recorder in the market that is as fast, dependable and versatile. But don't take our word for it. We'll be happy to give you a demonstration anytime, anywhere. Once you see it, we think you'll believe it too.

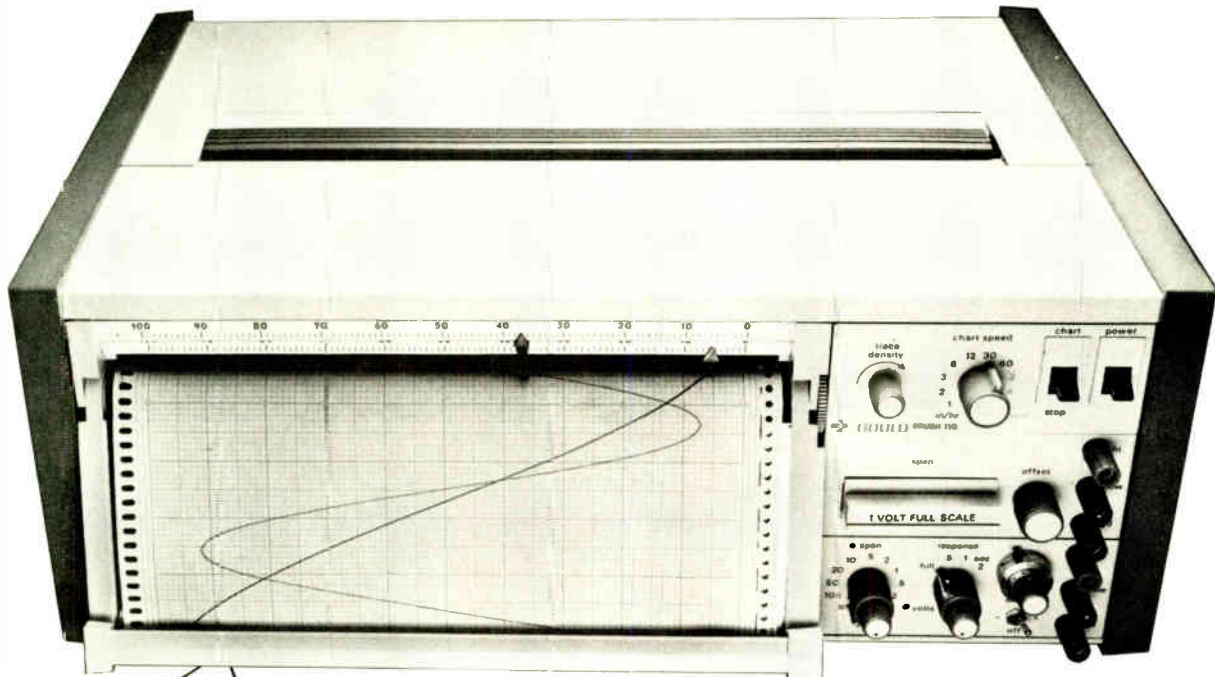

For brochure
call toll free at
(800) 325-6400
Extension 77
In Missouri:
(800) 342-6600

The GOULD/Brush
thermal pen with
a lifetime guarantee.

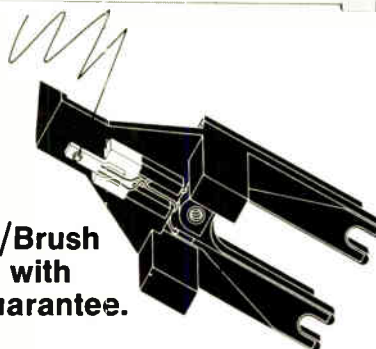

Call your nearest Gould Sales Engineer for a demonstration. Or write Gould, Inc., Instrument Systems Division, 3631 Perkins Avenue, Cleveland, Ohio 44114. Or Gould Allco S.A., 57 rue St. Sauveur, 91160 Ballainvilliers, France.

 **GOULD**

19¢^{*} ea.

An integrated bridge rectifier in a miniature dual in-line package

D I B

DUAL IN-LINE BRIDGE

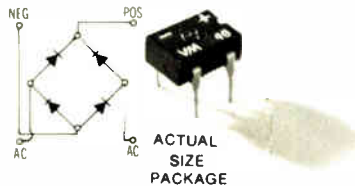

- 4-pin, low-profile DIP
- Leads on standard .10" (2,54 mm) grid
- Compatible with automatic testing, handling and inserting
- 1 Amp at 40°C (I_o)
- 25V to 1000V (V_{RRM})
- 25A Peak One-Half Cycle Surge (I_{FSM})
- Two devices will fit into standard 14-pin DIP socket
- Moisture resistant epoxy package
- Call Lee Miller 214/272-4551, Ext. 206 for more information.

* 100V; 100,000 qty.

Design us in . . . we'll stay there

VARO SEMICONDUCTOR, INC.

P.O. BOX 676, 1003 N. SHILOH, GARLAND, TEX. 75040
(214) 272-4551 TWX 910-860-5178

EUROPEAN OFFICE: UK: VARO SEMICONDUCTOR INTERNATIONAL, INC.
Deepdene House, Bellegrave Road, Welling, Kent, England DA163PY, 01-304-6519/0



New literature

Distributor and Special Products Division, 200 Clements Bridge Road, Deptford, N. J. 08096. Attn: Sales Promotion Services [425]

C-MOS products. All available C-MOS standard products are listed in a new catalog. Specifications and functional and pinout information on 98 different SCL4000B-series devices



and other items are offered. A description of the new Solid Plus low-cost/high-reliability screening program as an option for the logic and memory products is included. Al Genchi, Solid State Scientific Inc., Montgomeryville, Pa. 18936 [426]

Components. A components catalog for industry and military use contains technical and ordering information for circuit-protection devices, relays, switches, buzzers, and flashers. Time-current characteristics are also included. Littlefuse Inc., 800 E. Northwest Highway, Des Plaines, Ill. [428]

IC cross-reference guide. Now you can easily find the correct direct replacement of one IC for another. A cross-reference guide lists linear ICs that can replace those of five other manufacturers. It is based on electrical and mechanical characteristics as shown in current published data. Control and interface circuits are included. Interchangeability in particular applications is not guaranteed. Texas Instruments Inc., Inqui-

A "Special" reminder.

We don't stock this one.

We put it together to demonstrate Cutler-Hammer's unique capability to produce custom—and even proprietary—switch "specials" to satisfy virtually any end-product requirement.

We offer "specials" . . . toggle, rocker, paddle, rotary, slide, key, lever-lock or pushbutton. Both illuminated and non-illuminated.

. . . ac or ac/dc. For one-hole, flush, sub-panel, snap-in or nest mounting. In all sizes. With special circuits that can be ampere or horsepower rated . . . or both.

. . . with screw, spade, pc, solder lug, wire wrap, wire lead and integrated wire terminations.

For "special" assistance on commercial, industrial and MIL-Spec applications, call your Cutler-Hammer sales office or distributor.

And for the many "non-specials" we *do* stock—write Milwaukee for your copy of our new 144-page catalog.

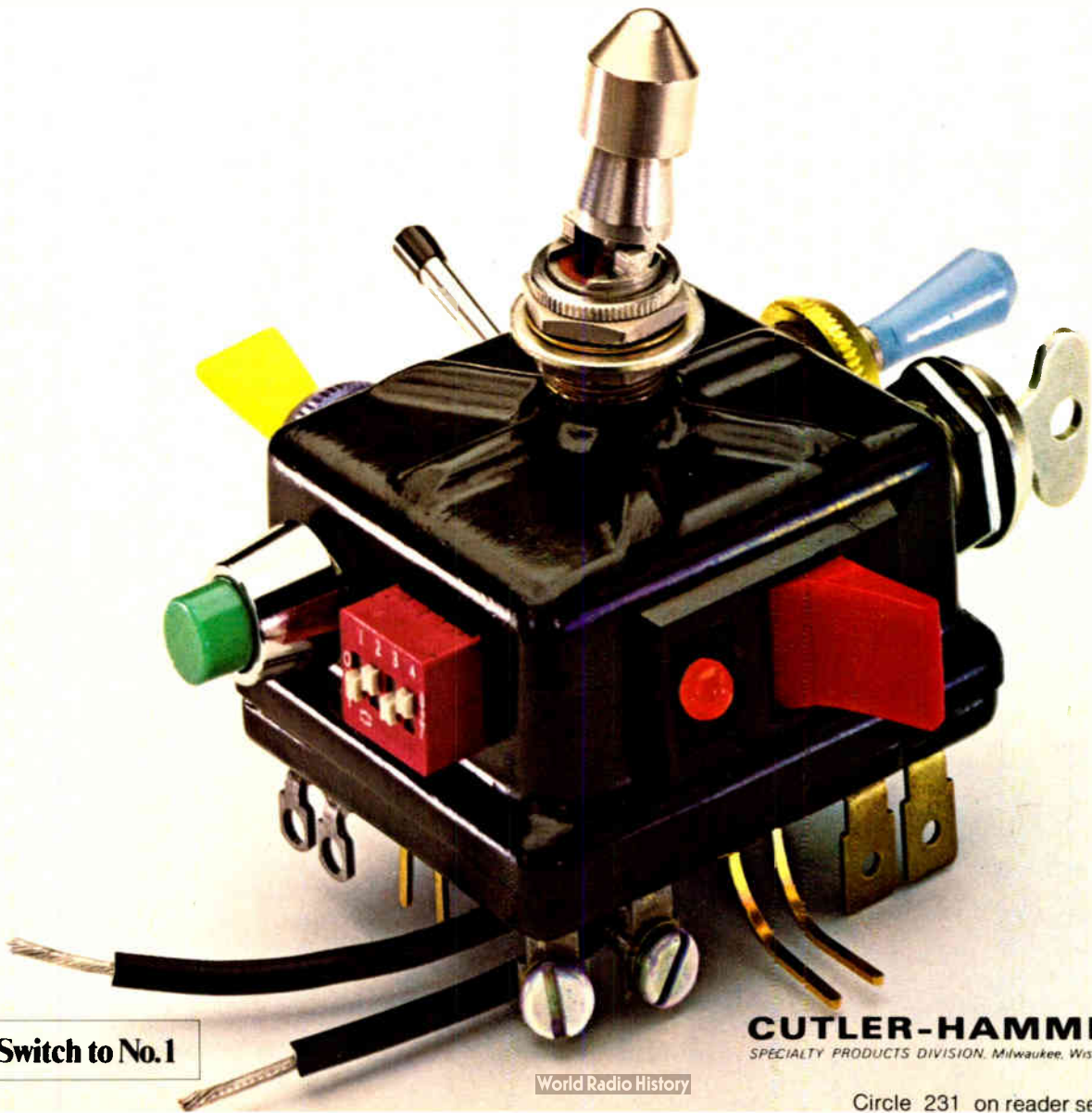

 **Switch to No. 1**

World Radio History

CUTLER-HAMMER
SPECIALTY PRODUCTS DIVISION, Milwaukee, Wis. 53201



Circle 231 on reader service card

AS LOUD AS A FREIGHT TRAIN.

As soft as a whisper.

Mallory Sonalert® Signals.

Choose from over 30 sounds.

Sound levels range from 55 to 100db —
at two feet.

100% solid state.

124 space-saving models.

AC or DC.

Ideal for battery-powered equipment.

Entire package can weigh less than an ounce
and install in 1¼" diameter hole.

We also make special environmental models
for military applications.

Available direct, or through authorized
Mallory Distributors in U.S. and overseas.

Give us a hearing. Send for our newest catalog.

P. R. Mallory & Co. Inc., Box 1284,
Indianapolis, Indiana 46206. (317) 856-3731.

Sonalert® is a registered
trademark of
P. R. Mallory & Co. Inc.



Continuous

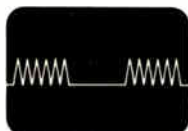

Slow pulse



Fast pulse



Short pulse



Warble

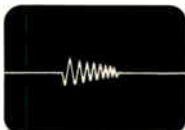

Chime

MALLORY

Sonalert signals... limited only by your imagination.

New literature

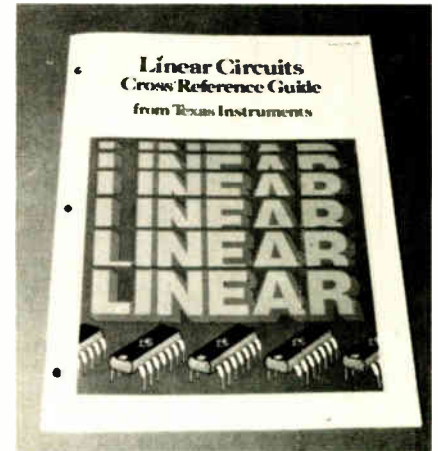

ry Answering Service, P. O. Box 5012, M/S 51 (Attn: Bulletin CB-245), Dallas, Texas 75222 [429]

Readout displays. Catalog SG744 provides detailed descriptions and specifications for incandescent, neon and light-emitting-diode readout displays. Its 54 pages cover a product line of four different character heights in discrete character modules, integrated-module and decoder-driver packages, and groups of characters in complete displays including bezel assemblies or panel brackets. A glossary of terms is included. Dialight, a North American Philips Co., 203 Harrison Place, Brooklyn, N. Y. 11237 [430]

DIP relays. Characteristics of the Magnecraft relay line in dual in-line packages are listed in a new 16-page booklet. There is also a section of application data, which provides

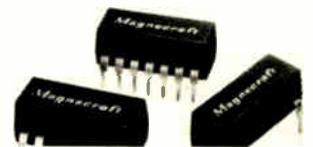

potential users with applications information. The line of relays includes 1 Form A, 2 Form A, 1 Form B, 1 Form C and 2 Form C. High-reliability, mercury, and position-free mercury types are also

The \$99.95 mystery...



B&K-PRECISION's new 3½ digit DMM

For over two years, our competition has been trying to figure out how B&K-PRECISION could sell a full-feature 3-digit DMM for only \$99.95. They've dissected it, analyzed it, and some even asked us how we did it. Well, they can start all over because we did it again!

B&K-PRECISION's new Model 2800 portable DMM features 3-1/2 digit display, auto-zeroing and 100% overrange reading for only \$99.95. Basic DC accuracy is 1%. Twenty-two ranges read up to 1000 volts DC or AC, 1000mA and 10 megohms.

All ranges are well protected against overloads. Even if you should accidentally apply +1000VDC to the 2800 while switched to an ohms range, no instrument damage will result. All DC and AC voltage ranges are protected up to ±1000 volts DC or AC. The current ranges receive the double protection of diodes and a series fuse.

See your local distributor for immediate delivery.

B&K PRECISION **DYNASCAN CORPORATION**

6460 West Cortland Avenue, Chicago, Illinois 60635 • 312/889-9087

In Canada: Atlas Electronics, Ontario • International Sales: Empire Exporters, Inc., 270 Newtown Road, Plainview, LI, NY 11803

Glenayre introduces a new line of 400 watt DC-DC converters

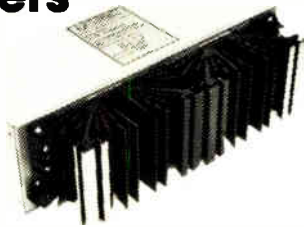

Our new 3000 series starts off with output current limiting, input/output isolation, input polarity protection along with high efficiency. You can also hitch 'em up in parallel for more power.

With a dust proof chassis and convection cooling these rugged units can run base station radio telephones, on-board vehicle telemetry, and on heavy equipment, even sealed beam headlights.

The first entries into the line are 72V to 12V, 48V to 12V and 24V to 12V all rated at 30 amps, at +60°C. Size 17½"W x 5"H x 9"D.

If you have unique needs in voltages, in or out, multiple outputs or packaging, give us a call.

Dealer inquiries invited.

Head Office and Sales

Glenayre Electronics Ltd.
1551 Columbia Street
North Vancouver, B.C. V7J 1A3
Phone: (604) 980-6041 Telex: 04-352520

In the U.S.A.

Glenayre Electronics Inc.
3631 Interlake Avenue North
Seattle, Washington 98103
Phone: (206) 633-4500

Circle 234 on reader service card

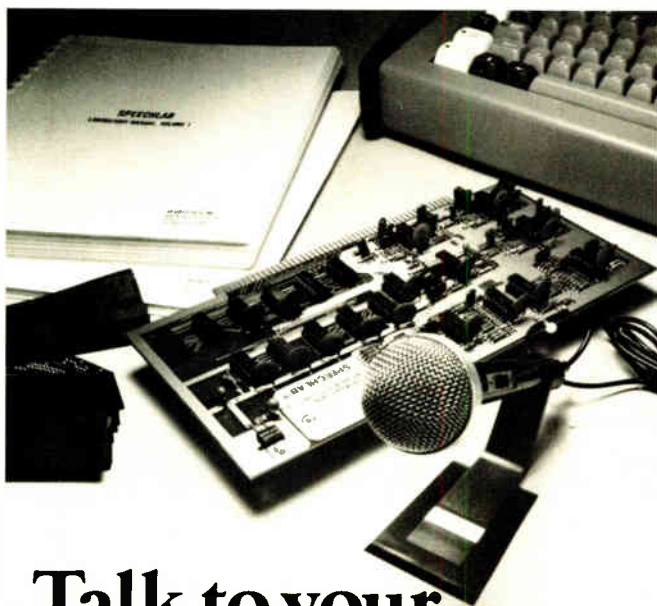

Talk to your computer for \$299.

SpeechLab™ lets you talk to and control any S-100 bus computer... Sol, Altair, IMSAI, etc. Use for computer input, research, vocal control and games. Price, \$299 assembled and tested. Complete hardware/software system, 275 page lab and 95 page hardware manuals.

Address Heuristics, Inc., 900 N. San Antonio Road, Los Altos, CA 94022.
Phone (415) 948-2548.

Heuristics

INC.

New literature

described. Magnecraft Electric Co., 5575 No. Lynch Ave., Chicago, Ill. 60630 [427]

Strain gauges. A new brochure, #100-1, is available for users of strain gauges in stress analysis. A strain-gauge selector chart is included. BLH Electronics, 42 Fourth Ave., Waltham, Mass. 02154 [431]

IC sockets. A 72-page catalog of high-reliability integrated-circuit sockets, socketboard systems, and IC interconnect accessories includes a special test-data section. This section gives details on operating temperatures, insertion and withdrawal forces, contact resistance, and similar parameters. Copies of the catalog are offered by Robinson-Nugent Inc., 800 East Eighth St., New Albany, Ind. 47150 [432]

Bell 301/303 Current Interface. A convenient wallet card that contains the Current Interface chart for Bell 301/303 modems is available from International Data Sciences Inc., 100 Nashua St., Providence, R.I. 02904. The chart gives the pin assignment, common mnemonic name, direction of signal flow, and the function of each signal in the Current Interface. [433]

Paralleling semiconductors. Tech Tips 5-6, entitled "A Graphical Approach to Paralleling Semiconductors," helps design engineers determine how many devices must be connected in parallel to satisfy the demands of a high-current system. An important point stressed in the note is the necessity for matching the forward voltage drops of the semiconductors at or near the ultimate operating current. For a copy, write to Semiconductor Division, Westinghouse Electric Corp., Youngwood, Pa. 15697. [434]

Using a levelmeter. An application note that tells how a frequency-selective level meter can be used to perform five different types of tests is offered by Cushman Electronics Inc., 830 Stewart Drive, Sunnyvale, Calif. 94086. Ask for Product Application No. 7. [435]

COMPARE THE TOP-RATED 4½-DIGIT DMMs.

Put these three 4½-digit multimeters side-by-side and you'll want the Keithley 172.

The 172 gives you superior accuracy, resolution and convenience with no compromise—at a competitive price.

If you want more evidence, send for our detailed "Comparative Guide to 4½-digit DMMs"

The Keithley 172 rates best—not on every factor, but on most.

If you want hands-on proof, put our 172 side-by-side with the Fluke 8600A, HP 3465A, or any other 4½-digit DMM. The Keithley will stand alone.

Check the chart below or make your own comparison, you'll pick the Keithley 172.

Fluke 8600A



HP 3465A



Keithley 172



| | Fluke 8600A | HP 3465A | Keithley 172 |
|---|------------------------------|------------------------------|------------------------------|
| Functions & Ranging: | | | |
| dcV | Auto/Manual | Manual | Auto/Manual |
| acV | Auto/Manual | Manual | Auto/Manual |
| dcA | Manual | Manual | Auto/Manual |
| acA | Manual | Manual | Auto/Manual |
| ohms | Auto/Manual | Manual | Auto/Manual |
| Basic Accuracy (dc volts @ 25°C ambient) | ± 0.02% reading + 1 digit | ± 0.02% reading + 1 digit | ± 0.01% reading + 1 digit |
| Full Range Display (Counts) | 19999 | 19999 | 29999 |
| HI/LO Ohms | No | No | Yes |
| Ohms Configuration | 2 terminals | 2 terminals | 2 or 4 terminals |
| Lighted Function Indicator | No | No | Yes |
| Price | \$549 | \$510 | \$525 |

Comparison based on manufacturers' published specifications. Prices are domestic U.S. for ac line-operated instruments.

It's easy to make your own comparison. Use coupon. Or call (216) 248-0400.

KEITHLEY INSTRUMENTS, 28775 Aurora Road, Cleveland, Ohio 44139.

In Europe: D-8000 München 70, Heighofstrasse 5, West Germany, (089) 7144065.

- Send specs on the Keithley 172. I'll make my own comparison.
- Send "Comparative Guide to 4½-digit DMMs." I need more proof.
- Bring in a Keithley 172 so I can make a side-by-side comparison.



Name _____ Title _____
 Company _____
 Address _____
 City _____ State _____ Zip _____
 Phone _____

KEITHLEY
The measurement engineers.

DETECTOR / FILTER ARRAYS

A SOLID STATE APPROACH
TO COLOR ANALYSIS

DESIGN FEATURES:

- Standard 16 pin DIP Package
- High speed parallel output
- Microprocessor compatible
- High resolution - 10nm HBW
- Wide selection of filtration 410 - 1000nm
- Photovoltaic operation - no bias required
- Linear over 5 decades

Isotek

Isotek Corporation

8 types are available to fit your requirements at prices ranging from \$325 to \$63 in quantity. Consider for a moment what high speed, parallel read out could do for your system.

WRITE OR CALL FOR PRICING INFORMATION

567 CHICKERING ROAD NO. ANDOVER, MASS. 01845 TELEPHONE 617 685-1511

Circle 236 on reader service card

The fabulous **Phi-Deck**[®] family of 5 cassette transports under \$100 in quantities of 10

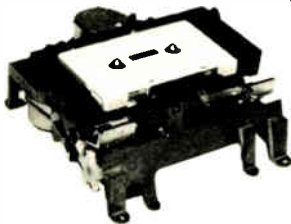

- Featuring:
- Die-cast frames
 - Remote controllable
 - Precise, fast head engage/disengage
 - Quick braking
 - Search FF/rewind 120 ips
 - Speed ranges from .4 to 20 ips

Electronic packages and mag heads for most applications

For application in:

- | | |
|-----------------------------------|---------------------------------------|
| 1. Micro processing | 7. Security/automatic warning systems |
| 2. Data recording/logging/storage | 8. Test applications |
| 3. Programming | 9. Audio visual/education |
| 4. Instrumentation | 10. Telephone interconnect |
| 5. Industrial Control | 11. Hi-Fi |
| 6. RS-232 Data storage | 12. Point of sale |



Triple I Incorporated
4605 N. Stiles P.O. Box 18209
Oklahoma City, Oklahoma 73118 (405) 521-9000

- I am interested in application no. _____
 Have Representative call Send application notes

Name _____ Title _____
Company Name _____
Address _____
City _____ State _____ Zip _____
Phone Number _____

236 Circle 50 on reader service card

World Radio History

New books

Digital Systems: Principles and Applications, Ronald J. Tocci, Prentice-Hall, 479 pp., \$15.95.

Introduction to Digital Computer Technology, 2nd ed., Louis Nashelsky, John Wiley & Sons, 529 pp., \$15.95.

Design of Systems and Circuits for Maximum Reliability or Maximum Production Yield, Peter W. Becker and Finn Jensen, McGraw-Hill, 293 pp., \$17.00.

The Reston Encyclopedia of Biomedical Engineering Terms, Rudolf F. Graf and George J. Whalen, Reston Publishing (Prentice-Hall), 415 pp., \$29.95.

Computer-Aided Design of Digital Systems, Douglas Lewin, Crane, Russak & Co., 313 pp., \$22.50.

Handbook of Components for Electronics, Charles A. Harper, ed., McGraw-Hill, 1,086 pp., \$36.50.

A Catalog of Operational Transfer Functions, Don Watts, Garland Publishing, 280 pp., \$26.00.

Secondary Radar: Fundamentals and Instrumentation, Peter Honold, Heyden & Son, 224 pp., \$19.00.

Management of Engineering Projects, Victor G. Hajek, McGraw-Hill, 264 pp., \$15.95.

Digital Communications by Satellite, J.J. Spilker Jr., Prentice-Hall, 672 pp., \$38.00.

Basic Digital Electronics with MSI Applications, John A. Dempsey, Addison-Wesley, 415 pp., \$14.50.

A Dictionary of Microcomputing, Philip E. Burton, Garland Publishing, 171 pp., \$12.50.

A Handbook on Mobile Communications, William G. Duff, Don White Consultants Inc. (Germantown, Md.), 270 pp., \$29.50.

Written Communication for Data

See How 1 Sanken Super Beta Transistor Does the Work of 2 Transistors.

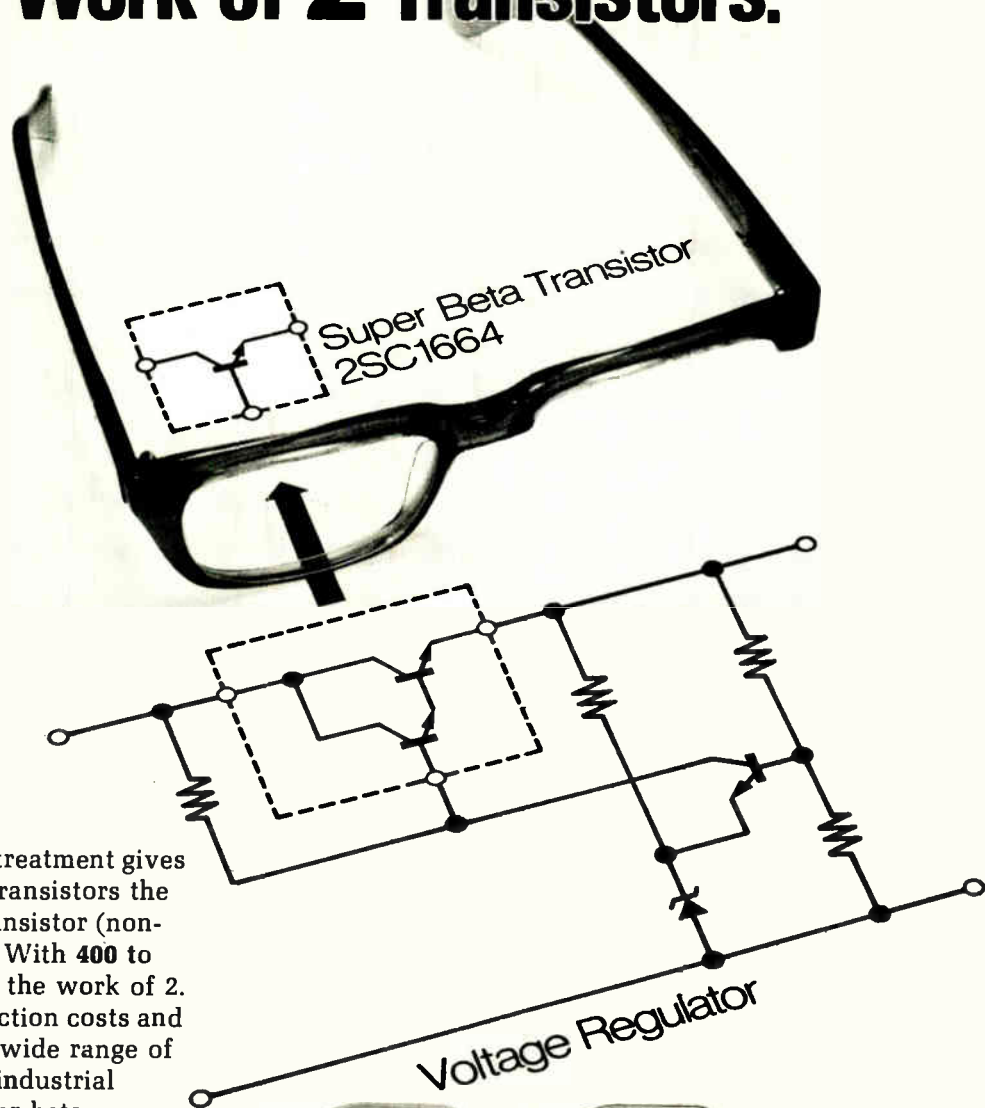

Sanken's unique surface treatment gives these super beta power transistors the world's highest single transistor (non-Darlington) current gain. With **400 to 2500 current gain**, 1 does the work of 2. The result is lower production costs and simplified assembly in a wide range of power supply/consumer/industrial applications. Sanken super beta transistors possess excellent secondary breakdown characteristics and large current handling capabilities which are the outstanding features of Sanken power transistors. They are extensively used in color TV regulated power supply circuits and are well reputed for their advantages.

About 30% of Japanese color TV's currently employ these super beta transistors and this percentage will surely increase. Compared to Darlington, collector saturation voltage $V_{CE(sat)}$ is 0.6 to 0.7V lower and internal power loss is minimal.

Write for complete details.



| NPN Type Number | V_{CBO} (V) | V_{CE0} (V) | I_C (A) | P_C (W) | T_{stg} (°C) | $V_{CE(sat)}$ | | | f_T | | |
|--------------------|------------------|------------------|--------------|--------------|-------------------|---------------|--------------|--------------|------------|--------------|-----------------|
| | | | | | | MAX. (V) | @ | | TYP. (MHz) | @ | |
| | | | | | | | I_C (A) | I_B (A) | | I_E (A) | V_{CE} (V) |
| 2SC1829 | 200 | 150 | 5 | 100 | -65~+150 | 2.0 | 1.5 | 0.05 | 15 | -0.1 | 12 |
| 2SC1831 | 90 | 70 | 8 | 100 | -65~+150 | 1.0 | 3 | 0.03 | 10 | -0.5 | 12 |
| 2SC1629 | 90 | 70 | 6 | 50 | -65~+150 | 1.0 | 3 | 0.06 | 10 | -0.5 | 12 |
| 2SC1768 | 200 | 150 | 5 | 50 | -65~+150 | 2.0 | 1.5 | 0.05 | 15 | -0.1 | 12 |
| 2SC1664 | 70 | 60 | 6 | 40 | -65~+150 | 1.0 | 3 | 0.06 | 10 | -0.5 | 10 |
| 2SC1664A | 100 | 80 | 6 | 40 | -65~+150 | 1.0 | 3 | 0.06 | 10 | -0.5 | 10 |
| 2SC1888 | 80 | 60 | 3 | 0.8 | -65~+150 | 1.0 | 0.5 | 0.005 | 15 | -0.1 | 5 |
| 2SC1889 | 100 | 80 | 3 | 0.8 | -65~+150 | 1.0 | 0.5 | 0.005 | 15 | -0.1 | 5 |
| 2SC1983 | 80 | 60 | 3 | 30 | -55~+150 | 1.0 | 2 | 0.05 | 15 | -0.2 | 12 |
| 2SC1984 | 100 | 80 | 3 | 30 | -55~+150 | 1.0 | 2 | 0.05 | 15 | -0.2 | 12 |
| 2SC2198 | 100 | 50 | 6 | 40 | -65~+150 | 1.0 | 5 | 0.1 | 17 | -0.5 | 10 |

Sanken SANKEN ELECTRIC CO., LTD.

1-22-8 Nishi-Ikebukuro, Toshima-ku, Tokyo, 171 Japan

Telex: 0272-2323 (SANKEN J) Cable: SANKELE TOKYO Phone: (03) 986-6151

Circle 237 on reader service card

17TH JAPAN ELECTRIC MEASUREMENT & CONTROL INSTRUMENT- AUTOMATION EXHIBITION

• NOV. 15th - 18th 1977
• TOKYO INTERNATIONAL TRADE CENTER (MARUMI)

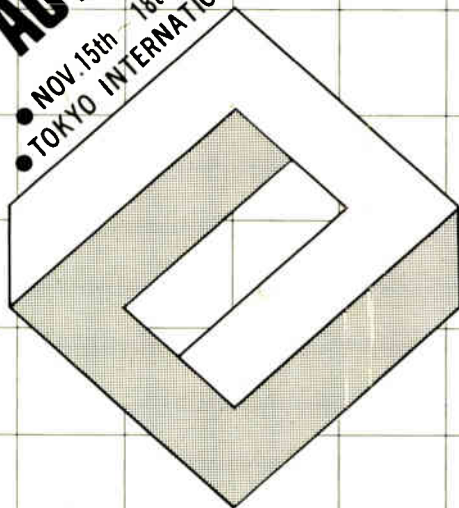

JEMIMA



JAPAN ELECTRIC MEASURING
INSTRUMENTS MANUFACTURERS' ASSOCIATION

20 SHIBA, KOTOHIRA-CHO, MINATO-KU, TOKYO, JAPAN

SPECIAL INVITATION TO:

The 17th Japan Electric Measurement & Control Instrument-Automation
Exhibition.

Nov. 15 - 18, 1977, Tokyo

Cut out this invitation and bring it to the Exhibition, and
an exhibitor list will be forwarded to you.

New books

Processing, Randi Sigmund Smith, Van Nostrand Reinhold, 199 pp., \$12.95.

Electricity and Electronics for Agriculture, Allen F. Butchbaker, The Iowa State University Press, 391 pp., \$19.95.

Biological Effects of Electric and Magnetic Fields of Extremely Low Frequency, Asher R. Sheppard and Merrill Eisenbud, New York University Press, 255 pp., \$15.00.

Practical Digital Design Using ICs, Joseph D. Greenfield, John Wiley & Sons, 569 pp., \$16.95.

Semiconductor Electronics Design, Fred K. Manasse, Prentice-Hall, 562 pp., \$18.95.

Power System Control and Stability, P.M. Anderson and A.A. Fouad, Iowa State University Press, 478 pp., \$45.00.

Handbook of Oscilloscope Waveform Analysis and Applications, Miles Ritter-Sanders Jr., Reston Publishing, 200 pp., \$15.95.

Coupling of External Electromagnetic Fields to Transmission Lines, Albert A. Smith Jr., John Wiley & Sons, 132 pp., \$14.50.

Advanced Systems Development Management, John de S. Coutinho, John Wiley & Sons, 433 pp., \$23.00.

Electronic Troubleshooting: A Manual for Engineers & Technicians, 2nd ed., Clyde N. Herrick, Reston Publishing, 348 pp., \$16.05.

Electronic Systems Theory and Applications, Henry Zanger, Prentice-Hall, 340 pp., \$15.95.

Laser Systems in Flow Measurement, Tariq S. Durrani and Clive A. Greated, Plenum Press, 289 pp., \$27.50.

Microcomputer Handbook, Charles J. Sippl, Petrocelli/Charter, 453 pp., \$19.95.

1977 Answer Book. It makes your job easier. \$25.

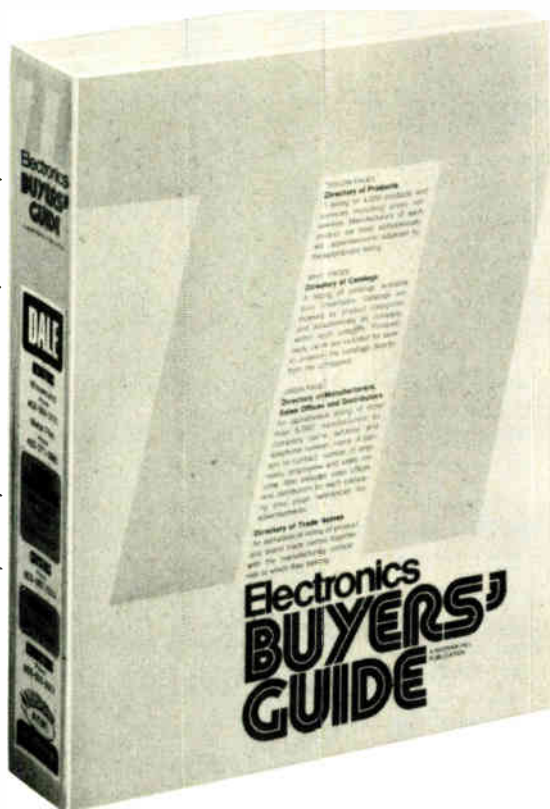

“WHO MAKES WHAT?”

**“WHAT COMPANIES
MAKE THE PRODUCTS
I NEED?”**

(See alphabetical directory
of 4000 products)

**“WHERE ARE THEIR
NEAREST
SALES OFFICES?”**

**“WHO ARE THEIR
DISTRIBUTORS?”**

**“WHAT ARE THEIR
LOCAL PHONE
NUMBERS?”**

(See alphabetical directory
of over 5000 manufacturers)

**“HOW CAN I GET THEIR
CURRENT CATALOGS
FAST?”**

(See directory of catalogs
by product and by company,
including catalog inquiry
cards for 5-second ordering)

**“WHO MANUFACTURES
THIS TRADE NAME?”**

(See Directory of
Trade Names)

**Special no-risk offer. If The Answer Book is not everything
we say it is and more, return the book to us within
ten days and we will refund your \$25.**

Electronics Buyers' Guide (EBG) is as easy to use as your telephone directory. The whole international world of electronics is at your fingertips. Great emphasis is put on *localizing* the information you need. You won't have to call half-way across the country to company headquarters because we list local sales offices and distributors.

To order from our Directory of Catalogs, simply circle the corresponding number on the post-paid Inquiry (“bingo”) Cards and mail. This way you get *current* catalogs. The Answer Book's objective: Make your job easier.

Electronics Buyers' Guide

1221 Avenue of the Americas
New York, N.Y. 10020

Yes, send me a copy of The Answer Book.

I've enclosed \$25 (USA and Canada only, elsewhere send \$35). Full money back guarantee if returned within 10 days.

Name _____

Company _____

Street _____

City _____

State _____

Zip _____



Classified section FOR ENGINEERING/TECHNICAL EMPLOYMENT OPPORTUNITIES

CLASSIFIED SALES REPRESENTATIVES

Atlanta ... Joe Lane ... 404/892-2868
 Boston ... Holt Buchanan ... 617/262-1160
 Chicago ... Bill Higgins ... 312/751-3733

Cleveland ... Mac Huestis ... 216/781-7000
 Dallas ... Mike Taylor ... 214/742-1747
 Denver ... Shirley Klotz ... 303/837-1010
 Detroit ... Mac Huestis ... 313/873-7410

Houston ... Mike Taylor ... 713/659-8381
 Los Angeles ... Stan Kassir ... 213/487-1160
 New York ... Dave Hawksby ... 212/997-3594
 Philadelphia ... Dan Ferro ... 215/568-6161

Pittsburgh ... Dan Ferro ... 412/391-1314
 San Francisco ... M.E. Kenny ... 415/362-4600
 Stamford ... Holt Buchanan ... 203/359-2860
 XEROX 400 TELECOPIER ... 212/997-6800

MOS Process Manager

You will start up industry standard MOS, N Channel, CMOS, and PMOS processes in our Portland, Oregon manufacturing facility. Having set up these processes, you will be responsible for managing the sustaining operation and implementing new processes into the system.

Extensive experience in MOS process engineering and manufacturing is necessary. You should have experience managing process engineers in a research or production environment.

In support of our development and manufacturing of precision electronic instrumentation, Tektronix designs and produces custom in-house state-of-the-art MOS and bipolar linear and digital IC's. Located near Portland, Oregon we are within a two hour drive from the Cascade Mountains or Ocean Beaches. The close-by nature playgrounds and the City of Portland provide a variety of recreational and cultural interests.

Salary is open. Benefits include educational support, insurance and profit sharing programs.

Send your resume to: Roy Epperson, TEKTRONIX, INC., P.O. Box 500, E78, Beaverton, OR 97077.

An Equal Opportunity Employer M/F.

Tektronix
 COMMITTED TO EXCELLENCE

POSITIONS VACANT

Senior Product Engineer—Electronic—The Door Operating Equipment Division of The Stanley Works, headquartered in Farmington, Conn., is seeking an Electronics Engineer. The successful applicant must have proven abilities as project manager on product development programs, and will be responsible for evaluation of field requirements and problems, for product design and development, and for coordination with factory on new design. Must be degreed, with a minimum of five years experience in electronics; solid state devices, logic circuits, and power control of fractional H. P. motors. Knowledge of microwave technology and infrared devices helpful. Submit your resume, including salary history to: The Stanley Works, Corporate Employment, Dept. 609E, P.O. Box 1800, New Britain, Conn. 06050, Stanley Tools, Stanley Hardware, Stanley Steel. An Equal Opportunity Affirmative Action Employer.

Electrical Engineering Technology faculty position—Assistant/Associate professor, depending upon qualifications, beginning in September 1977, hopefully to be filled by August 1. Applicants must have a Master's degree, preferably in the area of electrical/electronic engineering. P.E. or E.I.T. qualifications are highly desired. Three to five years of relevant work experience is necessary. Teaching experience is desired. Applicants should have competencies in electrical systems, digital logic, rotating machines, circuit design, energy converters and electrical distribution. Send resume and references to Dr. D. F. Hackett, Chairman, Technology Division, Georgia Southern College, Box 8044, Statesboro, GA 30458. Affirmative action/equal opportunity employer.

SELLING OPPORTUNITY WANTED

Manufacturers Rep metro. NY area wants additional lines to electronics industry. RA-5021, Electronics.

POSITION WANTED

Project & Technical Director/Research & System Engr. Manager — Over 15 years industrial and academic experience in electronic/electrical systems, controls, and instruments. Seek a challenging opportunity to apply my proven management and technical capabilities. Willing to discuss how I can make a major contribution to a growing organization. Reply to PW-5020, Electronics. (609) 799-1385.

OVERSEAS JOBS GUIDE

Job Hunting Guide + Directory of 600 Firms. Details on job sources, resumes, taxes. US\$6.00 + 50¢ P&H (US & Canada). To foreign addresses—add \$1.50 P&H. Friar Books, Dept. EL, 8965 E Ardendale, San Gabriel, CA 91775.

We have been placing graduate **ENGINEERS**

in **FEE-PAID** positions THROUGHOUT THE U.S. since '59. Over 1,000 client companies. We are graduate engineers working full-time for you. Send resume & salary history today or request confidential application.

ATOMIC PERSONNEL, INC.

Suite L, 1518 Walnut St., Phila., Pa. 19102
 An Employment Agency
 For All Technical Fields

* **SOFTWARE/FIRMWARE COMMUNICATIONS** Design & Project Eng'rs.
 • BS, MS, PH.D. •
 Nat'l Unadvertised Positions
 • \$16-30K •
 P'nB Consultants, Box 261 (M)
 Wayne, PA 19087

The Engineers Who
 Talk Your Language

BSEE/MSEE FOR MOS/LSI DESIGN NEW VACANCIES

An expansion in our design effort has created opportunities for professionals with two or more years of recent experience in logic and circuit design and a BSEE or MSEE degree. Device Application included in the experience is preferred.

Also, we have need for a design engineer specifically experienced in MOS/LSI circuit development. This individual must have a good familiarity with memory devices. Apart from the above, we will consider applications for an entry design engineer position. This requires a BSEE or MSEE and an interest in logic and circuit design.

Reply in confidence to:



**Mr. T. F. Wade, Manager
Personnel Resources
Microelectronics Division
NCR Corporation
8181 Byers Road
Miamisburg, Ohio 45342**

An Equal Opportunity Employer

FREE Your dream job.

We hope you're happy in your current position, but there's always that ideal job you'd prefer if you knew about it.

That's why it makes sense to have your resume on file in the Electronics Manpower Register, a computerized data bank containing the qualifications of career-conscious ELECTRONICS readers just like yourself.

You'll benefit from nation-wide exposure to industry firms privileged to search the system, and since the computer never forgets, if you match up with their job requirements you'll be brought together in confidence.

To take advantage of this free service, mail your resume to the address below.

**ELECTRONICS MANPOWER REGISTER
Post Office Box 900/New York, N.Y. 10020**

Help Create Tomorrow's Products at WANG!

Field Engineers

Job No. E 3116

Must be knowledgeable on 2314 type and/or storage module disk drives. Experience with vacuum column type (16 BPS) tape drives is a plus. BSEE preferred.

Computer Systems Engineer

Job No. E 3115

3 years experience in all areas of logic computer systems. Responsibilities include training of service personnel, documenting diagnostics and systems procedures. BSEE required.

Technical Writers - Hardware

Job No. E 3113

These positions require individuals with extensive writing experience in digital hardware and some exposure to software along with publications knowhow.

Component Reliability Engineers

Job No. E 3117

Put your true potential to the test! WANG is offering a unique opportunity for take-charge individuals. Candidates must be thoroughly familiar with semi-conductors with a strong background in ROM, RAM, microprocessors, etc. Position requires BS or MSEE degree and relevant experience. These are key positions with excellent salaries and earning potential.

Quality Control Engineer

Job No. E 3118

Self-motivated individual needed to assist and support our Quality Control and Manufacturing Departments in spotting problem areas and determining best solutions. Will also perform light tests and set up test parameters on computer products. You must have an engineering or equivalent degree and have relevant experience. Ability to communicate effectively, both in writing and orally, required.

Excellent salaries and earning potential plus superior company benefits. We are an affirmative action/equal opportunity employer. Please send resume including academic background and salary history and requirements, indicating Job Number to:

Manager, Professional Recruiting
(617) 851-4111



One Industrial Avenue, Lowell, Massachusetts 01851

**GTE LENKURT . . .
on the SAN FRANCISCO PENINSULA . . .**

is a leading supplier of microwave, multiplex, carrier and data transmission systems to the U.S. common carrier communications industry.

PCM & Data Product Development Engineer

I Immediate opportunity exists for an Engineer with 3-5 years experience in analog and digital circuit design for product development of high speed digital transmission systems. BSEE required.

We offer extremely attractive benefits and salary structure! Send detailed resume to Dean E. Hammer, Professional Employment, GTE Lenkurt, 1105 County Road, San Carlos, CA 94070. An equal opportunity employer.

GTE LENKURT

MOS/LSI TEST SYSTEMS ENGINEER

Project level responsibility to direct and coordinate all test program design, development and implementation for characterization, evaluation and production testing of MOS/LSI devices. Prior experience must include direct work with test systems and significant involvement with circuits and logic in systems applications. A creative approach to I.C. testing along with an MSEE and knowledge of computer controlled test systems hardware will make you a preferred candidate.

If you are interested in this position, send us a resume or letter defining your particular qualifications and accomplishments. We want experience with digital circuits and logic design, the implementation of MOS circuitry into a system, test program writing and some prior project leader responsibility.

NCR

**T.F. Wade, Manager
Personnel Resources
Microelectronics Div.
NCR Corporation
8181 Byers Rd.
Miamisburg, OH 45342**

An Equal Opportunity Employer

Opportunities to Challenge Yourself and Your Ideas.

The Environmental Research Institute of Michigan (ERIM), serves as a catalytic agent among government agencies, universities and industries for the application of advanced technology and associated scientific methodology to society's problems.

Formerly Willow Run Laboratories of the University of Michigan, ERIM offers qualified candidates the opportunity to explore the areas of scientific research and development usually found only in the academic world, in the less constricted atmosphere of a private non-profit research organization. The independent environment of ERIM breeds challenges and complexities of opportunity which extend beyond specific job classifications.

Our expanding research and development program has created a number of new, permanent engineering staff positions. If you hold an advanced degree and have experience in the areas of Radar, Remote Sensing, Optics, Data Processing, or Energy Technologies and Applications; we want to hear from you.

The location of ERIM in Ann Arbor, Michigan, adjacent to the University of Michigan, offers cultural, academic, sports and entertainment opportunities of every kind. Salaries are competitive and fringe benefits are above average. All replies strictly confidential.

Send your detailed resume to:

ENVIRONMENTAL RESEARCH INSTITUTE OF MICHIGAN

P.O. Box 618, Ann Arbor, Michigan 48107
Attention: Personnel Administrator
An Equal Opportunity Employer

Job-seekers... be the first to know with McGraw-Hill's Advance Job Listings

By having our weekly ADVANCE JOB LISTINGS sent to your home every Monday you can be the first to know about openings both in and out of your field. AJL will enable you to contact anxious recruitment managers BEFORE their ads appear in upcoming issues of 21 McGraw-Hill publications. To receive a free sample copy, plus information about our low subscription rates, fill out and return the coupon below.

ADVANCE JOB LISTINGS / P.O. BOX 900 / NY 10020

PLEASE SEND A SAMPLE COPY
OF ADVANCE JOB LISTINGS TO

NAME _____

ADDRESS _____

CITY _____

STATE / ZIP _____

MAKE YOUR
NEXT
MOVE A STEP
IN THE
RIGHT
DIRECTION



The road to professional fulfillment can be a real jungle. We can help you find the right path. Our affiliation with

National
Personnel
Associates®

keeps us informed of opportunities in the ELECTRONICS industry from coast to coast as they occur. Together with over 175 associates, we offer our knowledge and expertise at no charge to you. Fees are company paid.

BRENTWOOD PERSONNEL ASSOCIATES
1280 Route 46
Parsippany, New Jersey 07054
(201) 335-8700

WETERRINGS & AGNEW, INC.
425 Midtown Tower
Rochester, New York 14604
(716) 454-3888

PERSONNEL INC.
Jim Trexel
836 National Road
Wheeling, West Virginia
26003
(304) 233-3000

ALFRED J. ALLEN & ASSOCIATES, INC.
999 N. Sepulveda Blvd.,
Suite 704
El Segundo, California 90245
(213) 776-6852

AVAILABILITY, INC.
Engineering Consultants
1300 N. Westshore Blvd.
Tampa, Florida 33607
(813) 872-2631

ANDERSON-TAYLOR
P.O. Box 21
Exton, Pennsylvania 19341
(215) 363-1600

ENGINEERS PROGRAMMERS

**Now is the time to join ATI
on the San Francisco Peninsula.**

Noted for excellence in the field of computer based electronics, Applied Technology offers an atmosphere of excitement, challenge and opportunity to individuals looking for career growth. Contact us immediately if you qualify:

ELECTROMAGNETIC ENGINEERING

Engineering Specialist

Position requires ability to formulate, describe and specify general aspects of a receiving subsystem (i.e., frequency ranges, sensitivity, signal-to-noise, dynamic range, affects of compression and input-output interfaces). Must be thoroughly knowledgeable in present state-of-the-art components and techniques, their limitations and applied useages. A strong background in solid state circuits is also required. Candidates must have at least 10 years' experience in receiver subsystems, with at least 2 years in MIL-E-5400 airborne ECM receiver design. MSEE or PhD desired.

Senior Engineer

Candidate will provide technical contributions in the general area of wide-frequency range ECM-related RF receivers. Must be thoroughly knowledgeable in present state-of-the-art components and techniques—their limitations and applied useages. General receiver techniques utilized will include broad band crystal video, TRF (Yig tuned), and superheterodyne. Special emphasis will be on large, dynamic range, high gained broad band RF amplifiers and mixers, and associated passive and active circuit components. Candidate should have at least 5 years' experience in receiver subsystems, with at least 2 years in MIL-E-5400 airborne ECM receiver design. Recent experience in digital processor control-led receivers will be highly desirable. Qualified candidates should have at least a BSEE.

MECHANICAL ENGINEERING

Engineering Specialists

Your experience in the areas of electronic packaging and designing of electronic hardware for aerospace applications will be utilized in the performance of mechanical design of electronic hardware and implementation into hardware practical solutions to high density (Watts per cubic inch) packaging problems. You may also be required to exercise technical supervision of other engineers and designers. Proven experience in high density packaging of electronic components for military aircraft application in accordance with MIL-E-5400 and a minimum of 5-7 years' design experience in the aerospace environment is desirable. BSME/MSME and/or graduate study in thermo-analysis and computer technology highly desirable.

ADVANCED SYSTEMS SOFTWARE

Sr. Scientific Programmer

Our projects involve the programming of commercial micro and mini-computers and our own highly sophisticated family of avionics computers. Our needs are in applications programming and involve control processing, signal processing and interfacing with special purpose hardware. These software engineers will routinely use HP computer systems with disk base real time operating systems in developing programs for several types of avionics computers. You will perform hands-on computer operation during avionics systems integration. BS/MS/PhD in EE, Math, Physics or Computer Science plus 3-7 years' working knowledge of mini-computer assembly language required.

For consideration, please send resume with salary history and requirements to Professional Staffing, 645 Almanor Avenue, Sunnyvale, California 94086. We are an equal opportunity employer, m/f.

Itek Applied
Technology

A Division of Itek Corporation

Marketing Product Supervisor

The task is to plan and implement the total marketing program in the assigned product area. Activities will involve close relationships with Engineering and Sales groups during the planning, development, and introduction of products. Close customer interaction will be required to provide in-depth applications assistance.

Your industrial marketing experience will be necessary. Technical background should include broad experience in applications of general test equipment as well as computer interface standards such as GPIB. Software knowledge is necessary. Formal education might include BSEE/CS and MBA.

Salary is open. Benefits include educational support, insurance and profit sharing programs.

Please send detailed resume and salary history to: Bill Eppick, TEKTRONIX, INC., P.O. Box 500, E76, Beaverton, Oregon 97077.

An Equal Opportunity Employer M/F.



90,000 engineers and managers for \$46.00

For only \$46.00 per inch your recruitment advertising in ELECTRONICS' Classified Section will reach 90,000 career-conscious engineers and managers as they're reading to combat job obsolescence, while they're thinking about their future and bettering themselves.

There's no charge for typesetting and free layout service is provided. For more information call or write:

ELECTRONICS

Post Office Box 900
New York, N.Y. 10020 • Phone: 212/997-2556

SERVICE SPECIALIST CHEMISTRY INSTRUMENTS

Senior professional position open for a well trained and experienced technician who can maintain, repair, improve NMR and Mass Spectrometers (& I.R./U.V. instruments), and effectively manage their operation/use. Send resume in confidence to: Assistant Personnel Director, Box 636,

UNIVERSITY OF ROCHESTER
260 CRITTENDEN BOULEVARD
ROCHESTER, NEW YORK 14642

An Equal Opportunity Employer
(M/F)

POSITIONS VACANT

Electronics Design Engineer Sacramento Peak Observatory is seeking a highly qualified Engineer with a broad range of experience in analog, signal processing, video, computer, digital and interfacing. Work will consist of the development of circuitry related to scientific instrumentation as well as supervising the maintenance of existing equipment. This hands-on position requires hardware familiarity with a wide range of electronic devices and equipment. Salary \$19,000 and above. Send resume and salary history to: Frank A. Hegwer, Sacramento Peak Observatory, Sunspot, New Mexico 88349. AN EQUAL OPPORTUNITY EMPLOYER.

WHERE DO YOU FIT?

In today's job market, that is. One way to see if you're in demand is to check the employment opportunities contained in ELECTRONICS' Classified Section.

Another way to get a reading on your value is to place a blind (box number) Position Wanted ad there. The cost is low (only \$1.25 per line) and the results are often rewarding.

For more information call or write:

ELECTRONICS

Post Office Box 900
New York, N.Y. 10020
Phone: 212/997-2556

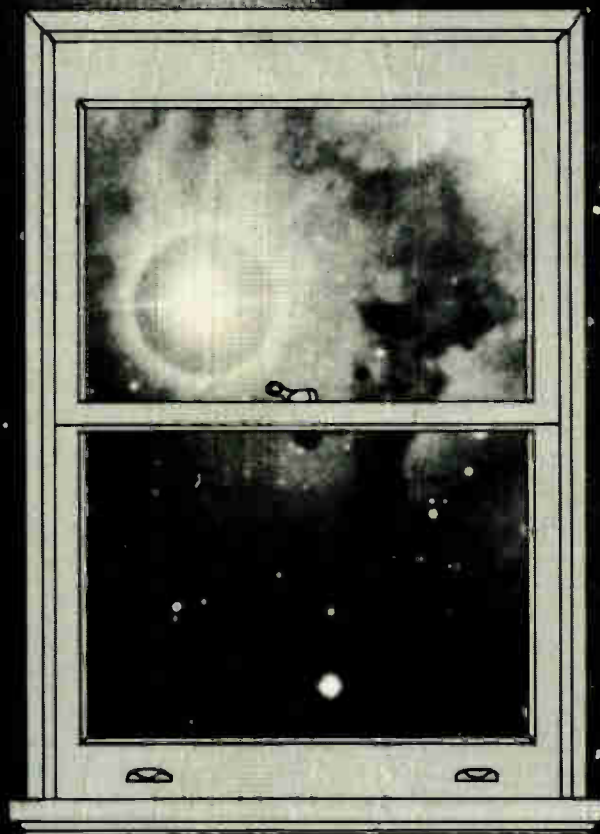

Exciting, New Electro-Optical Technologies Open New Windows in Space

Can you contribute to the development of an integrated, infrared focal plane containing millions of detectors, with charge-coupled devices for detector readout?

Can you advance micro-electronics and signal-processing technology to include space-borne, programmable, signal processors and electro-optical, tunable spectral filters?

Are you familiar with high-energy-laser beam control, adaptive optics, holographic-display lens design, thermal

imaging, or erectable optics structures?

Do you have the imagination and analytical skills to assemble these new technologies into revolutionary new system concepts?

If so, our steadily expanding Aerospace Groups would appreciate hearing from you.

We are involved with a wide variety of state-of-the-art programs.

It's exciting!

It's important!

It's fun!

Please send your resume to Engineering Employment, Hughes Aerospace Groups, 11940 West Jefferson Blvd., Culver City, CA 90230.

A degree from an accredited institution, varying levels of experience, and US citizenship are all required. We're an equal opportunity, M/F/HC employer.

HUGHES

HUGHES AIRCRAFT COMPANY
AEROSPACE GROUPS

Just off the press:

Newest in Electronics Magazine Book Series

New 408-page collection of electronic circuits edited for ease and practicality of use by Samuel Weber

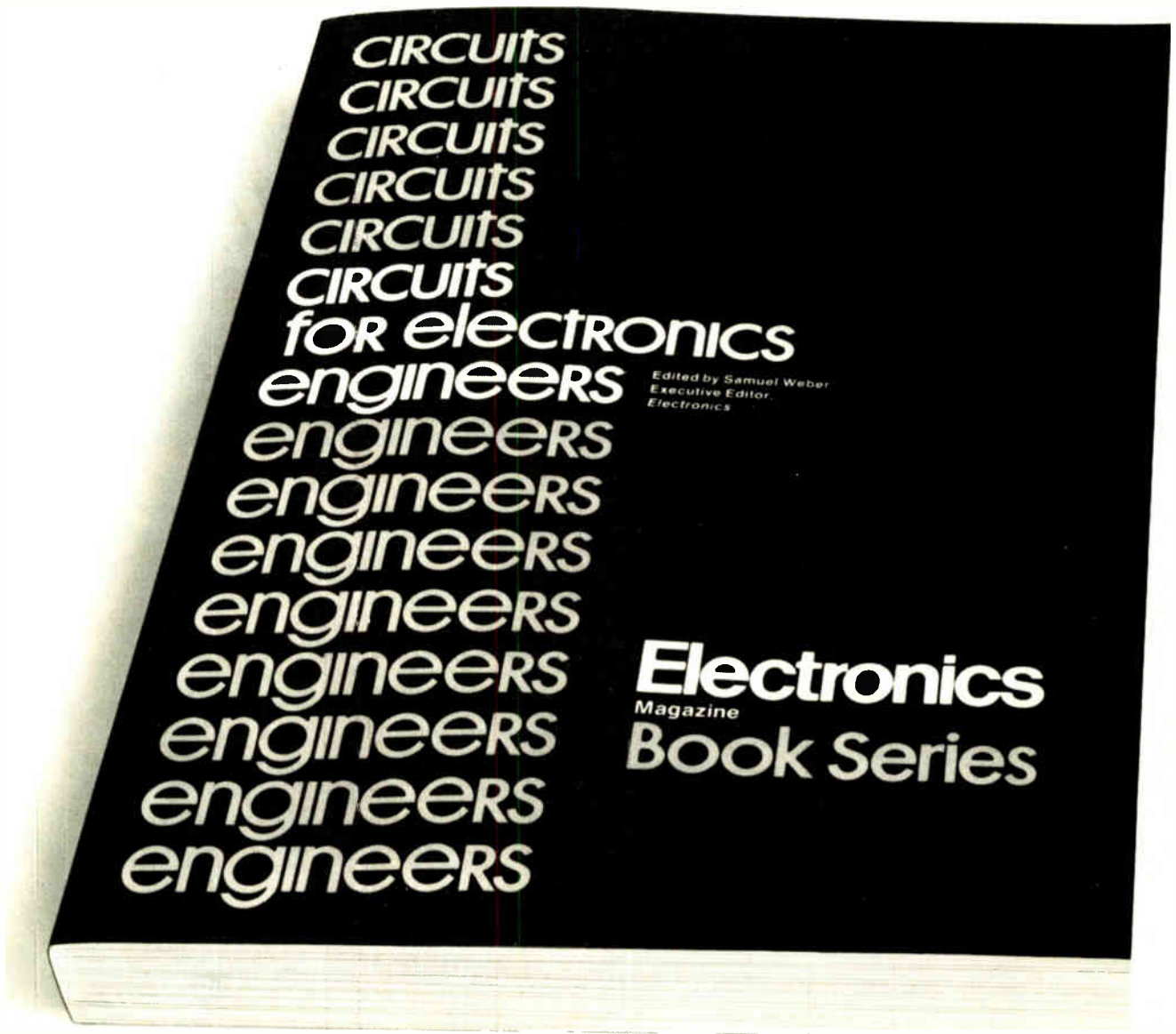

41. Protection circuits

Phase-sequence detector trips circuit breaker

by Terry Malarky
Motorola Semiconductor Products Inc. Phoenix, Ariz.

Some three-phase line-powered equipment is sensitive to the direction of rotation of the three phases. For example, if two of the connections to a three-phase motor are inadvertently reversed, the motor will reverse direction—a disaster if the motor is used to drive a pump or the compressor of an air conditioner. To guard against this failure, a low-power circuit can be built from standard complementary-MOS components that will detect the phase inversion and trigger a circuit breaker. Moreover, the circuit, which interfaces directly with a CMOS logic, can be appended easily to a line-undervoltage or line-unbalanced detector.

In the circuit (Fig. 1), the line voltages are stepped down and isolated by control transformers. The line waves for phases A, B, and C are half-wave-rectified and shaped by the MR4001 diode and MP55172 transistor, and shaped again by a C-MOS inverter. The resulting rectangular waveforms are shown as A', B', and C' in Fig. 2.

The shaped outputs A', B', and C' are now combined with one another in the AND gates G₁, G₂, and G₃, to produce the waveforms A-C, A-B, and B-C (or X, Y, and Z in Fig. 2). The pulses X, Y, Z appear sequentially; this sequence will change to YXZ if, for instance,

the B and C phases are interchanged. The X, Y, and Z pulse trains are applied to D-type flip-flops FF₁ and FF₂ in such a way that the Q₂ output of FF₂ is high if the sequence is XYZ (i.e., if the line phase sequence is ABC), and Q₂ is low if the sequence is YXZ. For the XYZ sequence, an X pulse sets Q₁ and D₂ high, but then the Y pulse resets Q₁ and D₂ low. The Z pulse then clocks the low from D₂ to Q₂, making Q₂ high.

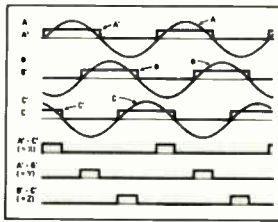

Fig. 1. Open-drain, line phases A, B, and C are rectified and shaped to produce waveforms A', B', and C'. Overlap of these rectangular waves produce AND-gate outputs A-C, A-B, and B-C, for convenience these outputs are referred to as X, Y, and Z. Line-phase sequence ABC generates XYZ, sequence ACB generates YXZ. These pulse trains cause flip-flop outputs to signal any phasing error.

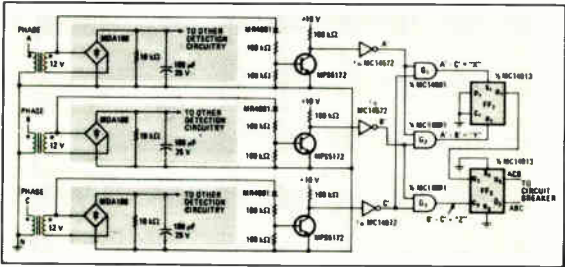

Fig. 2. Phase inverter: incorrect sequence of line phasing is detected by flip-flops which trigger circuit breaker to prevent three-phase motor from running in reverse. Phase sequence ABC makes Q₂ high; but sequence ACB makes Q₂ high, without output can be used to control protection devices. This phase-reversal detector can be a simple addition to other control circuitry, as shown here.

310

Either Q₁ or Q₂ can be used to trip a circuit breaker via a solid-state or electromechanical relay, and thus pull a valuable piece of equipment off the line before it is damaged. The MDA100 bridge rectifier, 10-k Ω resistor, and 100-microfarad capacitor, shown in the gray area of

Fig. 1, are representative of typical applications requiring line-voltage detection. They are included in Fig. 1 to demonstrate how easily the phase-sequence detector can be added to other detection circuitry. They can, of course, be omitted; and the "bottom" of the transformer can be connected directly to circuit ground.

Current and power limiter protects switching transistor

by R. M. Still
Bell-Boeing Research Corp. Tucson, Ariz.

Although a switching transistor dissipates little power in normal operation, it must be protected from destructive current and power overloads. Current-limiting alone is not sufficient protection; power-limiting is also necessary. But fortunately, a few components can be added to conventional current-limiting circuitry to provide power-limiting. A voltage rise across a transistor is sensed and used to cut down the drive current.

To understand why current-limiting alone fails to provide adequate protection, consider a switching transistor controlling a 100-ohm load connected to a 100-volt supply. The power dissipated in the load might be about 100 watts, but the maximum power dissipated in the transistor is merely the load current times the transistor's saturation voltage (if switching losses are neglected). The load current is about 1 ampere, so the transistor dissipates less than 1 w. A designer might use a 3-w device and provide a current-limiting level of 1.5 amperes.

Suppose, however, that the load is short-circuited so that the collector of the switching transistor is connected directly to the 100-v supply. Then the transistor dissipates 100 w, which destroys it.

To prevent this destruction, a power-limiter is required. Power-limiting can be added to a standard current-limiting by use of only four simple components. In Fig. 1, Q₁ is the switching transistor, and the conventional current-limiting is formed by Q₂, R₁, and R₂. The power-limiter consists of capacitor C, diodes D₁ and D₂, and resistor R₃. To illustrate the operation of the circuit, assume that Q₁ is saturated and in normal operation. As the load current increases, the voltage drop across R₂ increases, turning on transistor Q₂ and thus shunting drive current away from the base of Q₁. Therefore, Q₁ begins to come out of saturation, so its collector voltage rises. This voltage across Q₁ further turns on Q₂ through R₂ and regeneratively turns off Q₁. Diodes D₁ and D₂ form a switch so that the collector

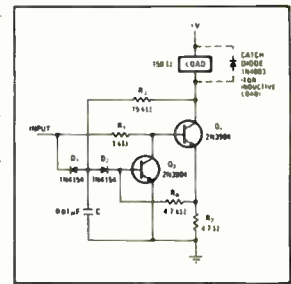

Three-way protection: Switching transistor Q₁ is protected against excess current and/or excess power dissipation. If load current approaches limit, R₂ drop turns on transistor Q₂ to shunt base drive from Q₁. A voltage rise across Q₁ acts through R₃ to turn on Q₂ and turn off Q₁. Capacitor C provides delay that allows Q₂ to saturate with each new cycle, and sets power-limiter ignore transient high currents. Diodes D₁ and D₂ reset power limiter when input is low.

voltage of Q₁ is sampled only when its input is high. This switch also resets the power-limiting circuitry with each cycle of the input. The value of capacitor C is chosen to give the power-limiting portion of the circuit a turn-on delay, allowing time for Q₂ to become saturated. This delay also permits higher current transients to flow during switching, such as those that might occur in a switching regulator in which the catch diode must be discharged during each cycle.

The current-limiting portion of the circuitry is active at all times, protecting the switching transistor from current overloads. The circuit was set up to be driven by a TTL-level signal and to switch a 100-ma load at 400 Hz to +15 v. The protection circuit can easily be modified for nearly any input and output configuration. If a pre-transistor switch is to be protected, transistor Q₂ should also be a pnp, and the polarities of D₁ and D₂ should be reversed.

311

Two typical pages. Note valuable explanatory text.

Here is a book compiled and organized to save electronics engineers many hours of drudgery designing what's already been designed or "re-inventing the wheel". This is the fifth in the Electronics Magazine Book Series, following *Microprocessors*, *Large Scale Integration*, *Basics of Data Communications*, and *Applying Microprocessors*.

Circuits For Electronics Engineers is a compilation of most useful circuits from the pages of Electronics magazine, most from the well-known Designer's Casebook series. More than a collection of circuit diagrams, the designer will find step-by-step rules, performance data, component values, manufacturers' type references, follow-up references, and other material for effective guidance.

The end result is a complete, practical easy-to-use manual for engineers and advanced technicians involved in research, development, design, tests, or production of any kind of electronics hardware.

Mail coupon now. Will pay for itself first time you use it.

Electronics Book Series

P.O. Box 669, Hightstown, NJ 08520

Send me _____ copies of "Circuits for Electronics Engineers" at \$15.95 per copy. Full payment must accompany order.

I must be fully satisfied or you will refund payment if the book is returned after ten-day free trial examination.

Name _____ Title _____

Company _____

Address _____

City _____ State _____ Zip _____ Country _____

Signature _____

After ten years of experience as an electronics engineer himself, Samuel Weber joined the staff of Electronics and has been Executive Editor of the magazine since 1970. In addition to his editorial responsibilities he has authored many articles on electronics and edited three books on electronics circuitry.



346 circuits from all over the world—arranged by 51 of the most useful functions designers use to implement their systems, including—Amplifiers • Analog to digital & digital to analog converters • Counters • Detectors • Discriminators • Display circuits • Function generators • Integrators • Logic circuits • Memory circuits • Operational amplifier circuits • Power supplies • Protection circuits • Switching circuits • Temperature control • Timing circuits • Voltage regulating circuits • . . . and many more.

Discounts of 40% on orders of ten or more copies.

Payment enclosed Bill firm Bill me

Credit Cards Charge My Book To:

American Express Diners Club
 Master Charge BankAmericard

Acct. No. _____

Date Card Expires _____

Interbank No. _____

1st No's above name of Master Charge only R-71A



| | | | | | |
|--|---------|---|----------|--|---------|
| ■ Abbott Transistors | 20 | Data I/O Corporation | 5 | ‡ Isala, Inc. | 160-161 |
| Acurex/Autodata | 24 | ■ Data Precision | 126,127 | Icom, Inc. | 209 |
| Adret Corporation | 179 | Datel Systems, Inc. | 13 | Intel Memory Systems | 72-73 |
| Advanced Micro Devices | 10-11 | Dialight Corp. | 211 | Intel—Microcomputer Components | 144-145 |
| ■ Alltech | 168-169 | ■ Digital Equipment Components | 90-91 | Interdata, Inc. | 177 |
| ■ Alrpax Electronics | 45 | DIT-MCO | 224 | International Crystal Mfg. Co. | 206 |
| Allied Chemical Co., Metglas Products | 221 | • Ducati Elettrotecnica Microferad | 12E | International Rectifier Corp., Crydom Div. | 39 |
| American Microsystems, Inc. | 94-95 | E. I. Dupont De Nemours & Co., Inc. | 197 | Interwitch | 225 |
| ■ Amp, Inc. | 18-19 | ‡ Eastman Kodak Co., Graphic Markets Division | 15 | Isotek Corp. | 236 |
| ‡ Analog Devices | 130-131 | Electrol | 223 | • Italtel/Siemens | 5E,9E |
| Anritsu Electric Co., Ltd. | 182 | Electronic Navigation Industries | 79 | Japan Electric Measuring Instr. Mfrs. Assoc. | 238 |
| ■ A P Products, Incorporated | 251 | Elevam Electronic Tube Co., Ltd. | 253 | Kaye Instruments | 208 |
| ■ Associated Electronics | 225 | EM Laboratories, Inc. | 213 | Keithley Instruments | 235 |
| AXIOM | 9 | EMR-Telemetry | 217 | • Kennedy Company | 123 |
| ■ Beckman Instruments | 39 | ■ Equipto Electronics Corp. | 212 | ■ M. S. Kennedy Corporation | 194 |
| ‡ Beckman Instruments, Helipot | 54 | Fairchild (Semiconductor Operations Division) | 46-47 | ■ Kepco, Inc. | 1 |
| Belden Corporation | 207 | Fairchild Systems Technology | 124-125 | ‡ Kollmorgen Corp., Photocircuits Division | 162-163 |
| ■ F. W. Bell, Inc., Div. of Arnold Eng. & Allegheny Ludlum | 218 | Faultfinders, Inc. | 199 | ■ Kulka Electric Corp., Div. North Amer. Philips | 254 |
| The Bendix Corporation, Electrical Comp. Div. | 86-87 | Ferranti-Packard Ltd. | 180 | ■ Lambda Electronics | 57-66 |
| ■ B & K Precision, Div. Dynascan Corp. | 233 | Figaro Engineering, Inc. | 252 | LDJ Electronics | 250 |
| Biomation | 92-93 | Florida Department of Commerce | 222 | • Magneti Marelli | 98 |
| Bourns, Inc. | 2nd c | • Fort Electronique | 18E | Mallory Capacitor Company | 232 |
| ‡ Bud Industries, Inc. | 123 | ■ Frequency Devices, Inc. | 250 | • Matsuo Electric Co. Ltd. | 22E |
| MGR/Bussmann Mfg. Co. | 201 | Fuji Electrochemical Co. | 226 | ■ Matsuo Electronics of America | 216 |
| ■ Cambridge Thermionic Corp. | 196 | Gates Rubber Company—Energy Products | 156-157 | Matsushita Electric Trading Company | 181 |
| • Carlo Erba S.P.A. | 155 | GCA-Sunnyvale | 21 | MDB Systems | 85 |
| ■ Centralab Electronics Division | 77 | GEM M-O Valve | 15 | M.E.S.L. Microwave Division | 20E |
| Centralab/USCC | 193,195 | ‡ General Electric, Valox | 158-159 | ■ MFE Corp. | 200 |
| Centronics | 183 | ■ General Electric Panel Meter | 27 | MFP Corp. | 252 |
| ■ Cherry Electrical Products | 74 | ‡ General Electric—Instrument Rental Div. | 186 | ■ Micro Networks | 44 |
| ■ Chomerics, Inc. | 84 | ■ GenRad | 37,173 | Mostek Corp. | 22-23 |
| ■ Clalrex Electronics | 4th c | ■ Germanium Power Devices Corp. | 253 | ■ Motorola Communications & Electronics | 35 |
| Computer Automation, Inc., Naked Mini Div. | 89 | Glenayre Electronics, Ltd. | 234 | ‡ Murata Corporation of America | 98 |
| Conic Data Systems | 202 | ■ Gould, Inc./Instrument Systems Div./T & M | 229 | McDonnell Douglas Co.—Nitron | 203 |
| Continental Rentals | 8 | ■ Hal Communications Corp. | 212 | National Semiconductor Corp. | 70-71 |
| ‡ Corning Glass Works Telecommunications Products Department | 170 | • Hamlin Inc. | 231 | NCR Power Systems Division | 176 |
| CTS Corporation | 223 | Harris Semiconductor | 184-185 | ‡ NEC Microcomputers | 155 |
| ‡ Cutler-Hammer, Specialty Products Division | 231 | Heuristica | 234 | Nichicon America Corporation | 253 |
| ■ Dana Labs | 220 | ■ Hewlett-Packard Corporation | 2,28,29 | ■ North Atlantic Industries | 81 |
| Data General Corp. | 68-69 | ■ Hughes Aircraft | 40,41,43 | ‡ Oak Industries | 181 |
| | | | | ■ O.K. Machine & Tool Company | 251 |

CONNECTOR PROBLEM? TRY ZEBRA[®] INSTEAD!

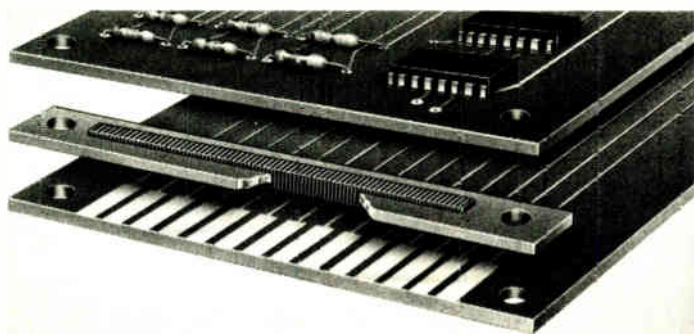

ZEBRA[®] THE INNOVATIVE CONDUCTIVE ELASTOMERIC CONNECTOR WITH OVER 100,000,000 CONNECTIONS NOW FUNCTIONING IN THE FIELD.

LCD, BOARD-TO-BOARD, FLAT CABLE

CONTACT



SEND FOR OUR NEW CONNECTOR CATALOG

EASTERN DIVISION • 129 DERMODY ST., CRANFORD, NJ 07016 (201) 272-5500

WESTERN DIVISION • 427 OLIVE ST., SANTA BARBARA, CA 93101 (805) 963-1867

SHOCK AND ENVIRONMENTAL PROTECTION

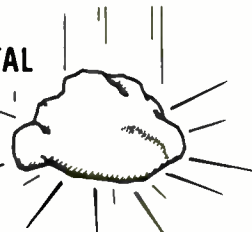
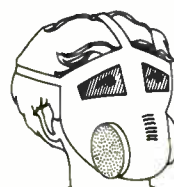

HIGH DENSITY

Circle 249 on reader service card

One Thomas Edison is not enough.



The world, with all its problems and difficulties, needs all the Edisons it can get. And while true genius is rare, there will always be a need for people who can continue what he began.

But there are two problems. Finding talented people. And developing their talents.

You can help with the first problem if you know a high school graduate who is interested in electricity or electronics.

If so, we can solve the second problem. The Navy offers what we believe to be some of the world's finest

training in advanced electronics. We can take a qualified young man or woman with no prior training, and, in a few months, have him well on the way to being not only an electronics expert, but a confident, mature individual.

Then, when his education is completed, he'll have the opportunity to see much of the world while he works with the most sophisticated electronic equipment he'll ever see. For which he'll receive a good salary as well as all Navy benefits.

We'd be happy to send more information about the Navy advanced electronics program. Simply send in the coupon below.

Because you may be helping someone who can help the world.

The Navy.

Capt. Robert W. Watkins
Navy Opportunity Information Center
P.O. Box 2000, Pelham Manor, N.Y. 10803

Please send more information on the Navy's Advanced Electronics Program. (If you don't want to wait, call 800-841-8000 toll-free, anytime.)

NAME _____ (Please Print)

ADDRESS _____

CITY _____ PHONE _____

STATE _____ ZIP _____

MAGNETIC MEASURING INSTRUMENTS

FEATURING: MODEL 511 HALL EFFECT GAUSSMETER.



- 0.01 Gauss Resolution
- 100,000 Gauss, Full Scale
- 5% FC Accuracy
- AC and DC Measurements to 1 kHz
- Digital Readout
- Price \$985.00 Less Probe.

OTHER INSTRUMENTS:

- Electronic Integrator/Fluxmeters
- Magnetizers
- Vibrating Sample Magnetometers
- Recording Permeameters
- BH Meters

LDJ ELECTRONICS, INC.
1064 Naughton Avenue
Troy, MI 48084
(313) 689-3623

Circle 56 on reader service card



Low Cost Quartz Crystals

Use Statek 10 to 300 kHz quartz crystals in TO-5s... they eliminate count down for oscillators, filters, tone generators, timers... They're rugged, accurate & resistant to high vibration and shock. Prices low as \$1.70 ea. in 1000 qty. Send your written application & we'll send you a sample. Call or write for literature. Details in Gold Book and EEM.

STATEK CORPORATION
512 N. Main
Orange, California 92668
Telephone: (714) 639-7810
TELEX 67-8394

250 Circle 250 on reader service card

| | |
|---|------------|
| Ovenaire (Division of Walter Kidde & Co.) | 8 |
| † Oxy Metals Industries | 219 |
| Pemotor | 218 |
| ■ Pearson Electronics | 254 |
| • Perlec Ped | 158-159 |
| Philippe Elcoma | 2E |
| ■ Philippe TMI | 227 |
| Plastics Engineering Company | 6 |
| Polaroid Corporation | 137 |
| ■ Powermate | 208 |
| Power—Science, Inc. | 8 |
| ■ PowerTech | 204 |
| Practiced Automation | 225 |
| ■ Precision Monolithics, Inc. | 7 |
| ■ Projects Unlimited | 85 |
| Pro-Log | 30 |
| Ramtek | 190-191 |
| • R 2E | 19E |
| • RCA Electro Optics & Devices | 11E |
| • Rhone Poulenc—Chimie Fine | 15E |
| Robinson Nugent, Inc. | 142-143 |
| Rockwell Microelectronic Device Division | 138-139 |
| Rogers Corporation | 228 |
| • Rohde & Schwarz | 1E, 25-28E |
| Rotron, Inc. (Commercial Prod. Div.) | 178 |
| Salota GmbH & Co. KG | 222 |
| Sangamo Data Recorder Division | 189 |
| Sanken Electric Co., Ltd. | 237 |
| • Schlumberger Dept. Instruments | 186 |
| S. E. Laboratories Ltd. | 175 |
| ■ Semiconductor Circuits | 205 |
| • SEPA S.P.A. | 170 |
| • Sfernice | 24E |
| • Shell International Chemical | 6E, 7E |
| • Siemens A G Karlsruhe | 17E |
| • Siemens AG Munich | 52 |
| Sodeco | 54 |
| Solitron Devices | 210 |
| Sonimag | 21E |
| Sprague Electric | 48 |
| ■ Statek Corp. | 250 |

PROFESSIONAL DISCOUNTS

Texas Instruments electronic calculator

| | | | |
|--------------|---------|-------------------------|---------|
| TI-1750 LCD | \$19.95 | SR-51 II | \$49.95 |
| TI-2550 III | 24.95 | SR-56 | 79.95 |
| Little Prof | 12.95 | SR-52 | 184.95 |
| Big Prof NEW | 22.50 | TI-57 NEW | 69.95 |
| TI-5100 | 44.95 | TI-58 NEW | 109.95 |
| TI-5015 NEW | 69.95 | TI-59 NEW | 259.95 |
| TI-5050M | 84.95 | PC 100A | 147.00 |
| TI-5040 PD | 99.95 | Money Mgr | 17.95 |
| TI-30SP | 17.95 | Bus Analyst | 29.95 |
| SR-40 | 24.95 | All Libraries Available | |



TI DIGITAL WATCHES*

HEWLETT PACKARD

We are franchised H-P dealer All accessories at discount

| | | | |
|--------|----------|-------|----------|
| HP-21 | \$ 64.00 | HP-27 | \$140.00 |
| HP-22 | 100.00 | HP-67 | 395.00 |
| HP-25 | 116.00 | HP-97 | 664.95 |
| HP-25C | 160.00 | HP-91 | 295.00 |

Also SCM, Olivetti, National Semiconductor, Casio, Canon, Corvus, APF, Sharp, Craig, Sanyo, Record-A-Call, and more All at great prices!

FAIRCHILD

Programmable Video Game \$149.95
2000 games possible
Cartridges 17.95
Also Fairchild Watches*

WE WILL BEAT OR MEET ANY COMPETITORS' PRICE IF HE HAS MERCHANDISE ON HAND. 30-day exchange by TK. 1-year warranty by manufacturers. All units shipped in original factory cartons with accessories according to manufacturers' specifications. In Calif. call (213) 370-5795 or ORDERS ONLY CALL (800) 421-0367 (other than CA). BankAmericard & Master Charge accepted on most sales. Send money order. Pers. ck (2 wks to clear); in CA add 6% sales tax. Add \$3.50 min. shipping charges US only; \$7.00 for SR-52, PC-100, HP-67, -97. Canada min. shipping charges \$6.50. WE SHIP UPS AIR. Send mail orders to DEPT. EL-F.

tk enterprises
BY THE BUSINESS PRODUCTS

16611 Hawthorne Blvd., Lawndale, Ca. 90260
(213) 370-5795 (800) 421-0367

Circle 58 on reader service card



SINEWAVE OSCILLATORS

Low Distortion
0.05Hz to 20kHz

FIXED FREQUENCY RESISTIVE TUNEABLE SINGLE PHASE QUADRATURE

F.D.I. also manufactures
Active Filters, Tone Encoders,
Tone Detectors and other
Communications products

Frequency Devices Inc.
25 Locust Street
Haverhill, Mass. 01830

(617) 374-0761/TWX 710-347-0314

Circle 59 on reader service card

IN WIRE-WRAPPING  HAS THE LINE.....

MODEL WD-30



PATENT PENDING

WIRE DISPENSER

- 50 FT. ROLL OF 30 AWG. KYNAR® WIRE-WRAPPING WIRE
- CUTS THE WIRE TO LENGTH
- STRIPS 1 INCH OF INSULATION

AVAILABLE IN FOUR COLORS

- WD-30-B BLUE WIRE
- WD-30-Y YELLOW WIRE
- WD-30-W WHITE WIRE
- WD-30-R RED WIRE

**\$345
EACH**

MINIMUM BILLING \$25.00
ADD SHIPPING CHARGE \$1.00
NEW YORK STATE RESIDENTS
ADD APPLICABLE TAX

®KYNAR PENNWALT

OK MACHINE & TOOL CORPORATION

3455 Conner St., Bronx, N.Y. 10475 (212) 994-6600 / Telex 125091

Circle 251 on reader service card

Clip DIP troubles in the bud.

Troubleshooting DIP ICs can be a pain in the probe if you can't get at their pins. But you can make the job faster and easier with Super-Grip™ IC test clips from A P. Our "contact comb" design prevents shorting while our superior gold-plated phosphor bronze terminals make contact. Then your probe is welcome aboard its handy topside pins. And this gutsy little spring clip is perfect as an IC puller, too. So use it for its connections or use it for its pull. Either way, you're full speed ahead with A P.



A P has a Super-Grip™ Clip for any DIP.

| MODEL | ROW-TO-ROW DIMENSION | PART NUMBER | PRICE |
|----------|----------------------|-------------|---------|
| TC-8 | .3 in. | 923695 | \$ 7.35 |
| TC-14 | .3 in. | 923698 | \$ 4.50 |
| TC-16 | .3 in. | 923700 | \$ 4.75 |
| TC-16LSI | .5/6 in. | 923702 | \$ 8.95 |
| TC-18 | .3 in. | 923703 | \$10.00 |
| TC-20 | .3 in. | 923704 | \$11.55 |
| TC-22 | .4 in. | 923705 | \$11.55 |
| TC-24 | .5/6 in. | 923714 | \$13.85 |
| TC-28 | .5/6 in. | 923718 | \$15.25 |
| TC-36 | .5/6 in. | 923720 | \$19.95 |
| TC-40 | .5/6 in. | 923722 | \$21.00 |

Order from your A P distributor today. For the name of the distributor nearest you call Toll-Free 800-321-9668.

Send for our complete A P catalog, The Faster and Easier Book.

Faster and Easier is what we're all about.

**A P PRODUCTS
INCORPORATED**

Box 110 • 72 Corwin Drive
Painesville, Ohio 44077
216/354-2101 TWX: 810-425-2250



Circle 63 on reader service card 251

LOWEST PRICES

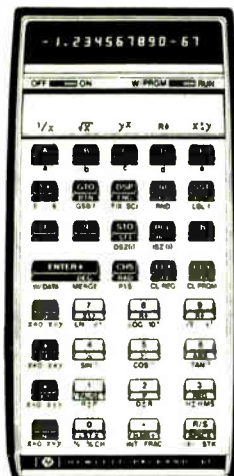

HEWLETT-PACKARD

| | |
|---------------|---------|
| HP-21 | \$68.00 |
| HP-22 | 106.25 |
| HP-25 | 123.25 |
| HP-25C | 170.00 |
| HP-27 | 148.75 |
| HP-67 | 382.50 |
| HP-91 | 276.25 |
| HP-97 | 637.50 |
| 67/97 Pacs | 31.50 |
| 120 Mag Cards | 40.50 |

TEXAS INSTRUMENTS

| | |
|--------------------------------|--------|
| Bus. Analyst | 29.95 |
| TI-1750, 2000 hour, ultra-thin | 22.95 |
| TI-5040PD | 99.95 |
| TI-5050M | 84.95 |
| TI-5100 | 42.95 |
| SR-40 | 26.95 |
| SR-51-II | 49.95 |
| PC100A | 159.95 |
| 52 Libraries | 22.95 |

ORDER NOW FOR EARLY DELIVERY:

| | |
|--|--------|
| SR-57 Keystroke Programmable | 69.95 |
| SR-58 Prog. Plug-in Libraries, 480 steps | 109.95 |
| SR-59 Plug-in Lib., Mag card, 960 steps | 249.95 |
| (Plotting and alphanumeric on PC100A with SR-58, 59) | |

For faster delivery use cashier's check or money order. Add shipping: 1% of your order (\$1.00 min.). East of Miss. Riv. add \$1.00. Air add \$1.00. Calif. Res. add 6% tax. B/A and M/C accepted (3% surcharge on HP calculators). Call (213) 744-1444 for technical info. U.S.A. prices only.

ORDER TOLL-FREE 800-421-8819 OUTSIDE CALIF. ONLY

Standard accessories included. Delivery subject to availability.



Tam's Dept. 8E
3303 S. Hoover St.
Los Angeles, CA 90007
Phone (213) 744-1444

Circle 60 on reader service card

FOR BIT ERROR RATE TESTING...

of Coaxial, Optical, Satellite and Digital Radio Systems



PTS-107, one of our line of digital test sets. Other models cover data rates to 1 GHz. User features: Clock recovery, auto phasing, burst and continuous data measurement and error injection.



11 Esquire Road, North Billerica, Mass. 01862
Tel: (617) 687-3874

252 Circle 252 on reader service card

| | |
|---|---------|
| System-Donner, Concord | 188 |
| Tally Corporation | 82 |
| Tam's Incorporated | 252 |
| Tau Tron, Inc. | 252 |
| Teac Corporation | 131 |
| Tecknit (Technical Wire) | 249 |
| Tektronix | 140-141 |
| Teledyne Philbrick | 227 |
| Teledyne Relays | 17 |
| Teletype | 214 |
| Texas Instruments, Inc., Digital Systems Div. | 128-219 |
| Texas Instruments, Components | 96-97 |
| Textool Products, Inc. | 14 |
| Thermometric | 172 |
| Thick Film Systems, Inc. | 215 |
| T-K Enterprises | 250 |
| Triple I | 236 |
| Triplet Corporation | 51 |
| TRW - Cinch Connectors | 146 |
| TRW/UTC Transformer | 161 |
| U. S. Instrument Rentals, Inc. | 52 |
| Vacuumchmelze | 174 |
| Varian Data Machines | 3rd c. |
| Varo Semiconductor | 230 |
| Viking Industries | 135 |
| V/O Techmashezport | 23E |
| Wabash Electronics | 51 |
| Wandel un Gottermann | 13E |
| Wavetek Indiana | 219 |
| Wilhelm Westermann | 16 |
| Zero Corporation | 198 |

Classified and employment advertising

F. J. Eberle, Manager 212-997-2557

| | |
|--------------------------------|----------|
| Atomic Personnel | 240 |
| Envir. Research Inst. of Mich. | 242 |
| GTE Lenkurt | 242 |
| Hughes Aircraft Co. | 245 |
| Itak | 243 |
| NCR | 241,242 |
| National Personnel | 243 |
| P'nB Consultants | 240 |
| Tektronix | 240, 244 |
| University of Rochester | 244 |
| Wang Laboratories | 241 |

For more information of complete product line see advertisement in the latest Electronics Buyers Guide
Advertisers in Electronics International
Advertisers in Electronics domestic edition

ULTRA FINE LINE PRINTING

50-70"
Lines & Spaces
by screen printing technique

custom production

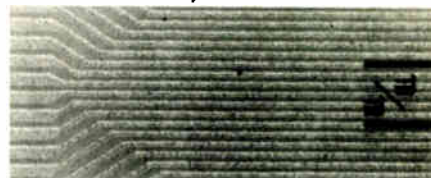

Low cost Mass production

Applications

1. Plasma display panel
2. Thermal printer head
3. Multi layer HIC etc.



MFP corp.

25-1, Minami-cho 6-chome, Fuchu,
Tokyo, 183 Japan Tel. 0423-68-3341

Circle 61 on reader service card

Gas Sensing Semiconductor

FIGARO TGS GAS SENSOR

quickly senses even small amount of gas.

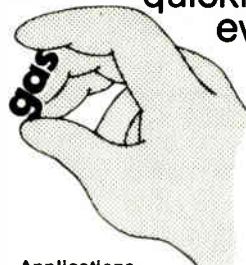

Applications

1. Natural Gas-Leak Alarm
2. Propane Gas-Leak Alarm
3. Carbon Monoxide Detector
4. Automatic Fan Control
5. Fire Alarm (Detecting combustible gases contained in smoke)
6. Alcohol Detector (Detector for drunken driver)
7. Air Pollution Monitor

Please contact any of the addresses below directly for catalogs and price/delivery information

FIGARO ENGINEERING INC.

Head Office: 3-7-3 Higashitoyonaka, Toyonaka City, Osaka, 560, JAPAN TELEX 05286155
FIGARO J CABLE FIGARO TOYONAKA
TEL: (06) 849-2156

North America: 3303 Harbor Boulevard, Suite D-8, Costa Mesa, California 92626, U.S.A.
TELEX 678396 CABLE FIGARENGIN
COSTAMESA TEL (714) 751-4103

Circle 62 on reader service card

Free!

fixed ceramic capacitor catalog

There's a Nichicon ceramic capacitor designed to let you meet or beat almost every electro-mechanical requirement ... in reliability, in dependability, in specialty applications.

OTHER PRODUCTION ITEMS INCLUDE: electrolytic capacitors, film capacitors, oil filled capacitors—without P.C.B., metallized paper capacitors, and wax paper capacitors,



NICHICON AMERICA CORPORATION
Division of NICHICON CAPACITOR LTD., Kyoto, Japan
6435 N. Proesel, Chicago, Ill. 60645 (312) 679-6530

Circle 64 on reader service card

SUPER MINIATURE

Neon Glow Lamps

Rated Voltage...AC 100V
Rated Current...AC 0.3mA
Total Flux...20mlm MIN.
Starting Voltage...AC 75V MAX.
External Resistance...150K Ω



NL-8S

ULTRA-HIGH BRIGHTNESS

Neon Glow Lamps

Rated Voltage...AC 100V
Rated Current...AC 5mA
Total Flux...500 mlm MIN.
Starting Voltage...AC 85V MAX.
External Resistance...8.2K Ω



NE-2HU

CLEAR-GREEN

Fluorescent Glow Lamps

Rated Voltage...AC 100V
Rated Current...AC 1.5 mA
Total Flux...90 mlm MIN.
Starting Voltage...AC 75V MAX.
External Resistance...27K Ω

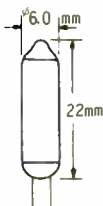

NL-21/G

● MAIN PRODUCT

NEON GLOW LAMP, XENON FLASH LAMP,
RARE GAS, DISCHARGE LAMP.
MINIATURE : BLACK-LIGHT, UV-LIGHT,
FLUORESCENT COLOR-LIGHT.

ELEVAM ELECTRONIC TUBE CO., LTD.

NO. 17-8 CHUO 2-CHOME OTA-KU, TOKYO JAPAN
TELEPHONE : 03 (774) 1231-5

EXPORT DIVISION : JAPAN NANOTRONIX CO., LTD.
OTA-KU TOKYO, TELEPHONE. (03)775-4811 TELEX 246-6583 JNANOX

Circle 65 on reader service card



GPD RISES TO YOUR GERMANIUM POWER NEEDS!

Earthy people with the world's broadest line of germanium power transistors. And recognized as the industry specialists. That's why Germanium Power Devices rises to meet your needs ... military, industrial or commercial.

Our 26-package pellet combinations include TO-3 to TO-68 with power dissipations from 1 to 75 Amps, DTG and MP types, EIA, PRO ELECTRON, and over 50 JAN devices. And if you need custom designed devices you'll find us high on quality yet down to earth on service and pricing. Call us!



Germanium Power Devices Corp.

P.O. Box 65 Shawsheen Village Station
Andover, Massachusetts 01810
(617) 475-5982 Telex: 94-7150 GPD Andr.

Circle 66 on reader service card

253

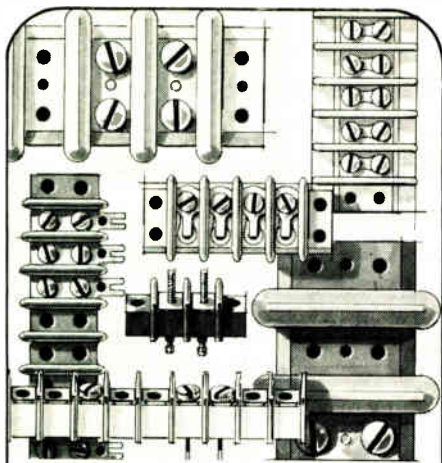

MORE Molding Materials

You can pick the exact material you need, GP, CFG, MFE, MDG, MME, MAI-60, GDI-30F, SDGF, and Thermoplastic are all shown in our new catalog. With this kind of choice, there is no need to compromise.

Kulka

520 S. Fulton Ave., Mt. Vernon, NY 10551

Circle 70 on reader service card

PEARSON Very High Voltage PULSE TRANSFORMERS

Pearson Electronics, Inc. specializes in the development, design and manufacture of very-high and super-high-voltage, high-power pulse transformers and related modulator components. Typical pulse transformers manufactured by Pearson Electronics, Inc. range in output voltage from 90kV to 600kV.

Other Pearson pulse-modulator components include precision current transformers, voltage dividers and charging inductors. Inquiries regarding specific requirements for these components are welcomed.

PEARSON ELECTRONICS, INC.

4007 Transport St., Palo Alto, California 94303, U. S. A.

Telephone (415) 494-6444

Circle 257 on reader service card

Advertising Sales Staff

Advertising sales manager: Paul W. Reiss

1221 Avenue of the Americas, New York, N.Y. 10020
[212] 997-4371

Atlanta, Ga. 30309: Glen N. Dougherty
100 Colony Square, 1175 Peachtree St., N.E.
[404] 892-2868

Boston, Mass. 02116: Frank Mitchell
607 Boylston St.
[617] 262-1160

Chicago, Ill. 60611

645 North Michigan Avenue
Robert W. Bartlett [312] 751-3739
Robert M. Denmead [312] 751-3738

Cleveland, Ohio 44113: William J. Boyle
[716] 586-5040

Dallas, Texas 75201: John J. Uphues
2001 Bryant Tower, Suite 1070
[214] 742-1747

Denver, Colo. 80203: Harry B. Doyle, Jr.
123 Speer Blvd. #400
[303] 837-1010

Detroit, Michigan 48202: Robert W. Bartlett
1400 Fisher Bldg.
[313] 873-7410

Houston, Texas 77002: John J. Uphues
601 Jefferson Street, Dresser Tower
[713] 659-8381

Los Angeles, Calif. 90010: Robert J. Rielly
Bradley K. Jones, 3200 Wilshire Blvd., South Tower
[213] 487-1160

Minneapolis, Minn. 55435: Robert M. Denmead
4015 W 65th St.
[312] 751-3738

New York, N.Y. 10020

1221 Avenue of the Americas
Michael J. Stoller [212] 997-3616
Matthew T. Reseska [212] 997-3617

Philadelphia, Pa. 19102: Matthew T. Reseska
Three Parkway
[212] 997-3617

Pittsburgh, Pa. 15222: Matthew T. Reseska
4 Gateway Center
[212] 997-3617

Rochester, N.Y. 14534: William J. Boyle
1175 Pittsford-Victor Rd., Pittsford, N.Y.
[716] 586-5040

San Francisco, Calif. 94111: Don Farris
Robert J. Rielly, 425 Battery Street,
[415] 362-4600

Paris: Alain Offergeld
17 Rue-Georges Bizet, 75116 Paris, France
Tel: 720-73-01

Geneva: Alain Offergeld
1 rue du Temple, Geneva, Switzerland
Tel: 32-35-63

United Kingdom & Scandinavia: Robert Ghey
34 Dover Street, London W1
Tel: 01-493-1451

Scandinavia: Andrew Karnig and Assoc.
Kungsholmsgatan 10
112 27 Stockholm, Sweden
Tel: 08 51 68 70 Telex: 179 51

Milan: Luigi Rancati
1 via Baracchini, Italy
Phone 86-90-656

Brussels: Alain Offergeld
23 Chaussee de Wavre
Brussels 1040, Belgium
Tel: 13-73-95

Frankfurt/Main: Fritz Krusebecker
Liebigstrasse 27c, Germany
Phone 72 01 81

Tokyo: Tatsumi Katagiri, McGraw-Hill
Publications Overseas Corporation,
Kasumigaseki Building 2-5, 3-chome,
Kasumigaseki, Chiyoda-Ku, Tokyo, Japan
[581] 9811

Business Department

Thomas M. Egan

Production Manager [212] 997-3140

Gayla Black

Production Manager [212] 997-2044

Carol Gallagher

Production Manager International

[212] 997-2045

Dorothy Carter

Production Manager Domestic

[212] 997-2908

Frances Vallone

Reader Service Manager

[212] 997-6057

Electronics Buyers' Guide

H.T. Howland, General Manager

[212] 997-6642

Regina Hera, Directory Manager

[212] 997-2544

Gayla Black, Production Manager

[212] 997-2044

Frances Vallone, Reader Service Manager

[212] 997-6057

Classified and Employment Advertising

Frank Eberle, Manager

[212] 997-2557

ELECTRONICS REPRINTS

No. of
copies
wanted

New reprints

- R-703 Special report—memories
16 pp \$3.00
- R-702 World market report 1977 24 pp
\$4.00
- R-616 Special issue—technology up-
date \$4.00
- R-614 Power supply choices for so-
phisticated designs 8 pp \$3.00
- R-612 Fiber-optic communications
special report 24 pp \$3.00
- R-610 Special report on hybrid-circuit
technology 19 pp \$3.00
- R-606 Special issue—microprocessors
\$4.00
- R-526 How reliable are today's compo-
nents 16 pp \$3.00

Charts

- R-516 Electronic symbols \$2.00
- R-213 Electromagnetic spectrum (up-
dated 1976) \$3.00
- R-326 Optical spectrum (6-page report
and chart) \$3.00

Books

- R-704 Thermal design in electronics
\$5.00
- R-701 Applying microprocessors—
Electronics Book Series \$9.95
- R-608 Basics of Data Communica-
tions—Electronics Book Series
\$12.50
- R-602 Large Scale Integration—Elec-
tronics Book Series \$9.95
- R-520 Microprocessors—Electronics
Book Series \$8.95
- R-011 Computer-aided Design 135 pp
\$4.00
- R-032 Active Filters 88 pp \$4.00
- R-031 Circuit Designer's Casebook 182
pp \$5.50 (outside U.S. \$12.00)

Payment must accompany your order

Make check or money order payable to Electronics Reprints. All orders are shipped prepaid by parcel post. Allow two to three weeks for delivery.

Mail your order to:

Janice Austin
ELECTRONICS REPRINTS
P.O. Box 669
Hightstown, N.J. 08520

Back issues now available:

1960 to 1969, \$5.00 each
1970 to 1973, \$3.00 each
1974 to 1976, \$4.00 each

Electronics/June 9, 1977

Electronics

Reader Service

For additional information on products advertised, new products or new literature, use these business reply cards.

Complete entire card. Please print or type.

Circle the number on the Reader Service postcard that corresponds to the number at the bottom of the advertisement, new product item, or new literature in which you are interested.

To aid the manufacturer in filling your request, please answer the three questions.

All inquiries from outside the U.S. that cannot reach Electronics before the expiration date noted on the Reader Service postcard must be mailed directly to the manufacturer. The manufacturer assumes all responsibilities for responding to inquiries.

Subscriptions & Renewals

Fill in the subscription card adjoining this card. Electronics will bill you at the address indicated on the card.

Electronics

June 9, 1977

This reader service card expires September 9, 1977

NAME _____ TITLE _____

PHONE (_____) _____ COMPANY _____

STREET ADDRESS (Company or home check one) _____

CITY _____ STATE _____ ZIP _____

Was This Magazine Personally Addressed to You? Yes No

Industry classification (check one):

- | | | |
|--|--|--|
| <input type="checkbox"/> a Computer & Related Equipment | <input type="checkbox"/> e Test & Measuring Equipment | <input type="checkbox"/> j Independent R&D Organizations |
| <input type="checkbox"/> b Communications Equipment & Systems | <input type="checkbox"/> f Consumer Products | <input type="checkbox"/> k Government |
| <input type="checkbox"/> c Navigation, Guidance or Control Systems | <input type="checkbox"/> g Industrial Controls & Equipment | |
| <input type="checkbox"/> d Aerospace, Underseas Ground Support | <input type="checkbox"/> h Components & Subassemblies | |

Your design function (check each letter that applies):

- x I do electronic design or development engineering work.
 y I supervise electronic design or development engineering work.
 z I set standards for, or evaluate electronic components, systems and materials.

Your principal job responsibility (check one)

- + Management
 Engineering

Estimate number of employees (at this location): 1. under 20 2. 20-99 3. 100-999 4. over 1000

| | | | | | | | |
|-------------|---------------|-----------------|-----------------|-----------------|-----------------|-----------------|-----------------|
| 1 16 31 46 | 61 76 91 106 | 121 136 151 166 | 181 196 211 226 | 241 256 271 348 | 363 378 393 408 | 423 438 453 468 | 483 498 703 718 |
| 2 17 32 47 | 62 77 92 107 | 122 137 152 167 | 182 197 212 227 | 242 257 272 349 | 364 379 394 409 | 424 439 454 469 | 484 499 704 719 |
| 3 18 33 48 | 63 78 93 108 | 123 138 153 168 | 183 198 213 228 | 243 258 273 350 | 365 380 395 410 | 425 440 455 470 | 485 500 705 720 |
| 4 19 34 49 | 64 79 94 109 | 124 139 154 169 | 184 199 214 229 | 244 259 274 351 | 366 381 396 411 | 426 441 456 471 | 486 501 706 900 |
| 5 20 35 50 | 65 80 95 110 | 125 140 155 170 | 185 200 215 230 | 245 260 275 352 | 367 382 397 412 | 427 442 457 472 | 487 502 707 901 |
| 6 21 36 51 | 66 81 96 111 | 126 141 156 171 | 186 201 216 231 | 246 261 338 353 | 368 383 398 413 | 428 443 458 473 | 488 503 708 902 |
| 7 22 37 52 | 67 82 97 112 | 127 142 157 172 | 187 202 217 232 | 247 262 339 354 | 369 384 399 414 | 429 444 459 474 | 489 504 709 951 |
| 8 23 38 53 | 68 83 98 113 | 128 143 158 173 | 188 203 218 233 | 248 263 340 355 | 370 385 400 415 | 430 445 460 475 | 490 505 710 952 |
| 9 24 39 54 | 69 84 99 114 | 129 144 159 174 | 189 204 219 234 | 249 264 341 356 | 371 386 401 416 | 431 446 461 476 | 491 506 711 953 |
| 10 25 40 55 | 70 85 100 115 | 130 145 160 175 | 190 205 220 235 | 250 265 342 357 | 372 387 402 417 | 432 447 462 477 | 492 507 712 954 |
| 11 26 41 56 | 71 86 101 116 | 131 146 161 176 | 191 206 221 236 | 251 266 343 358 | 373 388 403 418 | 433 448 463 478 | 493 508 713 956 |
| 12 27 42 57 | 72 87 102 117 | 132 147 162 177 | 192 207 222 237 | 252 267 344 359 | 374 389 404 419 | 434 449 464 479 | 494 509 714 957 |
| 13 28 43 58 | 73 88 103 118 | 133 148 163 178 | 193 208 223 238 | 253 268 345 360 | 375 390 405 420 | 435 450 465 480 | 495 510 715 958 |
| 14 29 44 59 | 74 89 104 119 | 134 149 164 179 | 194 209 224 239 | 254 269 346 361 | 376 391 406 421 | 436 451 466 481 | 496 701 716 959 |
| 15 30 45 60 | 75 90 105 120 | 135 150 165 180 | 195 210 225 240 | 255 270 347 362 | 377 392 407 422 | 437 452 467 482 | 497 702 717 960 |

Electronics

June 9, 1977

This reader service card expires September 9, 1977

NAME _____ TITLE _____

PHONE (_____) _____ COMPANY _____

STREET ADDRESS (Company or home check one) _____

CITY _____ STATE _____ ZIP _____

Was This Magazine Personally Addressed to You? Yes No

Industry classification (check one):

- | | | |
|--|--|--|
| <input type="checkbox"/> a Computer & Related Equipment | <input type="checkbox"/> e Test & Measuring Equipment | <input type="checkbox"/> j Independent R&D Organizations |
| <input type="checkbox"/> b Communications Equipment & Systems | <input type="checkbox"/> f Consumer Products | <input type="checkbox"/> k Government |
| <input type="checkbox"/> c Navigation, Guidance or Control Systems | <input type="checkbox"/> g Industrial Controls & Equipment | |
| <input type="checkbox"/> d Aerospace, Underseas Ground Support | <input type="checkbox"/> h Components & Subassemblies | |

Your design function (check each letter that applies):

- x I do electronic design or development engineering work.
 y I supervise electronic design or development engineering work.
 z I set standards for, or evaluate electronic components, systems and materials.

Your principal job responsibility (check one)

- + Management
 Engineering

Estimate number of employees (at this location): 1. under 20 2. 20-99 3. 100-999 4. over 1000

| | | | | | | | |
|-------------|---------------|-----------------|-----------------|-----------------|-----------------|-----------------|-----------------|
| 1 16 31 46 | 61 76 91 106 | 121 136 151 166 | 181 196 211 226 | 241 256 271 348 | 363 378 393 408 | 423 438 453 468 | 483 498 703 718 |
| 2 17 32 47 | 62 77 92 107 | 122 137 152 167 | 182 197 212 227 | 242 257 272 349 | 364 379 394 409 | 424 439 454 469 | 484 499 704 719 |
| 3 18 33 48 | 63 78 93 108 | 123 138 153 168 | 183 198 213 228 | 243 258 273 350 | 365 380 395 410 | 425 440 455 470 | 485 500 705 720 |
| 4 19 34 49 | 64 79 94 109 | 124 139 154 169 | 184 199 214 229 | 244 259 274 351 | 366 381 396 411 | 426 441 456 471 | 486 501 706 900 |
| 5 20 35 50 | 65 80 95 110 | 125 140 155 170 | 185 200 215 230 | 245 260 275 352 | 367 382 397 412 | 427 442 457 472 | 487 502 707 901 |
| 6 21 36 51 | 66 81 96 111 | 126 141 156 171 | 186 201 216 231 | 246 261 338 353 | 368 383 398 413 | 428 443 458 473 | 488 503 708 902 |
| 7 22 37 52 | 67 82 97 112 | 127 142 157 172 | 187 202 217 232 | 247 262 339 354 | 369 384 399 414 | 429 444 459 474 | 489 504 709 951 |
| 8 23 38 53 | 68 83 98 113 | 128 143 158 173 | 188 203 218 233 | 248 263 340 355 | 370 385 400 415 | 430 445 460 475 | 490 505 710 952 |
| 9 24 39 54 | 69 84 99 114 | 129 144 159 174 | 189 204 219 234 | 249 264 341 356 | 371 386 401 416 | 431 446 461 476 | 491 506 711 953 |
| 10 25 40 55 | 70 85 100 115 | 130 145 160 175 | 190 205 220 235 | 250 265 342 357 | 372 387 402 417 | 432 447 462 477 | 492 507 712 954 |
| 11 26 41 56 | 71 86 101 116 | 131 146 161 176 | 191 206 221 236 | 251 266 343 358 | 373 388 403 418 | 433 448 463 478 | 493 508 713 956 |
| 12 27 42 57 | 72 87 102 117 | 132 147 162 177 | 192 207 222 237 | 252 267 344 359 | 374 389 404 419 | 434 449 464 479 | 494 509 714 957 |
| 13 28 43 58 | 73 88 103 118 | 133 148 163 178 | 193 208 223 238 | 253 268 345 360 | 375 390 405 420 | 435 450 465 480 | 495 510 715 958 |
| 14 29 44 59 | 74 89 104 119 | 134 149 164 179 | 194 209 224 239 | 254 269 346 361 | 376 391 406 421 | 436 451 466 481 | 496 701 716 959 |
| 15 30 45 60 | 75 90 105 120 | 135 150 165 180 | 195 210 225 240 | 255 270 347 362 | 377 392 407 422 | 437 452 467 482 | 497 702 717 960 |

Electronics Reader Service

If the cards below have already been used, you may obtain the needed information by writing directly to the manufacturer, or by sending your name and address, plus the Reader Service number and issue date, to Electronics Reader Service Department, P.O. Box No. 2530, Clinton, Iowa 52732.

Affix
Postage
Here

Electronics

P.O. Box No. 2530
Clinton, Iowa 52732

Affix
Postage
Here

Electronics

P.O. Box No. 2530
Clinton, Iowa 52732

Varian's new mainframe-on-a-board: What you do with it is your business.

Whether your systems business is scientific, instrument control, or data communications, know this:

Our new V77-200 delivers more computing power than any other computer-on-a-board you can buy. Handling up to 32K/16-bit words of 660ns MOS memory.

Reason enough to call it the world's first mainframe-on-a-board. But there's more.

Because our new V77-200 comes loaded with "big machine" features. Like 8 programmable registers with byte, word and double word manipulation. Up to 32-bits of arithmetic precision. A powerful set of 187 instructions. Hardware multiply/divide. Direct memory access. Programed I/O. Multi-device automatic program loaders. A real-time clock. And a teletype/CRT controller. All standard. And all on a single 10.8" x 17" board.

There's even Virtual Console Logic that eliminates the need for a programmer's console by allowing you to control the V77-200 from a teletype or CRT keyboard.

You get "big machine" performance, too. Example: a microinstruction cycle time of 165ns that allows multiplication functions to be handled in just 4.9 microseconds — divide in just 8.

Plus your choice of OEM-tailored options. Like a variety of connector planes and general purpose interface boards for custom I/O designs. Three different 660ns memory boards (in 8K, 16K, and 32K-word modules). An operator's console. Power-fail detect and data save. Memory parity. Hardware for up to 64 priority vectored interrupts. An integral or modular power supply. And, of course, a system chassis. All the "unbundled" pieces you need for quick and easy system integrations.

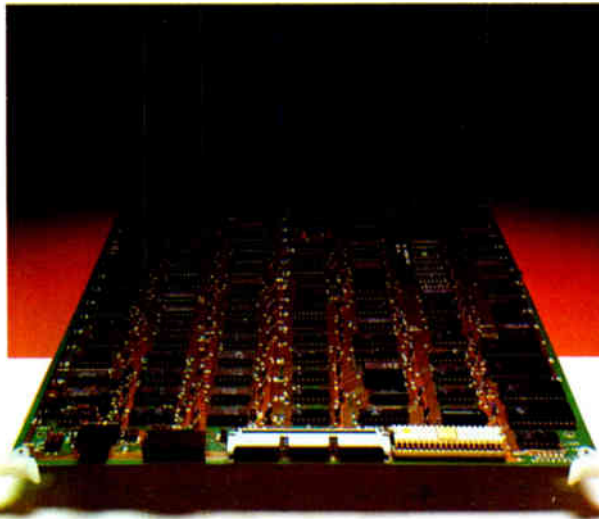

The new V77-200 also saves you time and money by allowing you to use Varian's well-established floppy or disk-based VORTEX real-time operating system. In effect, allowing you to concentrate on the development of your application software.

And giving you access to Varian's extensive library of software subsystems, language processors, and system utilities.

Best of all, the world's first mainframe-on-a-board has a base price of just \$1200. Plus a discount plan designed to give even modest-volume OEM buyers a big break. And you can take delivery in a matter of days — not months.

No matter how you configure it, the new V77-200 is the most economical Varian yet. Delivering the kind of price/performance value that just makes good sense. No matter what business your systems are in.

For more information on the world's first mainframe-on-a-board, please contact: Varian Data Machines, 2722 Michelson Drive, P.O. Box C-19504, Irvine, California 92713, Telephone (714) 833-2400. In Europe, please contact: Varian Associates, Ltd., Molesey Road, Walton-on-Thames, Surrey, England, Telephone 28971.



Mini's that think like mainframes.

First in the Industry!

LEDs with PHOTOCONDUCTORS

in DIP OPTO-ISOLATORS

Clairex has developed these four LED/photoconductive cell isolators in the conventional dual-in-line package. They are truly an industry first! The inherent slower speed response of a photoconductive cell, as compared to a silicon detector, provides an ideal unit for

noise and transient immunity.

All four units have a photoconductive cell output capability of 250 volts PAC along with an isolation voltage of 1500V PAC. They also feature a minimum R_{OFF} of one megohm and guaranteed R_{ON} maximums

at I_f biases of 16 ma and 1 ma respectively.

The CLM 50 and CLM 51 incorporate a GaP LED with a photoconductive cell for both linear and logic functions. The CLM 60 and CLM 61 feature two GaP LEDs connected in inverse parallel in their input cir-

cuits to facilitate an a-c input signal to the isolator.

For complete details or any other assistance with your opto-electronic problems, call 914-664-6602 or write Clairex®, 560 South Third Avenue, Mount Vernon, New York 10550.

LED-Photoconductor Dip Isolators

DUAL LED Photoconductor Dip Isolators

TECHNICAL DATA

| LED | CHARACTERISTICS | TEST CONDITIONS | Min. | CLM50-CLM51 Typ. | CLM60-CLM61 Max. | UNITS |
|---------------------|------------------------------|---|--------|------------------|------------------|-----------------|
| I_f max. | Maximum forward current | $I_f = 16 \text{ mA}$ | | 2.0 | 40 | mA |
| V_f | Forward voltage | $V_{in} = 3V$ | 2.0 | 2.5 | 2.0 | volts |
| I_r | Reverse current | | | 250 | 250 | volts DC or PAC |
| PHOTOCELL V_{max} | Cell voltage | | | 50 | 50 | multivolts |
| P | Power dissipation | $I_f = 1 \text{ mA}$ $I_r = 16 \text{ mA}$ | 5K | 1.5K | 7.5K | ohms |
| PHOTOMOD R_{on} | On resistance | 5 sec. after $I_f = 0$ 4 VDC on cell | 1 Meg. | | 1 Meg. | ohms |
| R_{off} | Off resistance | Time to 63% of total condition at $I_f = 16 \text{ mA}$ | | 500 | 500 | ohms |
| t_r | Rise time | Time to 63% of total condition at $I_f = 16 \text{ mA}$ | | 50 | 50 | nanoseconds |
| t_d | Decay time | Time to 100% | | 1500 | 1500 | nanoseconds |
| Yes | Isolation | | | | 1 | % P.C. |
| α/T_C | Cell temperature coefficient | $I_f \geq 1 \text{ mA}$ | | | | %/°C |

CLAIREX ELECTRONICS
A DIVISION OF CLAIREX CORPORATION
560 South Third Avenue, Mount Vernon, N.Y. 10550 (914) 664-6602

CLAIREX ELECTRONICS

A Division of Clairex Corporation

Circle Number 902 on Reader Service Card

World Radio History