

EASY-TO-BUILD BURGLAR ALARM FOR APARTMENT USE

Popular Electronics®

WORLD'S LARGEST-SELLING ELECTRONICS MAGAZINE

JULY 1976/\$1

**MOBILE COMMUNICATIONS:
CB vs. 2-METER FM**

**Microwave Ovens
for the Home**

**CMOS Probe
Extends
Multimeter Use**

**Guide to Choosing
TV & FM Antennas**

**Learning Electronic
Theory With
Hand Calculators**

TEST REPORTS:

**Nikko 7075 AM/FM
Stereo Receiver**

MXR Stereo Equalizer

**SBE "Opti/Scan"
Scanner**

**Hickok 370
Analog Multimeter**

EXCLUSIVE!

**Now You Can
Build a
HIGH-QUALITY
INTELLIGENT
TERMINAL**



303196 DRK
L DARKNESS
6450 WYRTLEND
SAN JOSE



Experience is the best teacher. You might settle for any CB first time around. Understandably. A lot of people think they're all pretty much alike. But you'll soon discover that, like everything else, there are exceptions.

Ask the pros. America's long distance truckers. These guys talk CB day in and day out. And they demand the best. That's why truckers refer to the Cobra 29 as "The Diesel Mobile."

Listen to Cobra. You'll hear a big difference. Because the Cobra 29 gives you features which assure crystal clear reception. Like switchable noise limiting and blanking, to cut out practically all pulse and ignition interference. Add squelch control and RF gain and you've got exceptional — adjustable — receiver clarity. Even in the heaviest CB traffic. You also get Delta Tuning which makes up for the other guy, because even off-frequency transmitters are pulled in. Perfectly.

Talk to Cobra. And you know you're punching through. One glance at the

29's over-sized illuminated meter tells you just how much power you're punching out and pulling in. For voice modulation the DynaMike delivers at 100%. Same way with power: The 29 transmits at maximum power levels.

Sooner or later you'll get a Cobra. And you'll get engineering and craftsmanship second to none. Performance that will make your first CB seem obsolete. Reliability and durability that have set standards for the industry. Above all, you'll get power. The power to punch through loud and clear like nothing else. Because when it comes to CB radio, nothing punches through loud and clear like a Cobra.



Punches through loud and clear.

Cobra Communications, Products of Dynascan Corp.
1801 W. Belle Plaine, Chicago, Illinois 60613

CIRCLE NO. 14 ON FREE INFORMATION CARD

IF YOUR FIRST CB ISN'T A COBRA YOUR SECOND ONE WILL BE.



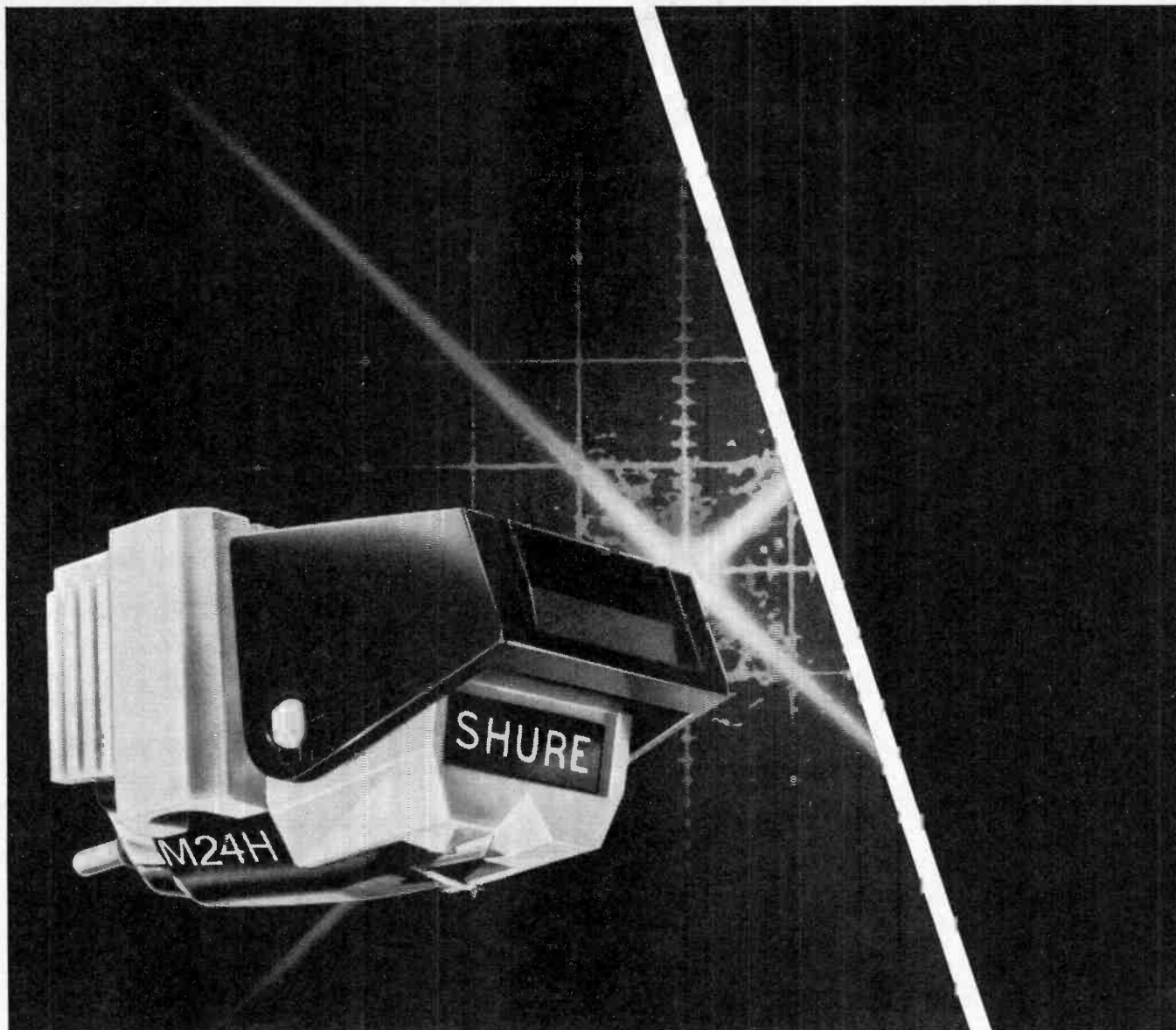

Uncompromised stereo/quadriphony —Undeniably Shure.



The new Shure M24H Cartridge offers audiophiles the best of both worlds: It is the only cartridge on the market that does not compromise stereo reproduction to add discrete quadriphonic capability. It eliminates the need to change cartridges every time you change record formats! This remarkable performance is achieved at only 1 to 1½ grams tracking force—comparable to that of some of the most expensive conventional stereo cartridges. Other M24H features include the lowest effective stylus mass (0.39 mg) in quadriphony, a hyperbolic stylus tip design, an exclusive “Dyneric® X” exotic high-energy magnetic assembly, and a rising frequency response in the supersonic carrier band frequencies that is optimized for both stereo and quadriphonic re-creation. If you are considering adding CD-4 capability, but intend to continue playing your stereo library, this is the ONE cartridge for you.

Shure Brothers Inc.
222 Hartrey Ave., Evanston, IL 60204
In Canada: A. C. Simmonds & Sons Limited



Manufacturers of high fidelity components, microphones, sound systems and related circuitry.

JULY 1976

CIRCLE NO. 55 ON FREE INFORMATION CARD

Famous Realistic® CB

PRICE CUT



MINI-23 MOBILE 2-WAY RADIO

NOW ONLY

9995*

YOU GET ALL THESE QUALITY FEATURES

- ✓ Full 23-channel coverage
- ✓ Built-in noise limiter
- ✓ Dual conversion receiver
- ✓ Lighted channel selector
- ✓ Modulation indicator light
- ✓ Plug-in dynamic mike
- ✓ Fits any vehicle or boat
- ✓ Positive or negative ground
- ✓ Complete mounting hardware

Specifications

Sensitivity for 10 dB S+N/N: 0.5 μ V
Selectivity at -6 dB: 6 kilohertz
Adjacent Channel Rejection: 50 dB
Audio Power: 3 watts maximum
Power Requirement: 12 volts DC

Reduced so you can easily afford to put more fun and safety into traveling. Call ahead for road and weather information. Radio for help. Use it for business. Get one for your wife's car for extra protection and companionship. Ceramic filtered IF circuitry for minimum interference. Silicon transistors for superior stability and reliability. 1½x5¼x7⅞" small. And our lower price will help pay for your (Archer®) antenna. Realistic transceivers are sold and serviced only by Radio Shack — leading the way in quality CB since 1960. Ask for 21-168.



Use Your Credit Card
at participating stores

SOLD ONLY WHERE YOU SEE THIS SIGN:

Radio Shack®

A TANDY CORPORATION COMPANY
4600 LOCATIONS • 50 STATES • 9 COUNTRIES

* At Participating Stores and Dealers.

CIRCLE NO. 47 ON FREE INFORMATION CARD

POPULAR ELECTRONICS

Popular Electronics®

WORLD'S LARGEST SELLING ELECTRONICS MAGAZINE

FEATURE ARTICLES

MICROWAVE OVENS FOR THE HOME	Bill Eva	39
<i>How they work and what to look for in selecting one.</i>		
LEARNING ELECTRONIC THEORY WITH HAND CALCULATORS	Edward M. Noll	43
<i>Part One: Basic Equations and Ohm's Law.</i>		
GUIDE TO CHOOSING TV & FM ANTENNAS	Julius Green	61
MOBILE COMMUNICATIONS: CB VS. 2-METER FM	John T. Frye	79
<i>The advantages and disadvantages of each type of system.</i>		
TEMPORARY PERMIT FORM 555-B FOR CB RADIO		98

CONSTRUCTION ARTICLES

BUILD SOL, AN INTELLIGENT COMPUTER TERMINAL	Robert M. Marsh & Lee Felsenstein	35
<i>Video terminal can interface with any mini- or microcomputer.</i>		
A FLASHER/BATTERY INDICATOR	Dave Hileman	46
<i>Indicates power is on to prevent using up the battery.</i>		
UPDATE YOUR MULTIMETER WITH A CMOS MILLIVOLTER	David H. Dage	47
<i>Converts any voltmeter to read in the low-millivolt range.</i>		
A LOW-COST APARTMENT BURGLAR ALARM	Randy J. Soule	50
<i>Self-powered system features adjustable time delay.</i>		
BUILD THE ULTIMATE METRONOME	Milton L. Chesnut	61
<i>Provides accented beats for timing and syncopation.</i>		

COLUMNS

STEREO SCENE	Ralph Hodges	22
<i>Perfecting Phono.</i>		
HOBBY SCENE	John McVeigh	30
SOLID STATE	Lou Garner	81
<i>Build Your Own Sonar System.</i>		
COMPUTER BITS	Hal Chamberlain	86
<i>Computer Graphics.</i>		
INSIDE BASIC ELECTRONICS		94
<i>Fixed and Variable Resistors.</i>		
CB SCENE	Ray Newhall	97
<i>A CB Primer.</i>		
EXPERIMENTER'S CORNER	Forrest M. Mims	104
<i>The Avalanche Transistor.</i>		

PRODUCT TEST REPORTS

NIKKO MODEL 7075 AM/STEREO FM RECEIVER		66
PIONEER MODEL SF-850 ELECTRONIC CROSSOVER		74
MXR STEREO GRAPHIC EQUALIZER		75
SBE MODEL 12SM OPTI/SCAN DIGITAL SCANNING RECEIVER		76
HICKOK MODEL 370 ANALOG MULTIMETER		77

DEPARTMENTS

EDITORIAL	Art Salsberg	4
<i>Who Killed TV Picture Quality?</i>		
LETTERS		6
OUT OF TUNE		6
<i>"A Simple Logic Probe," (May 1976)</i>		
<i>"Solid State," (April 1976)</i>		
NEW PRODUCTS		12
NEW LITERATURE		16
NEWS HIGHLIGHTS		32
OPERATION ASSIST		102
ELECTRONICS LIBRARY		103
ADVERTISERS INDEX		123

POPULAR ELECTRONICS, July 1976, Volume 10, Number 1. Published monthly at One Park Avenue, New York, NY 10016. One year subscription rate for U.S., \$9.98; U.S. Possessions and Canada, \$11.98; all other countries, \$12.98 (cash orders only, payable in U.S. currency). Second Class postage paid at New York, NY and at additional mailing offices. Authorized as second class mail by the Post Office Department, Ottawa, Canada and for payment of postage in cash.

POPULAR ELECTRONICS including ELECTRONICS WORLD, Trade Mark Registered. Indexed in the Reader's Guide to Periodical Literature. COPYRIGHT © 1976 BY ZIFF-DAVIS PUBLISHING COMPANY. ALL RIGHTS RESERVED.

Ziff-Davis also publishes Boating, Car and Driver, Cycle, Flying, Modern Bride, Popular Photography, Skiing and Stereo Review.

Material in this publication may not be reproduced in any form without permission. Requests for permission should be directed to Jerry Schneider, Rights and Permissions, Ziff-Davis Publishing Co., One Park Ave., New York, NY 10016.

Editorial correspondence: POPULAR ELECTRONICS, 1 Park Ave., New York, NY 10016. Editorial contributions must be accompanied by return postage and will be handled with reasonable care; however, publisher assumes no responsibility for return or safety of manuscripts, art work, or models.

Forms 3579 and all subscription correspondence: POPULAR ELECTRONICS, Circulation Dept., P.O. Box 2774, Boulder, CO 80302. Please allow at least eight weeks for change of address. Include your old address, enclosing, if possible, an address label from a recent issue.

EDGAR W. HOPPER
Publisher

ARTHUR P. SALSBERG
Editorial Director

LESLIE SOLOMON
Technical Editor

JOHN R. RIGGS
Managing Editor

ALEXANDER W. BURAWA
Feature Editor

EDWARD I. BUXBAUM
Art Director

JOHN McVEIGH
Associate Editor

ANDRE DUZANT
Technical Illustrator

PATRICIA BROWN
Editorial Assistant

LOU GARNER
GLENN HAUSER
JULIAN D. HIRSCH
RALPH HODGES
ART MARGOLIS
FORREST MIMS
HAL CHAMBERLAIN
WILFRED M. SCHERER
Contributing Editors

JOSEPH E. HALLORAN
Advertising Director

JOHN J. CORTON
Advertising Sales

LINDA BLUM
Advertising Service Manager

PEGI McENEANEY
Executive Assistant

STANLEY NEUFELD
Associate Publisher

ZIFF-DAVIS PUBLISHING COMPANY
Popular Electronics
Editorial and Executive Offices
One Park Avenue New York, New York 10016
212-725-3500

Hershel B. Sarbin, President
Furman Hebb, Executive Vice President
Phillip T. Heffernan, Senior Vice President, Marketing
Edward D. Muhlfeld, Senior Vice President, Sports Division
Philip Sine, Senior Vice President
Frank Pomerantz, Vice President, Creative Services
Arthur W. Butzow, Vice President, Production
Lawrence Sporn, Vice President, Circulation
George Morrissey, Vice President
Sydney H. Rogers, Vice President
Sidney Holtz, Vice President
Al Traina, Vice President
Phillip Korsant, Vice President
Paul H. Chook, Vice President, Market Planning
Charles B. Seton, Secretary
Edgar W. Hopper, Vice President, Electronics Div.

William Ziff, Chairman
W. Bradford Briggs, Vice Chairman

Midwestern Office
The Pattis Group, 4761 West Touhy Ave.,
Lincolnwood, Illinois 60644, 312 679-1100

GERALD E. WOLFE, THOMAS HOCKNEY
Western Office
9025 Wilshire Boulevard, Beverly Hills, CA 90211
213 273-8050; BRadshaw 2-1161
Western Advertising Manager: BUD DEAN

Japan: James Yagi
Oji Palace Aoyama: 6-25, Minami Aoyama
6 Chome, Minato-Ku, Tokyo 407-1930/6821,
582-2851

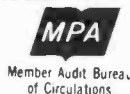

The publisher has no knowledge of any proprietary rights which will be violated by the making or using of any items disclosed in this issue.



Editorial

WHO KILLED TV PICTURE QUALITY?

The April 3 issue of *TV Guide* observed that U.S. citizens returning from Europe or Japan often "rave about beautiful TV reception there, the vividness of colors and detail in the picture..." Obviously, *their* system of TV must be better than ours, they conclude. Not so! The capabilities are essentially the same.

Whereas the European TV system employs a 625-line picture linked with 50 Hz, Japan (and the U.S.) use a 525-line system in sync with 60 Hz. Then why is our TV video reception so poor compared to that in other countries? The inconclusive reasons include: Americans just don't care or won't bother to adjust receivers properly, antenna systems and TV receivers are allowed to deteriorate, broadcasters are shortchanging us by transmitting poor-quality video and color, and receiver manufacturers take design shortcuts that prevent reception of good, clean signals.

There's probably some truth in all the foregoing speculations. Certainly, there is no question that many TV broadcasts are poor. You can prove this by switching from channel to channel, observe differences between film source and tape source, etc. But things are getting better (slowly, very slowly):

- The "purple plague" rarely touches the faces of TV performers nowadays.
- Broadcasters at least have a transmitted reference of tint and color intensity with which to make adjustments or to acknowledge that their equipment is obsolete.
- Broadcasters are also experimenting with "circular polarized" transmitting antennas, which might eliminate "ghosts" (a different outdoor receiving antenna design would be needed to take advantage of this).
- Receiver manufacturers have introduced models with automatic color screen grid tracking (RCA) and automatic adjustment to the broadcaster's color/tint intensity reference (General Electric). The latter is VIR, for vertical interval reference, but you cannot see it without a decoder and it's not yet universally used.

Surely these advances are welcome. But how come the other countries managed to produce substantially better color and black-and-white TV pictures without them? Ignoring all the possible causes for our "picture-quality lag" except for the TV receiver itself, we know that U.S. video reception can be significantly improved at the consumer equipment end.

Our technical editor, Les Solomon, for example, observed in his August 1973 "Test Scene" that most TV receivers are incapable of even reproducing 262½ lines, let alone close to our 525-line "standard." What interlace there is in most receivers (trace on "odd" lines and retrace on "even" lines) is reproduced as "pairing." That is, scanning lines of one field are positioned directly behind the lines of the other field. The result is a TV picture lacking good detail.

Another video-quality degenerator is the absence of good, if any, dc restoration. Instead of being capable of shifting to deep black, the typical receiver can only go to "tattle-tale gray." The black level is simply lost because the dc signal level, destroyed by capacitive coupling, hasn't been restored. Sadly, all it takes is a diode and a resistor to do the job.

Another improvement that is long overdue is providing an inexpensive audio output jack from the detector on a TV receiver. FM TV sound can go to 15 kHz. For the future, a video jack would be in order to handle TV electronic games, computers and video tape decks.

So the question is: in our free-enterprise system, why hasn't some TV manufacturer scooped the competition and come out with a model that has full interlaced scanning, proper dc restoration, etc.? Believe me, the American public would recognize a vastly superior TV picture and "latch on" to the unit. The hi-fi component industry proved that we recognize and appreciate good quality!

POPULAR ELECTRONICS

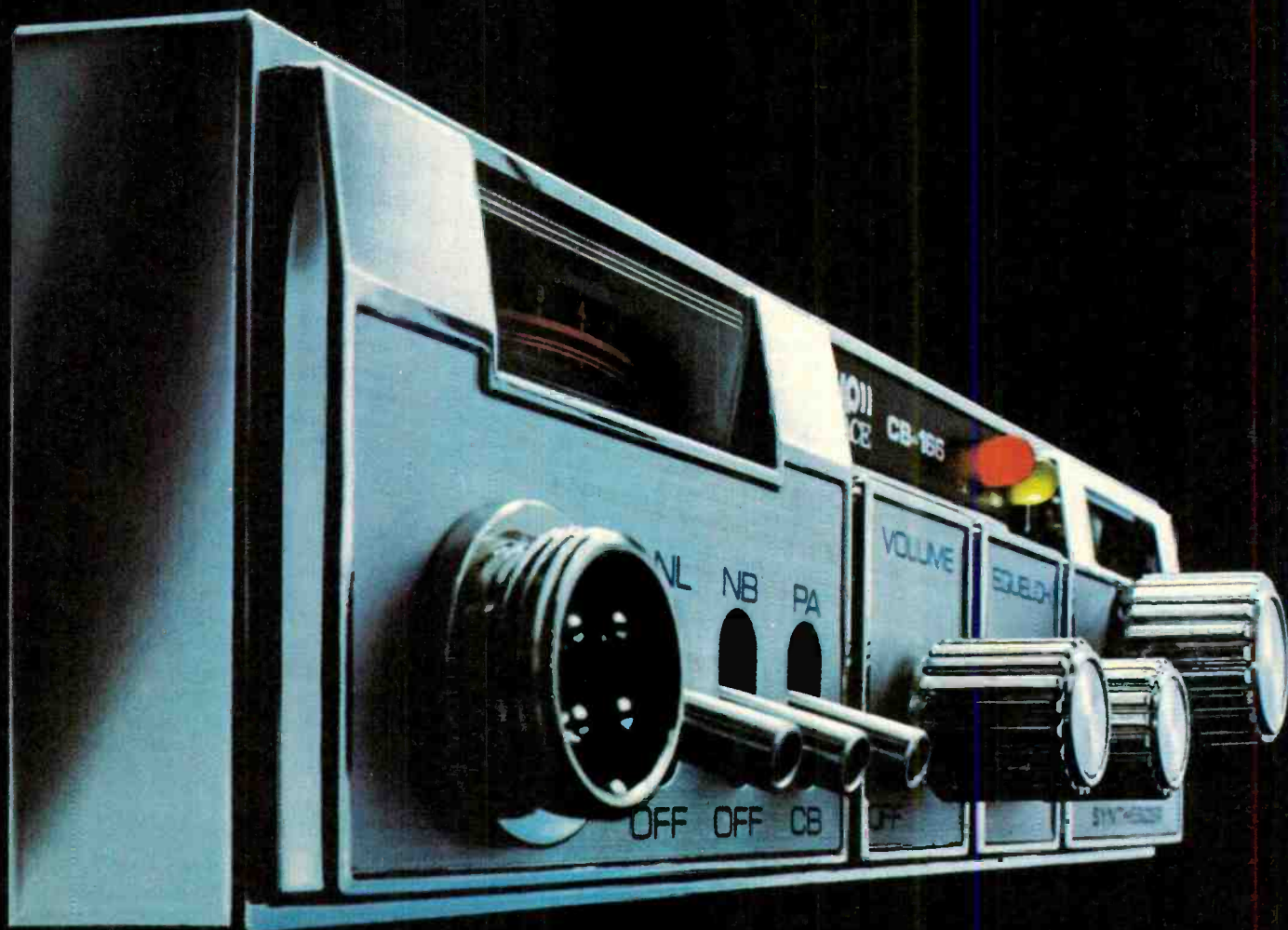

Pace. The best-selling CB in the world.

More people buy Pace than any other CB, based on estimates by Pathcom Inc.

Maybe it's because:

We wanted to be #1 — and we put our money & determination on the line to make the kind of radios that would make us the leader.

The warranty we offer — just ask anybody about it.

Our quality control — which means we don't just test an occasional sample off the line, we vicrate-test almost every mobile radio we make.

Our 23 models — the largest CB line in the world with suggested prices from \$50 to \$500. Which makes it easier to choose the right radio.

Is Pace for you? We think Number One deserves #1.

Write us — Pathcom Inc., (Los Angeles), Harbor City, CA. 90710.

PACE CB

When you've got a Pace,
you've got the world by the ears.

PACE TWO-WAY RADIOS, PRODUCTS OF PATHCOM INC.

CIRCLE NO. 42 ON FREE INFORMATION CARD

Flexible alternative

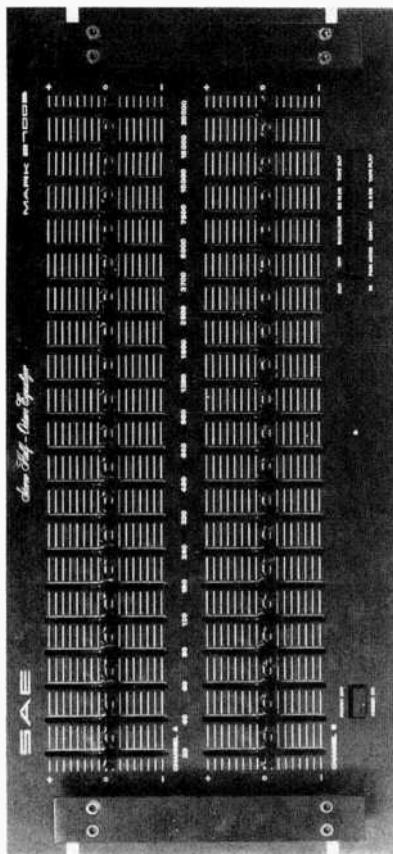

The SAE 2700B Half-Octave Stereo Equalizer

The 2700B can bring to your system the clarity & definition you have been looking for. Wayward sounds (booming bass, missing highs, blaring horns, or stifled solos) are all put in their place with the SAE 2700B Half-Octave Equalizer. The flexibility of 20 controls per channel only begins to tell the story. Some facts:

- * 0.02% THD & IM
 - * -100dB S/N Ratio
 - * Can drive any system
 - * FREE 5 YEAR Service Contract PLUS, long-throw oil-damped slide pots for better accuracy, precision wound toroid inductors for low distortion & a pink noise generator for system balance. Built with SAE quality, the 2700B is value packed with the capability and performance you need to control your system.
- PRICE: \$550.00 (suggested list)

SAE

Scientific Audio Electronics, Inc.

P.O. Box 60271, Terminal Annex
Los Angeles, Calif. 90060

Please send me more information on the
SAE 2700B Half-Octave Equalizer.

NAME _____

ADDRESS _____

CITY _____ STATE _____ ZIP _____



Letters

CBC RESPONDS TO QSL REPORTS

As many of us know, the CBC (Canada) has cut back on SW programming and requires QSL-seekers to fill in their own information. I can add that the CBC hasn't weakened its grip on QSL's for its MW stations. Such was the case when I reported receiving CMB Montreal last December 14 at 1600 EST. I sent in my report, including my log and reception figures, and two months later received not only my QSL but a program for the schedule for the Quebec Community Network (19 stations in the province anchored by CMB, which provides CBC coverage for Quebec).—*Charles E. Everett, Sag Harbor, NY.*

ARTWORK PACKAGE BLUES

With today's technology, some projects are so complex that they would occupy too much magazine space if they were described completely. Needless to say, I understand your problem in making available separately schematics and/or etching and drilling guides. However, I must take exception to the artwork package I received from M&R Enterprises for the "Pennywhistle Modem" (March 1976). The pc layouts were sloppily photocopied and of such low contrast that I would have to go over them with an inker before I could make work negatives from them. Also, the schematic that was claimed to be too large to fit on a POPULAR ELECTRONICS page (received from M&R on a single sheet) could easily have been included in the published article where space was wasted on a vague block diagram.—*David G. Potter, Sacramento, CA.*

These guides were not meant to be original artwork to be used in making pc boards. Rather, they were meant as guides for readers who wish to make exposure masks using the IC pattern, donut, and tape method of making exposure masks. Also, given a choice between a schematic and the block diagram, we chose the diagram as being more meaningful to most readers.

ACCESSING VIDEO INPUT

I'm planning to build the "Space-War Game" featured in the April 1976 issue of POPULAR ELECTRONICS. In reading over the article, I note that reference is made to connecting the game's output to the video

input of a TV receiver. Just how is this accomplished? Also, how does one go about trimming fixed resistors R13 through R16?—*Edward I. Williams, Peckville, PA*

The first thing to do is check the schematic diagram of your TV receiver to locate the connection between the video detector and video amplifier. Break this connection. Then connect the video game between the input of the video amp and ground. As for trimming the resistors, simply substitute resistor values as needed.

WHY PONGTRONICS IS BETTER

I was very intrigued by the "Pongtronics" tennis game featured in the April 1976 issue of PE. At the time I decided to build the project, I noticed that several other similar games became available completely assembled for about the same price. What advantages, if any does Pongtronics offer?—*E.L. Cassell, Allentown, PA*

Pongtronics is actually four games (tennis, gravity pong, handball, and basketball) with 10 game-player combinations in a single unit. Since it isn't designed around a single LSI chip (like department-store games), it is more flexible, offering player skill controls, variable rebound, variable court size, adjustable paddle size, etc. Pongtronics can also be modified to permit tennis doubles action.

DANGER—LIVE WIRES

Please remind readers that electric power lines are not insulated, except for the lead-in from the transformer to the house. Two of my neighbors were killed when the antenna they were putting up touched a power line. I fear that this type of accident will become rather common unless CB and TV antenna sales people warn the install-it-yourself hobbyist.—*Steve McKay, Athens, AL*

THEFT PREVENTION EXPANDED

Many thanks for "Theft Alarm for Handheld Calculators" (March 1976). I found the circuits presented useful for deterring thefts of transistor radios, tape recorders, etc., as well as keeping my calculator safe.—*David Hayes, Gander, Newfoundland*

Out of Tune

In "A Simple Logic Probe" (May, p 60), the Parts List should show C1 as a 1000-pF disc capacitor; C2 and C3 as 1- μ F, 25-V tantalum capacitors. The schematic is correct.

In "Solid State" (April, p 90), pins 7 and 8 of IC10 and IC11, in Fig. 3, should be grounded.

One look inside proves it! The new Royce Wireless Module CB's are years ahead of competition.

Look, no wires!

Modular construction. With not one single wire on any module.

And, no hand soldered connections to vibrate loose.

Plus the things you want and need — peak power, better reception, greater range. All in a rugged, vinyl-clad metal cabinet.

And, automated module assembly at the factory — plus computer tuning and testing — assures you of the highest quality no matter which Royce Wireless Model you choose.

What does it all add up to? You know already. Greater reliability and performance in CB than you had ever dreamed possible!

See all 6 Royce Wireless Module Mobile CB Transceivers at your

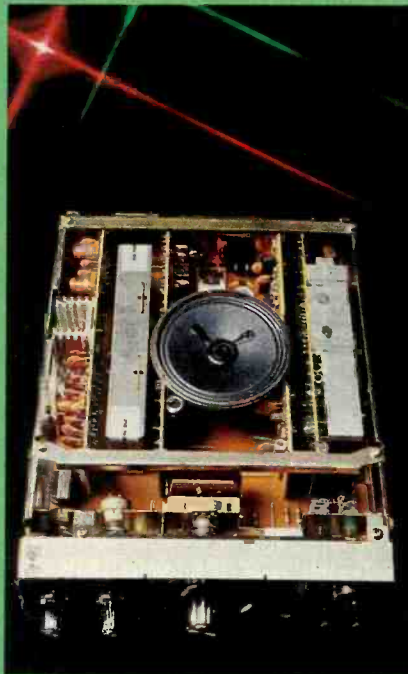

Royce dealer's soon! Write today for information on these models plus other innovative Royce CB's, antennas, and accessories.

Royce Wireless Model 1-650 — 23 channel mobile CB has Amplified Automatic Gain Control (AAGC) circuit to amplify weak signals, yet reduce nearby overload. Large, readable (1" X 1") S/RF meter. Exclusive IC audio stage for maximum clarity, power. 3 ceramic filters reduce channel interference. Dual conversion receiver + tuned RF stage pulls in even weakest signals. Rugged metal (not plastic) RF output transistor.

Royce Digital Wireless Model 1-660 — 23 channel mobile CB has digital readout dial system with bright L.E.D. numerals for fast channel selection. Phase Lock Loop Tuning adds greater reliability. ANL automatically minimizes noise, static. Pushbutton PA/CB activates powerful P.A.. AAGC, 3 ceramic filters. Exclusive IC audio stage for maximum clarity.

Model 1-650



Model 1-660



Royce



Royce Electronics Corporation
1746 Levee Road

North Kansas City, Mo. 64116
Call: (816) 842-7505 • Telex: 426-145

Follow the new leader!

CIRCLE NO. 48 ON FREE INFORMATION CARD

Imagine a microcomputer

Imagine a microcomputer with all the design savvy, ruggedness, and sophistication of the best minicomputers.

Imagine a microcomputer supported by dozens of interface, memory, and processor option boards. One that can be interfaced to an indefinite number of peripheral devices including dual floppy discs, CRT's, line printers, cassette recorders, video displays, paper tape readers, teleprinters, plotters, and custom devices.

Imagine a microcomputer supported by extensive software including Extended BASIC, Disk BASIC, DOS and a complete library of business, developmental, and industrial programs.

Imagine a microcomputer that will do everything a mini will do, only at a fraction of the cost.

You are imagining the Altair™ 8800b. The Altair 8800b is here today, and it may very well be the mainframe of the 70's.

The Altair 8800b is a second generation design of the most popular microcomputer in the field, the Altair 8800. Built around the 8800A microprocessor, the Altair 8800b is an open ended machine that is compatible with all Altair 8800 hardware and software. It can be configured to match most any system need.

MITS' plug-in compatible boards for the Altair 8800b now include: 4K static memory, 4K dynamic memory, 16K static memory, multi-port serial interface, multi-port parallel interface, audio cassette record interface, vectored interrupt, real time clock, PROM board, multiplexer, A/D convertor, extender card, disc controller, and line printer interface.

MITS' peripherals for the Altair 8800b include the Altair Floppy Disc, Altair Line Printer, teletypewriters, and the soon-to-be-announced Altair CRT terminal.

Introductory prices for the Altair 8800b are \$840 for a kit with complete assembly instructions, and \$1100 for an assembled unit. Complete documentation, membership into the Altair Users Club, subscription to "Computer Notes," access to the Altair Software Library, and a copy of Charles J. Sippl's Microcomputer Dictionary are included. BankAmericard or Master Charge accepted for mail order sales. Include \$8 for postage and handling.

Shouldn't you know more about the Altair 8800b? Send for our free Altair Information Package, or contact one of our many retail Altair Computer Centers.

mits 2450 ALAMO S.E. ALBUQUERQUE, NEW MEXICO 87106 (505) 243-7821

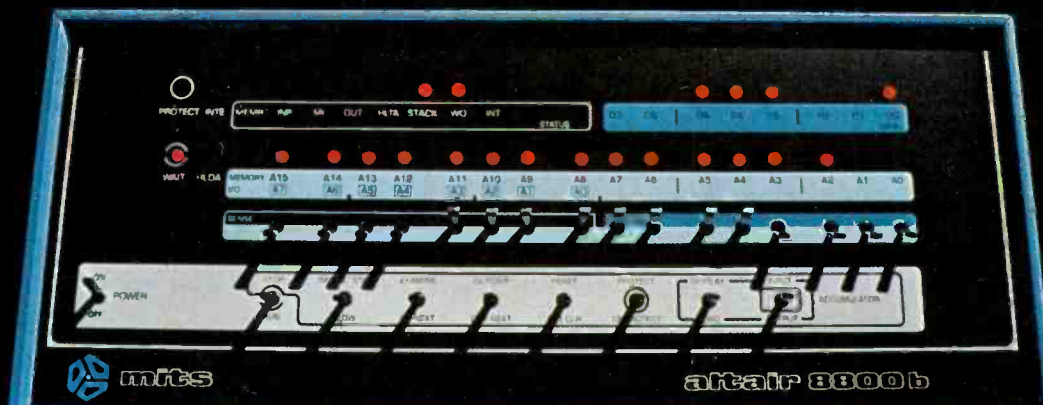

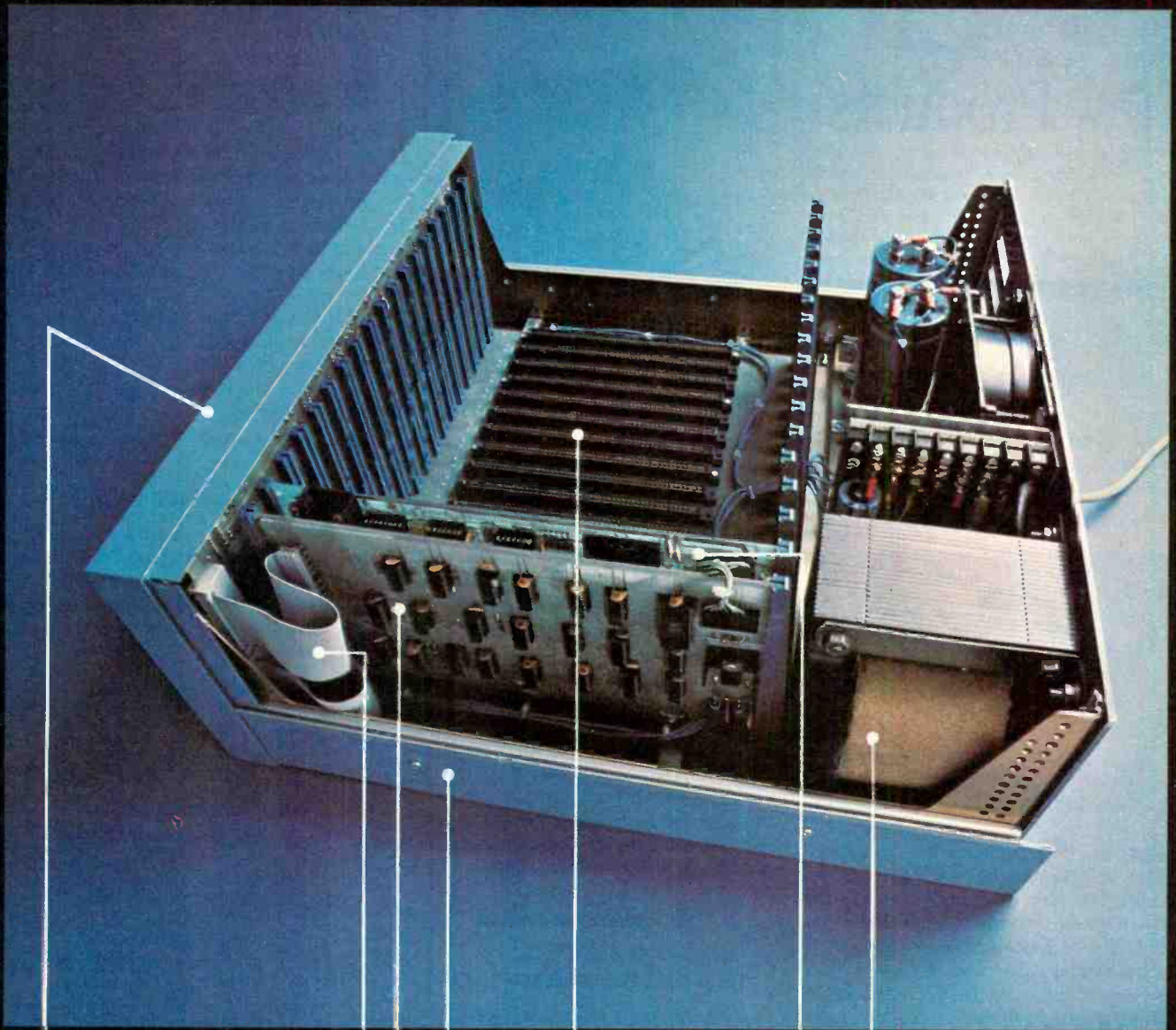

Redesigned front panel. Totally synchronous logic design. Same switch and LED arrangement as original Altair 8800. New backlit Duralith (laminated plastic and mylar, bonded to aluminum) dress panel with multi-color graphics. New longer, flat toggle switches. Five new functions stored on front panel PROM including: DISPLAY ACCUMULATOR (displays contents of accumulator), LOAD ACCUMULATOR (loads contents of the 8 data switches (A7-A0) into accumulator), OUTPUT ACCUMULATOR (Outputs contents of accumulator to I/O device addressed by the upper 8 address switches), INPUT ACCUMULATOR (inputs to the accumulator from the I/O device), and SLOW (causes program execution at a rate of about 5 cycles per second—for program debugging).

Full 18 slot motherboard.

Rugged, commercial grade Optima cabinet.

New front panel interface board buffers all lines to and from 8800b bus.

Two, 34 conductor ribbon cable assemblies. Connects front panel board to front panel interface board. Eliminates need for complicated front panel/bus wiring.

New, heavy duty power supply: +8 volts at 8 amps, +18 volts at 2 amps, -18 volts at 2 amps. 110 volt or 220 volt operation (50/60 Hz). Primary tapped for either high or low line operation.

New CPL board with 8080A micro-processor and Intel 8224 clock generator and 8216 bus drivers. Clock pulse widths and phasing as well as frequency are crystal controlled. Compatible with all current Altair 8800 software and hardware.

altair 8800-b



2450 Alamo SE/Albuquerque, NM 87106/505-243-7621
Prices, delivery and specifications subject to change.

NOTE: Altair is a trademark of MITS, Inc.

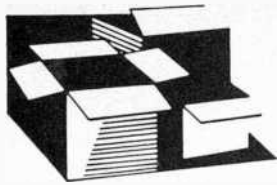

New Products

Additional information on new products covered in this section is available from the manufacturers. Either circle the item's code number on the Reader Service Card inside the back cover or write to the manufacturer at the address given.

B&K-PRECISION CB TEST INSTRUMENT

The B&K-Precision Model 1040 is a new test instrument designed for fast, efficient servicing of CB equipment. It features a peak-indicating r-f wattmeter, dummy load, audio signal generator, and audio

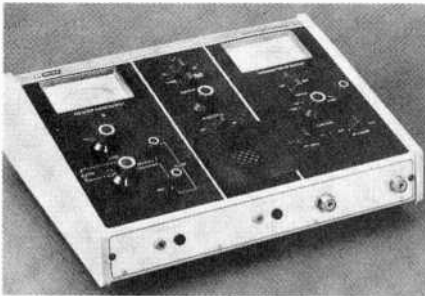

wattmeter. When used with an oscilloscope, stable r-f signal generator, and frequency counter, it becomes a complete CB service center. It tests r-f output power, AM and SSB modulation, and antenna SWR in the transmitter section. In the receiver section, it checks sensitivity (S/N ratio), audio output power and distortion, frequency response, agc and squelch action, and adjacent-channel rejection. All tests can be performed without changes in the initial connections to the transceiver. \$250.

CIRCLE NO. 85 ON FREE INFORMATION CARD

FINNEY MOBILE FM SIGNAL BOOSTER

The Finney Co. "Stereo One" mobile FM signal booster is designed to help eliminate signal fade and flutter associated with weak-signal FM reception. It can be used with any AM/FM car receiver without introducing adverse effects to normal reception. The device is said to more than triple the received signal level to provide clear FM reception in fringe signal areas. Even so, it is designed to avoid overloading the receiver in strong-signal areas. The two-piece Stereo One consists of an amplifier section that mounts close to the receiver and a small ON/OFF control box that self mounts where it is easily accessible.

CIRCLE NO. 86 ON FREE INFORMATION CARD

ADC REMOTE-CONTROL LOGIC TURNTABLE

The Audio Dynamic Corp. has introduced a unique single-play turntable called the Accutrac 4000. The direct-drive turntable



marries a digital-logic memory bank with an infrared generator and detector built into its special phono cartridge. The user can thus program which bands of an LP will be played in whatever desired sequence. Electronic controls include: automatic reject, cue and repeat, 13 track selection pushbuttons and separate all-tracks button, and 33 1/3- and 45-rpm speed-selector buttons. A handheld remote-control transmitter and remote receiver provide full track selection, reject, repeat, and cue control from a distance. Wow and flutter are reported to be less than 0.03% wrms, with DIN-weighted rumble down 70 dB. Tracking force range with the supplied cartridge is 3/4 to 1 1/2 grams, and low-capacitance wiring is used. Price is \$499.95, which includes base and dust cover.

CIRCLE NO. 87 ON FREE INFORMATION CARD

GBC HIGH-PERFORMANCE CCTV CAMERA

The "Mini-Max" Model CTC-3000 from GBC Closed Circuit TV Corp. features 600 lines of resolution; 10,000:1 automatic light compensation; adjustable white clip; and automatic voltage regulation. The camera employs a Vidicon tube and features plug-in circuit module construction. The case is heavy die cast aluminum. The camera can be operated from 24-, 117-, and 220-volt ac sources. When powered from a 24-volt source, it allows installation with a



single cable as far away as 2500' (762 m) without 117 volts ac being required at the camera points. The camera includes a 16-mm f/1.6 "C" mount lens. \$199.50.

CIRCLE NO. 88 ON FREE INFORMATION CARD

ROGERS ELECTRO-MATICS CB SWITCH

The new solid-state "Killer" switching system from Rogers Electro-Matics permits hands-free operation of both AM/FM radio and CB transceiver in a car. The device can be actuated by an incoming CB call, which immediately switches the speaker(s) from the AM/FM radio to the CB rig. The message is then heard through the radio's speakers. The Killer can also be activated when the CB mike button is pressed. A small time delay on drop-out prevents switching back and forth between words and transmissions, while virtually no time delay on pull-in cuts off the first part of a message. The Killer is designed to operate with almost all types of two-way radio systems, monitor receivers, scanners, etc. It is capable of controlling two speakers operating either monaurally or in stereo. Price is \$49.95.

CIRCLE NO. 89 ON FREE INFORMATION CARD

SIMPSON PORTABLE DIGITAL VOM

The Model 360 Series 2 from Simpson is a 3 1/2-decade DMM designed for both bench and field use. It can be operated on ac line power or its own internal batteries. The instrument has 29 ranges for measuring ac



rms and dc voltage, ac and dc current, and resistance. The 0.43" (11-mm) LED display automatically indicates polarity on dc and flashes when an overrange condition exists. All ranges are overload protected. Two low-power-ohms ranges (200 mV maximum full-scale voltage) allow the user to make in-circuit tests without biasing on most semiconductor junctions. A zero-center analog meter movement is provided for peaking and nulling operations. Special analog output terminals are provided for connection to a graphic recorder. \$257.

CIRCLE NO. 91 ON FREE INFORMATION CARD

VERO INSTRUMENT CASES

PVC-clad steel instrument cases are now available in five sizes from Vero Electronics, Inc. The three widths currently

POPULAR ELECTRONICS

state-of-the-art in sideband ...



Johnson sideband. again!

Nearly 10 years ago we introduced the world's first CB single sideband radio — a radio still sought after and prized today. In that tradition of state-of-the-art performance, Johnson offers you the Viking 352. With the most advanced SSB performance on-the-air... including crystal lattice filtering, an efficient RF noise blanker, individual professional controls for every function, and color-keyed lights for instant indication of USB, LSB, or AM mode. Viking 352 brings famous Johnson quality, performance, warranty and service to CB sideband! \$359.95.



JOHNSON

E. F. JOHNSON COMPANY, WASECA, MINNESOTA 56093

In Canada: A. C. Simmonds & Sons, Ltd.

CIRCLE NO. 33 ON FREE INFORMATION CARD

The problem solver



DC300A

The Crown DC-300A power amplifier is at least worth its weight in aspirin as a problem-solver for commercial sound installers.

Crown rates the DC-300A at 155 watts per channel RMS into 8 ohms (1Hz to 20KHz). Or 310 watts per channel into 4 ohms.* Or 500 watts per channel into 2.5 ohms.* Or 600 watts in the mono mode into 8 ohms. You can drive a 70 volt line directly.

Which solves the power problem.

The DC-300A front end long ago set standards of low distortion and noise that have not yet been surpassed.

Which solves the clarity problem.

The Crown DC-300A will drive any speaker load — even totally reactive ones — with no spikes, thumps or fly-backs. Each channel has separate controls and circuitry. It acts like two separate mono amps.

Which goes a long way towards solving the design problem.

The output protection circuitry prevents damage from shorts, mismatched loads and overheating. Its proven reliability record is a little short of awesome.

Which solves a service problem.

Price? Again, no problem. We still think the DC-300A always has been audio's best performance value.

Do you have some special problems on current bids? Call us at 219/294-5571. Our real-life problem solvers might be able to help.

*(Single channel operating; sine wave test signal into resistive load; extended operation or limited ventilation may require forced air cooling to maintain levels described.)

When listening
becomes an art,
crown

Box 1000, Elkhart, IN 46514

CIRCLE NO. 17 ON FREE INFORMATION CARD

being offered are 15.9", 12.4", and 10.9" (40.4, 31.5, and 27.7 cm) with depth and height of 8.7" and 6.2" (22.1 and 15.7 cm). The widest version is also available in a 12.4" depth and 4.5" height (32 x 11.4 cm), while a second depth of 12.1" (30.7 cm) is offered for the 12.4" wide case. The base and rear panels of the cases are louvered for ventilation. An anodized front panel and all mounting screws are supplied with each case. Prices start at \$17.43. Address: Vero Electronics Inc., 171 Bridge Rd., Hauppauge, NY 11787.

CIRCLE NO. 92 ON FREE INFORMATION CARD

JVC DELUXE AM/STEREO FM RECEIVER

Built into JVC's Model JR-S300 stereo receiver are direct-reading power output meters and an S.E.A. graphic equalizer.

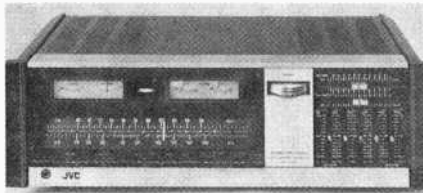

The 50-watt/channel (into 8 ohms) receiver is rated at less than 0.3% THD at full power. The equalizer section divides the musical spectrum into five frequency bands with 12-dB boost or cut. The tuner section features linearly calibrated scales on both AM and FM and a dual flywheel mechanism. IC's are used in the FM i-f, stereo FM decoder, and AM sections. A dual-gate MOS-FET and three-gang tuning capacitor are used in the front end. FM usable sensitivity is stated at 1.7 μ V (10.97 dBf), 50-dB quieting sensitivity at 3.5 μ V mono, S/N at 70 dB mono, selectivity at 60 dB, and capture ratio at 1.2 dB. \$400.

CIRCLE NO. 93 ON FREE INFORMATION CARD

CONTINENTAL SPECIALTIES DIGITAL PROBE

The Continental Specialties Corp. Model LP-1 test probe tests TTL/DTL and MOS devices in circuit. The low-cost pocket-sized probe also employs a pulse detector, pulse stretcher, and memory circuit for maximum testing flexibility. Power for the probe is obtained from the circuit under test simply by clipping its test leads to the positive and negative buses. A slide switch is then set to TTL/DTL or CMOS, depending on the logic family used in the circuit. If more than one logic family is used, it is a simple matter to change switch positions as needed. A second switch allows selection of either the PULSE or MEM mode. Separate HI, LO, and PULSE LED's indicate the logic state at any given point in the circuit to which the probe point is touched. High input impedance virtually eliminates loading problems in any circuit under test. \$44.95.

CIRCLE NO. 94 ON FREE INFORMATION CARD

MURA INTRODUCES THREE MIKES FOR CB

Mura Corp. has introduced three new CB microphones that feature a circuit designed to prevent voice-signal clipping and allow maximum modulated output power from limited-level amplifiers. The Peak-Redistribution Modulation (PRM) circuits used in the mikes are said to offer a fully modulated voltage gain of up to 16 dB for an average 4-dB increase in effective r-f transceiver output power. The mobile Model PRX-100 (\$39.95) and base-station Model PRX-300 (\$69.95) mikes provide an infinitely variable slide-type gain control, while the mobile Model PRX-200 offers a switch-selectable choice of 12, 14, or 16 dB of gain. All three mikes have push-to-talk switches (the Model PRX-300 also has a locking bar for hands-free operation) and are supplied with cords that can be wired for relay or electronic switching.

CIRCLE NO. 95 ON FREE INFORMATION CARD

CELESTION SPEAKER SYSTEMS

Three new speaker systems made by Celestion (England) and available in the U.S. from Rocelco Inc. offer a choice of performance and power-handling capacity. The tall, slim Model UL10 Data three-way system can handle 50 watts of continuous rms sine-wave power (100 watts peak music power) and has a frequency response of 70 to 20,000 Hz \pm 3 dB. The Model UL8 Data two-way speaker system is rated at 25 watts continuous rms power (50 watts peak) and has a frequency response of 70 to 20,000 Hz \pm 3 dB. The Compact Model UL6 Data two-way system's power-handling capacity is 20 watts continuous rms (40 watts peak) and frequency response is 80 to 20,000 Hz \pm 3.5 dB.

CIRCLE NO. 96 ON FREE INFORMATION CARD

MOTOROLA CB TRANSCEIVERS

Motorola's new line of MOCAT CB transceivers includes four under-dash models. The basic Model 2000 rig offers a phase-locked loop synthesizer for maximum on-frequency operation reliability; FET front end; plug-in microphone with built-in



amplifier; top-facing speaker; large illuminated S/r-f meter; external PA and speaker capability; automatic noise limiter; and automatic gain control. The Model 2005 includes the foregoing plus a noise blanker. The Model 2010 adds an LED digital channel display with dimmer to Model 2000 features. The top-of-the-line Model 2020 has both Extender blanker and digital display. Prices range from \$175 to \$225.

CIRCLE NO. 97 ON FREE INFORMATION CARD



Motorola CB is here!

Introducing Mocat—The CB radio backed by Motorola's 40 years experience in professional radio communications. Great looks. Great performance. Everything you'd expect from a radio built by Motorola. Yet it comes at a very affordable price.

Designed and engineered in the USA, Mocat is a 100% solid-state Motorola CB radio with the very latest in technological advances, and exciting features.

Motorola CB means reliability. A digital phase lock loop synthesizer assures on-frequency perform-

ance on all channels.

Motorola CB means quality reception. Automatic gain control, cross modulation rejection circuit and optional "Extender" noise blanker circuit give Mocat superior receiver performance.

Motorola CB means power. All models feature a rugged plug-in mike with built-in amplifier for maximum transmit signal strength.

Motorola CB means good looks. Contemporary styling across the line. Selected models offer easy channel identification with high-intensity L.E.D. digital channel read-

out and dimmer.

Motorola CB also means high performance and attractively styled antennas and accessories.

Motorola CB is the biggest news and greatest value in personal communications today. Mocat from Motorola. Now is the time to own a Motorola CB. For complete details, write us at Motorola, Inc., Dept. CB-700, 1301 East Algonquin Road, Schaumburg, IL 60172.

MOTOROLA

CIRCLE NO. 37 ON FREE INFORMATION CARD

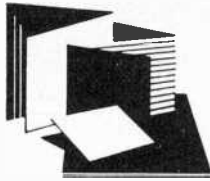

New Literature

PRINTED CIRCUIT ROTARY SWITCHES

An 8-page brochure from Oak Industries describes its family of rotary printed circuit switches. A chart illustrates the 17 categories of conventional rotary switches available with terminations. Diagrams and pictures of Oak's line of pc and pcb switches are also shown including 12- and 24-position models. Also covered is a technique for attaching conductor cable to rotary switches, and advantages such as compactness and elimination of harnessing are outlined. Address: Switch Division, Oak Industries, Inc. Crystal Lake, IL 60014.

ABOUT COMBINERS

"About Combiners," a new 20-page booklet from Decibel Products, describes, in detail, various types of transmitter and receiver combiners. The text, written for those engaged in two-way radio communi-

cations, but who are not engineers, includes a nontechnical presentation of different methods of combining a number of duplex or repeater and/or simplex systems on the same antenna. Address: Decibel Products, Inc. Box 47128, Dallas, TX 75247.

VHF EQUIPMENT CATALOG

Hamtronics' new catalog highlights vhf preamplifiers and FM communications subsystems for amateur and monitor applications. Included in the catalog are a vhf preamp, a uhf grounded-gate preamp for the 400-500-MHz region (both available in kit or wired form), a uhf converter, a vhf receiver and a uhf/vhf model (all in kit form). Address: Hamtronics, Inc., 182 Belmont Road, Rochester, NY 14612.

SEMICONDUCTOR REPLACEMENT SUPPLEMENT

GTE Sylvania announces its ECG Semiconductor Replacement Guide Supplement No. 1 (ECG 212F-1). Designed as a quick reference for technicians, engineers and hobbyists, the 18-page booklet includes substitute components for transistors, gate-controlled switches and integrated circuits for communications, audio, television and industrial applications. The booklet contains a product index, device specifications, package line drawings and dimensions, pin designations and a component cross-reference. A list of errata to

Replacement Catalog ECG212F is included, as well as a list of additions and deletions which reflect changes in the Sylvania ECG semiconductor line. Available for 35 cents from the GTE Sylvania Advertising Services Center, 70 Empire Dr., West Seneca, NY 14224.

SCAN CONVERTER TRANSCEIVER

Robot Research, Inc. offers complete literature on its Model 300 Scan Converter Transceiver. Used in conjunction with any black-and-white monitor (or commercial TV receiver), this \$995 converter can transmit pictures anywhere by telephone. Pictures have 256-line resolution. An entire image can be transmitted full-frame in 34 seconds or half-frame in 17 seconds. Address: Robot Research, Inc., 7591 Convoy Ct., San Diego, CA 92111.

CONTROL KNOBS CATALOG

Radial Controls offers a 16-page catalog illustrating its line of control knobs. Covered are low-profile knobs of uniform height, as well as calibrated, spinner, pointer and bar knobs. All are available in round, skirted, wing and concentric styles. Custom designs and optional indexing marks are also described. The catalog illustrates each knob and provides dimensional data. Address: Radial Controls, 2555 East 55th Pl., Indianapolis, IN 46220.

Why ACE solderless breadboards are more reliable than others.

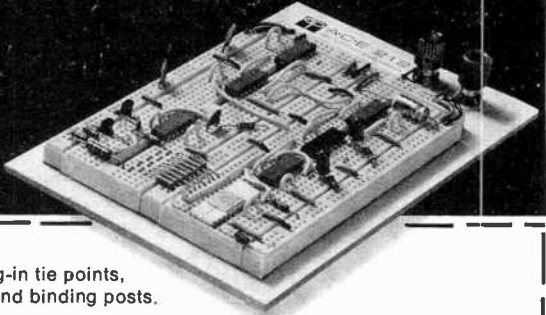
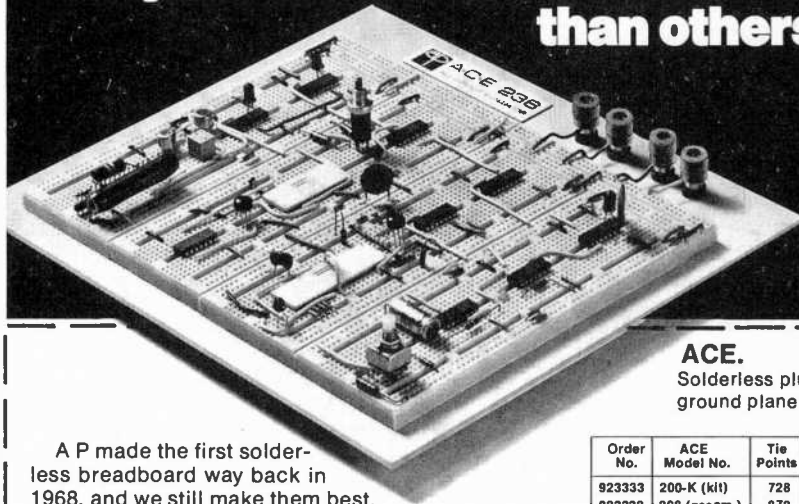

ACE.
Solderless plug-in tie points,
ground plane and binding posts.

A P made the first solderless breadboard way back in 1968, and we still make them best. Because our experience taught us to avoid the pitfalls that can mean circuit errors. We do it by paying attention to details. Like using non-corrosive nickel-silver in our frankly superior terminals. And like using a vinyl-insulated back that prevents short circuiting. That's why you can count on the reliability of our solderless boards when you specify A P ACE All Circuit Evaluator Boards, Super Strips™, Terminal and Distribution Strips.



A P PRODUCTS INCORPORATED
Box 110-H Painesville, OH 44077 (216) 354-2101 TWX: 810-425-2250

Order No.	ACE Model No.	Tie Points	DIP Capacity	No. Suses.	No. Posts	Board Size (inches)	Price Each	Qty.	Total
923333	200-K (kit)	728	8 (16's)	2	2	4-9/16x5-9/16	\$18.95		
923332	208 (assem.)	872	8 (16's)	6	2	4-9/16x5-9/16	28.95		
923334	201-K (kit)	1032	12 (14's)	2	2	4-9/16x7	24.95		
923331	212 (assem.)	1224	12 (14's)	8	2	4-9/16x7	34.95		
923326	218 (assem.)	1760	18 (14's)	10	2	6-1/2x7-1/8	46.95		
923325	227 (assem.)	2712	27 (14's)	28	4	8x9-1/4	59.95		
923324	236 (assem.)	3648	36 (14's)	36	4	10-1/4x9-1/4	79.95		

Total for merchandise

Sales Tax (OH and CA)

Shipping (see table)

TOTAL ENCLOSED

Credit Card Number _____

4 Numbers Above Name (MC) Good Thru _____

Signature _____

Print Name _____

Address _____

City _____ State _____ Zip _____

- Check or M.O. enclosed
- Charge BAC
- Charge MC
- Send catalog

Shipping/Handling
Up to \$10.00 \$1.00
10.01 to 25.00 1.50
25.01 to 50.00 2.00
50.01 to 100.00 2.50
100.01 to 200.00 3.00

Orders subject to acceptance at factory.

Company PO's FOB Painesville
No COD orders

DEALER INQUIRIES INVITED.

Introducing... SBE Brute

No other CB can take its measure

Imagine a mobile transceiver only 4.5" wide, 1.4" high, and 5.75" deep—miniaturized circuitry yielding full-size performance.

The 23-channel Brute with full legal power output, positive or negative ground, is compact enough to fit virtually anywhere—under the dash, in a glove compartment, or in the smallest sports car.

Despite its small size, the Brute is a highly sophisticated performer, engineered without compromise and assembled with painstaking care. And since it's made by SBE, it's as rugged as it is refined. Engineering highlights include sharp selectivity, full audio output into an oversized built-in speaker, and jacks for both PA and external speakers. The large channel selector is night-lighted for easy viewing, and a red transmit light indicates "on-the-air" operation.

The Brute, fully synthesized for maximum performance, is just one more reason why SBE is your best choice for the best in CB.



SBE Better Communications through Creative Technology

For information write: SBE, Inc., 220 Airport Blvd., Watsonville, CA 95076

INTERNATIONAL OFFICES: E. S. Gould Marketing Co. Ltd., Quebec, Canada/Linear Systems, S.A., Geneva, Switzerland

CIRCLE NO. 50 ON FREE INFORMATION CARD

Three different schools give you this 25" DIAGONAL hobby-kit Color TV...

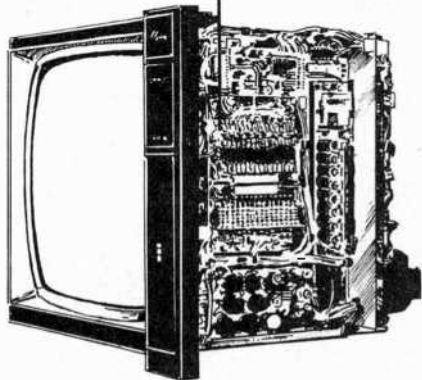

No other home training school gives you both an exclusive solid state color TV and an SQ® Quadraphonic Receiver complete with four speakers . . . all in one course. You get both for hundreds of dollars less than the combined tuition cost of TV and Audio courses at another school. And only NRI's Master Course in Color TV/Audio servicing lets you train on equipment specifically designed for training with exclusive "power-on" features. NRI doesn't give you hobby kits or commercial sub-assemblies. We invested the time and money to design equipment with learning in mind.

Only NRI gives you this 25" DIAGONAL designed-for-learning Color TV...

It's the only way you can (1) get the feel of typical commercial circuitry, (2) learn bench techniques while building complete units from the "ground" up, (3) perform over 35 "in-set" experiments during construction, and (4) end up with a 25" diagonal solid-state color TV with console cabinet and a 4-channel quadraphonic Audio Center.

NRI passes the savings on to you

NRI can save you money because our engineering eliminates the cost of buying from an outside source. We pay no salesman's commission. Students are enrolled by mail only. The savings are passed on to you in the form of low tuition fees, extras like the TV's console cabinet and the four speaker Quadraphonic System; a 5" triggered sweep

oscilloscope, CMOS digital frequency counter, and an integrated circuit color TV pattern generator. Where NRI supplies a professional color

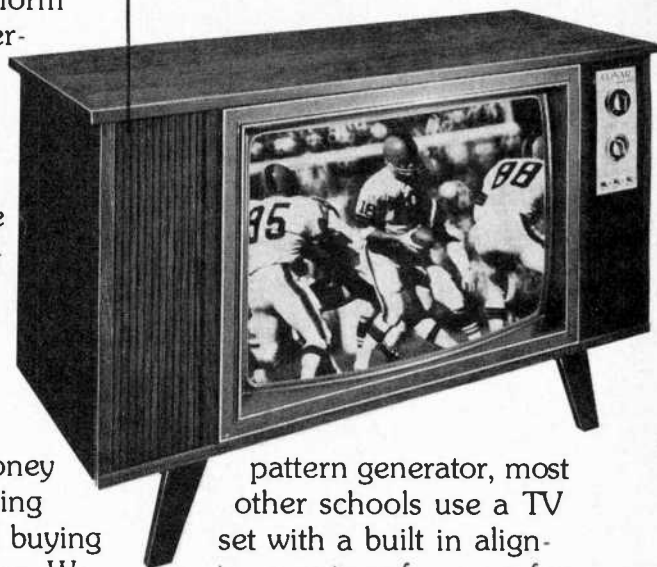

pattern generator, most other schools use a TV set with a built in alignment generator of no use for servicing other sets. Only NRI designs, engineers, and supplies training kits specifically for learning and professional use. You can pay hundreds of dollars more for a similar course and not get a nickel's worth more in training and equipment.

...plus complete Quadraphonic Audio Center!

More know-how per dollar

That's what it all boils down to, the quality of training you get for the money you spend. In our 62-year history, more than a million students have come to NRI and we're fully approved for career study under the G.I. Bill. We must be teaching something right. Some of those "right" things are bite-size lessons to ease understanding and speed learning . . . personal consultation, and prompt grading of all tests . . . a full-time staff of engineer/instructors to help if you need it . . . plenty of kits and experiments to give you hands-on training . . . and fully professional

programs oriented to full or part-time career needs.

Widest Choice of Courses with Communications, CB, Digital Computer, and other careers.



NRI offers not one, but five excellent TV/Audio servicing courses so you can tailor your training to your budget.

Or you can study other opportunity fields like Digital Computer Electronics, Citizens Band Radio, Communications, Aircraft or Marine Electronics, Mobile Radio, and more. Send for our free catalog and see for yourself that no one gives you more training and equipment for your dollar. There's no obligation, and no salesman will call.

If card is missing, write to:



NRI SCHOOLS
McGraw-Hill Continuing
Education Center
3939 Wisconsin Avenue,
Washington, D.C. 20016

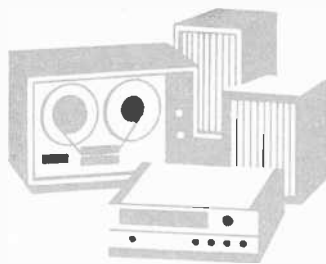

Stereo Scene

By Ralph Hodges

PERFECTING PHONO

FROM all indications, the principal program source for most hi-fi listeners is still the phonograph record. This is sensible, because phono discs continue to offer the (potentially) best signal-to-noise ratio of any consumer-available recording medium. But it is also nonsensical because the motional stability of *most* record-playing systems ranges from poor to abominable. By this, I don't mean to say that turntables suffer excessively from wow and flutter. On the contrary, most of them are excellent in this respect. I *do* mean that the typical cartridge/tonerarm/turntable/record combination is troubled by what might be termed wow and flutter, and worse.

The Insidious Jiggle. In an ideal record-playing system, only two things move: the turntable platter, which spins the record at a uniform rate, and the phono stylus, which gets buffeted around by the record groove in a (hopefully) musical way. In a real record-playing system, everything moves. The turntable base shudders with the seismic impact of traffic passing outside and other stimuli. The motorboard, even if it is well isolated from the base by spring mounts and dampers, sings the tune of the motor's vibrational rate as well as the acoustic feedback from the loudspeakers. And the tone arm, under the influence of all these inputs, plus the warps and wiggles of the record, does a dance all its own. Usually you can observe this dance by watching the stylus closely as it plays a record. The bobbing around that it does has nothing to do with information in the record groove; it's a sign that the tone arm is moving grossly relative to the stylus tip, which it should not do.

This insidious jiggle has three effects. First, it generates within the cartridge infrasonic output signals of very high intensity. These are of

course boosted by the RIAA equalization in the phono preamplifier, posing a serious threat of distortion or overdrive to subsequent stages and transducers. Second, the jiggle "modulates" the recorded information on the record. Third, it reduces the cartridge/record-groove alignment to complete ambiguity. Up to a few years ago this was probably a relatively minor side effect, but with modern stylus shapes there is mounting evidence that alignment is a cause for greater concern than heretofore.

The infrasonic signals are obvious enough on an oscilloscope. Often they even show up on the output-level meters of amplifiers equipped with them. The amount of trouble they cause depends heavily on the characteristics of the individual system, but in any case they are a persuasive argument for the use of sharp infrasonic cutoff filters in phono preamplifiers—features that are still all too rare in currently available equipment.

The "modulation" problem is, in my view, at least as serious if not more so. Figure 1 shows the right-channel frequency response of a high-quality record player, as measured with the sweep bands on the CBS STR 130 test record. The cyclical variations in the curve correspond to the $33\frac{1}{3}$ -rpm rotation rate of the record. The variations turned out to be symptoms of a slight amount of play in the tonearm's bearings—a condition that

had developed of its own accord over a period of about eighteen months of completely normal use. It's difficult to describe what this condition sounded like without resorting to words like "nervous" or "subtly fuzzy and indistinct." But it had, in any case, reduced the performance of a highly refined phono cartridge and an acclaimed tonearm to bewildering mediocrity. A few minutes' work on the bearings improved matters dramatically. However, the point is that, although this problem was attributable to an actual fault in the tonearm, it illustrates what can happen even with properly functioning cartridges and arms when they are not well suited to one another.

In the view of most authorities, phono cartridges will gracefully tolerate rather large errors in alignment when they are installed in the tonearm. In fact, the measured amounts of distortion caused by serious lateral or vertical tracking-angle misalignments seem pretty moderate compared with some of the other distortion-producing mechanisms involved in record playing. Nevertheless, many people are finding that a careful job of cartridge alignment amply repays the effort. This seems to be particularly true with CD-4 styli that, instead of making a two-point contact with the record groove, attempt to achieve line contacts that extend from (almost) the bottoms to the tops of the groove walls. Obviously, if the groove is to be properly traced, the contact lines must be reasonably parallel to the contours of the groove. In other words, the *rake angle* of the stylus must be properly adjusted.

In working with various CD-4 cartridges, I have found that alterations in rake angle are frequently quite audible and also usually measurable in terms of their effect on high-frequency response. There seem to be other effects as well, which will be discussed in detail a little later. Unfortunately, if the tonearm is imposing excessive gyrations on the stylus in response to warps and other record

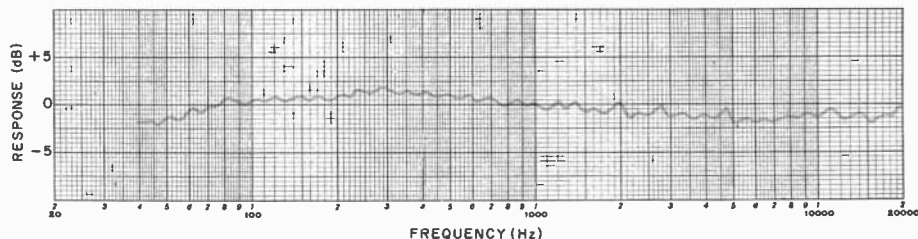

Fig. 1. Frequency response of good cartridge in misbehaving tonearm shows severe amplitude modulation by record-profile irregularities.

What's **new** in 4-channel?

Sansui is.

Sansui is already the leading name in advanced high performance 4-channel sound reproduction and technology. And only with Sansui's exclusive QS vario matrix system can you enjoy the full potential of quadrasonic sound. But there is still always something **new** in the Sansui world of 4-channel.

Now every Sansui 4-channel receiver and the new QSD-1 decoder from Sansui incorporate the unique QS vario matrix circuitry. Now you can synthesize brilliantly clear 4-channel from any mono or stereo source to create a 4-channel library in a moment. Any 4-channel matrix source material, QS- or SQ-encoded records, tapes and broadcasts, can be effectively decoded by any of Sansui's remarkable QRX receivers. These receivers also incorporate circuitry to demodulate CD-4.

All 4-channel Sansui receivers command excellent cost-to-performance ratios. The QRX-7001¹, at less than \$880.00,* delivers a full 35 watts per channel, min. RMS, all channels driven into 8 ohms, from 20Hz to 20kHz with no more than 0.4% total harmonic distortion. Every design element of this outstanding receiver lives up to Sansui's reputation for advanced high quality high fidel-

ity performance. Available in the same series are the QRX-6001¹, at less than \$760.00,* and the QRX-5001², at less than \$600.00,* with many of the same outstanding features.

Sansui's **new** QSD-1 is the most exciting and effective decoder available today. Its QS vario matrix allows for very high inter-channel separation, as high as 20dB between adjacent channels and 30dB across the diagonally opposite channels, without any of the annoying side effects found in other decoders.

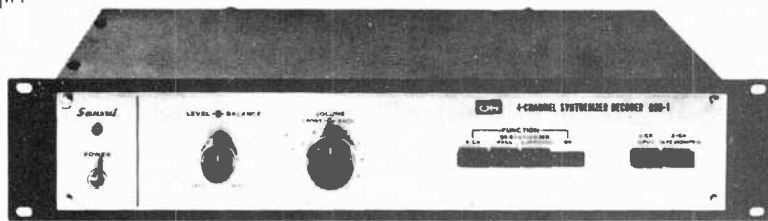

Quadrasonic sound is all around you. More than 70 FM stations now broadcast in the QS 4-channel way 24 hours a day. Hundreds of quadrasonic encoded records have been released — rock, classical, jazz, country, and "beautiful" music.

Stop in soon at your nearest Sansui franchised dealer to hear what Sansui 4-channel equipment can do. Whatever your preference, surround or hall, whatever your needs — synthesize, decode, or demodulate — Sansui 4-channel can do it all — and do it best.



1. simulated walnut grain wood cabinet
 2. all metal cabinet with simulated walnut grain
- *The value shown is for informational purposes only. The actual resale price will be set by the individual Sansui dealer at his option.

SANSUI ELECTRONICS CORP.

Woodside, New York 11377 • Gardena, California 90247
 SANSUI ELECTRIC CO., LTD., Tokyo, Japan • SANSUI AUDIO EUROPE S.A., Antwerp, Belgium
 In Canada: Electronic Distributors



undulations, the rake angle won't have any fixed value. Instead, it will change radically as the stylus cantilever squashes down and springs back up. The unappetizing prospect is that of a system in which record warps "modulate" the playback signal with tracing errors! Usually this is heard as an unsteadiness in the noise (tape hiss, for example) that exists on many records and which should have a very smooth and uniform character. Usually it is a bit too subtle to be identified readily in the musical information, although its presence tends to cause in the listener a vague feeling that all is not quite right.

Arm-Cartridge Resonance. The first step to take to avoid tonearm misbehavior is to adjust the arm's effective mass so that it interacts with the stylus compliance and produces a resonant frequency somewhat above 10 Hz but below 20 Hz. This range of frequencies is below that of the recorded information and above that of most warps and record-surface irregularities. Thus the arm-cartridge combination, with no stimulus to set it off, will theoretically behave in a very stable manner.

There are a few commercially available record players designed to meet this criterion, and hearing them at their best can be a genuine revelation. Unfortunately, however, this ideal condition is almost never achieved by accident. It must be designed into the arm and cartridge in anticipation of their being used together. Most top-quality cartridges are so compliant (and most tonearms so massy) that the resonance falls considerably below 10 Hz, where record warps can drive the system crazy.

Human nature being what it is, it's unlikely that many people will start selecting cartridges solely on the basis of how well they suit their tonearms' effective mass (although this may be a very logical way to assemble a high-performance system).

Instead, audiophiles are resorting to such stratagems as arm modifications to reduce effective mass and, recently, to tonearm damping.

A few tonearms, mostly of English origin, are designed with damped pivots. Others can have damping added, the usual procedure being to attach a "paddle" to the arm that dips down into a reservoir of some suitably viscous fluid. There is every reason to believe that damping can help with problem record players, but the amount must be worked out empirically, too much being as bad in its way as too little. It is also of limited or doubtful effectiveness with certain specific tonearm problems, such as the sloppy bearings of Figure 1, or tonearm resonances that extend up into the audible range. Spectrum analyses made on some tonearms have shown significant resonant contributions extending well past 1000 Hz. The effects of these resonances (when audible) run the gamut from a muddying of the sound to an increase in the system noise level. Moreover, they are exceedingly difficult to pin down without the assistance of a good spectrum analyzer.

Flex Mounting. Before getting into the complications of arm damping (which indeed may be necessary to coax the system into performing at its peak), it's worthwhile to experiment with some simpler ways of nullifying the tonearm's troubles. To begin with, installing the cartridge with nylon mounting hardware will reduce the coupling between cartridge and arm and also usually bring about a reduction in overall mass. This approach can be carried a step further with the use of adhesive foam.

This foam, which comes in rolls about an inch wide by a little under 1/8 inch thick with a strong adhesive on both sides, can be used to mount the cartridge in the arm without screws. If the cartridge requires standoffs for proper alignment the foam can be

built up layer by layer until the correct height is reached. What this type of "flex mounting" buys you is not the ideal method of installing a cartridge (in fact, it may introduce significant problems of its own), but it is the beginning of a test bed with which you can evaluate the effects of the tonearm on the reproduced sound.

For example, Fig. 2 shows the response of a cartridge so installed in the troubled tonearm of Figure 1. Note that the compliance of the foam introduced a serious resonant condition at about 200 Hz, which could readily be heard. However, in many other respects the performance of the system was audibly improved. The effects of the faulty bearings were reduced substantially, so that the treble re-acquired some of its former clarity and detail. Subjectively, the noise level also went down. On the basis of this, it seemed reasonable to diagnose tone-arm difficulties as the source of the record player's problems, and curative efforts could then be concentrated in that area.

Alignment. Aside from serving as a useful diagnostic tool, the adhesive foam can also assist in fine-tuning the alignment of a cartridge. The procedure is to re-install the cartridge mounting screws after the cartridge has been flex mounted, but to use the screws only to adjust the side-to-side and fore-to-aft tilt of the cartridge. The foam's resilience enables this to be done very precisely. With most cartridges, tightening both screws will tilt the front of the cartridge up (approaching a positive rake angle), while tightening the screws individually will alter the stylus azimuth.

So far, with alignment-sensitive cartridges, I haven't been able to work out any hard-and-fast rules for these adjustments. Generally, I set azimuth by eye, making sure that the front of the cartridge is vertical to the record surface, and set the rake angle by ear. The ear adjustment is really not as difficult as it might seem at first. As the screws are tightened in gradual increments, it's usually possible to hear changes in the character of the record noise. When the optimum setting is approached, the noise will begin to become quite clear and distinct, as will any high-frequency recorded material such as the overtones of cymbals. As a rule, when this sense of clarity is "locked in" I stop,

(Continued on page 28)

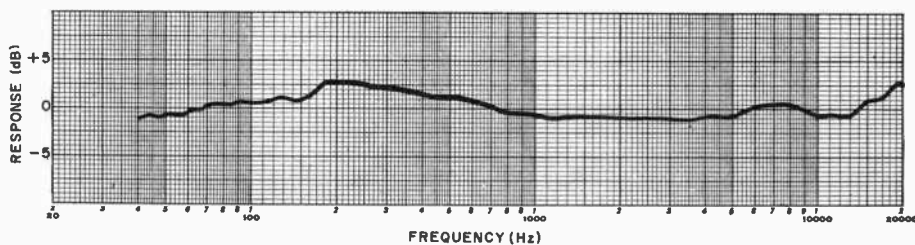

Fig. 2. Typical response irregularity introduced by flex mounting. Use of mounting screws with flex mount will improve the response.



EPC
Electronic
Parts

EXCITE
PUSH-PULL B.P.A.T.
SUBC. PRICE \$1.41
switch

speaker level

MALLORY

MALLORY

MALLORY

MALLORY

MALLORY

MALLORY

MALLORY

MALLORY

MALLORY

MALLORY

MALLORY

MALLORY

MALLORY

MALLORY

MALLORY

Mallobin®
Merchandise Cabinets

Rechargeable
Batteries

Duracell® Batteries

Resistors

Capacitors

Controls and Switches

Duratape
and Fliptape® Cassettes

Sonalert™ Audible Signals

PTC Semiconductors

Mallory-Richco Fastening Devices

**With a line like this, no wonder
your Mallory distributor is a yes man.**

He almost never has to say no. Which adds up to a lot of
single-source buying convenience for you.
Give your Mallory distributor a call. You'll like what you hear.
You'll like what he delivers.



MALLORY DISTRIBUTOR PRODUCTS COMPANY

a division of P. R. MALLORY & CO. INC.
Box 1284, Indianapolis, Indiana 46206; Telephone: 317-856-3731

® Registered trademark of P. R. Mallory & Co. Inc.

CIRCLE NO. 35 ON FREE INFORMATION CARD

The best way to judge the new Pioneer PL-510 turntable is to pretend it costs about \$100 more. Then see for yourself if it's worth that kind of money.

First, note the precision-machined look and feel of the PL-510.

The massive, die-cast, aluminum-alloy platter gives an immediate impression of quality. The strobe marks on the rim tell you that you don't have to worry about perfect accuracy of speed at either 33 1/3 or 45 RPM.

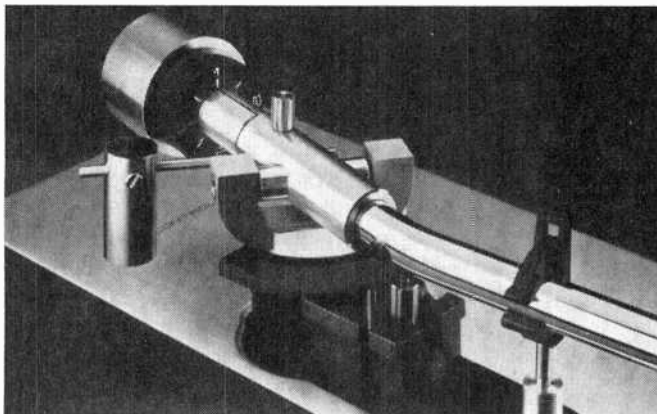

The S-shaped tone arm is made like a scientific instrument and seems to have practically no mass when you lift it off the arm rest. The controls are a sensuous delight to touch and are functionally grouped for one-handed operation.

But the most expensive feature of the PL-510 is hidden under the platter. Direct drive. With a brushless DC servo-controlled motor. The same as in the costliest turntables.

That's why the rumble level is down to -60 dB by the super-stringent JIS standard. And that's why

the wow and flutter remain below 0.03%. You can't get performance like that with idler drive or even belt drive. The PL-510 is truly the inaudible component a turntable should be.

Vibrations are damped out by the PL-510's double-floating suspension. The base floats on rubber insulators

inside the four feet. And the turntable chassis floats on springs suspended from the top panel of the base. Stylus hopping and tone arm skittering become virtually impossible.

But if all this won't persuade you to buy a high-priced turntable, even without the high price, Pioneer has three other new models for even less.

The PL-117D for under \$175*.

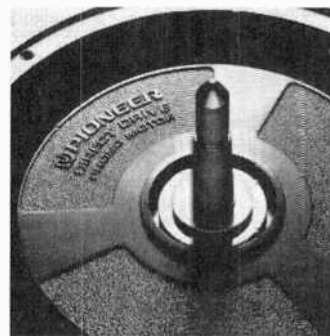

The PL-115D for under \$125*. And the amazing PL-112D for under \$100*.

None of these has a rumble level above -50 dB (JIS). None of them has more wow and flutter than 0.07%.

So it seems that Pioneer has also conquered the one big problem of low-priced turntables.

The low performance.

U.S. Pioneer Electronics Corp., 75 Oxford Drive, Moonachie, New Jersey 07074.

PIONEER

Anyone can hear the difference.

*For informational purposes only. The actual resale prices will be set by the individual Pioneer dealer at his option.

CIRCLE NO. 62 ON FREE INFORMATION CARD

although some of my correspondents go to much greater lengths, optimizing the rake angle for every record they play.

Ultimately, after going through this procedure (provided your cartridge is one of those that benefits from it), you will have a good idea of how the cartridge should be aligned when you remove the foam and re-install it in the conventional way. Or, as sometimes happens, you may find the flex mount has no deleterious effects on system

performance, in which case you can retain it.

Maintenance. Even with a record player that has been carefully aligned and damped as necessary, there may be a tendency for performance to go downhill over a period of time. The usual reason for this is, again, that something is moving that shouldn't. Check the cartridge shell to see that it is securely fixed to the body of the arm. Then grasp the shell and tug on it

a bit to see if any play is detectable throughout the arm mechanism. Any feeling of looseness is suspect, although there are some arms that are designed with loose bearings and seem to perform very well nonetheless. It is here that diagnosis gets tricky.

The great majority of tonearms have cone-type bearings that fit into ball races or finely machined sockets. Typically the cones are threaded, with a screwdriver slot at their rear; a locking nut holds the assembly in place. These are areas of potential wear, the effects of which can even differ with different cartridges. It's a good idea to ask the manufacturer how to adjust these bearings and to obtain from him whatever tools are used for the operation. One such tool is often a small spanner that engages the locking nut and has a hole through its center to accommodate a screwdriver for the cone. The spanner is an absolute necessity for working on this kind of bearing, since the cone and locking nut must be set simultaneously.

With proper adjustment and maintenance a good record player can attain a dazzling level of performance. Without it, there is little hope of its equaling the capabilities of a medium-priced cassette deck. As cartridges become more refined, it's likely that the demands on the tonearm and turntable will become more critical and complex. However, attention to the above considerations will take you a long way toward the best utilization of existing cartridges as we know them today. ♦



"How about that?
Twenty-six woofers, fourteen
tweeters, and 1250 watts!"

POPULAR ELECTRONICS

handic®

Swedish-designed quality in cb accessories, too!

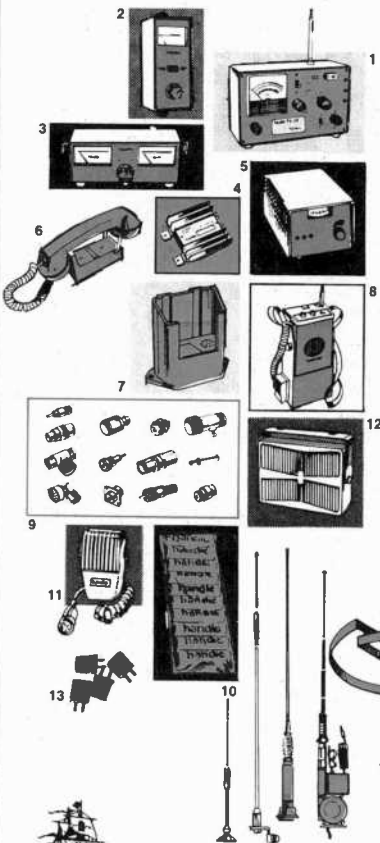

- 1) **FS-117 Universal Tester** — It's a power meter; SWR; a modulation meter; a crystal condition tester; and a tone frequency plus 27MHz signal generator! Checks entire CB band.
- 2) **SWR Bridge** — Measures field strength & SWR. Equipped with special Whip Antenna for checking SW conditions up to 1:3 on 50 Ohm cable.
- 3) **SP-1 Inline Watt Meter** — Monitors output power & SWR for top CB performance! 0-200W power range; 3-150MHz frequency range. Dual scale.
- 4) **LO-707 DC Converter** — Converts 6V to 12V (DC to DC) ... for use with all transceivers. Compact. Rugged.
- 5) **N-12-SA AC Adapter** — Converts 100VAC to 12VDC (2 Amp). Has variable control; electronic fuse & volt meter.
- 6) **HN/HMT Handset Telephone** — Handset telephone & holder with switch-over relay & cables. For all handic mobile & base units.
- 7) **"Powerpack" Sleeve** — Exclusive, portable power supply with stabilizer. Converts handic portables to mobile or base. Connects directly to 12VDC — it's A Battery Recharger, too!
- 8) **BK-305 "Powerpack"** — Portable power supply. Converts handic's 3-Ch. mobile & 008 Mini-Scanner into portables! Uses normal dry cells or rechargeable batteries.
- 9) **Connectors** — Modern design, space saving, quality products for lasting connections. Use with cables, chassis & panel mounts, antennas, etc.
- 10) **Battery "10-Pack"** — Load into all handic portables and converted mobiles. Features 10 Nickel Cadmium batteries, rechargeable more than 1000 times.
- 11) **Speaker/Microphone** — Use with handic 4-Ch. & 6-Ch. portables that convert for mobile & base use.
- 12) **External Speaker** — A wide range speaker design useful for cars, boats & indoors.
- 13) **Crystals** — 0.003% frequency tolerance 2 1/2 times better than FCC regulations! Assure high quality trouble-free performance.
- 14) **Antennas** — State-of-the-art design — 8 for portables; 6 for mobiles including motor-driven retractables; 2 marine types; and 2 base models. Noise suppressor kits also available.

Handic CB radios include: mobile/base transceivers; hand-held personal portable CB systems; scanners with FM radio option; antennas; microphones; selective call, and a full line of accessories.

Send For FREE Catalog!

handic® U.S.A. inc.

14560 N.W. 60th Ave., Kennedy Bldg., Miami Lakes, Fla. 33014 (305) 558-1522
In Canada: Scotcomm Radio Inc., Chomedey, Laval, Quebec



THE DEPENDABLE CB FROM SWEDEN



At TEAC, our fundamental mandate for any new product is performance and reliability. First and finally. Qualities that are measurable in terms of mechanical stability and inherent design integrity.

These are essentials. Because our technological resources established the cassette deck as a true high fidelity component. So we demand that a new product possess that measure of TEAC quality.

And that's what distinguishes the A-170. Compare it with other inexpensive cassette decks with Dolby, please. Just call (800) 447-4700* for the name of your nearest TEAC retailer. We think you'll agree it's a value you can rely on.

*In Illinois, call (800) 322-4400.

A-170

TEAC performance and reliability ...

how can you really afford anything less?

TEAC®

The leader. Always has been.

Dolby is a trademark of Dolby Laboratories, Inc.

TEAC Corporation of America/7733 Telegraph Road, Montebello, Ca. 90640 ©TEAC 1975

JULY 1976

29

Hobby Scene



Have a problem or question on circuitry, components, parts availability, etc.? Send it to the Hobby Scene Editor, POPULAR ELECTRONICS, One Park Ave., New York, NY 10016. Though all letters can't be answered individually, those with wide interest will be published.

By John McVeigh

NEW MICROCOMPUTER TERM

Q. I've recently come across the term "MPU" in mini- and microcomputer contexts. What does it mean?

—Paul Mottola, Scranton, PA

A. MPU stands for Micro-Processing Unit, and is synonymous with the older term, CPU (Central Processing Unit). They both contain key computer elements, such as accumulators, arithmetic logic units, I/O buffers, address drivers, multiplexers, timing and control, and instruction registers.

SAWTOOTH GENERATOR

Q. Do you have a circuit for a low-frequency sawtooth generator that can be used as an external scope sweep generator?

—John Blasing, Cincinnati, OH

A. The circuit shown will generate

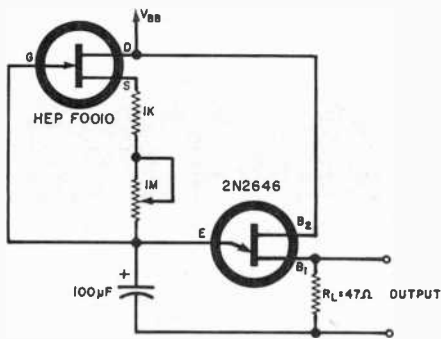

sawteeth over a 0.1-to-100-Hz range. Use a 5-volt supply (V_{BB}) and a linear taper 1-meg pot.

AUDIO INITIALS

Q. The owner's manual of my stereo amplifier refers to the initials DIN, RIAA, NAB and IHF. What do they mean?

—Hugh Banton, Windsor Locks, CT

A. They all refer to organizations that have set up certain standards as a gauge of amplifier, preamplifier, and

turntable performance. DIN stands for Deutscher Industrie Normenausschuss, a group of German manufacturers similar to our Electronics Industry Association or Institute of High Fidelity (or IHF). RIAA means the Record Industry Association of America, while NAB stands for the National Association of Broadcasters.

NONPOLAR ELECTROLYTICS

Q. I need large non-polarized coupling capacitors for dc and ac circuits. Can electrolytics and shunting diodes be used?

—David R. Currott, Florence, AL

A. Yes, they can. Extremely large coupling capacitors can be fabricated in this manner, especially useful for instrumentation amplifiers. I've used this method in building an EKG

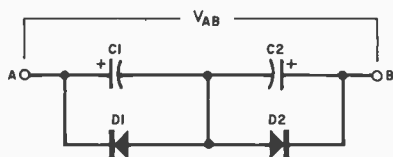

preamp and had no problems. When V_{AB} is negative, $D1$ shorts out $C1$, $D2$ is open and $C2$ acts as the coupling capacitor. When V_{AB} goes positive, $D2$ shorts and protects $C2$, $D1$ is open and $C1$ passes the signal. For best results, tantalum capacitors should be used.

Q. Here at an orphanage we need a sound-activated alarm so that the night nurse can tell at her desk when one of the children wakes and starts crying. Do you have a circuit that will light an appropriate LED and enable a beeper when this happens?

—Robert Wong, Aruba, N. Antilles

A. The circuit shown will work for you. When the infant starts to cry, the crystal mike (an inexpensive tape-recorder type) triggers the output of the op amp, which in turn activates the SCR. The SCR will cause the LED for that

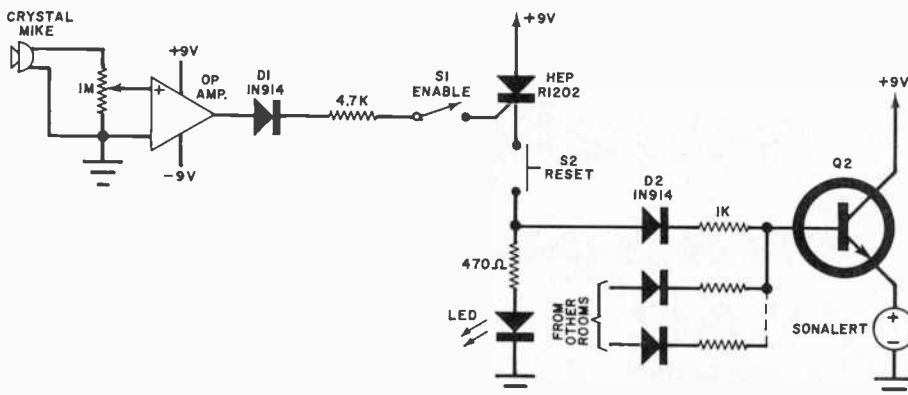

Note that the equivalent capacitance equals $C1$ or $C2$, not their series combination.

CURRENT LIMITING RESISTOR

Q. I want to use my 6-volt cassette player in my car, which has a 12-volt system. If I use a zener diode to drop the supply to 6 volts, what size resistor do I need for current limiting?

—Stewart Labus, Amarillo, TX

A. The accompanying sketch shows the common way of connecting a zener voltage regulator. Resistor R limits the current through the zener

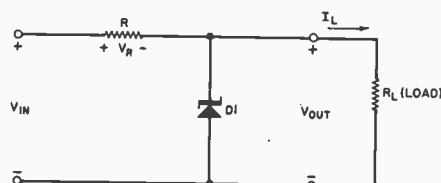

under all load conditions to a safe value. To determine the value of R , find the voltage across the resistor: $V_R = V_{in} - V_{out}$. Then determine the maximum current demand of the load (I_L) from specs or with an ammeter. The minimum rated power dissipation of the diode will be $P_Z = V_{out} \times I_L$. The value of the resistor will then be $R = V_R/I_L = (V_{in} - V_{out})/I_L$. Its power rating will be $P_R = I_L \times V_R$, or V_R^2/R .

INFANT ALERT

room to light, and enable the common beeper. When the nurse sees to the child's needs, she will push $S2$ and cut off the SCR and transistor $Q2$. The leads from the rooms to the LED's and diodes can be any convenient length. Any medium-power (1 watt or so) npn transistor is suitable for $Q2$. Note that separate op amps (any general-purpose type), SCR's, etc., are needed for each location. Total cost can be reduced by using quad op amps. When the child is awake, $S1$ should be left open to eliminate false triggering.

NEW 3½ Digit Multimeter from B&K-PRECISION



...you'll want it for its features
...but it's the price that will sell you!

- High intensity LED display is easily read from at least 6 feet in the brightest room.
- Measures AC and DC voltage, AC and DC current and resistance.
- 0.5% DC accuracy.
- 100% overrange (1000 scale reads to 1999).
- Automatic polarity.
- Automatic decimal point.
- Flashing overrange indication on display.
- Four voltage ranges to 1000V
- Four current ranges to 1000mA.
- Six resistance ranges to 10 meg.
- In-circuit resistance measurements at voltage levels below conduction threshold of semiconductors.
- Overload protection on all ranges.

Complete new circuitry makes the Model 283 the most dependable and versatile 3½ digit multimeter you can buy. The extra-bright display allows you to use it where other units would cause reading problems. The selectable "low ohms" function permits accurate measurement of semiconductor shunted resistors.

B&K PRECISION MODEL 283—\$170

An optional, internal battery pack (BP-83, \$50.00) provides 8 hours of continuous use on one overnight charging and charges when the Model 283 is in use on 115/230VAC.

Thoughtful, convenience features like a side carrying handle, tilt stand and detachable line cord add to its usefulness.

Your B&K-PRECISION distributor has them in stock and will be glad to demonstrate its features to you. Call him, or write for additional information.

B&K PRECISION
PRODUCTS OF DYNASCAN

6460 W. Cortland Avenue
Chicago, IL 60635 312/889-8870

In Canada: Atlas Electronics, Toronto

NEWS HIGHLIGHTS

Teaching Computers To Speak English

The trouble with computers is that operators must learn to think like computers and communicate in *their* language. Professor David Waltz of the University of Illinois at Urbana-Champaign wants things the other way around, for the computer to think and listen to instructions like a human. The professor is formulating an intelligent program that will accept queries in conventional English to allow a nontechnical user to talk to, rather than program, computers. The completion of the natural-language program will be particularly helpful to individuals with limited computer skills. Most important, man and machine will be speaking the same language, English.

FCC Clobbers TV Game Makers

Nine violation notices have been issued by the Federal Communications Commission to companies marketing electronic TV devices that allegedly disregard Commission regulations. The home TV games did not have an approved Class 1 TV device, necessary when video games are connected directly to a TV receiver's antenna terminals. Such a TV game cannot be advertised, announced or sold before being tested and approved by the FCC. All nine companies cited replied to the FCC within the deadline of 15 days, stating that none of the TV games had been shipped and would not be shipped until official Commission approval is obtained. The Commission plans to issue more violation notices in the near future.

Pioneer Sets Guinness Record

In a nonstop marathon of playing records for almost 12 days (284.5 hours), Pioneer beat the previous record of 268 hours established in Norway, ranking it a feat that belongs in the "Guinness Book of Records." Royal Air Force Senior Aircraftsman Mike Buckley worked toward the new record with two PL-12D turntables. In all, more than 5690 single-disc changes were required between the two turntables during the record-breaking period.

Amateur Radio Changes

Code—The FCC is deleting part of Section 97.29(c) of the Commission rules concerning the standard an Amateur radio licensee must meet in reception and transmission of international Morse Code. The Rules currently require the licensee to transmit and receive one full minute of code, free of omissions and other errors, at the prescribed speed during a five-minute testing period. Believing this to be unduly restrictive, the FCC is planning to use one or more alternative test methods. One of them is a multiple choice examination covering a five-minute transmission of plain text.

Such a test would relieve the applicant of copying one minute of mixed text without error, yet would provide an accurate gauge of competency in reception of code message content.

Study Guides—The FCC is releasing new study guides for amateur radio operator license examinations. They are in the form of a syllabus that outlines the various categories of questions from which the exams are devised and include sample questions representative of those appearing in the exams. The new guides have been reorganized to reduce the possibility of an individual acquiring a ham license simply by memorizing the answers to specific questions. Additionally, the guides have been designed to permit much greater flexibility in the selection of exam questions. This flexibility will allow more frequent revision of amateur examinations and, therefore, result in a more equitable exam program for all trainees.

Two Electronics Pioneers Die

On January 16, 1976, Dr. Hidetsugu Yagi died at the age of 89 in Tokyo, Japan. Dr. Yagi was the inventor of the Yagi array antenna commonly used in vhf and hf radio and TV communication.

On April 4, Swedish born and Yale educated Dr. Harry Nyquist died at the age of 87. Dr. Nyquist discovered a set of conditions to keep feedback circuits stable. The "Nyquist Criterion" is used to study electronic devices and to examine human reactions, such as driver responses to conditions while steering a car.

FCC Holds Off CB Expansion

The Federal Communications Commission has decided not to take immediate action on expanding the number of Class D CB radio channels on 27 MHz. Seems that there is a serious question of interference to CB operators on existing 23 channels. The FCC said that tighter specifications would be needed before there will be any approval of expansion.

Number of "E" Graduates Down For 1975

The engineering graduating class for the year ending June 1975 was the smallest in the last seven years, according to data compiled by the Engineering Manpower Commission of the Engineers Joint Council. Among engineering specialties, electrical engineering had the largest number of graduates at all degree levels—14,537—followed by civil engineering with 11,237. A separate engineering category, computers, produced 1384 degrees. Women and minorities are showing rapid growth in engineering. Women earned more than 2% and minorities more than 7% of the 1975 bachelor's degrees. A survey of 2-year technology schools, though not including many smaller schools, revealed 4805 associate degrees in electronics and 1541 in computers for the year ending June 1975.

FREE

The world's largest catalog
of easy-to-build, money-saving
electronic kits



- Power Supplies • Oscilloscopes • Frequency Counters
- VTVM's and VOM's • Ham Radio Gear • Color TV's
- Hi-Fi Components • Electronic Clocks • Electronics Learning Programs
- Auto, Fishing, Marine and Aircraft Accessories — over 400 kits in all!

Every Heathkit product comes with a fully-illustrated, step-by-step assembly manual that tells you everything you need to know to make kitbuilding fun and easy. Thousands of people have discovered the satisfaction—and savings—of handcrafting a fine piece of electronic equipment. You can build it better...let us show you how.

Send for your FREE Catalog today! ▶
Heath Company, Dept. 10-19, Benton Harbor, Michigan 49022

HEATH		Schlumberger		Heath Company, Dept. 10-19 Benton Harbor, Michigan 49022	
NAME _____					
ADDRESS _____					
CITY CL-601		STATE		ZIP _____	

Our most expensive AM mobile . . .



the NEW
Sabre

. . . featuring phase-lock loop
circuitry (PLL) and LED digital
readout. For complete speci-
fications write . . .

browning[®]
laboratories, inc.

LACONIA, N. H. 03246
(603) 524-5454



THERE are essentially two types of video computer terminals in common use. The "dumb" terminal—little more than a "glass Teletype®"—is a simple data transmitter/receiver whose only stand-alone function is its use as a TV typewriter. The "intelligent" (also known as "smart") terminal, on the other hand, offers powerful stand-alone features. Built around a sophisticated microprocessor, intelligent terminals allow you to write, store, and edit programs for transmission to a computer or a hard-copy device. It also provides very powerful word processing at relatively low cost.

The SOL video terminal project presented here is one of the most ad-

BUILD

SOL

**BY ROBERT M. MARSH
AND LEE FELSENSTEIN**

An Intelligent Computer Terminal

Based on an 8080 MPU, this hobbyist's computer terminal can compete with most commercial units

vanced of intelligent terminals. It can interface with any mini- or microcomputer via its built-in RS-232 or 20-mA current-loop interfaces, in either serial or parallel format. It can also tie into a time-sharing computer via a telephone line and a modem (such as the Pennywhistle described in the March 1976 issue of POPULAR ELECTRONICS). In fact, it is even possible for two SOL terminals to communicate with each other without human supervision.

The key to SOL's versatility is its integral 8080 microprocessor (μ P) chip. The μ P operates on instructions stored in PROM's (programmable

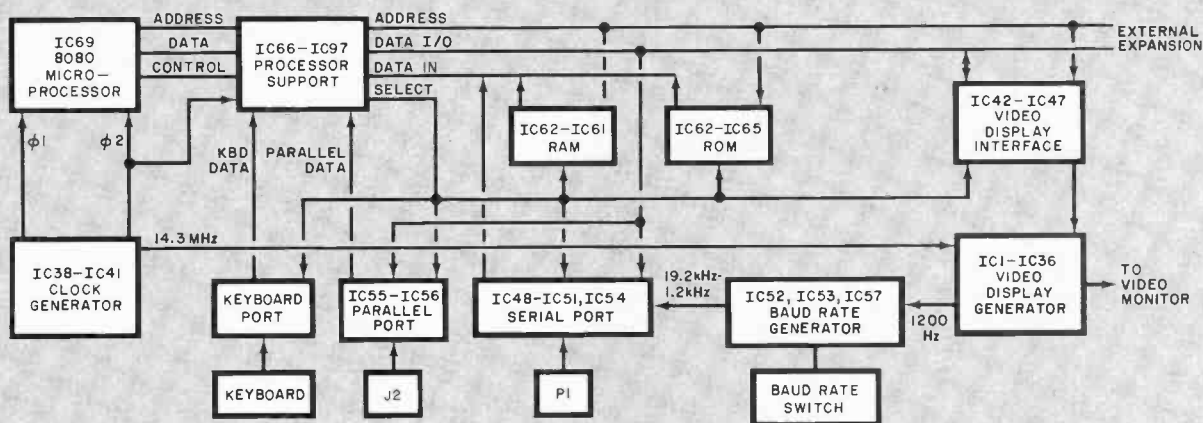

Fig. 1. Terminal accepts data from keyboard, parallel port, and RS-232 or 20-mA serial port. Output is 1 volt p-p for conventional TV requirements. Memory can be externally expanded to 65 k.

PARTS LIST

C1—10-pF disc capacitor
 C2, C11, C21, C22—0.001- μ F disc capacitor
 C3, C7, C15, C16, C17, C18, C20, C27 through C63—0.1- μ F disc capacitor
 C4, C5—680-pF mica capacitor monolithic
 C6—1.5- μ F, 25-volt ceramic capacitor
 C8, C13—1- μ F, 35-volt dipped tantalum capacitor
 C9, C10—15- μ F, 20-volt dipped tantalum capacitor
 C12—0.01- μ F disc capacitor
 C14, C23—680-pF disc capacitor
 C19—100- μ F, 16-volt upright aluminum electrolytic capacitor
 C24—0.1- μ F Mylar tubular capacitor
 C25—0.001- μ F Mylar tubular capacitor
 C26—0.01- μ F Mylar tubular capacitor
 D1, D2, D4 through D9—1N4148 diode
 D3—5.1-volt, 1-watt zener diode (1N5231B or similar)
 IC1, IC8, IC11, IC12, IC23, IC39, IC73, IC74—74LS175N quad latch IC
 IC2, IC79—74LS20N dual 4-input NAND gate IC
 IC3—74LS86N quad exclusive-OR gate IC
 IC4, IC42, IC45, IC47, IC71, IC72, IC94—74LS02N quad 2-input NOR gate IC
 IC5, IC51—7406N open-collector hex inverter IC
 IC6—DC4049AE CMOS hex inverter IC
 IC7, IC14, IC25, IC26, IC53, IC57—74LS161 or 74LS163 4-bit synchronous counter IC
 IC9—6575 MOS character generator IC
 IC10—74166N 8-bit parallel-in shift register IC
 IC13, IC24—CD4029AE 4-bit up/down counter IC
 IC15—74L161, 74L163, or 93L16 4-bit synchronous counter IC (do not substitute)
 IC16, IC93—74LS10N triple 3-input NAND gate IC
 IC17—CD4001AE CMOS quad 2-input NOR gate IC
 IC18 through IC21, IC29 through IC32—21L01-1 or 91L02APC MOS 1024-bit RAM IC
 IC22, IC33, IC40, IC46, IC66, IC67, IC68, IC75, IC80, IC81, IC82—8T97 hex tri-state buffer IC
 IC27, IC48, IC78, IC95—74LS109N dual JK flip-flop IC

IC28, IC50, IC89, IC96—74LS04N hex inverter IC
 IC34, IC35, IC36—74LS157N quad 2-input data selector IC
 IC37—74HOON high-speed quad 2-input NAND gate IC (do not substitute)
 IC38—74SO4N Schottky hex inverter IC (do not substitute)
 IC41—MH0026P MOS clock driver IC
 IC43, IC87, IC90—74LS74N dual D flip-flop IC
 IC44, IC83, IC86—74LS00N quad 2-input NAND gate IC
 IC49, IC88—74LS08N quad 2-input AND gate IC
 IC52—CD4046AE CMOS phase-locked loop IC
 IC54—TR1602B, AY-5-1013, or S1883 UART IC
 IC55, IC56—74173N quad tristate latch IC
 IC58 through IC61—21L01 or 91L01PC 256 \times 4 MOS RAM IC
 IC62, IC63, IC64, IC65—S5204A or MM5204Q 512 \times 8 MOS erasable PROM IC (optional: write to address below for details)
 IC69—8080, 8080A, or 9080A micro-processor IC
 IC70, IC77, IC84, IC91—74LS253N dual 4-input tristate data selector IC
 IC76—DM8836N quad 2-input NOR gate IC
 IC85, IC92—74LS155 dual 2-to-4 line decoder IC
 J1—Right-angle PC mount (AMP206584-1 or DB25S)
 Q1, Q2, Q3—2N2907 transistor
 The following resistors are 1/4-watt, 10% tolerance:
 R1, R2—330 ohms
 R3, R9, R10, R21, R23 through R30, R80—10,000 ohms
 R4, R5, R6, R14 through R20, R22, R31 through R35, R37, R39, R41, R43, R45, R46, R48, R52, R56, R57, R58, R65, R72, R73, R74, R76, R77, R78, R79, R82, R83, R84, R89 through R98, R100, R101—1500 ohms
 R7, R8—47 ohms
 R36, R67, R68, R99—4700 ohms
 R38, R40, R42, R47, R49, R53, R55—2200 ohms
 R44, R60, R81—3300 ohms
 R50, R54, R64, R87—100 ohms

R51—200 ohms
 R59, R63—33,000 ohms
 R61, R62, R66—1000 ohms
 R69—15,000 ohms
 R70, R71, R113—100,000 ohms
 R75, R88—3.3 megohms
 R85—75 ohms
 R103, R105, R107, R109, R110, R111, R112—8200 ohms
 R106, R108—39,000 ohms
 R11, R12, R13—100-ohm 1-watt, 10% tolerance resistor
 R86—330-ohm, 1/2-watt, 10% tolerance resistor
 R102, R104—50,000-ohm trimmer potentiometer (Bourns No. 3352-1-503 or similar)
 S1 through S4—Four-position dual in-line switch
 S5—Momentary-action spst switch
 S6—Single-pole, seven-position rotary switch
 S7, S8, S9—Spst switch
 S10—Spdt switch
 XTAL—14.318-MHz, 0.01% or better tolerance, series-resonant crystal in HC18U case
 Misc.—Two 40-pin, five 24-pin, 54 16-pin, and 31 14-pin IC sockets (optional); 75-ohm coaxial cable; TV monitor; ASCII keyboard; power supply; suitable chassis; mounting hardware; hookup wire; solder; etc.

Note: The following items are available from Processor Technology Corp., 6200 Hollis St., Emeryville, CA 94608: Complete SOL-PC kit of parts (does not include case, power supply, or keyboard) for \$297.00. Available separately are SOL-PCB etched and drilled printed circuit board for \$40.00; SOL-SS set of IC sockets for \$40.00; and SOL-FAN fan for \$20.00. A complete kit that includes all parts, pc board, power supply, ASCII keyboard, all cables and plugs, and a case is available for \$497.00; specify kit SOL-1. Free copies of the complete schematic, etching and drilling guide, and component placement guide are available from the same source on request when accompanied by a self-addressed stamped (26¢) envelope (9" \times 12").

read-only memories). In its basic configuration, the SOL terminal consists of a printed circuit assembly that contains the μ P, 512 eight-bit bytes of PROM, 2048 eight-bit words of RAM (random-access memory), 1024-character video display generator, keyboard interface, serial and parallel interfaces for connection to external devices, and an edge connector for memory expansion. All you add are a power supply, TV receiver or video monitor, ASCII keyboard, and a case.

Since the SOL terminal is 8080 based, its memory capability can be expanded to 65k bytes. Hence, one might ask, is the SOL an intelligent terminal or a powerful microcomputer? In essence, it is both.

How It Works. The complete schematic diagram for the SOL terminal is much too large to be reproduced in this article. Therefore, a complete schematic, an etching and drilling guide, and component layout diagram for the printed circuit board are available on request simply by sending a self-addressed stamped (26¢) envelope (9" x 12") to the source given in the Parts List.

The block diagram shown in Fig. 1 will be used to explain circuit operation. Notice the similarity of this diagram to that of a conventional 8080 microcomputer. The 8080 (or 8080A or 9080A) microprocessor, IC69, is the "heart" of the terminal. It is supported by IC66 through IC97, which include address and data line drivers and selectors; "wait state" timers; flag latches for data ports; and partial address decoding. Both address and data I/O (input/output) ports are available for expansion using currently available 8080-type memory cards.

As many as four PROMS (IC62 through IC65) allow up to 2048 bytes of program to be installed in the terminal. Up to 512 bytes of RAM can also be installed and are designated IC58 through IC61.

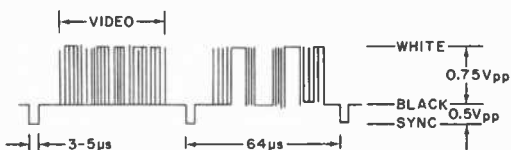

SOL TERMINAL SPECIFICATIONS

Display: 16 lines of 64 characters per line. Black characters on white background or reverse.

Character set: 96 printable ASCII upper- and lower-case characters. Plus 32 control characters (optional).

Display position: Continuously adjustable both horizontally and vertically.

Cursor: Solid video inversion (switch selectable blink), cursors are programmable.

Serial interface: RS-232 and 20-mA current loop, 75 to 9600 baud, synchronous.

Parallel interface: Eight data bits for input and output; output bus is tri-state for bidirectional interfaces; levels are standard TTL.

Keyboard interface: Seven-level ASCII encoded, TTL levels; requires strobe pulse with data stable for approximately 100 μ s following positive edge.

Microprocessor: 8080, 8080A, or 9080A.

On-card memory: 512 bytes PROM (expandable to 2048 bytes), 1280 bytes RAM (expandable to 1560 bytes).

External Memory: Expandable to 56k bytes total ROM, PROM, and RAM.

Signal output: 1.0 to 2.5 volts peak-to-peak with composite negative sync; nominal bandwidth is 7 MHz.

Power required: +5 volts at 2.5 amperes, +12 volts at 150 mA, and -12 volts at 200 mA; all buses must be well regulated.

The heart of the video display section is character generator ROM IC9. The generator provides both upper- and lower-case characters in a 7 x 9 dot matrix format. Descenders on lower-case characters g, j, p, q, and y go below the base line to provide true typewriter character formatting. The remainder of the IC's in the video section (IC1 through IC36) produce the horizontal and vertical sync, cursor options, video inversion (black characters on white background), and all video "handshake" requirements.

The video output has a maximum bandwidth of 7.15 MHz. It contains a composite sync to allow operation with any conventional video monitor or monochrome TV receiver converted for video input (Fig. 2). Color TV receiver CRT's may not be capable of providing the resolution required for a clean video display, although the authors have obtained acceptable results using a type-approved r-f modulator to feed color receivers through the antenna input. (CAUTION: Do not use a transformerless video monitor or TV receiver unless a line-isolating transformer is installed.)

The IC54 UART is used in the terminal for data transmission and reception. It is supported by IC48 and IC51. Clock pulses for the UART are provided by the baud-rate generator made up of IC52, IC53, and IC57. Phase-locked loop IC52 operates with dividers to produce the required clock signals. A switch is provided for setting the baud rate for 75, 110, 150, 300, 600, 1200, 2400, 4800, or 9600 baud (data bits per second). The serial port has both RS-232 and 20-mA current-loop provisions.

The parallel port consists of an eight-bit latch made up of IC55 and IC56. These IC's have tristate outputs that enable their use with a bidirectional parallel data channel if desired. Signals are eight data bits wide at standard TTL levels at the input and output.

The ASCII keyboard connects to the main terminal board by a single connector that provides power to the keyboard and accepts signals from the keys. The interface requires seven-level ASCII at TTL levels and a strobe pulse with the data stable for approximately 100 μ s following the positive edge.

Power for the main board must be 5 volts dc at 2.5 amperes, +12 volts at 150 mA, and -12 volts at 200 mA. The power bus lines must be well regulated.

Construction. Since the printed circuit board measures 13" x 11" (33 x 28 cm) and has numerous traces and pads that require careful registration, home fabrication of the board is not recommended unless you are highly experienced in making complex double-sided boards. Once you have the board and are ready to start mounting components, save IC installation for the last.

Start wiring the board by mounting

Fig. 2 Video output is conventional with negative sync and 1-volt p-p signal level.

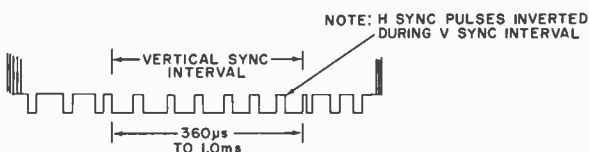

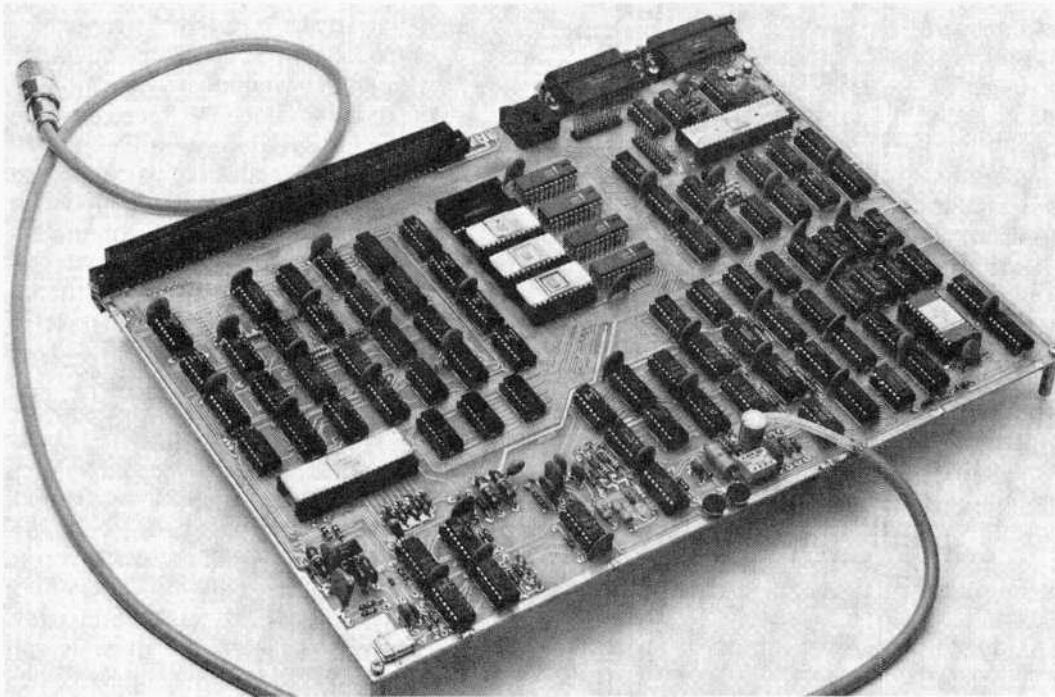

Large connector at left rear of assembled circuit board assembly is for external memory; coax cable is for composite video output. All input and output connectors are on rear edge.

IC sockets (recommended for all IC's to make removal and replacement easy) in place. Next, mount and solder into place the resistors, capacitors, diodes, and transistors. Then mount the baud rate switch and connectors flush to the surface of the board; make sure they do not sit askew after soldering them down.

Once the crystal is mounted and soldered into place, pass a length of bare hookup wire over its case and into the holes flanking the case. Solder the wire to the crystal's case and board pads. Install and solder into place the coaxial cable for the terminal's output.

Carefully check the board assembly for poor soldered connections, solder bridges between closely spaced pads and traces, and proper polarization of diodes and capacitors and basing of the transistors.

Checkout. Before installing any IC's, power up the circuit board assembly to verify that no short circuits exist. Measure the potential across zener diode *D3*; it should be -5 volts. Check the fine foil traces near *R85* (at the video output) for short circuits on the $+12$ -volt line. If everything checks out, turn off the power.

Insert *IC37* through *IC41* in their sockets, making sure you properly orient them. Install jumpers from pad A to pad B and pad D to pad E (next to *IC37*). Turn on the power and use an oscilloscope to check the 47-ohm resistors next to *IC41* for the clock

pulses. When you obtain the pulses, turn off the power.

Install *IC1* through *IC36*. Be particularly careful when handling *IC9* to avoid static discharges. After removing this IC from its protective foam carrier, be sure to touch the pc board with your other hand *before* bringing the IC into contact with its socket. Seat the IC carefully in its socket and gently press it home. (Note: If you encounter excessive resistance when trying to install *IC9*, replace the IC in its foam carrier. Then loosen the socket pin receptacles by repeatedly inserting and removing a non-MOS IC or piece of bare 24 gauge wire.) Install *IC9*.

Set horizontal and vertical sync controls *R104* and *R102* to midposition and the four-position dual in-line switch so that *S1* and *S4* are off and *S2* and *S3* are on. Connect SOL's video output cable to the video monitor and turn on the power to both monitor and terminal board. Displayed on the screen should be at least one line of random characters and white cursor blocks. Adjust the v and h controls on the terminal board for proper sync and the contrast and brightness controls on the monitor for the best display.

Set *S3* to off and *S4* to on; the cursor should flash at a slow rate. Set *S2* to off; the background should change from black to white. Set *S1* to on; the control characters (symbols or abbreviations, depending on the type of character generator being used) should disappear. Turn off the board's power supply. ◆

Install *IC42* through *IC50* and *IC66* through *IC97*. Practice the same precautions for *IC69*, the microprocessor chip, that you took for *IC9* above. Connect the "wait state" jumper at *IC71* from pad W to pad 1.

With the video monitor still connected to the terminal and operational, turn on the board's power. The CRT screen should display one or more lines of alternating 9 and "null" characters and should flicker every few seconds. This indicates that the μ P is working. If there is any doubt, briefly operate the RESET switch. If you observe no activity on the screen, turn off and remove power from the board and check that all IC's are in their proper sockets and properly oriented.

Install *IC52* through *IC61* and program PROM *IC62*. Use the same precautions detailed above for *IC9* and *IC69* when handling and installing *IC54*, *IC58* through *IC61*, and *IC62*. Make sure that the socket for UART *IC54* is not too tight. If you encounter difficulties during insertion, use a non-MOS IC or 24 gauge wire to loosen the socket pin receptacles.

Once everything seems to check out, power up the board. If the program is running properly, the monitor screen should display a blanked screen with the proper "message" at the bottom.

This completes construction of the SOL video terminal. You can now add an ASCII keyboard and hook up to the outside world via the serial and/or parallel ports. ◆



Microwave Ovens for the Home

*How they work and what to
look for in selecting one.*

BY BILL EVA

ONCE used almost exclusively for line-of-sight radio communication and in industrial heating applications, microwaves are now cooking food in homes. While the microwave oven existed as far back as 1945 and was first marketed by Tappan in 1955, its popularity as a consumer appliance didn't become established until the beginning of this decade. As a result of a reduction in prices, improvements in the ovens themselves, and availability of convenience features, microwave ovens are capturing a significant percentage of the total consumer dollar spent on major cooking appliances.

Microwaves cook foods faster than

conventional gas and electric ovens; and because the microwave oven is considerably more efficient than a radiant-heat oven, it is a great deal more economical to operate. Convenience features and noncooking aesthetics have also helped to make the microwave oven an attractive consumer appliance.

Market Trends. As can be seen from the graphs, the microwave-oven market began a meteoric rise in 1970 when it captured about 1.5% of the large cooking appliance market. By the end of last year, an estimated 26% of the consumer dollar had gone into pur-

chases of microwave ovens and combination conventional/microwave ranges. Extrapolating from this performance, estimates have been made that the microwave appliance will account for almost 50% of the worldwide market by the end of this decade.

It is interesting to note that the early microwave oven market was dominated by a few Japanese name brands but that the U.S. has since taken over the major portion of the market. Current figures give 75% of the market to U.S. manufacturers and the remainder to the Japanese manufacturers.

Ten manufacturers currently supply microwave-oven appliances to the

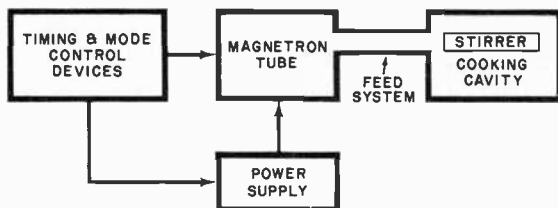

Magnetron tube, power supply, and cooking cavity make up basic elements of all microwave appliances.

consumer market. In the U.S., there are Amana, General Electric, Litton, Magic Chef, Tappan, and Thermador, while in Japan, there are Hayakawa (Sharp), Matsushita (Panasonic), Sanyo, and Toshiba. Together, these 10 companies offer a wide variety of appliances to meet any cooking need of virtually every budget.

Oven Operation. In its basic form (see block diagram), the microwave oven consists of a power supply, magnetron tube, and cooking cavity. The magnetron tube generates the r-f energy that cooks the food. It is designed to operate at a frequency in the 2400-to-2500-MHz (2.4-to-2.5-GHz) range. The magnetron tube is driven by a power supply that plugs directly into the normal ac line. The power supply is essentially a hefty transformer that delivers about 4000 volts to the magnetron.

The energy generated by the magnetron is coupled into the cooking (or microwave) cavity via a system of waveguides. Situated near the entrance to the cooking cavity is a "mode stirrer." This is a rotating device that has irregularly shaped reflective sections that scatter the microwave energy uniformly throughout the cavity to minimize hot and cold spots. (In some ovens, uniform energy distribution is obtained by having the food rotate on a turntable in the microwave energy field.)

Integral to every microwave cooking appliance are door seals and safety interlocks, both of which are required to make the appliance safe to operate. The seals block and absorb the potentially hazardous r-f energy to prevent it from escaping from the oven's cavity to the outside environment. The interlocks are designed to instantly remove the power from the magnetron tube in the event the door should be opened when the oven is turned on.

Another element basic to all consumer-type microwave ovens is a timer that precisely controls the cooking time. Since time is an important factor in microwave cooking, some oven models feature two timers—coarse and fine—to permit very accu-

rate setting of the cooking cycle. With other oven models, a single timer is provided with two operating speeds. The time can be indicated in either mechanical scalar format or numerically with LED displays driven by an all-electronic system. Deluxe oven models even feature countdown and hold modes on their timers. And some digitally generated numeric timer displays double as clocks when the oven isn't being operated.

Large countertop microwave ovens generally deliver between 600 and 700 watts of r-f power to the food load. Smaller ovens are rated at 400 to 500 watts.

Most microwave-oven appliances give the user a choice of operating modes. Almost all models provide cook and warm modes. The latest modes to be introduced are defrost and slow cook. The cook and warm modes generally operate the oven at full power. Defrost usually pulses the microwave energy on and off without cooking the food. Slow cook, useful for making stews, casseroles, and other dishes that require gentle sim-

mering, can be accomplished by operating the magnetron tube continuously at reduced power or by pulsing the full-power output on and off, with the on period determining the average cooking heat.

Bear in mind that no microwave oven can brown a roast or fowl, sear a steak, or form a crust on bread and pastry by microwave energy alone. For this, you need a source of radiant heat. Some microwave ovens feature internal browning elements to accomplish these tasks. Amana, however, does use microwave energy to brown, sear, and crust foods, but special Browning Skillets are required.

Microwave vs. Radiant. The modern microwave oven is more than just a new type of cooking appliance. It is a whole new approach to cooking. One must become accustomed to telescoped cooking times and take care to avoid using metallic cooking utensils (except in some Litton ovens).

The one great advantage the microwave oven has over conventional gas and electric ovens is its high efficiency. In conventional ovens, heat is radiated into the air before it gets to the food inside the oven. Hence, much of the energy goes into heating the air (a goodly portion of which escapes from the oven through a vent). The food being cooked heats from the outside toward the center. All told, only a

Typical magnetron tube is housed in rugged metal container along with necessary magnets.



fraction of the heat radiated into the oven goes into cooking the food.

By contrast, all of the heat developed by the microwave energy is generated uniformly inside the foods. Foods, therefore, cook uniformly throughout and have less of a tendency to dry out near the surface. No heat is wasted in heating the air surrounding the food in the microwave oven. As a result, the air and walls of the cooking cavity remain relatively cool, which means that foods and splatters don't bake on. Cleaning up is as easy as wiping with a wet sponge or cloth.

Since little or no energy is wasted in a microwave oven, foods cook faster and the energy demand is greatly reduced. Energy savings range from 50% to 75% in a microwave oven, depending on the amount of food being cooked. Likewise, cooking times are reduced to only about 25% of those required in conventional ovens.

Virtually all of the microwave energy developed by the magnetron tube is absorbed by the food in the oven, regardless of size. Hence, it takes twice as long to cook two same-size potatoes, for example, than it does to cook one potato in a microwave oven. As a rule, cooking times in a microwave oven increase in direct proportion to the increase in the amount of food being cooked.

Microwave ovens use high-reliability magnetron tubes, most of which are rated at 3000 or more hours of useful life. Since a microwave oven in a typical home is operated on an average of 100 hours per year, the magnetron tube has an implied life of about 30 years. Compare this to the typical 15-year useful life of the average gas or electric oven. And the power supply, the other major expense item, is at least as reliable as the magnetron tube. Door seals and interlocks, too, should last for the life of the oven. In fact, manufacturers have such a high opinion of the reliability of their microwave appliances that they generally offer warranties against defects and failures for periods ranging from three to five years.

Depending on size (and cooking power), basic microwave ovens draw between 8 and 15 amperes when operated from the 117-volt, 60-Hz ac line. The advantage here is that small countertop microwave ovens without built-in browning elements do not require an expensive overhaul of most electrical systems. Of course, if you decide

Amana's Touchmatic Radarange is first to use microprocessor to control all cooking functions and timing.

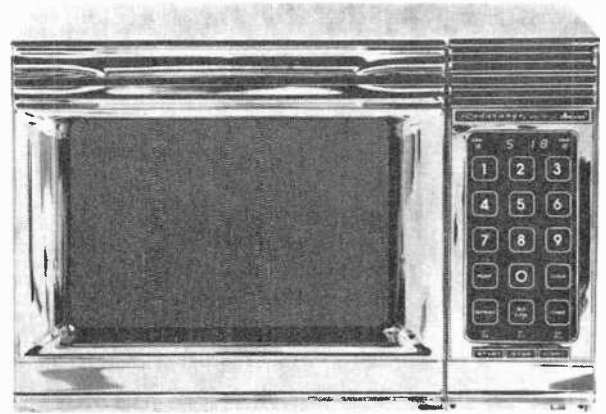

on a deluxe countertop oven with built-in radiant-heat elements for browning or a combination radiant-heat/microwave appliance, the power demand will be greater.

A Note On Safety. A few years ago, when the microwave oven was still relatively new to the consumer market, a question of safety arose with regard to the protection provided by the door seals against leakage of microwave energy.

While some controversy still remains, much of the discussion has abated. In the meantime, a number of private and government agencies have conducted much radiation research; new standards have been written; and better and more lasting door seals have been developed by microwave-oven manufacturers. Almost all of the original objections have been put to rest as a result. Although

microwave energy leakage has not been reduced to zero (an impossible task to say the least), leakage levels are now generally regarded to be well within the limits regarded as safe, even after an oven equipped with the new seals has been in service over a prolonged period of time.

The responsibility for producing microwave ovens that will maintain door-seal integrity rests with the manufacturers. To this end, all manufacturers perform exhaustive tests on every microwave oven for the consumer market. When a microwave oven has been put into its shipping carton and consigned for delivery to a retailer, you can be assured that it has been certified. (It is interesting to note that one manufacturer — Amana Refrigeration — has received a microwave oven warning label exemption from the government, which should provide some indication of

Litton's Micromatic combination range offers both radiant and microwave cooking and is the first microwave appliance to allow use of utensils.



MICROWAVE OVENS' GROWING SHARE OF MAJOR COOKING APPLIANCE MARKET

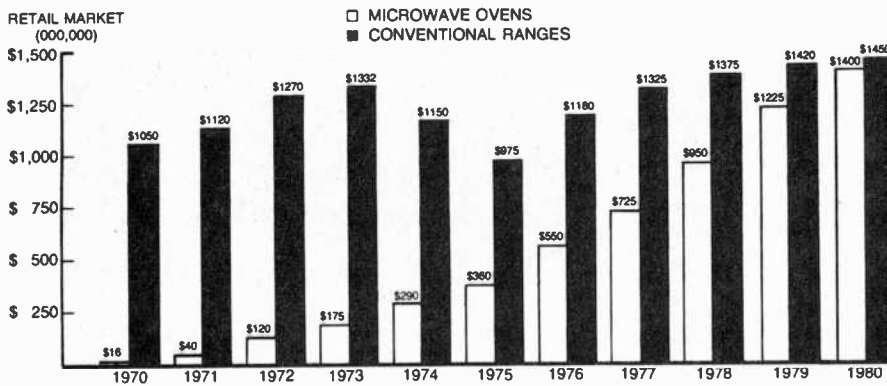

compensate for the lack of these features by using your oven with a little imagination.

It is very important that, once you get your microwave oven home and before you plug it into an outlet, you check to make sure the door closes tightly. Don't just try one opening and closure to verify proper door operation. Check to make sure that there's no lateral play around the hinges when the door is open. Should you detect a loosely fitted door or less than solid closure, you should immediately contact the dealer from which you bought the oven and inform him of the problem. Do not, under any circumstances, operate the oven if a door problem exists. You will run the risk of radiation leakage. It is rare that a situation like this arises. But even with the extreme precautions taken by manufacturers to deliver a safe product, rough handling during shipping may result in improper sealing.

What to Buy. The decision to buy a microwave appliance will depend partly on need and partly on the confidence you have in the product. As detailed above, new microwave appliances can be given a high degree of confidence with respect to reliability. If you still have reservations about buying a microwave oven, they probably stem from the fact that you have to learn a new technique for cooking foods. Rest assured that the technique isn't difficult to master in a very short time. To this end, you might be wise to pick up one or more of the books devoted to microwave cookery on the market. We can recommend "The Amana Guide To Great Cooking With a Microwave Oven," available at many paperback book racks or from Amana dealers for \$1.75. Litton Industries, P.O. Box 851, Maple Plain, MN 55359, has "Old-Fashioned Goodness With Variable Power Microwave Cooking" for \$9.95 and "Discover Combination Microwave Range Cooking" for \$12.95 (both hard-cover volumes).

While precooked and processed food packages are slow to list microwave cooking times (a situation that will doubtlessly be remedied as more and more microwave ovens come into use in consumer kitchens), several cooking magazines—at least one of which is devoted to gourmet cooking—recognize the merits of microwave cooking and are including a limited variety of recipes for the new cooking medium.

While precooked and processed food packages are slow to list microwave cooking times (a situation that will doubtlessly be remedied as more and more microwave ovens come into use in consumer kitchens), several cooking magazines—at least one of which is devoted to gourmet cooking—recognize the merits of microwave cooking and are including a limited variety of recipes for the new cooking medium.

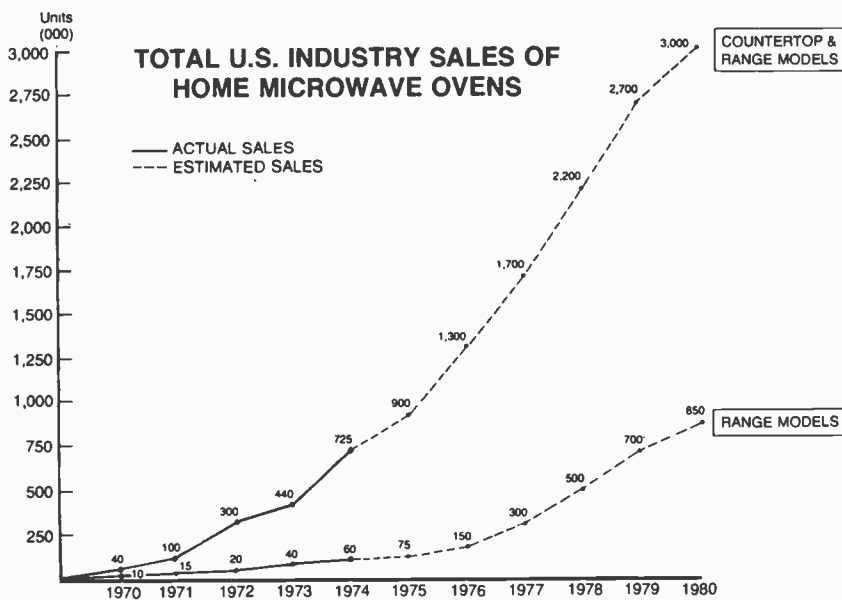

Source: Litton Microwave Cooking Products, July 1975

Graphs above left illustrate early market growth of microwave-oven appliances versus conventional ranges and predicted growth through 1980.

how much the safety of consumer microwave appliances have been upgraded in the past couple of years.)

Buying Tips. As with any other home appliance, the best advice is to shop around to determine which brand and model of microwave oven fills your needs. If you plan to do most of your cooking with a microwave oven and have a relatively large family (four or more individuals), look for a full-feature countertop oven or combination conventional/microwave range. On the other hand, if you have a small family and plan to use your conventional oven for most roasting, baking, and broiling, you can probably get along with a smaller, more economical model with fewer features.

Since a microwave oven represents a sizable investment, it pays to visit sources and make direct performance and cost comparisons. On occasion, large-appliance dealers—particularly discount centers—feature sales on microwave ovens. Pick up whatever manufacturer literature is available. And, if possible, have the salesperson demonstrate how the different models work.

If you're on a tight budget, look at the "economy" models. Economy ovens, after all, contain roughly the same basic cooking elements common to even the most deluxe types. True, you won't have all the conveniences (high/low-power cooking, defrosting, slow-cook, and countdown and hold), but it is usually possible to

LEARNING ELECTRONIC THEORY WITH HAND CALCULATORS

BY EDWARD M. NOLL

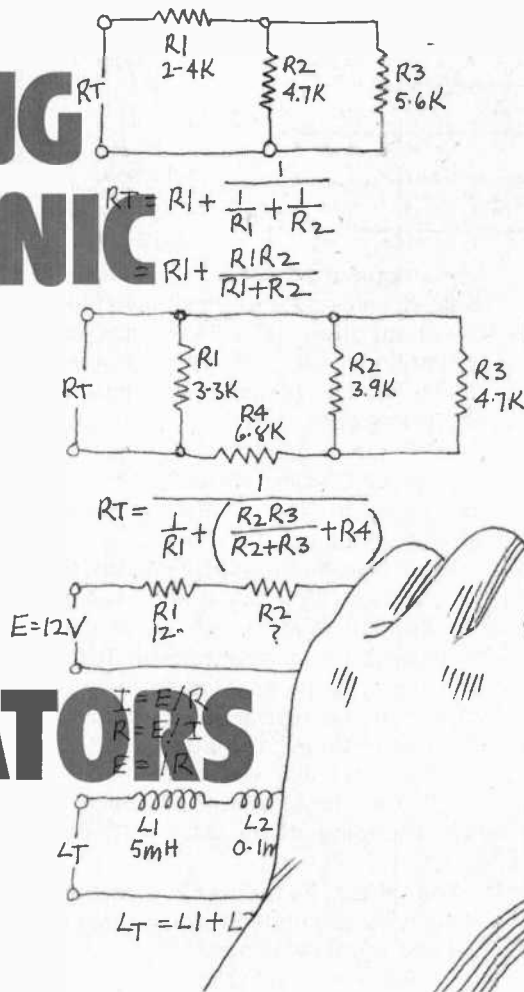

PART ONE: Basic Equations and Ohm's Law

THE deeper you get into electronics, the more you find how many mathematical manipulations are involved. The tedium involved in extracting roots, raising numbers to powers, calculating angles and vectors, and handling very large and very small numbers — sometimes in a single problem — often make students of electronics throw up their hands in despair.

Now, thanks to the availability of low-cost hand-held scientific calculators, you can put most of the drudgery of numer manipulation behind you. The calculator is an accurate, easy-to-use mathematical tool that eliminates the need for log and trig tables. It is also an extremely fast problem solver. Most people who become familiar with using a scientific calculator to solve problems actually want to learn the math that will take them deeper and deeper into electronics.

This article is the first of three in
JULY 1976

stallments on how to use a scientific calculator to solve basic electronics problems. We will discuss Ohm's Law and dc circuits; calculating the total resistance, capacitance, and inductance in series and parallel circuits; and resonance.

Throughout this series, the method of keyboard entry described is standard algebraic. If you are using a reverse-Polish notation (RPN) calculator, refer to its instruction manual for information on how to translate from algebraic to RPN format. In addition, it is pre-supposed that your calculator is equipped to handle two-digit power-of-ten superscript in the display and on command from the keyboard. It must also have parentheses (preferably "nested") and a memory register.

(Note: The answers to problems given in this series of articles were obtained with a Melcor calculator. If you use a calculator from a different manufacturer, you may obtain slightly dif-

ferent answers as you work the problems. The differences in answers will be negligible.)

Series and Parallel R. The simplest type of problem you are likely to encounter in electronics is finding the total resistance in a series circuit. The total resistance, R_T , is the sum of the individual resistances, as shown in the formula accompanying Fig. 1A. The value of R_T will always be greater than the highest value resistance in a series circuit.

In Fig. 1 are three series-resistor circuits, each containing four resistors of different values. Circuits A and B illustrate a very important rule to bear in mind: *Always make entries in identical units.* In Fig. 1A, you can simply add the resistances exactly as they are stated because they are all in kilohms units. However, if you look closely at the circuit of Fig. 1B, you will find that R_3 's value is given in megohms, which means that you must first convert 1.2

Fig. 1. In series-resistor circuit, total resistance is sum of individual resistances.

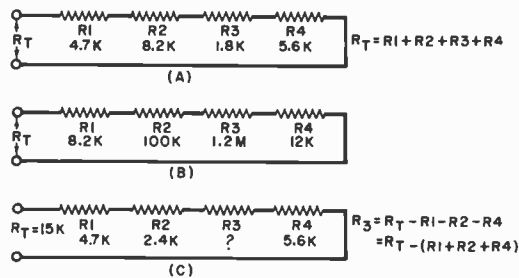

megohms to 1200 kilohms before attempting to sum the values.

What is the total resistance in kilohms for Fig. 1A? Using your calculator, solve the problem by making the following keyboard entries:

$$4.7 + 8.2 + 1.8 + 5.6 =$$

As soon as you make the last entry, the display should read 20.3, which is R_T in kilohms (20,300 ohms). To solve for R_T in kilohms for the Fig. 1B circuit, the keying sequence would be:

$$8.2 + 100 + 1200 + 12 =$$

yielding 1320.2 kilohms.

The object of the circuit shown in Fig. 1C is to find the value of R_3 , given R_T and the values of the remaining resistors. This is done simply by subtracting the given values from R_T as illustrated in the formula. The keying sequence is

$$15 - 4.7 - 2.4 - 5.6 =$$

or $15 - (4.7 + 2.4 + 5.6) =$

Note that the second keying sequence introduces the use of parentheses. Here, the sum of the resistances inside the parentheses is subtracted from the first entry. Both sequences yield the same answer: 2.3 kilohms (2300 ohms).

When resistors are connected in parallel, as shown in Fig. 2, R_T is the reciprocal of the sum of the reciprocals of the individual resistor values (see formula in Fig. 2A). Total resistance R_T is always less than the lowest resistance value in a parallel circuit.

The use of the scientific calculator makes short work of the manipula-

tions required for solving parallel circuits. In solving for R_T (in kilohms) for the values given in Fig. 2A, it is easiest to first find the sum of the reciprocals of R_1 , R_2 , and R_3 and then find the reciprocal of the result:

$$4.7 \ 1/x + 8.2 \ 1/x + 5.6 \ 1/x$$

$$= 1/x \ \text{Display: } 1.948221701$$

The answer in kilohms can be rounded off and stated as 1.95 kilohms.

Total resistance and the values of two of the three resistors are given in Fig. 2B. The objective is to determine the value of the unknown resistor. To do this, the basic parallel-resistance formula must be rearranged as shown. Then solve for R_3 as follows:

$$1.2 \ 1/x - 6.8 \ 1/x - 8.2 \ 1/x$$

$$= 1/x \ \text{Display: } 1.772033898$$

After rounding off, the value of R_3 becomes 1.8 kilohms.

The value of R_T for the circuit in Fig. 2C can be calculated using either of the two formulas shown:

$$6.8 \ 1/x + 2.4 \ 1/x = 1/x$$

or $6.8 \times 2.4 \div (6.8 + 2.4) =$

Display: 1.773913043

After rounding off the result, R_T becomes 1.8 kilohms.

Circuits containing both parallel and series grouping, like that shown in Fig. 3, must use a formula that includes all elements. The formula for R_T for the circuit shown is also given in Fig. 3. To solve for R_T here, make the following entries:

$$2.4 + (4.7 \ 1/x + 5.6 \ 1/x) \ 1/x =$$

or $2.4 + [4.7 \times 5.6 \div (4.7 + 5.6)] = \text{Display: } 4.955339806$

Round off the answer to 4.96 or 5 kilohms. Note that the second method introduces the use of nested parentheses. To be able to use the second method of entry, your calculator must have at least two levels of parentheses. Otherwise, you will have to use the calculator's memory register.

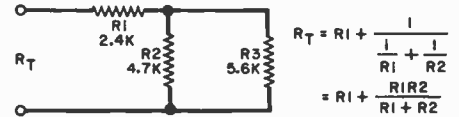

Fig. 3. In this series-parallel circuit, R_T is greater than R_1 .

The rather complex formula shown in Fig. 4 can be solved in several ways. We offer here two keyboard sequences you can use for solving for R_T . In the first, the calculator's memory register is used to store an intermediate result. In the second, the order of entry is slightly rearranged to avoid the use of the memory function and reduce by two the number of entries that must be performed. In both cases, however, the R_2/R_3 network is first converted to a product-over-sum format: $R_2 R_3 / (R_2 + R_3)$.

$$3.3 \ 1/x \ \text{STO } 3.9 \times 4.7 \div ($$

$$3.9 + 4.7) + 6.8 = 1/x +$$

RCL = $1/x$ Display: 2.409668219

or $3.9 \times 4.7 \div (3.9 + 4.7)$

$$+ 6.8 = 1/x + 3.3 \ 1/x =$$

$$1/x \ \text{Display: } 2.409668219$$

After rounding off, R_T becomes 2410 ohms.

Ohm's Law. The voltage/current/resistance relationship known as Ohm's Law is one of the most important in electronics. Ohm's Law states that the current in a circuit varies directly with the voltage and inversely with the resistance in a circuit. In equation form, this becomes $I = E/R$, from which we derive $E = IR$ and $I =$

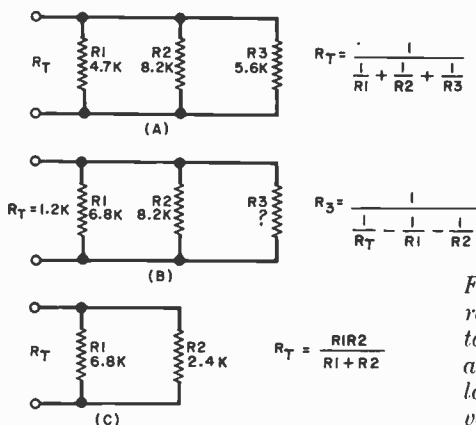
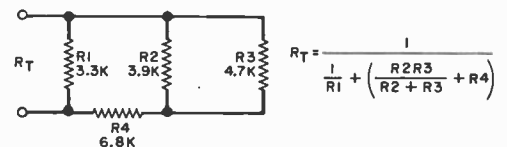

Fig. 4. Since R_1 is in parallel with rest of circuit R_T must be less than value of R_1 .



E/R . Now, referring back to Fig. 3 and using 4955 ohms as R_T , what is the current in the circuit if 200 volts is applied? Since $I = E/R$, your calculator entries would be:

$$200 \div 4955 =$$

Display: 4.036326942 -02

Note that the result in the display con-

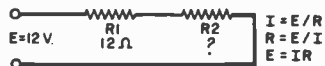

Fig. 5. Given any two I , E , R parameters, third can be derived.

tains an exponent of -02 , which means that the decimal point must be moved two places to the left. This yields an answer of 0.04036 ampere (40.36 mA) after rounding off.

Once you know the current flowing through the circuit, you can easily calculate the voltage drop across any given resistor in that circuit. For example, let us calculate the voltage dropped across $R1$ ($E_{R1} = IR$):

$$.04036 \times 2400 = \text{Display: } 96.864$$

Next, what is the voltage drop across $R2$ and $R3$? Bear in mind that while the full current flows through series resistor $R1$ in this circuit, it splits in proportion to the resistances in the parallel legs consisting of $R2$ and $R3$ so that the voltage dropped across one resistor will be identical with that dropped across the other resistor. Hence, $E_{R2,R3}$ will be the difference between supply voltage E_S and E_{R1} ($E_{R2,R3} = E_S - E_{R1}$):

$$200 - 96.864 = \text{Display: } 103.136$$

You can now calculate the current through $R2$ ($I_{R2} = E_{R2,R3}/R2$):

$$103.136 \div 4700 =$$

Display: 2.194383978 -02 (21.9 mA)

and through $R3$ ($I_{R3} = E_{R2,R3}/R3$):

$$103.136 \div 5600 =$$

Display: 1.841714285 -02 (18.4 mA)

As an example in learning how to use your calculator with confidence, determine the total current drawn by the circuit in Fig. 4. Then calculate the current through and voltage dropped by each resistor in the circuit. Hint: The entire 100-volt E_S is applied across $R1$ and also across the network made up of $R2$, $R3$, and $R4$. When you're through with your calculations your results should be: $E_{R1} = 100$ V; $E_{R2,R3} = 23.85$ V; $E_{R4} = 76.5$ V; $I_{R1} = 30.3$ mA; $I_{R2} = 6.1$ mA; $I_{R3} = 5.1$ mA; and $I_{R4} = 11.2$ mA.

In the Fig. 5 circuit, what must be the value of $R2$ if circuit current is to be limited to 200 mA. Since $I = E/(R1 + R2)$, restating the formula yields $R2 = (E/I) - R1$. Therefore, the keyboard entry would be:

$$12 \div .2 - 12 =$$

$$\text{or } (12 \div .2) - 12 =$$

Display: 48

Hence, the value of $R2$ must be 48 ohms.

Now, what is the total power (P_T)

consumed by the circuit in Fig. 5 and power dissipated by each resistor in the circuit? Power (in watts) is a simple voltage-current relationship ($P = IE$). For P_T :

$$.2 \times 12 = \text{Display: } 2.4 \text{ (watts)}$$

To determine the power dissipated by each resistor, use the formula $P = I^2R$. This introduces you to the use of the x^2 squaring key. For $R1$:

$$.2 \times^2 \times 12 = \text{Display: } 0.48 \text{ (watt)}$$

and for $R2$:

$$.2 \times^2 \times 48 = \text{Display: } 1.92 \text{ (watts)}$$

Add the two dissipation figures obtained for $R1$ and $R2$:

$$.48 + 1.92 = \text{Display: } 2.4 \text{ (watts)}$$

and you have P_T .

Series and Parallel L & C. When dealing with inductances in series and parallel circuits, the rules are the same as those for resistive circuits. For series inductances, simply add the various L values (don't forget to use a common number notation), while for

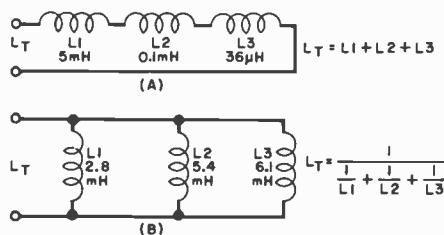

Fig. 6. L_T is calculated in a manner similar to finding R_T .

parallel circuits, calculate the reciprocal of the sum of the reciprocals of the various L values. Capacitances, on the other hand, are totalized in exactly the opposite manner: In a series circuit, C_T is the reciprocal of the sum of the reciprocals of the various C values, while in a parallel circuit, C_T is the simple sum of the C values.

Given the above criteria, calculate the total inductance, L_T , for Fig. 6a:

$$5 + .1 + .036 =$$

Display: 5.136 (mH)

and for Fig. 6B:

$$2.8 \ 1/x + 5.4 \ 1/x + 6.1 \ 1/x$$

$$= 1/x \ \text{Display: } 1.41590426$$

which when rounded off becomes 1.416 mH.

Now, calculate C_T for Fig. 7A:

$$.1 \ 1/x + .02 \ 1/x + .005 \ 1/x$$

$$= 1/x \ \text{Display: } 3.846153846 \ -03$$

which rounds off to approximately 3850 pF. To calculate C_T for the Fig. 7B circuit, simply add the various C values:

$$1500 + 820 + 680 =$$

Display: 3000 (pF)

The result can also be stated as 0.003 microfarads.

Resonance Formulas. Whenever a capacitor and an inductor are connected together in series or parallel, they will resonate at a frequency determined by the L and C values. The basic equation for determining resonance (f_r) is given in Fig. 8, as are the equations for determining the L and C values when f_r is given.

When working with the resonance formula, pay careful attention to the units in which the L and C values are stated. Values are generally stated in powers of 10, which may or may not be the same for L and C. However, you don't have to convert the numbers to a common exponent notation because you will be using the exponent key (EE or EEX, depending on the calculator you are using). On scientific calculators, the exponent key automatically states the number entry in "scientific notation" (power of 10).

Now, what is f_r for the Fig. 8 circuit? To solve this problem, make your keyboard entries as follows:

$$2 \times \pi \times (10 \ \text{EE} + / - 6 \times$$

$$20 \ \text{EE} + / - 12) \sqrt{x} = 1/x$$

Display: 11253953.95 (Hz)

In conventional notation, this would be 11.253954 Mhz, or 11.3 MHz. Note that in solving this problem we not only introduce the use of the EE key, but we also have occasion to use the π and square-root (\sqrt{x}) keys.

Since the same resonance equation applies to both series and parallel-resonant circuits, what is f_r for the circuit in Fig. 9? In solving this problem, bear in mind that capacitors connected in parallel with each other yield a C_T that is the sum of their values. Your keyboard entries would be:

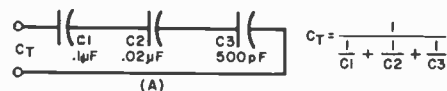
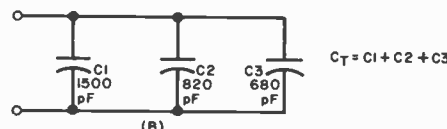

Fig. 7. Finding C_T for series and parallel circuits is similar to finding R_T for parallel and series circuits, respectively.



50 EE +/- 12 + 20 EE +/- 12 x
 40 EE +/- 6 = $\sqrt{x} \times 2 \times \pi = 1/x$
 or $2 \times \pi \times [(20 \text{ EE +/- } 12 + 50 \text{ EE$
 $\text{ +/- } 12 \times 40 \text{ EE +/- } 6) \sqrt{x}] = 1/x$
 The result displayed in both cases
 would be 3007745.709, which be-
 comes approximately 3 MHz.

A capacitor of 140 pF is to be used in
 a parallel circuit that must resonate at
 4 MHz. Using the equation given in
 Fig. 8 for determining the value of L,
 what must be the inductance used?
 The keyboard entry is as follows:

$$2 \times \pi \times 4 \text{ EE } 6 = 1/x \ x^2 \div$$

$$140 \text{ EE +/- } 12 =$$

Display: 1.130816781 -05

Hence, the inductor would have a
 value of roughly 11.3 μH . You can
 double check your calculation by solv-
 ing for f_r using 11.3 μH and 140 pF as
 the L and C values.

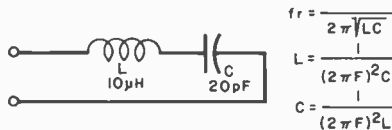

Fig. 8. Values of L and C
 determine resonant frequency.

Gain Formulas. Calculating power
 and voltage gain with a scientific cal-
 culator is a cinch because the cal-
 culator's built-in logarithm function
 eliminates the need for log tables. To
 see how simple the procedure is, let us
 assume that the output power of an

amplifier is 4 watts and its input is 2
 watts. What is the decibel (dB) gain of
 the amplifier, using the basic formula
 $\text{dB} = 10 \log (P_o/P_{in})$, we get:

$$4 \div 2 = \log \times 10 =$$

Display: 3.010299954 (dB)

You can round this off to 3.01 dB.
 (When you work this problem on your
 calculator, use only the common-
 logarithm, or "log," key. Do NOT use
 the natural-logarithm, or "ln," key in
 power and voltage gain calculations
 or your answer will be incorrect.) Note
 that a doubling of power corresponds
 to a 3 dB gain.

If the output voltage of the circuit is
 8 volts and the input is 4 volts, what is
 the voltage gain of the amplifier? Use
 the formula $\text{dB} = 20 \log (E_o/E_{in})$:

$$8 \div 4 = \log \times 20 =$$

Display: 6.020599908

which rounds out to a 6-dB gain. Note
 here that doubling the voltage corres-
 ponds to a 6-dB voltage gain. Voltage
 and current gain and loss figures are
 appropriate only when the input and
 output impedances are identical. As a
 result, power gain and loss values are
 given most often because in most
 practical situations the input and out-
 put impedances are not the same.

In passing through a network,
 the output power drops from 6 watts at
 the input to 3 watts at the output. What
 is the power loss in decibels, using the
 formula $\text{dB} = 10 \log (P_o/P_{in})$:

$$3 \div 6 = \log \times 10 =$$

Display: -3.0103 (or about -3 dB)

In a network that has the same input
 and output impedance, the voltage
 drops from 16 to 8 volts. What is the
 loss in decibels. Using the formula
 $\text{dB} = 20 \log (E_o/E_{in})$:

$$8 \div 16 = \log \times 20 =$$

Display: -6.020599918 (or -6 dB)

Finally, the input power to an amplifier

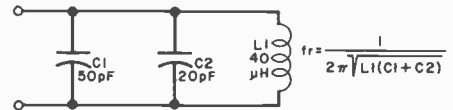

Fig. 9. C_T is sum of $C_1 + C_2$.

is 5 mW and the output power is 10
 watts. What is the gain of the
 amplifier? First, convert 5 mW to 0.005
 watt:

$$10 \div .005 = \log \times 10 =$$

Display: 33.01029995 (or 33 dB)

Summing Up. You have probably
 noted that it is a rather slow process
 making entries if mistakes are to be
 avoided. In the beginning, while you
 are becoming familiar with your cal-
 culator and the electronics math in-
 volved in problem solving, it is best to
 work each problem two or three times
 to avoid errors. As your confidence
 builds, however, you will find the
 process considerably speeded up.

In our second installment, we dis-
 cuss impedance and ac formulas. ♦

A FLASHER/BATTERY INDICATOR

BY DALE HILEMAN

SINCE readers have considerable
 interest in flasher circuits, per-
 haps this flasher and battery indicator
 circuit will be helpful for use in a
 battery-operated test instrument.

The flashing is intended to call the
 operator's attention to the fact that
 power is on so that he won't go away
 and leave the instrument operating. It
 flashes brightly about twice a second,

but average current consumption is
 only about 200 μA because the duty
 cycle is only about one percent.

Helping keep power consumption
 to a minimum, transistors Q1 and Q2,
 in an unusual complementary multi-
 vibrator circuit, are both cff 99 per-
 cent of the time, conducting only
 when the LED is on.

The circuit is intended for use with a

9-volt battery, and values are chosen
 so that R4 can be adjusted to stop the
 flashing when the voltage drops to six
 volts. This point may be changed by
 altering the ratio of R2 to R3.

As the battery voltage approaches
 the turnoff point, the flashing rate
 suddenly drops, to warn the operator
 of impending failure. Of course, when
 the battery voltage has dropped below
 this point, there is no flashing to re-
 mind the operator to turn the power
 off. Presumably, however, the battery
 is nearly dead anyway; so it doesn't
 matter much if left on. A germanium
 diode, D1, temperature-compensates
 the base-emitter junction of Q1 to
 keep the turnoff voltage stable. This
 diode must be a 1N198; you cannot
 substitute.

Average current can be further re-
 duced by increasing the values of R1,
 R7, and R9. The former two limit surge
 and the latter determines the current
 in the LED. ♦

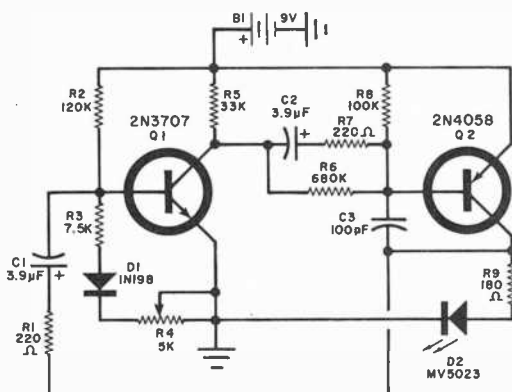

*While the 9-volt
 battery powers other
 equipment, this
 circuit indicates
 power on, and changes
 flash rate or
 turns off when battery
 gets low.*

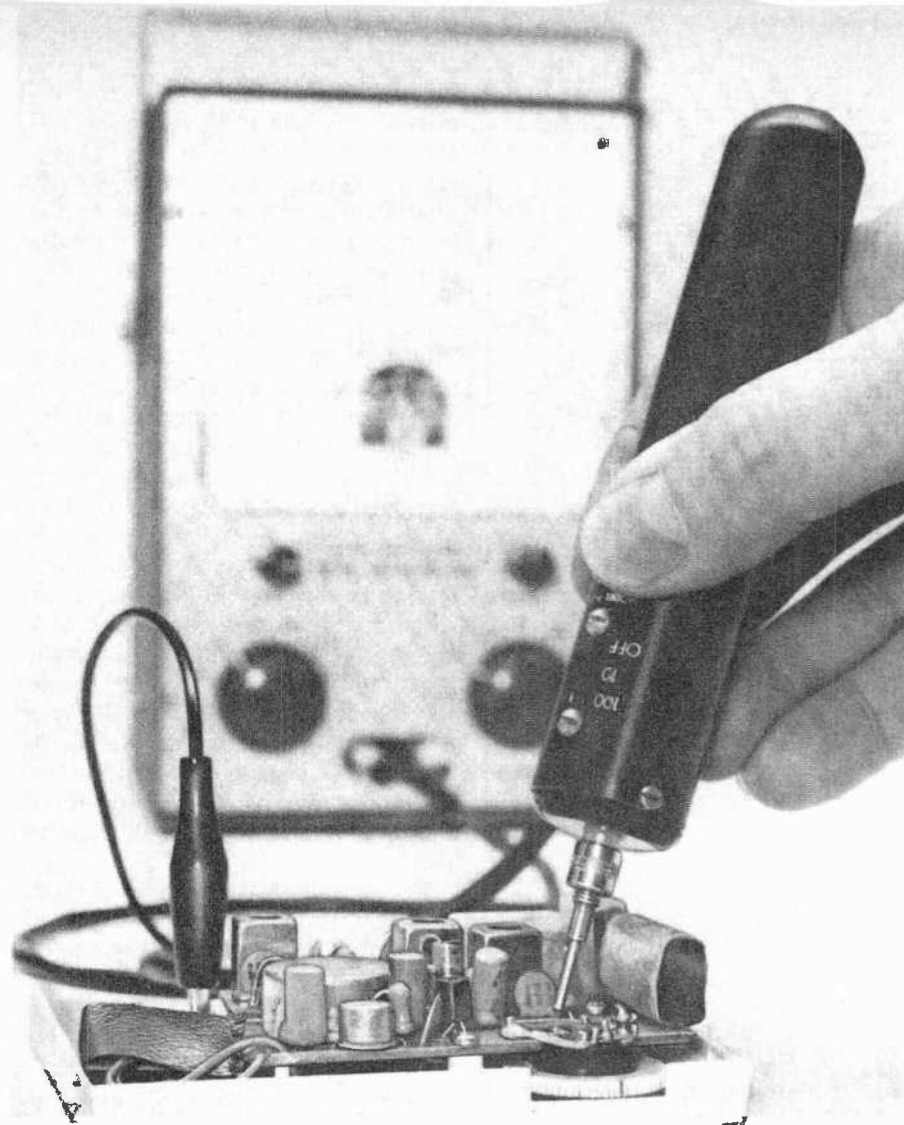

Update Your Multimeter with a CMOS Millivolter

*Converts any voltmeter into a
high-sensitivity input meter
for low millivolts measurements.*

BY DAVID H. DAGE

YOU CAN inexpensively update any dc voltmeter to measure in the low-millivolt range at an input sensitivity of 1000 megohms/volt with the Millivolter. The self-contained, battery-powered Millivolter is basically a high-sensitivity amplifier housed in a 5" (12.7-cm) long probe

that plugs into the standard input of any voltmeter rated at 1000 ohms (or greater) per volt.

When the Millivolter is used with an ordinary dc voltmeter, it can supply gains of $\times 10$ or $\times 100$ through its built-in CMOS operational amplifier circuit. This means that a 3-volt range

in the meter effectively becomes a 30-mV range and a 1-volt range becomes a 10-mV range full scale. Additionally, the probe can be used to measure current, with 1 nA indicating full scale on a 1-volt range.

You can build the Millivolter for about \$12, which is a great deal less than you would have to pay for a new instrument capable of providing its measurement features.

How It Works. The Millivolter is built around a new CA3130 linear CMOS op amp (IC1 in Fig. 1) that has extremely low bias current requirements. This permits large values of input resistance to be effectively used. In this case, 10 megohms is used without seriously affecting the output voltage when the probe inputs are shorted.

When using a CA3130 op amp with a 10-megohm input resistor (R1), the output changes only 5 mV, or 0.5% of the full-scale indication. This is a sharp contrast to the unusual behavior of most other op amps on the market.

The output of the new op amp consists of CMOS transistors that operate as a class-A amplifier whose gain is dependent on the load impedance that it drives. With a gain of 100 and a reasonably high-input-impedance voltmeter (5000 ohms/volt), negligible error is introduced even when driving the output to within a few millivolts of the supply potential. When driving low-impedance voltmeters (1000 ohms/volt), the output is reliable to within ± 3 volts with less than 2% load error. Shorting the output to ground will not damage the IC.

The circuit shown in Fig. 1 employs 1% tolerance resistors in the gain-setting feedback loop, which means that no gain-adjusting trimmer potentiometers are required. The offset voltage can be adequately trimmed to null by adjusting potentiometer R6.

With S1 in the OFF position, the probe is completely bypassed, the voltmeter operates in the normal manner, and power is removed from the probe's circuit. In either of the other two positions ($\times 10$ and $\times 100$), S3 applies power to the probe's circuit and simultaneously performs all switching functions for the gain selected.

A single 9.8-volt battery, B1, powers the op amp amplifier circuit through Q1 and the resistor network consisting of R7, R8, and R9. This network provides a common (ground) refer-

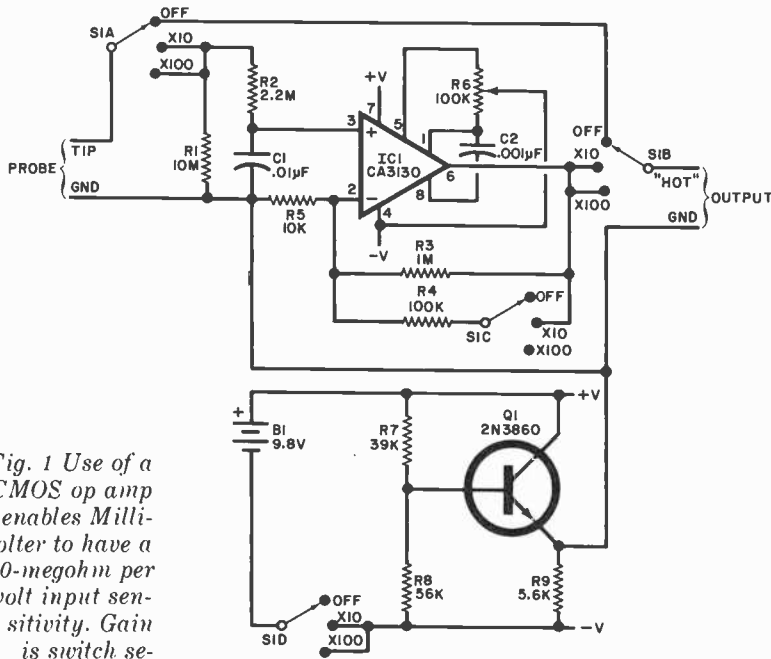

Fig. 1 Use of a new CMOS op amp enables Millivoltmeter to have a 1000-megohm per volt input sensitivity. Gain is switch-selectable between 10 and 100 times.

PARTS LIST

- B1—9.8-volt mercury battery (RCA No. VS177 or similar)
- C1—0.01-µF disc capacitor
- C2—0.001-µF disc capacitor
- IC1—CA3130 CMOS linear op amp IC (RCA)
- Q1—2N3860 or similar transistor
- R1—10-megohm, 5% resistor
- R2—2.2-megohm, 5% resistor
- R3—1-megohm, 1% resistor
- R4—100,000-ohm, 1% resistor
- R5—10,000-ohm, 1% resistor
- R6—100,000-ohm miniature trimmer potentiometer
- R7—39,000-ohm, 5% resistor
- R8—56,000-ohm, 5% resistor
- R9—5600-ohm, 5% resistor
- S1—Four-pole, three-position miniature slide switch

Misc.—Suitable probe assembly (see text); printed circuit or perforated board; battery connector clips; probe tip; shielded cable (audio or coaxial) for output; miniature alligator clip; brass angle bracket; rubber grommet and silicone adhesive (optional—see text); hookup and test-lead wire; machine hardware; dry-transfer lettering-kit; solder; etc.

Note: The following items are available from Dage Scientific Instruments, P.O. Box 1054, Livermore, CA 94550: Complete kit of parts (less battery and output cable connectors) for \$11.95 plus \$1.00 shipping and handling; RCA No. VS177 9.8-volt mercury battery for \$2.50. California residents, please add sales tax.

ence at approximately half the battery potential, or 4.9 volts.

Construction. The Millivoltmeter circuit can be assembled on either a printed circuit board or perforated board using point-to-point wiring techniques. It can also be housed in a small box instead of in a probe housing, although the latter is more convenient for testing purposes.

If you use pc wiring and plan to house the circuit in a probe body, use the actual-size etching and drilling guide in Fig. 2. Mount a small brass (not aluminum) angle bracket at the battery end of the board, sweat-soldering it into place. Then either solder or rivet a female battery connector clip to the bracket. This clip will accommodate the positive (+) terminal of the battery. Mount and solder into place trimmer potentiometer R6, about 1/16" (1.6mm) away from the

surface of the board. This pot mounts on the foil side of the board. Mount and solder into place all remaining components on the blank side of the board as shown in Fig. 2.

Although the input of IC1 is pro-

Fig. 2 Actual-size foil pattern and component installation on a board that can fit a 7/8" ID tube. The positive battery clip is soldered to one end of the board, with wire connection to the negative terminal.

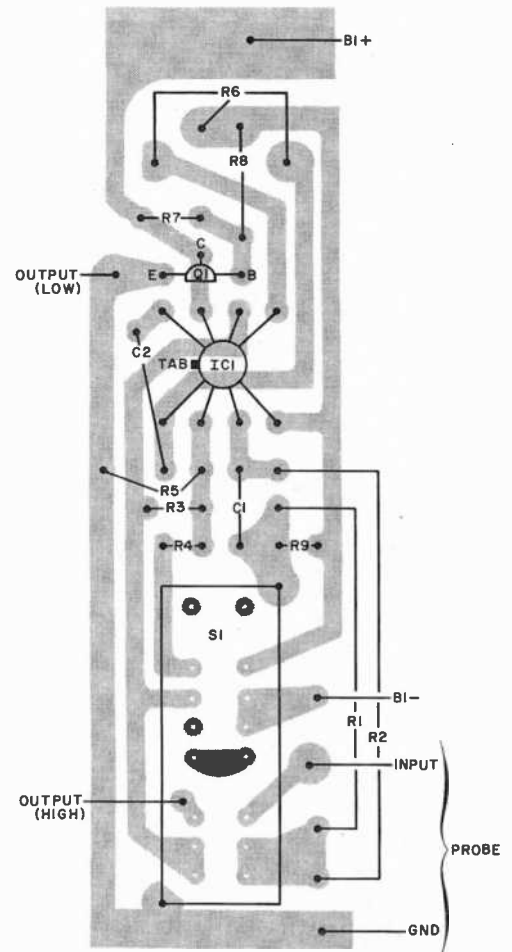
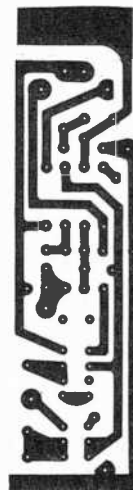

tected, it is still a MOS device and should be handled with care. Therefore, it is best not to handle the IC by its leads. Once IC1 is soldered to the board pads, all pins will be properly terminated and no further safety precautions need be practiced.

You can use just about any plastic tube that has a 7/8" (22.2-mm) inner diameter and measures 5" (12.7 cm) in length to house the pc board assembly. If you want to reduce the amount of ac pickup, you can use a metal tube, but make absolutely certain that none of the components on the board touch the metal probe body. (Only the common ground circuit should make good electrical contact with the metal tube.)

Before sliding the circuit assembly into the probe body, accurately locate and cut a slot in the body for S1. Prepare a length of stranded (preferably test-lead) wire; fasten one end to the circuit's common ground point and to the other end attach a small alligator clip.

If your voltmeter normally uses an isolation resistor (usually 1 megohm) in its "hot" probe, connect the same value resistor in series with the Millivoltmeter's output pad and output cable. You can conveniently mount this re-

FULL-SCALE CURRENT RANGES

Shunt Resistor	1-volt FS probe $\times 100$	3-volt FS probe $\times 100$	1-volt FS probe $\times 10$	3-volt FS probe $\times 10$
none	1 nA	3 nA	10 nA	30 nA
100,000 ohms	100 nA	300 nA	1 μ A	3 μ A
1000 ohms	10 μ A	30 μ A	100 μ A	300 μ A
10 ohms	1 mA	3 mA	10 mA	30 mA

sistor on the bottom (foil) side of the board.

Fashion a wood or plastic plug to fit the front of the probe body and mount a conventional test probe tip in it. Drill a hole through the rear of the probe body to allow the coaxial output cable to pass through. (If you're using a tube that's open at both ends for the probe body, you'll need another plug; drill the cable exit hole through the plug in this case.) The exit hole should be just large enough for a snug fit around the cable.

Solder the output cable to the appropriate points in the Millivoltmeter's circuit. You can fashion a strain relief for the cable by sliding onto it a snug-fitting rubber grommet and fixing the grommet into place with silicone adhesive. (Trial fit the circuit assembly into the probe body to locate where along the cable the grommet is to be positioned before cementing it into place.)

With *S1* set to the OFF position, connect the battery to the clip mounted on the brass bracket. To the free end of a length of hookup wire connected to the wiper contact of *S1D*, solder a male battery connector. Snap this connector onto the negative (-) terminal of *B1*. Then slide the entire circuit assembly into the probe body, positioning the slider of *S1* in the cut-out, and fasten the front plug into place with small machine screws. Finally, fit to the conductors at the free end of the output cable the appropriate connector(s) to mate with the input of your voltmeter.

Operation. Connect the assembled probe to your voltmeter, first setting the meter to the 1- or 3-volt dc range. The probe's output swing will be typically 4.5 volts in both the positive and negative directions. However, the maximum reliable output range should be limited to ± 3 volts. What this means is that if you were measuring voltages with the meter set to a range higher than 3 volts, an indication of 4 volts might represent a saturated out-

put and not a true voltage measurement.

Make sure that the pointer of your voltmeter is set at mechanical zero and to a low dc voltage range. Then short the ground lead to the probe tip. Zero the probe by adjusting *R6* (you'll have to partially disassemble the probe to do this) in first the $\times 10$ and then the $\times 100$ positions of *S1*. Remove the ground clip from the probe tip and reassemble the probe. A very slight negative voltage variation can be expected when you remove the ground clip from the probe tip. Don't attempt to zero this offset. If you find this slight offset objectionable you can reduce the value of *R1* until it disappears.

The Millivoltmeter probe is highly sensitive. Just touching the probe tip with

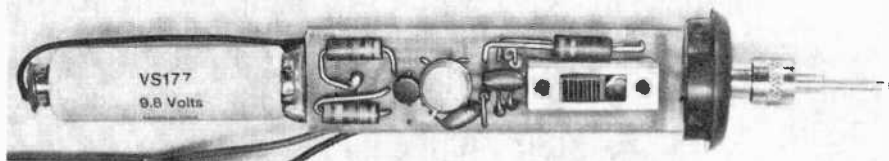

Photo shows component mounting details and location of battery bracket/connector at left end of pc board.

your finger is enough to cause the meter pointer to peg against its up-scale mechanical stop. Keep this in mind when measuring voltages in high-impedance circuits.

Switch *S1* should be kept in the OFF position when you're not using the probe's amplification function and when your meter is stored away. If you turn off the probe (*S1* set to OFF) when not in use and when you're measuring voltages in the bypass mode, you can expect the battery to last in excess of 70 hours when power is actually applied to the probe's circuit. (Current drain of the Millivoltmeter's circuit is less than 5 mA.)

You can check the condition of the probe's battery by applying a positive and then a negative potential great enough to drive the probe's amplifier into saturation. The saturation voltage at the output of the Millivoltmeter should

be greater than 3.5 V in both directions and greater than 8 V between the two readings. When the voltage drops below these levels, it's time to replace the battery.

Accidental application of up to 200 volts dc to the input of the probe will not damage the Millivoltmeter's circuit. Under no circumstances should you apply a voltage to the probe's output lead.

Other Applications. From Ohm's Law, we know that when 1 μ A is flowing through a 1-ohm resistor, the voltage dropped across the resistor is 1 μ V. If you connect the Millivoltmeter probe in series with a circuit (assuming the value of *R1* is 10 megohms), you have a 0-to-1-nA current probe. Since there isn't much demand for such a sensitive current scale, you can add appropriate shunt resistors across *R1* to produce the ranges detailed in the Table. Keep a supply of 1% resistors of the values indicated to use as current shunts.

The probe also makes an ideal nulling device for use with a precision bridge. If your voltmeter can be set up for center-scale zero, the probe will turn it into 500-0-500-pA nulling meter.

You can use current shunts if this range is too sensitive. Resistance in the milli-ohm range can be measured with the aid of a constant-current source pegged at 10 or 100 mA. Full-scale range will be 100 milliohms on a 1-volt meter scale with 100 mA test current.

You can also make a megohmmeter insulation tester by placing a 10-volt constant-voltage source in series with the unknown high resistance, while measuring the current flow with the probe. Resolution of up to 10^{12} ohms is possible with a full-scale reading of 100,000 megohms.

All in all, for a very small investment and a few hours of assembly time, you can build a really versatile Millivoltmeter probe that can make an inexpensive VOM perform like a laboratory instrument that ordinarily costs several hundred dollars. ◆



A Low-Cost APARTMENT BURGLAR ALARM

*Self-powered system features
adjustable time delay.*

MOST home intruder/burglar alarms employ sensors of some sort scattered throughout the premises which, when tripped, sound a loud gong or siren. Although such elaborate alarm systems may be a necessity for private homes, the apartment dweller living above the ground floor can get by with a simpler system. With access usually limited to a single door and perhaps one or two windows that feed onto a fire escape, only a few sensors are needed. In addition the piercing tone of a Sonalert®

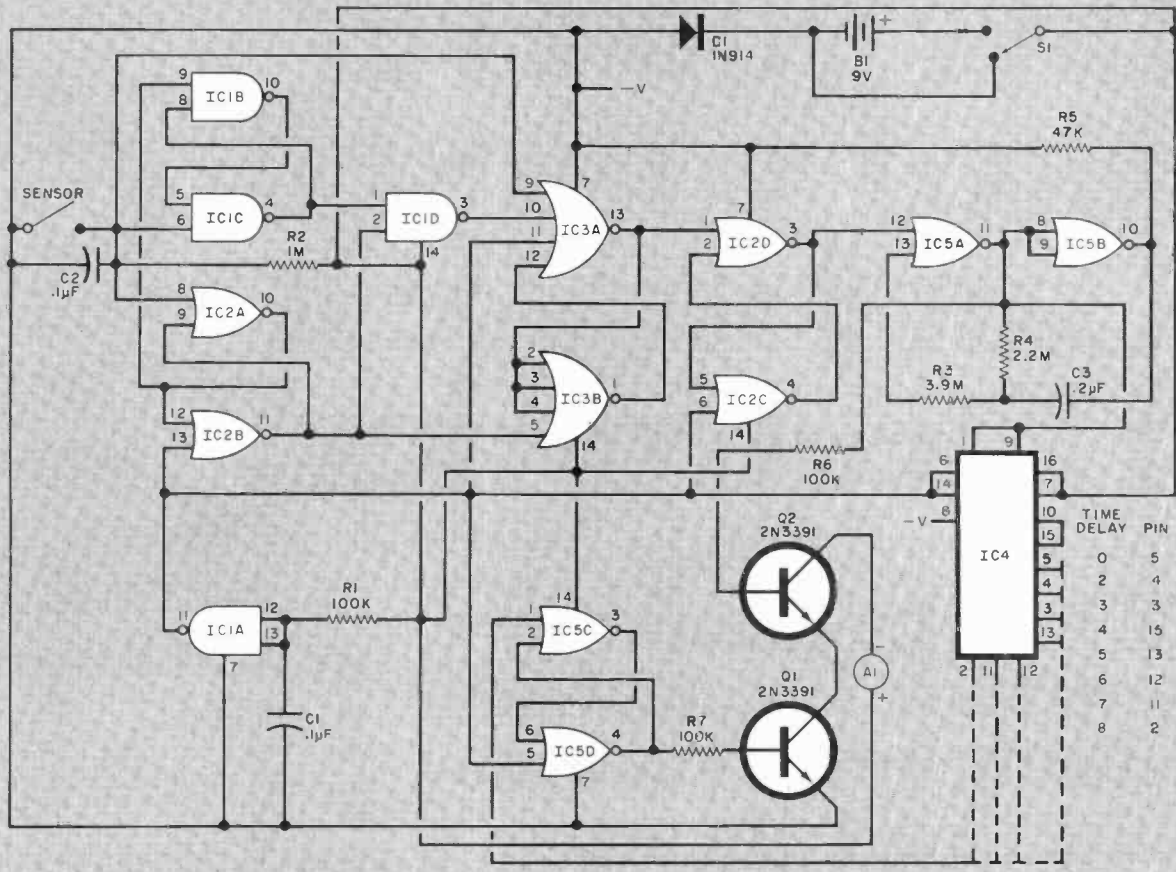

Fig. 1. When sensor contacts are shorted, the clock oscillator starts up. When timer counts desired delay, it causes the alarm to sound.

- A1—Alarm (Mallory No. SC-628 Sonalert)
- B1—9-volt battery
- C1, C2—0.1- μ F, 50-volt tantalum capacitor
- C3—0.2- μ F, 50-volt tantalum capacitor
- D1—1N914 diode
- IC1—4011 CMOS quad 2-input NAND gate IC
- IC2, IC5—4001 CMOS quad 2-input NOR gate IC
- IC3—4002 CMOS dual 4-input NOR gate IC

PARTS LIST

- IC4—4015 CMOS dual 4-stage static shift register IC
- Q1, Q2—2N3391 transistor
- R1, R6, R7—100,000-ohm, 1/4-watt, 5% tolerance resistor
- R2—1-megohm, 1/4-watt, 5% tolerance resistor
- R3—3.9-megohm, 1/4-watt, 5% tolerance resistor
- R4—2.2-megohm, 1/4-watt, 5% tolerance resistor
- R5—47,000-ohm, 1/4-watt, 5% tolerance resistor
- S1—Spst switch
- Misc.—Perforated board and solder clips; IC sockets (optional); battery connector; suitable enclosure (LMB-136 or similar); flexible aluminum strips (or reed switch and magnet) for sensor; machine hardware: hookup wire; solder; etc.

will usually be sufficient to alert an intruder that he has entered "protected" premises or warn occupants and neighbors of an illegal entry.

The low-cost apartment burglar alarm described here employs simple sliding metal contacts as sensors. It features a built-in selectable time delay of up to eight seconds so that you can enter your apartment and disarm the system before the alarm sounds. The alarm is battery powered so that, even if the power line is cut, full security will be maintained.

The alarm is armed by operating a simple switch. When you leave your apartment, you simply open the door and arm the alarm. The alarm then waits for the door to close, after which anyone gaining entry through the

door will trigger the delay circuit. At the end of the delay, assuming the alarm hasn't been turned off, the alarm sounds.

How It Works. The circuit for the apartment alarm is shown in Fig. 1. When power is turned on, gate IC1A initializes the logic as C1 charges up. The IC1B and IC1C gates form one RS flip-flop and IC2A and IC2B gates form another RS flip-flop. These flip-flops "remember" if the door was opened or closed, respectively. The combination of the RS flip-flop states is presented to IC1D to latch the IC3A/IC3B circuit. The IC3A/IC3B latch provides all the proper conditions for triggering the alarm control flip-flop made up of IC2C and IC2D. The output of this cir-

cuit turns on the oscillator circuit made up of IC5A and IC5B.

The oscillator supplies clock pulses to the IC4 timer and also drives Q2 to control the current flowing through the alarm. Transistors Q1 and Q2 form an AND circuit in which both transistors must be triggered on for the alarm to draw current and sound off. The output of the timer IC must be latched by IC5C and IC5D before Q1 is energized.

The frequency of the oscillator is about 1 Hz. (It can be changed by manipulating the values of the time-constant components.) Hence, Q2 allows current to flow through the alarm for about a half second. It then turns off the alarm for the other half second. The actual time delay of IC4's circuit is

Have you ever asked yourself, "Can I make it in Electronics?"

CIE may be the answer if you have a technical aptitude and a serious desire to get ahead.

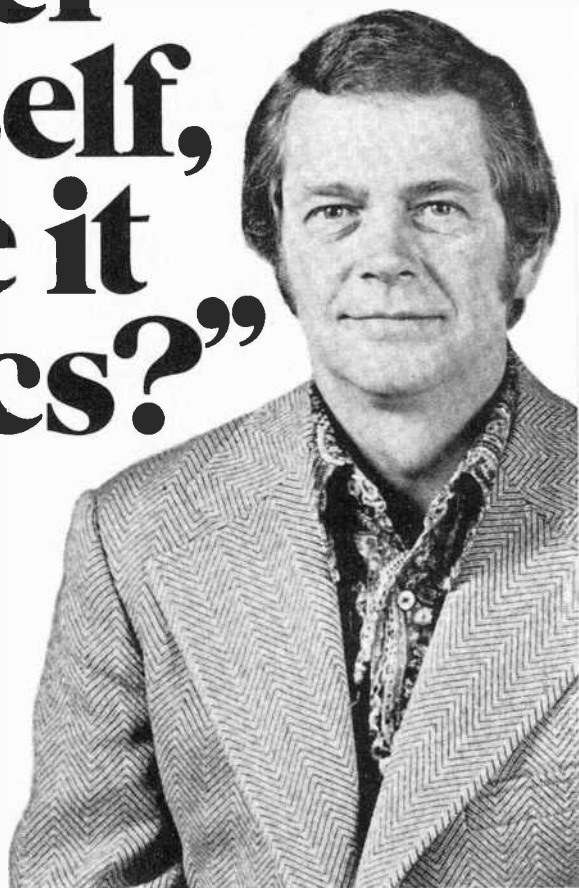

Right now, you're reading a technical magazine with articles that require a certain amount of electronics know-how. And that says a couple of things about you.

First, you're involved in Electronics . . . on the job, or as a hobby.

Second, you obviously realize the importance of staying up-to-date on the latest technical applications and developments. Reading a technical magazine *helps*, but it takes more than that to get you where *you* want to be . . . if you're serious about Electronics.

How can you afford

. . . *not* to continue with your electronics training?

You know the answer to that as well as we do.

To achieve continuing success, you have to keep building more knowledge into the Electronics background and experience you already have. You have to sharpen the tech skills you've already got and add new ones.

And one of the most logical ways for you to get what you need is to seriously consider an in-depth electronics training program that could help you achieve your ambitions in Electronics.

How can you afford

. . . the time and trouble of going back to school?

An excellent and *convenient* way for you to develop and expand your electronics knowledge is to "let the *school* come to *you*."

CIE's independent education plan does just that. Because we can effectively train you with an "education by mail" electronics training program that makes sense. And it makes sense for these reasons:

You can master *career* Electronics without missing one day of work. Without sacrificing one paycheck! Because you study in your free time . . . setting the study pace that best fits your schedule. *You* decide when and where *you* want to study. So you can go right on enjoying your leisure time because there are no *rigid* classroom schedules to be met. *You're* in control!

How can you afford

. . . the expense of the additional education you need?

A lot depends on which CIE course best fits your educational goals and background. We have a variety of electronics courses at beginner, intermediate, and advanced college-level. And there's a convenient payment plan available for every course. But, one way to evaluate your investment in CIE is this . . . you can *graduate* from CIE for about the cost of one year's tuition at some colleges or universities.

How can you afford

. . . to learn Career Electronics from anyone other than an electronics *specialist*?

If you are *serious* about your career in Electronics, you owe it to yourself to investigate *the* home study school that devotes its entire curriculum and instructional efforts to Electronics. That's CIE — Cleveland Institute of Electronics.

We have *specialized exclusively* in Electronics education-by-mail for more than 40 years. Just Electronics. Nothing else. And, the courses we offer today are the result of these years of teaching experience and proven methods of training . . . all based on the expert guidance of our



specialized Electronics Instruction Staff. Our lessons reflect this specialized experience. No frills. No unnecessary fancy stuff. Instruction is thorough . . . designed to meet the demands of electronics employers.

Each CIE course is built on the principle that the best way for you to *learn* and *retain* what you've learned is to *explain*; then to *check* your understanding; then to *reinforce* your comprehension with practical applications. In some courses, you will perform experiments and tests with your CIE Experimental Electronics Laboratory using authentic electronic components and gear. And, if you select a course that includes Color TV technology, you will not only build and keep a big screen Color TV which features digital circuitry . . . you'll also learn how to troubleshoot your TV.

The course you select will be a complete educational program, designed by *experts* to give you the best in Electronics independent home-study education. It will not be a "snap" course. No easy exams. It will make you work . . . and think. So that when you've earned your CIE Diploma, you'll *really* know your stuff.

In education just like in the "real world" of Electronics, your success depends on you and the effort you make. That's a real plus in CIE independent home-study . . . you build a strong foundation of self-discipline. And *that* pays off!

How can you afford . . . to stop now?

There is a lot more to CIE than this advertisement can tell you. And because you're looking for the *best*, we think it's well worth your while to find out what CIE is

all about. Detailed Courses of Study outlines. In-depth training programs in Electronics Technology, Broadcasting, Industrial, Color TV, Engineering, and 1st Class FCC License preparation. Special CIE Student Services.

All this information is available to you, **FREE**, when you mail the card or coupon to us. For your convenience, we'll try to have a school representative contact you to review the benefits of CIE training and assist in course selection. And as soon as we hear from you, we'll mail a complete package of information, including our school catalog, G. I. Bill details, special FCC License information. All the facts you need to start your Electronics career program with CIE.

Send TODAY for CIE'S FREE information.

CIE Cleveland Institute of Electronics, Inc.		
1776 East 17th Street, Cleveland, Ohio 44114		
Accredited Member National Home Study Council		
Yes, I want your FREE school catalog and career information package today.		
I am especially interested in:		PE-07
<input type="checkbox"/> Electronics Technology	<input type="checkbox"/> Industrial Electronics	
<input type="checkbox"/> FCC License Preparation	<input type="checkbox"/> Electronics Engineering	
<input type="checkbox"/> Color TV Maintenance	<input type="checkbox"/> Other _____	
<input type="checkbox"/> Mobile Communications	_____	
Print Name _____		
Address _____		Apt. _____
City _____		
State _____	Zip _____	Age _____
Check box for G.I. Bill information. <input type="checkbox"/> Veteran <input type="checkbox"/> On Active Duty		

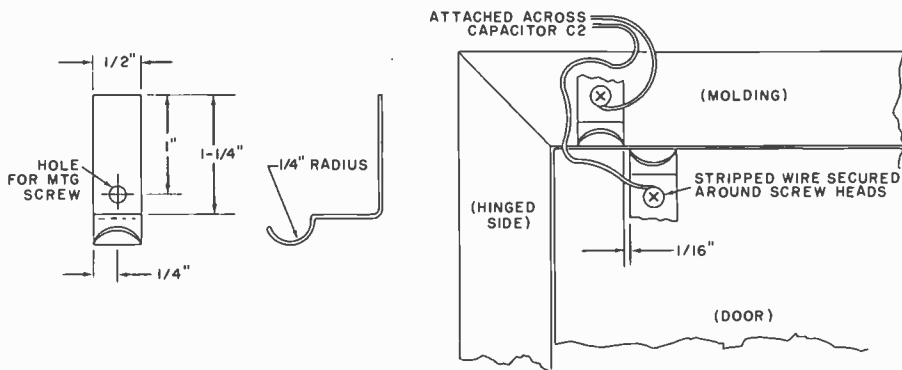

Fig. 2 The sensors can be made from small aluminum strips, or any other method where contacts are closed when the door is opened.

determined by which output pin is connected to the input of the IC5C/IC5D flip-flop.

The combination of C2 and R2 provides debouncing for the sensor contacts to prevent false triggering. Resistor R5 insures an easy discharge path for capacitor C3 to prevent the oscillator from locking up. The value of C3 can be changed if you wish to change the clock frequency.

Transistors Q1 and Q2 can sink about 50 mA of current, which is more than sufficient to drive alarm A1. If you wish to drive a higher current alarm, such as a gong or siren, you can install a load resistor in the collector circuit of Q2 and pick off the output of the circuit at the resistor/collector junction

to drive a high-power transistor. The high-power transistor will, in turn, drive the high-current alarm.

Diode D1 protects the logic in the alarm circuit from accidental application of reverse battery voltage. The alarm draws about 100 μ A of current when armed and 5 mA when sounding the Sonalert. With the Sonalert operating, the battery will deliver several hours of power before becoming depleted.

Construction. A simple approach to assembling the alarm circuit is to use perforated board, IC sockets, and solder clips. There is nothing critical about circuit arrangement or parts location. Once you have assembled the

circuit, mount it in any type of enclosure that will accommodate it and the battery.

You can fashion the sensor from pieces of flexible aluminum strip stock as shown in Fig. 2. Alternatively, you can use a reed switch and magnet (or any other type of sensor that provides an open circuit when the door is open).

Mount the circuit box in a location where you can get to the arming switch within the delay time. During operation, should the alarm be tripped and allowed to operate for more than two hours, replace the battery. If the circuit is operated only on standby, it is good practice to change the battery every six months or so. ♦

Consumer Tested Remedy for Sick Car Performance Sparks New Life in Pre-1975 Cars.

Owners of pre-1975 cars get better performance with less maintenance when they install one of the Mark Ten C.D. Electronic Ignition Systems. In fact, thousands of users testify the Mark Ten has noticeably improved their automobile's performance. As a California doctor stated after using the Mark Ten for 95,000 miles. "...I can 'feel' the difference in performance between my conventional ignition and the Mark Ten..."

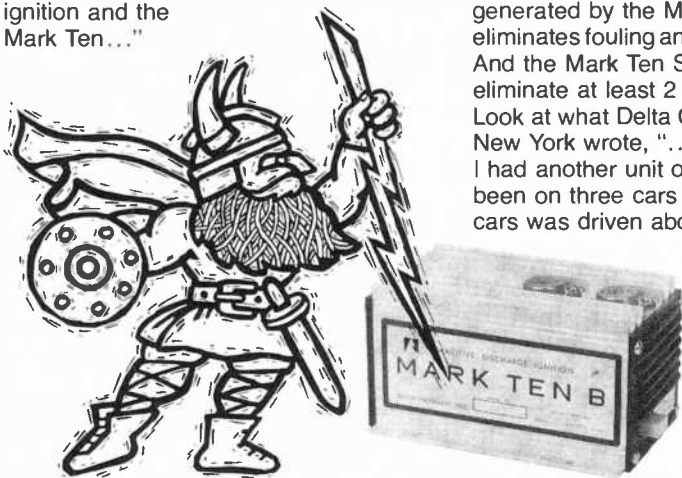

Mark Ten Systems* spark each plug with 50,000 to 60,000 volts in secondary output compared to a mere 25,000 volts in standard and most pointless systems. This means dramatic increases in acceleration and general engine performance, and substantial increases in gasoline mileage. Points will last the lifetime of the rubbing block. Spark plug life is extended three to ten times due to the hot spark generated by the Mark Tens, which eliminates fouling and cleans dirty plugs. And the Mark Ten Systems virtually eliminate at least 2 out of 3 tuneups! Look at what Delta Customer P.S. from New York wrote, "...I might add that I had another unit of yours that has been on three cars so far. Each of the cars was driven about 50,000 miles

before it was turned in. *Not one of the cars ever had a new set of points, new plugs or a tune-up.*

Now its on the fourth car with 20,000 miles on it and going strong." The result? BIG SAVINGS!

Send today for your copy of the new Delta brochure and learn how a Mark Ten System can spark your car into new life.

*Only Delta Products offers a full line of C.D. ignitions: The Mark Ten and Mark Ten B, available assembled or in kit form; and the Mark Ten C, assembled only.

DELTA PRODUCTS, INC.

P.O. Box 1147
Grand Junction, Colo. 81501
(303) 242-9000 Dept. PE

I want to know more about Mark Ten CDI's. Send me complete no-nonsense information on how they can improve the performance of my car.

Name _____

Address _____

City _____ State _____ Zip _____

BUILD THE

ULTIMATE METRONOME

*Provides accented beats
to make tuning and
syncopation easier.*

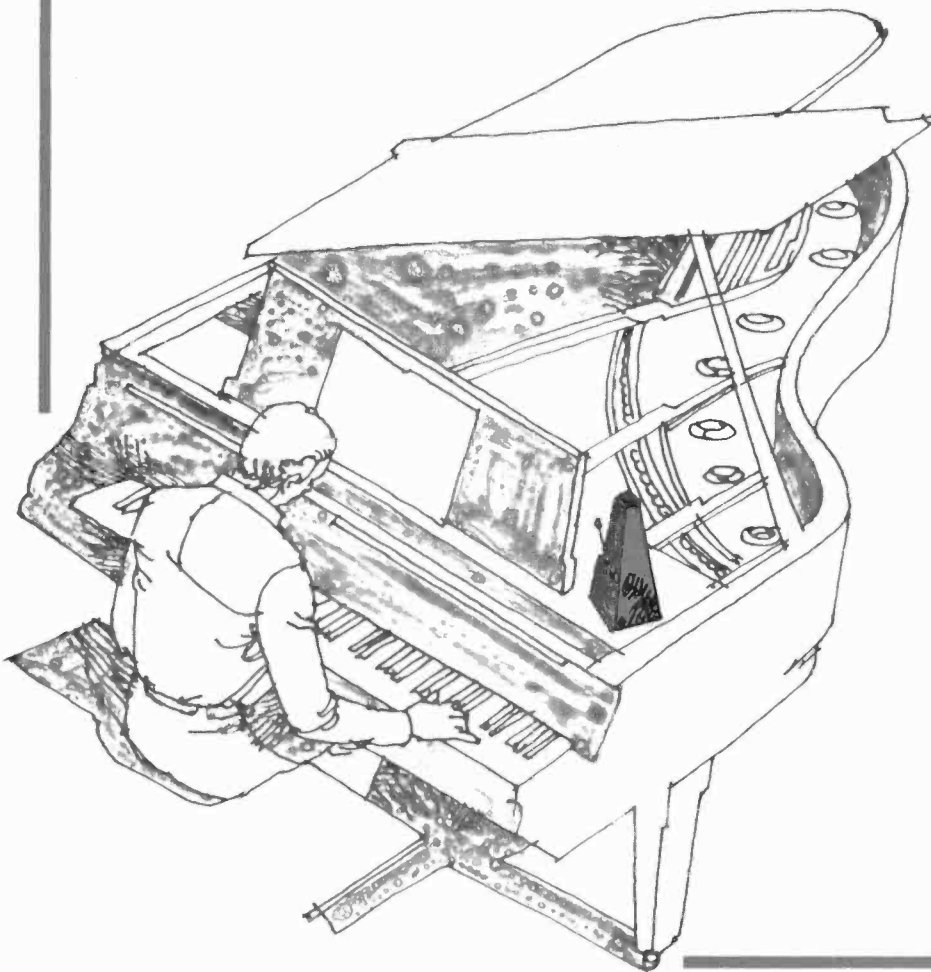

A METRONOME, whether mechanical or electrical in operation, provides some sort of audible signal on a fairly stable time basis. The drawback of such devices is that there is no provision for accenting certain beats in a measure. The Ultimate Metronome described here overcomes this disadvantage by providing accented beats. A switch is used to select accents on the basis of 1 in 1 up to 1 in 7. (1 in 15 is possible with a slight alteration.) Beats are indicated visually (LED) and audibly. The metronome can be built for about \$8.

How It Works. As shown in Fig. 1, the main timing signal is generated by IC1 connected as an astable multivibrator. The length of time that pin 3 is low (near zero volts) is determined by R3 and C4, while R3, R4, R5, and C4 determine how long pin 3 is high (near +5 volts). By adjusting R5, the output frequency can be varied from 30 to 1000 pulses per minute. Capacitor C5 is used to bypass the external modulation input, while R1 is a pull-up for the input to IC2. The latter is a monostable multivibrator that delivers a pulse whose width is determined by R2 and C3. The pulse width is independent of the input trigger and, with the values shown, is about 250 microseconds. This insures that both the speaker pulse and the IC3 counter input pulse will always have the same duration regardless of the trigger rate.

Fig. 1. The main timing is performed by IC1 while IC2, Q1 and Q2 produce the speaker tick or LED1 pulse. The other elements produce the selected beat.

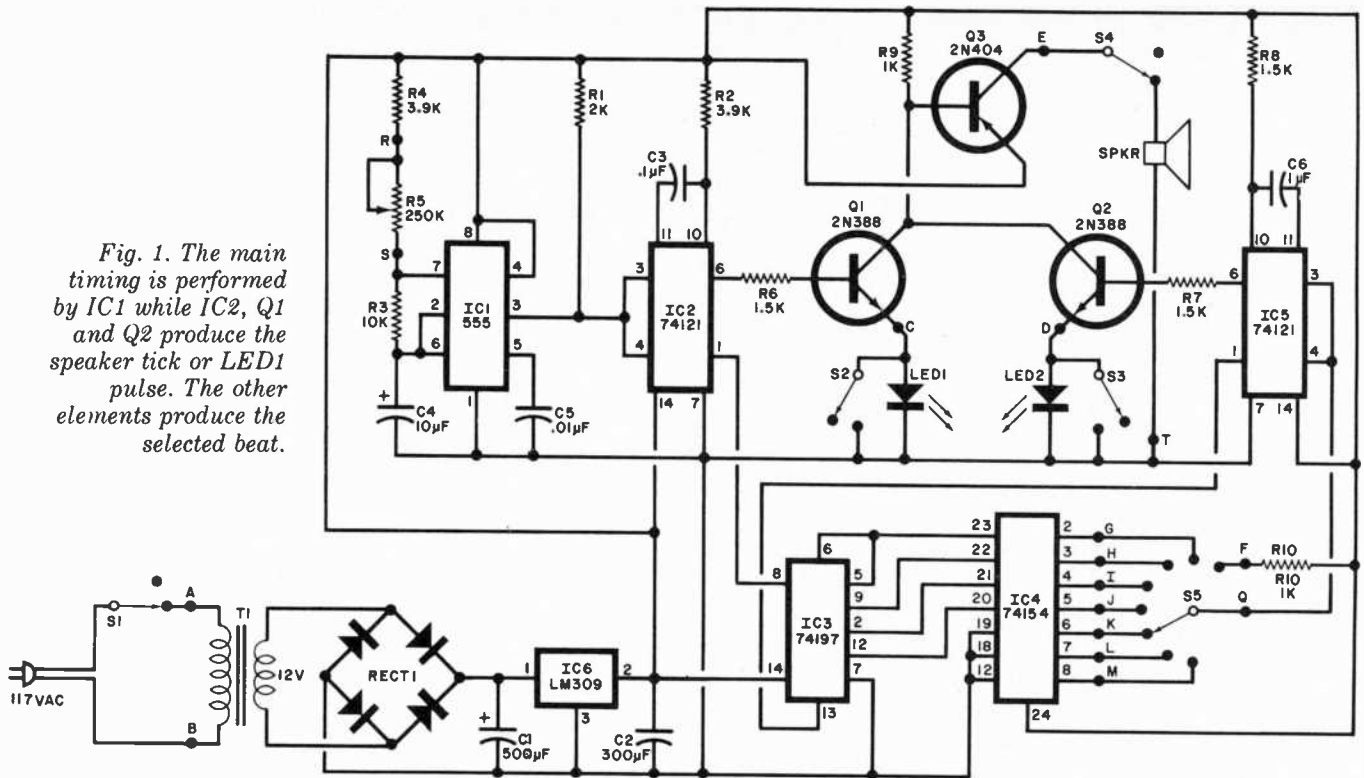

PARTS LIST

C1—500- μ F, 16-V electrolytic capacitor
 C2—300- μ F, 10-V electrolytic capacitor
 C3—0.1- μ F, 50-V ceramic disc capacitor
 C4—10- μ F, 6-V low-leakage electrolytic capacitor
 C5—0.01- μ F, 50-V ceramic disc capacitor
 C6—1- μ F ceramic capacitor
 IC1—555 timer
 IC2, IC5—74121
 IC3—74197
 IC4—74154

IC6—LM309, 5-V, 1-A regulator
 LED1, LED2—Red light emitting diode
 Q1, Q2—General-purpose transistor npn (2N388 or similar)
 Q3—General-purpose transistor pnp (2N404 or similar)
 R1—2000-ohm $\frac{1}{2}$ -W, 10% resistor
 R2, R4—3900-ohm, $\frac{1}{2}$ -W, 10% resistor
 R3—10,000-ohm, $\frac{1}{2}$ -W, 10% resistor
 R5—250,000-ohm, linear-taper potentiometer

R6, R7, R8—1500-ohm, $\frac{1}{2}$ -W, 10% resistor
 R9, R10—1000-ohm, $\frac{1}{2}$ -W, 10% resistor
 S1 to S4—Spst switch
 S5—Single-pole, 8-position, nonshorting rotary switch
 SPKR—8-ohm, 2" speaker
 T1—12-volt, 300-mA transformer (Radio Shack 273-1385 or similar)
 Misc.—Suitable enclosure, line cord, grommet, switch knob, mounting hardware, etc.

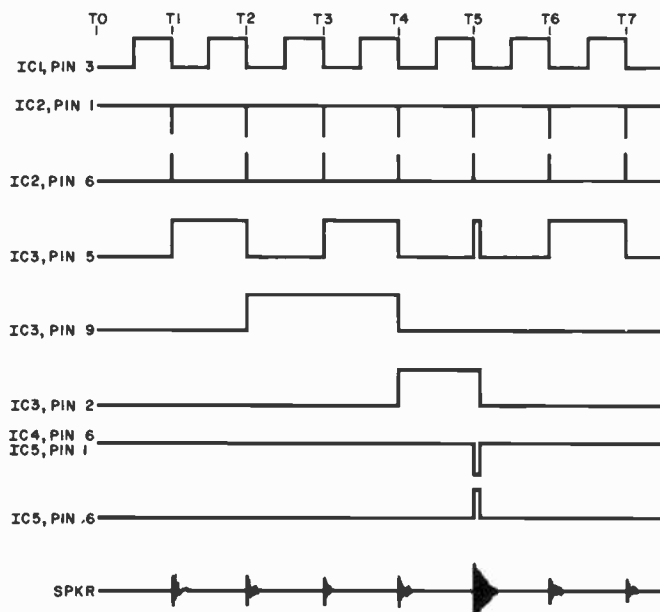

Fig. 2 Timing waveforms for the metronome.

The positive-going pulse from IC2 (pin 6) drives Q1 into conduction and, when S2 is open, causes LED1 to glow. When Q1 conducts, it also forward-biases Q3, causing a current surge through the speaker (when S4 is closed). This provides the main beat.

To generate the accented beat, the output from IC2 (pin 1) is fed to the clock-1 (pin 8) input of IC3, a binary-counter/latch. As shown in the timing diagram in Fig. 2, the IC3 output on pin 5 changes state with each input pulse. Pin 9 changes state every other input pulse, pin 2 every fourth input pulse, and pin 12 every eighth input pulse (not shown in Fig. 2). These four outputs thus make up a 4-bit binary count of the number of input pulses to IC3.

The four outputs are applied to IC4, a 4-to-16 decoder. The sixteen outputs of IC4 provide binary combinations from 0000 to 1111 of decimal 0 to 15. With the circuit shown in Fig. 1, only

the first 7 of these outputs can be selected by S5. The timing in Fig. 2 assumes that S5 is set to position 5 so that the accent pulse will occur every 5 beats.

The signal selected by S5 is used to trigger IC5, a monostable multivibrator that operates like IC2 except that the timing components (R8, C6) are selected to produce an output pulse of about 1 ms (instead of the 250 μ s of IC2). When pin 6 of IC5 goes high, Q1 is driven into saturation, causing LED2 to glow (S3 open) for about 750 ms after Q1 has stopped conducting due to the main beat. This action causes the speaker to produce a louder tone. When pin 6 of IC5 goes high, pin 1 goes low, resetting IC3 to a zero output. The next pulse from IC2 then counts as the first beat of the next series of pulses. This same action takes place regardless of the beats per minute or the setting of S5.

When S5 is in the F position, the trigger input of IC5 (pins 3 and 4) is held high by R10 to prevent any possibility of a stray accented beat. This also permits the use of the circuit as a conventional metronome. With S5 in position G, every beat is accented to provide a volume increase. As mentioned before, other outputs of IC4 and other positions of S5 can be used to select accented beats up to a rate of 1 in 15.

Construction. Any type of construction can be used to build the metronome; and surplus or junkbox components will do. However, the LED's should be selected for similar light output. The size of the transformer given in the Parts List will fit on a pc board. Mount the finished board in a small enclosure with the switches, R5 and LED's on the cover. Punch some holes in the cover for the speaker.

Calibration. Close S1 and S4 and set R5 to midscale with S5 in position F. Count the number of beats per minute (checking the operation of LED1 at the same time). Calibrate the dial of R5 accordingly. At higher speeds, use the accented beat to count. For example, with a 1-in-5 accent, count 27 accented beats in 60 seconds with R5 set for 135 beats per minute.

LED1 is for the main beat, while LED2 displays the accented beat. If you don't need these indicators, they and their associated switches can be omitted. ♦

SOLID STATE...BREAKERLESS ELECTRONIC IGNITION.

The BEST...The ULTIMATE of All Ignition Systems

ALLISON 'OPTO-ELECTRIC'

★ No Breaker-Points or Condenser to EVER wear out or need any maintenance.



★ Once installed and properly timed your Distributor will give you **CONTINUOUS PEAK PERFORMANCE!**



★ **PROVEN RELIABILITY**
Factory Tested to 15,000 RPM Road and Race PROVEN (Opto-Electric Systems Won at INDY Two Years in a Row)



● The Allison OPTO-ELECTRIC System ELIMINATES the Points and Condenser, replacing them with an OPTO-Electronic Trigger, using a Light-Emitting Diode and Phototransistor. This System operates on a BEAM OF LIGHT. There is NO "Breaker-Point Wiper-Arm" to wear down, Point bounce and erosion are completely eliminated thereby giving longer Timing ACCURACY than any System using "Mechanical" Breaker-Points. (and No Timing Fluctuation as with Magnetic Impulse Units). ACCURATE Timing gives the BEST in Engine EFFICIENCY...and that's the name of the Game for the BEST in GAS MILEAGE and ECONOMY.

● The Allison's "Built-In" OWELL never needs adjustment, it is PRE-SET to supply the OPTIMUM Performance at BOTH High and Low speeds. The RPM capability of the "OPTO-ELECTRIC" unit exceeds that of any known automotive internal combustion engine. Positive spark intensity and duration helps eliminate "misfire" and extends the Spark-Plug life.

● The Allison "OPTO-ELECTRIC" was engineered to OUT-LAST THE LIFE OF YOUR CAR. Only the Highest Grade Solid-State Components are used... UNAFFECTED by Moisture or Vibration! Easier engine starting under ANY Weather Condition. Solid, DEPENDABLE PERFORMANCE

★ Installed in your Distributor in same location as Points
COMPLETE INSTRUCTIONS FURNISHED.
(Not Necessary to Dismantle your Distributor)

● America's Oldest and Largest Manufacturer of Opto-Electronic Ignition Systems.



ALLISON
AUTOMOTIVE COMPANY

Our BEST Salesmen are the USERS of our ALLISON System!

ALLISON
AUTOMOTIVE COMPANY 1267 - E8 East EDNA PL., COVINA, CAL. 91722

CIRCLE NO. 3 ON FREE INFORMATION CARD

SPHERE

THE COMPUTER PEOPLE WITH THE LINE OF COMPLETE, VERSATILE, EXPANDABLE, EASY-TO-USE, COMPUTERS...

introduces to you, another great feature...

▶▶ The 4K ROM BOARD ◀◀

A 4000 bytes Read Only Memory (ROM) board featuring:

- INSTANT CALL UP as you turn the power on. (No more tedious programming of the most used programs.)
- NO LOSS OF PROGRAM as the power is turned off (Your PROGRAM is always there.)
- A MEMORY BOARD designed to use the 1702A programmable ROMS.(256 bytes per ROM)
- A BOARD completely assembled and tested with the SOCKETS for the PROMS already mounted.
- SIMPLY PLUG IN ONE OF THE APPLICATIONS PROMS available from SPHERE or insert your own specially programmed prom and with power-on immediately begin playing that computer game or using your own application.
- THE 4K ROM BOARD may be plugged right in to the standard SPHERE computer bus cable.

TWO SPECIALLY PROGRAMMED ROMS NOW AVAILABLE FROM SPHERE are:

- The GAME OF LIFE (1 chip) \$30.00 This program provides either a generation at a time solution or a continuous dynamic solution of the LIFE algorithm. Available in V3A, V3N, SDOS version.
- TELETYPE HANDLER (1chip) \$30.00 Allows paper tape transmission of data on teletype. Available in V3A, V3N versions.

Contact SPHERE for special programming prices and arrangements.

4K ROM BOARD(w/o roms) \$156.00
unprogrammed ROMS \$45.00

WHAT A POWERFUL, VERSATILE, EXPANDABLE, EASY-TO-USE, COMPUTER YOU HAVE WHEN... YOU GET IT ALL TOGETHER FROM SPHERE...THE COMPUTER PEOPLE! !

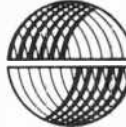

SPHERE
CORPORATION

940 North 400 East - North Salt Lake, Utah 84054
(801) 292-8466

IF YOU'RE NOT DESIGNING WITH A CSC PROTO-BOARD, LOOK AT ALL YOU'RE MISSING.

Utility—Models are available with or without built-in regulated power supplies (fixed or adjustable).

Economy—Eliminate heat and mechanical damage to expensive parts. Save money by re-using components.

Versatility—Use with virtually all types of parts, including resistors, capacitors, transistors, DIP's, TO-5's, LED's, transformers, relays, pots, etc. Most plug in directly, in seconds.

Durability—All Proto-Board models are carefully constructed of premium materials, designed and tested for long, trouble-free service.

Expandability—Proto-Board units can be instantly interconnected for greater capacity.

Visibility—All parts are instantly and easily visible, for quick circuit analysis and diagramming.

Speed—Assemble, test and modify circuits as fast as you can push in or pull out a lead. Save hours on every project.

Adaptability—Use in design, packaging, inspection, QC, etc. Works with most types of circuits, in many, many applications.

Flexibility—Use independently, or in conjunction with other accessories, such as scopes, counters, CSC Proto-Clip™ connectors, Design Mate™ test equipment, etc. One Proto-Board unit can serve a thousand applications.

Accessibility—All parts are instantly and easily accessible, for quick signal tracing, circuit modifications, etc.

Variety—A wide variety of models are available with capacities ranging from 630 to 3060 solderless tie-points (6 to 32 14-pin DIP's), to fit every technical and budget requirement.



Whatever type of electronic circuits you work with, you can do more in less time with CSC's solderless Proto-Board systems. As fast and easy as pushing in or pulling out a lead, you can design, test and modify circuits at will. Components plug into rugged 5-point terminals, and jumpers, where needed, are lengths of #22 AWG solid wire. In the same time you took to read this ad, you could be well on your way to assembling a new circuit. For more information, see your CSC dealer, or write for our catalog and distributor list.

CSC PROTO-BOARD SOLDERLESS BREADBOARDS

MODEL NUMBER	NO. OF SOLDERLESS TIE-POINTS	IC CAPACITY (14-PIN DIP'S)	MANUFACTURER'S SUGG LIST	OTHER FEATURES
PB-6	630	6	\$15.95	Kit — 10-minute assembly
PB-100	760	10	19.95	Kit — with larger capacity
PB-101	940	10	29.95	8 distribution buses, higher capacity
PB-102	1240	12	39.95	Large capacity, moderate price
PB-103	2250	24	59.95	Even larger capacity; only 2.7¢ per tie-point
PB-104	3060	32	79.95	Largest capacity; lowest price per tie-point
PB-203	2250	24	75.00	Built-in 1% regulated 5V, 1A low-ripple power supply
PB-203A	2250	24	120.00	As above plus separate ½-amp +15V and -15V internally adjustable regulated power supplies

CONTINENTAL SPECIALTIES CORPORATION



EASY DOES IT

44 Kendall Street, Box 1942
New Haven, CT 06509 • 203-624-3103 TWX: 710-465-1227
West Coast office: Box 7809, San Francisco, CA
94119 • 415-421-8872 TWX: 910-372-7992
Canada: Len Finkler Ltd., Ontario

© 1976 Continental Specialties Corp.
Prices and specifications subject to change without notice.

CIRCLE NO. 16 ON FREE INFORMATION CARD

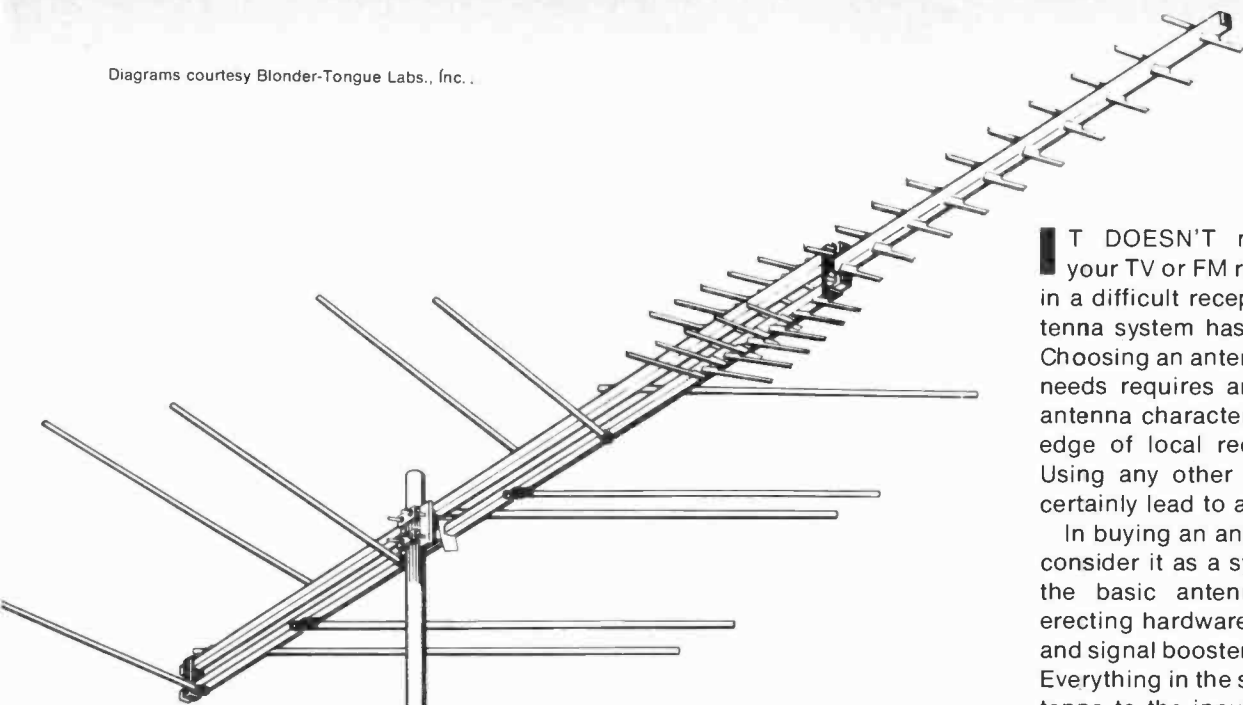

GUIDE TO CHOOSING TV & FM ANTENNAS

IT DOESN'T matter how good your TV or FM receiver is, if you are in a difficult reception area, your antenna system has to be satisfactory. Choosing an antenna that will fill your needs requires an understanding of antenna characteristics and a knowledge of local reception conditions. Using any other criteria will almost certainly lead to an improper choice.

In buying an antenna, remember to consider it as a system consisting of the basic antenna, mounting and erecting hardware, transmission line, and signal booster/splitter (if needed). Everything in the system, from the antenna to the input terminals on your receiver, must be selected to provide maximum signal transfer. Although this is important for any type of TV reception, it becomes increasingly so when dealing with color and fringe areas.

There are many electrical and mechanical characteristics of antennas that are important to making an intelligent choice.

By The Numbers. The one specification that is almost always included in the description of an antenna is the number of elements it has. As a rule, for a given design, the greater the number of elements, the greater the antenna's gain and the more signal captured. For all-band antennas, the numbers of vhf and uhf elements are generally specified separately.

Most reputable antenna manufacturers and retailers give an honest element count, but it pays to know how to count them properly. This may not be as simple as it sounds because of the configurations of some modern antennas. For example, the log-periodic type (Fig. 1) has its elements angled forward to improve high-frequency response. The antenna is fed at the front end and uses a double boom (instead of transposing the feed line that connects to the various elements). Connecting the individual antenna rods to the upper and lower boom elements effectively transposes or crosses the feedline connections. The two boom elements are insulated from the supporting mast. The design of the antenna, as well as the angle at which it is drawn, might make it dif-

BY JULIUS GREEN

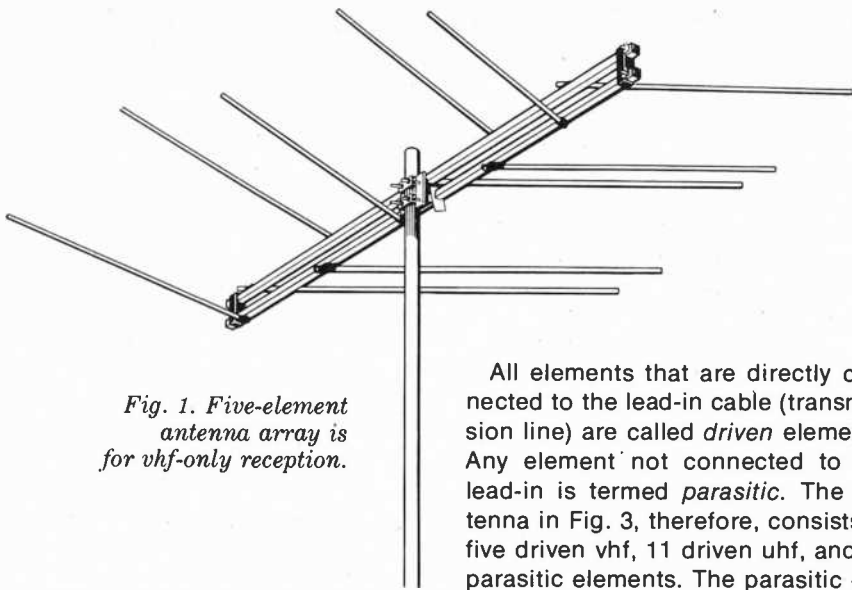

Fig. 1. Five-element antenna array is for vhf-only reception.

difficult for a person not familiar with this antenna to make a proper element count.

A reputable manufacturer and retailer would list the antenna in Fig. 1 as a five-element array. Each of the two rods that make up a single element is connected to the top and bottom of the boom. (A single element is a dipole consisting of two antenna rods.) If you were to view this antenna directly from top or bottom, the five-element structure would be very clear. One way to count the number of elements is to tally the number of rods on one side of the boom. Alternatively, you can count all elements on the boom (in the case of Fig. 1, both booms) and divide the number by two.

In Fig. 2 is illustrated an all-channel (vhf/uhf) TV antenna. The vhf section, located at the rear of the boom, consists of the long element rods and is similar to the antenna in Fig. 1. Forward of the vhf section is an array of element rods that make up the uhf section of the antenna. Note that the uhf rods are much shorter than those for vhf. If you count the number of rods visible on one side of the boom, the tally should come to 16 elements. Five of these are in the vhf section and the remaining 11 are in the uhf section.

The all-channel antenna illustrated in Fig. 3 consists of three sections. At the rear is the usual vhf section containing five elements. In the center is the 11-element uhf section. Sticking out in front is a 10-element array of uhf directors. The directors are passive elements that are not connected directly to the antenna lead-in as are the other two antenna sections. Even so, they help to increase the gain on the uhf TV channels.

All elements that are directly connected to the lead-in cable (transmission line) are called *driven* elements. Any element not connected to the lead-in is termed *parasitic*. The antenna in Fig. 3, therefore, consists of five driven vhf, 11 driven uhf, and 10 parasitic elements. The parasitic elements are electrically coupled to the other uhf elements by induction. All told, this antenna has 26 dipole elements.

A chart that relates the gain of a TV antenna to its overall boom length is shown in Fig. 4. This chart is for vhf/FM antennas only; for vhf/FM/uhf antennas, subtract 1.5 dB from the figures given along the vertical axis. Note also that this chart assumes a high-quality antenna, with elements spaced about 12" (30.5 cm) apart on the boom.

Importance of Gain. One of the most important antenna specs to look for is gain. As with most electronic devices, antenna gain is stated in decibels (dB). When comparing gain specifications, be sure that you know what reference signals were used to derive the gain figures.

The usual reference is the signal delivered by a simple half-wave dipole that is resonant at the frequency of the particular channel at which the antenna's gain is measured. The antenna in Fig. 2 has a gain of about 1.3 dB on Channel 2. The gain rises smoothly to about 3.3 dB at Channel 6 as shown in

Fig. 5. Then on the high-band vhf channels, this antenna's gain is about 3.6 dB on Channel 7 and rises to about 5 dB on Channel 13. A gain of 6 dB would mean that the antenna delivers twice the voltage or four times the power compared to the levels delivered by a single dipole cut to the specific frequency of the channel on which you want to specify the gain.

The uhf portion of the antenna in Fig. 2 has a gain between 6 and 10 dB over the entire uhf TV range (Channels 14 through 83).

Occasionally, a manufacturer quotes gain figures with reference to a theoretical isotropic antenna instead of a simple dipole. Such an antenna receives signals equally from all directions, while a standard full-size dipole receives in a figure-eight pattern. The dipole has a 2.16-dB gain over the theoretical isotropic antenna. This means that, to compare different antennas with gains stated at different references, you have to add 2.16 dB to the stated dipole-reference figures or subtract 2.16 dB from isotropic antenna reference figures.

Front-to-Back Ratio. The conventional dipole antenna receives signals equally well from transmitters located to the front and rear (along a line perpendicular to the axis of the antenna). Little or no signal is received along the axis of the antenna. By adding more and more properly designed and connected elements to a basic dipole, the antenna becomes more and more directional, favoring reception from the front at the expense of the rear. Hence, a multi-element antenna array can also be defined by a "front-to-back ratio" (F/B). An Electronics Industries Association (EIA) committee has tentatively defined F/B as the ratio in decibels of the gain of the peak of the main forward lobe to the gain of the peak of the largest lobe in the rear.

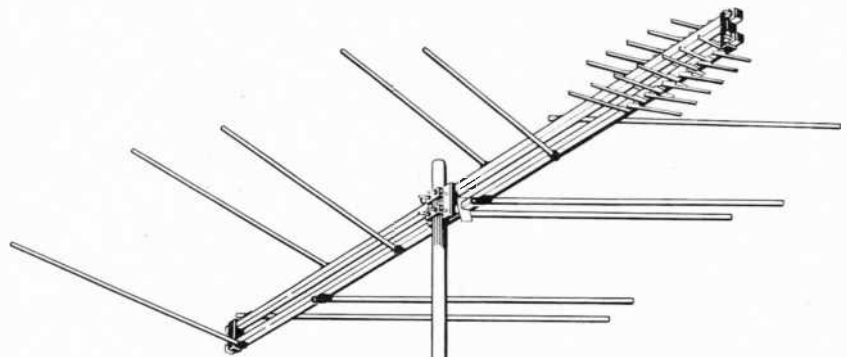

Fig. 2. Stubby elements are for uhf reception.

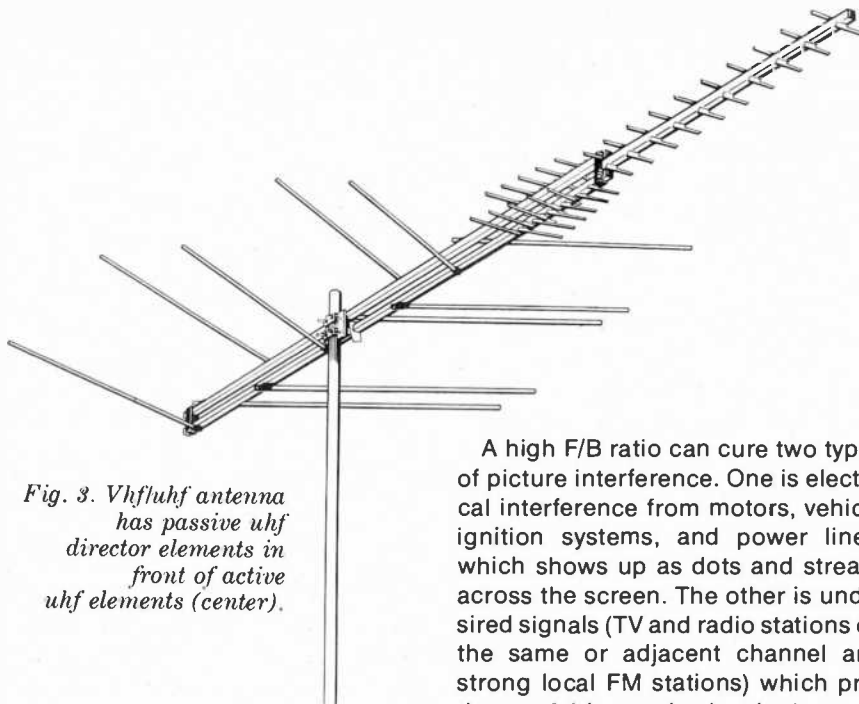

Fig. 3. Vhf/uhf antenna has passive uhf director elements in front of active uhf elements (center).

By measuring the angle between the two points at which the field strength voltage is 70% of maximum, the antenna's beamwidth can be measured. At these points, the power received is 50% of maximum, or 3 dB down. In general, the greater the gain of an antenna, the greater its directivity and the narrower the beamwidth. In addition to more desired signal delivery to the receiver, a highly directional antenna is less prone to picking up electrical interference (noise) and undesired signals off to the sides.

The directional characteristics of the antenna in Fig. 2 are shown in polar form in Fig. 5. This antenna has a beamwidth of about 76° on the vhf low, 31° on the vhf high, and 58° on the uhf bands. If the beamwidth is very narrow, the antenna must be precisely aligned with the distant transmitting antenna. Hence, if you're in a fringe reception area with transmitters located in different directions, your narrow beamwidth antenna system will have to include an antenna rotator to aim the antenna in the proper directions. An antenna with a broad beamwidth usually has lower gain and is less critical to align.

In addition to the main lobe, there are frequently a number of side and rear lobes which can pick up unwanted signals. It is possible to align such antennas so that a null between lobes is in line with an interfering signal. Of course, this may mean that the main lobe is slightly off-axis with the transmitter, with a loss of gain.

A high F/B ratio can cure two types of picture interference. One is electrical interference from motors, vehicle ignition systems, and power lines, which shows up as dots and streaks across the screen. The other is undesired signals (TV and radio stations on the same or adjacent channel and strong local FM stations) which produce a fairly regular herringbone or "venetian-blind" pattern. However, the improvement can occur only if the source of the interference is to the rear or sides of the antenna. If the interference originates between the transmitter and receiver antennas and within the beamwidth pattern of the latter's major lobe, some other means must be used to clear up the problem.

System Impedance. The impedance of a TV antenna is usually 300 or 75 ohms. Maximum signal transfer from antenna to TV receiver can occur only if the impedance of the antenna is

matched with the impedance of the line and the impedance of the line is, in turn, matched to the input impedance of the receiver.

In a mismatched system — such as when a 75-ohm lead-in cable is used to couple a 300-ohm antenna to a receiver's 300-ohm input — some of the signal being picked up by the antenna will not be transferred to the lead-in. What is more, that portion of the signal that does find its way into the lead-in encounters a mismatch at the receiver end. As a result, the signal bounces back and forth along the line, and standing waves are set up, with peaks and dips that do not move along the line. There is a consequent power loss and improper operation; and an antenna with a narrow beamwidth and high gain may actually deliver much less signal strength than is possible.

If you must use 75-ohm coaxial cable between a 300-ohm antenna and a 300-ohm receiver input, use impedance matching transformers at both ends of the line. While such transformers may introduce losses on the order of 1 dB, the results will be much better than if you left a mismatch in the system.

Selecting a Lead-in. Among the factors that determine the type of lead-in to use in your antenna system are interference environment, line losses, ease of installation, durability, and cost. Where interference pickup must be kept to an absolute minimum,

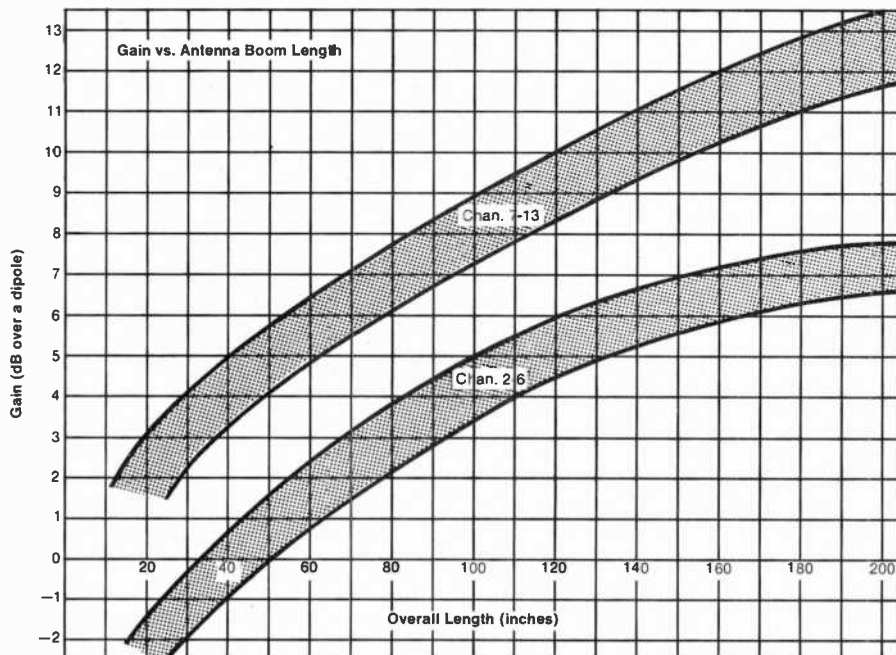
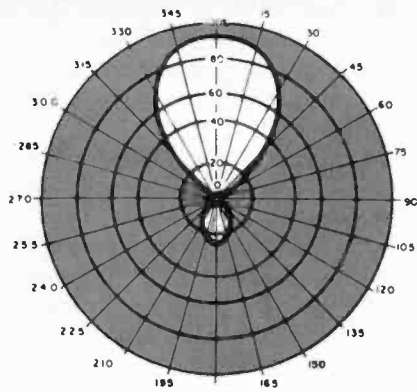
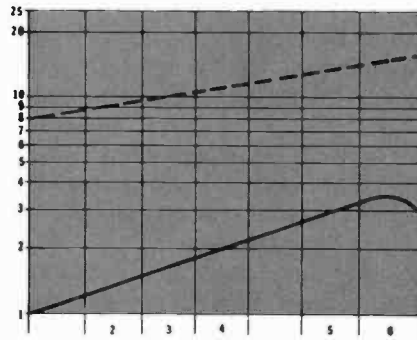

Fig. 4. Chart relates antenna gain to overall boom length.



Horizontal Pattern



CHANNEL
GAIN (dB) ———
Front-to-Back Ratio (dB) - - - -

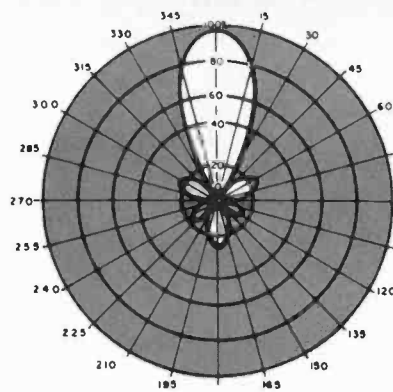

Horizontal Pattern

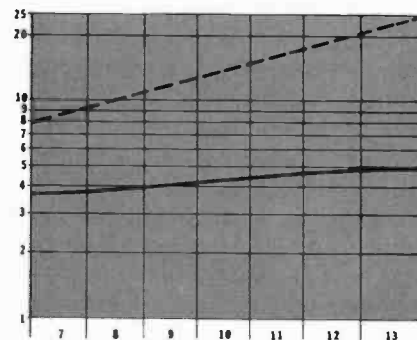

CHANNEL
GAIN (dB) ———
Front-to-Back Ratio (dB) - - - -

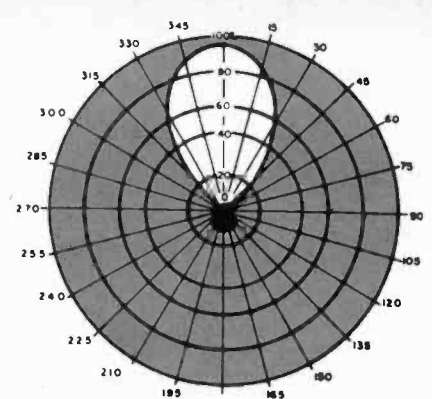

Horizontal Pattern

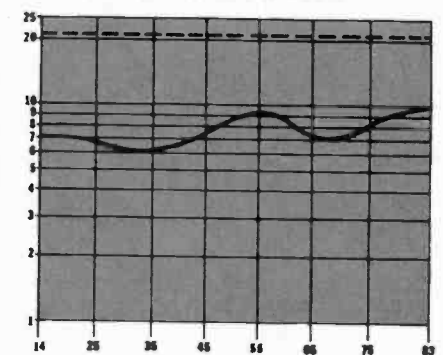

CHANNEL
GAIN (dB) ———
Front-to-Back Ratio (dB) - - - -

Fig. 5. Upper diagrams illustrate polar, while lower diagrams illustrate rectangular plots of gain and F/B ratio for low-vhf, high-vhf, and uhf sections of an all-channel antenna.

75-ohm coaxial cable is better than 300-ohm twinlead, but the former is more lossy. Coax is also superior when it comes to ease of installation and durability. The one main advantage to twinlead is that it has lower loss (when dry) than coax.

If your reception location is in an urban area or near power lines, the limiting factor on picture quality will most likely be interference from appliance motors, ignition noise, and corona from power lines. In this case, a shielded coaxial cable should be used. The shielded line, in combination with an antenna that has a good F/B ratio, will also minimize herringbone and venetian-blind interference from undesired TV and FM signals. Properly installed, a coaxial cable feedline will outlast your TV receiver.

In the cases where the lead-in run is very long and local reception is free of interference but weak in signal strength, a quality 300-ohm twinlead line will result in minimum losses and reduce picture snow and confetti. When you install the twinlead line, you will have to use standoffs to keep it several inches away from all metal objects. After installation, the line should

be inspected periodically for deterioration.

One piece of advice when it comes to selecting lead-in cable: Don't compromise on quality. When the extra

cost — only pennies per foot — is weighed against the labor involved in replacing the lead-in at frequent intervals, the use of low-quality line is only poor economy.

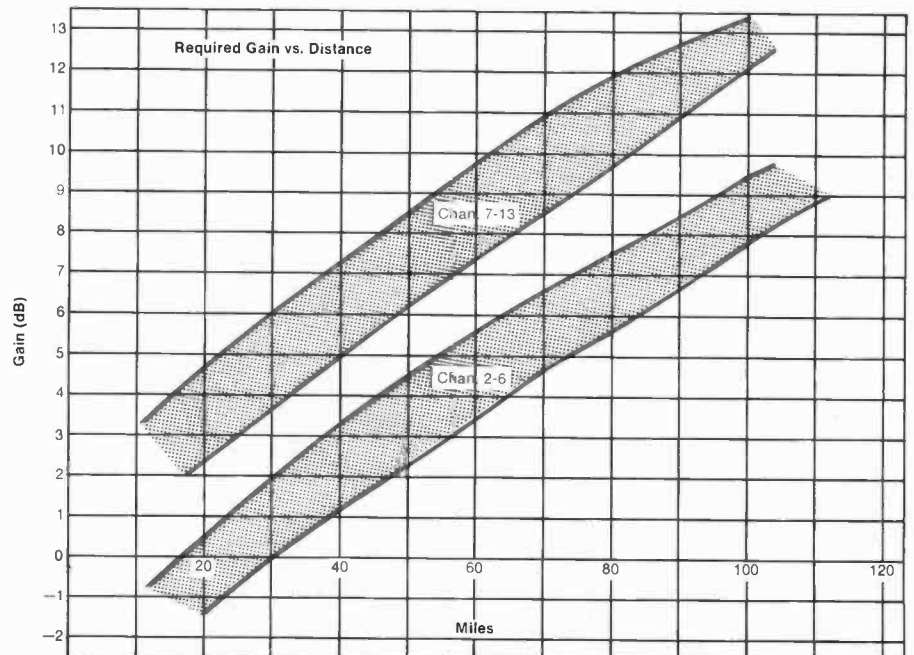

Fig. 6. Approximate required antenna gain is related to operating range.

Operating Range. It is almost impossible to accurately predict the actual operating range of a given antenna because of variables in terrain, signal conditions, etc. Over flat, unobstructed terrain, the operating range will always be greater than if TV signals must follow a path through dense foliage, a large grouping of buildings, and around hills and mountains. Of course, the distance from the transmitting antenna and how much power is being radiated are important. The sensitivity of your TV receiver will make a difference too.

A rough guide to typical operating range over average terrain for the simplest and least expensive vhf-only antennas is about 25 miles (40 km). The highest gain vhf/uhf antennas often have a usable range limit of 80 to 100 miles (130 to 160 km). Needless to say, these ranges are for typical rooftop antenna installations. They can be considerably increased if you mount the antenna atop a tall multi-section mast or tower. If you can mount your antenna above the height of the tallest nearby structure, you'll get the maximum benefit for your local signal conditions.

The graph shown in Fig. 6 relates the approximate gain required to the distance (operating range) of a TV antenna. A snow-free picture should be obtainable at a distance of about 60 miles (90 km). At 80 miles (130 km) and beyond, there is usually rapid deterioration in reception conditions, especially on the high vhf band, due to lack of line-of-sight conditions.

Signal Boosters. Poor picture quality as a result of weak signals and

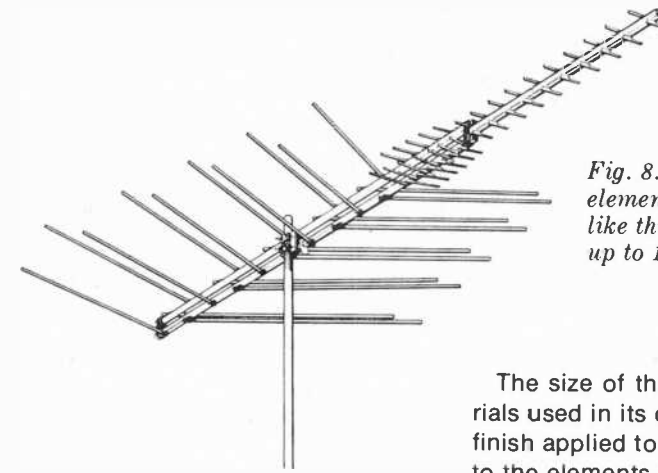

Fig. 8. Complex multi-element antennas like this can have booms up to 13¼' long.

thermal noise, can usually be remedied with the aid of a signal booster (preamplifier). The improvement obtained will depend on the gain of the booster and the length of the lead-in. The signal-to-noise ratio (S/N) of the antenna itself generally being fairly good, you can install the booster at the antenna, at the TV receiver, or anywhere along the lead-in that proves convenient. (The use of a booster is also recommended whenever you plan to use a single antenna system to feed two or more TV and/or FM receivers, whether or not only one receiver will be turned on at any given time.)

If your lead-in is picking up interference signals, mount the booster at the antenna end of the line. By increasing the gain of only the desired signal, the booster effectively improves the S/N ratio of the system. Bear in mind that, if the antenna is picking up interference directly, no amount of signal boosting will clear up the problem; any boosting of the signal will also result in an equal boost in the noise and produce a constant S/N.

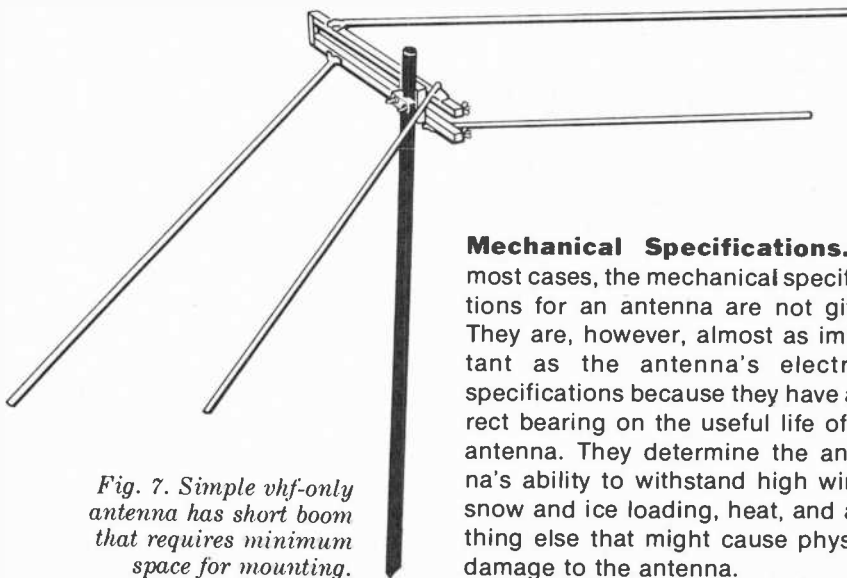

Fig. 7. Simple vhf-only antenna has short boom that requires minimum space for mounting.

Mechanical Specifications. In most cases, the mechanical specifications for an antenna are not given. They are, however, almost as important as the antenna's electrical specifications because they have a direct bearing on the useful life of the antenna. They determine the antenna's ability to withstand high winds, snow and ice loading, heat, and anything else that might cause physical damage to the antenna.

The size of the antenna, the materials used in its construction, and the finish applied to it to make it resistive to the elements determine the antenna's durability. Wall thickness of the tubing used for the boom and elements should be given special attention. The thicker the walls, the more durable the antenna.

Once you know exactly where you're going to mount the antenna, make sure that it will be unobstructed by nearby obstacles. Select an antenna with the proper electrical characteristics and a boom length to fit your needs. The longer the boom, the more elements it can accommodate and the heavier the antenna. TV antenna booms range in length from 25" (0.64 m) for the simple two-element vhf antenna shown in Fig. 7 to as much as 159" (4 m) for the elaborate 31-element all-band antenna shown in Fig. 8.

The turning radius of a TV antenna becomes important when you plan to use a rotator. The antenna must be allowed to swing around in a full circle without encountering obstructions. You can measure the turning radius from the tip of the longest vhf element (farthest to the rear) to the pivot point, or the point where the antenna's boom fastens to the mast.

A Look At Prices. While it's not exactly a "specification," price should be an important—and well-understood—consideration. Be sure you know exactly what's included in the quoted price of an antenna. In most cases, the stated price is for the antenna alone. However, in a few cases, it might include some mounting hardware, perhaps a short mast, sometimes a length of lead-in cable, and, in some rare cases, a vhf/uhf or vhf/FM/uhf splitter.

Be prepared to pay premium prices for premium-quality antennas. Top-quality materials and construction cost more, but they will prove a sound investment in the long run. ♦



Product Test Reports

ABOUT THIS MONTH'S HI-FI REPORTS

Stereo receivers in a given price range tend to have very similar specifications and features, as well as a strong physical resemblance to each other. However, among this large group of components, some are "more equal than others". The Nikko Model 7075 is an excellent example of unusually high performance from one of the lesser-known brands.

Modern receivers and amplifiers are equipped to interface with a wide variety of signal processing accessories. The Pioneer Model SF-850 electronic crossover is a highly versatile two- or three-way adjustable filter, which is placed in the signal path ahead of the power amplifiers. Driving each of the speaker groups in a multi-way system from its own amplifier avoids most of the distortion attributed to passive crossover networks, and the Pioneer system gives the user a wide choice of crossover frequencies and filter slopes.

The other product tested is an octave-band graphic equalizer. The remarkably compact MXR equalizer adjusts the response for each channel in 10 separate frequency bands. In the real world, our listening rooms, speakers, and program sources are rarely "flat" in their frequency characteristics, but this handy accessory can go a long way toward correcting any response aberrations.

—Julian D. Hirsch

NIKKO MODEL 7075 AM/STEREO FM RECEIVER

Medium-priced receiver, excellent performance.

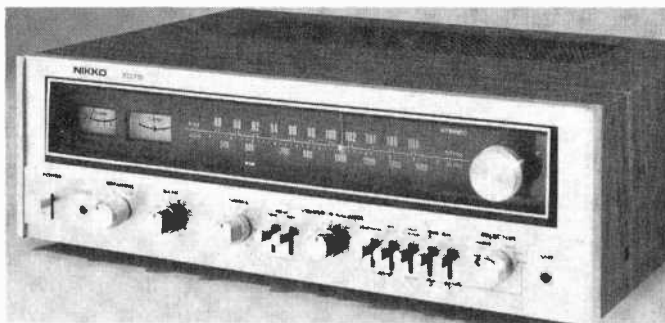

**HIRSCH-
HOUCK
LABS
REPORT**

The Nikko Model 7075 AM/stereo FM receiver features a full complement of operating controls, extensive use of integrated circuits, and performance of the highest order. The audio amplifiers are rated at 38 watts/channel into 8 ohms with both channels driven over a frequency range of 20 to 20,000 Hz, with less than 0.5% total harmonic distortion (THD). The FM tuner's sensitivity is rated at 1.9 μ V, the alternate-channel selectivity at 65

dB, and distortion at less than 0.2% in mono and 0.4% in stereo.

The receiver's extensive use of IC's results in a relatively inexpensive product. Following three pairs of linear-phase ceramic i-f filters in the FM tuner section, a single IC supplies virtually all the required gain, limiting, muting, and quadrature detection. Another IC, a phase-locked loop (PLL), supplies multiplex detection, while still another IC performs all the functions of the entire active portion of the AM tuner. In the audio section, an operational amplifier IC serves as a

feedback-type tone-control amplifier. The power amplifiers are composed of discrete elements and employ direct coupling all the way to the speakers. The outputs are complementary symmetry.

Supplied in a walnut-veneered wood cabinet, the receiver measures 19" W \times 16" D \times 6 $\frac{3}{8}$ " H (48.3 \times 40.6 \times 16.2 cm) and weighs approximately 26.4 lb (12 kg). Price is \$399.95.

General Description. The receiver's front panel is conventional in appearance with a satin gold finish and matching control knobs and switch levers. A "blackout" dial area across the upper portion of the panel has behind it the blue-illuminated FM and AM dial scales, large center-channel FM tuning and relative signal-strength meters, and illuminated legends that identify the selected program source. The last correspond to the settings of the input SELECTOR switch: AM, FM, PHONO, MIC, AUX, and DUB (for copying from one tape recorder to another). A red STEREO indicator above the dial area comes on when a stereo FM signal is received.

Lever switches control the POWER, LOW and HIGH cut filters, LOUDNESS compensation, FM MUTING, STEREO/MONO mode select, and TAPE MONITOR functions, the last from either of two decks that can be connected via jacks on the rear of the receiver. The SPEAKERS control allows selection of either, both, or neither of two pairs of speaker systems to the amplifier's outputs. (A PHONES jack next to it is always energized.)

The BASS and TREBLE tone controls, concentric for left and right channels, have 11 detented positions. The VOLUME and BALANCE controls, the latter detented at its center position, are also concentrically mounted. A MIC jack is also provided on the front panel for driving both amplifier outputs from a single dynamic microphone.

In addition to all the usual signal input and output jacks, the rear apron of the receiver also has a DIN connector that parallels the functions of the TAPE jacks. There is also a group of four jacks and a 4CH ADAPTOR slide switch for driving a quadrasonic adaptor and returning its front-channel outputs to the receiver's power amplifiers. The speaker connectors are insulated spring clips.

One of the three accessory ac outlets on the rear apron is switched. Rounding out the connector comple-

16 ways to move ahead in electronics!



Choose the one that's just right for you...the one that can make your future more rewarding, more secure, more enjoyable...starting now! These ways to move ahead are yours from Electronics Technical Institute...the finest electronics home study courses and programs ever offered!

Fundamental Electronics

Get a solid foundation for entering the fast-moving world of electronics where today is great, and tomorrow will be greater. Learn it the simple, easy, step-by-step, programmed way called *Autotext*, exclusive with ETI!

Electronics Drafting

Learn a vitally needed specialty that translates new technological concepts and developments to the practical drawing board. Become a specialist-in-demand, through ETI's training. Learn it at home...get your future moving now!

Color TV Servicing

There's a real future waiting for the established color television technician. You become that technician through this program that takes you step-by-step to *theoretical and practical* mastery of color TV. Get your tomorrow started today!

Master TV/Radio Servicing

Here is true "master" preparation for a career that can take you as far as you want to go into radio and television servicing, both black and white, and color. The helpful, practical ETI way can be your way to more money, security, success!

Communications

ETI's communications program opens up a whole range of career development possibilities in electronics. Solid-state receivers, solid-state audio equipment, communications equipment, CATV, as well as preparation for FCC-licensed positions in commercial broadcasting and mobile communications. You can find a real future here!

Industrial Electronics

You open great career opportunities through this program, as instrumentation technician, electronic equipment maintenance technician, electronic calculating machine technician and audio technician. It also prepares you to move into and up in communications, automation and industrial electronics!

Digital Technology

Join the digital revolution which is radically altering our lives today and tomorrow. Get solidly trained in the new digital specialties that can lead to a real future as a digital control technician, electronic calculating machine technician, field representative, computer sales representative, manufacturer's representative.

Electronics Technology

Learn electronics across the board! You'll be ready for real career advancement with training that can lead to technical positions in communication, automation and industrial electronics, and can also help you in sales positions, management and administration.

Computers

ETI offers training opportunities in Computer Technology and Computer Programming. Learn at home, and get ready to enter a field where incredible developments are sure to continue. It's practical, useful—the step-by-step ETI way!

Advanced Electronics

Want greater challenges and career advancement? This course is for you. It can be valuable preparation not only for a technical career, but also for the fields of sales, management and administration. Make your move now!

Digital Electronics—Advanced

Here's a special course for those already in the field of digital electronics, ready to move into more advanced areas. This is how to move up in sales, management and administration. Here's your tomorrow!

Black and White TV Servicing—Advanced

This can be your own "advance" course to black-and-white TV competence from A to Z. You'll construct a receiver yourself, if you wish. A key to lifetime success!

Industrial Instrumentation—Advanced

Move up in the world...the wonderful electronics world! This course opens up a whole range of careers in the industrial field, as instrumentation technician, laboratory technician, process control technician or electronic calculating machine technician. Get ready...and go!

Color TV Servicing—Advanced

Here is the "graduate" course in color TV for those who already know television fundamentals. You'll learn color TV from top to bottom, build your own set if you choose. A great way to build your future!

Solid-State Electronics—Advanced

Applications of transistors are increasing all the time and the transistor may be a breakthrough

comparable in importance to the development of nuclear energy. Solid-state can mean your solid career development, too, through ETI!

FCC License Preparation

Here is real down-to-earth practical preparation to take your 3rd, 2nd or 1st class Federal Communication Commission Radiotelephone License examinations. Get yourself ready now for any of the FCC-licensed positions involving broadcasting, mobile communications, microwave communications links, marine communications equipment or in many other positions in solid-state, communications, CATV. Get ready for tomorrow...today!

Get all the facts...free!

Send the coupon now for ETI's colorfully illustrated new



44-page catalog giving you all the details. You owe it to yourself.

There's no obligation, and no salesman will call. Send for yours today!

Electronics Technical Institute

Division of Technical Home Study Schools

Electronics Technical Institute, Dept. 2-473-076
Little Falls, New Jersey 07424

Send me the Electronics Technical Institute Catalog.

Name _____ (please print)
Address _____
City _____ State _____ Zip _____

Interested in another field? Check the Technical Home Study School program that interests you most. No salesman will call. PLEASE CHECK ONLY ONE.

Typewriter and Office Machine Repair Locksmithing
 Upholstery and Decorating Legal Investigation
 Accident and Insurance Claim Adjusting Security/Alarm Business
 Outdoor Careers in Conservation Photography

Check here for information on Veterans Benefits.
 Check here for information on learning by cassettes.

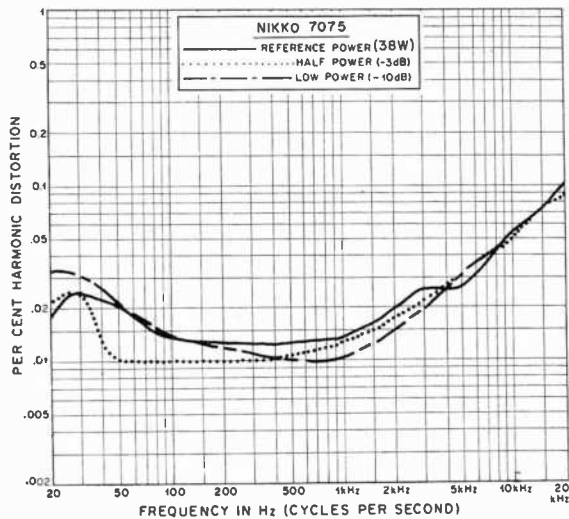

ment on the rear panel are antenna terminals for 300- and 75-ohm FM antennas and a wire-type AM antenna. (There is also a pivoted ferrite rod AM antenna.) Pushbutton circuit breakers protect the speaker outputs and the power-line input.

Laboratory Measurements. Following a preconditioning period, the amplifiers delivered 48.5 watts/channel into 8-ohm loads at 1000 Hz before clipping. Into 4- and 16-ohm loads, the output power measured 62.4 and 32 watts, respectively.

At 1000 Hz, the measured THD was about 0.01% at outputs between 1 and 20 watts. It rose to 0.018% at 40 watts and to 0.035% at 50 watts output. The IM distortion was about 0.06% from less than 50 mW to about 45 watts output. It reached 0.1% at 50 watts output.

At the rated 38-watt output level, and at lower power outputs down to about 4 watts, the THD was between 0.01% and 0.015% between 100 and 1000 Hz. It increased to 0.1% at 20,000 Hz and was 0.03% at 20 Hz. To develop a reference 10-watt output, 80 mV was required at the AUX input, 1.7 mV at the

PHONO input, and 1.3 mV at the MIC input. The corresponding S/N ratios, referred to 10 watts output, were 82, 74, and 56.5 dB, respectively. The phono inputs overloaded at a very safe 140 mV, while the microphone input overloaded at 120 mV.

The characteristics of the tone control system were rather unusual, since the first two or three positions of boost and cut (especially in the treble) changed the frequency response only slightly, while the last two positions had a much greater effect. In fact, we would consider the bass boost range to be somewhat excessive, since the maximum boost was 22.5 dB at 35 Hz. It is unlikely that any speaker system or listening environment would require such drastic equalization. Also the amplifiers could easily be driven to distortion if maximum boost were used.

The filters had gradual 6-dB/octave slopes, and their -3-dB response frequencies were at 200 and 4000 Hz. The low filter, in particular, cut out considerable program content while removing rumble and low-frequency noise. The loudness contours pro-

duced a moderate bass boost and a slight treble boost at low volume settings.

The RIAA phono equalization was accurate to within ± 0.5 dB from 40 to 20,000 Hz. Interaction with cartridge inductance caused a gentle downward response slope beginning at several kilohertz, reaching -1.5 dB between 10,000 and 15,000 Hz before rising to +2 or +3 dB at 20,000 Hz. The MIC frequency response was down 6 dB at 77 and 7700 Hz, relative to the 1000-Hz level.

The IHF usable sensitivity of the FM tuner was 11 dBf (2.0 μ V) in mono and 18.5 dBf (4.6 μ V) in stereo. The 50-dB quieting sensitivity in mono was 19.5 dBf (5.2 μ V), with 0.67% THD. In stereo, it was 36 dBf (34 μ V), with 0.47% THD. The distortion at 65 dBf (1000 μ V) input level was 0.2% in mono, 0.21% in stereo. The S/N at that level was 70.6 dB and 68.3 dB in mono and stereo, respectively. The stereo FM frequency response was ± 1 dB from 30 to 13,000 Hz. It was down 3 dB at 15,000 Hz. Channel separation was exceptionally uniform, measuring 33 to 36.5 dB from 30 to 10,000 Hz and 30 dB at 15,000 Hz. The AM frequency response was down 6 dB at 120 and 5000 Hz.

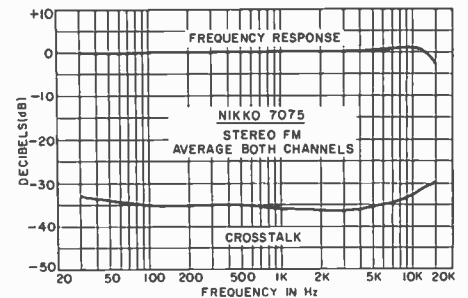

The FM capture ratio was 1.6 dB, and AM rejection was an excellent 73 dB. The image rejection and alternate-channel selectivity figures of 86 and 75 dB also represent very good performance. Adjacent-channel selectivity (called for in the latest IHF standards, though we have not measured it regularly in the past) was 5.4 dB. Adjacent-channel selectivity is usually far worse than the more important alternate-channel reading, but we feel the 5.4-dB figure measured for this receiver is somewhat below par, although it is of importance in only those rare cases where you want to listen to a station only 200 kHz removed.

The FM muting action occurred smoothly between 5.5 and 11 dBf (1

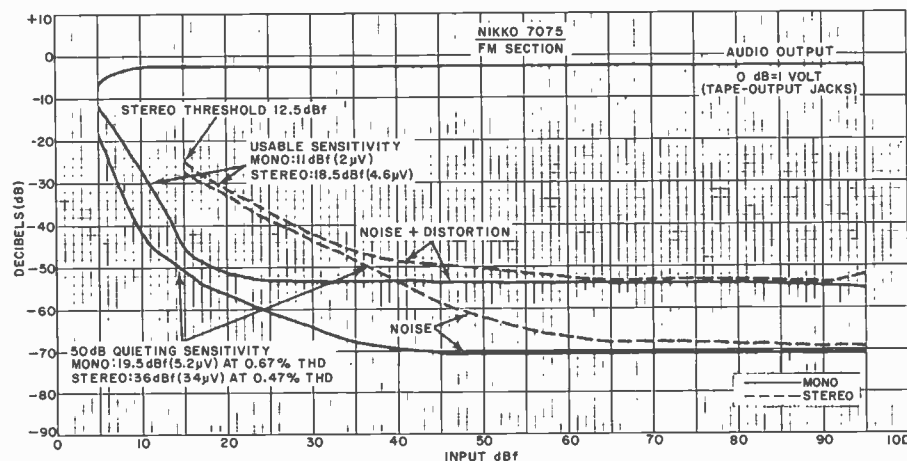

WHEN THIS ELECTRIC CB ANTENNA DISAPPEARS,

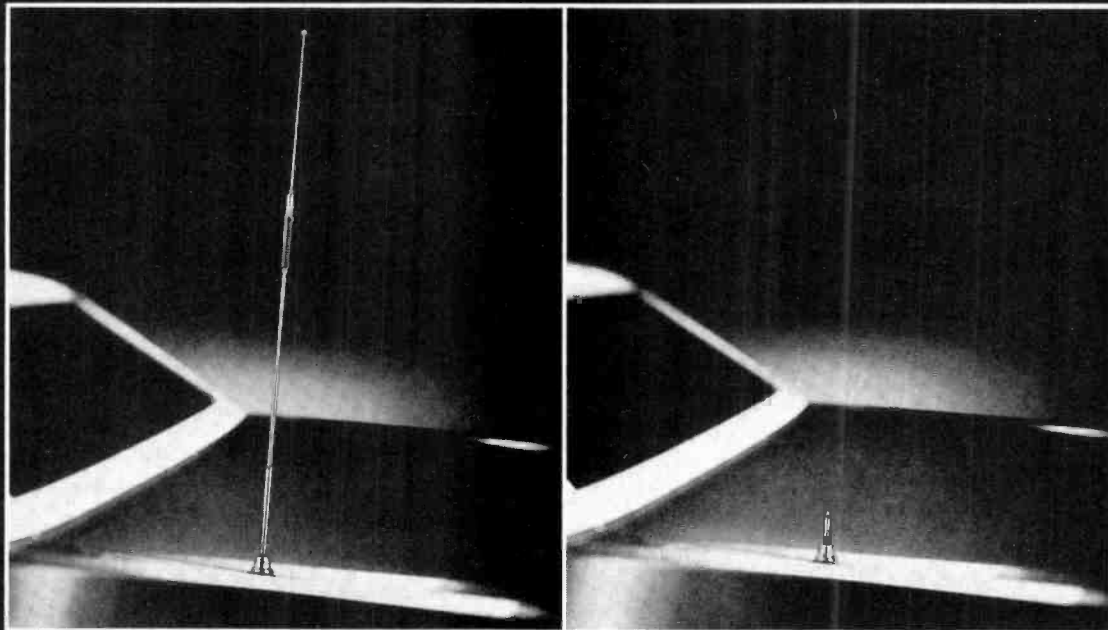

SO DOES THE CHANCE OF A RIP-OFF.

INTRODUCING THE TENNAPOWER DISAPPEARING CB ELECTRIC ANTENNA.

Thefts are CB's biggest problem.

With millions of CBers on the road, more and more thieves are turning their attention to the CB-equipped automobile as a prime and lucrative target. And thieves have learned to recognize a CB-equipped car by the telltale CB whip antenna it invariably sports. Take a look on any highway—each CBer is flying his whip antenna as a virtual flag.

Remove the CB whip antenna and you reduce the chance of theft.

With this simple truth in mind, Tenna designed a no-compromise CB antenna that "wouldn't be there" when it wasn't needed. Existing designs weren't good enough. Magnet mounts are inconvenient. Disguise antennas are poor performers. So Tenna came up with something new.

How Tenna created a no-compromise CB antenna that disappears.

Tenna motorized the antenna so it could elevate and retract electrically. And they decided on a center-loaded design, the most effective for reliable mobile CB use. One adjustable for optimum SWR. It took a powerful special "skinny" center-loading coil to make everything work, and Tenna's engineers developed a coil that disappears. So with the flick of a switch, the antenna extends to its full length for top performance and turns on the CB radio, automatically. But flick the switch again and it disappears into the fender, turning the radio off. And these antennas are built with top-quality materials for years of reliable service. Now the kind of workmanship that makes us the world leader in motorized AM-FM car antennas goes to work for you on the Citizens Band.

Where to find the TennaPower Disappearing CB Electric Antenna.

Don't look in a parking lot. If there's one there, you won't see it. Check with a dealer who sells CB or car stereo. Most of them will install your TennaPower Disappearing CB Antenna, or you can do it yourself. But one way or another, put one in soon. After all, you have a lot to lose.

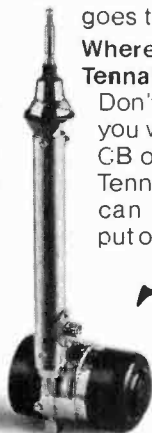

Tenna Corp.

Cleveland, Ohio 44128

We'd like to compare our But there's no

Send for
FREE
illustrated
career
guide

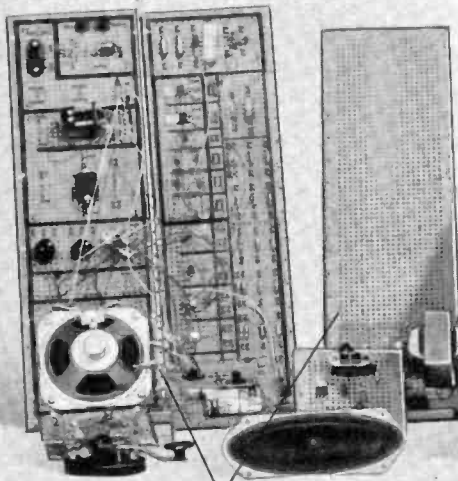
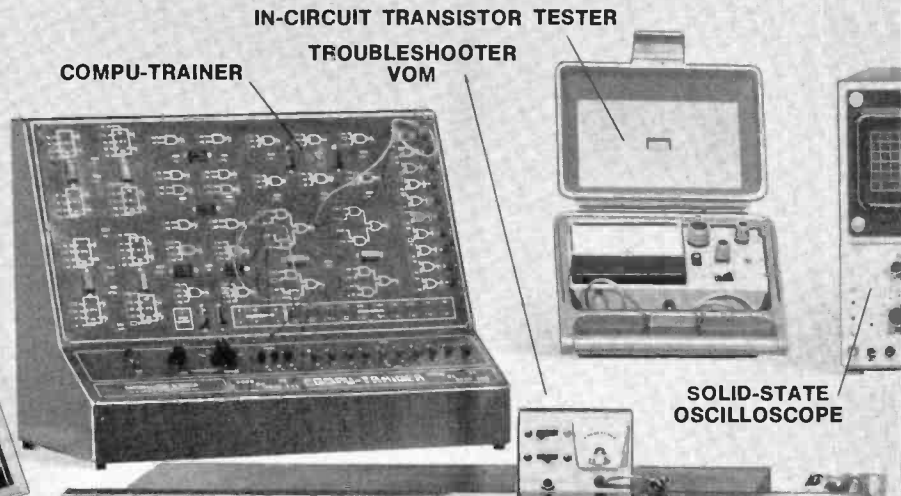
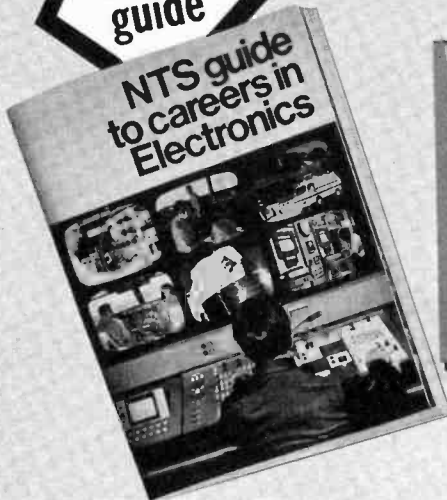

(Simulated TV Reception)

COMPARE OUR TRAINING PROGRAMS: NTS Electronics programs are considerably different from those of other schools, and, we believe, better designed to prepare you for entry-level opportunities in the field of your choice. For example, our Master Course in Electronics Technology includes over 170 lessons; another school offers fewer than half that many in a course with the same title. Our course includes 26 kits to build an Electro-Lab, a Solid-State Digital Computer-Trainer with transistor-diode logic circuits; a 5" wide-band solid-state Heath Oscilloscope; a Heath FET-VOM, and slide rule. Their course offers 10 kits to build a private label VOM and 2 experimental circuit chassis.

And even though you need an oscilloscope to perform their experiments, they don't provide it. You have to buy your own. And their course does not even include a Digital

Computer-Trainer. The closest thing to our program they offer costs over \$200 more than ours. Another school's course in Electronics Technology offers even fewer lessons, and kits to build only a VOM. That's all. Think it over, and check it out, course by course, program by program. There's no comparison.

COMPARE OUR EQUIPMENT: NTS selected Heath equipment because of Heath's international reputation as a prime designer of commercial and professional electronic equipment in kit form. Cooperation between Heath and NTS assures you of highest quality components, design, function and training. What's more, Heath equipment is the kind you'll meet in the field - not limited to training only. For instance, the Heath GR 2000 25" (diagonal) Color TV included in our Color TV courses is acclaimed as ahead of its time in features and engineering. And the Heath AM-FM

school to other schools. comparison.

COMPARE OUR
KITS AND LESSONS.
COMPARE OUR
TUITION.



Multiplex/Receiver offered in our Audio course is a 30-Watts-RMS-per-channel set that's designed for true High Fidelity performance, not built for training only. As for reliability, that's another word for Heath.

The same holds true for Heath Oscilloscopes, FET-VOM, Digital Multimeter, In-Circuit Transistor Tester, Solid-State 2-Meter FM Transceiver, and much more included in over a dozen NTS courses. Check it out! There's just no comparison.

COMPARE OUR LOW TUITION: We employ no salesmen, pay no commissions. You receive all home study information by mail. All kits, lessons and experiments are fully described in our Catalog and all equipment needed for your training is included in the tuition price. Nothing extra to buy for your training with NTS. Liberal refund policy and cancellation privileges spelled out.

Make your own comparisons. Check the number of lessons, check the subjects covered and check the amount and value of training equipment you will receive for your tuition dollars. Then make your own decision. Mail card today, or write for FREE Electronics catalog if card is missing. **FIND OUT!**

NO OBLIGATION. NO SALESMAN WILL CALL
APPROVED FOR VETERAN TRAINING
Get facts on new 2-year extension

NATIONAL TECHNICAL SCHOOLS
TECHNICAL-TRADE TRAINING SINCE 1905
Resident and Home-Study Schools
4000 So. Figueroa St., Los Angeles, Calif. 90037

and 2 μ V), and the stereo switching threshold was 12.5 dBf (2.3 μ V). Pilot carrier leakage into the receiver's outputs was 73 dB below 100% modulation.

User Comment. This was a thoroughly pleasant and satisfactory receiver to use. No operating "bugs" appeared during our extensive use tests. The controls operated smoothly and positively, and the sound quality was excellent.

Although the manual supplied with the receiver was quite complete, it made no reference to the 4CH ADAPTOR

feature. The schematic diagram reveals, however, that this circuit is really the equivalent of the separate preamplifier output/main amplifier input facility found in many receivers today. Setting the switch to 4CH interrupts the signal path at the appropriate point. Obviously, this feature can be used equally well for installing graphic equalizers, signal processors, electronic crossover networks, etc., into the system.

The FM dial calibrations are linearly spaced, but markings appear only at 2-MHz intervals. In spite of this wide spacing, the calibration was accurate,

and we had no difficulty tuning to any desired frequency without guesswork. The FM sound was notably free from background hiss and was the audible equal of any FM sound we have heard in our laboratory location. The muting action was free from noise bursts and revealed only a slight "thump" as it cut in and out.

Our experience with the Model 7075 convinces us that this receiver is easily the equal of others we have used at or near its price and with respect to the features and listening quality it provides.

CIRCLE NO. 80 ON FREE INFORMATION CARD

PIONEER MODEL SF-850 ELECTRONIC CROSSOVER

Active crossover gets most out of speaker systems.

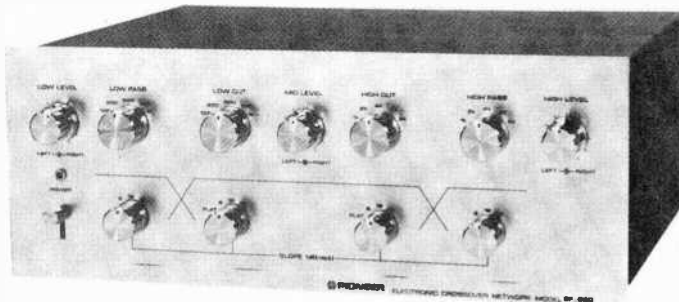

Passive crossover networks, it has been claimed, can degrade the performance of the speaker systems in which they are used. Nonlinear distortion can be created by the iron-core inductors and electrolytic capacitors in many speaker systems. Some power loss is also inevitable in the windings of inductors. Because of the large inductors and capacitors required, achieving a low woofer crossover frequency (200 Hz or lower) can be quite expensive. Although there is some difference of opinion as to the desirability of using crossover slopes steeper than 6-dB/octave, those networks that provide 12- and 18-dB/octave slopes require prohibitively expensive (for a low-cost speaker system) close-tolerance components.

All the difficulties encountered with passive crossover systems can be overcome by using an active crossover system and using separate amplifiers for the various drivers in a speaker system. Active crossover filters are inexpensive (using components that do not have to cope with high power) and essentially distortion-

less. They also have the virtue of making it easy to adjust cutoff frequencies and slopes. One such active crossover system is the Pioneer Model SF-850 that accomplishes virtually all the crossover operations needed for a two- or three-way stereo speaker system. Separate selectors are provided for the woofer/midrange and midrange/tweeter transitions.

The Model SF-850 measures 13 $\frac{3}{4}$ " W \times 13" D \times 5 $\frac{1}{2}$ " H (35 \times 33 \times 14 cm) and weighs 12 lb 6 oz (5.6 kg). Price is \$199.95.

General Description. The low-pass switch for the woofer has frequencies of 125, 250, 500, 700, and 1000 Hz, while the frequencies for the tweeter's high-pass switch are 1000, 2000, 4000, 6000, and 8000 Hz. The corresponding low- and high-pass filters for the midrange driver have matching cutoff frequencies. For each of the cutoff selectors, a separate SLOPE switch provides a choice of 6-, 12-, or 18-dB/octave slopes. This makes it possible to use different slopes for the separate drivers, which might be advantageous from a sonic point of view or merely to protect the tweeter against excessive low-frequency drive levels.

The slope controls for the midrange section also have FLAT positions. This offers complete flexibility for the two-way system, since the crossover frequency to the tweeter can be set at any of the frequencies from 125 to 8000 Hz. Each of the three frequency-band outputs has its own level control (concentric for the two channels). This is vital for any electronic crossover system to achieve the correct frequency balance with drivers of different efficiency. On the rear apron of the chassis are a pair of input and three pairs of output (woofer, midrange, tweeter) jacks and two switched and one unswitched ac outlets.

The crossover system's specified gain is rated nominally at unity. Maximum insertion loss is stated at less than 2 dB with any settings of the crossover controls. Input and output impedances are nominally 100,000 and 1000 ohms, respectively. The rated maximum output is 3.5 volts; S/N, referred to the rated output, is better than 85 dB; and harmonic distortion is specified at 0.3% or less.

Laboratory Measurements. During our tests, we plotted a number of response curves using different crossover frequencies and slope settings. In every case, the attenuation at the indicated crossover point was within 1 dB of the ideal 3-dB value. The gain, as specified, was 1.0 in the passbands at the maximum level-control settings.

We could not measure the output noise, which was well below the 100- μ V limit of our test equipment. This corresponds to better than 80 dB referred to 1 volt, or more than 91 dB below the rated output. Both harmonic and intermodulation (IM) distortion were very low at any usable output level. They measured less than

0.025% up to 1 volt output and about 0.1% at the rated 3-volt output. The output clipped at slightly greater than 5 volts.

User Comment. Since we did not have a two- or three-way speaker system that provided separate access to the individual drivers, we simulated a three-way system with three different full-range loudspeakers. Each speaker was driven by its own power amplifier. The crossover system was connected between the preamplifier and three power amplifiers.

As we experimented with different combinations of crossover frequencies and slopes, it became obvious that a hit-or-miss or arbitrary selection

of parameters, by means of a fixed passive crossover network, would be unlikely to produce the optimum performance of which the speakers are capable. Not only did the choice of crossover frequency make an appreciable difference in the sound, but we usually heard at least as much difference between different slope settings.

For the loudspeaker/speaker system experimenter, we can think of no accessory as useful as a fully adjustable electronic crossover system like the Model SF-850. The need for two or three amplifiers when using an electronic crossover system might seem to be a drawback, but it should be understood that only the woofer normally requires a powerful amplifier with a

very good low-frequency response and that the midrange and tweeter drivers normally require much less power. In fact, lower-power amplifiers are strongly recommended for the tweeter, which can easily be damaged by excessive driving power.

Whether or not bi- or tri-amplification has inherent sound advantages is not a question we will attempt to answer here. However, one thing is certain: there is no simpler or more convenient means of getting the most out of such a system than by using an active electronic crossover system. And the Pioneer Model SF-850 crossover system does everything claimed for it and does it very well indeed.

CIRCLE NO. 81 ON FREE INFORMATION CARD

MXR STEREO GRAPHIC EQUALIZER

Highly effective, moderately priced, 10-octave-band equalizer.

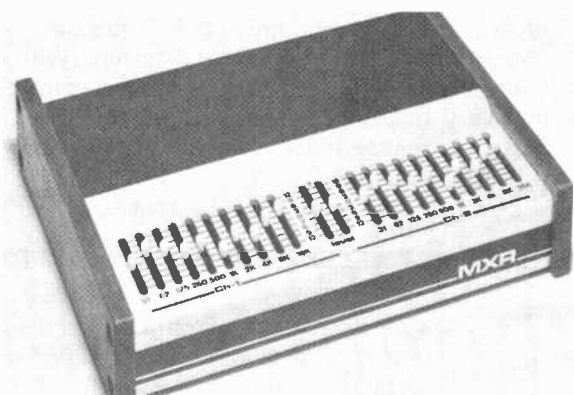

Graphic equalizers are acknowledged to provide an effective means of modifying the frequency response of a home audio system. Usually, slide-type potentiometers are used on a graphic equalizer to vary the response at different frequencies. The positions of the pot "knobs" roughly outline the frequency response curve of the equalizer, which accounts for the "graphic" part of the device's name.

In a sense, these equalizers are actually highly versatile tone controls. Practically speaking, a graphic equalizer should have at least five separate control frequencies; some of the more elaborate models have seven control frequencies. A much more desirable form, however, is the octave-band equalizer, which generally divides the audio range into 10 bands. A good example of such an equalizer is the very compact and relatively low-

cost octave-band equalizer from MXR Innovations. This equalizer has excellent performance characteristics, 10 frequency controls, and provides a boost and cut range in excess of 10 dB for each of its two stereo channels.

The MXR graphic equalizer measures 9 $\frac{1}{4}$ " W \times 7 $\frac{1}{4}$ " D \times 2" H (32.5 \times 18.4 \times 5.1 cm) and weighs 4.5 lb (2 kg). It sells for \$199.95 in the consumer version. (There are two electrically identical versions of the graphic equalizer. The consumer version uses phono-type input and output jacks and provides the tape monitor facility that would otherwise be eliminated when the equalizer is connected into a hi-fi system. The professional version uses standard phone jacks and does not supply tape monitoring facilities.)

General Description. The MXR equalizer is finished in satin aluminum with a pebbled black vinyl front panel to provide a pleasant contrast. In addition, it has walnut end panels.

On the forward section of the top panel are 22 small white knobs, 20 of which permit adjustments of the slide potentiometers and the remaining two provide the means for separately setting the gains of the two stereo channels. The center frequencies of the filters are plainly marked in front of the slide controls (31, 62, 125, 250, 500, 1000, 2000, 4000, 8000, and 16,000 Hz). Scales that extend across the control surface provide a means for indicating the approximate amount of boost and cut for each filter over a range of ± 12 dB.

On the rear apron are the line inputs and outputs and the tape recording inputs and outputs that replace the normal amplifier tape monitoring circuit. A slide switch replaces the usual program source with the tape playback output, while another switch bypasses the equalizer circuits. Since the equalizer draws negligible power and can safely and economically be left on at all times, there is no power switch.

The published specifications for the equalizer are in terms of professional program levels. The maximum output is rated at +15 dBm into 600 ohms, or +22 dBm into a high-impedance load. The gain is nominally unity; ± 1 dB from 20 to 20,000 Hz with the controls centered. The equivalent noise is rated at 95 dBm down. The stated input impedance is 47,000 ohms, while the output is designed to drive loads of 600 ohms or greater. The harmonic and IM distortion are rated at 0.05% or less at 0 dBm (0.775 volt).

Laboratory Measurements. The

frequency response characteristics agreed very closely with the specifications and panel markings when we tested the equalizer. It is possible to correct response in a single octave with little effect at frequencies only one octave removed. By using several controls simultaneously, one can shape almost any desired response curve. The positions of the control knobs actually do represent a valid picture of the response curve.

The measured total-harmonic distortion (THD) at 1000 Hz was the residual of our test equipment (less than 0.003%) for outputs up to about 0.2 volt. It increased smoothly to 0.05% at 8 volts output, just below the clipping level of 8.3 volts into a high-impedance termination. At 20 Hz, the THD was slightly higher—0.01% and 0.35% at 1- and 8-volt output levels.

The slewing rate of the equalizer set a limit on performance at the highest audio frequencies. At 20,000 Hz, the distortion rose from less than 0.005% at 10 mV to 0.035% at 0.1 volt and 0.71% at 1-volt output. The maximum output at 20,000 Hz was about 2 volts. The IM distortion, measured with 60- and 7000-Hz signals mixed in a 4:1 ratio, was between 0.06% and 0.07%

from 0.8 to 8 volts output. It was less at lower levels.

Although we did not measure the response of the equalizer outside the audio band, the square-wave risetime of 25 μ s indicates that the final rolloff is not far beyond 20,000 Hz. The output noise in a wideband measurement was barely detectable on our meter at approximately 90 μ V, which is 81 dB below 1 volt or 79 dB below MXR's reference level of 0 dBm. No doubt, the application of a weighting curve would have brought our measurement into closer agreement with the published specification, but the level would be an unmeasurable value.

User Comment. Laboratory measurements cannot adequately describe the true value of a good octave-band equalizer in a hi-fi system. A good equalizer can make a poor speaker system sound tolerable, a good speaker system sound very good, correct for room acoustics to some extent, reduce turntable noise, etc. Though a really good tone-control system can do some of these jobs to a limited extent, no such system can do the jobs as well as an octave-band equalizer.

The MXR is one of the best equalizers designed for the consumer market we have ever used. Of course, the equalizer's compact size groups the controls very close together so that much care must be exercised when making adjustments. (There are also no detents on the controls, and it is necessary to view the controls from directly overhead to avoid parallax errors.) However, this is a small price to pay for a full-range, highly effective device that rarely, if ever, requires readjustment after initial setup. You do not touch up the settings of the equalizer's controls to compensate for the deficiencies on a given record or tape after the system has been equalized for the speaker system, room acoustics, and cartridge being used. Instead, you make minor program corrections with the existing tone controls on the hi-fi system's amplifier.

In addition to being an excellent performer, the MXR equalizer is priced in a range that most hi-fi system owners can afford. In today's market, this equalizer represents a realistic investment for a device that is highly practical.

CIRCLE NO. 82 ON FREE INFORMATION CARD

SBE MODEL 12SM OPTI/SCAN DIGITAL SCANNING RECEIVER

Programming card gives simple choice of about 16,000 frequencies.



THE SBE Opti/Scan scanning monitor receiver has a digital frequency synthesizer that eliminates the need for crystals. Up to 10 channels in the Public Service Bands can be programmed onto special plastic cards that slide into a slot on the front of the receiver. An optical "reading" system then "tells" the receiver what channels to scan. Any of some 16,000 different frequencies in the ranges of 30 to 50, 150 to 170, 450 to 470, and 490 to 510 MHz can be selected in any sequence and combination. Several dif-

ferently programmed cards can be used to change channel frequencies instantly.

Except for the lack of a priority channel, the receiver offers all the usual scanner features: manual/automatic scanning select, channel indicators and lockout switches, variable squelch and volume controls, external-speaker jack, and rescanning delay. The receiver can be ac line or nominally 12 volt, negative-ground dc powered. The maximum power drawn from the ac line is rated at 15 watts,

while current drain from a 13.8-volt dc source is specified at 0.8 ampere.

The receiver measures 10" W \times 7 $\frac{3}{4}$ " D \times 2 $\frac{3}{4}$ " H (25.4 \times 20 \times 7 cm) and weighs 7.5 lb (3.4 kg). Price \$369.95.

General Information. Based on a visual inspection of the receiver, we would say that it has multiple conversion, the last to 455 kHz. The last i-f stage has a ceramic filter to provide selectivity. Separate r-f front ends are provided for the low and high vhf and the uhf bands.

A 40" (102-cm) telescoping antenna plugs into a connector on the rear of the receiver for receiving in the low- and high-vhf ranges. A separate 6" (15.2-cm) whip antenna plugs into a separate jack to provide reception on the uhf bands.

The programming cards provide binary information for the two-state logic levels required by the digital frequency synthesis system to develop the heterodyning frequencies for each channel. As supplied, the cards are optically opaque. The user programs them according to simple instructions in the manual.

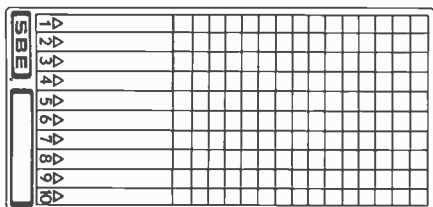

Close-up of programming card.

The maximum frequency coverage is limited to a 20-MHz spread for each band. However, the receiver can be specially ordered from the factory to cover only the 140-to-160, 470-to-490, and 492-to-512-MHz portions of the vhf and uhf bands. This means that coverage can encompass the 2-meter amateur radio band.

Measurements. In general, our performance measurements on the receiver fell within the published specification figures. Sensitivity measured 0.5 μ V average for 12 dB SINAD. The squelch range was from 0.25 to 330 μ V. Adjacent-channel selectivity was 50 dB down at 25 kHz. Modulation acceptance was \pm 7000 Hz. The audio output power measured 2 watts (rated 3 watts) into 4 ohms at the start of clipping with 2% (rated 10%) THD at 1000 Hz.

We noted several unwanted-signal responses with signals at 100-to-1000- μ V levels (40 to 60 dB above 1 μ V). With actual on-the-air reception, such responses occasionally appeared from signals that were 3 to 4

MHz lower than the desired frequency on the 150-to-174-MHz band, where most of the radio activity in our area takes place. This situation appears to be due to overload or spurious mixing products with the synthesizer, rather than the result of an i-f image. In any event, this should present few problems in most areas of the country.

User Comment. Two programming cards are supplied with the receiver. (More can be ordered separately.) Each consists of two layers of plastic bonded together. About two-thirds of the area on each card is given over to a "window" matrix made up of 15 columns and 10 rows. To the left of the matrix are 10 blank spaces labelled with the numbers 1 through 10 in which are entered the frequencies for the selected channels. A small blank space near the SBE logo can be used for identifying the card.

Programming starts by deciding on the frequencies you want to monitor. Then you look up the binary codes for each frequency in the tables in the manual. After entering the frequencies and, beside them, the binary number code that applies to each, the actual programming of the card can be done. Note that each frequency has a 15-digit binary code, which corresponds exactly with the number of columns in the window matrix.

After entering the frequencies in the blank spaces on the card next to the channel numbers, all tabs indicated by 0's in the binary codes are removed

from the matrix. Wherever a tab is removed, a transparent space will allow light to pass through, which the receiver's optical reading system will recognize as a logic 0.

The adhesive-backed tabs can easily be removed from the card with a fingernail, pointed instrument, or tweezers. The tabs can be saved, by sticking them to the rear page of the manual, should a card have to be reprogrammed or an error in the coding have to be rectified.

Using a program card is very simple. It goes into the reader slot on the front of the receiver, matrix foremost and SBE logo facing upward. However, should the card be fed in upside down, the scanner will still tune the proper frequencies, but the scanning sequence will be in reverse order.

The rescan time delay of the receiver is about a second. Scanning time through all 10 channels is also about a second. Pushbutton switches are used for the channel lockout function and MANUAL and SCAN select, while standard rotary pots are provided for VOLUME and SQUELCH adjustments.

The good signal sensitivity of this receiver provided very good reception results when we used the plug-in whip antennas supplied with the receiver. For mobile and outdoor external antennas, 50-ohm systems are recommended. We rate the audio quality from the top-facing speaker built into the receiver as excellent.

CIRCLE NO. 83 ON FREE INFORMATION CARD

HICKOK MODEL 370 ANALOG MULTIMETER

High-impedance multimeter also measures capacitance.



AT A TIME when it appears that digital instruments have completely taken over the test and measurements scene, it comes as a

pleasant surprise to see a top-quality analog multimeter on the market. The Hickok Model 370 is a bench-type, ac-powered auto-polarity FET (high-impedance) multimeter designed along the classic lines of "laboratory" test instruments. It features a large 5" (12.7-cm) rectangular meter movement with seven relatively uncrowded scales and an antiparallax mirror backing.

The multimeter can measure all the usual ac and dc voltages and currents and resistances. It can also be used to measure decibels and capacitance. The latter function can be found in some moderately priced digital instruments, but it is a rarity to be able to measure capacitance as high as

10,000 μ F with any but the most sophisticated analog multimeters. All function and range selections are accomplished with pushbutton switches, another rather radical departure from the traditional multiposition rotary switches used in analog VOM's.

The Model 370 measures 8½" W x 7" H x 6" D (21.6 x 17.8 x 15.2 cm) and weighs 4 lb, 12 oz (2.2 kg). It sells for \$189.00.

General Description. The front panel below the meter movement contains 15 pushbutton switches that control the entire operation of the multimeter. A LED indicator serves as both a "pilot lamp" and an auto-

IMSAI announces a unique 4K RAM board for just \$139.

Nobody has a 4K RAM board that gives you so much for your money. It's fully compatible with the Altair 8800.

Through the front panel or under software control, you can write protect or unprotect any 1K group of RAM's. Also under software control you can check the status of any 4K RAM board in 1K blocks to determine whether it's protected or not. The board has LED's that clearly show you the memory protect status of each 1K block and which block is active. And there's a circuit provided that will let you prevent the loss of data in the memory if there's a power failure. This low power board has a guaranteed 450 ns cycle time—no wait cycle required. There's nothing like the IMSAI 4K RAM board around.

Dealer inquiries invited.

IMS

IMS Associates, Inc.

IMS Associates, Inc.
14860 Wicks Boulevard
San Leandro, CA 94577
(415) 483-2093

PE-7

Order Your IMSAI 4K RAM Board For Only \$139. Use BankAmericard, Master Charge, personal check or money order.

- Send _____ 4K RAM boards today.
- Charge to my credit card.
- BAC No. _____
- MC No. _____

Signature _____

Name _____

Address _____

City/State/Zip _____

polarity indicator when the instrument is used in the dc mode.

The full-scale voltage ranges on both ac and dc are 0.15, 0.5, 1.5, 5, 15, 50, 150, 500, and 1500 volts. On dc, the input resistance is 10 megohms and accuracy is 2% of full scale. In the ac mode, which is rms calibrated (average responding), the input impedance is 10 megohms shunted by less than 75 pF. The frequency response goes out to at least 50,000 Hz, and worst-case accuracy is 5% of full scale. Calibration of the multimeter is accomplished in nine ranges, using two scales, from 0.4 to 4000 volts peak-to-peak.

There are nine decibel ranges from -30 to +65 dB, with 0 dB defined as 1 mW across 600 ohms. Input impedance is 10 megohms shunted by less than 75 pF. As on ac volts, the decibel frequency response goes out to at least 50,000 Hz.

To provide a broad resistance range, the instrument provides eight measuring ranges whose center-scale values are 10, 100, 1000, 10,000, 100,000, 1 meg-, 10 meg-, and 100 megohms. In this mode, the open-circuit potential is selectable for either low-power (0.15-volt) or high-power (1.3-volt) testing, except on the RX1 range. Accuracy on all resistance ranges is 3% of full scale.

The capacitance-measuring mode is broken up into six ranges to cover from 500 pF to 10,000 μ F with a measuring accuracy of 5%. A 0.15-volt 60-Hz drive signal is applied to capacitors under test. Electrolytic capacitors are also biased at +1.2 volts.

Nine ranges are provided for measuring both ac and dc currents, with full-scale values of 0.15, 0.5, 1.5, 5, 15, 50, 150, 500, and 1500 mA. In the dc mode, the accuracy is 3% of full scale; while on ac, the worst-case accuracy is 5% when measuring voltages at frequencies between 60 and 1000 Hz.

Overload protection on the dc and ac (including decibel) voltage ranges is provided by a 1500-volt protected input. A fuse and a circuit breaker take care of any possible damage to the ac and dc current-measuring circuits and the resistance and capacitance functions.

User Report. The Model 370 multimeter is as impressive looking as its specifications imply. Because of its high input impedance and excellent

low ranges, we found it to be eminently suitable for testing and troubleshooting solid-state circuits.

The large meter movement has plenty of area behind the pointer for scales that are easy to read and interpret, especially with the aid of the mirror backing. As a result, it was quite easy to interpret measurements accurately. The scales are clearly identified. The separate voltage and current scales are colored black and located above the arc of the mirror. The resistance and capacitance scales are green and red, respectively. These four scales are the most often used and are longer than the other scales as a result of being farthest from the movement's pointer pivot.

The decibel scale has a zero-center mark. The scale extends from -10 on the left to +5 on the right. The peak-to-peak voltage scales are located nearest the pointer pivot and are colored red. As you read ac voltage in rms on the upper voltage scale, you can simultaneously read its peak-to-peak value on the lower scale.

The clearly identified pushbutton switches are color coded the same as the scales to which they apply. They operated smoothly and positively, without any evidence of binding or wobble. The LED indicator glows steadily when power is turned on. Then, when the instrument is set to the dc function, it glows steadily when the test probes are properly polarized with the circuit under test or blinks when the polarity is reversed. This auto-polarity feature (there is no need to transpose test probes when the LED is blinking) saves a lot of time and manipulation during testing.

Being able to measure capacitance with this multimeter is a really handy feature we would like to see incorporated into more multimeters. The Model 370 has an unusually high upper capacitance range that permits checking out the large-value capacitors normally used in solid-state circuits.

During our normal use tests, we also made some checks on the instrument's accuracy using high-tolerance precision resistors and a laboratory voltage standard. In addition, we compared the measurements we obtained with this multimeter in the capacitance range to a high-accuracy DMM's readings. In all cases, the measured accuracies were well within the published specifications.

CIRCLE NO. 84 ON FREE INFORMATION CARD

POPULAR ELECTRONICS



Mobile Communications:

CB vs. 2-METER FM

By John T. Frye, W9EGV

THE cool air in the service shop felt good to Barney as he stepped inside from the hot, humid weather outside.

"Hi, Bart," he greeted the graying man sitting in a wheelchair chatting with Mac. "Why the antenna farm sprouting from the roof of your hotrod out front?"

"You like my guttermounts?" Bart asked with a grin. "The short one is a CB loaded whip, and the long one is a 2-meter 5/8-wave vertical. I'm planning on doing some travelling, and I'm checking out the relative effectiveness of these two modes of mobile communication for drivers in general and physically handicapped drivers in particular. Since that bout with polio, I figure I'm a representative 'worst case' of the latter group. Even a flat tire on my hand-controlled car means I must have help."

"What rigs are you using?"

"The CB rig is a deluxe synthesized 23-channel job with incremental tuning, mechanical filter, S-meter, 0.5-microvolt sensitivity, r-f noise blanker, speech compression, 4 watts of r-f output, and a pi-network. I can plug a little 5-watt horn speaker into a jack on the back of the set and stick the speaker on the car-top with rubber suction feet and have my own portable PA system—a form of short range communication that has come in very handy on a couple of occasions.

"The 2-meter rig is a hand-held transceiver with switchable r-f outputs of either 2 watts minimum or 1 watt maximum. It measures about 10" x 3½" x 2" and weighs 2 lb., 4 oz with a self-contained 14.4-V, 500-mAH NiCd battery. It has two ceramic i-f filters, provides 0.5 watts of audio output, and has a sensitivity of 0.7 μV for 20 dB quieting. There is provision for five

sets of transmit/receive crystals, and I have three simplex and two repeater sets installed at present. These include the national simplex frequency at 146.52 MHz and the old 146.94 MHz, plus the local repeater on 147.78/.18 and the popular 146.16/.76 that will access repeaters in neighboring Indianapolis, Fort Wayne, Lafayette, and Chicago. When I start travelling, I plan to replace two of the simplex channels with .34/.94 and .22/.82 that my knowledgeable 2-meter friends recommend.

"There are probably two dozen hand-held transceivers on the market, and each has special features to recommend it; but I chose this one because it and the accessories available made it particularly suited for my needs. I can take it with me in my wheelchair, in the motel, and in the car. Those accessories include an external dynamic mike with PTT switch, a dc power cord with cigarette lighter plug, earphone, leather carrying case, a flexible rubber-ducky antenna that can replace the normal telescoping antenna, and a dual-rate battery charger into which the transceiver is dropped for charging at a normal rate of 50 mA and a trickle rate of 15 mA. On squelched receive it draws 30 mA; so when it is operating in the charger set to a normal rate, the net charge is a trickle charge. That's a handy feature for long-term monitoring, say in a motel room."

"Sounds to me like you're giving CB a 2/1 power advantage."

Before answering, Bart pulled a black, metal-cased object from his coat pocket and handed it to Barney. It measured about 4¼" x 3" x 1⅞" and had an SO-239 coax fitting extending from either side and two wires coming out a grommeted hole in one end. The

wires were attached to a cigarette lighter plug. Closer inspection revealed the object was actually a large finned heat sink with a shallow (1" deep) cover snapped over the flat side.

"It matters not how great their size; depend on me, I'll equalize," Bart quoted." Barney, this is an amplifier that I bought as a kit and assembled on a furnished pc board that's fastened to the back side of the heat sink beneath the cover. It's a solid-state vhf amplifier utilizing a high-power Motorola module, and it covers the 135-to-175-MHz band. It's completely self-contained and requires no tuning or setup. With a minimum driving power of 100 mW, it will put out 20-25 watts with a supply of 12 to 13.6 volts dc. You just insert it in the antenna feedline, plug it into the cigarette lighter socket, and you're in business. It's assembled for the r-f input you intend to use. In my case, I wired it for 1 to 3 watts, but attenuator resistors are furnished for inputs of 250 mW or less, 250 to 500 mW, and 500 mW to 1 watt. Within limits, power out is a function of power in; so when I have my hand-held transceiver on the lower output level, I get 12 watts out of the amplifier. This jumps to 25 watts when I switch the transceiver to 2 watts output. That means I have a choice of 25 watts, 12 watts, 2 watts, or less than 1 watt for my 2-meter tests; but I usually run full power when trying to make an initial contact."

"I suppose you have to take the amplifier out of the feedline when you want to run the hand-held barefoot, don't you?" Barney asked.

"Not at all. The unit contains a little carrier-operated relay (COR) that only inserts the amplifier into the feedline when both a carrier is present at the input and power is fed to the amplifier. When no carrier is present, as on receive, the antenna connects through the COR contacts straight to the receiver. If the cigarette lighter plug is pulled out, the COR is not operated by the transceiver carrier and the RF goes, unamplified, to the antenna."

"Okay, Bart, now you've told us about the equipment you're using, what about your findings?" Mac interrupted. "If you need help or just information on the highway, are you better off with CB or 2-meter FM?"

Which Is Better? "Let's talk about CB first," Bart answered. "The chief thing it has going for it is the sheer number of CB units in use—some-

thing like six million sets—and the fact that they are all concentrated on 23 channels in a single band. One out of every 28 American families has one or more CB sets, and 1 out of 5 longhaul trucks is CB equipped. While only about 2 million or so CB licenses are valid today, this doesn't tell the story. Many licenses usually cover several transceivers, and there are probably more unlicensed CB users than licensed. This last, though, is changing, probably because the license fee has dropped from \$20 to \$4 and the FCC is cracking down on violators. In the last year 9000 CB violators have been belted with fines ranging from \$100-\$300. For repeat cases, licenses have been revoked and fines up to \$10,000 levied. CB license applications that were running less than 15,000 a month in 1972 are now up to 500,000 a month.

"Yes, CB is becoming more respectable. REACT teams, as well as state and local police, monitor Channel 9, CB's emergency channel; and it's estimated 5.2 million calls are made yearly on that channel. Missouri has installed CB radios in all 750 of its highway patrol cars, and in Indiana the state police operate several mobile units under the call of KFP2179; and they hope this year to install CB sets in all of the state police posts. Other states are taking similar action. In addition to Channel 9, some state units monitor the old 'Trucker Channel 10,' or the 'New Trucker Channel 19.'

"But CB has disadvantages, too. The band is crowded, and popular channels are jammed with heterodynes and interfering signals. The AM receivers are subject to both natural and man-made noise. Often signals skipping in from 750 to 2000 miles away will be so strong that talking across town is nearly impossible. This condition will worsen as Sunspot Cycle 21 progresses. Some CB stations run far more than the legal 4 watts output and overload the front ends of nearby receivers, "bleeding" across a half-dozen channels each side of the offending signal."

"We don't have these troubles on two meters," Barney said smugly. "FM receivers reject static and man-made noise. While skip is not unheard of on two meters, it happens rarely compared to the 11-meter CB band, and even then it produces no squealing heterodynes. A ham license is a hard-won and cherished possession, and the vast majority of hams abide by

the rules and regulations of the FCC. If one accidentally puts out a broad and interfering signal, he hears about it immediately from fellow hams before the Friendly Candy Company, hopefully, can take note."

"All true," Bart agreed, "but probably repeaters are the main advantage 2-meter FM has over CB. There are over 2000 repeater licenses extant, and new applications are coming in at the rate of a dozen a week. These machines run considerable power, and their antennas are put just as high as possible to take advantage of the line-of-sight propagation of 2-meter signals. If a signal from your hand-held or mobile transceiver can access the repeater, the full power and ideal antenna site of the latter is at your command. If that repeater is on a mountain top, as is often the case on the coasts, your hand-held's signal may be heard for a radius of a hundred miles by anyone monitoring the repeater channel. Some repeaters even use satellite receivers linked to the repeater receiver by vhf or uhf to extend the weak-signal pickup. The satellite inputs are sampled by a scanning or 'voting' device that selects the most noise-free signal for feeding to the repeater receiver.

"A lot of good commercial service technicians are attracted to the 2-meter band, and some of the repeaters they set up are unbelievably sophisticated. A few will respond only upon receipt of a special tone-coded command, thus restricting their use to the subscribers. Upon a different command, they will transmit time, weather, and road conditions. Many repeaters have autopatch facilities so that if the mobile or hand-held unit is equipped with a touch-tone pad, the owner can place a telephone call through the repeater to tell the wife he will be late for supper or to report an accident directly to the police. Note, however, he cannot engage a motel room, order a radio part, or engage in any other commercial activity on the ham band. He can do so on CB as it is intended for personal and business use.

"In all honesty, though, two meters has some disadvantages, too. On a watts-per-dollar basis, 2-meter equipment is more expensive than CB. My CB set costs \$200, but if you are willing to sacrifice a few features you can get a good set for around \$150. The hand-held job, complete with accessories and crystals for five chan-

nels runs about \$350. On top of that, repeaters are expensive to set up and operate, and this money must come from the hams using them, either through club dues or subscriptions.

"But in spite of all the work, money, and dedicated cooperation hams pour into repeaters," Bart concluded, "there just aren't enough hams monitoring their 45-odd simple and repeater frequencies during the weekday daylight hours out here in the sparsely settled flat lands to insure reliable interception of signals from passing mobiles. There are only 255,000 hams spread out over their many bands and they have various interests. I greatly doubt if 100,000 of them operate on two meters. The picture is undoubtedly different on the coasts where people and repeaters are more concentrated, but I plan to travel the width and breadth of the country; and I can't afford a hatfull of crystals or an expensive synthesizer to hit the many repeater frequencies shown in a repeater directory. Things may be different if proposed FCC changes regarding a 'no code' vhf phone ham license go through. That opens up a lot of possibilities. But for now, I've repeatedly called on .52 and .94 and on the frequency of a local repeater for road information with only the repeater identification or its squelch-tail for a reply.

"On the other hand, I seldom need to make a second call on CB Channels 10 or 19, in the city or out on the highway, to get an immediate answer. I enjoy the ham contacts I do make, and I believe hand-helds and repeaters constitute the wave of the future. I certainly plan to take my hand-held transceiver with me wherever I go, but when I need help or information, I'll reach first for the CB mike.

"There are times, though," Bart said with a grin, "when both a belt and suspenders are not enough. My ham friend, Joe, and his son-in-law, a non-believer in electronic wizardry, were going to Florida in a truck camper last year. About 30 miles west of Chattanooga on I24 a rod went out through the side of the motor. 'No sweat,' says Joe. 'I've got nine channels in my 2-meter transceiver and all 23 in my CB set; so I'll just summon help.' An hour or so later, after vainly yelling himself hoarse on all channels of both transceivers, Joe unstrapped his trail bike from the front of the truck and rode off to get help. His son-in-law has never let him forget this." ♦

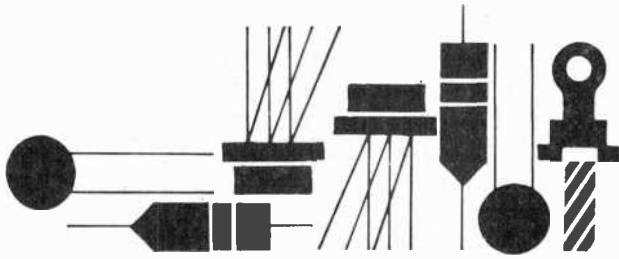

Solid State

BUILD YOUR OWN SONAR SYSTEM

By Lou Garner

SONAR — the name alone has an exciting quality, whether you're old enough to remember World War II, young enough just to have read about it in history books, or simply a viewer of the late-late TV movies. You have visions of determined, steely-jawed destroyer skippers searching relentlessly for killer U-boats. You hear the "ping-ping-ping" background sound as a tense and sweating American submarine commander attempts to elude an enemy patrol. Now, with a little skill, a dash of patience, a single IC, and a few accessory components, you can build your own sonar — not a military version, to be sure, but a practical down-to-earth (water?) instrument which can be used as a submerged object detector, depth finder, or fish locator, or, with a few modifications, for underwater data transmission and remote control applications. If you're not a yachtsman (yachtsperson) or fisherman (fisherperson), you can use the same IC to assemble an air ranging version called *sodar* (for SONic Detection and Ranging) suitable for remote sensing, collision avoidance, and intrusion or burglar alarm systems.

Utilizing a number of novel circuit design techniques, engineers at the National Semiconductor Corporation (2900 Semiconductor Drive, Santa Clara, CA 95051) have developed a monolithic IC which contains all the essential electronic circuitry for a complete sonar system within a chip area of only 80 by 93 mils. Affectionately dubbed the *fishfinder* by the firm's application engineers, the device, type LM1812, was released just recently for general distribution, although it has been in production on a semi-custom basis for over a year. Joining the manufacturer's growing family of special-purpose devices, which includes the LM3909 LED flasher, discussed in last year's July and October columns, and the NSL4944 universal LED, examined in our May issue, the LM1812's unusual circuit contains a 12-watt ultrasonic transmitter and a selective receiver featuring a 10-watt display driver. Despite its high peak power capabilities, the IC, in an 18-pin Epoxy B molded DIP, can be operated without an external heat sink in most applications.

Designed for use on standard 12-volt dc sources, the

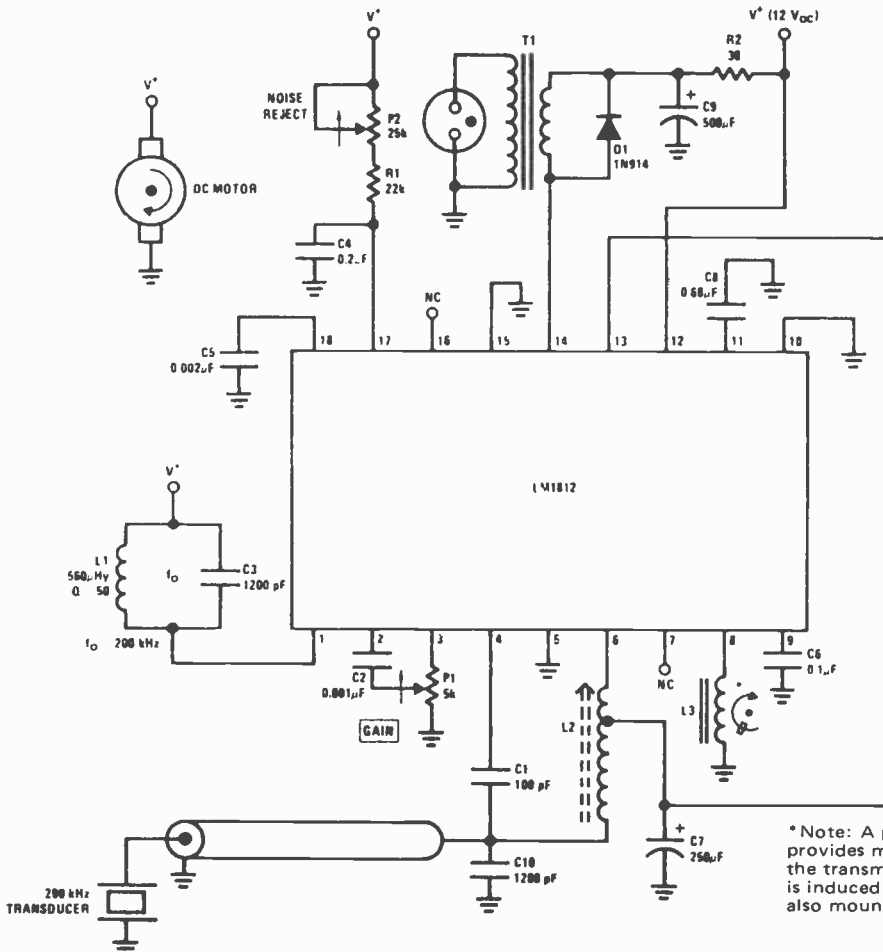

Fig. 1. A typical sonar system circuit. The component values are for operation in water.

* Note: A permanent magnet attached to a rotating wheel provides modulation pulses to pin 8. The time duration for the transmit mode is controlled by the voltage which is induced in a stationary pick-up coil. The neon display is also mounted on this wheel.

LM1812 has a maximum supply voltage rating of 18 volts, coupled with a maximum power dissipation of 600 mW. Its specified operating temperature range is from 0°C to +70°C. Under normal operating conditions, its receiver section has a typical sensitivity of 200 μ V p-p, with its display driver supplying a maximum current of 1 A for 1 ms. The unit's transmitter power output stage is capable of delivering a 1-A, 1- μ s pulse to a suitably matched load. Although generally used with a neon bulb or LED output display device, the LM1812 can be used in conjunction with a clocked digital readout or a CRT display.

A basic sonar system using the LM1812 is illustrated in Fig. 1. As in most conventional sonar systems, the basic design employs the "echo-ranging" principle—that is, the system transmits short, high-intensity ultrasonic pulses at fixed intervals and detects any resulting echos. In practice, the LM1812 transmits pulses of about 200 kHz for approximately 80 μ s through its external transducer, which also serves as a pick-up device. Between pulses, the receiver section is activated to detect any returning signals reflected by solid surfaces, such as a lake or river bottom, schools of fish, or submerged objects. These echo signals are detected and amplified, then used to drive the output display. The time differential between the original transmitted pulse and any returning signals is directly proportional to the distance from the object(s) causing the echo, permitting the output display to be calibrated in distance units (feet or meters) rather than time intervals.

A single resonant circuit, L1-C3, time-shared by both the receiver and transmitter sections, establishes the system's exact frequency of operation, thus eliminating the need for special alignment procedures and insuring that the two sections track over a relatively wide temperature range. The system's *transmit* mode is activated with the application of an externally generated positive-going timing pulse to the modulator control, pin 8. At this point, the gated oscillator is switched on, developing a controlled sinewave signal across resonant circuit L1-C3. Simultaneously, the second r-f stage is gated off, momentarily disabling the

receiver section. The sine-wave signal is internally amplified and squared, then applied to a one-shot multivibrator, where each leading edge triggers the generation of a 1- μ s pulse. Applied to the power amplifier, each pulse drives the stage into saturation, resulting in high-efficiency class-C operation. The amplified 200-kHz output signal is then coupled to the piezoelectric transducer by means of an impedance matching step-up auto-transformer, L2. The final transmitted signal, then, is a narrow burst of 200-kHz sonic energy. At the end of each timing pulse, the transmitter stages are deactivated and the receiving section gated on. During this period, and until the next timing pulse is applied, returning (echo) signals picked up by the transducer are applied to the receiver through coupling capacitor C1. An external gain control, P1, is provided between the first and second r-f amplifiers, coupled to the second stage through dc blocking capacitor C2. From here, the amplified signal is applied to a threshold detector which responds only to signals above an established level. Impulse noise is rejected by the combined action of the pulse train detector and integrator stages. The two circuits require a reasonable number of signal cycles for operation. If there is not a continuous train of pulses in the amplified signal (if 2 or 3 are missing, for example), representing a valid echo, the pulse train detector will "dump" the integrator, discharging the integration capacitor to ground. On the other hand, if the signal is valid, the display driver is switched on, activating the display device. An additional protective circuit momentarily disables the receiver if the display driver is kept on for too long a time period; this is accomplished by feeding back a signal from the display predriver stage to integration capacitor C8 which, in turn, furnishes a control bias to the duty-cycle control transistor.

Although the circuit's basic operation is the same whether it is used for sonar, data communications, or remote control, the external drive and output circuitry must be altered to meet individual system requirements. Generally, much less power is needed for communications and remote control applications than for echo ranging since the latter requires signal transmission over twice the distance (to the target and back). In remote-control systems, the display unit might be replaced by a relay or control device, such as an SCR or power transistor. On the other hand, if the LM1812 is used for communications, a high-impedance detector and audio amplifier should be connected to pin 1 for reception, with another used for modulation. Of course, a single amplifier can be used, if prefer-

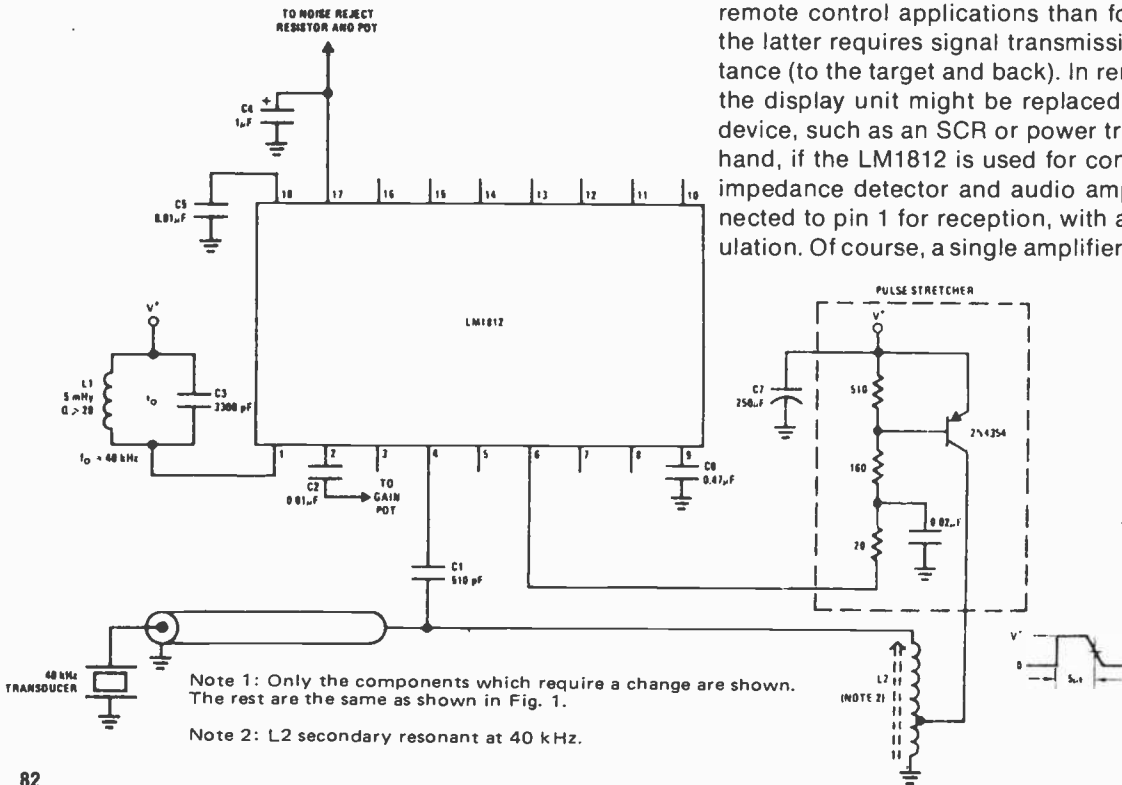

Fig. 2. Circuit modifications needed for a Sodar (air transmission) system.

red, switched back and forth between the modulator and receiver sections for transmission and reception. Variable rate pulse or other modulation techniques may be used for digital data or code communications.

Naturally, some means must be provided for measuring the time interval between the transmitted and echo pulses when the LM1812 is used in a sonar system. Any of several techniques may be used, including digital control and a clocked readout or an oscilloscope display with a calibrated linear sweep, but one popular method is illustrated in Fig. 1. Here, a small permanent magnet and a neon bulb are mounted near the rim of a wheel, with slip rings provided for applying a voltage to the bulb. The wheel is rotated by a constant-speed dc motor. The magnet serves to generate modulation pulses inductively as it passes a fixed pickup coil, *L3*. The neon bulb serves as the display device, driven by the receiver's output stage through transformer *T1*. Shunt diode *D1* is included to suppress switching transients, while a series filter, *R2-C9*, is provided to limit excessive current build up in the transformer's primary under rapid flashing conditions. The transformer must provide a substantial voltage step-up (from 12 to 100 volts or more) to insure flashing the bulb. In operation, the wheel's position at which the initial pulse is transmitted is considered "0," while the arc length traveled by the bulb before it flashes an echo represents the time required for the ultrasonic pulse to travel to the target and back. Since this time period is directly proportional to target distance, a fixed calibrated scale can be positioned around the wheel to indicate distances in feet or meters. Within system sensitivity limits, the sonar's maximum scale range is determined by the repetition rate of the transmitted pulses, for echoes can be received only during the intervening intervals. With a system design similar to the one shown in Fig. 1, then, the scale range is determined by the display wheel's rotational speed (hence motor rpm), for this determines the pulse rate.

Considering the relative attenuation of high-frequency ultrasonic signals in water and in air, a much lower operating frequency is recommended when the LM1812 is to be used in air transmission systems, such as sodar — typically 40 kHz rather than 200 kHz. The basic circuit modifications needed for operation in an air medium are given in Fig. 2. A different transducer is required, of course, together with a matching drive coil, *L2*. In addition, bypass and coupling capacitor values should be increased as indicated and the tuning elements (*L1* and *C3*) changed to achieve 40-kHz resonance, while an external "pulse stretcher" must be added to lengthen the drive pulse from 1 to 5 μ s. Driven by the LM1812, the pulse stretcher consists of a simple RC integration network and pnp power driver. Except for these few changes, the circuit arrangement and component values are identical to those of the system shown in Fig. 1.

When using the LM1812 in practical designs, special attention must be given to ground loops and common coupling paths due to the close proximity of transmitter and receiver circuits in the same package. Three ground pins (5, 10, 15) are provided on the device to simplify layout problems, but the ground path(s) still must be adequate to handle peak currents of as much as 2 amperes when the transmitter and display are energized simultaneously. Local sources of high-energy impulse noise, such as lightly loaded motors, if not shielded properly, can cause erroneous display signals or "blips." Ideally, these noise

Don't broadcast the fact that you've got a CB radio.

Now you don't have to let everyone know that you've got a mobile CB radio. Our model MR264 disguise antenna looks and acts just like a normal car radio antenna, operating on AM and FM as well as CB. We know the disguise is effective because we've been making them for law enforcement agencies for years. If you don't need a disguise antenna, but you do want superior CB performance in a cowl mounted 3-way antenna, check out our model M-267. Both models feature a stainless steel whip that detaches easily so your antenna won't get ripped off in the car wash either. When you're looking for antennas, 3-way, disguise or otherwise, take advantage of our 20 yrs. experience. Look for the Stripes of Quality.

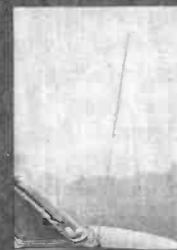

the antenna specialists co.



3 "Stripes of Quality"

a member of The Allen Group Inc.
12-35 Euclid Avenue
Cleveland, Ohio 44106
Export: 2200 Shames Drive
Westbury, L.I., New York 11590
Canada: A. C. Simmons & Sons, Ltd.

Distinctly Superior Performance.

©1976 by The Antenna Specialists Co.

THE COMPLETE DVM



\$348

FOR FASTER, MORE RELIABLE MEASUREMENTS

A NEW STANDARD IS BORN
High accuracy you can trust
Versatile measuring capabilities
An efficient, easy to operate meter
All at an affordable price
That's the DVM38 . . . The complete DVM that sets new performance standards in 4 key areas.

A NEW ACCURACY STANDARD
The 3 1/2 digit, .1% accuracy is backed by a 15 meg Ω input impedance, compared to 10 meg Ω input of conventional DVM's, which guarantees up to 50% greater accuracy with 1/3 less circuit loading on every measurement for high accuracy you can trust.

A STANDARD IN CAPABILITIES
The DVM38 is more accurate in MORE circuits with these versatile ranges:
100 μ V to 2000V DC, 1KV AC; .01 Ω to 20 meg Ω ; 0.1 μ A to 2A . . . Plus

HI and LO ohms and a 50KVDC range with accessory Hv probe.

A NEW STANDARD IN SPEED AND EASE OF OPERATION

Large pushbuttons and callouts — no need to hunt and peck. Large 4" L.E.D.'s with direct readout, down to V and mV indicators. SINGLE STEP AUTO-RANGING for maximum resolution and efficiency. 2KV DC protection minimizes downtime.

THE AFFORDABLE STANDARD

There are few .1% DVM's less expensive — there are none as complete in this price range, plus backed by a LIFETIME guarantee against factory workmanship errors.

THE DVM38 A NEW STANDARD IN DVM'S FOR SPEED, VERSATILITY AND ACCURACY.

DVM38 BACKED BY SENCORE'S 100% MADE RIGHT LIFETIME GUARANTEE

SENCORE 3200 Sencore Drive, Sioux Falls, S.D., 57107
Phone: 1 605 339-0100. TWX: 910-660-0300

CIRCLE NO. 54 ON FREE INFORMATION CARD

pulses should be filtered at the source, but their effects can be minimized by connecting a small capacitor (about 30 pF) across the first r-f stage (between pins 3 and 4) to reduce amplifier bandwidth. Finally, for optimum overall performance and maximum efficiency, the transducer driver coil (L_2 in Figs. 1 and 2) should be designed to resonate at the proper frequency (200 kHz for water and 40 kHz for air systems) with the sum of all output circuit capacitances, including distributed wiring, that of the coax cable feeding the transducer, and the transducer itself.

Reader's Circuits. Submitted by Peter Lefferts (1640 Decker Ave., San Martin, CA 95046), the two circuits given in Fig. 3 illustrate additional applications for the versatile NSL4944 universal LED. Both designs utilize the LED's unique current regulation characteristic, both are suitable for home projects, both use standard components, and both are noncritical as far as layout and lead dress are concerned. Referring, first, to Fig. 3A, this decoupling network can be used wherever stage isolation is required, as when powering a preamp in an audio amplifier. Essentially a standard pi filter network with a constant current LED used in place of a resistor or inductance, the circuit attenuates power supply ripple by some 60 dB while attenuating back-coupled signals more than 70 dB. The only critical factor is the load current, which must be within the LED's capability, yet, at the same time, large enough to insure LED operation within its constant-current mode — typically about 13 mA. If the load requirements are unusually small, as with some FET preamps, a shunt load resistor (R_1) is needed to increase the LED's current to within the

Fig. 3. Some applications for NSL4944:
(A) Decoupling filter;
(B) Capacitor tester.

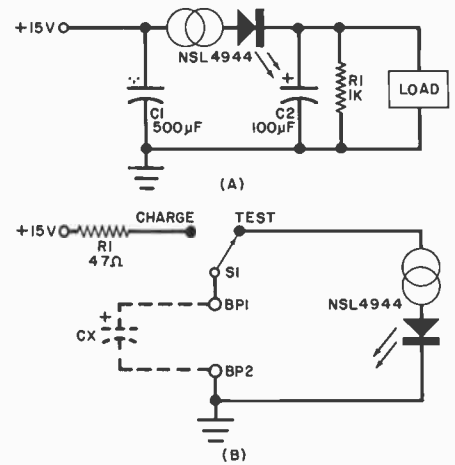

optimum range. The dc voltage drop across the LED is a little over 2 volts. The second circuit, Fig. 3B, is an extremely simple tester for large electrolytic capacitors. Control switch S_1 is a center-off, spdt toggle, lever, rotary or slide switch; series resistor R_1 is a 1/2-watt unit, and BP_1 and BP_2 are standard binding posts. In operation, the test capacitor, C_x , is connected to terminals BP_1 and BP_2 with correct dc polarity. Switch S_1 is thrown first to the *charge* position, charging the capacitor from the dc source through series limiting resistor R_1 , then to the *test* position. The constant-current LED will discharge the capacitor from 15 volts to 2 volts *linearly*, staying lit during this period. If a typical 13-mA NSL4944 is used, a 1000- μ F capacitor will discharge in just one second. Variations in the characteristics of individual LED's can be compensated by adjusting the supply voltage to a value just two volts more than the *actual* LED current in mA (i.e., an 11-mA LED would require a 13-volt supply). By estimating (or measuring) the discharge time, an experienced user can check capacitors with values from about 500 μ F to over 100,000 μ F (from 1/2 to 100 seconds). Leakage can be estimated by charging the capacitor a second time, waiting for one discharge period, then testing. With a nominal LED (13 mA), a 10% *decrease* in discharge time would indicate a leakage of 1.3 mA for the test unit. If the LED fails to light when S_1 is thrown to its test position, the capacitor is either shorted or open.

Device/Product News. Currently, microprocessors seem to be dominating the technical news front. Fairchild's Microsystems Division (1725 Technology Drive, San Jose, CA 95110), for example, has introduced a new microprocessor design kit on a fully assembled circuit board which comes complete with a connecting cable for power supply and terminal hookup. The circuit board contains Fairchild's 3850 F8 CPU device, the 3851 program storage unit circuit, the 3853 static memory interface circuit and eight 2102 static RAM's (1 kilobyte of memory). The complete kit is priced at \$185.00 in small quantities.

Both Signetics, Inc. and Motorola Semiconductor Products have slashed the prices of their microprocessors. Signetics has reduced the price of its Model 2650 general purpose, 8-bit, 5-volt, TTL compatible n-channel μ P from \$72.00 to \$26.50 in small quantities (1-24). Motorola has reduced the price of its type 6800 8-bit n-channel device from \$69.00 to \$35.00 in 1-9 units. The firm also has dropped the price of its MC6860 modem from \$32.00 to \$17.00 in small quantities.

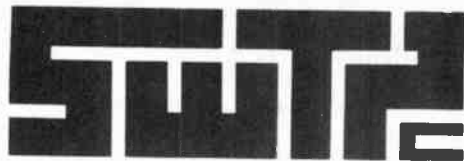

SUPPLIES THE MISSING LINK AC-30 CASSETTE INTERFACE

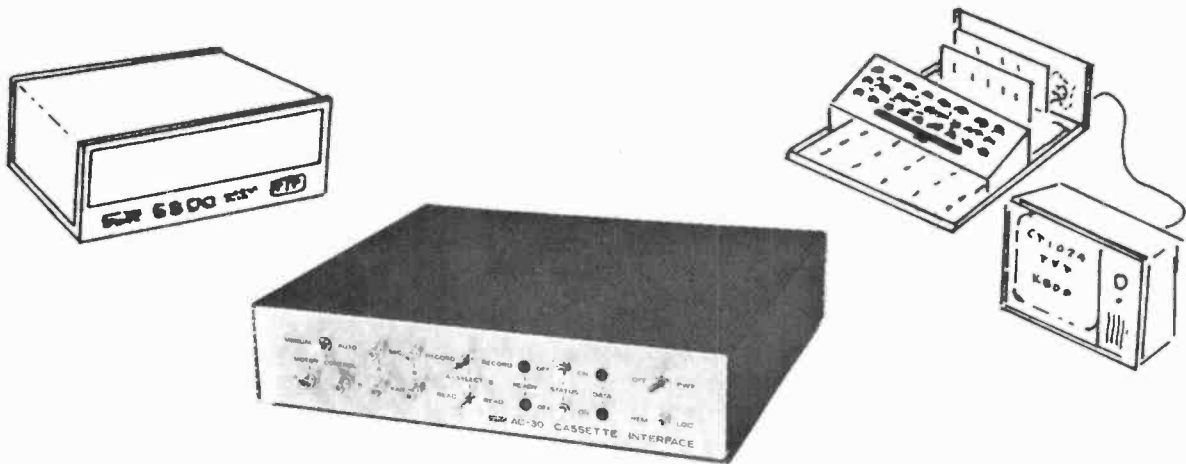

Been looking for a practical way to input and dump programs to your computer? Well your search is over.

With our new AC-30 Cassette Interface you will be able to store and input program data to any computer system having RS-232 serial interfaces and a UART circuit having an accessible 16X clock frequency. Data format is the "Kansas City" standard which was selected for its tolerance of speed variations in the recording device. The AC-30 may be used with any cassette recorder of reasonable quality.

If both your computer and terminal have accessible 16X UART clocks and will operate at 300 baud—as do our 6800 computer and CT-1024 terminal system—the AC-30 may be used between the terminal's serial interface and the computers control interface. This eliminates the need for a separate interface to drive the cassette unit. It also allows you to use the computer system's tape load and dump routines built into Mikbug® or similar ROM software.

Independent control circuits are provided

for two audio cassette recorders (not included in the kit). One recorder's tape may be read while the second is recording a new updated tape; making it possible to generate new program tapes, data tapes and to create program object tapes while reading and assembling program source tapes. The operating mode for each recorder is selected by switches on the front panel and LED indicators show the mode that is selected at any particular time. Computer controlled record, play and motor control commands may be used with this system if they are available from the terminal being used. This feature is available on our CT-1024 terminal if the CT-CA cursor control card is installed.

The AC-30 is housed in a 12¾" x 3" x 12½" aluminum chassis. It is powered by a self contained 115/230 Volt AC 50-60 Hz power supply. Data is FSK format using 1200 Hz and 2400 Hz at a 300 baud data rate. Recorder speed tolerance need be only ± 20%.

© Trademark Motorola

AC-30 Cassette Interface Kit \$79.50 ppd

Southwest Technical Products Corporation

219 W. Rhapsody

San Antonio, Texas 78216

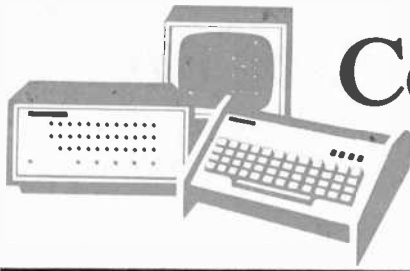

Computer Bits

By Hal Chamberlain

COMPUTER GRAPHICS

MORE and more of the sophisticated computer applications that were once reserved for big computer systems are being successfully pursued by hobbyists. Sooner or later, after the novelty of having "your very own computer" has worn off, the typical hobbyist will settle down and concentrate on one or two particular applications for his computer. In many cases, hardware specific to the chosen application will be built or purchased and increasingly complex software will be written to get the best performance possible out of the hardware.

The conceivable applications of hobby computers are almost too numerous and diverse to list. However, one application that might interest all computer hobbyists is computer "graphics".

What Is Computer Graphics? In a nutshell, computer graphics is a general term referring to the equipment and programs used for *pictorial* input and output rather than the usual alphanumeric input/output. Computer graphics is very useful for game-playing boards, artistic pursuits, architectural and engineering drawings, plotting mathematical curves, amateur slow-scan TV, and of course impressing your friends. Graphics can also be an integral part of other hobby

computer applications. Interactive computer games is one obvious example and electronic music is another where graphics might be used to enter and plot waveforms or envelope shapes.

If the user can control the pictorial display in real-time (the picture changes immediately when so commanded), the system is said to have *interactive* graphics capability. This is obviously very useful in action computer games such as Space War where objects are constantly moving around on a screen under both computer and player control. Interactive capability is also useful in artistic and drawing situations when editing of the picture is done.

Computer Graphics Hardware. Perhaps everybody with any exposure to commercial computers has at one time experimented with "printer pictures." These are created with standard characters printed at selected places on a printout page. Input of the image data is usually done by an imaginative and patient operator. The results are quite coarse and have to be looked at from across a room to be appreciated. For more practical results, specialized graphics hardware is needed.

The most common graphics output devices are CRT (cathode ray tube) displays and mechanical plotters. CRT's have the advantage of much lower cost and interactive capability. Plotters, of course, produce an image on paper that can be saved for later use away from the computer.

Graphic input devices are much more diverse. The most common are special "function keyboards" and potentiometer dials. A function key may, for example, erase a previously designated line from the image when depressed. Two potentiometers can be programmed to move an object around the screen in horizontal and

vertical directions. A "joystick" can replace two controls and provide greater ease of movement control. Light pens are used to "point out" or select an object that is being displayed. With proper programming, the operator can seemingly draw images directly on the CRT screen. A "graphic tablet" allows one to trace a paper drawing into the computer's memory. A digital TV camera such as the Cyclops (POPULAR ELECTRONICS, February 1975) can also be used for graphical input.

There are two fundamental methods of displaying or drawing a picture with a computer. Any image can be broken up into a number of dots as is done in newspapers or television. If the brightness or size of the individual dots can be controlled, then grey-scale pictures can be displayed. Images can also be broken up into straight lines of various lengths and angles. Although grey-scale display using lines is uncommon, it is possible. Computer graphics output equipment uses both methods on CRT displays and plotters. Let us compare these two output methods.

The earliest computer graphic displays were called "point plot" displays. These consisted of a modified oscilloscope and two digital-to-analog converters. A digital-to-analog converter (DAC) accepts binary numbers from a computer and translates them into corresponding dc voltages. One DAC would be connected to the x-axis deflection input and the other to the y-axis input on the oscilloscope. The computer program could display a dot at any point on the screen by giving its x and y coordinates. An image could be drawn by displaying the proper dots one at a time in rapid sequence. A later improvement in display circuit technology allowed straight lines to be drawn between points. This greatly increased the pos-

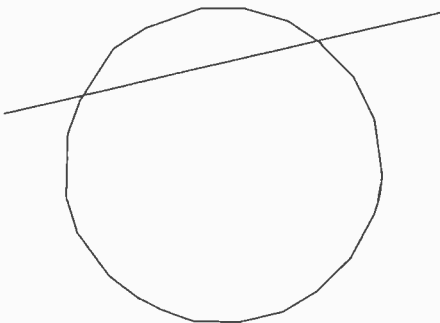

Circle and line drawn on vector display 30 x 30.

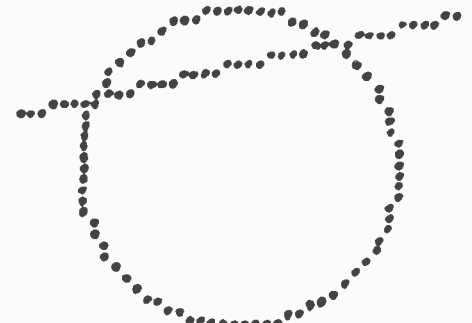

Circle and line drawn on raster display 30 x 30.

sible image complexity since one command from the computer could replace literally hundreds of individual dots. Displays capable of drawing lines from one point to another are called *vector* displays and the lines themselves are called *vectors*. Usually, when a computer professional talks about graphic displays, he means vector displays.

A major advantage of both point-plot and vector displays is that the amount of computer memory necessary to hold the image depends mainly on the image complexity (the number of points or lines actually displayed). Display resolution can be very high, with only a small increase in memory usage. For example, take a simple image containing 100 disjointed lines. A low resolution hobby display using only 8 bits for x and y coordinates would require four bytes for each line or 400 bytes in all. A high-resolution commercial display may use 12 bits for x and y resulting in a 600-byte display list. The first display has about 65,000 (256 x 256) addressable points. The second has nearly 17,000,000 possible points with only a 50% increase in storage requirements. It should be noted that the apparent resolution (sharpness) of a vector display may be high, even if the end point resolution is rather low. This is because the lines drawn are absolutely straight and their width is limited only by the electron beam focus.

An important consideration in point-plot and vector displays is speed. Since the points or lines are plotted one at a time, a complex image may require a significant amount of time to draw. If redrawing of the image is not done fast enough, then it may fade away from the CRT screen between "refreshes" and appear to flicker. Usually the display itself limits drawing speed; but, in a hobby system the computer may be the limiting fac-

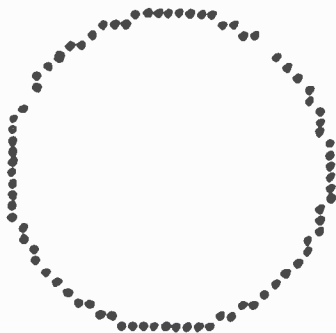

Circle on raster display with line erased.

tor. Use of special phosphors with a long persistence characteristic in the CRT slows image fading and allows a greater number of lines to be drawn without flicker. If the flicker can be tolerated, very complex images can be drawn even on a simple display.

A new type of dot display that has only recently become practical for computer graphics is the *raster-scan* display. In this type of display the electron beam is constantly scanning through a large matrix of dots in much the same way as a television receiver. In fact, raster-scan displays of interest to hobbyists actually use a television receiver modified for direct video input. To form an image, the computer must turn the beam on when it is scanning the desired dots and turn it off otherwise. The scanning speed in a TV receiver is so fast however that direct program control of the beam is almost never possible. Instead, a portion of the computer memory is read out by the display controller in step with the scanning beam and memory bits control whether or not the beam is turned on. Thus one bit in memory is required for each *possible* point on the display regardless of whether it is turned on or not. Additional bits for each display point may be used for grey scale or even full color.

A major advantage of raster-scan displays is that the display screen may be an ordinary television receiver. The rest of the display controller can be as simple as one or two circuit boards that plug directly into the computer. A vector display requires a fair amount of analog circuitry using op amps and an oscilloscope for the actual display. Although a suitable oscilloscope is already owned by many hobbyists, a large-screen display suitable for group viewing requires a special deflection yoke and high-power deflection amplifiers.

A primary disadvantage of the raster-scan technique is that the amount of memory necessary to hold the image depends on display resolution rather than image complexity. A 128-by-128 point matrix, which is an absolute minimum for graphics, has 16,384 points. At 8 bits per byte, 2K bytes of computer memory will be required to hold an image no matter how simple it is. Merely doubling the resolution to a 256-by-256 matrix quadruples the memory requirements to 8K bytes. Adding grey scale or rough color capability may quadruple the memory requirements again. It is this

THE BOOK

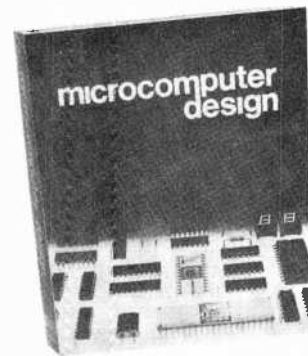

Now available for **\$25**

Thousands of copies of our innovative book on microprocessors, published in 1974, were purchased by engineers and designers around the world . . . for \$75 each. Now **Microcomputer Design**—revised, expanded, and reprinted in paperback—is available for \$25! Over 400 pages on quality white text paper, including:

- 8080 circuits, theory of operation
- Vectored interrupts, for all 8-bit CPUs
- Efficient bus structure design
- Interfacing to timers, A/D converters, keyboards, digits, and other I/O
- Plus much more!

Full schematics and circuit descriptions are provided for the 8080-based central processing unit of the **MIKE 3** microcomputer, in the **modular micro** series from Martin Research. Used as a textbook in many college courses, **MICROCOMPUTER DESIGN** is also a popular book with advanced home computer hobbyists.

THE SILVER BOX!



What's in the silver box? It depends on your application. Based on our **modular micro** computer series, the versatile industrial control package is currently being used as a time accounting machine; an industrial batching controller; and a multi-home security system—among others.

We know that many **Popular Electronics** readers have potential microcomputer applications in mind, in their own business environments. Yet few corporations can support a full-scale in-house microcomputer development program. If this problem sounds familiar, look into the **silver box** from Martin Research! Prompt quotes on specialized control systems.



martin research

3336 Commercial Ave.
Northbrook, IL 60062
(312) 498-5060

Bank Americard, Master Charge accepted.
U.S. prices; foreign delivery extra.

Now: available through Semiconductor Specialists!

CIRCLE NO. 36 ON FREE INFORMATION CARD

If you can't go to college for your career in electronics —read this!

CREI brings college-level training to you with eight educational advantages, including special arrangements for engineering degrees

The best way to qualify for top positions and top pay in electronics is obviously with college-level training. The person with such training usually steps more quickly into an engineering level position and is paid considerably more than the average technician who has been on the job several years.

A regular college engineering program, however, means several years of full-time resident training—and it often means waiting several years before *you can even start your career*. This, of course, is difficult if you must work full time to support yourself and your family.

If your career in electronics is limited without college-level training, take a look at the advantages a CREI home study program can offer you.

1. Convenient Training

CREI brings the college to you. Through the convenience of home study, you receive exactly the same level of training you will find in any college or university offering programs in electronic engineering technology. With CREI, however, you can “go to college” whenever you have spare time at home or on the job.

2. Specialized Programs

With CREI, you enjoy the advantage of *specialized* training. That is, your program will include only those courses directly applicable to your career in electronics. We omit such courses as English, social studies and other subjects, which are usually required in resident schools. Therefore, with CREI, you move ahead faster to the more interesting and useful part of your training.

3. Practical Engineering

CREI programs give you a *practical engineering* knowledge of electronics. That is, each part of your training is planned for your “use on the job.” By using your training, you reinforce the learning process. And by demonstrating your increased knowledge to your employer, you may qualify for faster career advancement.

4. Engineering Degrees

CREI offers you a number of special arrangements for earning engineering degrees at recognized colleges and universities. You can earn college credit while you are taking your CREI program or apply later, whatever is best for your career plans.

Career Training at Home

5. Unique Laboratory

Only CREI offers you the unique Electronic Design Laboratory Program. This complete college laboratory makes learning advanced electronics easier and it gives you extensive practical experience in many areas of engineering, including design of electronic circuits. No other school offers this unique program. It is a better "Lab" than we have found in many colleges. And the professional equipment included in the program becomes yours to keep and use throughout your professional career.

6. Wide Program Choice

CREI gives you a choice of specialization in 14 areas of electronics. You can select exactly the area of electronics best for your career field. You can specialize in such areas as computer electronics, communications engineering, microwave, CATV, television (broadcast) engineering and many other areas of modern electronics.

7. Prepared by Experts

Experts in industry and technical organizations of government develop CREI programs. Each part of your training is developed by a recognized expert in that area of electronics. That means you get the most up-to-date and practical instruction for your career.

8. Industry Recognition

That CREI training is recognized by industry and government is evident from the fact CREI provides training to advanced technical personnel in over 1,700 technical organizations. Many subsidize the training of their employees with CREI. If there is any question about the advantages of CREI training for you, ask your employer or any engineer to evaluate the outline of a CREI program for you.

Other Advantages

Of course, there are many other advantages to CREI training. For example, throughout your training, CREI's staff gives you personal instruction for each step of your program. And in many industrial areas, both in the U. S. and abroad, CREI Field Service Representatives provide a number of important personal services for your training and your career.

FREE Book

There isn't room here to give you all of the facts about career opportunities in advanced electronics and how CREI prepares you for them. So we invite you to send for our free catalog (if you are qualified). This fully illustrated, 80 page catalog describes in detail the programs, equipment and services of CREI.

Qualifications

You may be eligible to take a CREI college-level program in electronics if you are a high school graduate (or the true equivalent) and have previous training or experience in electronics. Program arrangements are available depending upon whether you have extensive or minimum experience in electronics.

Send for this **FREE Book** describing your opportunities and CREI college-level programs in electronics

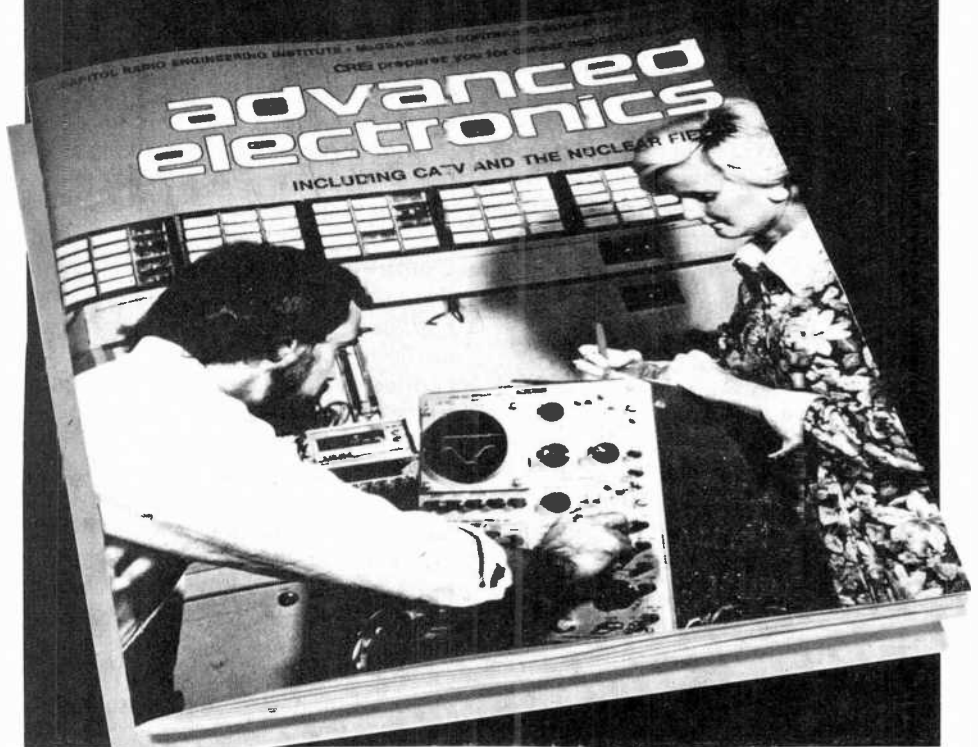

Mail card or write describing qualifications to

CREI **CAPITOL
RADIO
ENGINEERING
INSTITUTE**

McGraw-Hill Continuing Education Center
3939 Wisconsin Avenue Northwest
Washington, D.C. 20016

Accredited Member National Home Study Council

GI Bill

CREI programs are approved for training of veterans and servicemen under the G.I. Bill.



The IMSAI 8080.

A commercial yet personally affordable computer.

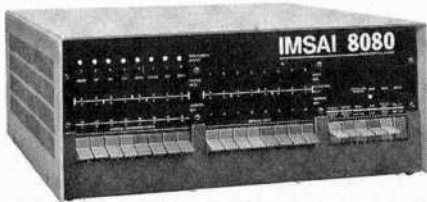

If you thought you could never afford a computer at home, think again. The IMSAI 8080 is built for rugged industrial performance. Yet its prices are competitive with Altair's hobbyist kit. Fully assembled, the 8080 is \$931. Unassembled, it's \$599.

The IMSAI 8080 is made for commercial users, and it looks it. Inside and out. The cabinet is attractive, heavy gauge aluminum. The heavy duty lucite front panel has an extra 8 program controlled LED's. It plugs directly into the Mother Board without a wire harness. And rugged commercial grade paddle switches are backed up by reliable debouncing circuits.

The system is optionally expandable to a substantial system with 22 slots in a single printed circuit board. And the durable card cage is made of commercial-grade anodized aluminum.

The IMSAI 8080 power supply produces a true 28 amp current, enough to power a full system. You can expand to a powerful system with 64K of software protectable memory plus an intelligent floppy disk controller. You can add an audio tape cassette input device, a printer plus a video terminal and a teletype. And these peripherals will function with an 8-level priority interrupt system. BASIC software is available in 4K, 8K and 12K.

Get a complete illustrated brochure describing the IMSAI 8080, options, peripherals, software, prices and specifications. Send one dollar to cover handling to IMS. The IMSAI 8080. From the same technology that developed the HYPERCUBE Computer architecture and Intelligent Disk systems.

Dealer inquiries invited.

IMS

IMS Associates, Inc.
14860 Wicks Boulevard
San Leandro, CA 94577
(415) 483-2093

PE-7

need for large amounts of memory that made raster-scan graphics prohibitively expensive in the past, when memory costs were 10 to 100 times more than they are now.

For some graphics applications such as engineering drawings, even a 256-by-256 resolution will not be enough. Grids of 512-by-512 or even 1024-by-1024 are used for serious graphics work. Although home televisions can theoretically handle 500-by-500 resolutions when modified for direct video input, the 30-Hz flicker of individual dots when viewed at close range may be objectionable. Higher resolutions require the special yokes and deflection amplifiers again.

While a vector display is far superior for line drawings, a raster scan display is best for pictorial material. Amateur slow-scan TV applications, weather-satellite picture reception, and computer art are all best accomplished with a raster-scan display. In particular, the TV Dazzler (POPULAR ELECTRONICS, February 1976) can produce some really spectacular patterns. Either type of display can do a good job on game boards. A graphic display of either type can often replace a TV typewriter since text characters are really just graphic shapes.

Computer Graphics Software.

Even the most sophisticated graphics hardware is useless without software to run it. A vector display is normally connected to several parallel output ports on the computer. Data sent to one pair of ports may cause the display to draw a line from where it was last to the new x and y positions specified by the data. The same program action using another pair of ports may just move the beam without drawing. Ordinary output instructions are used to send data to the display generator. A complete image is drawn by outputting data associated with each line until all lines are drawn. The program must continuously execute a loop to keep the image refreshed on the screen.

Image data for a vector display can be generated in three different ways. The simplest is to have the data stored in a display list in memory. A very simple program loop is used to work through the list and send data to the display. With some kinds of simple images it may be possible to compute the data in line. The x coordinate of a waveform display for example would always increase the same amount for

each waveform point displayed. This technique can save a lot of space in the display list but does slow down image refresh. In a system with graphic input devices, data can be read from an input and sent directly to the display without storing it in memory. In most graphic applications, a complete image can be drawn using a combination of these techniques.

A raster-scan display can only run from a display list in memory. Also the display controller automatically runs through the list to generate the display. The computer program is only responsible for storing the proper data patterns in the display list. Thus the program is free to do other tasks without having to constantly refresh the display.

The real software job in computer graphics is generating the data to be displayed. One obvious way is to work up the list by hand. This is quite straightforward using graph paper and the computer keyboard. The desired image is first drawn on the graph paper. Then, in the case of a vector display, the coordinates of the line's endpoints are read off and entered into the computer memory. With a raster display, all of the dot positions covered by the image will have to be entered. Although simple, this method hardly makes much use of the computer.

The real value of graphics is realized when the program computes a display list from pertinent data about the image rather than a line-by-line description of it. Consider a routine that would accept an image name (cube, pyramid, etc.), its size, and its position in three-dimensional space. The routine would then generate a display list to show that object in perspective on the two-dimensional screen. Changing a parameter and calling the routine again would generate a new list with the object in the new position. Motion can be programmed by changing the position slightly each time the image is refreshed. The calculations involved are really rather simple for line images and vector lists.

With a raster display, a subroutine is needed to accept line endpoints as input data and set bits in the display list to display the line. If the lines are always horizontal, vertical, or at 45-degree angles, the routine can be quite simple. A more complicated routine is needed if lines at any angle are to be handled.

It is also frequently desirable to edit

images on the display. The operator may want to add lines, delete lines, or move lines. With a vector display list, additions are handled by adding the extra lines to the end of the list. Deletions can be accomplished by replacing the deleted line coordinates with a null line such as a zero distance move. If the list gets too big during editing, a "garbage collection" routine can compress the null lines out of the list. A line change can be easily made right in the list.

Making additions to a raster display list is also easy; just set the bits covered by the added line or object. A deletion might be handled by calling the line generation subroutine with the endpoints of the line to be deleted and have it reset the bits covered by the line, thus erasing it. All lines crossed by the deleted line will have little gaps left over. The same problem occurs when a line is moved since it must first be deleted and then added elsewhere. The only real solution to this problem is to have two display lists. One is a vector list and the other is the raster list that is actually displayed. Editing is done on the vector list. Whenever any change is made to the vector list, the raster list is first cleared. Then it is completely regenerated from the vector list by repeatedly calling the line generation routine. Unfortunately, complete regeneration is slow, which restricts the kind of motion that can be programmed on a raster display.

In conclusion, graphics is one of the most creative applications for a hobby computer. It is simple enough to get gratifying results with only a little effort yet has the potential of keeping the most serious hobbyist occupied for years. Graphic output is readily appreciated by those with no computer experience and at the same time is appreciated by the experts. ♦

More Hobbyist Clubs:

Kentucky

Louisville Area Users of Microprocessors, Steve Roberts, Cybertronics, PO Box 18065, Louisville, KY 40218.

North Carolina

Triad Amateur Computer Society, Greensboro and Winston-Salem (NC) area. Doug Drye, (919) 373-0040.

Triangle Area Computer Club (temporary name), Raleigh, Durham, and Chapel Hill (NC) area. Russell Lyday, (919) 787-4137.

JULY 1976

FREE

McIntosh CATALOG and FM DIRECTORY

Get all the newest and latest information on the new McIntosh Solid State equipment in the McIntosh catalog. In addition you will receive an FM station directory that covers all of North America.



MX 113

FM/FM STEREO - AM TUNER AND PREAMPLIFIER

**SEND
TODAY!**

McIntosh Laboratory, Inc.
East Side Station P.O. Box 96
Binghamton, N.Y. 13904
Dept. PE

NAME _____

ADDRESS _____

CITY _____ STATE _____ ZIP _____

If you are in a hurry for your catalog please send the coupon to McIntosh.
For non rush service send the *Reader Service Card* to the magazine.

CIRCLE NO. 38 ON FREE INFORMATION CARD

PERIPHERALS for your ALTAIR or IMSAI

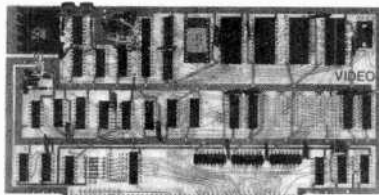

VIDEO TERMINAL INTERFACE

Connects to standard TV monitor (or modified receiver) to display 16 lines of 64 or 32 characters in a 7 x 9 matrix. Character set includes 128 upper and lower case ASCII characters and 64 graphic characters for plotting 48 x 64 (128 with memory option) array. Text and graphics may be mixed on the same screen. 8-bit keyboard input port is provided. Characters are stored in the on-board memory and may be read or written by the computer. Cursor control, text editing and graphics software is included. Fully compatible with Altair and IMSAI. Sockets included.

VTI/32 32 character line \$185.00 kit
VTI/64 64 character line \$210.00 kit \$285.00 asssd.

ANALOG INTERFACE

Complete interface for a CRT graphics display or X-Y plotter. Provides 8 channels of software-controlled A/D conversion. 1 or 2 channels of analog output with 10-bit resolution (0-10v or $\pm 5v$ out). 6 bits of latched digital output, and 8 analog comparators. Software included for A/D conversion by successive approximation and tracking. Sockets included.

ADA/1 1 analog output \$145.00 kit
ADA/2 2 analog outputs \$195.00 kit \$255.00 asssd.

All prices and specifications subject to change without notice. Prices are USA only. Calif. residents add 8% sales tax. Add 5% shipping, handling, and insurance.

POLYMORPHIC SYSTEMS

737 S. Kellogg, Goleta, CA 93017 (805) 967-2351

BankAmericard and Master Charge Accepted

CIRCLE NO. 45 ON FREE INFORMATION CARD

FREE catalog over 2000

unique tools,
handy kits,
precision
instruments,
technical
supplies.



Our 23rd year of service to the World's
finest craftsmen and technicians.

A carefully selected and tested assortment of unique, hard-to-find tools, clever gadgets, precision instruments, bargain kits. One-stop shopping for the technician, craftsman, hobbyist, lab specialist, production supervisor. Many tools and measuring instruments available nowhere else. One of the most unusual and complete tool catalogs anywhere. Get your copy of the NC FLASHER today.

National Camera
2000 West Union Ave., Dept. GGA
Englewood, Colorado 80110
(303) 789-1893

CIRCLE NO. 67 ON FREE INFORMATION CARD

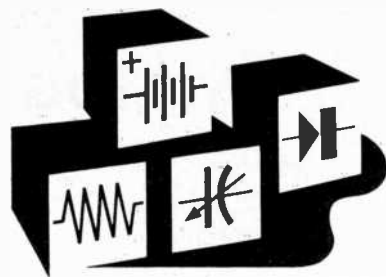

Inside Basic Electronics

FIXED AND VARIABLE RESISTORS

THE FUNDAMENTAL ground rules of electronics are simple enough: electronics deals with the flow of electrons, called *current*. *Voltage* is the pressure that causes electrons to flow, while *resistance* impedes the flow.

Though all material possesses resistance, resistors in electrical and electronic applications are designed to introduce some desirable amount of resistance to current flow, perhaps to obtain a specific voltage drop. In contrast, insulators may have a resistance as high as 10^{14} ohms, virtually stopping all current flow.

Resistors are considered to be passive devices. That is, they do not generate energy, but merely convert applied electrical energy into heat. Nor are resistors intended to be influenced by frequency, though resistance can change at high frequencies (say, much over 100,000 hertz).

Resistors are specified by three factors: resistance value (ohms), tolerance (a percentage) and power or heat dissipation (watts).

Resistance Value & Tolerance. The small size of fixed carbon and deposited-metal resistors makes it

prohibitive to have resistance and tolerance information printed on their cylindrical bodies. As a result, the use of circumferential color-coded bands was adopted to indicate ohmic value and tolerance at a glance.

Ten colors are used in the code to signify 0 through 9 for each of the first three bands. The third band is a multiplier (the number of zeros to be added). A fourth band can be missing, silver or gold. If missing, the resistor has a 20% tolerance; if silver or gold, the tolerance is 10% or 5%, respectively. Thus, a resistor with bands of brown, black, yellow, and silver has a value of 1 (brown), 0 (black), 0000 (yellow) and a 10% (silver) tolerance. That is, it is a 100,000-ohm $\pm 10\%$ resistor. A 1000-ohm resistor with a 10% tolerance will actually have a resistance somewhere between 900 and 1100 ohms.

Power. Power, in watts, tells us how much heat a resistor can safely dissipate with unrestricted air circulation over normal temperature variations specified by the manufacturer. Exceeding this will either destroy the component or cause it to permanently

change value, even when cooled.

To operate a resistor safely when the temperature exceeds its norm, the power rating should be *derated*. For example, if a 2-watt carbon composition resistor is operated at 120°C when the maximum should be 80°C, the power rating should be reduced by 40% to 0.8 watt. In practice, it's a good idea to operate a resistor at less than half its rated power. Also, the resistor should have at least one diameter of space between it and another heat-dissipating component when mounted.

Fixed Resistors. There are many types of resistors manufactured with values that cannot be varied:

Carbon Composition. Electronics hobbyists are most familiar with this type, made of carbon and a binder, formed into a short rod and having wire connection leads (pigtailed) on the ends. They're inexpensive (about 13 cents each for ½-watt units), widely available, highly reliable and unaffected by frequencies below vhf.

Standard types are available in resistance ranges of 1 ohm to 22 megohms; tolerances of 5%, 10% and 20%, maximum power ratings of ¼ watt, ½ watt, 1 watt and 2 watts. They rapidly increase in resistance at temperatures much above 60°C; but they have a low temperature coefficient (TC) within a normal operating temperature range. The TC is usually +0.1% which means that a 1000-ohm resistor at 20°C will increase to 1050 ohms at 70°C.

Resistance changes from an effective dc value when operating much above 100 kHz due to a variety of reasons, including the shunt capacitance of the resistor's short body. Noise is a consideration, also, in applications such as hi-fi and communications. A carbon-core resistor, for example, generates electronic noise that can reduce the readability of a signal or even mask it completely.

Wirewound Resistors are used where carbon composition types are not suitable—in high-power close-tolerance and high-stability applications, for example. They are made by wrapping a length of resistive wire around a ceramic core, which is then dipped in enamel to isolate the wire from the outside world. Precision wirewound resistors that are commonly available to hobbyists have 1% tolerances, values from 1 ohm to 300 kilohms, and power ratings from 1 to

RESISTOR COLOR CODE

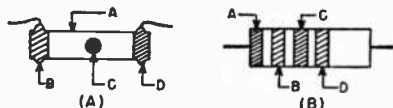

RETMA COLOR CODE CHART

COLOR	VALUE	MULTIPLIER
Black	0	1
Brown	1	10
Red	2	100
Orange	3	1000
Yellow	4	10,000
Green	5	100,000
Blue	6	1,000,000
Violet	7	10,000,000
Grey	8	100,000,000
White	9	1,000,000,000

TOLERANCE CODE

Gold— $\pm 5\%$	Silver— $\pm 10\%$
No Color— $\pm 20\%$	

The ohmic value of a resistor can be determined by means of the color code. There are two standard methods of indicating this value.

In Fig. A, the body (A) and end (B) indicate the first and second digits of the value while the dot (C) indicates the multiplier to be used. The tolerance of the unit is indicated by the end color (D). For example, if the body (A) is green the number is 5; if the end (B) is grey the second number is 8. If the dot (C) is red the multiplier is 100 or two zeros should be added. The resistor is then a 5800 ohm unit. If the end (D) has no color, the tolerance is $\pm 20\%$.

In Fig. B, the first two stripes indicate the first two digits; the third stripe the multiplier; the fourth stripe the tolerance. Thus, if stripe (A) is green, (B) is grey, (C) is red, and (D) is silver, the resistor is a 5800 ohm, $\pm 10\%$ unit.

50 watts. Typical costs vary from \$0.85 to \$5.60 in single-lot quantities. Power wirewounds can handle from 3 to 225 watts (depending on construction), and range from 0.5 to 100 kilohms with 5% tolerances. They cost between \$0.70 and \$4.00 in single-lot quantities.

Wirewound resistors hardly contribute any noise to circuits, but they are not used at frequencies above the audio range because their characteristics change with frequency.

In applications where wirewound characteristics (stability, precision, reliability, and low noise) are required as well as good high-frequency performance, film resistors are often used. These are made by depositing carbon or metal films on a ceramic substrate. The thickness of the film (proportional to the amount of material deposited and the deposition time) determines the resistance. There are two categories of film resistors, thick (the resistive film is greater than one-millionth of an inch thick) and thin (the film is less than 10^{-6} inches thick).

Thin carbon-film resistors range from 10 ohms to 10 megohms, in quarter- and half-watt ratings and 1% tolerance. They usually are priced from \$0.95 to \$2.20 individually. Thin-metal film models range from 10 ohms to 1.5 megohms, with tolerances of 0.1 to 1%, and power ratings of $\frac{1}{2}$ and 1 watt. Some can be bought singly at \$0.95 to \$1.40, but others (notably close-tolerance and high-resistance models) are available only in lots of 10 or more at \$1.35 to \$2.50 each.

Thick-film resistors offer many of the advantages of thin-film components, but are lower in cost (in many cases competitive with carbon composition types), are more durable, and can handle higher power levels. Besides thick-film carbon resistors, there are a number of metal types that fall into this class. Among them are metal oxide, metal glaze, cermet and bulk property types. Metal-oxide and metal-glaze resistors come in power and semi-precision varieties. Semi-precision types have tolerances of 2 and 5%, can dissipate between $\frac{1}{4}$ and 2 watts, with resistance values of 10 ohms to 1.5 megohms. Power models have 5 and 10% tolerances, power ratings of 2 to 115 watts, with resistance values of 10 ohms to 4.2 megohms.

Cermet types are rated to 10 watts, with 1% tolerance and resistances of 10 ohms to 10 megohms. Bulk property resistors vary from 30 ohms to 100

kilohms, with tolerances of 0.1 to 1% and power ratings of 0.3 to 0.75 watts. In general, thick-film resistors can be substituted for carbon-composition types without paying a premium price — their cost is fairly close (and in some cases competitive) to that of carbon compositions. Thick-film components can replace thin-film resistors (their noise contribution is small and high-frequency performance is good) at a substantial savings.

Variable Resistors. It is often desirable to have a resistor that can change its resistance over a specified range. For example, the volume control of a radio is a variable resistor which allows a given amount of signal to reach the speaker. Variable resistors can respond to many phenomena—some change resistance when a control shaft is rotated, others are affected by heat, light, or the voltage impressed across them.

Potentiometers are carbon composition, wirewound, or metal-film resistors formed in a linear or circular configuration. In circular potentiometers, a "wiper" contacts the resistive element. By turning the control shaft (mechanically linked to the wiper), a given amount of resistance is set between it and each of the two resistive terminals (see Fig. 1). As the shaft is turned clockwise, R_A increases while R_B decreases. If the wiper is connected to one resistive terminal, the

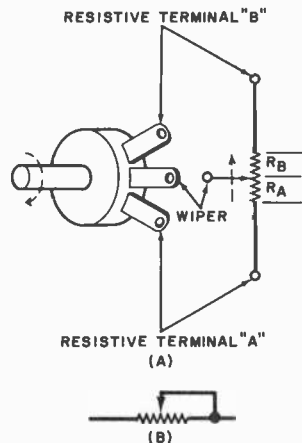

Fig. 1. Potentiometer operation.

potentiometer (or "pot") becomes a two-terminal variable resistor. Pots are specified by a resistance value, power rating, and tolerance. The resistance figure denotes the total resistance between terminals A and B ($R_A + R_B$). The power and tolerance ratings are analogous to those of a fixed resistor.

Put Professional Knowledge and a COLLEGE DEGREE in your Electronics Career through HOME STUDY

Earn Your DEGREE

by correspondence, while continuing your present job. No commuting to class. Study at your own pace. Learn from complete and explicit lesson materials, with additional assistance from our home study instructors. Advance as fast as you wish, but take all the time you need to master each topic. Profit from, and enjoy, the advantages of independent study.

The Grantham electronics degree program begins with basics, leads first to the A.S.E.T. degree, and then continues through the B.S.E.E. degree level. Our free bulletin gives complete details of the program itself, the degrees awarded, the requirements for each degree, and how to enroll. Write or phone (no collect calls please) and ask for BULLETIN E-76.

Grantham School of Engineering
2000 Stoner Ave., Los Angeles, CA 90025

• Telephone (213) 477-1901 •

Worldwide Career Training thru Home Study
CIRCLE NO. 26 ON FREE INFORMATION CARD

Dynaco SOUND IS Best



Completely assembled or in easy-to-build kits.

Write for free 24 page color catalog

Dynaco Dynakit

Dept. G, Box 88, Blackwood, N.J. 03012

CIRCLE NO. 64 ON FREE INFORMATION CARD

The control shaft typically rotates a total of 330°, and is made for either knob or screwdriver adjustment. Some pots have a power switch which is turned on in the first 20° of rotation, and some are ganged — with as many as four separate units controlled by the same shaft. Another variable in circular pots is the taper, which can be linear or logarithmic. That is, the way the values R_A and R_B vary with the amount of angular rotation. In linear pots, R_A and R_B vary directly with the rotation angle. If the shaft of a 10-kilohm, linear-taper pot is rotated 165° (out of a possible 330°), both R_A and R_B equal 5 kilohms. Other angular rotations will give proportional values of the two resistances. Log-taper pots, on the other hand, will give a logarithmic increase in R_A rather than a linear one. These are chiefly used in audio circuits, as volume and tone controls, because of the ear's logarithmic response.

Circular general-purpose pots are available with resistance of 500 ohms to 2 Megohms, with tolerances of 10 or 20%. Power dissipation runs up to 3 watts. They are generally used as panel-mounted controls, but some miniature models are made for printed circuit board installation. Cost ranges from \$0.50 to \$2.50 each. Precision circular models are available, in either one- or ten-turn configurations. They range from 100 ohms to 400 kilohms, with tolerances of 5, 3, or 1%, and power dissipations up to 5 watts.

Pots are available in two other configurations—rectangular and sliding-contact wirewound. Rectangular trimmer pots are ideal for pc board applications. They consist of a screw-driven sliding contact (wiper) which moves along a resistive winding. The three terminals are in the form of small pins (the middle one is the wiper). Most rectangular trimmers are wire-wound types, but metal-film units are also made. Common rectangular trimmers have 10 or 5% tolerances, half- or one-watt power ratings, and maximum resistance ratings of 10 ohms to 5 megohms. Since rectangular pots are ten-turn units, resistances can be set with great accuracy. Their prices vary from \$1.75 to \$6.00 each.

Sliding-contact wirewound pots look like a common wirewound resistor with two important differences. First, a portion of the enamel coating is missing, allowing access to a band of the resistive wire. Also, an adjustable-tension ring is slipped over

the body of the resistor, which can tap the resistive element at any point. Once the desired resistance is obtained, a tension screw or knob on the ring is tightened, holding the tap at that point. These variable resistors are used in high-wattage applications, such as power supplies. They are available with maximum resistances of 1 to 100,000 ohms, with power ratings of 12 to 100 watts, and a tolerance of 10%. They typically cost from \$1.30 to \$2.50 each.

Other Variable Resistors. The thermal- and light-sensitive properties of certain elements are employed to produce heat- or light-variable resistors.

Thermistors (thermal-sensitive resistors), which are used to protect power transistors in audio amplifiers, and as temperature transducers, may decrease or increase their resistance as temperature rises. Their coefficient of resistance (if negative, resistance goes down as temperature increases; if positive, resistance increases with temperature) specifies how resistance will change for a one-degree Celsius change in temperature. They are also rated in catalogs by their resistance at 25°C, and by giving the ratio of resistances at 0°C and 50°C. Values vary from 2.5 ohms to 1 megohm (room temperature), with power ratings from 0.1 to 1 watt.

Photocells (light-sensitive) resistors are used in electric-eye circuits, streetlight control, and similar applications. They are rated by specifying their resistance at low and high light levels. These typically vary from 600 ohms to 110 kilohms (bright), and from 100 kilohms to 200 megohms (dark). Power dissipation lies between 0.005 and 0.75 watts.

Pressure-sensitive resistors are also used by hobbyists. The two most common examples are strain gauges and carbon microphones. As the resistive element is physically deformed, its resistance varies. If a constant voltage is impressed across a carbon microphone element, a variable current, which is an electrical analog of the voice, will be generated. Most have resistances of 500 ohms or so in the absence of compression.

A final variety of variable resistors you are likely to encounter is the voltage-sensitive resistor (Varistor). It is chiefly used to protect equipment from power-line surges by limiting the peak voltage across its terminals to a

certain value. Above this voltage, the resistance drops, which in turn makes the voltage decrease. Catalogs specify voltage-variable resistors by power dissipation (0.25 to 1.5 watts) and peak voltage (30 to 300 volts). Varistors typically cost \$2.00 to \$6.00 each.

Resistors and Ohm's Law. How are voltage, current and resistance related? A simple expression links these three parameters, and is called *Ohm's Law*. This states that the voltage across a resistor is proportional to the current flowing through it and its resistance. Mathematically expressed, it appears as $E = IR$, where E is measured in volts, I in amperes, and R in ohms. It can be manipulated to appear as $I = E/R$ and $R = E/I$. For example, if we know that 2 amps is flowing through a ten-ohm resistor, what is the voltage across it? By Ohm's Law, $E = 2 \times 10$ or 20 volts.

The power dissipated by a resistor as heat is easily found by using the formula $P = EI$, which can also be expressed (by virtue of Ohm's Law) as $P = I^2R$ or $P = E^2/R$. Referring to our example, how much power is dissipated (in watts) by the ten-ohm resistor? Well, $P = EI$ (20×2 or 40 watts), but $P = E^2/R$ ($400/10$) and $P = I^2R$ (4×10) will give us the same results for power calculations.

Resistors and Heat. Resistors can be affected by many agents, especially heat and moisture. The moisture problem (resistance can decrease if the resistive element is moistened) can usually be corrected by drying out the resistor in a warm, nonhumid environment. Resistance changes caused by heat, whether it is generated by the resistor itself or by a soldering iron, are usually permanent. If it is heavily overloaded, the resistor might actually burn up.

Two precautions should therefore be observed. Always use a resistor which can handle twice the amount of power that it will generate. The power formulas $P = EI$, $P = E^2/R$, and $P = I^2R$ will determine this value. Also, use as little heat as possible during soldering. Leave "pigtailed" of at least ¼-inch between the resistor body and the circuit tie point.

The power dissipation ratings given to resistors assume the component will have an unrestricted air flow around it, and that its operating temperature will be close to a median figure for safe operation. ♦



CB Scene

By Ray Newhall, KWI6010

A CB PRIMER

CITIZEN'S BAND radios are the hottest items in the electronics marketplace these days. The rig manufacturers are forecasting a banner sales year; some say that well over five million sets will be sold before the end of 1976. Millions of citizens will be introduced to the CB scene for the first time.

Almost every day I am asked questions such as: "Which rig is the best?", "How many channels do I need?" and "Is it difficult to get a CB license?" This column will attempt to answer these and other questions you might ask before getting "on-the-air" for the first time.

Selection of a Rig. I wouldn't attempt to recommend a particular rig. There are several hundred very fine rigs among the brands and models available this year. If you are looking for a new CB rig and don't know what to buy, take your time, review the test reports and specifications in the POPULAR ELECTRONICS, CB Handbook, 1976, which will be on your newsstand soon, and evaluate as many new models as possible.

There are a few common-sense guidelines to keep in mind when selecting a rig:

- Buy a new rig, rather than a used one. There are several reasons for this. There have been tremendous technical advances during the past two years, and since mid-1974 all CB rigs have been required to meet minimum performance specifications to qualify for "type acceptance". Type acceptance is now mandatory for all new rigs being sold. While older transceivers without type acceptance can still be operated legally, they must be off the air by November 23, 1978.
- You will probably want to buy a 23-channel rig even though you do not currently plan on using more than one channel. If you are thinking of

buying a smaller, five- or six-channel transceiver, you should at least have channels 9 and 11, since they are officially designated as the emergency and calling channels respectively. In a mobile unit you will want to have channel 19, the frequency most generally used between vehicles on the highway. Channel 13 is a popular channel for marine use, but keep in mind that channel usage varies considerably from one locality to the next.

- The maximum allowable power that a CB rig may supply to its antenna terminal is 4 watts. Be certain that your new rig is rated at maximum power. It is only flea-power to begin with and you'll need every bit of it to make yourself heard over the noise of other distant CB'ers on the band. Keep in mind, however, that 3.5 W is, for all practical purposes, the same signal level as 4 W.
- When you buy your new rig be certain to get a signed and dated sales slip. Record the serial number on the sales slip and put the slip in a safe place. If you should later need warranty service or if your rig is ever stolen you will need that sales slip and the serial number.

Making It Legal. It is a violation of Federal law to operate a radio transmitter (other than one type-accepted for use under Part 15) unless you are legally authorized to operate it. The penalties for illegal operation can amount to fines of several thousand dollars and a jail sentence. A CB license does not require any test or

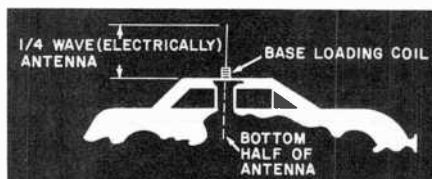

Fig. 1. Car provides half of half-wave antenna with $\frac{1}{4}$ on top.

other qualifications other than that the applicant be a citizen of the US and 18 years or older. The application must be filed on FCC Form 505 (usually packed with your new set), signed and mailed along with a filing fee of \$4.00 to the Federal Communication Commission, Gettysburg, PA, 17326. Your license, when issued, will be valid for a period of five years.

Because of the tremendous growth in popularity of CB Radio, the FCC has been receiving a half a million or more applications each month; they are swamped! It has sometimes taken up to eight weeks for applications to be processed. (Don't write them to inquire, that will slow it down even more.) Do not operate your transmitter until your license form and call sign have been returned to you. There has been a rumor circulating for several months that the FCC has authorized a six-month period of grace, during which time you may operate by using the last four digits of your Social Security Number as a Call Sign. This rumor is false.

However, the FCC has recently announced a new system of temporary authorization using Form 555-B. Details and a copy of the form are on pages 98 and 99.

Installing Your New Rig. The April issue of POPULAR ELECTRONICS includes an article describing the installation of a mobile unit, and another article on the installation of base antennas. I will not repeat that information here, but I would like to comment upon the selection and installation of mobile antennas, since about 80% of the new installations will be mobile.

There is a great deal of misinformation regarding antennas and their installation passed among CB'ers and the CB Clubs. The best advice I can give you is to buy a good-quality commercial CB mobile antenna and follow the manufacturer's installation instructions carefully. There is more to the installation of a high-performance mobile antenna than you might guess. An inefficient antenna installation can rob you of 50% or more of what little power you have available from your CB transmitter. Selection of a proper location for your mobile antenna requires a little basic knowledge and some planning.

Most mobile antennas are known technically as "1/4-wave whips", and they require mounting on a metal sur-

(Continued on page 100)

Temporary Permit

Class D Citizens Radio Station

1

Instructions

- Use this form only if you want a temporary permit while your regular application, FCC Form 505, is being processed by the FCC.
- Do not use this form if you already have a Class D license.
- Do not use this form when renewing your Class D license.

2

Certification

Read, Fill In
Blanks, and Sign

I Hereby Certify:

- I am at least 18 years of age.
- I am not a representative of a foreign government.
- I have applied for a Class D Citizens Radio Station License by mailing a completed Form 505 and \$4.00 filing fee to the Federal Communications Commission, Box 1010, Gettysburg, PA. 17325.
- I have not been denied a license or had my license revoked by the FCC.
- I am not the subject of any other legal action concerning the operation of a radio station.

Name

Signature

Address

Date Form 505 mailed to FCC

If you cannot certify to the above, you are not eligible for a temporary permit.
Willful false statements void this permit and are punishable by fine and/or imprisonment.

3

Temporary Call Sign

- Complete the blocks as indicated.
Use this temporary call sign until given a call sign by the Federal Communications Commission.

Initial of Applicant's First Name

Initial of Applicant's Last Name

Applicant's Zip Code

4

Limitations

Your authority under this permit is subject to all applicable laws, treaties and regulations and is subject to the right of use or control by the Government of the United States.
This permit is valid for 60 days from the date the Form 505 is mailed to the FCC.

You must have a temporary permit or a license from the FCC to operate your Citizens Band radio transmitter.

Do Not Mail this form, it is your Temporary Permit.

See the reverse side of this form for a summary of operating instructions.

HOW TO USE TEMPORARY PERMIT FORM 555-B

Just recently, in response to complaints about long delays, the FCC announced a system of temporary licensing which allows an owner to use his CB transceiver before the regular station license is issued. The Temporary Permit, Form 555-B, will be valid for 60 days, and is to be filled out and kept by the *user* at the same time that he submits his Form 505 license application. The new form is simple and straightforward to use.

A temporary call sign is determined by the new CB'er's initials and zip code. As with all CB licenses, the first letter of the three-letter prefix is *K*. So, if John Jones of New York, N.Y. 10016, is working with Form 555-B, his temporary call sign is *KJJ 10016*. The Temporary Permit should *not* be mailed, but retained by the CB'er during the interim operating period.

In announcing this new system, the FCC stresses that the number of available forms is severely limited, but photostatic copies can be used. For this reason, we are reproducing a copy of the new Form. If you are applying for a CB license for the first time, simply photocopy both sides of Form 555-B and fill it out. This should be done at the time you mail your Form 505 license application. Retain the photocopy—it will give you temporary authorization to operate your transceiver, and is valid for 60 days from the time you mail Form 505.



Welcome to the Citizens Radio Service

Citizens Band Radio is a shared communications service with many people using the same frequencies and channels.

The guidelines provided in this form are not intended as a substitute for FCC Rules, but as a general reference to those operating practices and procedures which will benefit you and other users of Citizens Radio.

Your compliance with these guidelines and your consideration for the rights of others in your radio service is necessary if the full potential and enjoyment of Citizens Radio is to be realized.

Using Your Citizens Radio Station

(See Part 95 of FCC Rules & Regulations for complete instructions on authorized station use.)

- 1 Who May Operate Your Citizens Radio Station?**

You, members of your immediate family living with you, and your employees while on the job.
- 2 How Many Transmitters Does this Permit Authorize?**

A maximum of five (5).
- 3 Can the FCC Inspect My Station?**

Your station and station records must be available for inspection by an authorized agent of the FCC.
- 4 Where Should I Keep This Permit?**

Keep it in a safe place. Post photocopies at all fixed station locations. Indicate on photocopies the location of this permit. Attach a card with your name, address and temporary call sign to each transmitter.
- 5 How Shall I Identify My Station?**

Identify transmissions in English with your temporary call sign.
- 6 How Can I Use My Station?**

Use it for private short-distance radio-communications for your personal or business activities. Channel 9 is reserved solely for emergency communications and to assist motorists.

Prohibited Communications Include:

 - Activities contrary to law
 - Transmitting obscene, indecent or profane messages
 - Communicating with non-Class D stations
 - Intentional interference to other radio stations
 - Transmitting for amusement, entertainment, or over a public address system
 - Transmitting false distress messages
 - Advertising, selling, or for hire
- 7 How High Can My Fixed Station Antenna Be?**

See Section 95.37 if your antenna will be over 20 feet above ground. Additional information is available in SS Bulletin 1004-h.
- 8 May Amplifiers Be Used With My Transmitter?**

'Linear' amplifiers are absolutely prohibited. 'Power' microphones may require adjustments to your transmitter
- 9 Who Can Make Adjustments to My Transmitters?**

Adjustments affecting proper operation may be made only by, or under the supervision of a licensed first or second-class radio operator.

FREE EICO CATALOG

346 Ways To Save On Instruments, Burglar Alarms, Automotive & Hobby Electronics!

The more you know about electronics, the more you'll appreciate EICO. We have a wide range of products for you to choose from, each designed to provide you with the most pleasure and quality performance for your money. The fact that more than 3 million EICO products are in use attests to their quality and performance.

"Build-it-Yourself" and save up to 50% with our famous electronic kits.

For latest EICO Catalog on Test Instruments, Automotive and Hobby Electronics, Eicocraft Project kits, Burglar-Fire Alarm Systems and name of nearest EICO Distributor, check reader service card or send 50¢ for fast first class mail service.

**EICO—283 Malta Street,
Brooklyn, N.Y. 11207**

*Leadership in creative electronics
since 1945.*



Operation Assist

If you need information on outdated or rare equipment—a schematic, parts list, etc.—another reader might be able to assist. Simply send a postcard to Operation Assist, POPULAR ELECTRONICS, 1 Park Ave., New York, NY 10016. For those who can help readers, please respond directly to them. They'll appreciate it. (Only those items regarding equipment not available from normal sources are published.)

DeForest type F-5 radio. Need schematic, power requirements, and operating instructions. William Anliker, Box 35, Bagdad, AZ 86321.

U.S. Navy Model RGB-2, CHC-46140 receiver. Built by Hammarlund, covers 0.54-30 MHz. Jim Brooks, 116 South Center St., Bardstown, KY 40004.

Alwa Model TP-1012 open-reel tape recorder, serial 153107. Schematic, manual, or any information. Randal W. Davis, 2015 Chestnut, Fort Worth, TX 76106.

Gonset Model 3311 FM automotive converter. Schematic and alignment instructions. David J. Bopp, Box 119, Oceanport, NJ 07757.

Meissner Traffic Master. Dial, tuner unit, or any coils wanted, or source for same. L. Marks, 14 Avenue Rd., Kingston, Surrey, England.

Ampex Model FR-100A, 14-channel tape recorder or 15,000 series tape deck. Documentation and schematics. Carol Ascillio, Park Lane, North Windham, ME 04062.

Hammarlund HQ-129-X receiver, **Heath** AT-1. Schematics. Information on whereabouts of DX100, property of W3ZHV, Mon. Valley ARC. XW8CRO/5, 608 E. Farmers Rd., Seagoville, TX 75159.

U.S. Govt. receivers, types AN-GRR5 and R-392 (Collins). Radio amateur or technician wanted for alignment. NE PA area. James B. Fromel, 62½ Cist St., Buttonwood, Wilkes-Barre, PA 18702.

Harman-Kardon Model CA-100 "Commander" PA amplifier. Source or specifications for mike input transformers, XE-4 level equalizer, XT-4 line match transformer, and CPE-3 phone/tape preamp. Phil Anzel, Box 3952, University Station, Laramie, WY 82071.

ARP Axse synthesizer. Schematic, parts list, pc artwork. Scott Bell, 7752 Montgomery Rd., Apt. 29, Cincinnati, OH 45236.

Realistic Model TRC-X23 CB transceiver. Schematic, photofact listing, any available information, or a working or nonworking set for cross reference. Tom M. King, 169 Lakeside Dr., Guilford, CT 06437.

Sears Model 5248 tape recorder, chassis 38152480. Instruction book, parts list. Yagista 2-volt storage batteries (sealed type). Source or importer address. Roy O. Kroeger, 3335 Eastern Ave., Davenport, IA 52807.

Squires & Sanders Model SS-310 CCTV camera. Schematic and service information. Allen Rees, Box 1271, Norman, OK 73069.

U.S. Navy oscilloscope TS-34/AP, NOA-s-1562, 1530 CW, O and R Ax 232. Any available information. Jonathan Huber, 520 Lincoln St., Boonton, NJ 07005.

Clough-Brengle Model OCA r-f signal generator serial 2601. Need schematic and manual. R.P. Hurlbut, 250 Verobeach Blvd., Weston, Ont. Canada M9M 1R6.

Candle Model MT510A black-and-white 4-inch TV. Service manual and schematic. AI's Radio and TV, 9 Leonard Rd., Hyannis, MA 02601.

Dictograph Model HFMT-M-100 music system. Need schematic and parts list for the Williamson-type amplifier circuit serial 16966/106 or similar. Unit uses Collaro RC 456 changer. Ben Layton, 6344 Laura Ave., St. Louis, MO 63136.

Atwater Kent Model 20, Tri-City Radio Electric Supply Co. Model W-41 one-tube regenerative receiver. Any restoration information available. Sam Canup, 902 S. Goliad, Rockwall, TX 75087.

Research Associates, Inc. Model TR-32-12 transistorized power supply, 6-32 V dc at 12 amps max. Operating/assembly manual or schematic. James DeMarr, 108 Laurel Ave., Gwinhurst, Wilmington, DE 19809.

Aetna Radio transceiver serial CX 367414. Contains 1A7, 1N5, 1H5, 1T5, and one unknown tube. Tim Childs, 3606 Tecumseh River Rd., Lansing, MI 48906.

A Major Advance...



- *EFFICIENT ENGINE PERFORMANCE
- *REDUCED MAINTENANCE EXPENSE
- *1 YEAR GUARANTEE OF PRODUCTS

For those who need maximum firing potential, Labtronics offers the Multiple Restrike Ignition. The system produces a high energy repetitive spark on each power stroke which insures the greatest statistical chance for proper ignition. Dependable system triggering from breaker-points, magnetic pick-ups or the extremely accurate '13A1-xx' infrared triggering unit. Order your system and enjoy the economy and peak performance of an efficient engine.

LABTRONICS, INCORPORATED

3635 HILLSIDE DRIVE • YPSILANTI, MICHIGAN 48157

MULTIPLE RESTRIKE SYSTEM		
[] Model VI	Programmable Duration	\$79.95
[] Model VI-B	Fixed Burst Duration	\$59.95
[] Model VI-C	Complete Optical System	\$79.95
HIGH ENERGY SYSTEM (Single Strike)		
[] Model V	Points Triggering System	\$29.95
[] Model V-C	Complete Optical System	\$47.95
TRIGGERING UNITS		
[] 13A1-xx	Optical Trigger Unit	\$24.95
[] 6129B	Magnetic Amplifier	\$ 4.95

CIRCLE NO. 32 ON FREE INFORMATION CARD

1976 BREAKERLESS IGNITION

AT A PRICE LESS
THAN A TUNEUP

\$38.00

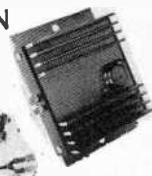

- No points or condenser — no more tuneups.
- Improves the ENGINE EFFICIENCY and FUEL ECONOMY.
- High timing accuracy & permanent dwell set
- Instant starting in all kinds of weather.
- One system fits all cars- U.S. or foreign.
- Uses a magnetic sensor for best timing accuracy as do ALL U.S. MFGD. AUTOMOBILES IN-1976.

Our magnetic pickup insures perfect timing with no fluctuation or retardation at any speed. Variable spark length- approx. 2 millisecc. at low speeds & 0.7 millisecc. at high speeds. This insures maximum engine performance- perfect for modern lean fuel mixtures. High spark intensity helps eliminate misfiring. The above superior operating features insure Challenge ignition systems will pay for themselves quickly.

A high performance Breakerless Capacitor Discharge system is offered for those who want the best possible ignition system.

Free BROCHURE

BANKAMERICARD / MASTERCHARGE

- Model 10 Breakerless ignition system \$38.00
- Model 11 Easy to build kit \$32.00
- Model 12 Capacitor Discharge System \$54.00
- Model 13 C.D. system in kit form . . \$44.00
- Model 14 Trigger unit —
- use with your present C.D. system . \$30.00

CHALLENGE ELECTRONICS

P.O. Box 1991 / 1162 No. Huntington Blvd.
Pomona, California 91768

CIRCLE NO. 15 ON FREE INFORMATION CARD

POPULAR ELECTRONICS

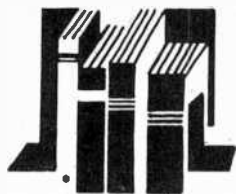

Electronics Library

COMPUTER PROGRAMMING HANDBOOK

by Peter A. Stark

This is a handy guide to computer programming and data processing written for the beginner with no special background in the field, including higher math. The 25 chapters are divided into five sections: General, Machine Language Programming, Symbolic Programming, Programming and Mathematical Techniques, and Problem-Oriented Languages. Although the format is that of a classroom text, there is no reason someone studying on his own can't benefit from the information presented. The author has provided examples of the various processes he discusses so that, even without access to a computer, the reader can pick up a lot of the tricks of the trade which will make his actual confrontation with a keyboard easier.

Published by Tab Books, Blue Ridge Summit, PA 17214. 503 pages. \$8.95 soft bound.

THE RADIO AMATEUR'S HANDBOOK FIFTY-THIRD EDITION

Fundamental theory and practices as well as the latest technical developments in radio communications are covered in this standard reference work. Transmitters, receivers, oscillators, power supplies, antennas, transmission lines and active devices are discussed. Communications modes such as CW, AM, SSB, and FM (with a special section on repeaters) are examined in depth. Tested circuit designs complement theory. Revised sections include receiving equipment, television interference reduction, test instruments, power supplies, speech processing, and station assembly. Among the new con-

struction projects are a regulated power supply, a 2-kilowatt, 2-meter amplifier, a communications receiver with digital readout, a calibrated field strength meter, a two-band solid-state transmitter, and a coupler for balanced lines.

Published by the American Radio Relay League, Inc., Newington, CT 06111. 704 pages. \$10.00 hardbound, \$6.00 soft cover (US and Possessions).

ELECTRONIC PROJECTS FOR MUSICIANS

by Craig Anderton

A number of the author's electronic music projects have appeared in these pages. Here he gets it all together in a series of "how-to" chapters, nineteen easy-to-build circuits, troubleshooting hints, and sources of additional information. The text is illustrated with sketches of everything from electrolytics to needlenose pliers so a musician with no electronics background can build accessories for his instrument. A six-minute demo record of electronic effects is bound into the book so that the musician-builder can compare how his project should sound with how it does sound.

Published by Guitar Player Productions, P.O. Box 615, Saratoga, CA 95070. 132 pages. \$6.95 soft cover.

OPERATIONAL AMPLIFIERS: THEORY AND SERVICING

by Edward Bannon

State of the art coverage of operational amplifiers is presented, with emphasis on practical circuit analysis, design, and application. Op amp theory and troubleshooting techniques are explained so that those with a marginal technical background will understand the subject matter. Practical instrumentation application are given with analysis of each circuit. Among the specialized applications covered are function generators, inductor simulation, automobile speed control, fuel injection, and non-skid circuits.

Published by Reston Publishing Co., Box 547, Reston, VA 22090, 195 pages. \$13.95 hard cover.

THE NLS LM-3 VOLKSMETER

World's lowest priced precision digital multimeter -- more accurate and rugged than the old pointer meter -- ideal for field service.

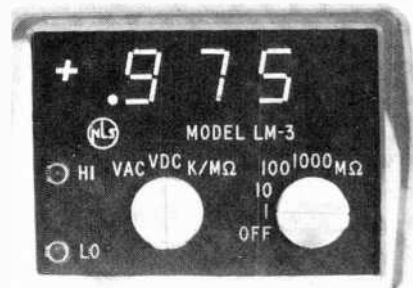

With Rechargeable Batteries & Charger Unit.

\$125

Standard Features:

- Automatic polarity and zeroing.
 - Large 0.3" LED display.
 - 13 ranges: vac, vdc & ohms with 1% accuracy.
 - Size: 1.9"H x 2.7"W x 3.9"D.
- Also available in 3-1/2-digit or laboratory quality 4-digit meter. Ask for LM-3.5 or LM-4

See your local distributor!

Distributor inquiries invited.



Non-Linear Systems, Inc.

Originator of the digital voltmeter.

Box N, Del Mar, California 92014

Telephone (714) 755-1134 TWX 910-322-1132

CIRCLE NO. 63 ON FREE INFORMATION CARD



save on gas! save on tune-ups! save on maintenance!

Electronic ignition is "IN"! So says Detroit.

Update your car with either a TIGER CD or a TIGER I breakerless system.

Enjoy the benefits of better gas mileage, quicker starting, elimination of tune-ups, 50,000 miles on points and plugs, and reduced maintenance expenses.

TIGER MAX CD	\$69.95
TIGER 500 CD	59.95
TIGER SST CD	42.95
SIMPLIKIT CD	31.95
TIGER I	45.95

Postpaid U.S.A. only.

Tri-Star Corporation

Dept. ZZ, P.O. Box 1727
Grand Junction, Colorado 81501

CIRCLE NO. 61 ON FREE INFORMATION CARD

103

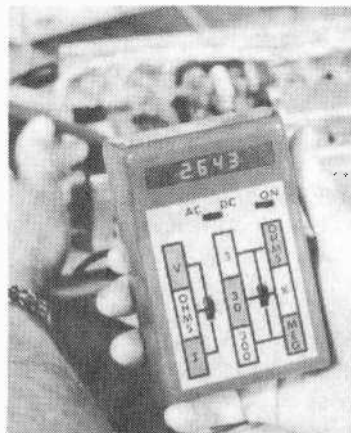

the PROFITMETER

AUTO ZERO/POLARITY
3 1/2 DIGIT MULTIMETER KIT
WITH BRIGHT RED LED DISPLAY

\$79.95

-2.95 P & H
LESS TEST LEADS
& BATTERIES

214-369-7309

ALPHA ELECTRONICS, TEXAS

PO BOX 64683
DALLAS, TEXAS 75206

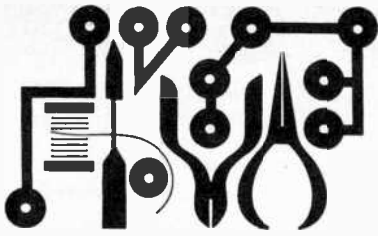

Experimenter's Corner

By Forrest M. Mims

THE AVALANCHE TRANSISTOR

THIS month we're going to take a close look at a rarely used phenomenon, the transistor operating in the avalanche mode. You can build an avalanche transistor demonstration circuit for under a dollar (less power supply)—for a lot less than that if you use junkbox components you probably have on hand.

Normally a bipolar (pnp or npn) transistor is made to conduct between its collector and emitter leads by placing a small signal on its base. This is how virtually all bipolar transistor amplifiers, oscillators, and switching circuits are made to operate.

Collector-emitter conduction can also be achieved automatically and *without* an input signal by simply placing a voltage which exceeds the collector-emitter breakdown voltage (BV_{CEX}) across the collector and emitter leads. This causes a spontaneous avalanche of carriers and the transistor conducts until the current flow through it drops below what is called the holding current (I_h).

A few rather specialized and hard-to-find transistors such as the 2N3034 and 2N3507 are especially suited for avalanche operation, but many readily available and low-cost switching transistors can also be used in an av-

alanche mode. I have had excellent results with such common types as the 2N914, 2N2222, 2N3643, 2N3904, 2N4400, 2N5188, HEP50, and many others.

There are lots of applications for avalanche transistors including oscillators, waveform generators, pulsers, and high speed switches. We'll examine an oscillator circuit later, but first let's consider the basic avalanche transistor circuit shown in Fig. 1.

Supply voltage V_{CC} is set to 10 or 15 volts below $Q1$'s BV_{CEX} . When a small input signal is applied to $Q1$'s base, the resultant base-emitter current stimulates the onset of avalanche and the resistance between $Q1$'s collector and emitter terminals drops to a few ohms or so within a couple of nanoseconds. Then $Q1$ will remain in the avalanche mode so long as the forward current through it exceeds I_h .

You can actually build the circuit in Fig. 1, but you'll need a pulse generator to operate it. Figure 2 shows a slightly modified version of the cir-

Fig. 1. Basic avalanche transistor circuit.

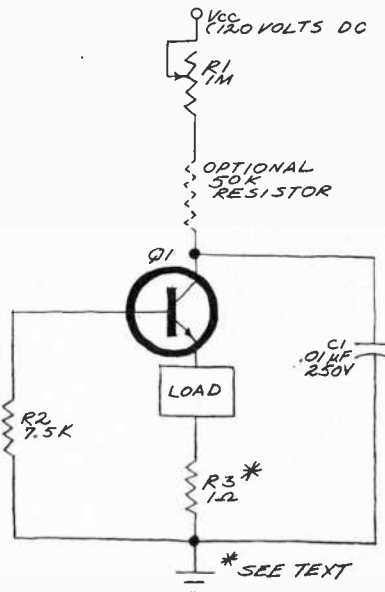
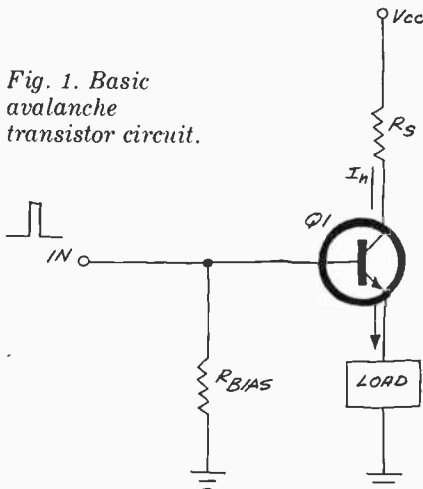

Fig. 2. Easily assembled relaxation oscillator.

cuit that is easier to operate since it repetitively avalanches on its own. The modification simply consists of hanging a capacitor between the collector of $Q1$ and ground and the result is a simple but effective relaxation oscillator. Here's how it works.

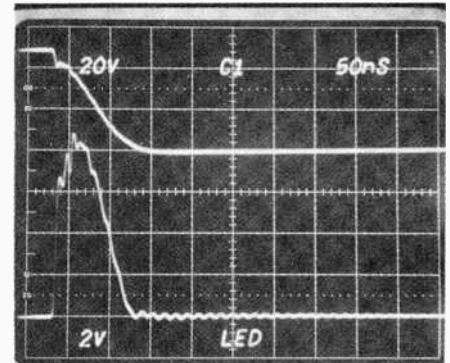

Fig. 3. Operation of Fig. 2 circuit driving an LED.

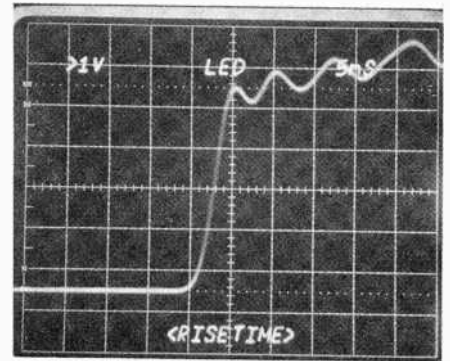

Fig. 4. Expanded view of lower trace in Fig. 3.

Though V_{CC} is higher than $Q1$'s BV_{CEX} , $R1$ limits current flow below that necessary to achieve breakdown and $Q1$ stays off. Simultaneously, $R1$ allows $C1$ to charge, and $Q1$ avalanches as soon as the charge on $C1$ reaches its BV_{CEX} . Then $C1$ discharges through $Q1$ and any other components which happen to be in the way. When $C1$'s charge drops to a point where the forward current is below $Q1$'s I_h , $Q1$ ceases to avalanche, $C1$ begins charging again, and the cycle repeats.

The best way to see the sledge hammer efficiency of this little circuit is to look at the scope picture in Fig. 3. The top trace shows the charge on $C1$ just prior to, at, and after it reaches the BV_{CEX} of $Q1$. In this case $Q1$ has a BV_{CEX} of about 50 volts. The bottom trace shows the relatively clean output pulse across current monitoring resistor $R3$. The pulse is not perfect, but it's not easy to produce a 60-nanosecond

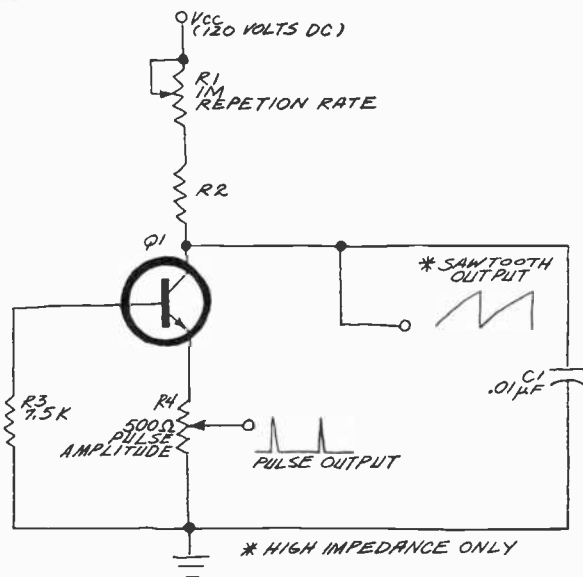

Fig. 5. How to use an avalanche transistor oscillator as an ultra-fast pulse and sawtooth generator.

pulse (1/2 amplitude points) with a peak amplitude of 8.4 amperes using only four active components. You can get a pulse with an amplitude of 25 amperes or more by using an avalanche transistor with a high BV_{CEX} .

Incidentally, the circuit in Fig. 2 has an incredibly fast risetime. As you can see by referring to the scope photo in Fig. 4, the approximate risetime is only 3.5 ns (10 and 90% amplitude points).

The one-ohm resistor, $R3$, in Fig. 2 can be made from a piece of nichrome wire. Simply cut the wire a bit at a time until it measures 1 ohm.

Now that you know how to put together a simple high-current, super-fast pulser, what can you do with it? Avalanche circuits are ideal for operating power sensitive LED's and semiconductor injection lasers. For example, a typical injection laser marketed by at least one of the parts dealers in the back of this magazine requires up to 10 amperes or more in a fast risetime pulse no wider than 200 nanoseconds. A wider pulse will overheat and melt the laser junction. SCR pulsers can be used, but they aren't nearly as fast or efficient. They also require a higher operating voltage to achieve the same discharge current levels.

Other uses include a miniature r-f tone transmitter, pulse generator, sawtooth generator, and audio oscillator. The ultra-fast risetime of the discharge pulse is rich in harmonics which can be broadcast to a nearby receiver. Figure 5 shows how to modify the basic circuit for use as a waveform generator or audio oscillator. The oscillator version is nice for initial experiments since you can easily hear the frequency of oscillation.

When you assemble an avalanche

transistor circuit, keep these tips in mind:

1. Keep $C1$ at 0.02 μF or smaller. Larger values may work, but with the increased discharge time, you run the risk of damaging $Q1$.

2. Avoid turning $R1$'s shaft to a very low resistance setting. If this occurs $Q1$ may avalanche through $R1$ and be destroyed by the resultant high and continuous discharge current. You can use a 50K resistor in series with $R1$ to be on the safe side.

3. If you don't have a 0-150-volt dc power supply, use a fresh 67.5-volt battery. Depending on the BV_{CEX} of $Q1$, you might need to use two 67.5-volt batteries in series.

4. Whatever power supply you choose, be sure to use caution when operating the circuit. Even a harmless looking 67.5-volt battery can supply an unpleasant jolt so keep one hand in your pocket when the circuit is operating to avoid accidental electrical shocks. Use well-insulated clip leads to connect the circuit to a power supply.

5. If you use the circuit to power an LED or injection laser, keep the leads in the discharge path as short as possible to avoid such inductance-caused effects as pulse stretching and ringing.

6. If you don't have a scope, a convenient way to measure the BV_{CEX} of various transistors used for $Q1$ is to increase $R1$ to a megohm or more to slow down the repetition rate to a few pulses per second while monitoring the voltage on $C1$ with a high-impedance VOM. The voltage on $C1$ will rise to the BV_{CEX} and then collapse as $Q1$ avalanches. Since $C1$ charges so fast, the meter reading will closely approximate BV_{CEX} .

SAVE!

MONEY • TIME • FREIGHT

QUALITY STEREO EQUIPMENT AT LOWEST PRICES.

YOUR REQUEST FOR QUOTATION RETURNED SAME DAY.

FACTORY SEALED CARTONS—GUARANTEED AND INSURED.

SAVE ON NAME BRANDS LIKE:

A.D.C.	KLH
A.R.	SHURE
DYNACO	KOSS
SONY	FISHER

PIONEER

AND MORE THAN 50 OTHERS

BUY THE MODERN WAY

BY MAIL—FROM

illinois audio

Department 217S

12 East Delaware

Chicago, Illinois 60611

312-664-0020

CIRCLE NO. 29 ON FREE INFORMATION CARD

MACHINE LANGUAGE PROGRAMMING FOR THE "8008"

AND SIMILAR MICROCOMPUTERS

READ IT FOR 15 DAYS! MONEY-BACK GUARANTEE

- Detailed presentation of "8008" codes
- Flow Charts • Mapping
- Floating-point Package
- Basic programs: loops, counters, masks
- Multiple-precision arithmetic
- Debugging • Organizing Tables
- Editing/Assembling • Math operations
- I/O, Real-Time Programming
- Maximizing memories • And lots more

19⁹⁵ ppd.

Here's the detailed, basic manual you need to develop today's machine language programs. 170 pages. Illustrated. Easy-to-read, understand. Most techniques applicable to other microcomputers, e.g. 8080, etc. Floating-point arithmetic package is worth the price alone.

Order today! Read the manual for 15 days. If not completely satisfied, return it in salable condition, for full refund.

SCELBI COMPUTER CONSULTING INC.
1322 Rear Boston Post Rd., Milford, CT 06460.
CIRCLE NO. 53 ON FREE INFORMATION CARD

ELECTRONICS MARKET PLACE

NON-DISPLAY CLASSIFIED: COMMERCIAL RATE: For firms or individuals offering commercial products or services, \$2.00 per word (including name and address). Minimum order \$30.00. Payment must accompany copy except when ads are placed by accredited advertising agencies. Frequency discount; 5% for 6 months; 10% for 12 months paid in advance. **READER RATE:** For individuals with a personal item to buy or sell, \$1.20 per word (including name and address.) No minimum! Payment must accompany copy. **DISPLAY CLASSIFIED:** 1" by 1 column (2-1/4" wide), \$230.00. 2" by 1 column, \$460.00. 3" by 1 column, \$690.00. Advertiser to supply film positives. For frequency rates, please inquire.

GENERAL INFORMATION: First word in all ads set in caps at no extra charge. All copy subject to publisher's approval. All advertisers using Post Office Boxes in their addresses **MUST** supply publisher with permanent address and telephone number before ad can be run. Advertisements will not be published which advertise or promote the use of devices for the surreptitious interception of communications. Ads are not acknowledged. They will appear in first issue to go to press after closing date. Closing Date: 1st of the 2nd month preceding cover date (for example, March issue closes January 1st. Send order and remittance to **POPULAR ELECTRONICS**, One Park Avenue, New York, New York 10016, Attention: Hal Cymes.

FOR SALE

FREE! Bargain Catalog—I.C.'s, LED's, readouts, fiber optics, calculators parts & kits, semiconductors, parts. Poly Paks, Box 942PE, Lynnfield, Mass. 01940.

GOVERNMENT Surplus Receivers, Transmitters, Snooperscopes, Radios, Parts, Picture Catalog 25 cents. Meshna, Nahant, Mass. 01908.

LOWEST Prices Electronic Parts. Confidential Catalog Free. KNAPP, 3174 8th Ave. S.W., Largo, Fla. 33540.

ELECTRONIC PARTS, semiconductors, kits. FREE FLYER. Large catalog \$1.00 deposit. BIGELOW ELECTRONICS, Bluffton, Ohio 45817.

RADIO—T.V. Tubes—36 cents each. Send for free catalog. Cornell, 4213 University, San Diego, Calif. 92105.

AMATEUR SCIENTISTS. Electronics Experimenters, Science Fair Students Construction plans—Complete, including drawings, schematics, parts list with prices and sources Robot Man — Psychedelic shows — Lasers — Emotion/Lie Detector — Touch Tone Dial — Quadraphonic Adapter — Transistorized Ignition — Burglar Alarm — Sound Meter over 60 items. Send 50 cents coin (no stamps) for complete catalog. Technical Writers Group, Box 5994, University Station, Raleigh, N.C. 27607.

METERS—Surplus, new, used, panel or portable. Send for list. Hanchett, Box 5577, Riverside, CA 92507.

250 PIECE assortment of hard to find nuts used in the electronics industry. Over 45 different sizes in brass, steel, aluminum, \$4.75 postpaid. Fastening Products, Box 151, Cheltenham, PA 19012.

SOUND SYNTHESIZER KITS—Surf \$12.95, Wind \$12.95, Wind Chimes \$17.95, Electronic Songbird \$6.95, Musical Accessories, many more. Catalog free. PAIA Electronics, Box J14359, Oklahoma City, OK 73114.

BUGGED??? New locator finds them fast. Write, Clifton, 11500-L N.W. 7th Avenue, Miami, Florida 33168.

DISCOUNT PRICES

B&K, SENCORE, LEADER, RCA EICO, FLUKE, HICKOK, SIMPSON Test Equipment

ICC Servicemaster, RCA and Raytheon Tubes Complete line of electronic supplies

Free Catalog

FORDHAM RADIO SUPPLY CO., INC.

855A Conklin St., Farmingdale, N.Y. 11735 (516) 752-0050

YOU WILL SAVE BIG MONEY! Surplus, Clearouts, Bankruptcy, Inventory, Deals. Catalog \$1 (redeemable). ETCOA Electronics, Box 741, Montreal, H3C 2V2. U.S. Inquiries.

HEAR POLICE/FIRE Dispatchers! Catalog shows exclusive directories of "confidential" channels, scanners. Send postage stamp. Communications, Box 56-PE, Commack, N.Y. 11725.

CD IGNITIONS, VHF/UHF monitors, crystals, CB radios, Southland, Box 3591-B, Baytown, Texas 77520.

SURPRISE! Build inexpensively, the most Unusual Test Instruments, Futuristic Gadgets using Numerical Readouts! Catalogue Free! GBS, Box 100A, Green Bank, West Virginia 24944.

TELEPHONES UNLIMITED, equipment, supplies. Catalog 50 cents. Box 1654E, Costa Mesa, Calif. 92626.

UNSCRAMBLERS: Fits any scanner or monitor, easily adjusts to all scrambled frequencies. Only 4" square \$29.95, fully guaranteed. Dealer inquiries welcomed. PDQ Electronics, Box 841, North Little Rock, Arkansas 72115.

SURPRISE! SURPRISE! Digital Piano Tuning Device tunes musical instruments Accurately! Perfectly! Inexpensively! Construction-Instruction-Plans Complete \$12.95 Airmailed Postpaid! Moonlighting quickly repays \$40 electronics investment! GBS, Box 100P, Green Bank, West Virginia 24944.

RECONDITIONED Test Equipment. \$0.50 for catalog. Walter's Test Equipment, 2697 Nickel, San Pablo, CA 94806.

POLICE, Fire monitors, scanners, crystals, CB Transceivers, New Crystal-less scanners. Discount priced. Box 19224, Denver, CO 80219.

TELETYPE EQUIPMENT for sale for beginners and experienced computer enthusiast. Teletype machines, parts, supplies. Catalogue \$1.00 to: ATLANTIC SALES, 3730 Nautilus Ave., Brooklyn, NY 11224, Tel: (212) 372-0349.

BUILD THAT ELECTRONIC ORGAN YOU ALWAYS WANTED AT A PRICE YOU CAN AFFORD. Third edition of "Organ Builder's Guide," pictured product kit line, circuits, block diagrams, design rationale using IC divider and independent generators with diode keying, \$3.00 postpaid. Also, free brochure on keyboards. DEVTRONIX ORGAN PRODUCTS, Dept. C, 5872 Amapol Dr., San Jose, CA 95129.

MECHANICAL, ELECTRONIC devices catalog 10 cents. Greatest Values — Lowest Prices, Fertik's, 5249 "D", Philadelphia, Pa. 19120.

JAPANESE TRANSISTORS, all transistors original factory made. Free catalog. West Pacific Electronics, P.O. Box 3879, Torrance, CA 90510.

CB RADIO, Scanners, Antennas. The best for less. Free List. Capitol Sound, Box 3523, Des Moines, Iowa 50322.

YOU WANT TO BUILD IT: WE WANT TO HELP. WE SELL CONSTRUCTION PLANS with an Engineering Service. TELEPHONE: Answering Machines, Speakerphones, Car-phones, Phonevision, Touch Button Dialers. TELEVISION: VTR, 1" Color TV Set, PONG, \$25.00 Camera, COLOR PROJECTION TV. HOBBYIST: Electron Microscope, \$75 software programmable computer. BROADCAST: Special Effects Generator, Chroma Key, Audio Board, DA's. COURSES: Telephone Engineering \$52.00, Detective Electronics \$29.50, IC Engineering \$65.00, PLUS MUCH MORE. NEW Super Hobby Catalog PLUS year's subscription to Electronic News Letter AIR MAILED \$1.00. Don Britton Enterprises, 6200 Wilshire Blvd., Los Angeles, Calif. 90048.

WHOLESALE C.B., Scanners, Antennas, Catalog 25 cents. Crystals: Special cut, \$4.95, Monitor \$3.95. Send make, model, frequency. G. Enterprises, Box 461P, Clearfield, UT 84015.

SEMICONDUCTOR AND PARTS Catalogue, \$1.00 refundable, from the semiconductor specialists, J & J Electronics, Box 1437P, Winnipeg, Manitoba, Canada. U.S. Inquiries.

ELECTRONIC ignition: Pointless, Transistor, Capacitor, Vapor inductors, Auburn Sparkplugs. Information 10 cents Anderson Engineering, Epsom, N.H. 03234.

TV PING PONG game. Plays through your set's antenna terminals: Plans \$3.25. ARS SYSTEMS, Box 1922, Sunnyvale, CA 94088.

6 MHZ CRYSTALS including schematic and info to generate 60 hz-12VAC to make your digital clock run on batteries, \$10.50 pp in US. Eastern Sales, Box 510, Raleigh, N.C. 27602.

ELECTRONICS DESIGN NEWSLETTER

★ Logic Design Techniques
★ Digital & Linear Design Theory & Procedures
★ Construction Projects

Subscription \$6 Sample Copy \$1

VALLEY WEST Box 2119-V Sunnyvale, CA 94087



WORLD'S SMALLEST RECHARGEABLE CALCULATOR...\$19.95!

Does Everything Big Ones Do

Small but mighty! 8-digit, 4-function electronic calculator even has automatic % key . . . for only \$19.95. Take it anywhere. Carry it in your pocket or purse — it's 2/3 the size of a pack of cigarettes. This 3 1/2-ounce dynamo features floating decimal, constant key, lead zero depression, clear entry, more! At Edmund's low price, the unit comes with a Ni-Cad rechargeable battery pack that can plug into any AC outlet. No need for special recharging adapters. Calculator overall is just 2 x 3 1/2 x 1/8" with plenty of room for most fingers. *Another Edmund first with advanced technology.* **\$19.95** ppd.

STOCK NO. 1945AV Only \$19.95 ppd.

GIANT FREE CATALOG!

NEW, 172 Pages. Over 4,500 Unusual Bargains for Hobbyists, Schools, Industry.



JUST CHECK COUPON!
EDMUND SCIENTIFIC CO.
300 EDSCORP BUILDING
Barrington, N. J. 08007
(609) 547-3488

America's Greatest Science • Optics • Hobby Mart

COMPLETE AND MAIL COUPON NOW

EDMUND SCIENTIFIC CO. 300 Edscorp Bldg., Barrington, N. J. 08007

SEND FREE 172 PAGE CATALOG "AV"
 Charge my BankAmericard
 Charge my Master Charge

Interbank No. _____
Card No. _____

Expiration Date _____
30-DAY MONEY-BACK GUARANTEE. You must be satisfied or return any purchase in 30 days for full refund.

City _____ State _____ Zip _____

Signature _____
Name _____ Please print

Address _____

City _____ State _____ Zip _____

HELPING TO DEVELOP AMERICA'S TECHNOLOGY FOR OVER 30 YEARS.

Poly Pak's EXCLUSIVE Avg. Ship: \$1.98 Wt. 6 ozs.



100'S OF BARRELS PURCHASED! TEST 'EM YOURSELF 'N SAVE!

For the first time anywhere, Poly Pak merchandisers introduce a new way in buying the economical way. Raw stock from the "barrel". Remember the "good ole days"? They're back again. The same way merchandisers

throughout the United States buy from various factories... their overruns in barrels. Poly Pak has done the same. Therefore you are getting the same type of material as the RE-TESTERS DO!

Every kit carries a money back guarantee!

YOUR CHOICE OF ANY KIT

<p>BARREL KIT #145 MINI TRANSFORMER 15 for \$1.98</p> <p>Miniature transformer back again. Asst. outputs, inter-stage and audio. Only 1 1/2" sq. Wt. 2 lbs. 7E3294</p>	<p>BARREL KIT #147 QV-FLO FLUORESCENT NIXIES 5 for \$1.98</p> <p>Used originally in table top calculators. Brand new. Gas discharge type, colors Blue. Cat. No. 7E3288</p>
<p>BARREL KIT #148 SEMI-KON SURPRISE 100 for \$1.98</p> <p>Imagine a factory unloading shelves of zeners, rectifiers, transistors, all types of shapes and barrels? Hard to believe. Cat. No. 7E3300</p>	<p>BARREL KIT #150 COIL FORMS 100 for \$1.98</p> <p>Factory barrels make economy the name! Wire your own coils. Imagine forms only 2¢ ea. Asst. sizes. Cat. No. 7E3304</p>
<p>BARREL KIT #152 VOLUME CONTROLS 15 for \$1.98</p> <p>Control maker discontinued line: simple controls with switches at ridiculous prices. Asst. values. Cat. No. 7E3306</p>	<p>BARREL KIT #155 MOLDED CAPACITORS 75 for \$1.98</p> <p>Asst. size voltages, red, green, yellow, blue plastic cases, axial leads. No. 7E3311</p>
<p>BARREL KIT #158 MAGNIFIED MAN-3'S 15 for \$1.98</p> <p>Cosmetic rejects! Famous style MAN-3, 7-seg readout, with built-in magnifier. Factory discontinued line. 100% material. Cat. No. 7E3325</p>	<p>BARREL KIT #159 MODULAR SWITCHES 25 for \$1.98</p> <p>Centralab "push-On" switches. TV-makers, excess. Dpdt, 6pdt, etc. Brand new. Cat. No. 7E3150</p>
<p>BARREL KIT #159 METAL CAN SCRS, TRIACS, QUADRACS 40 for \$1.98</p> <p>All the famous plastic power tab type. Raw factory stock! All the 10 amp types. Cat. No. 7E2419</p>	<p>BARREL KIT #160 POWER TAB TRANSISTORS 40 for \$1.98</p> <p>PNP, plastic TO220 type. Assorted 2N numbers. Cat. No. 7E2426</p>
<p>BARREL KIT #161 MOSFET TRANSISTORS 60 for \$1.98</p> <p>All 4 leads TO-18 case, includes UHF transistors too! Cat. No. 7E2429</p>	<p>BARREL KIT #162 RESISTOR NETWORKS 60 for \$1.98</p> <p>By Corning Glass, in 14-pin dip packs. Cat. No. 7E2427</p>
<p>BARREL KIT #163 LINEAR OP AMPS, DIPS 75 for \$1.98</p> <p>Un tested 75 for \$1.98. May include 700's, 741's, 703's, 560 series, 555 includes marked and unmarked. Cat. No. 7E2416</p>	<p>BARREL KIT #164 RECTIFIERS 100 for \$1.98</p> <p>These are the famous micro miniature rectifiers of the IN4000 series. May include 25, 60, 100, 200, 400, 600, 800 and 1000 volters. Cat. No. 7E2417</p>
<p>BARREL KIT #165 JUMBO RESISTOR PAK 100-pc. \$1.98</p> <p>Cat. No. 7E2721</p> <p>Assortment metal films, precision, carbons, metal oxide powders, from 1/2 watt to 7 watts. Color coded & 100% good. Worth \$10.</p>	<p>BARREL KIT #166 SLIDE SWITCHES 30 for \$1.98</p> <p>All shapes, sizes, spat, dpdt, momentaries, etc. Tremendous shop pak for 100's of switching projects. Cat. No. 7E2610</p>
<p>BARREL KIT #167 NATIONAL IC BONANZA 100 for \$1.98</p> <p>Factory dumps into barrels. Types 8000, 7400 series, DTL, ROM's, registers, decoders & calc. chips, linears, etc. Cat. No. 7E2860</p>	<p>BARREL KIT #168 TO-5 PLASTIC TRANSISTORS 40 for \$1.98</p> <p>Includes PNP, NPN, 2N-3638, 2N3641, 2N5000 series, etc. Un tested, but guaranteed to a 60% yield.</p>
<p>BARREL KIT #169 PHOTO ELECTRIC CELLS 10 for \$1.98</p> <p>Asst. GE types, CDS types. Mixed by factory. Big job for us to separate. 100% good. Cat. No. 7E3052</p>	<p>BARREL KIT #170 SUPPRESSOR DIODES 50 for \$1.98</p> <p>Keeps ignition noises out axial. Un tested, but the of your eqpt, car, industrial, etc. Double plug.</p>
<p>BARREL KIT #171 CAPACITOR SPECIAL 100 pcs. \$1.98</p> <p>Empty stockrooms into barrels of mylars, poly's, mica, muleds, plastics, ceramic, discs, etc. Nifty 100% good. Cat. No. 7E2738</p>	<p>BARREL KIT #172 TANTALUM ELECTRODS 30 for \$1.98</p> <p>Mixed, marked prime, top grade asst. values, voltages. GE, Centralab, etc. Cat. No. 7E3255</p>
<p>BARREL KIT #173 MIXED READOUTS 15 for \$1.98</p> <p>Factory returns such numbers as MAN-4's, MAN-7's, MAN-3's, 11 barrels & no time to separate. Cat. No. 7E2733</p>	<p>BARREL KIT #174 400MW ZENERS 150 for \$1.98</p> <p>Factory out of biz! Amazing offer: 6, 8, 10, 12 to 15V. You test. Hermetically sealed glass pak. Double plug. Cat. No. 7E2740</p>
<p>BARREL KIT #175 MICRO MINI LEDS 40 for \$1.98</p> <p>All the tiny leds, axial, up-right, of Monsanto, Litronix, variety of colors. Yield 60% or better. Cat. No. 7E3129</p>	<p>BARREL KIT #176 1-WATT ZENERS 100 for \$1.98</p> <p>Factory same as 400-mw's. Never-to-see-again offer. 6, 8, 10, 12, 15V, under glass. Double plug. Cat. No. 7E2741</p>
<p>BARREL KIT #176 "RED" BODY TRANSISTORS 40 for \$1.98</p> <p>D-12 series. You test into your own biz high current, hi-V, NPN. Cat. No. 7E2743</p>	<p>BARREL KIT #177 "BROWN" BODY TRANSISTORS 40 for \$1.98</p> <p>GE 11-10 Darlings: has hi-voltage. Darlington, hi-current, npn's. Factory line discontinued. Power tabs. Cat. No. 7E2742</p>
<p>BARREL KIT #177 "RED" BODY TRANSISTORS 40 for \$1.98</p> <p>D-12 series. You test into your own biz high current, hi-V, NPN. Cat. No. 7E2743</p>	<p>BARREL KIT #178 SUBMINI RESISTORS 200 for \$1.98</p> <p>PC, upright type, color coded. Un tested. Asst. values. Come to us in a barrel. Cat. No. 7E2746</p>
<p>BARREL KIT #178 "RED" BODY TRANSISTORS 40 for \$1.98</p> <p>D-12 series. You test into your own biz high current, hi-V, NPN. Cat. No. 7E2743</p>	<p>BARREL KIT #179 PHOTO ELECTRIC CELLS 10 for \$1.98</p> <p>Asst. GE types, CDS types. Mixed by factory. Big job for us to separate. 100% good. Cat. No. 7E3052</p>
<p>BARREL KIT #179 PHOTO ELECTRIC CELLS 10 for \$1.98</p> <p>Asst. GE types, CDS types. Mixed by factory. Big job for us to separate. 100% good. Cat. No. 7E3052</p>	<p>BARREL KIT #180 TERMINAL STRIPS 150 for \$1.98</p> <p>We asst. of terminal strip connectors, from 1 contact up. Strip manufacturers barrel dump is your gain. Wt. 1 lb. Cat. No. 7E3136</p>
<p>BARREL KIT #180 CLOCK CHIPS 5 for \$1.98</p> <p>National is dumping! MM-5316 - what's wrong with 'em, we don't know, but we got barrels. Hobby special. Wt. 2 oz.</p>	<p>BARREL KIT #181 MULTI DIGIT READOUTS 8 for \$1.98</p> <p>barrels of blemished 3, 4 and/or 6 digit readouts to USA for "dump". Un tested. Cat. No. 7E3138</p>
<p>BARREL KIT #181 MICRO MINI LEDS 40 for \$1.98</p> <p>All the tiny leds, axial, up-right, of Monsanto, Litronix, variety of colors. Yield 60% or better. Cat. No. 7E3129</p>	<p>BARREL KIT #182 TRIGGER DIODES 25 for \$1.98</p> <p>Type ER-900, same type used to trigger acry. tubes. Sometimes called "diacs". Un tested. No. 7E3160</p>
<p>BARREL KIT #182 UPRIGHT ELECTRODS 40 for \$1.98</p> <p>Wide asst. of values from 2mt to 300mf in mixture of voltages. 100% marked in a barrel. Why barreled? U-got-a-bud. Cat. No. 7E3226</p>	<p>BARREL KIT #183 C-MOS IC'S 60 for \$1.98</p> <p>Deliberately thrown in barrels, so we can't test 'em! The famous CD4000 series. How good? Who knows? Who cares? It's only 3¢ ea. Cat. No. 7E3257</p>
<p>BARREL KIT #183 CD-4002 C-MOS IC 15 for \$1.98</p> <p>Mostly good. But we have 250,000. Can never sell 'em out. YOUR GAIN! Their number is CD-8002. Cat. No. 7E3217</p>	<p>BARREL KIT #184 RCA PHONO PLUGS 40 for \$1.98</p> <p>1,000,000 RCA phono plugs for this one! You hi-fi-ers know what they are & 100% material. Look at the price. 7E3293</p>
<p>BARREL KIT #184 LAMPS 20 for \$1.98</p> <p>Precision, mini lamp all metal panel, with mfg hardware. Lamp maker's overstock. 7E3297</p>	<p>BARREL KIT #185 MOLEX SOCKETS 200 for \$1.98</p> <p>Calculator maker dump! We got a million of 'em. Used for IC sockets, etc. Cat. No. 7E3144</p>
<p>BARREL KIT #185 MOLEX SOCKETS 200 for \$1.98</p> <p>Calculator maker dump! We got a million of 'em. Used for IC sockets, etc. Cat. No. 7E3144</p>	<p>BARREL KIT #186 BUTTONS 'N MINIS 100 for \$1.98</p> <p>Truly worth a small fortune. Wide asst. of button-feed thru caps! HAMS TAKE NOTE! RE-IMP, etc. Wt. 1 lb. Cat. No. 7E3141</p>
<p>BARREL KIT #186 BUTTONS 'N MINIS 100 for \$1.98</p> <p>Truly worth a small fortune. Wide asst. of button-feed thru caps! HAMS TAKE NOTE! RE-IMP, etc. Wt. 1 lb. Cat. No. 7E3141</p>	<p>BARREL KIT #187 NATIONAL IC BONANZA 100 for \$1.98</p> <p>Factory dumps into barrels. Types 8000, 7400 series, DTL, ROM's, registers, decoders & calc. chips, linears, etc. Cat. No. 7E2860</p>
<p>BARREL KIT #187 DARLINGTON TRANSISTORS 40 for \$1.98</p> <p>TO-92, a Motorola dump, unknown numbers, but high yield to good darlings. Retesters didn't get 'em! You will. 7E3285</p>	<p>BARREL KIT #188 MINI SCRS 50 for \$1.98</p> <p>UNBELIEVABLE! TO-92 plastic SCRS in barrels... rke from factory. Includes all voltages up thru 200 prv. 7E3135</p>
<p>BARREL KIT #188 MINI SCRS 50 for \$1.98</p> <p>UNBELIEVABLE! TO-92 plastic SCRS in barrels... rke from factory. Includes all voltages up thru 200 prv. 7E3135</p>	<p>BARREL KIT #189 SUPPRESSOR DIODES 50 for \$1.98</p> <p>Keeps ignition noises out axial. Un tested, but the of your eqpt, car, industrial, etc. Double plug.</p>
<p>BARREL KIT #189 PHOTO ELECTRIC CELLS 10 for \$1.98</p> <p>Asst. GE types, CDS types. Mixed by factory. Big job for us to separate. 100% good. Cat. No. 7E3052</p>	<p>BARREL KIT #190 TERMINAL STRIPS 150 for \$1.98</p> <p>We asst. of terminal strip connectors, from 1 contact up. Strip manufacturers barrel dump is your gain. Wt. 1 lb. Cat. No. 7E3136</p>
<p>BARREL KIT #190 LAMPS 20 for \$1.98</p> <p>Precision, mini lamp all metal panel, with mfg hardware. Lamp maker's overstock. 7E3297</p>	<p>BARREL KIT #191 SILVER MICAS 100 for \$1.98</p> <p>For the first time silver mica so low in price! Axial, red case, variety of physical sizes & values. Big savings from distributor prices. Wt. 1 lb.</p>
<p>BARREL KIT #191 SILVER MICAS 100 for \$1.98</p> <p>For the first time silver mica so low in price! Axial, red case, variety of physical sizes & values. Big savings from distributor prices. Wt. 1 lb.</p>	<p>BARREL KIT #192 TRIGGER DIODES 25 for \$1.98</p> <p>Type ER-900, same type used to trigger acry. tubes. Sometimes called "diacs". Un tested. No. 7E3160</p>
<p>BARREL KIT #192 UPRIGHT ELECTRODS 40 for \$1.98</p> <p>Wide asst. of values from 2mt to 300mf in mixture of voltages. 100% marked in a barrel. Why barreled? U-got-a-bud. Cat. No. 7E3226</p>	<p>BARREL KIT #193 C-MOS IC'S 60 for \$1.98</p> <p>Deliberately thrown in barrels, so we can't test 'em! The famous CD4000 series. How good? Who knows? Who cares? It's only 3¢ ea. Cat. No. 7E3257</p>
<p>BARREL KIT #193 C-MOS IC'S 60 for \$1.98</p> <p>Deliberately thrown in barrels, so we can't test 'em! The famous CD4000 series. How good? Who knows? Who cares? It's only 3¢ ea. Cat. No. 7E3257</p>	<p>BARREL KIT #194 "BUBBLE" READOUTS 12 for \$1.98</p> <p>DL-33B bubble magnifiers. 56's missing. Truly good. 100% of 'em we don't care. Un tested. 3 oz. No. 7E3047</p>
<p>BARREL KIT #194 "BUBBLE" READOUTS 12 for \$1.98</p> <p>DL-33B bubble magnifiers. 56's missing. Truly good. 100% of 'em we don't care. Un tested. 3 oz. No. 7E3047</p>	<p>BARREL KIT #195 SUPPRESSOR DIODES 50 for \$1.98</p> <p>Keeps ignition noises out axial. Un tested, but the of your eqpt, car, industrial, etc. Double plug.</p>
<p>BARREL KIT #195 SUPPRESSOR DIODES 50 for \$1.98</p> <p>Keeps ignition noises out axial. Un tested, but the of your eqpt, car, industrial, etc. Double plug.</p>	<p>BARREL KIT #196 MINI MAGNETS 100 for \$1.98</p> <p>Magnet circular and rectangular cuttings from a major maker. For reed switches & micro-circuitry. Cat. No. 7E3168</p>
<p>BARREL KIT #196 MINI MAGNETS 100 for \$1.98</p> <p>Magnet circular and rectangular cuttings from a major maker. For reed switches & micro-circuitry. Cat. No. 7E3168</p>	<p>BARREL KIT #197 RIBBON CABLE 30-ft. \$1.98</p> <p>Wire maker closeout (barrels of 'em) 7-conductor #22 yellow jacket. In 3-ft lengths or longer. 7E3296</p>
<p>BARREL KIT #197 RIBBON CABLE 30-ft. \$1.98</p> <p>Wire maker closeout (barrels of 'em) 7-conductor #22 yellow jacket. In 3-ft lengths or longer. 7E3296</p>	<p>BARREL KIT #198 RIBBON CABLE 30-ft. \$1.98</p> <p>Wire maker closeout (barrels of 'em) 7-conductor #22 yellow jacket. In 3-ft lengths or longer. 7E3296</p>

Terms: Add postage. Rated: net 30.
Phone: Wakefield, Mass. (617) 245-3829
Retail: 16-18 Del Carmine St., Wakefield, MA
MINIMUM ORDER — \$6.00

POLY PAKS
P.O. BOX 942E LYNNFIELD, MASS. 01940

C.O.D.'s MAY BE PHONED

Send for FREE Summer-Fall CATALOG



DELTA ELECTRONICS CO.

P.O. BOX 2, AMESBURY, MASS. 01913

MAGNUS TONE GENERATOR BOARD

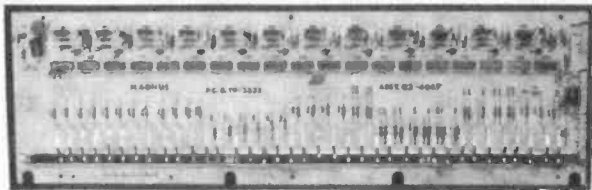

This MAGNUS tone generator board has 12 SCR oscillators & IC dividers for 37 notes (3 octaves), plus 3 chord oscillators. The basic component for your organ or synthesizer. Requires only +5v, +15v, and an amplifier. Use with our P5210 keyboard, below. 5 3/4" x 19 1/4"

STOCK NO. P5244 \$17.95 each, 2/35.00

Matching 13 watt amplifier for use with P5244 tone generator. Complete with power supply rectifiers & filters. 4 3/4" x 6"

STOCK NO. P5245 \$9.95 each, 2/18.00

STOCK NO. P5348 Power Transformer \$3.75 ea, 2/7.00

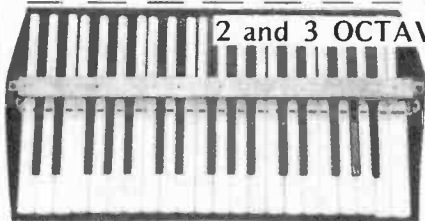

2 and 3 OCTAVE KEYBOARDS

We have a limited number of matching 2 & 3 octave keyboards. Use with tone generator, above, or with a synthesizer of your own. P5210 has 37 keys, is

9 3/4" x 19". P5280 has 25 keys, is 8 1/2" x 13".

STOCK NO. P5210 4 lbs. 3 octaves \$17.95 each, 2/35.00

STOCK NO. P5280 3 lbs. 2 octaves \$8.95 each, 2/17.00

Send for latest free catalog. Minimum order \$5, phone orders welcome: (617) 388-4705. Include sufficient postage; excess will be refunded. BANKAMERICARD & MASTERCARD welcome, ALL numbers needed for processing. Minimum charge \$15.

CIRCLE NO. 65 ON FREE INFORMATION CARD

For faster service

USE ZIP CODE

on all mail

DESCRAMBLERS: Several Professional Models that work with all Scanners. Tone Encoders/Decoders, Scanmate, AAPP, Radar Detectors. Big Ears, Alarms, Books, Kits, parts. Catalog 25 cents: KRYSTAL KITS, Box 445, Bentonville, Ark. 72712.

CARBON FILM RESISTORS. Brand new as low as 1.7 cents. Discounts of 20%. Prompt delivery. FREE samples/specifications. COMPONENTS CENTER, Box 134P, N.Y., N.Y. 10038.

TV TECHNICIANS, SERVICEMEN, HOBBYISTS—Vista Model 740 Digital Crosshatch Generator. Compact crystal divider for lowest-priced ultra-stable 5x7 crosshatch or 56 dot patterns. AC powered. \$31.95 complete kit; \$41.95 assembled. Postpaid in USA, Canada. Information available free. Photolume Corporation, Dept. PE-76, 118 East 28th Street, New York, New York 10016.

PLANS—Video Pong \$2.00, Laser \$2.00, Projection TV \$2.00. Catalog 50 cents. Technologic, Box 5262, Orchard Lake, Michigan 48033.

IC BONANZA

*Data Sheet included on these items

*MM5330	National DVM on a chip	\$ 9.95
*2102	1K Static Ram 450 NS	1.60
*5203 Q	Eraseable Prom 2K	11.95
*50310	Slide rule calculator chip	3.95
*50240	Top octave organ chip	5.95
*50250	Alarm clock chip	4.45
LM340K-5	5 Volt pos. regulator	.89
LM340K-12	12 Volt pos. regulator	.89
LM340K-15	15 Volt pos. regulator	.89
LM340K-24	24 Volt pos. regulator	.89
LM320K-5	5 volt neg. regulator	.84
LM320-5.2	5.2 Volt neg. regulator	.84
LM320K-12	12 Volt neg. regulator	.84
N8252B	BCD to decimal decoder	.79
962	Triple 3 Input NAND gate	.09
2N6050	Darlington	.75
2N6051	Darlington	.79
2N6285	Darlington	.99
2N6286	Darlington	1.04

SEND FOR FREE CATALOG

Minimum order \$5.00, data sheets 25 cents each. Include 5% of order for postage and handling. Texas residents include 5% state sales tax.

BONANZA ELECTRONICS

P. O. Box 24767 Dallas, Texas 75224

MSI

Wise move



MODULAR SCIENTIFIC INSTRUMENTATION

Now you can build some of the most advanced digital electronic instruments with our new series of low-cost modular scientific kits. These kits will expand the range of your electronic applications enormously—and all at a surprisingly low cost.

The heart of the system is our 4-digit Decade Counter (Kit 012) which features a full 4-digit LED readout (you choose the size best suited to your application). Combine this with a 5-volt regulated power supply (Kit 030) and you have the basis of a wide range of sophisticated electronic instruments, including:

A Digital Voltmeter (DVM) .. Kit 012 + Kit 030 + Kit 017
Frequency Counter..... Kit 012 + Kit 030 + Kit 016 +Time Base
RPM Counter..... Kit 012 + Kit 030 + Kit 020 + Kit 018

TIME BASES

1 Mhz crystal chain time base divider. Outputs; 1Mhz-100Khz-10Khz-1Khz-100Hz-10Hz-1Hz-0.1Hz. Accuracy better than .005% with proper adjustment.

Kit 013 complete CMOS with PC board \$15.75
Buffer Circuit for TTL Interfacing

Kit 014 Same as Kit 013, but with TTL..... \$13.75

Kit 015 50Hz or 60Hz chain time base using line frequency as reference. Accuracy 0.1-0.05%. Outputs 10Hz-1Hz-0.1Hz. Complete with CMOS shaping circuit and PC Board..... \$9.75

Kit 019 Same as Kit 015, but with TTL and 60Hz only..... \$7.75

Kit 018 60Hz chain time base using line frequency for Kit 020 RPM counter.

*Outputs: .6 sec. = 100th of RPM
6 sec. = 10th of RPM
60 sec. = full revolution

\$9.75

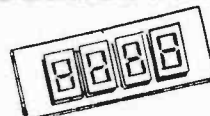

4-DIGIT DECADE COUNTER KIT
\$19.95
KIT 012

One chip 4 digit decade counter kit, with both 7 segment and BCD output.

1. Chip features internal oscillator for scanning speed.
2. Overflow and count extent outputs.
3. Transfer, reset, count, blanking and true compliment control inputs.
4. PC Boards can be cascaded to 8-12-16, etc. digits.
5. Kit includes counter chip, drive circuit for 4 cathode type displays and PC Board. (For readout board see (FND70-FND503)

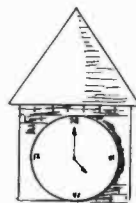

MORE TO COME

Watch this space in future issues for additional kits, including Multimeter, Timer, Capacitance Meter, Thermometer and many more. With our kits and your imagination, you'll find dozens of new and exciting applications.

KIT 016 FREQ. COUNTER

Features FET input front end with trigger circuit for measuring complex waveforms. Measures from 0.1Hz to 10MHz when used with Kit 015 or 019. Measures from .01Hz to 35MHz when used with Kit 013 and 014. \$24.50

KIT 017 DVM

1.999V as basic, with polarity indication. 1 M ohm input impedance and accuracy to 1% if properly adjusted \$13.50

KIT 020 RPM COUNTER

Counts from 1 to 100,000 RPM. RPM counter kit contains components and PC board. \$8.95

KIT 030 POWER SUPPLY

*Input voltage: 25V max. *Output current: 1 amp max. *Load regulation: 50mV. *Output voltage: 5V. *Line regulation: .01%. (requires 8-20V transformer) \$4.55

(Contains all parts except transformer)

ALTAJ ELECTRONICS

P. O. Box 38544, Dallas, Texas 75238

TERMS: Check or money order. No COD.

Telephone (214) 278-3561

Texas Residents Add 5%

MSI CLUB

Send for your membership card to the Modular Scientific Instrumentation Club and receive a big 10% off on future purchases of M.S.I. kits. Send \$3.00 with your name and address. We will promptly send your very own registered membership card. Don't miss out on the savings. Write now.

Memberships valid for one year from date of registration.

NEW MANAGEMENT!

- * Free Postage
- * No Minimum Order
- * 48 Hour Service
- * 24 Hour Phone Service



WE ARE EAGER TO SERVE YOU!

HP7730
 .33 in. high red very bright
 25mA per seg. Common anode. \$1.20

FND503
 \$1.00
 5/\$7.50

TI
 Fully multiplexed common cathode. Goldplated. Idea for mini 6 digit clock. \$1.30

DL727
 One of our best readouts
 .5 in. high, 20mA per segment. Common anode. \$3.75

**FND807 ANODE
 FND800 CATHODE**
 .8 in. High. The Best on the market. Ideal for large readout application. \$4.95

LEDS
 Mini red .12
 Jumbo red .15
 Jumbo green .20
 Jumbo yellow .25

BURROUGHS 12 DIGIT
 .25 in high orange digit. 160V dc. Free socket. \$2.50

OL33
 If you like an array of displays, we have it. Common cathode. \$1.45

4 & 6 DIGIT PC BOARDS

PC Board for 4 digit display FND 800 or 807	\$2.75
PC Board for 6 digit display FND 800 or 807	\$3.50
PC Board for 4 digit display MAN series or DL707	\$1.75
PC Board for 6 digit display MAN series or DL707	\$2.25
PC Board for 4 digit display FND503	\$2.00
PC Board for 6 digit display FND503	\$3.00
PC Board for 4 digit display DL747	\$2.50
PC Board for 6 digit display DL747	\$3.00
PC Board for 4 digit display DL727	\$3.25
PC Board for 6 digit display DL727	\$3.00
PC Board for 4 digit display FND70	\$1.75

All PC display boards are multiplexed for adding additional digits.

\$\$\$ SAVE! 4-DIGIT ALARM CLOCK

KIT NO. 1 \$13.95
 (with PC Board)

FEATURES:
 Direct drive display outputs, * Current control regulation on chip, * Low power brightness control on chip, * RFI eliminating slowup circuitry, * Sleep Radio feature, * 24 hr. snooze alarm, * Independent digit setting, * Non multiplexed output circuitry. 12VAC CT 1/2 amp transformer for Kit No. 1 \$2.00

***KIT NO. 2**
 Complete kit with components, PC Board, Transformer, wood grain case and filter for display window. Includes .25 in. readouts. **\$21.50**

KIT NO. 3
 Complete kit with components, PC Board, Transformer, wood grain case, and filter for display window. Includes .5 inch readouts. **\$22.50**

* Components for Kit No. 2 or Kit No. 3 sleep radio feature, add \$3.95

LSI INTEGRATION

MM5316 - 4-6 digit alarm clock 40 pin dip w/spec.....	\$ 4.25
7002 - 4 digit counter/latch decoder; 7 segment and BCD outputs. 28 pin dip w/spec.....	\$12.50
7005 - 4 digit counter/latch decoder; 7 segment output only. 24 pin dip w/spec.....	\$ 9.50
7007 - 4 digit counter/latch decoder with BCD output only. 16 pin dip w/spec.....	\$ 7.00
70250 - 4-6 digit alarm clock 28 pin dip w/spec.....	\$ 5.50
PC Board for 70250.....	\$ 4.25
70380 - 4 digit non-multiplexed radio alarm clock featuring direct drive display output 40 pin dip w/spec.....	\$3.50
PC Board for 70380.....	\$ 3.75
8008 - 8 bit parallel CPU.....	\$19.50
2102 - 1K static RAM for 8008.....	\$ 2.25
MM5203 - 2K UV erasable PROM.....	\$12.25
75491 - segment driver.....	\$ 0.35
75492 - digit driver.....	\$ 0.45
7020 - 6 function calculator chip with direct segment drive. 8 digit.....	\$ 2.25

GE TRANSISTOR ASSORTMENT
 T098 cased Darling., SCRs, NPN, PNP, ect.

50 for \$0.95
 100 for \$1.75
 300 for \$5.00

TTL BOARDS

MEMOREX computer boards with TTL's Diodes and Transistors, etc.

5 Boards containing 150-250 IC's **\$3.95**

GOT A CASE? HERE'S THE CURE!

Ideal for Frequency counter case function generator, etc. Overall height 4", length 12", width 7 1/2".

(Includes top, bottom, and hardware.)

\$5.95

MASTER II

LIGHTS

MUSIC 60 WATT COLOR ORGAN

Completely self contained unit with 120 volt power cord included. **\$1.50**

THE KING OF ALTAJ INTRODUCING: TANYA
 (60 Hz. Crystal Time Base)

ADDITIONAL FEATURES:
 1.) Low Power Consumption
 2.) Directly Interfaces with King MCS Clock. Chip.
 3.) 60 Hz output with crystal time base accuracy
 4.) Ideal for Cars, Boats, & Campers.

Kit Includes All Components, P.C. Board, and Instructions for Interfacing with "THE KING" 6-Digit Alarm Clock.

DELILA APPLIANCE STARTER \$9.95

(Example) Set your alarm for 7: a.m., set timer for 15 min. At exactly 7: a.m., the appliance will start; at 7:15 your clock alarm will wake you.

Kit includes all components, PC Board and instructions for interfacing with THE KING 6-digit alarm clock. Addition Number 2

FATIMA 4-DIGIT TEMP. KIT \$19.95

Features 4-digit temperature display; fahrenheit or centigrade; complete C-Max application; uses 7002 4-digit counter.

Kit Includes all components, PC Board and instructions for interfacing with THE KING 6-digit alarm clock. Addition Number 1

THE KING \$23.50 6-DIGIT ALARM CLOCK

THE KING FEATURES:

- 1) 6 digit , 12 hr. 60 cycle or 24 hr. 50 cycle alarm clock.
- 2) Time sharing capability for display of additional information
- 3) Single 12v. supply and a minimum of Interface components.
- 4) AM-PM and automatic power failure indications.
- 5) 10 minute snooze
- 6) Intensity control of LEDs.

All kits include components, PC Boards, Transformer, case, and construction manual.

TTL

7400 - .21	7447 - .94	74157 - .80
7402 - .21	7448 - .94	74153 - .94
7404 - .21	7453 - .21	74154 - 1.00
7406 - .29	7473 - .42	74161 - 1.04
7408 - .21	7474 - .42	74163 - 1.24
7410 - .21	7475 - .70	74164 - 1.94
7413 - .54	7476 - .44	74165 - 1.54
7420 - .21	7483 - .90	74175 - 1.44
7427 - .29	7490 - .74	74181 - 2.80
7430 - .21	7492 - .80	74192 - 1.30
7437 - .44	7493 - .80	74193 - 1.30
7438 - .39	7495 - .80	74195 - .84
7440 - .21	7496 - .80	74195 - .84
7442 - .74	74121 - .43	74197 - .84
	74123 - .80	

CMOS

4000 - .24	4018 - 1.49	4035 - 1.39
4001 - .24	4019 - .59	4037 - 4.50
4002 - .24	4020 - 1.59	4040 - 1.59
4006 - 1.49	4021 - 1.49	4041 - .89
4007 - .24	4022 - 1.19	4042 - .79
4008 - 1.15	4023 - .24	4043 - .80
4009 - .59	4024 - .99	4044 - .59
4010 - .55	4025 - .24	4047 - .59
4011 - .24	4026 - 1.49	4049 - .59
4012 - .24	4027 - .59	4050 - .59
4013 - .59	4028 - .99	4056 - .99
4014 - 1.49	4029 - 1.39	4077 - .39
4015 - 1.19	4030 - .49	74C92 - .29
4016 - .59	4032 - .24	74C04 - .29
4017 - 1.29	4033 - 1.49	74C107 - 1.29
	4034 - 3.25	

CONTINENTAL SPECIALTIES

THE ONE SOURCE FOR EVERYTHING NEW IN BREAD BOARDING

new Proto Board

CSC 100

\$29.95

Write for our FREE Brochure

TRANSISTORS-DIODES

RCA200V 115W T05 NPN	1.25
GE D40C1 NPN Darl.	0.25
2N4443SCR 400v8A T0220	0.65
2N2222 NPN Gen Ampl.	0.20
2N3904 NPN Driver	0.15
2N3906 PNP Compl. 2N3904	0.15
2N4400 NPN Low level noise	0.20
2N5401 PNP Nixie driver	0.25
1N4004 400PIV	15 for 1.00
1N4007 400PIV	10 for 1.00
1N476 3.3 Zen.	4 for 1.00
1N4148 Switch	20 for 1.00

LOOK!

From Altaj to you, a special offer.

Power Supply Kit: 5 Volt 1 Amp. Req. Line regulation .005% Load regulation 50mV

Kit includes Components, PC Board, Transf., Fuse, Pilot Light

Nothing else to buy: **\$5.50**

ALTAJ ELECTRONICS

P.O. BOX 38544 , Dallas, Texas 75238

TERMS: Check or money order. NO C.O.D.

Telephone (214) 278-3561

Texas Residents Add 5%

FREE Catalog. Ultrasonic Devices, LEDs, Transistors, IC's, Strobe Lights, UARTS, Memories, Digital Thermometers, Unique Components. Chaney's, Box 15431, Lakewood, Colo. 80215.

N-RAMS 2102-1.50		PREMIUM COMPONENTS INTRODUCTORY OFFER		PROMS 8223/S123-1.95	
TTL		SCHOTTKY		CMOS	
7400	14 74123 .50	74502	25 74LS153 .95	4001	16 4030 .35
7402	14 74150 .60	74537	40 74LS163 1.50	4002	16 4040 .95
7404	16 74151 .60	74585	2.00 74LS164 1.50	4006	90 4042 .60
7410	14 74157 .60	745140	50 74LS174 1.50	4007	16 4044 .70
7420	14 74160 .75	745172	3.50 74LS175 1.50	4011	16 4049 .38
7427	25 74161 .75	745175	1.50 74LS193 1.50	4012	16 4050 .38
7438	25 74163 .75	745181	3.50 74LS261 1.50	4013	35 4066 .65
7440	14 74165 .80	745197	1.50 74LS253 1.50	4021	95 4068 .35
7445	45 74174 .75	745257	1.50 74LS257 1.50	4023	16 4071 .16
7450	14 74175 .75			4024	75 4073 .16
7451	14 74177 .70	Loth Power		4025	20 4075 .16
7473	22 74180 .80	Schottky		4027	40 4516 .95
7474	23 74181 1.50	74LS00	25		
7493	50 74191 1.00	74LS02	25		
7495	49 74192 .70	74LS10	25		
74116	1.00 74193 .70	74LS73	40		
		74LS75	50		
		74LS151	85		

ELTRON—P.O. Box 2542
SUNNYVALE, CA 94087
Min. Order \$10.00 Add \$1.00
P.&H. Calif. Res. add 6% tax.

COMPUTER HOBBYISTS! Bargain hunt and sell via ON.LINE. 18 issues/year — \$3.75. Free Sample. ON.LINE. 24695 Santa Cruz Hwy., Los Gatos, CA 95030.

NEW ADJUSTABLE THREE OUTPUT REGULATED POWER SUPPLY plus 900 parts worth \$400.00 list. Solid state CARTRIVISION television recorder electronic unit. Schematics, parts cross reference. HEATHKIT television transistor substitutions. Power CB radios. MICRO-PROCESSORS. \$17.95 plus \$3.50 S&H. USA. Free Brochure. Master Charge. BankAmericard. MADISON ELECTRONICS COMPANY. INCORPORATED. Box 369. D55, Madison, Alabama 35758.

B&K test equipment 15% discount. Free shipping. Free catalog. Spacetron, Box 84B, Broadview, IL 60153.

Send for your information packet today— which also includes circuit functions, component line-up and accessories. Information Packet \$1.00 (refundable with order).

visulex P.O. Box 4204P Mountain View, CA 94040

ARIES brought you the first calculator kit, and the first digital clock kit... and now brings you three of the most innovative electronic kits ever made. The System 300 Electronic Music Synthesizer kit is the most advanced in the world today, regardless of price. The AR-781 is a space-age beauty for any decor. And the wholly solid state AR-830 does the work of a \$400.00 tape memory unit.



WARNING... if you're interested in a music synthesizer, don't make a move until you see our catalog first. It's more like a handbook than a catalog, with hundreds of in-depth photographs and descriptions to explain electronic music principles, and to show equipment to do the job. ARIES now offers a complete complement of modules, key boards, and cases, matched to the most rigorous professional standards. Starter systems priced as low as \$395.00.

A clear, ruby-red cylinder shows off all six digits of this modern calendar clock. Easy-to-read numbers show the hours, minutes, and seconds, as well as the month and day every ten seconds.



Red LED 7-segment numerals are 0.33" high, in a sturdy cylinder 2-1/2" in diameter and 4-3/4" long, with finished hardwood ends. Time and calendar are controlled by 60 Hz line frequency, with a 12-month movement. Separate time and calendar adjustments. Includes all the components, PC boards, housing, and instructions. Shipping weight 2 lbs. AR-781 Clock Kit \$34.50

Add finger-touch operation to your old-fashioned dial telephone with an ARIES AR-830 Automatic Digital Telephone Dialer. This has the same layout and convenience as Ma Bell, plus other features she doesn't offer yet. For instance... AR-830 always remembers the last number you dialed, in case the line was busy and you want to try again later. Not only that, but the Dialer's memory can store as many as ten of your favorite numbers for one-touch dialing. AR-830 uses standard dialing and muting contacts; consult local tariffs before connecting. Sh. wt. 2 lbs. AR-830 Dialer Kit \$69.50



QUALITY ELECTRONIC COMPONENTS

NEW DISCOUNT SCHEDULE SAVES YOU EVEN MORE!

AMD 8080A \$34.95 **2102-1 \$1.99**

MICROPROCESSOR 1024 Bit Random Access Memory
0-70°C 480 ns Clock Period 500 ns Max Access Time

INTEGRATED CIRCUITS — TTL, CMOS, LINEAR & MOS

7400	.21	7473	.30	74174	.98	4001	.23	4073	.23
7401	.21	7474	.30	74175	.93	4002	.23	4075	.23
7402	.21	7475	.49	74176	.79	4006	1.23	4081	.23
7403	.21	7476	.32	74177	.99	4007	.23	4082	.23
7404	.21	7480	.70	74180	.70	4008	.79	4502	.70
7405	.21	7482	.70	74181	2.15	4009	.44	4510	1.14
7406	.25	7483	.70	74182	.79	4010	.44	4511	1.05
7407	.25	7485	.89	74184	2.19	4011	.23	4514	2.80
7408	.21	7486	.28	74185	2.19	4012	.23	4515	2.80
7409	.21	7489	2.19	74188	3.50	4013	.40	4516	1.23
7410	.21	7490	.44	74189	3.50	4014	.96	4520	1.14
7411	.21	7491	.10	74190	1.23	4015	.96	4520	1.14
7412	.21	7492	.44	74191	1.23	4016	.40	4527	1.68
7413	.25	7493	.44	74192	.88	4017	1.05	4528	.88
7414	.89	7494	.70	74193	.88	4018	1.05	4535	1.23
7416	.25	7495	.70	74194	.88	4019	.23	LM390	1.80
7417	.25	7496	.70	74195	.88	4020	1.14	LM324N	1.28
7420	.21	74100	.28	74196	.88	4021	1.14	LM340T-5	1.25
7421	.25	74107	.28	74197	.88	4022	.96	LM340T-6	1.25
7423	.35	74109	.33	74198	1.49	4023	.23	LM340T-8	1.25
7425	.35	74121	.35	74199	1.49	4024	.88	LM340T-12	1.25
7426	.25	74122	.44	74201	1.09	4025	.23	LM340T-15	1.25
7427	.33	74123	.44	74202	.88	4026	1.68	LM340T-18	1.25
7428	.28	74125	.40	74203	.67	4027	.40	LM340T-24	1.25
7429	.21	74126	.40	74206	.67	4028	.89	LM3900N	.88
7432	.25	74127	.70	74207	.79	4029	1.24	NE504	2.44
7433	.30	74141	.88	74208	.67	4030	.23	NE540L	2.04
7437	.25	74145	.70	75150	1.31	4031	1.51	NE555V	4.48
7438	.25	74147	1.63	75450	.88	4034	3.50	NE556A	.88
7440	.21	74148	1.30	75451	.61	4035	1.51	NE560B	3.83
7441	.88	74150	1.10	75452	.61	4040	1.14	NE561B	3.83
7442	.53	74151	.70	75453	.61	4041	.79	NE562B	3.83
7443	.63	74153	.65	75454	.61	4042	.79	NE565A	.88
7444	.63	74157	.65	75491	.81	4043	.70	NE568V	1.28
7445	.70	74155	.70	75492	.84	4044	.70	NE567V	1.36
7446	.70	74156	.70	75493	1.09			uA709CV	.44
7447	.70	74157	.70	75494	1.19	4049	.40	uA710 CA	.44
7448	.70	74160	.88	8093	.40	4050	.40	uA711 CA	.53
7450	.21	74161	.88	8094	.40	4051	1.26	uA723CA	.60
7453	.21	74162	.88	8095	.67	4052	1.26	uA741 CV	.44
7454	.21	74163	.88	8096	.67	4053	.72	uA747 CA	.70
7460	.21	74164	.96	8097	.67	4060	1.58	uA748 CV	.49
7470	.30	74166	1.26	8098	.67	4066	.79	MC1458V	.53
7472	.30	74170	2.64	8225	2.19	4071	.23	2102	2.65
		74173	1.42	4000	.23	4072	.23	8080A	34.95

AP SUPER STRIP II—Universal Breadboarding Element with 840 Solderless Plug-In Tie-Points

\$17.00

IC TEST CLIPS
14 pin TC-14 \$4.50
16 pin TC-16 \$4.75
24 pin TC-24 \$13.85

7 models for fast building and testing of circuits

obsoletes ordinary breadboards

All solderless plug-in tie-points

In a hurry? Try these high-performance All-circuit Evaluators

On all models... simply plug in your components and interconnect with 22-gauge solid wire. All models accept all DIP's, TO-5's and diodes, with leads up to .032" diameter.

Multiple buses can easily be linked for power and ground distribution, reset and clock lines, shift command, etc. Bases: gold-anodized aluminum. Terminals: non-corrosive nickel-silver. Four rubber feet included.

ACE Model No.	Tie Points	DIP No.	No. Capacity Buses	Posts	Board Size (inches)	Price Each
200-K (kit)	728	8 (16's)	2	2	4-9/16x5-9/16	\$18.95
208 (assm.)	972	8 (16's)	8	2	4-9/16x5-9/16	28.95
2014 (kit)	1092	12 (14's)	2	2	4-9/16x5-9/16	34.95
212 (assm.)	1224	12 (14's)	8	2	4-9/16x5-9/16	34.95
218 (assm.)	1760	18 (14's)	10	2	6-1/2x7-1/8	46.95
227 (assm.)	2712	27 (14's)	28	4	6-6/16x1-1/8	59.95
228 (assm.)	3048	36 (14's)	36	4	10-1/4x6-1/8	79.95

BISHOP GRAPHICS Printed Circuit Drafting
Aids are now available from Dig-Key

DATA BOOKS

TTL IC's - 592 pages... \$4.00
INTERFACE IC's - 464 pages \$4.00
LINEAR IC's - 704 pages... \$4.00
VOLTAGE REGULATORS - 128 pages... \$3.00
CMOS IC's - 256 pages... \$3.00
LINEAR APPLICATIONS - 432 pages... \$4.00
TRANSISTORS - 288 pages... \$3.00
MEMORY IC's - 592 pages... \$3.00

CMOS DATABOOK \$1.50
Specifications and pin-outs for 80 different 4000 series parts.

REED RELAYS
1.5 Amp SPST N.O. Contacts

4.8V Coil \$1.70 \$125/C
6.0V Coil \$1.70 \$125/C
12V Coil \$1.70 \$125/C
24V Coil \$1.70 \$125/C

Sc each in multiples of 5 per value
\$1.70/100 of same value. 10 ohm to 1.0 meg

ARIES INC.
119 Foster Street
Peabody, Mass., 01960
(617) 532-0450

SILICON TRANSISTORS

MP5191B, MP5930, MP52222A, MP52369A, MP52712, MP52907A, MP53392, MP53393, MP53394, MP53395, MP53363, MP53365, MP53368, MP53368A, MP53640, MP53641, MP53643, MP53645, MP53646, 2N3904, 2N3906, 2N4124, 2N4126, 2N4140, 2N4403, 2N4410, 2N4488, 2N4507, 2N4509, 2N4509A, 2N4509B, 2N4509C, 2N4509D, 2N4509E, 2N4509F, 2N4509G, 2N4509H, 2N4509I, 2N4509J, 2N4509K, 2N4509L, 2N4509M, 2N4509N, 2N4509O, 2N4509P, 2N4509Q, 2N4509R, 2N4509S, 2N4509T, 2N4509U, 2N4509V, 2N4509W, 2N4509X, 2N4509Y, 2N4509Z, 2N4509AA, 2N4509AB, 2N4509AC, 2N4509AD, 2N4509AE, 2N4509AF, 2N4509AG, 2N4509AH, 2N4509AI, 2N4509AJ, 2N4509AK, 2N4509AL, 2N4509AM, 2N4509AN, 2N4509AO, 2N4509AP, 2N4509AQ, 2N4509AR, 2N4509AS, 2N4509AT, 2N4509AU, 2N4509AV, 2N4509AW, 2N4509AX, 2N4509AY, 2N4509AZ, 2N4509BA, 2N4509BB, 2N4509BC, 2N4509BD, 2N4509BE, 2N4509BF, 2N4509BG, 2N4509BH, 2N4509BI, 2N4509BJ, 2N4509BK, 2N4509BL, 2N4509BM, 2N4509BN, 2N4509BO, 2N4509BP, 2N4509BQ, 2N4509BR, 2N4509BS, 2N4509BT, 2N4509BU, 2N4509BV, 2N4509BW, 2N4509BX, 2N4509BY, 2N4509BZ, 2N4509CA, 2N4509CB, 2N4509CC, 2N4509CD, 2N4509CE, 2N4509CF, 2N4509CG, 2N4509CH, 2N4509CI, 2N4509CJ, 2N4509CK, 2N4509CL, 2N4509CM, 2N4509CN, 2N4509CO, 2N4509CP, 2N4509CQ, 2N4509CR, 2N4509CS, 2N4509CT, 2N4509CU, 2N4509CV, 2N4509CW, 2N4509CX, 2N4509CY, 2N4509CZ, 2N4509DA, 2N4509DB, 2N4509DC, 2N4509DD, 2N4509DE, 2N4509DF, 2N4509DG, 2N4509DH, 2N4509DI, 2N4509DJ, 2N4509DK, 2N4509DL, 2N4509DM, 2N4509DN, 2N4509DO, 2N4509DP, 2N4509DQ, 2N4509DR, 2N4509DS, 2N4509DT, 2N4509DU, 2N4509DV, 2N4509DW, 2N4509DX, 2N4509DY, 2N4509DZ, 2N4509EA, 2N4509EB, 2N4509EC, 2N4509ED, 2N4509EE, 2N4509EF, 2N4509EG, 2N4509EH, 2N4509EI, 2N4509EJ, 2N4509EK, 2N4509EL, 2N4509EM, 2N4509EN, 2N4509EO, 2N4509EP, 2N4509EQ, 2N4509ER, 2N4509ES, 2N4509ET, 2N4509EU, 2N4509EV, 2N4509EW, 2N4509EX, 2N4509EY, 2N4509EZ, 2N4509FA, 2N4509FB, 2N4509FC, 2N4509FD, 2N4509FE, 2N4509FF, 2N4509FG, 2N4509FH, 2N4509FI, 2N4509FJ, 2N4509FK, 2N4509FL, 2N4509FM, 2N4509FN, 2N4509FO, 2N4509FP, 2N4509FQ, 2N4509FR, 2N4509FS, 2N4509FT, 2N4509FU, 2N4509FV, 2N4509FW, 2N4509FX, 2N4509FY, 2N4509FZ, 2N4509GA, 2N4509GB, 2N4509GC, 2N4509GD, 2N4509GE, 2N4509GF, 2N4509GG, 2N4509GH, 2N4509GI, 2N4509GJ, 2N4509GK, 2N4509GL, 2N4509GM, 2N4509GN, 2N4509GO, 2N4509GP, 2N4509GQ, 2N4509GR, 2N4509GS, 2N4509GT, 2N4509GU, 2N4509GV, 2N4509GW, 2N4509GX, 2N4509GY, 2N4509GZ, 2N4509HA, 2N4509HB, 2N4509HC, 2N4509HD, 2N4509HE, 2N4509HF, 2N4509HG, 2N4509HH, 2N4509HI, 2N4509HJ, 2N4509HK, 2N4509HL, 2N4509HM, 2N4509HN, 2N4509HO, 2N4509HP, 2N4509HQ, 2N4509HR, 2N4509HS, 2N4509HT, 2N4509HU, 2N4509HV, 2N4509HW, 2N4509HX, 2N4509HY, 2N4509HZ, 2N4509IA, 2N4509IB, 2N4509IC, 2N4509ID, 2N4509IE, 2N4509IF, 2N4509IG, 2N4509IH, 2N4509II, 2N4509IJ, 2N4509IK, 2N4509IL, 2N4509IM, 2N4509IN, 2N4509IO, 2N4509IP, 2N4509IQ, 2N4509IR, 2N4509IS, 2N4509IT, 2N4509IU, 2N4509IV, 2N4509IW, 2N4509IX, 2N4509IY, 2N4509IZ, 2N4509JA, 2N4509JB, 2N4509JC, 2N4509JD, 2N4509JE, 2N4509JF, 2N4509JG, 2N4509JH, 2N4509JI, 2N4509JJ, 2N4509JK, 2N4509JL, 2N4509JM, 2N4509JN, 2N4509JO, 2N4509JP, 2N4509JQ, 2N4509JR, 2N4509JS, 2N4509JT, 2N4509JU, 2N4509JV, 2N4509JW, 2N4509JX, 2N4509JY, 2N4509JZ, 2N4509KA, 2N4509KB, 2N4509KC, 2N4509KD, 2N4509KE, 2N4509KF, 2N4509KG, 2N4509KH, 2N4509KI, 2N4509KJ, 2N4509KL, 2N4509KM, 2N4509KN, 2N4509KO, 2N4509KP, 2N4509KQ, 2N4509KR, 2N4509KS, 2N4509KT, 2N4509KU, 2N4509KV, 2N4509KW, 2N4509KX, 2N4509KY, 2N4509KZ, 2N4509LA, 2N4509LB, 2N4509LC, 2N4509LD, 2N4509LE, 2N4509LF, 2N4509LG, 2N4509LH, 2N4509LI, 2N4509LJ, 2N4509LK, 2N4509LL, 2N4509LM, 2N4509LN, 2N4509LO, 2N4509LP, 2N4509LQ, 2N4509LR, 2N4509LS, 2N4509LT, 2N4509LU, 2N4509LV, 2N4509LW, 2N4509LX, 2N4509LY, 2N4509LZ, 2N4509MA, 2N4509MB, 2N4509MC, 2N4509MD, 2N4509ME, 2N4509MF, 2N4509MG, 2N4509MH, 2N4509MI, 2N4509MJ, 2N4509MK, 2N4509ML, 2N4509MM, 2N4509MN, 2N4509MO, 2N4509MP, 2N4509MQ, 2N4509MR, 2N4509MS, 2N4509MT, 2N4509MU, 2N4509MV, 2N4509MW, 2N4509MX, 2N4509MY, 2N4509MZ, 2N4509NA, 2N4509NB, 2N4509NC, 2N4509ND, 2N4509NE, 2N4509NF, 2N4509NG, 2N4509NH, 2N4509NI, 2N4509NJ, 2N4509NK, 2N4509NL, 2N4509NM, 2N4509NN, 2N4509NO, 2N4509NP, 2N4509NQ, 2N4509NR, 2N4509NS, 2N4509NT, 2N4509NU, 2N4509NV, 2N4509NW, 2N4509NX, 2N4509NY, 2N4509NZ

COMPUTERS — Hexadecimal Calculator: \$35.95. Octal Calculator: \$14.95. Literature Free. Radix Precision, Box 13861-PE, Atlanta, Georgia 30324.

CIRCOLEX PRECISION PROCESS NEGATIVES. To 8x10 from artwork to 16x20 \$15. Specify circuit dimensions. Additional copies \$7. Postpaid. CIRCOLEX, Box 198, Marcy, N.Y. 13403.

500 MHZ Prescaler ±10 or ±100. \$59.95. CBS Enterprise, P.O. Box 1356, Cocoa Beach, Fla. 32931.

ELECTRONIC test equipment, receivers, transmitters, and components. Send stamp for illustrated catalog. E. French, P.O. Box 249, Aurora, Ill. 60507.

ALTAIR 8800 OWNERS, install 2K bytes of fast, easily programmed bipolar PROM. Completely assembled and tested board \$56.95 less PROMS. Digitech, P.O. Box 6838, Grosse Pointe, Mich. 48236.

ALTAIR 8800 OWNERS, add output registers with LED displays at few dollars. For complete, easy-to-build plans: checkout program; and demonstration, computer-game program; forward \$5.00 (postpaid continental U.S.) to: Computer Research, Inc., 1601 Penwood Drive, Hampton, VA 23666. Satisfaction guaranteed.

SCRAMBLER DECODERS

High Voice Quality No Annoying Tone
\$69.95 postpaid

Dealer Inquiries Welcome

TR ELECTRONICS

P.O. Box 527 Mason City, Iowa 50401

VIDEO TAPE. 9200 ft x 1/2" rolls of certified tape. \$18 each pd. Cartrivision cartridges \$5 each. Larry Terry, 281 Lakemuir, Sunnyvale, CA 94086.

ETCH PC boards cheaply in seconds. Engineer's new method reduces etching time by 90%. Send \$1.00 for exciting details. Grissom, 1955 Sternlee, Long Beach, CA 90815.

NEW FIVE WAVEFORM Signal Generator. Transceiver Burglar Ultralarm. CB Speech Compander. More! Flyer send 25 cents. Minitron, Box 184, Anoka, Minn. 55303.

SAVE MONEY! Guaranteed: lowest prices — quality parts. FREE catalog. Chriskim Company, Box 1782, Tampa, FL 33601.

COLOR VIDEO TAPE RECORDER \$250. TV Camera \$150. Videotapes \$4. Cartrivision, 5835 Herma, San Jose, CA 95123.

TRANSISTORS 10/\$1.00. 2N3904 or 2N3906. Horseshoe xenon flashtubes, \$1.00, guaranteed! Motorola I.C. similar to 5481A \$1.00. Flyer 25 cents. Aardvark, Box 155, Palos Park, Ill. 60465.

CITIZENS BAND EQUIPMENT. Lowest Discount Prices. Best national brands. Free List. CRS Communications, 1552 Central Park Ave., Yonkers, N.Y. 10710.

MICROCOMPUTER EQUIPMENT SUPPLIERS DIRECTORY. Cross indexed by product for easy reference. \$1. Entitles you to receive FREE upcoming catalog of new National Microcomputer Discount Purchasing Club. Mail to: Box 2427, La Habra, California 90631.

KEYBOARDS, for synthesizers. Three octave, \$65. Info for interfacing with Gnome Microsynthesizer. Brinkwood Electronics, Box 26, Sandy Spring, MD 20860.

USED OSCILLOSCOPES TEST EQUIPMENT

FREE INFORMATION. 35 CENT CATALOG.
American Calibration Services
Box 8104 • Athens, GA 30601

CB ELECTRICAL Quick Disconnect available from Waid & Assoc., Inc., 206 North West Street, Angola, Indiana 46703. \$1.00 each postage included

COMPUTER MUSIC

UNIVERSAL MUSIC INTERFACE

GIVES UP TO 16 ANALOG OUTPUT CHANNELS FOR CONTROL OF ELECTRONIC MUSIC SYNTHESIZERS OR DIGITAL WAVEFORM GENERATION AS WELL AS PROVIDING KEYBOARD INTERFACE.

COMPLETE KIT WITH DETAILED ASSEMBLY AND USING INSTRUCTIONS FOR LESS THAN \$40. FOR COMPLETE DETAILS WRITE FOR FREE BROCHURE #776.

AA ELECTRONICS, INC.
1020 W. WILSHIRE BLVD.
OKLAHOMA CITY, OK 73116

LINEAR					
301	mDIP	\$.33	81	DIP	1.7
304	TO-5	.92	383	DIP	1.75
305	TO-5	.82	550	DIP	1.02
307	mDIP TO-5	.30	535	mDIP	.69
308	mDIP TO-5	1.02	536-A	DIP	1.71
109K	TO-18	1.35	710	DIP	.69
310	mDIP	1.23	711	DIP	.69
311	mDIP TO-5	1.09	723	DIP	.71
320T	TO-220	7.33	TO-5	1.02	
5, 12, 15V	1.60	739	DIP	1.23	
320K	TO-3	1.60	741	mDIP	.37
5, 12	1.75	742	DIP TO-5	.82	
324	DIP	1.75	748	mDIP	.40
339	DIP	1.69	1456	mDIP	1.83
140T	TO-220	1.40	1458	mDIP	.71
5, 6, 8, 12	1.71	1800	DIP	2.85	
15, 18, 24V		3900	DIP	.49	
330K	TO-220		8038	DIP	-8.99
5, 6, 8, 12,		75491	DIP	.82	
15, 18, 24V	1.94	75492	DIP	.92	
300	DIP	1.30			

CMOS					
4000A	.30	4018A	1.39	4066A	1.02
4001A	.29	4020A	1.49	4068A	.51
4002A	.29	4021A	1.39	4069A	.51
4006A	1.55	4022A	1.10	4071A	.30
4007A	.30	4023A	.29	4072A	.40
4008A	1.79	4024A	1.02	4073A	.45
4009A	.86	4025A	.29	4075A	.45
4010A	.33	4027A	.68	4078A	.45
4011A	.52	4028A	1.13	4082A	.80
4012A	.29	4030A	.51	4518A	1.84
4013A	.52	4035A	1.46	4528A	1.49
4014A	1.49	4040A	1.39	4585A	2.10
4015A	1.49	4042A	1.69	4901A	.45
4016A	.56	4049A	.68		
4017A	1.19	4050A	.68		

74C00	.25	74C74	1.20	74C162	2.93
74C02	.30	74C76	1.54	74C163	3.06
74C04	.51	74C107	1.30	74C164	3.06
74C08	.78	74C151	3.00	74C173	2.61
74C10	.40	74C154	3.62	74C195	2.66
74C20	.40	74C157	2.02	80C95	1.35
74C42	1.55	74C160	2.85	80C97	1.13
74C73	1.20	74C161	2.93		

CALCULATOR CHIPS		
CT5002	12 digit, 4 function fixed decimal — battery operation	2.79
CT5005	12 digit, 4 function plus memory, fixed decimal	2.99
MM5725	8 digit, 4 function, floating decimal 28 pin	1.98
MM5736	6 digit, 4 function, 9V battery operation 18 pin	3.95
MM5738	8 digit, 5 function plus memory and constant floating decimal, 9V battery operation	4.50
MM5739	9 digit, 4 function, 9V battery operation 22 pin	5.35

MEMORIES			
1101	1.50	5262	2.25
1103	1.95	82523	3.69
1702A	14.95	F93410	1.95
2102	2.95	7489	2.48
5203	10.95	74187	5.95
5260	1.95	74200	5.90
5261	2.19		

CLOCK CHIPS			
MM5311	\$4.45	MM5314	4.45
MM5312	3.95	MM5316	5.39
MM5313	4.45	CT7001	7.95

POCKET CALCULATOR		
12 function plus constant — addressable memories with individual recall — 8 digit display plus overflow buffers — user-stored or rechargeable batteries — all necessary parts in ready-to-assemble form — instructions included.		
Calc. Kit, Kit only		\$10.95
Batteries (alkaline, disp.)		2.00
Adapter 60Hz		3.95
Kit, Batteries & Adapter		15.95

QUANTITY DISCOUNT NOT APPLICABLE ON THIS ITEM

TANALUM CAPACITORS BOLD-DIPPED +20%		
1-mil 35V 25 ea.	6.8 mil 6V .30 ea.	
33-mil 35V 25 ea.	6.8 mil 50V .40 ea.	
1-mil 35V 25 ea.	10-mil 25V .40 ea.	
2.2-mil 20V 25 ea.	15-mil 10V .40 ea.	
2.2-mil 35V 30 ea.	33-mil 10V .40 ea.	
4.7-mil 16V 30 ea.	47-mil 6V .40 ea.	

IC SOCKETS Solder Tail - low profile			
8 pin	\$.19	24 pin	.45
14 pin	.22	28 pin	.59
16 pin	.24	40 pin	.69
18 pin	.35		

UNIVERSAL BREADBOARD Silver plated copper circuit board 1-1/2" x 1-1/2" x 1/2" 2 rows of 27 holes for DIP IC's — space for transistors, resistors & capacitors. Versatile and simple low cost breadboarding IC circuits \$1.50 ea.

CTS005 CALCULATOR CHIP
12 digit — 4 function with memory \$1.39

7001 CLOCK CHIP
4-6 digit, 12-24 hr. alarm, timer and date circuits — with data \$6.95

DVM CHIP 4 1/2 DIGIT
MM5330 — P channel device provides all logic for 4 1/2 digit volt meter. 16 pin OIP with data \$12.95

ALARM CLOCK CHIP
MM5375AA 4-6 digit, 12 hour, 60Hz snooze alarm, brightness control capability, alarm tone output 24 pin DIP \$4.95

JULY SPECIALS

1103	Memory	10/\$10.00	10c/\$88
5260	"	10/\$11.90	10c/\$104
5261	"	10/\$11.90	10c/\$104
5262	"	10/\$11.90	10c/\$122
5002	Calculator Chip	10/\$11.90	10c/\$104
5005	"	10/\$13.90	10c/\$122
5738	"	10/\$20.00	10c/\$176
305K	5V Regulator	10/\$10.00	10c/\$89
741	Operational Ampl.	10/\$2.50	10c/\$22
3900	Quad amplifier DIP	10/\$3.20	10c/\$29
74123	Dual Monostable Multivibrator	10/\$5.60	10c/\$50
MAN 1	Display	10/\$11.90	10c/\$104

RESISTOR KIT
CARBON FILM 1%
1/8 WATT
455 RESISTORS 45 VALUES
SUPPLIED IN A 15 DRAWER
40 COMPARTMENT STORAGE
CABINET — TABLE OR WALL MOUNT, READY TO USE
\$24.95 ea.

RESISTOR ASSORTMENT R (OHMS)											
R	QTY	R	QTY	R	QTY	R	QTY	R	QTY	R	QTY
10	10	220	10	2.2K	20	22K	10	270K	5	4.7M	5
15	5	270	5	3.3K	10	33K	10	330K	5	5.6M	5
22	5	330	10	3.9K	10	39K	10	470K	10	6.8M	10
33	5	470	20	4.7K	20	47K	10	680K	10	10M	20
47	10	680	10	6.8K	10	68K	10	1.0M	20		

PACKAGE OF 10 — DEDUCT 15% PACKAGE OF 100 — DEDUCT 25%

6 DIGIT LED CLOCK KIT
INCLUDES:
MM3314 clock circuit
6 FN270 LED displays [250" red 7 segments]
All necessary transistors, resistors & capacitors
1 double sided PC board accommodates LED's & clock circuitry
Schematic & instructions
Does not include 12V-300 ma transformer, switches & case \$12.95

QUANTITY DISCOUNT NOT APPLICABLE ON THIS ITEM

TTL					
7400	.16	7451	.20	74153	1.14
7401	.18	7452	.20	74154	1.29
7402	.17	7453	.20	74155	1.23
7403	.18	7460	.20	74156	1.23
7404	.22	7464	.40	74157	1.14
7405	.22	7465	.40	74158	2.06
7406	.40	7470	.35	74160	1.60
7407	.40	7472	.35	74161	1.44
7408	.21	7473	.40	74162	1.71
7409	.22	7474	.40	74163	1.60
7410	.18	7475	.66	74164	1.83
7411	.29	7476	.45	74165	1.83
7413	.63	7483	.91	74166	1.71
7414	.81	7485	1.27	74170	2.65
7416	.40	7486	.46	74173	1.71
7417	.40	7489	2.48	74174	1.86
7420	.18	7490	.59	74175	1.60
7422	.30	7491	1.12	74176	1.02
7423	.33	7492	.82	74171	.97
7425	.31	7493	.69	74180	1.04
7426	.30	7494	1.68	74181	3.43
7427	.32	7495	.91	74184	.91
7430	.23	7496	.91	74184	2.29
7432	.26	74100	1.50	74185	2.29
7437	.40	74105	.51	74187	4.50
7438	.40	74107	.46	74190	1.35
7440	.20	74121	.48	74191	1.35
7441	1.13	74122	.52	74192	1.25
7442	.89	74123	.69	74193	1.19
7443	1.00	74125	.62	74194	1.25
7444	1.00	74126	.72	74195	1.02
7445	1.02	74132	1.02	74196	1.44
7446	1.07	74141	1.20	74197	1.02
7447	1.02	74145	1.20	74198	2.06
7448	1.20	74150	1.12	74199	2.06
7450	.20	74151	.91	74200	5.90
				74229	1.08

METAL FILM RESISTORS			
QTY	PRICE EACH	MINIMUM 100 PER VALUE	PRICE PER VALUE
0 - 100	\$.20		
100 - 1000	.15		
1000 - 10000	.10	\$.09	
10000 -	.08		

RESISTANCE (OHMS)			
22.6	71.5	182	887
23.7	78.7	182	1.15K
25.5	84.5	191	1.5 K
30.9	105	205	2.49K
34.8	110	232	3.57K
40.2	115	243	4.75K
45.3	137	498	4.9K
51.1	147	604	6.04K
61.9	158	715	7.15K
64.9	178	806	8.25K

CRYSTALS

THESE FREQUENCIES ONLY

Part #	Frequency	Case/Style	Price
CY1A	1.000 MHz	HC33/U	\$4.95
CY2A	2.000 MHz	HC33/U	\$4.95
CY3A	4.000 MHz	HC18/U	\$4.95
CY7A	5.000 MHz	HC18/U	\$4.95
CY12A	10.000 MHz	HC18/U	\$4.95
CY14A	14.31818 MHz	HC18/U	\$4.95
CY19A	18.000 MHz	HC18/U	\$4.95
CY24A	20.000 MHz	HC18/U	\$4.95
CY30B	32.000 MHz	HC18/U	\$4.95

CLOCK CHIPS — CALCULATOR CHIPS

MM5309	6 Digit, BCD Outputs, Reset Pin.	\$5.95
MM5311	6 Digit, BCD Outputs, 12 or 24 Hour	4.95
MM5312	4 Digit, BCD Outputs, 1 PPS Output	4.95
MM5313	6 Digit, BCD Outputs, 1 PPS Output	4.95
MM5314	6 Digit, 12 or 24 Hour, 50 or 60 Hz	4.95
MM5316	4 Digit, Alarm, 1 PPS Output	6.95
MM5318	Video Clock Chip, For Use With MM5814	9.95
CT7001	6 Digit, Calendar, Alarm, 12 or 24 Hour	6.95

CALCULATOR CHIPS

MM5725	6 Digit, Four Function, Less Decimal	\$2.95
MM5738	8 Digit, 5 Function: +, -, x, ÷, %	2.95
MM5739	8 Digit, 4 Function, Floating Decimal	2.95
CT5001	12 Digit, 4 Function	3.95
CT5005	12 Digit, 4 Function with Memory	5.95
CT5030	12 Digit, 4 Function & %	7.95

MISC. MOS

MM5320	TV Camera Sync. Generator	\$19.95
MM5369	4 1/2 Digit DVM Chip	9.95
MM5369	60 Hz Timebase Circuit From 3.58 MHz	5.00
MM5841	Video Generator For MM5318	18.00
MC1408-L7	7 Bit Digital to Analog Converter	9.95
MS5007	4 Decade Counter with Latches	10.95
LD10L011H	3 1/2 Digit DVM Chip Set	25.00
95H90	100 MHz ± 10 Counter For Prescalers	13.95

Filament Transformers

Tap	Secondary	Primary	Watts	Resistance	Wt.	Price
F-17X	3.0	115	1000	1.5	1.1	\$10.00
F-13X	6.3	115	1000	1.5	1.1	\$10.00
F-14X	6.3	115	1000	1.5	1.1	\$10.00
F-16X	6.3	115	1000	1.5	1.1	\$10.00
F-25X	12.6	115	1000	1.5	1.1	\$10.00
F-40X	25.2	115	1000	1.5	1.1	\$10.00
F-45X	25.2	115	1000	1.5	1.1	\$10.00
F-54X	25.2	115	1000	1.5	1.1	\$10.00

VECTOR WIRING PENCIL



Vector Wiring Pencil P173 consists of a hand held featherweight (under one ounce) tool which is used to guide and wrap insulated wire, fed off a self-contained retractable bobbin, onto component leads or terminals installed on pre-punched ("P" Pattern Vectorboard). Connections between the wrapped wire and component leads, pads or terminals are made by soldering. Complete with 250 FT of wire. **\$9.50**

REPLACEMENT WIRE — BOBBINS FOR WIRING PENCIL

W36-3-A-Pkg. 3	250 Ft. 36 AWG GREEN	\$2.40
W36-3-B-Pkg. 3	250 Ft. 36 AWG RED	\$2.40
W36-3-C-Pkg. 3	250 Ft. 36 AWG CLEAR	\$2.40
W36-3-D-Pkg. 3	250 Ft. 36 AWG BLUE	\$2.40

1/16 VECTOR BOARD

Part No.	Material	Price
PHENOLIC	6-3/4" x 9-1/2" x .0625"	1.72
GLASS	6-3/4" x 9-1/2" x .0625"	2.31
EPOXY GLASS	6-3/4" x 9-1/2" x .0625"	2.31
EPOXY GLASS	6-3/4" x 9-1/2" x .0625"	2.31
COPPER CLAD	6-3/4" x 9-1/2" x .0625"	2.31

VECTOR TERMINALS

Series	Gold Plated	Post Size	25 pcs	50 pcs
T44	T44-1	.025 sq.	1.50	1.00
T46	T46-1	.028 sq.	1.75	1.25
T49	T49-1	.025 sq.	1.75	1.25
T42-1	Pkg. 100	Terminals	\$3.50	\$13.00

DIP SWITCH

These switches feature seven SPST slide switches in a molded dip. They are ideally suited for microprocessor applications. **\$1.95**

100 PER STRIP MOLEX PINS

Intended for use as an inexpensive substitute for IC sockets. Also perfect for use as board connectors and in subassemblies. **SPECIAL — 100/1.49 — 1000/12.00**

64 KEY KEYBOARD

The ideal item for the real homebrew computer hobbyist. This keyboard features 64 unenclosed SPST keys, unattached to any kind of P.C.B. A very solid suited most applications. **\$24.95 ea.**

JOYSTICK

These joysticks feature four 100K potentiometers, that vary resistance proportional to the angle of the stick. Sturdy metal construction with plastic components only at the movable joint. Perfect for electronic games and instrumentation. **\$9.95 ea.**

MICROPROCESSOR COMPONENTS

8080 SUPPORT DEVICES		8080
8080A 8212	8 BIT INPUT/OUTPUT PORT FOR 8080	\$ 5.95
8080A 8224	CLOCK GENERATOR AND DRIVER FOR 8080	12.95
8080A 8228	SYSTEM CONTROLLER AND BUS DRIVER FOR 8080	12.95

2K RAM SPECIAL
MM5262 Fully decoded 2Kx1 dynamic RAM. All inputs except clocks are TTL compatible. Provides a 635 ns minimum access time, and requires a +5, +8.5, and -15V power supply. Low power provides non-volatile memory using battery back up. **\$0.99 ea. (0.05 cents per bit)**

Special Requested Items		
RC4194	Dual Track V Reg	\$ 5.95
RC4195	±15V Track Reg	3.25
F935E	Decoder	3.95
LD10L1111	DVM Chip Set	25.00
CA3130	Super CMOS Dp Amp	1.49
MC1408L7	D/A	9.95
F3441	FIFO	6.95
MM5841	Character Gen.	18.00
AVS-9100	Push Button Dialer	17.50

Continental Specialties
Proto Board 100 **\$19.95**
Proto Board 121 **\$29.95**
Proto Board 182 **\$39.95**
Proto Board 183 **\$59.95**



Proto Board 100 \$19.95
The Mini-Board Budget Kit. Proto Board 100, 10.16 pin DIP capacity, 7.95.
Proto Board 121, 2.560 sockets per board, 32.14 pin DIP capacity, 29.95.
Proto Board 182, Compact 10.16 pin DIP capacity, 39.95.
Proto Board 183, 2.560 sockets per board, 32.14 pin DIP capacity, 59.95.

DESIGN MATE 1
Circuit Designer. This board is used for prototyping and testing of logic circuits. It features a built-in logic analyzer and a logic probe. **\$49.95**

LOGIC MONITOR
Simultaneously displays static and dynamic logic states of TTL, HTL or CMOS DIP ICs. **\$84.95**

OT type	holes	price
OT-595	595	\$2.50
OT-598	598	2.50
OT-475	475	4.00
OT-478	478	2.25
OT-355	355	8.50
OT-358	358	2.00
OT-185	185	4.75
OT-125	125	3.75
OT-85	85	3.25
OT-75	75	3.00

DIGITAL CLOCK KIT — 3 1/2 INCH DIGITS

This clock features big 3 1/2" high digits for viewing in offices, auditoriums, etc. Each digit is formed by 28 bright 0.2" LEDs. The clock operates from 117 VAC, has either 12 or 24 hr. operation. The 6 digit version is 27" x 3 1/2" x 1 1/2", and the 12 digit version is 27" x 3 1/2" x 1 1/2". Kits come complete with all components, case and transformer. **Specialty 12 Or 24 Hr. When Ordering**

Satisfaction Guaranteed. \$5.00 Min. Order. U.S. Funds.
California Residents — Add 6% Sales Tax — Data Sheets 25c each
Send a 13c Stamp (postage) for a FREE 1976 Catalog

JAMES
1021 HOWARD ST., SAN CARLOS, CA. 94070
PHONE ORDERS — (415) 592-8097

AUTOTEL

WARNING LIGHTS ARE NOT ENOUGH



AN AUDIBLE ALARM INDICATING POTENTIAL ENGINE DAMAGE

AUTOTEL is an efficient (15 ms current standby) device by which every owner of an automobile, truck or vehicle equipped with indicator lights for temperature and oil pressure can be assured of a reliable warning before an impending failure. AUTOTEL, by means of an audible signal 70 db pushing immediately forwards the vehicle operator of a malfunction or failure, allowing time to correct and prevent major engine failures. It is programmed so there is no sound during normal operation conditions.

AUTOTEL features CMOS circuitry, packaged in a 2 1/2" sq. x 1 1/2" case. The kit comes complete with all components, hardware and a case to hook directly into your car's warning light system. **\$14.95 Assembled \$9.95 Per Kit**

IMS 3 1/2 DIGIT DVM KIT



This 0-2 VDC, .05 per cent digital voltmeter features the Motorola 3 1/2 digit DVM chip set. It has a 4" LED display and operates from a single +5V power supply. The unit is provided complete with an injection molded black plastic case complete with Bezel. An optional power supply is available which fits into the same case as the 0-2V DVM allowing 117VAC operation.

A. 0-2V DVM with Case \$49.95
B. 5V Power Supply \$14.95

JE700 CLOCK

The JE700 is a low cost digital clock, but is a very high quality unit. The unit features a simulated walnut case with dimensions of 6" x 2 1/2" x 1". It utilizes a MAX72 high brightness reseau, and the MM5314 clock chip.

115 VAC \$19.95

Liquid Crystal Temperature Display
Six Digit Light Emitting Diode Display
DL 33 Display

This clock makes an attractive addition to any desk. It has an extruded, black anodized aluminum case. It displays hours, minutes, and seconds with .1 inch displays, and comes complete with a liquid crystal thermometer. It operates off 115 VAC at 50 or 60 Hz. **\$24.95**

Kit - All Components & Case \$34.95
Wired & Assembled \$39.95

JE803 PROBE

The Logic Probe is a unit which is for the most part indispensable in trouble shooting logic families. TTL, DTL, RTL, CMOS. It derives the power levels to operate directly off the circuit under test, drawing a scant 10 mA max. It uses a RAM3 readout to indicate any of the following states: This probe can detect: (H) - 1 (LOW) - 0 (PULSE) - P. The Probe can detect logic frequency up to 45 MHz if it can be used at MOS levels or circuit damage will result. **\$9.95 Per Kit** printed circuit board

ELECTRONIC TOOLS

QUICK CHARGE CORDLESS SOLDERING IRON
This versatile tool weighs only six ounces, and can be operated without power anywhere. It gives the performance of a 50 watt iron with a tip temperature of over 700°F. It will solder an average of 160 3 twist 22 gauge wire joints on one charge. It has a charge time of 4 hours, and heats in 5 seconds. Complete with recharger. **\$29.95 EACH**

NIBBLING TOOL DIAGONAL CUTTER

The Nibbling Tool is perfect for cutting components to match a hole in a PCB. It is available in 1/16" and 1/8" sizes. The Nibbling Tool can be used to cut a hole in a PCB. It is available in 1/16" and 1/8" sizes. The Nibbling Tool can be used to cut a hole in a PCB. It is available in 1/16" and 1/8" sizes. **\$6.95**
Replacement Punch \$3.75 Each
Light Blue Handle \$8.50 ea.

SOLDER SOLDER WICK

Part No.	Wire Dia.	Price/lb Spool	Stock	Width	Price
SN60	.031	6.50/Spool	40-1	.025	\$2.00 ea
SN50	.040	6.50/Spool	40-2	.050	2.00 ea
			40-3	.075	2.00 ea

7400N TTL

SN7400N	13	SN7453N	27	SN74150N	1.00
SN7401N	16	SN7454N	20	SN74151N	.79
SN7402N	21	SN7455N	25	SN74152N	.89
SN7403N	16	SN7460N	22	SN74154N	1.25
SN7404N	16	SN7470N	45	SN74155N	.99
SN7405N	24	SN7471N	69	SN74156N	.99
SN7406N	20	SN7472N	39	SN74157N	.99
SN7407N	29	SN7473N	37	SN74160N	1.25
SN7408N	25	SN7474N	32	SN74161N	.99
SN7409N	25	SN7475N	30	SN74163N	.99
SN7410N	16	SN7476N	32	SN74164N	1.10
SN7411N	30	SN7479N	5.00	SN74165N	1.10
SN7412N	33	SN7480N	40	SN74166N	1.25
SN7413N	45	SN7482N	98	SN74167N	5.50
SN7414N	70	SN7483N	98	SN74170N	2.10
SN7416N	35	SN7485N	89	SN74172N	18.00
SN7417N	35	SN7486N	39	SN74173N	1.50
SN7420N	21	SN7488N	8.00	SN74174N	1.25
SN7421N	33	SN7489N	2.25	SN74175N	.99
SN7422N	49	SN7490N	4.5	SN74176N	.90
SN7423N	37	SN7491N	75	SN74177N	.90
SN7425N	37	SN7492N	49	SN74180N	.99
SN7426N	29	SN7493N	49	SN74181N	2.49
SN7427N	37	SN7494N	79	SN74182N	.95
SN7429N	42	SN7495N	79	SN74184N	1.95
SN7430N	26	SN7496N	39	SN74185N	6.50
SN7432N	31	SN7497N	4.00	SN74186N	5.00
SN7437N	27	SN74100N	1.00	SN74187N	6.00
SN7438N	27	SN74107N	39	SN74190N	1.19
SN7439N	25	SN74112N	39	SN74191N	1.25
SN7440N	26	SN74122N	39	SN74192N	1.19
SN7441N	89	SN74123N	70	SN74193N	.89
SN7442N	59	SN74125N	60	SN74194N	1.25
SN7443N	75	SN74126N	60	SN74195N	.75
SN7444N	75	SN74127N	1.00	SN74196N	1.25
SN7445N	75	SN74136N	95	SN74197N	.75
SN7447N	61	SN74141N	1.15	SN74196N	1.75
SN7448N	79	SN74142N	1.50	SN74199N	1.75
SN7450N	26	SN74143N	4.50	SN74200N	5.59
SN7451N	27	SN74145N	1.15	SN74201N	1.79
		SN74147N	2.35	SN74281N	6.00
		SN74148N	2.00	SN74285N	6.00

MANY OTHERS AVAILABLE ON REQUEST
20% Discount for 100 Combined 7400's

CMOS

CD4001	25	74C04N	.75
CD4002	25	74C10N	.65
CD4006	2.50	74C20N	.65
CD4007	25	74C42N	2.15
CD4009	59	74C73N	1.50
CD4010	59	74C74N	1.15
CD4011	25	74C90N	3.00
CD4012	25	74C93N	2.00
CD4013	47	74C107N	1.25
CD4016	56	74C151	2.90
CD4017	1.35	74C154	3.00
CD4019	55	74C157	2.15
CD4020	1.49	74C160	3.00
CD4022	1.25	74C161	3.25
CD4023	2.50	74C163	3.00
CD4024	1.50	74C164	3.25
CD4025	25	74C173	2.60
CD4027	69	74C183	2.75
CD4028	1.65	74C193	2.75
CD4029	2.90	74C195	2.75
CD4030	65	74C200N	5.59
		74C201N	1.79
		74C202N	6.00
		74C203N	6.00

LINEAR

LM1000	80	LM1351N	1.65
LM101H	.35	LM1414N	1.75
LM101CN	.35	LM1456N	.85
LM102H	.75	LM1459N	.95
LM103H	1.00	LM1556N	1.85
LM105H	.95	LM1211N	1.95
LM107CN	.35	LM2051N	2.95
LM108H	1.00	LM3051N	.69
LM109H	1.00	LM3905N	.69
LM1305H	1.10	NE5311H	3.00
LM1309K	.99	NE5311H	3.00
LM1310CN	1.15	NE540L	6.00
LM1311H	.90	NE540L	6.00
LM1312H	.90	NE553	2.50
LM1316CN	1.50	NE555V	.45
LM1319H	1.30	NE560B*	5.00
LM1320H	1.35	NE560B*	5.00
LM1320K-2	4.35	NE565H*	.99
LM1320K-12	1.35	NE565H*	1.25
LM1320N-15	1.35	NE565H*	1.95
LM1320N-5	1.75	NE567H*	1.25
LM1320T-8	1.75	NE567H*	1.50
LM1320T-12	1.75	LM703CN	45
LM1320T-18	1.75	LM709H	29
LM1320T-5	9.95	LM709H	29
LM1324H	1.80	LM710N	39
LM1329H	1.70	LM711N	79
LM1340K-1	1.95	LM723N	55
LM1340K-12	1.95	LM723N	55
LM1340K-15	1.95	LM733N	1.00
LM1340K-24	1.95	LM739N	1.29
LM1340T-1	1.75	LM741D	35
LM1340T-6	1.75	LM741D	35
LM1340T-8	1.75	LM741H	39
LM1340T-18	1.75	LM747H	79
LM1340T-12	1.75	LM747H	79
LM1340T-15	1.75	LM748H	39
LM1340T-24	1.75	LM748H	39
LM1350N	3.00	LM1303N	.89
LM1351CN	65	LM1304N	1.10
LM1370N	1.15	LM1305N	1.40
LM1370H	1.15	LM1307N	1.40
LM1373N	3.25	LM1310N	2.95

KITS EXAR ICS

XR-2206KA Includes monolithic function generator IC, PC board, and assembly instruction manual.

XR-2206KB Same as XR 2206KA above and includes external components for PC board.

TIMERS		STEREO DECODERS	
XR-555CP	5.69	XR-1310P	3.20
XR-555CP	1.55	XR-1310EP	3.20
XR-555CP	1.85	XR1800P	3.20
XR-2256CP	3.20		
XR-2240CP	3.25	WAVEFORM GENERATORS	
		XR-205	6.40
		XR-2206CP	4.49
		XR-2207CP	3.85
PHASE LOCKED LOOPS		MISCELLANEOUS	
XR-210	5.20	XR-2211CP	6.70
XR-215	6.60	XR-2251	3.79
XR-567CP	1.95	XR-2251	3.79
XR-2567CP	2.99	XR4136	2.00

DATA HANDBOOKS

7400 Pin-out & Description of 5400/7400 ICS \$2.95

CMOS Pin-out & Description of 4000 Series ICS \$2.95

LINEAR Pin-out & Description of 7400 Series ICS \$2.95

ALL THREE HANDBOOKS \$6.95

CONSUMER ELECTRONICS

exelar



DIGITAL WATCH
This watch is manufactured by National Semiconductor. It provides 5 functions: hours, minutes, seconds, date, A.M. indicator dot. Accuracy is assured to 5 seconds per month by precision quartz crystal. If something should go wrong with the watch, repair is assured within 48 hours after it is received. Complete with steel black leather band.

ES4-YS
3 MICRON GOLD PLATE BEZEL
\$29.95
NOT A KIT

Novus



DIGITAL ALARM CLOCK
This 4 digit Novus Alarm Clock is a very reliable and smartly styled unit. It provides such features as an alarm settable to any minute of the day, a 7 minutes snooze alarm, a power failure indicator, and even an A.M., P.M. indicator.

\$19.95
NOT A KIT

OPTO ELECTRONICS

XCITON LITRONIX MONSANTO

DISCRETE LEDES

R - RED
G - GREEN
Y - YELLOW
O - ORANGE

XC209R	5/31	XC326R	5/51	XC111R	5/51
XC209G	4/51	XC326G	4/51	XC111G	4/51
XC209Y	4/51	XC326Y	4/51	XC111Y	4/51
XC209O	4/51	XC326O	4/51	XC111O	4/51

125" dia. 185" dia. 190" dia.

DISPLAY LEDES

FND503	FND70	DL707	MAN 2	MAN 3	MAN 4	MAN 7	DL747	DL338
--------	-------	-------	-------	-------	-------	-------	-------	-------

TYPE	POLARITY	HT	PRICE	TYPE	POLARITY	HT	PRICE
MAN 1	COMMON ANODE	270	53.25	MAN 7	COMMON CATHODE	300	\$1.50
MAN 2	5 x 7 DOT MATRIX	400	4.95	DL747	COMMON ANODE	300	\$1.50
MAN 3	COMMON CATHODE	125	.39	DL750	COMMON ANODE	600	2.25
MAN 4	COMMON CATHODE	187	1.95	DL750	COMMON ANODE	600	2.25
MAN 7	COMMON ANODE	300	1.50	DL338	COMMON CATHODE	110	1.25
MAN 7G	COMMON ANODE-GREEN	300	2.50	FND70	COMMON CATHODE	250	.30
MAN 7Y	COMMON ANODE-YELLOW	300	2.50	FND503	COMMON CATHODE	500	1.75
MAN 7Z	COMMON ANODE	300	1.50	FND507	COMMON CATHODE	500	1.75

IC SOLDEARTAIL - LOW PROFILE (TIN) SOCKETS

8 pin	1-24	25-49	50-160	24 pin	1-24	25-49	50-100
8 pin	\$17	16	15	24 pin	5.38	.37	.35
14 pin	20	19	18	28 pin	15	14	13
16 pin	22	21	20	36 pin	60	59	58
18 pin	29	28	27	40 pin	63	62	61
22 pin	37	36	35				

SOLDERTAIL STANDARD (GOLD)

8 pin	5.30	27	24	24 pin	5.70	63	57
14 pin	35	32	29	28 pin	1.10	1.00	.90
16 pin	38	35	32	36 pin	1.75	1.40	1.26
18 pin	52	47	43	40 pin	1.75	1.59	1.45

WIRE WRAP SOCKETS (GOLD) LEVEL #3

10 pin	\$45	41	37	24 pin	51.05	95	85
14 pin	39	38	37	28 pin	1.40	1.25	1.10
16 pin	43	42	41	36 pin	1.59	1.45	1.30
18 pin	75	68	62	40 pin	1.75	1.55	1.40

50 PCS. RESISTOR ASSORTMENTS \$1.75 PER ASST.

ASST. 1	5 ea.	27 OHM	33 OHM	39 OHM	47 OHM	56 OHM	1/4 WATT 5% - 50 PCS.
ASST. 2	5 ea.	68 OHM	82 OHM	100 OHM	120 OHM	150 OHM	1/4 WATT 5% - 50 PCS.
ASST. 3	5 ea.	180 OHM	220 OHM	270 OHM	330 OHM	390 OHM	1/4 WATT 5% - 50 PCS.
ASST. 4	5 ea.	470 OHM	560 OHM	680 OHM	820 OHM	1K	1/4 WATT 5% - 50 PCS.
ASST. 5	5 ea.	1.2K	1.5K	1.8K	2.2K	2.7K	1/4 WATT 5% - 50 PCS.
ASST. 6	5 ea.	3.3K	3.9K	4.7K	5.6K	6.8K	1/4 WATT 5% - 50 PCS.
ASST. 7	5 ea.	8.2K	10K	12K	15K	18K	1/4 WATT 5% - 50 PCS.
ASST. 8	5 ea.	22K	27K	33K	39K	47K	1/4 WATT 5% - 50 PCS.
ASST. 9	5 ea.	56K	68K	82K	100K	120K	1/4 WATT 5% - 50 PCS.
ASST. 10	5 ea.	150K	180K	220K	270K	330K	1/4 WATT 5% - 50 PCS.
ASST. 11	5 ea.	390K	470K	560K	680K	820K	1/4 WATT 5% - 50 PCS.
ASST. 12	5 ea.	1M	1.2M	1.5M	1.8M	2.2M	1/4 WATT 5% - 50 PCS.
ASST. 13	5 ea.	2.7M	3.3M	3.9M	4.7M	5.6M	1/4 WATT 5% - 50 PCS.

ALL OTHER RESISTORS FROM 2.2 OHMS - 5.6M AVAILABLE IN MULTIPLES UP TO ea

5-25 PCS - 05 ea. 30-95 PCS - 04 ea. 100-495 PCS - 03 ea. 500-995 0275 ea

14 PCS. POTENTIOMETER ASSORTMENTS

ASST. A 2 ea. 10 OHM-20 OHM-50 OHM-100 OHM-200 OHM-500 OHM

ASST. B 2 ea. 1K, 2K, 5K, 10K, 20K, 25K, 50K

ASST. C 2 ea. 50K, 100K, 200K, 250K, 500K, 1M, 2M

\$9.95 Per Asst.

Each assortment contains 14 pcs of 10 turn pots. All pots are available in single unit quantities. \$9.95 ea.

Astrick Denotes Items On Special For This Month
Satisfaction Guaranteed. \$5.00 Min. Order. U.S. Funds.
California Residents - Add 6% Sales Tax - Data Sheets 25c each
Send a 13c Stamp (postage) for a FREE 1976 Catalog

JAMES

1021 HOWARD ST., SAN CARLOS, CA. 94070
PHONE ORDERS - (415) 592-8097

74LS00 TTL

74LS00	39	74LS55	39	74LS151	1.55
74LS02	39	74LS73	65	74LS153	1.89
74LS03	39	74LS74	65	74LS157	1.55
74LS04	45	74LS75	79	74LS162	2.25
74LS05	45	74LS76	65	74LS163	2.25
74LS08	39	74LS83	2.19	74LS164	2.25
74LS10	39	74LS86	65	74LS181	3.69
74LS13	79	74LS90	1.25	74LS190	2.85
74LS14	2.19	74LS92	1.25	74LS191	2.85
74LS20	39	74LS93	1.25	74LS192	2.85
74LS26	49	74LS95	2.19	74LS193	2.85
74LS27	45	74LS96	1.89	74LS194	2.25
74LS28	49	74LS107	65	74LS195	2.25
74LS30	39	74LS112	65	74LS197	1.89
74LS32	39	74LS132	1.55	74LS198	5.5
74LS40	49	74LS136	65	74LS279	79
74LS51	39	74LS138	1.89	74LS670	5.95

DL728

The DL728 is a dual 0.5" common cathode red display. It is ideal for use with clock chips, as segments are already multiplexed.

\$2.95

DPDT	ON	OFF	ON	ON	2 1/2	1 1/2	1 1/2	1 1/2	MINIATURE TOGGLE
DL728	ON	OFF	ON	ON	22	3.05	2.86	1.97	1.76
DL728	ON	OFF	ON	ON	22	2.86	2.25	1.68	1.51
DL728	ON	OFF	ON	ON	12	2.35	1.95	1.43	1.30
DL728	ON	OFF	ON	ON	12	2.05	1.65	1.21	1.10

PUSH BUTTON

Model 1 Quantity net prices

NEW KITS

LOGIC PROBE KIT—Use with CMOS, TTL, DTL, RTL, HTL, HINIL and most MOS IC's. Built-in protection against polarity reversal and overvoltage. Draws only a few mA from circuit under test. Dual LED readout. Complete kit includes case and clip leads. \$8.95

VARIABLE REGULATED POWER SUPPLY KIT—Continuously variable from 3 to over 15 Volts. Short-circuit proof with electronic current limiting at 300 mA. Compact size and typical regulation of 0.1% make this a great bench or lab power supply. \$11.95

FIXED REGULATED POWER SUPPLY KITS—Short-circuit proof with thermal current limiting. Compact size and typical regulation of 0.05% make these ideal for most electronic projects. Available for 5V @ 500mA, 6V @ 500mA, 9V @ 500mA, 12V @ 400mA, 15V @ 300mA. Specify voltage when ordering. \$8.95 ea.

These easy-to-assemble kits include all components, complete detailed instructions and plated fiberglass PC boards. Power supply kits do not include case or meters. Add \$1.25 per kit for postage and handling.

TRANSISTORS (NPN)

2N918 TYPE RF Amp & Oscillator to 1 GHz	3/\$1.00
2N3563 TYPE RF Amp & Osc to 1 GHz (pl. 2N918)	6/\$1.00
2N3565 TYPE Gen. Purpose Amp (TO-92/106)	6/\$1.00
2N3866 TYPE RF Power Amp 1.5 W @ 450 MHz	\$0.75
2N3904 TYPE GP Amp & Sw to 100 mA HFE 100	6/\$1.00
Assort. NPN GP TYPES, e.g. 2N3694, 2N3903, etc. (15)	\$2.00
2N3638 TYPE (PNP) GP Amp & Sw to 300 mA	6/\$1.00
2N3906 TYPE (PNP) GP Amp & Sw to 30 MHz	6/\$1.00

FET's:

N-CHANNEL (LOW-NOISE)

2N4091 TYPE RF Amp & Switch (TO-18/106)	3/\$1.00
2N4416 TYPE RF Amplifier to 450 MHz (TO-72)	2/\$1.00
2N5163 TYPE Gen. Purpose Amp & Sw (TO-106)	3/\$1.00
2N5486 TYPE RF Amp to 450 MHz (plastic 2N4416)	2/\$1.00
E100 TYPE Low-Cost Audio Amplifier	4/\$1.00
1TE4888 TYPE Ultra-Low Noise Audio Amp	2/\$1.00
T1574 TYPE High-Speed Switch 40S2	3/\$1.00
Assort. RF & GP FET's, e.g. 2N5163, MPF102, etc. (8)	\$2.00

P-CHANNEL:

2N4350 TYPE Gen. Purpose Amp & Sw (TO-106)	3/\$1.00
E175 TYPE High-Speed Switch 125S2 (TO-106)	3/\$1.00

SUPER SPECIALS:

2N2222 NPN TRANSISTOR GP Amp & Switch	6/\$1.00
2N2907 PNP TRANSISTOR GP Amp & Switch	6/\$1.00
2N3563 RF Power Amp 5 W @ 150 MHz, 7 W @ 50 MHz	\$1.50
MPF102 N-CHANNEL FET RF Amp-200 MHz	3/\$1.00
555 DUAL 555 TIMER 1 µsec to 1 hour (DIP)	\$0.90
723 VOLT. REGULATOR 3-30 V @ 1-200 mA (DIP/TO-5)	3/\$1.00
2740 FET Op Amp, Like NE536 and µA740 (TO-5)	\$1.95
µA7805 VOLTAGE REGULATOR 5 V @ 1 A (TO-220)	\$1.25
8038 WAVEFORM GENERATOR ~~~~~Wave Wkts	\$4.50
1N4154 DIODE 30 V/10mA-1N914 except 30 V	25/\$1.00
BR1 BRIDGE RECTIFIER 50 V PIV, 500 mA (DIP)	4/\$1.00
MM5314 DIGITAL CLOCK CHIP-With Specs/Schematics	\$4.95

LINEAR IC's:

308 Micro-Power Op Amp (TO-5/MINI-DIP)	\$1.00
309K Voltage Regulator 5 V @ 1 A (TO-3)	\$1.25
324 Quad 741 Op Amp, Compensated (DIP)	\$1.50
340T Volt. Reg.-1 Amp-Specify 5, 6, 12, 15 or 24 V-w/ckts	\$1.75
380 2.5 Watt Audio Amplifier 34 dB (DIP)	\$1.29
555 Timer 1 µs to 1 hr. NE555, LM555, etc. (MINI-DIP)	2/\$1.00
709 Popular Op Amp (DIP/TO-5)	\$0.29
739 Dual Low-Noise Audio Preamp/Op Amp (OIP)	\$1.00
1458 Dual 741 Op Amp (MINI-DIP)	2/\$1.00
741 Freq. Comp. Op Amp (DIP/TO-5/MINI-DIP)	4/\$1.00

DIODES:

ZENERS—Specify Voltage 3.3, 3.9, 4.3, 5.1, 6.8, 8.2	400mA W/\$1.00
9.1, 10, 12, 15, 16, 18, 20, 22, 24, 27, or 33V (±10%)	1 Watt 3/\$1.00
1N914 or 1N4148 TYPE General Purpose 100V/10mA	15/\$1.00
1N3893 TYPE RECTIFIER Stud Mount 400 V/12 A	2/\$1.00
D5 VARACTOR 5-50 W Output @ 30-250 MHz, 7-70 pF	\$5.00
F7 VARACTOR 1-3 W Output @ 100-500 MHz, 5-30 pF	\$1.00

*MAIL NOW! FREE DATA SHEETS supplied with every item from this ad. ORDER TODAY—All items subject to prior sale and prices subject to change without notice. All items are new surplus parts—100% functionally tested. WRITE FOR FREE CATALOG #7510 offering over 350 semiconductor carriers in stock. Send 13¢ stamp. TERMS: Send check or money order (U.S. funds) with order. We pay 1st Class postage to U.S., Canada and Mexico (except on kits). \$1.00 handling charge on orders under \$10. Calif. residents add 6% sales tax. Foreign orders add postage. COD orders—add \$1.00 service charge.

ADVA ELECTRONICS
BOX 4181 BW, WOODSIDE, CA 94062
Tel. (415) 851-0455

CIRCLE NO. 2 ON FREE INFORMATION CARD

PLANS AND KITS

FREE CATALOGUE KITS, COMPONENTS, Audio equipment, Sinclair Kits, radio parts. Gladstone Electronics, 1736 Avenue RD., Toronto, Canada, M5M 3Y7, U.S. Inquiries.

AMAZING ELECTRONIC PRODUCTS

LASERS SUPER POWERED, RIFLE, PISTOL, POCKET - SEE IN DARK - PYRO-TECHNICAL DE-BUGGING - UNCRAMBLERS - GIANT TESLA - STUNNARD - TV DISRUPTER - ENERGY PRODUCING, SCIENTIFIC DETECTION, ELECTRIFYING CHEMICAL, ULTRASONIC, CB, AERO, AUTO AND MECH DEVICES, HUNDREDS MORE... ALL NEW PLUS INFO UNLTD PARTS SERVICE

INFORMATION unlimited.

Box 626 Lord Jeffery PZ. • Amherst, N.H. 03031

CATALOG \$1

ELECTRONICS kits for home or school project. Select from over 50 kits. Many under \$5.00. Send \$1.00 for catalog. Refundable with first order. Graymark, 1751 McGraw Ave., Irvine, CA 92714.

6 TV GAMES ON ONE CHIP

MOS/LSI Design/Supply Limited

Chip \$39.95 Kit \$69.95

Send \$1.00 for kit info & data sheet

Advanced Microcomputer Products

P. O. Box 17329, Irvine, CA 92713

CBers — "TRIPLE YOUR POWER" using NEW 46" all-directional CB Antenna!!! Plans \$2. Astrobeam-3, 704 Edwards, Visalia, CA 93277.

FREE ELECTRONIC siren plans with catalog. Send 25 cents for handling with self-addressed stamped envelope to: Duer Electronics, 733 Lower Donnelly Road, Charleston, West Virginia 25304.

ETCH IT YOURSELF Printed Circuit Kit, Photo-positive method — all the supplies for four P.C. Boards, direct from magazine article in less than 2 hours only \$16.95. Liquid positive resist also available, SASE for details. Excel Circuits, 116 Delaware, Detroit, Michigan 48202.

FREE KIT Catalog contains Test and Experimenter's Equipment. Dale Scientific Instruments, Box 1054P, Livermore, CA 94550.

PROFESSIONAL ELECTRONIC MUSIC PRODUCTS Available in kit or assembled form. Plans and parts lists. Catalogue \$2.00. ELECTRONIC PIANO, honkytonk, clavichord, piano / organ switch, top octave synthesizer. Plans \$10.00, Kit \$300.00, Assembled \$450.00. COMBO ORGAN-61 Note, percussion, echo, sustain, bass, pian, glide, rotator, etc. Plans \$10.00, Kit \$500.00, Assembled \$750.00. RHYTHM UNIT-40 pin LSI, 10 patterns, 8 drums, manual drum keyboard, digital beatcounter. LED display, 4 measure patterns. Plans \$8.00, Kit \$150.00, Assembled \$200.00. SKS SYSTEMS KIT, 205 East 17 Street, New York, New York 10003.

SPEAKER LAMP PHENY! Convert lamps to speakers. Send \$3.00 to: B.J. Feeney, 15-10 Skytop Gardens, Parlin, N.J. 08859.

BURGLAR ALARMS

BURGLAR-FIRE alarm supplies and information. Free catalog. Protecto Alarm Sales, Box 357-G, Birch Run, Michigan 48415.

DIALING Unit automatically calls police. Immediate delivery \$29.95. Free literature. S&S Systems, 5619-C St. John, Kansas City, MO 64123. (816) 483-4612.

HIGH FIDELITY

DIAMOND NEEDLES and Stereo Cartridges at Discount prices for Shure, Pickering, Stanton, Empire, Grado and ADC. Send for free catalog. LYLE CARTRIDGES, Dept. P, Box 69, Kensington Station, Brooklyn, New York 11218.

BUY HI-FI COMPONENTS THE MODERN WAY:

AR • HY-GAIN^{CB} DYNACO • DUAL KOSS • SHURE MANY OTHERS

PHONE & MAIL

Call TOLL FREE or write for LOW PRICES

Nationwide **800/854-7769**
California **800/472-1783**

Approved by Phone

MCK SALES

250 N THOMAS, PO BOX 2100
POMONA CA 91766

TUBES

RADIO & T.V. Tubes—36 cents each. Send for free Catalog. Cornell, 4213 University, San Diego, Calif. 92105.

TUBES receiving, factory boxed, low prices, free price list. Translertonic, Inc., 1365 39th Street, Brooklyn, N.Y. 11218A, Telephone: 212-633-2800.

TUBES: "Oldies". Latest. Supplies, components, schematics. Catalog Free (stamp appreciated). Steinmetz, 7519-PE Maplewood, Hammond, Ind. 46324.

REAL ESTATE

280-PAGE CATALOG... Free! Over 2,600 top values coast to coast! UNITED FARM AGENCY, 612-EP, West 47th St., Kansas City, MO 64112.

Olson

Electronics Parts and Accessories



TL-477. Soldering Iron	2.99
VC-274. 12-Pc. Volume Control Kit	.49c
XM-501. 40-Pc. Terminal Strip	.79c
XM-370. 7 Seg. L.E.D. Display	1.29
TR-446. 25-Pc. Ass'd. SCR	1.49
SW-555. 90-120 V AC Relay	.59c
SW-156. Ctr.-Off Toggle Switch DPDT. Pkg. 2 249	
SW-460. 3 Button Push Switch	.29c
SW-636. Thermostatic Switch 50-600 NO	.39c
SW-752. Unimax 15A Switch SPST	.49c
SW-587. 5A Toggle SPST NO	.39c
SW-431. Phone Type Lever Switch 4 SPST	.62c
SW-632. Reed Switch W/Magnet SPST. Pkg. 10 1.29	
MO-359. 30 RPM Timing Motor 120V AC	.49c
TT-092. 2500 OHM Output Transformer	.64c
TF-047. 6 V 1/2 A. Filament Transformer	.44c
TF-050. 12V .2A Filament Transformer	.47c
KN-030. 25-Pcs. Assorted Knobs	.49c
ME-182. 0-1 Ma Panel Meter 1 3/8" Mtg. Hole	.89c
ME-205. 0-200 UA. Panel Meter 1 5/16 x 5/8"	.74c
ME-204. 0-150 UA. Panel Meter 1 x 1 x 7/8"	.74c
ME-203. 100-0-100 UA. 1'x1'x7/8" Meter	.74c

When ordering allow for postage. COD 20% Deposit. Residents of the following states please add Sales Tax: Ca. 5%, Fl. 4%, GA. 3%, Il. 4%, Ky. 5%, Ma. 5%, Mi. 4%, Mo. 3%, N.Y. 4%, Oh. 4%, Pa. 6%, Tx. 4%.

FREE
7 Olson Catalogs

FREE
Olson CB Catalog

NEXT 7 ISSUES SENT TO YOU FREE

WITH DEALERS PRICE LIST

Olson Electronics, 260 S. Forge St., Dept. IN, Akron, Ohio 44327
Please send me Olson catalog CB catalog Both Please Print

NAME _____

ADDRESS _____

CITY _____

STATE _____ ZIP _____

CIRCLE NO. 41 ON FREE INFORMATION CARD

GOVERNMENT SURPLUS

MANUALS for Govt Surplus radios, test sets, scopes. List 50 cents (coin). Books, 7218 Roanne Drive, Washington, D.C. 20021.

JEEPS, TRUCKS, Typically From \$52.40 Automobiles, Boats, Motorcycles, Airplanes, Oscilloscopes, Tools, Clothing, Sports, Camping, Photographic, Electronics Equipment... 200,000 Bid Bargains Nationwide Direct From Government... Low as 2 cents on Dollar! Surplus Catalog and Sales Directory \$1.00 (refundable first order). National Surplus Center, 240 Eastcass-PEL, Joliet, IL 60432.

GOVERNMENT SURPLUS. Buy in your area. How, Where. Send \$2.00. Surplus, 30177-PE Headquarters Building, Washington, D.C. 20014.

SURPLUS ELECTRONIC EQUIPMENT, government and manufacturers' Grab Box Assortment—diverse, useful new and used parts, assemblies, etc. Carton packed: 50 lbs. \$6.00; 100 lbs. \$10.00. F.O.B. Lima. Send for BIG Free Catalog! Fair Radio, Box 1105-E, Lima, Ohio 45802.

S. D. SALES CO.

P. O. BOX 28810 DALLAS, TEXAS 75228

ALARM CLOCK KIT SIX DIGIT LED

Thousands of hobbyists have bought and built our original clock kit and were completely satisfied. But we have received many requests for an alarm clock kit with the same value and quality that you have come to expect from S.D. So, here it is!

THE KIT INCLUDES:

- 1 Mostek 50252 Alarm Clock Chip
- 6 Hewlett Packard .30 in. common cathode readouts.
- 15 NPN Driver Transistors
- 2 Switches for time set
- 2 Slide Switches for alarm set and enable
- 1 Filter Cap
- 4 IN4002 Rectifiers
- 1 IN914 Diode
- 1 .01 Disc Cap
- 15 Resistors
- 1 Speaker for alarm
- 1 LED lamp for PM indicator.

\$9.95

PCB - 3.00
VFMR - 1.50

60 Hz. Crystal Time Base

FOR DIGITAL CLOCKS **\$5.95**
S. D. SALES EXCLUSIVE!

KIT FEATURES:

- A. 60 Hz output with accuracy comparable to a digital watch.
- B. Directly interfaces with all MOS clock chips.
- C. Super low power consumption (1.5 Ma typ.)
- D. Uses latest MOS 17 stage divider IC.
- E. Eliminates forever the problem of AC line glitches.
- F. Perfect for cars, boats, campers, or even for portable clocks at ham field days.
- G. Small size, can be used in existing enclosures.

BUY TWO FOR \$10.00

Kit includes crystal, divider IC, P.C. Board plus all other necessary parts and specs.

MOS 4 DIGIT COUNTER IC

All in one 28 PIN DIP. 4 Decade counters, latches, MUX circuits, display decoders, etc. Features: 5VDC operation, 25 MW power consumption, BOTH 7 segment and BCD outputs. Perfect for DVM's, frequency meters, tach's, etc. Can be cascaded for more digits. #5002 - \$8.95.

8008-1 MICRO PROCESSOR

New Units. High speed 8008. Almost twice as fast as units sold by others. Still a very versatile and widely used MPU. No data book, only pinout date included at this price. \$12.50 LIMITED QTY.

1101 A RAM IC

256 XI BITS. Perfect for 8008 or small systems such as telephone dials that do not require a lot of memory. Special 59c. 8 FOR \$4.

C & K MINI TOGGLE SWITCH

#7103 SUB MINI SPDT Center OFF. Special - 99c.

TTL IC'S

7400 - 19c	7420 - 19c	74153 - 75c	74154 - 1.00
7402 - 19c	7432 - 34c	7437 - 39c	74157 - 75c
7404 - 19c	7485 - 95c	7438 - 39c	74161 - 95c
74204 - 29c	7486 - 45c	7447 - 85c	74164 - 1.10
7406 - 29c	7490 - 65c	7448 - 85c	74165 - 1.10
7408 - 19c	7492 - 75c	7473 - 39c	74174 - 95c
74504 - 44c	7495 - 75c	7474 - 35c	74181 - 2.50
7410 - 19c	74121 - 38c	7475 - 69c	74191 - 1.25
7411 - 29c	74123 - 65c	7476 - 35c	74192 - 1.25
7413 - 50c	74141 - 75c	7483 - 95c	74193 - 1.00

2102 1K RAM's - 8 FOR \$12.95

New units _____ We bought a load on a super deal, hence this fantastic price.
Units tested for 500NS Speed.

MOTOROLA RTL IC'S

Brand new, factory prime. Hard to find, but still used in a variety of projects. (See the RTL Cookbook by Howard W. Sams.)

MC724P-59c	MC780P-89c	MC791P-69c
MC725P-59c	MC785P-49c	MC792P-59c
MC764P-49c	MC787P-89c	MC799P-59c
MC767P-69c	MC788P-49c	MC9704P-89c
MC771P-49c	MC789P-59c	MC9709P-69c
MC775P-89c	MC790P-89c	MC9760P-69c

MV-50 TYPE LED'S

by LITRONIX
10 for \$1
Factory Prime!

3 DIGIT LED ARRAY - 75c

by LITRONIX
DL33MMB. 3 MAN-3 Size Readouts in one package. These are factory prime, not retested rejects as sold by others. compare this price! 75c 3 for \$2.

SALE ON CUT LEAD SEMICONDUCTORS

Leads were cut for PCB insertion. Still very useable.

1N914/1N4148	100/\$2
1N4002 1 Amp 100 PIV	40/\$1
1N4745A 16V 1W Zener	20/\$1
EN2222 NPN Transistor	25/\$1
EN2907 PNP Transistor	25/\$1
2N3904 NPN Driver Xstr.	25/\$1
2N3392 GE Pre-amp Xstr.	25/\$1
C103Y SCR. 800MA. 60V.	10/\$1

ALL NEW.
UNUSED.
SOME ARE
HOUSE #

SLIDE SWITCH ASSORTMENT

Our best seller. Includes miniature and standard sizes, single and multi-position units. All new, first quality, name brand switches. Try one package and you'll reorder more. Special - 12 for \$1 (Assortment)



DISC CAP ASSORTMENT

PC leads. At least 10 different values. Includes .001, .01, .05, plus other standard values.
60 FOR \$1



UPRIGHT ELECTROLYTIC CAPS

47 mfd 35 V-10/\$1 68 mfd 25V-8/\$1
Brand new by Sprague. PC leads.

RESISTOR ASSORTMENT

1/4 W 5% and 10%. PC leads.
A good mix of values. 200/\$2



1000 MFD FILTER CAPS

Rated 35 WVDC. Upright style with P.C. leads. Most popular value for hobbyists. Compare at up to \$1.19 each from franchise type electronic parts stores. S.D. Special 4 for \$1



FAIRCHILD BIG LED READOUTS

A big, 50 inch easy to read character. Now available in either common anode or common cathode. Take your pick. Super low current drain, only 5 MA per segment typical.

FND - 510	Common Anode	YOUR CHOICE
FND - 503	Common Cathode	\$1.50 ea. 6 for \$7.50

DUAL 741C (5558) OP AMPS

Mini dip. New house numbered units by RAYTHEON.
4 FOR \$1

FET'S BY TEXAS INSTRUMENTS - SPECIAL 5 for \$1
#TIS-75 but with an internal house number. TO-92 plastic case. N. Channel, Junction type FET.

We do not sell junk. Money back guarantee on every item. No C.O.D. Texas Res. add 5% tax. Postage rates went up 30%! Please add 5% of your total order to help cover shipping.

S. D. SALES CO.

P.O. BOX 28810
DALLAS, TEXAS 75228

ORDERS UNDER \$10

ADD 75c HANDLING.

ORDERS OVER \$15 CHOOSE \$1 FREE MERCHANDISE

INSTRUCTION

LEARN ELECTRONIC ORGAN SERVICING at home all makes including transistor. Experimental kit troubleshooting. Accredited NHSC. Free Booklet. NILES BRYANT SCHOOL. 3631 Stockton, Dept. A, Sacramento, Calif 95820.

EARN ELECTRONICS DEGREE by correspondence Free information bulletin. Granham, 2000 Stoner Avenue. Los Angeles, California 90025.

INTENSIVE 5 week course for Broadcast Engineers F C C First Class license Radio Engineering Incorporated, 61 N Pineapple Ave., Sarasota, Florida 33577 and 2402 Tide-water Trail, Fredericksburg, VA 22401.

FCC LICENSE STUDY GUIDE - 377 pages, 1465 questions with answers/discussions covering third, second first radiotelephone examinations. \$9.95 postpaid GSE, 2000 Stoner, Los Angeles, California 90025.

ACHIEVEMENT in Electronics-Mathematics can be yours through independent study with individualized instruction For your trial lesson, send \$2.00 to. Vinther Institute, Box 9447P, Berkeley, CA 94709.

F.C.C. EXAM MANUAL

PASS FCC EXAMS! Memorize, study - "Test Answers" for FCC 1st and 2nd class Radio-Telephone licenses. Newly revised multiple choice questions and diagrams cover all areas tested in FCC exams plus "Self-Study Ability Test." \$9.95 postpaid. Moneyback Guarantee.

COMMAND PRODUCTIONS
RADIO ENGINEERING DIVISION SAN FRANCISCO, CALIF. 94125

Tests Answers for FCC First and Second Class Commercial License

SCORE high on F.C.C. Exams Over 300 questions and answers. Covers 3rd, 2nd, 1st and even Radar. Third and Second Test, \$14.50; First Class Test, \$15.00 All tests, \$26.50 R.E.I., Inc. Box 806, Sarasota, Fla. 33577

UNIVERSITY DEGREES BY MAIL! Bachelors, Masters, Ph.D's Free revealing details Counseling, Box 317-FE7 Tustin, California 92680.

SELF-STUDY CB RADIO REPAIR COURSE THERE'S MONEY TO BE MADE REPAIRING CB RADIOS. This easy-to-learn course can prepare you for a career in electronics enabling you to earn as much as \$16.00 an hour in your spare time For more information write: CB RADIO REPAIR COURSE, Dept. PE076, 531 N. Ann Arbor, Oklahoma City, Okla. 73127

NO FCC LICENSE? Tried every way but the right way? It's time for Genn Tech. Home Study. Free Catalog. 5540 Hollywood Blvd., Los Angeles, Calif. 90028.

LEARN Basic Digital Troubleshooting by correspondence. Information Free. Educational Technologies, Box 224, Reynoldsburg, Ohio 43068.

LEARN WHILE ASLEEP! HYPNOTIZE! Astonishing details, strange catalog free! Autosuggestion, Box 24-ZD, Olympia, Washington 98507.

BURGLAR/FIRE ALARM EXPERTS NEEDED for cars, homes, industry Learn high profit systems installation at home spare time Simple, quick, complete. Free information by mail. No salesmen. Security Systems Management School (homestudy), Dept. 7373-076, Little Falls, N.J. 07424.

PERSONALS

MAKE FRIENDS WORLDWIDE through international correspondence. Illustrated brochure free. Hermes, Berlin 11, Box 110660ZD, Germany.

Ph.D.'S, MASTER'S, BACHELOR'S - official nonresident College Degrees easily acquired through mailorder Universities Complete Revealing Directory - \$2. Counseling Connection, 5495 Claremont, No. BPE, Oakland, CA 94618.

INVENTIONS WANTED

INVENTORS: Manufacturers Need New Products. Free "Recommended Procedure." by a creative fee-based invention service company. Washington Inventors Service, 422-T Washington Building, Washington, D. C. 20005.

INVENTORS

RECOGNITION...FINANCIAL REWARD...OR CREDIT FOR "INVENTING IT FIRST" MAY BE YOURS!

If you have an idea for a new product, or a way to make an old product better, contact us, "the idea people" We'll develop your idea, introduce it to industry, negotiate for cash sale or royalty licensing. Write now without cost or obligation for free information. Fees are charged only for contracted services. So send for your FREE "Inventor's Kit." It has important Marketing Information, a special "Invention Record Form" and a Directory of 500 Corporations Seeking New Products.

RAYMOND LEE ORGANIZATION
230 Park Avenue North, New York, NY 10017
At no cost or obligation, please rush my FREE "Inventor's Kit No. A-112".

Name Please Print
Address
City State Zip

FREE PAMPHLET: "Tips on Marketing Your Invention," from an experienced fee-based invention service company. Write United States Inventors Service Company, Dept. T, 1435 G Street NW, Washington, D. C. 20005.

HYPNOTISM

SLEEP learning. Hypnotic method. 92% effective. Details free. ASR Foundation, Box 23429EG, Fort Lauderdale, Florida 33307.

FREE Hypnotism, Self-Hypnosis. Sleep Learning Catalog! Drawer H400, Ruidoso, New Mexico 88345.

AMAZING self-hypnosis record releases fantastic mental power. Instant results! Free trial. Write: Forum (AA7), 333 North Michigan, Chicago 60601.

RECORDS

RECORD RATERS WANTED! Anyone qualifies. We ship you nationally released LP's to rate. We pay postage and handling. You pay nothing for LP's. All you pay is small membership fee. Applicants accepted "first come basis." Write: E.A.R.S., Inc., Dept PE, Box 10245, 5521 W. Center Street, Milwaukee, Wisconsin 53210.

RECORDS - TAPES! Discounts to 73%; all labels; no purchase obligations; newsletter; discount dividend certificates; 100% guarantees. Free details Discount Music Club, 650 Main St., Dept 5-776, New Rochelle, New York, N.Y. 10801.

ACE OF THE MONTH SPECIALS

All new **ENGINEERING APPRAISAL ASSORTMENTS** first quality

SLIDE SWITCH ASSORTMENT standard and miniature 40 for \$5.00	200 ELECTROLYTIC ASSORTMENT \$9.95 MINIATURE ALUMINUM Axial Lead FROM 1/2 50v to 470uF 25v																																			
KEYBOARD ASSORTMENT 5 for \$9.95 CALCULATOR & COMPUTER	1% PRECISION RESISTORS 200 for \$9.95 Assortment contains a balanced inventory																																			
DISC CAP ASSORTMENT includes 22pf 270pf 300pf 330pf 360pf 390pf 430pf 470pf 510pf 560pf 620pf 680pf 750pf 820pf 910pf 1000pf 1500pf 2200pf 3300pf 4700pf 6800pf 10000pf 15000pf 22000pf 33000pf 47000pf 68000pf 100000pf Prime values 100pf 001uF 022uF 200 PCS FOR \$3.95	AC adapter ASSORTMENT 4 DIFFERENT models for \$9.95																																			
POWER CORD ASSORTMENT 6 for \$2.95 2 and 3 conductor 6-8-ft. U.L. Listed	DIPPED POLYESTER FILM CAPACITORS 100 for \$4.95																																			
SWITCHCRAFT Micro-Jax 10 --- \$ 2.95 100 --- 25.00 TR-2A 1000 --- 199.50 10M --- 1250.00	SPEEDY BEND by PRODUCTION DEVICES 195 1/2 W RES 195 1/2 W RES																																			
KEMET CK06BX 104K 0.1 uF 100 VDC 1-9 --- .50 10 --- .40 100 --- .34	MOLEX I.C. PINS 1000 for \$6.95																																			
SN74S201 13 ns 256 Bit RAM Three-State Output Plug In Replacement \$ 2.95 for SN74200 10 for \$24.95	TMS 4030 JL, 4096-BIT DYNAMIC RAM Low Power 400 mW \$9.95 with data and 22 Pin SDCKET removed from sockets 8 FOR \$64.95 Tested and guaranteed																																			
TMS 5000 ASCII keyboard encoder with data \$14.95 ASR33 Teletype Code	PITTMAN 12 VDC MOTOR runs on as low as 2 volts rated 12 Volts 250 ma, 2.8 inch of torque at 5000 RPM Size 1 1/8" DIA X 2" long with 0.118 inch shaft New Guaranteed \$1.95 each 10 for \$15.00																																			
ACOUSTIC COUPLER This coupler was manufactured by Novation, Inc. Tarzana, California for use in Texas Instrument's model 725 Electronic Data Terminal. It is compatible with Bell 103 and 113 data sets or equivalent. The coupler operates asynchronously to a maximum speed of 450 baud in the full-or-half-duplex mode coupled to a standard telephone handset. Transmit freq. is 1270hz for mark and 1070hz for space. Receive frequency is 2225hz for mark and 2025hz for space. Unit required ± 12 VOLTS and + 5 VOLTS for operation. Complete with schematic & all pertinent information, fully reconditioned, calibrated, and guaranteed \$47.50	ASCII COMPUTER KEYBOARDS These keyboards were manufactured for use on Texas Instrument's line of Silent 700 series data terminals. They are fully encoded with TTL large scale integrated circuits (T.I. TMS-5000 in 28 pin socket). Additional IC's provide a parallel 7 bit, without parity, code plus a strobe signal indicating "valid" data and six other independent outputs for those special keys which are not encoded. The keys are reed type with a format similar to typewriter. Internal circuitry provides for two key rollover and de-bounce. Output is on standard 10 pin double readout connector for data and power input. And 8 pin double readout connector for six special switch functions. KB-6: Clare/Pendar 720627-1 New - tested \$39.95 T.I. Part number 959327-1 Used - tested \$29.95 A 56 key ASCII encoded Alphabetic keyboard with six extra switch closures to ground marked HERE IS, PAPER ADV., BREAK, REPEAT, TAPE → TAPE → KB-7: Clare/Pendar 720731-1 New - tested \$49.95 T.I. Part number 959326-1 Used - tested \$39.95 This is a 64 key full ASCII encoded keyboard.																																			
PRINTED CIRCUIT BOARD G-10-116 thick, unetched copper clad 1 oz. 2 sides Size 1 10 100 3x6" .50 2.50 19.95 4x12" 1.00 5.00 39.95 8x8" 1.50 9.95 39.95	BURROUGHS PANAPLEX II 12 DIGIT 25 in high BR 16254 160V DC Insulation voltage WITH SOCKET \$2.95 ea. 10 for \$25.00																																			
SEMICONDUCTOR	CLOCK OR CALCU-VAC LATOR PRIMARY 117 VOLT 60 Hz OUTPUT 1 OUTPUT 2 DCMa VAC DCMa 20CT 50 80 20 Weight, 1/2 oz. 10 for \$15.00 100 for \$69.95 1000 for \$595.00																																			
<table border="1"> <tr><th>SEMICONDUCTOR</th><th>10</th><th>100</th><th>1000</th><th>10,000</th></tr> <tr><td>MPS3704</td><td>2.00</td><td>12.50</td><td>99.95</td><td>750.00</td></tr> <tr><td>IN4448 IN914B</td><td></td><td>5.60</td><td>48.00</td><td>394.45</td></tr> <tr><td>SZ13709 - IN749A</td><td>1.95</td><td>14.95</td><td>99.95</td><td>750.00</td></tr> <tr><td>2N930</td><td>2.50</td><td>19.95</td><td>150.00</td><td></td></tr> <tr><td>2N5449</td><td>2.00</td><td>12.50</td><td>99.95</td><td>750.00</td></tr> <tr><td>IN752A</td><td>2.40</td><td>19.00</td><td>150.00</td><td></td></tr> </table>	SEMICONDUCTOR	10	100	1000	10,000	MPS3704	2.00	12.50	99.95	750.00	IN4448 IN914B		5.60	48.00	394.45	SZ13709 - IN749A	1.95	14.95	99.95	750.00	2N930	2.50	19.95	150.00		2N5449	2.00	12.50	99.95	750.00	IN752A	2.40	19.00	150.00		BISMUTH ALLOY. Melts in boiling water 4 oz. ingot: \$3.95
SEMICONDUCTOR	10	100	1000	10,000																																
MPS3704	2.00	12.50	99.95	750.00																																
IN4448 IN914B		5.60	48.00	394.45																																
SZ13709 - IN749A	1.95	14.95	99.95	750.00																																
2N930	2.50	19.95	150.00																																	
2N5449	2.00	12.50	99.95	750.00																																
IN752A	2.40	19.00	150.00																																	

ORDERS OVER 10 lbs. are shipped Collect

We will ship UPS unless otherwise specified. TERMS We pay postage, unless otherwise specified. Include check or money order, no COD Texas residents add 5% sales tax. Canada and Mexico add \$2.50 overseas countries add \$5.00. TXVX 910-881-2411

P.O. Box 4430C Santa Clara, CA 95054

TERMS: \$5.00 min. order U.S. funds
Calif. residents add 6% tax.

FREE: Send for your copy of
our 1976 QUEST CATALOG.

Include
13¢
stamp.

Same day shipment
First line parts only. Factory
tested. Guaranteed money
back. Quality IC's and other
components at factory prices.

INTEGRATED CIRCUITS

7400 TTL	17	SN74LS00N	1.10	NE565A	1.00	DISPLAY LEDS	1.00
SN7400N	17	SN74LS00N	1.89	NE565A	1.00	MAN1	CA 270 1.80
SN7401N	19	SN74LS01N	52	NE566V	1.85	MAN3	CC 125 3.00
SN7408N	23	SN74LS132N	1.50	NE567N	1.75	MAN4	CC 187 1.95
SN7410N	17	SN74LS151N	1.28	SN75450CN	47	MAN7	CA 300 1.35
SN7416N	39	SN74LS157N	2.05	SN75451CN	39	MAN7A	CC 300 1.35
SN7420N	39	SN74LS160N	2.05	SN75452CN	37	DL707	CA 300 1.35
SN7423N	17	SN74LS170N	2.85	CMOS	37	DL747	CA 600 2.00
SN7428N	37	SN74LS182N	2.60	CD34001	42	FND503	CC 500 1.75
SN7440N	17	SN74LS197N	2.00	CD40011	25	FND510	CA 500 1.75
SN7447N	38	SN74LS258N	2.20	CD4017	2.00	2102-1	2.75
SN7450N	17	SN74LS290N	2.00	CD4020	2.00	2102-2	2.75
SN7473N	36	SN74LS670N	3.50	CD4027	55	2107	18.50
SN7474N	39			CD4033	65	2132-2	7.90
SN7475N	69			CD4049	62	UART	
SN7489N	3.00			CD4050	60	AYS-1013	6.20
SN7490N	45			CD4071	125	CD4071	40
SN7494N	39			CD4072	40	A to D CONVERTER	
SN74107N	39			CD4082	45	8700CN	16.00
SN74121N	49			CD4082	45	8700CN	16.00
SN74122N	59			CD4082	45	8700CN	16.00
SN74123N	89			CD4082	45	8700CN	16.00
SN74124N	89			CD4082	45	8700CN	16.00
SN74125N	89			CD4082	45	8700CN	16.00
SN74126N	89			CD4082	45	8700CN	16.00
SN74127N	89			CD4082	45	8700CN	16.00
SN74128N	89			CD4082	45	8700CN	16.00
SN74129N	89			CD4082	45	8700CN	16.00
SN74130N	89			CD4082	45	8700CN	16.00
SN74131N	89			CD4082	45	8700CN	16.00
SN74132N	89			CD4082	45	8700CN	16.00
SN74133N	89			CD4082	45	8700CN	16.00
SN74134N	89			CD4082	45	8700CN	16.00
SN74135N	89			CD4082	45	8700CN	16.00
SN74136N	89			CD4082	45	8700CN	16.00
SN74137N	89			CD4082	45	8700CN	16.00
SN74138N	89			CD4082	45	8700CN	16.00
SN74139N	89			CD4082	45	8700CN	16.00
SN74140N	89			CD4082	45	8700CN	16.00
SN74141N	89			CD4082	45	8700CN	16.00
SN74142N	89			CD4082	45	8700CN	16.00
SN74143N	89			CD4082	45	8700CN	16.00
SN74144N	89			CD4082	45	8700CN	16.00
SN74145N	89			CD4082	45	8700CN	16.00
SN74146N	89			CD4082	45	8700CN	16.00
SN74147N	89			CD4082	45	8700CN	16.00
SN74148N	89			CD4082	45	8700CN	16.00
SN74149N	89			CD4082	45	8700CN	16.00
SN74150N	89			CD4082	45	8700CN	16.00
SN74151N	89			CD4082	45	8700CN	16.00
SN74152N	89			CD4082	45	8700CN	16.00
SN74153N	89			CD4082	45	8700CN	16.00
SN74154N	89			CD4082	45	8700CN	16.00
SN74155N	89			CD4082	45	8700CN	16.00
SN74156N	89			CD4082	45	8700CN	16.00
SN74157N	89			CD4082	45	8700CN	16.00
SN74158N	89			CD4082	45	8700CN	16.00
SN74159N	89			CD4082	45	8700CN	16.00
SN74160N	89			CD4082	45	8700CN	16.00
SN74161N	89			CD4082	45	8700CN	16.00
SN74162N	89			CD4082	45	8700CN	16.00
SN74163N	89			CD4082	45	8700CN	16.00
SN74164N	89			CD4082	45	8700CN	16.00
SN74165N	89			CD4082	45	8700CN	16.00
SN74166N	89			CD4082	45	8700CN	16.00
SN74167N	89			CD4082	45	8700CN	16.00
SN74168N	89			CD4082	45	8700CN	16.00
SN74169N	89			CD4082	45	8700CN	16.00
SN74170N	89			CD4082	45	8700CN	16.00
SN74171N	89			CD4082	45	8700CN	16.00
SN74172N	89			CD4082	45	8700CN	16.00
SN74173N	89			CD4082	45	8700CN	16.00
SN74174N	89			CD4082	45	8700CN	16.00
SN74175N	89			CD4082	45	8700CN	16.00
SN74176N	89			CD4082	45	8700CN	16.00
SN74177N	89			CD4082	45	8700CN	16.00
SN74178N	89			CD4082	45	8700CN	16.00
SN74179N	89			CD4082	45	8700CN	16.00
SN74180N	89			CD4082	45	8700CN	16.00
SN74181N	89			CD4082	45	8700CN	16.00
SN74182N	89			CD4082	45	8700CN	16.00
SN74183N	89			CD4082	45	8700CN	16.00
SN74184N	89			CD4082	45	8700CN	16.00
SN74185N	89			CD4082	45	8700CN	16.00
SN74186N	89			CD4082	45	8700CN	16.00
SN74187N	89			CD4082	45	8700CN	16.00
SN74188N	89			CD4082	45	8700CN	16.00
SN74189N	89			CD4082	45	8700CN	16.00
SN74190N	89			CD4082	45	8700CN	16.00
SN74191N	89			CD4082	45	8700CN	16.00
SN74192N	89			CD4082	45	8700CN	16.00
SN74193N	89			CD4082	45	8700CN	16.00
SN74194N	89			CD4082	45	8700CN	16.00
SN74195N	89			CD4082	45	8700CN	16.00
SN74196N	89			CD4082	45	8700CN	16.00
SN74197N	89			CD4082	45	8700CN	16.00
SN74198N	89			CD4082	45	8700CN	16.00
SN74199N	89			CD4082	45	8700CN	16.00
SN74200N	89			CD4082	45	8700CN	16.00
SN74201N	89			CD4082	45	8700CN	16.00
SN74202N	89			CD4082	45	8700CN	16.00
SN74203N	89			CD4082	45	8700CN	16.00
SN74204N	89			CD4082	45	8700CN	16.00
SN74205N	89			CD4082	45	8700CN	16.00
SN74206N	89			CD4082	45	8700CN	16.00
SN74207N	89			CD4082	45	8700CN	16.00
SN74208N	89			CD4082	45	8700CN	16.00
SN74209N	89			CD4082	45	8700CN	16.00
SN74210N	89			CD4082	45	8700CN	16.00
SN74211N	89			CD4082	45	8700CN	16.00
SN74212N	89			CD4082	45	8700CN	16.00
SN74213N	89			CD4082	45	8700CN	16.00
SN74214N	89			CD4082	45	8700CN	16.00
SN74215N	89			CD4082	45	8700CN	16.00
SN74216N	89			CD4082	45	8700CN	16.00
SN74217N	89			CD4082	45	8700CN	16.00
SN74218N	89			CD4082	45	8700CN	16.00
SN74219N	89			CD4082	45	8700CN	16.00
SN74220N	89			CD4082	45	8700CN	16.00
SN74221N	89			CD4082	45	8700CN	16.00
SN74222N	89			CD4082	45	8700CN	16.00
SN74223N	89			CD4082	45	8700CN	16.00
SN74224N	89			CD4082	45	8700CN	16.00
SN74225N	89			CD4082	45	8700CN	16.00
SN74226N	89			CD4082	45	8700CN	16.00
SN74227N	89			CD4082	45	8700CN	16.00
SN74228N	89			CD4082	45	8700CN	16.00
SN74229N	89			CD4082	45	8700CN	16.00
SN74230N	89			CD4082	45	8700CN	16.00
SN74231N	89			CD4082	45	8700CN	16.00
SN74232N	89			CD4082	45	8700CN	16.00
SN74233N	89			CD4082	45	8700CN	16.00
SN74234N	89			CD4082	45	8700CN	16.00
SN74235N	89			CD4082	45	8700CN	16.00
SN74236N	89			CD4082	45	8700CN	16.00
SN74237N	89			CD4082	45	8700CN	16.00
SN74238N	89			CD4082	45	8700CN	16.00
SN74239N	89			CD4082	45	8700CN	16.00
SN74240N	89			CD4082	45	8700CN	16.00
SN74241N	89			CD4082	45	8700CN	16.00
SN74242N	89			CD4082	45	8700CN	16.00
SN74243N	89			CD4082	45	8700CN	16.00
SN74244N	89			CD4082	45	8700CN	16.00
SN74245N	89			CD4082	45	8700CN	16.00
SN74246N	89			CD4082	45	8700CN	16.00
SN74247N	89			CD4082	45	8700CN	16.00
SN74248N	89			CD4082	45	8700CN	16.00
SN74249N	89			CD4082	45	8700CN	16.00
SN74250N	89			CD4082	45	8700CN	16.00
SN74251N	89			CD4082	45	8700CN	16.00</

NEW BUILD YOUR OWN DIGIKIT™ Electronic Games

Each DIGIKIT Game is Quick, Easy & Fun to Build, Fun-to-Play, & Includes:

- All PRE-TESTED, "state-of-the-art" 100% warranted parts
- PREDRILLED PC boards for quick easy installation of digital components
- Complete professional assembly instructions
- Detailed schematic diagram and assembly drawing
- IC logic diagrams
- Exclusive . . . screened film top panel overlay for professional appearance

SLOT MACHINE

An electronic "push button bandit". 3 LED's read out C for Cherry, O for Orange, L for Lemon and P for Prune. Hit any three alike, and you win. Oscillates at different rates, so game cannot be "fixed".

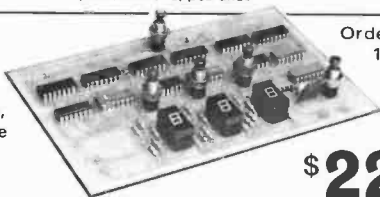

Order No. 10712

\$22⁹⁵

Reaction TENNIS

Like Tennis, this is a game of timing. LED's firing in sequence show the flight of the ball. Player receiving serve must react in time to return the shot. Change speeds to fast or slow.



Order No. 10711 \$20.95

SPINNER

10 sequentially lit LED's fire in a circle. Push the button and only one LED stays lit. Designed to indicate the number of moves in games that require a numbered spinner.



Order No. 10705

\$11.95

7-LIGHT DICE-A PAIR

A roll of the dice with all possible outcomes (2 thru 12) at the push of a button. 14 LED's represent spots on dice. Use to play MONOPOLY, LIFE, electronic "craps", any game that requires a roll of the dice.

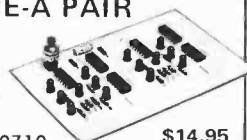

Order No. 10710

\$14.95

Regulated POWER SUPPLY

±15v. @ 500 ma. +5 v. @ 1 amp.

Ideal for all hobbyists. Completely assembled. Used & tested. Includes line cord, transformer & modification kit.

Limited Quantity!

Order No. 10716 . . . Only \$29.95

Order Your DIGIKITS Today! Indicate quantity and order no.



Min. Charge \$15.

Include all card No's.

FREE! DIGIKIT CATALOG Send for your copy.

California residents add 6% sales tax. Add \$1 postage & handling on orders under \$10. Phone Orders — Call (213) 993-1311 Send Check or Money Order to:

DIGIKIT ENTERPRISES, INC. Dept. PE 776 20450 Plummer St., Chatsworth, CA 91311

CIRCLE NO. 20 ON FREE INFORMATION CARD

TAPE AND RECORDERS

RENT 4-Track open reel tapes—free brochure. Stereo-Parti, P.O. Box 7, Fulton, CA 95401.

1930-1962 Radio Programs. Reels, \$1.00 Hour! Cassettes, \$1.00 Show! Mammoth Catalog, \$1.25. AM Treasures, Box 192PE, Babylon, N.Y. 11702.

RUBBER STAMPS

RUBBER ADDRESS STAMPS. Free Catalog. 45 type styles. Jackson's, Dept. K, Brownsville Rd., Mt. Vernon, Ill. 62864.

NEW Pocket Case Address STAMPER. \$11.95 100,000 Impressions without Re-Inking! 25 Yr. Unconditional Guaranty. NO INK PAD! LEE GARLAND, Box 17056, San Diego, CA 92117.

BOOKS AND MAGAZINES

FREE book prophet Elijah coming before Christ. Wonderful bible evidence. Megiddo Mission, Dept. 64, 481 Thurston Rd., Rochester, N.Y. 14619.

FREE CATALOG. Aviation and Space Books. Aero Publishers, 329PE West Aviation, Fallbrook, California 92028.

THE AUDIO AMATEUR—A quarterly publication for the serious audio constructor. Free prospectus. The Audio Amateur, Box 176Z, Peterborough, N.H. 03458.

CB SLANG DICTIONARY—Most complete CB Dictionary Handbook available. Hundreds of slang terms plus part 95 mandatory FCC rules. Great gift. Order NOW. Send \$5.00 to: Communication Books, Inc., Dept. PE, Box 10198, Milwaukee, WI 53210.

CRIMEFIGHTERS! SHOPLIFTING! LOCKPICKING! DE-BUGGING! All 3 books for only \$5.00. Don-Q, 548-PE, Seattle, Washington 98111.

WANTED

GOLD. Silver, Platinum, Mercury wanted. Highest prices paid by refinery. Ores assayed. Free circular. Mercury Terminal, Norwood, MA 02062.

WANTED HYCOM Model 622-D Power Transformer. Robert Jackson, 648 Broadway, Venice, Calif. 90291.

SOLVE YOUR TEST CONNECTION PROBLEMS WITH E-Z-HOOK

E-Z Hooks have been designed and field tested throughout the industry to save time and money in commercial electronic production and servicing. The spring-loaded hook attaches firmly, yet so gently it will not damage component — frees hands while testing. Durably constructed and fully insulated to a single contact point assuring true readings. Meets exacting laboratory and space age computer technology requirements. AVAILABLE IN 10 RETMA COLORS: Red, black, blue, green, orange, yellow, white, violet, brown or gray. The most unique field-serviceable test connectors available. Fast, safe, sure and trouble-free. NOW AVAILABLE FROM ANCRONA . . . the source you can trust for fine quality, industrial-grade electronic components and accessories.

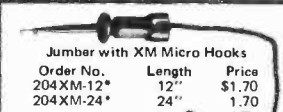

Specify color.
Jumper with X-100W Mini Hooks
Order No. Length Price
204-12W* 12" \$1.60
204-24W* 24" 1.60

Specify color.
Jumper with XM Micro Hooks
Order No. Length Price
204XM-12* 12" \$1.70
204XM-24* 24" 1.70

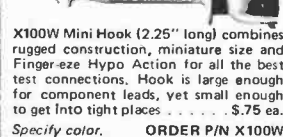
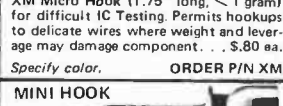

Jumper, XM Micro Hook to Banana Plug
Order No. Length Price
201XM* 32" \$1.40 Specify color.

Jumper X-100W Mini Hook** to Stacking Banana Plug
Order No. Length Price
201W* 32" \$1.35 Specify color.

XM Micro Hook (1.75" long, < 1 gram) for difficult IC Testing. Permits hookups to delicate wires where weight and leverage may damage component. . . \$.80 ea.
Specify color. ORDER P/N XM

MINI HOOK
X100W Mini Hook (2.25" long) combines rugged construction, miniature size and Finger-eze Hypo Action for all the best test connections. Hook is large enough for component leads, yet small enough to get into tight spaces. . . \$.75 ea.
Specify color. ORDER P/N X100W

EXTRA LONG MINI HOOK

ORDER P/N XL-1
XL-1 Mini Hook (5.0" long) combines all the proven features of the X100W with an extra long body. It will make safe, short-free test connections in card racks and through deep wiring nest up to 4". \$1.25 ea.



Jumper with XL-1 Mini Hooks
Order No. Length Price
204XL1-12 12" \$2.80
204XL1-24 24" 2.80 Specify color.

Jumper, XL-1 Mini Hook** to Stacking Banana Plug
Order No. Length Price
201XL-1* 32" \$1.95

*Specify color. **Square hole tip for hooking laterally to leads or vertically over square wire-wrap pins.

NEW FROM verowire® WIRING SYSTEM

WIRING PEN — The wiring pen with self-contained spool of poly-urthane lacquer insulated copper wire is used to route and wrap onto component leads, terminal pin, etc. Connections are completed by soldering which melts the insulation and at the same time makes a permanent solder joint.

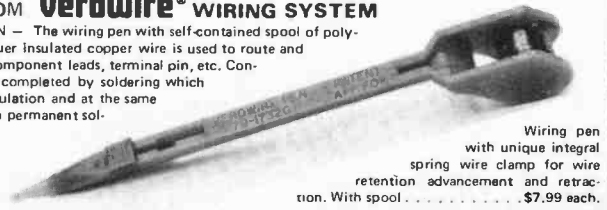

Wiring pen with unique integral spring wire clamp for wire retention advancement and retraction. With spool. \$7.99 each.

ADDITIONAL WIRE SPOOLS — Package of 2 spools (120 meters) of 34 AWG wire \$2.68

Prices effective through July 31, 1976.
Minimum order \$10.00. Add \$1.00 to cover postage and handling. California residents add 6% sales tax.
PLEASE VISIT OUR ELECTRONIC STORES

ARIZONA 4518 East Broadway Tucson, Arizona 85711	CALIFORNIA 11080 Jefferson Blvd., Culver City, CA 90230	1300 E. Edinger Ave., Santa Ana, CA 92705	CANADA 5656 Fraser Street Vancouver, B.C. V5W 2Z4
--	---	--	---

SEND CHECK OR MONEY ORDER TO:
ANCRONA CORP.
Mail order: P.O. Box 2208P, Culver City, CA 90230, Phone order: (213) 641-4064
Prices may vary at over-the-counter locations.

ZENER DIODES 500 mW - 5%

V	1.9 10up	1.9 10up	
IN5223B	2.7 .45 .40	IN5246B	16 .45 .40
IN5224B	2.8 .45 .40	IN5247B	17 .45 .40
IN5225B	3.0 .45 .40	IN5248B	18 .45 .40
IN5226B	3.3 .45 .40	IN5249B	19 .45 .40
IN5227B	3.6 .45 .40	IN5250B	20 .45 .40
IN5228B	3.9 .45 .40	IN5251B	22 .45 .40
IN5229B	4.3 .45 .40	IN5252B	24 .45 .40
IN5230B	4.7 .45 .40	IN5253B	26 .45 .40
IN5231B	5.1 .45 .40	IN5254B	27 .45 .40
IN5232B	5.6 .45 .40	IN5255B	28 .45 .40
IN5233B	6.0 .45 .40	IN5256B	30 .45 .40
IN5234B	6.2 .45 .40	IN5257B	33 .45 .40
IN5235B	6.8 .45 .40	IN5258B	36 .45 .40
IN5236B	7.5 .45 .40	IN5259B	39 .45 .40
IN5237B	8.2 .45 .40	IN5260B	43 .45 .40
IN5238B	8.7 .45 .40	IN5261B	47 .45 .40
IN5239B	9.1 .45 .40	IN5262B	51 .45 .40
IN5240B	10 .45 .40	IN5263B	56 .50 .50
IN5241B	11 .45 .40	IN5264B	60 .55 .50
IN5242B	12 .45 .40	IN5265B	62 .55 .50
IN5243B	13 .45 .40	IN5266B	68 .55 .50
IN5244B	14 .45 .40	IN5267B	75 .55 .50
IN5245B	15 .45 .40		

7400N TTL

1-9 10up	1-9 10up	1-9 10up			
7400N	.14 .13	7470N	.40 .30	74152N	1.04 .94
7401N	.18 .16	7472N	.40 .30	74153N	8.5 .75
7402N	.18 .16	7473N	.42 .38	74154N	1.08 .94
7403N	.18 .16	7474N	.44 .40	74155N	1.02 .92
7404N	.21 .19	7475N	.55 .50	74156N	1.02 .92
7405N	.20 .19	7476N	.44 .40	74157N	9.0 .80
7406N	.36 .28	7480N	.80 .72	74158N	1.50 .130
7407N	.36 .28	7481N	1.30 .125	74160N	1.02 .92
7408N	.24 .20	7482N	.98 .96	74161N	1.10 .104
7409N	.28 .21	7483N	.82 .76	74162N	1.40 .130
7410N	.22 .19	7484N	1.80 .170	74163N	1.00 .90
7411N	.26 .20	7485N	2.10 .108	74164N	1.16 .105
7412N	.34 .27	7486N	.44 .40	74165N	2.10 .110
7413N	.45 .32	7487N	2.20 .210	74166N	1.20 .110
7414N	.98 .95	7490N	.56 .51	74167N	5.00 .450
7416N	.35 .32	7491N	.84 .76	74170N	2.00 .180
7417N	.35 .32	7492N	.56 .50	74173N	1.66 .150
7418N	.30 .27	7493N	.62 .56	74174N	1.00 .90
7420N	.15 .14	7494N	.88 .80	74175N	.96 .90
7421N	.30 .26	7495N	.80 .72	74176N	1.08 .100
7422N	.50 .45	7496N	.75 .68	74177N	1.08 .100
7423N	.37 .36	7497N	5.00 .480	74178N	1.42 .130
7425N	.20 .23	74100N	1.00 .170	74179N	1.80 .170
7426N	.28 .26	74104N	1.00 .90	74180N	1.12 .102
7427N	.28 .28	74105N	1.00 .90	74181N	3.00 .270
7428N	.40 .33	74107N	.40 .36	74182N	1.00 .90
7430N	.32 .30	74109N	.40 .36	74184N	8.00 .250
7432N	.32 .30	74110N	.90 .70	74185N	5.00 .450
7433N	.44 .40	74111N	1.00 .90	74188N	5.00 .480
7437N	.29 .20	74116N	2.00 .180	74190N	1.20 .110
7438N	.29 .27	74118N	2.20 .210	74191N	1.20 .110
7439N	.44 .40	74119N	4.00 .360	74192N	.98 .90
7440N	.17 .16	74121N	.80 .64	74193N	1.00 .90
7441N	.85 .83	74122N	.48 .43	74194N	1.36 .123
7442N	.40 .39	74123N	.68 .62	74195N	.75 .70
7443N	.72 .65	74125N	.50 .45	74196N	1.40 .130
7444N	.44 .40	74126N	.80 .45	74197N	1.40 .130
7445N	.90 .81	74128N	.50 .45	74198N	4.00 .300
7446N	.90 .81	74132N	.92 .86	74199N	1.40 .130
7447N	.98 .90	74136N	.80 .72	74200N	9.00 .800
7448N	.98 .90	74141N	1.70 .150	74221N	1.36 .125
7450N	.14 .13	74142N	1.10 .100	74222N	2.20 .210
7451N	.14 .13	74147N	1.90 .170	74251N	1.90 .180
7453N	.14 .13	74148N	1.50 .135	74278N	2.90 .250
7454N	.14 .13	74150N	1.52 .140	74279N	.66 .60
7459N	.20 .18	74151N	.02 .92	74298N	2.00 .180
7460N	.14 .13	HIGH SPEED TTL			

LOW POWER TTL

74L00N	74L01N	74L02N	74L03N	74L04N	
74L00N	.24	74L01N	.34	74L02N	1.62
74L02N	.24	74L02N	.33	74L03N	.43
74L03N	.39	74L04N	1.33	74L04N	1.62
74L04N	.33				

74LS00

1-9 10up	1-9 10up	1-9 10up			
74LS00N	.36 .35	74LS55N	.39 .38	74LS161N	3.00 .270
74LS01N	.44 .40	74LS73N	.58 .55	74LS162N	3.06 .280
74LS02N	.36 .35	74LS74N	.56 .54	74LS163N	3.00 .270
74LS03N	.45 .43	74LS76N	.65 .64	74LS170N	5.80 .530
74LS04N	.44 .40	74LS78N	2.00 .190	74LS171N	2.20 .210
74LS05N	.45 .44	74LS95N	2.08 .200	74LS176N	2.40 .220
74LS06N	.38 .37	74LS107N	.59 .58	74LS181N	3.69 .368
74LS09N	.46 .42	74LS109N	.92 .86	74LS190N	2.85 .270
74LS10N	.46 .42	74LS112N	.58 .55	74LS193N	2.85 .270
74LS11N	.46 .42	74LS113N	.92 .86	74LS193A	2.50 .240
74LS15N	.68 .64	74LS114N	.92 .85	74LS194N	2.25 .220
74LS20N	.44 .40	74LS123N	1.60 .150	74LS195AJ	2.40 .220
74LS21N	.58 .54	74LS138N	1.89 .180	74LS196AJ	2.76 .250
74LS22N	.58 .54	74LS139N	2.00 .190	74LS200N	2.40 .220
74LS27N	.44 .40	74LS151N	1.68 .150	74LS215AJ	2.08 .190
74LS30N	.39 .38	74LS152N	1.80 .179	74LS253AJ	2.42 .220
74LS32N	.45 .44	74LS157N	1.55 .184	74LS257AJ	1.89 .180
74LS33N	.58 .54	74LS158N	1.61 .160	74LS258AJ	2.06 .190
74LS51N	.39 .38	74LS160N	2.00 .270	74LS260AJ	.44 .40
74LS54N	.58 .54	SCHOTTKY TTL			

9300 SERIES

74S00	74S01	74S02	74S03	74S04	74S05	74S06	74S07	74S08	74S09	74S10	74S11	74S15	74S20	74S21	74S30
74S00	.44	74S01	.65	74S02	.60	74S03	.75	74S04	.55	74S05	.65	74S06	.80	74S07	.65
74S08	.80	74S09	.75	74S10	.55	74S11	.65	74S15	.75	74S20	.65	74S21	.76	74S30	.80
74S113	1.50	74S114	1.20	74S115	2.90	74S116	6.00	74S117	4.40	74S118	3.30	74S119	3.30	74S120	3.30
74S121	2.20	74S122	2.20	74S123	2.20	74S124	3.30	74S125	3.30	74S126	3.30	74S127	3.30	74S128	3.30
74S129	3.30	74S130	3.30	74S131	3.30	74S132	3.30	74S133	3.30	74S134	3.30	74S135	3.30	74S136	3.30
74S137	3.30	74S138	3.30	74S139	3.30	74S140	3.30	74S141	3.30	74S142	3.30	74S143	3.30	74S144	3.30
74S145	3.30	74S146	3.30	74S147	3.30	74S148	3.30	74S149	3.30	74S150	3.30	74S151	3.30	74S152	3.30
74S153	3.30	74S154	3.30	74S155	3.30	74S156	3.30	74S157	3.30	74S158	3.30	74S159	3.30	74S160	3.30
74S161	3.30	74S162	3.30	74S163	3.30	74S164	3.30	74S165	3.30	74S166	3.30	74S167	3.30	74S168	3.30
74S169	3.30	74S170	3.30	74S171	3.30	74S172	3.30	74S173	3.30	74S174	3.30	74S175	3.30	74S176	3.30
74S177	3.30	74S178	3.30	74S179	3.30	74S180	3.30	74S181	3.30	74S182	3.30	74S183	3.30	74S184	3.30
74S185	3.30	74S186	3.30	74S187	3.30	74S188	3.30	74S189	3.30	74S190	3.30	74S191	3.30	74S192	3.30
74S193	3.30	74S194	3.30	74S195	3.30	74S196	3.30	74S197	3.30	74S198	3.30	74S199	3.30	74S200	3.30

LINEAR IC's

H=TO-5	N=DIP	M=MINI-DIP	D=CER-DIP	K=TO-3	
LM105H	3.90	LM311D	.90	LM709CN	.75 .40
LM108H	4.90	LM311M	1.75	LM710CH	.90
LM111H	1.50	LM312H	1.75	LM711CN	.90
LM300H	1.20	LM318H	1.50	LM711CH	.90
LM300N	1.20	LM318M	2.40	LM711CN	.90
LM301AH	.50	LM319N	3.40	LM715CH	3.50
LM301AM	.80	LM324N	1.90	LM715CH	4.60
LM301AN	.80	LM331H	1.25	LM723CN	.60
LM302N	1.30	LM335K	2.40	LM723CN	.65
LM302H	1.40	LM336K	2.40	LM725CH	1.50
LM305H	.85	LM337K	2.40	LM725CH	5.00
LM305AH	.85	LM339N	2.20	LM733CH	1.40
LM305N	1.00	LM320.5K	.90	LM733CH	3.80
LM306N	.95	LM320.12K	.90	LM741CH	1.25
LM307H	.60	LM320.12T	2.90	LM741CH	1.40
LM307M	1.50	LM340.1K	2.60	LM747CN	.90
LM307N	1.60	LM340.6K	2.60	LM747CN	.75
LM308H	.85	LM340.8K	2.60	LM747CN	.90
LM308AH	5.00	LM340.12K	2.60	LM748CN	.65
LM308E	2.25	LM340.15K	2.60	LN777H	2.15
LM308M	1.00	LM340.18K	2.60	LM777CN	2.10
LM309H	1.75	LM340.24K	2.60	LM3046CN	.95
LM309K	1.50	LM555CN	.70	LM3054CN	1.50
LM310H	1.50	LM566CN	1.30	SG4501	2.40
LM311H	1.20	LM567	1.70	SG4502	2.40
LM311H	1.20	LM709CH	.75	LM500CK	7.50

CMOS

1-9 10up	1-9 10up	1-9 10up			
4000AA	15 .14	40218E	1.15	40566A	1.9 10up
4000AF	28 .24	4022AE	1.05 .100	40566B	2.0 10up
4000BE	19 .18	4022BE	1.10 .105	40666A	1.70 .168
4001AE	24 .20	4023AA	2.4 .22	4063AE	2.50 .249
4001BE	27 .24	4023BB	3.0 .28	4066AE	.90 .89
4002AE	14 .16	4024AE	8.0 .74	4071AE	.45 .44
4002AF	34 .26	4024AF	9.5 .85	40668E	53 .48
4002BE	30 .18	4024BE	8.5 .75	4069AE	44 .43
4004AE	4.00 .380	4028AE	24 .20	40698E	53 .48
4006AE	1.30 .120	4025AA	.45 .35	40708E	.60 .59
4006AF	1.50 .130	4025AA	3.0 .28	4071AE	.45 .44
4006BE	1.35 .125	4026AE	1.50 .149	4072AE	34 .33
4007AE	.24 .23	4027AE	.55 .50	4073AE	40 .39
4007AF	.40 .35	4027BE	.60 .55	4075AE	40 .39
4008AE	1.30 .125	4028AE	9.5 .90	4075AE	1.24 .122
4008AF	1.15 .114	4028BE	1.00 .95	4077AE	40 .39
4008AA	3.0 .250	4029AE	1.20 .110	4077BE	44 .43
4009AE	.50 .45	4029BE	1.25 .115	4078AE	40 .39
4009BE	.55 .50	4030AE	4.8 .40	4078BE	44 .43
4010AE	1.50 .130	4031AE	9.5 .90	4078AE	1.24 .122

VIDEO CAMERA KIT

A UNIQUE ALL SOLID STATE CAMERA KIT
FEATURING A . . . 100 x 100 BIT
SELF SCANNING CHARGED
COUPLED DEVICE

INCLUDES THE FOLLOWING
UNIQUE FEATURES . . .
FOUND IN FAR MORE
EXPENSIVE CAMERAS
IF AVAILABLE

- LOW VOLTAGE SUPPLY (OR BATTERIES) + 9 AND 15 VOLTS
- SENSITIVE TO INFRARED AS WELL AS VISIBLE LIGHT
- MAY BE USED FOR IN-SURVEILLANCE WITH AN IR LIGHT SOURCE
- EXCELLENT FOR STANDARD SURVEILLANCE WORK BECAUSE OF ITS LIGHTWEIGHT AND SMALL SIZE
- ALL COMPONENTS MOUNTED ON TWO PARALLEL 3" x 5" SINGLE SIDED BOARDS TOTAL WEIGHT UNDER 2 LBS.
- MAY BE WIRED BY PERSON WITH SOME TECHNICAL EXPERIENCE IN 4-6 HRS.

**SUPER UNBELIEVABLE
ONLY \$225.00**

ADD \$2.00 POSTAGE AND HANDLING, PLUS \$6.00 FOR ALL IC SOCKETS (OPTIONAL)

SCHEMATIC FOR
COMPUTER
INTERFACE
SUPPLIED

MAY BE USED
WITH AMATEUR
RADIO FOR VIDEO

USED FOR CHARAC-
TER RECOGNITION
FOR COMPUTERS
WITH EXTERNAL
CIRCUITS

MAY BE USED IN
A VACUUM, UNDER
WATER, HIGH
ALTITUDE, AND
IN MAGNETIC
ENVIRONMENT
BECAUSE THERE
IS NO HIGH
VOLTAGE OR
MAGNETIC
DEFLECTION

WE SUPPLY ALL
SEMICONDUCTORS,
BOARDS, DATA SHEETS,
DIAGRAMS, RESISTORS
AND CAPACITORS

SORRY, WE DO NOT SUPPLY
THE CASE, BATTERIES
(OR SUPPLY) THE LENS
(NOT SUPPLIED) DEPENDS
UPON THE USER

VERAS-8 MICROPROCESSOR KIT

IS ONE OF THE MOST ADVANCED MCU
SYSTEMS ON THE MARKET TODAY FOR ONLY
\$159.00

- This three chip 8-bit microprocessor system has the following advantages:
- 1) Driven by a +5 and +12 volt power supply.
 - 2) Two I/O ports on the CPU chip, and ROM, making 32 bidirectional lines.
 - 3) 64 bytes of fast RAM scratchpad built into the CPU chip.
 - 4) A built in clock generator and power-on reset built into the CPU chip.
 - 5) A programmable internal timer built into the ROM chip.
 - 6) 60% of the instructions are 1 byte.
 - 7) TTL I/O compatibility.
 - 8) Consumes less than 300mw of power per chip.
 - 9) A local interrupt with automatic address vector.
 - 10) Expandable to 64K bytes (2102-1's) of memory.
 - 11) 20 mil top and P-232 included.
 - 12) minimum frag. response 1 MHz.
 - 13) 22 pin edge for easy servicing.

The VERAS-8 Kit has enough parts and instructions to demonstrate microprocessor programs up to 1K byte, and to debug those programs.

We supply:

1. 3850 CPU
 1. 3851 A FAIR-BUG programmed storage unit, provides the programmer with all its I/O subroutines, and allows the programmer to display or alter memory, and register contents via a network terminal.
 1. 3853 Static memory interface
 8. 2102-1's
- Plus CMOS gates and buffers, PC card, instruction manuals, programming guide.

4K MEMORY KIT \$159.00

- Memory Board: Our unique memory card features:
- 1) 8 bit bidirectional port, outputs buffered.
 - 2) On board decoding for any four of 64 pages.
 - 3) Address buffered.
 - 4) 4K bytes of 2102-1 static RAM's.
 - 5) No on board regulation to cause heat problems.
 - 6) Only .5 volt supply needed.

The memory card, like our other computer cards, has a 24 pin gold plated edge 156 pin connector. This feature makes the system completely stackable to save space, service problems, and hard wiring. It will also allow plug-in capability for our other cards when they become available.

EXPANDER BOARD

This board will expand the memory capability to 16 kilobytes with full buffering. Individual power terminals for each memory card are on board. This system can be expanded to the full 64 kilobytes of memory by adding expander cards into this one with the 44 pin connector options.

EXPANDER KIT WITH ONE EDGE CONNECTOR \$59.00

To the best of our knowledge, ours is the only kit on the market designed for easy expansion to full memory capability. Extra 44 Pin Connectors: \$2.50 ea.

MUSICAL INSTRUMENTS

UP TO 60% DISCOUNT. Name brand instruments catalog. Freeport Music, 114 N. Mahan St., W. Babylon, N.Y. 11704.
WHOLESALE! Professional Guitars, PA Systems, Altect Speakers, 240W RMS Amplifiers. Free Catalog. Carvin, Escondido, Calif. 92028.

BUSINESS OPPORTUNITIES

I MADE \$40,000.00 Year by Mailorder! Helped others make money! Free Proof. Torrey, Box 318-NN, Ypsilanti, Michigan 48197.

FREE CATALOGS. Repair air conditioning, refrigeration. Tools, supplies, full instructions. Doolin, 2016 Canton, Dallas, Texas 75201.

MAILORDER MILLIONAIRE helps beginners make \$500 weekly. Free report reveals secret plan! Executive (1K7), 333 North Michigan, Chicago 60601.

\$178 WEEKLY. Work one hour daily. Completely Guaranteed. Free. FAS, Box 13703-R, San Antonio, Texas 78213.

FREE SECRET BOOK "2042 UNIQUE, Proven Enterprises" Fabulous "Little Knowns". Work home! Haylings-B, Carlsbad, Calif. 92008.

**START YOUR OWN
Electronics Mini-Shack!**

CB BUYERS BE A DEALER

SELL ALL NAME BRANDS
Royce, E F Johnson
SBE, A/S, Pace, Handic
Turner, Astatic, Kris
Pal, Regency, Hustler
Channel Master, Pioneer

RUSH me your FREE distributor/dealer Electronic Mini-Shack Business Plan

Name _____
Address _____
City _____ St _____ Zip _____

CAMBRIDGE ELECTRONIC PRODUCTS, Dept. pa6a
26 Down St. Kingston, NY 12401 914/331-8226

PIANO TUNING LEARNED QUICKLY AT HOME! Musical knowledge unnecessary. Free information. Empire School, Box 450327, Miami 33145.

GET RICH with Secret Law that smashes debts and brings you \$500 to \$5 Million cash. Free report! Credit 4K7, 333 North Michigan, Chicago 60601.

HOW TO MAKE \$2,000 WEEKLY at home using other people's money. Guaranteed. Free details. Richlieu, Box 25277, Dept. F7, Houston, Texas 77005.

HIGHLY PROFITABLE ONE-MAN ELECTRONIC FACTORY

Investment unnecessary, knowledge not required, sales handled by professionals. Postcard brings facts about this unusual opportunity. Write today! Barta-DG, Box 248, Walnut Creek, CA 94597.

FREE DETAILS on how to borrow \$300-\$3,000 entirely by mail. Write Postal Finance. Dept. 613-07, 6018 Maple, Omaha, Nebraska 68104.

DO-IT-YOURSELF

TV PHONES? Send symptoms / copy schematic / self addressed-stamped envelope with \$3.00. Troubleshooter, Box 4553-PE, Downey, Calif. 90241.

MODULAR TELEPHONES now available. Sets and components, compatible with Western Electric concept. Catalog 50 cents. Box 1654W, Costa Mesa, California 92626.

TREASURE FINDERS

TREASURE FINDER locates buried gold, silver, coins, treasures. 6 powerful models. Instant financing available. Write or call for free catalog. Phone (713) 682-2728 day or night. Dealer inquiries Invited. Relco, Dept. AA20, Box 10839, Houston, Texas 77018.

DISCOVER true treasure hunting with world-famous deep-detecting mineral/metal detectors from White's! Locate gold, silver, rings, coins, artifacts and more! Sold, serviced, warehoused world wide. Priced from \$79.50. Free Catalog! White's Electronics, Dept. PD6U, 1011 Pleasant Valley Rd., Sweet Home, OR 97386.

INTEL 8080 CPU	\$29.50
2518-HEX 32 BIT SR	\$6.00
8088 8 BIT MICRO PROCESSING CHIP (with Data Book)	\$19.00
2102-1 1024 BIT RAM	\$ 2.60
5202A UV PROM	\$12.50
MM5203 UV PROM	\$12.50
1702A UV PROM	\$12.50
5204 4K PROM	\$24.95
MINIATURE MULTI-TURN TRIM POT'S 100, 500, 5K, 10K, 25K, 50K, 100K, 200K, S.75 each	3/\$2.00
MULTI-TURN TRIM POT'S Similar to Bourns 3010 style 3/16"x5/8"x1-1/4": 50, 100, 1K, 10K, 50K ohms	3/\$4.00
SI 50 ea	\$1.50
LIGHT ACTIVATED SCR'S	\$ 1.75
180W, 200V 1A.	

PRINTED CIRCUIT BOARD

4-1/2" x 6-1/2" SINGLE SIDED EPOXY BOARD 1/16" thick, unetched	\$5.20
VECTOR BOARD 1" SPACING	\$1.50
4.5" x 6" SHEET	\$1.50

4 WATT IR LASER DIODE \$7.95

2N 5460 P FET	\$.45
2N 5457 N FET	\$.45
2N 4891 UJT	\$.45
TIS 43 UJT	\$.35
ER 900 TRIGGER DIODES.	4/\$1.00
2N 6028 PROM. UJT	\$.65

VERIPAX PC BOARD

This board is a 1/16" single sided paper epoxy board, 4 1/2"x6 1/2". DRILLED and ETCHED which will hold up to 21 single 14 pin IC's or 8, 16, or LSI DIP IC's with buses for power supply connector. \$5.25

MV 5691 YELLOW-GREEN BIPOLAR LED	\$1.25
MT-2 PHOTO TRANS	\$.60
RED, YELLOW, GREEN OR AMBER LARGE LED'S	ea. \$.20
14 PIN DIP SOCKETS	\$.35
16 PIN DIP SOCKETS	\$.35
MOLEX PINS	100/\$1.00
8 PIN MINI DIP SOCKETS	\$.30
10 WATT ZENERS 3.9, 4.7, 18 OR 22V	ea. \$.60
1 WATT ZENERS 4.7, 5.6, 10, 12, 15, 18 OR 22V	ea. \$.25

Silicon Power Rectifiers

PRV 1A	3A	12A	50A	125A
100 .06	14	30	80	3.70
200 .07	20	35	1.15	4.25
400 .09	.25	50	1.40	6.50
600 .11	.30	.70	1.80	8.50
800 .15	.35	90	2.30	10.50
1000 .20	.45	1.10	2.75	12.50

REGULATED MODULAR POWER SUPPLIES

+ 15 VDC AT 100ma	
115VAC INPUT	\$27.95
5VDC AT 1A. 115VAC INPUT	\$24.95
12 VDC AT .5A	\$24.95
IN 4148 (IN914)	15/\$1.00

SILICON SOLAR CELLS

2 1/4" diameter

5V at 500 ma. . . . \$5.00 ea., 6/\$27.50

TRANSISTOR SPECIALS

2N3585 NPN Si TO-66	\$.95
2N3772 NPN Si TO-3	\$ 1.60
2N4008 PNP Si TO-3	\$ 1.00
2N6055 NPN Si TO-3	Darlington \$ 1.30
2N5086 PNP Si TO-92	4/5 1.00
2N4898 PNP TO-66	\$.60
2N404 PNP GE TO-5	5/5 1.00
2N3919 NPN Si TO-3 RF	\$ 1.50
MPSA-13 NPN Si TO-92	3/5 1.00
2N3767 NPN Si TO-66	\$ 1.00
2N2222 NPN Si TO-18	5/5 1.00
2N3055 NPN Si TO-3	\$.80
2N3904 NPN Si TO-92	5/5 1.00
2N3906 PNP Si TO-92	5/5 1.00
2N5206 NPN Si TO-220	\$.50
2N6109 NPN Si TO-220	\$.55
2N3866 NPN Si TO-5 RF	\$.75
2N3638 PNP Si TO-5	5/5 1.00
2N6517 NPN TO-92 Si	3/5 1.00

TANTULUM CAPACITORS

.22UF 35V 5/S1.00	6.8UF 35V 3/S1.00
4.7UF 35V 5/S1.00	33UF 25V \$.40
50UF 35V 5/S1.00	30UF 6V 5/S1.00
1UF 35V 5/S1.00	150UF 20V \$.50
4.7UF 35V 4/S1.00	
CT 7001 ALARM CLOCK CHIP	\$5.75

NATIONAL MOS DEVICES

MM1402-3-20	MM5057-4-00
MM1403-3-20	MM5058-4-95
MM1404-2-50	MM5060-4-95
MM5013-7-75	MM5061-4-30
MM5016-3-50	MM5065-6-25
MM5017-4-75	MM5066-6-25
MM5055-4-00	MM5260-2-95
MM5056-4-00	

TTL IC SERIES

74L00-25	7442-50	74126-80
7400-16	7445-80	74150-1.00
7401-16	7446-90	74151-80
7402-16	7447-87	74153-79
7403-20	7448-80	74154-1.05
7404-20	7472-35	74155-1.00
7405-22	7473-40	74157-75
7406-35	7474-35	74161-1.00
7407-33	7474-35	74164-1.05
7408-22	7475-50	74166-1.05
7409-25	7476-35	74167-1.05
7410-16	7483-80	74173-1.35
7411-25	7485-95	74176-95
7412-30	7486-95	74177-1.00
7413-30	7486-95	74180-1.00
7414-80	7489-2.00	74181-2.10
7416-33	7490-52	74189-1.15
7417-33	7491-79	74190-1.15
7418-33	7492-55	74191-1.10
7420-16	7493-55	74192-75
7426-35	7494-80	74193-95
7427-28	7494-80	74194-1.25
7430-16	7495-80	74195-74
7432-30	7496-73	74196-1.10
7433-29	74107-34	74197-1.05
7437-29	74121-50	74283-1.50
7438-29	74123-70	75324-1.75
7440-18	74125-70	75491-60
7441-82	74125-70	75492-60

MINIATURE DIP SWITCHES

CTS-206-4 Four SPST switches in one minidip package.	\$1.80
CTS-206-8 Eight SPST switches in a 16 pin DIP package.	\$2.75

AT-5-1013-30K ser./par., par./ser., uni-versal UART. \$8.50

ALCO MINIATURE TOGGLE SWITCHES

MTA 106 SPDT	\$1.20
MTA 206 DPDT	\$1.70

CMOS (DIODE CLAMPED)

74C02-30	4016-50	4035-1.25
74C01-30	4017-1.10	4042-75
4001-24	4018-1.20	4046-2.20
4002-24	4019-50	4047-2.20
4006-1.20	4022-1.00	4049-50
4007-30	4023-25	4050-50
4009-50	4024-85	4055-1.95
4010-50	4025-25	4066-1.10
4011-25	4027-55	4071-25
4012-25	4028-95	4077-25
4013-35	4029-1.25	4081-25
4016-1.10	4030-95	4076-1.20

LED READOUTS

FND 500-5' C.C.	\$1.75
HP 7740-3' C.C.	\$1.40
MAN 4-25' C.C.	\$1.20
MAN 7-3' C.A.	\$1.25
DL747-6' C.A.	\$1.95
NS 33-3 dig. array	\$1.35

Full Wave Bridges

PRV 2A	6A	25A
200 .95	1.25	2.00
400 1.15	1.50	3.00
600 1.35	1.75	4.00

CD 110 LINEAR 256 XI BIT SELF SCANNING CHARGED COUPLED DEVICE \$125.00

SANKEN AUDIO POWER AMPS

SI 1010 G 10 WATTS	\$ 6.90
SI 1020 G 20 WATTS	\$13.95
SI 1050 G 50 WATTS	\$24.95

LINEAR CIRCUITS

LM 309K 5V 1A REGULATOR	\$1.00
723 - 40 + 40VV REGULATOR	\$.54
301748-HI Ref. Op. Amp.	\$.35
320T 5, 12, 15, OR 24V NEGATIVE REG	\$1.35
741A OR 741C OP AMP.	\$.35
710 COMPARTOR	\$.32
307 OP AMP	\$.25
CA 3047 HI Ref. Op. Amp.	\$.95
340T 5, 6, 8, 12, 15, 18, 24V POS	\$1.20
101 OPER. AMP. HI PERFOM.	\$.75
LM 308 Oper. Amp., Low Power	\$1.05
747 - DUAL 741	\$.65
556 - DUAL TIMER	\$.95
537 - PRECISION OP. AMP.	\$1.70
540-70W POWER DRIVE	\$2.75
LM 3900 - QUAD OP. AMP.	\$.49
LM 324 - QUAD 741	\$1.50
560 - PHASE LOCK LOOP	\$2.00
561 - PHASE LOCK LOOP	\$2.00
565 - PHASE LOCK LOOP	\$1.50
566 FUNCTION GEN.	\$1.65
567 - TONE DECODER	\$1.65
LM 1310N FM STEREO DEMOD.	\$2.75
8038 IC VOLTAGE CONT. OSC.	\$3.90
LM 370 - AGC SQUELCH AMP.	\$1.15
555 - 24 - 2 HR. TIMER	\$.53
553 QUAD TIMER	\$2.50
FC810 OPTO-ISOLATOR	\$.80
1458 DUAL OP AMP.	\$.55
LM 380 - 2W AUDIO AMP.	\$.95
LM 377 - 2W Stereo Audio Amp.	\$2.50
LM 381 - STEHO PREAMP	\$1.25
LM 382 - DUAL AUDIO PREAMP	\$1.25
LM 311 - HI-RES. COMPARTOR	\$.95
LM 319 - Dual Hi Speed Comp.	\$1.10
LM 339 - QUAD COMPARTOR	\$1.40

TRIACS SCR'S

PRV 1A	10A	25A	1.5A	6A	35A
100 .40	.70	1.30	.40	.50	1.20
200 .70	1.10	1.75	.60	.70	1.60
400 1.10	1.60	2.60	1.00	1.20	2.20
600 1.70	2.30	3.60	1.50	3.00	

Send 25c for our catalog featuring Transistors and Rectifiers 145 Hampshire St., Cambridge, Mass.

SOLID STATE SALES

P.O. BOX 74A
SOMERVILLE, MASS. 02143 TEL. (617) 547-4005

WE SHIP OVER 95% OF OUR ORDERS THE DAY WE RECEIVE THEM

CIRCLE NO. 56 ON FREE INFORMATION CARD

122

Terms: FOB Cambridge, Mass. Send Check or Money Order. Include Postage. Minimum Order \$5.00, CPD'S \$20.00



Popular Electronics

JULY 1976

ADVERTISERS INDEX

READER SERVICE NO.	ADVERTISER	PAGE NUMBER
11	A P Products	116
1	Ace Electronics	118
2	Adva Electronics	116
3	Allison Automotive Company	59
	Alpha Electronics	103
6	Altaj Electronics	110
66	Altaj Electronics	111
7	Anrona Corp.	120
8	Anrona Corp.	121
9	Antenna Specialists Co	83
10	Aries Inc	112
12	B & : Product of Dynascan	31
	Babylon Electronics	119
13	Browning Labs	34
	CREI Capitol Radio Engineering Institute	88, 89, 90, 91
15	Challenge Electronics	102
	Cleveland Institute of Electronics	52, 53, 54, 55
14	Cobra, Product of Dynascan	SECOND COVER
16	Continental Specialties Corporation	60
17	Crown	14
65	Delta Electronics Co	110
18	Delta Products, Inc	56
19	Digi-ley Corporation	112
20	Digitik Enterprises, Inc	120
64	Dynaco	95
21	EICO	102
22	Edlie Electronics Co	123
23	Edmund Scientific Co	106
24	Edmund Scientific Co	124
25	Electronics Technical Institute	67
26	Granham School of Electronics	95
27	Hal Communications Corp	101
28	Handic USA Inc	28
5	Heath Company	33
	IMS Associates Inc	78, 92
29	Illinois Audio	105
30	International Electronics Unlimited	113
31	James	114, 115
33	Johnson Co., E.F.	13
32	Labtronics Inc	102
38	McIntosh Laboratory Inc	93
	MITS	8, 9, 10, 11
35	Mallory Distributor Products Co	25
36	Martin Research	87
37	Motorola	15
	NRI Schools	18, 19, 20, 21
67	National Camera Supply	93
	National Technical Schools	70, 71, 72, 73
39	New-Tone	119
40	Non-Linear Systems	101
63	Non-Linear Systems	103
41	Olson Electronics	116
42	Pathcom Inc	5
43	Pickering & Co	THIRD COVER
44	Poly Paks	109
45	Polymorphic Systems	93
	Processor Technology	100
46	Quest Electronics	119
47	Radio Shack	2
48	Royce Electronics	7
49	SAE, Inc	6
50	SBE, Inc	17
51	S.D. Sales Co	117
52	Sansui Electronics Corporation	23
53	Scelbi Computer Consulting, The	105
54	Sencore	84
55	Shure Brothers Inc	1
56	Solid State Sales	122
57	Southwest Technical Products Corporation	85
	Sphere	59
59	Stereo Discounters	101
	TEAC Corporation	29
60	Tenna Corporation	69
61	Tri-Star Corporation	103
62	U.S. Pioneer Electronics	26, 27
4	United Audio Products, Inc	FOURTH COVER
CLASSIFIED ADVERTISING ...106, 110, 112, 113, 116, 118, 120, 122, 123		

PRO SPORTS ACTION FILMS

SAVE \$2.00 ON EVERY PRINT YOU BUY! NFL Football Follies (bloopers), Standard 8, B&W, \$6.95 ea; Color, \$17.95 ea on 200' reels. '72 Super Bowl (Cowboys/Dolphins), Super 8, B&W, \$6.95 ea. 1970 Super Bowl (Vikings/KC Chiefs), Standard 8, B&W, \$6.95 ea. World Cup Soccer (Italy/Brazil (Pele)) or (Germany/Italy), Super 8, B&W, \$6.95 ea. Take advantage of these specials while they last! 40 cents for new Castle catalog; 30 cents each for Columbia or Sportlite order forms (coins, stamps, no checks pls). SPORTLITE, Elect-7, Box 24-500, Speedway, Indiana 46224.

EMPLOYMENT OPPORTUNITIES

ELECTRONICS/AVIONICS EMPLOYMENT OPPORTUNITIES. Report on jobs now open. Details FREE. Aviation Employment Information Service, Box 240E, Northport, New York 11768.

CALIFORNIA companies hiring Engineers and Technicians. Current openings bulletin \$3. Dynamics, Box 1867-K, Covina, Calif. 91722.

MAGNETS

MAGNETS. All types. Specials-20 disc. or 10 bar, or 2 stick or 8 assorted magnets. \$1.00. Magnets, Box 192-H Randallstown, Maryland 21133.

MISCELLANEOUS

WINEMAKERS: Free illustrated catalog yeasts, equipment. Semplex, Box 12276P, Minneapolis, Minn. 55412.

NAME YOUR BUDDY! "1001 exciting handles." \$1 plus stamped, addressed envelope. NAMESAKE, Box 481D, Maumee, Ohio 43537.

EDLIE'S BARGAIN BONANZA

ONLY HIGHEST QUALITY PRODUCTS



- (DP017) COPPER CLAD BOARDS! Copper on one side, 1/16" thick. Excellent quality for either production or experimental work.
- B) 4"x16 1/2" 99c ea. 3/\$2.69
- D) 8"x16 1/2" \$1.19 ea. 3/\$2.99
- E) 6 1/2"x17 1/2" \$1.19 ea. 3/\$2.99

JUST ARRIVED

Copper on both sides. 1/16" thick. Size 12"x18"

- (DP018) \$1.99 ea. 3/\$4.99

- (DP134) 8 ROTARY SWITCHES Some multiple gang. \$1.00

- (DP128) 13 MINIATURE ELECTROLYTIC CAPACITORS \$1.00 Axial & upright, popular values.

- (DP144) TRANSISTOR REPAIR KIT \$1.19 Various parts used to repair transistorized devices.

- (DP336) TO-3 TRANSISTOR SOCKETS 12 for \$1.00

- (DP298) 1 WATT ZENERS 60c Available in 5V, 9.1V, 12V, 20V.

- (DP164) 4 ROLLS OF WIRE \$1.00 Approx 25 ft. per roll, 20-28ga.

- (DP140) TAPE RECORDER SPARE PARTS KIT \$2.95 Parts for repairing most tape recorders: capacitors, meter, pilot lamp, jacks, and MUCH MORE.

- (DP167) 10 MINIATURE POTENTIOMETERS \$1.00

- (DP182) 2 MISC. METERS \$1.00 Miniature.

- (DP156) 60 DISC CAPACITORS \$1.00 Asst. from .0001 to .1, most 600v, Z5U, NPO, N750, etc.

SURPLUS TUBES

All guaranteed for 1 full year. ANY 3 FOR \$1.25

Acquired from U.S. Defense depots or removed from equipment (new and used). These are laboratory tested and guaranteed for one full year. Most are of such standard makes as RCA, GE, etc.

- | | | | |
|------|------|------|-------|
| 3A3 | 6AQ7 | 6CM7 | 6X4 |
| 3AF4 | 6AT6 | 6DE4 | 10EW7 |
| 3BN6 | 6AU6 | 6DR7 | 12AE7 |
| 3DG4 | 6AV6 | 6DW4 | 12AL5 |
| 3KT6 | 6AX4 | 6EB8 | 12AU7 |
| 3Q4 | 6AX5 | 6EM7 | 12AV6 |
| 4BC5 | 6AY3 | 6GF7 | 12BE6 |
| 4BN6 | 6BA6 | 6GH8 | 12BH7 |
| 4BU8 | 6BG6 | 6K6 | 18FW6 |
| 4BZ7 | 6BJ8 | 6K11 | 25L6 |
| 5V6 | 6BQ6 | 6LB6 | 35EH5 |
| 6AF4 | 6BZ6 | 6SN7 | 36AM3 |
| 6AG5 | 6CB6 | 6E8 | 50A5 |
| 6AG7 | 6CG7 | 6W4 | 50L6 |
| 6AL5 | | | |

- (DP147) 4 lb. GRAB BAG SPECIAL \$1.00 Full of exotic and exciting electronics parts

- (DP55) TUBE BONANZA! \$1.00 20 asst. popular tubes, untested.

- (DP142) 50 PRECISION RESISTORS \$1.00 All 1%, 1/2w and 1w. low and high ohmages.

- (DP150) 15 HI-FI KNOBS \$1.00 Every one superb! Purchased from Harmon, Kardon, Fisher, etc.

- (DP102) CALCULATOR KEYBOARD \$2.95 Wild Rover C-1380. Can be used with CT5001. 4 function, clear, clear entry and constant. 7 cm x 9 cm.

- (DP175) 70 1/2w CARBON RESISTORS \$1.00 Asst. values. Some 5%.

- (DP154) 150 CUT LEAD RESISTORS \$1.00 Carbon. all leads long enough for soldering.

- (DP149) 20 POLYSTYRENE TOP GRADE CAPACITORS \$1.00

- (DP132) 20 DUAL POTS \$1.00

- 24V. C.T. FILAMENT TRANSFORMER 1/2A. WITH 150V. TAP.

- (DP202) 99c ea 6 for \$4.99

MONEY BACK GUARANTEE

Terms: Minimum order \$4.00. Include postage. Either full payment with order or 20% deposit, balance C.O.D.

- BONUS FREE CAPACITOR KIT With Every \$5 Purchase

- WRITE FOR FREE 1976 VALUE PACKED CATALOG Listing thousands of components, tubes, transistors, IC's, kits, test equipment.

THIS MONTH'S SPECIALS!

- | | | | |
|-------------------------------|--------|--------------------------------|-----|
| TTL | | | |
| <input type="checkbox"/> 7400 | 16c | <input type="checkbox"/> 7446 | 80c |
| <input type="checkbox"/> 7401 | 18c | <input type="checkbox"/> 7447 | 80c |
| <input type="checkbox"/> 7402 | 22c | <input type="checkbox"/> 7448 | 80c |
| <input type="checkbox"/> 7403 | 23c | <input type="checkbox"/> 7473 | 49c |
| <input type="checkbox"/> 7404 | 23c | <input type="checkbox"/> 7474 | 49c |
| <input type="checkbox"/> 7405 | 23c | <input type="checkbox"/> 7475 | 85c |
| <input type="checkbox"/> 7406 | 23c | <input type="checkbox"/> 7476 | 53c |
| <input type="checkbox"/> 7410 | 23c | <input type="checkbox"/> 7490 | 79c |
| <input type="checkbox"/> 7411 | 27c | <input type="checkbox"/> 7492 | 79c |
| <input type="checkbox"/> 7413 | 40c | <input type="checkbox"/> 7493 | 69c |
| <input type="checkbox"/> 7420 | 23c | <input type="checkbox"/> 7495 | 79c |
| <input type="checkbox"/> 7430 | 23c | <input type="checkbox"/> 74121 | 57c |
| <input type="checkbox"/> 7440 | 30c | <input type="checkbox"/> 74122 | 57c |
| <input type="checkbox"/> 7442 | \$1.12 | <input type="checkbox"/> 74123 | 67c |

LINEARS

- LM309K 5v 1a. reg. \$1.15
- 555 Timer 75c
- 556 Dual 555 \$1.00
- 566 Function gen. \$1.75
- 567 Tone decoder \$1.95
- 741 comp. op amp 39c
- 2102 1024 bit RAM \$4.95
- 6038 volt cont osc \$4.25

CLOCK CHIPS WITH DATA

- (MM5314) 6 dig clock \$4.95
- CT7001 Alarm & Date \$5.95

LED'S

- (DP223) 10 Asst LEDs \$1.00
- (DP242) 5 Jumbo Green LEDs \$1.00
- (DP242) 5 Med Yellow LEDs \$1.00
- (DP001) 5 Jumbo Red LEDs \$1.00
- (DP011) 5 Med Red LEDs \$1.00
- (DP012) 5 Mini Red LEDs \$1.00
- (DP293) DL707 (equiv.) 7 seg red LED, .3" char., comm anode \$1.00
- (DP006) DL 704 (equiv.) same as DL707 except comm cath \$1.35
- (DP007) DL747 7 seg red LED, .6" char., comm anode \$1.95
- (DP013) MAN 5 (equiv.) 7 seg green LED, .27 char. comm. anode \$1.49

IC BREADBOARDS & TERMINALS

Boards have .042 holes. Made of 1/16" polyester glass.

- (BB663) 3"x4" 94c
- (BB664) 3"x6" \$1.29
- (BB665) 4"x6" \$1.65
- (BB666) 4"x8" \$2.12

Push-in terminals

- (DP6601-20) pkg 20/90c
- (DP6601-100) pkg 100/\$2.98

Push-in flanged pins

- (BB6602-20) pkg 20/90c
- (BB6602-100) pkg 100/\$2.98

Push-in flea clips

- (BB6603-20) pkg 20/90c
- (BB6603-100) pkg 100/\$2.98
- (B008) 14 pin DIP sockets 3 for \$1
- (DP1104) IC REMOVAL AND INSERTION TOOL \$4.95 "Pul-n-seric" extracts and inserts ICs without damage.

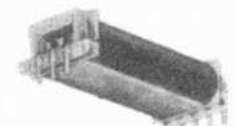

REED RELAYS

- (DP203) SPST, 12V, 1000 ohms coil. Price 79c
- (DP204) DPDT, 12V, 500 ohm coil. Price 99c

EDLIE ELECTRONICS, INC. 2700-DP HEMPSTEAD TPKE., LEVITTOWN, N.Y. 11756

LIVE IN THE WORLD OF TOMORROW... TODAY!

And our FREE 164 PAGE CATALOG is packed with exciting and unusual values in electronic, hobby and science items — plus 4,500 finds for fun, study or profit... for every member of the family.

A BETTER LIFE STARTS HERE

WORLD'S SMALLEST RECHARGEABLE CALCULATOR!

Small but mighty! 8-digit, 4-function electronic calculator does everything big ones do—even has automatic % key... for only \$19.95. Take it anywhere. Fits in your pocket— $\frac{3}{4}$ size of cigarette pack. 3 $\frac{1}{2}$ oz. dynamo features floating decimal, constant key, lead zero depression, more! Includes plug-in rechargeable Ni-Cad battery pack. 2 x 3 $\frac{1}{2}$ x $\frac{9}{16}$ " with plenty of room for most fingers. Another Edmund first with advanced technology.



Stock No. 1945AV \$19.95 Ppd.

SUPER POWER FOR ANY AM RADIO

New antenna assist turns a tiny transistor into a tiger, has pulled in stations up to 1000+ miles away! Just set beside radio (no wires, clips, grounding) and fine-tune Select-A-Tenna's dial to same frequency — "gangbusters"! Great for clearing weak signals in radio depressed areas, off-coast islands, crowded frequency stations. Solid state—uses no electricity. batts., tubes.



Stock No. 72,095AV \$15.95 Ppd.
ULTRA SELECT-A-TENNA
No. 72,147AV (*OVER 1000 MI.) \$22.95 Ppd.

KNOW YOUR ALPHA FROM THETA!

For greater relaxation, concentration, monitor your Alpha/Theta brainwaves w/ audible or visible signal on Biosone II. Has 3 feedback modes, outputs to monitor logic signal, filter sel. feedback, broad sensitivity control; other professional feats. of \$200-up units. Easily operated 4-lb. portable has total brainwave monitoring capability! 2 9v tr. batteries.



No. 1668 (9 $\frac{1}{2}$ x 5 $\frac{3}{8}$ x 4 $\frac{1}{4}$ ") \$149.95 Ppd.
LOW COST STARTERS' UNIT (PORTABLE)
No. 71,809 AV (4 $\frac{1}{2}$ x 2 $\frac{3}{4}$ x 4 $\frac{1}{4}$ ") \$55.00 Ppd.

SEE MUSIC IN PULSATING COLOR

New 3-Channel Color Organ adds to music listening pleasure, lets you modulate 3 independent strings of colored lamps with intensity of your music to create an audio "light show." They flash, vary in brightness related to music's rhythm, pitch, volume—pulsating lighting performance to music! Fully assembled & priced half that of others, the Edmund Sound to Light Control is a terrific value. Plug in, turn on!



No. 42,309AV... (ASSEMBLED) \$17.95 Ppd.
No. 42,336AV... (UNASSEMBLED) \$13.95 Ppd.

WHEN YOU COME TO PHILADELPHIA BE SURE TO SEE
FREE BICENTENNIAL LIGHT SHOW
IN BARRINGTON, N.J. ONLY 10 MINUTES AWAY AT
EDMUND FACTORY STORE



INCLUDED FREE
33° ORTHOSCOPIC
EYEPIECE
(TIL 7/31/78)

7/4" ASTRONOMICAL TELESCOPE

FREE EYEPIECE: 12.5mm F.L., 96X w/ 48" F.L. Objective
See moon craters, rings of Saturn, double stars. Features fine f/10 mirror (verified better than 1/10 wave with a scatter plate interferometer) to insure performance to theoretical limit of resolution. Equatorial mount; rack & pinion focusing; aluminum tube, 6X finder, 25mm F.L. 45X Kellner achromatic eyepiece & Barlow lens to double and triple power to 135X. Incl. FREE Star Chart plus 2 Books. *Pyrex.*
No. 85,260AV (SHIPG. WT. 42 LB.) \$159.50 FOB
No. 85,261AV (CLOCK DR.; 45 LB.) \$199.50 FOB



SAVE ON DIGITAL MULTIMETERS!

Get superior .1% accuracy with under-\$200 professional Electronic Digital Multimeter comparable to units at \$320 up! Fast, one-hand op'n. Measures AC. DC voltages from .001V to 750V, resistances from 1 ohm to 19.99 megohms. Feats.: 3/2 digit LED display; autoranging; autopolarity; auto. decimal; overload indicator. Incl. AC adaptor/charger, NiCd batts., case, op. manual.
No. 72,199AV... (10 $\frac{1}{2}$ oz.) \$199.95 Ppd.
WITH TEMPERATURE MEAS. PROBE
No. 72,198AV... (°C, VDC, VAC, OHMS) \$259.95 Ppd.



ELECTRONIC DIGITAL STOPWATCH: \$49.95

The price alone obsolesces your wind-up timer and it's $\pm 0.002\%$ accurate! Hand-held, you start, stop, reset compact 6-ouncer w/one hand; times to 59 mins, 59.9 secs in 1/10 increments. Failsafe design (cannot be accidentally reset), solid-state electronics! Incl. neckstrap, repl. batts.
No. 1671AV (5-DIGIT LED DISPLAY) \$49.95 Ppd.
SPLIT ACTION W/NICADS, RECHARGER
No. 1669AV (5-DIGIT LED DISPLAY) \$79.95 Ppd.
DELUXE SPLIT ACTION BATTERY MODEL
No. 1653AV (6-DIGIT NEON DISPLAY) \$149.95 Ppd.



LOW COST INFRA-RED VIEWER

For Infra-red crime detection surveillance, security system alignment, I.R. detection, laser checking, nite wildlife study, any work req. I.R. detection & conv. to visible spectrum. Self cont. scope w/ everything incl. I.R. light source. 6v or 12v power, 6032 I.R. converter tube, f/3.5 objective lens, adjust. triplet eyepiece. Provides 1.6X, focuses from 10' to infinity.
No. 1659AV (11 x 14 $\frac{1}{4}$ x 3") \$285.00 Ppd.
WITHOUT LIGHT SOURCE
No. 1663AV \$225.00 Ppd.



WOW! TR METAL DETECTOR: \$69.95

Super-sensitive transmitter/receiver unit at a never-before price, w/feats. of \$150 types. Terrific selectivity—10-turn (not just 90°) metal/mineral tuner! 6" waterproof search coil find a cent at 6"; telescoping adjust. shaft gives 44" lgh.; $\frac{1}{4}$ " stereo earphone jack; all metal constr. Perfect balance & feather light, it incl. 8 "AA" batteries. Lifetime warranty!
No. 80,251AV (JUST 38 OZ.!) \$69.95 Ppd.
STARTERS' BFO CHALLENGER I (32 OZ.)
No. 80,222AV (ALUMINUM CONSTR.) \$39.95 Ppd.



MAIL COUPON FOR GIANT FREE CATALOG!

164 PAGES • MORE THAN 4500 UNUSUAL BARGAINS

Completely new 1976 edition. New items, categories, illustrations. Dozens of electrical and electromagnetic parts, accessories. Enormous selection of Astronomical Telescopes. Unique lighting and ecological items. Microscopes, Binoculars, Magnifiers, Magnets, Lenses, Prisms. Hard-to-get surplus bargains. Ingenious scientific tools. 1000's of components.
EDMUND SCIENTIFIC CO.
300 Edscorp Building, Barrington, N.J. 08007
Please rush Free Giant Catalog "AV"

Name _____
Address _____
City _____ State _____ Zip _____

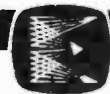

COMPLETE & MAIL WITH CHECK OR M.O.

EDMUND SCIENTIFIC CO. 300 Edscorp Building, Barrington, N.J. 08007

How Many Stock No. Description (609) 547-3488 Price Each Total

<input type="checkbox"/>	PLEASE SEND GIANT FREE CATALOG "AV"			
<input type="checkbox"/>	Charge my BankAmericard			
<input type="checkbox"/>	Charge my Master Charge			
	Interbank No. _____			
	My Card No. is _____			
	Card Expiration Date _____			

Add Service and Handling Charge \$1.00

I enclose check money order for TOTAL \$ _____

Signature _____

30-DAY MONEY-BACK GUARANTEE. You must be satisfied or return any purchase in 30 days for full refund. *\$15.00 minimum

Name _____
Address _____
City _____ State _____ Zip _____

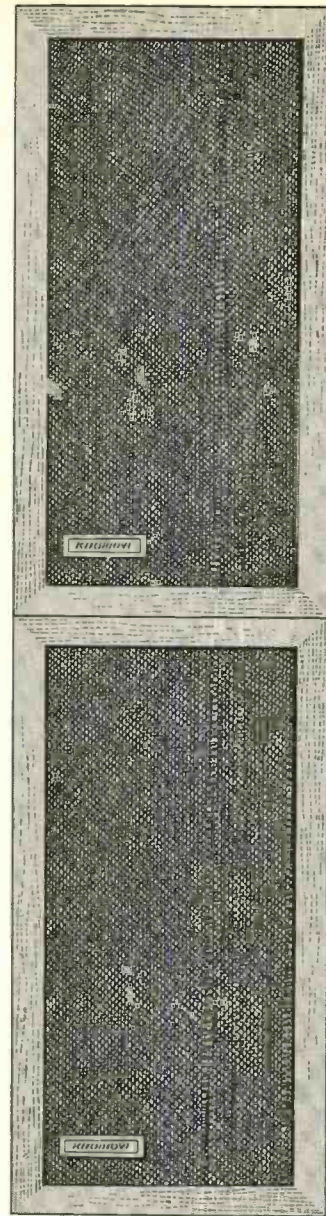
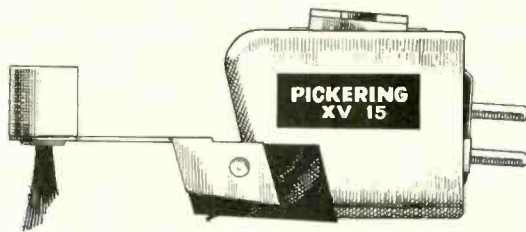
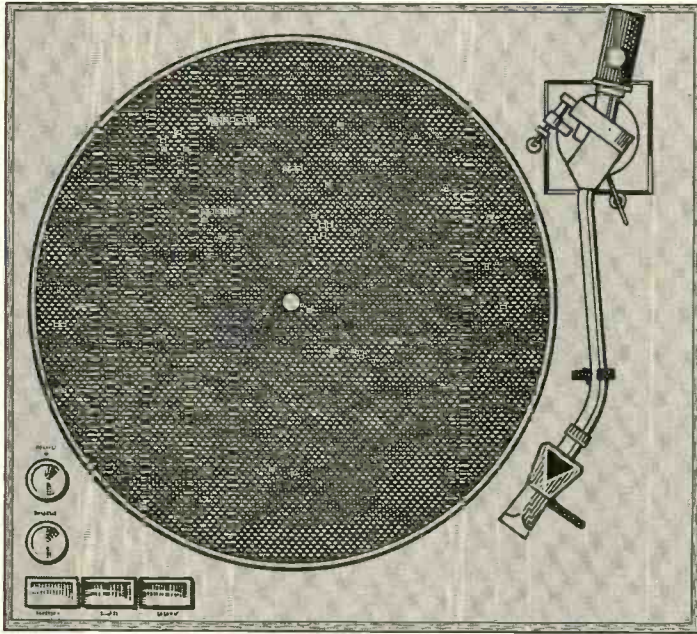
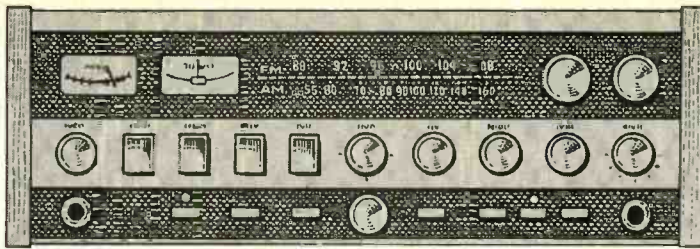

Discover The ~~Fourth~~ ^{First} Component!

What is your First component? Is it your receiver? Your turntable? Your speakers? Or is it your phono cartridge?

We have become convinced that it really is your phono cartridge, even though we have been modestly advertising it for the past few years as your *Fourth*.

Let's face it, the cartridge *is* that important *first* point where the music begins, and if the stylus cannot follow its path accurately, no amount of expensive equipment . . . speakers, turntable or receiver . . . can make up the distortion it can produce. That is why you need a cartridge you can depend on. One that's the best your money can buy. Specifically, a Pickering:

Because a Pickering cartridge has the superior ability to "move in the groove", from side to side and up and down, without shattering the sound of your music on your records.

Because a Pickering cartridge possesses low frequency tracking ability and high frequency tracing ability (which

Pickering calls *traceAbility*™). It picks up the highest highs and the lowest lows of musical tones to reveal the distinctive quality of each instrument.

Because Pickering offers a broad range of cartridges to meet any application whether you have an automatic record changer, or a high quality manual turntable, a stereo, or a 4-channel sound system. Your Hi-Fi dealer will be able to recommend a Pickering cartridge that is just right for your system.

Your stereo cartridge is the *First* part of your music system. It is too important to overlook, and so is a Pickering.

For further information, see reader service card or write to Pickering & Co., Inc. Dept. PE, 101 Sunnyside Blvd., Plainview, N.Y. 11803



"for those who can hear the difference"

CIRCLE NO. 43 ON FREE INFORMATION CARD

Some reasonably unbiased suggestions on how to select your next record player.

Since you read this magazine, chances are you already own a record player. If you're considering replacing it, it probably no longer meets your requirements. One way or another.

For example, if your turntable operates only manually, you may now prefer the convenience and safety of automatic operation. If it already provides automatic start and stop, but only in single play, you may now want the ability to play a series of records in sequence and without interruption.

You may also be taking an expensive risk with your records every time you play them. Remember: your record collection probably costs more than the rest of your equipment combined. This alone should prompt you to give thought to a new turntable.

For years, Dual's approach has been to build every turntable with more precision than your records are likely to need. Since we traditionally lead the state of the art, every Dual tonearm produces optimum performance from today's finest cartridges and maximum longevity from every record.

This is as true of the least expensive Dual, the 1225, as it is of the CS701. All Dual tonearms, for example, follow the same basic design principles: straight line between pivot and cartridge for maximum rigidity and lowest mass; dynamic balance maintained throughout play; stylus pressure applied around the vertical pivot; anti-skating that automatically compensates for the inherent changes in skating during play.

As for rumble, wow, flutter and deviation from speed accuracy, all are far below audibility in every Dual. (With the direct-drive CS701, they are virtually unmeasurable.)

We don't suggest that Dual is the *only* quality brand turntable available. But where Dual does indeed stand alone is in the many years of proven reliability and durability. For example, many Duals that come in for servicing (usually only for lubrication and cleaning) are more than ten years old. And many Dual owners tell us (via letters and warranty cards) that they now own their second Dual... usually for their second system.

Dual quality comes in a variety of models: semi-automatic, single-play; fully automatic, single-play; single-play/multi-play. Seven models in all as described. We think it only reasonably biased to suggest that you will find your next turntable among them.



Dual 1225.



Dual 1249



Dual CS701.

Dual 1225. Fully automatic, single-play/multi-play. Viscous damped cue-control, pitch-control. 10 $\frac{1}{2}$ " platter. Less than \$140, less base.
Dual 1226, with cast platter, rotating single-play spindle, less than \$170.
Dual 122E, with gimballed tonearm, synchronous motor, illuminated strobe, variable tracking angle. Less than \$200.

Dual 1249. Fully automatic, single-play/multi-play. Belt drive. 12" dynamically-balanced platter. Less than \$280, less base. Full size belt-drive models include: Dual 510, semi-automatic, less than \$200; Dual 601, fully automatic, less than \$250. (Dual CS601, with base and cover, less than \$270.)

Dual CS701. Fully automatic, single-play. D.C. brushless, electronic direct drive motor. Tuned anti resonance filters. Less than \$400, including base and cover.

United Audio Products, 120 So. Columbus Ave., Mt. Vernon, N.Y. 10553

Exclusive U.S. Distribution Agency for Dual

