

CONSUMER ELECTRONICS SHOW ROUND UP

May 1995

# Popular Electronics

## Security In The

# INFORMATION AGE

Just how safe are your electronic messages and transactions?

### Build the "g" Machine

Measure acceleration with this easy-to-build circuit

### Build A Variometer Radio

### Build the PK Tester

Do you have psychokinetic ability?



#BXBDCH\*\*\*\*\*3-DIGIT 950  
MAR 1997  
#95014DRK654MR003# RESP 114  
LLOYD DARKNELL  
6540 WATLEWOOD DR  
CUPERTINO CA 95014  
BFP

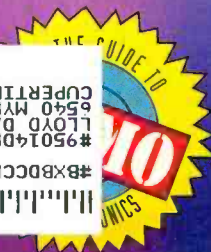

\$3.50 U.S.  
\$3.95 CAN.



A GERNSBACH PUBLICATION

from the past

# MIXED-MODE POWER

## Design & Verify Faster with Electronics Workbench®

**New  
Version 4**

### Analog, Digital & Mixed Circuits

Electronics Workbench® Version 4 is a fully integrated schematic capture, simulator and graphical waveform generator. It is simple to mix analog and digital parts in any combination.

### Design and Verify Circuits... Fast!

Electronics Workbench's simple, direct interface helps you build circuits in a fraction of the time. Try 'what if' scenarios and fine tune your designs painlessly.

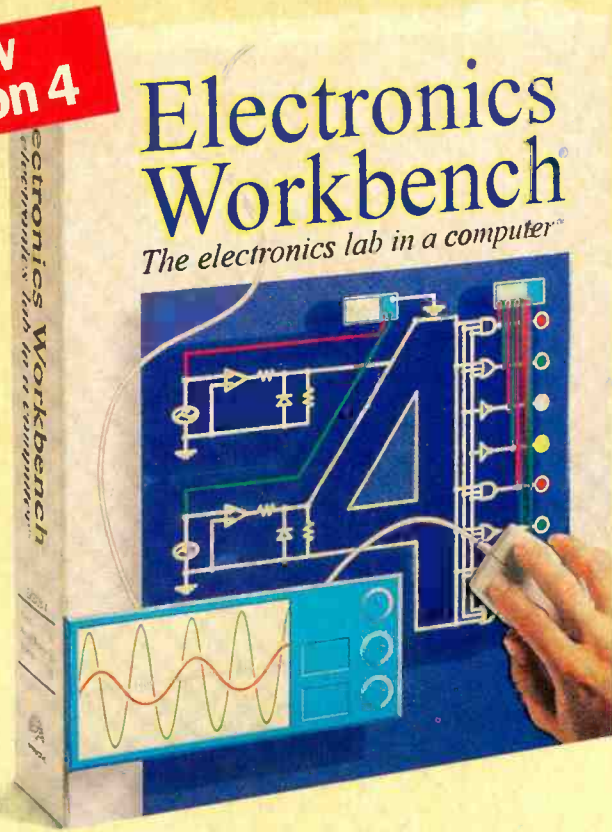

### More Power

Simulate bigger and more complex circuits. Faster. On average, Electronics Workbench Version 4 is more than 5 times faster than Version 3.

### More Parts

Multiple parts bins contain over twice the components of Version 3.

### More Models

Over 350 real world analog and digital models are included free with Electronics Workbench. And, if you need more, an additional 2,000 models are available.

Electronics Workbench delivers the power you need to design and verify analog, digital and true mixed mode circuits. Over 20,000 customers have already put Electronics Workbench to the test. The result: Better designs... Faster. And over 90% would recommend it to their colleagues.

Electronics Workbench will save you time and money. We guarantee it.\*

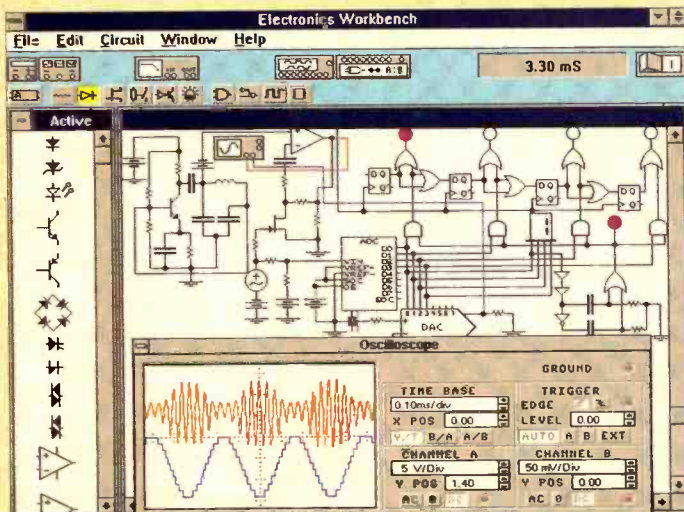

True mixed-mode simulation: Simultaneous AM transmission, digitization and pulse-code modulation of a signal.

Trademarks are property of their respective holders. Offer is in U.S. dollars and valid only in the United States and Canada.

**Call Now: 800-263-5552**

**Just \$299** <sup>+\$15</sup> <sub>S/H</sub> For Windows, DOS or Macintosh

\*30 day money-back guarantee  
Free unlimited technical support



Yes, I'm interested in Electronics Workbench.

Name: \_\_\_\_\_  
 Title: \_\_\_\_\_  
 Organization: \_\_\_\_\_  
 Address: \_\_\_\_\_  
 Phone: \_\_\_\_\_

I prefer to be contacted by e-mail/fax at:

**INTERACTIVE IMAGE TECHNOLOGIES LTD.**  
 908 Niagara Falls Blvd. #068, North Tonawanda, NY 14120-2060  
 Telephone: 416-977-5550 FAX: 416-977-1818  
 E-mail: ewb@interactiv.com  
 CompuServe: 71333,3435 BBS: 416-977-3540



Australia: 25193933 • Brazil: 11-453-5588 • Cyprus: 262-1068 • Denmark: 33-25-0017 • Finland: 0297-5033 • France: 1-908-9000 • Germany: 711-62-7740 • Greece: 1-524-9981 • Hungary: 1-21-50082 • India: 11-5-44-13-48  
 Israel: 3-647-5613 • Italy: 11-437-5549 • Japan: 3-3382-3136 • Malaysia: 3-774-2189 • Mexico: 5-396-3075 • Netherlands: 18031-7866 • New Zealand: 9-267-1756 • Norway: 22-16-7045 • Portugal: 1-81-46603  
 Singapore: 462-0006 • Slovenia: 61-317-830 • South Africa: 331-6-8309 • South Korea: 2-2-222-3431 • Spain: 1-553-3234 • Sri Lanka: 1-86-5970 • Sweden: 8-740-5500 • Thailand: 66-2-398-6952 • UK: 203-23-3216

CIRCLE 157 ON FREE INFORMATION CARD

[AmericanRadioHistory.com](http://AmericanRadioHistory.com)

# Popular Electronics®

MAY 1995

Vol. 12, No. 5

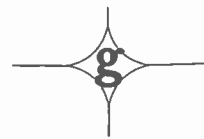

## COVER STORY

### 33 Security in the Information Age

Learn about PGP, DES, and other techniques used to keep electronic communications away from prying eyes, and how those techniques can be compromised—*Craig Howard*

## CONSTRUCTION

### 46 Build the "g" Machine

Measure acceleration with this portable and easy-to-build circuit—*Anthony J. Caristi*

### 55 Build a Variometer Radio

A simple radio circuit that features a modern variation of an old-time principle—*Larry Lisle*

### 57 Build the PK Tester

Find out if you or your friends have psychokinetic ability with this fun-to-use project—*Larry A. Duarte*

### 60 Add a Switch to your Serial Port

A simple way around a common yet troublesome computer conflict—*Marc Spiwak*

## FEATURES

### 37 Antenna Safety for Hams and SWL's

These easy-to-follow guidelines can keep your gear, your property, and you healthy and happy—*Karl T. Thurber*

### 51 Tuned Circuits and Resonance

Learn how series- and parallel-tuned resonant circuits work, and how to analyze them—*Paul Coxwell*



Page 9

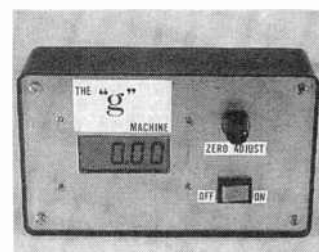

Page 46

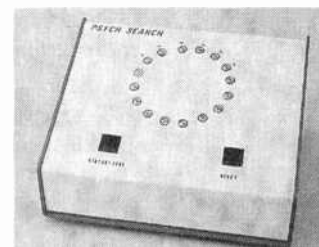

Page 57

POPULAR ELECTRONICS (ISSN 1042-170-X) Published monthly by Gernsback Publications, Inc. 500-B Bi-County Boulevard, Farmingdale, NY 11735. Second-Class postage paid at Farmingdale, NY and at additional mailing offices. One-year, twelve issues, subscription rate U.S. and possessions \$21.95, Canada \$28.84 (includes G.S.T. Canadian Goods and Services Tax Registration No. R125166280), all other countries \$29.45. Subscription orders payable in U.S. funds only. International Postal Money Order or check drawn on a U.S. bank. U.S. single copy price \$3.50. Copyright 1995 by Gernsback Publications, Inc. All rights reserved. Hands-on Electronics and Gizmo trademarks are registered in U.S. and Canada by Gernsback Publications, Inc. Popular Electronics trademark is registered in U.S. and Canada by Electronics Technology Today, Inc. and is licensed to Gernsback Publications, Inc. Printed in U.S.A.

Postmaster: Please send address changes to Popular Electronics, Subscription Dept., P.O. Box 338, Mount Morris, IL 61054-9932

A stamped self-addressed envelope must accompany all submitted manuscripts and/or artwork or photographs if their return is desired should they be rejected. We disclaim any responsibility for the loss or damage of manuscripts and/or artwork or photographs while in our possession or otherwise.

As a service to readers, Popular Electronics publishes available plans or information relating to newsworthy products, techniques, and scientific and technological developments. Because of possible variances in the quality and condition of materials and workmanship used by readers, Popular Electronics disclaims any responsibility for the safe and proper functioning of reader-built projects based upon or from plans or information published in this magazine.

P R O D U C T R E V I E W S

**9 Gizmo**

A look at the new products, technologies, and trends unveiled for the first time at the 1995 Consumer Electronics Show

**24 Hands-On-Report**

Elenco Electronics function-generator kit

C O L U M N S

**6 Multimedia Watch**

A virtual guitar—*Marc Spiwak*

**29 Think Tank**

Some workshop circuits—*John Yacono*

**64 Antique Radio**

The Minerva restoration begins—*Marc Ellis*

**67 Computer Bits**

Inspiration—*Jeff Holtzman*

**69 Circuit Circus**

More motorcycle circuits—*Charles D. Rakes*

**74 DX Listening**

Shortwave from the "great, white north"—*Don Jensen*

**76 Ham Radio**

More on the NE-602—*Joseph J. Carr*

**82 Scanner Scene**

The Russians are coming—*Marc Saxon*

D E P A R T M E N T S

**3 Editorial**

**4 Letters**

**72 Electronics Market Place**

**84 Electronics Library**

**87 New Products**

**95 Popular Electronics Market Center**

**128 Advertiser's Index**

**129 Free Information Card**

**Popular Electronics**

**Larry Steckler**, EHF, CET  
editor-in-chief and publisher

**EDITORIAL DEPARTMENT**

**Carl Laron**, editor  
**Dan Karagiannis**, associate editor  
**Teri Scaduto**, assistant editor  
**Evelyn Rose**, editorial assistant  
**Marc Spiwak**, editorial associate  
**Joseph J. Carr, K4IPV**, contributing editor  
**Marc Ellis**, contributing editor  
**Jeffrey K. Holtzman**, contributing editor  
**Don Jensen**, contributing editor  
**Charles D. Rakes**, contributing editor  
**Marc Saxon**, contributing editor  
**John Yacono**, contributing editor

**PRODUCTION DEPARTMENT**

**Ruby M. Yee**, production director  
**Karen S. Brown**, production manager  
**Kathy Campbell**, production assistant

**ART DEPARTMENT**

**Andre Duzant**, art director  
**Russell C. Truelson**, illustrator

**Jacqueline P. Cheeseboro**, circulation director

**Michele Torrillo**, POPULAR ELECTRONICS bookstore

**BUSINESS AND EDITORIAL OFFICES**

Gernsback Publications, Inc.  
500-B Bi-County Blvd.  
Farmingdale, NY 11735  
1-516-293-3000  
FAX: 1-516-293-3115  
President: **Larry Steckler**

**SUBSCRIPTION CUSTOMER SERVICE/ORDER ENTRY**

1-800-827-0383  
7:30 AM - 8:30 PM EST

**Advertising Sales Offices listed on page 128**

Composition by Mates Graphics

Cover by Loewy Design  
Photo Illustration by Chris Gould

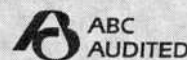

Since some of the equipment and circuitry described in POPULAR ELECTRONICS may relate to or be covered by U.S. patents, POPULAR ELECTRONICS disclaims any liability for the infringement of such patents by the making, using, or selling of such equipment or circuitry, and suggests that anyone interested in such projects consult a patent attorney.

# EDITORIAL

## SECURITY IN THE INFORMATION AGE

There are some important issues that need to be addressed if our headlong dash onto the information superhighway is not to end in frustration, or even disaster. Chief among those is the issue of security.

For instance, how do you ensure that a monetary transaction remains secure over the Internet? How can you be sure that your private or sensitive e-mail isn't read by anyone or everyone? And what about the government's right to monitor illegal activities? Do they have a right to insist that all cellular phones, computers, etc. provide some way for the government to decrypt messages?

Those issues, and more, are discussed in this issue's cover story, "Security in the Information Age." It provides some background on the science of codes and ciphers, then goes on to discuss the ways individuals, companies, and governments can secure sensitive information. We also show how it is often surprisingly easy to get around many security measures. The story begins on page 33.

Also this month there is our annual round-up of the goings on at the Winter Consumer Electronics (CES). The article, in the "Gizmo" section, looks at the continued growth of DSS; "Bob," a new computer "friend" from Microsoft, and lots, lots more. CES coverage begins on page 9.



Carl Laron  
Editor

Just the thing for  
people who want to get  
weather information  
first hand!

Over 20  
Functions

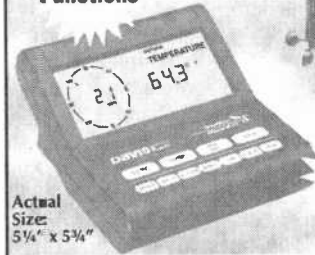

Actual  
Size:  
5 1/4" x 5 1/4"

Only  
\$195!

Haven't you always wanted a weather station? The Weather Wizard III combines all the most requested features into one incredible package!

### FEATURES INCLUDE:

- Inside & Outside Temps
- Wind Speed & Direction
- Compass Rose
- Wind Chill
- Alarms
- Highs & Lows
- Instant Metric Conversions
- Optional PC Interface (\$165)

**\$75** Optional Rain Collector  
Order today:

**1-800-678-3669**

M-F 7 a.m. to 5:30 p.m. Pacific Time • PE653J  
FAX 1-510-670-0589 • M/C and VISA  
Add \$8.00 for Shipping and Handling  
One-year warranty • 30-day money-back guarantee

**DAVIS INSTRUMENTS**

3465 Diablo Ave., Hayward, CA 94545

Our 30th Year!

USA Made!

CIRCLE 162 ON FREE INFORMATION CARD

## Electronic Security

2 for 1  
SALE!



**Mini Long Range FM Voice Transmitter (3 ml) Ultra Sensitive** - with fine tune, range control, more! Detects even whispers! FMX1 Kit and Plans.....~~\$49.50~~

**Tiny Telephone FM Transmitter**



(3 ml) - automatically operates when phone is used. Crystal clear clarity with fine tune and range control. TELX-1 Kit and Plans.....~~\$39.50~~

**Both Easy-to-Build Kits Above only \$49.50!**

**Extended Play Telephone**



**Recording System - \$129.50**

- Automatic - Crystal Clear - Easy to Use - Connects to Any Phone - Automatically controls and records both sides of the conversation on our extended play recorder. Caution - check local laws as some states require an alerting beeper. TAP20X Ready-to-Use System ..... only \$129.50

**INFORMATION UNLIMITED** FREE CATALOG with order - or send \$1.00 P&H  
MC, VISA, Check, Cash or C.O.D.  
Send or Fax Orders to: Dept pe16  
PO Box 719, Amherst, NH 03031  
Orders: 800-221-1705 FAX 603-672-5406 Tel 603-673-4730

## "SIMPLIFIED" DX BEAM-AIMER PROGRAM

The "DX Beam-Aimer Program" (*Popular Electronics*, January 1995) caught my eye, as it is very much like a program for sailboat navigation that I wrote in 1983. I recently rewrote the program in QuickBASIC and simplified it, after reaching a better understanding of the trigonometry involved. For real use at a ham station, I would suggest applying the same simplifications and removing some time bombs that appeared in the DX Beam-Aimer Program.

To be practical, one should not have to enter any more than absolutely necessary, and the printout need not contain more than necessary. In line 410, delete the CLS and leave the inputs showing. Then delete lines 420 to 570, which simply repeat the same information. For practical use at a ham station, I have my location as point A with values permanently

in the program so only the location of the distant point need be entered.

One does not have to worry about not calculating the values for the larger triangle as the trig formulas take care of it automatically. Some simplifications can be made. Do not bother to calculate the colatitudes of the two points. Instead, add four lines of code that make the south latitudes negative and the east longitudes negative. For example, add line 345: 345 IF J\$ = "S" THEN A(1) = -A(1). Delete lines 590 to 620. The north polar angle can be calculated eastward simply by subtracting point B longitude from point A longitude.

Replace lines 640 to 700 by new line: 640 I = A(2) - A(4). Revise lines 710 to 730 if you want to retain them. The sine of

a latitude is the same as the cosine of colatitude, and the cosine of a latitude is the same as the sine of colatitude. So now in lines 760 to 810 and line 940, where there is a sine or cosine of E or F, replace SIN by COS, COS by SIN, E by A(3), and F by A(1). Change line 1000 to read: 1000 IF I > 180 OR IF I < 0 THEN Y = 360 - Y.

Now for the time bomb removal. If you have entered points 180 degrees apart, the value of D will be -1, and you will get an error message about not dividing by zero in the calculation of Y in line 840. The easy way to handle that is to add a line of code: 825 IF D <= -1 THEN PRINT "B IS DIAMETRICALLY OPPOSITE A AT ANY BEARING AND 10800 N. MILES FROM A." : END.

The next problem is in the azimuth calculation. It can happen that the calculated value of G will be very slightly outside the range of -1 to +1 due to internal rounding and line 980 will bomb because you can't get the square root of a negative number. Also, if G is -1 or +1, you will get an error message about trying to divide by zero. To take care of this, I use the equivalent of: 975 IF G <= -1 THEN Y = 3.14159 : GOTO 990 and 976 IF G >= 1 THEN Y = 0 : GOTO 990.

If you can use double precision calculations, the results will be better where angles near zero and multiples of 90 degrees are involved. K.E.S., WA2VWS  
Cherryvale, KS

*Hallelujah! BASIC programming is not really dead after all! At least, so it would seem from the number of letters I've received referring to my "DX Beam-Aimer Program." They included a translation for Commodore BASIC (from Bill Stiles, Stiles Electronics, 4599 Jarvis Road, Hillsboro, MO 63050), and an Apple II Applesoft translation (from Tom Stevens, K9FNK, Stevens Enterprises, 2749 East Irwin,*

*Mesa, AZ 85204), as well as requests for program disks from as far away as Malaysia.*

*In the letter printed above, the reader offers some valid suggestions to "simplify" my original program, but in so doing has only complicated the explanation. As with all my writing—now more than 700 articles and five books about electronics, microcomputers, and flying—I strive to provide tutorial value as well as simple use.*

*There is no doubt that virtually any "simple" program written in BASIC (or any other computer language) can be modified, debugged, transformed, converted, and otherwise simplified (or made more convoluted) by a programmer competent in the language. I have not tried every change suggested, but I'm sure that he has. Any reader who wants to avoid the "time bombs" he refers to should feel free to make the changes. I've used the program since I first wrote it for my TRS-80 Model I back in 1980, and I've subsequently translated it for use on the Timex 2068 Color Computer, a Sanyo MBC-550, and an IBM PC—and I've never had it "bomb"!—Fred Blechman*

## HAVES & NEEDS

I am in need of an oscilloscope. It doesn't matter if the scope works or not, as long as it is inexpensive. I will consider any manufacturer's, but prefer Tektronix or B + K Precision. I am also interested in any other test equipment your readers might have available.

I have a lot of components available, including TV circuit boards, CRT's, horizontal output transistors, vacuum tubes, TV capacitors, and plenty more.

Anyone that can help me, or who is interested in what I have, can contact me at the address below. Thanks.

DENNIS GIFFORD  
P. O. Box 304  
Henagar, AL 35978

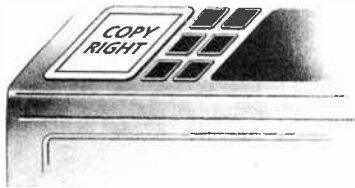

*THE MOST*  
**AN IMPORTANT PART  
OF YOUR PHOTOCOPIER  
ISN'T PART OF  
YOUR PHOTOCOPIER**

Having a machine may not permit you to photocopy books, journals, newsletters and magazines.

The Copyright Clearance Center CAN.

Contact us to find out  
how you too can COPY RIGHT!<sup>SM</sup>

## COPYRIGHT CLEARANCE CENTER

222 Rosewood Drive, Danvers, MA 01923 □ Tel. (508) 744-3350 □ Fax (508) 741-2318

© 1993 Copyright Clearance Center

# The Four-Year Electronics Degree Program That Really Hits Home!

**Bring The Technology Home With A Bachelor Of Electronics Engineering Degree. No Hassles. No High Cost!**



*Now's the time to prepare for a profitable career.*

## We've lowered the cost of higher education.

It's true! You can earn a four-year Bachelor of Electronics Engineering Technology degree today ... and prepare yourself for a high-paying electronics career ... without quitting your job or ever leaving your home. Because World College, an affiliate of the Cleveland Institute of Electronics, offers you the total flexibility of independent study programs proven effective for people like you who truly want to succeed! World College independent study lessons help you build valuable skills

**Mail/Fax Today  
or Call  
1-800-696-7532**

step-by-step, and expert instructors are personally available to you with a toll-free call. What a way to earn an education!

## A world of opportunity.

Where is your career headed? With a four-year bachelor's degree from World College, you call the shots, choosing from incredible, high-paying opportunities in electronics, telecommunications, computer, electrical power, and many other growing fields.

World College gives you the skills, the knowledge, the power to take advantage of your best opportunity in electronics. And you can do it all at your own pace!

## Without leaving home.

World College continually works to provide its students with the most advanced education tools. From the latest equipment and reference books to breakthrough computer-simulated experiments, students are exposed to the latest technological advancements.

All the equipment, parts, and software you need are included in your affordable tuition, including more than 300 hands-on lab experiments you can complete in your home.

## Choose your own pace.

Earn your bachelor's degree on your time — and at your pace — because you pay tuition to World College only as you complete the upper-level semesters close to graduation. The faster you make it through, the less you pay. So you have an incentive to make your future happen quickly — yet the freedom to choose your own pace!

Send today for your FREE course catalog — and give yourself that future you've always wanted — with an electronics degree education from World College.



*Take charge of your future in electronics.*

## Four Powerful Reasons To Connect With World College Today:

- 1. Earn your four-year degree!**
- 2. Self-paced training!**
- 3. Independent study in your home!**
- 4. Expert instruction!**

## Give Me The Power!

Send me a FREE World College course catalog today!



(Please Print Neatly)

Name \_\_\_\_\_

Address \_\_\_\_\_

City \_\_\_\_\_

State, Zip \_\_\_\_\_

Phone (     ) \_\_\_\_\_

Age \_\_\_\_\_

**For faster service, call  
1-800-696-7532,  
or call  
1-804-464-4600.**

**Or fax this coupon to  
1-804-464-3687.**



Lake Shores Plaza  
5193 Drive, Suite 113  
Virginia Beach, VA 23455-2500



Affiliated with  
Cleveland Institute of Electronics  
WAH20

# MULTIMEDIA WATCH

By Marc Spiwak

## A Virtual Guitar

When I first heard about the upcoming *Virtual Guitar*, with its bundled virtual music, I wasn't sure what to expect. Would Ahead, Inc.'s new gadget be a musical instrument in some way, or would it be just a toy. After playing with one recently, I have to say that the Virtual Guitar is indeed part musical instrument, part toy, and part computer peripheral. The device is like a musical "joystick" that you use to interface with special virtual music software.

The Virtual Guitar looks like a regular electric guitar,

The guitar has a single, replaceable wire string, that is wound back and forth across the strumming area forming six strings. The guitar uses MIDI to generate notes and chords from that single string; if you pluck any string several times, the reproduced note changes in pitch with each pluck and then repeats the scale if you continue to pluck. If you strum the guitar, a chord is produced. Similarly, if you strum the guitar several times, the chords change in pitch and then repeat. To someone in another room, it might sound like you are playing a real guitar, but someone watching could see that you aren't.

Welcome to the West Feedback turns your PC screen into various multimedia environments where you must perform with the guitar. It starts out with you up in a bedroom where you can jam along with a virtual music jukebox loaded with six popular songs. With the software running, a keypad on the Virtual Guitar lets you control everything you normally would with your mouse, and adds volume, distortion, feedback, and solo guitar controls.

Depending on the selected skill level, the player is asked to match a series of rhythms from a song shown as pulses running across a display. The better the player can match the rhythms, the better the song sounds, and it really begins to feel like you are par-

ticipating in the performance. The idea behind the game is that the better you get with the Virtual Guitar, the farther along you advance in where you can play. If you do well enough up in the bedroom, you can join a garage band and soon after play in clubs. Failure lands you in the Polyester Lounge where you must stay until you improve enough to get out. Top honors is an invitation to play a guest solo in a concert.

One add-on disc that's now available for the Virtual Guitar, *Quest for Fame: Featuring Aerosmith*, similarly lets the player jam to eight popular Aerosmith songs, both new and old. Top honors here is where you play in concert with Aerosmith and are asked to help lay down some tracks on a new song they are recording.

The Virtual Guitar has a street price under \$100, and it is especially fun for those not able to play a real one. The Virtual Guitar certainly is different, and it is just one of the unique things that multimedia has to offer. Anyone who can keep a rhythm might enjoy the new kind of entertainment it provides.

### TOP-NOTCH SPEAKERS

It is unfortunate that you can't or don't want to hear much from a PC's built-in speaker. Multimedia demands a sound card, and then some decent speakers to go with it. I've been

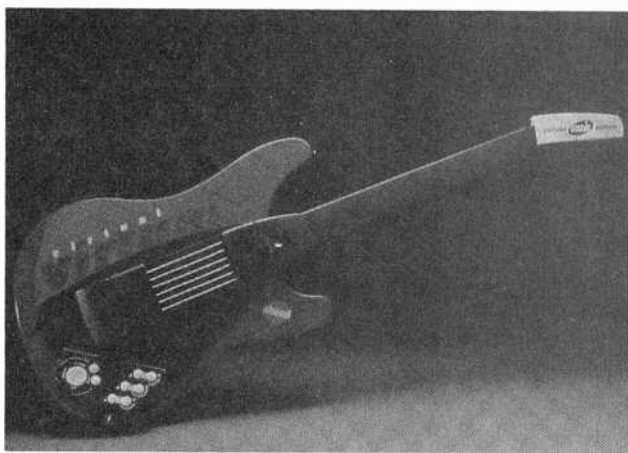

The virtual guitar can make anyone who can tap their foot feel like a virtual rock star.

although somewhat smaller, made of plastic in shades of blue, black, and yellow. The guitar links to a PC with a special serial-port adapter; a free serial port is necessary for the guitar to work. One CD-ROM, *Welcome to the West Feedback*, is included with the guitar; the software installs and runs under Windows.



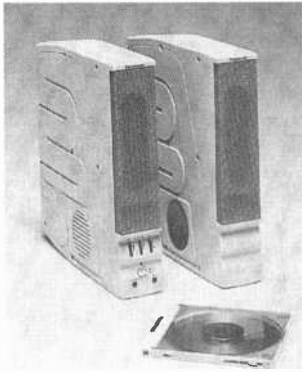

*Panasonic's EAB-710P amplified speakers will help squeeze the most out of any multimedia setup.*

testing out a new pair of multimedia speakers that will help make the most of the Virtual Guitar or any other multimedia device, especially on a cramped desktop.

Panasonic's new EAB-401P (\$99 list) and EAB-710 (\$249 list) amplified speakers have a unique trimline shape, much like a book. For their size and weight, the EAB-710P's kick out a surprising amount of power, and exceptionally good bass. The bass response of both pairs of speakers is enhanced by horn-shaped sound tubes.

The 710's are quite versatile. Power, volume, bass, and balance controls for both speakers are located on the front of the right speaker, along with a headphone and microphone jack. On the back of the right speaker are line-in, line-out, mic-thru, and DC-input jacks, and another jack that connects to the left speaker. Even though I did not test the 401's, the 710's sound quite good and are versatile enough for any multimedia setup. Depending on what street prices might be, I might like a pair of those myself.

#### A NEW MOUSE

I've played with lots of different controllers in the

past year or so. Some of them have been quite unusual, both in function and appearance. Others were more conventional. But one new controller, *Remote Point* from Interlink Electronics, is both new and different, yet familiar at the same time. It is also so simple in its use that I'm surprised nobody came up with one sooner (to my knowledge, at least). *Remote Point* is a handheld, wireless infrared (IR) mouse.

Interlink Electronics is famous for its force-sensitive resistor (FSR) technology in which a thin film changes in resistance with applied pressure. A sheet of that

puter. *Remote Point* is available in three versions—standard PC serial port, PS/2, and Mac—with the plug on the receiver being the only real difference. No special software is required when the device is used with Windows, DOS, and OS/2 operating systems. Just swap it with your regular mouse and it works right out of the box. Even so, DOS and Windows mouse drivers are included in case none are already installed.

*Remote Point* has a very comfortable teardrop shape; I wish all of my remote controls were as easy to hold as this is. Two AAA

clearly geared toward presentation use, *Remote Point* is pretty much just as easy to use at the desktop as any other mouse. You do have to pick it up, though. But it is also a very compact mouse that doesn't need a mouse pad and is impervious to dirt and dust—we all know how dirty mouse balls can get.

The wireless mouse has a suggested list price of \$199, but it will most likely sell for less on the street. While not everybody will want to junk their \$9 mice in favor of one of these, I'm sure *Remote Point* will be the perfect solution to certain people's problems.

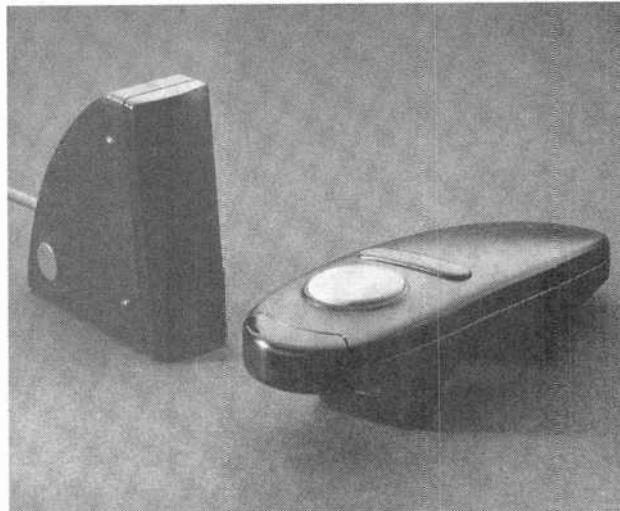

*Remote Point is a handheld mouse that lets you control a PC or Mac from up to 40 feet away.*

material can indicate both the amount of pressure applied, and where on the sheet pressure is being applied. *Remote Point's* pointing control uses that FSR technology. A circular rubber disc on top of *Remote Point* can be "tilted" 360 degrees. The mouse cursor on screen moves in the direction that the disc is tilted in, and at a speed that depends on the pressure applied to the disc.

You point *Remote Point* at a small desktop IR receiver that plugs into your com-

batteries install inside. What would normally be the primary (left) mouse button is located on the underside of the transmitter in a comfortable trigger position and is just as easy to use in either hand. The secondary (right) mouse button is on top, and spans the width of the remote, again to make it fit left or right hands. Mouse-driver software can swap those for you if you like.

*Remote Point* will work from up to 40 feet away from the receiver. While it is

#### NEW STUFF

This month I've got some new software from HarperCollins Interactive.

*HealthDesk* helps people monitor and analyze their own medical records. It lets you record visits to the doctor, immunizations, allergies, prescriptions, and so on. *HealthDesk* comes on four Windows-compatible diskettes for \$59.95. *The American Sign Language Dictionary On CD-ROM* contains 2200 signs and is the first multimedia product available to help people learn sign language. The disc sells for \$69.95.

A new disc from Books That Work and Hearst New Media helps people buy new cars. The *Popular Mechanics New Car Buyers Guide—1995* lets you select from over 800 vehicles with over 2000 photos, and video footage for 320 cars. All features and options are described. The \$60 disc also includes dealer-invoice prices for all vehicles and options. I wish I had that disc when I bought my new car—maybe I could have been able to negotiate an even better price.

*(Continued on page 90)*

# New device turns any electrical outlet into a phone jack

Engineering breakthrough gives you unlimited phone extensions without wires or expensive installation fees

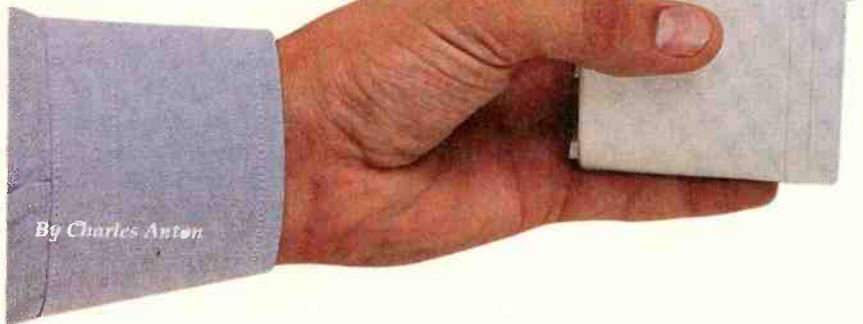

By Charles Anton

**Y**ou don't have to have a teenager to appreciate having extra phone jacks. Almost everyone wishes they had more phone jacks around the house.

When I decided to put an office in my home, I called the phone company to find out how much it would cost to add extra phone jacks. Would you believe it was \$158?

### No more excuses.

Today, there are a thousand reasons to get an extra phone jack and a thousand excuses not to get one. Now an engineering breakthrough allows you to add a jack anywhere you have an electrical outlet. Without the hassle. Without the expense. And without the miles of wires.

### Like plugging in an appliance.

Now you can add extensions with a remarkable new device called the Wireless Phone Jack. It allows you to convert your phone signal into an FM signal and then broadcast it over your home's existing electrical wiring.

Just plug the transmitter into a phone jack and an electrical outlet. You can then insert a receiver into any outlet anywhere in your house. You'll be

able to move your phone to rooms or areas that have never had jacks before.

**Clear reception at any distance.** The Wireless Phone Jack uses your home's existing electrical wiring to transmit signals. This gives you sound quality that far exceeds cordless phones. It even exceeds the quality of previous devices. In fact, the Wireless Phone Jack has ten times the power of its predecessor.

Your range extends as far as you have electrical outlets: five feet or five hundred feet. If you have an outlet, you can turn it into a phone jack—no matter how far away it is. The Wireless Phone Jack's advanced companding noise reduction features guarantee you crystal-clear reception throughout even the largest home.

**Privacy guarantee.** You can use The Wireless Phone Jack in any electrical outlet in or around your home, even if it's on a different circuit than the transmitter. Each Wireless Phone Jack uses one of 65,000 different security codes. You can be assured that only your receiver will be able to pick up transmissions from your transmitter.

### Is the Wireless Phone Jack right for you?

The Wireless Phone Jack works with any single-line phone device. Almost anyone could use it, especially if...

- **Few jacks.** You want more phone extensions without the hassle and expense of calling the phone company.
- **Bad location.** You have jacks, but not where you need them most, like in the kitchen, garage, home office or outside on the deck.
- **Renting.** You want to add extensions, but you don't want to pay each time you move.
- **Other phone devices.** You have an answering machine, modem or fax machine you want to move to a more convenient place.

### The Wireless Phone Jack System

consists of a transmitter (right) and a receiver (left). One transmitter will operate an unlimited number of receivers.



**Unlimited extensions—no monthly charge.** Most phone lines can only handle up to five extensions with regular phone jacks. Not with the Wireless Phone Jack. All you need is one transmitter, and you can add as many receivers as you want. Six, ten, there's no limit. And with the Wireless Phone Jack, you'll never get a monthly charge for the extra receivers.

### Works with any phone device.

This breakthrough technology will fulfill all of your single-line phone needs. It has a special digital interface for use with your fax machine or modem. You can even use it with your answering machine just by plugging it into the Wireless Phone Jack receiver.

### Special factory-direct offer.

To introduce this new technology, we are offering a special factory-direct package. For a limited time, the transmitter is only \$49. One transmitter works an unlimited number of receivers priced at \$49 for the first one and \$39 for each additional receiver. Plus, with any Wireless Phone Jack purchase, we'll throw in a phone card with 30 minutes of long distance (a \$30 value) for only \$9.95!

**Try it risk-free.** The Wireless Phone Jack is backed by Comtrad's exclusive 30-day risk-free home trial. If you're not completely satisfied, return it for a full "No Questions Asked" refund. It is also backed by a one-year manufacturer's limited warranty. Most orders are processed within 72 hours and shipped UPS.

Wireless Phone Jack transmitter...\$49 \$4 S&H  
Wireless Phone Jack receiver.....\$49 \$4 S&H  
**save \$10 on each additional receiver—\$39**

30-minute long distance phone card.....\$30  
**\$9.95 with Wireless Phone Jack purchase**

Please mention promotional code 017-PL-1116.

For fastest service, call toll-free 24 hours day

**800-992-2966**

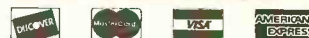

To order by mail, send check or money order for the total amount including S&H (VA residents add 4.5% sales tax). Or charge it to your credit card by enclosing your account number and expiration date.

**COMTRAD INDUSTRIES**

2820 Waterford Lake Drive, Suite 106  
Midlothian, Virginia 23113



The Wireless Phone Jack lets you add a phone, modem, fax machine or answering machine almost anywhere.

# GIZMO®



## Showtime in Las Vegas

The Annual Consumer Electronics Show had its share of surprises.

On the surface, the 1995 Winter Consumer Electronics Show, held in January in Las Vegas, was little different from the shows that had preceded it in past years. The Las Vegas Convention Center was bustling, packed with exhibitors, dealers, buyers, and, of course, members of the press. The hype was flying, as exhibitors showcased the latest and greatest, the biggest and best (or the smallest and smartest), of their product lines. On the main floor, major manufacturers displayed their wares—primarily mainstream audio and video products. In the separate tent-like pavilions set up for video games, multimedia products, and communications products, action was brisk and the noise level was deafening. Ditto for the indoor and outdoor mobile electronics exhibits. In the area surrounding the convention center, traffic was bumper-to-bumper, waiting lines for shuttle buses were long, and taxi queues stretched around the block.

Beneath the surface, however, several factors set this show apart from its many

predecessors. First, last year's demise of the Summer CES—to be replaced by several small, specialized shows held throughout the year—leaves WCES as virtually the sole trade show serving the vast consumer-electronics industry. While the winter show has always been the industry's primary convention, its solo status has increased its importance. Second, some of the "shows-within-the-show" that had become associated with the Summer CES have, by necessity, found a new niche at the winter show. Third—least obvious but perhaps most important—there was a buzz of excitement underlying this show, an undercurrent of expectation generated by one hot new product that some insiders think might be the "next VCR."

The Consumer Electronics Show has always been interesting and exciting, whether you approach it as a consumer or from a more technical angle. Where else can you see, gathered under one roof (and in several nearby hotel suites), products that represent the state-of-the-art in consumer electronics? (Well, there's the Innoventions display at Disney World's Epcot Center, but that can't match the size, scope, and timeliness of CES.)

True, most CES product introductions are evolutionary and represent minor improvements on established technologies—ergonomically refined remote controls, easier user interfaces, larger picture tubes,

smaller audio components, and so forth. A much smaller percentage of new items could be considered new subcategories of established product lines; for instance, Sharp's Viewcam has spawned a host of camcorders with LCD screens.

Of course, the most fascinating, and newsworthy, introductions at the Consumer Electronics Shows involve *new* technologies—every show has at least one. MiniDisc, DCC, and Video CD are some of the more recent innovations.

Although hot new technologies generate the most publicity and press coverage, one very important group cautiously reserves judgment. Retail buyers are understandably wary of any new product category. Retailers know very well how difficult it is to create consumer awareness and desire for new products, and how many hot new products grow cold on the shelves. Even those products that eventually do strike gold—color TV's and CD players, for example—often take years to "catch on."

Ever since the VCR caught fire, the industry has been seeking "the next VCR"—the single product that will quickly become a household staple, and will spur the growth of auxiliary businesses, such as videotape sale and rentals. That elusive goal just *might* be within sight, in the form of a technology that was introduced at last winter's show and of



RCA's Digital Satellite System, the surprise big-seller of 1994, drew big crowds at WCES.

ficially launched at the 1994 summer show. We're talking about the RCA Digital Satellite System, or DSS, the small-dish satellite-TV system that's literally been flying off the shelves since its introduction last summer.

#### AND THE DISH RAN AWAY WITH THE SHOW

DSS's strong consumer appeal can be traced to several factors. The system uses a stationary, 18-inch dish to receive signals from high-powered Hughes satellites. That translates to easy do-it-yourself installation, with no need for a clear line-of-sight to a large area or complex alignments to pick up signals from all the satellites in the "arc." The dish size is a major plus—particularly when compared to traditional C-band satellite dishes, which are usually between six and ten feet in diameter. The DSS dish can be installed unobtrusively even in densely populated urban and suburban areas.

Of course, the target market for this new satellite system lives not in the city or suburbs, but in rural areas, where cable TV is often unavailable and broadcast TV signals are weak and unreliable. But those city dwellers should not be discounted—many of them view DSS as a welcome alternative to the cable monopoly that they've come to hate.

The DSS system is reasonably priced—at least in comparison with other just-introduced consumer-electronic products.

Gizmo is published by Gernsback Publications, Inc., 500-B Bi-County Blvd., Farmingdale, NY 11735. Senior Writers: Chris F. O'Brian and Teri Scaduto. Copyright 1995 by Gernsback Publications, Inc. Gizmo is a registered trademark. All rights reserved.

The two available models cost \$699 and \$999, including set-top receiver, dish, and remote control. Do-it-yourself installation kits are offered, as is professional installation service (costing about \$200). Programming packages are available to fit just about any budget, and are priced competitively with cable services.

Unlike cable, the DSS system is entirely digital, delivering CD-quality audio and MPEG-1-compatible video (soon to be upgraded to MPEG-2). Using high-power satellites and digital compression, DSS currently can deliver more than 150 channels of programming. The launch of



**DSS delivers up to 175 channels of satellite-TV programming to consumers anywhere in the lower 48 states. The system includes an 18-inch dish antenna, a digital receiver/decoder, and an interactive remote control.**

the third bird, scheduled for sometime later this year, will further increase the system's channel capacity.

Despite its obvious attractions, no one—not even RCA or program suppliers DirecTV and USSB—anticipated the level of success reached by DSS in its first several months on the market. DSS was introduced in several markets back in June 1994, with nationwide rollout achieved in October. By the end of 1994, Thomson Consumer Electronics had shipped 593,098 RCA-brand DSS systems to dealers—who had trouble meeting customer demand. With back orders for more than 400,000 units, RCA DSS could reach the 1,000,000 unit sales point sometime this spring, a mere seven months after its national introduction.

To get some perspective on that figure, consider the introductory sales of some of the consumer-electronic products that are historically considered smash hits. Forty years before DSS, RCA introduced color television to the American market. It took *ten years* for color TV to reach the one-million units sold per year mark. The undeniably successful VCR (found in four out of five American homes) sold only about 200,000 units in 1977, when it was first widely marketed. CD players were off to a slow start in their first year, 1983, with only about 35,000 units sold. They caught on fairly quickly, though, taking just two years to reach the one-million-per-year mark.

Adding to the excitement surrounding DSS, there is the imminent promise of increased competition. According to Thomson's original agreement with Hughes Electronics and United States Satellite Broadcasting (USSB), Thomson's exclusive right to sell DSS systems ends 18 months after the introduction, or after one-million units are sold. Sony then becomes the second DSS licensee—and you can be sure that company is gearing up to get product to market. Meanwhile, Thomson has announced the start of a \$40-million expansion of its Juarez, Mexico manufacturing facility to meet the demand for DSS. Increased competition and a more balanced supply-demand equation should result in lower prices for consumers.

DSS is not the only digital direct broadcast satellite (DBS) to be exceeding its stated goals. Primestar announced at WCES that it had surpassed its new subscriber goals for 1994, with more than 250,000 authorized receivers in service by year's end. Since August, 1994, when the company began shipping digital boxes, the Primestar subscriber base has experienced 30% growth each month.

"The demand for Primestar service continues to exceed supply," said John Cusick, President and CEO of Primestar Partners. "We believe that quadrupling

our subscriber count is not out of the question in 1995." The company attributed its success to its high-profile national advertising program (which drew 750,000 phone calls from potential subscribers), the strength of its distributor network, and the customer appeal of its worry-free, all-in-one service plan.

Unlike DSS, which is a retail product that requires a substantial cash investment on the part of the consumer along with monthly fees for programming packages, Primestar is solely a subscription service, similar to cable TV. The equipment—consisting of a mini-dish (less than 3 feet across), and a set-top decoder and remote control, both manufactured by General Instrument—is owned, installed, and maintained by Primestar distributors. Primestar customers pay an initial installation fee (ranging from about \$100 to \$200), and then a monthly service charge that covers both programming and hardware. The monthly fee starts at about \$30, with premium programming upping the cost.

Primestar currently delivers close to 70 channels, including movie, sports, news, network, and pay-per-view channels, and also offers a half dozen digital music channels. By the end of the year, Primestar expects its offerings to exceed 80 channels. And, when it begins broadcasting from a high-powered DBS satellite in 1996, up to 200 channels could be delivered.

At a WCES press conference, Primestar announced plans to bring its service into the retail arena. John Cusick said that the company is "in serious negotiations with several major retail chains to bring Primestar into outlets as a point of sale," with full details to be announced by mid-March 1995. Cusick also announced that when the MPEG-2 standard is adopted, existing Primestar receivers will be upgraded at Primestar's cost.

It's no wonder that small-dish, digital satellite TV was the hot item at WCES. In fact, a WCES workshop on the future of satellite TV—an area once considered outside the realm of traditional consumer electronics—was completely "sold out." Fifteen minutes before the panel discussion was supposed to begin, a crowd of angry buyers were massed outside the room in which a standing-room-only crowd of early arrivers was gathered. The outside group was informed that they would be unable to attend the workshop, but could purchase an audio tape of the proceedings. One group loudly proclaimed that the only reason they came to WCES was to learn more about the new digital satellite services, and the general consensus was that the least the show management could do was supply free tapes to those who had arrived at the session on time, only to be locked out.

## BOB TAKES A BOW

The satellite-TV session wasn't the only one to attract overflow crowds. Microsoft founder and CEO, Bill Gates, a media star in his own right, drew a star-studded crowd—including Stephen Spielberg, Barry Diller, and Jeffrey Katzenberg—to the first WCES "Executive Perspective" presentation. Lesser mortals who arrived too late to get a seat watched his speech on projection TV's set up to handle the spillover crowd milling around outside the Las Vegas Hilton Ballroom.

According to the EIA/CEG, the Executive Perspective is a "one-hour presentation designed to showcase the personal vision and philosophies of a leading industry executive." Gates' vision starts with "a PC in every home" and extends to a software interface that everybody can use. He noted that while Windows' graphical user interface is "great for business users," it lacks something when it comes to home use. It's too complicated and too impersonal, intimidating many potential PC users.

To meet the needs of those people (as determined by extensive market research), Gates introduced Bob, Microsoft's first product with a "social interface." Microsoft learned that home PC users do best when they are helped by a friend who's an expert. The social interface provides the user with one unthreatening place to go for all advice, by building in an assortment of personal guides. Each is an "active/intelligent" character who not only has a distinct personality, but also has the ability to remember what you learned to do in the past so that it knows when you need help and when to stay out of your way.

More than a dozen personal guides, a.k.a. "Friends of Bob," are available. Their different personae are intended to appeal to different user personalities, skill levels, and age groups. There's Rover the friendly dog, Ruby the wise-cracking parrot, Chaos the intelligent cat, Java the coffee-guzzling dragon ("very popular in Seattle"), and Scuz the rat ("definitely designed for the MTV generation").

Bob, which carries a suggested retail price of \$99, is designed to be used by all members of a family. Each user can select his or her own personal guide, and can personalize his or her "home environment," including furnishings and even the view outside the window. As in many popular interactive children's programs, by clicking on an object within the room, the user can enter the application represented by that object. For instance, an on-screen calendar might represent Bob's Calendar program. Bob also offers Letter Writer, Checkbook, Household Manager, Address Book, E-Mail, and Financial Guide programs, as well as GeoSafari, a multimedia quiz game. Other programs will appear as on-screen icons resembling their actual packaging.

Gates expects Bob to be the first in a whole-new software product group. As PC's become more powerful, and more developers jump on the social-interface bandwagon, Gates hopes to see software with 3D images, voice recognition, and other advanced features. He also expects to see social-interface software used to help non-techie consumers navigate the information superhighway, and pocket-sized personal computers ("wallet PC's) becoming a consumer item.



Chaos the cat is just one of the "Friends of Bob," active/intelligent characters who help the home PC user navigate through the eight functions provided by Microsoft's Bob software program and start other programs.

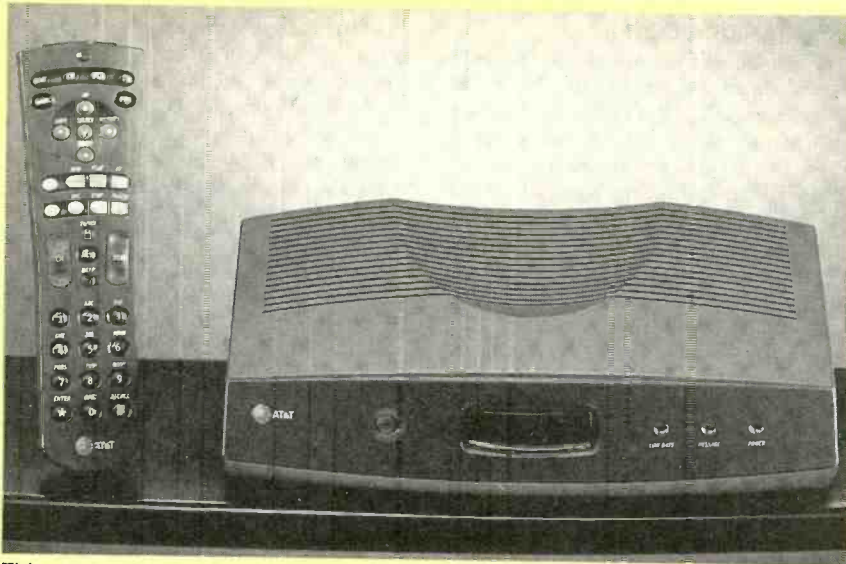

This set-top box and remote control adds the AT&T TV Information Center to any television, allowing the consumer to receive phone messages, perform electronic banking tasks, and pay bills using a TV instead of a PC.

### INFORMATION EVERYWHERE

Microsoft wasn't the only company to introduce a product designed to help the typical consumer overcome his aversion to PC-based information services. AT&T, for instance, introduced its TV Information Center at WCES.

The TV Information Center links two products already found in virtually every home—the television and the telephone—combining them to provide an easy way for people to manage their personal information needs. Those might include telephone answering, electronic banking and bill-paying, and receiving personalized information on topic-specific news items, sports scores, local traffic and weather, and daily stock-portfolio updates. All information is delivered over regular phone lines and displayed on the TV screen. A remote control is used to select options from an on-screen menu of information and telephone-answering services. The same remote can be used to control the owner's TV and VCR.

The TV Information Center represents the first in a family of "intelligent devices" that AT&T Consumer Products plans to introduce in 1995. It contains an AMD 29200 microprocessor, an AT&T DSP 16 chip, a 2400 bits/second modem, and more than a megabyte of DRAM and flash memory. It can store up to 20 minutes of digital voice messages in its telephone-answering mode. According to Dee Dee Nye, AT&T Intelligent Devices vice president, "Only about 30 percent of the PC's in homes today include a modem. But everyone has a TV, so TV represents a whole new market for interactive services."

The first TV Information Center product is a set-top box, to be introduced in the Northeast in the first half of the year, and



Zenith plans to offer televisions with the AT&T TV Information Center built-in, beginning in 1996.

nationwide by year end, at a suggested price of \$329. Next year, Zenith plans to integrate the technology into television sets and set-top boxes. AT&T plans to

offer at least four versions of intelligent devices this year, all of which will be able to display information on a screen—on a TV, on a PC, or on a screen built into the phone itself. The Two-Line Personal Information Center 882 telephone will be available by the time you read this for \$199.

### TAMING THE TV

We suspect that there are more consumers out there who would like some help managing the programming that's already coming in on their TV's before they start getting still more information. Several companies were ready to oblige.

StarSight Telecast Inc., developers of a patented on-screen interactive television program guide with one-button VCR recording, chose WCES 95 to announce three new product enhancements that will be available this year. First, StarSight Time Set (STS) eliminates the "flashing 12:00" dilemma. Within minutes of plugging in StarSight-equipped and StarSight-ready products, the correct date and time will be automatically programmed into the consumer's TV or VCR, even if the consumer does not subscribe to StarSight. The first product to feature STS will be the Samsung VR8905 VCR—the first StarSight-equipped VCR—expected to be available in May at a suggested retail price of \$549.

Two Auto Demonstration Modes will be available on some StarSight products, as determined by individual manufacturer. By selecting "Brief StarSight Demonstration" from the on-screen menu, new users will get an instant demonstration of the product's capabilities. And retailers can choose "Continuous StarSight Demonstration" to present the technology to potential customers.

The third enhancement is aimed at manufacturers, not consumers or retailers. A new StarSight-ready configuration will allow consumer-electronics manufacturers



StarSight Telecast faces competition from newcomer VideoGuide, also offering an on-screen program guide with one-touch VCR recording.

to incorporate the technology into their products at substantially lower prices. StarSight-ready capability, will give consumers the benefit of STS immediately, and allow them to later purchase an external module to make the system fully StarSight compatible. The module will be available directly from StarSight at a retail price expected to be less than \$100.

StarSight is facing competition from a newcomer called VideoGuide, which made its debut at WCES 95. Like StarSight, VideoGuide offers an on-screen program guide and one-touch VCR recording (which it claims does not violate StarSight's patent). Both systems allow viewers to see up to seven days of programming information, to select programs by category or theme, and to see descriptions of shows. Unlike StarSight, which sends programming information to its devices via the vertical blanking interval of PBS stations, VideoGuide uses BellSouth's Mobile Comm wireless network to distribute information. The wireless network, according to VideoGuide, allows that information to be more timely than its competition, because it can be broadcast on an up-to-the-minute basis.

Besides having more accurate scheduling information (particularly during sports playoffs), the wireless network allows for other time-sensitive information to be sent to the subscriber. VideoGuide features up-to-the-minute sports scores, lines, and game summaries, and allows viewers to follow the progress of dozens of games simultaneously, in greater detail than is provided by conventional "sports ticker" services. VideoGuide also offers a real-time "video newspaper," featuring regional, national, and international stories from AP and UPI news wires. That feature can learn the types of stories that most interest a viewer, and will position those stories at the top of the screen.

The ViewGuide system consists of a low-profile, stand-alone set-top receiver and a universal remote control with built-in joystick. It will be available in regional East Coast markets this spring, with national roll-out in the fall. The hardware will cost less than \$100, and a basic subscription (programming grid, one-touch recording, and "smart sorting" of programs by viewer preference) will cost \$4.99 a month. The newspaper and sports services will be priced at \$2.99 for the first service ordered, and \$1.99 for the second.

Intended more to help viewers take control of their VCR's (and their libraries of videotapes) than their TV's, Gemstar—developer of the hugely successful VCR Plus+ Instant Programming System—introduced Index Plus+, an indexing and cataloging feature designed to be built into VCR's. Gemstar envisions the technology as allowing VCR's to "locate and play



The VideoGuide system consists of a small set-top box and a remote control. It receives up-to-the-minute program information, as well as late-breaking sports scores, news items from the wire services, and personalized stock portfolio updates, wirelessly, over BellSouth's Mobile Comm network.

INDEX PLUS + TAPE 21	
Title	Min.
MURPHY BROWN	30
20/20 - ABC NEWS	60
FRESH PRINCE	30
COACH	30
BULLS v. NETS	120
Blank Tape Remaining	90

Gemstar's Index Plus+ system allows frequent videotapers to take control of their library of tapes.

back videotaped material the same way compact disc players play songs, with the added convenience of an on-screen directory."

Index Plus+ will use proprietary computer chips to "grab" program titles and other information (perhaps the program's VCR Plus+ code number) included in the vertical blanking interval of broadcasted video signals. The titles and data will then be displayed on screen on demand—and will be encoded on videotape whenever a program is recorded. Tapes recorded on Index Plus+ -equipped VCR's will have a "table of contents" showing the show title and recording time. The viewer can easily fast-forward or rewind to the show of his or her choice, at the push of a button. A library of all the shows recorded using that VCR is created, and can be displayed on screen through several different search formats. An internal memory device also re-

members up to 400 shows taped on Index Plus+ VCR's.

The technology has some added attractions. While watching a show, the viewer can press a button to see the program name and channel displayed on screen. An on-screen program guide that covers the rest of the day's programming on that specific channel can also be accessed instantly, with no subscription fees required. That feature also allows point-and-record capabilities for one-touch recording. Index Plus+ will also set the VCR clock automatically.

CapCities/ABC and other (to-be-announced) major broadcast and cable networks have agreed to support the Index Plus+ system. But the technology does not rely solely on broadcaster support—Gemstar plans to broadcast program title data itself on a nationwide basis. Gemstar expects support from most major VCR manufacturers, anticipating to see Index Plus+ -equipped VCR's marketed in the United States under the RCA, GE, ProScan, Panasonic, Hitachi, JVC, Sanyo, Fisher, Mitsubishi, and Sharp labels, beginning in the third quarter of 1995.

#### INTERACTIVE COMMERCIALS

Gemstar also demonstrated a unique use for its VCR Plus+ technology—"infomercials on demand." Realizing that interested potential customers often require more detailed information than can be conveyed in a 30- or 60-second primetime spot, advertisers can take advantage of the low-cost advertising time available in the middle of the night to broadcast more detailed "infomercials." Through print ads in program guides featuring VCR Plus+ codes, or by a line of text at the bottom of their regular ad, they can then direct interested consumers to enter the VCR Plus+ code to record the middle-of-the-night commercials. So far, the service has been used by car manufacturers and movie studios, which offer previews of coming attractions.

In a similar vein, Thomson Consumer Electronics and Sun Microsystems Computer Company announced a jointly designed digital interactive TV system, dubbed Open TV. The technology allows viewers to order concert or sports tickets, request additional information from advertisers, and order video-on-demand, via a set-top box and remote control. Broadcasters and content providers can download interactive applications through existing networks, and viewers' responses are sent back via the return path of the set-top boxes. Says Dr. Norman Koo, CEO of the Sun and TCE alliance, "Open TV provides a scalable solution that can run on existing broadcast networks today and will support the full-service point-to-point networks of the future."

# World's first wireless home theater system makes professional-quality surround sound affordable...

Now you can add surround sound to your home entertainment lineup with the amazing new Chase Technologies decoder that works with your existing stereo and an assortment of wired and wireless speakers.

by John Lindner

Let's face it. As much fun as renting a video can be, it's just not the same as seeing a movie in a theater. I remember the first time I saw *Jurassic Park*—I nearly jumped out of my seat when the dinosaurs roared. One of the reasons movies seem so real is because surround sound makes it seem

like you're actually there when events are happening. Now there's an incredible new device that lets you use your stereo receiver to get that same surround sound in your home.

**The secret's in the signal.** To get surround sound, you need to do more than simply add extra speakers. There needs to be a way of separating the signal from the musical score or movie soundtrack into distinct channels for each speaker. The new Chase Technologies HTS-1 surround sound decoder does just that, and in a revolutionary way that rivals the best Dolby Pro-Logic and THX systems available today.

**Wins over critics.** In the September 1994 issue of "High Performance Review," noted audio critic Daniel Kumin said "the HTS-1 can do quite a job of recreating a 3D theatrical experience...surround effects emanated with satisfying fullness...sound was clean at any level...with quite involving and natural sound ambience."

Plus, John Sunier, a leading authority on surround sound and producer of *Audiophile Audition*, a nationally syndicated radio program for audio enthusiasts, says, "...the new Chase HTS-1, when used to decode the hidden ambience in all musical recordings, definitely outperforms all the Dolby and THX processors (which could cost you up to \$3,000)...I am impressed!"

**Decoding breakthrough.** Last year, audio industry veteran Bob Rapoport invented a new five-channel "passive" circuit for decoding the *Dolby Surround™* signals in every stereo, videotape or laserdisc. This passive method is superior to active decoders such as Dolby and THX because it requires no AC current to decode. As a result, you experience more clarity, more detail, and a greater sense of space. Plus, you won't experience the noise or distortion which can occur with active decoding methods. You don't need any extra amps! Just connect the HTS-1 to your stereo, add your speakers, and you'll experience the magic of home theater at a fraction of the cost of other systems.

**The new HTS-1 decoder won the Design and Engineering Award at the Consumer Electronics Show for being one of the best and most innovative new products.**

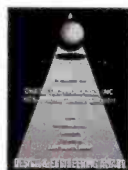

## The secret of surround sound

Surround sound has become the rage of the '90s because it adds depth and realism to stereo sound, giving you the home theater experience. In short, it makes you feel like you are actually at a concert a theater.

To get surround sound, some people have tried simply adding additional speakers to their home entertainment lineup. But it takes more than additional speakers to get surround sound; there needs to be a way of separating the original signal into distinct channels so that you're not just duplicating the same sounds and broadcasting them from different areas of the room.

The new Chase Technologies HTS-1 surround sound decoder does just that, and in a revolutionary way that rivals the best Dolby Pro-Logic and THX systems available. The HTS-1 provides five channels of sound from any two-channel stereo source.

The HTS-1 works with a variety of speakers. In the front, you can use your existing stereo speakers. For the rear, choose from inexpensive wired speakers, high-quality wireless speakers, or even an audiophile-quality wireless satellite subwoofer system. The HTS-1 also gives you the ability to add a powered center channel speaker (instead of using your TV's built-in speaker).



**Five channel options.** The HTS-1 decoder can be used with two, three, four or five channels of amplification, making it the most cost effective method for upgrading your stereo system to full home theater performance on the market. Best of all, the HTS-1 works with a variety of hard wired and wireless speakers.

In the front, most people use wired stereo speakers. Use your existing stereo's speakers or use one of a variety of wired speakers. Comtrad also offers the Chase Dialog center channel speaker. If your front speakers are more than eight feet apart, adding a center channel speaker will help keep voices and sound effects centered on the screen for stunning localization and clarity. The Dialog is self powered and video shielded to prevent interference with your television set.

**The Chase HTS-1 decoder is the most cost-effective method for upgrading an existing stereo system to full home theater performance on the market.**





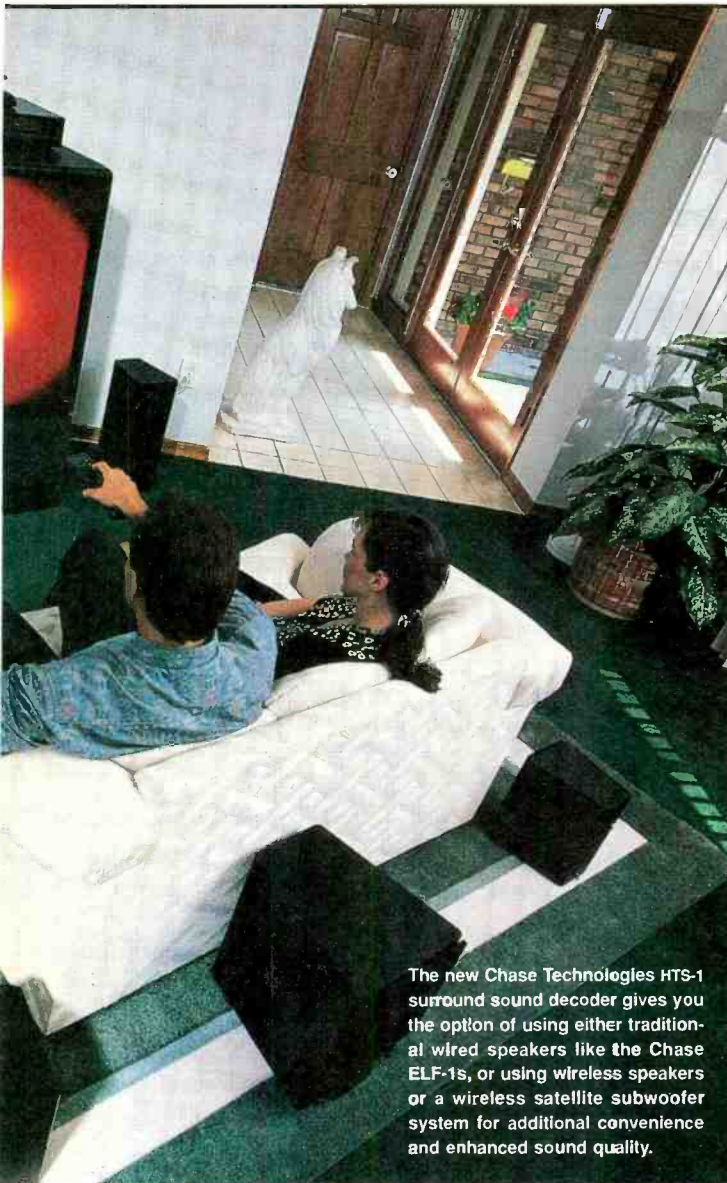

The new Chase Technologies HTS-1 surround sound decoder gives you the option of using either traditional wired speakers like the Chase ELF-1s, or using wireless speakers or a wireless satellite subwoofer system for additional convenience and enhanced sound quality.

**Wireless freedom.** When it comes to rear speakers, you can again choose standard wired speakers like the Chase ELF-1s. But if you want to avoid the hassle of running speaker wire up and down walls, behind furniture, and under carpet, you can add the freedom and convenience of wireless speakers.

Recoton wireless speakers utilize a transmitter which broadcasts sound signals up to 150 feet through walls, floors and ceilings. The speakers can be placed anywhere; they plug into a standard electric outlet. This eliminates the need to have wires running from the stereo to the speakers, which can be a nuisance with surround sound since the rear speakers are often elevated or wall mounted.

**Affordable option.** Recoton's W440 speakers allow you to add wireless rear channel speakers without compromising the sound quality that wired speakers deliver. Each self-amplified speaker contains a two-inch tweeter and four-inch woofer. They deliver 10 watts per channel for strong, clear fill sound. Their compact design (9" high x 6" wide x 5.5" long), make them the perfect bookshelf-sized companion to your home entertainment set up.

**Audiophile quality.** For the true stereo enthusiast, we offer the Recoton self-amplified wireless satellite subwoofer system. The satellite speakers in the system each bolster 25 watts of clean, distortion-free sound. The subwoofer adds a whole new dimension to your home theater with its 50-watt amplifier that's capable of creating enough rumble to make you feel like you're in the middle of an earthquake.

**The Recoton wireless subwoofer's 50-watt 10-inch speaker delivers thunderous bass that adds depth and realism to the surround sound experience.**



Even the most discriminating surround sound enthusiast will be engulfed by the abundant power and delighted with the full-range, first-rate sound from these black oak vinyl veneer speakers.

**Easy to install.** Every speaker option offered by Comtrad can be easily installed with the HTS-1 in a matter of minutes. Just connect the speaker outputs of your receiver or amp to the HTS-1, then

connect speaker wire to the front and rear speakers. When using wireless speakers, connect the transmitter to the output. One transmitter will broadcast to each wireless speaker.

**Risk-free home trial.** The best way to evaluate surround sound is in your home—not a showroom. That's why we're offering the 30-day risk-free home trial. Try these products in your home and if you're not delighted with the the surround sound experience, return them for a full "No Questions Asked" refund.

HTS-1 surround sound decoder.....\$99 \$10 S&H

Please mention promotional code 711-PL-1115.

For fastest service call toll-free 24 hours a day

**800-704-1211**



To order by mail, send check or money order for the total amount including S&H (VA residents add 4.5% sales tax.) Or charge it to your credit card, enclosing your account number and expiration date.

**COMTRAD INDUSTRIES**

2820 Waterford Lake Drive, Suite 106  
Midlothian, Virginia 23113

## Speaker Options

### Wired Speaker Options

**Front Speakers:** The Chase HTS-1 surround sound decoder can utilize your existing stereo speakers, or any of a variety of wired speakers available through Comtrad or your local electronics dealer.



**Center channel speaker.** If the front speakers are more than eight feet apart, adding a center channel speaker will keep voice cues centered on the screen. We offer the Dialog. It is self-powered and video shielded to prevent interference with TVs. Dialog \$75 \$8 S&H



**Rear channel speakers.** We recommend the quality Chase ELF-1 in either white or black for inexpensive rear channel speakers. Mount them with the enclosed color-matched mounting brackets or flush mount them on the wall. ELF-1 .....\$99/pair \$10 S&H

### Wireless Speaker Options



**Rear channel speakers.** Recoton W440 wireless speakers are the perfect option for people who want quality stereo rear channel speakers without having to run speaker wire. Their two-inch tweeters and four-inch woofers deliver 10 watts per channel—clear, strong stereo fill sound. The speakers work up to 150 feet from the transmitter without loss of sound quality. TX1000 transmitter (works unlimited speakers) . . . \$69 \$7 S&H W440 wireless speaker (each) . . . \$89 \$9 S&H

Get the Chase HTS-1 half off (\$49) when you buy the W440 speaker system!



**Rear channel speakers.** For true audiophile-quality rear channel speakers, we offer the Recoton wireless satellite subwoofer system. This first-of-its-kind system combines a 10-inch rear-firing subwoofer with a pair of 25-watt satellite speakers. The subwoofer provides that distinctive "low-end punch" that you feel in movie theaters, while the satellites are designed to coincide



with surround sound processor specifications balance perfectly with the front speakers. WHT470 transmitter . . . \$69 \$7 S&H WHT421 wireless 50-watt subwoofer . . . \$299 \$24 S&H WHT462 pair of wireless 25-watt satellite speakers \$329 \$24 S&H

Get the Chase HTS-1 FREE when you buy the satellite subwoofer system!



With Nipper and Chipper providing on-screen prompts, viewers can use Open TV interactive technology to buy concert tickets, request additional information from advertisers, or order video-on-demand.

Several sample applications were demonstrated at WCES. Those included a ticket channel with interactive graphics overlaying its MTV-style programming, allowing viewers to choose and order tickets—even viewing an on-screen seating plan of the concert hall or stadium—to musical events; an interactive advertisement that invites the consumer to request further information; browse through a catalog, or order specific products; and a scrollable list of video-on-demand from which the viewer could order films or concerts. The video-on-demand application included full VCR-like control of the purchased video, allowing the viewer to fast forward, rewind, and pause it.

### THE BIG PICTURE

At an industry convention of the size and scope of the Consumer Electronics Show, it's often difficult to "see the forest for the trees." Roaming from booth to booth, seeing the newest offerings in audio, video, computer, software, multimedia, videogame, mobile electronics, home office, telephone, and other product categories, you begin to think that the only "big picture" is found at home-theater exhibits.

WCES 95 did have some unifying themes, however, suggesting trends and directions in which the industry as a whole might be heading. One was interactivity. In fact, all of the products and technologies we've mentioned so far are, to varying extents, interactive.

The other "buzzword" at WCES was "digital." The show's keynote address, given by Michael F. Schulhof, president and CEO of Sony Corporation of America, was titled "Defining the Digital Future."

Schulhof had some strong words on the

subject. "The world of electronics is poised to explode. Consumers are getting ready to embrace an all-digital entertainment and communications world. And those of us who are not prepared to meet this challenge will—in no uncertain terms—jeopardize their entire business."

He cited three technological advancements that make video digitization a practical reality: digital compression; Asynchronous Transfer Mode (ATM), which enables cable systems and phone companies to store huge quantities of digitized motion pictures and other interactive programming, to be delivered on demand; and "an easing of government regulatory control over both the cable and telecommunications industry... triggering a frenzied race to build the so-called Information Superhighway."

Also speaking at the opening of the WCES 95, FCC chairman R.E. Hundt said that as each of the five lanes of the information highway—satellite, cable, wireless, wired, and broadcast—is being converted from analog to digital signals, "digitization is the Morse code of the twenty-first century." He emphasized the importance of competition in delivering voice, video, and data products: "Competition will build the information highway in the fastest, cheapest, fairest, and most consumer-friendly way conceivable."

Schulhof challenged retailers to rise to the challenge of that competition. He urged them to "remain the critical point of contact—the interface—with the end user," by keeping up with, and introducing consumers to, such new technologies as the Digital Video Disc, or Video CD (V-CD).

### DIGITAL PRODUCTS TO WATCH

During WCES, Sony and Philips an-

ALPINE ELECTRONICS  
19145 Gramercy Place  
Torrance, CA 90501  
310-326-8000

**CIRCLE 50 ON FREE INFORMATION CARD**

AT&T CONSUMER PRODUCTS  
5 Wood Hollow Road, 3L11  
Parsippany, NJ 07054  
201-581-3000

**CIRCLE 51 ON FREE INFORMATION CARD**

CASIO, INC.  
570 Mt. Pleasant Ave.  
Dover, NJ 07801  
201-361-5400

**CIRCLE 52 ON FREE INFORMATION CARD**

CLARION SALES CORPORATION  
661 W. Redondo Beach Blvd.  
Gardena, CA 90247  
310-237-9100

**CIRCLE 53 ON FREE INFORMATION CARD**

DELCO ELECTRONICS  
CORPORATION  
One Corporate Center  
Kokomo, IN 46904-9005  
317-451-0658

**CIRCLE 54 ON FREE INFORMATION CARD**

DIRECTV  
P. O. Box 92424  
Los Angeles, CA 90009  
310-535-5062

**CIRCLE 55 ON FREE INFORMATION CARD**

DOLBY LABORATORIES  
100 Potrero Ave.  
San Francisco, CA 94103  
415-558-0200

**CIRCLE 56 ON FREE INFORMATION CARD**

ECLIPSE MOBILE ELECTRONICS  
19600 South Vermont Ave.  
Torrance, CA 90502  
310-532-3062

**CIRCLE 57 ON FREE INFORMATION CARD**

EIA/CEG  
2500 Wilson Blvd.  
Arlington, VA 22201  
703-907-7600

**CIRCLE 58 ON FREE INFORMATION CARD**

ETAK, INC.  
1430 O'Brien Drive  
Menlo Park, CA 94025  
800-295-MAPS

**CIRCLE 59 ON FREE INFORMATION CARD**

GEMSTAR DEVELOPMENT  
CORPORATION  
135 N. Los Robles Avenue  
Suite 870  
Pasadena, CA 91101  
818-792-5700

**CIRCLE 60 ON FREE INFORMATION CARD**

GENERAL INSTRUMENT  
6262 Lusk Blvd.  
San Diego, CA 92121  
619-535-2557

**CIRCLE 61 ON FREE INFORMATION CARD**

## NAMES AND ADDRESSES

JVC COMPANY OF AMERICA  
41 Slater Drive  
Elmwood Park, NJ 07407  
201-794-3900  
**CIRCLE 62 ON FREE INFORMATION CARD**

KENWOOD USA CORPORATION  
2201 E. Dominguez  
P. O. Box 22745  
Long Beach, CA 90801-5745  
310-639-9000  
**CIRCLE 63 ON FREE INFORMATION CARD**

MASPRO DENKOH CORP.  
Asada, Nisshin-Choh  
Aichi-Gun, Nagoya  
Aichi Pref. 470-01 Japan  
**CIRCLE 64 ON FREE INFORMATION CARD**

MICROSOFT CORP.  
One Microsoft Way  
Redmond, WA 98052  
206-882-8080  
**CIRCLE 65 ON FREE INFORMATION CARD**

MOTOROLA, INC.  
1303 Algonquin Rd.  
Schaumburg, IL 60196  
708-576-5000  
**CIRCLE 66 ON FREE INFORMATION CARD**

ONKYO USA CORP.  
200 Williams Dr.  
Ramsey, NJ 07446  
201-825-7950  
**CIRCLE 67 ON FREE INFORMATION CARD**

PANASONIC COMPANY  
One Panasonic Way  
Secaucus, NJ 07094  
201-348-7000  
**CIRCLE 68 ON FREE INFORMATION CARD**

PHILIPS INTERACTIVE MEDIA  
11111 Santa Monica Blvd.  
Los Angeles, CA 90025  
310-444-6600  
**CIRCLE 69 ON FREE INFORMATION CARD**

PIONEER ELECTRONICS USA  
2265 East 220th St.  
Long Beach, CA 90810  
213-PIONEER  
**CIRCLE 70 ON FREE INFORMATION CARD**

PRIMESTAR PARTNERS  
3 Bala Plaza West  
Suite 700  
Bala Cynwyd, PA 19004  
800-PRIMESTAR  
**CIRCLE 71 ON FREE INFORMATION CARD**

SAMSUNG ELECTRONICS  
AMERICA, INC.  
105 Challenger Road  
Ridgefield Park, NJ 07660  
201-229-4000  
**CIRCLE 72 ON FREE INFORMATION CARD**

SANYO FISHER (USA)  
CORPORATION  
21350 Lassen Street  
P. O. Box 2329  
Chatsworth, CA 91311-2329  
818-998-7322  
**CIRCLE 73 ON FREE INFORMATION CARD**

SHARP ELECTRONICS  
CORPORATION  
Sharp Plaza  
Mahwah, NJ 07430-2135  
201-529-8200  
**CIRCLE 74 ON FREE INFORMATION CARD**

SONY ELECTRONICS, INC.  
Consumer Products Group  
Sony Drive  
Park Ridge, NJ 07656  
201-930-1000  
**CIRCLE 75 ON FREE INFORMATION CARD**

STARSIGHT TELECAST  
39650 Liberty Street  
Third Floor  
Southborough, MA 01772  
508-460-1100  
**CIRCLE 76 ON FREE INFORMATION CARD**

SUN MICROSYSTEMS  
COMPUTER CORP.  
2250 Garcia Ave.  
Mountain View, CA 94043-1100  
415-960-1300  
**CIRCLE 77 ON FREE INFORMATION CARD**

THOMSON CONSUMER  
ELECTRONICS  
6000 North Sherman Drive  
MS27-214  
Indianapolis, IN 46201  
317-267-5000  
**CIRCLE 78 ON FREE INFORMATION CARD**

TOSHIBA AMERICA  
82 Totowa Road  
Wayne, NJ 07470  
**CIRCLE 79 ON FREE INFORMATION CARD**

TRIMBLE NAVIGATION  
645 North Mary Avenue  
Sunnyvale, CA 94088  
408-481-8000  
**CIRCLE 80 ON FREE INFORMATION CARD**

UNITED STATES SATELLITE  
BROADCASTING (USSB)  
3415 University Avenue  
St. Paul/Minneapolis, MN 55114  
612-645-4500  
**CIRCLE 81 ON FREE INFORMATION CARD**

VIDEOGUIDE, INC  
209 Burlington Road  
Bedford, MA 01730  
617-276-8953  
**CIRCLE 82 ON FREE INFORMATION CARD**

ZENITH ELECTRONICS CORP.  
1000 Milwaukee Ave  
Glenview, IL 60025  
708-391-8181  
**CIRCLE 83 ON FREE INFORMATION CARD**

nounced that their jointly developed Video CD system was complete, and that they planned to solicit support for the format from other major manufacturers. Each five-inch V-CD holds 7.4 gigabytes of data, allowing it to hold up to 135 minutes of MPEG-2 compressed digital video with CD-quality audio. Instead of two-sided play, as provided on competing digital video disc formats from companies including JVC, the Sony-Philips discs have two layers of programming encoded at different depth levels on the same side.

Philips sees the current V-CD format, which stores up to 74 minutes of MPEG-I video, as a way to increase the consumer appeal of its CD-i system. MGM/UA, Paramount, and Orion have licensed movies for the format, and, as of last fall, there were about 45 titles available on V-CD.

Sony and Philips also joined forces to create a set of basic specifications for CD Plus, compact discs that contain CD-ROM information along with digital audio. They can be played on a standard CD player for music only, but a CD-ROM multimedia player is required to access the additional data. Microsoft has agreed to support the CD Plus format and to provide authoring tools to the software industry.

Although they are partners in digital video, Sony and Philips remain competitors in the digital audio arena, pushing MiniDisc and Digital Compact Cassettes, respectively. At this point, however, the game seems to be pretty one-sided.



**Sanyo introduced the world's first AM/FM/CD/MD/cassette-equipped boombox, the MDC-100, at the Winter Consumer Electronics Show.**

WCES saw several MD introductions and lower prices on the latest generation of products. Sanyo exhibited the first AM/FM boombox to feature CD, MD, and cassette tape. The model MDC-100, which carries a suggested retail price of \$999.99, allows one-touch recording from CD to MD, and one-touch synchronized dubbing from CD to tape. Sony's \$599 MDX C150 car MD/receiver replaces a model with similar features and a \$999 price tag. And Sanyo is reducing the price of its three-disc in-dash MD changer/receiver by \$300, to \$1199. Kenwood announced plans to introduce car MD, and Eclipse plans to market an in-dash AM/FM/MD changer this spring.

In contrast, there were no new DCC

introductions at WCES, and no companies announced intentions to join the DCC camp. Marantz, however, plans to have some new home DCC recorders by the end of the year.

Also on the digital front, Dolby Surround AC-3 was being demonstrated at several WCES locations. "Digital Dolby," created by Pioneer Electronics in conjunction with Dolby Laboratories, replaces the right FM (analog) audio channel of a laserdisc with Dolby's AC-3 digital bitstream. The AC-3 bitstream provides five discrete channels of information—left, center, right, left surround, right surround—all full range (3 Hz to 20,000 Hz). An additional subwoofer channel provides the bass information found in movie soundtracks.

AC-3 is backward compatible; laserdiscs with AC-3 bitstreams will work as usual on any Dolby Surround-equipped home-theater gear. To hear the AC-3 version of a soundtrack, special equipment is required.

At least eight manufacturers at WCES 95 were supporting Digital Dolby. Among those, Yamaha demonstrated its RX-V2090 seven-channel A/V receiver, which is AC-3 ready and also provides multiroom capability. Pioneer showed prototypes of its top-of-the-line model VSX-DS3S A/V receiver, and it plans to offer this summer an added AC-3 decoder.

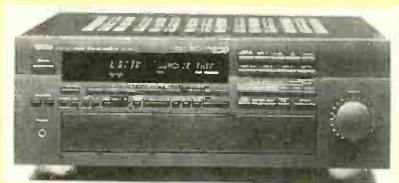

Yamaha's RX-V2090 audio/video receiver was one of several AC-3-ready products displayed.

Compact-disc changers are by no means a new product category, but new at WCES were lower prices for 100-disc changers—in the \$400 to \$600 range. Aiwa entered the 100-disc changer market with its DX-C100M, which allows quick direct access to any one disc and track, plus a variety of programming options. Another newcomer to the 100-disc changer market is Kenwood, whose two models feature RAM memory buffers for continuous music play even when changing between discs.

### IN THE RIGHT DIRECTION

One valuable reason to attend CES is to get a glimpse into the future through the new technologies demonstrated there. Each show has its share, ranging from fanciful, wishful thinking to prototypes that shape the industry.

For several years now, we've had the opportunity to survey various approaches



Aiwa's DX-C100M was one of a crop of reasonably priced 100-disc CD changers showcased at WCES.

to vehicle navigation and intelligent highway systems. It has been interesting to compare the different techniques that have been tried, to weigh the benefits and costs of the various navigation systems, and to place our bets on what form would finally be the one accepted by both the industry and the public.

The vehicle navigation systems demonstrations held this year, however, felt different. No longer did navigation systems seem like pie-in-the-sky technology still years away from becoming a real product category. Instead, navigation products looked real and ready to hit the market, and even earned their own spot at the show, in the newly created "Intelligent Transportation Systems Pavilion."

All of the systems demonstrated rely either wholly or partly on global-positioning system (GPS) satellites to track the



Navigation-system displays drew crowds of attendees who were interested in learning more about the technology.

vehicle location. Many of the systems use the GPS information to display the vehicle's location on a video moving map on an LCD screen inside the vehicle. Sony, Pioneer, and Panasonic were among those.

Sony's NVX-F15, for example, contains a five-inch, dash-mounted, color LCD screen; a GPS antenna; and a map-disc player. The antenna, a small disc about 3/4-inch thick and 3 1/2 inches in diameter, must be mounted where it will have a clear line of sight to the satellites. Normally, that would be on the roof of the vehicle, but it could be mounted inside the vehicle by a window as well.

The map-disc player contains the GPS receiver and a CD-ROM drive that plays removable and interchangeable map and database discs. The system is designed to conform to specifications established by the Navigation Research Association (NRA), a Japan-based organization that promotes hardware and software compliance among manufacturers. Map discs that conform to the standards will be interchangeable between navigation systems manufactured by different companies.

Bundled with the system is EtakGuide, a digital map database and software for navigation. Users are able to zoom in on areas of interest on the map, which moves to track vehicle location. The map database not only contains street information, but also the location of various attractions. For example, users can search for parks, lodging, shopping, restaurants, and more.

A wireless remote control is provided for controlling the on-screen menus. For safety, menus are not available while the vehicle is in motion, although the map can be displayed.

Other companies displaying NRA-compatible systems with Etak software include Kenwood, Sharp, Toshiba, Alpine, and Maspro Denkoh.

Pioneer showed its GPS-X77 GPS-based in-vehicle navigation system. The \$2800 GPS-X77 uses proprietary CD-ROM digital maps and includes route-planning capability and a synthesized voice that guides the driver. The combination GPS receiver and microcomputer is housed in a single DIN-sized chassis. The system includes a five-inch display and a wireless remote control. Eight zoom levels provide maps with varying details.

The CD-ROM database contains not only maps, but several data categories including shopping, government, entertainment, automotive, school, travel, food, services, medical, and more. An interesting tracking mode leaves a trail of dots on the screen to track your path—sort of a high-tech Hansel and Gretel. The tracks can be stored and recalled later.

Four aftermarket audio manufacturers—Alpine, Clarion, Eclipse, and



Sony's NVX-F15 vehicle-navigation system is compatible with standards established by the Navigation Research Institute. It consists of an integrated GPS receiver/CD-ROM drive and a 5-inch LCD video screen.



Pioneer's GPS-X77 uses a proprietary map database. The vehicle location is indicated on the moving-map display, and a synthesized voice calls out route-guidance instructions.

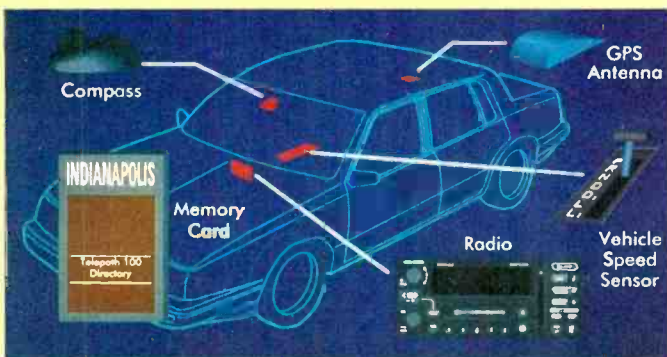

The Telepath 100 system from Delco Electronics supplies neither maps nor route guidance. Instead, it indicates the direction and distance to the destination.



Kenwood—introduced systems based on technology from Amerigon. The systems use digitized maps to determine travel routes. However, they don't display the maps. Instead, a voice directs drivers to their destinations. The voice-activated systems use the audio system's CD player to read the maps, and they use the audio system to deliver the travel instructions.

Delco Electronics demonstrated its Telepath 100 automotive navigation system. Unlike most other systems, the Telepath has neither a map display nor voice guidance. Instead, a display indicates the distance and direction (as the crow flies) to the destination. The navigation display doubles as the radio information readout. A heads-up display also allows the navigation information to be displayed on the windshield.

To use the system, the driver selects a destination from a menu. The system relies on the latitude and longitude coordinates that are in its database (which is stored on a PC card) and determined by the GPS receiver. An on-board compass and speed sensor are also used to determine the distance and direction to the destination. Because no digital maps are stored, the Telepath cannot suggest routes. If the vehicle is equipped with a cellular phone, however, the driver can take advantage of one-touch dialing to contact the destination for more detailed directions and, perhaps, to make room or dinner reservations.

Trimble Navigation, a leading supplier of marine navigation equipment demonstrated its Mobile GPS Intelligent Sensor 100 and Mobile GPS PCMCIA Card 110. The devices are intended for mobile professionals who already use a laptop computer. They work in conjunction with mobile maps published by several different companies. According to Trimble, the products are supported by more than a half-dozen major mapping programs.

The intelligent sensor 100 is a GPS receiver and antenna integrated in a single device. It communicates with a computer through its serial port. The PCMCIA Card 110, of course, plugs into the computer's

PC-card slot. A small, outboard GPS antenna is required.

### "NEATNESS" COUNTS

Walking around the show floor, we saw several new products that deserve mention here because they offer some "neat" features, new technology, or sensible improvements over previous models. Here are a few of our favorites.

Several were found at Pioneer's large exhibit. The CUB-1, a good-looking micro-cube system, offers "audiophile" features including bi-amping and a subwoofer/satellite speaker design. The split amplifier delivers 20 watts RMS to the satellites and 40 watts of power to the subwoofer. The CCS-LVI is a "home-theater mini system"—a bookshelf stereo that includes a laserdisc player. And Pioneer debuted its Intelligent System Control in this year's A/V receiver line. The remote-controlled on-screen programming capability integrates multi-brand home-theater setups, with a graphic user interface that allows users to create "macros" for one-touch control. For instance, to view a laserdisc, one button could be programmed to turn on the TV, A/V receiver, and laserdisc player, select the proper source and audio mode, and start the laserdisc playing.



Pioneer's CUB-1 "mini-cube" system features a subwoofer that can be tucked out of sight, and two satellite speakers ideal for wall-mounting.

Thomson also added an on-screen graphic user interface to its new ProScan line of TV's. With RCA's canine mascot, Nipper, as a guide, the user can "move" around a screen resembling a typical family room to easily access convenience features and set-up procedures.

With the exception of one two-head model, every VCR in Sharp's 1995 lineup incorporates a 19-micron video head, which provides high picture quality when recording in the EP mode, the slowest recording mode found on most VCR's. While the difference in quality is dramatic, the prices remains reasonable, ranging from \$350 to \$450 (suggested retail).

Casio Computer Company and Phone-Mate introduced the LT-70P Videophone System, which uses ordinary phone lines to transmit and receive audio and normal sequential video frames or high-resolution color video still frames simultaneously.



Every 4-head and Hi-Fi VCR in Sharp's 1995 lineup features a 19-micron video head system that significantly improves the picture quality of video recording in EP mode.

Based on a technology called CATN, for Casio Talkvision Network, the Videophone System uses a television as an output device, or it can be connected to a PC. The picture is updated every 3.5 seconds without interrupting the conversation. It is expected to be available in June at a suggested retail price of \$1280.

Onkyo's Integra TX-SV727DSP audio/video receiver caught our attention be-



Casio's LT-70P Videophone System uses ordinary analog phone lines to send and receive simultaneous voice and picture via the user's TV or PC.

cause it incorporates Motorola's 24-bit 56004 digital signal processor for performing digital Dolby Pro Logic decoding and producing various soundfield modes.

Thanks to the increased performance of the processor, the digital soundfield-processing modes can be made more realistic. For example, the simulated reverberations and reflections that are added in processing can be much closer to what would be heard at a live performance.

Panasonic introduced a personal intelligent communicator based on Magic Cap software and Telescript technology. The user operates the communicator via its touch-sensitive, high-resolution LCD screen. Simply touch an icon (the on-screen Rolodex, for example) and the desired application is launched.

The real strength of the product is in its ability to receive E-mail, thanks to the inclusion of AT&T PersonaLink Services. The network, launched last September, allows subscribers to perform many routine communication activities with the help of electronic "intelligent assistants." PersonaLink provides gateway connections to the Internet, X.400-based mail services, and more.

### INNOVATIONS

We weren't the only ones to single out some interesting products at WCES. The winner of the Innovations '95 awards were announced during the Winter Consumer Electronics Show, and exhibited in a special pavilion. The Innovations Design and Engineering Honors Program recognizes eight broad categories of hardware; a separate Innovations Software Showcase honors innovative home and business software products, games, multimedia, and educational products. This month's Wish List consists of assorted products honored at Innovations '95.

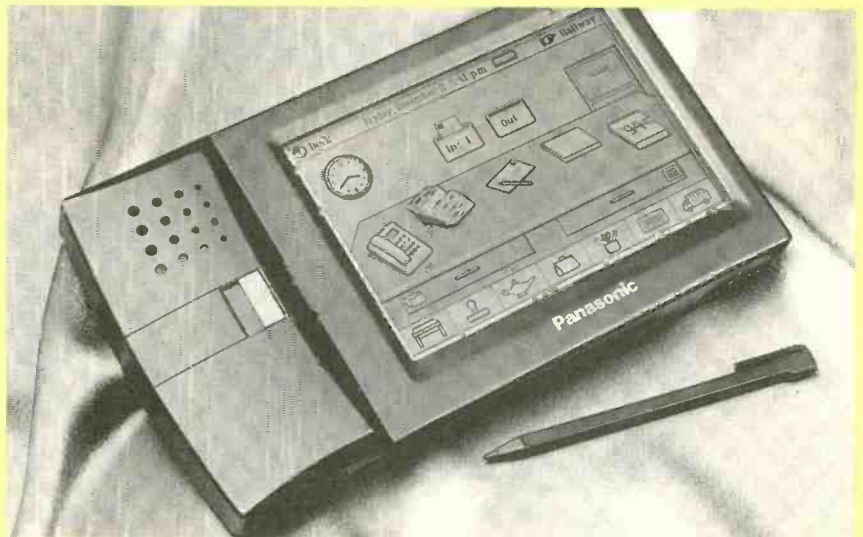

Panasonic's personal intelligent communicator is based on Magic Cap software and Telescript technology.

# ELECTRONICS WISH LIST

## Digital Answering System

Families whose phones seem to ring ceaselessly will appreciate the model AN-8420 telephone answering system from *Cobra Electronics Corp.* (6500 W. Cortland St., Chicago, IL 60635). The answering system features three individual mailboxes and one general mailbox so that the family members can keep track of their own calls. User-selected access codes help to ensure privacy. The system stores both the greeting message and the incoming messages digitally in semiconductor memory. Other features include remote message retrieval and automatic time and day stamping of messages. A two-speed message-playback capability allows long-winded messages to be reviewed quickly. To ensure that messages are not lost during a power failure, the answering system features a 9-volt battery-backup system. Up to 30 minutes can be recorded, and the LED display indicates not only how many messages have been received, but the remaining recording capacity as well. Price: \$129.95.

CIRCLE 173 ON FREE INFORMATION CARD

## Video Modem

The VR-MSIU *Viewcamteleport* from *Sharp Electronics Corp.* (Sharp Plaza, Mahway, NJ 07430) is perfect for those occasions when an ordinary phone call won't do. The *Viewcamteleport* allows still video images to be sent over the phone lines to another *Teleport* device. Designed to interface elegantly with the Sharp *Viewcam* camcorder, the *Viewcamteleport* can transmit either recorded or "live" video still images. Because the device has audio and video input and output jacks, users are not required to use Sharp's *Viewcam*, but can use other video equipment. The *Viewcam*, however, has the convenient advantage of having a built-in LCD video screen, and a "no-wires" interface. A built-in semiconductor memory stores up to ten images for later transmission; ten received images can be stored also. Finally, the device can also act as an audio/video telephone answering machine for unattended recording. Price: \$899.95

CIRCLE 174 ON FREE INFORMATION CARD

## Sweet Edit Suite

Advanced videographers will appreciate the new *Edit Suite* A/B-roll edit controller from *Videonics* (1370 Dell Avenue, Campbell, CA 95008). The *Edit Suite* allows users to create video productions that rival those produced in professional studios. The controller supports Sony Control-L, Panasonic Control-M, RS-232, RS-422, and infrared VCR control protocols. It also supports all major timecode formats including RC, VITC, and LTC. Video productions can be assembled from either sequential or random scenes. The desired scenes can be found and marked with the aid of the weighted jog/shuttle control, or their time locations can be entered manually through the keyboard. The locations of up to 250 scenes can be stored in the controller's memory, and the edit-decision lists can be transferred to a computer in an industry-standard CMX 3400-compatible file. Although the controller can be used by itself, it also works with any GPI-compatible mixer, titler, and other equipment. For example, when used in conjunction with the *Videonics* MX-1 digital video mixer, the *Edit Suite* can control up to 4 play VCR's and 1 record VCR. Price: \$699

CIRCLE 175 ON FREE INFORMATION CARD

## THX at Home

THX certification was designed to ensure that the sound reproduced in a home theater is just what the movie director wanted. *Kenwood's* (P.O. Box 22745, Long Beach, CA 90801) model KR-X1000 A/V receiver, with its THX certification and Dolby Pro Logic decoding, is designed to turn any home theater into a movie screening room. The receiver delivers up to 100 watts per channel for left-, right-, and center-channel speakers, and 50-watts to each surround speaker. In stereo mode, the receiver delivers up to 120 watts per channel. An on-screen display and a universal pre-programmed remote control allow viewers to conveniently operate their entire home-theater and stereo systems at the touch of a button. Price: \$1100.

CIRCLE 176 ON FREE INFORMATION CARD



All-Digital Telephone Answering System



Multimedia Telephone Camcorder



Video A/B Roll Editor



Home-Theater A/V Receiver

# ELECTRONICS WISH LIST



60-Disc CD Management System

## CD Management System

The success of the Fisher (21350 Lassen St., Chatsworth, CA 91311) *Studio 24* has inspired the company to introduce a CD player with 2-1/2 times the capacity: the *Studio 60*. More than just a changer, the Studio 60 is a CD management system that allows users to store and play back up to 60 discs by name and/or category—"Mom" and "Jazz," for example. Up to 60 user-programmed categories and subcategories can be stored in the changer's non-volatile memory, and they are automatically alphabetized. Convenience features such as track programming, intro scan, and random play can be used on a single CD, a category, a subcategory, or all stored CD's. The Studio 60 also adds optical digital outputs. Price: \$499.95.

CIRCLE 177 ON FREE INFORMATION CARD



Powered Home-Theater Speaker System

## Was that an Earthquake?

Nothing is more important to the home-theater experience than the speaker system. But the integration of audio and video systems is not always easy or convenient—especially when a subwoofer is involved. That's why the *Sensurround Powered System 6* was developed by Cerwin-Vega (555 Easy Street, Simi Valley, CA 93065). The system, with its built-in power amplifiers, does away with the need for a second, dedicated audio system. The System 6 consists of the HT-MDC two-way center channel speaker, two-way HT-S5 satellite speakers, and HT-10PWR 10-inch powered subwoofer with remote control. The HT-10PWR contains a 100-watt amplifier. The center-channel speaker is magnetically shielded so that it can be placed directly on top of a TV or monitor. Price: \$1835

CIRCLE 178 ON FREE INFORMATION CARD



Futuristic Telephone

## That's a Telephone?

Bored by ordinary-looking telephones? The new super-modern *Beocom 1600* telephone from Bang & Olufsen (1200 Business Center Drive, #100, Mount Prospect, IL 60056) should provide a change of pace. From the curved keypad on the right side of the unit to the ultralight vertical handset, the phone sure looks unique. It contains a healthy assortment of convenient features, including two quick-call keys for emergencies, redial for the last six numbers, four distinctive ringing tones, a talk-time monitor, and a ten-number memory for frequently-called numbers. Price: \$199.

CIRCLE 179 ON FREE INFORMATION CARD



Travelling CD Player

## On the Road Again

Although portable CD players have traditionally been easy to carry from one place to another, they have not provided adequate performance when used on-the-go. However, the *DX-F71* portable CD player from Onkyo U.S.A. (200 Williams Drive, Ramsey, NJ 07446) is designed with "shock-proof" features that make it especially suitable for mobile use. The anti-shock design includes a suspension that provides mechanical isolation coupled with electronic anti-shock protection, where three seconds of data from the CD is stored in semiconductor memory. If the CD player laser mistracks because of external mechanical shock, the three-second buffer memory allows the player to correct itself without interrupting the audio output. The DX-F71 ships with a pair of headphones, a rechargeable battery, power adapter, a 12-volt cigarette-lighter adapter, and an adapter that allows the CD player to play through an in-dash cassette player. The LCD is backlit for night-driving use. Price: \$240.

CIRCLE 180 ON FREE INFORMATION CARD



# Take this GIANT CIRCUIT LIBRARY for only \$14.95

when you join the *Electronics Engineers' Book Club*®

## THE ENCYCLOPEDIA OF ELECTRONIC CIRCUITS —Vols. 1-4 by Rudolf F. Graf

**Hundreds of circuit ideas alphabetically arranged — from Alarm circuits to Zero crossing detector circuits!**

"... includes schematics for the latest electronics circuits from industry leaders..."

—Popular Electronics

Turn to this comprehensive circuit library for hundreds of project ideas... valuable troubleshooting and repair tips... and concise pinout diagrams and schematics. In each volume you'll find more than 700 electronic and integrated circuits and 100+ circuit categories right at your fingertips to give you ideas you can use on the job or at your workbench.

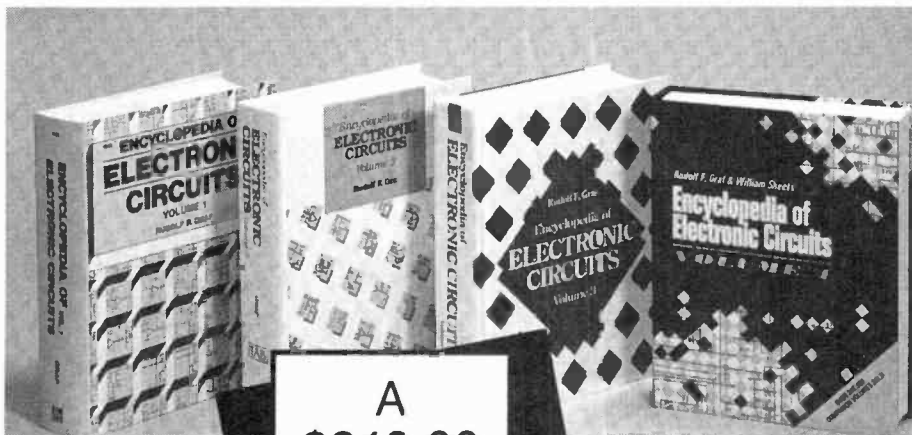

A  
\$240.00  
Value!

3,088 total pages 4,490 total illustrations

Book No. 5861488 Hardcover

If coupon is missing, write to: Electronics Engineers' Book Club, Blue Ridge Summit, PA 17294-0860

### **ELECTRONICS ENGINEERS'** BOOK CLUB®

Blue Ridge Summit, PA 17294-0860

**YES!** Please send me *The Encyclopedia of Electronic Circuits—Vols. 1-4* (5861488), billing me \$14.95 plus shipping/handling & tax. Enroll me as a member of the **Electronics Engineers' Book Club** according to the terms outlined in this ad. If not satisfied, I may return the books within 10 days and have my membership cancelled.

Name \_\_\_\_\_

Address \_\_\_\_\_

City \_\_\_\_\_

State \_\_\_\_\_

Zip \_\_\_\_\_ Phone \_\_\_\_\_

Valid for new members only, subject to acceptance by EEBC. Canada must remit in U.S. funds drawn on U.S. banks. Applicants outside the U.S. and Canada will receive special ordering instructions. A shipping/handling charge & sales tax will be added to all orders.

PIIF955

### As a member of the **Electronics Engineers' Book Club** . . .

. . . you'll enjoy receiving Club bulletins every 3-4 weeks containing exciting offers on the latest books in the field at savings of up to 50% off of regular publishers' prices. If you want the Main Selection, do nothing and it will be shipped automatically. If you want another book, or no book at all, simply return the reply form to us by the date specified. You'll have at least 10 days to decide. If you ever receive a book you don't want due to late delivery of the news, you can return it at our expense. And you'll be eligible for **FREE BOOKS** through the Bonus Book Plan. Your only obligation is to purchase 3 more books during the next 2 years, after which you may cancel your membership at any time.

Publisher's price shown. ©1995 EEBC



# Elenco Electronics FG-500K Function- Generator Kit



CIRCLE 119 ON FREE INFORMATION CARD

*Build a valuable addition to any hobbyist's workbench.*

If you are reading this magazine, the odds are good that you are an electronics hobbyist. Most electronics hobbyists engage in a variety of activities, including designing circuitry, building projects, and troubleshooting and servicing balky electronics gear.

Another popular pastime is kit building. An electronics kit provides the hobbyist with everything he or she needs to build a useful or entertaining device. However, while devices that merely entertain are fun, the enjoyment one gets from building something that fills an important and useful role in our hobby or elsewhere can last for years. Among that class of projects are things like clocks, amplifiers, and test gear.

**Features.** One piece of test gear I recently built was the \$39.95 Elenco Electronics FG-500K Function Generator kit. The unit is also available completely assembled, as the FG-500, for \$54.95.

A function generator is a device that generates an output signal for use with other circuitry or equipment.

Different kinds of circuitry require different kinds of input signals. A sine-wave might be used to test analog circuitry. For example, in an audio amplifier, one would expect to find a signal of the same frequency at different points in the circuit; of course, the signal would have different amplitudes at different points. The frequency response of an amplifier could also be tested by injecting signals at the input and checking for an output of the same frequency.

A square wave can be used to clock a digital-logic circuit. By varying the clock signal, a logic circuit can be made to run at different speeds. There are many other possible applications for a function generator, but you get the point—a function generator is a valuable tool on the test bench.

While the FG-500K is not the kind of instrument that would be used in a government laboratory, it is certainly adequate for the average electronics hobbyist. The unit can generate sine, square, and triangle waveforms. The frequency of the output can be varied from 0.1 Hz to 200 kHz. Frequency stability is about 10 ppm/°C. The

FG-500K's output is variable from 0 to 3 volts, with an output impedance of about 600 ohms. The unit can be powered from a 9-volt battery or a 9- to 18-volt DC supply. The sine output has a distortion of less than 1%. The square wave has a symmetry error of less than 5% at 1 kHz, with a rise and fall time of less than 300 nanoseconds at 1 kHz. Finally, the triangle wave has a linearity error of less than 1% up to 100 kHz.

**Using The FG-500K.** The FG-500K is housed in a rugged hand-held case with an aluminum front panel. A 9-volt battery can be installed inside the case. But for bench-top use, there's also a DC-input jack that can power the unit from any 9- to 18-volt DC supply. A switch in the center of the front panel turns power on and off.

Three output jacks are provided: a combination sine/triangle (labeled saw) output, a square-wave output, and common (or ground). The FG-500K continuously outputs both square waves and either sine or triangle waves. A switch on the front panel selects either sine or triangle

# Be a high-paid computer service technician

Train With NRI — America's #1 Choice in Computer Training

Only NRI gets you inside a powerful 486DX2/66 MHz Intel-based computer system you keep—giving you the hands-on experience you need to work with, troubleshoot, and repair today's most widely used computer systems. There's no more affordable way to start a money-making career, even a business of your own, as a computer service technician.

## Rely on the original -- NRI

Over a decade ago, NRI pioneered at-home training in computer servicing. Today, NRI offers the *only* computer servicing course with real-world experiments using state-of-the-art computer equipment and professional diagnostic tools.

There's no doubt about it: Working "hands-on" with all the most sought-after technology gives you practical skills and lasting confidence. Performing key tests and demonstrations, you're able to see for yourself how things work, what can go wrong, and how you can fix it.

## Train with and keep the most advanced computer in home study today

NRI's unique training has you explore a top-notch computer system and its peripherals, beginning with the 486DX2 Intel CPU and Pentium Overdrive-ready motherboard.

Your computer features 8 meg RAM, 420 meg hard drive, and fax/modem to store, receive, and send huge amounts of data.

You'll also appreciate the brilliant display of your Super VGA color monitor, the drama of your CD-ROM drive and 16-bit sound card, as well as the cutting-edge technology of Windows 95.

Plus learn to use Ultra-X professional diagnostic hardware and software to pinpoint problems on any IBM-compatible machine.

## No experience needed, NRI builds it in

Studies show that jobs for computer service technicians will be up by 38% in the next 10 years. Even if you've never worked with



## YOU GET EVERYTHING YOU NEED FOR SUCCESS

- **POWERFUL 486DX2/66 MHz INTEL-BASED COMPUTER**  
Features IBM compatibility, 8 meg RAM, Pentium Overdrive-ready motherboard, and math coprocessor
- **SUPER VGA COLOR MONITOR**  
With .28mm dot pitch for high-resolution graphics and tilt-swivel base
- **420 MEG HARD DRIVE**  
For greater data storage capacity and data access speed
- **EXCITING MULTIMEDIA PERIPHERALS**  
Double-speed CD-ROM drive, 16-bit sound card with speakers, and reference CD
- **FAX/MODEM**  
Gives you access to a world of on-line information
- **ULTRA-X DIAGNOSTIC PACKAGE**

R.A.C.E.R. plug-in card and

QuickTech-PRO software help you detect problems on virtually all IBM-compatible machines, even if computer is 5% operational.

- **NRI DISCOVERY LAB**  
Complete breadboarding system lets you design and modify circuits, diagnose and repair faults
- **DIGITAL MULTIMETER**  
Professional, hand-held test instrument for quick and easy measurements
- **WINDOWS 95**  
The time-saving operating system that everyone will be using tomorrow

computers before, NRI's interactive training builds such a solid foundation of know-how and practical experience that tomorrow's jobs can be yours.

Right from the start, hands-on experiments reinforce concepts presented in NRI's bite-sized lessons. And because your work is reviewed by your personal instructor, you know for certain that you can apply theory to real-world demands.

## FREE NRI catalog tells more

Send today for your free, full-color catalog describing every aspect of NRI's innovative computer training in the up-and-coming field of your choice.

If the coupon is missing, write to: NRI Schools, McGraw-Hill Continuing Education Center, 4401 Connecticut Avenue, NW, Washington, DC 20008.

IBM is a registered trademark of the IBM Corporation. R.A.C.E.R. and QuickTech-PRO are registered trademarks of Ultra-X, Inc.

## SEND TODAY FOR FREE NRI CATALOG!



McGraw-Hill Continuing Education Center  
4401 Connecticut Avenue, NW, Washington, DC 20008



Check one FREE catalog only

MICROCOMPUTER SERVICING

- Computer Programming
- TV/Video/Audio Servicing
- Desktop Publishing & Design

- LAN Specialist
- Bookkeeping and Accounting
- Programming in C++ with Windows

Check for details on career courses approved under GI Bill

Name (please print)		Age	
Address			
City		State	Zip

Accredited Member, National Home Study Council

18-0595

# Measure It All!

## The DMM/LCR Meter/ Frequency Counter. All in One.

**T**roubleshoot down to the component level — any component! Verify poorly marked parts, test for tolerances and damage. Wavetek's new DM27XT is not only a full-function DMM, but also includes complete inductance, capacitance, and frequency measurement capabilities.

- **Wide LCR range:**  
10  $\Omega$  to 2000 M $\Omega$   
10 pF to 2000  $\mu$ F  
100  $\mu$ H to 20 H
- **Autoranging frequency meter** 10 Hz to 20 MHz
- **Ac and dc current to 20 A**
- **Logic test, diode test, max reading hold, continuity beeper, input warning beeper, fused input protection, battery saver**

Consolidate your test bench with one meter that does it all — Wavetek's high-performing, full-function XT Series DMM. It's all in one compact, rugged, field-ready package with a big 0.7-inch, 3 1/2-digit display. Insulated probes and alligator clip leads are included, and there is a huge selection of accessories, including current, rf and HV probes, temperature converters, holsters, and cases. Ask for Wavetek DMMs. They're the meters to pick when you have things to fix.



**\$119<sup>95</sup>**

Other XT Series DMMs from \$89.95

U.S.A.: (619)279-2200  
Europe: (44/243) 531323  
Asia Pacific: (852)865-1903

©1993 Wavetek Corporation

CIRCLE 168 ON FREE INFORMATION CARD



**WAVETEK**

waves to be output at the sine/saw jack shared by both.

A third switch on the front panel multiplies the output by 1, 100, or 10,000. That, in combination with a frequency-control potentiometer, allows the unit to output frequencies from 0.1 Hz to 200 kHz. An amplitude-control potentiometer sets the amplitude, or voltage level of the output.

**The Kit.** Even though one can purchase the unit completely assembled, many readers of this magazine will want to build it from a kit. While an avid builder will probably complete this kit in one evening, there is enough here to keep a novice busy for perhaps two nights.

Fortunately, the instruction manual included with the kit is simple enough for any hobbyist to follow. Diagrams of all components are included to help the builder identify the different parts. Instructions for identifying resistor and capacitor values are also included, as are soldering tips.

All components mount on a single PC board. The builder will gain experience working with resistors, capacitors, semiconductors, wiring, controls, and jacks. While the input jacks mount on the front panel and are wired to the circuit board, the other controls mount on the board and protrude through the front panel.

After a thorough inspection of one's handiwork, an oscilloscope is needed to make sure the FG-500K is operating properly. Of course, anyone with a need for a function generator should also have access to an oscilloscope, as the two go hand in hand. Should any problems arise in the operation of the unit, tips on troubleshooting are also provided. The manual also includes an explanation of how the FG-500K's circuitry operates, along with a schematic of the circuit.

For more information on the FG-500K function-generator kit, contact Elenco Electronics at the address given below, or circle No. 119 on the Free Information Card. ■

### FOR MORE INFORMATION

**Elenco Electronics, Inc.**  
150 W. Carpenter Avenue  
Wheeling, IL 60090  
Tel. 708-541-3800

# THINK TANK

By John J. Yacono  
Technical Editor  
Windows Magazine

## Shop Equipment

I've been saving some particularly involved but worthy letters for a column when I didn't have enough time to write a tutorial. Well, thanks to a pretty nasty case of the flu, this column turned out to be the one. My apologies to those seeking the usual tutorial, but I hope that you understand. If it's any consolation, the following letters present some well-thought-out shop equipment.

### ULTRASONIC TESTER

I have a circuit I would like to share with you and

your readers, and later I would like to ask a favor of you and/or the staff of **Popular Electronics**. The circuit complements a simple infrared remote-control analyzer I believe I saw in the June 1992 issue of **Popular Electronics**.

My circuit submission is an ultrasonic remote-control tester (see Fig. 1) that is rather simple in operation. It amplifies high-frequency sound and converts it to something that you can hear. Most ultrasound remote controls produce a continuous 40–60-Hz tone

when a particular button is pressed; each button invokes a slightly different frequency. My unit divides the received frequency by 10. For example, if the received frequency is 45 kHz, the output will be 4.5 kHz.

The circuit works like this: MIC1 (a high-impedance crystal or ceramic unit) picks up the ultrasound signal and converts it to a low-level electrical voltage. Components R1 and C1 form a high-pass filter. Capacitor C2 provides input coupling and DC isolation for the first amplification stage. Resistors R2, R3, and capacitor C3 provide a stable reference voltage for the single-supply op-amps. Resistor R4 provides negative feedback to DC balance amplifier U1-a, one half of an LM358 dual CMOS IC. Parts C4, R5, C6, R6, and U1-b (the second stage) provide additional filtering and amplification. The two stages provide enough sensitivity for the unit to work well at up to ten feet from the source.

Capacitor C6 provides input coupling and DC isolation for Q1. Components R7, D1, and C7 provide a stable 5-volt supply for Q1 and U2 (a 74L590 TTL IC). Transistor Q1 serves two purposes: First, it provides wave shaping for U2. Second, and most important, it converts the CMOS-level signals to a nice 5-volt TTL signal for input to U2. That IC is configured as a symmetrical decade counter (divide-by-ten device).

Resistor R11 provides current limiting for U2's input; transistor Q2 boosts the signal back to a 9-volt level and drives BZ1, a piezo ele-

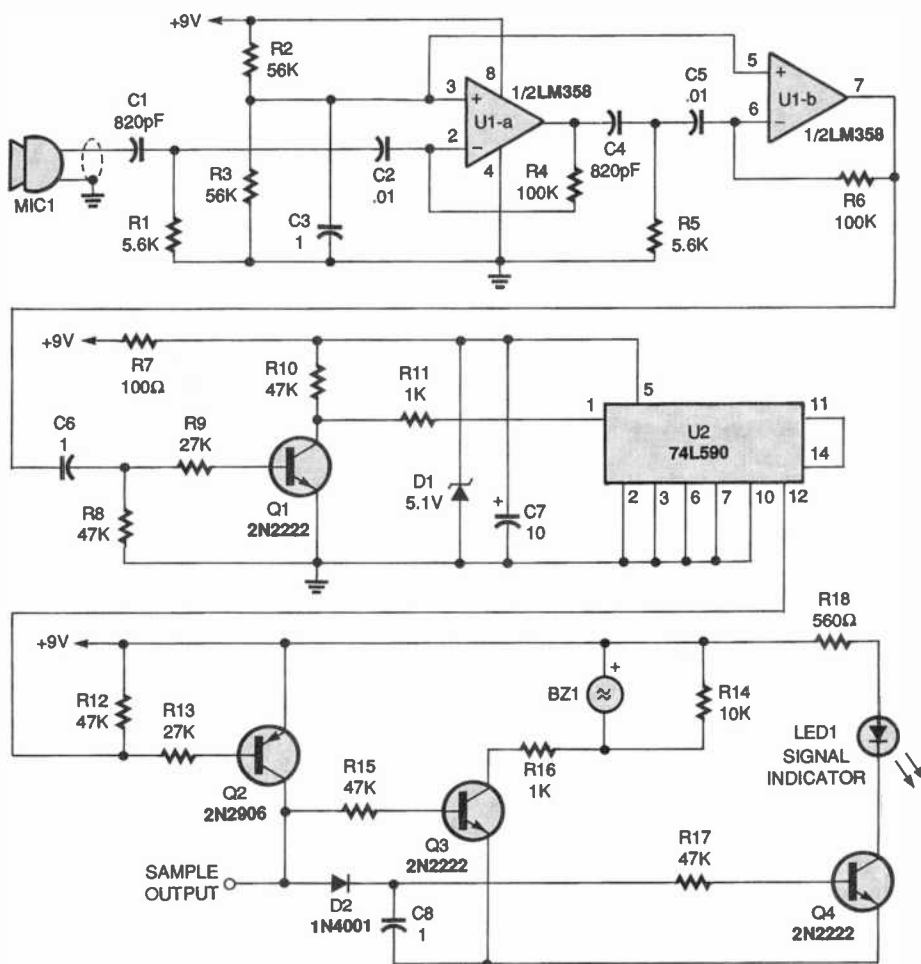

Fig. 1. Like fiddling with ultrasonic remotes? This circuit converts their signals into audible tones.

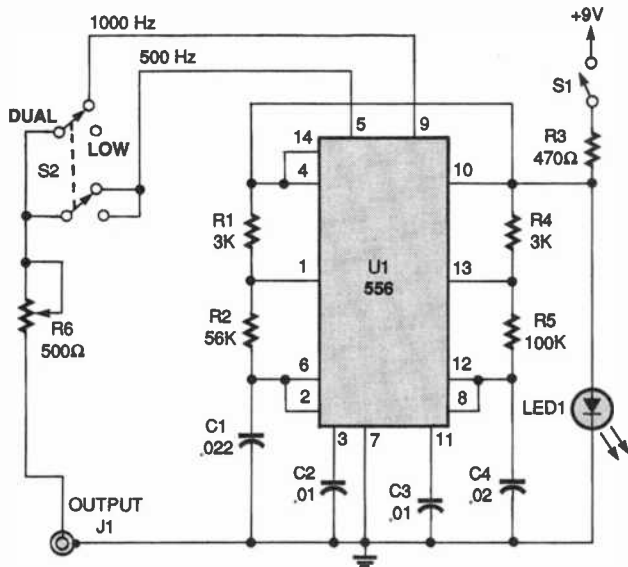

Fig. 2. This dual-tone generator can insert a distinctive tone in the audio sections of a circuit under test. That way you can work your way back from the speaker, stage-by-stage, to locate a faulty section.

ment. I would not recommend using a standard speaker, because the sound would be distorted and the voice coil would not last long. The symmetrical output of U2 requires ten pulses to go high and ten more to go low again. If it stops receiving pulses while the output is high, the output will stay high until something happens to change it (either the power is turned off or more input pulses are received). That won't bother a piezo sounder much, but would surely fry a speaker's voice coil!

The piezo sounder I used is from a discarded toy, but you can obtain one from Radio Shack and many other sources. The sounder will work best if it is fastened to your project box with a thin strip of double-sided tape around the rim and then vented through the lid with a small hole in the center.

The unit functions well and thoroughly rejects low-frequency noise. Each key on a remote makes it's own unique tone through the

unit. You can use the sample output to feed a frequency counter and determine the original frequency; just multiply the reading you get by ten.

As for the favor I mentioned earlier, I would like to know where I can get a copy of *Engineer's Notebooks* by Forrest Mims III. It was originally sold by Radio Shack, part #276-5001 in 1980. They (Radio Shack) no longer carry it and can not help me locate a copy.

Thank you sincerely.

—Christopher Fullerton, Reynolds, IN

Thank you for your circuit. If anyone out there has a copy of the book, drop me a line and let me know what Christopher can do to purchase it from you or get a photocopy.

### DUAL-TONE GENERATOR

I bought much of my test equipment, but lacked a two-tone signal generator useful for repairing CB radios. Seeing how I am on a limited budget (and my wife doesn't want me to spend a lot of money on

"toys"), I set out to build my own.

Looking through many books, I found lots of single-tone, but no dual-tone, generators. I then grabbed a pencil and paper and drew up two separate signal generators. When they were finished, I swapped a 556 timer in place of the two 555 timers in my design. The result is shown in Fig. 2.

Pins 2 and 6, and 8 and 12 are tied together so that each section triggers itself and acts as an oscillator.

Due to the low number of support components and the simplicity of the unit, I assembled it on one half of a Radio Shack 276-159 dual IC board. The LED, 500-ohm potentiometer, and the switches were mounted to the front panel of a Radio Shack 270-253 metal box. I used an RCA connector for the output. A test probe with an alligator clip and a 9-volt battery were all that were needed to finish the unit.

—David Hickman, St. Louis, MO

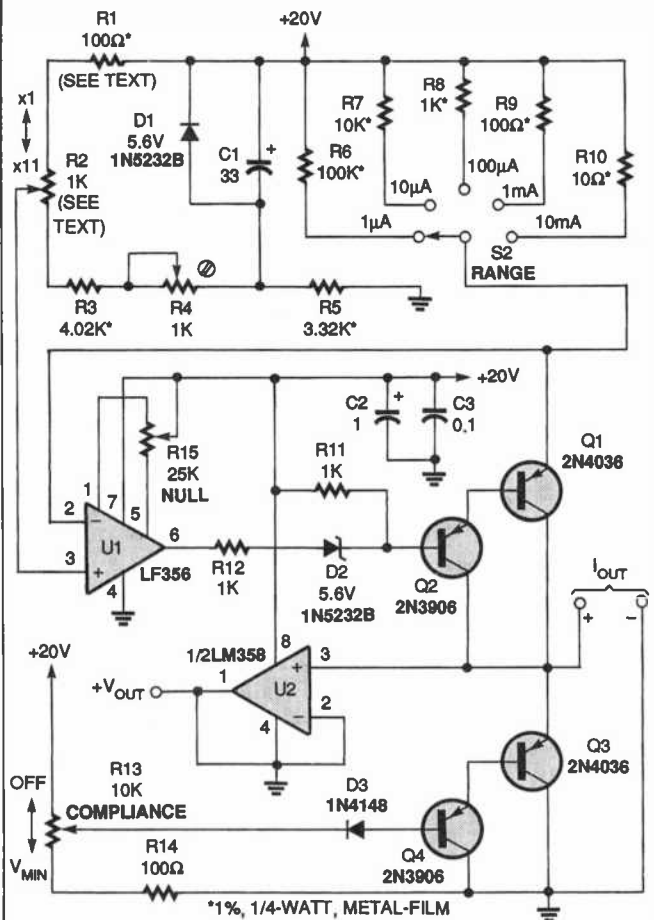

Fig. 3. A true precision instrument, this current generator is just what everyone needs to characterize semiconductors. It even includes a compliance section that prevents component damage.

Components C1, R1, and R2 set the frequency of the high tone, while C4, R4, and R5 set the low-tone. Potentiometer R6 sets the output level.

Well done. At first your use of S2 to mix frequencies threw me, but I understand it now. Placing a resistor between each output (pins 5 and 9) and S2 will prevent

the outputs from "pulling" at each other in dual-tone mode. That should improve the unit's battery life.

## PRECISION CURRENT SOURCE

There's no doubt about it, a variable current source can be an extremely handy device to have on your test bench! It can be used to test LED's, laser diodes, Zener diodes, and to test/ identify bipolar transistor polarities and pin-outs. Also, it can help identify the range and DC resistance of analog panel meters, among other things.

As you can see by the circuit diagram shown in Fig. 3, the design is fairly simple and easy to build. Resistors R6 to R10 set the minimum current on each range and can be matched to  $\pm 0.1$  percent with a multimeter if desired. That will give you an overall accuracy of about  $\pm 0.2$  percent. Without matching, you can expect about  $\pm 2.0$  percent or better. Potentiometer R2 is a ten-turn precision unit with a 15-turn counter on its shaft, which is set at 1.00 in its full counter-clockwise position. That is the range multiplier, which gives a range of  $\times 1$  to  $\times 11$  for each position of S2, the range switch, yielding a total range of 1.0  $\mu\text{A}$  to 110 mA.

Components Q3, Q4, D3, R13, and R14 adjust the output-voltage compliance from a maximum of about 18.5 to a minimum of 1.0 volts. Integrated circuits U1 (an LF356) and U2 (an LM358) were selected for highest performance—use no substitutes for them! Measure the actual resistance of R2 and select R1 to be exactly 10 percent of R2's value. Although layout is not critical, use 22-gauge wire for all connections to

(Continued on page 94)

## TIPS FOR MAIL ORDER PURCHASE

It is impossible for us to verify the claims of advertisers, including but not limited to product availability, credibility, reliability and existence of warranties. The following information is provided as a service for your protection. It is not intended to constitute legal advice and readers are advised to obtain independent advice on how to best protect their own interests based upon their individual circumstances and jurisdictions.

**1. Confirm price and merchandise information** with the seller, including brand, model, color or finish, accessories and rebates included in the price.

**2. Understand the seller's return and/or refund policy**, including the allowable return period, who pays the postage for returned merchandise and whether there is any "restocking" or "return" charge.

**3. Understand the product's warranty.** Is there a manufacturer's warranty, and if so, is it for a U.S. or foreign manufacturer? Note that many manufacturers assert that, even if the product comes with a U.S. manufacturer's warranty, if you purchase from an unauthorized dealer, you are not covered by the manufacturer's warranty. If in doubt, contact the manufacturer directly. In addition to, or instead of the manufacturer's warranty, the seller may offer its own warranty. In either case, what is covered by warranty, how long is the warranty period, where will the product be serviced, is there a charge for service, what do you have to do to obtain service and will the product be repaired or replaced? You may want to receive a copy of the written warranty before placing your order.

**4. Keep a copy of all transactions**, including but not limited to cancelled check, receipt and correspondence. For phone orders, make a note of the order including merchandise ordered, price, order date, expected delivery date and salesperson's name.

**5. If the merchandise is not shipped within the promised time**, or if no time was promised, within 30 days of receipt of the order, you generally have the right to cancel the order and get a refund.

**6. Merchandise substitution** without your express prior consent is generally not allowed.

**7. If you have a problem with your order or the merchandise**, write a letter to the seller with all the pertinent information and keep a copy.

**8. If you are unable to obtain satisfaction from the seller**, contact the consumer protection agency in the seller's state and your local Post Office.

If, after following the guidelines, you experience a problem with a mail order advertiser that you are unable to resolve, please let us know. Write to Advertising Department, Gernsback Publications Inc., 500B Bi-County Blvd. Farmingdale, NY 11735.

Be sure to include copies of all correspondence.

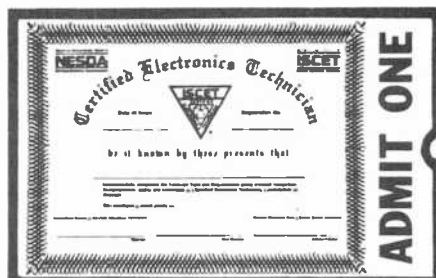

## Your Ticket To SUCCESS

Over 28,000 technicians have gained admittance worldwide as certified professionals. Let your ticket start opening doors for you.

ISCET offers Journeyman certification in Consumer Electronics, Industrial, Medical, Communications, Radar, Computer and Video. For more information, contact the International Society of Certified Electronics Technicians, 2708 West Berry Street, Fort Worth, TX 76109; (817) 921-9101.

Name \_\_\_\_\_  
Address \_\_\_\_\_  
City \_\_\_\_\_  
State \_\_\_\_\_ Zip \_\_\_\_\_

Send material about ISCET and becoming certified.

Send one "Study Guide for the Associate Level CET Test." Enclosed is \$10 (inc. postage).

Make  
U.S. Savings Bonds  
part of your  
retirement savings  
program.



They're the safe, easy and affordable way to save for retirement. Buy U.S. Savings Bonds for as little as \$25. Ask your banker or your employer about including U.S. Savings Bonds in your retirement savings program.

For more information, write U.S. Savings Bonds, Washington, DC 20226. For a recorded message of current rate information, call 1-800-4US BOND • 1-800-487-2663

Take Stock in America **U.S. SAVINGS BONDS** A public service of this magazine

# Countersurveillance

**Never before has so much professional information on the art of detecting and eliminating electronic snooping devices—and how to defend against experienced information thieves—been placed in one VHS video. If you are a Fortune 500 CEO, an executive in any hi-tech industry, or a novice seeking entry into an honorable, rewarding field of work in countersurveillance, you must view this video presentation again and again.**



**CALL NOW!**

**1-516-293-3751**

**HAVE YOUR VISA or MC CARD AVAILABLE**

*Wake up!* You may be the victim of stolen words—precious ideas that would have made you very wealthy! Yes, professionals, even rank amateurs, may be listening to your most private conversations.

*Wake up!* If you are not the victim, then you are surrounded by countless victims who need your help if you know how to discover telephone taps, locate bugs, or "sweep" a room clean.

There is a thriving professional service steeped in high-tech techniques that you can become a part of! But first, you must know and understand Countersurveillance Technology. Your very first insight into this highly rewarding field is made possible by a video VHS presentation that you cannot view on broadcast television, satellite, or cable. It presents an informative program prepared by professionals in the field who know their industry, its techniques, kinks and loopholes. Men who can tell you more in 45 minutes in a straightforward, exclusive talk than was ever attempted before.

## Foiling Information Thieves

Discover the targets professional snoopers seek out! The prey are stock brokers, arbitrage firms, manufacturers, high-tech companies, any competitive industry, or even small businesses in the same community. The valuable information they filch may be marketing strategies, customer lists, product formulas, manufacturing techniques, even advertising plans. Information thieves eavesdrop on court decisions, bidding information, financial data. The list is unlimited in the mind of man—especially if he is a thief!

You know that the Russians secretly installed countless microphones in the concrete work of the American Embassy building in Moscow. They converted

what was to be an embassy and private residence into the most sophisticated recording studio the world had ever known. The building had to be torn down in order to remove all the bugs.

## Stolen Information

The open taps from where the information pours out may be from FAX's, computer communications, telephone calls, and everyday business meetings and lunchtime encounters. Businessmen need counselling on how to eliminate this information drain. Basic telephone use coupled with the user's understanding that someone may be listening or recording vital data and information greatly reduces the opportunity for others to purloin meaningful information.

The professional discussions seen on the TV screen in your home reveals how to detect and disable wiretaps, midget radio-frequency transmitters, and other bugs, plus when to use disinformation to confuse the unwanted listener, and the technique of voice scrambling telephone communications. In fact, do you know how to look for a bug, where to look for a bug, and what to do when you find it?

Bugs of a very small size are easy to build and they can be placed quickly in a matter of seconds, in any object or room. Today you may have used a telephone handset that was bugged. It probably contained three bugs. One was a phony bug to fool you into believing you found a bug and secured the telephone. The second bug placates the investigator when he finds the real thing! And the third bug is found only by the professional, who continued to search just in case there were more bugs.

The professional is not without his tools. Special equipment has been designed so that the professional can sweep a room so that he can detect voice-activated (VOX) and remote-activated bugs. Some of this equipment can be operated by novices, others require a trained countersurveillance professional.

The professionals viewed on your television screen reveal information on the latest technological advances like laser-beam snoopers that are installed hundreds of feet away from the room they snoop on. The professionals disclose that computers yield information too easily.

This advertisement was not written by a countersurveillance professional, but by a beginner whose only experience came from viewing the video tape in the privacy of his home. After you review the video carefully and understand its contents, you have taken the first important step in either acquiring professional help with your surveillance problems, or you may very well consider a career as a countersurveillance professional.

## The Dollars You Save

To obtain the information contained in the video VHS cassette, you would attend a professional seminar costing \$350-750 and possibly pay hundreds of dollars more if you had to travel to a distant city to attend. Now, for only \$49.95 (plus \$4.00 P&H) you can view *Countersurveillance Techniques* at home and take refresher views often. To obtain your copy, complete the coupon or call.

**CLAGGK INC. P.E.**  
P.O. Box 4099 • Farmingdale, NY 11735

Please rush my copy of the Countersurveillance Techniques Video VHS Cassette for a total cost of \$53.95 each (which includes \$4.00 postage and handling).

No. of Cassettes ordered \_\_\_\_\_  
Amount of payment \$ \_\_\_\_\_  
Sales tax (N.Y.S. only) \_\_\_\_\_  
Total enclosed \_\_\_\_\_  
Bill my:  VISA  MasterCard  
Card No. \_\_\_\_\_  
Expire Date \_\_\_\_ / \_\_\_\_  
Signature \_\_\_\_\_  
Name \_\_\_\_\_  
Address \_\_\_\_\_  
City \_\_\_\_\_ State \_\_\_\_\_ ZIP \_\_\_\_\_

All payments in U.S.A. funds. Canadians add \$4.00 per VHS cassette. No foreign orders.



# Security in the Information Age

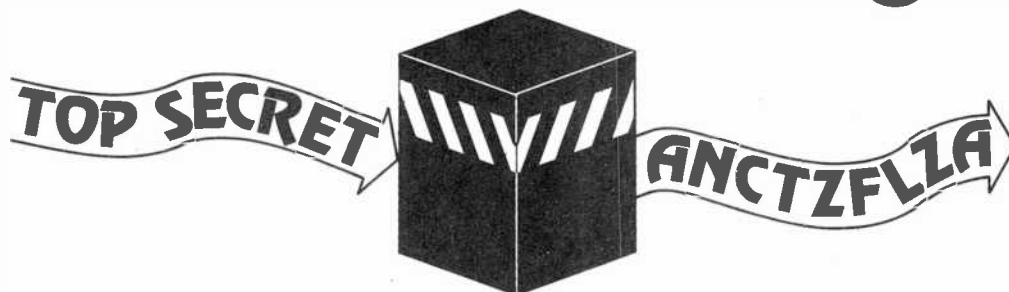

*How information is protected from falling into the wrong hands.*

BY CRAIG HOWARD

**C**ryptology, the science of codes and ciphers, has until fairly recently only been used by kings and generals. Because few people could read, illiteracy was the ultimate file protection. However, with the advent of universal literacy, the personal computer, and a government that can eavesdrop on a world-wide scale, cryptology has moved out from the back chambers and into the public domain. We can now protect information at the push of a computer RETURN key.

But how is that done? Well, before we can take a look at achieving true security in the information age, perhaps a little background material on codes and ciphers is in order.

**Codes and Ciphers.** Codes and ciphers are completely different entities, even though the two terms are often incorrectly used interchangeably. The first type, codes, changes the value of entire words, phrases, or sentences. For instance, the code phrase "CLIMB MOUNT NIITAKA" was used by the Japanese Navy to mean "ATTACK PEARL HARBOR."

Ciphers change the position or value of each individual character in the message. Ciphers are much easier to use than codes, which require large code books listing every word or group of words that will be used. A

cipher, on the other hand, requires only a mathematical formula, called an algorithm, that can often be easily memorized. The message to be encrypted is called *plaintext*; the message after it is encrypted is called *ciphertext*.

Ciphers can be divided into either *transposition* or *substitution* groups. A transposition cipher shuffles the plaintext message until it is unreadable. For example, the plaintext message "RETREAT AT ONCE" becomes "ETRNECTORA TE." Break the ciphertext into sequential blocks of five characters, in order to hide the placement of obvious words like "AT."

A substitution cipher changes the value of each character in the plaintext. Most substitution ciphers use a key, which can be a word that's easy to remember, a passage from a book, or even a piece of music. To use a key, convert the plaintext into numbers—"A" becomes 00, "B" becomes 01, and so on. Do the same with your key. Then add each plaintext number to its corresponding key number and you get the ciphertext.

For example, if you wanted to convert the plaintext word "ATTACK" into numbers, it would become: 00 19 19 00 02 10. To encrypt that word you would need a key; let's say that the key used was "BUSBUS." That key would become 01 20 18 01 20 18 when convert-

ed. To create the final ciphertext you would have to add those series of numbers, one series on top of the other, like this:

00	19	19	00	02	10
+01	20	18	01	20	18
01	39	27	01	22	28

Notice that noncarry addition was used; that reduces the number of errors. Because the key provides three different numbers, a plaintext number can be converted into three possible ciphertext numbers. For example, the first "T" in plaintext (19) is added to a "U" (20) in the key, and is turned into a ciphertext 39, but the second "T" is added to an "S" (18) in the key, which results in a ciphertext 27. That variation makes the cipher harder to crack.

**One-Time Pads.** Instead of using a key "word" that repeats, what if the key was a random string of numbers the length of the message? It would be unbreakable. Period. That unbreakable cipher is called a one-time pad, and is the favorite of spies everywhere. It requires only a pad of paper filled with random numbers on each page. That pad is the key.

Here is how to use the method. First of all, come up with a one-time pad of random numbers, and use them to encrypt your message, just like a substitution cipher. Then, tear off the

pages that were used and burn them, because they could never be used again. Your friend who receives the message can use a one-time pad, which is an exact duplicate of yours, to decrypt the message.

If that cipher is so secure, why don't banks and governments use it for all of their message traffic? Because the cipher requires that each sender and receiver have exactly the same one-time pads. Banks transmit and receive so many messages that they'd need millions of pads per day, all of which would have to be distributed in complete security to everyone communicating with the bank. Hence, the infallible one-time pad is used only by those who must communicate with bomb-proof security, such as a spy.

**Numbers Stations.** Occasionally, shortwave listeners will hear an announcer on an unlicensed station reading off a seemingly random string of numbers. The announcer is sending a message to a spy who's equipped with nothing more than a shortwave receiver and a one-time pad the size of a postage stamp. Shortwaves can reach halfway around the world, so the transmitter can be located on friendly soil.

Although most "numbers stations" transmit their messages in four- or five-digit blocks, occasionally you can hear a three/two station. On those stations, each block consists of three digits, a pause, then two digits. Those messages are using a dictionary-key system. The first three digits of each block are the page number of a book. The last two digits are the location of the word on the page. By looking up each word, the message is reconstructed. The dictionary-key system is safer than the one-time pad because being caught with a pad of random numbers is bad news, whereas being caught with a paperback novel is not.

Numbers stations can be found across the short-wave spectrum, but are especially active on 6840 kHz and 7415 kHz in the evening to morning hours. Brush up on your Spanish; it seems to be the language of choice for those types of stations in the western hemisphere. For more information, read *The Shortwave Listening Guidebook*, listed in the "Further Reading" box.

## MODULAR MATH CIPHERS

Modular math is easy; we use it every day. If the time is 10:00, what will it be in 6 hours? Well, 10 plus 6 equals 16, but a regular clock only goes up to 12 (it is a mod 12 system). Therefore, we have to also figure out that 16 mod 12 equals 4 (o'clock). To do that, simply divide the number by the modulus, keeping only the remainder. Subtraction could also work in that case, but not always. For example, if it's 10:00, and you want to know what time it will be in 34 hours, then you'd use 44 mod 12, which equals 8 ( $44/12 = 3$  remainder 8).

Modular math is good for locking up secrets in code. Even though finding 14 mod 12 is easy (the answer is 2), doing the reverse is difficult, even if you know the modulus. If the remainder is 2, then the original number can be 2, 14, 26, etc.

To use modular math for an RSA cipher, start by picking two prime numbers,  $p$  and  $q$ . For this example, we'll use 3 and 5, but in practice, the two numbers should be 100 digits long each. We'll also need a public key ( $r$ ), but first we have to come up with its modifier ( $n$ ), using:

$$n = pq$$

In this case  $n$  equals 15. Next, you have to figure out the value of  $e$ , a number that determines the range of the public key ( $r$ ). To find  $e$ , use:

$$(p-1)(q-1)$$

which equals 8. So, in this case, the public key ( $r$ ) is any number between 1 and 8, which isn't a factor of 8 (that eliminates 2 and 4). Let's have  $r$  equal 3.

Then, find a number that when multiplied by  $r$  and divided by  $e$  leaves a remainder of 1. We'll use 11, which will be  $s$ , the private key. Now you're ready to give your friends the numbers  $n$  (15) and  $r$  (3).

If a friend wants to send you a message, say the number 12, he or she can use the public key to encrypt the message.  $12^r \text{ mod } n$ , or simplified,  $1728 \text{ mod } 15$ , which equals 3. The ciphertext message 3 can then be transmitted.

To decrypt to get the plaintext message, use  $3^s \text{ mod } n$ , or  $177147 \text{ mod } 15$ , which equals 12. With a little practice, it's not as complicated as it seems at first. ■

**Electronic One-Time Pads.** As we saw earlier, a one-time-pad cipher uses a random key that is the length of the plaintext message. The key is different for every message, and is added to the plaintext using noncarry addition. To make an electronic one-time pad, you can use the exclusive-OR gate (XOR) to perform the addition. That can be done either with

hardware—an XOR-gate chip (Fig. 1A), or with software—the XOR instruction in BASIC.

Looking at the truth table in Fig. 1B, we can see that the XOR gate is a binary adding machine. Input A is added to input B, and the sum is shown in the output column. Now, look at the last line. If  $A = 1$  and  $B = 1$  then  $1 + 1 = 10$ . Because the XOR uses noncarry addition, the 1 is dropped, leaving the output to equal 0.

The best source of random bits for the key is not the RND instruction in BASIC. That instruction doesn't grab a random number out of the air; instead, it generates a pseudo-random sequence that repeats after a long time. The sequence could be broken given enough ciphertext messages.

Instead, use random noise in the form of radio static. Fill a CD ROM with static, and make a copy for the other one-time pad (see Fig. 2). Use a CD ROM drive that has its laser power boosted. As the laser reads a bit, the bit is burned away. That makes it impossible to crack previous messages if the CD ROM is captured.

**Encryption in Banking.** Every day the Clearinghouse Interbank Payment System electronically moves more than 1-trillion dollars. That data is encrypted with the Data Encryption Standard (DES), which is based on IBM's Lucifer algorithm. The original Lucifer used a 128-bit key, but the US government thought that a key that long would make the cipher too hard to break by their people at the NSA. So DES was given a 56-bit key, making the cipher too difficult to break by anyone except the government.

How weak is DES with a 56-bit key? A 56-bit binary key has  $2^{56}$  possible keys, which is equal to  $7.2 \times 10^{16}$  or 72,000,000,000,000,000 possible keys. A 128-bit key has  $2^{128}$  or  $3.4 \times 10^{38}$  possibilities (that's written as 34 followed by 37 zeros!). Double the size of the key, and you square the number of possible keys and the amount of work a codebreaker must put in.

DES encrypts a chunk of data by using a three-step cycle of substitution, transposition, and exclusive-OR'ing, which is repeated for a total of sixteen cycles. It has three modes: Electronic Codebook (ECB), Cipher Feedback (CFB) Cipher Block Chaining (CBC).

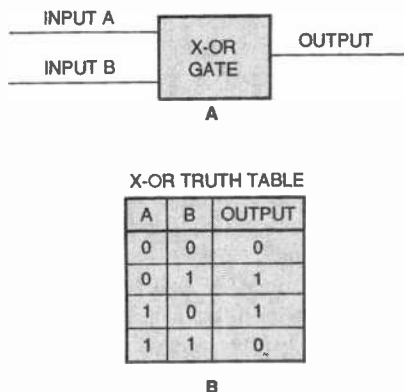

Fig. 1. This is the block diagram of a XOR-gate chip (A). The truth table (B) shows that the XOR gate is really a binary adding machine.

The Electronic Codebook mode is so weak that even the government recommends not using it. Ironically, a number of commercial encryption programs use it anyway. For a complete description of DES, read *Security in Computing*, listed in the "Further Reading" box.

Can DES be broken? Michael Wiener of Bell Northern Research in Ottawa wrote a paper on how to do just that. He designed a chip that breaks DES keys by trying every combination until it finds the right one, the brute-force attack. The chip costs \$10.50 to manufacture. For \$1 million, you could build a machine that uses 57,000 of those chips to try every key in 7 hours, with the average time to solution being 3.5 hours. For \$10 million, you can get a solution in an average time of 21 minutes. Finally, for \$100 million, you can have a solution in 2 minutes! Wiener hasn't built the chip yet, but it is feasible.

DES will retire soon. Among its other flaws it uses a single key for encryption and decryption, just like the basic ciphers we looked at earlier. A single-key system, also called a conventional system, allows anyone who sends you an encrypted message to also decrypt your other messages. The solution: either use a separate key for each person with whom you communicate, or use the latest rage, the public-key cipher.

**Public-Key Ciphers.** Let's dust off some basic math terminology. Remember prime numbers? They're numbers that can be divided only by themselves and one. Three is a prime number; so is five. Take two prime

numbers, say 100 digits each, and multiply them together to get a 200-digit number, X. If a computer is given X, it will take years to find the original prime numbers again. Public-key ciphers use prime numbers for that very reason.

A public-key cipher is perfect for computers and E-mail. It uses two keys: a public key that can be given to anyone, and a private key that is kept secret. If someone wishes to send you a message, he or she would encrypt it with your public key. Once it has been turned into ciphertext, the public key cannot decrypt it: only the private key can do that. So you can distribute your

**Pretty Good Privacy.** In 1978, three researchers at the Massachusetts Institute of Technology introduced a public-key algorithm. They called it RSA after their names—Rivest, Shamir, and Adleman. The researchers published their algorithm before filing a patent, out of fear that the U.S. government would classify the patent a national secret, disallowing them to write about it. Because the rest of the world requires patenting before publication, RSA is patented only in the United States.

Enter Philip Zimmermann, a computer consultant in Boulder, Colorado. He wrote an encryption program that

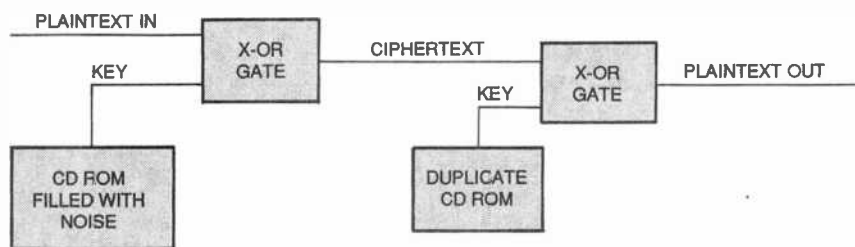

Fig. 2. To use an electronic one-time pad, fill a CD ROM with static, and make a copy for the other one-time pad. Use a CD ROM drive that has its laser power boosted. As it reads each bit, the laser burns the bit away, making it impossible to crack previous messages if the CD ROM is captured.

public key to the four winds, but no one can use it to decrypt any messages sent to you.

**Digital Signatures.** You get a call from Icepick: he wants the money you owe him. Now. The bank closes in a few minutes, and it's too far to drive. If you send a message to the bank to transfer money to Icepick's account, how will the bank know that it's you?

We know that a public key encrypts; a private key decrypts. However a public-key system is commutative—that is, it can also encrypt with the private key and decrypt with the public one. Of course! You fire up the computer, and write a quick note to the bank. You encrypt the note with your private key and send it. The bank then looks up your public key and uses it to decrypt the message. Icepick gets his money, and your kneecaps feel great.

Using a private key to encrypt a message is called a digital signature, because it is unique, like your own handwriting. To make sure that no one but the bank can read your note, simply encrypt the note with your private key, then encrypt the ciphertext using the bank's public key.

uses the RSA algorithm and called it PGP, for Pretty Good Privacy. He posted it on a local computer bulletin board. Someone else downloaded PGP from the bulletin board, and posted it on the Internet. Copies of PGP multiplied exponentially, with thousands of people around the world downloading the program from one bulletin board, and posting it on another.

PGP is simple and free for the taking. It can encrypt personal files that you keep on disk, E-mail messages, or files to be sent to someone else. The best source for a clean, bug-free copy of the program is the bulletin board "The Catacombs," 303-772-1062. Grab the PGP Shell too, which has screen menus to make PGP easier to use.

When PGP first came out, the RSA patent holders claimed infringement. That is odd considering that RSA was created with public funds, and was published in widely read academic journals. Today, the infringement battle is over: the 2.6 version of PGP uses encryption algorithms that have no license fees for personal, non-commercial use.

**The Clipper Chip.** PGP has a distant cousin, the Clipper chip, which is the U.S. Government's replacement for DES. The chip is based on the Skipjack algorithm, which is classified.

But why look any further than RSA and PGP for use as our national encryption standard? If RSA is good enough for protecting our nation's nuclear weapons (and according to Ron Rivest, it is used for precisely that), why can't banks and phone companies use it? Because if everyone used an unbreakable encryption method, court-ordered wiretapping would be useless. The NSA, whose mission is to break codes and to eavesdrop on all forms of communication, would be defunct. Thus the Clipper was born. It allows the government to break any messages sent or received by that chip.

During the chip-manufacturing process, each chip is loaded with a serial number, a family key, and a unit key. The family key is the same for all Clipper chips; the serial number and unit key are unique to each chip. Two random, 80-bit binary numbers are factored (multiplied) together to form the unit key. A copy of the unit key is made, then split in half, each half being tagged with the chip's serial number. One half of the key is kept at the US Treasury Department, the other half at the National Institute of Standards and Technology (NIST).

If a law enforcement agency wishes to decrypt the messages of a specific Clipper-equipped phone, fax machine, or modem, it will need a court order for permission to place a wiretap. Every time a Clipper transmits a ciphertext message, it also sends its serial number in the clear, in a format called a LEAF—Law Enforcement Access Field. The police write down the serial number and fax it, along with the court order, to NIST and the Treasury Department. The two halves of the unit key are faxed to the wiretappers, who can then decrypt any messages sent by that Clipper.

If you design and manufacture secure phones or modems, must you use the Clipper? Only if you want to do business with the government, or plan on exporting your product. Though it's doubtful whether a worldwide market exists for encryption devices that can be broken by the US government.

Whenever two Clippers attempt to communicate with each other, a session key is created, which is used for only that communications session. A copy of the session key is encrypted with the Clipper's unit key, and is transmitted in the LEAF. The two Clippers exchange LEAF's, checking to see if they are valid. Thus if you possess the unit key, you can get the session key every time the chip communicates. The LEAF is 128 bits total, and contains the 80-bit session key, 32-bit serial number, and 16-bit checksum. The en-

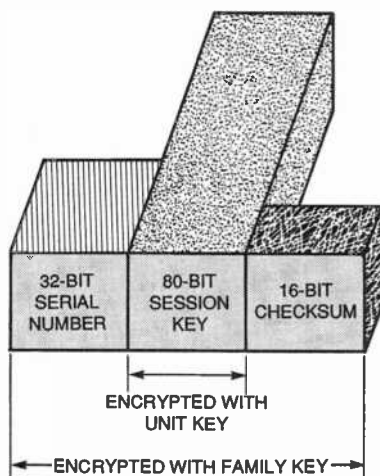

*Fig. 3. The Clipper chip's LEAF (Law Enforcement Access Field) is shown here. It is 128 bits total, and contains the 80-bit session key, 32-bit serial number, and 16-bit checksum. The entire LEAF is encrypted with the family key.*

tire LEAF is encrypted with the family key (see Fig. 3).

The Clipper is manufactured by Mykotronix in Torrance, California. It is also called an EES chip, for Escrowed Encryption Standard. There will be two EES chips: the Clipper or MYK-78, which will be used mainly in secure telephones, and the Capstone or MYK-80, which is a jazzed-up Clipper that can use public-key ciphers to encrypt computer files and E-mail. It will also have digital signature capability.

The Clipper chip itself is tamper-proof—anyone who tries to crack open the chip to examine its "guts" is wasting their time. However, the information entering and exiting the Clipper is not tamper-proof, as we shall see.

**The Clipper's Flaw.** When DES, RSA, and PGP were first devised, their

creators published full details of the systems and challenged the world's top math and code experts to "break it." That approach made it easy to find any flaws in the ciphers. Not so with the Clipper chip; the NSA allowed only five outside cryptologists to examine it, which was a big mistake.

The June 3, 1994 *Wall Street Journal* mentions an AT&T Bell Labs scientist who experimented with a prototype Clipper. Matthew Blaze found a way to make the chip generate a "bogus" LEAF, making it impossible for a wiretapper to get the right escrow key.

Simply removing the LEAF will not work; the receiving Clipper will not decrypt data unless the LEAF is present and its checksum appears to be valid. Generating the fake checksum is done by the brute-force attack. That takes a computer about 42 minutes, and it must be done each time the Clipper chip wants to connect with another, making that technique useless for a phone. It is quite useful for a fax machine or E-mail system, however.

You could speed up the process by using parallel-processing—a machine using 60 Clippers wired together could find a valid-looking LEAF in under 45 seconds. Also, the machine could precompute a list of session keys and fake LEAF's (if the number of possible recipients is small), but that will work only with fax and E-mail, not phones.

The government could counter that method by doubling the size of the checksum, which would square the number of possible checksums, making a brute-force attack too time-consuming. For that to work, however, the Clipper would have to be redesigned extensively.

**Do Citizens Need Encryption?** In the past, if the government wanted to read someone's paper mail, it required a lot of time and effort: opening, reading, copying, and resealing the letters. Today many letters are in the form of E-mail, which is nothing more than a stream of digits flowing from one computer to another.

It is possible to listen in on those messages and run them through a computer, which is programmed to copy any messages that contain trigger words such as "bomb," "assassi-

*(Continued on page 93)*

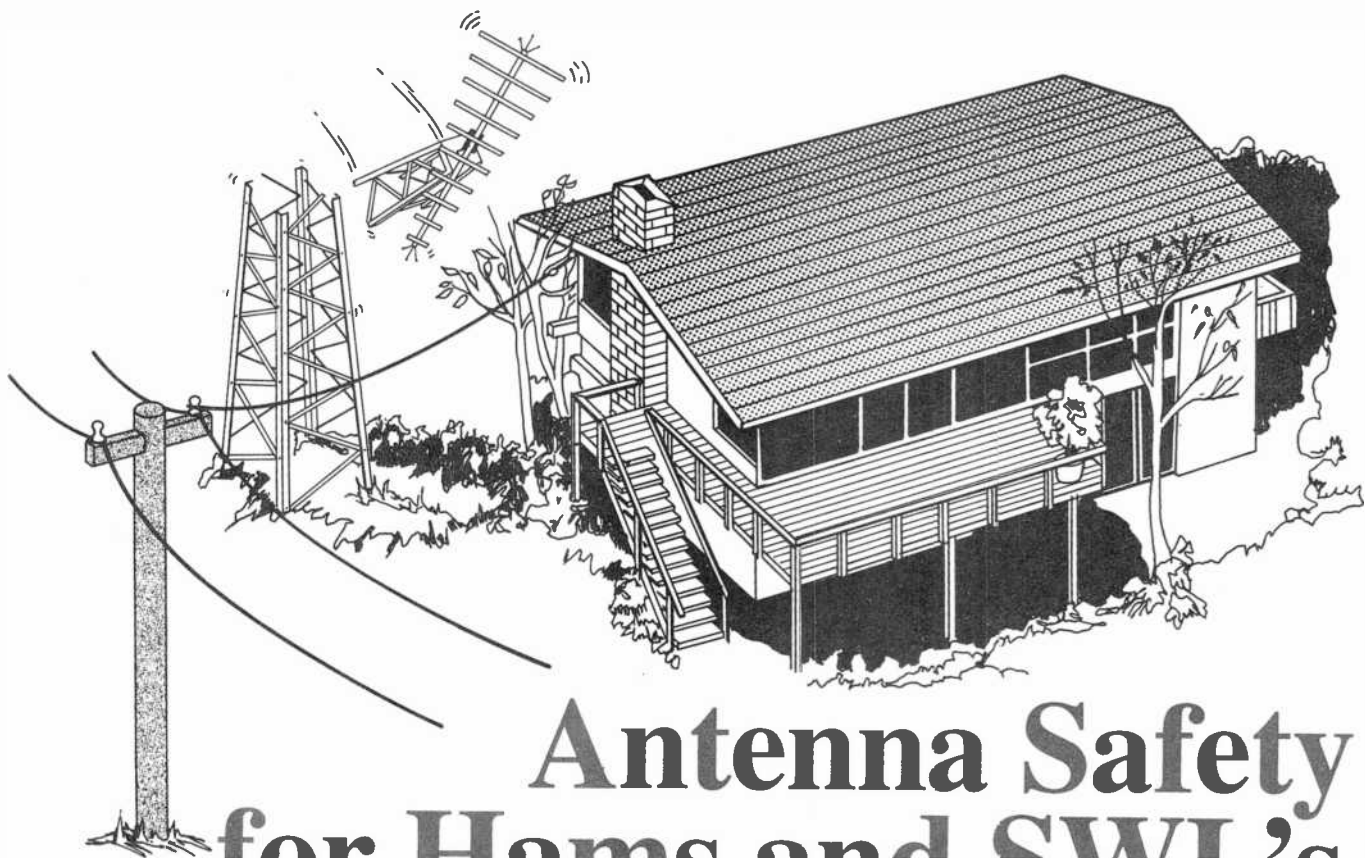

# Antenna Safety for Hams and SWL's

*These easy-to-follow antenna-safety guidelines can keep you, your equipment, and your property healthy and happy.*

BY KARL T. THURBER, JR.

**R**egardless of the antenna you're considering—whether it's a large transmitting or a small receiving skyhook, a simple wire antenna, or a multi-element beam—keep safety in the forefront of your plans. Safe antennas work better than unsafe antennas, to be sure, but more important, inattention to safety can kill, maim, and otherwise spoil a very fine day!

This article focuses on safety considerations when erecting outdoor antennas, towers, and masts. Topics such as safely installing wire and vertical antennas, tower installation and safety, lightning protection, and grounding are discussed.

If you already have an antenna, the first thing you should do is to give your antenna a safety audit. That is important because most of us are much more aware of our antenna system's electrical performance characteristics than its physical and mechanical safety.

Give your antenna a critical and thorough once-over. Clean up the system, perform routine maintenance, take preventive measures against future damage, and install new (and safer) antennas if necessary. Further, one such audit is not sufficient. You should audit your antenna system every few months, or at least once a year, as a minimum.

The procedures for an antenna system audit vary, and you might find it helpful to use a checklist to ensure you don't overlook anything. Inspect your antennas, towers, and masts for sturdiness, structural defects, weathered connections and fittings, and corrosion or rusting—you never can tell what you'll find after an antenna is exposed to the elements.

Pay close attention to tower and mast integrity, guy wires and support lines, antenna wire and insulator condition, and soldered connections. While wearing your inspector's hat, clean and re-wrap coaxial cable

connectors and fittings with electrical tape or weatherproofing materials to keep out moisture and corrosive pollutants. Carefully check the condition of all coaxial cables to see if they need replacing; replace old coax with more modern, weather-resistant cable.

Also check the hardware, tightening any screws and nuts as needed. Check the tension of guy wires, adjusting them if necessary. Replace excessively weathered or frayed, support lines and rusted guy wires; you might find it expedient to periodically replace them even if they aren't visibly deteriorated.

The basic idea is to catch problems before they're serious. Preventive maintenance never hurt anyone, and should give lie to the old saw that "your antenna will stay in the air until it falls down!" Eyeball your antennas and their supports to ensure that they are safely installed and positioned, especially with respect to power and

telephone lines (which often look alike). If your tower or skywire fell, where would it land, considering the prevailing wind direction in your area, and what damage would it cause?

**Antenna-Construction Considerations.** Working with antennas and their supports is inherently dangerous: You often must climb a ladder, tower, or tree, or walk on your roof. However, the danger can be minimized if you apply a liberal dose of common sense. Work slowly, carefully, and deliberately. Never work alone; ensure that there's someone to go for help if you're injured. If you climb a tower, use a safety belt and keep your tools buttoned down to avoid dropping them on a helper. Don't use a metal ladder, and don't work on a wet, windy, stormy, or snowy day. Remember that the foremost consideration when

doing tower and antenna work is always personal safety.

Before selecting an antenna, you must first find a place to install it—and your first priority is to ensure that its location and support structure are safe. To do that, you first should visibly survey your property and adjoining property to check out various installation possibilities.

From a performance standpoint, for best results, antennas should be high and far removed from noise sources. From a safety standpoint, the antenna (whether a horizontal wire, a vertical, or a beam) shouldn't be installed where it might fall or blow down on power lines, or where power lines might fall on it.

Be sure that the ends of wire antennas are high enough so that people won't walk into them; keep them out of the reach of passersbys and play-

ing children. That is especially important if you use "drooping-end dipoles" or slopers. Unpleasant radio-frequency (RF) burns can result to anyone who touches a portion of the antenna that's "hot" for RF, even at low power levels.

If you're using a vertical antenna mounted at ground level, erect a nonconducting (wooden) safety fence around the base, to minimize its becoming an "attractive nuisance." Also, take care with the routing of elevated ground-plane radials used with some verticals and the placement of uninsulated open-wire transmission line. Again, there can be high RF voltages when transmitting that can cause nasty RF burns to yourself or a passerby upon contact.

There are many types of supports you can use for wire antennas: trees, poles, masts, towers, buildings, roofs, chimneys, and the like. Short masts on roofs and chimneys are convenient and inexpensive, but they bring the antenna close to the house, reducing antenna performance and increasing noise pickup and possibly lightning-strike-damage potential. Keep antennas as far away from buildings as you can, and avoid using buildings to support both ends of wire antennas.

Up to about 30 feet in height, you need to take few special support precautions; fabricated wooden poles and A-frames, rather than commercial towers and masts, often suffice. Up to about 50 feet or so, telescoping galvanized steel TV-type masts and wooden telephone poles can be safe supports.

For heights up to 100 feet or more, three- or four-sided lattice-type masts typically are used, and often can be made self-supporting provided the proper base is used. Never use a utility company's pole as a support for an antenna or guy wire, and don't climb an in-use utility pole.

Trees can appear to be convenient and cheap supports, but they can be very frustrating. They're unstable in winds, particularly if they're skinny and tall, so don't attach anything to the top. The "sway factor" is doubly significant if you run your antenna between two unstable trees likely moving in opposite directions during windy conditions! Compromise by fastening one end of your skyhook to your house or

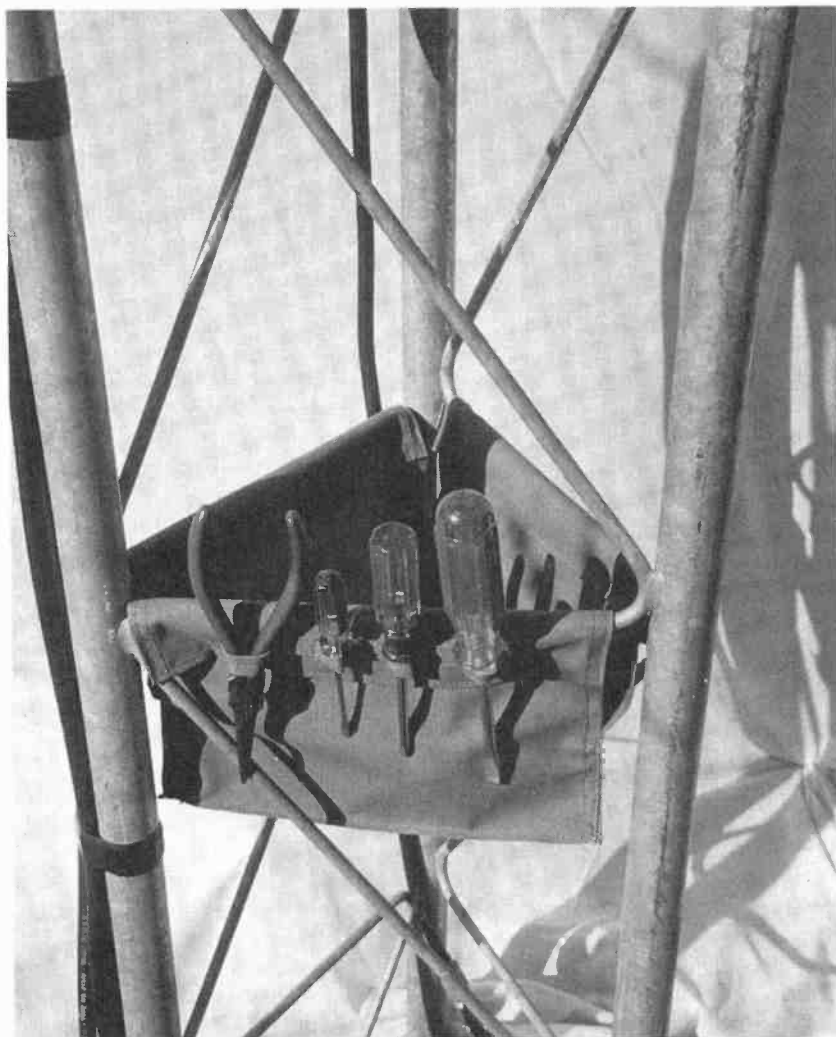

*Tower builders never have enough pockets! An "accessory pouch" like this one from Tower-Mate (P.O. Box 601616, Sacramento, CA 95860-1616) provides a place for all those bolts, tools, etc.*

to a short, roof- or eaves-mounted mast.

If your antenna is suspended between trees or flexible masts, you might need some type of wind compensation. Consider using a heavy spring under tension or husky counterweights at the end of a halyard to stabilize an antenna attached to trees and prevent undue stretching of the wire when the trees sway.

Because wire antennas usually aren't heavy, anchoring the ends of the wires normally isn't a big problem. As a rule, you can use most any anchorage that appears to be sufficiently solid. You can support most wire antennas with sturdy hooks or screw eyes, provided you sink them one or two inches into solid wood.

If you're using a wooden support mast, give it the same protection against weather as you would your home's exterior woodwork. Untreated, uncoated, or unpainted wood will eventually rot, with potentially disastrous results to your antenna and anything near it. Sink nail heads and screws into the wood so that they can be puttied over; paint hooks, screw eyes, and other hardware to inhibit rusting or corrosion. Protect portions of wooden masts lying below the ground with creosote.

You can use several types of wire to build a sturdy, long-lasting wire antenna. The two most popular wire types are hard-drawn copper and copper-clad steel. In most applications, #12 or #14 stranded, hard-drawn copper wire is strong enough, though it has a short life expectancy near ocean areas. When you need a long span of wire, or if heavy insulators result in considerable tension, consider using #12 or #14 copper-clad steel wire. Don't use soft-drawn copper, steel, aluminum, or similar utility wire. Almost as important as the size of wire used is the careful soldering of joints to ensure the antenna's electrical integrity.

**Tower Safety.** The installation and dismantling of towers is inherently dangerous. Many serious, even fatal accidents have occurred because people assumed that situations were safe when in fact they were not. Tower dismantling can actually be more dangerous than installation since the condition of the tower, guys, anchors, or roof may be unknown.

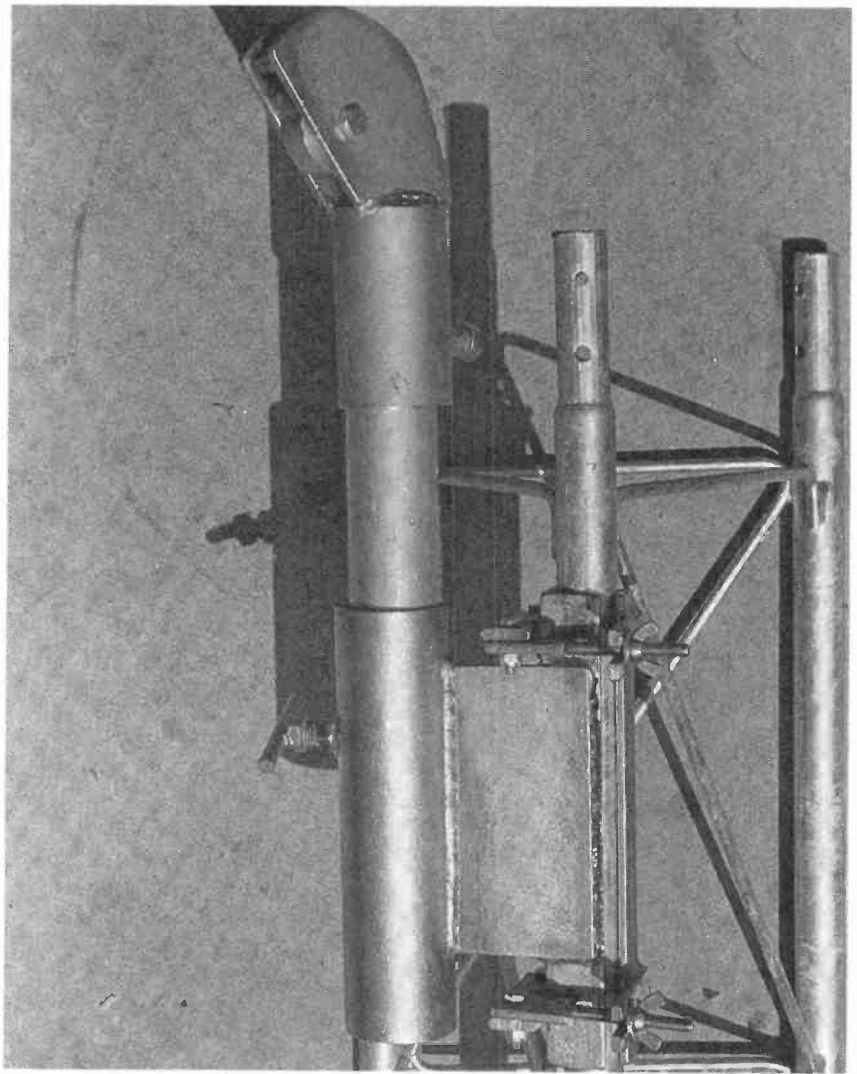

*The gin pole is a mechanical device for safely and conveniently working with masts and tower sections. A "raising fixture," the gin pole fosters safety by giving the tower climber the heavy lifting ability the ground person provides.*

There are three tower-safety rules that you should always follow. First, don't take unnecessary chances when climbing a tower. Second, don't hesitate to quit climbing if things aren't going well. And, third, read and follow all safety precautions when working with towers and masts. (An informative, four-page "Antenna Safety Advisory" pamphlet is available free of charge upon request from Universal Radio, Inc., 6830 Americana Pkwy., Reynoldsville, OH 43068; Tel. 800-431-3939).

Before installing a tower, be sure to check local ordinances, owners'- and renters'-association rules, deed restrictions, and the like to ensure that what you plan to erect complies with various officials' ideas on antenna safety and esthetics.

Also check into your local climatic

profile, including typical and maximum wind speeds. Local building codes might require you to submit various prints and calculations to the local building department for a construction permit. Your tower should comply with Electronic Industry Association (EIA) or Uniform Building Code (UBC) requirements. If your tower is very tall, you'll also have to comply with Federal Aviation Administration (FAA) rules, especially if you live near an airport.

Safety-wise, there are several basic and crucial tower-selection considerations. Those include locating the tower so it's a safe distance from, and can't fall on, power lines or a neighbor's property; ensuring there's sufficient yard space for adequate guying; and checking that neighborhood children won't be able to

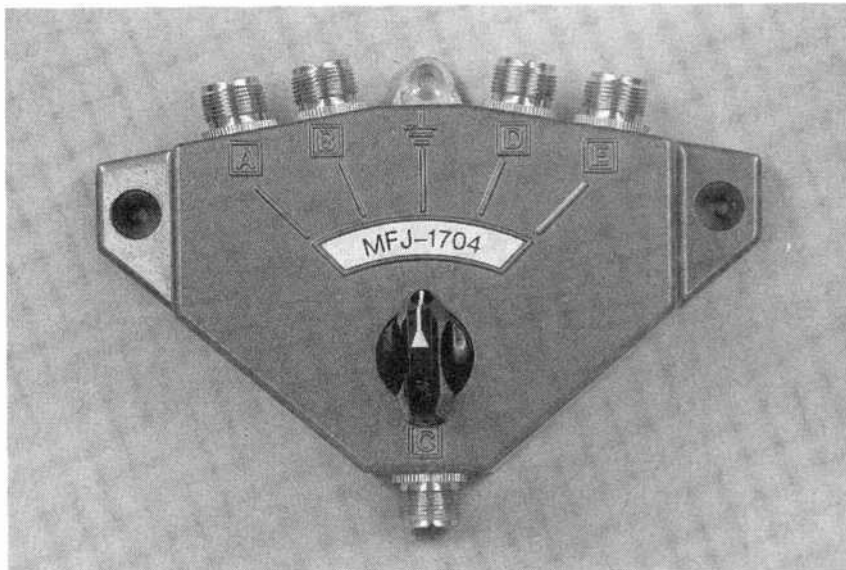

*This multi-position coax switch from MFJ Enterprises (P.O. Box 494, Mississippi State, MS 39762) gives you a center ground position, automatically grounds unused positions, and works to over 500 MHz. A built-in, replaceable surge protector helps protect against lightning-induced surges on your transmission line.*

climb the tower. Also, ensure that you are physically able to climb and maintain the tower, or that you have someone who can do those things.

Choosing the right tower is a three-step process. The first important step is determining the projected area of the antenna system you'll mount on it. Normally, that figure is included in the antenna's technical specs. Standard TV antennas are about 2 square feet in area; small VHF and UHF antennas may be 2 to 5 square feet. High-frequency beams are larger: a 40- or 20-meter beam, or multiple arrays, may be 25 square feet or larger. When using a rotator, a rule of thumb is to add 1 square foot plus an additional square foot for the mast, to whatever size antenna you plan to use.

The second step is to decide on height. Many towers are offered in short sections to afford many possible heights. Limit the height of the mast above the tower to six feet with any antenna configuration.

The third step is to choose the tower that's appropriate for you and your particular location, considering steps one and two. To make that choice, the tower manufacturer usually provides a wind-load comparison chart.

Determining tower wind loading is complex. It depends upon several factors, such as wind-loading characteristics of the antenna and whatever else is installed on the tower; concrete base size; type of concrete; soil condi-

tions (type of soil and whether the soil is wet, dry, or frozen); maximum expected sustained winds and gusts; and the probability of icing.

In some cases, with really elaborate and tall towers, you'll need special accessories for your tower. Those might include ladders, safety cages, anti-climbing devices, work and rest platforms, fencing, and FAA-compliant painting or lighting.

Don't make your tower selection decisions in a vacuum, especially if yours is a first-time installation. Solicit the assistance of more experienced hobbyists or an expert, asking for their help, to include looking over plans, hardware, and safety aspects. Do all that before you start work. If in doubt about the distance from power lines, call the power company and ask them to review your site—and never dig without contacting utilities.

One of the most important parts of a tower is its base. There are several types of base configuration. The tower manufacturer should provide you with technical data that includes detailed plans, including dimensions, for properly constructing the base; follow them closely. Large towers generally require a concrete base, which might be quite large, especially if the tower is free-standing (that is, un-guyed and self-supporting). The torque exerted on the base of a tall, self-supporting tower with a large rotor and antenna atop it is considerable in high winds.

Because the base provides all the strength for a self-supporting tower, it must be done right.

Some towers are crank-ups, letting you lower the tower during high winds and to do "antenna work" with the antenna near the ground. Another convenience is the fold-over or tilting base, where you can fold over all or a portion of the tower. But you must be careful in using those designs to avoid accidents. Have some knowledge of your tower's limits, since free-standing towers are self-supporting only if they use a base that meets specs.

When installing a tower you're setting in concrete, don't just "eyeball it." Instead, use a carpenter's level to ensure that the tower is level. Even minor errors in leveling the tower at the base will be accentuated greatly in the upper sections.

Roof-mount towers are more economical than conventional ground-mounted towers and may be considered safe. However, the lack of base support limits the tower height and the weight of the antenna and rotor if supports.

If a tower is not self-supporting, guy wires will be required. Even in the case of self-supporting towers, guys can be used to allow for greater wind loads and heights.

A guy might experience a tension or "pull" of over 1,000 pounds in a typical installation. Thus, you should follow the manufacturer's guying recommendations, especially with regard to the number and placement of guy-wire sets; guy-wire strength, type, and size; and guying hardware. Guy wires should never be pulled taut; a small amount of slack is desirable. There should not be any kinks in the wire, since they weaken the guy.

Most guys are metallic: copper-clad-steel antenna wire; solid, galvanized steel wire; or stranded, galvanized TV guy wire. Those are conductors, of course, so for transmitting you should break up guy wire resonances (which might distort or degrade performance) with strain insulators. Use strong, egg-type strain (compression) insulators; regular insulators might not be strong enough.

An alternative to metallic guy wires are guys made from high-strength, nonconductive and noncorrosive materials, such as Kevlar. Their advantage derives from the isolation of the



guys from the antenna field. Those guys are "electrically transparent" to the antenna field, reduce maintenance needs, and present a neater appearance. Further, there is no need to use insulators to break up guy-wire resonances. One of the more popular nonconductive guying materials is Phillystran, from United Ropeworks (151 Commerce Drive, Montgomeryville, PA 18936-9628; Tel. 215-368-6611).

For good tower safety it is important to properly anchor guy wires. Simple installations use "driven" or buried "dead-man" anchors, with one or two, 4- or 5-foot pipes being driven into the ground at an angle with the driven type of anchor, and a buried auto bumper or wheel with the buried dead-man type of anchor.

Two main types of heavy duty anchors are used. One is the "earth screw," having a blade 6-8 inches in diameter and 4 to 6 feet long; it's suitable for "normal" soil. A second type is the concrete-block anchor, typically about 3 feet square and installed about 4 feet below ground. The latter type is harder to install than the earth screw, but can be used in almost all soils.

**Working with Towers.** All antenna and tower installations are different, but all need adequate planning—especially if it's a tall tower, heavy antenna, and husky rotor that you and your ground crew will work with. Discuss raising procedures in advance and designate someone as a foreman or boss to watch for signs of trouble. Decide what tools and hardware must be taken up the tower and who will rig ropes and pulleys to raise the antenna. Do all that before the antenna leaves the ground. Your clothing should be comfortable, safe, and warm; long pants offer protection from cuts and scrapes. Minimize buttons and openings that can snag on hardware; long-sleeved pullover shirts are ideal. Wear heavy work shoes, preferably with ribbed soles and steel shanks (steel inserts in the soles) for support when standing on tower rungs. Heavy gloves offer hand protection, warmth, and a good grip when handling rope. Wear a hard hat, especially if you're a ground-crew person, to protect yourself from falling hardware. You also might want to wear safety glasses.

Have the right tools when doing tower work, especially when you're high in the air. Don't begin work until you have the full range of tools you'll need; using a checklist helps.

One of the most important tools is a high-quality safety belt that's commercially manufactured, tested, and approved. Don't scrimp here, because you're trusting your life to your belt every time you climb the tower, even for a short distance. Be sure to check your belt's condition each time you use it. While the climbing belt is important for safety, it also frees up both hands for work and it lets you lean back, away from the tower, to reach hardware.

Another device you will need is a gin pole. A gin pole is a mechanical device for safety and conveniently working with masts and tower sections. A "raising fixture," it fosters safety by giving the tower climber the heavy lifting ability the ground person provides. Two people using a gin pole can make tower and antenna assembly and disassembly a simple, fast, and safe procedure.

The gin pole is made up of three components. Those are the pulley assembly, which provides a mechanical advantage while lifting; a pole, used to gain the height needed for the lift; and a clamp assembly, used to attach everything to the tower. Usually,



*If you use a dipole or other antenna that normally uses a balanced (open-wire, ladder-lead, or twin-lead) transmission line, consider placing a BALUN at the feedpoint of the antenna to allow coaxial feedline to be used. Also, BALUN's offer limited static buildup and lightning protection.*

the ground-based person does the heavy lifting; the person on the tower has the freedom needed to guide in and fasten together the tower and antenna components.

You typically use the gin pole by clamping it to a tower leg to assist in the assembly of the tower sections and installation of the mast. A rope or other support line is routed through the tubing and over the pulley mounted at the top of the pole.

Because the gin pole can be expensive for an individual to buy for a one-time tower or mast installation, it makes sense for radio clubs to purchase them for community use by members. Some tower dealers will also rent or loan you a gin pole.

Once you have completed your antenna or tower installation, ensure that everything looks right and works as it should. Weatherproof coax and control cables; weatherproof all RF connectors with electrical tape, heat-shrink tubing, or weatherproofing putty; and secure all cables to prevent their flapping in the wind.

**Lightning Protection.** The secret to protecting antennas, towers, transmission lines, and your radio shack from lightning is to control the lightning strike's energy. That means that you must provide a direct path to ground so that the electrical charges picked up from the atmosphere are discharged directly to the earth.

Ground all towers and masts, including those mounted on roofs. With wooden towers, you should run a heavy ground wire up to the hardware on top of the tower. Metal towers are usually well grounded and don't need ground wires run up through the tower, although several ground rods should be attached to the tower legs.

Metal beam antennas are partially self-protecting because they usually are at DC ground potential through the mast and tower that support them. That assumes good connections, so use an anti-oxidant, conductive grease compound to ensure solid contact and prevent dissimilar metal corrosion.

If you use a dipole or other wire antenna that normally uses a balanced (open-wire) transmission line, consider placing a BALUN at the antenna to allow coaxial feedline to be used. Most BALUNS put the antenna at

DC ground potential, offering limited built-in static buildup and lightning protection. Multiband dipole-antenna traps are unprotected from damage during an electrical storm, so induced currents from nearby discharges might cause damage. Just replace BALUNS and traps if they're damaged by discharges.

Don't forget to protect a vertical ground-plane antenna, even if it's at DC ground potential. When that type of antenna is elevated above the ground, run a direct ground wire to its radial system. Don't rely on the coax-feedline shield alone to provide grounding and lightning protection.

Although the antenna itself might be well grounded, the transmission line can cause damage to your home and radio equipment if left unprotected, by acting as a conduit for static discharges. Allow some distance between the tower and the entry point of the transmission line to your home. That provides an opportunity for the ground to absorb strike energy before it can enter your radio shack.

Protect the feedline at its entry point to your home, if possible. A good protective measure is to install a gas-discharge-type plug or lightning arrester in the feedline where it enters the building. While nothing can protect from a direct strike, by bleeding off the charges, those units head off problems from nearby discharges that might induce high voltages in your equipment.

During an electrical storm, the only safe conductor is a grounded conductor. That axiom suggests that, regardless of the type of antenna and feedline used, you should ground all antennas (or disconnect them if possible) when a storm threatens.

One way to accomplish that is to use an antenna-selector switch that automatically grounds all antennas except the one in use and that has enough positions so that you can turn the antenna selector to an unused position when not using the equipment. Putting a couple of loops or turns in your coaxial transmission line, either near the antenna or where the coax enters the radio shack, also might help prevent discharges from entering your home.

While coax is the most popular transmission line today, for receiving

set-ups you can protect a flattop fed with ladder-line or twin-lead by using a simple TV-type lightning arrester. Just don't transmit using that type of set-up: that might short out the arrester. Commercial, balanced-line suppressors are also available, though they can get expensive.

Keep in mind that transmission-line lightning arrestors, of whatever type—especially if located indoors at the back of your radio—offer only secondary protection from static buildup. Your primary protection should be the measures you take with the tower, antenna, and transmission line outdoors.

**Grounds.** There are big differences in grounds for RF grounding and RFI (radio-frequency interference) suppression, for power returns, and for lightning protection. Although every radio shack needs an effective ground system, a "good ground" for one purpose may not be so good for another.

An RF ground improves antenna-system efficiency and reduces RFI to nearby TV's and radios by providing a low-impedance path to ground for stray RF currents in the station. In listening posts, RF grounding often improves reception.

A power return or safety ground for electrical ground faults is often referred to as a "DC ground." That is a good ground for low frequencies (such as the 60-Hz AC power) but might not be a good ground for RF or lightning. Note, however, that in many installations, the RF ground and the DC ground are one and the same.

A lightning ground must be capable of handling high but short-duration currents. Safety-wise, it's that ground that we are most concerned with here, and it's the most difficult one to establish properly.

The most important single element affecting the safety and effectiveness of most conventional lightning-protection equipment and devices is the adequacy of the ground to which they are connected. Have a good, short connection between your antenna system, tower, and ground. Don't use hot-water pipes, gas lines, or electrical-conduit pipe as grounds.

Several six- to eight-foot ground rods connected together with heavy (#6 or #8 gauge) copper or alumi-

*(Continued on page 93)*

## Just like these Fully Trained Electronics Professionals



"Thanks to CIE I have tripled my previous salary, and I am now in a challenging and rewarding new field where only the sky is the limit."

Daniel Wade Reynolds  
Industrial Electrician  
Ore-Ida Foods



"CIE was recommended to me by my boss. It was appealing since I could study at my own pace at home and during business travel."

Dan Parks  
Marketing Manager/Consumer Products  
Analog Devices, Inc.



"I loved the flexibility CIE offered. It was the only way I could continue both school and my demanding job."

Britt A. Hanks  
Director of Engineering  
Petroleum Helicopters, Inc.



"I liked the way the school was set up with laboratory assignments to enforce conceptual learning. The thing which impressed me the most about CIE's curriculum is the way they show application for all the theory that is presented."

Daniel N. Parkman  
Missile Electro-Mechanical Technician  
U.S. Air Force



"Completing the course gave me the ability to efficiently troubleshoot modern microprocessor based audio and video systems and enjoy a sense of job security."

Tony Reynolds  
Service Manager/Technician  
Threshold Audio & Video

# Graduate with an Associate Degree from CIE!

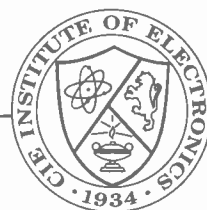

CIE is the best educational value you can receive if you want to learn about electronics, and earn a good income with that knowledge. CIE's reputation as the world leader in home study electronics is based solely on the success of our graduates. And we've earned our reputation with an unconditional commitment to provide our students with the very best electronics training.

Just ask any of the 150,000-plus graduates of the Cleveland Institute of Electronics who are working in high-paying positions with aerospace, computer, medical, automotive and communications firms throughout the world. They'll tell you success didn't come easy...but it did come...thanks to their CIE training. And today, a career in electronics offers more rewards than ever before.

### CIE'S COMMITTED TO BEING THE BEST...IN ONE AREA...ELECTRONICS.

CIE isn't another be-everything-to-everyone school. CIE teaches only one subject and we believe we're the best at what we do. Also, CIE is accredited by the National Home Study Council. And with more than 1,000 graduates each year, we're the largest home study school specializing exclusively in electronics. CIE has been training career-minded students for nearly sixty years and we're the best at our subject...  
**ELECTRONICS... IT'S THE ONLY SUBJECT WE TEACH!**

### CIE PROVIDES A LEARNING METHOD SO GOOD IT'S PATENTED.

CIE's AUTO-PROGRAMMED® lessons are a proven learning method for building valuable electronics

career skills. Each lesson is designed to take you step-by-step and principle-by-principle. And while all of CIE's lessons are designed for independent study, CIE's instructors are personally available to assist you with just a toll free call. The result is practical training... the kind of experience you can put to work in today's marketplace.

### LEARN BY DOING...WITH STATE-OF-THE-ART EQUIPMENT AND TRAINING.

CIE pioneered the first Electronics Laboratory

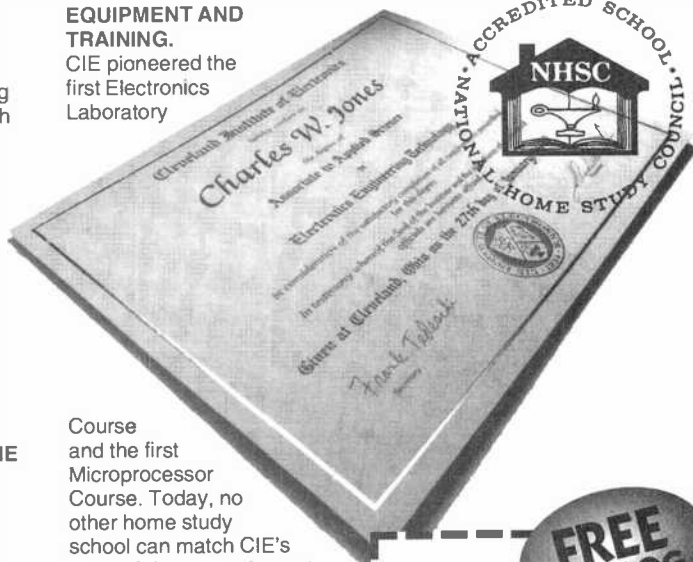

Course and the first Microprocessor Course. Today, no other home study school can match CIE's state-of-the-art equipment and training. And all your laboratory equipment, books and lessons are included in your tuition. It's all yours to use while you study and for on-the-job after you graduate.

### PERSONALIZED TRAINING...TO MATCH YOUR BACKGROUND.

While some of our students have a working knowledge of electronics others are just starting out. That's why CIE has developed twelve career courses and an A.A.S. Degree program to choose from. So, even if you're not sure which electronics career is best for you, CIE can get you started with core lessons applicable to all areas in

electronics. And every CIE Course earns credit towards the completion of your Associate in Applied Science Degree. So you can work toward your degree in stages or as fast as you wish. In fact, CIE is the only school that actually rewards you for fast study, which can save you money.



**YES!** I want to get started. Send me my CIE course catalog including details about the Associate Degree Program. (For your convenience, CIE will have a representative contact you - there is no obligation.)

Please Print Clearly

Name \_\_\_\_\_

Address \_\_\_\_\_

City \_\_\_\_\_

State \_\_\_\_\_ Zip \_\_\_\_\_ Age \_\_\_\_\_

Phone No. \_\_\_\_\_

Check box for G.I. Bill Benefits.  
 Veteran \_\_\_\_\_  
 Active Duty \_\_\_\_\_ **AH65**

Cleveland Institute of Electronics, Inc.  
1776 East 17th Street  
Cleveland, OH 44114

A School of Thousands.  
A Class of One. Since 1934.

Send for CIE's FREE Course Catalog and See How We Can Help Your Career Too!

May 1995, Popular Electronics

# BUILD THE "g" MACHINE

BY ANTHONY J. CARISTI

*Determine the "g" forces generated by your car with this portable, digital acceleration-measurement system.*

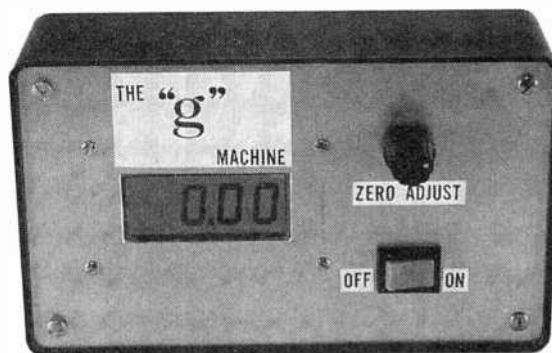

If you would like a high-tech way to measure the gravitational or "g" forces generated by your car, then this unusual project might be right for you. It's called the "g" Machine, and if you build it, you'll probably be the first one in your circle of friends to have a car equipped with a sophisticated g meter!

The "g" Machine measures acceleration and deceleration levels encountered in any moving vehicle, and displays those levels on an LCD. You can use it to compare the performance of your car's engine and braking system with that of other vehicles. The unit can also be used as a sophisticated electronic level by taking advantage of its sensitivity to the Earth's gravitational force.

**Velocity and Acceleration.** Before we get into how the "g" Machine works, let's quickly review how velocity and acceleration are measured. Velocity is the change in distance with respect to time, and can be specified as ft/s (feet per second). Acceleration is the change in velocity with respect to time and is specified as ft/s<sup>2</sup>. Sometimes, acceleration is referred to in terms of "g's," where 1 g is equal to the acceleration caused by Earth's gravitational field, or 32 ft/s<sup>2</sup>. Let's now look at an example:

An automobile traveling at a constant speed of 60 mi/hr (miles per hour) has an acceleration of zero, because there is no change in its velocity with respect to time. The velocity, 60 mi/hr, can also be spec-

ified in the unit of ft/s by using a simple algebraic equation that converts miles to feet and hours to seconds:

$$(60 \text{ mi/hr} \times 5280 \text{ ft/mi} \times 1 \text{ hr}) / 3600 \text{ s} = 88 \text{ ft/s}$$

Note that miles (mi) and hours (hr) are canceled out in the above equation to arrive at the desired units of ft/s.

Acceleration can easily be calculated using the equation

$$\text{acceleration} = \text{velocity}/\text{time}$$

Let's say that the automobile from the preceding example starts out at 0 ft/s and accelerates to 88 ft/s (60 mi/hr) in 8 seconds. That car has an average acceleration of

$$(88 \text{ ft/s}) / 8 \text{ s}$$

or 11 ft/s<sup>2</sup>. Because 1 g = 32 ft/s<sup>2</sup>, the automobile has an average acceleration of 11/32 or about 0.34 g's.

If the automobile was driven at a constant rate of acceleration as its speed increased from zero to 60 mi/hr, the "g" Machine would measure and display that automobile's performance with a display of about 0.34 g's. However, if the braking system could similarly stop the vehicle in 8 seconds, the deceleration would be displayed as -0.34 g's.

**The Accelerometer.** The "g" Machine uses the ADXL50 accelerometer, which is a monolithic integrated circuit designed by Analog Devices (the IC is available from the source in the Parts List or from an Analog Devices distributor). An accel-

erometer is a device that generates an electrical output signal that is proportional to any acceleration forces (changes in velocity) affecting it. The ADXL50 is used by at least one automobile manufacturer in airbag-deployment systems, and by other companies for different applications.

How does the accelerometer work? The ADXL50 IC is a completely self-contained measurement system that uses a change in capacitance to determine acceleration. Figures 1A and 1B are simplified diagrams of the sensor at rest and when subjected to the force of acceleration, respectively. The actual structure of the sensor consists of 42 unit cells, only one of which is shown in the figures. Its construction is such that each cell comprises a differential capacitor shown as C<sub>a</sub> and C<sub>b</sub>.

When the sensor is at rest, the values of C<sub>a</sub> and C<sub>b</sub> in each unit cell are identical. However, when the sensor experiences a change in velocity (acceleration), the center beam structure of the IC is deflected (as shown in Fig. 1B). That causes the capacitance value of C<sub>a</sub> to decrease while that of C<sub>b</sub> increases.

The fixed capacitor plates of the sensor are each driven by a 1-MHz square wave, and are 180 degrees out-of-phase with each other. With no acceleration force present, the voltages fed through the capacitors to the center plate cancel each other out, resulting in a voltage output at the center plate of zero.

When the force of acceleration is

present, the change in the capacitance of  $C_a$  and  $C_b$  causes an unbalance in the system, and a 1-MHz output signal is produced at the center plate. That signal is passed through a synchronous demodulator to produce a DC output voltage that is proportional to acceleration. Circuitry within the IC, if connected to the correct external components, provides an output voltage of 2.5 volts when the sensor is at rest. That voltage will increase or decrease in magnitude in accordance with the level of acceleration or deceleration affecting the sensor.

**Circuit Description.** Power for the "g" Machine (shown in Fig. 2) is taken from a 9-volt battery, B1. That battery's output voltage is regulated by U1, which supplies a constant 5 volts to drive the remainder of the circuit. Of course, the circuit can also run off of a car battery.

The heart of the circuit is U2, the ADXL50 accelerometer. The sensitivity of that chip is set to  $\pm 20$  g's in order to accommodate the full scale capability of LCD module DISP1 (19.99). Circuit gain is determined by the values of R4, R5, and R6, which control the gain of the internal buffer amplifier of the accelerometer. The series string composed of R1, potentiometer R2, and R3 provides a way to manually set the zero-g voltage-output level at pin 9 of U2 to half the supply voltage—2.5 volts. That output voltage will vary linearly by 0.1-volt-per-g of acceleration. Therefore, when sub-

ject to the maximum value of 20 g's, the output voltage will swing 2 volts from its zero-g level of 2.5 volts.

In order to achieve good circuit performance at low g levels, the bandwidth of the amplifier is limited to about 30 Hz by C6. That capacitor is externally connected across the feedback resistor of the internal op-amp of the accelerometer.

The digital-display section of the circuit is composed of DISP1 and U3. The latter is an analog-to-digital converter chip that contains all the necessary active components to drive DISP1, the 3½-digit LCD module. Included in U3 are the A/D converter, clock oscillator, storage registers and latches, 3½-digit seven-segment decoders, and backplane generator.

The differential analog input of U3 is applied between pins 30 and 31. The positive input, pin 31, is driven by output-pin 9 of U2 through R8, a buffer resistor, and the negative input, pin 30, is biased at a fixed voltage of 2.5 volts by a voltage-divider string composed of R9 and R10. That provides the desired display of 0.00 when the accelerometer is at rest.

A reference voltage is required by U3. That is applied between pins 35 and 36 to set the full-scale display range of the A/D converter. Full-scale display, 19.99, occurs when the differential, analog input voltage applied between pins 31 and 30 is equal to twice the reference voltage. Because the scale factor of U2 has been set to 2.0 volts for 20 g's, the reference voltage must be 1.0 volts. The voltage-

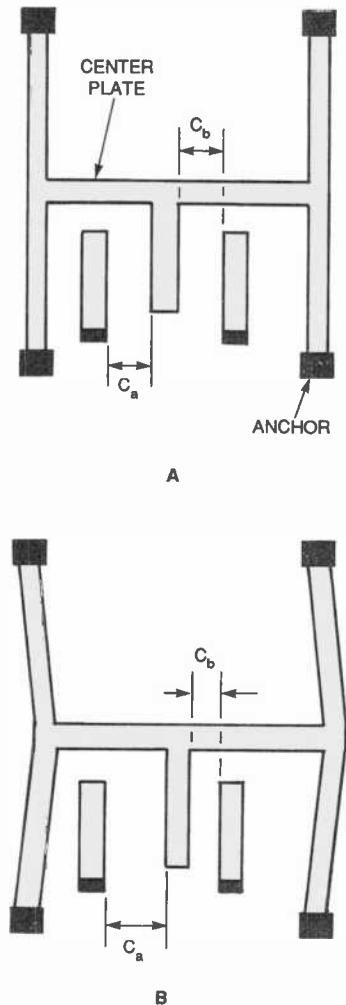

Fig. 1. When the accelerometer sensor is at rest (A), the capacitance of  $C_a$  is equal to that of  $C_b$ . However, when the sensor is accelerated to the left (B), the center plate shifts to the right, causing the capacitance of  $C_b$  to increase, and that of  $C_a$  to decrease.

## PARTS LIST FOR THE "g" MACHINE

### SEMICONDUCTORS

U1—78L05 5-volt regulator, integrated circuit  
 U2—ADXL50 accelerometer, integrated circuit (Analog Devices)  
 U3—ICL7106 A/D converter, integrated circuit  
 DISP1—3½-digit LCD module (Digi-Key LCD002VT-ND or similar)  
 Q1—BS170 N-channel enhancement MOSFET

### RESISTORS

(All fixed resistors are ¼-watt, 1%, metal-film units unless otherwise noted.)  
 R1, R3—20,000-ohm  
 R2—10,000-ohm potentiometer, panel-mount

R4—23,700-ohm  
 R5—5000-ohm, cermet potentiometer, PC-mount  
 R6—137,000-ohm  
 R7, R9, R10, R11, R13—100,000-ohm  
 R8—1-megohm, 5%, carbon  
 R12—49,900-ohm  
 R14, R16—100,000-ohm, 5%, carbon  
 R15—470,000-ohm, 5%, carbon

### CAPACITORS

C1—47- $\mu$ F, 25-WVDC, electrolytic  
 C2, C3, C7, C9—0.1- $\mu$ F, metallized-film  
 C4, C5—0.022- $\mu$ F, metallized-film  
 C6, C10—0.047- $\mu$ F, metallized-film  
 C8—100-pF, ceramic-disc  
 C11—0.22- $\mu$ F, metallized-film

### ADDITIONAL PARTS AND MATERIALS

S1—SPST toggle or slide switch  
 B1—9-volt battery  
 Printed-circuit materials, project enclosure, 90-degree header (see text), 40-pin IC socket, battery snap with leads, spacers, machine screws and nuts, wire, solder, hardware, etc.

**Note:** The following parts are available from A. Caristi (69 White Pond Road, Waldwick, NJ 07463). Set of 3 PC boards: \$24.95; U1: \$2.00; U2: \$66.50; U3: \$14.95; Q1: \$2.00; set of 10 1% resistors: \$5.00. Please add \$5.00 postage/handling. New Jersey residents please add appropriate sales tax.

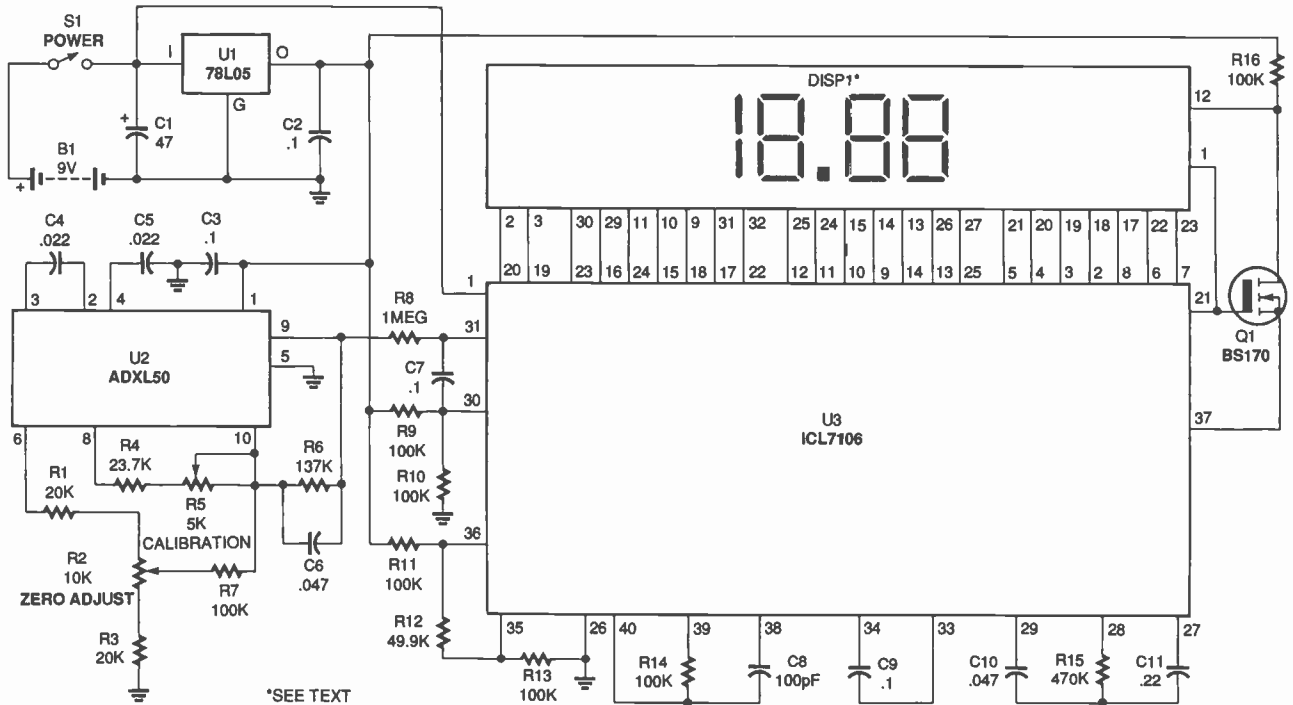

Fig. 2. As this schematic shows, the ADXL50 accelerometer, U2, interfaces with an A/D converter, U3, to drive a 3 1/2-digit LCD module, DISP1. Because that module displays any number from -19.99 to +19.99, the circuit is designed to measure g's within that range.

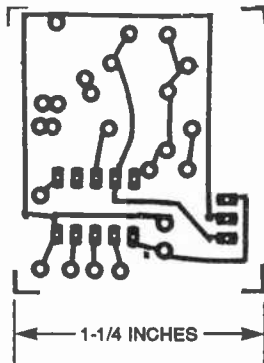

Fig. 3. Here is the template for the accelerometer printed-circuit board.

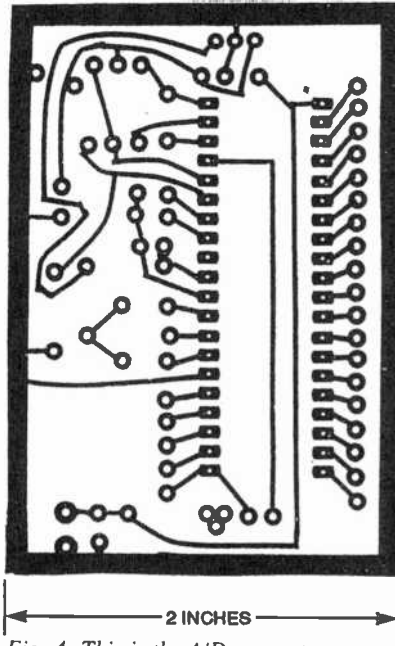

Fig. 4. This is the A/D-converter printed-circuit board.

If you choose to build the project on PC boards, use Figs. 6, 7, and 8 as guides to ensure that you properly orient all polarized components. Install those parts first, then install the other capacitors and resistors. Next, install U3 using a 40-pin socket.

The accelerometer, U2, can be soldered directly onto the accelerometer board. Note the position of U2's tab shown in Fig. 6, and make sure that the orientation of the part matches. Then, gently bend the leads to fit into the ten holes on the board.

divider string composed of R11, R12, and R13 provides that voltage.

The decimal point of the LCD has to be illuminated to display readings from 0.00 to 19.99. That is done by inverting the backplane square-wave drive signal appearing at pin 21 of U3, through MOSFET Q1, and applying the 180-degree out-of-phase signal to pin 12 of DISP1.

**Construction.** The author's prototype for the "g" Machine was assembled using three single-sided printed-circuit boards that are mounted within a small enclosure. Those are the accelerometer board (Fig. 3), the A/D-converter board (Fig.

4), and the display-module board (Fig. 5). The printed-circuit boards can be obtained from the source given in the Parts List, or you can etch and drill your own. Alternatively, the circuit can be hard-wired on one or more perfboards providing that proper orientation of the accelerometer is maintained, as explained later.

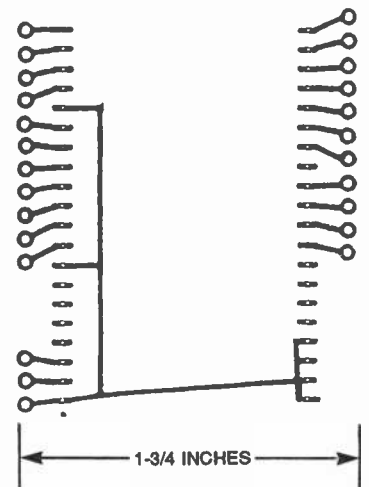

Fig. 5. The display board template is shown here.

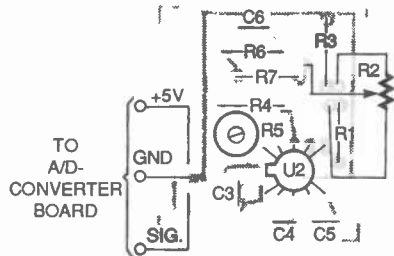

Fig. 6. Use this parts-placement diagram as a guide when assembling the accelerometer board. Check the position of the tab on U2 to make sure the accelerometer is oriented correctly. Also, note the connections to the A/D-converter board that can be made with a 3-pin header.

Be careful with that operation; the leads are fragile and you don't want to inadvertently break any of them with repeated bending.

The accuracy of the circuit relies on the stability of the accelerometer and A/D-converter voltage-reference-resistor values. For that reason, you should use only metal-film resistors for the resistors specified in the Parts List as 1% units. Ordinary carbon resistors are not temperature stable and should only be used where specified.

When you have completed assembly of the circuit boards, examine them very carefully for bad solder joints and/or incorrect orientation of parts. It is much easier to correct problems at this stage rather than after the boards are connected.

**Connecting the Boards.** Before you can connect the printed-circuit boards to the front panel of the enclosure, the A/D-converter board and display board must be wired together using light gauge (#22 to #26), insulated stranded wire (do not use solid wire—it has a tendency to break). Those connections include three sets of seven wires, each labeled a through g, for the seven-segment display digits, the half digit (1), the minus sign, and the backplane drive.

Use Figs. 2, 7, and 8 as guides when making the connections. Be sure to allow sufficient wire length to accommodate the final position of the boards. Check the wiring between the two boards carefully; an error there will result in garbled display digits, or no display at all.

A rectangular cutout measuring 2 by 7/8 inches should be made at the desired location in the front panel of

your enclosure. The two operating controls, S1 and R2, can be placed at any convenient location; they will be connected to the circuit boards later.

For the "g" Machine to provide a positive acceleration reading when it is facing the user, the accelerometer PC board must be oriented perpendicular to the front panel of the enclosure. The tab of U2 has to point towards the front panel of the instrument, as indicated in Fig. 9 (a side view of the assembly from the bottom edge of the front panel). Precise orientation of U2 is important to ensure a

balance between positive- and negative-acceleration forces.

One way to accomplish proper orientation of U2 is to mount the accelerometer board to the A/D-converter board using a 3-pin, 90-degree header with 0.1-inch spacing (Digi-Key S1112-3-ND or similar), as was done in the author's prototype. The assembly can then be stacked with the display board and mounted to the front panel of the enclosure with spacers, machine screws, and nuts (as shown in Fig. 9). If you are not planning on using the supplied PC-board tem-

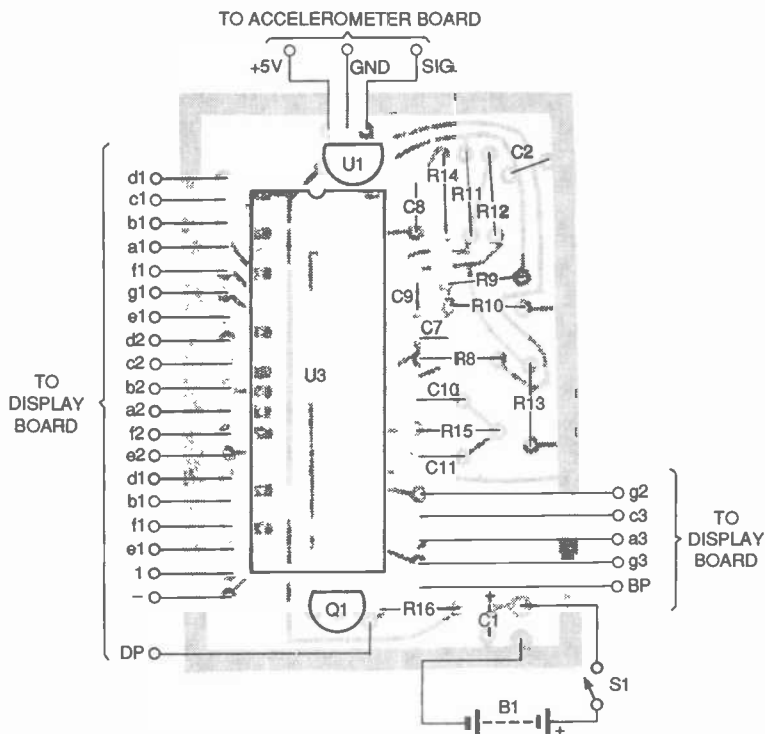

Fig. 7. On-board component placement on this A/D-converter board is pretty simple. Just be careful when making the off-board connections to the display board. Also, note the placement of the 3-pin header.

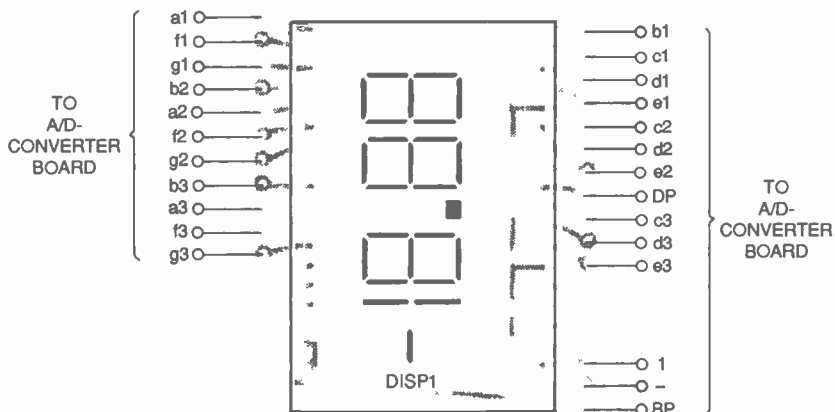

Fig. 8. The only component that mounts on this board is DISP1. However, watch those connections to the A/D converter board!

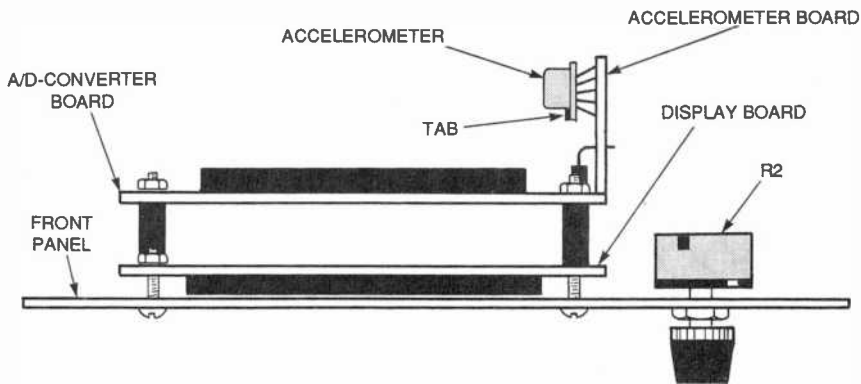

Fig. 9. This is a top-side view of the "g" Machine. Make sure U2 is placed so that its tab points towards the front panel, as shown. The boards are mounted with spacers and machine screws and nuts.

plates, and will use a different parts layout, make sure that the accelerometer is still aligned properly (with the tab pointing to the front panel).

Attach a battery clip, switch S1, and potentiometer R2 to the circuit using Figs. 6 and 7 as guides. Be sure to check polarity when wiring the clip to the circuit. The battery should be secured within the cabinet to keep it from moving around.

**Checkout.** The checkout procedure requires the use of a digital voltmeter or VOM. Set R2 and R5 to mid-position and connect a fresh 9-volt battery to the circuit. Turn the power on and measure the voltage at the output of U1 with respect to the circuit common (negative battery terminal). If all is well, it should measure between 4.75 to 5.25 volts.

Do not proceed with the checkout procedure if you do not obtain the correct voltage reading. Instead, check the orientation of C1 and U1. The next step in the procedure is to check the positive battery-terminal voltage and polarity under load to be sure it is delivering at least +7 volts to the circuit. If it's not, turn off the power and check the resistance between the 5-volt bus and circuit common to be sure that there is no short circuit. Locate and repair the fault before proceeding.

With the 5-volt regulator operating properly, apply power to the circuit and measure the voltage at pin 9 of U2 while adjusting potentiometer R2 over its range. A normal indication is about +2.3 to +2.7 volts. If necessary, a different-valued resistor can be used for R1 and/or R3 to obtain a swing that is centered about 2.5 volts.

If you do not obtain the correct voltage at pin 9 of U2, disconnect power and check the orientation of U2 on its board to be sure it is correct as shown in Fig. 6. Check the wiring to R2, and all the components on the accelerometer board. Check the voltage between pins 1 and 5 of U2 to be sure it is being powered by the +5-volt regulated supply.

With U2 operating properly, check the display as R2, the ZERO ADJUST control, is rotated over its range. You should obtain readings that cover the range of at least -1.00 to +1.00, or more. Of course, adjustment of R2 should allow the display to be set to 0.00.

If the display is blank, check the orientation of U3 and DISP1, and verify that all component values associated with U3 are correct. Check pin 21 of U3 with an oscilloscope to verify the presence of the 5-volt, peak-to-peak, 55-Hz, backplane square-wave signal.

If some of the digits are not properly formed, then there is either a wiring error, a short, or an open in one or more of the connections between the A/D-converter and display boards. Check the boards for solder bridges or poor connections. If the decimal point is not illuminated, check Q1 and its associated wiring, and if that is correct, try a new transistor.

**Calibration.** You will have to calibrate the "g" Machine against the force of gravity, which averages 1g. To do that, set R5 to approximately mid-position first. Then, hold the enclosure so that the front panel is exactly vertical, and apply power. Carefully adjust R2, the ZERO ADJUST front-panel potentiometer, for a display of 0.00.

Now place the panel in a horizontal position with the display facing upward. The reading should be a negative number. Position the panel in a horizontal position so that the display faces down. The reading should be a positive number. Proper calibration is attained by adjusting R5 so that the readings in the last two positions are as close to -1.00 and +1.00 as possible. That will take several adjustments of R5. Before each adjustment, always hold the panel in an exact vertical position and re-zero the display to 0.00 with the front-panel potentiometer, R2.

Note: If there seems to be an imbalance in the positive and negative readings with the panel placed in each horizontal direction, the orientation of U2 is not exact. It will be possible to balance the readings by slightly adjusting the position of U2 on its board, rotating it either clockwise or counterclockwise as required. With careful calibration it should be possible to obtain positive and negative readings that are reasonably close to each other, within 0.1 g's or less.

**Using the "g" Machine.** The best way to check the operation of the "g" Machine is to take it for a test run in a vehicle. Be sure to have someone drive while you operate the instrument. Always hold the front panel in a vertical direction and zero the display while stopped, before taking a measurement.

Remember: acceleration is the rate of change of velocity or speed, so maximum acceleration readings occur when the vehicle is starting out. When a final speed is attained, the acceleration should become zero. For example, if the vehicle is driven so that its speed increases from zero to 55 MPH in as short a time as is practical, the g force will be about 0.3 to 0.5 when beginning the test and it will decrease to zero when speed becomes constant.

It should be noted that it is possible to attain much-higher g forces when braking. When that is done, the instrument will display a negative number, indicating deceleration.

The display will start to become erratic, and will eventually go blank, when the battery needs to be replaced. To extend battery life, shut off the unit when it's not in use. ■



# Tuned Circuits and Resonance

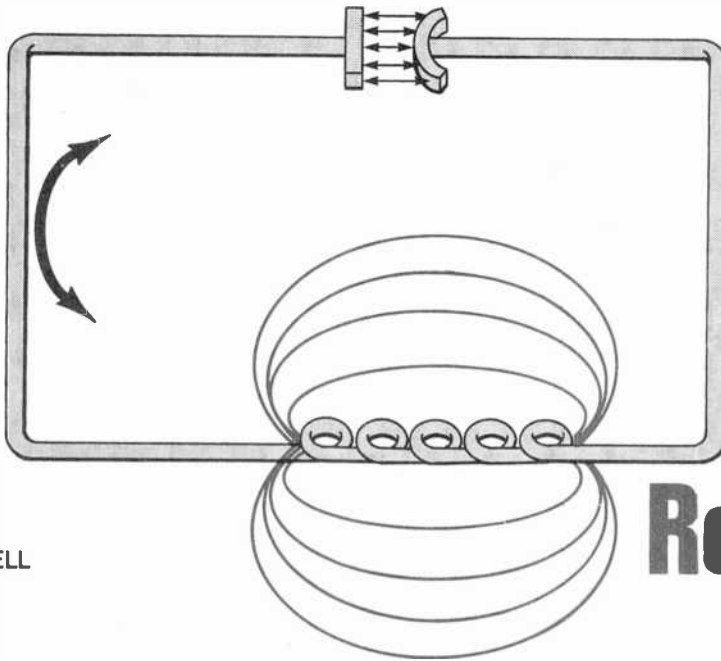

BY PAUL COXWELL

*Learn how series- and parallel-tuned resonant circuits work, and how to analyze them.*

Capacitors and inductors are collectively known as reactive components. As you probably know, reactance causes a phase shift between voltage and current in a circuit. So the voltages and currents in reactive AC circuits must be plotted and analyzed by the use of vector diagrams. In this article, we'll use vector diagrams to examine one of the more interesting types of reactive circuits, known as tuned or resonant circuits. If you need to refresh your memory on vector analysis or reactance, see *Introduction to Reactance* in the September 1994 issue of **Popular Electronics**.

**Series RLC Circuits.** To begin, refer to Fig. 1A, which shows a series circuit that contains both capacitance and inductance. At 60 Hz, the reactance of the capacitor is 5308 ohms and that of the inductor is 1131 ohms. To verify that for yourself, you can use these equations:

$$X_C = 1/(2\pi fC)$$

$$X_L = (2\pi fL)$$

where  $f$  is the source's frequency, and  $X_C$  and  $X_L$  are the reactances of the capacitor and inductor, respectively.

The coil and capacitor are in series, so the current through each component is in phase. The voltage across the capacitor lags the current by 90 degrees, while that across the induc-

tor leads the current by 90 degrees. Since the two voltages,  $E_C$  and  $E_L$ , are exactly 180 degrees out of phase, one partially cancels the other.

In this particular case, the capacitor's reactance is greater than the coil's, so the total reactance of the two combined components is determined by subtracting  $X_L$  from  $X_C$ . The result is 4177 ohms.

Now that we know the total reactance, we can use it and the resistance to find the total impedance. For that, we use the Pythagorean Theorem as though the resistance and reactance were legs of a right triangle and the impedance ( $Z$ ) was the hypotenuse, as follows:

$$Z = \sqrt{R^2 + C^2}$$

For our example, the impedance works out to 4295 ohms. By a variant of Ohm's Law, (in this case written  $I = E/Z$ ) that means the circuit current is 23 mA. The voltage across each component can be calculated by using Ohm's Law, with  $X_L$  in place of  $R$  for the coil and  $X_C$  in place of  $R$  for the capacitor. That works out to 26 volts for the  $E_L$  and 122 volts for  $E_C$ . Notice that the voltage across the capacitor is greater than the supply voltage; a little later we will see that the reactive voltages often exceed the supply voltage by a considerable factor.

Figure 1B shows the vector diagram for the voltages involved. Since  $E_L$  will partially cancel  $E_C$ , the diagram can be redrawn as in Fig. 1C, with the one vector,  $E_x$ , representing the overall reactive voltage across both components. All the usual geometric relations can then be used. Using the relation:

$$\theta = \cos^{-1}(E_R/E)$$

the phase angle of this circuit can be

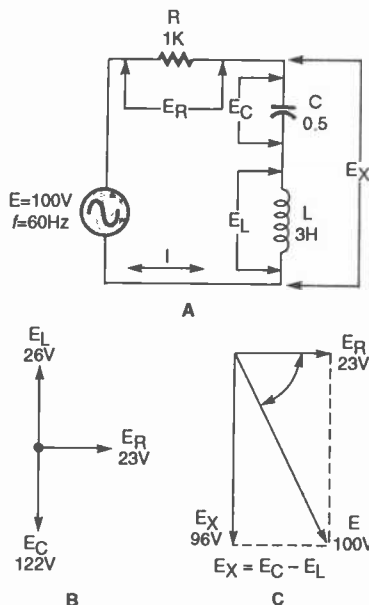

*Fig. 1. Inductive reactance and capacitance reactance in a series tuned circuit (A) cancel each other. Hence, their voltages are of opposite polarity (B). So the over-all reactive voltage is their difference (C).*

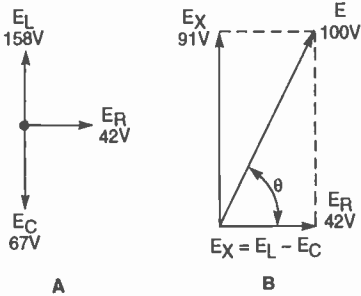

Fig. 2. When the inductive reactance is greater than the capacitive reactance, a circuit becomes inductive.

calculated as 76.7 degrees, and the source voltage will lag the current, because overall the circuit appears to be capacitive.

The resistance of the series circuit is independent of the operating frequency, but the reactance will vary as the frequency is varied. Recall that inductive reactance increases with rising frequency, whereas capacitive reactance decreases.

For example, let's take the same series RLC circuit, but observe its operation at 200 Hz. This time the value of inductive reactance (3770 ohms) is greater than the value of capacitive reactance (1592). The vector diagram of Fig. 2 shows the circuit now behaves inductively as a result.

**Series Resonance.** As the frequency is raised up from zero,  $X_L$  increases and  $X_C$  decreases, so there must be some point at which those two values are equal. For the values of capacitance and inductance used in our example, that will be true if the supply frequency is 130 Hz. At that frequency, both  $X_L$  and  $X_C$  are 2450 ohms, and completely cancel one other. The reactive components effectively "disappear," leaving a series circuit with an impedance equal to the resistance alone, and a phase angle of zero.

Assuming that the supply voltage is still 100 volts, the circuit current will be 100 mA. Use of Ohm's Law will show that the voltage drop across the resistor is 100 volts, while  $E_L$  and  $E_C$  are each 245 volts. Although those figures may, at first glance, appear to be in conflict with the supply voltage of just 100 volts, you must remember that  $E_L$  and  $E_C$  are 180 degrees out of phase and completely cancel. A meter connected across the coil or capacitor individually would show 245 volts, but

connected across the two components together would show zero.

A circuit that contains both inductance and capacitance is known as a tuned circuit, and the frequency at which  $X_L$  and  $X_C$  are equal is called the resonant frequency. The formula used to determine that frequency is:

$$f_o = 1/(2\pi\sqrt{LC})$$

A series tuned circuit has some very important properties. For example

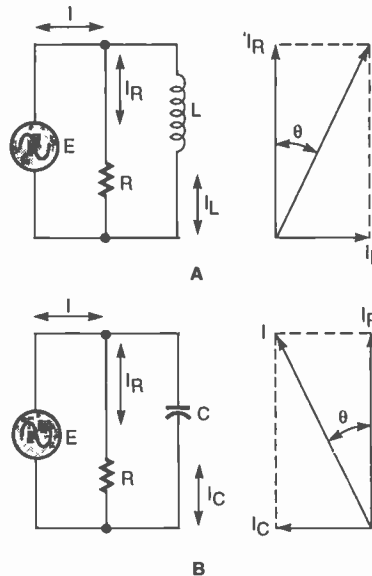

Fig. 3. Reactance in a parallel circuit causes component currents to be out of phase.

current in a series tuned circuit is greatest at resonance, since at that frequency the reactance is reduced to zero and the circuit's impedance is at its lowest value (being equal to just the resistance). Notice, though, that the resistance has no effect on the actual resonant frequency of the circuit; that is determined solely by the values of inductance and capacitance.

The voltages across the coil and across the capacitor will be greatest at resonance, because the current is at a maximum. Those two voltages will also be equal but 180 degrees out of phase, as has already been shown. Since the reactive portion of the circuit has a net voltage across it of zero, the full supply voltage will appear across the resistance.

**Parallel RLC Circuits.** Figure 3 summarizes the essential points of the parallel circuit that contains either capacitance or inductance. As the voltages across all components in a

parallel circuit must be the same, voltage is used as the zero-degree reference point. Current through the resistor is, naturally, in phase with the supply voltage, but the current through the coil,  $I_L$ , or capacitor,  $I_C$ , will be 90 degrees out of phase with  $I_R$ . The geometry leads to the equations:

$$I = \sqrt{I_R^2 + I_L^2}$$

$$Z = 1/\sqrt{(1/R)^2 + (1/X_L)^2}$$

for the circuit in Fig. 3A, and:

$$I = \sqrt{I_R^2 + I_C^2}$$

$$Z = 1/\sqrt{(1/R)^2 + (1/X_C)^2}$$

for the circuit in Fig. 3B.

Now look at Fig. 4A, which shows a parallel circuit that contains both inductance and capacitance. The values of the components are the same as those that were used in the series circuit earlier, so the figures for capacitive and inductive reactance should be familiar to you. Ohm's Law allows the current through each branch of the circuit to be determined quite easily. Unlike the simple resistive network, however, the total supply current cannot be determined by simply adding the individual branch currents because they are not in phase.

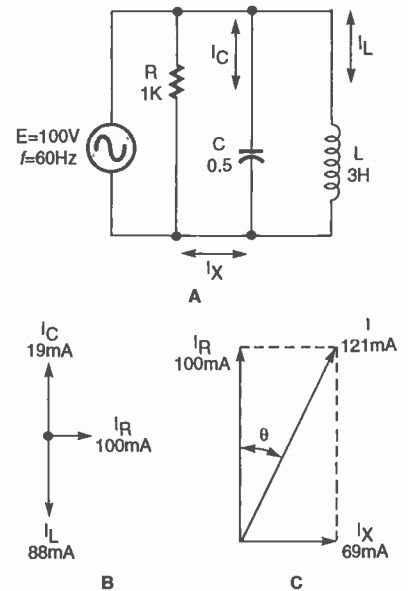

Fig. 4. Capacitors and inductors can be arranged to form a parallel tuned circuit (A). The current through the capacitor opposes that in the inductor (B). The net result is the vector shown in C.

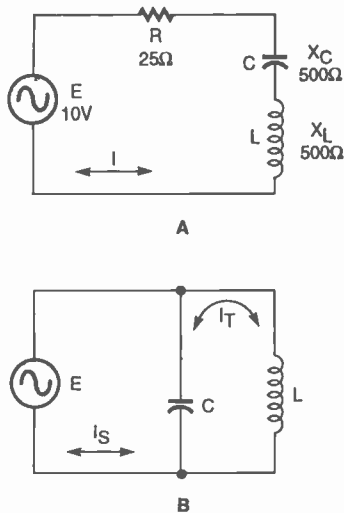

Fig. 5. The magnification factor ( $Q$ ) shows what voltage will appear across the coil and capacitor in a series resonant circuit (A), and what current will develop in the parallel tuned tank (B).

The vector diagram in Fig. 4B shows the individual currents. Remember that the circuit voltage is the reference point in the parallel circuit: In the capacitive branch, current will lead the voltage by 90 degrees and in the inductive branch it will lag the voltage by 90 degrees. The consequence of this is that  $I_C$  and  $I_L$  are 180 degrees out of phase; when current is flowing up through the capacitor in the schematic, current flows down through the coil, and vice versa. In this example,  $I_L$  is the greater current, so the net current can be calculated by subtracting  $I_C$  from  $I_L$ . A new vector diagram (see Fig. 4C) can then be drawn to determine the phase angle and source current, as shown.

This circuit is operating at a frequency below resonance, and appears to the source as an inductance, because the supply current is lagging behind the voltage. Compare this with the series circuit which appears to be capacitive when operating below resonance. If the frequency of the supply were increased to 200 Hz, the circuit would be operating above the resonant frequency,  $I_C$  would be greater than  $I_L$ , and the source would "see" a capacitive load.

**Parallel Resonance.** Now, let us examine the parallel tuned circuit at resonance. The resonant frequency is calculated in just the same way as the series tuned circuit, so as we have kept the same values as before,  $f_0$  will

be 130 Hz once again.

In an earlier example we determined that  $X_C$  and  $X_L$  will both be 2450 ohms at 130 Hz. When connected to a supply of 100 volts, that results in a current of approximately 41 mA through each reactive component. But those two currents are exactly 180 degrees out of phase, so they completely cancel each other, leaving the supply current equal to the current through the resistor. Just as in the series-resonant circuit, the reactance has "disappeared," to leave just resistance.

The current flowing back and forth through the coil and capacitor is known as a circulating current, and the two components form a tank circuit. We will analyze the action by starting at a point where the capacitor plates are fully charged. Current

from the capacitor will flow through the coil, thereby building up a magnetic field around the coil. That action continues until the capacitor is discharged and current stops flowing. At that time, the magnetic field around the coil starts to collapse, and in doing so induces a current in the coil. The current causes the capacitor to charge once more, although this time the plates will be charged with the opposite polarity. When the induced current in the coil stops, the capacitor discharges again into the coil and the whole process repeats.

The tank circuit, therefore, sets up oscillations at the resonant frequency by continuously transferring energy between the electrostatic field of the capacitor and the electromagnetic field of the inductor. In a theoretical, perfect tuned circuit, these oscillations

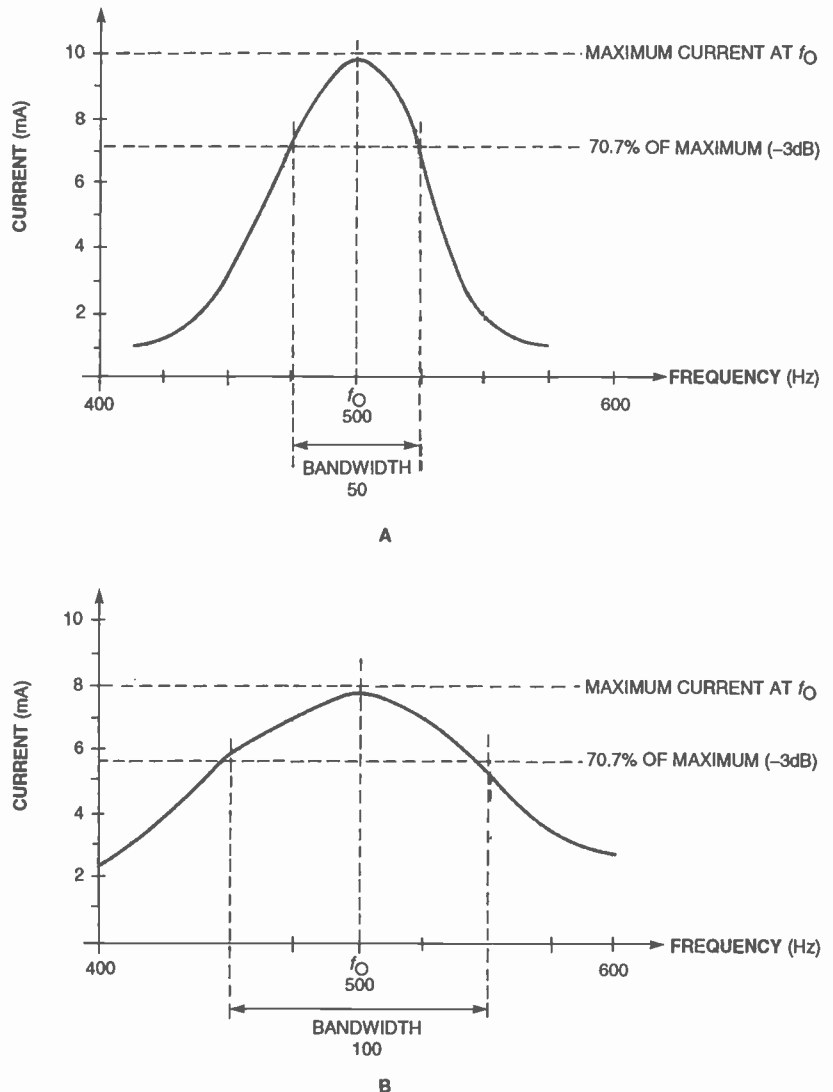

Fig. 6. The response of a high- $Q$  circuit (A) will be sharper (taller and more narrow) than that of a lower- $Q$  circuit.

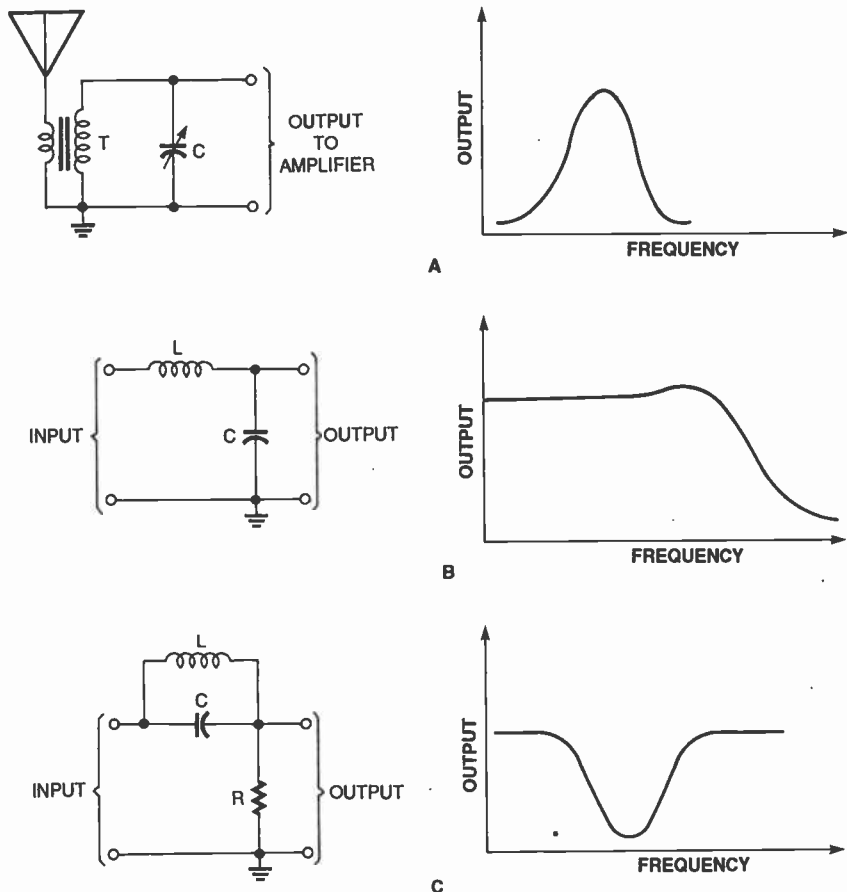

Fig. 7. A band-pass filter (A) is typically used as a receiver front end. This low-pass filter (B) acts as a frequency-selective voltage divider. The high-impedance of the parallel tuned circuit in C at resonance makes the circuit act like a band-stop filter.

tions would continue indefinitely, even when the original power source is removed.

A real circuit, however, must have some amount of resistance, so in practice the oscillations would soon die away without external power. The resistance in the coil means that  $I_C$  and  $I_L$  are almost equal, but not exactly so. The small difference forms the reactive current,  $I_X$ , so the power source must supply just enough current to overcome the resistance loss. (There is also likely to be very slight leakage through the capacitor, but its resistance is usually so high as to be of no consequence.)

Let us review the important facts about the parallel tuned circuit. At resonance, the impedance of the tuned circuit rises to a very high value, so the current drawn from the supply drops to a minimum. The circulating current in the coil and capacitor can be many times greater than the supply current. Also, the circuit does not appear reactive to the source. If the frequency is increased,  $I_C$  becomes

greater than  $I_L$  and the circuit appears to be capacitive; if the frequency is reduced below resonance,  $I_L$  becomes dominant so the circuit appears to be inductive.

**Circuit Q.** Many of our examples have assumed that the inductor is a perfect component that exhibits no resistance, although it has been mentioned that a practical coil has some resistance. Indeed, many inductors are wound with many thousands of turns of fine wire, so the resistance can be in the order of several-hundred ohms, or more.

The resistive portion of a circuit consumes power, whereas the inductive portion does not, and the ratio of the energy stored by the inductor to the energy dissipated by its resistance is called the Q, which is also known as the quality, figure of merit, or magnification factor. (The origin of the last term will become clear shortly.)

Since the Q of a coil is the ratio of energy stored to energy dissipated, Q can also be expressed as the ratio of

inductive reactance to resistance. Assume that a coil has an inductive reactance of 1000 ohms at the frequency in use, and a resistance of 100 ohms. The Q of the coil would be 10. Remember, though, that as the frequency is increased, the inductive reactance of the coil increases, so the Q will also rise.

Now, look at the series tuned circuit of Fig. 5A. The reactances are equal in value, so the circuit is at resonance. The Q of the circuit is determined by dividing the inductive reactance by the resistance, which gives a value of 20. (To keep the example simple, we have assumed that the coil is pure inductance and has no resistance of its own.) Because inductive and capacitive reactance are equal at resonance, the Q can also be calculated by using  $X_C$  in place of  $X_L$ .

You know that the voltage measured across a resonant series circuit must be zero, so it is easy to calculate the current that flows by dividing the source voltage by the 25-ohm resistance. Further application of Ohm's Law will show that the voltages developed across the coil and capacitor are each 200 volts (but 180 degrees out of phase). The voltages  $E_L$  and  $E_C$  are equal to the source voltage, 10 volts, multiplied by the Q of the circuit, which is why the Q is also known as the magnification factor.

Experimenting with some different component values shows that  $E_C$  and  $E_L$  can always be calculated from the source voltage and Q. Suppose that the resistance of the circuit is changed from 25 ohms to 250 ohms. The new value of Q is just 2, so  $E_L$  and  $E_C$  will be reduced to 20 volts and the circuit current will be 40 mA. If the resistance was reduced to, say, 10 ohms, the current would rise to 1 A. The new value of Q would be 50, giving coil and capacitor voltages of 500 volts. Given a high enough magnification factor, very high voltages can be developed across the reactive components from a low-voltage supply.

The relationship between the supply voltage and reactive voltages provides a simple way to determine the Q of a circuit without having to measure the total reactance and resistance. Just measure the coil voltage and the supply voltage: The ratio between them is the Q of the circuit.

(Continued on page 91)

I've always wanted to make a radio using a variometer. In the old radio books that I read as a kid, variometers were pictured as two coils connected in series, one inside the other. The inner coil could be rotated and would either cancel or add to the inductance of the outer coil, depending on how it was oriented. Variometers were used to tune radios before variable capacitors became common. Unfortunately, I couldn't figure out an easy way to build one.

The problem must have stuck in my subconscious, because forty years later I realized that the coils didn't have to rotate; one coil could be slid over another. When I realized that, I put together the *Variometer Radio* described in this article in a couple of hours, and it works great! Even though it doesn't use a variable capacitor, it can still be tuned "on the nose" to stations in the broadcast band.

**The Variometer Principle.** In the original variometer design, when the inner coil is rotated to a 90-degree position with respect to the outer coil, the mutual inductance of the coils is at its minimum. For the mutual inductance of the coils to be at its maximum, the coils have to be aligned.

Figure 1 is a schematic diagram of how the variometer principle was adapted to a linear design in the project. Three coils, L1-L3, are connected in series; L1 and L3 are fixed, while L2 can be slid over them. Unlike in the

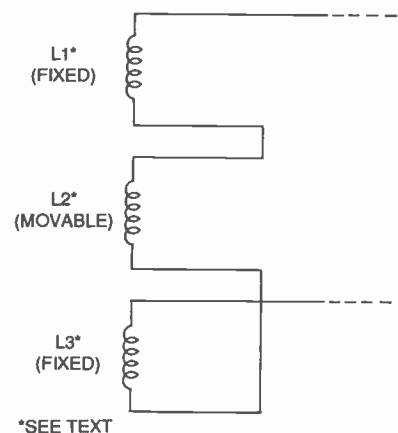

*Fig. 1. This is the principle at work in the modern variometer. The middle coil, L2, can be slid over either of the other two. Because L1 and L3 are connected in opposite directions, the inductance of L2 will either add or cancel when it is moved over the other coils.*

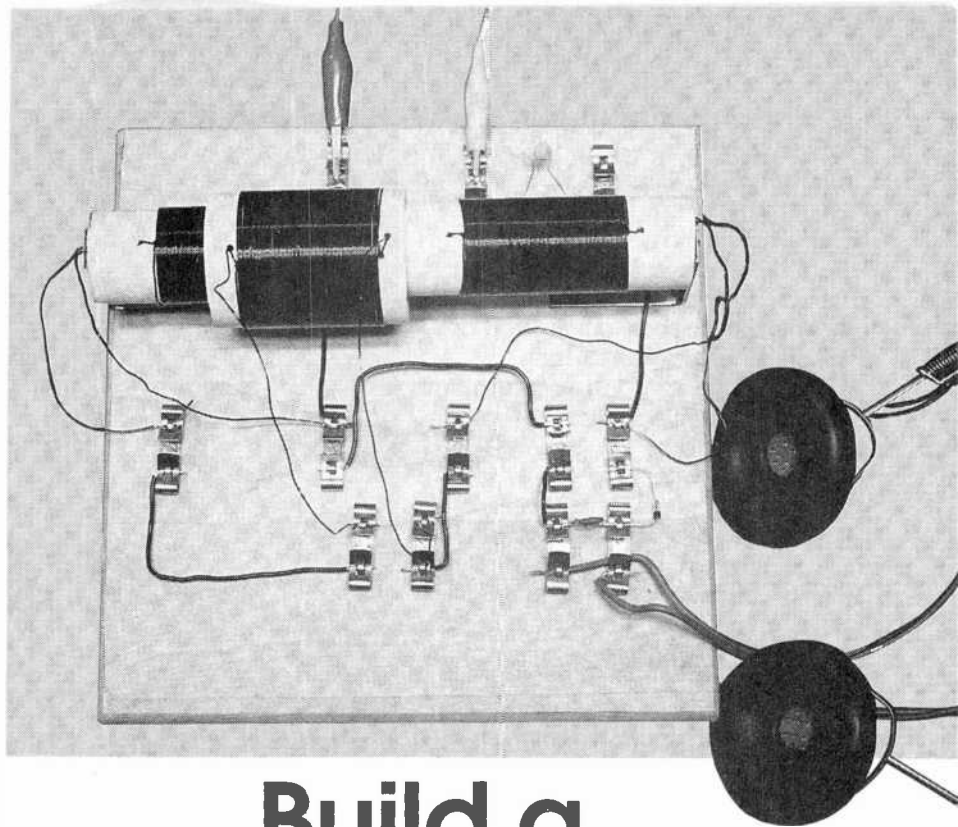

# Build a Variometer Radio

*A new version of a classic design.*

BY LARRY LISLE

original variometer, it is the outer coil that moves over the inner coils. As L2 is moved over L1, their mutual inductance is increased to the maximum. But when L2 is moved over L3, their inductances cancel out because L3 is connected backwards (with respect to L2).

**The Circuit.** The schematic of the complete Variometer Radio is shown in Fig. 2. An antenna can be connected to the Radio through either of two points labeled ANT: either directly to the circuit or through a 100-pF capacitor. The ground connection can be made at any of the points marked GND. There is a reason for the preceding options: By varying the antenna capacitance, the ground connection, and the position of the sliding coil, the entire AM broadcast band can be tuned.

Depending on the antenna and ground connections, it might be necessary to add a small capacitor, C3, at

the point indicated in the schematic. If so, experiment with values between 25 and 200 pF (separately or in parallel) to find which gives the best result. If you build the Variometer using Fahnestock clips (as explained later), adding the capacitor(s) after the Radio is built should be easy, if the need arises.

When a signal is selected by adjusting the antenna, ground connection, and position of L2, the signal is passed on to the diode-detector part of the circuit, composed of D1, which demodulates the signal. That signal then goes through bypass capacitor C2 to the earphones. Only high-impedance earphones should be used with the Variometer.

**Construction.** The two fixed coils of the Variometer, L1 and L3, are wound on an 8½-inch-long piece of 1-inch-diameter plastic pipe (its outer diameter is about 1¼ inches). Each coil is 2¼-inches long. The number of turns is

not critical, but in the author's prototype, 86 tightly wound turns of number-22 enameled wire were used. When winding the coils, make sure you start at a point that will allow them to be placed 2 inches apart on the pipe. Drill holes in the pipe and run the leads of the coils out the end of the pipe that is closest to each.

The movable coil, L2, is wound on a piece of 1½-inch plastic pipe (its outer diameter is about 1⅞ inches). The winding is 2 inches long. Like L1 and L3, the actual number of windings of this coil are not critical, as long as the winding is approximately the right length. However, in the author's prototype, 74 tightly wound turns of number-22 enameled wire were used.

One final note on winding the coils: Plastic pipe was used in the author's prototype for durability. An alternative to that is to use cardboard tubes, especially if you only plan on experimenting with the Variometer Radio.

To support the smaller plastic pipe that contains L1 and L3, get an 8½-inch-long piece of 1-inch dowel rod. Using sandpaper or a knife, slightly flatten one side of the dowel. Then, insert the dowel rod into the pipe, and orient the flattened side of the rod so that the wires can run along it with some clearance. Mount the assembly

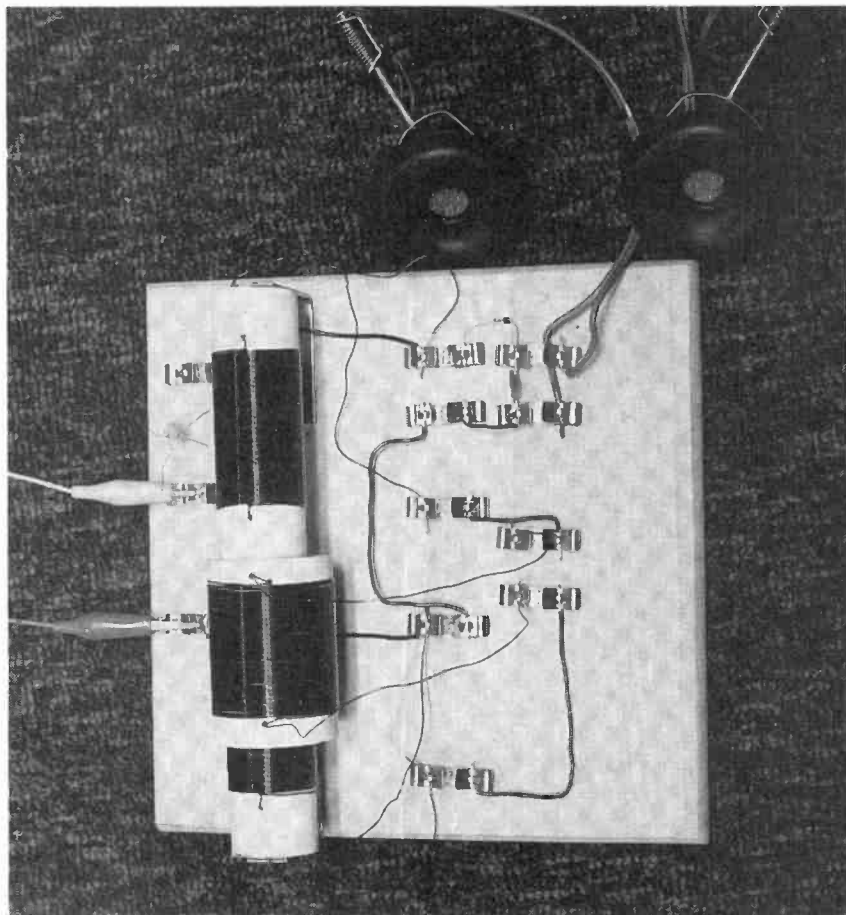

Here's the author's completed radio. For simplicity, it is laid out much like the schematic shown in Fig. 2.

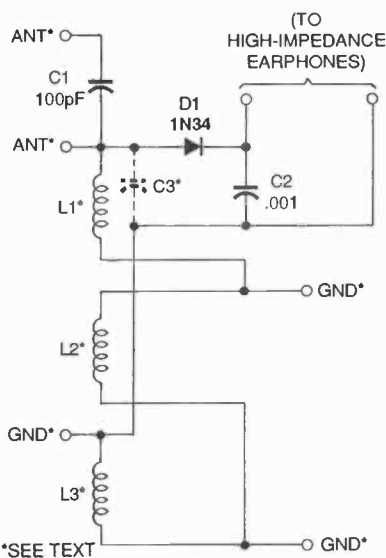

Fig. 2. Here is the modern variometer principle at use in a complete Variometer Radio. Even if you've never built a radio before, you can build this crystal set; the parts count is low, and the coil windings are not critical.

on a wooden baseboard (approximately 9-inches square) using a couple of corner brackets.

To make it easier to change ground and antenna connections, the prototype was built using Fahnestock clips. When laying out the placement of the parts on the baseboard, make sure to include adequate connection points for the possible use of capacitor C3 in the circuit. If you can't get Fahnestock clips, don't worry; an al-

ternative way to build the Radio is to use brass wood screws for the common points and simply wrap the wire around them.

**Other Uses.** Just by assembling your Variometer Radio and experimenting with tuning different stations, you might not realize that the variometer principle can be used in other applications as well. Some of those include uses in antenna loading coils, couplers, or matching devices.

Also, taps on one coil could give coarse adjustment, while a sliding coil can be used for fine tuning. With variable capacitors suitable for medium- or high-power ham transmitters becoming expensive and hard to find, the variometer principle might also find a use in the final output stage on the low-frequency bands.

The Variometer Radio is a modern version of an idea from radio past that's fun to play with in radio present. However, as you can see, the variometer principle might also become important in radio future. ■

#### PARTS LIST FOR THE VARIOMETER RADIO

- D1—1N34 germanium diode
- C1—100-pF ceramic-disc
- C2—0.001-μF ceramic-disc
- C3—Optional, see text
- L1, L3—See text
- L2—See text
- Baseboard (about 9-inches square), 1-inch-diameter dowel rod, 2 pieces of plastic pipe (see text), Fahnestock clips, corner brackets, screws, wire, hardware, etc.

Discover and develop your latent mind-over-matter abilities.

# Build the PK Tester

BY LARRY A. DUARTE

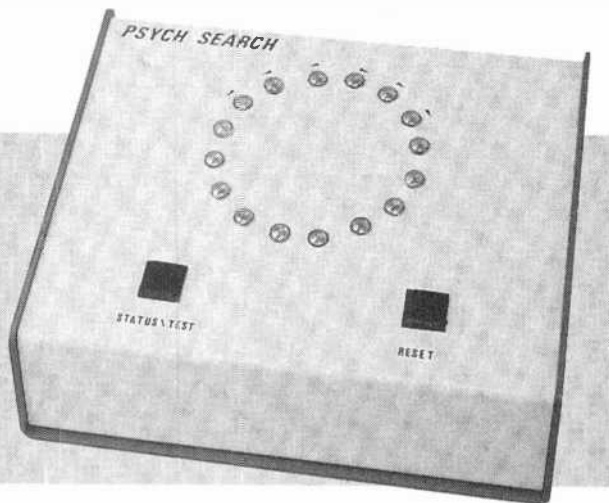

**P**sycho kinesis (PK) is the supposed ability of being able to move objects or influence events with one's mind. Over the years, many scientific investigations have gathered surprising evidence to support a belief in PK, but there is a continued skepticism among the general population. If you would like to settle that issue for yourself and your friends, build the *PK Tester* described in this article.

The project duplicates a device created by the German physicist Helmut Schmidt. In 1969, Schmidt was working for the Boeing Company, which allowed him time and resources to do PK and ESP research. With his traditional physics training, he believed psychic powers could not exist. However, being open minded, Schmidt decided to design an experiment that would scientifically attempt to resolve the mind-over-matter question.

**Schmidt's Experiment.** The heart of Schmidt's device was a random-number generator (RNG). To make that RNG, Schmidt used a radioactive substance called Strontium-90, which created a random strobe due to its erratic decay. That would cause a sample to be taken of a 50%-duty-cycle square wave at random intervals (see Fig. 1). The result was a totally random series of lows and highs (0's and 1's) that would cancel out over time.

Schmidt linked the output of his RNG to a box with 10 lights on it, arranged in a circle. Only one light would be lit at a time. Therefore, the light would give the appearance of

moving counterclockwise or clockwise depending on the RNG state. When the device was not being "influenced" by PK, it would drift in one direction or the other, but over time, its movement should be statistically neutral.

The person whose PK abilities were being tested was asked to "think" the lights in either a clockwise or counterclockwise direction. It is interesting to note that the people tested were not aware of the underlying method or electronics used to create the light's movement. Schmidt's results were startling: some people influenced the motion of the light by odds of over 10,000 to 1.

**A Modern Approach.** In his day, Schmidt used some very advanced equipment to carry out his experiments. However, Strontium-90 is a radioactive isotope that many scientists believe to be dangerous. For that reason, a different method is used to create the random strobe in this project (that is discussed later). However, developing an RNG is only part of the

process of recreating Schmidt's experiment. A method is also needed for translating the random output into directional movement, and for keeping track of the direction of that movement.

The solution to those problems is a Microchip Technology PIC16C55 microcontroller. The PIC's RISC-like architecture combined with its top clock of 20-MHz allows it to process 5-million-instructions-per-second (MIPS), making it one of the fastest microcontrollers around. The PIC used in the PK Tester is available preprogrammed from the source given in the Parts List. However, if you have the ability and equipment to program your own PIC, the firmware listing is available on the Gernsback BBS (516-293-2283).

**Circuit Description.** The schematic for the PK Tester is shown in Fig. 2. Power is provided by a 12-volt-DC wall adapter, which plugs into power-jack J1. That is used instead of batteries because, to guarantee the PK Tester's randomness, the circuit should be tested for many hours or even days at

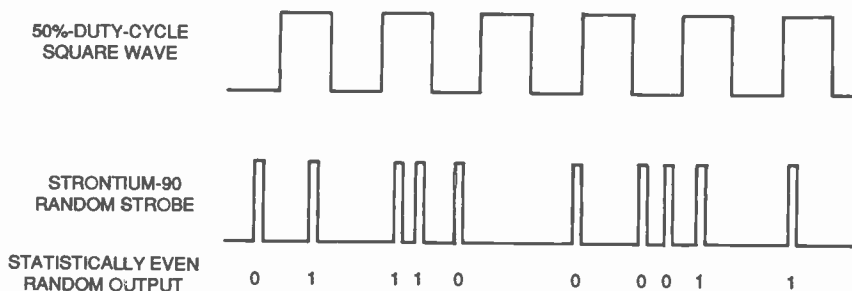

Fig. 1. Here's a sample of the statistically even output produced by Schmidt's random-number generator. A similar output is generated by the PK Tester using a non-radioactive method.

a stretch. A regulated 10 volts is needed by the noise circuit; that is provided by U4, an LM317 adjustable voltage regulator. High ripple rejection is accomplished by R11 and C10. The rest of the circuit runs off a regulated 5 volts produced by U5, a 7805.

Resistor R2 and capacitor C1 provide the RC timing for the PIC (U1), giving it a 78- $\mu$ s clock. The cathodes of LED1-LED16 are directly connected to the PIC. The anodes of the LED's are connected in common through R1, a 220-ohm resistor, to +5 volts. During

normal use, only one LED is on at a time, so that bypasses the need for separate current-limiting resistors on each LED. Two push-button switches, S1 and S2, are used to initiate the STATUS/TEST and RESET functions described later.

The random strobe is produced this way: Transistor Q1's emitter-to-base junction is reverse-biased over the breakdown point. That type of configuration produces random noise that is then amplified by Q2. The resulting output is fed into U2, an LM311 comparator, and comes out as a clean, TTL-logic-level high or low signal.

The other signal that is needed to reproduce Schmidt's experiment is a square wave with a 50% duty cycle. That is created by U3, a 555 timer. Diodes D1 and D2 are used to generate the separate timing paths necessary for a precision 50% duty cycle. Also, to ensure that the square wave has a perfect 50% duty cycle, potentiometer R5 should be properly adjusted (more on that later). The combination of that square wave plus the random strobe equals a random but statistically neutral series of highs and lows.

The output of highs and lows is fed to pins 6 and 7 of U1. A section of the firmware then translates the signals into LED "movement." Each individual movement is also recorded by the PIC and the total number of movements are tabulated for display once the STATUS/TEST button is pressed.

**Construction.** The construction technique used is not critical, but if you would like to build the circuit on a PC board, a full-size pattern is shown in Fig. 3. An etched and drilled printed-circuit board (as well as a pre-programmed PIC) is available from the source given in the Parts List. The other parts for the PK Tester can be readily acquired from hobbyist sources like Radio Shack or Digi-Key.

If you decide to build the project on a PC board, use the parts-placement diagram in Fig. 4 as a guide. Mount all the resistors, capacitors, and IC sockets first; then insert the IC's in their sockets. Last, mount the LED's so that they stand on 3/4-inch leads. That will ensure that there is enough room for the other components when the circuit is placed in the case.

Wire the ground connection from power-jack J1 to the board as shown

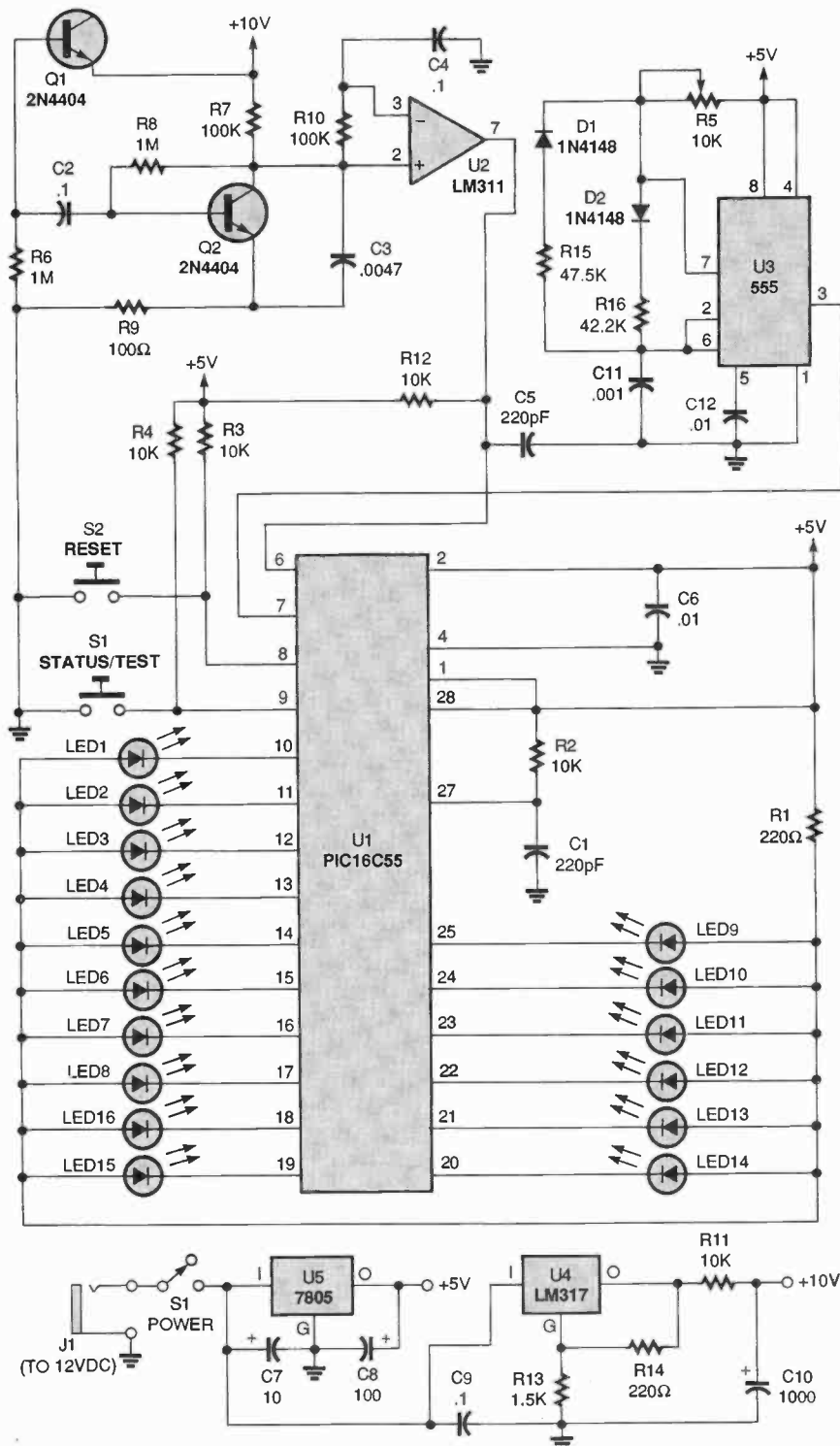

Fig. 2. This circuit generates a random output that is translated into LED "movement" by a preprogrammed PIC16C55 microcontroller, U1. That PIC also senses and records the bias of the LED's movement.



## PARTS LIST FOR THE PK TESTER

### SEMICONDUCTORS

U1—PIC16C55 microcontroller,  
integrated circuit  
U2—LM311 comparator, integrated  
circuit  
U3—555 timer, integrated circuit  
U4—LM317 adjustable voltage  
regulator, integrated circuit  
U5—7805 5-volt regulator, integrated  
circuit  
Q1, Q2—2N4404 general-purpose  
NPN transistor  
D1, D2—1N4148 small-signal diode  
LED1-LED16—Red light-emitting  
diode

### RESISTORS

(All fixed resistors are 1/4-watt, 5%  
units, unless otherwise noted.)  
R1, R14—220-ohm, 1/2 watt  
R2, R3, R4, R11, R12—10,000-ohm  
R5—10,000-ohm, 15-turn  
potentiometer  
R6, R8—1-megohm  
R7, R10—100,000-ohm  
R9—100-ohm  
R13—1,500-ohm  
R15—47,500-ohm, 1%  
R16—42,200-ohm, 1%

### CAPACITORS

C1, C5—220-pF, ceramic-disc  
C2, C4, C9—0.1- $\mu$ F, polyester  
C3—0.0047- $\mu$ F, polyester  
C6, C12—0.01- $\mu$ F, polyester  
C7—10- $\mu$ F, 25-WVDC, electrolytic  
C8—100- $\mu$ F, 16-WVDC, electrolytic  
C10—1000- $\mu$ F, 16-WVDC,  
electrolytic  
C11—0.001- $\mu$ F, polyester

### ADDITIONAL PARTS AND MATERIALS

J1—Mono phone jack  
S1, S2—Normally open SPST,  
momentary pushbutton switch  
S3—SPST switch  
Printed-circuit materials, enclosure,  
IC sockets, lens caps for LED's,  
12-volt AC adapter (with plug to  
match J1), wire, solder, hardware,  
etc.

**Note:** The following are available  
from Larry Duarte (P.O. Box 1232,  
Englewood, CO 80150): a pre-  
programmed PIC16C55: \$12.00; an  
etched and drilled PC board:  
\$12.00; add \$4.50 S&H to all  
orders. Colorado residents must  
add appropriate sales tax.

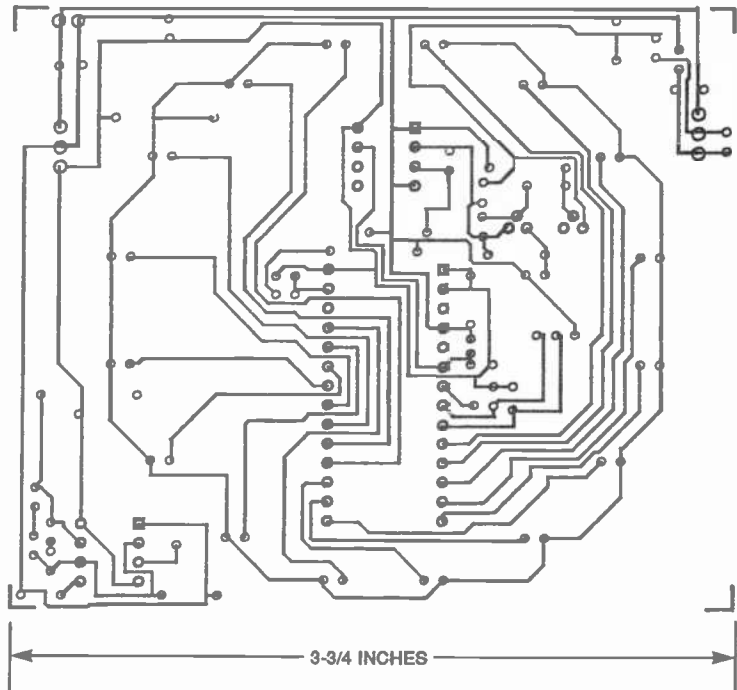

Fig. 3. Use this full-size template to etch your own PC board.

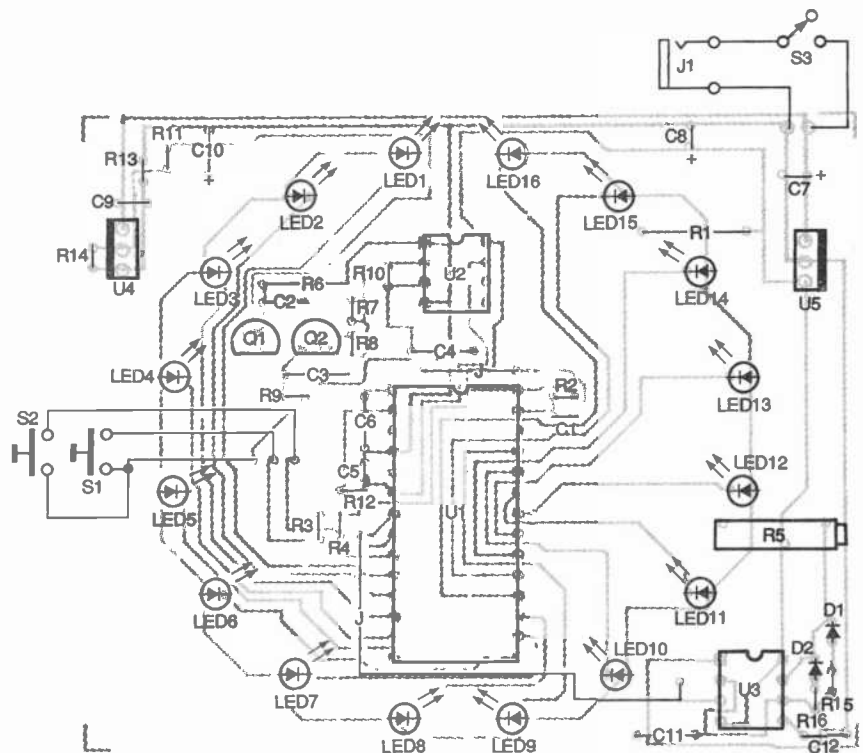

Fig. 4. When assembling the PK Tester, use this parts-placement diagram as a guide.

in Fig. 4, and then make the other off-board connections shown in that diagram. Mount the switches and the jack to the case.

Before you can mount the PC board in the case, you will have to adjust potentiometer R5 so that U3 produces a 50%-duty-cycle square

wave. The best way to accomplish that is by using a scope. However, if you do not have a scope handy, you could adjust R5 to an approximately "halfway" setting, and then use trial and error to determine if the output of the PK Tester is statistically neutral.

(Continued on page 92)

# Add a Switch to your Serial Port

BY MARC SPIWAK

*Enable or disable serial ports with a simple flip of a switch!*

Sometimes a simple solution to an annoying problem is staring you right in the face, although you don't even know it. You see, at home, I have a pretty loaded 486 PC that's used not only as a day-to-day workhorse, but also as a test bed for various peripherals and accessories for review in this magazine and other purposes. While setting up the software for a computer-controlled construction set I was reviewing, I had a tough time getting the COM2 serial port to work peacefully with the set's interface. Using COM1 was out of the question, since it was used by my serial mouse. So here I was with this presumably easy-to-use interface unit that would not respond to COM2. What was going on? Could it be "the dreaded IRQ conflict?"

Now, I consider myself pretty good at setting up computers; I'm just not very good at remembering how things are set up (or at remembering where I put the piece of paper on which I jotted down the settings). Sometimes diagnostic software can be used to find a conflict, or a peripheral's setup program (if you are fortunate enough to have peripherals whose IRQ's are set via software) can give you the information you need. More often, however, you are left with one unpleasant task; opening the case. Of course, if you are like me, it's not that simple. First, all the junk piled on top of the case has to be moved. Then the case has to be opened. Then *lots* of cables have to be disconnected so that *lots* of cards can be removed so that *lots* of jumper settings can be noted.

After doing all of that, I found the problem. My internal modem was set on COM2, and so my machine's multi-I/O card was set to disable its own COM2—the one I was trying to use for the construction set's serial-interface unit. The first solution was to simply enable COM2 on the multi-I/O card; but the situation got worse. Now, not only wouldn't the serial interface respond, but the modem would no longer connect with any other modem—although it would dial out. Trying to get the modem and mouse to share an interrupt led to even more flakiness with both the modem and the mouse.

So I set the modem back to its original settings where it worked perfectly. "Try another interrupt" you say. Let's see: IRQ0 is reserved for the system timer, IRQ1 is for the keyboard, IRQ2 is a DOS system area, the

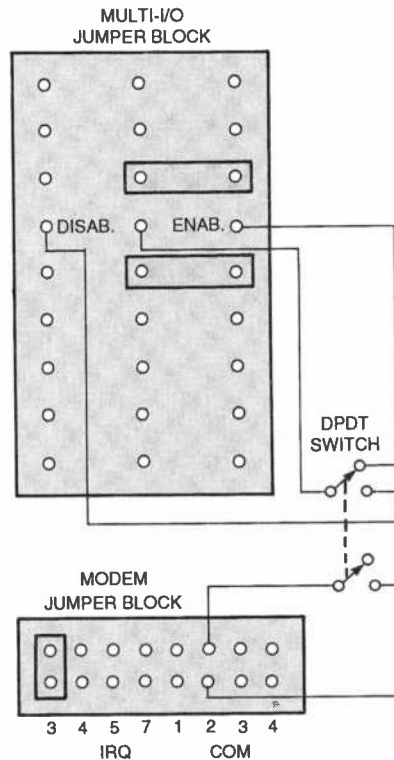
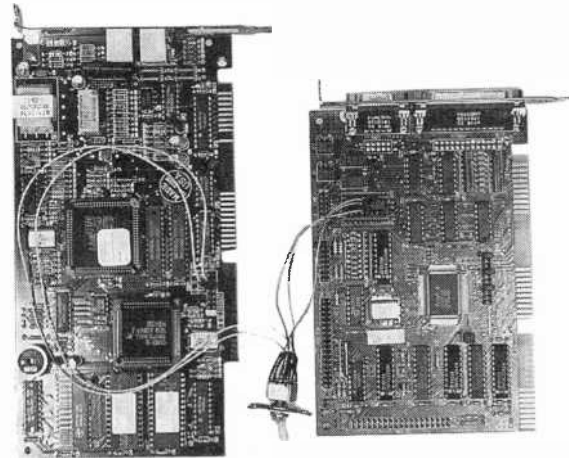

*Fig. 1. This switching scheme allowed an internal modem and COM2 on a multi I/O card to share the same interrupt (IRQ). While it won't work as shown for every set-up, it can be modified to handle similar problems.*

## MATERIALS LIST FOR THE PC SWITCH

- DPDT switch
- Wire-crimp single-pin header sockets
- Wire, heat-shrink tubing, unused expansion slot cover, solder, hardware, etc.

modem (COM2) uses IRQ3, the mouse (COM1) uses IRQ4, my sound card uses IRQ5, diskette drives use IRQ6, and the printer (LPT1) uses IRQ7. These settings are pretty much standard—depending on your hardware and software, it is unlikely you'd be able to configure any of these devices to more obscure settings. Oh how I just love the flexibility of PC architecture!

That sort of problem has plagued PC users starting with the first IBM PC's right up to the present-day 486's. Even on the newer local-bus systems, where the COM ports are often set in CMOS, a modem's settings still have to be checked visually, or at least through hard-to-find setup menus—and changing settings usually requires that jumpers be moved manually. The odds are, in a loaded system, a game of musical jumpers usually forces you to return a card to its original settings because it worked properly that way in the first place. Another solution, although often not a very good one, is disabling the least-significant device that's conflicting with the most-significant device. That's what led me to having a disabled COM2 on the multi-I/O card.

**A Partial Solution.** As it seemed, after many hours of experimenting, the only way to get the serial interface to work was to enable COM2 on the multi-I/O card and to either remove the modem from the computer or to disable it—which meant removing it from the machine anyway! At least I could now work with the construction  
*(Continued on page 89)*

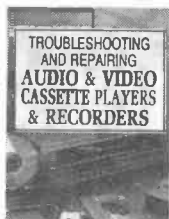

3795P \$19.95

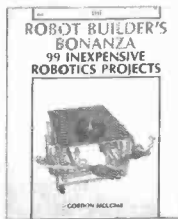

2800P \$17.95

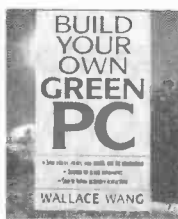

0681562 \$19.95

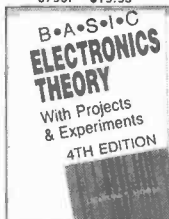

4261P \$24.95



3475P \$21.95



3279P \$26.95



4270H \$29.95 Hardcover



0156697 \$44.95 Hardcover

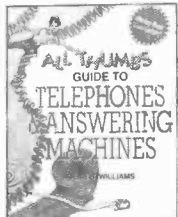

4416P \$9.95



4362P \$16.95



2613P \$19.95



0376026 \$42.95

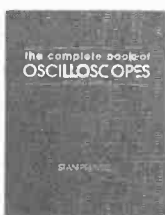

3825P \$17.95



3711P \$19.95

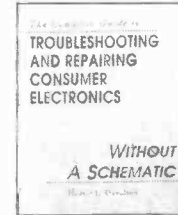

0156492 \$34.95 Hardcover



3621H-XX \$39.95 Counts as 2/Hardcover



4227P \$15.95

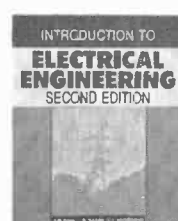

011322X-XX \$50.53 Counts as 2



4179H \$28.95 Hardcover

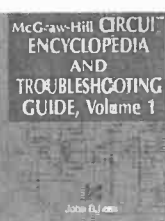

0376034-XXX \$59.50 Counts as 3/Hardcover



3258P \$19.95

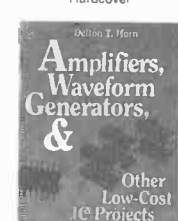

0304157 \$19.95

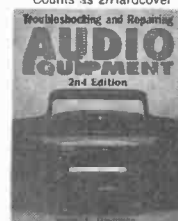

4112H \$32.95 Hardcover



3765P \$19.95

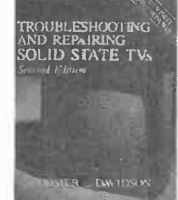

3700H-XX \$36.95 Counts as 2/Hardcover



2790P \$17.95

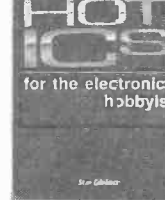

4122H \$36.95 Hardcover



3671P \$18.95



0156778 \$44.95



0673764-XX \$54.95 Counts as 2/Hardcover



3802H-XXX \$84.95 Counts as 3/Hardcover

# Select any 5 books

## for only \$4<sup>95</sup>

(values up to \$202.75)

when you join the Electronics Book Club®

**As a member of the Electronics Book Club . . .**

. . . you'll enjoy receiving Club Bulletins every 3-4 weeks containing exciting offers on the latest books in the field at savings of up to 50% off of regular publishers' prices. If you want the Main Selection, do nothing and it will be shipped automatically. If you want another book, or no book at all, simply return the reply form to us by the date specified. If you ever receive a book you don't want due to late delivery of the Bulletin, you can return it at our expense. You'll have at least 10 days to decide. And you'll be eligible for FREE BOOKS through the Bonus Book Program. Your only obligation is to purchase 3 more books during the next 12 months, after which you may cancel your membership at any time. A shipping/handling charge and sales tax will be added to all orders. All books are softcover unless otherwise noted. (Publishers' prices shown). If you select a book that counts as 2 choices, write the book number in one box and XX in the next. If you select a book that counts as 3 choices, write the book number in one box and XXX in the next 2 boxes. ©1995 Electronics Book Club PE595

If card is missing, write to: Electronics Book Club, A Division of McGraw-Hill, Inc., Blue Ridge Summit, PA 17294-0610

# ANTIQUE RADIO

By Marc Ellis

## The Minerva Restoration Begins

Let me tell you, gentle readers, I had a very hard time getting the column together this month! Even though it will be spring when you see these words, right now it's the end of December. I've just returned from a very pleasant week-long visit with relatives in another state where, like almost everybody else during the holiday season, I ate and drank a little too much. So, like many others at this time of year, I'm out of the work mode and feel-

### IF YOU JUST JOINED US

Let's backtrack a bit to fill in those who might not have seen last month's issue. The Tropicmaster, a table model BC/SW radio, was released just after World War II by the Minerva Company—which vanished soon afterwards. The heavy-duty construction style and physical appearance of the set suggest those of a military "morale" receiver, and we theorize that it might have been a surplus military unit repainted for the civilian market. Readers who have more details about the Minerva Company or the origins of the Tropicmaster are definitely encouraged to write and share their information!

This radio is not only physically robust but also, as you'll note from the schematic, quite serious from an electronic point of view. It's an AC-DC set based on the typical "All American 5" circuit. However, unlike most such radios, it has an additional RF amplifier stage (the 6SK7 labeled "1" on the schematic).

That is followed by the usual 6SA7 converter, 6SK7 IF amplifier, and 6SQ7 detector-avc-first audio-amplifier tube. In place of the single 50L6 usually employed as final AF amplifier, the Tropicmaster uses a 6SC7 phase inverter (labeled "5" on the schematic) followed by a pair of push-pull 50L6's.

### PHYSICAL CONDITION OF THE SET

As discussed last month, this radio has a cosmetically excellent cabinet and front panel—and is not

in very bad shape inside either. However, there's no doubt that the set had been stored in a damp environment for some time. The speaker frame is completely covered with a fine dusting of rust, and the chassis, though not exactly rusty, has a discolored, pitted finish.

Further evidence of dampness can be seen under the chassis, where the shells of most paper and electrolytic capacitors are coated with a fine, whitish mold. One of the electrolytics was disconnected at one end, as if someone had been attempting to isolate a short in the B-plus line. The other one had been replaced by a crudely wired-in unit of half the specified size, its joints insulated with medical adhesive tape.

Except for the two odd problems discussed last month—a peculiarly dented oscillator-coil shield can (looking almost as if it had been pounded on with a pointed instrument) and a taped-up filter choke having one disconnected lead—the Tropicmaster was otherwise in what appeared to be original condition.

### RESTORATION STRATEGY

The set needs a fair amount of work, but by no means requires an exhaustive renovation. As far as the cosmetics are concerned, I first plan to clean up the cabinet, front panel, and chassis with a detergent solution. That will be followed by an application of metal polish to remove

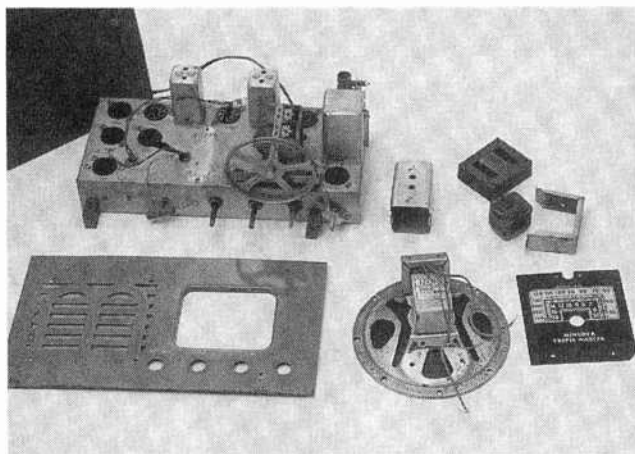

Here's the receiver as it appeared at the close of this month's work session. Note the filter choke in pieces and the repaired oscillator coil can (all at upper right).

ing just a bit fat and lazy.

The result is that—although I'll be reporting some significant progress on the *Minerva Tropicmaster*—I won't have as much to talk about as I had hoped. Because we'll be a little lean on words, I'm taking the opportunity to show you the Minerva's large schematic diagram, which I couldn't run last time for lack of room; it appears on page 66. We'll be referring to it from time to time as the receiver's renovation progresses.

as much of the discoloration and pitting as possible from the chassis.

The IF cans and coil shields, though not corroded or pitted, will also receive a (light) going-over with metal polish. However, the dented oscillator-coil can (removed in the last session to make sure there was no hidden damage to the coil itself) would first have to be repaired.

The messed-up filter choke needs to be repaired or replaced. And if a set ever required complete recapping, it's this one. The deleterious effects of a damp environment on cardboard or cardboard-and-wax-covered capacitors have been documented over and over again in the antique-radio press.

My restoration plan also includes checking all the tubes, sanding and repainting the speaker, and restringing the dial cord. Though the dial is now operational, it's very common for the cord on an old set to break soon after it is placed in service after a long period of disuse. I'd rather replace the cord while the set is dismantled for restoration than after it has been reassembled and placed on the display shelf.

As a finishing touch, I intend to realign and recalibrate the Tropic-master on both its broadcast and shortwave bands.

#### WHAT'S BEEN DONE

I began this short restoration session by dismantling the radio to the point where the cleaning and restoration processes just described could conveniently begin. You'll recall from last month's discussion that the chassis of the set is "sandwiched" between its front and rear panels. Both of those would have to come off.

The rear panel slipped right off after a few screws were removed, but the front panel was a little harder. The loudspeaker was mounted on it, and would have to come off first. So would all the control knobs. The speaker needed to be removed for refinishing anyway.

Before taking out the speaker mounting screws, I clipped the three leads from the output transformer (which is mounted on the speaker) at their connection points under the chassis, making careful notes for later reconnection. Then I dismantled the speaker, separated it from the radio, and set it aside to be worked on later.

After taking off the control knobs (they were stuck tight, but eventually yielded to a firm rocking/pulling motion), the front-panel mounting screws were removed so that the panel and plastic dial window could be taken off and set aside. The dial pointer was then gently pulled off so that the dial itself could be removed to prepare for the restringing to be done later.

The only other component now requiring removal was the filter choke, which would have to be replaced or repaired as discussed earlier. Its leads were disconnected under the chassis (making careful notes for reconnection), and the chassis mounting screws were taken out.

#### FILTER-CHOKE ADVENTURE

As the choke was removed from the chassis, a couple of things happened. The one lead that was still connected to it fell off, and the choke's core dropped out of the open frame—the retaining tabs had been cut off.

Careful inspection of the

## EARN YOUR B.S. DEGREE IN COMPUTERS OR ELECTRONICS



### By Studying at Home

Grantham College of Engineering, now in our 45th year, is highly experienced in "distance education"—teaching by correspondence—through printed materials, computer materials, fax, modem, and phone.

No commuting to class. Study at your own pace, while continuing on your present job. Learn from easy-to-understand but complete and thorough lesson materials, with additional help from our instructors.

Our Engineering Technology B.S. Degree Program is available in either of two options:

- (1) The B.S.E.T. with Major Emphasis in Electronics, OR
- (2) The B.S.E.T. with Major Emphasis in Computers.

Our Computer Science B.S. Degree Program leads to the B.S.C.S.—the Bachelor of Science in Computer Science.

An important part of being prepared to *move up* is holding the right college degree, and the absolutely necessary part is knowing your field. Grantham can help you both ways—to learn more and to earn your degree in the process.

Write or phone for our free catalog. Toll free, 1-800-955-2527, or see mailing address below.

Accredited by  
the Accrediting Commission of the  
Distance Education and  
Training Council

**GRANTHAM**  
*College of Engineering*  
Grantham College Road  
Slidell, LA 70460

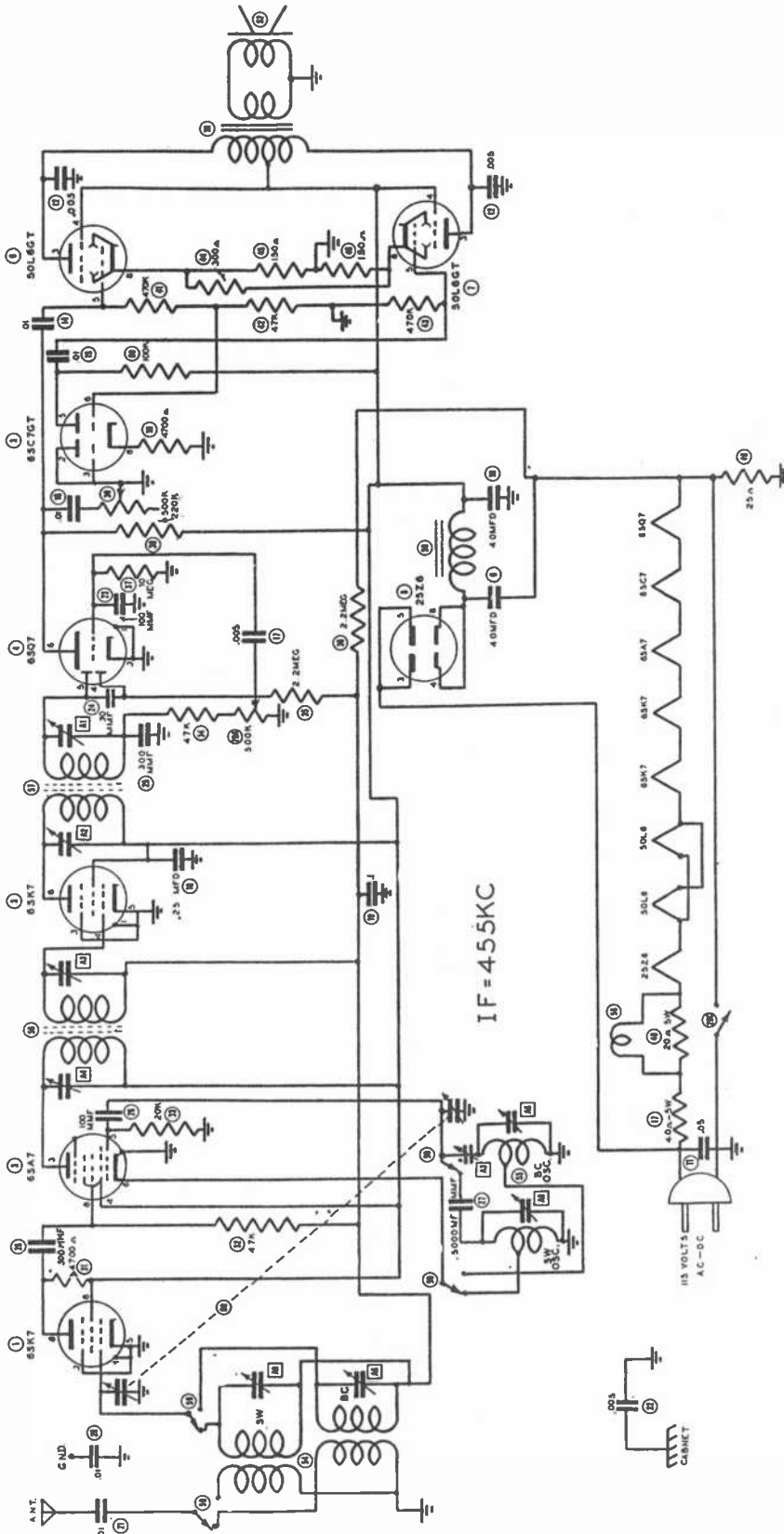

Tropicmaster's eight-tube circuit includes a stage of RF amplification as well as push-pull audio output (see text).

choke showed that the unit had received quite a bit of

working over. Perhaps it had become open, and was

then taken apart in hopes of locating the break.

The coil winding was easily slipped off the core, having been removed once before by the prior "repairman." And after I had it off, I could see that it was covered by layers of Scotch tape, the adhesive of which had become soft and gooey with age.

Working carefully with a pocket knife, I began peeling off those deteriorating layers until I found the free ends of the enamel-covered wire winding.

After sandpapering off some enamel at each free end to expose the bare copper, I checked for continuity with an ohmmeter. The 91-ohm reading I got was close enough to the 85-ohm DC resistance specified for this unit in the Sams service notes.

So it seems that the choke is definitely savable. All I have to do is find a reliable method for reconnecting the leads to the coil winding and securely fastening them in place.

#### FINAL EFFORTS

All of the tubes tested good except the 25Z6 rectifier. Though its heater glowed brightly, there was no emission on either diode section. That was hardly surprising in view of the earlier work that had apparently been done.

Before finishing this month's session, I turned my attention to the tortured metal of the oscillator-coil shield. The can is never going to look smooth again, but I was able to remove most of the craters by wedging wood blocks at strategic points inside the can and tapping against them from the outside. It really doesn't look bad at all now—if you don't look too closely!

So long until next month, when we'll continue this restoration. ■

# COMPUTER BITS

By Jeff Holtzman

## Inspiration

Object-oriented technology has been our subject the past few months. For the sake of variety, I want to provide my impressions of a new Windows program called *Inspiration*. *Inspiration* is the newest member of a category of products I have examined here several times in the past. The category might be called creative-thinking enhancers. Prior products examined include *Idea Generator* (in the March, 1993 issue) and *IdeaFisher* (in October of 1994).

traverse ideas from one hyperlink node to the next, *IdeaFisher* explicitly points out related concepts.

*Inspiration* takes another tack. The purpose of *Inspiration* is to help you brainstorm ideas and organize them into a logical structure, whether the ultimate outcome be a project plan, a written essay, a schedule, a flow chart, or something else altogether. *Inspiration* doesn't have an integrated idea database, nor does it walk you through a structured question-and-answer process. In other words, it leaves the "how" (as handled by *Idea Generator*) and the "what" (as handled by *IdeaFisher*) up to you. Instead, it attempts to provide a special environment for rapidly generating ideas, visually linking them, and arranging them into a comprehensible hierarchical outline.

In use, *Inspiration* functions like a cross between a word processor and a drawing program. In fact, *Inspiration* operates much like one of my all-time-favorite PC applications, *Visio*, but with one crucial difference: Whereas *Visio* provides only the graphical display of the elements composing a drawing, *Inspiration* can easily toggle between diagram and outline views; changes made in one view carry through to the other.

### FEATURES

*Inspiration* is full of features for creating diagrams. For example, each node in the diagram can have a custom symbol. The pro-

gram comes with a fairly large collection of symbols, organized into libraries. Libraries include basic shapes, flow-chart symbols, business, designer, images, fun, flags, documents, frames, miscellaneous, geometric, icons, network, pointers, and signs. There are also two user libraries, and you can add your own symbols to any library. You can also paste any graphic you can get onto the Windows clipboard into *Inspiration* as either an element of a user diagram or a library symbol.

Text displayed in symbols can be styled in a certain way; the same text in outline view can have a different style. There are all sorts of options for varying line thickness, color, font, sizing and scaling, and so on. The program contains an integrated spelling checker, and provides functions for exporting both text and graphics in standard formats.

*Inspiration* has an innovative way of using a grid for placing symbols. The program also has a nice system for redistributing symbols in various predefined patterns. Drawings can span multiple pages, and complex drawings can be broken down into parents and children that can be manipulated in separate windows. You can zoom in and out on drawings; another interesting feature allows you to "focus" on a particular branch of the hierarchy by hiding everything but the selected node and its child nodes.

In outline view, you can drag and drop headings

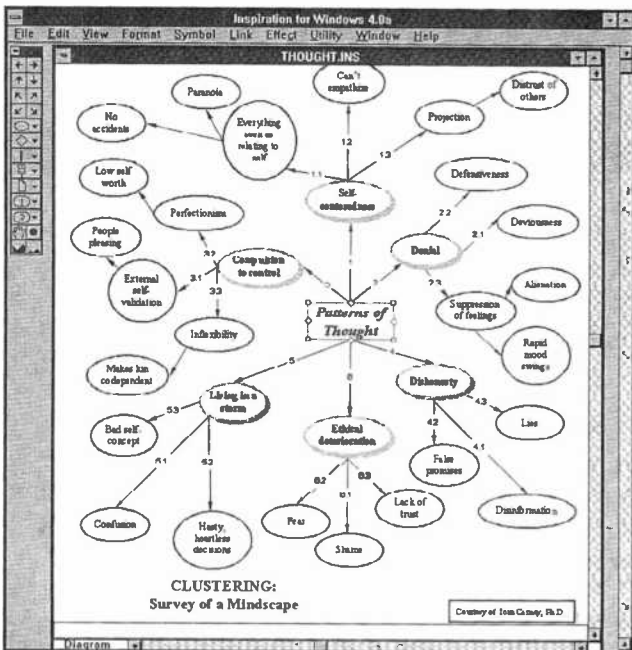

*Inspiration* is a visual idea-development tool that can show both a hierarchical/textual and a graphical representation of the same document.

*Idea Generator* helps you create ideas by walking you through a structured series of questions designed to get you to think about your problem from different points of view. *IdeaFisher*, by contrast, is a hyperlinked database of ideas. As you

# 3 NEW BOOKS for the Project Builder



**BP350—ELECTRONIC BOARD GAMES .....\$6.00**

Twenty novel electronic board games that you can build from the plans in this book. Whether you are interested in motor racing, searching for buried treasure on a desert island or for gold in Fort Knox, spinning the wheel of fortune, or doing a musical quiz—there is something for you to build and enjoy!

**PCP119—ELECTRONIC MUSIC AND MIDI PROJECTS .....\$14.95**

Save cash by building the MIDI gadgets you need. Want a MIDI THRU box, program change pedal, Metronome, analog echo unit, MIDI patchbay or switcher? Over 16 practical and very useful music and MIDI projects—all in this book! The projects are explained in detail with full instructions on assembly.

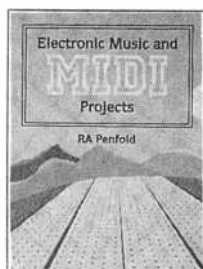

**BP301—ANTENNAS FOR VHF AND UHF .....\$6.00**

From installing a TV or FM antenna to setting up a multi-antenna array for shortwave listening or amateur radio, this book explains the basics of VHF and UHF antenna operation and installation. The text describes in easy-to-understand terms the essential information about how antennas work, the advantages of different antenna types, and how to get the best performance from an antenna.

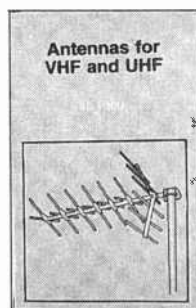

Mail to: **Electronic Technology Today, Inc.**  
P.O. Box 240 • Massapequa Park, NY 11762-0240

**Shipping Charges in USA & Canada**

\$0.01 to \$5.00.....	\$1.50	\$30.01 to \$40.00 .....	\$5.50
\$5.01 to \$10.00.....	\$2.50	\$40.01 to \$50.00 .....	\$6.50
\$10.01 to \$20.00.....	\$3.50	\$50.01 and above .....	\$8.00
\$20.01 to \$30.00.....	\$4.50		

Sorry, no orders accepted outside of USA and Canada. All payments must be in U.S. funds only.

Number of books ordered.

Total price of books .....	\$ _____
Shipping (see chart) .....	\$ _____
Subtotal .....	\$ _____
Sales Tax (NYS only) .....	\$ _____
Total enclosed .....	\$ _____

Name \_\_\_\_\_  
Address \_\_\_\_\_  
City \_\_\_\_\_ State \_\_\_\_\_ ZIP \_\_\_\_\_

Please allow 6-8 weeks for delivery.

around to change the hierarchy; you can also expand and contract the hierarchy at any given level. Body text in the outline view is not normally displayed in diagram view, but it can be accessed there via a pop-up window for editing what Inspiration calls notes.

Documentation includes three bound booklets comprising a total of about 300 pages. On-line help mostly duplicates the printed material. Installation is simple, and requires about 4.5 MB of disk space.

Inspiration was ported from the Macintosh, where it has been running for several years. In general, the company has done a good job of adhering to Windows standards, although there are occasional lapses. For example, some dialog boxes look like their Macintosh equivalents. In addition, windows don't scroll continuously when you click and hold the up or down arrow. Also, the documentation refers to "folders" where a DOS/Windows user would expect subdirectories. In outline view, the <PgUp> and <PgDn> keys scroll the window but don't move the insertion point, so even after locating a desired line of interest, you have to explicitly click on it with the mouse. Those are quibbles, however.

More serious is my impression that the distribution of functions across the menus is not well organized. In learning the program, I frequently lost track of how to accomplish some task. A more visual approach to text and graphics styling, and to different document views, would be a good way of evolving into the next version.

More serious yet is my nagging suspicion that In-

spiration is more a drawing and presentation tool than a brainstorming tool. There are an awful lot of nice functions for aligning and styling symbols and text. But there is nothing specifically geared toward generating ideas (as in Idea Generator) or associating them with other ideas (as in IdeaFisher).

Looked at in isolation, the outliner is no match for the really good outliners that were popular in the mid and late 1980's, such as Symantec's *GrandView*. Even if you don't want to go back to a character-mode DOS program, I don't believe there is a single outlining function in Inspiration that is not also available in Microsoft's *Word for Windows*. Likewise, the drawing module has a few good tricks, most of which can be accomplished by Visio. On the other hand, it is not fair to say that a combination of Word and Visio is the equivalent of Inspiration, because only Inspiration provides two-way access between the outline and diagram views.

What I'd really like to see is Inspiration used as a front end to an enhanced version of IdeaFisher's database, along with optional add-in "interviews" for structured idea generation. That would be the best of all possible worlds. ■

**Vendor Information**

INSPIRATION  
**Inspiration Software**  
2920 SW Dolph Ct., No. 3  
Portland, OR 97219

IDEAFISHER  
**IdeaFisher Systems, Inc.**  
2222 Martin St., #110  
Irvine, CA 92715

THE IDEA GENERATOR PLUS  
**Experience in Software**  
2000 Hearst Avenue, Suite 202  
Berkeley, CA 94709-9944



# CIRCUIT CIRCUS

By Charles D. Rakes

## More Motorcycle Circuits

**A**t closing time last month we were deep into motorcycle circuits and had to leave off before all of the circuits could be shared. So this visit we'll continue with a few more circuits that can be used with your two, three, or four wheeler.

### SMART TURN SIGNAL

Our first entry this visit is a turn-signal circuit (see Fig. 1) that is designed for people who can't remember to turn their signal off after completing a turn. Naturally, that applies to most of us, right? The circuit only uses a single lamp (double for a

front/rear system) for each indicator position. The lamps in this circuit, as well as those in the next one, can be of any 12-volt type with a current rating of one amp or less. The circuit's timing functions are performed by three 555-timer IC's.

Here's how the smart turn-signal circuit operates: Momentarily pressing S1 starts the left on-time timer and produces a positive output at pin 3 of U1. Power for the on/off signal timer, U3, is supplied through D1.

Also, a positive bias is supplied from U1's output to the base of Q3, turning it on

and turning Q4 off. That unclamps the gate of Q1, an IRF511 hexFET, from ground. Timer U3 is connected in a low-frequency oscillator circuit with its output at pin 3 supplying a positive pulse to the gates of Q1 and Q2. Un-clamped Q1 turns the left turn-signal lamp on and off at that same low-frequency rate. Because U2 is not activated, its output at pin 3 is low, keeping Q5 off. With Q5 turned off, Q6 is on, clamping the gate of Q2 to ground and keeping it from responding and supplying an output for the right turn-signal lamp. The left turn signal continues to operate until the U1 timer circuit times out; the right turn signal operates in a similar manner, with U2 setting its operating time.

Potentiometer R10 sets the running time for the left turn signal and R11 sets that for the right turn signal. Those two potentiometers should be set to produce the same "on time" for each signal. The turn-signal on/off rate is set by R12 and will be the same for both the left and right turn lamps.

### FLASHY BRAKE LIGHT

Our next motorcycle add-on circuit (see Fig. 2) can turn your cycle's brake light into a flashing attention-getting indicator. This circuit can be used in addition to the cycle's standard brake light to give the person behind you a better chance of determining that you have hit your brakes.

When brake-light switch S1 is closed, power is applied to U1 and U2. Two

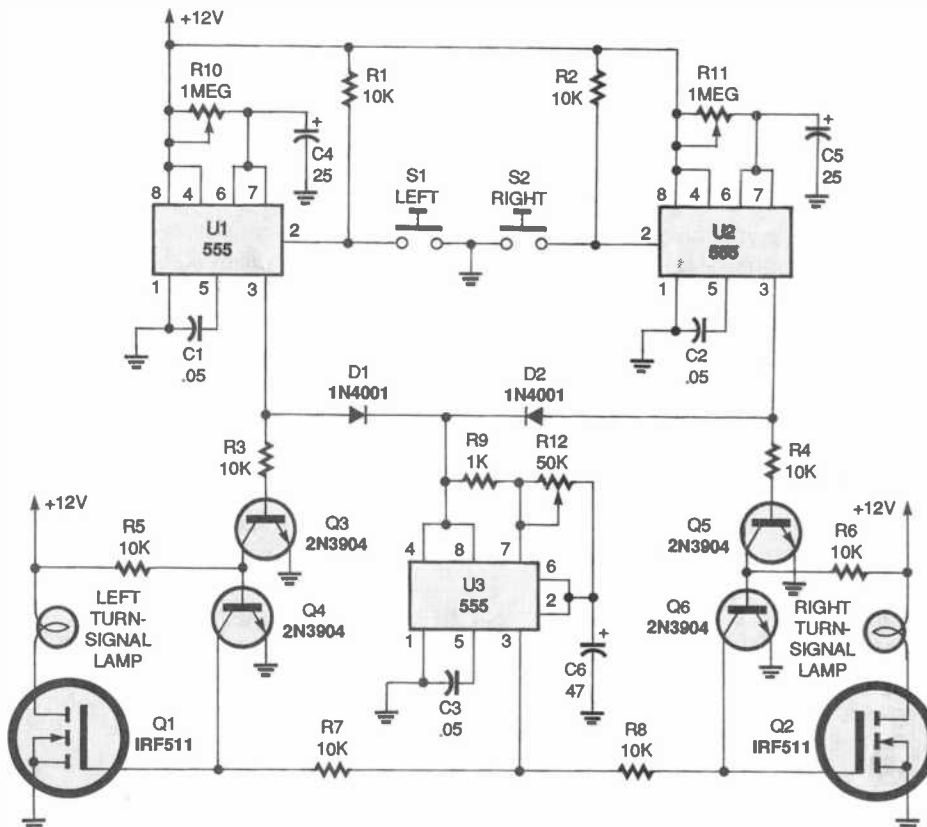

Fig. 1. This smart turn-signal will help keep you from irritating those driving behind you. It shuts off your left and right turn signals after a time that is preset by potentiometers R10 and R11, respectively.

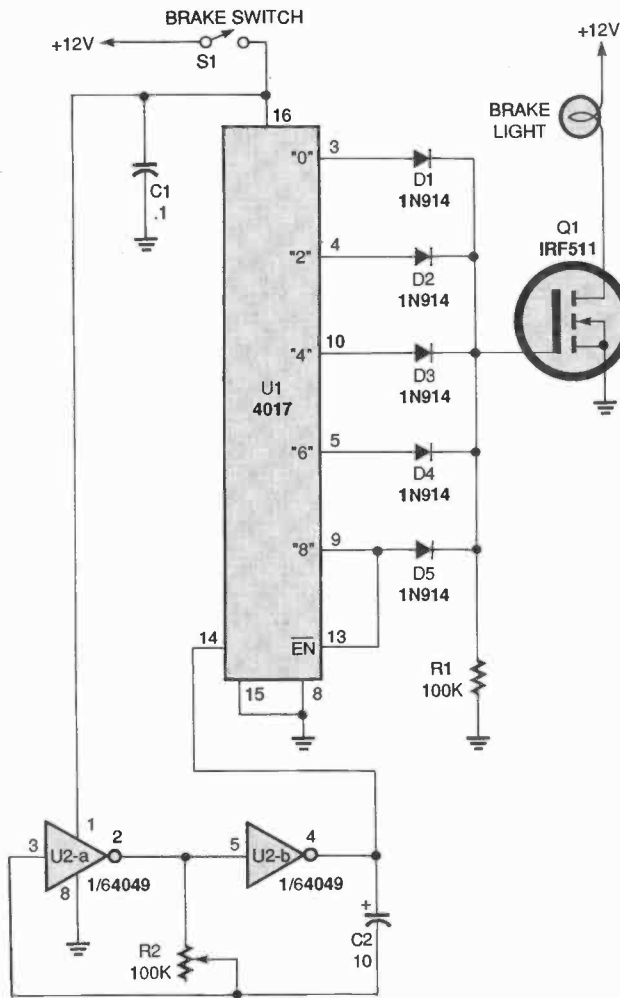

Fig. 2. Installing this flashy brake light should make it easier for others to determine if you're applying your brakes.

inverters of U2, a 4049 hex inverting buffer, are connected in a low-frequency oscillator circuit that feeds clock pulses into U1, a 4017 decade counter/divider. Outputs 0, 2, 4, 6, and 8 of U1 are coupled to the gate of Q1 through a 1N914 diode. As the 4017 counts down, it turns the brake light on and off four times and then leaves it on until the brake switch is released. The on/off rate can be set by potentiometer R2; for best results, the on/off rate should be set so that it is rapid.

Coming up next are two fun add-on circuits that will give your "wheels" some audible character. But before adding those or any

other circuits to your bike's standard equipment, be

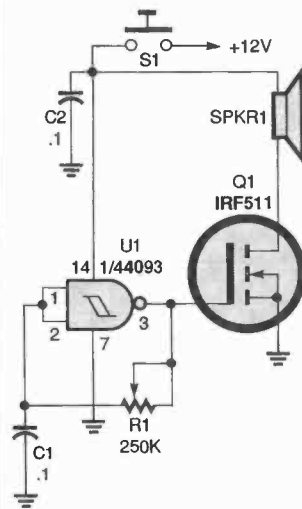

Fig. 3. Easy to build and adjust, this simple horn lets you tell others that your bike is coming.

### PARTS LIST FOR THE SMART TURN SIGNAL (Fig. 1)

#### SEMICONDUCTORS

U1-U3—555 timer, integrated circuit  
Q1, Q2—IRF511 hexFET transistor  
Q3-Q6—2N3904 NPN transistor  
D1, D2—1N4001 silicon diode

#### RESISTORS

(All fixed resistors are 1/4-watt, 5% units.)  
R1-R8—10,000-ohm  
R9—1000-ohm  
R10, R11—1-megohm potentiometer  
R12—50,000-ohm potentiometer

#### CAPACITORS

C1-C3—.05- $\mu$ F, ceramic-disc  
C4, C5—25- $\mu$ F, 25-WVDC, electrolytic  
C6—47- $\mu$ F, 25-WVDC, electrolytic

#### ADDITIONAL PARTS AND MATERIALS

Lamps (see text), wire, solder, etc.

### PARTS LIST FOR THE FLASHY BRAKE LIGHT (Fig. 2)

#### SEMICONDUCTORS

U1—4017 decade counter/divider, integrated circuit  
U2—4049 inverting hex buffer, integrated circuit  
Q1—IRF511 hexFET transistor  
D1-D5—1N914 silicon diode

#### ADDITIONAL PARTS AND MATERIALS

R1—100,000-ohm, 1/4-watt, 5% resistor  
R2—100,000-ohm potentiometer  
C1—0.1- $\mu$ F, ceramic-disc capacitor  
C2—10- $\mu$ F, 25-WVDC, electrolytic capacitor  
Lamps (see text), wire, solder, etc.

sure that doing so does not go against any local, state, or federal law.

#### SIMPLE HORN

The first horn circuit (see Fig. 3) uses only one gate of a 4093 quad 2-input NAND Schmitt trigger, U1, connected in a simple, low-frequency, square-wave oscillator circuit. The

oscillator's output, at pin 3, drives the gate of Q1. The drain of that FET drives a small horn speaker.

Potentiometer R1 can be adjusted to set the horn's output frequency. Some horn speakers are frequency sensitive, so play with the oscillator's frequency control for the best or loudest sound.

### PARTS LIST FOR THE IMPROVED HORN (Fig. 4)

U1—4093 quad 2-input NAND Schmitt trigger, integrated circuit  
Q1—IRF511 hexFET transistor  
R1—500,000-ohm potentiometer  
R2—250,000-ohm potentiometer  
C1-C3—0.1- $\mu$ F, ceramic-disc capacitor  
S1—Pushbutton switch  
SPKR1—4- or 8-ohm horn speaker  
Wire, solder, etc.

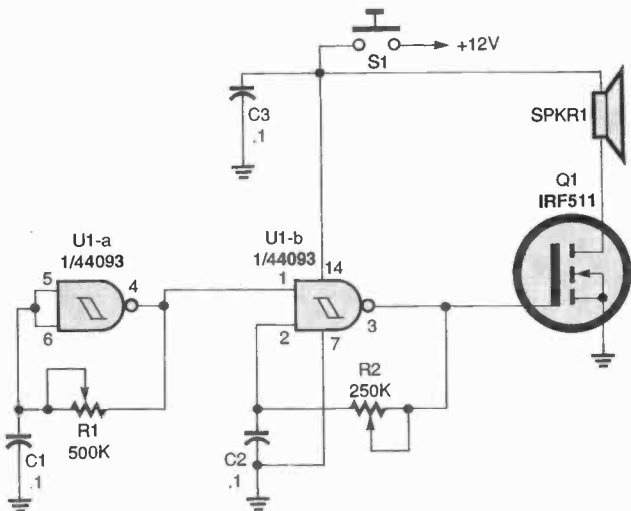

Fig. 4. Give your motorcycle a distinctive "voice" of its own. This improved horn lets you choose from a wide variety of sounds by adjusting potentiometers R1 and R2.

### PARTS LIST FOR THE SIMPLE HORN (Fig. 3)

- U1—4093 quad 2-input NAND Schmitt trigger, integrated circuit
- Q1—IRF511 hexFET transistor
- R1—250,000-ohm potentiometer
- C1, C2—0.1- $\mu$ F, ceramic-disc capacitor
- S1—Pushbutton switch
- SPKR1—4- or 8-ohm horn speaker
- Wire, solder, etc.

### AN IMPROVED HORN

Our last entry (see Fig. 4) for this visit is a dual-oscillator horn circuit. Gates U1-a and U1-b of the 4093 quad 2-input NAND Schmitt trigger are connected in variable, low-frequency, square-wave oscillator circuits.

The output of gate U1-a is connected to one of the inputs of gate U1-b. The

square-wave output of gate U1-a modulates oscillator U1-b, producing a two-tone output. A really interesting sound can be produced by carefully adjusting potentiometers R1 and R2.

Of course, all of our motorcycle circuits can be built as shown or modified to suit your own needs. Happy trails until we meet here again next month. ■

# Earn \$1000

## A Week While You Learn High Paying VCR Repair.

### Earn While You Learn . . . Secrets Revealed . . .



### Train at Home

If you are able to work with small hand tools and possess average mechanical ability, you could earn top dollar part time or full

time. Our learn by doing method teaches you how to work on VCR's without boring unnecessary electronic basics.

For Free Information Package Send Coupon to:

Foley-Belsaw Institute, 6301 Equitable Road, Kansas City, MO 64120

Check VCR or another High Paying Career Field	(Check One Box Only)
	<input type="checkbox"/> VCR Repair, Dept. 62311 <input type="checkbox"/> Computer Repair, Dept. 64209 <input type="checkbox"/> TV/Satellite Dish, Dept. 31096 <input type="checkbox"/> Advance VCR Repair, Dept. 65037 <input type="checkbox"/> Camcorder Repair, Dept. 66047 <input type="checkbox"/> Fax Repair, Dept. 67047 <input type="checkbox"/> Printer Repair, Dept. 68046
<b>FOLEY BELSAW</b>	
Since 1926	
Name	_____
Address	_____
City	_____
State	_____ Zip _____

CIRCLE 154 ON FREE INFORMATION CARD

“If I don't get a good education, I could end up an alcoholic or lose my family because I'd be worthless.”  
 Katrina Davies  
 5th grade

America needs more schools that encourage our children to fulfill their promise.

## KEEP THE PROMISE.

For information on how you can help change the schools in your community, call 1 800-96-PROMISE.



Education Excellence Partnership

**HOW FAR YOU GO DEPENDS ON WHERE YOU GET YOUR START.**

1-800-854-CLUB

*The Positive Place For Kids*

# ELECTRONICS MARKET PLACE

## FOR SALE

**CABLE test chips.** Jerrold, Tocom, S.A., Zenith. Puts cable boxes into full service mode! \$29.95 to \$59.95. 1 (800) 452-7090, (310) 902-0841.

T.V. notch filters, free brochure, **MICROTHINC**, Box 63/6025, Margate, FL 33063. (305) 752-9202.

**PARTS for \$1.00.** Resistors .25W 12, .5W 8. Capacitors .001uF 5, .01uF 5, .1uF 4, 1uF 3, 10uF 2, 100uF 1. Semiconductors 1N4004 4, 2N2222 1, 2N3904 2, 2N3906 2, TIP31A 1, TIP32A 1, LM741 1, LM555 1, LEDs red 3, green 2. Catalog \$1.00, foreign add \$1.00. **ZIPFAST**, Box 12238, Lexington, KY 40581-2238.

**PRINTED circuit boards** — etched, drilled, tin plated. Single sided \$1.25/sq. inch. **CHELCO ELECTRONICS**, 61 Water Street, Mayville, NY 14757. 1 (800) 388-8521. Fax (716) 753-3220.

**THE Case Against Patents.** Thoroughly tested and proven alternatives that work in the real world. \$28.50. **SYNERGETICS PRESS**, Box 809-C, Thatcher, AZ 85552. (602) 428-4073. Visa/MC.

## CLASSIFIED AD ORDER FORM

To run your own classified ad, put one word on each of the lines below and send this form along with your check to:

**Popular Electronics Classified Ads**, 500-B Bi-County Boulevard, Farmingdale, N.Y. 11735

**PLEASE INDICATE** in which category of classified advertising you wish your ad to appear. For special headings, there is a surcharge of **\$11.00**.

( ) Plans/Kits ( ) Business Opportunities ( ) For Sale  
( ) Education/Instruction ( ) Wanted ( ) Satellite Television

Special Category: \$11.00

**PLEASE PRINT EACH WORD SEPARATELY, IN BLOCK LETTERS.**

(No refunds or credits for typesetting errors can be made unless you clearly print or type your copy.) Rates indicated are for standard style classified ads only. See below for additional charges for special ads. **Minimum: 15 words.**

1	2	3	4	5
6	7	8	9	10
11	12	13	14	15 (\$23.25)
16 (\$24.80)	17 (\$26.35)	18 (\$27.90)	19 (\$29.45)	20 (\$31.00)
21 (\$32.55)	22 (\$34.10)	23 (\$35.65)	24 (\$37.20)	25 (\$38.75)
26 (\$40.30)	27 (\$41.85)	28 (\$43.40)	29 (\$44.95)	30 (\$46.50)
31 (\$48.05)	32 (\$49.60)	33 (\$51.15)	34 (\$52.70)	35 (\$54.25)

We accept MasterCard and Visa for payment of orders. If you wish to use your credit card to pay for your ad fill in the following additional information (Sorry, no telephone orders can be accepted):

Card Number

Expiration Date

PRINT NAME

SIGNATURE

**IF YOU USE A BOX NUMBER YOU MUST INCLUDE YOUR PERMANENT ADDRESS AND PHONE NUMBER FOR OUR FILES. ADS SUBMITTED WITHOUT THIS INFORMATION WILL NOT BE ACCEPTED.**

**CLASSIFIED COMMERCIAL RATE:** (for firms or individuals offering commercial products or services) \$1.55 per word prepaid (no charge for ZIP code)...**MINIMUM 15 WORDS.** 5% discount for same ad in 6 issues within one year; 10% discount for 12 issues within one year if prepaid. **NON-COMMERCIAL RATE:** (for individuals who want to buy or sell a personal item) \$1.25 per word, prepaid...no minimum. **ONLY FIRST WORD AND NAME set in bold caps at no extra charge.** Additional bold face (not available as all caps) 30¢ per word additional. Entire ad in boldface, \$1.85 per word. **TINT SCREEN BEHIND ENTIRE AD: \$1.90 per word. TINT SCREEN BEHIND ENTIRE AD PLUS ALL BOLD FACE AD: \$2.25 per word. EXPANDED TYPE AD: \$2.05 per word prepaid.** Entire ad in boldface, \$2.45 per word. **TINT SCREEN BEHIND ENTIRE EXPANDED TYPE AD: \$2.55 per word. TINT SCREEN BEHIND ENTIRE EXPANDED TYPE AD PLUS ALL BOLD FACE AD: \$2.95 per word. DISPLAY ADS: 1" x 2 1/2"—\$225.00; 2" x 2 1/2"—\$450.00; 3" x 2 1/2"—\$675.00.** General Information: Frequency rates and prepayment discounts are available. **ALL COPY SUBJECT TO PUBLISHERS APPROVAL. ADVERTISEMENTS USING P.O. BOX ADDRESS WILL NOT BE ACCEPTED UNTIL ADVERTISER SUPPLIES PUBLISHER WITH PERMANENT ADDRESS AND PHONE NUMBER.** Copy to be in our hands on the 13th of the fourth month preceding the date of issue (i.e.; Sept. issue copy must be received by May 13th). When normal closing date falls on Saturday, Sunday or Holiday, issue closes on preceding work day. Send for the classified brochure. **Circle Number 49 on the Free Information Card.**

## CABLE TV CONVERTER & DESCRAMBLER COMBINATION SPECIALS!

All you need for one LOW price



**1-800-228-7404**



**NU-TEK ELECTRONICS**  
3250 Hatch Cedar Park TX 78613



**CABLE descrambler!** Build with 7 Radio Shack parts for under \$12.00. Complete instructions. \$8.00: **FAST**, Box 369-PE, Pt. Salerno, FL 34992-0369.

**HOME automation and computer control:** Two-way IR, two-way X-10, & hardwire. Control devices from serial computer link. **COMPCO**, (615) 436-5189 BBS ext. 12 RIBINFO.ZIP.

**CABLE descramblers.** Bargain headquarters, below wholesale prices. Absolutely the lowest prices! Money-back guarantee. Nobody beats us! **RP ELECTRONICS**, 1 (800) 304-3604.

**CABLE converters, descramblers.** Lowest prices available. 2 year warranty, money back guarantee. Visa/MC/C.O.D. 1 (800) 848-3049 **C&C SUPPLY**.

## Learn VCR repair!

Home study. Learn high-profit repairs without investing in high tech instruments. **Free career literature: 800-223-4542.**

Name \_\_\_\_\_ Age \_\_\_\_\_

Address \_\_\_\_\_

City \_\_\_\_\_ State \_\_\_\_\_ Zip \_\_\_\_\_

**The School of VCR Repair, Dept. VRF341**  
PCDI, 6065 Roswell Rd., Atlanta, GA 30328

**SECRET cable descramblers!** Build your own descrambler for less than \$12.00 in seven easy steps! Radio Shack parts list and free descrambling methods that cost nothing to try, included. Send \$10.00 to: **INFORMATION FACTORY**, Dept. 5, PO Box 669, Seabrook, TX 77586. For COD's (713) 922-3512 any time.

**300 Experimenters Circuits** — Complete in 6 practical books using diodes, relays, FET's, LED's, IC 555's, and IC CA3130's for building blocks. Only \$33.00 plus \$5.50 for shipping. USA and Canada only. US funds. **ETT, INC.**, PO Box 240, Massapequa Park, NY 11762-0240.

## BEST BY MAIL

Rates: Write National, Box 5, Sarasota, FL 34230

### EDUCATION

**HIGH SCHOOL DIPLOMA** Fast New Program, Credit For Experience. 1-800-470-4723.

### FINANCIAL

**SIGNATURE-LOANS \$1000** — \$50,000 No-Collateral (\$3.00) Refundable: TAYOE ODESANYA, 427 Church Street, Williamstown, NJ 08094.

**ERASE YOUR DEBTS** Learn How. Write: POB 80550-(PE), Memphis, TN 38108.

**\$1,000 WEEKLY STUFFING** Envelopes from home. Send self addressed stamped envelope to: PO Box 3339, Lubbock, TX 79452.

**GUARANTEED LOANS WITHIN** two weeks! No income, credit checks! PLUS! \$1,000 credit card! **GUARANTEED APPROVAL!** Limit increased \$300.00 annually! Reports, **PRE-APPROVED** applications, \$5.00. **NEWSOM**, 3352 Broadway, Garland, TX 75043.

### OF INTEREST TO ALL

**SUCCESSFUL HERBAL CANCER/AIDS** Treatment Stories — FREE 1-800-DR-HEALS.

**MEXICO TRADE DIRECTORY \$15.00** Postpaid. Box 661, Dallas, GA 30132.

**RECYCLE PERSONAL COPIERS Cartridges, Instructions** \$14.95. Charles Bruns, Box 543, Applegate, CA 95703.

### VIDEOS

**FREE CATALOG! SPECIAL Interest Videos.** 3,500 Of The World's Best Instructional, Educational Videos. Many Subjects. Write: How To Videos, 328 Flatbush Ave., Box 308-(PE), Brooklyn, NY 11238.

## EDUCATION/INSTRUCTION

**FCC General Radiotelephone Operator's license.** Answers, solutions to latest 889 for elements 1,3 examinations. Prepared by professional engineer. To receive this publication, send \$20.00 to **UNIVERSAL COMMUNICATIONS**, PO Box 11646, Palm Desert, CA 92255-1646.

**ELECTRICITY/Electronics training series** used by U.S. military. 24 volumes, other courses available. Free catalog. **FEDERAL TECHNICAL PUBLISHERS**, Box 1218 E Glen Lake, MN 55345.

## You Need Tree City USA

City trees add the soft touch of nature to our busy lives.

Support Tree City USA where you live. For your free booklet, write: Tree City USA, The National Arbor Day Foundation, Nebraska City, NE 68410.



**The National Arbor Day Foundation**

## PLANS & KITS

**60 Solderless Breadboard Projects** in two easy-to-read pocket books. Complete with circuit descriptions, schematics, parts layouts, component listings, etc. Both books (BP107 & BP113) only \$11.90 plus \$3.50 for shipping. USA and Canada only. US funds. **ETT, INC.**, PO Box 240, Massapequa Park, NY 11762-0240.

**SURVEILLANCE/countersurveillance, bugging/phone tapping detector, telephone/fax encryption, vehicle tracking, covert video, transmitter kit, and more...** **A.B. ELECTRONICS**, 1 (800) U-ANTI-BUG.

**CRYSTAL set Handbook** — Visit antiquity by building the radios your grandfather built. Assemble a "Quaker Oats" rig, wind coils that work and make it look like the 1920's! Only \$10.95 plus \$3.50 for shipping and handling. **CLAGGK INC.**, PO Box 4099, Farmingdale, NY 11735. US funds only! USA and Canada — no foreign orders.

**BUILD a 486 personal computer.** Easy reading guide \$19.95. **QUANTA ENTERPRISES**, PO Box 273, Dept. 50, Northfield, NJ 08225.

**FIBER optics experimenters parts, supplies and tools:** Fiber, cable, connectors, splices, detectors, lasers, kits, plans, newsletter. Send \$2.00 for catalog. **LIGHTLINE ENGINEERING**, PO Box 24, Mullica Hill, NJ 08062.

**FASCINATING kits!** Lasers, voice changers, gas sensors, and more! Send \$1.00 for catalog. **LNS TECHNOLOGIES**, 20993 Foothill Blvd., Suite 307P, Hayward, CA 94541-1511.

## BUSINESS OPPORTUNITIES

**EASY work!** Excellent pay! Assemble products at home. Call toll free 1 (800) 467-5566 ext. 5730.

**START your own technical venture!** Don Lancaster's newly updated **Incredible Secret Money Machine II** tells how. We now have autographed copies of the Guru's underground classic for \$18.50. **SYNERGETICS PRESS**, Box 809-C, Thatcher, AZ 85552. (602) 428-4073. Visa/MC.

**GET paid \$268.20** per roll taking easy snapshots! No experience. Film supplied. **PHOTOTEK**, Box 2457, Dept. 2, Pinecove, CA 92549. Recorded information: (909) 659-9757 ext. 8.

**GREAT extra income!** Assemble craft products at home. Easy/fun to do. Guaranteed! 1 (800) 377-6000 ex7930.

## INVENTIONS

**FREE Invention package:** **DAVISON & ASSOCIATES** offers customized development, patenting, and licensing for new products and ideas. Proven results: 1 (800) 677-6382.

## BOOKS

**ROBOT books!** Free catalog by mail! Write: **COGNITIONS**, Dept. 1200, 71 Widow Sweets Rd., Exeter, RI 02822.

## NEW DESCRAMBLER TECHNOLOGY REVEALED

**REVEALED** Halcyon's new universal 4000 descrambler! My manual/kits perfects all universal descramblers guaranteed. **SNOW**, POB 22048, Lansdowne, St. John, Canada E2K 4T7.

**MASTERCARD AND VISA** are now accepted for payment of your advertising. Simply complete the Classified Ad order form and we will bill you.

## BUY BONDS

## Be a computer repair expert!

Career-level home study course. Learn all about PC repairs, troubleshooting, installation, upgrading, servicing.

Open your own business; become a more valuable employee. **Free literature: send or call 24 hours a day.**

**800-223-4542**

Name \_\_\_\_\_ Age \_\_\_\_\_  
Address \_\_\_\_\_ Phone ( ) \_\_\_\_\_  
City \_\_\_\_\_ State \_\_\_\_\_ Zip \_\_\_\_\_

## The School of PC Repair

PCDI, 6065 Roswell Road  
Dept. JF341, Atlanta, Georgia 30328



## ANTIQUE RADIO CLASSIFIED

### Free Sample!

Antique Radio's Largest Circulation Monthly. Articles, Ads & Classifieds.

6-Month Trial: \$17.95. 1-Yr: \$34.95 (\$51.95-1st Class).

A.R.C., P.O. Box 802-L14, Carlisle, MA 01741

Phone:(508) 371-0512 VISA/MC Fax:(508) 371-7129

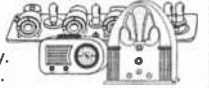

## BE AN ELECTRICIAN!

Home study. Make good money—maintain, install wiring in homes and businesses: electrical systems, cable, controls, utilities, phones, and more. **Free literature: 800-223-4542.**

Name \_\_\_\_\_ Age \_\_\_\_\_  
Address \_\_\_\_\_  
City \_\_\_\_\_ State \_\_\_\_\_ Zip \_\_\_\_\_  
The Electrician School, Dept. TEF 341, PCDI  
6065 Roswell Road, Atlanta, Georgia 30328



## The Greatest Thing Since Sliced Bread

No matter how you slice it, our free Consumer Information Catalog is great food for thought.

The Catalog dishes up more than 200 free and low-cost government booklets on subjects such as staying healthy, eating right, finding a job, getting federal benefits, using credit, buying a home, helping your kids, taking care of your car, and much, much more.

To get your free copy, send your name and address to:

**Consumer Information Center  
Department GT  
Pueblo, Colorado 81009**

U.S. General Services Administration

# DX LISTENING

By Don Jensen

## A Voice from the North



Greetings from KNLS, the New Life Station, P.O. Box 473, Anchor Point, Alaska 99556, United States of America

A voice from the great white north, this is KNLS in Anchor Point, Alaska.

Next to WKRP in Cincinnati, probably the best-known fictional radio station is KBHR, 570 kHz, known to TV viewers as the hometown voice of the equally fictitious town of Cicely, Alaska. SWLs, however, can find a real Alaskan station to give them a bit of genuine "Northern Exposure." The station is *KNLS*, a high-tech, low-maintenance shortwave broadcaster located in one of the more remote corners of our 50th state, Alaska's Kenai Peninsula.

For almost a dozen years, that low-key religious broadcaster, owned and operated by World Christian Broadcasting, a Tennessee-based religious organization, has been aiming its transmissions across the polar zone to China and Russia. *KNLS*, which stands for "New Life Station," operates from Anchor Point, a little dot in the Alaskan wilderness, some 120 miles down the gravel road from Anchorage.

DX'er Carl Mann visited *KNLS* last year and offered a fascinating look at one of the world's most northerly SW stations in the pages of

*The Journal*, the monthly bulletin of the North American SW Association.

During the past five years, Mann reports, *KNLS* has pumped \$350,000 into its Alaskan radio. In earlier years, when the station needed a large broadcasting crew, those staff members were housed in a pair of separate living modules. Now the station is so fully automated that the 100-kilowatt SW broadcaster can be operated by a single person and those living modules are used only when the occasional visitor drops by.

The on-site chief engineer, Kevin Chambers, originally from Oregon, has been with *KNLS* since 1983, when the station went on the air.

*KNLS* broadcasts 10 hours daily, mostly in Russian and Chinese, but with a bit of English. Programming originates thousands of miles away, in WCB's program studios in Franklin, Tennessee. There, a week's worth of programs are recorded on long-playing cartridges and shipped to Alaska by parcel service.

At the station, after the day's 10-hour program cassette is loaded up, a computer control system takes over, starting each show right on time, while automatically recording its own running program log. A second computer tends to the big Harris SW transmitter, changing transmitting frequencies as programmed and automatically altering the antenna beam. Twin 365-foot antenna towers rise directly behind the one-story

broadcasting building. A square curtain array antenna, supported from those masts, beams the signal toward Asia.

Once *KNLS*'s overnight schedule is underway, the duty engineer can catch his 40 winks in an adjoining bedroom, knowing an alarm will sound in case of a computer glitch.

You can tune for *KNLS* English-language programming from 0800 to 0900 UTC, or 1300 to 1400 UTC, on 7,355 kHz.

Mann says that reception reports are welcome. You can address your letter to Chief Engineer Kevin Chambers at *KNLS*, P.O. Box 473, Anchor Point, AK 99556, or to the World Christian Broadcasting Operations Center, 605 Bradley Court, Franklin, TN 37064. Be sure to enclose the appropriate return postage if you'd like a QSL card reply.

### IN THE MAILBOX

William Etchells of Panama City, FL, has a problem.

"I'm a retired military veteran and used to take a shortwave radio with me on all of my overseas duty assignments. I served my country in many isolated locations and it made those times a little easier.

"I use a General Electric World Monitor, Model 7-2990A, which I purchased from my military PX at Tyndall AFB, FL. It worked flawlessly for about seven years, but now the tuning mechanism doesn't operate properly.

"I'd like to have it repaired but my attempts to find a repair source in

northwest Florida have met with no success. Can you tell me where I can send my SW radio to be repaired?"

General Electric says that Thomson Consumer Electronics in Texas handles its line of portable radios and other small audio devices. Call Thomson's toll free number, 800-933-5489, for information on how and where to ship your GE World Monitor receiver for repairs. Since it is no longer within the warranty period, they'll also give you an estimate of the repair cost when you call.

The next letter comes from Barry Fonk, Bethesda, MD, who asks about SW broadcasting in the nations that once comprised the USSR.

"Soviet shortwave used to be such a huge monolith," Barry observes. "What's going on in places like Armenia and Georgia in the way of SW broadcasting these days?"

From monolith to mess, Barry! Things continue to change almost too rapidly to report with any real hope of being current. However, thanks to Mike Barraclough, editor of the World DX Club's bulletin, *Contact*, here's a report on some SW activity in those ex-Soviet countries.

English from Armenia's *Radio Yerevan* is broadcast to Europe from 1845 to 1900 UTC on several frequencies, including 5,930 and 6,065 kHz. A better opportunity on this side of the Atlantic would be the English pro-

gram at 2330-2345 UTC on 9,480 and 11,960 kHz.

*Radio Belerus* is said to transmit from high-powered transmitters in the Ukraine, with an abbreviated English schedule, at 1945 UTC on Tuesdays. SW frequencies include 7,105 and 7,405 kHz.

*Abkhaz Radio* in former Soviet Georgia was supposed to start broadcasting in English in the near future. Schedule and frequencies have not yet been reported, although the station has been known to operate on 9,373 kHz in lower-sideband transmission mode.

A powerful relay of Kazakhstan's *Radio Almaty* has been reported in Europe on 5,940 kHz at 0600 UTC, and on 7,205 kHz at 0800 UTC. Another report says *Radio Almaty* is on 21,490 kHz at 1730 UTC with English programming.

*Radio Vilnius*, Lithuania's international SW broadcaster, is noted in English at 0000 (midnight) UTC, Saturdays and Sundays on either 7,120 or 7,150 kHz.

Moldovia (formerly Moldavia) operates its *Radio Moldova International's* English service to North America from transmitters in Romania. Look for it from 0200 to 0225 UTC on 7,190 kHz.

Uzbekistan's *Radio Tashkent* has been reported with two English periods, 1200 to 1230 UTC, and 1330 to 1400 UTC, on 13,785 kHz. It supposedly also uses two other SW frequencies, 6,025 and 9,715 kHz.

Remember, in the SWL hobby, time references are always given in Universal Coordinated Time (abbreviated as UTC and equivalent to EST + 5 hours, CST + 6, MST + 7 or PST + 8) and in the 24-hour military type system (1 PM = 1300 hours, 2 PM = 1400 hours, etc.).

Do you have a question

about SWL'ing, a comment on the shortwave scene, or your own loggings to share? You can write me in care of DX Listening, **Popular Electronics**, 500-B Bi-County Blvd., Farmingdale, NY 11735.

## DOWN THE DIAL

Here are some other stations to look for on the shortwave frequencies:

**ANTIQUA**—5,975 kHz. The *British Broadcasting Corporation's* English programming at 0435 UTC is relayed by powerful transmitters on that Caribbean island nation. It was logged with news and identification announcement.

**CANADA**—9,630 kHz. The *Canadian Broadcasting Corp.* Northern Service, aimed at listeners in the Canadian northland, is reported on this frequency

around 0320 UTC with country and western music.

**COLOMBIA**—4,785 kHz. *Radio Super* is noted here around 1000 UTC with identification, frequency announcement and news in Spanish.

**RUSSIA**—7,125 kHz. *Radio Atlantika* is heard here with Russian language news and announcements, followed by a musical program. Look for it around 0200 UTC.

**TURKEY**—9,400 kHz. The *Voice of Turkey's* English programming has been logged here until 2050 UTC sign off.

**UKRAINE**—9,685 kHz. *Radio Ukraine* broadcasts in English, including a mail-bag program, music dedications, and news on this frequency and a parallel channel, 9,680 kHz at around 0025 UTC. ■

### Coil Design and Construction Manual

• • •

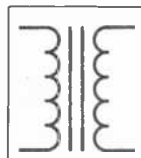

## YOU CAN WIND YOUR OWN COILS?

There's no trick to it except knowing what you are doing. In a unique, 106-page book you can become expert in winding RF, IF, audio and power coils, chokes and transformers. Practically every type of coil is discussed and necessary calculations are given

with the mathematical data simplified for use by anyone. Get your copy today!

Mail coupon to:

**Electronics Technology Today, Inc.**  
P.O. Box 240 • Massapequa Park, NY 11762-0240

Please send me my copy of *Coil Design and Construction Manual* (BP160). I enclose a check or money order for \$8.45 to cover the book's cost and shipping-and-handling expenses. NY state residents must add local sales tax.

Name \_\_\_\_\_

Address \_\_\_\_\_

City \_\_\_\_\_ State \_\_\_\_\_ ZIP \_\_\_\_\_

All orders must be paid in U.S. funds only. Sorry, no orders accepted outside of USA and Canada. Please allow 6-8 weeks for delivery.

\*CREDITS: Richard D'Angelo, PA; Pete Grenier, NV; Rufus Jordan, PA; Fred Kohlbrenner, PA; Don Moore, IA; Sheryl Paszkiewicz, WI; Doug Robertson, CA; North American SW Association, 45 Wildflower Road, Levittown PA 19057; World DX Club, c/o 2216 Burkey Drive, Wyomissing PA 19610

# HAM RADIO

By Joseph J. Carr, K4IPV

## NE-602 Input and Output Circuits

Last month, we took a look at the NE-602 chip and discussed basic DC power-supply circuits that can be used with the device. This time, we will take a look at RF-input and RF/IF-output circuits that can be used with the device.

### NE-602 INPUT CIRCUITS

The NE-602 uses pin 1 (input "A") and pin 2 (input "B") to form a balanced input. The input impedance of the NE-602 is on the order of 1500 ohms shunted

scheme is shown. The signal is applied to pin 1 (although pin 2 could have been used instead) through a capacitor, C1, that has a low impedance at the operating frequency. The signal level should be less than -25 dBm, or about 70 mV rms (180 mV peak-to-peak). The unused input should be bypassed to ground through a low-value capacitor (0.05  $\mu$ F to 0.1  $\mu$ F depending on frequency).

A wideband, transformer-coupled, RF-input circuit is shown in Fig. 1B. In that configuration, a wideband RF transformer is connected so that the secondary is connected across pins 1 and 2 of the NE-602, with the primary of the transformer connected to the signal source or antenna. The turns ratio of the transformer can be used to transform the source impedance to 1500 ohms (the NE-602's input impedance). Either conventional or toroid-core transformers can be used for T1. Note that one input is bypassed to ground through a low-reactance capacitor (C1).

Tuned RF-input circuits are shown in Fig. 2. Each of those circuits performs two functions: it selects the desired RF frequency while rejecting others, and it matches the 1500-ohm input impedance of the NE-602 to the source or antenna-system impedance (50 or 75 ohms). Tuning selects the desired signal while suppressing unwanted signals, keeping the NE-602's dynamic range available for the desired signal.

The circuit shown in Fig.

2A uses an inductor (L1) and capacitor (C1) tuned to the input frequency; the impedance-matching function is done by tapping the inductor. A DC-blocking capacitor is used between the antenna connection and the coil. A third capacitor, C3, is used to bypass one of the inputs (pin 2) to ground.

Another version of that circuit is shown in Fig. 2B. It is similar in concept to the previous circuit, but uses a tapped capacitor voltage divider (C2/C3) for the impedance-matching function. Resonance with the inductor is established by the combination of C1, the main tuning capacitor, in parallel with the series combination of C2 and C3.

The previous two circuits are designed for use when the source or antenna system impedance is less than the 1500-ohm input impedance of the NE-602. The circuit of Fig. 2C can be used when the source or antenna impedance is lower than, higher than, or equal to the NE-602's input impedance, depending on the ratio of the number of turns in the primary winding (L2) to number of turns in the secondary winding (L1). The situation shown in Fig. 2C is for the case where the source impedance is less than the input impedance of the NE-602.

The secondary of the RF transformer (L1) resonates with a capacitance made up of C1 (main-tuning), C2 (trimmer tuning or band-spread), and fixed capacitor C3. One advantage of that circuit is that the frame of the main-tuning capacitor is grounded.

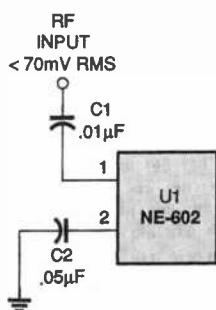

A

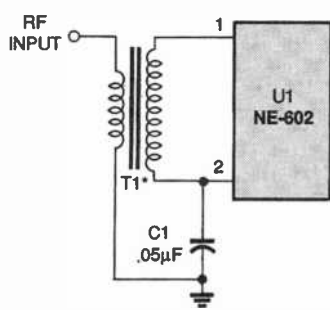

B

\*PRIMARY: 4 TURNS, #28 ENAMELED WIRE, ON AMIDON ASSOCIATES T-50-6 OR T-50-2 TOROID CORE; SECONDARY: 20 TURNS, #28 ENAMELED WIRE

Fig. 1 A variety of single-ended input circuits can be used with the NE-602 including a broadband capacitor-coupled input (A) and a broadband transformer-coupled input (B).

by 3 pF at lower frequencies; in the VHF region the impedance drops to about 1000 ohms. That impedance normally must be matched to 50 or 75 ohms for best operation.

Several different RF input configurations are shown in Figs. 1 and 2; both single-ended (unbalanced) and differential (balanced) input circuits can be used with the NE-602. In Fig. 1A, a capacitor-coupled, un-tuned, unbalanced input



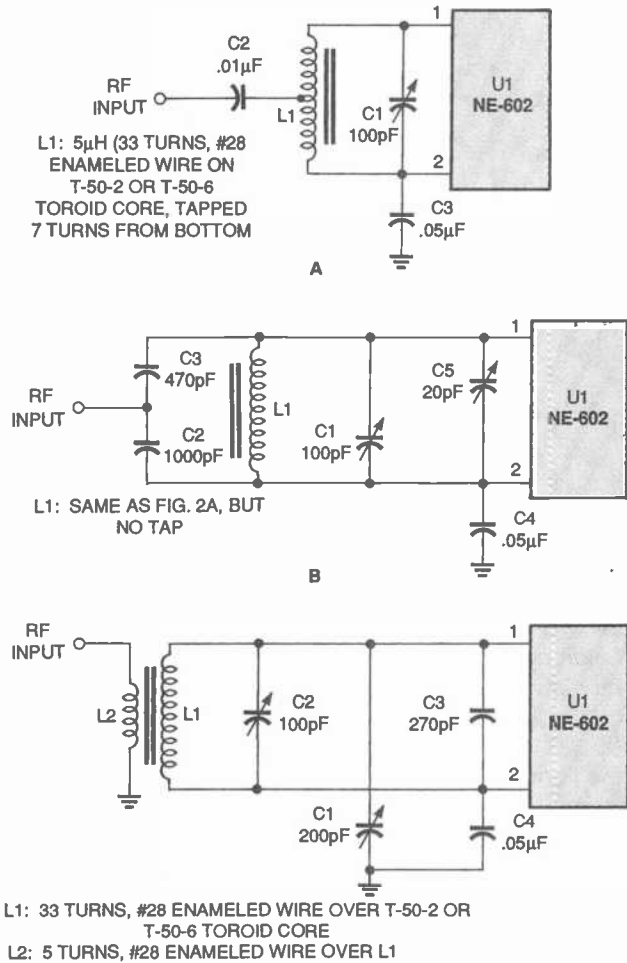

Fig. 2. Here are three tuned-input circuits. A tapped-inductor LC-tuned circuit is shown in A, a tapped-capacitor voltage-divider input is shown in B, and a flexible, tuned-input circuit that can be used in a variety of situations is shown in C.

That is an advantage because most tuning capacitors are designed for grounded-frame operation, so construction is easier. In addition, most of the variable-frequency oscillator circuits used with the NE-602, and discussed later in this series, also use a grounded-frame capacitor. The input circuit of Fig. 2C can therefore use a single, dual-section capacitor for single-knob tuning of both the RF input and the local oscillator.

### OUTPUT CIRCUITS

The NE-602 outputs are available on pin 4 (output "A") and pin 5 (output "B"). In single-ended output configurations, only one

terminal is used (it generally doesn't matter which), and the alternate output terminal is ignored. Each output terminal is connected internally to the NE-602 to V+ through separate 1500-ohm resistors.

Figure 3A shows the wide-band, high-impedance (1500-ohm) output configuration. Either pin 4 or 5 (or both) can be used. A capacitor is used to provide DC blocking. That capacitor should have a low reactance at the frequency of operation, so values between 0.001 µF and 0.1 µF are generally used.

Transformer output coupling is shown in Fig. 3B. In that circuit, the primary of a transformer is connected

between pins 4 and 5 of the NE-602. For frequency-converter or translator applications, the transformer could be a broadband RF transformer wound on either a conventional slug-tuned or toroid form. For direct-conversion autodyne receivers, the transformer

circuit for the NE-602. The tuned primary of the transformer is connected across pins 4 and 5 of the NE-602, while a secondary winding (which could be tuned or untuned) is used to couple signal to the following stages.

A single-ended, RF-tuned,

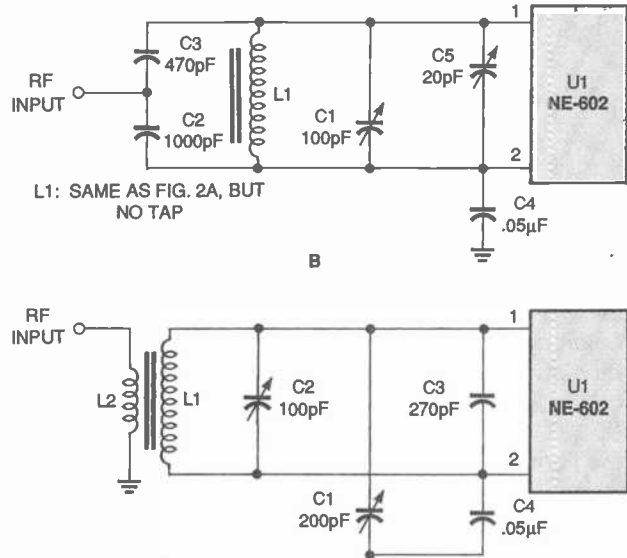

Fig. 3. Two single-ended output circuits. A capacitor output is shown in A, while a single-ended transformer output is shown in B.

would be an audio transformer. The standard 1:1 transformers used for audio coupling can be used. Those transformers are sometimes marked with their impedance ratio rather than the turns ratio (e.g. 600-ohm:600-ohm, or 1500-ohm:1500-ohm).

Frequency converters and translators are the same thing, except that the "converter" terminology generally refers to a stage in a superhet receiver, while "translator" is more generic. For those circuits, a broadband transformer will work, but it is probably better to use a tuned RF/IF transformer for the output of the NE-602. The resonant circuit will reject all but the desired frequency product; for example, the sum or difference IF frequency. Figure 4 shows a common form of resonant output cir-

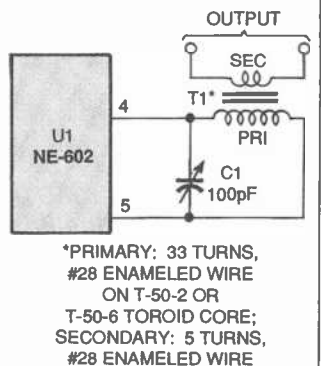

Fig. 4. A tuned output like this one will reject all but the desired output signal.

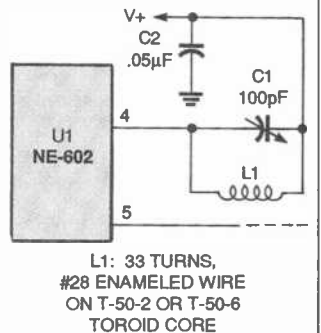

Fig. 5. Here is a single-ended tuned-output circuit.

transformer-output network for the NE-602 is shown in Fig. 5. In that coupling scheme, the output terminal of the IC is coupled to the V+ DC power-supply rail through a tuned transformer.

Still another single-ended, tuned-output circuit is

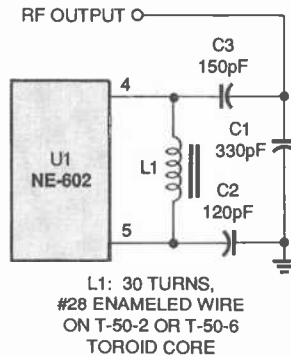

Fig. 6. In this LC single-ended output circuit, tuning is a function of the inductance and the combined capacitances in the circuit.

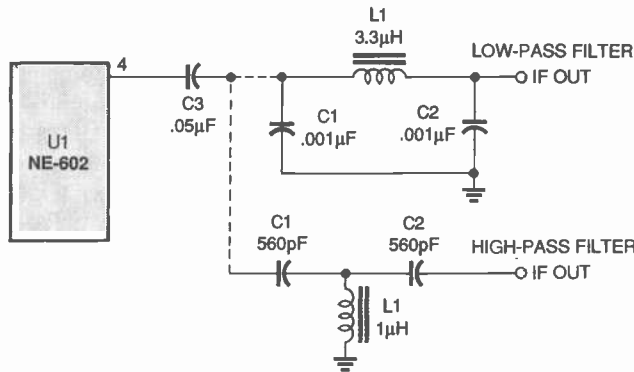

Fig. 7. Either the low-pass filter or high-pass filter outputs can be used, depending on the situation.

shown in Fig. 6. In that circuit, one of the outputs is grounded for RF frequencies through a capacitor. Tuning is a function of the inductance of L1 and the combined series capacitance of C1, C2, and C3.

The single-ended output network of Fig. 7 uses either a low-pass filter or high-pass filter as the frequency-selective element, depend-

ing on whether you want the difference or sum IF, respectively. That type of circuit can be used for applications such as a heterodyne-signal generator, in which the local-oscillator frequency of the NE-602 is heterodyned with the signal from another source applied to the RF input pins of the IC. The difference frequency is selected at the output when the low-pass filter is designed so that its cut-off frequency is between the sum and difference frequencies.

In Fig. 8, an IF filter is used to select the desired output frequency. Those filters are available in a variety of different frequencies and configurations, including the Collins mechanical filters that were once used extensively in high-grade communications receivers (260-kHz, 455-kHz, and 500-kHz center frequencies). Current high-grade com-

munications receivers typically use crystal IF filters centered on 8.83 MHz, 9 MHz, 10.7 MHz, or 455 kHz (with bandwidths of 100 Hz to 30 kHz). Even broadcast-radio receivers use IF filters. Such filters are made of piezoceramic material, and are usually centered on either 260 or 262.5 kHz (AM auto radios), 455 or 460 kHz (other AM radios), or 10.7 MHz (FM radios). The lower-frequency versions typically have 4-, 6-, or 12-kHz bandwidths, while the 10.7-MHz versions have bandwidths of 150 to 300 kHz.

In the circuit shown in Fig. 8, it is assumed that the low-cost ceramic AM or FM filters are used (for other types, compatible resistances or capacitances are needed to make the filter work properly). The input side of the filter (FL1) is connected to the NE-602 through a 470-ohm resistor and an optional DC-blocking capacitor (C1). The output of the filter is terminated in a 3900-ohm resistor. The difference IF frequency resulting from the conversion process appears at that point.

One of the delights of the NE-602 chip is that it contains an internal oscillator circuit that is already coupled to an internal double-balanced mixer. The base and emitter connections to the oscillator transistor inside the NE-602 are available through pins 6 and 7, respectively. The internal oscillator can be operated at frequencies up to 200 MHz. The internal mixer works to 500 MHz. If higher oscillator frequencies are needed, then use an external local oscillator. An external signal can be coupled to the NE-602 through pin 6, but must be limited to less than about -13.8 dBm, or 250 mV across 1500 ohms.

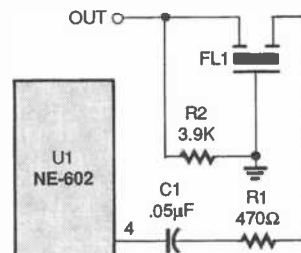

Fig. 8. Ceramic or mechanical filters can be used to provide a frequency-selective output.

# From Not-Working to Networking!

## Troubleshooting Local-Area Networks!

Now, complete for the first time in one detailed booklet!

Gain a fuller knowledge of network fundamentals and how they developed from the early days of main frames, from XNS to Ethernet technology, the OSI stack for interconnecting different computers, basic and specialized test instruments, etc. Several tough LAN case histories bring from theory to the practical side of troubleshooting.



**ONLY \$5.00**

CLAGGK Inc., Reprint Bookstore  
P.O. Box 4099, Farmingdale, NY 11735

Please rush my copy of "From Not-Working to Networking." I enclosed payment of \$5.00 which includes shipping charges.

Name \_\_\_\_\_  
Address \_\_\_\_\_  
City \_\_\_\_\_ State \_\_\_\_\_ ZIP \_\_\_\_\_

Sorry, no orders excepted outside of United States and Canada. All Payments must be in U.S. funds. Send check or money order payable to CLAGGK Inc.—do not send cash or stamps. New York State residents add applicable sales tax.

# Prepare for today's fastest-growing computer field: Be a LAN Specialist!

*All-new from America's #1 source for computer training!  
Now you can get the equipment, experience, and credentials you need to make money installing, maintaining and upgrading Local Area Networks!*

## Discover what developments in LAN technology can mean for you

Today's LANs are able to transform individual PCs, departments, divisions, and entire corporations into productive information resources. This dynamic, in-demand technology can be your specialization with NRI training, the ticket to a new, secure future.

Now you can be one of the key technicians able to sell, select, install, use, maintain, and manage office networks. And this know-how will earn you top dollar! Only NRI, the leader in at-home training for over 80 years, gives you everything you need to start a new career or business of your own as a sought-after LAN Specialist.

## Train with and keep the most advanced computer system available in home study today!

NRI knows: To master a revolutionary technology like LAN, you need to train with exceptional equipment. That's why your course includes a 486DX2/66 MHz PC with all these exciting features...

- Pentium Overdrive-ready processor
- Intel CPU
- Math coprocessor
- 8 meg RAM
- 128K secondary cache
- 420 meg hard drive
- 1.44 meg 3.5" floppy disk drive
- Super VGA color monitor with .28mm dot pitch
- Double-speed CD-ROM drive
- 16-bit sound card with speakers
- Fax/modem
- Windows 95
- Space-saving mini-tower design
- Two network interface cards
- Thin, Ethernet cable
- Special coax cable-assembly tools

Using LANtastic, award-winning LAN software, you connect this top-of-the-line system to your existing computer (386SX or better, with hard drive, 3.5" floppy drive, and at least one meg RAM). Then you're set to explore first-hand the

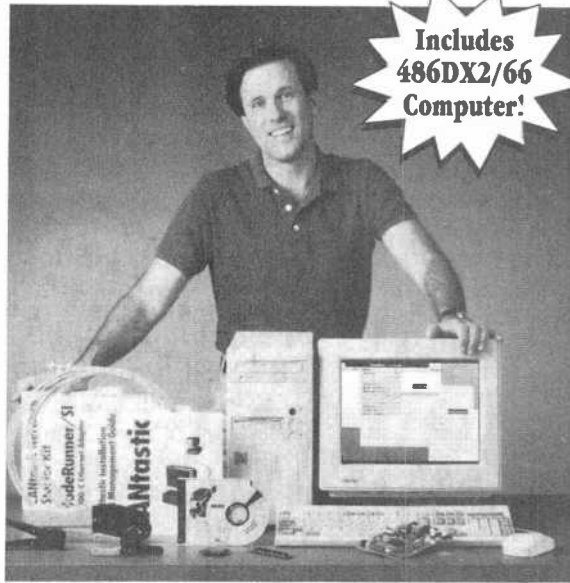

## Hands-on training builds confidence

Leaving nothing to chance, NRI's LAN Specialist course goes beyond reading to give you real experience, the kind that makes you proficient on the job.

As an NRI student, you get a chance to build, configure, test, and use your own LAN system! No other school goes the extra mile to make your learning experience so enjoyable and effective.

## Flexible, convenient studying with your own instructor

You study at home, at your own pace. And with NRI's easy new TeleGrading system, you can check your knowledge and progress over the phone - 24 hours a day!

What's more, you have an expert instructor available throughout your training and career. Offering advice and feedback, your instructor will become a trusted mentor, able to help you move up and make good money as a successful LAN Specialist.

## FREE catalog gives all the details

Find out more about NRI's LAN Specialist training by requesting your free, full-color catalog.

If the coupon is missing, write to NRI Schools, McGraw-Hill Continuing Education Center, 4401 Connecticut Avenue, NW, Washington, DC 20008.

**CALL 1-800-321-4634,  
Ext. 1147**

tremendous potential of today's LAN technology.

## Lessons cover entire LAN spectrum

NRI's "bite-sized" lessons explain computer electronics and LAN technology step by easy step. Even if you have no experience in this field, you'll be able to understand these expertly written texts because they're loaded with diagrams and illustrations. Plus, they present each subject in clear, everyday language so you won't get bogged down in technical jargon.



## SEND TODAY FOR FREE CATALOG!

**NRI Schools**

McGraw-Hill Continuing Education Center  
4401 Connecticut Avenue, NW, Washington, DC 20008



CHECK HERE  
For career courses  
approved under GI Bill

Check for one FREE catalog only

- |   |  |  |
|---|--|--|
| <input type="checkbox"/> LAN SPECIALIST           | <input type="checkbox"/> Computer-Aided Drafting           | <input type="checkbox"/> Desktop Publishing & Design     |
| <input type="checkbox"/> Microcomputer Servicing  | <input type="checkbox"/> Multimedia Programming            | <input type="checkbox"/> PC Applications Specialist      |
| <input type="checkbox"/> TV/Video/Audio Servicing | <input type="checkbox"/> Computer Programming              | <input type="checkbox"/> Programming in C++ With Windows |
| <input type="checkbox"/> Basic Electronics        | <input type="checkbox"/> Industrial Electronics & Robotics |  |

NAME \_\_\_\_\_ (Please Print) \_\_\_\_\_ AGE \_\_\_\_\_

ADDRESS \_\_\_\_\_

CITY \_\_\_\_\_ STATE \_\_\_\_\_ ZIP \_\_\_\_\_

Accredited Member, National Home Study Council

4609-0595

# SCANNER SCENE

By Marc Saxon

## The Russians (and Others) Are Coming!

**R**adio Shack has brought out its first true super-scanner: the PRO-2035 base station. It's hard to know how or where to begin describing this versatile, multi-featured receiver. Let's begin by simply stating that there are 1000 memory channels (10 banks of 100 channels), plus an additional 100 monitor channels.



Radio Shack's new super-scanner base station, the PRO-2035, features 1000 memory channels, 100 additional monitor channels, and a host of versatile, sophisticated features.

The frequency coverage is 25 MHz through 1300 MHz, with a gap in the UHF-TV band from 520 to 760 MHz. According to FCC edict, the 824-848-MHz and 869-894-MHz cellular bands are locked out at the factory. The PRO-2035 can operate in NFM, WFM, and AM modes. It can search in increments of 5, 12.5, and 50 kHz. It searches and scans at a single speed, which is approximately 50 channels per second.

Among the interesting features of the PRO-2035 is instant access to 10 pre-programmed weather channels. There's a rotary tuning knob that allows you to (optionally) tune across a band and check out frequencies at your own speed, just like on a communications receiver. The PRO-2035 can scan up or down the memory channels, as well as search either up or down in frequency. The scanner allows its owner to pick any combination of its 10 search banks, from one to all 10, for searching in-turn during each sweep-through.

An auto-store feature stores active frequencies in available memory slots. You can easily move frequencies from a monitor memory to a specific channel, or to any unspecified spot in a particular bank. You can also shift frequencies around within banks, as well as move frequencies from banks to the monitor memory.

No memory-backup battery is needed, and the PRO-2035 will hold its memory storage for up to three months during power loss. The unit operates from AC, or from 12-volt vehicle power (with an optional cigarette-lighter cord).

Somewhat taller than its popular predecessor, the PRO-2006, the PRO-2035 is easy to operate, attractive, and a hot performer. Those things, along with its 1000 channels, make it a sure attention-getter.

### TOAST OF THE TOWN

The end of the Cold War and the opening of commerce with many formerly off-limits nations has resulted in an increasing flow of foreign heads of state, diplomats, and other dignitaries to our shores. Those people often visit around the United States as a public-relations gesture, or to establish trade agreements, or to visit their own diplomatic embassies here.

During the past year, several members of the British Royal family have visited the States. Russian President Yeltsin, among others, also visited here.

That brings into focus the fact that there are certain frequencies in use that relate to foreign dignitaries and diplomatic missions in this country. With foreign royalty as well as high-ranking politicians and diplomats showing up here so often, it's good to keep those special frequencies ready for use.

The State Department is involved in some of the security for visiting diplomats. Their operations use repeaters on 409.625 and 409.70 MHz. Agents use short-range direct communications units on 407.60 and 408.60 MHz. Portables operate on 164.70, 169.05, 169.10, 169.6125, 169.625, and 169.70 MHz.

When Boris Yeltsin visited the United States last year, he apparently had some of his own security people with him. They were monitored speaking Russian

on 168.625, 168.725, 169.10, and 169.80 MHz. Note that one of those matches a known State Department channel. The frequencies *might* be State Department allocations set aside for use by visiting security forces.

One reporter tells us that some foreign missions in the U.S. operate communications systems on 148.10 kHz.

The Secret Service has a channel designated for protecting foreign dignitaries: 414/775 MHz. The agency's regular operations at foreign missions here are on 414.85 and 419.725 MHz, with an emergency frequency of 415.975 MHz. Transportation services, which would be used in motorcades, are on 414.80 MHz.

Plug in those channels and be in on the extensive planning and security preparations for important foreign visitors. It's a lot more involved than you (or they) would think. Obviously, it must be, what with all of the kooks on the loose out there these days!

### BIG CHANGE FOR LAPD

The Los Angeles Police Department's communications system has long been a favorite with scanner owners within range. But LAPD officers, who had eight-channel radios, complained about the system. The radios didn't have enough channels to allow the cops to communicate with officers in adjacent areas or divisions.

The new radio system that the LAPD is getting will give each officer a radio that can operate on 250 channels. Not only will they be able to contact all LAPD commands, they will also have access to the 57 channels licensed to the City of Los Angeles for all other municipal services. In addition, they will be able

to communicate with the Sheriff and other area police and emergency agencies.

The need for improved communications was spotlighted during recent civil unrest incidents and last year's earthquake, which pointed up how completely outdated the existing radio system had become. The new system, which costs almost \$8 million, is presently being phased in.

When fully operational—that is, when all 3000 handheld transceivers are distributed to officers and the base station transmitters are completed—it will be bad news for LA-area scanner owners. That's when the system will switch into digital mode, and present-era scanners will no longer be able to monitor LAPD communications.

### MAILBAG

From the mailbag we extract a card from Wallace Newman of Louisiana, who asks how he can listen to the American Red Cross vans that roll out during floods and storms. They have long whip antennas, he reports.

The American Red Cross uses 47.42 MHz nationwide, and on a rather exclusive basis. When there's a wide-area disaster of any kind, that frequency shows lots of activity. It's well worth keeping it programmed into a scanner, since it brings in distant stations via skip propagation.

As always, we appreciate your input. Please send us your frequency information, questions, and ideas. While you are at it, why not pass along a photo of your station, too? Write to us at *Scanner Scene*, **Popular Electronics**, 500-B Bi-County Blvd., Farmingdale, NY 11735. Your letters help keep this column tops! ■

## FUN WITH ELECTRONICS



◀  **160—COIL DESIGN & CONSTRUCTION MANUAL** ... \$5.95. How to make RF, IF, audio and power coils; chokes and transformers. Practically every possible type is discussed.

**PCP113—THE PC MUSIC HANDBOOK** .... \$13.95. Learn the basics of computer music systems. For the professional musician, gifted amateur or just plain curious.



◀  **BP297—LOUDSPEAKERS FOR MUSICIANS** .... \$6.25. Loudspeaker design from the musician's point of view! All you need to know, and you should be able to design your own after reading this.

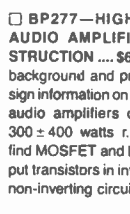

**BP277—HIGH POWER AUDIO AMPLIFIER CONSTRUCTION** .... \$6.25. Here's background and practical design information on high power audio amplifiers capable of 300 ± 400 watts r.m.s. You'll find MOSFET and bipolar output transistors in inverting and non-inverting circuits.



◀  **BP302—A CONCISE USER'S GUIDE TO LOTUS 1-2-3 RELEASE 3.1** .... \$6.25. If you are a PC user and want to upgrade to Lotus 1-2-3 release 3.1, this book can teach you how to do that in the shortest and most effective way.

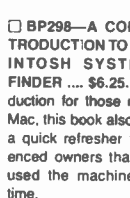

**BP298—A CONCISE INTRODUCTION TO THE MACINTOSH SYSTEM AND FINDER** .... \$6.25. This introduction for those new to the Mac, this book also serves as a quick refresher for experienced owners that have not used the machine in some time.



MAIL TO: **Electronic Technology Today, Inc.**  
P.O. Box 240  
Massapequa Park, NY 11762-0240

#### SHIPPING CHARGES IN USA AND CANADA

\$0.01 to \$5.00	... \$1.50	\$30.01 to \$40.00	.. \$5.50
\$5.01 to \$10.00	.. \$2.50	\$40.01 to \$50.00	.. \$6.50
\$10.01 to \$20.00	.. \$3.50	\$50.01 and above	.. \$8.00
\$20.01 to \$30.00	.. \$4.50		

**SORRY, No orders accepted outside of USA and Canada**

Total price of merchandise ..... \$ \_\_\_\_\_  
Shipping (see chart) ..... \$ \_\_\_\_\_  
Subtotal ..... \$ \_\_\_\_\_  
Sales Tax (NYS only) ..... \$ \_\_\_\_\_  
Total Enclosed ..... \$ \_\_\_\_\_

Name \_\_\_\_\_  
Address \_\_\_\_\_  
City \_\_\_\_\_ State \_\_\_\_\_ Zip \_\_\_\_\_

# ELECTRONICS LIBRARY

## Old-Time Telephones! Technology, Restoration, and Repair

by Ralph O. Meyer



Serious collectors of antique telephones, as well as casual hobbyists and museum curators, will be intrigued with the historical information on the past 120 years of telephones contained in this book. Much of the material, obtained from the author's painstaking research of patents and journal articles and his precise electrical measurements, has never been widely published before.

The book is divided into four sections covering the development of the telephone, types of telephones used in commercial service, electrical circuits used throughout the telephone's history, and a comprehensive

guide to the restoration and repair of antique telephones. The fourth section covers mechanical and electrical repairs, testing, modifications to put an-

tique phones to use today, and FCC regulations on the restoration of antique instruments.

The book contains many photographs and drawings of antique phones, as well as unique schematic drawings. There is also an appendix of electronics fundamentals, conventions, and related physics principles.

*Old-Time Telephones! Technology, Restoration, and Repair costs \$19.95 and is published by Tab Books Inc., Blue Ridge Summit, PA 17294-0850; Tel. 1-800-233-1128.*

**CIRCLE 98 ON FREE INFORMATION CARD**

### INTRODUCTION TO RADIO FREQUENCY DESIGN

by Wes Hayward, W7ZO1

Aimed at engineers and advanced radio amateurs who are comfortable with digital hardware methods and basic analog design, this book-and-disk package presents basic RF-design concepts using mathematics as needed. Whenever possible, simple circuit models are used to prepare readers to actually design HF, VHF, and UHF equipment.

The book emphasizes the use of models and their application to both linear and nonlinear circuits. Traditional materials are reviewed from the viewpoint of the RF designer. The book presents system design using the communications receiver as an example, and further illustrates subject matter with numerical examples. A discussion of oscillator design covers oscillator noise, starting conditions, and limiting mechanisms. Two-port network methods are applied to the design of amplifiers and oscillators, including the use of S-parameters.

The 3½-inch disk (for IBM PC and compatible computers) in-

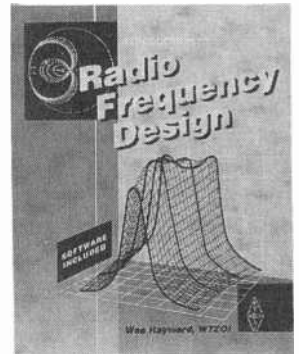

cludes programs that will design and analyze LC bandpass, low-pass, and high-pass filters; crystal ladder filters; feedback amplifiers; RF system dynamic range; phase-locked loops; and more. A user manual is included on the disk.

*Introduction to Radio Frequency Design costs \$30 and is published by The American Radio Relay League, 225 Main Street, Newington, CT 06111; Tel. 203-666-1541; Fax: 203-665-7531.*

**CIRCLE 88 ON FREE INFORMATION CARD**

### ELECTRONIC TEST ACCESSORIES CATALOG

from ITT Pomona Electronics

Although test accessories are a major market in their own right, many test-equipment directories and buyer's guide fail to include a separate test-accessory category. This catalog is intended to

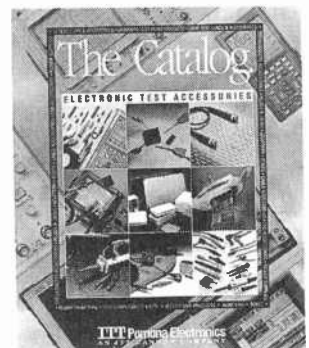

1990 was a Great Year for

# Popular Electronics®

The twelve 1990 issues of *Popular Electronics* reveal many fascinating articles. There's a bonanza of build-it project plans, informative theory articles and timeless feature stories. Check out the partial list of titles packed into the 1990 issues and you'll agree that 1990 was a banner year. If you see an article about a project, theory topic or newsworthy feature, you can have that article, with the entire issue for only \$6.50. To get your 1990 issue(s) of *Popular Electronics*, place an  in the box that indicates the month you want and complete the coupon below. Note that ordering six or more copies reduces the price per issue! Tear out this page, or make a photo copy of it, and mail or FAX it today! Just follow the directions below.

## Popular Electronics 1990 Issues

### TOPICS FROM THE PAST

#### Selected Projects

Audio Ambiance Ditherizer, **April**  
 Bit Grabber for Parallel I/O Testing, **December**  
 Car-Radio Silencer, **October**  
 Cordless Test Probes, **January**  
 CW and SSB, Add to a SW Receiver, **May**  
 Digital Entry Switch, **November**  
 Economy Portable SW Receiver, **August**  
 Exhaust Monitor for Car, **June**  
 Experimental AC Hum Sniffer, **September**  
 Game Reaction Timer, **April**  
 Headphone Output for Your CD Player, **July**  
 Hot-Wire Glass Bottle Cutter, **December**  
 Indoor Burglar Alarm, **December**  
 IR-Triggered Sound-Effects Generator, **October**  
 Lie Detector, Simple, **January**  
 Microphone Preamp, Simplest, **March**  
 Mobile Battery Charger, **March**  
 NiCd Battery Tester, **August**  
 Plasma Display, Custom, **February**  
 Receiver Circuits You Can Build, **March**  
 Remote-Control FAX Switch, **August**  
 Serial Cable Tester, **January**  
 Telephone Toll Totalizer, **August**  
 Tesla's Lightning Generators, **September**  
 The Lepton Candle, **October**  
 Ultrasonic Morse-Code Transceivers, **July**  
 Universal 3-Terminal Power Supply, **November**  
 Video Titrer, Super Simple, **September**  
 Vision System for Robotic Toys, **March**  
 VLF Receiver and Transmitter, **July**  
 Water Leak Alarm, **January**

External Drive for Laptop, **June**  
 First Electric Motor Project, **October**  
 Ground Fault Technology, **November**  
 Keeping Up with Pacemakers, **July**  
 Living with Lightning, **October**  
 Make Your Own Iron-on PC Patterns, **July**  
 Old-time Radio Circuits, **March**  
 Oliver Lodge: Radio's Forgotten Pioneer, **July**  
 Restoring a Classic SW Receiver, **April**  
 Solar Power, Experimenting with, **June**  
 St. Elmo's Fire, **September**  
 Surface Mount Technology, **November**  
 Television Night, a Look Back, **July**  
 Tune-in to Satellite Radio, **May**  
 Using Appliances Overseas, **January**

#### Theory for Everyone

3-Terminal Voltage Regulators, **May**  
 200,000-volt van de Graaff Generator, **October**  
 All About Batteries, **August**  
 All About Thermistors, **December**  
 CCTV Installation Guide, **November**  
 Connect Anything to Your Computer, **August**  
 Designing Power-supply Circuits, **February**  
 Digital Electronics Introduction, **April**  
 Experiments in Electrophotography, **March**  
 Fiber-Optic Communications, **April**  
 Galvanometer, Build and Learn, **September**  
 Lasers, All About, **September**  
 Printer Technology, **October**  
 Signal Generator Circuits Cookbook, **November**  
 Stepping Motors Introduction, **March**  
 Troubleshooting Computer Disk Drives, **May**  
 Troubleshooting Your Printer, **December**  
 Typing Practice Program, **August**  
 Sideband Amplifiers, **January**  
 Wimshurst Machine, **December**  
 WW1 Long Island Spy Station, **December**

#### Special Features

Antenna Installation, **September**  
 Capacitors, Choosing and Using, **June**  
 Classic Amateur Receivers, **November**  
 Drying Out Flood-Damaged Equipment, **January**  
 Early Radio Transmitters, **May**

January	February	March	April	May	June	July	August	Sept.	Oct.	Nov.	Dec.
---------	----------	-------	-------	-----	------	------	--------	-------	------	------	------

Check the issue(s) you want.  
**How to Determine Cost per Copy**

Quantity	Price per copy		
	United States	Canada	Foreign
1-5	\$6.75 US	\$7.75 US	
6-12	5.75	6.75	\$8.50 US

Prices include handling and shipping costs. Prices subject to change. All Canada and foreign orders payable in U.S.A. funds only, via international money order, check drawn on a U.S. bank, or acceptable credit card (Visa, MasterCard) in U.S.A. funds. Allow 6-8 weeks delivery. Minimum foreign order-6 issues. Foreign orders may take longer.

Visa  MasterCard  USA Bank Check  US or International Money Order

Credit Card Number \_\_\_\_\_ Exp. Date \_\_\_\_/\_\_\_\_  
 (If used)

Signature \_\_\_\_\_ Total No. of Copies \_\_\_\_\_

Print Name \_\_\_\_\_ Total Amount \$ \_\_\_\_\_

Address \_\_\_\_\_

City \_\_\_\_\_ State \_\_\_\_\_ ZIP \_\_\_\_\_

Send orders to: CLAGGK, Inc. P.O. Box 4099, Farmingdale, NY 11735. No COD orders. Credit Card user may telephone or FAX order. Telephone 516-293-3791 or FAX 516-293-3115.

May 1995, Popular Electronics

fill that gap by providing an easy-to-use source of accessories. Its 172 pages contain more than 3800 specialized products logically arranged and accompanied by helpful selection guides. All of the accessories are designed to optimize the performance of electronic test equipment and to guarantee consistently reliable test results. The catalog also includes short tutorial sections, such as "Selecting the Right Scope Probe" and "Extending Your DMM's Capability."

*The Electronic Test Accessories Catalog is free upon request from ITT Pomona, Customer Service, 1500 East Ninth Street, Pomona, CA 91766-3835; Tel. 909-469-2900; Fax: 909-629-3317.*

**CIRCLE 89 ON FREE INFORMATION CARD**

## OPERATING A DESKTOP VIDEO SERVICE ON YOUR HOME-BASED PC

by Harvey Summers

Desktop video is one of the hottest technologies of the decade, with industry experts predicting that it will have as much impact on the video field as desktop publishing has had on the publishing world. This book shows entrepreneurial readers how to capitalize on the

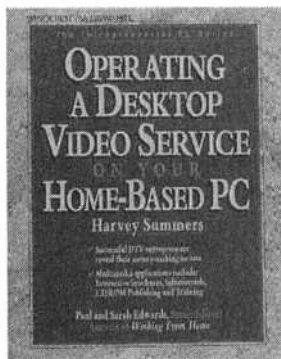

opportunities offered by this growing trend.

The book explains how to start and run a profitable desktop-video business. It shows readers how to use a computer to combine video, sound, animation, and graphics to create professional-quality business presentations, sales videos, documentary films, and more.

The book also provides the

knowledge needed to open a business and start making money. It covers creating a business plan, developing a marketing plan and finding clients, and dealing with legal matters such as contracts, copyrights, releases and permits. On the technical end, the book covers selecting the right hardware and software (for IBM PC, Macintosh, and Amiga systems), and discusses directing, producing, lighting, audio, video editing, authoring, and animation. Profiles of successful desktop-video businesses and products are included, along with more than \$1500 in money-saving coupons.

*Operating a Desktop Video Service on Your Home-Based PC costs \$17.95 and is published by Windcrest/McGraw-Hill, Blue Ridge Summit, PA 17294-0850; Tel. 1-800-233-1128; Fax: 717-794-2103.*

**CIRCLE 96 ON FREE INFORMATION CARD**

## RADIO/TECH MODIFICATIONS & ALIGNMENT CONTROLS Editions 7A and 7B

from Artsci Inc.

This perennially popular book provides radio-repair technicians and amateur-radio hobbyists with the tools they need to enhance radio transceivers and scanners. Edition 7A contains all known modifications for ICOM and Kenwood radios and Uniden, Regency, and Radio Shack Scanners. Edition 7B completes the set with all the modifications for Alinco, Yaesu, Standard, Azden, and other amateur radios, as well as modifications for citizen-band radios. The latest editions of this book include all of the information presented in the previous editions along with coverage of radios introduced in 1994.

Most of the modifications presented are intended to expand the radio's frequency transmit and reception coverage. Many of the modifications will allow a radio or scanner to monitor illegal frequencies. Besides modifications, the book includes the alignment points for each of the radios. The text is accom-

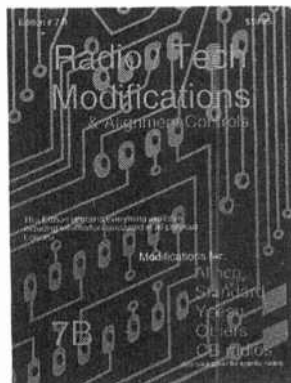

panied by detailed, easy-to-follow illustrations.

*Radio/Tech Modifications and Alignment Controls, Editions 7A and 7B, are available for \$19.95 plus \$4 shipping from Artsci Inc., P.O. Box 1428, Burbank, CA 91507; Tel. 818-843-4080; Fax: 818-846-2298.*

**CIRCLE 90 ON FREE INFORMATION CARD**

## SUPERCHARGING MS-DOS

by Van Wolverton

If you've been wanting to take charge of your computer, this intermediate DOS book can show you how to control your keyboard, display, and printer in ways the manuals never clearly reveal. An emphasis is placed on how to use batch files and small assembly language programs to control the various elements of your computer system.

Aimed at people who are already familiar with MS-DOS, the book is not a step-by-step tutorial or a reference that lists every command. Instead, it is a hands-on guide to making DOS more than just an operating system, but a useful tool. It explains how to use the DOS Debug program to create your own programs, how to improve the appearance and efficiency of your batch files, how to control your printer when you aren't using an application program, and how to use ANSI.SYS commands and printer commands and how to build a complete menu system for running programs with one keystroke.

*Supercharging MS-DOS is available for \$25 postpaid from Forsyth-Wolf Communications, P.O. Box 248, Alberton, MT*

*59820; Tel. 800-835-2246, extension 68. A disk that contains all the batch files and programs in the book is available for \$15 postpaid.*

**CIRCLE 91 ON FREE INFORMATION CARD**

## BUILDING AND USING BALUNS AND UNUNS: Practical Designs for the Experimenter

by Jerry Sevick, W2FMI

Every ham needs an antenna and a way to move signals efficiently between the antenna and the radio. A balun is a transmission line transformer that connects between a balanced antenna, such as a dipole, and an unbalanced feedline, such as coaxial cable.

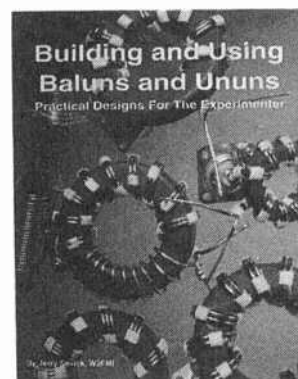

An unun goes between an unbalanced feedline and an unbalanced antenna.

This book, written by a noted authority on transmission-line transformer theory, offers practical information and designs, and provides a unique opportunity to learn about the application of baluns and ununs for dipoles, Yagis, log periodics, Beverages, antenna tuners, and countless others. It also includes appendices covering a ground-radial system for verticals, short ground-mounted verticals, a short ground-radial system for short verticals, and a study of the loading coil.

*Building and Using Baluns and Ununs: Practical Designs for the Experimenter is available for \$19.95 at ham dealers or directly from CQ Communications, Inc., 76 North Broadway, Hicksville, NY 11801; Tel. 800-853-9797.*

**CIRCLE 92 ON FREE INFORMATION CARD**



# NEW PRODUCTS

## "Next-Generation" HF Transceiver

DX'ers can work all the HF bands and receive 300 kHz to 29.995 MHz with Icom's "next-generation" IC-738 transceiver. SSB, CW, AM, and FM are built in for a full 100-watts output (40 watts in FM). A heatsink with two large cooling fans ensures stable 100% duty-cycle operation even during DX'ing marathons. The IC-738 offers an analog feeling to the tuning, faster PLL lockup times, improved phase-noise blocking, and high dynamic range. Bringing the IC-738 into the "next-generation" are an automatic antenna tuner, frequency-management features, and CW-contest features.

The built-in antenna tuner has preset memories for each band (in 100-kHz steps), providing high-speed tuning on the HF

quency operation. A split-lock function prevents users from accidentally changing the receive frequency while changing the transmit frequency, and a dial-lock function electronically locks the main dial.

CW contest features of the unit include a built-in electronic keyer with separate key jack, full break-in (QSK) operation, and separate jacks for an extended CW key or memory keyer. The CW enthusiast can use a memory keyer (or TNC with CW capability) to easily make contacts, then use the paddle for normal operation.

The IC-738 also features a double-band stacking register, which memorizes two frequencies and the mode in each band, allowing it to be used like two VFO's in one band. For contesting or DX'ing, up to 10 electronic memo pads are available to temporarily store the frequency and mode by pushing the memo-pad/write switch. Three scanning functions provide operating versatility: Programmed scan searches for signals over a specified range, memory scan searches all memories, and memory select scan searches only those memories specified by the user. Other features include pass-band tuning, a notch filter, a set mode for adjusting infrequently changed values or conditions, a VOX function for convenient phone operation, fast/slow selectable AGC time constant, multiple metering, a keypad for direct frequency input, and compatibility with Icom's CI-V system for control from a personal computer.

The IC-738, including a hand-held microphone, has a suggested retail price of \$1935. For more information on the unit, contact Icom America, Inc., 2380 116th Avenue N.E., Bellevue, WA 98004; Tel. 206-454-8155.

**CIRCLE 100 ON FREE INFORMATION CARD**

and six-meter bands. The transceiver's two antenna connectors are directed by an automatic antenna selector that switches to antenna one or antenna two when you change the operating band.

Frequency management is accomplished with the unit's quick-split function, which allows the offset frequency to be programmed in advance. Pressing the SPLIT button then automatically selects all the necessary settings for split-fre-

## 20-INCH MONITORS

Two high-resolution, color monitors from ViewSonic feature 20-inch screens and are compatible with PC, Mac, and Power Mac computer systems. Capable of displaying two pages of text and graphics, and offering a maximum resolution of 1600 x 1280, 0.28mm dot pitch, and a refresh rate of 77 Hz at 1280 x 1024, the monitors are ideal for CAD/CAM/CAE

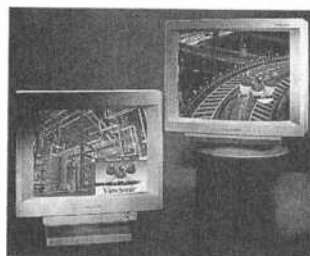

and desktop-publishing applications. Both offer the ViewMatch color-control system, which allows the user to adjust the screen image to match printer or plotter output. The monitors comply with the EPA's Energy Star program by powering down to under 8 watts in off mode, and are MPR-11 certified for low radiation.

The ViewSonic 20 PS, part of the high-end professional series, offers an on-screen control system that permits the user to customize screen images, choosing from and adjusting more than 20 different functions, including trapezoid, parallelogram, moire, pincushioning, and ViewMatch color control. It also includes a tilt-management system to counteract the effect of the earth's magnetic field, thereby ensuring precise screen alignment to the bezel. A special coating virtually eliminates screen glare and reflection, and a super-dark screen provides greater contrast and brilliance to colors.

The ViewSonic 20G, part of the midrange Graphics Series, features an Invar Shadow mask

for sharply defined screen images and a digital control system for adjusting screen size, position, and geometry. It also offers tilt management.

The ViewSonic 20PS and 20G have suggested list prices of \$1695 and \$1495, respectively. For further information, contact ViewSonic Corporation, 20480 Business Parkway, Walnut, CA 91789; Tel. 909-869-7976 or 800-888-8583; Fax: 909-869-7958.

**CIRCLE 101 ON FREE INFORMATION CARD**

## FOUR-PORT SERIAL BOARD

B&B Electronics' Model 3PXCC4A serial card features four serial ports in a single slot, saving valuable space for other applications. Each of the ports can be independently configured for any I/O address and any IRQ, as well as RS-232, 422, or 485 data protocols, allowing it to fit any serial application.

TD, RD, RTS, CTS, DSR, DCD, and DTR port lines are supported by the RS-232 mode, with each port using a buffered, high-speed UART. In addition, the 3PXCC4A has interrupt-sharing capabilities and an interrupt-status register to increase throughput in shared

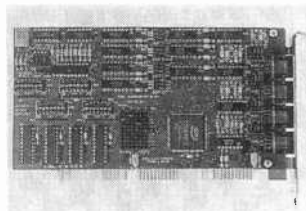

IRQ applications, and to increase the number of available interrupts in the system.

The 3PXCC4A uses eight-conductor RJ45 connectors. Optional pre-wired adaptor kits allow the user to convert to DB-9 or DB-25 connectors, and various adaptors to configure the pinouts to fit any custom application are available.

The 3PXCC4A four-port serial card costs \$209.95. The optional adaptor kits, including seven feet of RJ45 cable, each cost \$10.95. For additional information, contact B&B Electronics Manufacturing Company, 707

Dayton Road, P. O. Box 1040, Ottawa, IL 61350; Tel. 815-434-0846; Fax: 815-434-7094; BBS: 815-434-2927.

**CIRCLE 102 ON FREE INFORMATION CARD**

## THERMOMETER-TIMER ALARM

Exttech's Model 401362 thermometer-timer alarm provides instant, simultaneous readout of temperature, countdown time, and setpoints on a large (1.4-inch) LCD. When the temperature setting or countdown time is reached, an alarm sounds. A remote temperature probe measures from 32 to 392°F (0 to

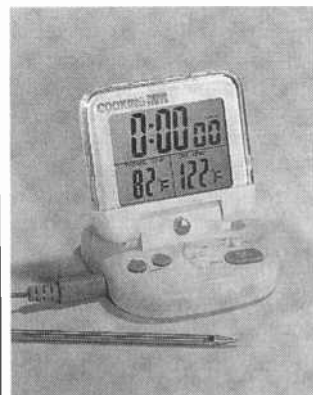

200°C) with an accuracy of 2°C and a 1° resolution. The thermometer-timer alarm features an adjustable desktop stand as well as a magnetic wall-mounting device. It comes complete with a heat-resistant, six-inch stainless-steel probe and an "AAA" battery.

The Model 401362 thermometer-timer alarm costs \$29. For additional information, contact Exttech Instruments, 335 Bear Hill Road, Waltham, MA 02154-1020; Tel. 617-890-7440; Fax: 617-890-7864.

**CIRCLE 103 ON FREE INFORMATION CARD**

## PACKET-ONLY VHF DATA RADIO

The MFJ-8621 "Packet Only" VHF data radio will continuously monitor your favorite packet channel, 24 hours a day. The two-meter FM data receiver will run all data rates through 9600 straight out of the box. By plugging in an appropriate TNC cable, your antenna, and a 12-

VDC power supply, you're ready to enjoy error-free packet. Once it's set up, there's nothing to adjust, and because it runs full time, there is no start-up drift or synthesizer lock-up delay.

The data radio provides 5 watts output—plenty to cover your operating area without disrupting distant nodes. The MFJ-8621 will operate on 145.01 MHz with crystals pre-installed, but you can also order plug-in



crystals for the packet channel of your choice.

For excellent signal reception and freedom from intermodulation, the data radio features a dual-conversion receiver, a 0.25- $\mu$ V low-noise preamp, and a double-tuned front end. Ultra-fast PIN diode switching gives you nearly instantaneous changeover between transmit and receive modes. A narrow 10.7-MHz IF filter plus a special full data-bandwidth, 455-kHz IF filter provide optimum passband and steep skirts for error-free data reception.

The MFJ-8621 "Packet Only" VHF data radio costs \$119.95. For more information, contact MFJ Enterprises, Inc., P. O. Box 494, Mississippi State, MS 39762; Tel. 601-323-5869; Fax: 601-323-6551.

**CIRCLE 104 ON FREE INFORMATION CARD**

## MULTIMEDIA SPEAKERS

Marketed under the "Bell Equipment" brand of home-office accessories, *Jasco's HO7624* two-way amplified multimedia speakers feature single-side front-panel controls, a built-in amplifier with bass boost, and an AC/DC adaptor. Two output jacks accommodate headphones and microphones, eliminating the need to constantly change connections on the back of the CPU. The speakers are magnetically



shielded for trouble-free placement close to a computer monitor.

The HO7624 amplified multimedia speakers have a suggested retail price of \$59.99. For additional information, contact Jasco Products Company, Inc., 311 N.W. 122nd, Oklahoma City, OK 73114;

Tel. 800-654-8483.

**CIRCLE 105 ON FREE INFORMATION CARD**

## COMPACT OSCILLOSCOPE PROBES

According to *ITT Pomona*, its *SL-Series* of passive voltage oscilloscope probes represent a technological leap forward. Accurate, laser-trimmed, surface-mount devices replace the discrete circuitry of conventional probes, resulting in an easy-to-handle, high-performance product. The compact, monolithic probes feature bandwidths of up to 450 MHz and input capacitance as low as 7pF ( $\times 10$ ) to minimize signal distortion. The new series also features a wide compensation range (10–30pF) to maintain signal integrity during use. Popular switchable attenuation ( $1 \times / 10 \times$ ) versions are also available.

The SL-Series probes are constructed of engineering-grade thermoplastic for durability and are compliant to IEC1010 safety standards. They come with a replaceable gold-plated test tip and a 1.2-meter (48-inch) cable. All standard accessories are included.

SL-Series oscilloscope probes, featuring bandwidths from 30 to 450 MHz, are priced from approximately \$33 to \$49. For further information, contact ITT Pomona Electronics, 1500 East Ninth Street, Pomona, CA 91766-3835; Tel. 1-800-241-2060; Fax: 909-629-3317.

**CIRCLE 106 ON FREE INFORMATION CARD**

## ADD A SWITCH

(Continued from page 60)

set, although after a day of jumper hunting I was somewhat less than enthusiastic.

The worst part in all this was that the PC could not be closed up until I was through playing with the construction set. As we all know, a PC with its cover removed is an accident just waiting to happen. If only there was a way to get both the construction set and the modem to work properly, at least using only one of them at a time, without having to reconfigure jumpers—and of course shutting down the computer—every time I switched between the two.

**A Total Solution.** Staring at my PC strewn across the floor, a total solution came to me: If a double-pole, double-throw switch could be connected to both the enable/disable-COM2 jumper on the I/O card and the COM2-enable jumper on the modem, all it would take to switch between the two would be a flip of the switch. The switch could easily be mounted on a spare expansion-slot cover or on a blank connector plate on the back of the computer case.

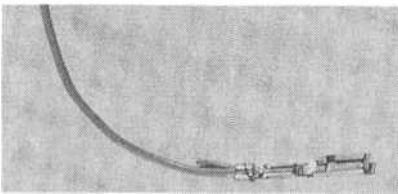

To avoid soldering to your computer peripherals, wire-crimp single-pin header sockets can be used to connect the switch to the cards.

The only problem I could foresee was how to connect switch leads to the male jumper-block pins on the two cards in question without soldering directly to them. The solution was to use five wire-crimp single-pin header sockets. Leads were crimped to each header socket and the metal body of each socket was covered with heat-shrink tubing. Figure 1 shows how the switch was connected to the jumper block on each card. With this addition to my PC, the modem works with the switch in one position and the serial port—along with the construction set—works in the other. ■

## It started in America!

# The creators are the masters in manufacturing the finest video products...

You probably don't associate VCR's with American technology. Fact is, video recording has its origins in America and it was 3M that brought video recording out of the lab and into your living room. Today, 3M video tape is the choice of all the major networks. No other tape company has ever won an Oscar or an Emmy, 3M Black Watch tape follows in this tradition—service and quality go hand in hand. Here are three Black Watch products you should be using at home!

**Clean up!** With constant playing and using of degrading dry or wet cleaners, the output of your video tapes has slowly diminished to an unacceptable level and the VCR plays as if it has a head cold! The culprit is most likely clogged and dirty video and/or audio heads. The 3M Black Watch™ Head Cleaner Videocassette uses a patented magnetic tape-based cleaning formation to remove head clogging debris. No foreign substances such as cloth, plastics or messy liquids and no harsh abrasive materials are present. The cleaner's usable life is 400 cleanings or more!

It's easy to use. Place the 3M Black Watch™ Head Cleaner Videocassette in the VCR and press the Play button. A pre-recorded message will appear clearly on your screen and an audible tone is heard, telling you that the cleaning process is now completed. No guess work; you never over clean! Priced at \$19.95.

**For the VCR!** Once your VCR's record and playback heads are cured, and the unit plays like new, consider using the finest videocassette you can buy—the 3M Black Watch™ T120 Hi Pro VHS 4410 Videocassette. The 4410 is the highest performing videocassette available today for use with all standard format VHS recording hardware!

Here's what you hear and see....A sharp, clear picture—brightest ever colors—freedom from streaks, flashes and snow—outstanding high-fidelity audio reproduction—optimum camcorder performance—maintains recording integrity. 3M Black Watch™ video tape is 100% laser inspected to guarantee surface smoothness and drop-out free performance. Priced at \$8.00

**You saw it here first!** 3M Black Watch™ 0900 8mm video tape cassette loaded into your Hi Band camcorder delivers the finest picture and sound possible in the 8mm format. Extremely fine particles of pure iron alloyed with nickel and cobalt deliver a video performance exceeding 400 lines of horizontal resolution. You get the advantage of an exceptional video image with superior audio re-



**For the clearest pictures you ever record!**

production. This means your Hi 8 format camcorder will produce the best video and audio definition possible. With the 3M Black Watch™ 8mm cassette, the recording capability and performance of your camcorder will be significantly enhanced. Priced at \$14.95.

Clagg Inc. — 3M VHS Special Offer  
P.O. Box 4099,  
Farmingdale,  
New York 11735

Yes, I like your offer and here is my order for 3M Black Watch™ products!

- \_\_\_ 3M Black Watch™ 0900 Hi Band-120 8mm Cassette (\$14.95 each) \$ \_\_\_\_\_
- \_\_\_ 3M Black Watch™ T120 Hi Pro VHS 4410 Videocassette (\$8.00 each) \$ \_\_\_\_\_
- \_\_\_ 3M Black Watch™ Head Cleaner Videocassette (\$19.95 each) \$ \_\_\_\_\_

Shipping and handling per order \$4.00

Total Amount in U.S. Funds only \$ \_\_\_\_\_

New York residents add local sales tax. Canadians add \$6.00 per order. No foreign orders. Do not send cash.

Bill my  VISA  MasterCard  
Card No. \_\_\_\_\_  
Expire Date \_\_\_/\_\_\_/\_\_\_  
Signature \_\_\_\_\_  
Name (Please print) \_\_\_\_\_  
Address \_\_\_\_\_  
City \_\_\_\_\_ State \_\_\_\_\_ ZIP \_\_\_\_\_

## MULTIMEDIA WATCH

(Continued from page 7)

The *Hijaak Graphics Suite* from Inset Systems just keeps getting better and better. It is the ultimate graphics viewing and conversion software package available anywhere. The software lets you view nearly any conceivable file format, and convert it to nearly any other format. It's also the best screen-capture software I've ever used. In addition to many new features, the *Hijaak Graphics Suite* now comes with the software on a bonus CD-ROM in addition to the diskettes. *Hijaak* software has helped me out of a jam many times over the years, and now with the CD-ROM I can run the software right from the disc without loading it on my hard drive. You can get

WHERE TO GET IT	
<b>Ahead, Inc.</b> 19A Crosby Drive Bedford, MA 01730	<b>HyperGlot</b> P.O. Box 10746 Knoxville, TN 37939
<b>Bethesda Softworks</b> 1370 Piccard Drive, Suite 120 Rockville, MD 20850	<b>Inset Systems, Inc.</b> 71 Commerce Drive Brookfield, CT 06804
<b>Blizzard Entertainment</b> 3152 Redhill Avenue, Suite 230 Costa Mesa, CA 92626	<b>Interlink Electronics</b> 546 Flynn Road Camarillo, CA 93012
<b>Books That Work</b> 285 Hamilton, Suite 260 Palo Alto, CA 94301	<b>LucasArts Entertainment</b> P.O. Box 10307 San Rafael, CA 94912
<b>HarperCollins Interactive</b> 10 East 53rd Street New York, NY 10022	<b>Panasonic Communications &amp; Systems Company</b> Two Panasonic Way Secaucus, NJ 07094

your own copy for around \$99.

HyperGlot, the company that specializes in multimedia language-teaching software, is now selling a CD-ROM *Pronunciation Tutor* series for Spanish, French, and German. The discs let you hear a native

speaker properly pronounce words while providing visual clues at the same time. You can also record your own voice and play back both pronunciations (yours and the native speaker) for comparison. The *Pronunciation Tutor* series sell for \$59.95 each.

On a lighter note, *Warcraft: Orcs and Humans* from Blizzard Entertainment, is a real-time strategic contest in which the Orcs battle the Humans in a quest for supremacy. *Warcraft* includes three-dimensional scenery, detailed graphics, narrations, and sound effects, with a background of classical war music. The game, available in CD-ROM and floppy formats sells for about \$45.

Bethesda Softworks has some new games out, some on CD-ROM and some not, but all entertaining. Basketball fans will want to check out *NCAA Basketball: Road To The Final Four 2* with its quick action and lifelike basketball simulation. *Delta-V* is a wild, futuristic flight simulation game for lovers of speed. *The Terminator Rampage* plays much like *Wolf 3D* or *Doom*, but it's you, the Terminator, who gets to do all the shooting. *The Elder Scrolls Arena* combines a little magic and some hand-to-hand combat in a multimedia fantasy environment. What separates *Arena* from other computer role-playing games is the freedom of exploration it allows. You can visit and interact with the residents of over 400 cities, but keep your sword handy!

Last but not least this month, I've got two new products from LucasArts. *X-Wing Collector's CD-ROM* is loaded with new missions, graphic upgrades, and sound enhancements. There are also two tour-of-duty extensions on the disc, *Imperial Pursuit* and *B-Wing*, all for around \$49.95. *Defender of the Empire* is floppy-disk based, and adds new missions and features to the game *TIE Fighter*. The upgrade, which requires *TIE Fighter* to run, sells for \$24.95.

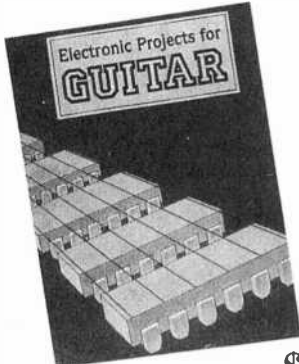

Whether you wish to save money, boldly go where no guitarist has gone before or simply have fun building electronic gadgets designed for your musical pleasure, then read

## Electronic Projects for GUITAR

Some of the add-on guitar gadgets you can build are:

**\$12<sup>95</sup>**

- Preamplifier • Headphone Amplifier • Soft Distortion Effects Unit • Compressor • Auto-waa • Waa-waa Pedal • Phaser • Dual Tracking Effects • Distortion Unit • Expander • Dynamic Treble Booster • Direct Injection Box • Dynamic Tremelo • Thin Distortion Unit • and Guitar Tuner.

Anyone with some previous electronic project building experience should have no problem assembling the projects.

ELECTRONICS TECHNOLOGY TODAY INC.  
P.O. Box 240, Massapequa Park, NY 11762-0240

Yes, send my copy of ELECTRONIC PROJECTS FOR GUITAR by RA Penfold to the address at right. I am enclosing \$12.95 plus \$2.95 for shipping charges in USA and Canada. All payments must be made in US funds. Sorry, no orders accepted outside of USA and Canada. New York State residents add local sales tax.. Allow 6-8 weeks for delivery.  
 Check enclosed.

Please charge my  Visa  MasterCard

Signature \_\_\_\_\_

Account No. \_\_\_\_\_ Expir. Date \_\_\_\_\_

Name \_\_\_\_\_

Address \_\_\_\_\_

City \_\_\_\_\_ State \_\_\_\_\_ ZIP \_\_\_\_\_

## CIRCUITS AND RESONANCE

(Continued from page 54)

Figure 5B shows a parallel tuned circuit. Whereas in the series circuit the  $Q$  represents the voltage magnification factor, in the parallel circuit it represents the current and impedance magnification, written:

$$Q = I_T / I_S = Z_{TANK} / X_L$$

where  $I_T$  is the tank current, and  $I_S$  is the source current. Recall that the parallel tank circuit, once set into oscillation, keeps a current,  $I_T$ , circulating by continuously transferring energy between the electrostatic field of the capacitor and the electromagnetic field of the coil. The source need only supply sufficient current to overcome the losses due to any resistance in the circuit. The tank current is usually greater than the source current.

The parallel-resonant circuit has an impedance that is much higher than that of either  $X_L$  or  $X_C$  alone. The value of  $Q$  also represents the ratio of tank impedance to inductive reactance:

$$Q = Z_{TANK} / X_L$$

If a resistor is connected in parallel with the tank circuit, the current drawn from the supply increases. This reduces the  $Q$  of the whole circuit, just as extra series resistance in the series resonant circuit reduces  $Q$ .

**Bandwidth.** Figure 6A shows the frequency response of a typical series tuned circuit. The resonant frequency is 500 Hz and the current is 10 mA at resonance. As the frequency is raised or lowered, the capacitive and inductive reactance are no longer equal, so the overall impedance of the circuit increases, causing the current to drop. The frequencies above and below  $f_0$ , at which the current drops to 70.7% of its peak value, are known as the half-power points.

The value of 70.7% comes about because 0.707 times the peak current, times 0.707 times the peak voltage, yields 0.5 times the peak power. In the example shown, the half-power points are at 475 and 525 Hz. The bandwidth of a tuned circuit is measured between the two half-power points, so in this case it is 50 Hz.

The addition of resistance in the series tuned circuit raises the imped-

TABLE 1—TUNED CIRCUIT PROPERTIES

Series-Resonant	Parallel-Resonant
Impedance minimum at resonance	Impedance maximum at resonance
Current maximum at resonance	Source current minimum at resonance
Appears purely resistive at $f_0$	Appears purely resistive at $f_0$
Appears capacitive below $f_0$	Appears inductive below $f_0$
Appears inductive above $f_0$	Appears capacitive above $f_0$
$Q = \frac{X_L}{R} = \frac{E_C}{E} = \frac{E_L}{E}$	$Q = \frac{X_C}{R} = \frac{I_{TANK}}{I_{SOURCE}} = \frac{Z_{TANK}}{X_L}$
$BW = f_0 / Q$	$BW = f_0 / Q$

ance of the circuit at its resonant frequency. That causes the peak current at resonance to be lower than if no resistance were present, so the curve will become more like that shown in Fig. 6B. Notice that the bandwidth has now increased to 100 Hz, and the curve has much shallower slopes. The reduction of circuit  $Q$  by adding resistance always broadens and flattens the response curve in this way, and in some cases a designer may deliberately add resistance to a tuned circuit in order to widen the bandwidth.

There is a direct relationship between the  $Q$ , resonant frequency ( $f_0$ ), and bandwidth (BW) of a circuit. If the resonant frequency and bandwidth of a circuit are known, the  $Q$  is equal to the ratio of  $f_0$  to bandwidth, or:

$$Q = f_0 / BW$$

If circuit  $Q$  is known, the bandwidth of a tuned circuit can be determined by dividing  $f_0$  by  $Q$ .

**Applications of Tuned Circuits.** The series and parallel tuned circuits in Fig. 7 show just a few ways simple reactive circuits are used.

Figure 7A is the antenna-input circuit of a radio receiver. Signals from the antenna are coupled to a tuned LC circuit from the antenna-side winding of the transformer. The capacitor is used to adjust the resonant frequency of the tuned circuit to the required station. Maximum current flow in the LC circuit can only take place at the resonant frequency, so other stations are greatly attenuated in strength.

Figure 7B shows a simple low-pass filter. The coil and capacitor form a voltage divider, and as the input frequency increases the output voltage decreases. That is because with rising frequency the inductive reactance increases and the capacitive reactance decreases, thereby attenuating the signal. Reversing the positions

of the coil and capacitor results in a high-pass filter.

Finally, Fig. 7C shows a band-stop filter. At the resonant frequency, the impedance of the parallel tuned circuit is very high, and effectively blocks the passage of a signal. As the frequency is raised or lowered, the tank circuit's impedance drops rapidly, giving the response curve shown.

There are many different ways in which combinations of capacitance, inductance, and tuned circuits can be arranged to achieve desirable results, but all are based on the principles that have been presented here. Table 1 summarizes the most important points about series and parallel tuned circuits. ■



## MULTIMEDIA on the PC!

What is Multimedia? What can it do for you? It can do lots of nice things! This 184-page book helps you create your own multimedia presentation. Multimedia applications by people like you can revolutionize educational and business applications as well bring more FUN, FUN, FUN into your leisure computer activities.

Mail coupon to:

**Electronics Technology Today, Inc.**  
P.O. Box 240  
Massapequa Park, NY 11762-0240

Please send me my copy of *Multimedia on the PC* (PCP120). I enclose a check or money order for \$18.45 to cover the book's cost and shipping-and-handling expenses. NY state residents must add local sales tax.

Name \_\_\_\_\_

Address \_\_\_\_\_

City \_\_\_\_\_ State \_\_\_\_\_ ZIP \_\_\_\_\_

All orders must be paid in U.S. funds only. Sorry, no orders accepted outside of USA and Canada. Please allow 6-8 weeks for delivery.

# NOW Find the Right Part for Your VCR!

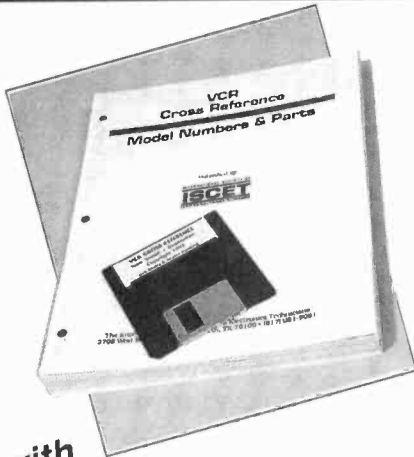

Only \$36.00 for pages  
\$69.95 diskette

The 320-page, Fourth Edition of the VCR Cross Reference contains both model and part number cross references. Over 1300 new parts and 360 new models have been added.

VCR's are made in a few factories from which hundreds of different brand names and model numbers identify cosmetically-changed identical and near-identical manufactured units. Interchangeable parts are very common. An exact replacement part may be available only a few minutes away from you even though the original brand-name supplier is out of stock. Also, you may be able to cannibalize scrap units at no cost.

## with the ISCET VCR CROSS REFERENCE

**NEW!** The Fourth Edition is contained on a diskette for IBM PC AT/XT compatibles, DOS 2.1 or higher. The disk software allows technicians to search by manufacturer for model numbers and description of part numbers. A parts editing sequence gives an on-screen view of all substitutes for parts entered. With the diskette, the technician can update files by adding model and parts

crosses of future models. The Fourth Edition can be printed on pages completely from the diskette.

The ISCET VCR Cross Reference, Fourth Edition, is on 8½ × 11-in., pre-punched pages and sells for \$36.00. The 3½ inch diskette sells for \$69.95 and you can view listings from a monitor or printed page.

Clagg Inc.  
VCR CROSS REFERENCE OFFER  
P.O. Box 4099  
Farmingdale, New York 11735

Name \_\_\_\_\_  
Business \_\_\_\_\_  
Address \_\_\_\_\_  
City \_\_\_\_\_  
State \_\_\_\_\_ Zip \_\_\_\_\_  
Phone \_\_\_\_\_

Enclosed \$36.00 for the ISCET VCR Cross Reference, Fourth Edition.

Enclosed \$69.95 for the diskette containing the ISCET VCR Cross Reference, Fourth Edition. Please specify:

5¼ Diskettes (2) 3½ Diskette (1)

Include \$3.00 for shipping each Cross Reference (Pages or Diskette)

The total amount of my order is \$ \_\_\_\_\_

Check enclosed—do not send cash.

Visa  MasterCard Exp. Date \_\_\_/\_\_\_/\_\_\_

Signature \_\_\_\_\_

New York State residents must add applicable local sales tax to total.

## PK TESTER

(Continued from page 59)

With R5 adjusted, you can complete the assembly of the unit. Drill 16 holes on the top panel of the project case to match the pattern of the LED's. Insert an LED lens cap into each of the holes, then lift the board and press the LED's into their respective caps. When that is done, the PC board will be held firmly under the panel.

**Using the Tester.** The finished unit has two pushbutton switches (S1 and S2). If the STATUS/TEST button (S1) is depressed when power-switch S3 is on, the Tester will go into a self-test mode. It will take 480 samples and see if the RNG is operating correctly. If it is, all the LED's will flash and the unit will then proceed into its normal-operation mode. If there is a problem with the circuit, all the LED's will continue flashing, indicating an error, until the unit is powered down. Check the calibration of R5 if that occurs.

Once in the normal-operation mode, the PIC keeps track of LED "movements" to the left or right. To find out if one direction has been coming up more frequently, hold down the STATUS/TEST button. If the top two LED's light up, then there is no excess movement. If one or more light to the left or right, then that means the unit is biased in the indicated direction. To determine the *maximum* number of moves that the unit is biased in that direction, use:

$$n \times 16$$

where n is the number of LED's lit. The system of LED's used in the PK Tester can only indicate the left or right bias in increments of 16 moves. For that reason, the *minimum* number of moves is 15 less than the maximum number. For example, if three LED's are lit to the right, then movement to the right exceeds normal by 33 to 48 moves. As a guide, a reading of seven LED's to the left or right indicates an extreme bias in that direction. When you have finished taking a reading,

you can either let go of the STATUS/TEST button and resume testing, or clear the "movement" counters and restart the PK Tester by pressing S2.

**An Experiment.** Leave the box on for 24 hours and verify its randomness by pressing STATUS/TEST. Then, have a test subject concentrate on the PK Tester. Have him or her "will" the movement of the LED either clockwise or counterclockwise. After about ten minutes, verify whether the LED movements are neutral by again pressing the STATUS/TEST button. Should the LED movement be biased in one direction, have the subject continue his or her "willing" so that you can see if the bias is coincidental. After another ten minutes the status response should show an even greater bias if the RNG actually is being influenced. Next, press the RESET button and ask the subject to concentrate in the reverse direction. If the bias follows the desired direction after several reversals, your subject most likely has a notable level of PK ability. ■

## ANTENNA SAFETY

(Continued from page 42)

num wire, or heavy (¾- or 1-inch) copper braid, usually will provide a satisfactory ground—the more rods the better. If your soil is dry and sandy, you should use at least two ground rods spaced at least 6-feet apart and bonded together by heavy wire or copper braid. You also can increase soil conductivity and help retain water by “doping” the soil with special salt compounds.

From a practical standpoint, your best bet might be to remove all of your equipment from AC power and RF transmission lines whenever an electrical storm is brewing; or better still, disconnect your equipment whenever you're not using it. That can be done by either physically removing the cables or switching them out of the line.

Grounding within the shack is also important. To be safe, and to improve equipment performance and reliability, connect your radio to an earth ground. Connect all antenna-related hardware and cables, metal cabinets, rotor-control boxes, and the like to a common ground bus or wire which, in turn, should be connected to the main station ground. That might be a cold-water pipe and/or ground rods and the home's electrical ground system.

Use an ohmmeter or multimeter to check that station grounds are actually connected to one another. Use three-wire power cords whenever possible; assuming your shack's power is wired correctly, those cords automatically electrically ground all the equipment chassis and cabinets whenever the power plugs are inserted in the wall sockets.

**In Conclusion.** What's the bottom line on antenna safety? Use common sense and take the appropriate safety precautions when installing, maintaining, or dismantling an antenna system. Consider experienced, professional help for the really big jobs. And be sure to read the manufacturers' catalogs and instruction sheets before erecting or dismantling a tower or putting up an antenna of any type. Think and work safely; you'll be glad you did. ■

## SECURITY

(Continued from page 36)

nate,” or “protest.” That can be done quickly, automatically, and without detection. The listeners don't even have to put a tap on your phone, because most long-distance calls are transmitted via microwaves. An NSA listening post located in the microwave flow can intercept thousands of calls an hour.

**Storm on the Horizon.** Computer monitors are low-powered, radio-frequency (RF) transmitters. For about \$300, a receiver can be built to read the information displayed on a computer monitor from several-hundred feet away. In fact, the U.S. government takes that problem seriously enough to have devised a set of standards for low-emission computers called TEMPEST, for Transient ElectroMagnetic Pulse Emanation Standard. A computer product meets TEMPEST standards by using two methods: modifying the RF emissions by adding dummy signals, or by capturing the emissions. The first method is classified, but the second can be done by anyone.

To capture the RF emissions, a monitor should be completely enclosed with copper that is grounded, with a fine copper mesh on the monitor screen itself. The monitor ca-

ble and its junctions should be shielded also. The entire computer room can be shielded with copper, but water pipes and heating ducts leading out of the shielded room can act like antennae, so that approach must be used carefully.

Using a laptop computer with a low-powered, LCD screen isn't foolproof. The computer processor, disk drive, and modem also generate RF signals. Even the phone cable running from the modem to the wall jack acts like an antenna. Other sources of RF leakage are: the printed-circuit board, internal wires, the power cable, switching transistors, and high-power amplifiers.

If the computer's wall outlet has a bad earth ground, it can also increase the amount of RF emissions. In fact, if even part of the earth ground has bad conduction, as from paint on a water pipe, it will increase the RF signal.

What about a roomful of computers, all using the same type of monitor? Wouldn't they emit RF signals all on the same frequency, making it impossible to sort through the signals? Not really. Even if two monitors are exactly the same model, they might have been manufactured at different times, using different components due to a change in the design. If so, they will not have the same RF signature. As a general rule, digital equipment emits RF signals in the form of pulses, which is easier to reconstruct than the non-pulse RF signals generated by analog equipment.

So, as you can see, there are ways to protect your private information from becoming a little too public. However, advances in computer technology will probably continue to make the ciphers of today obsolete tomorrow, which means cryptology will have to constantly strive to keep up. That should make the science worth watching in the future. ■

### FURTHER READING

*The Puzzle Palace*, by James Bamford, 1982, Houghton Mifflin Company, Boston. This is the story of the NSA.

*Protocol Failure in the Escrowed Encryption Standard*, by Matthew Blaze, June 1994. A paper on how to defeat the Clipper chip.

*Cryptologia*, Rose-Hulman Institute of Technology, Terre Haute, IN 47803; Tel. 812-877-1511. The quarterly journal on cryptology. Heavy math, but worth the struggle. \$34 per year.

*Shortwave Listening Guidebook*, by Harry Helms, 1993, High Text Publications, Solana Beach, CA.

*Kahn On Codes*, by David Kahn, 1983, Macmillan, NY. The history of cryptology.

*Security In Computing*, by Charles P. Pfleeger, 1989, Prentice Hall, Englewood Cliffs, NJ. An excellent textbook on encryption, computer and network security, copy protection, viruses, and more. ■



“Oh, I cornered the market in 8-track tapes.”

## THINK TANK

(Continued from page 31)

keep voltage drops to a minimum. Use snap-on heat sinks for Q1 and Q3, and metal-film resistors where indicated for stability in the schematic.

The output of U2 goes to your DMM input. Two 9-volt alkaline batteries can power the circuit, but I advise using an AC-powered 20-volt supply. (Send me an SASE at the address below for a supply diagram or any other information on this project.)

To calibrate the circuit, connect a 1000-ohm, 5-percent resistor to the output terminals, set the range to 1 mA, and set R15 for a reading of 0.00 mV between pins 2 and 3 of U1. Then, connect your DVM from the +20V-supply bus to pin 2 of U1 and set R2 to  $\cdot 1$  (full counter-clockwise). Adjust R4 for a reading of 100.0 mV, then advance R2 to  $\cdot 11$  (full clockwise). The voltage will go to 1.100 volts, and will be linear with the shaft rotation.

Let's say that the unit is ready for use, and you want to check the forward voltage of an LED at 15 mA. First, set the range switch to 10 mA, then set the multiplier to  $\times 1.50$ , but don't connect the LED yet. Because most LEDs have a maximum reverse voltage of 3 volts, you must first set the voltage compliance control (R13) for an output of 3.0 volts. That will protect the LED from excessive reverse current if your connection is accidentally reversed. Connect the LED and make the voltage check on your DMM—you will see a normal 1.5 to 2.0-volt reading, with the LED drawing all of the current. The compliance circuit is in a reverse-bias state and

draws no current to disturb accuracy.

You can obtain all of the parts in this project from one source: Circuit Specialists, Inc. (P.O. Box 3047, Scottsdale, AZ 85271-3047; Tel. 1-800-528-1417). The 15-turn pot and 15-turn counter will cost you about \$16.00 for the pair.

—Skip Campisi, 143 Cedar St., South Bound Brook, NJ 08880

*Excellent work as usual, Skip. Although it isn't apparent from Fig. 3, Skip's original schematic indicates that the junction of Q1-Q3, U2, and  $I_{out}$  should be made at a single point (i.e., with a single blob of solder). That "star connection," as it's called, ensures the accuracy of the output-voltage reading.*

## REGULATED POWER SUPPLY

Here is a regulator circuit that is reliable, flexible, cheap, and that can be built from more-or-less random parts with little or no advance testing. The base/emitter junction of most silicon transistors can act as a pretty fair Zener diode, often for Zener voltages between 7 and 8 volts, but the junction cannot usually handle more than a few milliamperes of current. That is not enough for a normal Zener-regulated power supply, but it is plenty to drive the base of an NPN series-pass transistor. Most transistors, even the smallest plastic-case types, can dissipate at least 100 milliwatts. Furthermore, by using two NPN series-pass transistors in parallel instead of one, with a couple of matched, low-valued resistors to help equalize the current flow, the available output current can be increased.

So, by using salvaged transistors in the circuit shown in Fig. 4A, you can

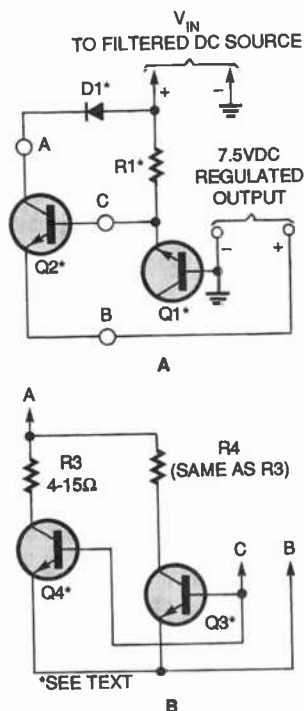

Fig. 4. Old transistors can make excellent regulators. Simply use one as a Zener to control the base current to another transistor (A). If the pass transistor cannot supply enough current, you can use two pass transistors in its place (B).

build a regulator delivering up to about 30 milliamperes at just under 8 volts with excellent regulation, for pennies in additional parts. The circuit uses a diode, which can be any small-signal unit, and a Zener-current-limiting resistor, R1. The resistance value of R1 is calculated by the following formula (for a Zener current of 5 milliamperes):

$$(\text{source voltage} - \text{Zener voltage})/0.005$$

If the calculated value is non-standard for a resistor, as is likely, round upward and use the next standard value resistor.

The wattage rating needed for the current-limiting resistor can be calculated by:

$$(\text{source voltage} - \text{Zener voltage}) \times 0.005$$

You'll usually find that even

the smallest 1/10-watt resistors are adequate. After building the circuit, test it for maximum current-handling capacity by attaching, in succession, resistor loads that draw 15, 20, and 30 milliamperes, and hold your finger on the pass transistor (Q2). If it gets uncomfortably warm, it is passing too much current.

To increase the current capacity of the circuit, you can replace Q2 with the circuit shown in Fig. 4B. That circuit uses two series-pass transistors in parallel, and two extra, well-matched, low-valued resistors. The transistors should be of the same type, but transistors, even of the same type, are seldom identical, so the total current will not divide equally. While the resistors will help to equalize the currents somewhat, one transistor will get hotter than the other. A better way to get more current is simply to substitute a different pass transistor with higher power dissipation for Q2.

—Curt C. Stadler, Waynesville, NC

*Terrific salvage tip. As Curt points out in his original drawing, you can have multiple D1's and R1's, one pair for each source of filtered DC you might have in your shop. By the way, heat sinking should be used and it might help improve through current, too.*

That's all for now. Next month I'll pick up the tutorial series on basic electronics where we left off.

Until then, have some safe, healthy fun with our hobby, and be sure to send your work to me at *Think Tank*, Popular Electronics, 500-B Bi-County Blvd., Farmingdale, NY 11735. If it appears in this column, you'll receive a *Think Tank II* or another book from our library. ■



# Market Center <sup>TM</sup>

## CABLE TV DESCRAMBLER KITS

### Universal-New Product

This Product includes all the Parts, PC Board, Complete Schematic with Functional Guide. Generates Sync for most Video Applications.

**\$79.95**

### Tri-Mode Descrambler

This product includes all the parts PC Board and AC Adaptor. NO Enclosure included.

**\$59.95**

### SB-3 Descrambler

This Product includes all the Parts, PC Board and AC Adaptor. Enclosure is not included.

**\$44.95**



**Call Toll Free 1-800-886-8699**

M & G Electronics, P.O. Box 3310, No. Attleboro Mass. 02761



Anyone implying theft of Cable service will be denied assistance.

NO MASSACHUSETTS SALES!

# Weeder Technologies

**FREE**  
construction plans for  
any of these kits  
Call 513-752-0279

# Pro-Kit <sup>TM</sup>

P.O. Box 421, Batavia, OH 45103

Educational Kits for the Serious Hobbyist

### Caller Block

Connects between your telephone and its wall jack, and prevents the phone from ringing unless the calling party is one which you've entered into memory using your touch-tone phone. Your answering machine can handle all other calls. Change between two separate directories of callers with a simple flip of a switch.

### Telephone Caller ID

Connects to telephone wall jack. Shows the telephone number of the calling party along with the time of day the call was received, on a 16x1 character LCD display. Stores the info from the last five calls in memory. Complete stand alone, no computer interface needed.

### Telephone Call Restrictor

Connects to telephone wall jack. Disables all phones on the line if attempting to either: dial a number that has been stored in memory 'Block Mode' or, dial a number that has not been stored in memory 'Allow Mode'. Use touch-tone phone to enter telephone numbers into memory, and choose mode. Program from any phone on the line using your password.

### 50 MHz Frequency Counter

Reads frequency from 1Hz to 50MHz and displays it on a 16x1 character LCD display. Auto-range feature provides floating decimal point and automatically affixes the correct suffix (Hz, KHz, or MHz). Microcontroller based, very few additional components.

### Telephone Scrambler

Scrambles your voice before sending it over the telephone line, and descrambles it on the other end. Connects between your telephone and wall jack. No modifications are required to your telephone. Full duplex operation.

### Electronic Message Module

Use a set of four pushbutton switches to write and store your own personal message in a 8-pin non-volatile EEPROM, which can then be printed across a 16x1 LCD display. Message can be up to 240 characters long. EEPROM can be removed from socket and still retain message. Re-program over and over with new messages.

### Vocal Filter

An audio device which can be used with a home component stereo system, to filter out the main vocal sound track from standard stereo recordings (CD, tape, record or FM), leaving the background music to sing along with. Produce your own karaoke tapes.

### DTMF Decoder/Logger

Keep track of all numbers dialed from any telephone on your line. Connects to your telephone wall jack. Decodes all 16 touch-tones and displays them on a LCD display. Holds the last 240 digits in a nonvolatile memory. Use the 'shift back' and 'shift forward' buttons to scroll through and view all numbers in memory.

# ALFA ELECTRONICS

HIGH QUALITY TEST EQUIPMENT  
BEST PRICE

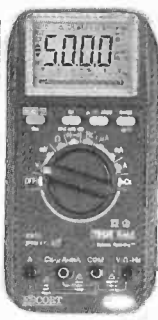

**DMM 89 \$199.95**  
**Most Advanced DMM**  
*All Purpose & Communication*  
-80.7 to 81.4 dBm with 4Ω-1200Ω  
20 reference impedances  
True RMS  
Frequency counter: 0.01Hz-10MHz  
Capacitance: 1pF-50,000μF  
Measure AC volt to 20kHz  
5000 counts, 0.1% accuracy  
Auto/manual range, fast bar graph  
Min/Max/Ave/DH/Relative/Zoom  
Auto power off  
Input warning  
Splash proof  
Volt, amp, ohm, logic, diode, continuity  
Ruggedized case  
Rubber holster included



**DMM 2360 \$119.95**  
**DMM+LCR Meter**  
*Very Versatile DMM*  
Inductance: 1μH-40H  
Capacitance: 1pF-40μF  
Frequency: 1Hz - 4MHz  
Temperature: -40-302 °F  
TTL Logic Test: 20MHz  
Diode, Continuity  
Volt, Amp, Ohm  
3999 count display  
Peak Hold  
Auto power off  
Ruggedized case.  
Temperature probe included  
Rubber Holster \$8.00



**DMM 20 \$74.95**  
Inductance: 1μH-40H  
Capacitance: 1pF-200μF  
Frequency: 1Hz-20MHz  
Volt, amp, ohm, diode,  
20 Amp AC/DC current  
Transistor HFE  
Continuity, duty %  
Peak hold/Max  
Ruggedized case  
Rubber holster \$8.00  
  
Full line of DMMs,  
economy, compact,  
ruggedized, solar cell,  
automotive, heavy  
duty, industrial,  
starts from \$15.95

**Fluke Multimeter**  
Fluke 12 \$84.95  
Holster C-10 \$10  
Fluke 70 II \$67.5  
Fluke 73 II \$94  
Fluke 75 II \$129  
Holster C-70 \$16  
Fluke 77 II \$149  
Fluke 79 II \$169  
Fluke 29 II \$169  
  
Fluke 83 \$225  
Fluke 85 \$259  
Fluke 87 \$287  
  
Fluke 97  
Scope Meter \$1785



**LCR Meter 131D \$229.95**  
**Most Advanced LCR**  
Dual display L/Q or C/D  
Inductance: 0.1μH-1000H  
Capacitance: 0.1pF-10,000μF  
Impedance: 1mΩ-10MΩ  
0.7% basic accuracy  
Auto/manual range  
Dissipation factor & Q factor  
Serial & parallel mode  
Relative mode for comparison  
and to remove parasitics  
Statistics, tolerance,  
Best for design, incoming  
testing & production  
SMD and chip component  
test probe \$25.00



**LCR Meter 814 \$189.95**  
**Best Resolution LCR**  
Inductance: 0.1μH-200H  
Capacitance: 0.1pF-20,000μF  
Resistance: 1mΩ-20MΩ  
1% basic accuracy  
Dissipation factor indicates leakage  
in capacitor and Q factor in inductor  
Zero adjustment to reduce parasitics  
Best for high frequency RF  
SMD and chip component test probe  
\$25.00  
**LIMITED QUANTITY SPECIAL**  
**DIGITAL LCR METER \$74.95**  
0.1pF, 1μH, 10mΩ resolution

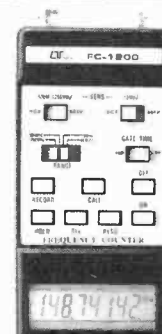

**Frequency Counter FC-1200 \$129.95**  
Frequency: 0.1Hz-1.25GHz  
Display: 8 digit LCD  
Period: 0.1μs-0.1s  
Records Max/Min/Average  
Data hold, relative mode  
Telescoping antenna \$8.00  
Deluxe case \$5.00  
  
Also Available:  
AC/DC clamp meter, Light meter,  
Thermometer, pH meter, High  
voltage probe, Digital caliper,  
Anemometer, Electronic scale,  
Force gauge, Tachometer,  
Stroboscope, Humidity & EMF  
adapter, Sound level meter,  
Frequency counter, SWR/field  
strength/power meter, Dip meter

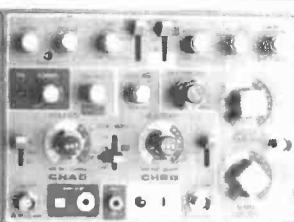

**20 MHz Oscilloscope with Delay Sweep PS-205 \$429.95**  
Dual Trace, Component test, 6" CRT, X-Y Operation, TV Sync, Z-Modulation, CH2 Output, Graticule Illum, 2 probes each has x1, x10 switch. Best price with delay sweep.  
PS-200 20 MHz DUAL TRACE \$339.95  
PS-400 40 MHz DUAL TRACE \$494.95  
PS-405 40 MHz DELAY SWEEP \$569.95  
PS-605 60 MHz DELAY SWEEP \$769.95  
**Scope Probe: 60MHz x1, x10 \$15, 100MHz x1, x10 \$22 250MHz x1, x10 \$29, 250MHz x100 \$39**

**Digital Storage Scope**  
DS-203 20MHz, 10M Sample/sec \$729.95  
DS-303 30MHz, 20M Sample/sec \$849.95  
DS-303P with RS-232 interface \$1,049.95  
Switchable between digital and analog modes  
2 K word per channel storage  
8 bit vertical resolution (25 Level/div)  
Expanded Timebase 10ms/div - 0.5 s/div  
Refresh, Roll, Save all, Save CH2, Pre-Trig  
Plotter control

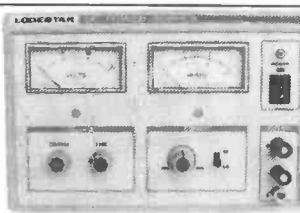

**DC Power Supply PS-303 \$159.00**  
**0-30 VDC, 0-3A output**  
Constant voltage & constant current mode  
0.02% + 2mV line regulation  
0.02% + 3mV load regulation  
1 mVrms noise and ripple  
Short circuit and overload protected  
PS-8200 with digital voltmeter \$179.00  
Also available: 30V/5A, 60V/3A, 60V/5A 16V/10A, 30V/10A

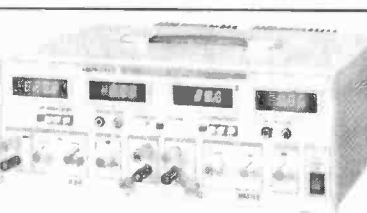

**DC Power Supply Triple Output PS-8200 \$499.95**  
Two 0-30 VDC, 0-3A outputs  
One fixed 5VDC, 3A output  
Capable of independent or tracking operation  
Constant voltage and constant current mode  
Four digital meters for volt and current display  
Excellent regulation and low ripple  
Short circuit and overload protected  
Also available: 30V/5A triple output \$549.95  
Dual tracking 30V/3A, 30V/5A, 60V/3A, 60V/5A

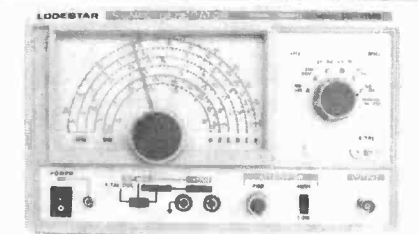

**RF SIGNAL GENERATOR SG-4160B \$119.00**  
100 kHz-150MHz sinewave in 6 ranges  
RF Output 100mVrms to 35 MHz  
Internal 1kHz, External 50Hz-20kHz  
AM modulation  
Audio output 1 kHz, 1 Vrms

**AUDIO GENERATOR AG-2601A \$119.00**  
10Hz - 1MHz in 5 ranges  
Output 0-8Vrms sinewave  
0-10Vp-p squarewave  
Synchronization: ±3% of oscillation frequency per Vrms  
Output distortion:  
0.05% 500Hz - 50kHz  
0.5% 50Hz - 500kHz  
Output impedance: 600 ohm

**FUNCTION GENERATOR FG-2100A \$169.95**  
0.2 Hz - 2 MHz in 7 ranges  
Sine, square, triangle, pulse and ramp  
Output 5mV-20Vp-p  
1% distortion, DC offset ± 10V  
VCF: 0-10V control frequency to 1000:1

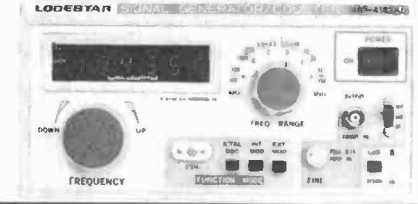

**RF SIGNAL GEN./COUNTER SG-4162 AD \$229.95**  
Generates RF signal same as SG-4160B  
6 digit frequency counter 1Hz - 150 MHz for internal and external source Sensitivity <50mV

**AUDIO GEN./COUNTER AG-2603AD \$229.95**  
Generates audio signal same as AG-2601A  
6 digit frequency counter 1Hz-150MHz for internal and external sources Sensitivity <50mV

**FUNCTION GEN./COUNTER FG-2102AD \$229.95**  
Generates signal same as FG-2100A  
Frequency counter 4 digits  
Feature TTL and CMOS output  
  
**SWEEP FUNCTION GEN./COUNTER \$329.95**  
0.5Hz to 5 MHz in 7 ranges  
Sweep: Linear 10:1/Log 10:1 20ms to 2s  
AM Modulation  
Gated Burst, Voltage Control Generator  
Generator Control Voltage & 6 digit counter  
1Hz-10MHz for internal & external sources

**ALFA ELECTRONICS**  
741 Alexander Rd., Princeton, NJ 08540

(800) 526-2532/(609) 520-2002 15 DAY MONEY BACK GUARANTEE. 1 YEAR WARRANTY  
FAX:(609) 520-2007  
CALL OR WRITE FOR FREE CATALOG AND BEST OFFER.  
Visa, Master Card, American Express COD, Purchase Order Welcome

CIRCLE 26 ON FREE INFORMATION CARD

May 1995, Popular Electronics 96

# 500 MHz SPECTRUM ANALYZER \$895

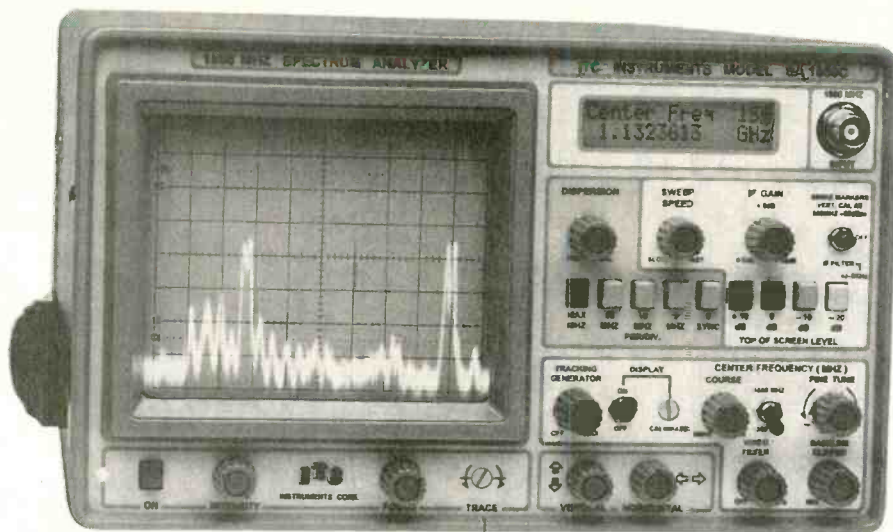

6" x 12" x 16" (H x W x D)  
(only 16 L.B)

SA1800C SHOWN  
\$2295.00

## 1-1300 MHz *In One Sweep* \$1895 MADE IN THE USA

**ALL NEW SPECTRUM DISPLAY MONITOR PLUS FULL FUNCTION SPECTRUM ANALYZER**

**LET THE SA500A SPOT THOSE HIDDEN SIGNALS**  
The SA500A easily attaches to any receiver IF output jack. Providing a panoramic signal display of your 1-30 MHz and 30 to 2000 MHz scanner or communication receiver. The SA500A is a Professional Spectrum Surveillance Technology Monitor. A Full Function Spectrum Analyzer with +/- 5KHz Narrow Band Filter, Center Freq. Display, 50 MHz Marker Generator. Capable of Tuning Duplexes, Amps, Filters Receivers, Transmitters & Perform EMI, RFI, FCC, Testing. SA500A First affordable Professional Spectrum Monitor/Analyzer for all serious Ham Radio and Radio Monitoring Operators. just **\$895.00**

**.2-1.3GHz SA1300B THE ULTIMATE LOW COST ANALYZER**  
Quality & Performance that's what ITC Spectrum Analyzers are known for. 80 dB on Screen, -110 dBm Sensitivity, Center Frequency Display, +/- 5KHz Narrow Band Filter (for 5KHz resolution band width) 50 MHz Marker. DISPERSION ZOOM, Baseline Clipper, Sweep Speed, Adjustable Video Filter, 40dB of Input Attenuation. Standard on all **ADVANTAGE** Spectrum Analyzer specials. The SA1300B and SA1800C provide Laboratory Performance at a fraction of the normal cost. The SA1300B **\$1895.00** -SA1800C .2-1.3GHz & .8-1.8GHz **\$2295.00**. Add a 1.3GHz Tracking Generator to any unit

## 1.3GHz FREQUENCY COUNTER .001 ppm

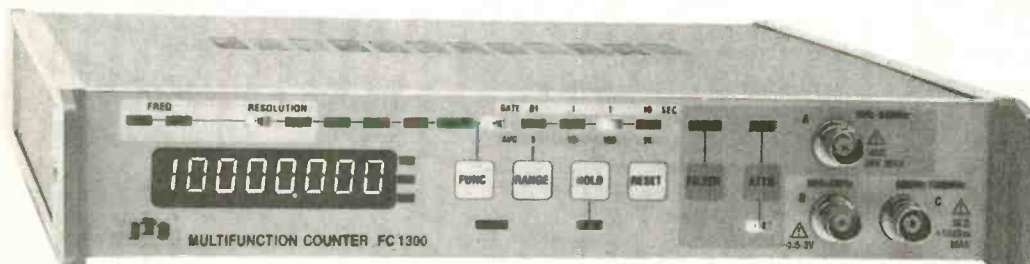

**\$479.00**

ISO9002 CERTIFIED  
**FIVE YEAR  
WARRANTEE**  
REG. PRICE \$599.00  
SAVE \$120.00

## Laboratory Performance PROCESSOR STABILIZED OVEN OSCILLATOR .001 ppm

**ITC FC1300: the first truly Accurate low cost Frequency Counter.** Accuracy is the #1 Frequency Counter Requirement. The \$200 - \$800 counters being advertised the past few years are but toys when it comes to accuracy. These guess-so-matic units are off 5 to 10 PPM over temperature & time (That's +/- 6,000 -13,000 Hz at 1.3 GHz) The **FC1300** is accurate to within **+/-13 Hz at 1.3 GHz 0-40 degrees C.** Sensitivity is < 5mV 1Hz to 13 GHz, 50 Ohm & 1 Meg Ohm inputs, LP filter, 1x -10x input Att. Frequency Measurement, Period Averaging, Time Interval, External Counter, Freq. Ratio, Hold & Reset Functions, 4 Gate times .01 to 10 Sec. Tired of guess-so-matic Counters: **Serious About Accuracy:** Ready to step up to **Laboratory Performance Accuracy:** Call Today & **Order**

Call 800-566-1818  
To Order or Info.  
Free 1995 Catalog  
**ADVANTAGE**  
Carries a full line of  
Scopes - Analyzers  
Frequency Counters  
Generators  
LCR Bridges & DMM'S

**ADVANTAGE INSTRUMENTS CORP. MASTER CARD -VISA - DISCOVER - AMX**

3817 S. CARSON ST. # 818 CARSON CITY NV. 89701 Terms: **COD - Check - Money Order**  
702-885-0234 FAX 702-885-7600 Call Toll Free 800-566-1818 - BBS 310-549-0321

PRICES & SPECIFICATIONS SUBJECT TO CHANGE WITHOUT NOTICE OR OBLIGATION. F.O.B. CARSON CITY NV. NV. RESIDENTS ADD SALES TAX.

CIRCLE 153 ON FREE INFORMATION CARD

May 1995, Popular Electronics

# ALL ELECTRONICS CORP.

QUALITY PARTS • DISCOUNT PRICES • FAST SERVICE • HUGE SELECTION

## JUMBO LEDs

Liton # LTL 327C - 8MM  
Ideal for eye-catching indicators and displays. A recent quantity purchase of these BIG, 8mm diameter, red diffused LEDs enables us to provide some very special pricing. The leads on these devices are 0.325" long with plenty of room for soldering.



**5 for \$1<sup>00</sup>** CAT# LED-23  
100 for \$ 15.00  
1000 for \$ 120.00

## GREAT DEAL! SURFACE MOUNT SPEAKERS

These surface mount speakers were designed for use with car stereo, but they will work as well, or better as intercom or communications

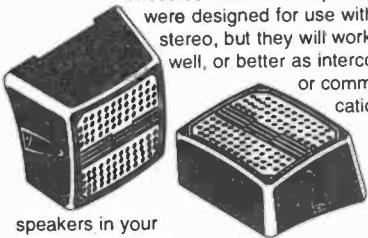

speakers in your home or workshop. 4", 4 ohm, speakers mounted in an unbreakable black plastic, slant-faced enclosure. They are rated 5 watts. Enclosure measures 4.82" X 4.5" X 2.45". Each pair is boxed and includes two short pieces of hook-up wire.

**\$3<sup>75</sup>** per pair

CAT# SK-411

## "HI-8" VIDEO CASSETTE (USED)

8 mm Video Camcorder Users!

SONY HI-8  
Top quality, metal particle 120 minute video cassettes. Used for a short time, then bulk-erased. Each cassette has its own plastic storage box. Satisfaction Guaranteed.

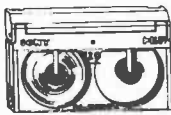

**\$3<sup>00</sup>** each

CAT # VCU-8

10 for \$28.00 • 100 for \$250.00

## MINIATURE SWITCHES



### D.P.D.T. (ON-ON)

ALCOSWITCH # MTM206NPC  
Short bat handle,.025" long.  
PC terminals

CAT # MTS-82PC **\$1<sup>25</sup>** each

25 for \$25.00 • 100 for \$90.00

**SPECIAL  
REDUCED PRICE!**

## MINIATURE D.P.D.T. PUSH/ON PUSH/OFF

Auga/Alcoswitch # MPE206N  
Miniature DPDT, push/on push/off switch. Splashproof: O-ring on shoulder and inside movable shaft provides moisture seal. Rated 6 amps @ 125 Vac. RED 0.4" diameter cap. 0.25" diameter threaded bushing. 0.8" behind panel depth. Solder lug terminals. UL and CSA listed.



**\$1<sup>75</sup>** each

CAT# MPB-20

25 for \$37.50

## 7 Vdc MOTOR

Matsushita  
# MMX- 7AÇ O 8A  
1.25" diameter x 1.25" high motor. Prepped with 1.61" diameter flywheel, pulley and fiberglass mounting board.



CAT# DCM-54

**\$1<sup>00</sup>** each

10 for \$9.00  
100 for \$80.00

## 2 1/2" 8 ohm SPEAKER



Special purchase of these 8 ohm, 1 watt speakers allows us to sell quantities at very special low prices. Mounting frame is 2.6" square. Overall depth, 0.75."

CAT# SK-251

**\$1<sup>25</sup>**

10 for \$10.00  
100 for \$75.00  
1000 for \$ 600.00

## 9 VOLT 60 MA SOLAR PANEL



These 6" X 6" glass enclosed photovoltaic panels produce 9 Vdc at 60 ma. Ideal for charging batteries and powering small devices. Put two or more together for more current and voltage. Includes hook-up instructions.

CAT # SPL-960 **\$5<sup>25</sup>** each

## 7.2 VOLT, 1000 mA NICKEL-CAD BATTERY PACK

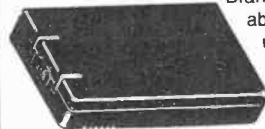

Brand new rechargeable nickel-cadmium battery pack fits Olympus and other camcorders.

Originally sold for over \$35.00.  
3.56" X 2.12" X 0.75"

**\$5<sup>50</sup>** each

CAT# NCB-72

## A.C. LINE CORDS

### 6 INCH IEC POWER CORD



Standard 3 prong grounded male one end and 3 prong IEC receptacle on other end. CSA listed. Large quantity available.

**\$1<sup>00</sup>** each

CAT # LCAC-36

10 for \$7.50

### ROUND 4' BLACK 16/3 CORD



0.32" od, SJT insulation. Standard 3 prong grounded plug one end, moulded strain relief on other end. Pigtail leads. CSA listed. Large quantity available

CAT # LCAC-35

100 for \$150.00

**\$1<sup>75</sup>** each

MANUFACTURERS - We Purchase EXCESS INVENTORIES... Call, Write or Fax YOUR LIST.

CALL, WRITE  
or FAX For A  
Free 64 Page  
CATALOG.

Outside the U.S.A.  
send \$2.00 postage.

ORDER TOLL FREE

**1-800-826-5432**

MAIL ORDERS TO:  
ALL ELECTRONICS CORP.  
P.O. BOX 567  
VAN NUYS, CA 91408-0567

FAX (818) 781-2653  
INFO (818) 904-0524

Minimum Order \$10.00 • All Orders Can Be Charged to Visa, Mastercard or Discover • Checks and Money Orders Accepted by Mail • Orders Delivered in the State of California must include California State Sales Tax • NO C.O.D. • Shipping and Handling \$4.00 for the 48 Continental United States • ALL OTHERS including Alaska, Hawaii, P.R. and Canada Must Pay Full Shipping • Quantities Limited • Prices Subject to change without notice.

VISA

MasterCard

DISCOVER

CIRCLE 28 ON FREE INFORMATION CARD

# CircuitMaker® vs. Electronics Workbench®

## A NEW STANDARD HAS JUST BEEN SET!

### State-Of-The-Art Analog Simulation

**CircuitMaker's** analog simulation results are shown in graph windows that provide powerful, interactive analysis options. You can plot multiple waveforms by clicking on the desired nodes and can select linear or logarithmic axes. Horizontal and vertical cursors facilitate quick and accurate measurements. You can also zoom in on any portion of the graph to obtain additional detail.

**Electronics Workbench** offers a single, small scope or Bode plot instrument window. The windows are not sizeable and only two waveforms can be plotted at a time. EWB has a single measurement cursor and provides no direct way to read results from the instruments.

### Superior Digital Simulation

**CircuitMaker** has an exclusive Trace feature where the state of every node is indicated in color as the simulation runs. You can monitor as many waveforms as your screen will allow, set edge or level breakpoints for analysis, and interactively see the state of any node by touching the logic probe to it. The data sequencer provides 1024 words of pattern data. Additional digital instruments include ASCII and HEX input keys and an ASCII display. CircuitMaker includes tri-state devices and devices have programmable propagation delays.

**Electronic Workbench** has no interactive logic probe or Trace capability and no Hex or ASCII keys. Their "word generator" is limited to 16 words. EWB does not have tri-state devices and digital devices do not have programmable propagation delays.

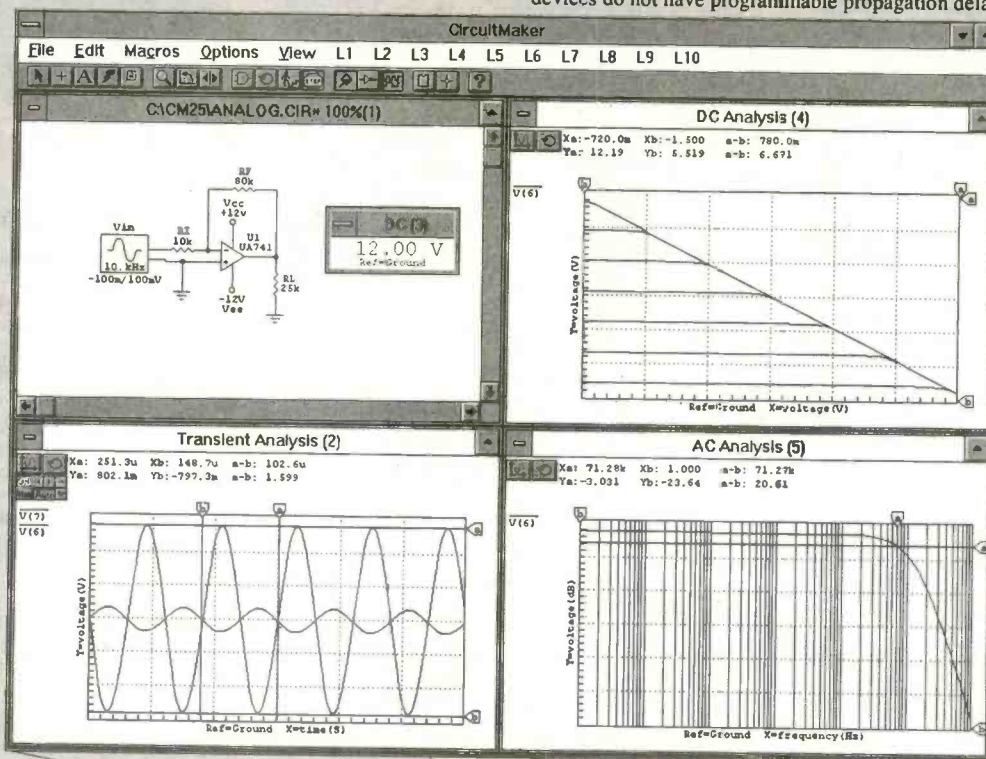

### Comprehensive Device Libraries

**CircuitMaker** includes libraries containing programmable, TTL, CMOS, generic analog and digital devices, and many powerful I/O devices. With CircuitMaker's macro function you can quickly and easily create your own functional devices and symbols. Now that's giving you the tools you need to get the job done right!

**Electronics Workbench** ships with only 17 digital devices. If you want additional devices you pay extra.



### Competitive Upgrade Offer

You deserve the best. Upgrade from any competing product for only \$149 (Call for details). For new users CircuitMaker is a tremendous value at just \$299.

### Technical Support

**MicroCode Engineering** offers free phone support from knowledgeable engineers. And, you won't find yourself listening to music when you call for help.

**Interactive Image Technologies** offers 3 free calls and then you have to pay for all subsequent calls.

Comparison based on CircuitMaker 2.5 for Windows and Electronics Workbench 3.0 for Windows. All products and company names are trademarks of their respective owners.

**CALL 800-419-4242 MicroCode Engineering**  
Product satisfaction is guaranteed.

1943 N. 205 W. Orem, UT 84057  
Fax (801) 226-6532  
Phone (801) 226-4470



CIRCLE 42 ON FREE INFORMATION CARD

**CALL TOLL FREE**  
1-800-292-7711  
1-800-445-3201 (Can)

# C&S SALES

## EXCELLENCE IN SERVICE

**WRITE FOR  
FREE CATALOG**



**Line Tracker**  
MV-963  
**\$52.95**  
(Infra-red Sensor)  
The robot follows  
a black line  
on white paper  
Preassembled PCB



**Dual-Display  
LCR Meter**  
w/ Stat Functions  
B+K Model 878  
**\$239.95**  
Auto/manual range  
Many features  
with Q factor  
High Accuracy

**Electronic Tool Kit Model TK-1000**  
A professional organizer tool kit at affordable prices. No student should be without this unique tool kit that holds all the tools you need.  
Including:  
Diagonal Cutter  
Long Nose Pliers  
6" Wire Stripper  
Solder 60/40  
6" Screwdriver  
6" Phillips Driver  
Safety Goggles  
IC Puller  
3pc Nut Drivers  
Iron 25W  
Iron Stand  
Solder Wick  
Desoldering Pump  
5 pc Solder Ease Kit  
6pc Precision Screwdrivers  
**\$39.95**



**Robotic Arm**  
Y-01  
**\$49.95**  
(Wired Control)  
Movement grabs  
& releases,  
lifts & lowers,  
pivots from side to side



**Stereo Cassette Player  
Kit**  
Model  
TR-18K  
**\$16.95**  
Headphones  
Included



**Digital  
Multimeter**  
EDM-83B  
**\$175.00**  
Almost every  
feature available  
Bargain of  
the decade



**Elenco  
LCR + DMM**  
LCM-1950  
**\$79**  
12 Functions  
Freq to 4MHz  
Inductance  
Capacitance



**Digital  
Capacitance  
Meter**  
CM-1555  
**\$49.95**  
Measures capacitors  
from .1pf to 20,000µf



**Digital  
LCR Meter**  
LCR-680  
**\$79.95**  
3-1/2 Digit  
LCD Display  
Inductance  
1uH to 20MΩ

**Function Generator**  
GF-8026  
**\$239**  
Int/Ext  
Operation  
Sine, Square, Triangle, Pulse  
Ramp, .2 to 2MHz, Freq Ctr



**3-3/4 Digit Multimeter**  
BK-390  
**\$139.00**  
0.1% DCV acy  
Analog bar graph  
Auto/manual ranging  
Capacitance meas  
Temperature probe



**Digital  
Multimeter Kit**  
w/ Training Course  
M-2665K  
**\$49.95**  
Full function 34 ranges  
Ideal school project  
M-2661 (Assembled) **\$55.00**



**Frequency Counter**  
F-1225  
**\$225.00**  
8 Digit LED display  
Wide meas range  
High sensitivity  
Data hold function  
Input impedance 1MΩ or 50Ω  
10:1 input attenuation function

**Fluke Multimeters**  
(All Models Available Call)

Scopemeters	70 Series
Model 97 \$1,795	Model 70II \$69.95
10 Series	Model 73II \$97.50
Model 10 \$62.95	Model 77II \$149
Model 12 \$84.95	Model 79II \$175
20 Series	80 Series
Model 29II \$175	Model 87 \$289



**Triple Power  
Supply**  
XP-620  
By Elenco  
**\$75.00**

3 fully regulated supplies; 1.5-15V @ 1A, -1.5 to -15V @ 1A or 3-30V @ 1A & 5V @ 3A Kit XP-620K **\$49.95**



**Quad Power  
Supply**  
XP-581  
By Elenco  
**\$79.95**

Four supplies in one unit; 2-20V @ 2.5A, 5V @ 3A, -5V @ .5A and 12V @ 1A. All regulated and short protected



**High Current DC  
Power Supply**  
BK-1686 **\$169.95**  
3 to 14 VDC Output  
12A @ 13.8V  
For servicing high  
power car stereos,  
camcorders, ham radios, etc.  
Connect 2 or more in parallel



**Wide Band  
Signal  
Generators**  
SG-9000  
**\$124.95**  
RF Frequency 100K-450MHz  
AM modulation of 1KHz Variable  
SG-9500 150MHz **\$239.00**

**Telephone Kit**  
PT-223K  
**\$14.95**



Available  
Assembled  
PT-223  
**\$15.95**

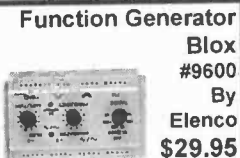

**Function Generator  
Blox**  
#9600  
By  
Elenco  
**\$29.95**  
Kit **\$28.95**  
Sine, Triangle, Square Wave

**Learn to Build & Program  
Computers with this Kit**



MM-8000  
By Elenco  
**\$129.00**

From scratch you build a complete system. Our Micro-Master trainer teaches you to write into RAMs, ROMs and run a 8085 microprocessor, which uses similar machine language as IBM PC.

**Digital/Analog Trainer**  
Complete Mini-Lab For Building,  
Testing, Prototyping Analog and Digital



By Elenco  
in U.S.A.  
XK-525  
**\$159.95**  
Kit  
XK-525K  
**\$129.95**

Designed for school projects, with 5 built-in power supplies. Includes a function generator with continuously variable, sine, triangular, square wave forms. All power supplies are regulated and protected against shorts.

**AM/FM Transistor  
Radio Kit**  
with Training Course  
Model AM/FM 108  
**\$29.95**

14 Transistor, 5 Diodes  
Easy to build because  
schematic is printed on the PCB  
Makes a great school project  
Model AM-550 AM Only **\$17.95**

**Telephone Line  
Analyzer**



Kit TT-400K **\$19.95**  
Assembled TT-400 **\$26.95**

**WE WILL NOT BE UNDERSOLD**  
UPS SHIPPING: 48 STATES 5%  
IL RES 7.5% TAX (\$3 min \$10 max)  
OTHERS CALL

**C&S SALES INC.**  
1245 ROSEWOOD, DEERFIELD, IL 60015  
FAX: 708-520-0085 (708) 541-0710



**15 DAY MONEY BACK  
GUARANTEE**  
**FULL FACTORY WARRANTY**  
PRICES SUBJECT TO CHANGE WITHOUT NOTICE

**FREE PROBES  
WITH ALL  
SCOPES**

**ELENCO ♦ HITACHI ♦ B+K  
SCOPES  
AT GUARANTEED LOWEST PRICES**

**WRITE FOR  
FREE  
CATALOG**

**QUALITY - ELENCO OSCILLOSCOPES**

**2-YEAR WARRANTY**

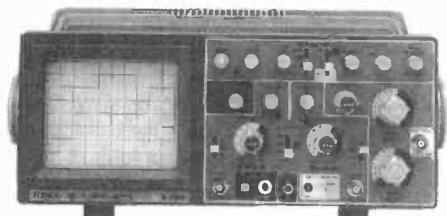

**60MHz**

**S-1360 \$775**

Delayed Sweep

**S-1365 \$849**

Cursor Readout

- ♦ Voltage, Time
- ♦ Frequency differences displayed on CRT

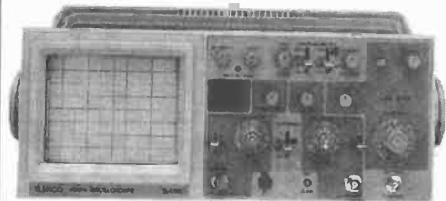

**40MHz**

**S-1340 \$495**

2- Channel

**S-1345 \$575**

Delayed Sweep

- ♦ Beam Find
- ♦ Component Tester



**25MHz**

**S-1325 \$349**

2- Channel

**S-1330 \$449**

Delayed Sweep

- ♦ Beam Find
- ♦ Component Tester

*Dependable Equipment at Affordable Prices*

**B+K 20MHz**

2 Channel

**Model 2120 \$389.00**



Delayed Sweep

**Model 2125 \$539.95**

**40MHz DUAL -TRACE**

**Model 1541B**

**\$749.95**

- 1mV/div sensitivity
- Video sync separators
- Z axis input
- Single sweep
- V mode-displays 2 signals unrelated in frequency

**60MHz DUAL-TRACE**

**Model 2160**

**\$949.95**

- 1mV/div sensitivity
- Sweep to 5ns/div
- Dual time base
- Signal delay line
- Component tester
- V mode-displays 2 signals unrelated in frequency

**100MHz THREE-TRACE**

**Model 2190**

**\$1,379.95**

- 1mV/div sensitivity
- Sweeps to 2ns/div
- Dual time base
- Signal delay line
- 19kV accelerating voltage
- Calibrated delay time multiplier

**20MHz ANALOG with  
DIGITAL STORAGE**

**Model 2522A**

**\$869.95**

- 20MHz analog bandwidth
- 20MS/s sampling rate
- 2k memory per channel
- 20MHz equivalent time sampling

**HITACHI POPULAR SERIES**

V-212 - 20MHz, 2 Channel	\$425.00
V-222 - 20MHz, DC Offset	\$695.00
V-422 - 40MHz, Dual Trace	\$849.00
V-522 - 50MHz, Dual Trace	\$975.00
V-523 - 50MHz, Delayed Sweep	\$995.00
V-525 - 50MHz, w/ Cursor	\$1,069.00

**HITACHI COMPACT SERIES SCOPES**

V-660 - 60MHz, Dual Trace	\$1,375.00
V-665A - 60MHz, DT, w/cursor	\$1,449.00
V-1060 - 100MHz, Dual Trace	\$1,549.00
V-1065A - 100MHz, DT, w/cursor	\$1,695.00
V-1085 - 100MHz, QT, w/cursor	\$2,125.00
VC-6045A - 100MHz, Digital Stor	CALL
VC-6025A - 50MHz, Digital Stor	CALL

**Elenco DS-203 20MHz, 10MS/s  
Digital Storage Oscilloscope**

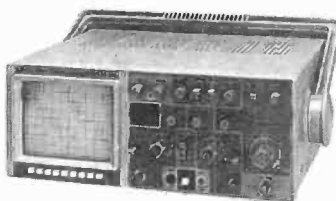

**\$749**

2K Word Per Channel • Plotter Output  
8 Bit Vert. Resolution • 2048 Pts Hor.  
Resolution • Much More.....

**FLUKE SCOPEMETERS**

A handheld instrument that combines a 50MHz, 25MS/s dual channel digital storage oscilloscope with feature-packed 3000 count digital multimeter.



**Model 93 - \$1,225**

**Model 95 - \$1,549**

**Model 97 - \$1,795**

- Autoset, automatically sets voltage, time & trigger
- Multimeter display; 3-2/3 digits (>3000 counts)
- True RMS volts; AC or AC+DC up to 600V

**C&S SALES INC.**

1245 ROSEWOOD, DEERFIELD, IL 60015  
FAX: 708-520-0085 (708) 541-0710

**CALL TOLL FREE**

**1-800-292-7711**

**1-800-445-3201 (Can)**



**15 DAY MONEY BACK GUARANTEE  
FULL FACTORY WARRANTY  
ALL PRODUCTS ARE FACTORY NEW**

PRICES SUBJECT TO CHANGE WITHOUT NOTICE

CIRCLE 132 ON FREE INFORMATION CARD

# RAINBOW KITS

## Laser Pens 4 mW

Beam visible up to 500'.

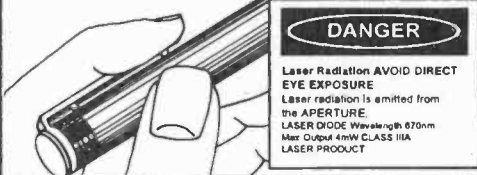

**DANGER**

Laser Radiation AVOID DIRECT EYE EXPOSURE  
Laser radiation is emitted from the APERTURE  
LASER DIODE Wavelength 670nm  
Max Output 4mW CLASS IIIA  
LASER PRODUCT

INCLUDES  
2 AAA Batteries  
Pen Size: 5 1/2" x 1/2"

**SUPER  
NEW LOW PRICE**

**\$59.95**

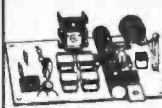

## STROBE LIGHT

Do you need an attention getter, warning light, or flashing light for model

airplanes? Then this kit is for you. Use it as an emergency light for your auto, radio tower, even use it on your bicycle. Has a variable flash rate. Size 3.5"x1.8" operates on 6 or 12v DC only.

ST-1

**\$9.95**

## The Exciting New TELEPHONE MONITOR



*Monitors your phone system, See how accurate your phone company really is!*

- RECORDS OUTGOING CALLS :**
  - Date & time of each call.
  - Length of the call.
  - What number was dialed.
  - If you use a credit card it records the card number.
- RECORDS INCOMING CALLS :**
  - Date & time of call.
  - How many times phone rings.
  - If answered the length of call.
- RECORDS ANY DTMF TONE :**
  - Detects any tone on line sent by phone company or any other source.

*Records to Screen or Floppy Disk*

**EASY TO INSTALL**

- Connects to parallel port
- Phone line in.
- Phone line out to telephone.

**All software included!**

TM-1 ONLY **\$99.95** KIT

**BUILT \$169.95**

## WIDE BAND PREAMP

The ideal preamp for scanners, hand held radios, frequency counters. Amplifies low level

(weak) signals. If the signal is extremely low 2 amps can be used in series. 1MHz to 2.5MHz @ 2.8dB of 10B compression = +0 dBm gain: 1MHz-20dB to 2.5Hz-6dB Requires 12vDC @ 16Ma

WBA-6

**\$19.95**



## MICRO-MINIATURE PHONE TRANSMITTER

We haven't seen a smaller phone transmitter than the MMPT2 kit. Powered by the phone, it requires no battery. Transmits both sides of a phone conversation to an FM radio up to a 1/4 mile away. Tunable from 88 to 108MHz FM. Attach it to one phone or add it to the line to pick up all incoming calls. The MMPT2 is undetectable if properly installed. Unit has surface mounted parts, you install the leaded parts. Size .45"x.6"

MMPT2

**\$29.95**

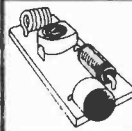

## MICRO-MINIATURE WIRELESS MIKE

So small you could hide this one on some real bugs! It's the smallest we've ever seen. With it's super sensitive mike it transmits a whisper or a room of conversation to an FM radio, tunable from 88 to 108MHz FM. With a proper antenna & 9v it transmits about 1 mile. The kit is made with surface mounted parts, we have already mounted these parts. You install the leaded parts. Can operate on 6 to 12v DC. Size .35"x.9"

MMW5

**\$34.95**



## WIRELESS FM MICROPHONE

Small but mighty this little jewel will out perform most units many times its price. It really

slumps out a signal. The WM-1 kit is a buffered wireless mike that operates from 80MHz to 120MHz FM, the frequency of any broadcast FM radio. Includes a mini-electret mike. SIZE: .8"x1" 6 to 12vDC

WM-2

**\$14.95**

## TV NOTCH FOR CHANNELS

2 thru 22 SNOOP & BULLET

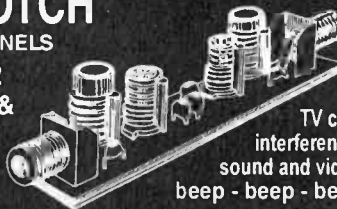

## FILTERS

Our TV filters eliminate unwanted TV channels or interference that alters both sound and video with a beep - beep - beep.

NOTE: All TV Filter Kits are sold for educational purposes only. You must obtain permission from your local cable company before using these filters on your cable system.

DF-222 Kit

**\$14.95**

## FM STEREO TRANSMITTER

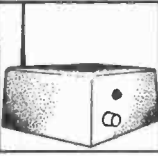

Own your own FM radio station. Any stereo signal you plug into the FMST-100 will be transmitted to any FM radio tuneable from 76 to 108MHz FM. Transmit a wireless link through an auditorium, from your car to your camper, listen to your cd's while mowing the lawn, Play music on one channel sing on the other. Clarity is excellent, approx. 40dB stereo separation. Length of antenna determines the distance of transmission. Complete with stereo input level controls, & crystal for stereo separation. 9v battery operation.

FMST-100 \$29.95 / FMSTC cabinet \$8.95

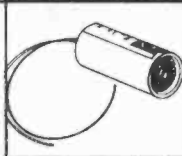

## 5.0 mW Laser Diode

Great for making a gun sight, use as a transit, makes a super experimenters project. The beam is

visible with a wavelength of 670 nm. Size of beam is 6mm at 5 meters. Operates on 3 volts DC at 85mA. Size: 10.5mm x 18.5mm with an adjustable collimating lens.

LDM-5

**NEW LOW PRICE  
\$59.95**

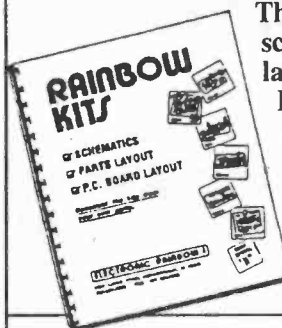

This Manual contains all schematics, parts lists, P.C.B., layouts for most of the Rainbow Kits. Use your own parts to construct any of our kits.

**KIT BOOK  
\$14.95**

**\$9.95** with the purchase of any kit.

Please add sufficient postage First lb \$5.00 Canada \$7.00 Additional LB. Add \$1.00 US FUNDS ONLY We will accept telephone orders for Visa or Mastercard



To Order Call  
**317-291-7262**



## PHONE TRANSMITTER



Small but mighty, it fits anywhere. Phone line powered, never needs batteries. Transmits both sides of a phone

conversation loud and clear, wireless, to any FM radio at great distances. Variable tunes from 70MHz to 130MHz FM. You can also use it as a speaker phone. SIZE .5"x1"

TEL-B1 **\$12.95**

**BUILT \$29.95**

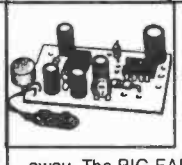

## SUPER SNOOPER BIG EAR

Listen through walls, hear conversations across the room. Add a parabolic reflector and hear blocks away. The BIG EAR can be hidden about anywhere. Makes an ultra sensitive intercom. Can be used as a 1.5W AMP. We supply a mini-electret mike in the kit. SIZE: 1"x.75" 6 to 12vDC

AA-1 **\$10.95**

**BUILT \$29.95**

## ELECTRONIC RAINBOW INC

6254 LaPas Trail • Indianapolis, IN 46268  
FAX 317-291-7269

CIRCLE 147 ON FREE INFORMATION CARD





**Get instant tech information FREE from your Fax or Computer!**

You can obtain specs, freq. info, software and more from our automated services. For fax facts, call from your stand alone fax machine and follow the voice prompts. Use the BBS from your modem of fax/modem equipped computer. Dial 317-849-8683 for fax back service, or dial 317-579-2045 for our computer bulletin board service.

## Total Coverage Radios

### TRIDENT

**TR1200XLT**  
AM Broadcast to  
Microwave 1000 Scan  
Channels \$389.00

500KHz to 1300MHz coverage in a programmable hand held. Ten scan banks, ten search banks. Lockout on search and scan. AM plus narrow and broadcast FM. Priority, hold, delay and selectable search increments. Cell Lock. Permanent memory. 4 AA ni-cads and wall plus cig charger included along with belt clip, case, ant. & earphone. Size: 6 7/8 x 1 3/4 x 2 1/2. Wt 12 oz. Fax fact document # 205



### TRIDENT

**TR 4500 \$449**  
2016 Channels  
1 to 1300MHz  
Computer Control

62 Scan Banks, 16 Search Banks, 35 Channels per second. Patented Computer control for logging and spectrum display. AM, NFM, WFM, & BFO for CW/SSB. Priority bank, delay/hold and selectable search. Cell Lock Permanent memory. DC or AC with adaptors. Mtng Brkt & Antenna included. Size: 2 1/4H x 5 5/8W x 6 1/2D. Wt. 11lb. Fax fact #305



### TRIDENT

**TR980 \$279.00**  
125 Channels  
5MHz to  
999MHz

Most Economical receiver in its class, offers AM, NFM Wide FM, modes. 5KHz increments. Delay & hold & Search. Cell Lock NiCads, chgr & whip ant. Size: 5 7/8H x 1 1/2W x 2 D. Wt 14oz.



## Continuous Coverage



Three new Bearcat units offer expanded coverage and more memory than before. The 890 offers 200 channels, base/mobile operation, VFO tuning, service search, weather alert, search and store, and more. The 2500 hand held has 400 channels, fast scan and more. The Bearcat 8500 has 500 channels in 20 banks, VFO, auto store, alpha numeric display, 10 priority channels, aux tape output jacks, and coverage to 1.3 Gigahertz.

**Bearcat 2500XLTA hand held.....\$349.95**  
**Bearcat 8500XLTC mobile.....\$389.95**  
**Bearcat 890XLTB mobile.....\$259.95**  
25-1300MHz, 500 ch. in 8500, 400 in 2500. 890 has 200 ch & 29-956MHz. All cell locked. Features include turbo scan, VFO, search and store, Priority, LCD display, and more. Fax Facts #74, 475, 476



## Mobile Scanners

### TRIDENT

**TR2C**  
Police & CB  
\$69.95

Scans police pre-programmed by state channel plus the CB channel of your choice. Also has Mobile Repeater and Weather. Extra cost option of CB and laser detectors built in. Compact size allows for dash or visor mounting. Mtng hardware and power connectors included. Size: 5 5/8 x 4 7/8 x 1 3/4. Wt: 1.5lbs. Fax fact #580



**Bearcat 700AX 50Ch w/800..... \$159.95**  
**Bearcat 350A 50 Ch H/L/U..... \$119.95**  
**Bearcat 560XLJ 16 Ch H/L/U..... \$ 89.95**  
**Bearcat 760XM100Ch H/L/U/Air/800 \$219.95**  
**Bearcat T2 state/state scan..... \$144.95**

## Shortwave Radios

**Sangean ATS-818CS..... \$219.95**  
**Sangean ATS-818..... \$184.95**  
**Sangean ATS-803A..... \$169.95**  
**Sangean ATS-808..... \$179.95**  
**Sangean ATS-606..... \$149.95**  
**Sangean ATS-606P..... \$169.95**  
**Sangean ATS-800..... \$89.95**  
**Grundig YB400..... \$219.00**  
**Grundig Satellit 700..... \$399.00**

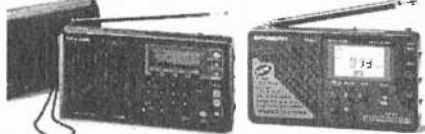

## Hand Held Scanners

### Bearcat 200XLTN

**\$209.95 200 Channels 800 MHz**  
Ten scan banks plus search. Covers 29-54, 118-174, 406-512 and 806-956MHz (with cell lock). Features scan, search, delay, 10 priorities, mem backup, lockout, WX search, keylock. Includes NiCad & Chgr. Size: 1 3/8 x 2 11/16 x 7 1/2.  
**Bearcat 120XL TJ 100Ch H/L/U..... \$149.95**  
**Bearcat 150XLT 100Ch H/L/U/8..... \$199.95**  
**Bearcat 220XL TJ 200 Ch H/L/U/8.... \$249.95**



Coverage of above hand helds is: 29-54, 136-174, 406-512, and 800MHz band as indicated. Fax facts #475

## Table Top Scanners

**Bearcat 855XLTE 50 Ch w/800..... \$159.95**  
**Bearcat 142XLM 10Ch H/L/U..... \$ 73.95**  
**Bearcat 147XLJ 16 Ch H/L/U..... \$ 89.95**  
**Bearcat 172XM 20Ch H/L/U/Air..... \$124.95**  
**Bearcat 145 16Ch H/L/U..... \$ 79.95**

## Accessories & Etc.

**Mag Mount Mobile Ant MA100..... \$ 19.95**  
**Base Ant. 25-1000MHz AS300..... \$ 59.95**  
**Pre-Amp .1-1500MHz GW2..... \$ 89.00**  
**Wide Coverage Antenna..... \$119.95**  
**Base Discone Ant DA300..... \$ 89.00**  
**External Speaker MS190/opt. amp... \$ 19.95**  
**Old Scanner Repair, all brands..... \$ CALL**  
**Extended Warranties..... \$ CALL**  
**Frequency Info FaxFact/Modem..... \$ FREE**  
**On Glass Mobile Antenna..... \$ 32.95**

## 2 Way Radios

VHF hi band programmable mobiles as low as \$299.95. Call for quotes or Fax Fact #775

**TRIDENT Winner of the 1994 INNOVATIONS Design & Engineering Honors, Electronic Industries Association. Trident TR2400 Total Coverage Receiver**

Trident TR2400: 100KHz to 2060MHz. Ten scan banks of 100 channels each, ten search banks. Tuning increments as low as 1KHz. Beat Freq. Oscillator for SSB and CW modes. Search lockout and store. VFO tuning knob. Permanent memory. Bank lock and linking. Attenuator switch. Backlit LCD. 1 Yr Warranty. AM/NFM/WFM. Selectable increments. Delay, Hold, Priority. 5 7/8H x 1 1/2D x 2W. Wt 14 oz. \$499.00



**Toll Free, 24 Hours! 800-445-7717 Fax Orders 800-448-1084 Fax Facts 317-849-8683**

Computer BBS Modem & Fax/Modem, 317-579-2045. Toll Free Tech Support, Dial 800-874-3468

International Fax: en Espanol, en Francais, und auf Deutsch, or just fax in plain English to: 317-849-8794

**ACE Communications 6975 Hillsdale Court, Indianapolis, IN 46250**

Service & Support hours: Mon.-Fri. 9AM to 6PM, Sat. 10-4 EST. Mastercard, Visa, Checks, Approved P.O.'s & COD (add \$5.50) & AMEX, Discover. Prices, specifications and availability subject to change. Flat rate ground shipping and handling charge only \$6.95 per unit. Express Air only \$9.95, for most units, to most locations. One week trial, no returns accepted two weeks after original receipt without substantial restocking charge. All units carry full factory warranty. Indiana residents add 5 per cent sales tax.



**FLY IT! ONLY \$9.95**

# CELLULAR SOFTWARE AND MODIFICATION GUIDES

*Call Spy Supply for all of your Cellular needs!*

*We Carry:*

## CELLULAR SOFTWARE

(We have the software to do New Motorola Phones)

## CELLULAR CABLES

(For the Motorola, Panasonic, and Nokia Phones)

## CELLULAR MODIFICATION GUIDES

(Covers all cellular manufacturers)

## CELLULAR PHONES

(We carry a complete line of cellular phones)



## FREE TECHNICAL SUPPORT!

We now offer Cellular Phones cloned with your existing number! Buy a handheld, transportable or car mounted phone ready to go and have only one monthly bill!

### *Don't Get Ripped Off!*

Before you buy our competitor's manual, call and ask if they offer **FREE TECHNICAL SUPPORT**

### **SPY SUPPLY**

Find out why the CIA - FBI - DEA - SECRET SERVICE Have ordered from our catalog To receive yours, send \$5.00 to:

### **SPY SUPPLY**

1212 Boylston St. #120  
Chestnut Hill, MA 02167

**SPY SUPPLY, 1212 Boylston St. #120, Chestnut Hill, MA 02167**

**(617) 327-7272**

*Sold for educational purposes only*

# Are Cable Companies Sucking You Dry?



**FREE  
Catalog!**

**All Major  
Brands!**

Take a Bite out of High Rental Fees  
with your own

## Converters & Descramblers



Everquest • Panasonic • Jerrold • Zenith • Pioneer  
Scientific Atlanta • Oak • Eagle • Hamlin • Tocom

DISCOVER

VISA MasterCard

Order  
Toll-Free **1 800 624-1150**

Call today for a FREE catalog!

# MD Electronics

875 S. 72 Street • Omaha, NE 68114

**NCCA**

Member of  
National Consumer  
Cable Association

**NCCA**

Member of  
National Consumer  
Cable Association

# New and Pre-Owned Test Equipment

SALES • RENTALS • SERVICE

Substantial Savings on new & pre-owned Fluke, Hewlett Packard, Leader, Tektronix and more ...

## LEADER

FOR PROFESSIONALS WHO KNOW THE DIFFERENCE



We buy surplus Electronic Equipment. Fax us your list!

\* Pre-Owned Oscilloscope Specials \*

Tektronix 465 100 MHz.....\$499.00  
 Tektronix 465B 100 MHz.....\$599.00  
 Tektronix 475 200 MHz.....\$679.00

Fully refurbished and calibrated to original specifications

OSCILLOSCOPES		Reg. \$
8020	20 MHz 2-Ch. High Sens., TV Sync.....	\$525.00
8060	60 MHz 3-Ch. Dlyd. Swp., TV Sync.....	\$1,345.00
8100	100 MHz 2-Ch. Dlyd. Swp., TV Sync.....	\$1,595.00
FREQUENCY COUNTERS		
LDC-822	80 MHz, 7 digit, 5 ppm.....	\$395.00
LDC-823S	250 MHz, 8 digit, 1 ppm.....	\$595.00
FUNCTION & RF SIGNAL GENERATORS		
LFG-1300S	2 MHz Sweep/Function Generator.....	\$575.00
LFG-1310	10 MHz Sweep/Function Generator.....	\$1,095.00
POWER SUPPLIES		
LPS-151	Triple Output, +6V/3A, +/- 25V/0.5A.....	\$555.00
LPS-152	Triple Output, +6A/5A, +/- 25V/1.0A.....	\$645.00

Sale

Call for latest sale price!

Full line of Oscilloscopes, Video & Audio Test Equipment, Power Supplies, Probes and Accessories. Call for a FREE Line Catalog!

**FOTRONIC CORPORATION**



TOLL FREE 1-800-99-METER

For more GREAT VALUES Call, Write or FAX • P.O. Box 708, Medford, MA 02155 • FAX (617) 665-0780

## CONTROL MEASURE INPUT

RELAYS • LIGHTS • MOTORS  
 TEMPERATURE • PRESSURE • LIGHT LEVELS • HUMIDITY  
 SWITCH POSITIONS • THERMOSTATS • LIQUID LEVELS

MODEL 30 ..... \$79

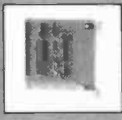

- PLUGS INTO PC BUS
- 24 LINES DIGITAL I/O
- 8 CHANNEL
- 8 BIT A/D / IN
- 12 BIT COUNTER
- UP TO 14K SMP/SEC

MODEL 30 SOFTWARE

- SCHOONER ... \$39
- REAL TIME DATA PLOT • DISK DATA LOGGING
- SOFTWARE CALIBRATION
- PROTEUS (REQUIRES SCHOONER) ... \$39
- GRAPHICAL DATA VIEW • ANALYSIS OF DATA

MODEL 150-02 .... \$179



- RS-232 INTERFACE
- TRMS, 20 AMPS
- 12 BIT A/D
- OPTO-ISOLATED
- COMPLETE DMH

MODEL 45 ..... \$189

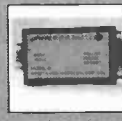

- RS-232 INTERFACE
- 8 DIGITAL I/O
- 8 ANALOG INPUTS
- 2 ANALOG OUTPUTS
- 2 COUNTERS-24 BIT

MODEL 40 ..... \$99



- RS-232 INTERFACE
- 28 LINES DIGITAL I/O
- 8 ANALOG INPUTS
- PWM OUTPUT

MODEL 70 ..... \$239



- RS-232 INTERFACE
- 18 BIT A/D
- 5.5 DIGIT
- UP TO 60 SMP/SEC

**Prairie Digital, Inc.**

PHONE 608-643-8599 • FAX 608-643-6754  
 846 SEVENTEENTH STREET • PRAIRIE DU SAC, WISCONSIN 53578

## GENUINE Electronics, Inc.

### Cable TV & Electronic Equipment

Genuine Electronics, Inc. can help you with virtually any electronic need:

- Cable TV Descramblers/Converters
- Bullet Protectors
- Immunizers
- Voice-Mail Systems
- Digital On-Hold Announcers
- Laser Pens

**GUARANTEED & LOWEST PRICES!**

**CALL GENUINE ELECTRONICS INC.**

**1-800-833-2915**

# Introducing the Video Communication Terminal

**Compatible with Jerrold,  
Scientific Atlanta  
and Pioneer**

*Latest high-tech features...*

- 750 MHz
- Infra-Red Wireless Remote Control
- Integrated Volume and Mute Control
- On Screen Menu Displays For All User Functions
- Clock
- Favorite Channel Memory Bank
- Programmable Parental Lockout
- Channel 3/4 Switchable
- Last Channel Recall
- Sequential or Direct Channel Access
- HRC / STD / IRC Programmable
- Auto Frequency Control Tuning
- Sleep Timer
- Audio and Video Ports
- Switched Electrical Outlet
- Inview Video Pass-Thru Technology

PRICES AS LOW AS  
**\$199<sup>95</sup>**



**Add on Descrambler for Jerrold Systems**

	1-9	10-19	20*
TVT GOLD (orig)	\$49	\$42	\$39
PURPLE or PINK	\$59	\$49	\$45
TVT (4X4)	\$49	\$42	\$39
STEALTH+ (new)	\$59	\$52	\$45
TNT (orig)	\$75	\$65	\$59



**Add on Descrambler for Scientific Atlanta**

	1-9	10-19	20*
SADF	\$69	\$65	\$59
SA - 3	\$59	\$55	\$49
M80 (orig)	\$75	\$65	\$59



**Add on Descrambler for Pioneer Systems**

	1-9	10-19	20*
PIO - GRN	\$79	\$69	\$59
PIO - GRN+ (new)	\$99	\$89	\$79
PIO - TNT (new)	\$75	\$65	\$59

**CONVERTERS**

**Wave Master 5500-3**

- Parental Control
- Favorite Channel Memory
- Sleep Timer
- Wireless Remote Control
- Last Channel Recall
- HRC / STD Switchable
- 99 Channel

1-9	10-19	20*
\$75.00	\$69.00	\$63.00

**Millenium M-3**

- Parental Control
- Favorite Channel Memory
- Wireless Remote Control
- Last Channel Recall
- HRC / STD Switchable
- 99 Channel
- Available With Built In Descrambler
- Available With A/B

1-9	10-19	20*
\$69.00	\$65.00	\$55.00

**VCS**  
VIDEO COMMUNICATION SYSTEMS INC.

ask about our complete line of products

**1-800-872-6585**

# Electronics made Easy with UCANDO



UCANDO's unique computer animation makes learning electronics fast and easy. These videos will...allow you to learn at your own pace...help you remember more of what you learn ... give you years of quality use... become a valuable source of reference material...make your understanding of electronics complete ... and help you build your future today. **Call today and see how UCANDO is...**

*"Changing The Way The World Learns Electronics."*

### New Release!!!

- VT102 Introduction to VCR Repair ... \$44.95
- VT103 VCR Maintenance & Repair .. \$29.95
- VT201 Direct Current ..... \$44.95
- VT202 Alternating Current ..... \$44.95
- VT203 Semiconductors ..... \$44.95
- VT204 Power Supplies ..... \$44.95
- VT205 Amplifiers ..... \$44.95

### VT405 TV Part 2 "The Front End" ..... \$44.95

- VT206 Oscillators .... \$44.95
- VT301 Digital 1 ..... \$44.95
- VT302 Digital 2 ..... \$44.95
- VT303 Digital 3 ..... \$44.95
- VT304 Digital 4 ..... \$44.95
- VT305 Digital 5 ..... \$44.95
- VT306 Digital 6 ..... \$44.95
- VT401 AM Radio ..... \$44.95
- VT402 FM Radio Part 1 ..... \$44.95
- VT403 FM Radio Part 2 ..... \$44.95
- VT404 TV Part 1 "Intro to TV" .. \$44.95
- VT501 Fiber Optics ..... \$44.95

**SAVE!!! Buy any 6 videos for only \$240 ... SAVE MORE!!! Buy any 12 videos for only \$450**

**MONEY BACK GUARANTEE! Call for details.**

## Call toll-free 1-800-678-6113

or mail check or money order to:

UCANDO Videos, P.O. Box 928, Greenville, OH 45331

## FREE Shipping ... FREE Catalog

CIRCLE 136 ON FREE INFORMATION CARD



## PROTOTYPE PC BOARDS!

Made in USA!



only \$595!

\*free CAD/CAM

18"x18"x4.6" WORK AREA

### THIS IS THE MACHINE YOU'VE BEEN WAITING FOR!

Have you ever dreamed of letting your computer prototype PC boards directly from your CAD drawings? If so, the Neuractor CNC-4+ Desktop Manufacturing System may be just the machine you need! This fourth-generation CNC machining center can automatically drill, mill and route printed circuit boards, not to mention three-dimensional products in wood, plastic and light metals DIRECTLY FROM YOUR CAD DRAWINGS! You've seen the rapid-prototyping and "Santa Claus" machines that cost thousands of dollars, but did you know that as an electronic technician you can assemble one yourself from this inexpensive kit? Utilizing patent pending technology the Neuractor CNC-4+ kit provides you with everything you need to machine products in three dimensions with a resolution of .001". All mechanical components are pre-fabricated, pre-machined, plated and painted. Includes four 83 oz/in digital CY-MOTORS, interface card, 5 amp power supply, 10 pitch steel lead screws, 4 proprietary Slide Block actuator mechanisms, 4 aluminum linear-actuator channels, polished steel guide-rods, Dremel bracket, hardware, etc. (You provide Dremel MotoTool(tm) or flex-shaft router and work surface.) It's a complete kit! All you do is put it together and calibrate it! IF THAT'S NOT ENOUGH, WE'RE THROWING IN A FREE FULL-FEATURED 3D CAD/CAM SOFTWARE PACKAGE WITH EACH UNIT! Large 18"x18"x4.6" cutter travel directly from CAD-generated or scanned ASCII, DXF & HPGL plot files !. Get started by ordering your own Neuractor CNC-4+ today! ACT NOW! Kit \$595 + \$24.95 S/H. (For PC board routing the heavy-duty upgrade is suggested, add \$149) Allow 4-8 weeks for del. U.S. CYBERLAB, 14786 Slate Gap Rd., West Fork, AR 72774 (501) 839-8293. **Free info! X-Y Power/Rotary Tables and larger CNCs now available!**



# CABLE TV Converters & Descramblers

Compatible with

**Jerrold, Scientific Atlanta,  
Pioneer, Oak, & Hamlin  
Equipment**

**BRAND NEW!**

**6-MONTH GUARANTEE**

**LOWEST PRICES**

*Volume Control & Parental Lockout Available*

**Greenleaf Electronics**

**1-800-742-2567**

**NO ILLINOIS SALES**

It is not the intent of Greenleaf Electronics to defraud any pay television operator and we will not assist any company or individual in doing the same.

# MICRO Kits An educational and fun to build module line

Long range, high sensitivity FM microphone. 1.5-12 V bat.



Tiny. Use it to monitor sounds from a distance or to sing or play an electric guitar on your stereo.

### FM MICROPHONE

**K100 \$14.99**

250 mW general purpose audio amp. Ideal as a bench monitor or together with K104 to hear sounds at a distance. 2-30 Ω output, Hi or Lo input Uses 5-12V



### MINI AMP

**K101 \$11.99**

2.5 W discrete transistor audio amp. Low Z input. Great for understanding audio amps. Ideal for monitoring an electric guitar on headphones or a loudspeaker.

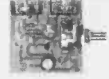

### 2.5 W AUDIO AMP

**K102 \$14.99**

8 W Audio amp, 2-16 Ω output. Ideal for singers, electric musical instruments, car radio power boosting, etc. Great sound quality. Overload protected.



### 8 W AUDIO AMP

**K103 \$19.99**

High gain audio preamplifier. Boosts any signal level for a power amplifier. Ideal combo with K101 for "snooping" sounds at a distance. Uses 6-12V.



### AUDIO PREAMP

**K104 \$10.99**

Understand the secrets of regeneration with this simple and fun to build FM superregenerative, 2 transistor receiver. Uses 9 V battery.



### REGENER. RADIO

**K105 \$17.99**

0.1 to 20 minute programmable/ resetable timer. Relay rated at 250 V 2.5 A. Requires 12 V DC. Use it to warm up your car, turn off your TV or lights, etc.



### TIMER

**K106 \$19.99**

Transistor tester tells if device is NPN, PNP, FET-N, FET-P, OK or bad. Ideal for any shop, even professionals. Uses 9 V battery.



### TRANSISTOR TESTER

**K107 \$12.99**

Regulated power supply (1.2-32 V, 1.5 A). Overload protected. Transformer is not included.



### POWER SUPPLY

**K108 \$19.99**

Prevent skids from your bit when drilling printed circuit boards or mock-ups. Controls rate of acceleration and speed on 12 V mini drills.



### SPEED CONTROL

**K109 \$24.99**

Antenna booster. Amplifies signals for any radio (1-100 MHz). Ideal for older receivers, SW listening or car radios.



### ANTENNA BOOSTER

**K110 \$11.99**

Busy & hold button. When the green LED is on, the line is free. Press the button to put on hold. Plugs between the phone and the socket in the wall.



### PHONE HOLD

**K111 \$14.95**

#680-177 Telegraph Rd.  
Bellingham WA 98226  
TOLL FREE: (800) 474 7644  
Fax: (604) 985 6417

**Add \$7 shipping & handling**

We accept VISA, MO or cheques (sorry, no COD)

Check our BBS at (604) 985 1380 for other products

## DC/CAD *introducing...*

### THE TERMINATOR

Super High Density Router  
(Complete with Schematic & PCB EDITOR)

Features the following powerful algorithm & capability:

- Rip - up and Retry
- Pre-routing of SMT components
- Real-Time via minimization
- Real-Time clean up passes
- User defined strategies
- Window 3.0 capability as DOS Task
- 1-mil Autoplacer and Autopanning
- Two-way Gerber and DXF
- Automatic Ground Plane w/ Cross-Hatching
- Complete w/ Schematic & Dolly Libraries
- Optional simulation capability & protected mode for 386 users

\* PCB LAYOUT SERVICE AT LOW COST \*

LEASE PROGRAM & SITE LICENSE AVAILABLE



Design  
Computation

1771 State Highway 34  
Farmingdale, NJ 07727  
(908) 681 - 7700 • (908) 681 - 8733 (FAX)

"DC/CAD... The focal point of future CAD market"

## B&S SALES

CALL (810)566-7248 FAX (810)566-7258 24 hrs.  
Hours: Monday thru Friday 8:30 am to 6:00 pm EST,  
Saturday 10:00 am to 3:00 pm EST  
51756 Van Dyke, Suite 330, Shelby Twp., MI 48316

### CABLE CONVERTERS AND DESCRAMBLERS

Compatible for all types of converters:

**Jerrold  
Scientific Atlanta  
Pioneer  
Zenith  
Tocom**

"6 Month Warranty" on all equipment!!!

SPECIALIZING IN QUANTITY PRICING!!

Fax us your invoice and we will match the price!  
Free catalog!

Call for availability & prices!

**(810) 566-7248**

No Michigan Sales

CIRCLE 146 ON FREE INFORMATION CARD

# MIRACLES NEVER CEASE



## MICRO TX2000 KIT

**\$59<sup>95</sup>**

- SMALLEST 120 MW FM VOICE/PHONE TRANSMITTER
- SMALL SIZE 1-7/16" x 2 1/32"
- 89-110MHz ON ANY BROADCAST RECEIVER
- ROCK SOLID TUNING, DOESN'T DRIFT
- 5 MIN. ASSEM. HEAR A WHISPER UP TO 2 MILES
- SMT PARTS PREASSEMBLED
- INCLUDES TXMTR, MIC, ANTENNA, BATTERY CLIP, TUNING TOOL, AND INSTRUCTIONS

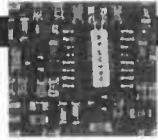

## VOICE SCRAMBLER/DESCRAMBLER KIT

**\$69<sup>95</sup>**  
2 FOR  
**\$129.95**

- WORLDS SMALLEST AUDIO SCRAM/DESCRAM.
- TALK IN PRIVACY ON AUDIO, SPKR. OR MIC LINE
- HEAR THOSE GARBLED SCANNER VOICES
- SMALL SIZE 1" x 7/8" x 1/4"
- CRYSTAL CONTROLLED DIGITAL SPEECH INVERSION
- 7-15 VOLT DC SUPPLY
- LOUD HALF WATT AUDIO AMPLIFIER
- EXCELLENT AUDIO QUALITY
- INCLUDES FULL DOCUMENTATION
- DUPEX SCRAMBLE & DESCRAMBLE AT THE SAME TIME

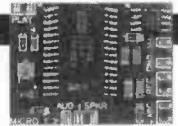

## MICRO 1.2 VOICE RECORDER

**\$69<sup>95</sup>**

- SMALL SIZE 1-1/4" x 1 5/16" x 1/4"
- HUNDREDS OF APPLICATIONS
- EXCELLENT AUDIO QUALITY
- 60 SECONDS REC/PLAY
- 8 OHM SPEAKER OUTPUT
- 7-15 VOLT DC SUPPLY
- 100 YEAR MEMORY WITHOUT POWER
- INCLUDES MIC, SWITCHES AND FULL DOCUMENTATION

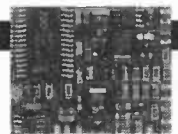

## MICRO 2B VOICE RECORDER

**\$109<sup>95</sup>**

- MICRO 2B FEATURES**  
SAME AS 1.2 PLUS:
- MULTI MESSAGES (UP TO 600 MEM.)
  - SMALL SIZE 1-5/16" x 1-5/8" x 1/8"
  - VARIABLE AUTO PLAY TIMER
  - 5 VOLT KEY OUT DURING PLAYBACK

ORDER BY PHONE OR MAIL  
IN U.S.A. ADD \$5 FOR S&H

C.O.D. CHARGES APPLY  
NYS RESIDENTS ADD SALES TAX

## VFC400 VHF/UHF FM VOICE TRANSMITTER KIT



**ONLY \$99<sup>95</sup>**

**NEW**

- SMALLEST 400 MILLIWATT VOICE TRANSMITTER ANYWHERE! (1.5" x .56")
- RECEIVE ON ANY SCANNER OR VHF/UHF SURVEILLANCE RECEIVER
- RELIABLE CRYSTAL CONTROL OSCILLATOR
- 5 MILE RANGE (OR BETTER!)
- SUPER SENSITIVE OP-AMP PICKS UP SOUNDS AT WHISPER LEVEL
- LINE LEVEL AUDIO INPUT FOR DATA, STATION ID, OR INTERFACE TO OUR POPULAR VOICE RECORDERS
- SIMPLE 5 MINUTE ASSEMBLY, ALL CHIP COMPONENTS ARE PRE-ASSEMBLED
- CUSTOM FREQUENCIES AVAILABLE FOR LAW ENFORCEMENT
- INCLUDES TRANSMITTER, CRYSTAL, BATTERY HOLDER, MICROPHONE, ANTENNA, & INSTRUCTIONS
- CHANNEL A) 146.565 MHZ B) 149.000 MHZ (SELECT ONE WHEN ORDERING)

## MICRO-4 MULTI-MESSAGE VOICE RECORDER

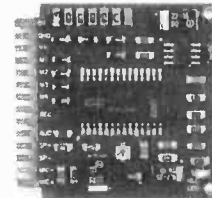

- EXACT SOUND REPRODUCTION
- SMALL SIZE 1-3/4" x 1-5/8"
- NEW EDGE CARD DESIGN IS STANDARD .100 SPACING
- 4 MESSAGE MAX. UP TO 20 SECONDS
- LED INDICATES RECORDING IN PROGRESS
- 6 VOLT INPUT ONLY DRAWS .5 uA STANDBY
- 7-13.8 VOLT REGULATED INPUT @ 30ma
- 8 OHM 50 MILLIWATT SPEAKER OUTPUT
- LINE LEVEL AUDIO OUTPUT (VARIABLE)
- FULLY ASSEMBLED (NOT A KIT)
- 100'S OF APPLICATIONS, ALARMS, PRODUCT DISPLAY, NOTE PAD, HAM, CB, MUSEUMS, ETC
- SWITCHES, MICROPHONE, & INSTRUCTIONS INCLUDED

**NEW**

**ONLY \$89<sup>95</sup>**

**COMING SOON**



**MICRO-3**  
REC/PLAY UP TO 4.5 MINUTES  
UP TO 1800 MESSAGES (NO DIODES)  
MESSAGE CUEING (FAST FORWARD)

TECH. FAX: 518-381-1058

TO ORDER: CALL 1-(800)-588 4300



TECH. SUPPORT: 518-381-1057

# INSTEK Test & Measuring Instruments

## DC POWER SUPPLIES

### PR-Middle Series (Analog/Digital)

ISO 9002  
CERTIFICATION  
#934163



- Continuous or Dynamic load for internal selectable
- Low ripple and noise
- 0.01% high regulation
- Overload and Reverse polarity protection
- Constant voltage and constant current modes
- 3 1/2 Digits 0.5" LED display (Digital type only)

**MODEL #PR6030D (Digital)**  
Regular \$500.00  
Sale \$399.95

**MODEL #PR6030 (Analog)**  
Regular \$379.00  
Sale \$299.95

	Model	Output Volts (V)	Output Amps (A)	Weight (kg)
Analog	PR-6030	0-60	0-3	11.5
Digital	PR-6030D	0-60	0-3	11.5



**TOLL FREE 800-638-2020**

**NEW 84 PAGE CATALOG!!!**  
Call Today For Your FREE Copy  
Of The 1994 Print Test  
Equipment Catalog!



# There's No Easier Way to TROUBLESHOOT AND REPAIR Your Electronics!



It's easy, fast and rewarding to do it yourself with the Electronics Repair Manual!

- TVs VCRs
- Hi-Fi Stereo Amplifiers
- Turntables
- Speakers
- Shortwave Radios
- Camcorders
- Tape Decks
- CD Players
- Walkmans
- AM & FM Receivers
- PC Systems
- Automobile Sound Systems
- PC Peripherals
- Telephone Systems
- Fax Machines
- Electronic Home Appliances

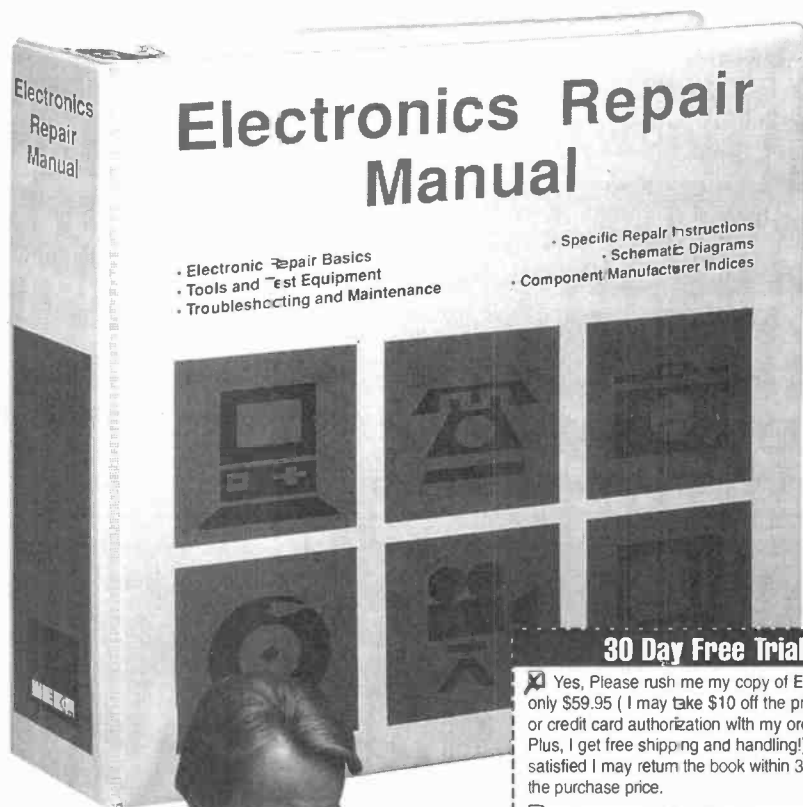

- 900-PAGE, MODULAR FORMAT MANUAL
- TROUBLE ANALYSIS FLOWCHARTS
- SCHEMATIC DIAGRAMS
- HANDS-ON, DETAILED, TROUBLESHOOTING INSTRUCTIONS
- "HOW TO" PRIMER FOR TEST EQUIPMENT SUCH AS OSCILLOSCOPES, FREQUENCY COUNTERS, AND VIDEO ANALYZERS
- SAFETY PRECAUTION CHECKLISTS
- COMPREHENSIVE REPLACEMENT PARTS LISTS
- PREVENTIVE MAINTENANCE TECHNIQUES
- DIRECTORY OF MANUFACTURERS



## 30 Day Free Trial Order Form

Yes, Please rush me my copy of Electronics Repair Manual for only \$59.95 ( I may take \$10 off the price when I enclose my check or credit card authorization with my order within the next 30 days. Plus, I get free shipping and handling!) I understand that if I am not satisfied I may return the book within 30 days for a full 100% refund of the purchase price.

My payment of \$59.95 is enclosed (\$49.95 when ordering within the next 30 days.)

Check enclosed.

Optional express delivery (available in U.S. only). Enclose an additional \$10.00 and we'll guarantee delivery within 5 business days from receipt of your order (prepaid orders only).

\_\_\_\_\_  
Credit card no.

\_\_\_\_\_  
Expiration Date Dayline phone no.

\_\_\_\_\_  
Signature

Bill me later for \$59.95 plus \$6.50 shipping and handling, subject to credit approval. Signature and phone number required to process your order. P.O. Box addresses must be prepaid.

Mr./Mrs./Ms. \_\_\_\_\_

Company \_\_\_\_\_

Address \_\_\_\_\_

City \_\_\_\_\_ State \_\_\_\_\_ Zip \_\_\_\_\_

Shipping and handling to Canada, \$10 (U.S. currency); Overseas, \$15 (foreign orders must be prepaid). CT residents add 6% sales tax. Supplements will be sent 4-5 times a year on a fully-guaranteed, 30-day trial basis. They may be cancelled at any time.

30900

MAIL TO: WEKA Publishing, Inc.  
1077 Bridgeport Avenue, Shelton, Connecticut 06484

1-800-222-WEKA FAX: 1-203-944-3663

## Keep Your Skills Up-to-Date!

The Electronics Repair Manual will be a valuable reference for years to come. Supplements, each containing 140 pages, add new repair projects, valuable insights into new technologies, diagnostic and repair techniques, and more schematic diagrams into your manual. Just \$30 each plus shipping and handling. Supplements are sent 4-5 times a year and are fully guaranteed. Return any supplements you don't want within 30-days and owe nothing. Cancel anytime.

# Cellular Programming Software

## \$\$ BLOW OUT PRICES \$\$

### WE'LL BEAT ALL COMPETITORS' ADVERTISED PRICES

**MOTOROLA**..... ABOVE 9122 ALLMODELS SOFTWARE OR LOADER FROM \$395.00  
**NOKIA & TECHNPHONE** ..... 100 - 101 - 121 - 201 - 400 - 405 - 415 - 515 — TANDY MODELS  
**NEC** ..... P100 - P110 - P120 - P180 - P400 - P600 — ATT3610  
**PANASONIC**..... ALL PORTABLES HP600 - HH700 - HH900 - EBH30 - EBH40 - EBH50 - EBH60  
**GE & ERICSSON** ..... HOTLINE - POCKET II - MICROPORTABLE - AH97 - AH98 - CT100 - CT700  
**MITSUBISHI & DIAMONDTel** ..... 3500 - 4500 - 20X - 22X      **SONY** ..... CMR - 111 - 333

### MOTOROLA SOFTWARE TO REPAIR LOANER AND OOFFFFF

ALL PRODUCTS ARE IN STOCK  
 SHIPPED OVERNIGHT UPS/COD

# CELLSOFT®

609-751-2242 Ext 2

FAX 609-751-5549 • FREE TECHNICAL SUPPORT

## CopyCat®

No PC — No Loaner  
 Only 10 Seconds  
 Programs & Repairs  
 Complete with Cables  
 \* \* \*  
 All Motorola Including  
 Digital - Analog - All Versions  
 \* \* \*  
 Models Available from \$2300.00  
 \* \* \*  
 Sony - Ericsson - Panasonic  
 Audiovox - NEC - Mitsuabshi  
 Dimontel - GE - Uniden

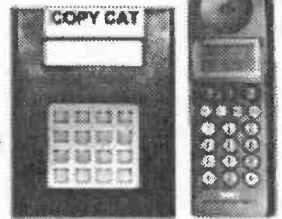

Serving the public since 1981



## XANDI ELECTRONICS

1270 E Broadway Rd. # 113, Tempe AZ 85282

**SATISFACTION  
 GUARANTEED!**

**BUY WITH CONFIDENCE FROM XANDI**

• 30-DAY REFUND POLICY  
 • TECH SUPPORT NUMBER  
 (602-894-0992)

- Tunes 88-108 MHz.
- Powerful 2 stage audio amplifier.
- Sensitive, picks up sounds at the level of a whisper.
- Up to 1 mile range.
- Requires 9V battery. (Not Incl.)



**SUPER-MINIATURE FM TRANSMITTER**  
 Super small FM transmitter. Use with any FM broadcast receiver. Easy to assemble, all chip (SMT) parts are pre-assembled to the circuit board.

**XST500 (E-Z) Kit** ..... \$44.95

- Miniature photo battery mounts right on circuit board. (Included)
- Tunes 88-108 MHz.
- Up to 1/2 mile range.
- Sensitive 2 stage audio amplifier, picks up sounds at the level of a whisper.



**MICRO-MINIATURE FM TRANSMITTER**  
 Including the battery, this is the World's smallest FM transmitter. Use with any FM broadcast receiver. Easy to assemble, uses pre-assembled circuit board.

**XWB1000 E-Z KIT** ..... \$49.95

- Transmits at 143 MHz.
- Up to 1 mile range.
- Miniature photo battery mounts right on circuit board. (Included)
- Amazing audio sensitivity, picks up sounds at the level of a whisper.



**CRYSTAL CONTROLLED FM TRANSMITTER**  
 Including the battery, this is the World's smallest crystal controlled FM transmitter. Transmits to any scanner type receiver. Easy to assemble, uses pre-assembled circuit board.

**XTL1000 E-Z KIT** ..... \$69.95

- Smallest Phone transmitter anywhere!
- Tunes 88-108 MHz.
- No batteries required, powered by phone line.
- Up to 1/4 mile range.
- Attach to phone line anywhere in house, even inside phone.



**SUPER-MINIATURE PHONE TRANSMITTER**  
 World's smallest FM phone transmitter. Use with any FM broadcast receiver. Easy to assemble, all chip components are pre-assembled to the circuit board.

**XSP250 (E-Z) Kit** ..... \$34.95

- Dial your phone from anywhere and listen to the sounds inside your home.
- Two digit Touch Tone code for secure operation.



**TELEPHONE SNOOP**  
 The latest in home or office security. Call home from anywhere, enter a two digit security code, and hear the sounds in your home. Automatically turns on without ringing the phone, verifies code, then activates for one and a half minutes.

**XPS-CASE KIT** ..... \$13.95

**XPS1000 (C) Kit** ..... \$49.95

- Transmits a continuous beeping tone.
- Adjustable from 88 to 108 MHz.
- Up to 1 mile range.
- Works with any FM broadcast receiver.



**TRACKING TRANSMITTER**  
 Only 0.7 by 2.4 inches, the XTR100 operates at voltages of 3 to 18 Volts and is ideal for use in locating lost model rockets, bicycles, automobiles, games of hide and seek, and contests.

**XTR100 (C) Kit** ..... \$33.95

- Uses sensitive microwave transistor amplifier.
- Covers 1 to 2,000 MHz.
- Compact hand held unit.
- Includes miniature loud speaker for audio indication of detected signals.



**SUPER SENSITIVE BUG DETECTOR**  
 When the XBD200 intercepts a signal in the 1 to 2,000 MHz range, it emits a growl that increases to a high pitched squeal as the signal strength increases.

**XBD200 (C) Kit** ..... \$49.95

- Use with any FM broadcast receiver.
- Hear every sound in an entire house!
- Up to 1 mile range
- Powerful 2 stage audio amplifier.



**MINIATURE FM TRANSMITTER**  
 The XFM100 has a super sensitive microphone and is capable of picking up sounds at the level of a whisper and transmitting them to any FM broadcast receiver.

**XFM100 (C) Kit** ..... \$32.95

- Digital voice changing: male to female, female to male, adult to child, child to adult.
- Anonymity on any call.
- Button for normal operation.
- 16 levels of voice masking.



**VOICE CHANGING TELEPHONE**  
 STOP THOSE ANNOYING TELEPHONE CALLS! Sound older and tougher when you want to. Not a kit. Fully assembled. Single phone operation only.

**TRANSITION 2000** ..... \$89.95

- Digital voice changing: male to female, female to male, adult to child, child to adult.
- Use with any modular phone.
- 16 levels of voice masking.
- Connects between handset and phone.



**VOICE CHANGING ACCESSORY**  
 STOP THOSE ANNOYING TELEPHONE CALLS! Sound older and tougher when you want to. Not a kit. Fully assembled. Use with single or multi-line phones.

**TRANSITION 2001** ..... \$59.95

- Uninterrupted coverage of 800 to 950 MHz.
- Works with any scanner that can receive 400 to 550 MHz.



**800-950 MHz SCANNER CONVERTER KIT**  
 If your scanner can receive 400-550 MHz, just add the XLC900 for uninterrupted 800-950 MHz coverage. It converts all 800-950 MHz signals down to 400-550 MHz so your scanner can receive them! Add our custom case kit for that "Professional" look!

**XLC-CASE KIT** ..... \$13.95

**XLC900 (C) Kit** ..... \$49.95

- Transmits high quality stereo to any FM stereo receiver.
- Built-in output level monitor for quick and easy tuning.
- Ideal for use with personal CD player.



**FM STEREO TRANSMITTER**  
 Transmits full-bodied Hi Fi stereo to any FM stereo receiver. Separate left and right inputs and gain controls. Includes an output booster stage for greater range.

**XFS-CASE KIT** ..... \$13.95

**XFS108 (C) Kit** ..... \$41.95



WE ACCEPT VISA, MC, MO, COD  
 SHIPPING & HANDLING EXTRA

**TOLL FREE ORDER LINE**  
 1-800-336-7389  
 ASK FOR FREE CATALOG OF OUR PRODUCTS

**SEND MAIL**      **XANDI ELECTRONICS**  
**ORDERS TO:**      **BOX 25647**  
                                  **TEMPE, AZ 85285-5647**



150 LE - Student 200 LE - Technician 300 LE - Auto-Range 400 LE - Engineer

**KELVIN 100 Basic**  
# 990087 **\$19<sup>95</sup>**

- AC & DC VOLTAGES
- DC CURRENT
- RESISTANCE
- 3 1/2 Digit LCD
- CONTINUITY TEST
- Buzzer
- LOW BATTERY INDICATOR
- DIODE TEST • BATTERY TEST



**CAPACITANCE KELVIN METER 250 LE \$59<sup>95</sup>**  
# 990126

- 0.5% ACCURACY
- RANGES: 20mF, 2000uF, 200uF, 20uF, 2uF, 200nF, 20nF, 2000pF, 200pF
- Zero Adjust
- Safety Test Leads
- Test Socket for Plug-in Components



**150 LE**  
Stock # 990122  
**\$29<sup>95</sup>**

**FREQ COUNTER**  
up to 20MHz  
**CAPACITANCE**  
from 1pF to 20uF  
**TRANSISTOR**  
**AC/DC CURRENT**  
10 Amp

**200 LE**  
Stock # 990123  
**\$49<sup>95</sup>**

**AUTO RANGE**  
with 3200 counts  
**AC CURRENT**  
**DC CURRENT**  
**ANALOG BAR**  
10 Amp

**300 LE**  
Stock # 990125  
**\$49<sup>95</sup>**

**INDUCTANCE**  
Resolution 1uH  
**FREQ COUNTER**  
up to 20MHz  
**CAPACITANCE**  
from 1pF to 200uF  
**AC/DC CURRENT**  
**TRANSISTOR**  
**DUTY %**  
20 Amp

**400 LE**  
Stock # 990124  
**\$79<sup>95</sup>**

**Standard Features** • AC & DC VOLTAGES • DC CURRENT  
• RESISTANCE • CONTINUITY TESTER - Buzzer • DIODE TEST  
• 10M ohm INPUT IMPEDANCE • ACCURACY +/- 0.5% RDG

Designed to meet IEC-348 & UL-1244 safety specifications.

**Protective Cases**

For Models 100 Basic, 150LE, 200LE, 300LE  
..... \$4.<sup>95</sup> (#990088)  
Case For Model 400LE ..... \$9.<sup>95</sup> (#990116)

**2 Year Warranty (Parts & Labor)**

**The Ultimate Meter**  
TRUE RMS - LCR - Hz - dBm

Popular Electronics (Reviewed - May 1993)

"Not only does the Kelvin 94 boast alot of features ... the features go the extra distance."

"If we had to run into a burning building to do some emergency trouble-shooting and could carry in only one piece of equipment, the Kelvin 94 would be it!"

**12 INSTRUMENTS IN ONE -**

DC VOLTMETER, AC VOLTMETER, OHMMETER, AC CURRENT, DC CURRENT, DIODE TESTER, AUDIBLE CONTINUITY TESTER, dBm, FREQ COUNTER, CAPACITANCE METER, INDUCTANCE METER, LOGIC PROBE

- 0.1% ACCURACY ON DC VOLTAGES
- TRUE RMS on AC VOLTAGES & CURRENT
- FREQUENCY COUNTER TO 20 MHz
- LARGE EASY-TO-READ 3 3/4 DIGIT LCD DISPLAY
- AUTO SLEEP & AUTO POWER OFF BUILT-IN TO SAVE BATTERY LIFE with Bypass
- SHOCK RESISTANT HEAVY DUTY CASE WITH YELLOW RUBBER HOLSTER & TILT STAND
- WATER RESISTANT SEALED CASE
- 30 DAY MONEY BACK SATISFACTION GUARANTEE

**\$199<sup>95</sup>** MODEL 94 #990111

COMES COMPLETE WITH YELLOW HOLSTER, PROBES, BATTERY, FUSE, STAND

0.1% ACCURACY on DC Voltages Water Resistant

Freq Counter to 20 MHz

**Protective Cases for Model 94**

Regular Padded Zippered ..... \$9.<sup>95</sup> (#990116)  
Deluxe Padded Zippered ..... \$14.<sup>95</sup> (#990115)

Meter is designed in accordance with safety requirements specified in IEC-348, UL-1244 VDE-0411.

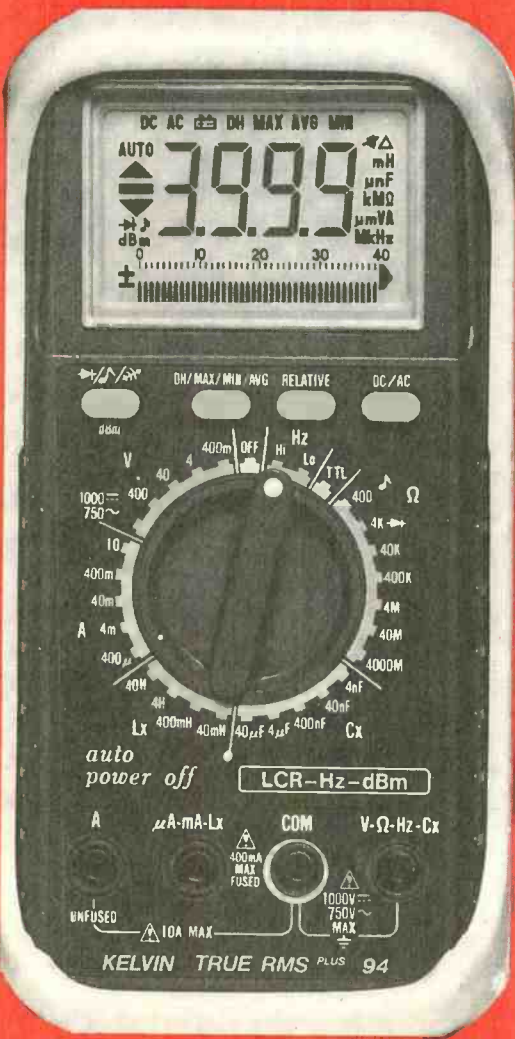

# "I earned \$1,000 on just 12 VCR Repairs"

*You can too! Learn to earn in one of these exciting areas. Your interest in electronics and these Foley-Belsaw Repair Manuals teach you how to make big profits in the exciting and profitable world of electronics.*

- ✓ VCR Repair Training
- ✓ Advanced VCR Repair Training
- ✓ Camcorder Repair Training
- ✓ Computer Printer Repair Training
- ✓ Basic/Digital Electronics Training
- ✓ Fax Repair Training

## Repair Manual and Video Tape will Make you a Professional Repair Expert!

All service manuals and training videos are developed and produced in a repair shop. You will discover valuable repair "secrets" and tips that are virtually impossible to obtain anywhere else. The service manuals and training videos are thorough, practical, easy to understand, with lots of illustrations.



### You'll learn to:

- Pinpoint and analyze problems quickly.
- Successfully complete repairs with hands-on trouble shooting instructions.
- How to use service manuals.
- How to competently use test equipment.
- How to diagnose malfunctions.
- How to keep your equipment in top condition with effective preventive maintenance.

### One Source For All Your Repair Needs

Better than a magazine, more current than a book.

- Each service manual developed in a repair shop.
- Easy to follow detailed instructions.
- Troubleshooting charts.
- Safety precaution guidelines.
- Pricing your repairs for others.
- Successful customer relations techniques.
- More, more, more.

### 30 Day Money Back Guarantee

If you are not completely satisfied with your purchase from our company, return it (Freight Prepaid) within 30 days with your original invoice; we will gladly replace the product, give you credit, or refund your money in the original method of payment.



**For faster service, call Toll-Free,  
1-800-821-3452  
Or fax your order - 816/483-5010**

**Order Form - YES, please send me the items checked below.**

I am enclosing a check or money order payable to:  
Foley-Belsaw Co. • 6301 Equitable Rd.  
Kansas City, MO 64120-1395



- BKDG7025 VCR Training Manual (400 pages) ..... \$49.95 with 30 minute video tape.
- BKDG7026 Advanced VCR Training Manual (200..... 49.95 pages) with 84 minute video tape.
- BKDG7027 Camcorder Training Manual (500 pages) ... 49.95 with 60 minute video tape.
- BKDG7029 Computer Printer Training Manual ..... 49.95 (300 pages) with 90 minute video tape.
- BKDG7028 Fax Training Manual (400 pages) ..... 49.95 with 30 minute video tape.
- BKD6100032 Basic Digital Electronics Training ..... 39.95 Manual (240 pages only).
- BKD6100078 30 minute VCR Tricks & Tips Video Tape . 29.95
- BKD6100037 30 minute Trouble Shooting VCR's ..... 29.95 with the Oscilloscope Video Tape

Add Postage & Handling	\$ 3.00
Sales Tax: MO 6.475%, MN Metro Mpls. 7%	
Non-Metro Mpls 6.5%, MI 4%, NY 8%, WI 5.5%	
<b>Total Enclosed:</b>	

Name \_\_\_\_\_

Address \_\_\_\_\_

City \_\_\_\_\_ State \_\_\_\_\_ Zip \_\_\_\_\_

Please charge to my:  Discover Card  MasterCard  VISA  
Signature X \_\_\_\_\_

if MasterCard, please fill in small numbers at left above name.

AMERICAN RELIANCE

## AMREL Offers Lowest Prices & Best Warranties on DC Power Supplies ANYWHERE!

3 YEAR WARRANTY



3 YEAR WARRANTY

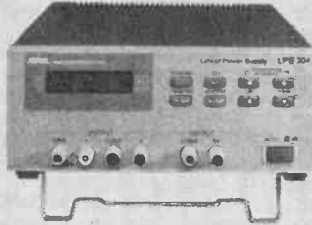

### AMREL Offers Superior Analog Power Supplies Starting as Low as \$149.00

- Low Output noise rating less than 0.3mV.
- Line/load regulation rated at low 0.01% + 1mV.
- Transient response time of 50µ Sec.
- Overload protection, and Output enable/disable.
- Coarse and fine voltage/current adjustment.
- Auto series/parallel operations for triple output supplies.

### AMREL Offers Features And Prices on Digital Power Supplies That The Competition Can't Beat!

- Microprocessor controlled.
- User friendly keypad data entry.
- Low output noise rating less than 1mV.
- Line/Load regulation rated less than 2mV.
- Output enable/disable and Power off memory.
- Optional RS-232 interface capability.

Model	LPS-101	LPS-102	LPS-103	LPS-104	LPS-105	LPS-106	LPS-301	LPS-302	LPS-303	LPS-304	LPS-305
Rating	30V/1A	30V/2A	30V/3A	+30V/1A -30V/1A 3-6.5V/3A	+30V/3A -30V/3A 3-6.5V/3A	60V/1A	15V/2A(H) 30V/1A(L)	15V/4A(H) 30V/2A(L)	30V/3A	+30V/1A -30V/1A 5V/2A	+30V/2.5A -30V/2.5A 3-3.5V/3A
List Price	\$195	\$225	\$295	\$395	\$495	\$245	\$249	\$299	\$369	\$399	\$599
Sale Price	\$149	\$179	\$199	\$375	\$469	\$219	\$199	\$285	\$350	\$379	\$569

**PRINT**<sup>TM</sup>  
Products International Inc.



Call: 1-800-638-2020



8931 Brookville Road • Silver Spring, Maryland 20910 • Fax: 800-545-0058 •

CIRCLE 46 ON FREE INFORMATION CARD

## DESKTOP MANUFACTURING!

Made in USA!

only \$595!  
\*free CAD/CAM

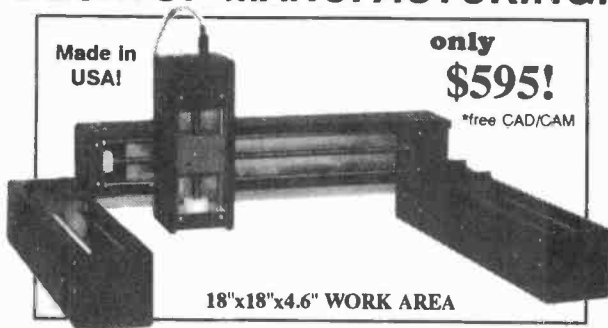

18"x18"x4.6" WORK AREA

### THIS IS THE MACHINE YOU'VE BEEN WAITING FOR!

Have you ever dreamed of letting your computer manufacture products directly from your CAD drawings? If so, the Neuractor CNC-4+ Desktop Manufacturing System may be just the edge you need! This fourth-generation CNC machining center can automatically drill, mill and route three-dimensional products in wood, plastic and light metals DIRECTLY FROM YOUR CAD DRAWINGS! You've seen the rapid-prototyping and "Santa Claus" machines that cost thousands of dollars, but did you know that as an electronic technician you can assemble one yourself from this inexpensive kit? Utilizing patent pending technology the Neuractor CNC-4+ kit provides you with everything you need to machine products in three dimensions with a resolution of .001". All mechanical components are pre-fabricated, pre-machined, plated and painted. Includes four 83 oz/in digital CY-MOTORS, interface card, 5 amp power supply, 10 pitch steel lead screws, 4 proprietary Silde Block actuator mechanisms, 4 aluminum linear actuator channels, polished steel guide-rods, Dremel bracket, hardware, etc. (You provide Dremel MotoTool(tm) or flex-shaft router and work surface.) It's a complete kit! All you do is put it together and calibrate it! IF THAT'S NOT ENOUGH, WE'RE THROWING IN A FREE FULL-FEATURED 3D CAD/CAM SOFTWARE PACKAGE WITH EACH UNIT! Large 18"x18"x4.6" cutter travel for crafts, electronics and printed circuit board drilling and routing, not to mention model-making, mold-making and even painting! Get started by ordering your own Neuractor CNC-4+ today! ACT NOW! Kit \$595 + \$24.95 UPS S/H. (For heavy-duty upgrade add \$149) Allow 4-8 weeks for delivery. U.S. CYBERLAB, 14786 Slate Gap Rd., West Fork, AR 72774 (501) 839-8293. **Free Info! X-Y Power/Rotary Tables and larger CNCs now available!**

## Learn MICROCONTROLLERS and EMBEDDED SYSTEMS with the AES-10

The AES-10... a complete learning system, a complete embedded control system. Extensive manuals guide you through your 8051 development project. Assembly, BASIC, and C programming. All hardware details, complete schematics. Learn to program the LCD, keypad, digital and analog I/Os for your applications.

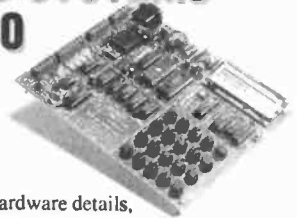

### 80C32 Computer/Microcontroller board with:

- 32K ROM, 32K RAM
- 2 by 16 Liquid Crystal Display
- 4 by 5 Keypad
- Digital, A/D, D/A, and PWM, I/O
- Built in Logic Probe
- Power supply, (can also be battery operated)
- Extended AES BASIC and AES Monitor in ROM  
Built-in routines for LCD, Keypad, A/D, D/A and Digital I/O ports  
See 80C32 registers while you Step  
See all memory locations and data on LCD  
See memory contents in dec. hex. and binary
- RS-232 cable to connect to PC for programming
- 8051/52 DOS Cross Assembler
- Program disks with well documented examples
- User's Manual, Language Manual, and Text

**AES**  
Advanced Embedded Systems

1407 North Batavia Street, Orange, California 92667, USA

\$365, Money Back Guarantee  
Free Brochure, M/C Visa  
800 - 730-3232  
714 - 744-0981  
Fax 714 - 744-2693

May 1995, Popular Electronics

115

Tap into a World of...

## FREE ELECTRICITY

Our 150+ page **Self-Reliance Catalog**  
IS JUST LOADED WITH DC to AC  
ENERGY INDEPENDENCE ...

We offer:

Solar, Wind & Hydroelectric energy systems. True Sine Wave DC to AC Inverters. Electric Boat & Car kits. Portable power packs. Solar Lighting & Cooling systems. Solar Pool Heaters. Solar Battery chargers. Solar Books & Toys. DC Appliances. Active & Passive Solar Air & Water Heating Systems. Composting Toilets. Hydroponic, Fish-Farming, Solarium & Greenhouse Systems. Water Testing, Treatment, & Pumping Systems. Emergency Food & H<sub>2</sub>O Kits. High Efficiency AC/DC Refrigeration + More...

A LOT OF INFORMATION FOR ONLY \$5.75 ...

SEND CHECK or MO TO:

**Self-Reliance Company Inc.**  
P.O. Box 306, Florissant, MO 63032

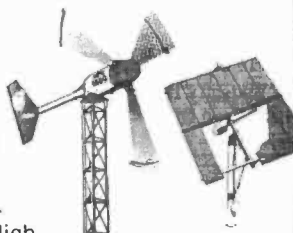

Low Cost CAD Software  
for the IBM PC and Compatibles  
Now In Windows™

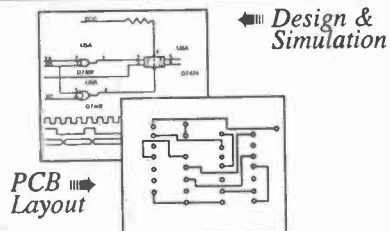

- Easy to use schematic entry program (SuperCAD) for circuit diagrams, only \$149. Includes netlisting, bill of materials, extensive parts libraries, More parts, and automatic wiring available in enhanced CAD package (SuperCAD+) for only \$249.
- Powerful, event-driven digital simulator (SuperSIM) allows you to check logic circuitry quickly before actually wiring it up. Works directly within the SuperCAD editor from a pulldown menu and displays results in "logic analyzer" display window. Starting at \$149 this is the lowest cost simulator on the market. Support for PALs, a larger library, and a separate interactive logic viewer are available in full-featured SuperSIM+ for only \$399. Library parts include TTL, CMOS and ECL devices.
- Circuit board artwork editor and autorouter programs (SuperPCB), starting at \$149. Produce high quality artwork directly on dot matrix or laser printers. You can do boards up to 16 layers including surface mount. Includes Gerber and Excellon file output. Autorouter accepts netlists and placement data directly from the SuperCAD schematic editor.
- Low cost combination packages with schematics and PCB design: 2-layer for \$399, 16-layer for \$649.
- DOS version available.

Write or call for free demo disks:  
**MENTAL AUTOMATION**   
5415 - 136th Place S.E.  
Bellevue, WA 98006  
(206) 641-2141  
BBS (206) 641-2846

# FACTCARDS

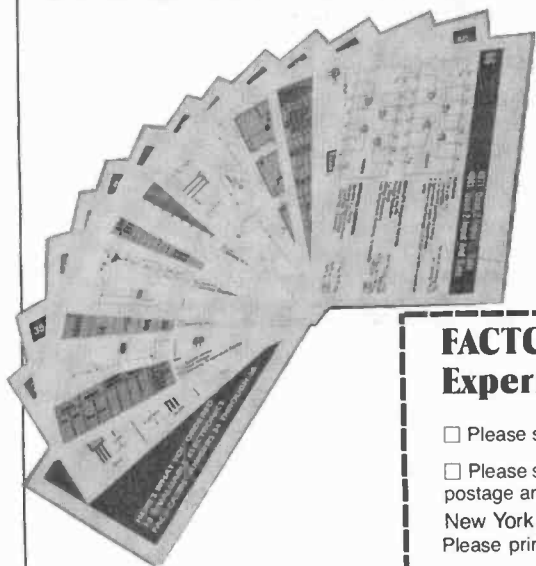

■ ALL YOU NEED to know about electronics from transistor packaging to substitution and replacement guides. FACTCARDS numbers 34 through 66 are now available. These beautifully-printed cards measure a full three-by-five inches and are printed in two colors. They cover a wide range of subjects from Triac circuit/replacement guides to flip-flops, Schmitt triggers, Thyristor circuits, Opto-Isolator/Coupler selection and replacement. All are clearly explained with typical circuit applications.

■ WANT TO EXPAND your knowledge of electronics? Do it the easy way

by studying the Electronics Fact Cards. Do you travel to and from your job each day? Drop a handful of cards in your pocket before you leave, and the bus becomes a schoolroom! At home, you can build some of the projects and not only have fun building and using them, but learn how they work at the same time.

■ YOU'LL BE AMAZED both at how rapidly you learn with these cards, and how easy it is to understand. These new cards are available right now. Don't miss out. Send your check or money order today.

## FACTCARDS—Facts at your fingertips for Experimenters and Project Builders!

Please send one copy of FACTCARDS at \$3.50. Shipping \$1.00 (U.S. and Canada only).

Please send \_\_\_\_\_ copies of FACTCARDS. Total cost is sum of copy price and First Class postage and handling cost multiplied by number of card sets ordered.

New York residents add sales tax to total cost of each order.

Please print

Allow 6-8 weeks for the material to arrive.

\_\_\_\_\_  
(Name)

\_\_\_\_\_  
(Street Address)

\_\_\_\_\_  
(City)

\_\_\_\_\_  
(State)

\_\_\_\_\_  
(Zip)

Detach and mail today:  
CLAGGK Inc.  
P.O. Box 4099  
Farmingdale, NY 11735

All Payment must be in U.S. Funds!

**Jampacked with information at your fingertips**

## Cable Test Aids Information

Orders only 1-800-452-7090 (310)902-0841

Test chips for JERROLD, TOCOM, ZENITH, S.A. & more. Puts cable boxes in full service mode. Easy installation. Zenith only \$39.95. Most others under \$50ea. FAX: (310)902-0851. Quantity prices available. No Ch. sales. Not for use in cable co. owned equip. For use as a test aid only.

### Satellite-TV

SAVE 40% - 60%  
800-334-6455  
218-739-5231 Int'l  
218-739-4879 Fax

**FREE Catalog**

**Skyvision Inc.**  
1048 FRONTIER DRIVE • FERGUS FALLS, MN 56537

### SMALL COMPANY • BIG DISCOUNTS!

CABLE TV DESCRAMBLERS AND CONVERTERS

Discover Top Brands Available American Express  
MasterCard SATISFACTION GUARANTEED! COD  
Visa 1-800-775-0444 Check by Phone

**T.C. ELECTRONICS**

Decoders and Descramblers must be not used without authorization by your local cable operator. No Tennessee sales.

## PE MARKET CENTER CLASSIFIEDS

### CABLE TV

**"BULLET" BUSTER.** Protect your cable box against the infamous cable "bullet." The "Bullet" Buster acts as an electronic shield. Installs in-line in seconds. Don't wait until it's too late! \$19.95 + \$3.00 S&H. Visa/MC. **ELECTROMAN**, Box 24474, New Orleans, LA 70184. (504) 482-3017.

**CABLE — SAFE.** Guarantee cable privacy. The one way valve for your cable TV signal. Cable signals come in, but they don't go out! \$29.95, + \$3.00 S&H. Visa/MC. **ELECTROMAN**, Box 24474, New Orleans, LA 70184. (504) 482-3017.

**DESCRAMBLER SCHEMATICS REVEALED.** A powerful guide to descrambling schemes. \$10.00. Visa/MC. **ELECTROMAN**, Box 24474, New Orleans, LA 70184. (504) 482-3017.

**CABLE UNSCRAMBLED.** Everything you want to know about cable, but are afraid to ask. \$10.00. Visa/MC. **ELECTROMAN**, Box 24474, New Orleans, LA 70184. (504) 482-3017.

**UNIVERSAL DESCRAMBLER.** Unscramble signals using your VCR as the tuner. Works with virtually any system, this is the only one you need. Declare cable box independence! \$129.95 + \$5.00 S&H. Visa/MC. **ELECTROMAN**, Box 24474, New Orleans, LA 70184. (504) 482-3017.

**CABLE DESCRAMBLERS,** build your own, SSAVI, gated sync, slinewave. \$14.95. Cabletronics, Box 30502PE, Bethesda, MD 20824.

**ACE PERSONAL security PRODUCTS** Cable boxes have make model ready. Call for free brochure 1 (800) 234-0726.

**ATTN. CABLE box owners.** Get your Bullet and ID stopper before it's too late. Send \$20.50 to R.R. Enterprise, Box 3532 Easton, PA 18043.

**CABLE DESCRAMBLER!** Build with Radio Shack parts for under \$12.00. Complete instructions. \$8.00: FAST, Box 369-EP, Pt. Salerno, FL 34992-0369.

**SAVE \$100'S** Facts, information, products, kits, descramblers **CABLE COMPANIES DON'T WANT KNOWN!!** Complete package. \$10.00 **SATISFACTION GUARANTEED!** ART, PO Box 5552PE, Hollywood, FL 33083-5552. (305) 537-3153.

# CABLE TV DESCRAMBLERS

Best Prices in the U.S.A.! Guaranteed to Work!

## WE WILL BEAT ANY PRICE!



JERROLD, SCIENTIFIC ATLANTA, PIONEER, FTB-3, SA3  
**THE NEWEST & THE LATEST**

Stealth - Jerrold Impulse & Starcom Series (advanced version of TNT & TVT)  
M80 - Scientific Atlantas incl. 8536/+, 8580, Drop-Field  
Super-Pio - Pioneer Systems (advanced version of Pioneer "Green")

PANASONIC TZPC145G 99 Channel Wireless Cable Converters  
ZENITEK XL2100 99 Channel Wireless Cable Converters

# 1-800-818-9688

M-F: 9-6 EST  
U.S. Cable TV, Inc. Dept.: KPE025

4100 N. Powerline Rd, Bldg. F-4 Pompano Beach FL 33073  
NO FLORIDA SALES!

## Earn \$4,000 Per Month From Your Home With A Computer!



**FREE** CBSI 486 Computer

Begin part-time and still retain the security of your present position. This is a proven turnkey business an individual or couple can run. If you purchase our software and business program, we will give you the computer and printer. If you already own a computer, you may receive a discount. You do not need to own, or know how to run, a computer—we will provide free, home office training. Financing available. We accept AMEX, MC, Visa and Discover.

To receive free cassettes and color literature, call:

**1-800-343-8014, ext. 1681**

Or Write:

Computer Business Services, Inc.  
CBSI Plaza, Ste. 1681, Sheridan, IN 46069

## SURVEILLANCE & SECURITY

### FM TRANSMITTERS MINI (KITS)

- 3-VOLT FM XMTR, up to 300 ft. Indoors, 1500 ft. outdoors
- PHONE XMTR, range to 500 ft., uses phone-line power
- Sound-Activated XMTR, range to 500 ft.
- 2-STAGE XMTR, 9-Volt, very powerful

All above require simple soldering at 2 to 4 places. **\$29.95\*\***

**TELE CALL FORWARDER.** Transfers incoming calls. **\$99.00\***

**CALLER ID.** Registers incoming number. **\$99.00\***

**TEL REGISTER WITH PRINTER.** Records dialed number, duration, and prints record. **\$169.00\***

**TEL REGISTER W/O PRINTER.** Records dialed number & time. 16-digit display. **\$99.00\***

**12-HOUR LONG-PLAY RECORDER.** Modified Panasonic. Records 6 hrs. on each side of 120 tape (supplied). Compatible with VOX and Tel Rec Adapter. **\$119.00\***

**VOX VOICE-ACTIVATED SWITCH.** Makes recorder self-activating with voices or other sounds. **\$28.50\*\***

**TELE RECORDING ADAPTER.** Records incoming and outgoing calls. **\$28.50\***

**TELEPHONE SCRAMBLERS.** Over 4,000 separate codes. **\$199.00\***

**VOICE CHANGER.** Changes man's voice to lady's and vice versa. **\$49.00\*\***

For Shipping & Handling add \*\*\$5.00 and \*\*\$2.00 per item. Colo. residents add sales tax. Mail Order, VISA, M/C, COD's o.k. Inquire for dealer prices. Free catalog.

**MUCH, MUCH MORE — OUR 25TH YEAR!**

**TOLL FREE 1-800-926-2488**

**A.M.C. SALES, INC.**

193 Vaquero Dr., Boulder, CO 80303  
Tel: (303) 499-5405, Fax: (303) 494-4924  
Mon.-Fri. 8 a.m.-5 p.m. Mtn. Time

# EARN MORE MONEY!

## Be an FCC LICENSED ELECTRONIC TECHNICIAN!



No costly school. No commuting to class. The Original Home-Study course prepares you for the "FCC Commercial Radio-telephone License." This valuable license is your professional "ticket" to thousands of exciting jobs in Communications, Radio-TV, Microwave, Maritime, Radar, Avionics and more...even start your own business! You don't need a college degree to qualify, but you do need an FCC License.

**No Need to Quit Your Job or Go To School**  
This proven course is easy, fast and low cost! **GUARANTEED PASS**—You get your FCC License or money refunded. **Send for FREE facts now. MAIL COUPON TODAY!**

Or, Call 1-800-932-4268 Ext. 240

### COMMAND PRODUCTIONS

FCC LICENSE TRAINING, Dept. 240  
P.O. Box 2824, San Francisco, CA 94126  
Please rush FREE details immediately!

NAME \_\_\_\_\_  
ADDRESS \_\_\_\_\_  
CITY \_\_\_\_\_ STATE \_\_\_\_\_ ZIP \_\_\_\_\_

Make your projects speak for themselves...  
Ours do!

### DIGITAL VOICE RECORDERS

- Record up to 218 seconds
- 1 to 8 messages
- High quality speech 12 bit
- Switch-closure actuation
- Sample rates up to 20Khz
- On-board backup
- Direct speaker output
- Wide operating range
- Small size 2.6" X 2.6"
- Made in U.S.A.

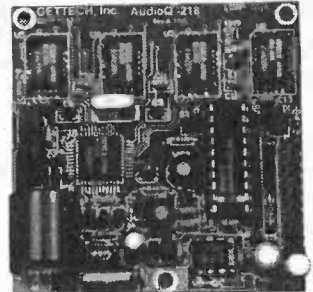

MODEL AudioQ™-218

Call or write for more information  
OEM price and delivery available  
Custom designs and enclosures  
Single unit price \$149.00 plus s+h  
Quantity pricing as low as \$99.00

## GETTECH, Inc.

402 Riley Road, New Windsor, NY 12553  
(914) 564-5347

Specifications and price subject to change.

## PCBoards

## PCB Artwork Made Easy!

PRINTED CIRCUIT DESIGN SOFTWARE  
for  
**Layout - Autorouting - Schematic**

- \* Supports all Video Modes including SVGA
- \* Copper Flooding for Ground Areas
- \* Mirror Imaging for Laser Output
- \* Circuit Simulation Programs available
- \* **NEW - WINDOWS**™ versions
- \* **NEW - DOS** versions
- \* **FREE** - Heat Transfer Film with Order
- \* Great for All Printed Circuit Projects

Download Demos from BBS (205)933-2954

**PCBoards Layout Only ... \$99.00**

**Layout** for Windows™ starts at ... **\$149.00**

Call or Write for Full Product Line, Prices & Demo Packages

PCBoards  
2110 14th Ave. South  
Birmingham, AL 35205

(800) 473-7227  
Fax (205) 933-2954  
Phone (205) 933-1122



Powerful Integrated Digital and Analog (Berkeley Compatible Spice)  
Circuit Design and Simulation Software for Microsoft Windows (network compatible)

**Best value in town!! Includes 4 Integrated Modules: LogicDesigner + WinSpice + WinScope + Symbol Editor**

**Perfect For Students, Technicians and Engineers!!!**

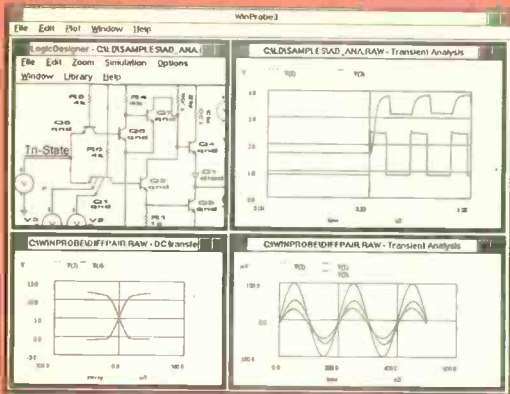

Simply connect your circuit on the screen, enter simulation options, then kick back and watch it work!! Comes with two Spice libraries plus 5 more libraries of Active Digital Devices CMOS, 74xx, 74xxx, ALUs, counters, MUX, FFs etc. Plus a Passive symbol library of Microprocessors and more. Use the Symbol Library Editor to Design your own symbols and symbols to represent Sub-circuits, True Bussing, Buss pins can be assigned Unique Names, Parts Billing List, Legends, Nested Subcircuits for Hierarchical Top Down or Bottom Up Design, Checks Fan Out Violation and Electronic Rules, Device Unit Numbers/Chip Pinouts Automatically added as per Data Books, Connectors Spice Netlist Generation, Continuous ZOOM In/Out, Cut/Copy/Paste, Multiple Rotatable Fonts, Rotatable Symbols, Multipage Zoomed In/Out: Printouts to any Windows Printer. ON LINE HELP

**LogicDesigner Digital Simulation/Schematic Capture Module**

Interactive Digital Simulation and Schematic Capture, Single Step Mode, Variable Speed Simulation, Programmable Digital Delays, Multi Waveform Scrolling Timing Diagram Memcrizes up to 30000 Ticks Worth Of Timing Data, Truth Table Generation, Binary to 7 Segment Displays, Hex Keypads, Programmable Clock Sources, Logic Probes. Built in Logic Analyzer can be set up to generate Edge or Level Sensitive Breakpoints, or when Signals are Equal To, Greater Than, or Less Than a Certain Value or any AND/OR Combination. Sequential Breakpoints help Track Down and Debug Circuit Race Conditions Glitches, Setup and Hold Violation and other Circuit Design Errors. Simulates Tri State, Open Collector & Don't Care Logic, RAM/ROM, One Shot, Carry Look Ahead, Shift reg, Full Up/Down Resistors.

**WinSpice Simulator & WinScope Data Analyzer Modules**

**SPICE LIBRARY:** MOSFET, GaSFET, BJT, FET, Diode, OpAmps, Compators, 555 Timer, Resistor, Cap, Inductor, Transmission Line, Controlled, Independent, Dependent, Arbitrary Source, Pulse, Sin, Piece Wise Linear, and FM Sources, Current and Voltage Controlled Switches. All models Expandable And User Modifiable. Imports **MACRO MODELS** of Your Favorite Manufacturer Supplied Parts.

**ANALYSIS TYPES:** AC, DC, TRANSIENT, POLE-ZERO, NOISE, SENSITIVITY, FOURIER, TRANSFER FUNCTION, AND OPERATING POINT ANALYSIS.

**DATA ANALYZER:** Graphs Simulation Results using Multiple Plot Windows and Waveforms. Plots Linear, Logarithmic, Polar, Smith Chart, BODE Type Plots + More. ZOOM in and out of Plot Waveforms. Plots Complex Math Expressions Using Plot Variables As Arguments, Calculates Derivatives, Log, Trig functions, Define Macros of Complex Math Formulas.

Price \$99.99 reg \$179.99 S&H \$3.00 VISA/MC

**ISLAND LOGIX INC.**

920 South West 95 Terrace  
Pembroke Pines, Florida 33025 U.S.A.  
PH (817) 428-0070 FAX (817) 428-0006

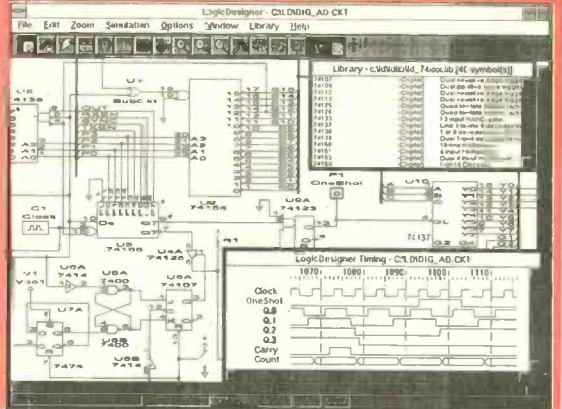

CIRCLE 144 ON FREE INFORMATION CARD

# MCM Electronics<sup>SM</sup>

## Discover The Difference

MCM Electronics is the comprehensive source for all of your electronics needs. We feature TENMA test equipment, a wide variety of speaker components (over 140 woofer models), two way radio products and accessories, computer and security products. In addition, we have a huge variety of semiconductors, service and repair parts, specialized tools and much more. Call for your free catalog and discover the MCM Electronics difference today.

**FREE CATALOG...**  
**1-800-543-4330**

Product questions ...1-800-824-TECH (8324)

New Hours: M-F 7a.m.- 9p.m.,  
Sat. 9a.m.- 6p.m. EST  
Over 21,000 items stocked and  
shipped within 24 hours



**MCM ELECTRONICS<sup>SM</sup>**  
650 CONGRESS PARK DR  
CENTERVILLE, OH 45459-4072  
A PREMIER Company



GET FAST DELIVERY FROM OUR DISTRIBUTION CENTERS IN DAYTON, OH AND RENO, NV!

POP-18

CIRCLE 155 ON FREE INFORMATION CARD

May 1995, Popular Electronics

# FINDER Modular Data System - The Electronic Data Book -

FINDER MDS Version 5.0 is a program specially designed to search for Electronic components characteristics. It's the perfect tool for Students, Hobbyists, Engineers and repair companies.

## MAIN FEATURES

- Searching for components by Name, Function or Technical characteristics.
- Equivalences for Diodes, Transistors and MosFet (including package compatibility).
- Integrated Circuits cross reference table which gives more than 283,000 ICs substitutions.
- Technical forms up to 900 lines of information for a component, customizable forms for Discrete semi conductors search.
- More than 260 layout files wick include package drawings and dimensions.
- Printout facilities for technical forms and drawings, Graphic and text editors included with the program.

The 32,000 component references Data Base covers the following families

## DISCRETE SEMI CONDUCTORS

- 15,000 Bipolar Transistors (up to 2,200 V, 200 A) including references for 2SA, 2SB, 2SC, 2SD.
- 2,400 MOSFET, V-MOSFET including references for 2SK, 3SK, 2SJ, 3SJ.
- 4,700 Diodes including Regulation, Varicap, Zener, Signal, Rectifiers...

## MEMORIES

2,000 memories including RAM, PROM, EPROM.

## INTEGRATED CIRCUITS

More than 7,800 circuits including TTL-LS, CD4000, HC-MOS, Op Amps, Audios Amps, Voltage Regulators / Supervisors / Comparators, PALs, Display Drivers, Data Transmission, TV-Video, Micro Processors 68000 MOTOROLA.

**FINDER MDS Version 5.0 - Now Only \$ 149.95 (S & H charges not included)**

**To order call : 1- 800 (305) 561 3237**

Visa & Mastercard accepted - Florida residents must add local sales tax.

FINDER MDS runs on IBM PC AT or true compatibles with 1 Mo RAM, HD, EGA/VGA display, DOS 3.1 min.

## Electronics Software Solutions

3025 N. Ocean Blvd, Fort Lauderdale, Florida 33308 - Phone : (305) 561 4340 - Fax : (305) 561 4418

## CABLE TV EQUIPMENT

We carry a complete line of all major brands including test chips and all accessories  
BELOW WHOLESALE PRICES • QUANTITY DISCOUNTS  
30 DAY MONEYBACK GUAR. • 1 YR. WARRANTY  
YEARS OF CUSTOMER SATISFACTION  
**C & C ELECTRONICS**  
CALL NOW 1-800-995-1749  
Immed. Delivery from Giant Stock! Sorry no Florida Sales

## SURVEILLANCE

& COUNTERSURVEILLANCE Electronic Devices  
Covert Video Cameras • Transmitter Kits • Voice Changers  
Bug and Phone Tap Detectors • Shotgun Mics • Micro Recorders  
• Vehicle Tracking • Locksmithing • AND MORE!  
16 - Hour Telephone Recorder - silently tapes incoming/outgoing phone calls automatically. **\$199.00**  
SDY FOR CATALOG SEND \$5.00 TO... CREDIT CARDS WELCOME  
OUTLET P.O. Box 337, Buffalo, NY 14226 (716) 691-3476

## PE MARKET CENTER CLASSIFIEDS

### SATELLITE EQUIPMENT

**SATELLITE RADIO BOOK AND GUIDE.** New book covers all audio services, SCPC, subcarriers, FM squared, facsimile, press services, weather services. Simple how-to-receive instructions. \$16.95 plus \$3.00 Priority Mail. UNIVERSAL ELECTRONICS, 4555 Groves Road, #12, Columbus, OH 43232. (614) 866-4605.

**VIDEOCIPHER II** descrambling manual. Schematics, video and audio, \$18.95. Software, \$25.00. Videocipher II 032, \$15.00. Videocipher II Plus, \$20.00. VCII Plus software, \$30.00. Cabletronics, Box 30502PE, Bethesda, MD 20824.

**SATELLITE TV REPORT.** Easy-to-read consumer guide explains how-to choose, install, and maintain large and small dish home TV systems. Free information. NCK Publications, 26893 Bouquet Canyon Rd., Suite C2 #173, Santa Clarita, CA 91350.

### SECURITY

**SECURITY SYSTEMS** Devices of all types, control panels, motions, sirens, CCTV, more. **SPECIAL PACKAGE** DSC 6 zone control with remote keypad fully programmable digital communicator for monitoring back-up battery siren contacts motion **ONLY \$195.00.** Catalog with order 1 (800) 335-2296, fax (519) 541-1277. Check/Visa: A-1, 2-1200 London Rd., Suite 274, Sarnia, Ontario N7S-1P4 Canada.

## \$139\* Laser LightShow

Draw with a laser beam! Animation, text, music & more! Includes galvos, servo amp, oscillators, software listing, analog & digital computer interfaces. Call for details

## Computerized Motors \$39\*

Includes: 2 Stepper motors, computer interface, 32 page training manual, & software listing. Expandable system! Up to 12 motors, up to 3 amps per phase. Call for details

\* Add \$6 for shipping. Computer with parallel printer port, Assembly, Power supply, & Laser are required

Call or fax for **FREE FLYER**

**SVS**

Light & Motion  
in kit form

1273 Industrial Pkwy. West Bldg. 460  
PO Box 55125  
Hayward CA 94545-0125

Voice **510-582-6602**  
Fax **510-582-6603**

## CABLE TV CHANNELS

**Direct!** **GUARANTEED**  
The nationwide source for cable TV equipment.

**"BUY WHERE THE DEALERS BUY."**

**FREE** TV Cable Descramblers and Converters Catalog. Open Every Day!

**YOUR VCR TAPES CAN PLAY AS CLEAR AS DAY!**

UNJAM NOW WITH **Video Decoder**

- Easy Connections
- Eliminates "jamming"
- Copy any tape
- RC Plugs Included
- 2 Year Warranty
- 30 Day Money Back Guarantee

VISA • MC C.O.D. **1-800-676-6342** SAVE 1000's

21 S. Main St., Winter Garden, FL 34787

## Digital Storage Oscilloscope For \$169.95 ???

And much, much more!

O-Scope I turns PC-ATs into DSO, spectrum analyzer, frequency counter, DVM. DC-50KHz

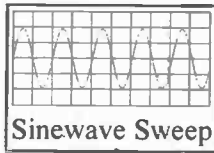

Actual O-Scope  
Signal Traces

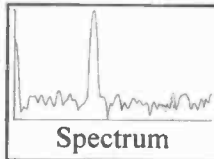

For Orders and Inquiries Call: 1-800-980-9806  
For Technical Assistance: 1-713-777-0401

**Allison Technology Corporation**  
8343 Carvel, Houston, TX 77036  
FAX and BBS 1-713-777-4746

## SHOW TIME CABLE

*Your Cable  
Connection  
To The Stars!*



Order your **FREE**  
catalog today!  
**1-800-643-4258**



### STARGATE SST

- Converters & Descramblers
- All Makes & Models
- Quantity Discounts
- 30-day Money Back Guarantee
- Best Warranties

Show Time Cable  
643 N 98th St STE 260  
Omaha, NE 68114

COD • MasterCard • Visa • Amex • Discover

## ❖ ATTENTION CABLE VIEWERS ❖

**CABLE VIEWERS...** get back to your **BASIC** Cable Needs

**Call 800-577-8775**

For information regarding all of your **BASIC** cable needs.

**5 GOOD REASONS TO BUY OUR FAR SUPERIOR PRODUCT**

- ❖ PRICE
- ❖ EFFICIENT SALES AND SERVICE
- ❖ WE SPECIALIZE IN 5, 10 LOT PRICING
- ❖ ALL FUNCTIONS (COMPATIBLE WITH ALL MAJOR BRANDS)
- ❖ **ANY SIZE ORDER FILLED WITH SAME DAY SHIPPING**

We handle **NEW** equipment **ONLY** - Don't trust last year's **OBSOLETE** and **UNSOLD** stock!  
**COMPETITIVE PRICING—DEALERS WELCOME**

**HOURS: Monday-Saturday 9-5 C.S.T.**

It is not the intent of B.E.S.W. to defraud any pay television operator and we will not assist any company or individual in doing the same.  
\*Refer to sales personnel for specifications.



**BASIC**  
**ELECTRICAL**  
**SUPPLY &**  
**WAREHOUSING**  
**CORPORATION**

**P.O. Box 8180 ■ Bartlett, IL 60103 ■ 800-577-8775**

# BLACK FEATHER ELECTRONICS

## 3 1/2 Digit LCD Panel Meter

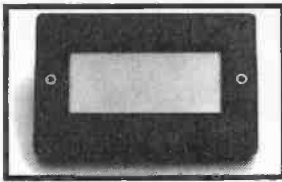

Features: 200mV full scale input 9VDC operation. Decimal point selectable. 13mm digit height, auto polarity indication, zero reading for 0 volt input. Measures 2.67" x 1.73" x 0.28" above panel thickness, 0.57" overall thickness. LCD size: 1.83" x 0.8". Has many useful applications and is easy to install.  
CAT# PM-1 **\$17.00 each**

## Stepper Motor Controller Kit

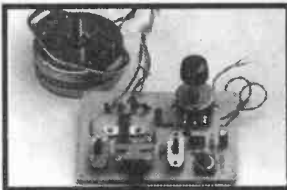

This kit allows you to adjust the speed and direction of a stepper motor. You can move the motor in one step increments or rotate it at a constant speed. Visual indicators show the sequence of motion. Includes stepper motor, pc board, parts and instructions. (12vdc power source not included.)  
CAT# SMK-1 **\$25.00 each**

## Camcorder Video Tape



**HI-8 120 MINUTE TAPE (used)**  
They were recorded on once and played only a few times. Made by a major brand name manufacturer. Professional series metal tapes. Includes plastic jewel box.  
CAT# CCT-1 **\$3.00 each**  
**10 or more - 2.80 each**

**1-800-526-3717**

645 Temple 78 ▲ Long Beach ▲ California 90814  
▲ (310) 434-5641 ▲ FAX (310) 434-9142 ▲

1. California residents must include sales tax.
2. Checks and money order accepted.
3. Quantities limited - prices subject to change.



One tree can make  
3,000,000 matches.



One match can burn  
3,000,000 trees.



A Public Service of The Magazine  
& The Advertising Council

## EPROM+ PROGRAMMING SYSTEM USES PARALLEL PORT

**EPROMS (24,28,32 & 40 PIN\*) PLUS 27CXXX**  
1702\*, 2708, TMS2716\*, 32, 32A, 64, 64A, 128, 128A  
256, 512, 513, 011, 010, 101, 1001, 1000, 1024, 210, 020  
2001, 220, 204R, 4001, 040, 240, 4096, 25XX, 68764/66  
**FLASH EPROMS** 28F256, 28F512, 28F010  
28F020, 29C257, 29C010, 29F010  
**EEPROMS & NVRAMS (18, 24 & 28 PIN+CXX)**  
2210, 2212, 2804, 2816, 2816A, 2817, 2864, 2865, 28256  
28C010, DS1220, DS1225, DS1230  
**SERIAL EEPROMS\* (8 & 14 PIN PLUS CXX)**  
ER1400, MS8657, 2401, 02, 04, 08, 16, 2444, 59C11  
9306, 46, 56, 66, 8572, 82, 92  
**BIPOLAR PROMS\* (16 THROUGH 24 PINS)**  
74SXXX AND 82SXXX FAMILY  
**MICROCONTROLLERS\*** 8741, 42, 48, 49, 8751  
CS1, 8752, 87C52, 87C5XX, 87C751, 87C752, 68705  
68HC705, 68HC711E9, PIC16C5X, TMS7742  
\*ADAPTER REQ'D - DIAGRAMS INCLUDED

**SOFTWARE - READ, VERIFY, PROGRAM, COPY**  
DISK FILE LOAD/SAVE, CHECKSUM, FULL  
SCREEN BUFFER EDITOR W/20 COMMANDS  
**READS HEX, S-RECORD AND BINARY FILES**  
**FAST-DEVICES PROGRAM IN UNDER 60 SEC**  
**RUGGED (8" X7" X3") ENCLOSURE W/HANDLE**  
**MADE IN USA - 1 YEAR WARRANTY**

**ANDROMEDA RESEARCH, P.O. BOX 222, MILFORD, OH 45150**  
**(513) 831-9708 FAX (513) 831-7562**



**SYSTEM INCLUDES:**  
PROGRAMMING UNIT  
PRINTER PORT CABLE  
POWER PACK, MANUAL  
AND SOFTWARE.

**\$289**

ADD \$5.00 SHIPPING  
\$5.00 C.O.D.  
VISA/MASTERCARD



## AUTOMATE YOUR HOME

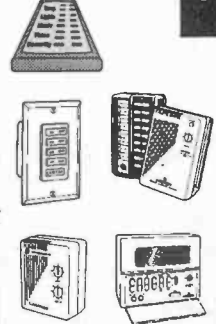

Hundreds of hard-to-find home automation and wireless control products. Computer control of your home, security systems, surveillance cameras, audio/video control, HVAC, pet care automation and much more. Easy do-it-yourself installation on most products. Affordable, systems start at about \$20.



*Largest Selection of X10 Compatible Products in the World*  
Call for our Free 64 page Color Catalog  
**800-SMART-HOME (800-762-7846)**  
**HOME AUTOMATION SYSTEMS, INC.**

151 Kalmus Dr., Ste M6, Dept. PE2, Costa Mesa, CA 92626  
Questions 714-708-0610 Fax 714-708-0614

## MICRO CAMERA

Sees an entire room through an 1/8" hole

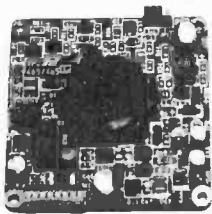

**\$215** introductory price

Only 1.65 x 1.65 x .5 inches  
90° field of view  
operates on 12 volts DC  
380 lines of resolution  
built in electronic iris  
low light .5 lux  
standard video output

NortheastMicro

1-800-886-8699

Po box 176 Elmwood Park NJ 07407

## MEETING TOMORROW'S CHALLENGES TODAY

The men and women in the Navy's Seaman/Airman/Fireman Program are working for America, while learning valuable skills through on-the-job training. They're building solid futures, succeeding in a competitive, high-tech world and advancing as quickly as their abilities and performance allow. Find out more about the Seaman/Airman/Fireman Program, as well as other exciting Navy job opportunities, from your local Navy recruiter. This ad is brought to you as a public service.

**Navy. Full Speed Ahead.**



# FCC Commercial License

## Why Take Chances?

Discover how easy it is to pass the exams. Study with the most current materials available. Our Homestudy Guides, Audio, Video or PC "Q&A" pools make it so fast, easy and inexpensive. No college or experience needed. The new commercial FCC exams have been revised, covering updated Aviation, Marine, Radar, Microwave, New Rules & Regs, Digital Circuitry & more. We feature the Popular "Complete Electronic Career Guide"

1000's of satisfied customers  
**Guarantee** to pass or money back.  
 Send for **FREE DETAILS** or call

**1-800-800-7588**

WPT Publications  
 4701 N.E. 47th Street  
 Vancouver, WA 98661

Name \_\_\_\_\_

Address \_\_\_\_\_

City \_\_\_\_\_ St. \_\_\_\_\_ Zip \_\_\_\_\_

**1-800-800-7588**

# CABLE TV DESCRAMBLERS



We have Descramblers for:

- Jerrold™ Systems
- Scientific Atlanta™ Systems
- Tocom™ Systems
- Zenith™ Systems
- Pioneer™ Systems

**GUARANTEED TO WORK OR YOUR MONEY BACK!**  
**BEST PRICES FREE CATALOG**

Please have the **MAKE & MODEL #** of your area's cable box ready when you call!

**ALLSTAR ELECTRONICS**  
**800-782-7214**

**HOURS: 9-6 M-F 10-3 Sat EST**

It is not the intent of ALLSTAR ELECTRONICS to defraud any pay TV operator and we will not assist any company or individual in doing the same. Prices subject to change without notice.

# PE MARKET CENTER CLASSIFIEDS

## MISCELLANEOUS ELECTRONICS FOR SALE

**THE CASE Against Patents.** Thoroughly tested and proven alternatives that work in the real world. \$28.50. **SYNERGETICS PRESS**, Box 809-C, Thatcher, AZ 85552. (602) 428-4073. Visa/MC.

**TURBO CHARGE** your amplifier. Guide to increase wattage of existing power amplifiers. Send \$7.50 for complete book. **JAM Electronics**, 7391 St. Hwy 78, Gratiot, WI 53541.

## PLANS-KITS-SCHEMATICS

**BUILD — FIVE-digit**, ohms, capacitance, frequency, pulse, multimeter. Board and instructions. \$9.95. **Bagnall Electronics**, 179 May, Fairfield, CT 06430.

**ALL-IN-ONE catalog.** AM/FM/ham/spy, transmitters, amplifiers, receivers. Voice scramblers/disguisers, audio, TV, Tesla coils, plans, "secret" books, kits, imports, exports and more. Start your own licensed or unlicensed radio station, 60 full pages for \$1.00. **PAN-COM INTERNATIONAL**, PO Box 130-H5, Paradise, CA 95967.

**FM STEREO TRANSMITTER** kit broadcasts any audio signal to FM stereo radios throughout your home. Uses unique BA1404 IC. Complete kit: PC board/components — \$24.00. Visa/MC. **TENTRONIX**, 3605 Broken Arrow, Coeur d'Alene, ID 83814. (208) 664-2312.

**HOBBYIST CIRCUITS** — Remote room monitor, tone decoder, long distance circuit control and more. Simple experiments for the beginner. **CATALOG \$2.00** — Garrett Plans, Box 155, Jamesburg, NJ 08831.

**SURVEILLANCE TRANSMITTER** kits. 65 to 305 Mhz. Quick & Easy. Partially assembled units. Five minutes completion. 110-volt duplex receptacle, room battery types, and telephone. Counter-surveillance. Catalog: \$2.00. **SHEFFIELD ELECTRONICS**, PO Box 377940-B, Chicago, IL 60637-7940.

**YOU WON'T** be caught flashing with **SILENT SAM**. Patented vehicle turn signal reminder warns when not to. Kit w/case \$15.00. Also, \$22.00/\$27.00 wired models plus \$2.50 S&H. Visa/MC. Money back guar. Toll free 1 (800) 398-5605, free flyer. **Silent Sam**, 1627 Basil Dr., Columbus, OH 43227.

**CRYSTAL SET Handbook** — Visit antiquity by building the radios your grandfather built. Assemble a "Quaker Oats" rig, wind coils that work and make it look like the 1920's! Only \$10.95 plus \$3.50 for shipping and handling. **CLAGGK Inc.**, PO Box 4099, Farmingdale, NY 11735. US funds only! USA and Canada — no foreign orders.

**SPY EQUIPMENT!** Transmitters! Surveillance, countersurveillance! Scramblers! Catalog, free plan \$5.00. **KDT WHOLESALERS**, 2219 Paliswood Place SW, Calgary, Alberta, Canada, T2V 3R3.

**THIS AD COULD SAVE YOUR LIFE, COMBUSTIBLE GAS, CO2, EMI AND OTHER EXOTIC SENSORS + SMT (Surface Mount Tech) Kits** w/tools, manuals, & PCB's both analog and digital. For free catalog write **pcSMT Co.**, 9047 Willis #3, PC, CA 91402. Or call (818) 891-9892 7-5pm PST.

**MICROCONTROLLER: SABB0C535**, A/D conv., 64K RAM/EPPROM, RS232, 32-bit I/O, expandable, 5V operation, small size. Runs Basic31, Basic535, TBasic or 8051 code. PCB \$20.00, kit \$95.00, A&T \$130.00. Check or credit card. **ACE**, 2413 S. Collins, Arlington, TX 76014. (817) 860-1131.

**NIGHT VISION** Complete kits and plans. Easy assembly. **Military quality components.** Save big bucks! Also sell preassembled, fully warranted units and unusual electronic kits. Write or call for free brochure: **Mike Piligian**, PO Box 1088, Sturbridge, MA 01566. (508) 347-7238.

**Quality Microwave TV Antennas**

**WIRELESS CABLE - IFTS - MMD5 - Amateur TV**  
 Ultra High Gain 50db(+) • Tuneable 1.9 to 2.7 Ghz.

- 55-Channel Dish System \$199.95
- 36-Channel Dish System \$149.95
- 20-Channel Dish System \$124.95
- Optional Commercial Grid Antenna (not shown) Add \$50.00
- Yagi Antennas, Components, Custom Tuning Available
- Call or write (SASE) for "FREE" Catalog

**PHILLIPS-TECH ELECTRONICS**  
 P.O. Box 8533 • Scottsdale, AZ 85252  
**LIFETIME WARRANTY** MasterCard • Visa • American Express • C.O.B.'s • Quantity Pricing

**FASCINATING DEVICES! FREE** plans with parts special! Super spy microphone \$19.50! Super FM transmitter varactor tuned \$22.50! Vocal truth detector \$39.50! Bug detector 10 GHz bargraph, audible \$47.50! Universal IC tester tests any IC \$24.50! Hypersonic dazer defend yourself \$34.50! Radar cloaker electronic shield \$29.50! Laser jammer \$39.50! PC Boards \$10.00 each. Package of all 8 plans \$25.00! S&H \$5.00, catalog \$4.00 (creditable) or included with order!  
**QUANTUM RESEARCH**, 17919 - 77th Avenue, Edmonton, Alberta, Canada T5T 2S1.

**1TUBE 80-40** Breadboard transmitter kit. Not a toy! Complete kit for both 80 and 40 meter amateur bands. To order send \$39.00 to N2EDF, PO Box 185, Ogdensburg, NJ 07439. Or write for more information.

**SERVO SUBWOOFER!** Build this high performance servo subwoofer from readily available parts. Great addition to a high quality audio system. For plans, send \$6.00 to Servo Loudspeaker Company, 5540 South 235 East, Murray, Utah 84107.

# BUGGED??

**SAVESDROPPING** is unbelievably widespread! Electronic Devices with amazing capabilities can be monitoring your telephone and room conversations **RIGHT NOW!** Are you sure you're safe? **FREE CATALOG** tells you fast! Includes Free Bonus details on fantastic opportunities now open in Counter-Surveillance field. Exciting, immensely interesting and **EXTREMELY** profitable (up to \$250/hr) full/part-time income. Call Now! **1-800-732-5000**

## MISCELLANEOUS ELECTRONICS WANTED

**TEST EQUIPMENT WANTED.** I will buy your late model test equipment, electronic components, commercial and military connectors. Small quantities or entire inventories. **Bob Morgan**, Test Equipment Sales, Ph/Fx (717) 842-1534.

# !!! BROADCAST FARTHER !!!

The model 1525 is a 75-110MHz RF amplifier that connects to mono or stereo FM transmitters and produces a powerful 15-20 watt signal which could broadcast up to 5 miles or more! Requires 75-250 mW drive. Step by step plans complete with part source information and antenna designs... **ONLY \$14 PLUS \$2 S&H NO C.O.D.'S**

**Progressive Concepts**  
 1434 N. MILLS AVE., SUITE A  
 CLAREMONT, CA 91711 (909) 626-4969 (909) 626-4FAX

# Prototype it..... FAST!

with ProtoQuick 8051 or 8052

- Complete single board computer
- Up to 32K EPROM and 8K RAM
- 12 on-chip, buffered, through probe area
- RS232 C serial port w/ DB25 conn.
- Chip eyes in EPROM w/ accurate code
- Assembled, ready to run - for only
- MS-DOS cross assembler included

ProtoQuick 28 and 8051  
**\$99.00 each**

Software Solutions  
 2700 Rockwood Road  
 Clarks Summit, PA 17015 USA  
 (513) 561-2080

Run prototype applications or experimental hardware from the serial port - WITHOUT PROGRAMMING!

## EDUCATION

**LEARN IBM PC ASSEMBLY LANGUAGE.** Disk \$5.00, Book \$18.00. ZIPFAST, Box 12238, Lexington, KY 40581-2238.

THE #1 YEAR CLOSING • END OF YEAR CLEARANCE

# MECI

VALUES

**Free Catalog**

1-800-344-4465

If you are not getting this catalog you are missing out on some of the best deals in electronics today! We have thousands of items ranging from unique, hard-to-find parts to standard production components. Call, write, or fax today to start your free subscription to the most unique catalog in the industry, filled with super values on surplus electronic and hobbyist type items. If you have a friend who would like to receive our catalog, send us their name and address and we will gladly forward them a complementary 56 page catalog.

Why pay more? Call today.



340 East First Street Fax Order Line  
Dayton, Ohio 45404 1-800-344-6324

Order Toll-Free  
1-800-344-4465

CIRCLE 149 ON FREE INFORMATION CARD

Save Big \$ and watch what you want!

## Cable TV Descramblers

Converters \* Filters \* Accessories

30 day Free Trial - NO RISK!  
Unbeatable wholesale prices!  
Affordable extended warranty  
1 Year Warranty on all products

Free Catalog

Call the cable professionals!

Credit Cards Welcome!

1-800-379-3976

We'll beat anyone's price!

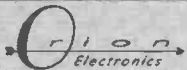

Prices starting as low as \$99!

## Get your copy of the CRYSTAL SET HANDBOOK

Go back to antiquity and build the radios that your grandfather built. Build the "Quaker Oats" type rig, wind coils that work and make it look like the 1920's! Only \$10.95 plus \$3.50 for shipping and handling. Clagg Inc., P.O. Box 4099, Farmingdale, NY 11735 USA Funds ONLY! USA and Canada—no foreign orders.

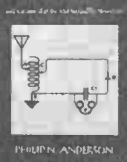

## PROFESSIONAL SURVEILLANCE EQUIPMENT Used By Law Enforcement Agencies

### VHF-FM CRYSTAL CONTROLLED TRANSMITTERS

A - 139MHz, B - 139.970 MHz, C - 149 MHz, D - 149.450 MHz  
All kits assemble in less than 5 mins.

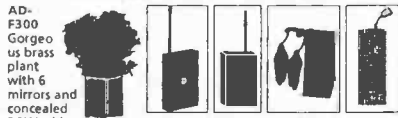

AD-F300	AD-700	AD-80	AD-550	AD-400
Gorgeo us brass plant with 6 mirrors and concealed B&W video camera and video transmitter. Great for monitoring in living room, conf. room, office, or anywhere. Range 150 ft. \$880. (\$990 w/aud)	Mic Range: up to 5 Mile Power 750MW \$272	Mic Range: up to 1.8 Mile Power 80MW \$187	Tel. Range: up to 5 Mile Power 35MW \$150	Mic Range: up to 2.5 Mile Power 400MW \$163

If you need our technology in a diff. configuration for your needs, call! We can probably build it for you. We have other state-of-the-art surveillance equip. too!

We sell a variety of cameras, bug detectors, night vision equipment, video transmitters, time lapse recorders, remote video monitoring systems, and many more...

### A&D ELECTRONICS

P.O. Box 601, Monsey, NY 10952  
914-356-7541 • Fax 914-356-7505  
Request our full catalog for \$6, get \$10 off your first order.  
Credit Cards accepted

## Get the Best Meter .....for your Dollar

### An Engineering Workhorse for...\$29.95

#### Dealer List

Sunex Electronic Supply  
4 Locations in FL  
(813) 885-4074

Lyntronics Phoenix, AZ  
(602) 841-8690

Minute Max Electronics Fremont, CA  
(510) 791-8036

Gateway Electronics 3 Locations  
(314) 427-8115

ACE Electronics San Jose, CA  
(408) 297-1383

Alltronics San Jose, CA  
(408) 943-9774

Wairdstuff Sunnyvale, CA  
(408) 746-1066

Additional Dealers Welcome

Large 13/16" LCD Display

1 Yr Warranty

Auto PWR Off

Diode Test with Buzzer

Resistance 200 Ohms to 20M Ohms

DC Current 200µA to 20A

AC Current 200µA to 20A

Gray Colored Case 3.5"W x 6.75"H



Engineering Unit Display

Transistor Tester

DC Volts 200mV to 1000V

AC Volts 200mV to 700V

Precision Rotary Switch

Easy Access Battery Compartment

Tilt Stand

See Your Local Dealer or Call

9am to 5pm Pacific Std. Time  
800-470-WIND (9463)  
Fax: 408-987-7735

Item# X3900 **\$29.95**

Item# X3910 with Capacitance..... **\$39.95**

Item# X3920 with Capacitance & Temp. .... **\$44.95**

Note: Add \$4.00 for Shipping and Handling

# Windward Products

We Stand Behind our Products..Satisfaction Guaranteed  
P.O. Box 378, Moffett Field, CA. 94035

## Surface Mount Chip Component Prototyping Kits—



Only \$49.95



CC-1 Capacitor Kit contains 365 pieces. 5 ea. of every 10% value from 1pf to .33µf. CR-1 Resistor Kit contains 1540 pieces; 10 ea. of every 5% value from 10Ω to 10 megΩ. Sizes are 0805 and 1206. Each kit is ONLY \$49.95 and available for Immediate One Day Delivery!

Order by toll-free phone, FAX, or mail. We accept VISA, MC, COD, or Pre-paid orders. Company PO's accepted with approved credit. Call for free detailed brochure.

COMMUNICATIONS SPECIALISTS, INC.  
426 West Taft Ave. • Orange, CA 92665-4296  
Local (714) 998-3021 • FAX (714) 974-3420

Entire USA 1-800-854-0547

May 1995, Popular Electronics

# CABLE DIRECT

CONVERTERS  
DESCRAMBLERS  
VIDEO STABILIZERS  
FILTERS



100%  
MONEY BACK  
GUARANTEE!

30 DAY  
FREE  
TRIAL!

FREE Cable TV Catalog.



Now you can tune-in your favorite cable TV programming and SAVE \$100'S - EVEN \$1000'S on premium CABLE TV EQUIPMENT.

## MODERN ELECTRONICS

### 1-800-906-6664

2125 S. 156TH CIRCLE • OMAHA, NE 68130

**Control your project with a PC.** Operate relays, motors, fans, lights etc. via the parallel port. No programming necessary. Includes IBM compatible software and a step-by-step manual. Send \$29.50 to:



**Project Solution**  
242 Ashbourne Trail  
Lawrenceville, GA 30243  
(404) 963-6382

## DIGITAL VIDEO STABILIZER

Get clear videos every time! Enjoy a clear picture with pure color and clarity on all your rented video tapes. The Digital Video Stabilizer (DVS) eliminates darkening and shifting of colors, unwanted lines and flashing or jagged edges caused by copyguards. State of the art digital circuitry completely eliminates all copy protection and jamming signals. The DVS is ultra compact and fully automatic. Just pop in one 9V battery and hook it up! Compatible with all VCRs and TVs. 30 day money back guarantee. Order Now!

**ONLY \$29.95 + S/H**

WARNING: The DVS is not intended to copy rental video tapes that may constitute copyright infringement.

**A-Plus Electronics 800-877-7587**

## MARYMAC®

The New Realistic®  
PRO-43 Scanner

### Radio Shack®

PHONES

Our 19th year of DISCOUNTS

**Toll Free 800-231-3680**

PRO-2035 List \$449.99

**Our Delivered Price \$385.00**

**IF ON SALE, WE ARE CHEAPER!**

*We discount everything in the RS catalog*

22511 Katy Fwy.

Katy (Houston), TX 77450

1-713-392-0747 FAX 713-574-4567

### ARE YOU LOOKING FOR NEW, AND MOST INNOVATIVE ELECTRONIC PRODUCTS?

If so, we have just the right products for you! Products for all ages can be found in our 3 catalogs. The best known name brands such as: Bell Atlantic, Fuji, Panasonic, Sony, Sharp, Franklin, Casio, Quorum, MCI, Uniden and so much more can be at your fingertips! All you have to do is send \$15.00 to become a member of the great selection of products that Mana Electronics has to offer! After becoming a member and purchasing from our catalog, you are currently updated with catalogs of the newest and most innovative electronic products available today!

**ORDER NOW!**

To order send cheque or money order to:

**MANA ELECTRONICS**

P.O. Box 67002 RPO Maples  
Winnipeg MB R2P 2T3

Do not send cash

## Device Programmers

WE BUY AND SELL NEW & USED DATA I/O PROGRAMMERS	
\$ 579 EETOOLS ALLMAX	
\$ 479 EETOOLS PROMAX	
\$ 350 XELTEK SUPERPRO (R)	
\$ 599 LOGICAL DEVICES 3000	
\$ 599 ADVANTECH PC-UPROG	
\$ 269 SUNSHINE UNIVERSAL	
\$ 129 PAL PROGRAMMER	
\$ 449 JDR EMUP UNIVERSAL	
\$ 429 NEEDHAMS EMP-20	
\$ 679 NEEDHAMS SA-20 S/ALONE	
\$ 139 EETOOLS 1 GANG	24
\$ 199 EETOOLS 4 GANG	HOUR
\$ 49 SUNSHINE 1 GANG	BBS
\$ 99 SUNSHINE 4 GANG	(408)
\$ 169 SUNSHINE 8 GANG	983-
\$ 299 SUNSHINE 16 GANG	1234

**General Device Instruments**  
(408) 241-7376 Fax 241-6375



## The Pocket Programmer

The portable Eprom programmer that uses the printer port of your PC instead of an internal card. The software has 24 easy to use functions and programs 27/25/28/68764 & Cmos from 16K (2K x 8)—2M (256K x 8) Eproms (32 pin socket, UpGradeable to 8Meg). Adapters available for MCU's, 40-Pin Eproms, 5-Gang and Eprom Emulator to 32K x 8.

**\$129.95**  
Box I3723 Add \$4.00 for shipping.  
Edwardsville, KS 66113 Add \$4.50 for COD.  
(913) 422-2094 Visa/Master Charge

## NEW EASY PC

BRITISH DESIGN AWARD

**SCHEMATIC and PCB C.A.D.**

ONLY **\$195**

- Includes
  - MGA, CGA, EGA & VGA compatible.
  - Design large multi layer boards.
  - One level pull down menu and quick keys for fast layout.
  - Dot matrix, laser, plotter, Gerber & N.C. drill output.
- 6 Month Free update
- Free Demo

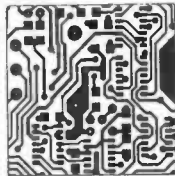

7840 ANGEL RIDGE ROAD  
ATHENS, OHIO 45701  
(614) 592-1810

Visa & MasterCard Accepted

**RCA** NOW USA & CANADA  
**DSS** AVAILABLE

SHARPER PICTURE - CLEARER SOUND - GREATER CHOICE

Introducing the RCA brand DSS™ (Digital Satellite System) the ultimate digital entertainment experience. The advanced digital compression technology delivers broadcast pictures with laser disc precision accuracy and CD-quality sound clarity. All from a small 18" dish that can be easily installed on your home or property. RCA Brand DSS. The future of television today...and beyond!

**\$699.00**

U.S. CURRENCY  
+S&H and 1st MONTHS DIRECTV  
AND RECEIVE 1 MONTH FREE US\$B



**TRI STAR SATELLITE**  
1-800-929-2485



## CONTROL AND DATA ACQUISITION FROM A COMPUTER SERIAL PORT (RS232 or RS485)

**I/O-232 SMART BOARDS DO NOT REQUIRE PROGRAMMING!** These boards connect directly to your computer serial port. Commands are very simple e.g. PRA [Enter] reads Port A. Results are sent back to the computer as an ASCII string allowing the use of PROCOMM, MAC240, or your own programs. In addition to interfacing, the I/O-232 boards have the following embedded functions:

- Uses ITC232-A IC.
- All standard Baud rates (300-115KB) supported.
- Bin, Hex or Dec formats.
- 24 I/O lines configurable individually as Inputs or latched Outputs.
- 8, 10 or 12 bit, 10 channel Analog to Digital converter.
- 10-10,000 Hz, 0-100% Pulse Width Modulation output.
- 3 EASY to use stepper motor logic interfaces (Muxable to more).
- Relative resistance or capacitance measurements using an RC network (ideal to read temperatures using a thermistor).

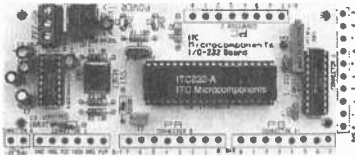

DESCRIPTION	KIT	ASSEMBLED
I/O-232-12 (12 bit ADC)	\$ 109	\$ 119
I/O-232-10 (10 bit ADC)	\$ 99	\$ 109
I/O-232-8 (8 bit ADC)	\$ 79	\$ 89

Enclosure: \$14, Serial cable: \$9 (specify connector), Power Supply: \$11 Add \$10 for manuals, diskette containing program examples and Shipping & Handling. Pay by cheque, M. Order, VISA or Master Card.

### ITC MICROCOMPONENTS INC.

814 West 15th St. Unit 206, North Vancouver, B.C. Canada.  
V7P-1M6. PHONE US TOLL FREE AT: (800) 474 7644  
Fax: (604) 985 6417. Explore our BBS: (604) 985 1380

**THE I/O-485 BOARDS** are multiple addressable units containing 2 ITC232-A chips and a 10 channel, 8, 10 or 12 bit Analog/Digital converter each. The ITC232-A chips used ensure great simplicity of commands. 32 of these units can be ganged-up on a single RS485 line attached to a computer. A smaller board which plugs onto the computer serial port allows for RS232/RS485 conversion. **I/O-485 boards block diagram**

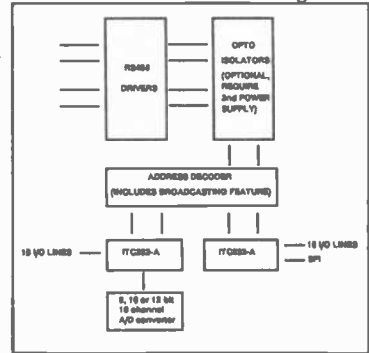

- 32 I/O lines configurable individually as Inputs or latched Outputs organized in 4 x 8 bit ports.
- 10 analog inputs, 8, 10 or 12 bits resolution.
- 32 different addresses plus broadcasting which allows commanding all the boards at once.
- Individual stations or the entire network is software resettable
- Direct or optoisolated link
- Speeds of up to 115200 Bauds.
- All the stations can be hooked onto a single 4 wire cable up to 1 mile long using standard phone jacks.

All of the following boards are pre-assembled and tested.

I/O-485-8 (8 Bit ADC)	\$ 139
I/O-485-10 (10 Bit ADC)	\$ 159
I/O-485-12 (12 Bit ADC)	\$ 179
432/485 Converter	\$ 49

For optoisolated option: Add \$19 to each item.

**NEW!**

## PE MARKET CENTER CLASSIFIEDS

### TEST EQUIPMENT

**CATV TEST CHIPS** as low as \$8.95 for testing converter boxes in full service modes. Jerrold, Tocom, Scientific Atlanta, Pioneer BA5XXX — BA67XX cubes clears E2-E5 Micro Masters, 1 (800) 360-7654.

**USED PRINTERS:** Fluke 2020A \$75.00; Fluke 2030A \$150.00; HP 5150A \$200.00; HP 7470A \$100.00; (908) 685-2296.

**USED NETWORK analyzers:** HP 8407A network analyzer \$200.00; HP 8410A network analyzer \$200.00; HP 8413A phase gain indicator \$100.00; HP 8414A polar display \$150.00; (908) 685-2296.

**HP3575A GAIN/phase** \$1,500.00, hp651A oscillator \$200.00, hp466A amp \$75.00, hp204D oscillator \$200.00, hp333A distortion analyzer \$200.00, Tek575 curve tracer \$100.00, DAS-56B voltage source \$100.00, hp355C attenuator \$100.00, Marquardt Engineering, 1226 James, Syracuse, NY 13203. (315) 475-9899.

### BUSINESS OPPORTUNITIES

**START** your own technical venture! Don Lancaster's newly updated **Incredible Secret Money Machine II** tells how. We now have autographed copies of the Guru's underground classic for \$18.50. **SYNERGETICS PRESS**, Box 809-C, Thatcher, AZ 85552. (602) 428-4073. Visa/MC.

**BUY THE company.** Nationally marketed product. Sales potential in the millions. Two U.S. patents included. \$75-125K. Owner retiring. Days: (205) 863-6718. Nights: (205) 449-6482. Ask for Boyd.

**GET GOVERNMENT GRANTS** and loans. Plus, a list of companies offering home employment. \$8.00. Money order only. Joe Bencsics, Dept. W, PO Box 3643, South Bend, IN 46619-0643.

### COMPUTER HARDWARE

**AMIGA PARTS** software Commodore 64/128 and much more. Custom chips, ICs, new computers, fast free catalog (415) 871-5158 24hrs.

### COMPONENTS

**STAINLESS STEEL** Screws. Kits available. Free catalog. "Rusty Bolt," Box 708X, North Attleboro, MA 02761.

### AUDIO-VIDEO-LASERS

**LASERS, LIGHTSHOWS, Holography.** Lowest prices. For free catalog write: Midwest Laser Products, PO Box 2187, Bridgeview, IL 60455. Or call: (708) 460-9595.

### PUBLICATIONS

**HISTORIC AND Classic** hardware support magazine. *The Computer Journal* provides how-to information on keeping S-100, Kaypro, Z80, 6809, CP/M, and PC/XT systems running. Over TEN years of hardware, software projects. 6 issues \$24.00. Free sample. 1 (800) 424-8825. TCJ, PO Box 535, Lincoln, CA 95648.

**SURVEILLANCE/COUNTERSURVEILLANCE Security Equipment Directory** cctv, motion, heat detectors, night vision, bullet proofing, vehicle barriers, fencing, access control, computer security. Over 300+ sources listed. \$19.95. Send order to: Desktop Publishing, PO Box 593, Dept. S. S. Dennis, MA 02660.

**57 TOP** electronics journals. How to get free subscriptions. Send \$5.00 to Cabletronics, Box 30502PE, Bethesda, MD 20824.

## IMPROVE YOUR IMAGE!

WITH OUR VIDEO STABILIZERS

BEFORE



AFTER



**SUPER VHS MODEL AVAILABLE!**

The clearest picture possible playing back movies. **GUARANTEE** to eliminate copy protection.

- No Rolls/Jitters/Flickers/Fading
- Works on all TV's, VCR's Beta & Cable
- Gold Video Connectors & Cables Included
- 2 Year Warranty
- Money Back Guarantee



## VISION ELECTRONICS

**1-800-562-2252**

2125 S. 155TH CIRCLE • OMAHA, NE 68130

# ADVERTISING INDEX

POPULAR ELECTRONICS magazine does not assume any responsibility for errors that may appear in the index below.

Free Information No.	Page	Free Information No.	Page
—	A&D Electronics . . . . .	144	Island LogiX Inc. . . . .
—	A-Plus Electronics . . . . .	—	ITC Microcomponents Inc. . . . .
125	Ace Communications . . . . .	—	ITC Microcomponents Inc. . . . .
153	Advantage Instruments . . . . .	38	Kelvin Electronics . . . . .
—	Agrelo Engineering . . . . .	—	M&G Electronics . . . . .
26	Alfa Electronics . . . . .	—	Mana . . . . .
28	All Electronics . . . . .	—	Marymac Industries Inc. . . . .
—	Allen Engineering . . . . .	155	MCM Electronics . . . . .
—	Allison Technology . . . . .	—	MD Electronics . . . . .
—	Allstar Electronics . . . . .	—	Mega Electronics . . . . .
158	AMC Sales . . . . .	149	Mendelsohn's . . . . .
—	Andromeda Research . . . . .	—	Mental Automation . . . . .
—	Antique Radio Classified . . . . .	42	MicroCode Engineering . . . . .
146	B&S Sales . . . . .	—	Modern Electronics . . . . .
—	Basic Electrical Supply . . . . .	—	Northeast Micro . . . . .
—	Black Feather . . . . .	—	NRI Schools . . . . .
—	C&C Electronics . . . . .	—	Nu-Tek Electronics . . . . .
—	C&C Specialties . . . . .	—	Ohio Automation . . . . .
132	C&S Sales . . . . .	43	Optoelectronics . . . . .
—	Cellsoft . . . . .	—	Orion Electronics . . . . .
—	CLAGGK, Inc. . . . .	—	PC Boards . . . . .
—	Cleveland Inst. of Electronics . . . . .	—	Phillips Tech . . . . .
—	Command Productions . . . . .	145	Prairie Digital Inc. . . . .
—	Communication Specialists . . . . .	46	Print . . . . .
—	Computer Business Services . . . . .	159	Print . . . . .
—	Comtrad Industries . . . . .	—	Progressive Concepts . . . . .
—	Consumertronics . . . . .	—	Project Solution . . . . .
—	Copyright Clearance Center . . . . .	—	The Electrician's School . . . . .
162	Davis Instruments . . . . .	—	The School of PC Repair . . . . .
—	Design Computation . . . . .	—	The School of VCR Repair . . . . .
—	EDE Spy Outlet . . . . .	—	Self-Reliance Co. Inc. . . . .
147	Electronic Rainbow . . . . .	—	Show Time . . . . .
—	Electronics Software Solutions . . . . .	—	Silicon Valley Surplus . . . . .
—	Electronics Tech. Today CV3, 18, 75 . . . . .	—	Skyvision (Small) . . . . .
—	Electronics Tech. Today . . . . .	—	Software Science . . . . .
—	Foley-Belsaw Institute . . . . .	—	Spy Supply . . . . .
154	Foley-Belsaw Institute . . . . .	—	Tab Books . . . . .
—	Forest Electronics . . . . .	—	Tri Star Satellite Systems . . . . .
—	Fotronic Corporation . . . . .	136	UCANDO Videos . . . . .
—	General Device Instruments . . . . .	—	US Cable (Zentek) . . . . .
—	Genuine Electronics . . . . .	—	US Cable Supply . . . . .
—	Get-Tech Inc. . . . .	—	US Cyberlab . . . . .
—	Great Southern Security . . . . .	—	US Cyberlab . . . . .
—	Grantham College of Engineering . . . . .	—	Video Communications Systems . . . . .
—	Greenleaf Electronics Inc. . . . .	—	Video Electronics . . . . .
—	Halcyon Group . . . . .	168	Wavetek Corp. . . . .
—	Home Automation Systems . . . . .	—	Weeder Technologies . . . . .
—	Information Unlimited . . . . .	—	Weka Publishing . . . . .
—	Intronics . . . . .	—	Windward Electronics . . . . .
157	Interactive Image Technologies . . . . .	—	WPT Publications . . . . .
—	ISCET . . . . .	134	Xandi Electronics . . . . .

## ADVERTISING SALES OFFICE

**Gernsback Publications, Inc.**  
500-B Bi-County Blvd.  
Farmingdale, NY 11735  
1-(516) 293-3000

**Larry Steckler, EHF/CET**  
President

**Christina Estrada**  
Assistant to the President

**For Advertising ONLY**  
516-293-3000  
Fax 1-516-293-3115

**Larry Steckler**  
publisher

**Arline Fishman**  
advertising director

**Denise Mullen**  
advertising assistant

**Kelly Twist**  
credit manager

**Subscription/  
Customer Service/  
Order Entry**  
1-800-827-0383  
7:30 AM - 8:30 PM EST

## ADVERTISING SALES OFFICES EAST/SOUTHEAST

**Stanley Levitan**  
Eastern Sales  
1 Overlook Ave.  
Great Neck, NY 11021  
1-516-487-9357, 1-516-293-3000  
Fax 1-516-487-8402

## MIDWEST/Texas/Arkansas/ Oklahoma, Colorado, Arizona

**Ralph Bergen**  
Midwest Sales  
One Northfield Plaza, Suite 300  
Northfield, IL 60093-1214  
1-708-446-1444  
Fax 1-708-559-0562

## PACIFIC COAST/Mountain States

**Anita Bartman**  
Hutch Looney & Assoc., Inc.  
6310 San Vicente Blvd.  
Suite 360  
Los Angeles, CA 90048  
1-213-931-3444  
Fax 1-213-931-7309

# Electronics Paperback Books



□ **BP88—How to Use Op Amps...\$5.95.** A designer's guide that covers operational amplifiers. Serving as both a source book of circuits and a reference book for design calculations. The text is non-mathematical and easy to understand by most readers.



□ **BP113—30 Solderless Breadboard Projects-Book 2...\$5.95.** Numerous hobbyist projects of useful gadgets and circuits using "Verobloc" breadboards. All the breadboard projects in this book are based on CMOS logic integrated circuits.

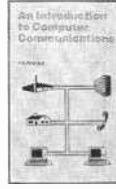

□ **BP177—Introduction to Computer Communications...\$5.95.** Details on types of modems and their suitability for specific application, plus details of connecting various computers to modems, and modems to the telephone system.



□ **BP276—Shortwave Superhet Receiver Construction...\$6.95.** Provides construction details, including coil winding, of a number of advanced-design receivers which should have performance levels at least equal to commercial sets of similar complexity.



□ **BP61—Beginners Guide to Digital Techniques...\$5.00.** Covers the basics of digital techniques—decimal, binary, octal and hexadecimal numbering systems are covered plus insights on weighted and non-weighted binary-coded-decimal codes and alpha-numeric codes. The basic building blocks of circuit logic, the common AND, OR, NAND, NOR and EXCLUSIVE-OR gates and bi-stables, are thoroughly covered.



□ **BP285—A Beginners Guide to Modern Electronic Components...\$6.50.** It is easy for newcomers to electronics to become confused. There are a great many different types of components available often with numerous variations of each type. This book presents the reader with a vast amount of invaluable parts information to enable the right component to be selected every time for repairs and projects.



□ **PCP103—Practical MIDI Handbook...\$9.95.** The Musical Instrument Digital Interface (MIDI) is surrounded by a great deal of misunderstanding. This book is aimed at musicians and technicians who want to explore the vast capabilities of MIDI. It covers MIDI-based equipment you can use: keyboards, drum machines, sequencers, effects units, mixers, drum pads guitars. There's also a section on computer music.



□ **BP90—Audio Projects...\$5.50.** Details the construction of preamplifiers and mixers, power amplifiers, tone controls and matching projects. All projects are fairly simple to build and include a number of board layouts and wiring diagrams.



□ **BP121—How to Design and Make Your Own PCB's...\$5.75.** Simple methods for copying printed-circuit board designs from magazines and books on to copper. Covers all aspects of simple PCB construction as comprehensively as possible.



□ **BP44—IC 555 Projects...\$5.95.** Every so often a device appears that is so useful that one wonders how life went on before without it. The 555 timer integrated-circuit chip is one such device. Included are basic and general circuits used by most hobbyists.

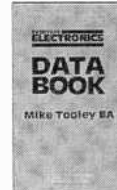

□ **PCP109—Everyday Electronics Data Book...\$10.00.** An invaluable source of electronics information—the text contains sections that deal with the underlying theory of electronic circuits and a wide range of practical electronic uses for everyone.



□ **BP60—Practical Construction of Pre-Amps, Tone Controls, Filters and Attenuators...\$5.50.** The book offers practical designs and details thereby enabling the project-builder enthusiast to construct, with the minimum of difficulty and expense, various audio pre-amplifier and tone control circuits, etc., which may be used with home-constructed audio equipment or even complex commercial gear.



□ **BP297—Loudspeakers for Musicians...\$6.25.** Contains all the information that a working musician needs to know about loudspeakers; the different types, how they work, the most suitable for different instruments, for cabaret work, and for vocals. It gives tips on constructing cabinets, wiring up, available fittings, finishing and how to connect multi-speaker arrays, etc. Includes ten enclosure designs with plans.



□ **PCP110—Electronic Power Supply Handbook...\$10.95.** All types of power supplies used for electronics purposes are covered in detail, starting with cells and batteries and extending by way of rectified supplies and linear stabilizers to modern switch-mode systems. IC switch-mode regulators, DC-converters and inverters. The devices, their operating principles and typical circuits, are dealt with in detail.



□ **BP254—From Atoms to Amperes...\$6.50.** Explains in crystal-clear terms the fundamentals behind the whole of electricity and electronics. Really helps you to understand the basis of the complex subject perhaps for the first time ever.



□ **PCP101—Practical Digital Electronics Handbook...\$9.95.** An introduction to digital circuits, logic gates, bi-stables, timers, micro-processors, memory and I/O devices. A special feature of the book is the section on digital test gear projects.



□ **BP315—Introduction to the Electromagnetic Wave...\$5.95.** A fundamental and easy-to-understand approach to a complicated theory topic. The beginner requires no more than elementary mathematics and basic knowledge of electronics.

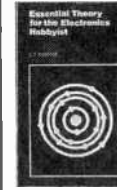

□ **#228—Essential Theory for the Hobbyist...\$5.25.** Supplies to the hobbyist background knowledge tailored to the specific requirements of their activities. Relevant material is presented in a readable manner with a minimum of mathematics.

## TEST EQUIPMENT SPECIALS

- **BP239—Getting the Most from Your Multimeter...\$5.95**  
Covers analog and digital gear, component and gear testing.
- **BP267—How to Use Oscilloscopes & Other Test Equipment...\$6.95**  
Get with the next step to proficient troubleshooting.
- **PCP111—Electronic Test Equipment Handbook...\$13.95**  
The all-inclusive text covering test gear you'll use!

## SUBSTITUTION GUIDES FOR HOBBYISTS

- **BP85—International Transistor Equivalents Guide...\$7.50**  
The ultimate guide to replacing foreign and domestic transistors.
- **BP108—International Diode Equivalents Guide...\$5.95**  
Rectifiers, Zeners, LEDs, OCIs, diacs, triacs...all hobby types.
- **BP140—Digital Equivalents and Pin Connectors...\$12.50**  
A master reference for builders who design projects.

**ELECTRONIC TECHNOLOGY TODAY INC.**  
P.O. BOX 240, Massapequa, NY 11762-0240

Name \_\_\_\_\_

Address \_\_\_\_\_

City \_\_\_\_\_ State \_\_\_\_\_ Zip \_\_\_\_\_

PE1

### SHIPPING CHARGES IN USA AND CANADA

\$0.01 to \$5.00 .....	\$1.50
\$5.01 to \$10.00 .....	\$2.50
\$10.01 to 20.00 .....	\$3.50
\$20.01 to 30.00 .....	\$4.50
\$30.01 to 40.00 .....	\$5.50
\$40.01 to 50.00 .....	\$6.50
\$50.01 and above .....	\$8.00

**SORRY** No orders accepted outside of USA & Canada

Total price of merchandise .....	\$ _____
Shipping (see chart) .....	\$ _____
Subtotal .....	\$ _____
Sales Tax (NYS only) .....	\$ _____
Total Enclosed .....	\$ _____

Number of books ordered

**All payments must be in U.S. funds!**

# OPTOELECTRONICS

## WILL TAKE YOU PLACES YOU ONLY DREAMED OF BEFORE

### R10 AND R20 INTERCEPTORS

Self-tuning near field receivers with signal strength indicators.

- R10.....\$359.00
- R20.....\$119.00



**R10 Interceptor** is the fastest way to pick up nearby two way radio transmission, no matter what the frequency. The R10 is a totally unique instrument for two way communications test, security, surveillance, and recreation monitoring. Twin LED bargraph for signal strength and deviation are on the front panel. Audio output is suitable for tone decoding with the DC440. Earphone, antenna, internal NiCad batteries, and adapter are included.

**R20 RF** General purpose Signal Strength detector also can intercept AM signals for earphone monitoring. Its small size and low cost make the R20 useful for transmitter checking, RF room sweeping, and monitoring nearby AM transmissions. R20 comes with a 9V battery and a built-in antenna.

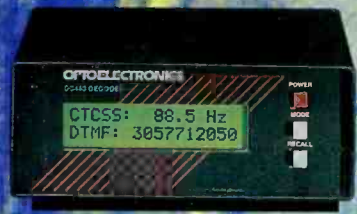

### DC440 DECODER

Decodes DTMF, CTCSS, and DCS  
CIV compatible, optional nicad.

- DC440.....\$259.00
- Opt/nicads.....\$39.00

**DC440 Decoder** works with any receiver, service monitor or the R10 Interceptor to decode Subaudible tones (CTCSS) and codes (DCS) and Touch-tone (DTMF) characters. The display is a two line alpha numeric LCD with back light. Push-button switches control all functions from the front panel. CI-V serial interface supports computer controlled scanning with ScanStar Commercial software. NiCad battery pack is optional.

### SCOUT 40

New frequency recorder-records up to 400 frequencies with 250 hits on each frequency and much more.

SCOUT.....\$449.00



**Scout** is much more than a counter, it is a frequency recorder with a 400 frequency memory. Up to 250 repetitions are also stored with each frequency. Perfect for drive by monitoring. Exclusive "Reaction Tune" feature tunes an OS40 or Icom receiver instantly for monitoring. PC software is included to download frequencies and an optional Computer Spectrum for the Scout, can look them up in the FCC database. Rapid Charge, High Capacity Batteries, back lit LCD display, serial interface, beeper and pager style vibrator are included.

### OPTOSCAN 456

Computer controlled interface. For use with the Radio Shack Pro 2005/6 Series Scanners.

OS456.....\$299.00



**OptoScan 456** is the fastest computer controlled scanning system and the only one with Tone (CTCSS) Codes (DCS) and touch tone (DTMF) decoding standard. When installed in the highly regarded Pro-2005/6 receiver the OS456 is also much less expensive than any other computer controlled scanning system. Installation is easy with simple hand tools and only two solder connections. Supported by all popular Scanning Software.

### ACCESSORIES

- N100-FM Broadcast Band Notch Filter.....\$99.00
- CF802-Cellular Band Pass Filter/Amplifier.....\$149.00
- BLP70-Low Pass Filter.....\$36.00
- BHP70-High Pass Filter.....\$40.00
- CX12-RS232/CIV Interface Converter.....\$89.00
- TA100S-Telescoping Whip Ant. with BNC connector.....\$12.00
- DB32-Dual band VHF/UHF miniature antenna.....\$29.00

# OPTOELECTRONICS

## ORDER LINE 8003275912

TEL: (305) 771-2050 FAX: (305)771-2050  
 5821 NE 14TH AVE, FORT LAUDERDALE, FL, 33334  
 VISA, MC, C.O.D., CASH OR MONEY ORDER-SHIPPING  
 ADDITIONAL  
 ALL SPECIFICATIONS & PRICES ARE SUBJECT TO  
 CHANGE  
 WITHOUT NOTICE OR OBLIGATION.  
 CIRCLE 43 ON FREE INFORMATION CARD