

RADIO - ELECTRONICS

JULY 1952

LATEST IN TELEVISION • SERVICING • AUDIO

HUGO GERNSBACK, Editor



30¢

U. S. and
CANADA

**AUDION AND TRANSISTOR
TWO ERAS IN ELECTRONICS**

See page 4

***In this issue:* Loudspeaker Crossover Networks •
Diagnosing TV Troubles • Simple Echo Box**

MORE THAN A REPLACEMENT
-a definite improvement!

Better performance means better customers paying better prices for your better service, thanks to better Du Mont Teletrons. Why settle for less? Tell them it's a Du Mont and you'll sell them on your service.

DU MONT
*Teletrons**

Cathode-ray Tube Division,
Allen B. Du Mont Laboratories, Inc.
Clifton, N. J.

*trade mark



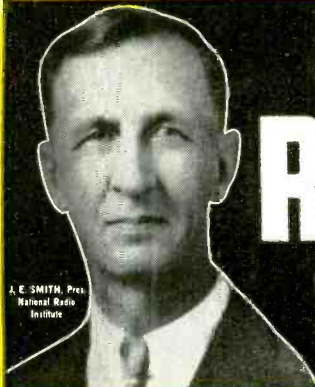

J. E. SMITH, Pres. National Radio Institute

BE A SUCCESS AS A RADIO-TELEVISION TECHNICIAN

2 FREE BOOKS SHOW HOW MAIL COUPON

America's Fast Growing Industry Offers You

EXTRA PAY IN ARMY, NAVY, AIR FORCE

If you expect to go into military service, mail coupon NOW. Knowing Radio, TV, Electronics can help you get extra work, extra pay, more interesting duty at pay up to several times a private's base pay. You are also prepared for good Radio-TV jobs upon leaving service. IT'S SMART TO TRAIN WITH N. R. I. NOW. Mail Coupon TODAY

1. EXTRA MONEY IN SPARE TIME

Many students make \$5, \$10 a week extra fixing neighbors' Radios in spare time while earning. The day you enroll I start sending you SPECIAL BOOKLETS to show you how to do this. Tester you build with parts I send helps you service sets. All equipment is yours to keep.

I TRAINED THESE MEN

Chief Inspector, Police Radio
Soon after finishing the N. R. I. course, worked my servicing shop. Now I am Chief Engineer of WGNR, WSPK, Lowway FM Police Radio Installation, S.W. DINWIDDIE, Jacksonville, Ill.

Over 144 Month Spare Time
"When I enrolled, had no idea it would be so easy to learn. Have equipped my shop with of spare time earning... I am clearing about \$10 to \$60 a month. Full credit to N. R. I. J. D. KNIGHT, Decatur, Texas.

111 Week in Spare Time
"Before finishing your course, I earned as much as \$1 a week in Radio servicing, at home in my spare time. I recommend N. R. I. to everyone who shows interest in Radio." S. J. PETRUFF Miami, Fla.

One's First Job Through N. R. I.
"My first job was as an operator with KDLK, obtained for me by your Graduate Service Dept. I am now Chief Engineer of Police Radio Station WQOX." T. S. NORSTON, Hamilton, Ohio.

They Operated in "Service"
"Have my own shop Am authorized serviceman for 2 large man-facturers and do servicing for 3 dealers. N. R. I. has enabled me to build an enviable reputation in Television." P. WILLEB, Maumee, O.

NRI Graduate, Division Bakery
"Am with Station WKBO as transmitter operator. Have more than doubled my income since starting in Radio. Future looks bright. N. R. I. has been an exacting help to me." A. HERR, New Cumberland, Pa.

Years of Success with You
"I operate in own shop and have over 500 customers. My profit average about \$350 a month. Have had years of successful experience and still praise N. R. I. training." J. H. AMERSON, Atlanta, Ga.

Regret Not Enrolling Before
"Am proud of my diploma. I cannot say enough for the N. R. I. course. Regret I didn't take it years ago when I used to see you ads. Now I have a spare time shop." FRANK S. TUCKER, Hilton Village, Fla.

2. GOOD PAY JOB

Your next step is a good job installing and servicing Radio-Television sets or becoming boss of your own Radio-Television sales and service shop or getting a good job in a Broadcasting Station. Today there are over 90,000,000 home and auto Radios. 3100 Broadcasting Stations are on the air. Aviation and Police Radio, Micro-Wave Relay, Two-Way Radio are all expanding, making more and better opportunities for servicing and communication technicians and FCC licensed operators.

3. BRIGHT FUTURE

And think of the opportunities in Television! In 1950 over 5,000,000 Television sets were sold. By 1954 authorities estimate 25,000,000 Television sets will be in use. Over 100 Television Stations are now operating, with experts predicting 1,000. Now is the time to get in line for success and a bright future in America's fast-growing industry. Be a Radio-Television Technician. Mail coupon for Lesson and Book—FREE.



I Will Train You at Home

Read How You Practice Servicing or Communications with Many Kits of Parts You Get!

YOU BUILD this modern Radio (above) as part of my Servicing Course. Build this complete, powerful Radio Receiver that brings in local and distant stations. N. R. I. gives you ALL the Radio parts... speaker, tubes, chassis, transformer, sockets, loop antenna, EVERYTHING you need. You use material to get practical Radio experience. Make EXTRA money fixing neighbors' Radios in spare time while training.

YOU MEASURE current, voltage (AC, DC and RF), resistance and impedance circuits with Electronic Multimeter (above right). You build as part of my Servicing or Communications Course.

YOU BUILD this Transmitter (right). As part of my Communications Course. I SEND YOU parts to build this low-power broadcasting transmitter. You learn how to put a station "on the air," perform procedures demanded of Broadcast Station operators, make many practical tests.

YOU BUILD this Wavemeter (below) in my Communications Course with parts I send you. Use it to determine frequency of operation and make other tests on transmitter currents. You conduct many interesting experiments.

This is just part of the equipment my students build. You keep all parts I send.

NOW! Advanced Television Practice

New, special TV kits furnished to build high-definition SCOPE... RF OSCILLATOR with flyback power supply... complete TV set... many other wave forms. Get pulse, trapezoidal, saw-tooth wave experience locating and correcting TV troubles. Mail coupon

Keep your job while training at home. Hundreds of you trained are successful RADIO-TELEVISION TECHNICIANS. Most had no previous experience; many no more than grammar school education. Learn Radio-Television principles from illustrated lessons. GET PRACTICAL EXPERIENCE—build valuable Electronic Multimeter for conducting tests; also practice servicing Radios or operating Transmitters—experiment with circuits common to Radio and Television. At left is just part of the equipment my students build with many kits of parts I furnish. All equipment is yours to keep. Many students make \$5, \$10 a week extra fixing neighbors' Radios in spare time.

Mail Coupon For 2 Books FREE

Act Now! Send for my FREE DOUBLE OFFER. Coupon entitles you to actual lesson on Servicing; shows how you learn Radio-Television at home. You'll also receive my 64-page book, "How to Be a Success in Radio-Television." You'll read what my graduates are doing, earning; see photos of equipment you practice with at home. Send coupon in envelope or paste on postal. J. E. SMITH, Pres. Dept. 2GF, National Radio Institute, Washington 9, D. C. Our 50th year.

Good for Both—FREE

Mr. J. E. SMITH, President, Dept. 2GF National Radio Institute, Washington 9, D. C.

Mail me Sample Lesson and 64-page Book about How to Win Success in Radio-Television. Both FREE. (No salesman will call. Please write plainly.)

Name..... Age.....

Address.....

City..... Zone..... State.....

Approved Under J. I. Bill

The ABC's of SERVICING

How to Be a Success in RADIO-TELEVISION

RADIO - ELECTRONICS

Formerly RADIO-CRAFT • Incorporating SHORT WAVE CRAFT • TELEVISION NEWS • RADIO & TELEVISION*

Hugo Gernsback
Editor-in-Chief

M. Harvey Gernsback
Editorial Director

Fred Shunaman
Managing Editor

Robert F. Scott
W2PWG, Technical Editor

I. Queen
Editorial Associate

Angie Pascale
Production Manager

Wm. Lyon McLaughlin
Tech. Illustration Director

Sol Ehrlich
Art Director

Lee Robinson
General Manager

John J. Lamson
Sales Manager

G. Aliquo
Circulation Manager

Robert Fallath
Promotion Manager

ON THE COVER

Dr. Lee de Forest and Dr. William Shockley hold a transistor and an Audion, respectively, during de Forest's recent visit to the Bell Telephone Laboratories in New Jersey.
*Color original courtesy
Bell Telephone Labs.*

CONTENTS

JULY 1952

Editorial (Page 25)

53 Million TV Sets by 1960.....by Hugo Gernsback 25

Electronics (Pages 26-27)

The Future of the Transistor.....by Lee de Forest 26

Television (Pages 28-34)

Flyback Squealby Fred Shunaman 28
21 MC Hams and TVI.....by Richard I. Baldwin, WIKE 29
Can you Diagnose these TV Troubles?.....by John B. Ledbetter 30
TV Service Clinic.....Conducted by Matthew Mandl 32
TV DX in July..... 33
The Service Tech and TVI.....by Norman Helfont, W2EBP 34

Servicing—Test Instruments (Pages 35-42)

How to use and handle a Load Checking Meter.....by Harry Leeper 35
Combined Measuring Set.....by A. Iwanivsky 36
Short Circuits.....by Robert F. Scott 38
There's Money in Midgets.....by H. L. Matsinger 40
Rare Trouble in a B.F.O.....by Geo. Rulffs, Jr. 41
The Pest.....by B. W. Welz 42

Audio (Pages 43-51)

Loudspeaker Crossover Design.....by Norman H. Crowhurst 43
Practical Williamson Amplifier.....by Francis A. Gicca 46
Electronics and Music, Part XXV.....by Richard H. Dorf 48
Simple Echo Box.....by Charles L. Hansen 51

Construction (Pages 52-56)

Push Button Tuner.....by Robert G. Masching 52
A Preselector and its possibilities.....by Jack V. Roberson 53
Automatic Door Controller.....by Dan Anglin 55

Amateur (Pages 57-58)

Novice Transmitter.....by I. Queen 57
All Channel Receiver for WWV..... 58

Theory and Engineering (Pages 59-62)

Selecting the Right Radio School.....by E. H. Rietzke 59
Rectifying without Rectifiers.....by H. B. Conant 61
Transistor Production At All Time High Level..... 62

New Design (Pages 64-66)

New Tubes 64

Departments

The Radio Month	8	New Patents ...	82	Technotes	98
Radio Business..	16	Try This One ...	88	Miscellany	100
New Devices ...	68	Radio-Electronic		People	106
With the		Circuits	90	Communications	108
Technician ...	78	Question Box ..	94	Book Reviews...	111



MEMBER Audit Bureau of Circulations

RADIO-ELECTRONICS

Published monthly by Radcraft Publications, Inc., at Erie Ave., F to G Streets, Philadelphia 32, Pa.

Vol. XXIII, No. 10

EXECUTIVE, EDITORIAL and ADVERTISING OFFICES: 25 West Broadway, New York 7, N. Y. Telephone REctor 2-8630. Hugo Gernsback, President; M. Harvey Gernsback, Vice-President; G. Aliquo, Secretary.
SUBSCRIPTIONS: Address Correspondence to Radio-Electronics, Subscription Dept., Erie Avenue, F to G Sts., Philadelphia 32, Pa., or 25 West Broadway, New York 7, N. Y. When ordering a change please furnish an address stencil impression from a recent wrapper. Allow one month for change of address.
SUBSCRIPTION RATES: In U. S. and Canada, In U. S. possessions, Mexico, South and Central American countries, \$3.50 for one year; \$6.00 for two years; \$8.00 for three years; single copies 30c. All other foreign countries \$4.50 a year, \$8.00 for two years; \$11.00 for three years. Entered as second class matter September 27, 1948 at the post office at Philadelphia, Pa., under the Act of March 3, 1879. Copyright 1952 by Radcraft Publications, Inc. Text and illustrations must not be reproduced without permission of copyright owners.
BRANCH ADVERTISING OFFICES: Chicago: 100 E. Ohio St., Tel. Superior 7-1796. Los Angeles: Ralph W. Harker, 1127 Wilshire Blvd.; Tel. Madison 6-1271. San Francisco: Ralph W. Harker, 582 Market St., Tel. GARfield 1-2481. **Holland:** Trilectron, Heemstede. **Greece:** International Book & News Agency, Athens. **So. Africa:** Central News Agency, Ltd., Johannesburg; Capetown; Durban. **Natal:** Universal Book Agency, Johannesburg. **Middle East:** Steimatzky Middle East Agency, Jerusalem. **India:** Broadway News Centre, Dadar, Bombay-14. **K. L. Kannappa Mudaliar, Madras 2. Pakistan:** Paradise Book Stall, Karachi 3.
POSTMASTER: If undeliverable send form 3578 to: RADIO-ELECTRONICS, 25 West Broadway, New York 7, N. Y. *Trademark registered U.S. Patent Office.

RADIO-ELECTRONICS

TRAIN

for Security! Good-Paying Jobs!

MAKE THE MONEY YOU'VE ALWAYS DREAMED OF!



**LEARN RADIO
-TELEVISION
AND ELECTRONICS
BY EASY SHOP METHOD
TRAINING AT HOME!**

You get all the parts—even tubes!—
for this modern Superheterodyne Receiver. You learn to build it step by step. And you keep it! Get all the facts. Mail coupon now.

Let **NATIONAL SCHOOLS**—a resident-training school for nearly 50 years—train you at home for today's unlimited opportunities in Radio-Television-Electronics. National Schools is one of the largest schools of its kind. It is located in Los Angeles—the center of Radio and TV world! It has four large buildings of modern shops and labs. Its faculty is considered tops in the business.



You learn from lessons prepared by experienced instructors and engineers. Men who are successful Radio and Television technicians. Men who have trained 1000's of men like YOU!



FREE BOOK TELLS YOU HOW!

Page after page—in color—tells you everything you want to know. Mail the coupon. Get this valuable book today. And if you hurry—YOU GET A FREE SAMPLE LESSON, TOO! Shows how easy National Schools Home Training is. Mail the coupon today.

You Train At Home—In Your Spare Time

National Schools Shop Method Home Training gives you basic and advanced instruction in all phases of Radio-TV-Electronics. And remember—your training is based on resident school training principles. You learn fast from hundreds of diagrams and pictures. All instructions are written by experienced technicians who work in Radio and TV every day. All instructions have been developed and tested in National Schools' own labs and studios, which are equipped with the latest RCA equipment. No wonder this National Schools course is so up-to-date, practical, interesting. And so easy to learn! And no wonder it is held in such high regard by leaders of American industry! Approved for eligible Veterans.

We Teach You How To Make Welcome Extra Money—While You Learn!

Many National Schools students—men like you—make plenty of extra dollars each week in spare time! Fixing neighbors' radios, appliances—and other ways we teach you. You start learning and earning from the day you enroll. From the very first lesson!

WE SEND YOU LOTS OF PARTS LIKE THIS!

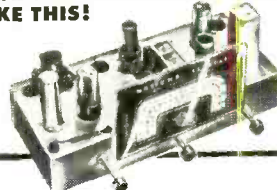

With National Schools Shop Method Home Training, you get basic principles and plenty of practical training. You learn by doing. No wonder you learn so fast! We send you many parts—all of professional, modern quality. You do lots of practical experiments. You advance day by day, step by step. Until you can even build the modern Superheterodyne Receiver you see above—plus other important testing units. The free book tells you all about it. The free sample lesson shows how easy the training is. Use the coupon. Send today—without fail!



Only National Schools Gives You This Professional Multi-Tester!

You get this amazing, new testing instrument—factory-made and tested—complete—ready to use! Simple to operate. Accurate and dependable. An instrument every Radio-TV man needs. Light enough to carry around—so you can use it at home or on service calls. You'll be proud to own this valuable equipment.

Here are only a Few of the Good-Paying Jobs You Can Choose

Radio Station Engineer, District Service Manager, Aircraft Radio Inspector, Own Your Own Repair Shop, Inspector Technician, Service Specialist, Special Government Jobs, Complete TV Service, Sound Truck Operator. Many more! National Schools graduates have secure, good-paying jobs like these! So don't wait—mail the coupon today. Now—while you're thinking about it!

Attention! Men Going into Service Soon!

National Schools' course quickly prepares you for many important jobs in the Armed Services. With National Schools Training you have an opportunity to get into special service classifications—with higher pay and grade—immediately!

FREE SERVICE FOR GRADUATES

National Schools uses its great influence and prestige to help you find your place in the field of your choice. Don't put it off! Start yourself toward a skilled trade! Get the big pay you've always wanted!

NATIONAL SCHOOLS

LOS ANGELES 37, CALIFORNIA • ESTABLISHED 1905
In Canada: 193 E. Hastings St. Vancouver, B. C.

Today's Shortage of Trained Technicians Creates Chance of a Lifetime For You!

Think of it! With guided missiles, radar, and other electronic devices so important to national defense! With big, new developments in TV. With over 90,000,000 home and auto radios, over 12,000,000 TV sets. With more than 3100 radio stations...over 100 TV stations—and more building every day...yes, imagine the great opportunity you have today! YOU are wanted in Radio-Television-Electronics! America's fastest-growing field. High-pay jobs—the kind you've always wanted—are waiting for YOU!

Job Security! Big Money! For YOU! in Today's Expanding Industries!

Trained Radio and Television technicians really make important money these days. Thousands of National Schools graduates—men just like you—are earning good money all over the country. Why not you? And—National Schools graduates get the personal satisfaction of being highly-skilled technicians. Men people respect. Men who enjoy their work—rather than having to drag along in just any old job.

National Schools Has Trained 1000's of Successful Men! Why Not YOU?

In almost every state—and many foreign countries—National Schools graduates are filling big jobs with famous companies. Or running their own successful businesses. What are YOU waiting for? National Schools training is complete training. So when you graduate you can take advantage of today's big opportunities in Radio-Television-Electronics—fast.

DON'T PUT IT OFF! GET THE BIG SALARY YOU HAVE ALWAYS WANTED!

MAIL THIS COUPON TODAY—WITHOUT FAIL!

NATIONAL SCHOOLS, Dept. RG-72
4000 South Figueroa Street
Los Angeles 37, California

Mail in envelope or paste on penny post card.

Mail me FREE the book mentioned in this ad. Also a free sample lesson. I understand no salesman will call on me.

NAME _____ AGE _____

ADDRESS _____

CITY _____ ZONE _____ STATE _____

Check here if you were released from the Service less than 4 years ago.

Be Sure of Your Installations...Next Year

Use

Aptitude-Tested

**MIKE
CABLE**
Now!

• Now, you can be sure of your installations with Belden Microphone Cables. They are *Aptitude-Tested* and rated to give you safe and complete knowledge of their characteristics. Furthermore, Belden Mike Cables are built for maximum service. Put them to work for you now—and be sure... specify Belden.

Belden Manufacturing Co., 4623 W. Van Buren Street
Chicago 44, Illinois



To You,
Belden's Golden Anniversary
Means
—product performance that can come only from a "know-how" that has grown through actual service since the inception of Radio.

—an ability to co-operate in pioneering new wires to meet or anticipate industry's growing needs.

In the years that follow

This Belden Program Is—

— TO BE CONTINUED



No. 8411
Nominal Capacitance 37 mmf per ft. Use particularly for lapel microphone.

No. 8401
Nominal Capacitance 25 mmf per ft. For crystal, ribbon, carbon microphones.

No. 8422
Nominal Capacitance 32 mmf per ft. Use specially for carbon microphones.

No. 8410
Nominal Capacitance 33 mmf per ft. For crystal, ribbon, carbon microphones.

No. 8412
Nominal Capacitance 68 mmf per ft. Use specially for carbon microphones.

No. 8423
Nominal Capacitance 54 mmf per ft. Use particularly for carbon microphones.

No. 8424
Use for interconnecting power cable for all electronic uses. Also microphone cable.

Belden
Radio WIRE

The
Aptitude-Tested **LINE**



← *The data that Launched Thousands of Careers is yours FREE . . . to show*

HOW YOU CAN BE SUCCESSFUL IN RADIO-TV-ELECTRONICS

YOU CAN plod along for years, getting a paltry increase now and then, enjoying little security, finding your work dull and drab.

Then something happens. Things look up. You become more confident. Your earnings rise. You feel more important.

“Luck,” some may say.
“Contacts,” others may suggest.

But in your heart, you will know the answer: “Training.” And it all may have started the moment you filled out a coupon requesting a copy of a free booklet named “Your Future in the New World of Electronics.” From this data you get knowledge of where you stand in Electronics. Tremendous expansion leaves this gigantic industry pleading for trained men. In the defense build-up alone, more than \$7 billion in electronics contracts have been awarded. Top manufacturers sold about \$3 billion worth of electronic merchandise in 1951. By 1960, the radio-electronics industry should do no less than 10 billion dollars per year, not counting military orders.

Today there are over 50,000 radio-equipped police cars; an even larger number of taxis are radio equipped (at least 65,000); 28,000 civilian planes have radio; 27,000 American ships have radio; there are 9,200 industrial radio network installations.

Today there are over 100,000,000 radios in use. There are 16,184,000 TV sets and 109 TV stations in operation. The freeze-lifting makes possible 2,053 new TV stations, and untold millions more TV sets. Countless positions must be filled—in development, research, design, production, testing and inspection, manufacture, broadcasting, telecasting and servicing. To fill these posts, trained men are needed—men who somewhere along the line take time to improve their knowledge, their skills. Men who, today, perhaps, take two minutes to send for a booklet.

“Your Future in the New World of Electronics” shows you how CREI Home Study leads the way to greater earnings through the inviting opportunities described above.

However, CREI does not promise you a “snap.” With an accredited technical school such as this, you must *study* to convert your ambition into technical knowledge you can sell in the fabulous Electronics market.

Since its founding in 1927, CREI has provided thou-

sands of professional radio men with technical educations. During World War II CREI trained thousands for the Armed Services. Leading firms choose CREI courses for group training in electronics at company expense, among them United Air Lines, Canadian Broadcasting Corporation, Trans Canada Airlines, Sears, Roebuck and Co., Bendix Products Division, All-American Cables and Radio, Inc., and RCA Victor Division.

CREI courses are prepared by recognized experts, in a practical, easily understood manner. You get the benefit of time-tested materials, under the personal supervision of a CREI Staff Instructor, who *knows* and *teaches* you what industry wants. This is accomplished on your own time, during hours selected by you, and controlled by your own will power. This complete training is the reason that graduates find their CREI diplomas keys-to-success in Radio, TV and Electronics. CREI alumni hold top positions in America's leading firms. At your service is the CREI Placement Bureau, which finds positions for advanced students and grad-

uates. Although CREI does not guarantee jobs, requests for personnel far exceed current supply.

Now is the time of decision for you. Luck will not propel you forward unless it finds you trained. Contacts won't budge you an inch unless you have the skill to back them up. The answer is: Technical Training . . . and willingness to learn. Together they will bring you increased earnings in this new Age of Electronics. Fill out the coupon and mail it now. We'll promptly send you your free copy of “Your Future in the New World of Electronics.” The rest—your future—is up to you.

CREI Resident Instruction (day or night) is offered in Washington, D.C Here work is done with the latest equipment, in ideal surroundings, under close personal supervision. New classes start once a month. For a CREI Residence School catalog, check the last line of the coupon below.

MAIL COUPON FOR FREE BOOKLET

CAPITOL RADIO ENGINEERING INSTITUTE
 Dept. 147D 3224 16th St., N.W., Washington 10, D. C.

Send booklet “Your Future in the New World of Electronics” and course outline.

CHECK TV, FM & Advanced AM Servicing Aeronautical Radio Engineering
 FIELD OF Practical Television Engineering
 GREATEST Broadcast Radio Engineering (AM, FM, TV)
 INTEREST Practical Radio Engineering

Name.....
 Street.....
 City..... Zone..... State.....
 If residence school in Wash., D. C. preferred, check here

Six quality features of all Tung-Sol Picture Tubes mean better TV receiver operation

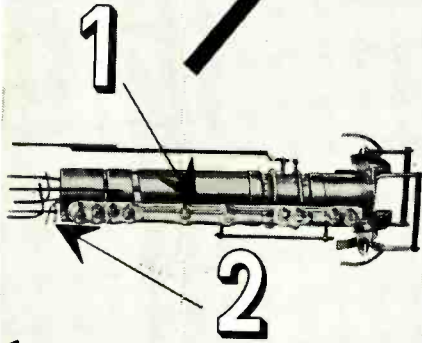

1. Glass bead type assembly is stronger, both mechanically and electrically—gives greater protection against leakages and arcing.

2. Double cathode tab provides double protection against failure in the cathode circuit.

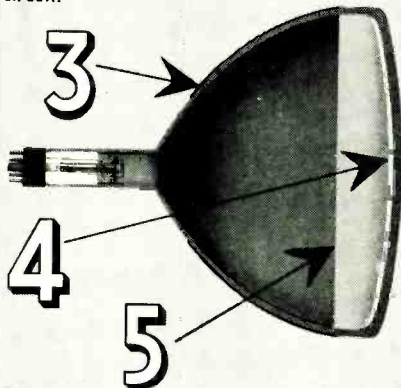

3. Low resistance of outside conductive coating minimizes radiation of horizontal oscillator sweep frequency.

4. Fortified screen composition resists burning (X pattern).

5. Rigid control of internal conductive coating materially improves service reliability.

6 Tung-Sol Picture Tubes can be used with single or double field ion trap designs.

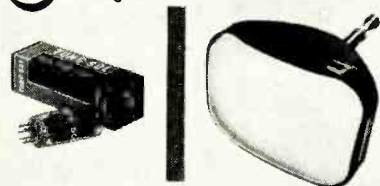

TUNG-SOL®
RADIO, TV TUBES, DIAL LAMPS

TUNG-SOL ELECTRIC INC., Newark 4, N. J.
Sales Offices: Atlanta • Chicago • Culver City (Calif.)
Dallas • Denver • Detroit • Newark

Tung-Sol makes All-Glass Sealed Beam Lamps, Miniature Lamps, Signal Flashers, Picture Tubes, Radio, TV and Special Purpose Electron Tubes.

NEW CONTRIBUTION to air safety is an automatic plane-position indicator developed by Arma Corporation, subsidiary of American Bosch. CAA omnirange signals are translated automatically into movements of a symbol on an illuminated map, giving the plane's actual position, course, and compass bearing at all times.

The equipment consists of the panel-mounted indicator shown in the photograph, and an amplifier-servo unit which fits the standard aircraft communications rack. Total weight is only 37 pounds.

whose relative times of arrival at the plane give the pilot an accurate bearing on the station and enable him to follow a prescribed course. (See the February, 1951, issue of RADIO-ELECTRONICS.)

Ordinary omnirange receiving instruments show only that the plane is on (or off) course without giving its actual position over the ground. In the new automatic computer, charts are projected as required on a 10-inch screen, and the plane's position (accurate within 0.4 mile) bearing, (within 1/2 degree) and heading (within 1 degree), are shown by a symbolic marker (see arrow)

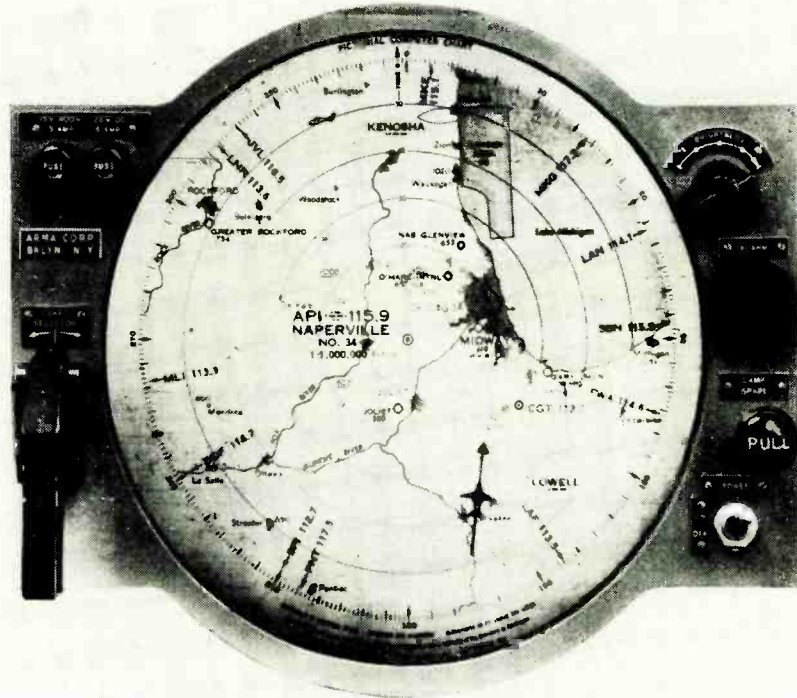

Map and arrow-like symbolic marker are projected on the radar-like screen.

In the Arma pictorial computer as many as 700 translucent charts covering the plane's route are printed on a roll of 35-mm film. Each chart covers an area 34, 64, 137, or 274 miles across, depending on the scale, and is centered on one of the 291 omnirange bearing stations currently in operation. These stations transmit two v.h.f. signals

projected on the screen. Instead of calculating his position, the pilot can see where he is at a glance.

Code perforations on each chart automatically compensate through actuating fingers for scale changes and different station frequencies. Charts may be changed in 10 seconds and are automatically centered on the screen.

RADIO TELESCOPES—newest tools of astronomy, the world's oldest science—are taking widely different forms in the United States and Great Britain. In this country, Ohio State University will use an array of 6-element helical antennas. Eight bays—48 elements in all—mounted on a 160-foot movable steel cradle, will probe interstellar space for 250-mc radiations from cosmic disturbances and island universes more than a million light years away. Similar bays, added from time to time, will extend its range to even vaster distances.

In England, Manchester University will use a gigantic "searchlight" beam at Jodrell Bank. Floating on columns 185 feet high, the 250-foot, 1,270-ton

parabolic reflector will take four years to build.

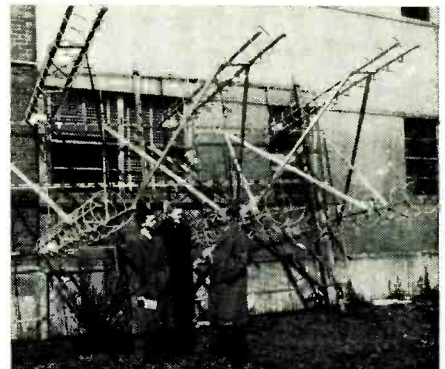

Single bay of Ohio State's antenna array.

Now IN YOUR OWN HOME Learn

TELEVISION RADIO

the Amazingly Effective

D.T.I. WAY

—with the aid of **BOTH HOME EQUIPMENT and HOME MOVIES**

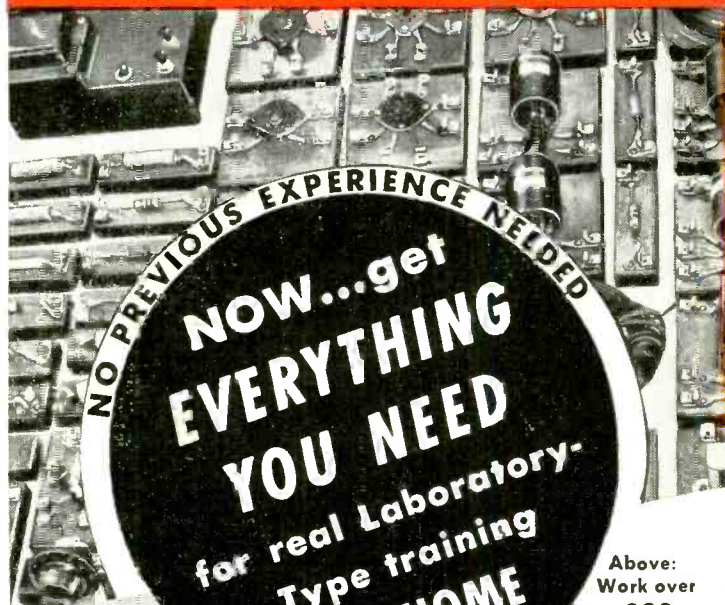

Above: Work over **300** fascinating experiments with this equipment

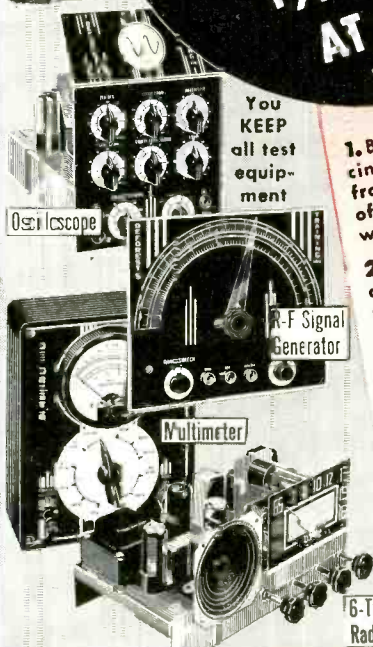

You **KEEP** all test equipment

1. Build over 300 fascinating experiments from 16 **BIG SHIPMENTS** of Electronic-Radio parts which you **KEEP**.

2. Build valuable commercial-type test equipment—as shown to the left—which you **KEEP**. This includes a quality **OSCILLOSCOPE**—a must for Television work.

3. Use a 16 mm. movie projector and new series of Hollywood produced instructive movies—a wonderful aid to help you grasp important fundamentals faster...easier...better.

4. Enjoy well-illustrated, easy-to-read lessons with handy **FOLD-OUT** diagrams.

5. Get an honest-to-goodness **EMPLOYMENT SERVICE** to help you get a good job after graduating—or assistance in starting your **OWN SALES AND SERVICE BUSINESS**. Mail coupon today for the complete details.

What will mailing the coupon below do for YOU? Just this! You'll find out about one of today's most remarkable... practical ways to prepare to get into America's amazing billion dollar opportunity field of **TELEVISION-RADIO-ELECTRONICS**. You'll see how to get into fascinating work that pays well... that offers one of America's most promising futures... that enables you to start your own business almost "on a shoe string," if you prefer this to a job opportunity.

And above all, you'll get some **GOOD NEWS** especially welcomed by men anxious to earn **REAL MONEY** in this thrilling field. For you'll see that **NOW** you can get the kind of practical, laboratory-type training so desirable for making real progress in **Television-Radio-Electronics**... and **WITHOUT LEAVING HOME**.

You'll see that DeForest's Training, Inc. sends everything needed to set up your own **HOME LABORATORY**. You get and keep the same type of basic electronic equipment used in our modern Chicago Training Laboratories. You get home training that includes the knowledge and experience gained from training thousands of students first hand in Chicago. And to top it all, you use DTI's amazingly effective and exclusive home training aid—**INSTRUCTIVE MOVIES**. But why not get the complete story? Mail coupon today for information-packed literature.

MODERN LABORATORIES

If you prefer, get all your preparation in our new Chicago Training Laboratories—one of the finest of its kind. Ample instructors, modern equipment. Write for details!

MILITARY SERVICE!

If you're subject to military service, the information we have for you should prove very helpful. Mail coupon today.

Get **BOTH** of these colorful, information-packed folders **FREE**

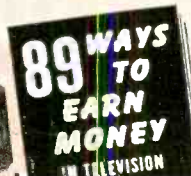

Mail Coupon Today



New "black" RECTANGULAR TUBE

DeFOREST'S TRAINING, INC.

AFFILIATED WITH De Vry Technical Institute CHICAGO 14, ILLINOIS

DeFOREST'S TRAINING, INC., DEPT. RE-7-1
2533 N. Ashland Avenue, Chicago 14, Ill.

I would like valuable, information-packed folders showing how I may get started toward a good job or my own business in Television-Radio-Electronics.

Name..... Age.....
Street..... Apt.....
City..... Zone..... State.....

NEW • ADVANCED
SUPERIOR IN PERFORMANCE

THE
SCANAFAR



ASTATIC'S
NEW
TV BOOSTER
MODEL CT-1

The Scanafar, new Astatic TV Booster development, incorporates improvements that match the forward strides made in newer model TV Receiver front-ends. It stands alone as a working companion with the new receivers, for added picture brilliance and clarity . . . and offers a still higher measure of reception improvement for older style sets. The Scanafar presents a new minimum noise figure with maximum gain. Band width (over seven megacycles on all channels) and picture definition are excellent. A balanced, cascaded circuit is employed, with a neutralized 6J6 tube driving a 6BQ7 (the highly touted "quiet tube"). Both tubes are used over the entire TV frequency range. It all adds up to booster performance that is unparalleled today. Test this new unit yourself . . . at your first opportunity. Be prepared for a new experience in booster aid to TV reception.

EXPORT DEPARTMENT
401 Broadway, New York 13, N. Y.
Cable Address:
ASTATIC, New York

THE
Astatic
CORPORATION
CONNEAUT, OHIO
IN CANADA CANADIAN ASTATIC LTD, TORONTO, ONTARIO

The story of the Jodrell Bank station was told in the May, 1951, issue of RADIO-ELECTRONICS by Professor A. C. B. Lovell, head of the British project.



LEGION OF MERIT was awarded Master Sergeants Forrest C. Wolferd and Robert C. Williams, U.S. Air Force, designers of the vacuum tube trainer pictured on our June cover, for their work on the device.



RADIO'S LIFE HISTORY, the 5,000-volume "RCA-Clark Collection of Radioana," was presented April 16 to Massachusetts Institute of Technology by RCA. More than half a century of radio pioneering and development is represented in the files of early companies, photographs, blueprints, log books, biographies, and scrapbooks assembled by George H. Clark, M.I.T. alumnus and retired RCA executive.

AN 8-MONTH SEARCH for the cause of frequent television blackouts in Port Jefferson, L. I., ended successfully through the combined efforts of a citizens' committee, the Long Island Rail Road, a power company, a United States Congressman, and the FCC.

The railroad, long a popular target for complaints, finally proved its new Diesel engines were not to blame. An appeal to Congressman Ernest Greenwood brought a truckload of FCC engineers and direction-finding equipment from Washington. They pin-pointed a highway light pole as the culprit. Vibration from passing vehicles and trains had damaged an insulator at the top. A new one, supplied by the power company, cured the trouble completely.

—end—

RADIO-ELECTRONICS



EDW. H. GUILFORD
Vice President

I can train you to pass your FCC License Exams in a minimum of time if you've had any practical radio experience—amateur, Army, Navy, radio servicing, or other. My time-proved plan can help put you, too, on the road to success.

Let me send you FREE the entire story

Just fill out the coupon and mail it. I will send you, free of charge, a copy of "How to Pass FCC License Exams," plus a sample FCC-type Exam, and the amazing new booklet, "Money-Making FCC License Information."

How to Pass FCC License Exams

**Commercial
Radio Operator**



FREE

Tells where to apply and take FCC examinations, location of examining office, scope of knowledge required, approved way to prepare for FCC examinations, positive method of checking your knowledge before taking the examination.

Get Your FCC Ticket in a Minimum of Time

Get this Amazing Booklet FREE

TELLS HOW—

**WE GUARANTEE
TO TRAIN AND COACH YOU AT HOME
IN SPARE TIME UNTIL YOU GET
YOUR FCC LICENSE**

If you have had any practical experience—Amateur, Army, Navy, radio repair, or experimenting

TELLS HOW—

**Employers make
JOB OFFERS Like These
to Our Graduates Every Month**

Letter from Chief Engineer, Broadcast Station, North Carolina, "Need men with radio-telephone 1st class licenses, no experience necessary. Will learn more than at average station for we are equipped with Diesel Electric power, transmitting and studio equipment."

Telegram from Chief Engineer, Broadcast Station, Wyoming, "Please send latest list available first class operators. Have November 10th opening for two combo men."

These are just a few examples of the job offers that come to our office periodically. Some licensed radiomen filled each of these jobs . . . if might have been you!

HERE'S PROOF FCC LICENSES ARE OFTEN SECURED IN A FEW HOURS OF STUDY WITH OUR COACHING AT HOME IN SPARE TIME

Name and Address	License	Lessons
Lee Worthy 2210 1/2 Wilshire St., Bakersfield, Cal.	2nd Phone	16
Clifford E. Voot Box 1016, Danis, Fla.	1st Phone	20
Francis X. Forch 38 Beucier Pl., Bergenfield, N. J.	1st Phone	38
S/Sgt. Ben H. Davis 317 North Roosevelt, Lebanon, Ill.	1st Phone	28
Albert Schoell 110 West 11th St., Escondido, Cal.	2nd Phone	23

CLEVELAND INSTITUTE OF RADIO ELECTRONICS
Carl E. Smith, E. E., Consulting Engineer, President
Desk RE-43—4900 Euclid Bldg., Cleveland 3, Ohio

TELLS HOW—

**Our Amazingly Effective
JOB-FINDING SERVICE**

Helps GIRE Students Get Better Jobs

Here are a few recent examples of Job-Finding results

GETS FIVE JOB-OFFERS FROM BROADCAST STATIONS
"Your 'Chief Engineer's Bulletin' is a grand way of obtaining employment for your graduates who have obtained their 1st class license. Since my name has been on the list I have received calls or letters from five stations in the southern states, and am now employed as Transmitting Engineer at WMMT."
Elmer Powell, Box 274, Sparta, Tenn.

GETS CIVIL SERVICE JOB
"I have obtained a position at Wright-Patterson Air Force Base, Dayton, Ohio, as Junior Electronic Equipment Repairman. The Employment Application you prepared for me had a lot to do with my landing this desirable position."
Charles E. Loomis, 4516 Genesee Ave., Dayton 6, Ohio.

GETS JOB WITH CAA
"I have had half a dozen or so offers since I mailed some fifty of the two hundred employment applications your school forwarded me. I accepted a position with the Civil Aeronautics Administration as Maintenance Technician. Thank you very much for the fine cooperation and help your organization has given me in finding a job in the radio field."
Dale E. Young, 122 Robbins St., Owosso, Mich.

OUR IS THE ONLY HOME STUDY COURSE WHICH SUPPLIES FCC-TYPE EXAMINATIONS WITH ALL LESSONS AND FINAL TESTS.



Your FCC Ticket is recognized in all radio fields as proof of your technical ability.

**Get All 3 FREE
MAIL COUPON NOW**

CLEVELAND INSTITUTE OF RADIO ELECTRONICS
Desk RE-43, 4900 Euclid Bldg., Cleveland 3, Ohio
(Address to Desk No. to avoid delay)

I want to know how I can get my FCC ticket in a minimum of time. Send me your FREE booklet, "How to Pass FCC License Examinations" (does not cover exams for Amateur License), as well as a Sample FCC-type exam and the amazing new booklet, "Money-Making FCC License Information."
 Tell me how I can get a TV Engineering Course without additional charge.

NAME.....
ADDRESS.....
CITY..... ZONE..... STATE.....
Paste on 2-cent post card or send air mail

the most convenient TV tower ever made

THE TEL-A-RAY

SWING-OVER* TOWER

*swings over
to the ground
for servicing . . .*

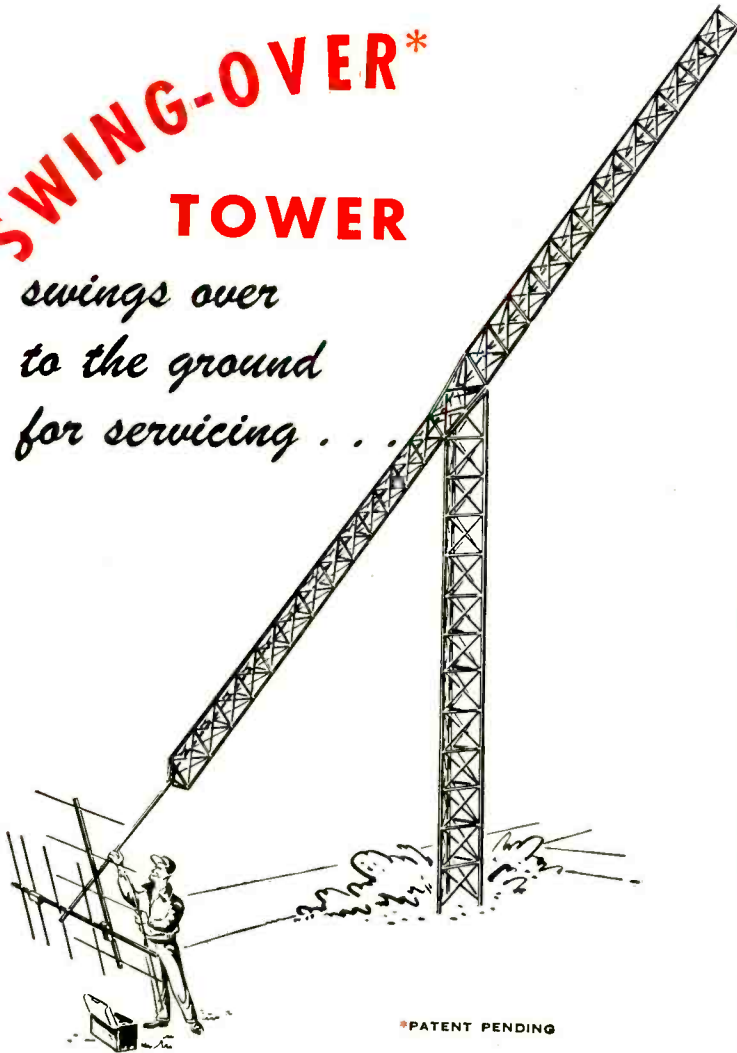

The biggest new idea in television — the Tel-a-Ray Swing-Over Tower* — swings over to the ground for easy servicing! One man can raise or lower this counterbalanced tower in three minutes! Model TT1, for ground installations, is 50 feet high when a recommended 10 feet of water pipe is added — can be quickly erected with no guy wires. Model TT2 is designed for roof tops, reaches up 24 feet with the addition of an eight-foot pipe. Although light in weight, the Swing-Over Tower is ruggedly built with steel angles and welded construction. Simple to assemble . . . no machinery necessary . . . low in price. Write today for information.

FOR WONDERFUL
TV RECEPTION
WHEREVER YOU ARE

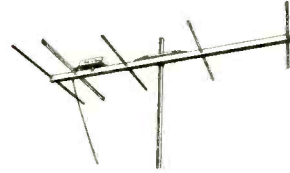

The weatherproof Model T antenna . . . brings in wonderful reception up to 200 miles.



Only low-priced Pre-Amplifier on the market, the TB. Multiplies signal gain . . . holds noise to a minimum.



Butterfly Swivel-Positioned TV and FM antenna . . . designed to give the finest reception in primary areas.

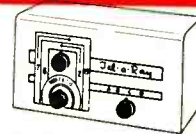

Tel-a-Ray's new Switching Booster (Model PTB1) — one switch changes channels and antennas. Eliminates the need for a separate booster for each antenna . . . for as many as four antennas. Automatic features make this outstanding.

FOR COMPLETE INFORMATION WRITE

Tel-a-Ray

ENTERPRISES, INC.



BOX 332E
HENDERSON, KY.

RADIO-ELECTRONICS

Don't miss Sylvania's unbeatable 3-way Service Helper — "SIT-'N-FIXIT"

FREE

WITH 16 SYLVANIA PREMIUM TOKENS



Entire kit folds into a neat compact carrying case.

A TOOL KIT,
STOOL AND
DROP CLOTH...
ALL IN ONE!



Sylvania now offers you the world's handiest and most complete servicing kit. Nothing else like it! It'll speed your work, spare your back, impress your customers!

Here, in a neat sail-cloth carrying case, is a sturdy, aluminum and canvas, folding stool. Equipped with zippered pocket for tools and parts. Also open pockets for Sylvania Wrench Kit and Pliers Kit. And get this! The unzipped case opens out to a broad, turned-up-edge drop-cloth.

How to get your "Sit-'N-Fixit"

You get this complete servicing kit FREE for only 16 Sylvania Premium Tokens shown above. One of these tokens is yours free with every Sylvania Picture Tube or with every 25 Sylvania Receiving Tubes purchased from your distributor. When you have 16 tokens, take them to this distributor and pick up your "Sit-'N-Fixit." *Note, these tokens will be honored only by the one distributor where you buy all your tubes.*

Don't delay

This is a special summer offer. Good only from July 1st to August 31st. So, call your Sylvania Distributor and get in those tube orders TODAY!

SYLVANIA



RADIO TUBES; TELEVISION PICTURE TUBES; ELECTRONIC PRODUCTS; ELECTRONIC TEST EQUIPMENT; FLUORESCENT TUBES, FIXTURES, SIGN TUBING, WIRING DEVICES; LIGHT BULBS; PHOTOLAMPS; TELEVISION SETS



In quest of the "skeleton of speech"

In the famous Quiet Room at Bell Laboratories, this young volunteer records speech for analysis. Scientists seek to isolate the frequencies and intensities which give meaning to words . . . stripping away non-essential parts of word sounds to get the basic "skeleton" of speech.

A child or an adult . . . a man or a woman . . . an American or an Englishman—all speak a certain word. Their voices differ greatly. Yet listeners understand the word at once. What are the common factors in speech which convey this information to the hearer's brain?

Bell scientists are searching for the key. Once discovered, it could lead to new electrical systems obedient in new ways to the spoken word, saving time and money in telephony.

Chief tool in the research is the sound spectrograph which Bell Telephone Laboratories developed to make speech visible. Many kinds of persons record their voices, each trying to duplicate an electrically produced "model" sound. While their voice patterns are studied, a parallel investigation is made of the way human vocal cords, mouth, nose and throat produce speech.

Thus, scientists at Bell Laboratories dig deeply into the fundamentals of the way people talk, so that tomorrow's telephone system may carry your voice still more efficiently—offering more value, keeping the cost low.

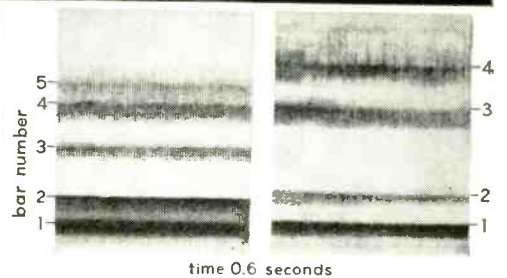

Spectrograms of young girl's voice (right) and man's voice making "uh" sound as in "up." Horizontal bars reveal frequencies in the vocal cavities at which energy is concentrated. The top of the picture is 6000 cycles per second. Pictures show how child's resonance bars are pitched higher than man's.

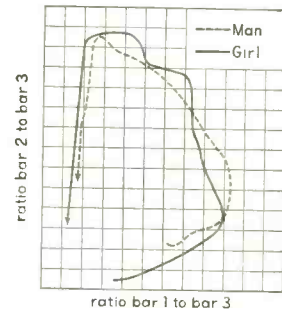

The word "five." Graph shows ratio of frequency of spectrogram bars. The solid line is for a girl and the dotted line is for a man. Note the similar patterns despite pitch differences. Human hearing extracts the speech sounds from this sort of pattern in the identification of words. Scientists aim at machines that can do the same.



BELL TELEPHONE LABORATORIES

Improving telephone service for America provides careers for creative men in scientific and technical fields.

the only complete catalog
for everything in Radio,
TV & Industrial Electronics

your 1952 **free!**
ALLIED 212-page
value-packed catalog



Send for it today!

Here's the *one* authoritative, complete, up-to-date Buying Guide to TV, Radio and Industrial Electronics. Make your selections from the world's largest stocks of quality equipment at lowest, money-saving prices. See the latest and most complete presentation of electronic apparatus: new TV, AM and FM receivers; High-Fidelity Custom Sound components; latest P.A. Systems and accessories; recorders; fullest selections of Amateur receivers and station gear; specialized industrial electronic equipment; test instruments; builders' kits; huge listings of parts, tubes, tools, books—the world's *most complete stocks* of quality equipment.

ALLIED gives you *every* buying advantage: speedy delivery, expert personal help, lowest prices, liberal time payment terms, assured satisfaction. Get the latest 1952 ALLIED Catalog. Keep it handy—and save time and money. Send for your FREE copy today!

**the world's
largest stocks**

- Radio Parts Unlimited
- Test Instruments
- Television & Home Radios
- P.A. and Hi-Fi Equipment
- Amateur Station Gear
- Builders' Supplies
- Equipment for Industry

quick, expert service



ALLIED IS YOUR TV and HI-FI HEADQUARTERS



Count on ALLIED for the latest in TV! If it's made—we have it for quick delivery. We specialize, too, in High-Fidelity sound components—everything in amplifiers, speakers, tuners, phono gear and accessories. For TV or Hi-Fi—think of ALLIED!



ALLIED RADIO
the World's Largest Radio Supply House
EVERYTHING IN ELECTRONICS

free

**SEND TODAY FOR RADIO'S
LEADING BUYING GUIDE**

ALLIED RADIO CORP., Dept. 2-G-2
833 W. Jackson Blvd., Chicago 7, Illinois

Send FREE 212-page 1952 ALLIED Catalog No. 127.

Name _____

Address _____

City _____ Zone _____ State _____

MERIT
 tv full-line*
 components give
 universal coverage

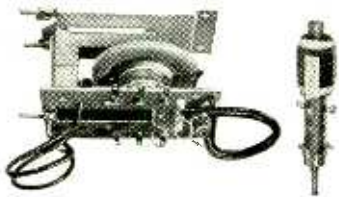

NEW IMPROVED HVO-7 FOR GREATER COVERAGE
 Tapped AFC Winding. Covers Admiral Chassis 21-24 Series
MWC-1 UNIVERSAL WIDTH COIL
 (3-27 MH) A Tapped Secondary For AGC or AFC.

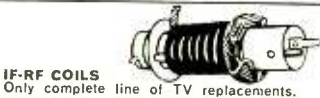

IF-RF COILS
 Only complete line of TV replacements.

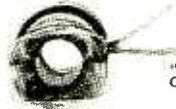

"COSINE" YOKES
 Complete with leads & network.

MATCHED FOR DIRECT DRIVE



MDF-30 HVO-8
 A-3080 Vert. Mfg.
 A-3081 Horiz. Mfg.
 Autoformer



KIT NO. 1000
 MATCHED SET FOR SPEEDY PROFITABLE SERVICE!

MERIT HQ for PRACTICAL TV Service Aids

MERIT'S 1952 Catalog No. 5211 with new MERIT IF-RF Coils.
 Other MERIT service aids:
 TV Repl Guide No. 404, 3500 models & chassis.
 Cross Ref Data, IF-RF Coils, Form No. 14.
 See your Jobber or write: Merit Coil and Transformer Corp., 4425 Clark Street, Chicago 40.



These three MERIT extras help you:
 Exclusive: Tapemarked with specs and hook-up data.
 Full technical data packed with every item.
 Listed in Howard Sams Photo-facts.



*Merit is meeting the TV improvement, replacement and conversion demand with a line as complete as our advance information warrants!



BAROMETER of the PARTS INDUSTRY

During May, 54 of the leading 400 manufacturers of Radio-Television-Electronic parts and equipment made changes in their lines. May also showed the heaviest increase in "change activity" since the beginning of the year, notably among the tube manufacturers. In price revisions by the number of manufacturers and products affected, the following summary illustrates the comparative trend for April and May.

	No. of Manufacturers		No. of Products	
	April	May	April	May
Increased prices	10	13	179	885
Decreased prices	14	25	321	302

For a summary of the most active product categories, see the following table:

Products Group	Increased Prices		Decreased Prices		New Products		Discontinued Products	
	No. of Mfrs.	No. of Products	No. of Mfrs.	No. of Products	No. of Mfrs.	No. of Products	No. of Mfrs.	No. of Products
Antennas & Access.	2	6**	5	68*	8	97*	5	32*
Capacitors	1	7**	0	0**	1	137*	1	28*
Controls & Resistors	0	0**	1	1*	4	51**	3	61*
Sound & Audio	1	1	2	2*	10	35**	4	12**
Test Equipment	2	7*	2	19*	2	2**	2	11*
Transformers	0	0	0	0	3	33*	0	0
Tubes	6	862*	13	299*	4	194*	5	123*
Wire, Cable, Connectors	1	1**	1	1**	2	3**	0	0**

*Increase over April **Decrease

*Increase over April **Decrease

Comment: While tube prices have been extremely active during the past 4 months, receiving tube prices have increased while cathode ray and special purpose tubes have shown a steady decline.

Comment: With the exception of the tube manufacturers, most of the other parts and equipment manufacturers continue the trend toward product changes rather than price adjustments.

This data is prepared by the staff of United Catalog Publishers, Inc., 110 Lafayette Street, New York City, publishers of RADIO'S MASTER, the Official Buying Guide of the Parts Industry.

Merchandising and Promotion

Philco Corp., Philadelphia, is offering its factory-supervised service technicians a chance to tie in with the biggest promotion the company has ever launched. Philco is supplying newspaper ad layouts, handbills, truck banners, window streamers, etc., promoting a special TV set tune-up to coincide with Philco's sponsoring of radio and TV broadcasts of the Republican and Democratic National Conventions.

Allen B. Du Mont Laboratories Teletest Service Control Department is sponsoring a series of service seminars in co-operation with receiver sales distributors. A Dynamic Demonstrator is used

to simplify illustration of the processes of trouble-shooting and component functions. Du Mont also announced the distribution of the latest edition of its Picture Tube Data Chart by the Cathode-Ray Tube Division. The chart lists the electrical and physical characteristics of modern RTMA-registered TV picture tubes.

The RCA Tube Department is carrying on a two-pronged promotion drive designed to build up consumer demand for RCA TV picture and receiving tubes to support service technicians in their local business building efforts. The program embraces national radio and TV advertising, window displays, direct mail, sales kits, and a promotion-plan catalog. Another RCA promotion, spon-

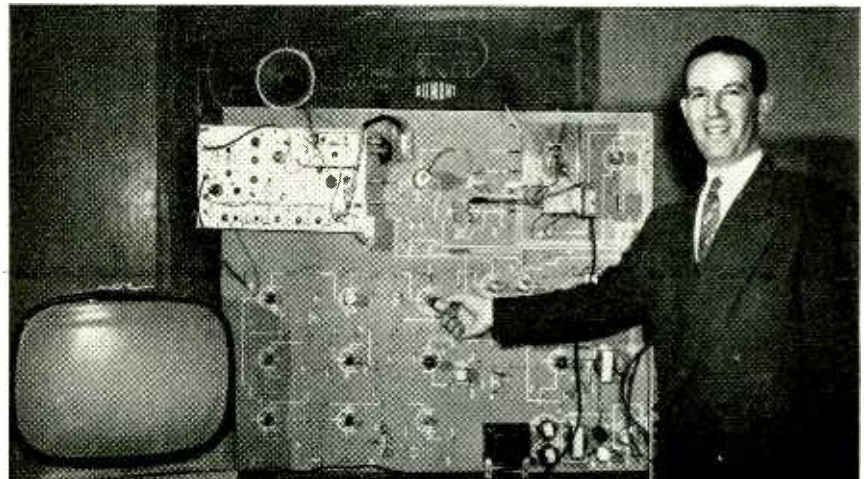

sored by the Home Instruments Department, features a 30-minute institutional film, "The Most Natural Thing in the World," as part of the third RCA Victor TV Sales Clinic for TV dealers and their sales staffs in all parts of the country.

Walter L. Schott Co., Los Angeles, introduced its new "Walsco 50" line of radio and TV hardware with a new package, a new price and a new display. The line offers service technicians a way to store small hardware in a

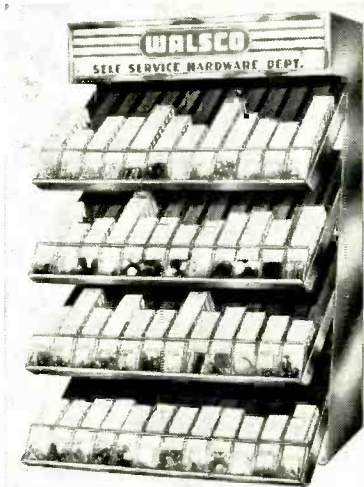

plastic container which has unlimited uses on the work bench. The company is providing jobbers with an attractive self-service display.

Jensen Manufacturing Co., Chicago loudspeaker manufacturer, will use the "Silver Anniversary" theme in current and future 1952 advertising and promotion.

Channel Master Corp., Ellenville, N. Y., published a 12-page booklet, "Your Guide to Channel Master Tele-



vision Antennas," describing more than fifty types of its antennas, accessories, and kits.

Jersey Specialty Co., Little Falls, N. J., sent over 1,000 orange-and-blue discs to its distributors proclaiming them as authorized distributors of J.S.C. wire products.

Raytheon Manufacturing Co., Waltham, Mass., featured a display of electronic equipment at its 1952 Sales

JULY, 1952



NEW!

UNIVERSAL REPLACEMENT HI-VOLTAGE "DOORKNOB" CERAMIC ...



FURNISHED WITH

SCREW-IN TERMINALS TO MEET EVERY NEED!

An ingenious screw-in terminal system makes Sprague's new type 20DK-T5, 500 mmf, 20,000 volt molded case ceramic capacitor fit most every TV set. All you have to do is select the proper set of terminals, two twists of the wrist, and there you are!

With this new Sprague development, you need only one capacitor in your kit to service sets up to 21" tubes.

Sprague's 20DK-T5 "Doorknob" ceramic is molded in genuine thermosetting plastic, non-flammable and moisture-resistant. Guard rings are molded in both faces to lengthen the surface leakage path. Write for complete catalog C-608 to Sprague Products Co., 81 Marshall St., North Adams, Mass.



**Don't Be Vague!
Insist On Sprague**

**WORLD'S LARGEST
CAPACITOR MANUFACTURER**

The staff of MORT FARR

of Philadelphia—one of America's leading TV Service dealers—shows

How to use

KRYLON[®]

to cut down service calls

Krylon is a tough, quick-drying Acrylic coating with many important TV applications. To apply, just push the button on the aerosol can and spray—that's all you do!



Because of its high dielectric strength, Krylon helps prevent corona. Here technician Bernard Vanella "Krylon-izes" high voltage coil and insulation, the socket of the high voltage rectifier, component parts of the rectifier circuit.



Edward Weigand, Farr service man, sprays Krylon on entire antenna. Krylon shuts out moisture, rain, salt spray—prevents corrosion and pitting—keeps picture quality at peak.

"Krylon-izing" increases your customer's satisfaction and jumps your own profits! Nationally advertised to your customers!

See your jobber, or write direct.

KRYLON, Inc., Dept. 317
2601 N. Broad St., Phila. 32, Pa.

and Service Conference in Cambridge, Mass. The company's "reflection plotter" which adds memory to radar, was one of the highlights.

Javex, Garland, Texas manufacturer of electronic devices, is giving distributor purchasers of its products a handmade walnut desk nameplate.

Electrovox Co., Inc., East Orange, N. J., is promoting the sale of its "Walco" phonograph needles with a dealer display which permits consumers to study phonograph needles under a high-powered microscope.

Talk-A-Phone Co., Chicago, launched a new sales promotional program built around the theme, "It's Easy to Sell Intercom." A new catalog with a fold-over section, titled "Where to Use Intercom—and How to Figure Your Requirements", is featured.

John F. Rider Publisher, New York City, is giving its distributors a one-piece transparent plastic index display rack. The new three-color rack permits distributors to display a quantity of the company's "Tek-File" indexes at all times.

Production and Sales

The RTMA reported that radio and television set production for the first quarter of this year dropped more than 40% below 1951's output for the same period. Radio sets produced numbered 2,367,800; TV sets, 1,324,831. Of the total radio production, 959,117 were home sets, 241,019 were portables, 806,240 were auto sets, and 361,424 were clock radios.

Receiving tube sales of 85,934,322 units were reported by the RTMA for the first quarter of 1952, compared to 118,277,243 for the 1951 period. Of these 19,513,454 were sold for initial equipment, and 7,231,186 for replacement. The others were sold for export and Government use.

The association also reported sales of 1,040,829 TV picture tubes for the first quarter of 1952, which was considerably below last year's figures. The RTMA noted that rectangular picture tubes, 16 inches or larger in size, accounted for 98% of the total sales.

New Plants and Expansions

General Electric took a long-term lease on a new \$875,000 building now under construction in Chicago. G-E will use it as sales, warehouse, and commercial-service headquarters for the central regional operations of the Tube Department. When the building is completed late this year, it is expected to be the largest electronic tube warehouse ever built.

Sylvania Electric Products leased a 50,000-square-foot factory building in York, Pa. It will be used for the fabrication of metal parts and operated as a unit of Sylvania's Parts Division. It will be completed by the end of the year. The company also announced that it had leased 20,000 square feet of warehouse and office space in Seattle as headquarters for lighting, radio-tube, and photolamp sales and service

USE PHOTOFAC

the world's best Radio and TV Service Data...



WE'LL PROVE YOU'LL SAVE TIME and EARN MORE WITH PHOTOFAC

FREE Service Technicians: We'll send you any Photofact Folder listed in the "PF INDEX and Technical Digest."

If you haven't an Index, get a free copy from your local Photofact distributor or write for it today. To obtain Free Folder, be sure to state Photofact Set and Folder Number as shown in the Index.

NOW—learn for yourself how PHOTOFAC makes your Radio and TV work quicker, easier, more profitable! Just get and use an actual PHOTOFAC Folder. Discover why over 35,000 successful service technicians count on this invaluable data daily. No other service gives you PHOTOFAC's completeness, accuracy, uniformity and lowest cost. PHOTOFAC is the only Radio-TV service data prepared from laboratory analysis on the actual equipment. Get your FREE Folder now. Examine, use, compare. See why you can't afford to be without PHOTOFAC!

NOTE: Our FREE Folder offer is limited to Service Technicians only. Attach coupon below to your letterhead and mention your jobber's name. Experimenters and others may obtain the Photofact Folder by remitting amount shown below.

HOWARD W. SAMS & CO., INC.

HOWARD W. SAMS & CO., INC.
2201 E. 46th St., Indianapolis 5, Ind.

I am a Service Technician. Send me Free Folder No. which appears in Photofact Set No. (as listed in the PF Index).

I am an Experimenter. Enclosed \$..... Send me Folder No. which appears in Photofact Set No. (TV—\$1.00. AM/FM—50c. Record Changer or Communication Receiver—75c)

Name.....

Address.....

City..... Zone..... State.....

**EASY
PAY
PLAN!**

PAY AS YOU EARN! Ask your distributor about this amazing plan. Only \$18.39 puts the entire profit-boosting Photofact library in your shop now!

activities in the Pacific Northwest.

Davis Electronics, manufacturer of "Super-Vision" TV antennas, moved from Los Angeles to a new plant with enlarged facilities at Burbank, Calif.

Super Electric Products Corp., Jersey City, N. J. transformer and electronic equipment manufacturer, purchased the plant and business of the Union Spring and Manufacturing Co., New Kensington, Pa. Super changed its name to that of the latter company. The Jersey City plant will be operated as the Electronic Division.

Chatham Electronics Corp., Newark, N. J., constructed an additional plant in Livingston, N. J.

Television Associates, Manchester, N. H. manufacturer of TV antennas, is now building a new plant with nearly five times the capacity of its old one, to take care of the demand for its products.

Raytheon Manufacturing Co. marked the opening of its new plant on Seyon St., Waltham, Mass., with open house for the 700 employees of its Equipment Manufacturing Divisions and their families.

Business Briefs

... RCA awarded eight fellowships to young scientists and graduate engineering students for advanced study. The company also established the Frank M. Folsom Scholarship at the University of Notre Dame for undergraduate students majoring in pure science or engineering.

... Sylvania Electric Products' Radio Tube Division this spring celebrated the production of its billionth vacuum tube since 1924. The progress of the "one billionth and one" tube was traced through the company's dealer channels to the ultimate consumer who was awarded two trips to Bermuda.

... Technical Appliance Corp., Sherburne, N. Y. manufacturer of Taco radio and TV antenna equipment, established a scholarship to provide financial aid toward a technical degree for a qualified graduate of Sherburne Central School.

... Thomas Electronics, Inc., Passaic, N. J., extended the guarantee covering its cathode-ray tubes from six months from date of tube installation to a full year, effective from April 1, 1952.

... Allen B. Du Mont Laboratories' Instrument Division announced that its shipments of cathode-ray instruments for the first four fiscal periods of 1952 were double those for the same periods in 1951.

... Capitol Radio Engineering Institute, Washington, D. C., celebrated its 25th anniversary with the broadening of its Group Training for Industry Program. A brochure describing the program has been prepared by the institute.

... Astron Corp., East Newark, N. J., is offering the services of its noise-suppression laboratory and engineering staff to manufacturers concerned with specific noise-suppression problems of the Armed Services and electronic industry.

—end—

JULY, 1952

on **RADIO-TV-RADAR**
production lines

American Beauty
ELECTRIC SOLDERING IRONS

DURABLE

DEPENDABLE

EFFICIENT!

Day after day — shift after shift — American Beauty Electric Soldering Irons are at work on production lines throughout the nation. Faithful performers for America's safety — and enjoyment — for over half a century.

Let American Beauty Electric Soldering Irons prove to YOU their durability — dependability — efficiency.

123

For descriptive catalog pages write Dept. S-3

AMERICAN ELECTRICAL HEATER CO.

DETROIT 2, MICH.

103 BIG PRIZES FOR

To be given in G.E.'s great **B\$S\$B***

THREE BRAND-NEW



LOOK AT THESE BEAUTIFUL PRIZES YOU CAN WIN!



MEN'S CALENDAR WATCH, a handsome Benrus with gold expansion band, *plus* gold wind-proof cigarette lighter and matching gold cuff links and tie bar. All fitted in a smart and distinctive case.



LADIES' WRIST WATCH, a beautiful Benrus hinged-cuff "Embraceable" with safety chain; also, chic gold earrings and a stunning pendant-and-brooch combination. Can be a wonderful gift from *you*.

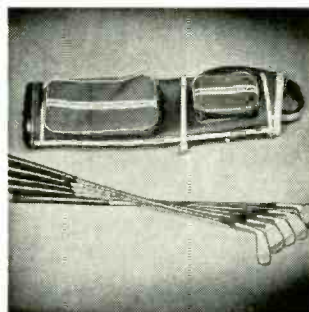

MATCHED GOLF IRONS, Wilson, with long-lasting nylon Wilson golf bag. Nos. 2, 5, 7, 9, and putter, Gene Sarazen Stroke-master model. Clubs, nationally distributed, can be filled in any time.

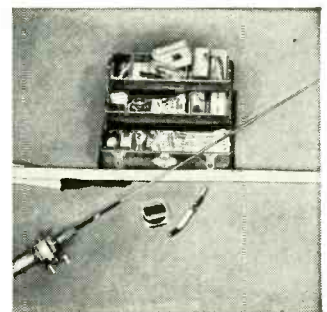

FISHING KIT, 27 items in a double-tray cork-lined tackle box. Gep glass casting rod, Green Hornet level-wind reel, fish rule and scale, Pflueger spoons and spinners, plugs, hooks and leaders.

RADIO-ELECTRONICS

SERVICE DEALERS!

Promotion Contest topped by

'52 DODGE TRUCKS!

***B. S. B.—Bigger Summer Business** tells the story! Increase your profits and walk off with a brand-new Dodge panel truck! General Electric's B. S. B. Contest offers you this double bonus.

The contest's loaded with 103 prizes! It's primed with new sales-getting helps for you, as shown at right. Contest starts now and ends August 15—weeks that are summer radio-TV check-up time for millions.

Yardstick of the contest will be how successfully you promote your own service business in terms of *planning, originality, and results*. G. E. will support you with special full-page tie-in ads in national magazines read by 35,000,000.

First prize to each of the three top winners will be a new '52 Dodge panel truck, handsomely lettered with your name and address.

100 other prizes—all big values, all mighty attractive!

ENTER NOW—HERE'S HOW!

● **Phone, write, or see your G-E tube distributor** for (1) descriptive folder that gives all details about the contest, (2) streamers, mailers, and other promotion items to help you win!

From the folder you will learn exactly what the contest covers, how to obtain and fill in your entry blank, how to make your promotion a success, what records to keep, and what type report to send in when the contest is over.

Five men of national prominence in the radio-TV service industry will serve as judges. Their names and positions are given in the contest folder. Act today! Profits plus a costly prize are waiting for you!



GENERAL  ELECTRIC

161-1A3

The Nationally Advertised

RAYTHEON *Bonded Electronic Technician*
Program — with its cash-
 protected Bond, its code of Business ethics,
 and tremendous public appeal — builds
 business and profits by creating customer
 confidence in you . . .



*Better look into it today.
 This sales stimulating program
 costs you nothing if you
 can qualify.*



*Ask your Raytheon Tube Distributor
 for complete information.

RIGHT...FOR SOUND AND SIGHT

Excellence in Electronics



RAYTHEON MANUFACTURING COMPANY

Receiving Tube Division

Newton, Mass., Chicago, Ill., Atlanta, Ga., Los Angeles, Calif.

RECEIVING AND PICTURE TUBES • RELIABLE SUBMINIATURE AND MINIATURE TUBES • GERMANIUM DIODES AND TRANSISTORS • RADIAC TUBES • MICROWAVE TUBES •

RADIO-ELECTRONICS

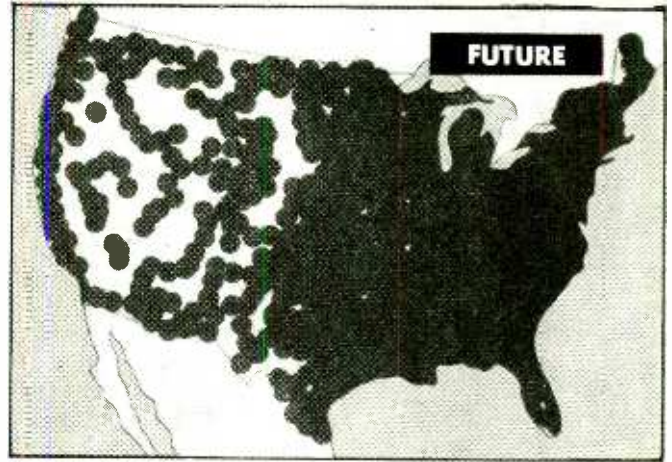
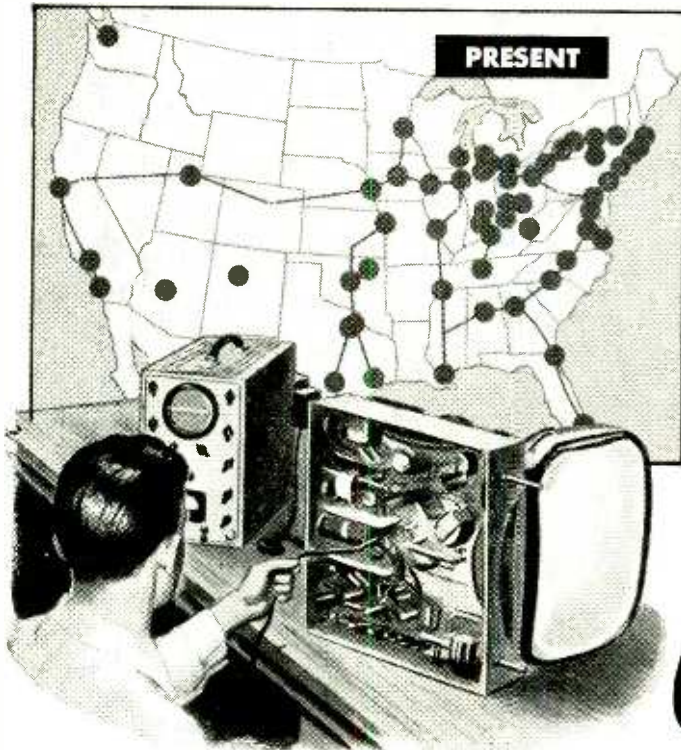

FUTURE—How new TV stations are expected to cover the nation.
PRESENT—Chart shows extent of current coverage.

Cash in on this Great Opportunity

... for good-pay jobs in TV SERVICING

YES, thousands of opportunities are going begging right now for good-pay jobs in TV Servicing.

The lifting of the "freeze" on new television stations clears the way for the expansion of the industry for 2,053 new stations, in 1,291 communities in the United States, its territories and possessions. There are only 108 stations telecasting now.

This is your golden opportunity to get all set for a good job that can mean employment security and a bright future for years to come. It's a great opportunity that can lead you, as a trained and experienced TV Serviceman, into establishing a profitable business of your own.

Big shortage of TV Technicians creates opportunities—NOW

Industry experts have estimated over 130,000 experienced TV technicians will be needed for the installation, trouble-shooting and repairing of television receivers in use by 1955. There are fewer than 50,000 fully trained TV service technicians available today. What an opportunity this creates for you!

Here are some of the good-pay jobs you can

choose—installation and trouble-shooting of TV receivers in homes . . . bench technician in radio-TV service shops . . . inspector, tester, repairman, field serviceman for TV receiver manufacturers, distributors and dealers . . . testing and servicing with electronic instrument manufacturers and companies with military contracts for electronic equipment . . . civilian serviceman with U. S. Military Bases . . . your own TV service shop—and many more.

RCA Institutes home study course trains you in your spare time

If you are associated with the radio-electronics industry, with no experience in TV servicing, the addition of the RCA Institutes Home Study Course in TV Servicing to your present experience will quickly qualify you to step out and grasp the good jobs now open in television.

The RCA Institutes course gives you a sound knowledge of television fundamentals . . . intensive practical instruction on the proper maintenance and servicing of TV receiver circuits . . . teaches you the "short cuts" on TV installation and trouble-shooting. Learn TV servicing (based on actual experience of hundreds of skilled technicians) from RCA engi-

neers and experienced instructors—pioneers and leaders in radio, television and electronic developments.

RCA Institutes home study course planned to your needs

You keep your present job. In your spare time, you study at home. You learn "How-to-do-it" techniques with "How-it-works" information in easy-to-study lessons prepared in ten units. Cost of RCA Home Study Course in Television Servicing has been cut to a minimum—as a service to the industry. You pay for the course on a "pay-as-you-learn" unit lesson basis. You receive an RCA Institutes certificate upon completion of the course. The RCA Institutes Home Study Course in Television Servicing is approved by leading servicemen's associations.

Don't pass up this lifetime opportunity for financial security and a bright future in TV.

SEND FOR FREE BOOKLET

Mail the coupon—today. Get complete information on the RCA INSTITUTES Home Study Course in Television Servicing. Booklet gives you a general outline of the course by units. See how this practical home study course trains you quickly, easily. Mail coupon in envelope or paste on postal card.

RCA Institutes conducts a resident school in New York City offering day and evening courses in Radio and TV Servicing, Radio Code and Radio Operating, Radio Broadcasting, Advanced Technology. Write for free catalog on resident courses.



RCA INSTITUTES, INC.
 A SERVICE OF RADIO CORPORATION OF AMERICA
 350 WEST FOURTH STREET, NEW YORK 14, N. Y.

JULY, 1952

MAIL COUPON NOW!

RCA INSTITUTES, INC., Home Study Department RE-752
 350 West Fourth Street, New York 14, N. Y.

Without obligation on my part, please send me copy of booklet "RCA INSTITUTES Home Study Course in TELEVISION SERVICING." (No salesman will call.)

Name _____ (please print)

Address _____

City _____ Zone _____ State _____



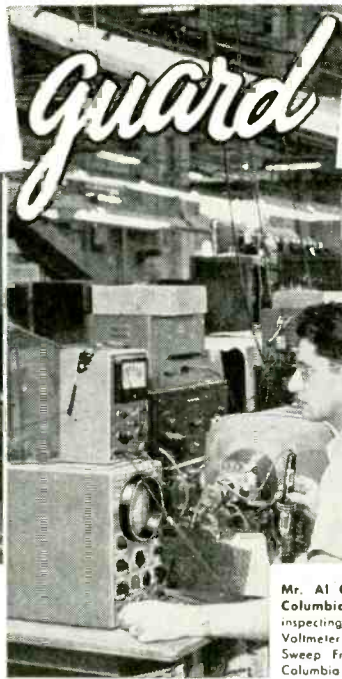

CBS-Columbia Inc.
HIGH STANDARDS OF
TELEVISION PRODUCTION QUALITY

In the CBS-Columbia design laboratories, Al Goldberg takes some important readings with the EICO Model 221 Vacuum Tube Voltmeter and Model 555 Multimeter, as Harry R. Ashley looks on.

Mr. Al Goldberg, Assistant Chief Engineer of CBS-Columbia, and Harry R. Ashley, President of EICO, inspecting the use of the EICO Model 221 Vacuum Tube Voltmeter and Model HVP-1 High Voltage Probe at the Sweep Frequency Troubleshooting Position on the CBS-Columbia Television production lines.



NEW
221K VTVM KIT \$25.95
WIRED \$49.95



HIGH VOLTAGE
PROBE \$6.95

KITS
WIRED INSTRUMENTS



NEW 565K MULTIMETER
KIT \$24.95 WIRED \$29.95
20,000 ohms/volt



320K SIG.
GEN. KIT \$19.95. WIRED \$29.95

NEW 322K SIG. GEN.
KIT \$23.95. WIRED \$34.95



NEW 950K R-C BRIDGE &
R-C COMP. KIT \$19.95
WIRED \$29.95



NEW 1040K BATTERY ELIM.
KIT \$25.95. WIRED \$34.95



51K VOM
KIT \$14.95
WIRED \$17.95



NEW 536K MULTI-
METER KIT \$12.90
WIRED \$14.50
1000 ohms/volt

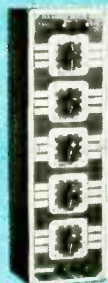

NEW 1171K RES.
DECADE BOX KIT
\$19.95
WIRED \$24.95



NEW 315K DELUXE SIG.
GEN. KIT \$39.95
WIRED \$59.95



145K SIG.
TRACER KIT
\$19.95
WIRED \$28.95



NEW 625K
TUBE TESTER KIT \$34.95
WIRED \$49.95
NEW C.R.A. LK ADAPTOR
for above \$4.50



360K SWEEP GEN. KIT \$34.95
WIRED \$49.95



NEW 377K Sine & Square Wave
AUDIO GEN. KIT \$31.95 WIRED \$49.95

*For Laboratory Precision at Lowest Cost—
the Leaders Look to EICO!*

WHY does CBS-Columbia, Inc., another one of America's leading TV manufacturers, use EICO Test Instruments on both its production lines and in its design laboratories?

BECAUSE — like Emerson, Tele-King, Tele-Tone, Majestic, and many another famous TV manufacturer coast to coast, CBS-Columbia knows that ...

*Only EICO Test Equipment delivers
All 10 EICO nomical Features!*

1. Laboratory Precision
2. Lowest Cost
3. Lifetime Dependability
4. Speedy Operation
5. Rugged Construction
6. Quality Components
7. Latest Engineering
8. Super-Simplified Assembly and Use Instructions
9. Laboratory-Styled Appearance
10. Exclusive EICO Make-Good Guarantee

Before You buy any higher-priced equipment, look at the EICO line — in *Wired and Kit form!* Each EICO product is jam-packed with unbelievable value. Compare, see *EICO instruments today*—in stock at your local jobber—and SAVE! Write NOW for FREE newest Catalog 7-C.

**FOLLOW THE LEADERS
... INSIST ON EICO!**



REG.
U.S.
PAT.
OFF.

ELECTRONIC INSTRUMENT CO., Inc.
84 WITHERS STREET, BROOKLYN 11, N. Y.

©1951, Electronic Instrument Co., Inc. Prices 5% higher on West Coast. Due to unstable conditions, prices and specifications are subject to change without notice.

53 Million TV Sets by 1960

... unlimited vistas are opened for television ...

By HUGO GERNSBACH

IN THE past we have been highly optimistic about the future of the electronics industry—and sometimes we have been criticized for it. It appears now that perhaps we held our enthusiasm too firmly in check.

In a forecast made last month, Dr. W. R. G. Baker, vice president of the General Electric Company and general manager of its electronics division, declared that more than 53,000,000 television receivers would be in operation by 1960. This would constitute a 300% rise over present-day receivers, which now number around 18,000,000. This is 5,000,000 more than the number of homes which may reasonably be expected to have electricity by 1960. Dr. Baker also indicated that there will be a very substantial increase in the number of television sets in clubs, bars, and many other non-home locations.

What did Dr. Baker have in mind when he said that 5,000,000 more sets would be used than the number of houses wired for electricity? Obviously either a significant percentage of homes will have more than one television receiver (this closely parallels the present vogue of multiple radio sets in the home) or, there would be battery-operated television sets, now practically unknown.

The latter, in view of the terrific strides made by electronics recently, now looms as a certainty. The reason, of course, lies in the transistor—electronics' latest wonder child. To us it seems certain that by 1960 there will be millions of such battery television sets, and most of them will be portables for home and outdoor use. This again would parallel the vogue of portable radio sets, which has been on the upgrade during the past few years. It is certain, also, that these receivers will parallel the engineering of some of our present radios, which can be either used as straight portables with batteries, or can be plugged into any handy electric outlet.

Indeed, if we add the portable television sets to the stationary ones, we will find that by 1960, Dr. Baker's 53,000,000-television-receivers forecast may well be exceeded.

Add to this dizzying pyramid of television receivers, color television, which will be here long before 1960, and it will be found that many more millions of television receivers will have to be added to the grand total.

From the present outlook, it would appear that when color television sets are finally placed upon the market, they will be operated by compatible means. That is, present-day receivers will be able to receive color telecasts in black and white just as they do now, while color television sets will, of course, have full color. This inevitably means that many homes, public places, hotels, etc., will have a multiplicity of sets, the old ones receiving in black and white, the new ones—installed in another location in the building or in another room—in full color.

It remains to be seen what the impact of color television will mean to the public, but from the meager experience that we have had with color television so far, it seems reasonably certain that once color television receivers are made, the manufacture of black and white sets will lag far behind color sets. Indeed, it would appear that within 25 years, the black and white television receiver will be on a par with the crystal set today!

One of the largest television outlets in the future prob-

ably will be our larger hotels. Just as most first-class hotels today have radios in every room, so they will have television in every room, if they wish to be up-to-date and give their guests every facility that Americans demand. While television sets are costly, by 1960 they will be as much a hotel necessity as the proverbial bath tub, and no up-to-date hotel will wish to be without them. How many millions of television sets will be installed in hotels between now and 1960 is anyone's guess. One thing is certain, the quantity will be enormous.

The small and medium size hotels will probably furnish regulation TV receivers to their guests on a rental basis at so much a day, as is the present custom. The big hotels however, of 300 rooms and up, even today find it a nuisance to send up sets from their store rooms—the wear and tear is too great and the manpower requirements often impossible. Then there is the inevitable antenna problem—always a difficult one in large congested cities.

The future large-hotel television receiver will probably be compact, the size dependent upon the screen dimension. The main component will be a television tube, power supply and speaker with a switch for the different channels. A central point will feed the amplified TV impulses to each room. This system also eliminates the antenna nuisance. Such hotel television receivers will be reasonable in price, yet they will bring in as good a picture as a complex regulation set.

At the present time, practically all hotels charge a fee for television receivers in hotel rooms. It is quite possible that by 1960 most hotel-room television sets will be coin-operated. We already today have such receivers in many hotel and motels. You feed the set either quarters or dimes and thus have its use for a certain length of time. Most guests do not object to this; the coin-operated television sets also will pay their way, making the installation attractive to the hotel management.

In the future the hotel television set also may help advertise the facilities of the hotel. Many of our big hotels have night clubs and public dining rooms, all of which can be televised throughout the hotel, thus at a given time guests can see what is going on in the public rooms of the hotel. To be sure when it comes to night clubs located in hotels—which feature high-priced entertainers—the hotel may not wish to televise such shows free, but they may give you a short “peek” once in a while, just as the motion pictures do in advertising their coming attractions. This usually has been good business for the motion picture interests and will probably prove itself to hotels as well.

While we are on the subject of electronics, Dr. Baker also predicted that one of the major increases in the use of electronics would be the elimination of electric meter reading as done at present—by humans. Household electric meters will be read electronically in the future, according to Dr. Baker, and while such applications will be costly, they are feasible, because industry must cut costs and servicing.

In our November, 1951, issue, we predicted that by 1960 the electronics industry would reach a turnover of \$10,000,000,000. It now appears that our prediction will probably be found far too conservative.

THE FUTURE OF THE TRANSISTOR

The "Father of Radio"
sees transistors
and tubes inseparable
active partners

By LEE de FOREST



Dr. de Forest's granddaughter, flanked by the inventor (right), and Admiral Ellery W. Stone, unveils the bust presented to Yale University by *The de Forest Pioneers*.

IN the year 1912 some editor had requested of me an article on the "Future of the Electronic Tube," I probably would have felt quite as incompetent and short-sighted a prophet of the developments of that, my most outstanding invention, the grid amplifier and oscillator tube, as I feel today as Mr. Gernsback requests from me an outlook over the future of the transistor, that possible successor of the grid tube.

In 1912 I had already accrued the benefit of six years experimentation with the electron tube, whereas today I have had little experience with these delightful little transistor midgets recently handed to me, ready made, by the Bell Laboratories.

The transistor is as yet far too young a baby for even its most intimate engineering parents, under the astute guidance of Dr. William Shockley, to predict with absolute certainty its future possibilities, the degree or scope of its acceptance by the engineering and manufacturing professions, its unquestionable advantages, and its inherent limitations.

When Admiral Ellery Stone, president of the All America Cables and Radio Corporation, recently informed me that his ever-progressive company was now estimating a proposed trans-Atlantic coaxial relay cable, similar to that which the A. T. & T. Co. recently laid between Key West and Havana, I remarked that of course his engineers would use transistors in place of the 22-year-life triode tubes now in the Havana cable for two important con-

siderations: first, the great saving in electric current which the 30 or 40 cable-enclosed amplifier groups would demand (transistors vs. tubes); and second, that the life of the transistors would be eternal—the relays would never need replacement. To my amazement, Admiral Stone replied that as yet no one knows what is the useful life of the transistor!

Later conversations with Dr. Shockley and other Bell Laboratories engineers confirmed this uncertainty as to the life endurance of the transistor, contact or junction types. The device is yet too young to afford positive knowledge regarding its useful life. Although one would naturally feel justified in assuming it to be eternal, it is actually "indefinite" today, for the reason that the transistor crystal is a synthetic compound, made up, in molten state, of germanium plus one or several other elements as impurities (gallium, arsenic, and others). It is conceivable, although apparently highly improbable, that a gradual dissemination or diffusion of the injected impurities which might in time occur would act to alter materially the initial amplifying characteristics of the presently preferred junction type of the transistor.

It must be recognized that transistor development is today in a state of flux, being carried on independently in each of a substantial number of independent laboratories: Bell, RCA, Sylvania, Westinghouse, Hazeltine, and others, all operating under licenses from the Bell Laboratories' parent patents. The sum of all the knowledge and manufac-

turing know-how that is certain to result from all this intensive investigation ultimately may make appear quite rudimentary all that is known today regarding this amazing little triode, the transistor. For, after all, the transistor, like its predecessor, the audion tube, is a triode. The two instrumentalities have this in common: both are triodes, three-electrode devices, and both amplify electronically—one using free electrons *in vacuo* or in gas, the other using electrons bound (not very tightly) to solid metal, where they can yet hop, skip, and slide about, like bunker marbles, from hole to hole.

Obviously the prime basic advantage possessed by the transistor over the audion tube is its smallness. In bulk the transistor is less than one quarter that of the smallest sub-miniature tube. Twenty of them could be packed within the envelope of a normal-sized miniature tube. This fact alone proves its great advantage in every case where amplifier space is an important item. Unquestionably the transistor will soon replace vacuum tubes in all hearing-aid devices, in all proximity fuses, in self-guiding missiles. Its indestructibility under terrific shock and impact indicates the absolute certainty of its employment in possible future warfare.

Already the Western Electric Company is turning out a thousand contact-type transistors per day, all of which are at present for the U. S. Government. The cost is estimated—so I am informed—at more than \$10.00 each, a figure which soon should be greatly reduced.

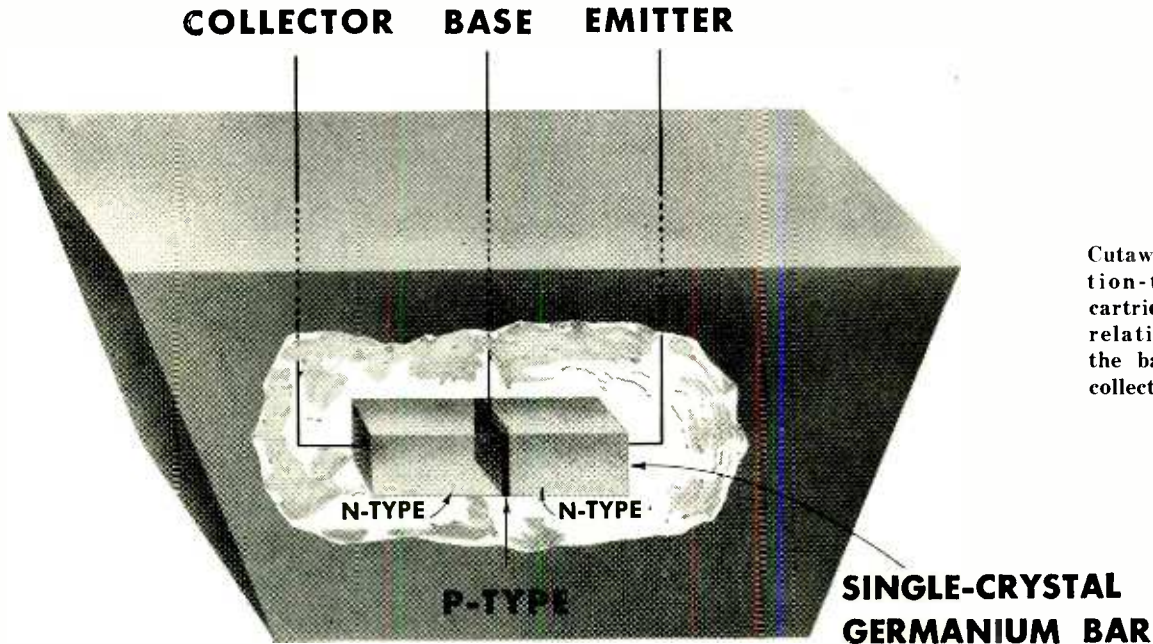

Cutaway view of junction-type transistor cartridge, showing the relationship between the base, emitter, and collector electrodes.

In all types of calculating machines, regardless of its noise factor or any other shortcomings inherent in today's transistor (which are certain to be reduced or eliminated by the research now devoted to the problems) there are great advantages to be derived by its use, as against the shortcomings of the electron tube.

Where operations are enormously involved, communications by elaborate permutations and combinations of an on-off, yes-no, dot-dash, or 0-1 symbolism, the "flip-flop" circuits employing transistors offer the ideal in simplification. I have in mind especially that great marvel in electronic calculating and computing machines, the IBM selective-sequence electronic calculator, which now occupies three sides of a gigantic hall on Madison Avenue, New York City, and comprises among its labyrinthian circuits and relays 6,000 electron tubes, occupying a tube rack some 150 square feet in size. Barring the space required in the rear for the essential conductors, this tube area could now be reduced to one-fiftieth of the present required board area, with corresponding reduction in cathode heating requirements.

A tremendously useful field for the transistor of the future will include every type of calculating machine, where compactness and durability of electron-operated components are desirable or essential features.

Certain limitations on reduction of space requirements are imposed upon the designer of such apparatus in the future by the unavoidable space re-

quirements of the electromagnets and the necessary cabling requirements. But in the realm of calculating machines the advantages of the transistor over the heretofore employed electron tubes are obvious.

In the field of radio and television receivers, it is yet too early to speak with authority as to just how far the substitution of the solid-bound electron for the vacuum-free electron can be advantageously carried out. Unquestionably there will be such radical substitutions in many types of radio and television receiver and amplifier circuits. The day is coming when, by virtue of the small volume of the transistor units in miniature printed circuits, the dimensions of present television chassis will appear gigantic by comparison. The match-case radio receiver and the pocket-size television chassis will make possible radical price reductions.

The recent banquet in New York, honoring Dr. Lee de Forest for his invention of the three-element electron tube, was given by *The de Forest Pioneers*, a group of past and present associates of the noted inventor. In reporting the event in "The Radio Month" column of last month's *RADIO-ELECTRONICS*, sponsorship was inadvertently attributed to *The Radio Pioneers*, another organization whose members have contributed notably to the development of modern electronics.

We will still demand loudspeakers rather than head-telephone sets, and will demand kinescopes of ever enlarging dimensions—at least until the future "projector lens" popularizes the roll-down, roll-up, wide-angle viewing screen in the home.

Would God that the cultural improvements in television programs were as certain as are the engineering improvements hereinabove visioned!

After all is said of the transistor and its wide horizons of utility, it will be found that for certain purposes and employments the audion tube will continue to maintain its present indispensability; and unquestionably the tetrode and pentode tube will continue to perform circuitual functions not so readily achieved by any type of triode, vacuum or solid-state. Especially will such considerations dictate circuiting designs where factors of larger voltage and grid-control are dominant.

As yet we know very little regarding the power limitations of the solid-matter type of amplifier, having in mind also its frequency limits, defined today by the inverse capacitance limitations inherent to the transistor type of detector and amplifier.

Certain it is, however, that this new type of triode amplifier, typified by the transistor and its kin (already discovered and soon to multiply) in today's new solid-state physics, is destined greatly to alter our heretofore-held concepts of the practical application of electronics to the multifarious projects to be faced by the engineer.

—end—

FLYBACK SQUEAL

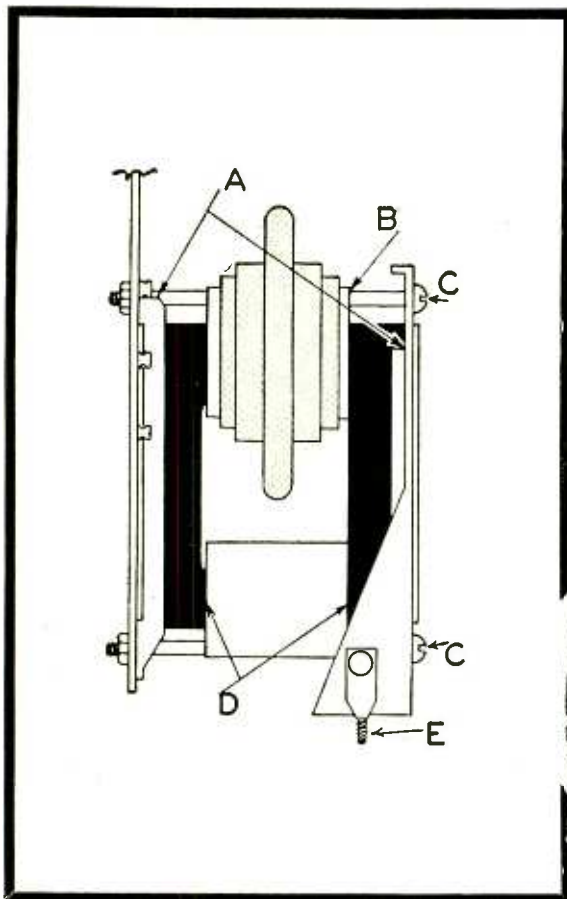

Methods of quieting squeal from horizontal flyback transformer are described in detail in the text.

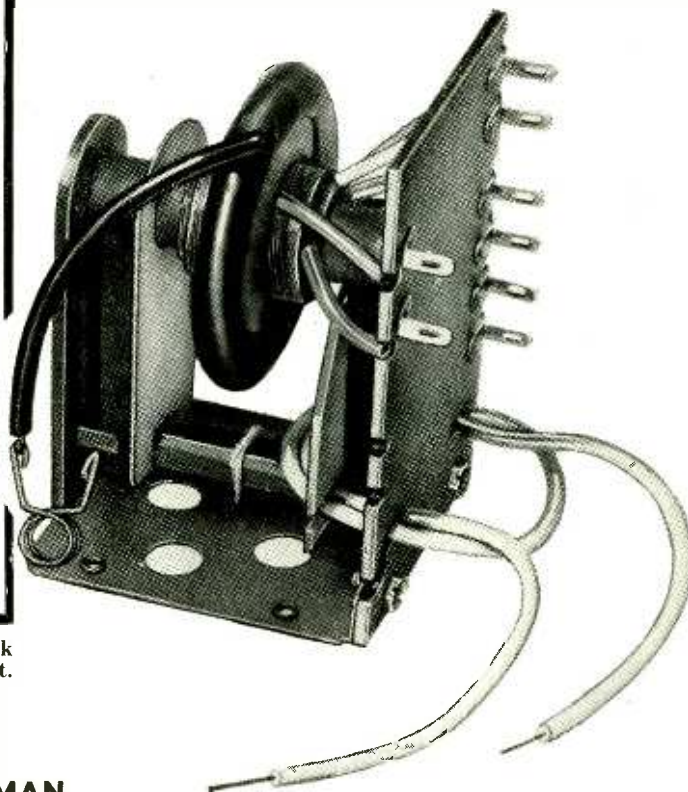

By FRED SHUNAMAN

A LETTER from Leo W. Maki, printed in our March issue, has aroused more comment than any communication in several years. He complained about "the worst form of TVI" which to him was "the nerve-racking, insanity-producing whistle heard in all TV sets." This 15,750-cycle note, he said, is heard by about half the TV viewers under 30, and is a reason why many people will not buy a set.

The letter was not taken too seriously by the RADIO-ELECTRONICS editorial staff (most of whom are over 30) and some members even wondered if the writer might not be a crank. He himself admitted: "Magazines, books, and other sources that cover TV, blithely ignore it." One of the staff remembered, however, that his wife could always tell whether the TV set was on or not—even with brightness and volume controls turned all the way down. She said it was because of a whistle the receiver emitted. The letter was printed without comment and with no idea that that it would get more answers than any letter which has appeared in the communications section in recent years.

The first response—from a Washington, D. C. technician—took the matter rather lightly. The Washington man stated in part: "Many of my customers are under 30 years of age and I have never had complaints of this nature. . . . If Mr. Maki is troubled with headaches I would suggest that he check the horizontal frequency and turn the volume of the TV set to normal room level."

Service technician David C. Graves of Barnesville, Ohio, was more familiar with the situation. He reported: "We had a 17-inch table model on which the complaint was a very loud audio whistle. I could not hear it, and thought perhaps the customer might be fooling me. The noise is the 15,750-cycle horizontal sweep frequency, and is due to mechanical vibration either of the chassis or the horizontal output transformer core. Since that first complaint, I have experienced the same circumstance several times, and have always been able to eliminate the sound by simply tightening nuts and screws till the vibrating part is damped down. Elimination is easy enough, but in my case I have to use somebody else's ears!"

But there are TV repair technicians under 30 years—plenty of them. Have they all been immunized to the near-ultrasonic sound? Service technician John W. Carey of Hopkinton, Mass., writes: "I must heartily endorse Mr. Maki's complaint. . . . Being a "dog" myself, the only thing I can suggest is a 7-inch electrostatic set. At a manufacturer's school I asked one of the instructors what to do about the trouble. The answer was a laugh and the advice to find a set the customer couldn't hear." Mr. Carey would like to see the problem solved "if only for comfort on the service bench."

What can be done about it

And a solution exists—in more than one form. Elmer Cummings of Oakland, Calif., referred us to our own magazine. The answers, he says, are in the August and November, 1951, issues. The August item, a Sentinel service note, states that a steady or intermittent squeal in models 419, 420, or 423 may be caused by mechanical vibration in the horizontal output transformer. To eliminate it, pour Glyptal or similar cement between the U-shaped channel

brackets and the iron core (point A in the figure). Then, with a pair of pliers, squeeze the channel brackets until they touch both sides of the core, being careful not to damage the coil. If the coil is loose on the core, push wedges B towards the coil's center, using additional wedges if necessary. If the noise doesn't stop, tighten the screws C, apply Glyptal to the cardboard sleeving D so it is glued to the core, tighten nuts on E, and make sure all leads are dressed away from the transformer, being especially careful with the lead going to the fuse.

A similar suggestion is made in the Television Clinic, November, 1951. Matt Mandl suggests curing "transformer sizz" by boiling the transformer in sealing compound. On direct inquiry, Mr. Mandl confirmed that large numbers of young people hear the squeal, and that in one of his classes at Temple University, "most of the students" heard it. "Some youngsters," he said, "actually have a rise in the reception of higher frequencies. In such instances the 15,750-cycle squeal would sound abnormally loud. Evidently Mr. Maki has a 'resonant hump' around that frequency. This is unfortunate and it would almost seem that television is not for him." Mandl goes on to suggest "proper drive adjustment and a well-designed horizontal output transformer and yoke" as a means of minimizing the squeal.

J. W. Richards, Lakeland Television, Warsaw, Ind., refers to Stewart-Warner service notes: "Careful inspection of the flyback transformer for loose turns or leads, coating it with a compound such as *Insulex*, and proper lead dress around the width and linearity coils will aid materially in correcting this fault."

One or two correspondents appear to believe that the sound comes from the speaker, and suggest low-pass audio filters. These would not help—the sound comes directly from the transformer, not through the speaker. Those whose hearing goes up past 15,750 cycles hear the whistle at the same level regardless of the volume control setting. And the audio system of the average TV is a fairly efficient filter for frequencies above (and considerably below) 15,000.

The 15,750-cycle audio squeal undoubtedly does annoy some listeners to the point of going without television. It probably niars reception for many listeners who may feel (as Mr. Maki reports children commonly do) that it is an unavoidable part of the program. Any work done to kill this whistle is certainly worth while. And there may be another dividend. It is quite possible that transients set up by vibrating parts in the field of the horizontal sweep coils may be a factor in producing the oscillations which interfere with nearby broadcast receivers. Measures taken to remedy the high-audio squeal may help reduce or eliminate the r.f. hash which infuriates the surviving radio listeners!

—end—

21-MC HAMS AND TVI

TVI from 21-mc stations appears in sound i.f. Realigning set removes the trouble

RICHARD I. BALDWIN, WIKE*

SOMETHING new has been added—amateur radio occupancy of the 21.0 to 21.45-mc band. As a service technician, make a mental note of this; it will undoubtedly cause TV set owners to call on you for advice and assistance. Amateur operation on these frequencies will create some interference problems. Two things must be kept in mind. First, such interference is *not* the fault of the amateurs' transmitters. Second, in most cases you can readily eliminate such interference by i.f. realignment.

So that there'll be a better understanding of the situation, let's briefly review 21 mc history. In the latter days of the war the United States proposed that a new band for amateurs be established in the vicinity of 21 mc. As a result of the Atlantic City conference in 1947, the band 21.0 to 21.45 mc was earmarked for amateurs. However, it was not until May of this year that they were permitted to use that band.

Meanwhile, the manufacturers of TV receivers decided to use the frequencies 21.25-21.9 mc as the frequency range of the i.f. sound channel. When this proposal was announced by the Radio Manufacturers Association, the American Radio Relay League protested and pointed out that amateurs were scheduled to occupy a band of frequencies in that region. Nevertheless, RMA adopted that i.f. sound channel in 1946.

Realizing that eventually there would be trouble, the League secured permission from FCC to conduct special tests on 21 mc, to determine just what interference would result from amateur transmissions on that frequency and what could be done about curing or preventing it. A special station was set up outside New York City and observations and tests were made for several months. These tests, conducted by the national organization of amateur radio operators, are going to make it easy for you to overcome interference to TV sets with 21-mc. i.f.'s resulting from amateur transmissions on the 21-mc. band.

This type of interference either reduces or entirely wipes out the TV sound. Depending on whether the TV set is intercarrier or not and on the nature of the interfering signal, there may be miscellaneous effects on the picture. This interference will be more severe on TV sets whose sound



Efficient stations like this can cause interference on sets with 21-mc i.f.'s.

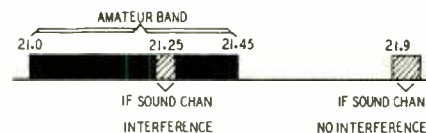

TVI is unavoidable when sets' i.f.'s are in range covered by black bar. Realigning i.f.'s to 21.9-mc will cure trouble.

i.f.'s are in the vicinity of 21.25 mc. It can be eliminated or largely reduced by moving the i.f. up as far as possible in the direction of 21.9 mc. Certainly you should make an effort to move the i.f. up above 21.45 mc, which is the upper edge of the amateur band.

Newer TV sets are coming out with i.f.'s in the vicinity of 40 mc, and 21-mc amateur transmissions will probably cause little difficulty. But there are still a good many of the older models around. In most cases realigning the i.f.'s to bring the sound channel at least above 21.5 mc will do the trick, but don't overlook the possibility of traps in the antenna lead-in, or a high-pass filter.

We repeat again that this 21 mc i.f. pickup interference resulting from amateur transmissions on the 21 mc band is definitely not the fault of the amateurs, and the amateur can do nothing to improve the situation at the transmitter end. It results from an unfortunate choice of intermediate frequencies by the TV manufacturers, but it's the sort of thing you can easily cure. In other words, here's a good way for you to improve your customers' TV set and your reputation as a skilled technician.

—end—

* Assistant Secretary, ARRL

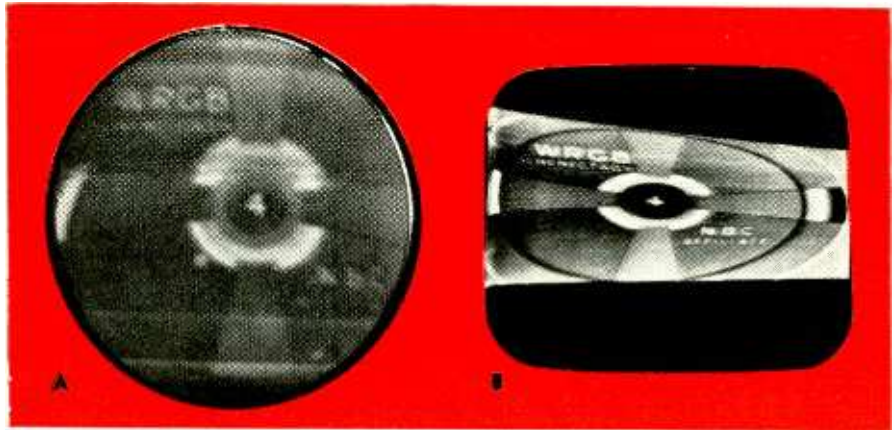

CAN YOU DIAGNOSE THESE

By JOHN B. LEDBETTER*

WHILE the picture tube screen is one of the most reliable test instruments for diagnosing and tracing receiver troubles, it is not infallible. Here are a few effects which can easily be misinterpreted. How many can you diagnose correctly at first glance?

Increase in vertical and horizontal size; loss of brightness (Photo A). This trouble could be hard to find. The symptoms indicate a loss of high voltage, which ordinarily suggests a defective high-voltage rectifier or horizontal output tube, a leaky high-voltage terminal or filter capacitor, or similar trouble in the h.v. supply. In this case the trouble was caused by a poor connection under the rubber hood at the second-anode contact of the picture tube. The resultant arc caused the drop in high voltage.

Vertical keystone (Photo B.) Caused by a short circuit in one of the vertical-deflection coils. A similar short in the opposite half of the vertical windings would cause keystone in the opposite direction. Although this trouble is not rare, it can result in wasted time if you attempt to repair or trace the short. (Most shorts occur deep within the windings.) Yoke replacement is the only remedy.

Similar troubles may occur in the horizontal deflection coils. In this case, keystone would appear at either the top or bottom, depending on which half of the coil is affected. Yoke replacement is necessary here, too.

Vertical black lines at left of screen (Photo C). In most cases you would describe this trouble as Barkhausen oscillation or incorrect adjustment of horizontal drive. It was actually caused by an arc at the solder connection to the plate cap of the 1B3-GT. The arc evidently generated frequencies which approximate those usually developed by Barkhausen oscillation. Be sure to check all such points for poor solder connections, loose or corroded mechanical connections (plate caps and high-voltage fuse connectors), sharp bends,

and protruding solder edges, when the usual checks for Barkhausen oscillation and horizontal drive misadjustment do not locate the trouble.

Vertical foldover (Photo D and Photo E). This trouble is not unusual, but a knowledge of its various sources can save a lot of time in checking the vertical sweep circuits. The "curtain-raising" effect (Photo D) is probably the most common. This is usually caused by a leaky grid-bypass capacitor in the vertical oscillator circuit, a leaky coupling capacitor in the vertical output stage, or a changed value in the vertical oscillator cathode circuit. These correspond to C304, C312, and R304 in Fig. 1. (This is part of the vertical sweep circuit in current G-E receivers).

Complete vertical foldover (Photo E) is caused by leakage across one of the integrating capacitors (C37 in Fig. 2). This circuit is used in the G-E 810 and in other receivers. When this is replaced, be sure to check the series resistors, and replace the other integrating capacitors at the same time. Use 600-volt units for replacement.

"Pie-crust" oscillation (Photo F). Ordinarily caused by an open or defective capacitor in the horizontal oscillator grid circuit. In receivers which use an r.f. or kick-back high-voltage power supply, this can be caused by stray or

direct coupling between the power supply and the kinescope leads. (In the Motorola VT-71 and similar receivers, direct contact between the power-supply shield can and the metal shield around the picture tube neck will cause "pie-crust" oscillation. This can happen if the insulating sheet between the two is left off or moved.) A similar effect can result if the ground return of the picture-tube grid circuit is not making good contact with the chassis.

Horizontal retrace (Photo G). This trouble shows up in many receivers converted to larger-screen picture tubes. In most cases, it is due to the use of too large a capacitor across the horizontal output winding, or failure to change the horizontal output transformer when picture tubes having different deflection angles are used. (The retrace in either case is too slow.) If the receiver has not been modified or converted, a simple circuit like Fig. 3 will usually correct the trouble. (This circuit, suggested by G-E, supplies normal B plus voltage to the picture tube accelerator grid during the horizontal scanning period, but applies a negative blanking pulse during the retrace.) Remove the capacitor from one side of the horizontal deflection coil. (This is shown as 47 μ f in Fig 3 but may be a different value in other circuits.) Replace this capacitor with a piece of 72-

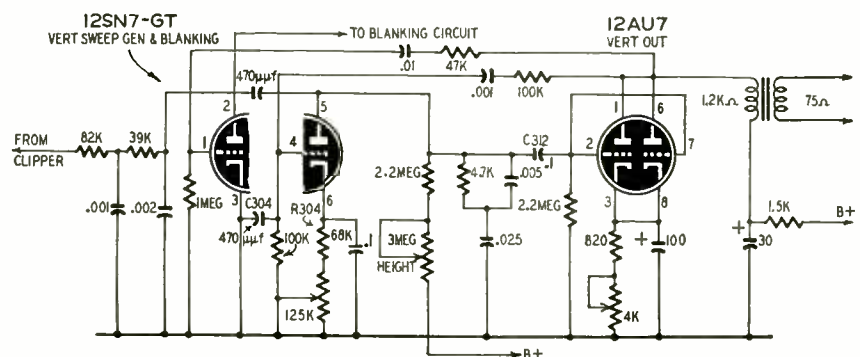
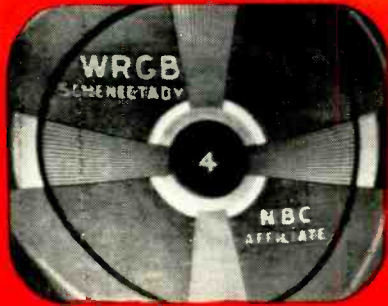

Fig. 1—Partial schematic of vertical sweep circuits in recent G-E receivers.

*Engineer, W KRC-TV



C



D



E

TV TROUBLES?

ohm coaxial about 12 or 14 inches long (the length will depend on the size of the capacitor removed; some experiment may be required.) Disconnect the lead to pin 10 of the picture tube and tape it out of the way. Then connect the coaxial as shown. Do not ground the coaxial shield. Tape the coaxial to the neck of the picture tube as its length requires.

Striations or vertical ripple (Photo H). Would you diagnose this as "ringing" or oscillation, or trouble in the damper circuit? Actually, this trouble is due to cross-talk from the horizontal sweep circuit into the vertical deflection coils. One source is the capacitor which shunts one half of the horizontal deflection winding. This capacitor is used to eliminate cross-talk by balancing each half of the horizontal winding to ground. If the capacitor is leaky, open,

or has changed value, the balance is upset and the horizontal pulses cause amplitude modulation of the vertical deflection coils. If replacing this capacitor does not correct the trouble, the deflection yoke is probably defective.

Photo I and Photo J. These effects are unusual and apparently indicate horizontal foldover or damper troubles. Actually, both are caused by open filter capacitors in the low-voltage power supply. These troubles occurred in a G-E 805 (see Fig. 4), but could also happen in similar receivers. In Photo I, filter capacitor C373 (Fig. 4) is open. This reduces the 265 volts which supplies the horizontal output and damper tubes and causes the extreme foldover at the left. In Photo J, the alternate dark and light vertical bars (left to center of raster) and the large white area at the right are caused when filter capacitor C374 in Fig. 4 is open. This drops the 150-volt line to such an extent that the horizontal a.f.c. tube is inoperative. The horizontal hold control also will not function properly.

Many other odd and misleading effects will be found in various receivers. Study the effect, but take nothing for granted! Even simple defects can be misleading. (Photos and schematics in this article first appeared in G-E's service publication *Techni-Talk*. Their permission to use them in this article is gratefully acknowledged.)

—end—

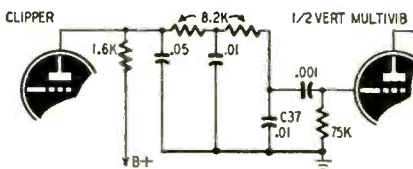

Fig. 2—Vertical-syne integrator circuit.

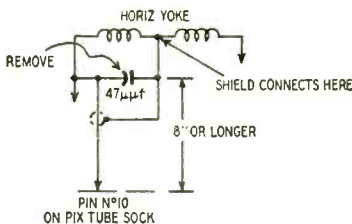

Fig. 3—Horizontal retrace elimination.

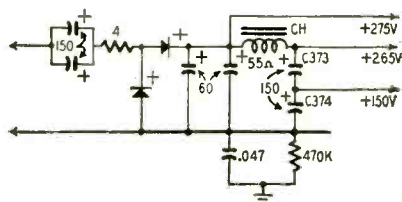

Fig. 4—G-E 805 voltage-doubler circuit.



F



G



H

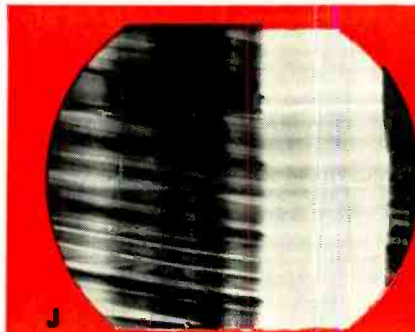

I



J

TV SERVICE CLINIC

Conducted By
MATTHEW MANDL*

AN INCREASING number of queries are being received regarding retrace elimination. The circuit itself is simple, but several precautions must be taken to minimize loss of fine detail or brilliancy. Such a circuit should not be used to correct for circuit faults or poor reception. If retrace lines are annoying, there may be trouble in the brilliancy control circuit or in the picture signal amplification. Except in extreme fringe areas, retrace lines should not show if the contrast and brilliancy controls have been properly adjusted. Poor alignment and tracking, a misadjusted ion trap, or a deficient antenna system all can contribute to insufficient blanking or improper bias in the picture tube. Thus, retrace lines are visible on most channels.

If the set is working properly you may see occasional retrace lines during camera changes or station breaks. If this is troublesome, or if weak fringe-area reception is to be improved, the retrace-elimination circuit can be added.

The circuit can consist of a single coupling capacitor from the secondary of the vertical output transformer to the picture tube. The R-C network shown in Fig. 1 is preferable because of its better blanking waveshape. This type circuit is used in many Raytheon receivers. Since the output of this circuit is a shunt capacitor combination (0.1 μf in series with .02 μf), it will diminish high-frequency signal detail if applied to a circuit carrying the composite video information. If the last video amplifier feeds the grid of the picture tube, the eliminator circuit should be put in the cathode. If the video amplifier is connected to the cathode, the elimination circuit can be applied to the grid. Use the eliminator in the circuit containing the brilliancy control.

Other precautions may be necessary. Refer to Fig. 2, where a typical video output system is shown. If the retrace elimination circuit were applied to the cathode, the 0.5- μf bypass would shunt the retrace elimination pulse.

To prevent this, the 0.5- μf cathode bypass capacitor must be removed. This will not affect performance, because its duties will be largely taken over by the two series capacitors in the output of the eliminator. Since a positive pulse is needed, the terminals marked "x" in Fig. 1 should be reversed if the system doesn't eliminate retrace. It can be tested by advancing brilliancy and decreasing the contrast-control setting. At extreme settings retrace lines may be faintly visible. For any setting less than full brilliancy, retrace lines will be eliminated. Fig. 3 shows the screen of a receiver (Admiral 30A1) which, in spite of high brilliancy and poor signal (to the point of sync instability) still has perfect retrace elimination with this circuit.

Retrace elimination circuits are used in many late-model receivers. In the General Electric 20C150 series, a special vertical blanking amplifier is used as shown in Fig. 4 to assure adequate retrace blanking at all times.

Flyback transformer burnout

Q. I have recently converted a Traveler model 12L50A to use a 16RP4 picture tube. The manufacturer uses the same horizontal output transformer and yoke in both 12- and 16-inch models. The only changes I made were to substitute a 6CD6 for the 6BQ6, replace the width coil, and make the necessary changes for the 6CD6 circuit. The receiver worked for several hours, after which the horizontal output coil burned out. It had overheated to the point where the insulating wax melted, but the fuse did not blow. I could find no defective components which might cause this. R. O. B., Rochester 9, N. Y.

A. The probable cause of this was an over-age and weakened secondary winding. The additional sweep voltage developed by your 6CD6 was probably sufficient to cause breakdown. Use a replacement transformer designed for 16-inch tubes and, for best results, a matching yoke.

Line reflections

Q. This is a fringe area and I have installed an antenna on a nearby hill

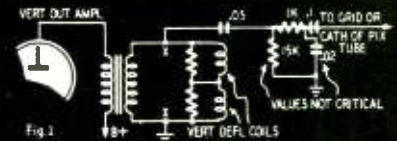

Fig 1

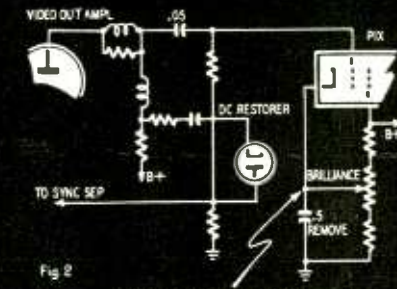

Fig 2

1,000 feet from the receiver. Originally 300-ohm ribbon line was used, but because of breakage caused by wind conditions, I installed an open wire line.

Since then ghost reception seems to prevail. A stub section seems to reduce this effect, but the picture still isn't as clear as it was. What causes this? P. R., Morgantown, W. Va.

A. The open wire line you used was evidently a 400-ohm impedance type which does not match the receiver. This causes line reflections which now blur your picture. With a very long run and severe mismatch, distinctly separate pictures are produced by the direct and reflected waves. This simulates ghost reception.

Try moving the stub along the line until the best picture is secured, or leave the stub in one place and vary its length until the best value is obtained. Start with a long stub and keep cutting off small sections. Shorted sections of ribbon line will work well.

For low losses slotted 300-ohm ribbon line can be used instead of the 400-ohm open wire line.

CRT socket defects

Q. On a Westinghouse 636T17 receiver the picture (and raster) are intermittent. On occasion the raster would remain but the picture would disappear. During this time arcing occurs in the 1X2-A tube and at the ground strap for the cathode-ray tube. I've cleaned the strap and replaced the 1X2-A without results. By tapping the base of the tube I can snap the picture back for a short time. Could this trouble be a defective picture tube? G. K. S., Council Bluffs, Iowa.

A. From your description it would seem that you have a defective cathode-ray tube socket. This would explain why normal operation can be restored by tapping the base or socket of the picture tube. An intermittent connection could open the cathode circuit and cut off emission. This would also remove the load from the high-voltage power supply and cause the arcing you describe. Without load the high voltage increases and usually causes corona and

*Author Mandl's Television Servicing

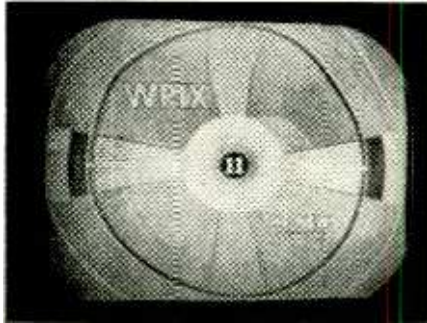

Fig. 3—Absence of retrace lines indicates efficient vertical blanking system.

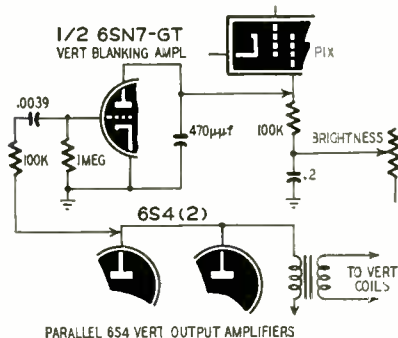

Fig. 4—Circuit of a blanking amplifier.



Fig. 5—Line caused by poor linearity.

arcng. This would also cause repeated burnout of the rectifier tube.

Remove the picture-tube socket and inspect all soldered connections. Resolder where necessary or replace with a new socket. Also inspect the base of the tube and note whether or not it is loose from the glass neck. Also check the soldered connections at the base of the tube pins. If the socket is all right, the trouble could be caused by defects in the base or in the tube itself.

Rhombic dimensions

Q. What are the actual dimensions of the diamond-shaped true rhombic? I've heard conflicting stories on this and would appreciate information and comparisons with the Yagi type. E. E. H., Massena, N. Y.

A. The true rhombic gives optimum results when each leg of the diamond-shaped affair has a length of at least three wavelengths for the lowest frequency to be received. Thus, for channel 2, based on an approximate wavelength of 16 feet, each leg of a true rhombic would have to be at least 48 feet long for best results! This makes

such an antenna too cumbersome for ordinary use at v.h.f. television frequencies.

Gain in excess of 10 db can be secured with a Yagi, but the bandwidth is reduced to one channel (and sometimes less than that). Stacked biconicals are fairly broad-band, but have a gain of only about 5 db. As soon as both wide-band and exceptional gain are desired, the design becomes too unwieldy for v.h.f. television—though it will probably find use in the new u.h.f. channels.

Vertical center bar

Q. In an RCA TC166 receiver there is a bright bar (vertical) near the center of the screen. This shows in the picture and started after I had to correct for a decrease in width. I've adjusted the drive control and changed tubes (including the damper). What would cause this condition? R. W. M., Memphis, Tenn.

A. This condition is usually caused by a combination of misadjusted drive control, horizontal linearity, and width. Reduce the drive until the picture no longer shows a compressed center, then adjust the linearity and width to fill out the screen horizontally with good linearity. Do this on a test pattern or with a linearity pattern generator.

An oscillogram of the sawtooth would show a sharp dip at the center of the slope, indicating poor linearity. This causes the white line (or lines) near the center which will be present with or without a picture. (See Fig. 5.) Vertical white lines caused by damping defects are nearer the left of the screen.

If control adjustments fail to give results, check capacitors and resistors in the discharge circuit feeding the grid of the 6BG6 tube, as well as cathode and screen capacitors. Replace any components more than 10% off rated value.

Pulling on one channel only

Q. In an Emerson 663 receiver horizontal pulling has developed recently. This occurs only on channel 6, and tube changes do not seem to help. Could this be caused by a.g.c. defects? H. J. S., Hatboro, Pa.

A. Yes, this condition could be caused by overload which the a.g.c. circuit is unable to overcome. This receiver doesn't have adjustable a.g.c. The a.g.c. and sync take-off points are ahead of the contrast control, which is of no help in relieving the condition.

Try antenna reorientation for channel 6, or insert attenuating traps in the antenna system to cut the signal down below the pulling point. See that no defect exists in the a.g.c. line to the first r.f. stage and the first i.f. amplifier. An open circuit would remove the a.g.c. bias and cause overloading, particularly on the strongest station in your area. Measure each r.f. and i.f. tube's grid-to-cathode voltage with a v.t.v.m. (This receiver does not apply a.g.c. to the second and third video i.f. stages.)

—end—

TV DX IN JULY

If our last TV dx forecast was correct many of you will have received TV broadcasts direct from stations several hundred or a thousand miles away. If you haven't, it may be that local stations are blocking out dx on the channels which they occupy.

The reader of this monthly forecast will do well to take careful note of what happens during June, if he would know what to expect in July. The major openings of June are almost certain to recur in July, about 27 days later, so June's record is probably the best indication of what July holds in store.

Sporadic-E dx will not be quite so frequent during July as it was in June, but will follow a very similar pattern. Signals from distances of 600 to 1,200 miles will be very strong at times, and there will be several opportunities for "double-hop" dx, bringing in signals from points as much as 2,500 miles distant. There is some possibility that South American stations may be received, too. Since such reception has been extremely rare to date we are particularly interested in hearing complete details of any such intercontinental dx.

Tropospheric propagation will be generally good, and there will be many times when the high channels, particularly, will come through extraordinarily well. The full potentialities of the high channels have not been realized heretofore, because of the relatively poor high-band performance of TV receivers manufactured prior to this year. Many among the 1952 crop of receivers have greatly improved performance on channels 7 through 13. Where high-gain antenna systems that favor these channels are used it should be possible to get results on some occasions over distances as great as 500 miles, perhaps more. This type of propagation is most likely to develop in the early morning hours, in the early evening around sundown, and late at night. It is associated with fair calm weather, or increasing cloudiness preceding a storm. A steady high barometer reading, or the beginning of a slow fall after a prolonged high period, are good indications that tropospheric propagation well beyond normal distances can be expected.

July is usually good for at least one pronounced aurora display, and in this month aurora is frequently accompanied by sporadic-E type dx reception. A directional array aimed north to west (for an eastern station) or north to east for a western station, may bring in two kinds of signals under such conditions. One will be shadowy and distorted reception from stations up to 500 miles or so; the other will be strong and clear dx from the normal sporadic-E distances. Aurora effects are much more pronounced on the low channels, though the possibility of high-band dx should not be ruled out entirely.

—end—

THE SERVICE TECH AND

TVI



By **NORMAN HELFANT, W2EBP**

ONE cause of television interference is faulty operation of nearby short-wave equipment.

The other is inadequate design of the receiver being "interfered with." Interference of the first kind is seldom found. The FCC rules and regulations just don't permit it. If the owner of transmitting, diathermy, or other equipment can show one TV receiver operating within 100 feet with no interference, the short-wave equipment cannot be accused of causing the trouble.

Manufacturers of TV sets have underestimated the need for filters, traps, and screening. The job therefore becomes one for the service technician.

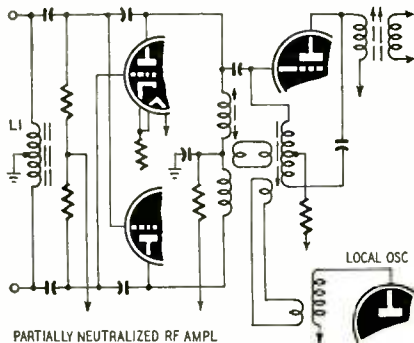

Fig. 1—Broad-band TV input circuit.

I. Front end overloading

This trouble produces internal harmonics. Refer to Fig. 1. L1 is the only tuned circuit at the input of the set. This circuit (typical of many front ends) has a curve which is expected to pass the TV spectrum 54 to 216 megacycles, and cannot be expected to drop off sharply at 54 or 216 mc. Therefore a local signal from approximately 27 to 54 and 216 to 255 mc will pass to the grid circuit with only slight attenuation. A signal on any service between 54 and 216 mc. will pass with *no* bucking. Therefore an unwanted local signal can have a much higher strength at the grids than the desired TV sigs. This may cause the first r.f. tube to double or become completely saturated. Obviously, short-wave equipment operating properly at half the frequency of a given channel can thus appear as if it had a second harmonic.

The cure is to prevent the unwanted signal from reaching the front end. You can do that in either of two ways. If the unwanted signal is within or

above the TV spectrum, use tuned traps for its frequency in the lead-in wire. If it is below the TV band it may be a better idea to use a high-pass filter which sharply attenuates all signals below the TV band, because stations in the short-wave region often change frequency to suit communication conditions. Interference from stations above 216 mc is rare, and for this reason low-pass filters to attenuate signals above the TV spectrum are rare. High-pass filters for TV are readily obtainable from the average radio jobber. The service technician may have to build traps, however. Construction information on traps and filters can be found in the article "Practical TVI Filters," in the May issue of *RADIO-ELECTRONICS*, in many of the publications of The American Radio Relay League, and in the Rand book "Television Interference," (Remington Rand, 315 Fourth Ave., New York 10, N. Y. 25c.)

Most interference is due to equipment in the 54-mc region or below and a high-pass filter should be tried before time is consumed finding out what frequency the unwanted signal is on.

Be sure to install the trap or filter as close as possible to the front end of the set. Otherwise the wire from the filter to the front end may act as an antenna and pick up the unwanted signal.

II. Interference at the i. f.

Unwanted frequencies may be brought directly into the i.f. amplifier through the three series capacitors to the mixer grid along the top line of Fig. 1. Interference is seen on all channels. It is treated the same as Trouble I.

III. Direct i. f. pickup

Signals at the intermediate frequency may be picked up direct through the bottom of the set. This usually becomes bothersome only when the picture or sound i.f. strip is very close to or on the same frequency as the unwanted signal. It shows up on all channels on either the respective picture or sound carrier. Don't confuse it with an exaggerated case of Trouble I where saturation of the first r.f. tube may cause severe interference on all channels, both sound and picture. Direct i.f. pickup can be seen definitely with antenna grounded.

Complete screening of the bottom and top of set are usually required. Most sets with i.f. pickup will also need treatment as in Trouble I.

IV. Grid-leak detection

Strong AM signals may be detected in the audio or video stages. All channels are affected, with or without front end and i.f. stages operating.

Pickup of this type is more common in the audio section than in the video. The cure for the audio trouble here also applies to phonos, public-address systems, and radios, and is cleared in the same manner. Refer to Fig. 2. All or one of the following steps may be necessary to clear audio trouble: Make all audio leads short. Shield hot leads in the high-gain voltage-amplifier stage or stages. Use resistors R1 and R2 as shown in all voltage amplifiers. The value should be reduced in stages drawing grid current. The capacitors C, from grid to ground—if found necessary—should be as small as possible. Using mica capacitors, start with 100 μ f and work upward until the trouble disappears. If the smallest value that clears the interference also mars the audio highs, leave it out and screen the stage or stages not cured by the other steps.

Video pickup, also through grid detection, cannot be cleared in this way. Screen the set as in Trouble III.

V. Signals via the line cord

Most manufacturers include a certain amount of line filtering, which usually suffices. An additional line filter should be tried if the preceding cures don't

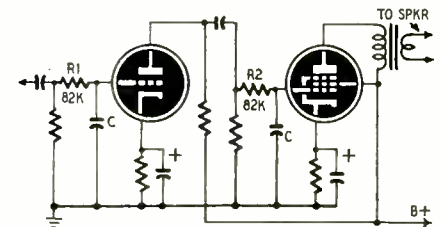

Fig. 2—Remedies for a.f. grid detection.

completely clear the trouble for which they are intended. A line filter may be obtained readily or built from one of the many obtainable circuits. Install close to back apron, inside or out, and ground to chassis or cold side of line. Beware of a.c.-d.c. sets. If you are using a filter on one of them, connect a .001- μ f mica and 0.1- μ f paper or oil capacitor in parallel and hook the combination between the case of the filter and earth.

Screening as recommended in Trouble III and IV (video) should be done carefully with the purpose in mind of keeping the r.f. from entering the set's wiring. Usually when screening is needed, only a thorough job does the trick. Copper window screening is probably best adapted to the work. Obviously one can't screen the front of the picture tube. Luckily the aquadag grounds it capacitively. But the average speaker—if left unscreened on the front—can let enough r.f. through to defeat the purpose of the whole job. Closely bond the edges of the screening and spot-solder to chassis at regular intervals.

—end—

how to use and handle a LOAD-CHECKING METER

By HARRY LEEPER

Many radio and TV receiver troubles can be spotted quickly by checking actual power consumption against manufacturer's nameplate ratings. For example, shorted or leaky filter capacitors cause an increase in consumption; an open bleeder or a burned-out tube will reduce the load below normal. Use of the method has been limited in the past by the high cost and complexity of the

equipment. However, the recent introduction of compact, reasonably-priced instruments makes this method of diagnosis generally available.

Use of the wattmeter as illustrated often makes it possible to give the customer a quick and accurate estimate of repair costs. As a final check before returning the set, it may save an unpaid return call.

The Triplett "Load-Chek" is typical of the new instruments. The a.c. line voltage and power consumption of the device to be tested are measured simultaneously when the equipment is plugged into the meter. Two ranges on the wattmeter scale will measure equipment loads up to 1,000 watts maximum.

Accuracy in measuring loads of less than 100 watts can be improved by using a cube tap and a fixed load (such as a soldering iron), to move the pointer up to the more expanded portion of the scale. The device to be checked is then added, and the difference between the readings is the live-load wattage.

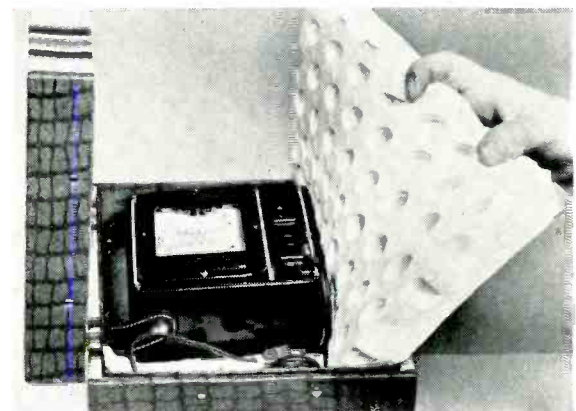
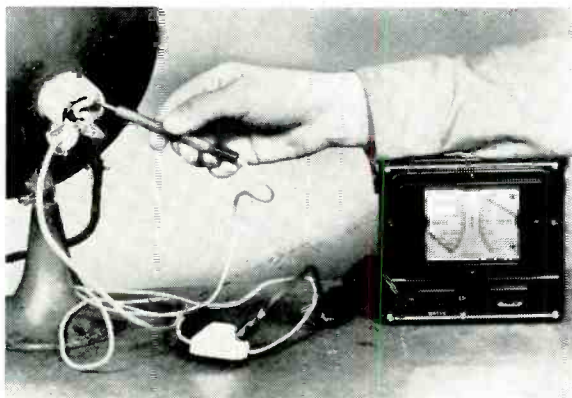
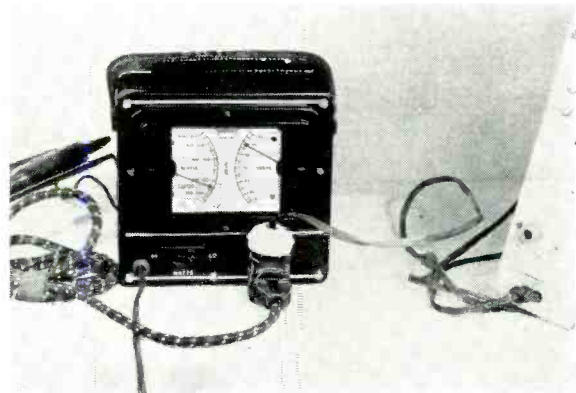

The voltmeter section may be used independently by plugging the instrument line cord into an extension-cord receptacle, with test prods or any suitable connector at the other end of the extension. Test leads may also be clipped directly to the meter line plug.

An inexpensive case will protect the meter in the car or shop. The case shown in the photo is 8 1/2 x 12 x 5 inches, and cost about \$1.50. A piece of sponge or foam rubber is placed in the bottom and another folded over the top and sides of the instrument.

COMBINED MEASURING SET

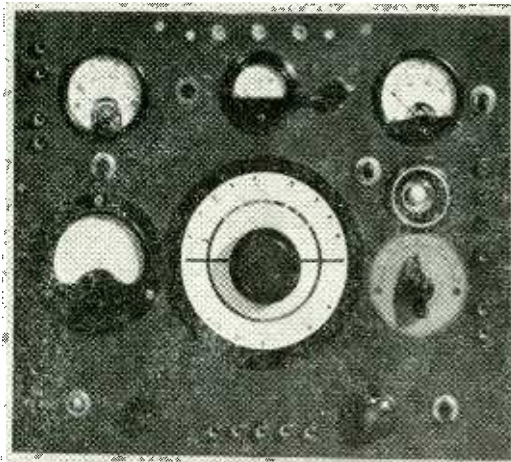

Front panel of the combined measuring set.

Five instruments in one form a complete portable laboratory for the service technician or experimenter—any section may be built as a separate unit.

By A. IWANIWSKY

THIS device combines five highly useful electronic instruments in a single compact unit. It will handle practically any measurements required in routine servicing, and in addition provides facilities for capacitance, inductance, and high-resistance measurements.

The circuits used are not original with the author, but have been selected on the basis of successful application over a period of years in this country and abroad.

The five functions of the instrument are as follows:

- Straight volt-ohm-milliammeter (2,000 ohms per volt).
- Audio output meter.
- V.t.v.m.
- Capacitance and inductance grid-dip meter.
- High-resistance and capacitance bridge.

Volt-ohm-milliammeter

The schematic of this section is shown in Fig. 1. The meter is a 0-500 μ amp movement with an internal resistance of 500 ohms. The rectifier is a full-wave-bridge instrument type available from several manufacturers. Voltage ranges of 30, 300, and 3,000 (a.c. or d.c.) are provided, although these can be changed or extended by substituting suitable values for R1, R2, and R3. The values shown for these resistors should be obtained by combining suitable units in series or parallel. The current ranges are 10 ma and 100 ma. These too can be changed by the use of different shunts. (See "Multirange Milliammeter", on page 37 of RADIO-ELECTRONICS for April, 1952.) A single resistance range is included, with a mid-scale value of 500 ohms.

Audio output meter

For maximum sensitivity, this section is designed to operate from the primary side of the receiver or amplifier output transformer. (See Fig. 2.) The meter and instrument rectifier are identical to those used for volt-ohm-milliammeter measurements. Any meter of the same sensitivity may be used provided its internal resistance is at least 250 ohms. The adjustable series resistor is for calibrating the meter.

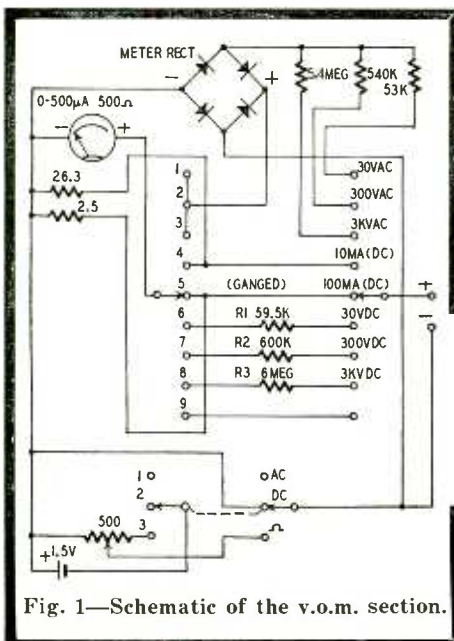

Fig. 1—Schematic of the v.o.m. section.

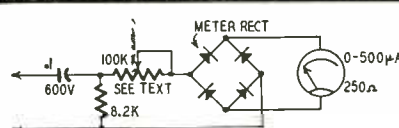

Fig. 2—The audio output voltmeter.

V.t.v.m. section

The circuit shown in Fig. 3 is used for grid-bias and signal voltage measurements in low-level audio stages and

oscillator circuits. Its full-scale sensitivity is 3 volts a.c. or d.c. The 2,000-ohm potentiometer is a calibrating control. Zero adjustment is provided by the 250-ohm control.

Capacitance and inductance tests

A grid-dip oscillator (Fig. 4-a) is used for these measurements. This principle is used in many commercial instruments, and the circuit employed here was suggested by M. Katreczko, E.E., of the YMCA Radio School in Brunswick, Germany.

Capacitance values up to 500 μ f are measured by connecting the unknown capacitor directly across L2 (terminals 1 and 3). This forms a resonant circuit. The oscillator is then tuned to the same frequency by varying C1. Resonance is indicated by *minimum* grid current. Higher values (up to 5,000 μ f) are measured by connecting the unknown capacitor across terminals 2 and 3. The C1 tuning dial is calibrated by connecting various standard capacitors across the test terminals. Coil details are given in Fig. 4-b.

Small inductance values may be

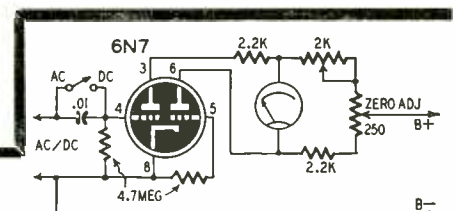
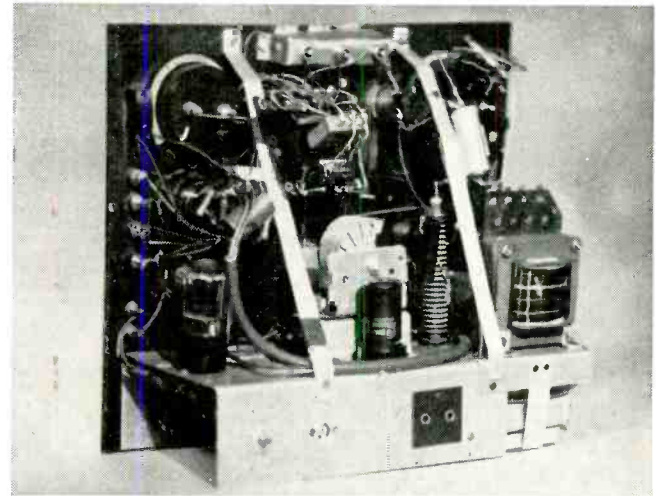
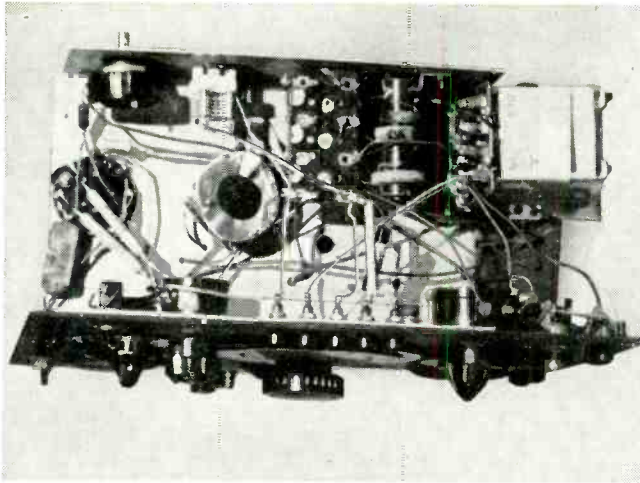

Fig. 3—Vacuum-tube-voltmeter circuit.

checked in the same way. R.f. chokes and TV peaking coils can be used for calibrating the inductance ranges of the instrument.

The meter should have a minimum full-scale reading of 10 ma. Its sensitivity is controlled by the 25-ohm rheostat. The trimmer capacitors across L2 and



Under-chassis view of the combined measuring set. Some European-type components were used in this version.

Behind the panel. The multi-plate metallic rectifier mounted next to the power transformer has been changed to a 6X4.

L3 are used to balance out stray capacitances. Coils and capacitors should be connected directly to the terminals.

Resistance-capacitance bridge

Higher values of resistance and capacitance are measured by the circuit shown in Fig. 5. A low a.c. voltage from the heater circuit is applied through standard resistors or capacitors to the 6H6 diode rectifier. The output of the 6H6 is fed to the 5,000-ohm potentiometer which controls the shadow area of the 6E5 electron-ray indicator. This control is adjusted for maximum shadow area with the test terminals open.

Any impedance (resistance or capacitive reactance) inserted in the a.c. supply reduces the current through the 6H6 and narrows the shadow. The potentiometer is then adjusted to restore the shadow to its original size, and the

unknown value read from the dial, which may be calibrated with standard resistors and capacitors.

Three 6.3-volt pilot lamps wired to an extra section on the selector switch, show which range is in use.

Power supply

A standard rectifier circuit (Fig. 6) using a small power transformer and 6X4 supplies all operating voltages.

Although individual meters are used in each of the first four circuits, a single 0-500- μ a movement can be used by providing pin jacks at the meter terminals in each section. This will also require a number of different scales for the meter.

Obviously, any one of the sections described may be built as a separate unit. For that reason, separate parts lists for each section are given below.

Materials for Measuring Set

Volt-ohm-milliammeter

Resistors: 1—5.9 megohms, 1—590,000 ohms, 1—59,000 ohms, 1/2 watt (see text); 1—250 ohms, 1—2.5 ohms, 1/2 watt (see text); 1—500-ohm potentiometer. Miscellaneous: 1—2-pole, 9-position selector switch; 1—1-pole, 3 position selector switch; 1—0-500 microammeter, internal resistance 500 ohms; 1—full-wave-bridge instrument rectifier (Conant 160B, Electroxx AA-4, or equivalent); 1—1.5-volt dry cell; wire, hardware.

Audio output meter

Resistors: 1—8,200 ohms, 1/2 watt, 1—100,000-ohm potentiometer. Capacitor: 1—0.1 μ f, 600 volts, paper. Miscellaneous: 1—0-500 microammeter; 1—full-wave-bridge instrument rectifier (Conant 160B, Electroxx AA-4, or equivalent); wire, hardware.

V.t.v.m.

Resistors: 2—4.7 megohms, 2—2,200 ohms, 1/2 watt; 1—2,000-ohms, 1—250-ohms, potentiometers. Capacitor: 1—0.01- μ f, 600 volts, paper. Miscellaneous: 1—0-500 microammeter; 1—6N7 tube; 1—s.p.s.t. toggle switch; wire, hardware.

L-C grid-dip meter

Resistors: 1—510 ohms, 1/2 watt; 1—25-ohm rheostat. Capacitors: (Paper) 1—0.1 μ f, 600 volts; (Ceramic or mica) 1—500 μ uf. (Air variable) 1—500 μ uf. max. (Trimmers) 2—20 μ uf max. Miscellaneous: 1—oscillator coil (see text); 1—6C5 tube; 1—octal socket; wire, hardware.

R-C bridge

Resistors: 3—1 megohm, 2—100,000 ohms, 2—10,000 ohms, 2—220 ohms, 1/2 watt; 1—5,000 ohms potentiometer. Capacitors: (Paper) 1—1.0 μ f, 2—0.1 μ f, 1—0.02 μ f, 1—0.01 μ f, 600 volts; (Variable), mica trimmers 2—20 μ uf. Miscellaneous: 1—6H6 tube, 1—6E5 tube; 2—tube sockets; 1—2-gang 6-position wafar switch; 3—6.3-V pilot lamps; 3—pilot-lamp sockets, wire, terminals, hardware.

Power Supply

1—power transformer (470 volts center-tapped, at 40 ma; 6.3 volts at 1.5 amp) 1—6X4 or 6X5 tube; 2—4- μ f, 350-volt electrolytic capacitors, 1—6,800-ohm, 2-watt resistor; 1—tube socket; 1—s.p.s.t. toggle switch; 1—line cord and plug; wire, hardware.

—end—

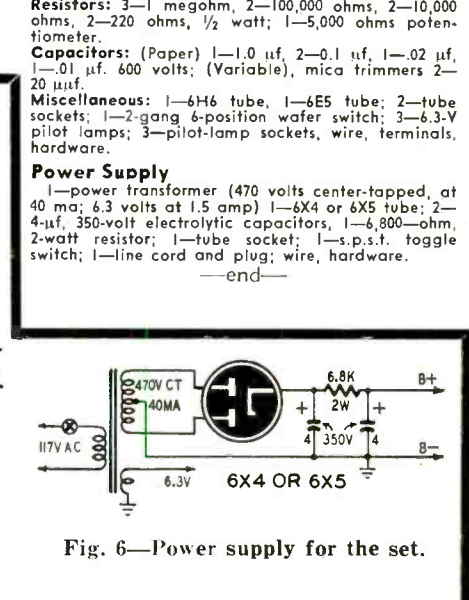
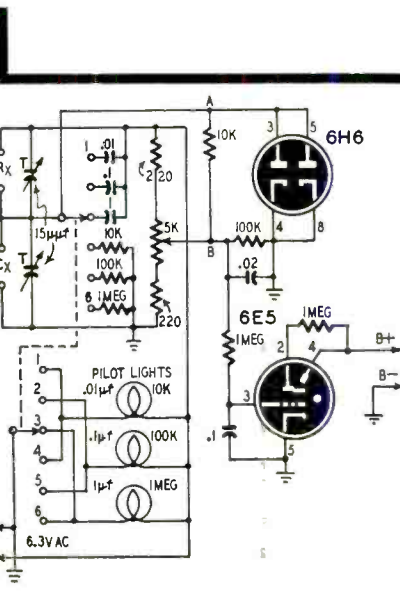
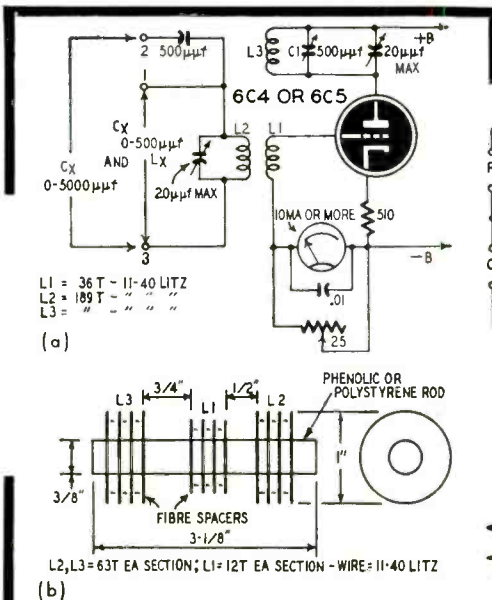

Fig. 4—Grid-dip oscillator and coil data. Fig. 5—Bridge for R-C measurements. Fig. 6—Power supply for the set.

Familiar tube types find unusual applications in late-model TV receivers. By ROBERT F. SCOTT

short

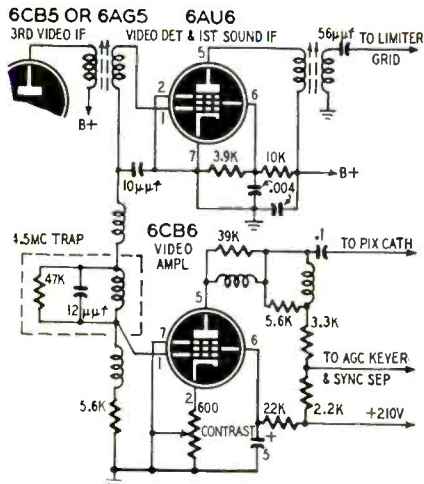

Fig. 1—Magnavox video-detector circuit.

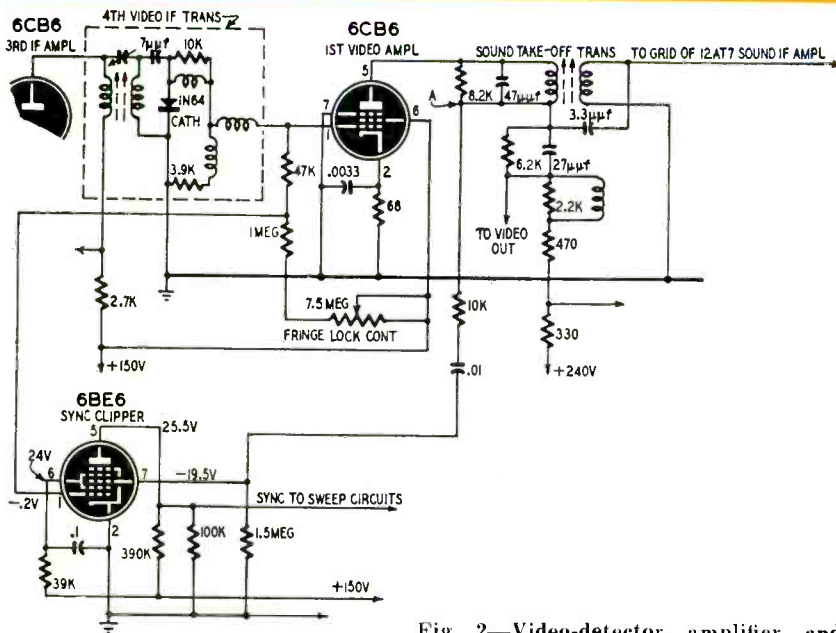

Fig. 2—Video-detector, amplifier, and sync-clipper stages of the Zenith 20J21.

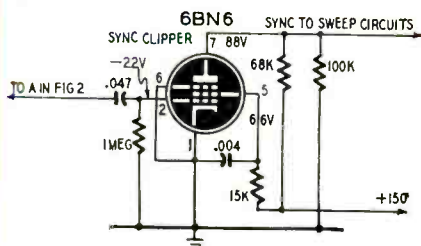

Fig. 3 (above)—6BN6 sync-clipper circuit used in Zenith model 20H20.

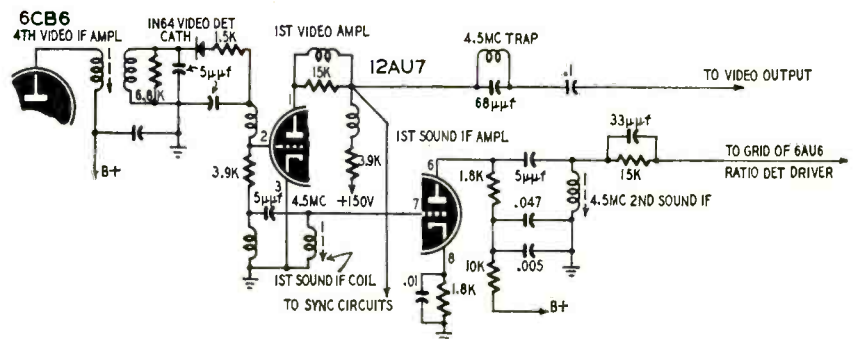

Fig. 4 (right)—Stromberg-Carlson twin-triode video and sound-i.f. amplifiers.

THE average TV service technician has had sufficient experience with receiver circuitry and common tube types to be able to make a good guess as to the circuit function of each tube in the set simply from its type and its position in relation to transformers, traps, and other components on the chassis. Recently some TV designers have omitted a few of the usual tube types or have substituted types which are foreign to the usual circuitry. One manufacturer has abandoned the usual diode video detector in some of his models, another has taken a 6BE6 from the usual All-American-5 broadcast receiver line-up and has incorporated it in his new receivers as a sync clipper. We have selected these circuits for discussion, as well as a few other unusual ones which we feel will interest the technician, the engineer, and the home TV experimenter.

Magnavox series 105

No matter how hard you look, you'll never find the usual vacuum-tube or germanium-diode video detector in the Magnavox CT341-D and similar sets of the 105 series. Instead, the designers have used a 6AU6 sharp-cutoff pentode in a novel circuit which enables it to perform as the video detector and the first sound-i.f. amplifier. The circuit shown in Fig. 1 is a modified grid-leak detector. The control grid corresponds to the plate of the conventional video-detector diode. Rectified grid currents flow through the 5,600-ohm resistor. The video-modulated d.c. voltage appearing across this resistor is fed directly to the grid of the 6CB6 video amplifier where it is amplified and fed through a 0.1-µf coupling capacitor to the cathode of the picture tube.

The parallel-tuned 4.5-mc trap is in series with the detector and the video amplifier grid, where it effectively prevents any 4.5-mc beat from entering the

circuits

video amplifier and appearing in the picture.

The rectified output of the grid-cathode section of the 6AU6 also contains the sound-modulated 4.5-mc beat. Since the 4.5-mc trap is in series with the grid and its 5,600-ohm grid resistor, its high impedance accentuates the 4.5-mc sound i.f. signal appearing at the grid. This voltage is amplified as in any i.f. stage and appears in the plate circuit of the 6AU6. A double-tuned 4.5-mc transformer is used in the plate circuit of the 6AU6 video detector and first sound i.f. amplifier to discriminate against any video signal in the plate circuit and prevent it from appearing in the second sound i.f. amplifier. In this operation, the circuit may be considered as a sound i.f. amplifier direct-coupled to the output of the video detector. The amplified signal is applied to the grid of a 6AU6 second sound i.f. amplifier.

This stage operates as a limiter and drives a discriminator detector.

Zenith sync clippers

According to the data in tube manuals, the 6BE6 is a pentagrid converter designed "to perform simultaneously the combined functions of the mixer and oscillator in superheterodyne circuits, especially those of the all-wave type." Similarly, the 6BN6 is described as a "miniature beam tube designed primarily to perform the combined functions of the limiter, discriminator, and audio-voltage amplifier in FM and intercarrier television receivers." In addition Dr. Robert Adler and other engineers of the Zenith research laboratories have developed circuits which use these tubes as sync separators and clippers. The sync separation circuits—called Fringelock—are used to insure positive sync stability over a wide range of noise and signal levels present in different TV receiving areas.

The Fringelock circuit of the Zenith 20J21 and similar models uses a 6BE6 in the circuit shown in Fig. 2.

The video detector develops a negative-going composite video signal of about 2 volts peak. This signal is applied simultaneously to the control grid of the 6CB6 first video amplifier and to the oscillator grid (grid 1) of the 6BE6 sync clipper. The signal applied to the video amplifier is amplified to about 40 volts peak and appears with positive polarity in the plate circuit of the 6CB6. This signal is tapped off at point A and applied to the control grid (grid 3) of the 6BE6 through a 10,000-ohm resistor and .01- μ f coupling capacitor.

The time constant of this combination and the 1.5-megohm grid leak is such that the grid is biased negatively to about 20 volts. Since the major portion of the video information is below this level, the plate current controlled by grid 3 flows only during the time that the sync pulses are strong enough to overcome the developed operating bias. The tube is operated with low plate voltage so the sync tips drive the plate to saturation and the tips are compressed or clipped in the plate circuit. Weak noise pulses on grid 3 are below the plate-cutoff point so they are not passed on to the oscillators. Strong noise pulses are clipped in amplitude just as the normal sync pulses.

With grid 3 alone controlling the plate current, strong noise pulses may ride through and trigger the oscillators. For this reason, the unamplified negative video from the detector is applied to grid 1 which is operated with a positive bias set with the variable FRINGELock CONTROL. When the normal 2-volt sync pulses are applied, grid 1 has no effect on the flow of plate current. However, if a noise pulse drives grid 1 beyond the 2-volt level, the plate current is instantly cut off. Thus the noise—although it appears on grid 3—cannot pass through to falsely trigger the sweep oscillators. During the brief period that the plate current is cut off, the flywheel action of the sweep tank circuits enables these oscillators to remain in sync.

The Fringelock in the 20H20 chassis uses the 6BN6 connected as in Fig. 3. The circuit of the video detector and first video amplifier are substantially the same as those in Fig. 2 so they are not shown. The 40-volt composite video signal is taken off the plate circuit of the video amplifier at point A (see Fig. 2) and applied to grid 1 of the 6BN6. The time constant of the 1-megohm grid resistor and the .047- μ f coupling capacitor is such that the capacitor charges and biases the grid to the point where plate current is cut off during the period that video information is being transmitted. If the positive-going grid signal overrides the bias, the plate current rises sharply and reaches saturation when the grid is more than 3 volts positive. Operating bias is set automatically by the strength of the composite video signal, so only the middle portions of the sync pulses are passed. The bottoms are clipped because they are not sufficiently positive to overcome the cutoff bias and the tips are clipped by plate saturation.

One disadvantage of this 6BN6 circuit is that frequent high-amplitude noise pulses charge the coupling capacitor to such a high bias level that sync pulses are clipped to the point where sync output is drastically reduced or removed entirely for several horizontal periods. This results in a loss of sync or tearing and jitter.

Another disadvantage is that noise pulses are clipped top and bottom in exactly the same way as the sync pulses and they appear in the sync output where they may falsely trigger the sweep oscillators.

In the April, 1952, issue of *Electronics* magazine, Mr. Meyer Marks of Zenith's research staff describes a modification of the 6BN6 circuit in which the amplified composite video is applied to grid 3 and the unamplified detector output is applied to grid 1. This circuit then operates in much the same manner as the 6BE6 described previously.

Triode video and i.f. amplifiers

The 12AU7 twin-medium-mu triode is widely used in TV receivers in almost every type of circuit where medium-mu triodes are applicable. According to popular engineering conceptions, triodes are not suitable for use as i.f. amplifiers because of the need for neutralization. Within the last few years, a few receiver design engineers—who apparently didn't know better—have dared to defy engineering conventions and have installed triode sound i.f. amplifiers in their sets. They seem to have the necessary savvy to do the trick and get away with it without neutralization. We know that some of those i.f. strips radiate, but we know that oscillation would play havoc with the sound. As an example of what can be done with triode i.f. amplifiers, take a look at Fig. 4, which was taken from the schematic of the Stromberg-Carlson 321 series.

The first triode section of the 12AU7 is a direct-coupled video amplifier which is entirely conventional. The second triode is the first sound-i.f. amplifier operating at 4.5 mc. Under normal conditions, any triode would require neutralization to prevent feedback through the plate-to-grid capacitance whenever the plate and grid circuits are tuned to the same frequency. However, by operating this amplifier at low gain with a small plate load resistor it is quite possible to prevent oscillations through careful layout of components in the grid and plate circuits.

—end—

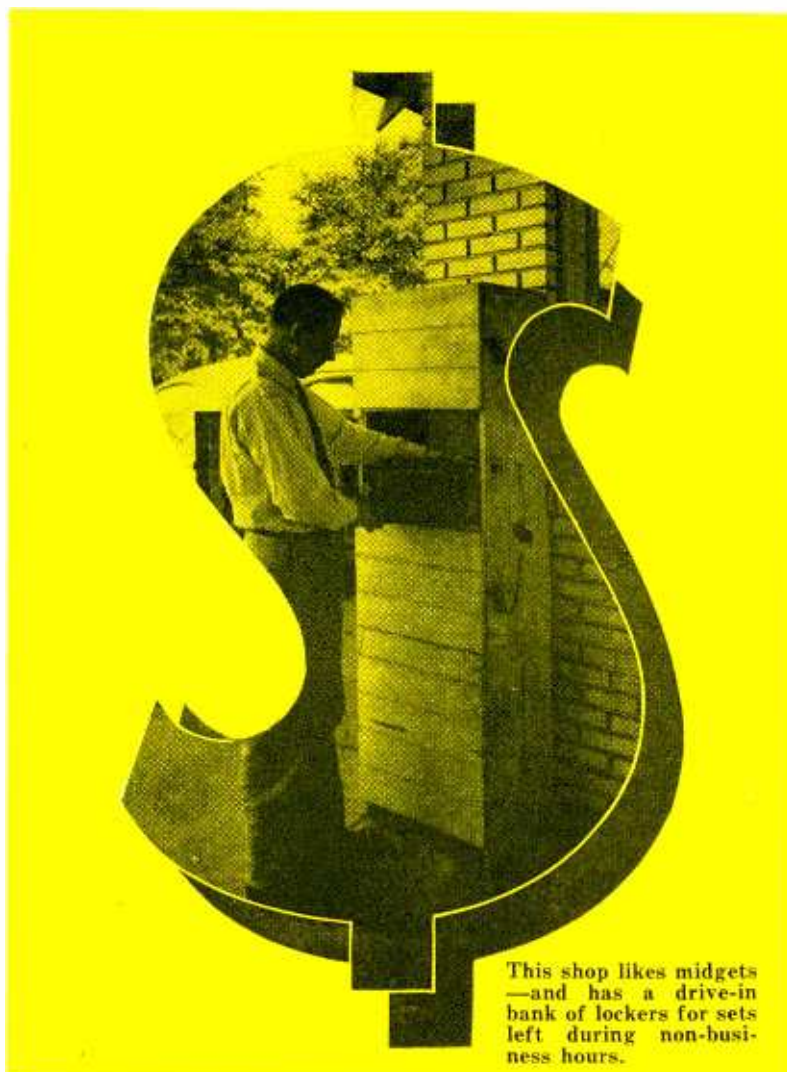

This shop likes midgets—and has a drive-in bank of lockers for sets left during non-business hours.

THERE'S MONEY IN MIDGETS

By H. L. MATSINGER

of the complaint, and find out the minimum for which he will settle.) You will often get a set which has a very bad rattle in the speaker in addition to some other complaint. Sometimes your client has become so accustomed to the rattle that he doesn't hear it, and is interested only in getting the set to play. Remember, you are working on a small margin—you can't afford to redesign the heap for \$3.50. If you have a counter tube checker, pull the chassis and check the tubes. Explain to the customer that while your price includes the replacement of those which are bad, it does not cover any which are merely weak or low in emission so long as they operate satisfactorily. Don't make a sermon of this. Don't waste too much time talking. Don't be abrupt, just be pleasant, and thank him.

If you find that your daily business in midgets increases as the direct result of an advertising campaign, keep at it, don't let it be a flash in the pan. Bear in mind that you have something to shout about, you are giving a guarantee that for \$3.50 or \$4.00 people may once more get pleasure out of a dead set. But they must be told, and constantly reminded of this fact in some manner. A 1-inch ad in your neighborhood weekly is usually better than the classified in the bigger daily.

As I hinted earlier, you must change your operating habits if you are to make money. Arrange to check several sets in succession, assuming that you have checked tubes at the time the set was brought in; quickly run through the voltages. If you have one of those signal squirters, touch it to each grid, starting with the audio. When you locate the faulty stage, and the trouble, lay the set aside with a written notation, and check the next. After you find the trouble in all sets on hand, then consider what you require to repair them. If only resistors and capacitors are needed you probably have them in stock. You can then make the repairs at once on all sets at the same time. When you follow this routine, you will be surprised at the amount of work you can do in a very short time. It is

WHEN I was a young lad, a vaudeville troupe known as "Singer's Midgets" was highly successful from a monetary standpoint. "General" and Mrs. Tom Thumb enriched the coffers of P. T. Barnum. So too, if properly handled, the much-maligned midget radio can fatten your purse.

At the risk of being branded a heretic, I suggest that you establish and advertise that you will repair, cash and carry, any midget radio for the sum of \$3.50 or \$4.00. Don't be shy about this feature. Hang a sign in your window, put it in your local paper, even put out circulars proclaiming the fact, but get it out there in front of the people! We all know that there is nothing wrong with business today that a few customers wouldn't correct, so let's go out and get them.

A lot of technicians hate the very sight of a midget. They claim there are too many parts in too small a space, that they're too hard to work on, and bring up countless other objections. This is a negative attitude which should be corrected. The average midget set is one of the simplest electronic devices to service.

In the first place, the customer is not

too critical of its quality. He is often satisfied if he can get his favorite stations without too many squeals—he will even tolerate a lot of hum before he gripes.

In the second place, the set is easy to service. Most consist of a combination oscillator and first detector, an i.f. stage, second detector and a.v.c., a stage of audio, and the necessary rectifier. This means about a dozen resistors, maybe six paper capacitors, a dual hi-mike electrolytic, two i.f. transformers, r.f. coil, an oscillator coil, an output transformer and speaker, and five tubes. Certainly not a formidable combination for a service technician of any ability.

To make any money you must achieve two things: volume and a change of pace. Most service technicians approach a radio chassis under test as though it were some new version of an electronic computer. News for you, boys! The same old time-tested theory still holds. With a little acumen one can spot the trouble in the first few moments of twiddling, often at the time the customer drops it on your counter. (In this connection, it is always a matter of good policy to plug in the set while the customer is present, get his version



Courtesy Harco Radio Service, Little Rock, Ark.

This station is devoted entirely to the cash-and-carry service of small receivers.

much better than approaching each set as an individual task.

Except for tubes, the most common causes for trouble are blown filters, line bypasses, and audio coupling capacitors. Next are open coils, oscillator or i.f. An oscillating i.f. can usually be cured by putting a larger resistor in the screen circuit.

Normally, it requires too much labor to align midgets with a standard type signal generator; you spend too much time in changing frequencies. An auxiliary generator similar to the one shown in the schematic will provide amply for the alignment frequencies required by midgets, with each one available at the twist of a knob or the push of a button.

Almost any triode will do for V1, and a wide range of pentodes for V2. If you have a wide choice, try a 6J5 or 6C5 for V1, and a 6J7 for V2. Since midgets are not the most sensitive of sets, that small audio amplifier, the 89, is well adapted for the job. It is an excellent oscillator and puts out plenty of power. The transformer T may be almost any audio type, though one of the old cheap 3-1 transformers is best. Put the primary in the plate circuit. The coil L1 is an oscillator coil used in the cathode circuits of superhets (6SA7 or 6BE6 hookup). The switch may be either a rotary or push-button type.

In this type of work, an output meter is generally impractical. That extra minute or two that you lose hooking it on is not repaid in increased performance.

Don't get me wrong! I'm not suggesting that you turn out sloppy work. I am merely trying to impress upon you the fact that you can't afford to spend more than an average of thirty minutes on any one set. Some may take a little longer, some may take a little less, but if the total average time is more than a half hour from start to finish, you should better do a little analysis! In the depression days of 1932, I tested and aligned some little things at the rate of thirty-five an hour, and that included a police band, so my experience with midgets is not entirely theoretical.

The shop illustrated in the photographs, I am told, advertises that it makes "most repairs" for a small fixed labor fee plus the price of parts. Large jobs are not welcomed, and the business is strictly cash-and-carry. Sets are accepted 24 hours a day. If the proprietor is not around, the customer puts his set into a locker, closes and padlocks it, and calls later for a report on the repair.

There are millions of these little sets in the country, and about half of them need repairs. Most folks are afraid to call a technician because they hesitate to pay eight to ten dollars for a set that cost fifteen or twenty originally. If you offer repairs at a reasonably low figure, and can establish yourself as a man who does a good job, you are getting a foothold in a virtually unlimited field. You need no expensive test instruments, no vast stock, no delivery truck. Your low price is cash and carry. Naturally, in a few cases, you will lose money, but in the aggregate you will prosper.

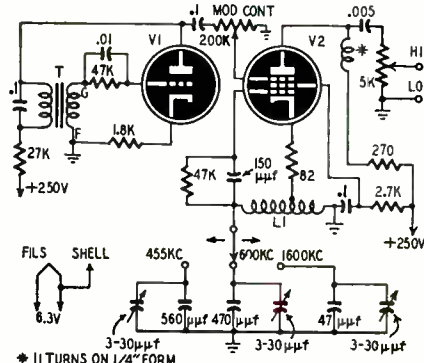

Switch-tuned alignment signal generator.

Materials for Signal Generator

- Resistors:** 1—27, 1—1,800, 1—2,700, 1—27,000, 2—47,000 ohms, 1/2 watt; 1—5,000-ohm, 1—200,000-ohm potentiometers.
- Capacitors:** (Paper) 1—.005, 1—.01, 2—.01 μf. (Mica) 1—47, 1—150, 1—470, 1—560 μmf. (Variable trimmer) 3—3-30 μmf.
- Miscellaneous:** 1 audio transformer (see text); 1 tuning coil (see text); 1 radio-frequency choke (11 turns No. 30 or smaller wire on 1/4-inch form); wire, hardware, minor essentials.

—end—

RARE TROUBLE IN A B.F.O.

By GEO. RULFFS, JR.

A local novice ham brought his homemade superhet in to be checked and aligned. Among the several bugs which were isolated and cleaned up was one persistent cuss which affected the proper operation of the beat-frequency oscillator. Fig. 1 shows the circuit employed, an old reliable one in use for many years in superhets.

The trouble which developed was unusual. When voltage was applied to the b.f.o. no beat note was produced but the b.f.o. could be heard to "swish" by the intermediate frequency (1500 kc) as C1 was varied. However, in the background a weak and very high-pitched audio squeal was evident. The squeal could not be peaked nor the pitch varied by tuning either C1 or the ganged r.f., mixer and h.f.-oscillator tuning capacitors. Changing the set-

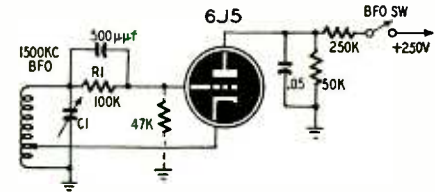

ting of one trimmer in the i.f. transformers did attenuate the unwanted oscillation, and of course the gain. Further tests indicated no regeneration in the i.f. amplifier and that the value of the grid resistor R1 was correct.

The difficulty was finally eliminated by connecting a 47,000-ohm resistor between the grid and ground. This solution was suggested when it was observed that by momentarily shorting either the grid or cathode to ground, the condition would correct itself for a few seconds duration, resulting in normal b.f.o. behavior.

Apparently the grid resistor specified had too much resistance to drain off the charge on the grid and produced parasitic oscillations.

We put the additional grid resistor between grid and ground because the original resistor was inside the can and it was more convenient to compromise than to dig into the b.f.o. coil enclosure.

TV SERVICE KINK

Don't throw away those weak 5U4's, 5Y3's, and similar rectifier tubes which you remove from TV receivers. The next time you have a set with an intermittent B plus short in it, stick in one of these weak tubes and save the new replacement until after the short has been located and eliminated.—Ralph E. Hahn

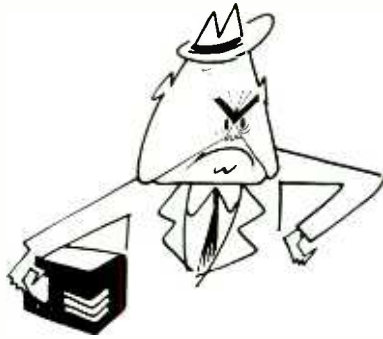

THE PEST

By B. W. WELZ

ALL radio repairmen, jewelers, auto mechanics, and the like are crooks. Everybody knows they take the parts out of what you bring in for repairs and put in old stuff; that they're out to get all they can from you and don't care what cheap tricks they use to do it.

That's why I insisted on *watching* the repairs on my 5-tube table model set when I brought it to the service shop. I kept a careful eye on the repairman while he made some tests and when he picked up a pair of snippers and started to cut something out of my radio, I let him know I was watching.

"What are you doing?" I asked.

"Move over a little," he said, and prodded me with his elbow. I suppose I was crowding him. I moved, but kept my eyes on my radio.

"The trouble is an open resistor," he said, holding up a small, colorful object. He looked through some boxes and found another jigger that looked something like it, and soldered it into my radio. When he turned the set on it worked all right.

Then right away he tried to sell me something else.

"The speaker's warped," he said. "You'll need a new one."

"It sounds all right if I keep the volume down," I said, feeling firmly that I wouldn't buy anything I didn't want.

"If I put in a new speaker now," he said, "it will cost you less because the time will be charged to the same hour with putting in the resistor."

"The speaker's good enough for me," I said with finality.

He was still probing around inside the set, and suddenly he found something else. "Oh, oh," he said, "the isolating condenser is shorted."

This man was deliberately trying to raise my bill. "The set sounds perfectly all right," I said.

"The isolating condenser," he explained, "isolates the 110-volt line from the chassis. If it's shorted you might get a bad shock or even electrocute yourself."

There seemed to be no stopping this fellow. He'd go to any lengths to make a sale, even to the extent of frightening people. I said coldly, trying to make myself perfectly clear, "Since my set works nicely as it is, I hardly think it necessary to buy anything else for it."

"Where do you keep this radio?" he asked.

I always kept it on a window shelf over a radiator. "I don't see why that should be important," I replied.

"Well," he told me, "this radio's got fancy metal designs on the front of the cabinet that touch the chassis. If you get between them and a grounded object you could get a fatal shock."

"I don't intend to buy a new condenser," I repeated, solid in my stand against having anything I didn't want forced on me. "The radio is O.K. as it is."

He sighed. I think he was getting the



idea I wasn't a yokel he could hoodwink. When he turned the set over it made a little static noise I had been noticing lately. He picked up a pencil and tapped the tubes with the eraser.

"Be careful," I warned.

Suddenly the radio went dead as he tapped one of the tubes.

Naturally that made me sore. "Now what did you do?" I demanded heatedly.

"The tube was shorting intermittently," he told me. "Tapping made the short permanent. You need a new tube."

"I never needed one before you hit it," I said.

He put his pencil down on the bench. I backed away from him because he seemed angry, but his voice was quite calm as he said, "You brought your radio here for repairs and I'm trying to repair it the best way I know. It has a bad tube. A radio in that condition never leaves this shop without a new tube or without the customer knowing about it. Otherwise it will come back and reflect on my workmanship, and to stay in business I have to do good work. You can buy your tube somewhere else. I'm interested in your knowing that the

work you buy from me is complete."

His remarks didn't have the slightest effect on me. Like I told you, I've heard a hundred times how these fellows operate. "Put in a new tube," I said, "and let that finish the job. I definitely don't want anything else."

He looked angry again as he put the radio back in the cabinet. I don't think he was used to getting caught ruining tubes. One thing I was sure of: he was going to hear more about this from me. I planned to get action through the Better Business Bureau!

We went out to the front of the shop and he put my radio on the counter and wrote up my bill. Forty cents for the resistor—that was all right; two dollars and twenty-five cents for the tube—that was all right; but when he put down two dollars and fifty cents for labor, I blew my top.

"You're making a profit from the resistor and tube," I said. "What more do you want?"

"People like you ought to know," he said, pointing an angry finger at me, "that repairmen like me are in business to sell time. A shoemaker makes a profit on his leather when he repairs your shoes, doesn't he? But he charges you more for his time. So does a carpenter. Their time is their most valuable asset, just like my time is to me."

"Radio repairmen are all crooks," I retorted. "They get you one way or another. I've heard how they take hard-to-get parts out of radios and put cheap parts in their places. I've heard how they're liable to 'fix' a radio so it has to come back to the shop and they can make more money on it. And I've heard how they charge for parts they don't replace, and . . ."

He looked so mad that I thought he was going to jump over the counter at me so I backed a safe distance away. Then he opened up as if I was at fault:

"Once in a while I get a customer like you. You're in a very small minority, thank God! When are people like you going to learn that businessmen like me have to satisfy their customers to remain in business?" he said, getting control of himself. "If I can't satisfy them, the shop around the corner will. It doesn't take a customer long to learn when he's being robbed, and when he finds out he spreads the word around and the shop that's robbing him soon finds itself with bankruptcy papers. I've been in business for ten years. I wouldn't have lasted ten days if I were dishonest . . ."

A woman walked into the store, interrupting him. She wanted a radio she had brought in for repair.

"I'll get it from the back room," the repairman told her. To me he said, "I'll be back in a minute and we'll settle this."

While he was in the back of the store, I picked up my radio and hurried out without paying. He hadn't convinced me with all his talking. Radio repairmen and others in business like that are just plain dishonest.

—end—

Greater realism
through correct dual-
speaker phasing—
A direct approach to

LOUDSPEAKER CROSSOVER DESIGN



By **NORMAN H. CROWHURST**

SOME points about the functioning of loudspeaker crossover networks should be clarified. Most classical treatments derive crossover networks from wave filter theory, which in turn is derived from the theory of artificial lines. The resulting designs may not satisfy all the requirements of a crossover network in the best possible way.

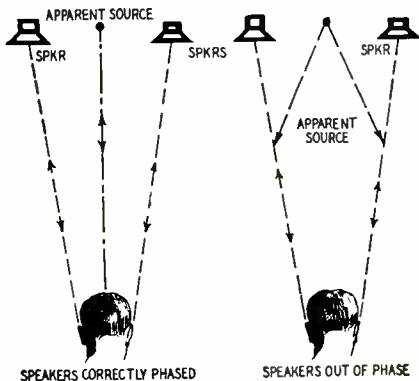

Fig. 1—The apparent source of sound shifts when speakers are not in phase.

The first and most obvious requirement of a crossover network is to deliver low-frequency energy to one speaker and high-frequency energy to another. This is usually taken care of reasonably well, using a roll-off slope to suit the designer's whim.

A second factor (and one that often receives less attention) is the impedance presented to the amplifier by the combined network. Frequently this varies widely over the audio range and includes sizeable reactive components in the vicinity of the crossover frequency. To obtain best performance from the amplifier, a constant, resistive impedance should be presented to it as a load.

The third requirement often receives even less attention. This is the *realism* of the acoustic output from the combination. While this is in some respects a matter of individual conditioning and preference, it depends fundamentally on certain electro-acoustic requirements. One of the most important, and frequently the one least considered, is the phasing, or apparent source of the sound output.

Tests have shown that phase distortion with single speakers is not normally detectable, but when *two* sources are employed, the phase relations between them influence the character of the radiated sound field. The frequency response as registered by a good pressure microphone may be flat, but what about the wave-shapes? The pressure microphone does not answer that, but a pair of human ears can detect such phase peculiarities, and failure to consider this factor has made many dual-unit combinations sound noticeably unreal, even though their frequency response may look perfect, and there may be no measurable distortion.

Source of the sound

The reader may have checked two speakers for phasing by listening to them while connections to one of them are reversed. Standing some distance in front of them, on the center line (as in Fig. 1), when they are correctly phased the sound seems to come from a point midway between the two units; but when incorrectly phased, two effects can be noticed: There is a deficiency of low frequencies (due to cancellation effects) and the source of sound at higher frequencies no longer seems to be associated with the units actually radiating it. This is because the air-particle move-

ment caused by the radiated sound is no longer back and forth along a line from the common source, but approximately at right angles to it. The sound field around the listener's head is perpendicular to what it should be, causing, through our binaural perception, the confused impression which may be called "dissociation effect."

A similar dissociation effect will occur with dual units driven by a crossover system, at any frequency where the two speakers are out of phase. It is best to keep the two units close together. Some favor putting the smaller unit on the axis of the larger one and immediately in front of it. But, however the units are arranged, the dissociation effect can become noticeable if there is an out-of-phase condition at some frequency near the crossover point. The

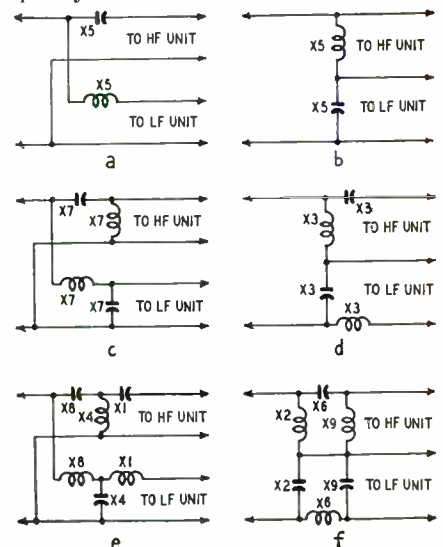

Fig. 2—Examples of crossover networks for two-way loudspeaker systems.

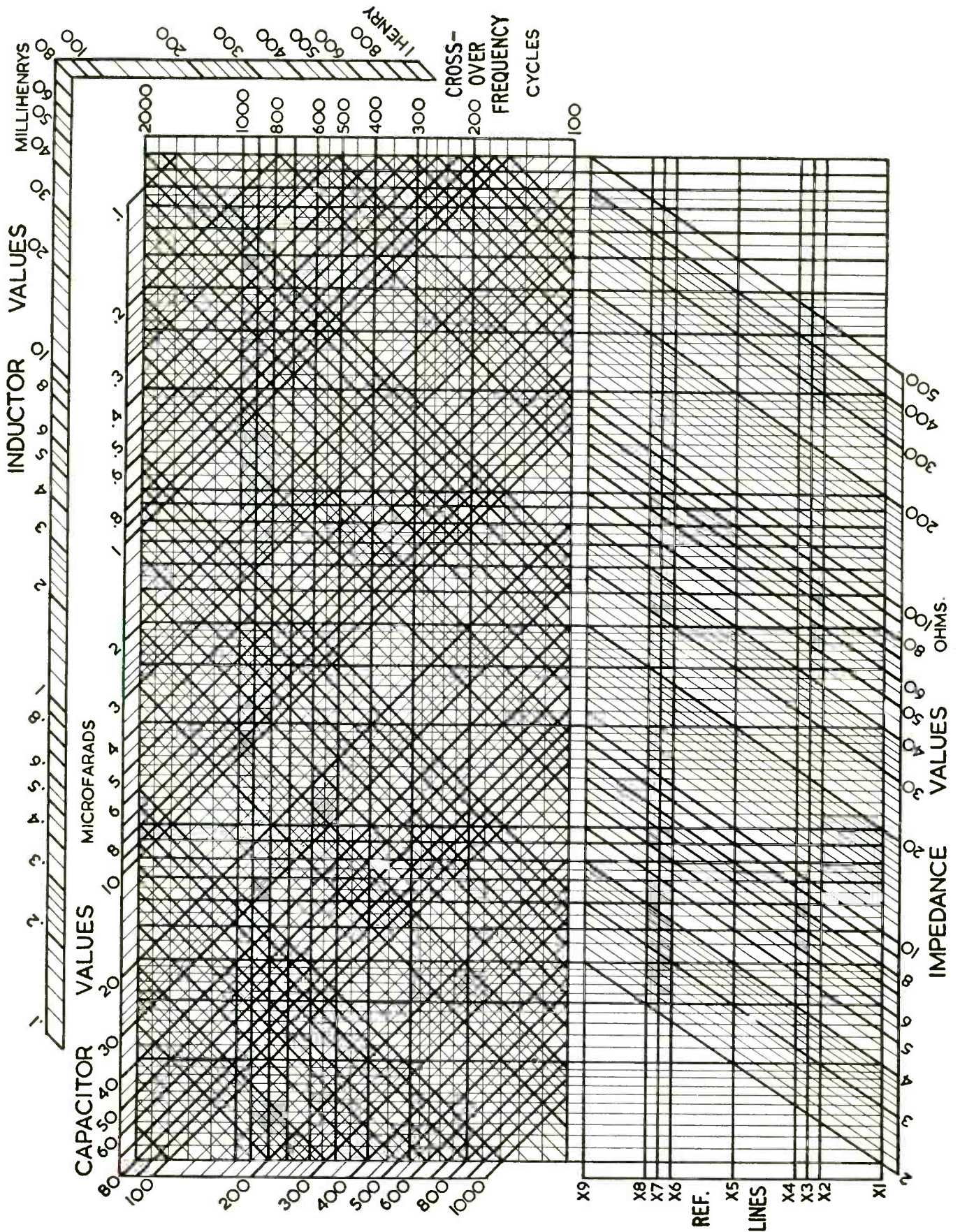

Chart for finding exact values of inductance and capacitance for any of the networks shown in Fig. 2. Use of the chart for a typical solution (Fig. 2-e) is illustrated in Fig. 3 on the opposite page.

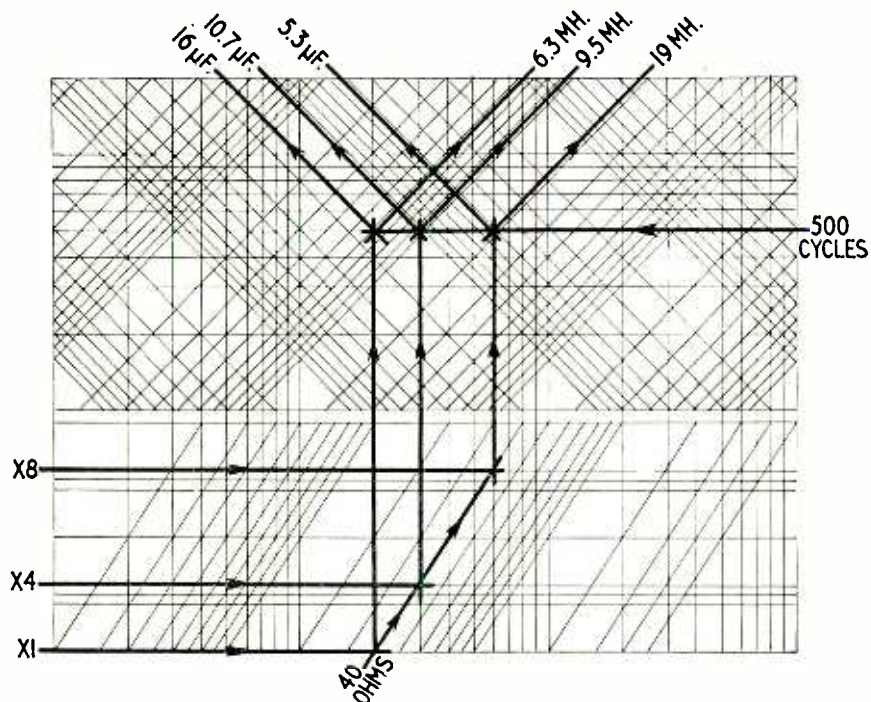

Fig. 3—How the chart on the opposite page is used to find inductance and capacitance values for Fig. 2-e. Each speaker has a 40-ohm voice-coil impedance.

relative phase at crossover can be adjusted by positioning the diaphragms on their common axis so the wave from the low-frequency unit emerges in phase with that from the high-frequency one. When the units are mounted side by side on the same baffle, the sound should emerge in phase at the baffle surface.

Constant-resistance networks

But how does the crossover network affect the relative phase at frequencies near crossover? This question often seems to be overlooked, and neglecting it can cause the trouble just described. Some networks, of the kind employing two or more reactances for each unit, have values adjusted to give an accentuated frequency rolloff. For example, the networks shown at Fig. 2, *c* and *d*, using values given by the chart in this article, are of the constant-resistance type, giving a rolloff of 12 db per octave; the phase difference between the outputs is always 180 degrees; but using values designed for a sharper rolloff, the phase difference is not the same. At frequencies near crossover, phase difference changes rapidly. Some out-of-phase effect in the vicinity of the crossover frequency is unavoidable unless a constant-resistance type network is used. It is fortunate that this type takes care of both the second and third requirements mentioned above.

The chart may be used to design any of the six types of crossover network illustrated in Fig. 2. Those at *a* and *b* give a rolloff of 6 db per octave and a constant phase difference of 90 degrees. For best results the positions of the two diaphragms should be adjusted so the difference in their distances from the face of the baffle is about one-quarter wavelength at the crossover frequency. The phase difference will not be serious

within the range where appreciable energy is coming from both units.

The networks at *c* and *d* give a rolloff of 12 db per octave, and a constant phase difference of 180 degrees, which means that reversing connections to one unit will bring the phase right. The units should be mounted so their diaphragms are in the same plane.

For cases where the frequency response of the units used requires a rolloff steeper than 12 db per octave, the networks shown at *e* or *f* are recommended. These give a rolloff of 18 db per octave, and a constant phase difference of 270 degrees. This means that mounting the diaphragms a quarter-wavelength apart at the crossover frequency will give in-phase outputs by appropriate connection.

All these networks are designed to present a constant, resistive impedance to the amplifier over the entire frequency range.

The impedance varies

One more point is often overlooked: The networks are designed on the theory that they are feeding resistance loads of the same value as the nominal voice-coil impedance. The voice-coil impedance is *not* pure resistance, so the performance of the networks is altered. The most serious effect is usually due to the inductance of the low-frequency unit voice coil. By using networks *a*, *d*, or *e*, each of which feeds the low-frequency unit through a series inductance, this effect can be overcome by subtracting the voice-coil inductance value from the network inductance value derived from the chart. Even if the available data is insufficient to allow this, these networks will minimize the effect, because the inductance of the voice coil will add very little to the effective in-

ductance of the network. In the other networks the shunt capacitor combined with the voice coil inductance will cause a greater variation in input impedance.

Each diagram in Fig. 2 has the inductors and capacitors marked with symbols. These identify the reference line (in the bottom part of the design chart) to be used for finding each component's value. Fig. 3 illustrates the use of the chart to find values for a network of the type of Fig. 2-e, and Fig. 4 shows the actual circuit calculated in this way for a crossover frequency of 500 cycles, at 40 ohms impedance.

The input impedance is the same as each speaker voice-coil impedance. Some prefer to design the crossover network for 500-ohms impedance and use matching transformers at the outputs to feed the individual voice coils. This method has two advantages: The two units need not have the same voice-coil impedance; and smaller capacitors can be used. The range of impedances covered by the chart extends up to 500 ohms to include such designs.

One modern trend has been to use separate amplifier channels for each unit. In this case the chart can be used for designing an interstage filter to separate the channels, by making the following adjustments: multiply all impedance values by 1,000 (this means the

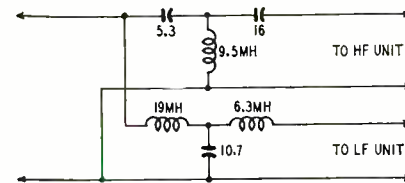

Fig. 4—Crossover-network component values for the circuit of Fig. 2-e derived by the method shown in Fig. 3.

impedance used to terminate each output as a grid shunt); change inductance values to *henries* instead of millihenries; divide capacitor values by 1,000. Suitable networks for this application are *a*, *c* or *e*, since these allow the input to each amplifier circuit to be grounded on one side.

The characteristics of the final output from any type of network and combination of speakers can only be predicted accurately if the source (amplifier) impedance is known. This can be measured with simple equipment by the methods described in the article "Audio Impedance Measurements," by James A. Mitchell, in the April, 1952, issue of RADIO-ELECTRONICS.

The amplifier impedance should be as low as possible, and practically constant over the entire frequency range to be reproduced. With present-day components, this can be achieved only by using multiple low-impedance output triodes, or by carefully-designed inverse feedback circuits. The series of articles "Audio Feedback Design," by George Fletcher Cooper (RADIO-ELECTRONICS, October, 1950—November, 1951), covers many applications of feedback to amplifier circuits.

—end—

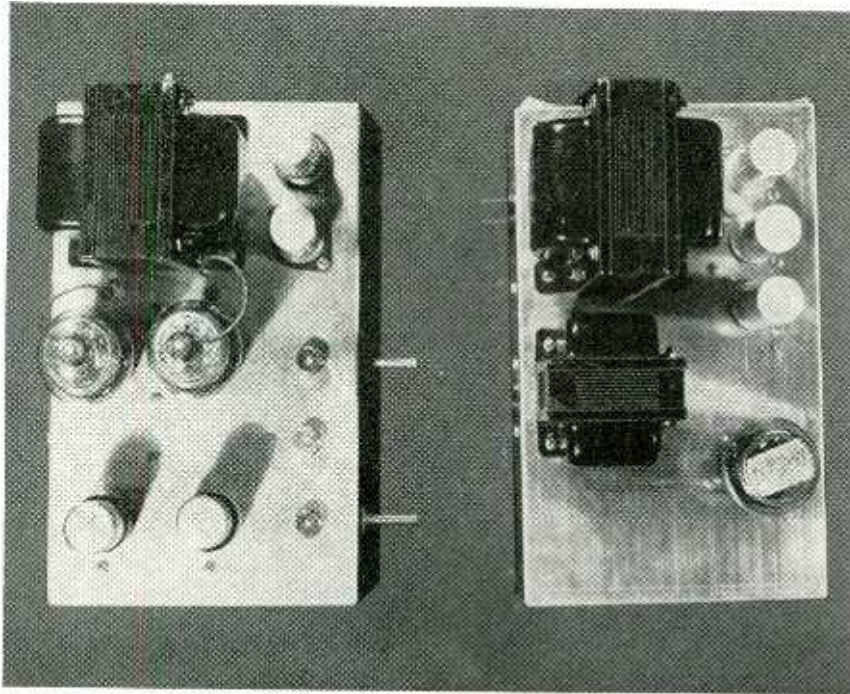

Separate amplifier and power-supply chassis reduce hum, allow uncrowded layouts.

Easily-built

American versions of
the Williamson circuits

give superb results

at comparatively

low cost

PRACTICAL WILLIAMSON AMPLIFIER

By FRANCIS A. GICCA

FOR many years the high-fidelity fan has been looking for the "perfect" amplifier circuit, one that would be flat throughout the audio range, practically distortionless, with adequate power output, and relatively inexpensive. Many circuits have been devised and many have come close to the ideal, but each has left something to be desired. The most popular circuit of recent years is the Williamson amplifier.

Although the original specifications called for the use of a British-made output transformer (Partridge) and British tube types (KT-66), several American versions have appeared. Complete Williamson amplifier kits, including punched chassis, are now available from several American manufacturers, including Heathkit, Stancor, and UTC. Other American companies, such as Acrosound, ADC, Peerless, and Triad, are producing special Williamson output transformers. Many distributors are also supplying complete or foundation kits. This amplifier used Stancor transformers and follows that company's version of the Williamson circuit. (See Figs. 1 and 2.)

Construction

The power supply is built on a separate chassis to keep a.c. transformer fields away from the amplifier. Power

is brought to the amplifier through a 4-wire cable.

Stancor suggests using two 9 x 7 x 2-inch chassis for the amplifier and power supply. However, this was found to be too small for the layout and wiring desired. We found an 11 x 7 x 2-inch aluminum chassis adequate.

The power supply itself is conventional and should cause no trouble. The core of the choke should be perpendicular to the core of the power transformer to reduce the effects of stray magnetic fields.

The layout of the amplifier is not critical, because of the isolated power supply. Be sure the 807's have enough ventilation. The layout used gave no trouble; it is suggested for ease of wiring.

The heater circuits should be wired first with twisted pair. These leads should run first to the 807's and then to the 6SN7's. To prevent ground loops all ground returns should be connected to a floating bus and the bus grounded to the chassis only at the input connector. Be sure to use insulated mountings for metal-shell decoupling capacitors and connect their negative terminals to the ground bus. Use insulated mountings also for the jacks in the cathode circuits of the 807's.

All resistors should have a tolerance of 10% or better. It is very important

that the starred resistors be matched pairs. If unbalance occurs in the direct-coupled stage it might bias the tube almost to cut-off. Unbalance in the phase-inverter circuit will cause unequal drive to the 807's. To get matched pairs take an ohmmeter to your parts distributor and measure resistors until you find two that give the same reading within 10% of the required value. Most distributors will let you do this. It is unnecessary to use a Wheatstone bridge to get two perfectly matched resistors; the ohmmeter will suffice.

A few precautions must be taken to prevent attenuation of the high audio frequencies. Do not use any shielded wire; mount all parts as far above the chassis as possible; keep all leads short; avoid cabling wires together; keep your wiring compact. It is amazing how much difference these small details can make. In this amplifier raising parts above the chassis extended the response 3 kc at the high-frequency end.

Tests and adjustments

Having completed the amplifier we started making the usual voltage checks. Suddenly we noticed one 807 glowing bright red just as the fuse blew out. We checked the setting of the potentiometer which balances the plate currents of the 807's. It was set at one

ELECTRONICS and MUSIC

Part XXV—Further
interesting features
of the Minshall
electronic organ

By RICHARD H. DORF



Fig. 1—This Minshall spinet Model H is identical to 2-manual models except for pedals and fewer stops. Designed for the home and the small church and radio station, it has built-in power amplifier and speaker.

THE tone-generator system of the Minshall electronic organ, described in last month's article, is common to all models of the instrument. Model H, shown in Fig. 1, is a single-manual spinet organ with a standard 5-octave manual and a 12-note toe-pedal complement. With built-in power amplifier and speaker, it is probably the lowest-priced electronic organ available today and is suitable for the home or the small church or radio station.

Minshall power supply

Fig. 2 shows a schematic diagram of the power supply used in all Minshall models for the tone generators and electronic tone filters. It is standard except that it includes a vibrato oscillator. The vibrato system employs a 6SN7 connected as a Wien-bridge oscillator with a frequency of about 6 cycles. The oscillator is supplied from a regulated 300-volt source. The 5,000-ohm potentiometer in the plate circuit of the right-hand triode supplies plate voltage for the 12 master oscillators of the generator system. The tap for the master oscillators is bypassed for oscillator frequencies by the 1- μ f capacitor. However, the voltage drop due to the plate current of the 6SN7 varies at the vibrato frequency, which is too low to be effectively bypassed. Thus, the voltage fed to the master oscillator plates is amplitude-modulated at a 6-cycle rate.

The master oscillators are unaffected by normal slow changes in supply vol-

tage. However, the relatively rapid 6-cycle change varies the oscillator frequencies slightly and produces vibrato. The vibrato is turned off at the tablet board by shorting the grid of the right-hand 6SN7 triode to ground. This grid lead goes to the tablet board socket in Fig. 2.

The power output plug furnishes power for the dividers and the amplifier: 300 volts regulated for the oscillators; 300 volts unregulated for the dividers; 390 volts unregulated for the amplifier; and 6.3 volts for all heaters. The tablet board socket connects supply voltages and control lines to the tablet board, which holds the electronic tone filters and the controls.

Fig. 3 shows the compact electronic assembly of the model H spinet. This is a top view with the cover raised. A chassis frame running almost the width of the instrument carries the power supply on the left, the 12 tone-generator chassis in the center, and the amplifier on the right. Each of the tone-generator chassis is held in place by the two plugs at the ends, so that it can be removed for service or replacement merely by pulling upward. The plugs are tight enough to hold the strips firmly in place under normal shock or vibration with the lower protective cover removed.

Fig. 4 is a rear view of the console. The main chassis is protected from casually exploring fingers by a wire screen. A 12-inch speaker is mounted at the lower left of the front board, and the ex-

pression pedal is linked to a special attenuator assembly which will be described in next month's concluding installment on the Minshall electronic organ.

The keying system

The keying system of the Minshall is simple but not so simple as to throw away the desirable features of a good organ. It eliminates objectionable clicks, uses standard leaf-switch contacts, and provides three separate registers—4-, 8-, and 16-foot for the GREAT; 4- and 8-foot plus a "quint" for the SWELL; and a single pedal bus which gives the effect of an extra lower octave.

The keying for a single generator output is diagrammed in Fig. 5. The output from the plate of each divider tube is fed through 10-megohm, 2.7-megohm, and 1-megohm resistors to the output bus. The key switch connected between the 10-megohm and 2.7-megohm resistors and ground is normally closed, grounding the divider's output. When the key is pressed, the switch opens and the tone goes to the output bus. The capacitor and the first two resistors form a simple low-pass filter. The capacitor value is selected so that the fundamental and most of the harmonic content of each octave are unimpaired, but the "click band" (which is higher than the highest note on the organ) is attenuated. Although this system does not remove all clicks, their level is so low that even this critical listener was unable to find them objectionable.

The circuit for the entire GREAT manual is shown in Fig. 6 in explanatory form. Across the top of the diagram the octave designations indicate the five octave keys on the manual. The small circles above the 10-megohm re-

sistors to the 10-megohm and 2.7-megohm resistors to a sub-bus to which all 12 notes of this octave connect. This sub-bus is connected through a 1-megohm resistor to the main 16-foot bus and through a .0022- μ f key-click capacitor

one of the three connected throughout in this manner. The bottom octave of keys produces for the 16-foot register the same octave of tones as does the second octave of keys; and the top octave of keys produces for the 4-foot register the same octave of tones as the fourth octave of keys. These tied-together octaves do not require different click-filter values so their octave sub-buses are commoned, as shown in Fig. 6.

In 2-manual models the SWELL manual is connected in exactly the same way, except that instead of a 16-foot register it has a quint bus. This carries tones one octave and a fifth above the key pressed. The quint note for C₃, for instance, is G₄; for G₃ it is D₅, and so on. The quint is not available on the stop controls as a separate register but is used in the tone-color blends for simulating certain organ stops.

Obtaining low notes

The 25-note pedal clavier operates in the same basic manner but is wired somewhat differently for a good reason. The lowest note generated in the Minshall is equivalent to the 8-foot tone of the lowest organ pedal, but it is necessary to have a tone one octave below that, equivalent to a 16-foot, for a good bass foundation. This is obtained in the Minshall by mixing the fundamental and the tone a musical fifth above it.

Fig. 7 shows how this is done. The tone from divider C₁ is fed through the customary 10-megohm and 2.7-megohm resistors to the output bus. No click filters are needed in the pedal circuit, since there are only two octaves of tones and clicks are removed by the low-pass character of the pedal tone filter on the tablet board. Pressing the C₁ pedal ungrounds the generator output in the usual way.

In addition to the C₁ tone, however, a certain amount of tone from the G₁ divider, a fifth above, is injected as well through the 22-megohm resistor. The difference between the C₁ frequency of

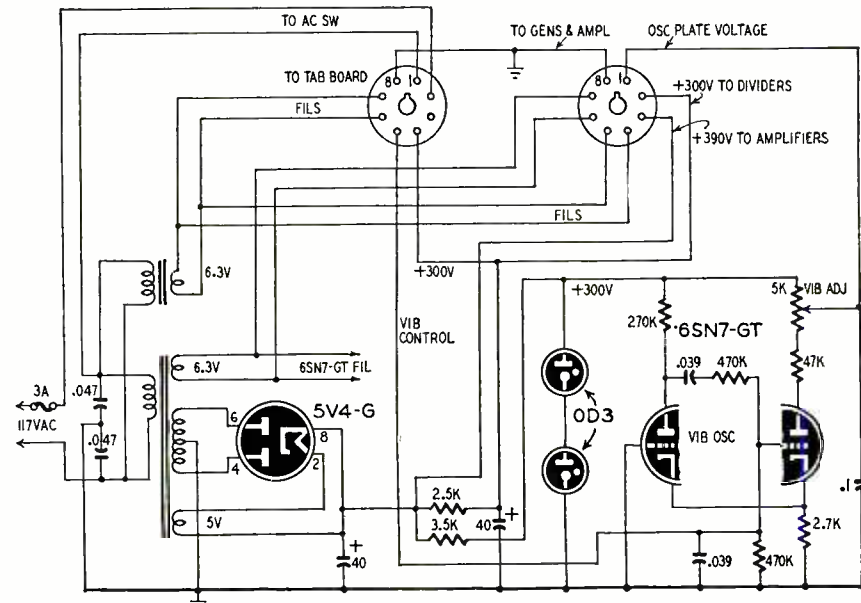

Fig. 2—The power-supply chassis furnishes regulated voltage to the tone oscillators, with vibrato if desired, and supplies all power for generator system and amplifier through bus wiring to plug-in receptacles under each unit chassis.

sistors in octave 3 indicate divider output tones and are marked with the note and octave actually generated; thus, "C₂" means the second C generated or 130.8 cycles (see the note-frequency chart in the August, 1950, issue of RADIO-ELECTRONICS).

Each key operates three switches simultaneously. For example, when D in octave 3 is played, the switch in the uppermost section ungrounds the output of D₂, which is one octave below the actual key pressed. This sends D₂ tone

to ground. The same action also takes place in the center section with respect to the output of the D₃ generator, which goes through a similar path to the 8-foot bus; and in the bottom section for D₄, which goes to the 4-foot bus.

In this way, each key produces three different tones in three different buses, and each octave in each register is separately filtered for key clicks. Since there are only five octaves of tones generated in the organ (plus the usual extra C), the 8-foot register is the only

Fig. 3—Top view of the model H spinet with cover raised shows the single chassis which holds electronic assembly. Each sub-chassis is instantly removable for servicing.

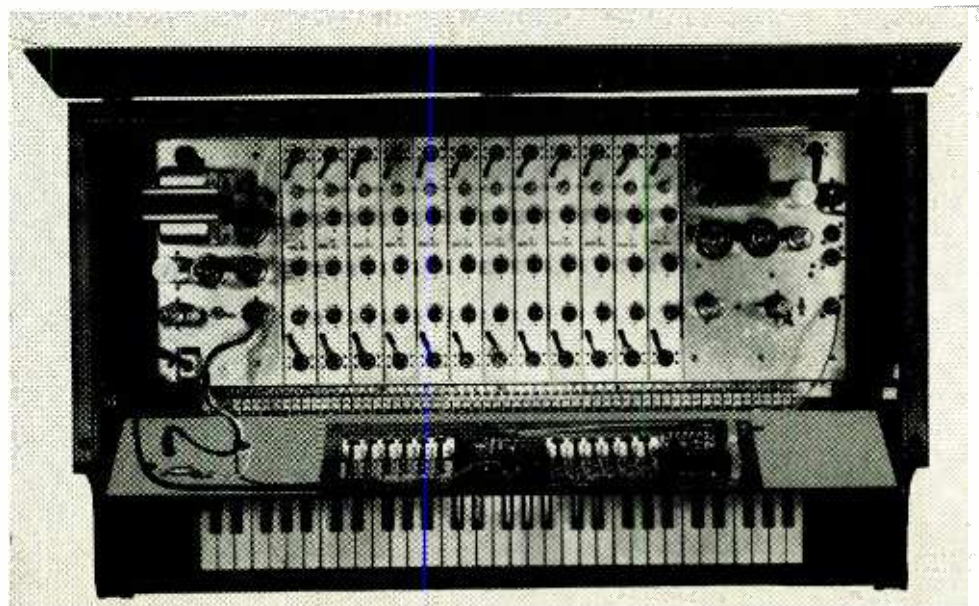

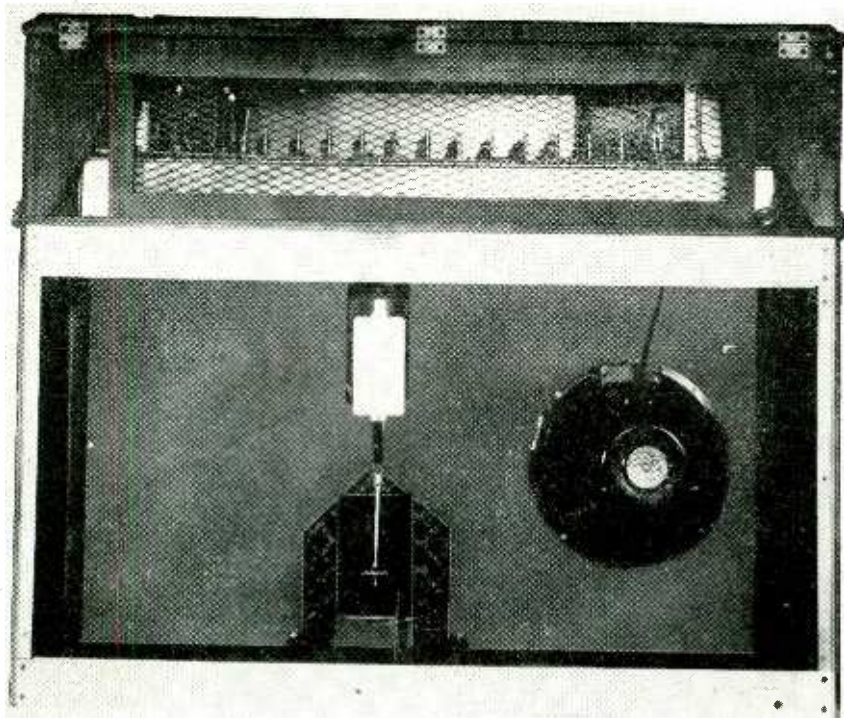

Fig. 4—Rear view of the Model H illustrates compact construction.

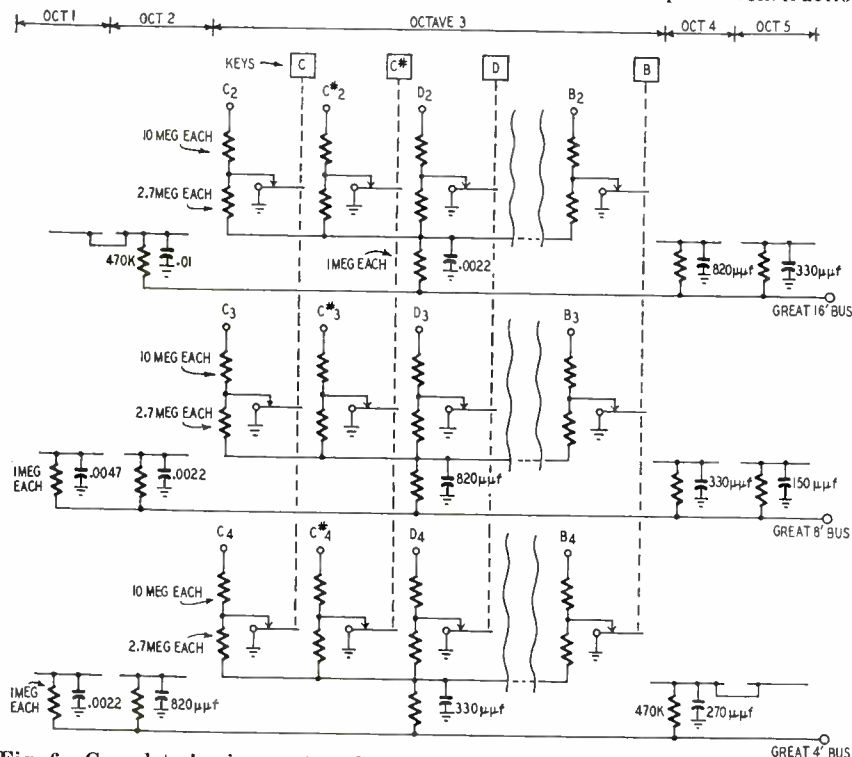

Fig. 6—Complete keying system for GREAT manual of larger models is similar to that for the spinet model. Capacitors are used to suppress keying clicks.

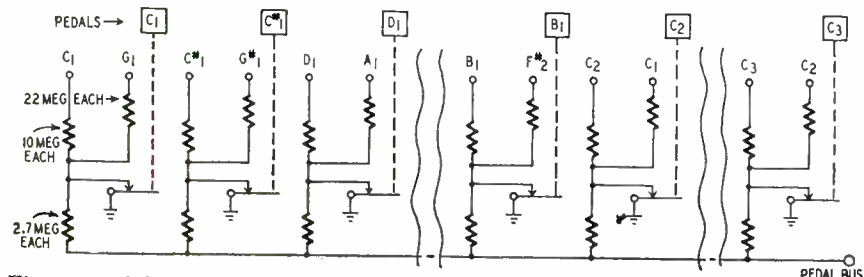

Fig. 7—Pedal key-switch circuit diagram shows how the quint is added to the basic tone in the first octave to give effect of a bass an octave lower than actual tone.

65.41 cycles and the G_1 frequency of 98 cycles is 32.59 cycles, within 0.11 cycle of the frequency of the C one octave below C_1 . When the fundamental and fifth are mixed in the right proportions the fifth itself cannot be heard but the listener hears the 32-cycle tone and a good foundation bass is obtained.

This scheme of adding the first octave of the pedals, as Fig. 7 illustrates. Beginning with the second octave of pedals (C_2) the fifth is no longer needed, since the first octave of generated notes can be used. The fifth input is therefore replaced with a certain amount of tone from $C_1, C_1 \dots$, through the 22-meg-ohm resistors.

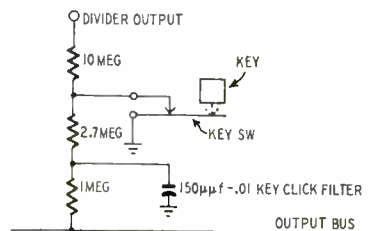

Fig. 5—Single keying circuit demonstrates the shunt keying system used in the Minshall electronic organ.

In next month's article our description of the Minshall electronic organ will conclude with complete diagrams of the electronic tone-color filters, the control system, and the amplifiers. Particularly interesting are the graphs showing actual frequency responses of the filters as illustrations of how the formant principle is used in this organ and how the colors can be duplicated experimentally.

(to be continued)

Other Organ Articles In This Series

September, 1951—The Hammond Organ; Music from Spinning Wheels and Electronic Circuits

October, 1951—Hammond Organ continued; preamplifier, vibrato, reverberation, speakers

November, 1951—The Baldwin, an Instrument of the All-Electronic Type.

December, 1951—The Baldwin Keying and Tone Color Circuits

January, 1952—More on the Baldwin; Tone coloring and note blending circuits

February, 1952—Consonata—Overall Description and Circuitry

March, 1952—Consonata—Keying, Mixing, and Tone Injection Circuitry

April, 1952—New Electronic Instrument [Lowrey Organo] Makes Organ of any Piano

May, 1952—Construction and Circuit Details of Solovox

June, 1952—Minshall Electronic Organ; True Organ Tones with Few Components

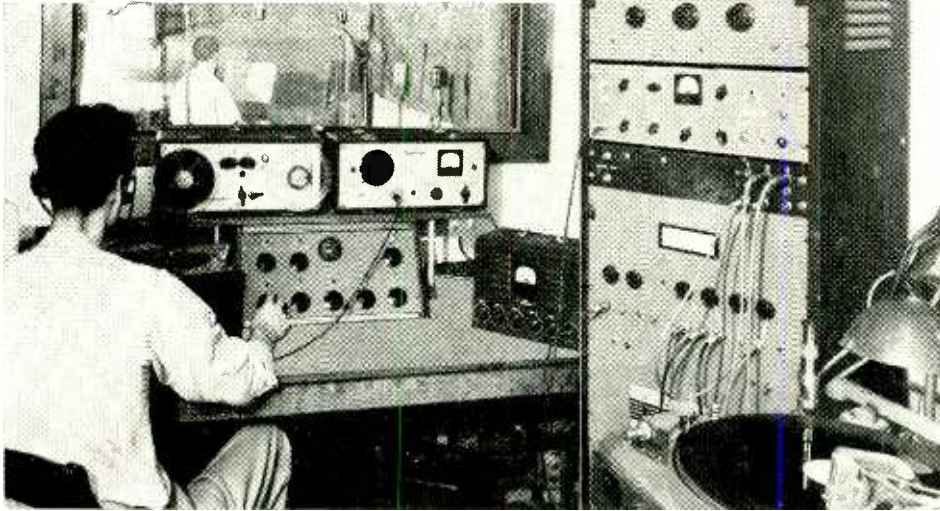

Recording-studio control room. The echo box and its controls are at the top of the rack.

Echo effects for recording and broadcast work can be produced at low cost.

SIMPLE ECHO BOX

By CHARLES L. HANSEN

SEARCH for a simple artificial reverberation generator began when we lost a customer because we could not furnish a reverberation effect. The embarrassment of the situation sparked us into action.

We had no space for a true reverberation chamber. A tape-delay system sounded good, but the cost of a commercial unit was too great. We considered a system using 50 feet or more of coiled-up hose with a speaker, mike, and equalizer, but did not think it versatile enough to investigate further. The idea of three or more pickup heads riding behind each other in the same record groove was also thrown out. A re-

volving disc painted with fluorescent material, actuated by a modulated light source, with photocells and an optical system to reproduce the transient images was discarded as too complicated.

In one attempt a contact mike was attached to the sounding board of a piano. A speaker inside the piano caused the strings to vibrate sympathetically. This effect is quite strange and when mixed with the proper amount of original sound gives a tremendous reverberation effect. But one piano is all we can afford and we have no padded closet for storing a piano reverberation generator. I even went as far as to have my wife make a gallon of Jello in a special container. A speaker would drive one side of the jello and a crystal pickup with multiple arms would pick up the vibrations at the other end. I recorded a

reverberation effect but the stuff started to melt and I didn't have time to look for an elastic gel that would remain in a permanent state.

One day I connected a recording head to one end of a 50-foot length of iron wire and a phono cartridge to the other end. The results were so good my partner and I agreed that this system had possibilities if it could be reduced in size and installed in a soundproof box so that room noise would not affect it.

The unit was finally boiled down to a crystal driver, two piano-wire springs, and a reproducer mounted in a can about four inches long and two inches in diameter. This was inserted in a larger can packed with sound-absorbing material and suspended behind the equipment rack. (See Fig. 1.)

The delay mechanism consists of two piano-wire coil springs (5, 6) obtainable

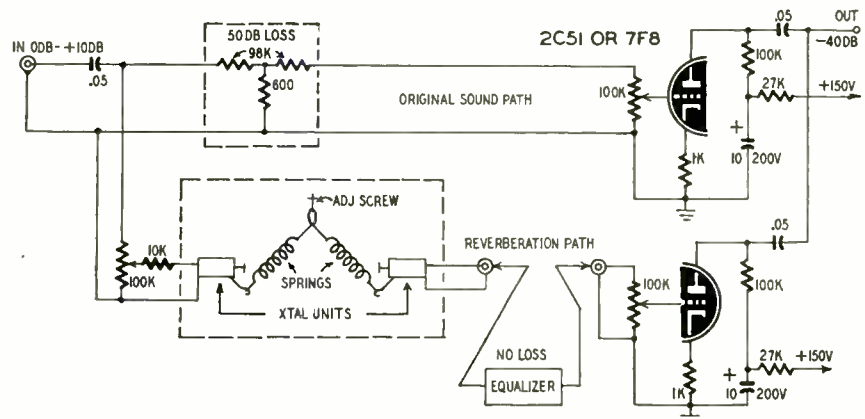
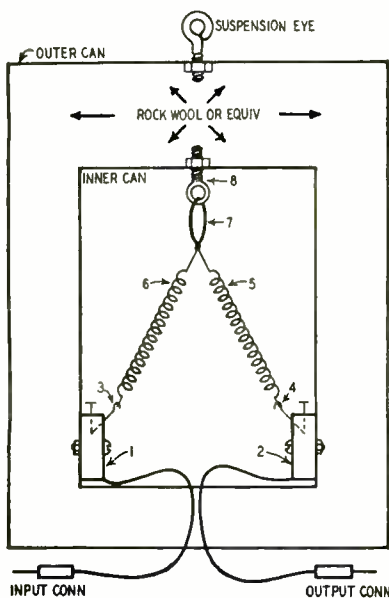

Fig. 1 (left)—Echo-box construction data. Fig. 2 (above)—Schematic of the complete reverberation unit. All units except the equalizer are on the top panel.

PUSH-BUTTON TUNER

By ROBERT G. MASCHING

at any hardware store. The spring wire should be of smallest possible diameter. A good way to gauge such a spring is to hold one end and see that the other end droops downward. The springs should be about 2 to 2½ inches long.

The springs are attached at one end to the high-output crystal driver and the reproducer (1, 2) by hooked wires (3, 4) inserted in the needle chucks. The free ends of the springs are hooked together and connected by a stiff rubber band (7) to the adjusting screw (8).

The proper adjustment can be found by feeding the driver from a radio and connecting the reproducer to an amplifier and speaker. If the tension is too great the stress will distort the crystal cartridge. If the tension is too low no sound will be transmitted through the unit. The springs attached to a stiff material act like an improperly terminated electrical transmission line. The abrupt impedance change at the junction point sets up reflections in the line. The rubber band acts as a damper. If too much audio power is applied the springs will be shocked and the reproduced sound will contain "pings" like rifle shots at the start of each word. The volume level should be set so the crystal just starts to "talk back" on peaks. Maximum reverberation time is three seconds.

We also built a larger unit with a reverberation time of 10 seconds, which is installed in a trunk under the operating desk. Reverberation time naturally varies with the size, length, and stiffness of the delay mechanism. Our larger unit was wound with No. 20 armature binding wire.

The correct amount of original sound must be mixed with the artificially reverberated sound to produce the effect wanted. This is done by the three controls on the echo box panel at the top of the equipment rack in the photo. The schematic of this panel is shown in Fig 2. The first control on the left varies the mechanical drive to the spring. The second knob feeds through the desired amount of original sound. The third control is a reverberation quantity control. An infinite number of combinations can be obtained.

An equalizer is indispensable with this reverberation generator. The one used in our installation is a universal equalizer with zero insertion loss, mounted on top of the rack. With an equalizer in the output circuit the reverberated sound can be made to sound crisp. The effect can be described as changing the echo-chamber size, shape, and surface. It will be up to the builder to make adjustments and changes in the unit to obtain what he wants.

Although this unit was designed for voice, such a unit might be inserted in any amplifier playback system as a "presence control". Many weird and varied effects can be obtained. Television and radio stations could use such a device for obtaining novel effects in local programs and spot announcements. The disc jockeys would love it.

—end—

SOME years ago no receiver could be sold unless it had push-button tuning. This feature has practically disappeared, but many of us would still appreciate the convenience.

If you would like push-button tuning, you can add it to your receiver with little trouble. All you need is a switch (latch type not necessary) and a supply of small fixed and trimmer capacitors. The time spent in hooking them up will be returned to you in the convenience of flicking on a favorite program or news broadcast instantaneously.

I built my own receiver from junk box parts. As is often the case, it was difficult to find mixer and oscillator coils which tracked. But fixed tuning solved the problem nicely. Having but two coils and only a 2-gang variable capacitor (for manual tuning when desired) I used no r.f. stage. A 2-gang 6-position switch tuned in six of the seven local stations. If more stations are desired a 12- or 24-position switch can be used, and of course additional capacitors. A 3-gang switch is needed if your receiver has an r.f. stage.

Notice in the circuit that each station is tuned by the capacitance of its particular switch position. Capacitors would be saved by using a progressively shorting type switch to add just a bit more capacitance as the switch is rotated, but this would mean that adjustment of one station would affect the adjustment of all. In the circuit shown the station adjustments are independent of each other.

First align the i.f.'s. Then solder a small variable trimmer across the switch in the first position for the highest-frequency station. Adjust the trimmer for the oscillator until the desired station is heard, or use a signal generator if available. Then solder a trimmer

to the r.f. and or mixer stages and tune. Switch to the next position, solder in a capacitor and tune the next lowest station in frequency, always adjusting the oscillator first. Continue until all desired stations are tuned. The receiver's own variable capacitor may be then attached to the last switch position for regular manual tuning.

An idea of succeeding values of capacitance necessary to tune progressively lower frequency stations may be obtained from the formula

$$f = \frac{1}{2\pi\sqrt{LC}}$$

which shows that with a fixed coil the frequency is inversely proportional to the square root of the capacitance. Thus if 20 µmf is necessary to tune the r.f. to 1400 kc, 80 µmf will be needed at 700 kc. If the i.f. of your receiver is 455 kc the oscillator will tune from 1005-1955 kc in covering stations from 550 to 1500 kc. Therefore slightly less than four times the capacitance necessary to tune the oscillator at 1500 will be required at 550 kc.

Since the distributed capacitance of the switch, wiring and coil is part of the total minimum capacitance, and it cannot be calculated easily, the above will give only a rough estimate. The simpler method is by trial and error to add the capacitance necessary to tune the desired station.

To give an idea of expected capacitances, the values used in my receiver are given below. These values will vary with the individual receiver.

Results have been more than gratifying. The stability of the tuning is excellent despite the fact that no precautions were used in wiring, no special capacitors were used, and the switch is an ordinary bakelite wafer type.

—end—

TABLE OF CAPACITANCES

Switch Position	Frequency of Station kc	Osc. Capacitance (µmf)	Mixer Cap (µmf)
1	1380	C1 —3-30	C2 —3-30
2	920	C3 —3-30	C4 —3-30, C5 — 25
3	760	C6 —3-30, C7 — 60	C8 —3-30, C9 —100
4	690	C10—3-30, C11— 80	C12—3-30, C13—100
5	590	C14—3-30, C15—130	C16—3-30, C17—150
6	Manual	C19—3-30	C21—3-30

C18 and C20 are the receiver's regular ganged variable tuning capacitors.

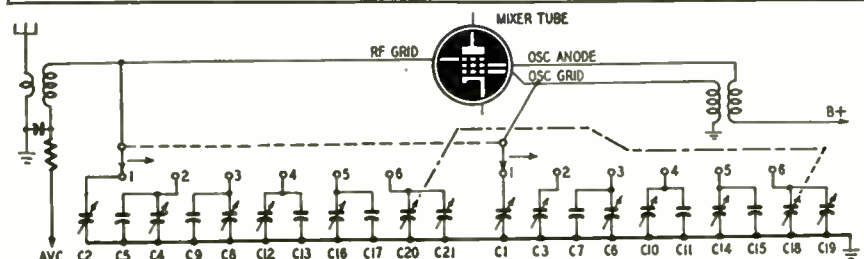

PRESELECTOR and its POSSIBILITIES

By JACK V. ROBERSON

EVERY amateur, whether novice, dx hound, or rag chewer, is limited in his contacts by two things—how many stations he can hear, and how many can hear him. Whether you're operating a 10-watt rig or a kilowatt, you must be able to copy the other station, and it's a comfortable feeling to know that you have plenty of receiving power. If your receiver has fewer than two r.f. stages, you may be missing many enjoyable contacts—or losing some of those rare ones. A preselector can be a big help.

The following list of stations illustrates the difference between using and not using a preselector. These stations were logged on December 23, 1951, between 1500 and 1530 CST.

PRESELECTOR REGENERATIVE

Station	OUT	IN
W90SR	S1 plus	S9 plus 10DB
K8ARR	**	S8
W4ITB	S2 plus	S9 plus 20DB

PRESELECTOR NONREGENERATIVE

Station	OUT	IN
W8LAX	S1	S5 ½
W2DYR	S1	S6
W8LIO	S2	S7
VE3DGX	**	S2

**Very slight indication on S meter—not readable

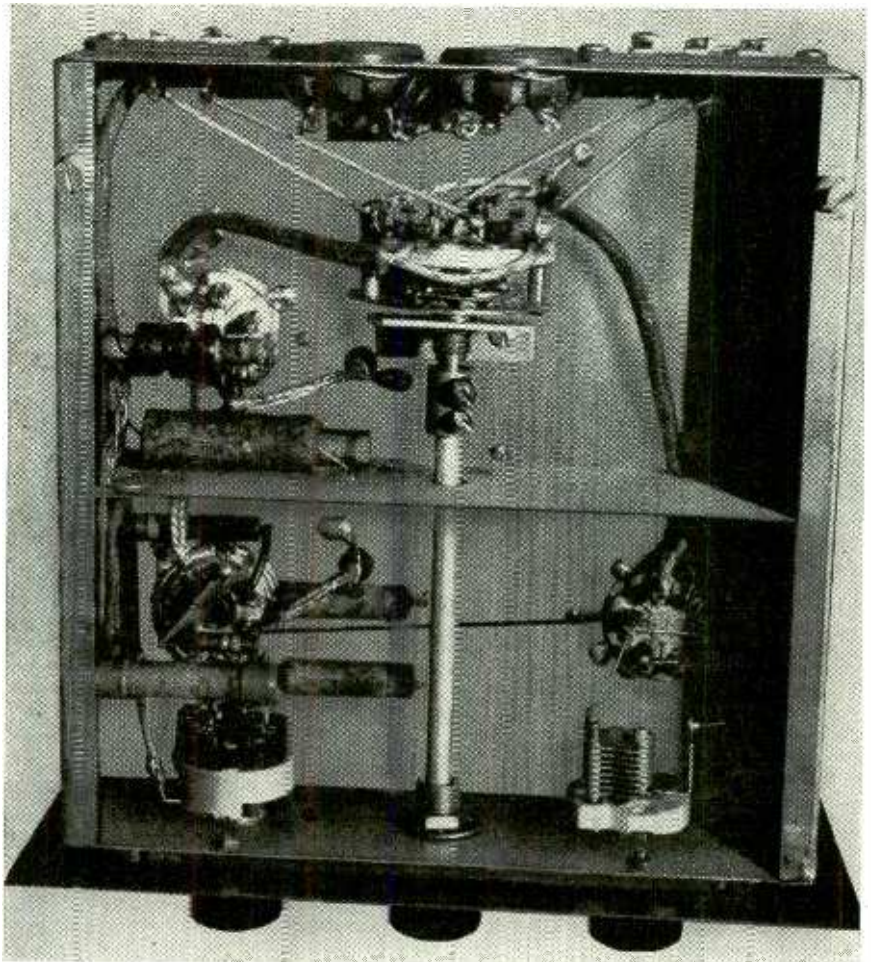

The underside of the preselector chassis. Thorough shielding prevents oscillation.

A preselector is primarily used to boost the signal strength of weak stations. A secondary function is, as the name implies, the "preselection" or the pre-separation of frequencies.

Preselection cannot eliminate the effects of poor receiver alignment, but it can put more signal into your receiver, and assist the receiver to reject unwanted signals, especially image frequencies. A preselector usually consists of one or more t.r.f. stages, and controlled regeneration is sometimes introduced to increase gain and selectivity. A preselector should have a convenient method of IN-OUT switching, and a calibrated dial.

The preselector described in this article was built to work with an NC-57 receiver. The schematic diagram is shown in Fig. 1. Power supply requirements are low—6.3 v.a.c. at 0.3 amp, and 100 to 200 volts d.c. at 10 ma. Nearly all receivers will stand this small additional power drain. If not, a supply like the one suggested in Fig. 2 may be constructed. The preselector was built into an 8 x 10 x 8-inch metal cabinet, and the chassis size was approximately

2 x 7 x 7 inches. In order to get the rear of the chassis to come at the cut out space in the back of the cabinet, the chassis was bolted to the front panel 5/8 inch from the bottom—the rear of the chassis being supported by flat-head screws. The main tuning capacitor, C1 and C2, is a three-gang b.c. type of about 435 µmf per section. The center section was removed so that a shield could be placed between the front and back sections. All but two rotor plates were removed on each section in order to obtain enough bandwidth. (Two ganged capacitors, each having a maximum capacity of 50 to 70 µmf may be used.) The shield across the bottom of the chassis (shown above) isolates the input and output coil sockets.

The IN-OUT switch is mounted under the chassis toward the back. Its shaft extends through the shield to the front panel. The antenna tuning trimmer has a capacitance of about 8 µmf. This was originally a 50-µmf air trimmer from which all rotor plates but one were removed.

The leads from the IN-OUT switch to



Completed preselector and plug-in coils.

JULY, 1952

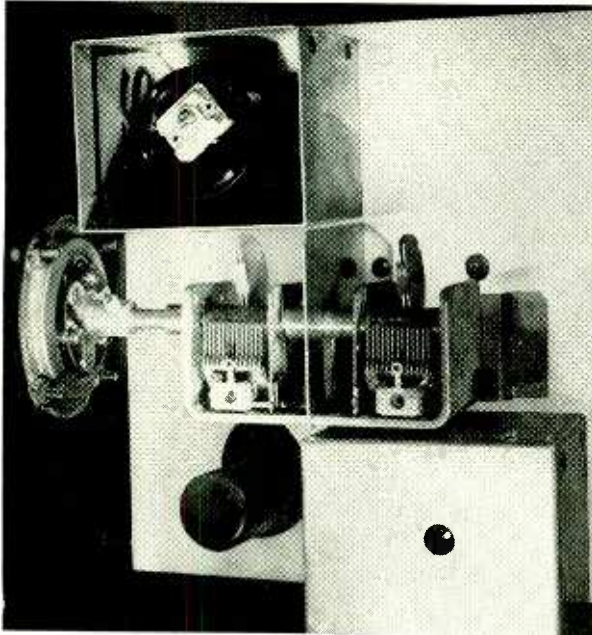

Shielded plug-in coils and modified broadcast-type tuning capacitor on the upper side of the preselector chassis.

the input and output coils are shielded. Do not shield the lead from the 6SG7 grid to the input coil since the shielding introduces too much capacitance. The grid lead should be stretched from the coil socket to the tube socket, and should not run along the chassis. It is also advisable to shield the filament and B plus leads.

Coils were wound on 1 1/2-inch diameter 6-prong forms. The small trimmer capacitors are connected by heavy copper wire rigid enough to permit the trimmers to be adjusted from the top as shown above. The wires are first soldered to the trimmers and then positioned inside the coil form before soldering to the socket prongs. These trimmers are for peaking each coil set at the center of an amateur band. Each coil is enclosed in an aluminum box 2 5/8 inches high, 2 1/4 inches wide, and 2 7/8 inches deep.

The size of resistor R1 will depend on the B voltage and the value of R2. R1 is chosen so that the 6SG7 will cut off when the gain control is fully counterclockwise (maximum positive cathode voltage). This value may be determined by inserting a milliammeter in series with the plate lead and adjusting R1 until no plate current flows.

The preselector is connected to the receiver input terminals by unshielded twisted leads since regeneration may not be possible with shielded wires. Whether or not one input lead to the receiver should be grounded is deter-

mined by experiment. Reversing the twisted lead connections at the preselector output terminals will make the preselector either "normal" or regenerative. Under regenerative conditions, with an antenna connected to the preselector, advancing the r.f. gain control to maximum should cause the preselector to break into oscillation. It should be possible to bring the gain up to just under the point of oscillation. At this point a signal that normally can't be heard will often come up to S5 or better, and the selectivity is extremely sharp. Feedback on the lower amateur bands is ample, and the input and output leads should be physically separated as much as possible to prevent too much regeneration. On 10 meters adequate feedback may not be obtained unless a few turns of the antenna lead are wrapped around the twisted pair leading to the receiver.

With the r.f. gain set at maximum clockwise position (maximum gain) and with the preselector connected to the receiver input, but with no antenna, check to see that no oscillation exists in the preselector. Oscillation will be indicated by a sudden large change in S meter reading, or by a "plop" in the speaker. If oscillation does exist it will be necessary to improve the shielding between the input and output. As shown in the photo a small metal shield is soldered to pin 1 of the tube socket and serves to isolate the grid (pin 4) from the plate (pin 8).

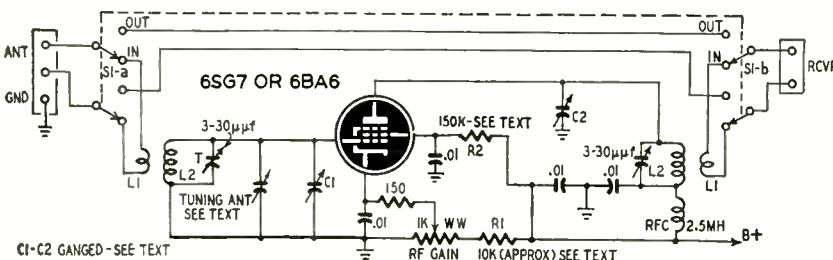

Fig. 1—Schematic of the preselector. Regeneration increases gain and selectivity.

Each set of coils should be peaked at the center of an amateur band. Tune the receiver to a weak amateur station (or use a signal generator) and adjust the receiver with the preselector out for maximum response on the S meter or maximum output. Now turn the preselector to the IN position and adjust the r.f. gain to just below maximum with the ANT TUNING trimmer in mid-position. Set the preselector tuning capacitor to the desired position on the dial and adjust the input and output trimmers for maximum volume. (If the trimmers do not peak at the desired points on the dial, add or subtract one or two turns from each coil and try again.) After the trimmers are set at the proper points, rock the receiver antenna trimmer and repeak the converter. Continue until no further improvement is noted (the r.f. gain may have to be backed off to prevent oscillation). If alignment has been carried out properly, moving the ANT TUNING trimmer from its mid-position should cause the S meter indication to decrease. It should not be necessary to vary the receiver's antenna trimmer after alignment, but the ANT TUNING may have to be adjusted slightly for the ends of the bands. Hand capacitance will have some effect under regenerative conditions, but this effect may be compensated for by increasing or decreasing the r.f. gain.

When using the preselector don't feel discouraged if you fail to work quite a few of the stations you hear—the guy on the other end may also need one.

Materials for Preselector

Resistors: 1—150,000 ohms, 1—10,000 ohms, 1—150 ohms, 1/2 watt; 1—1,000-ohm potentiometer.
Capacitors: (Paper) 1—0.1 µf, 400 v d.c. (Ceramic or mica) 4—0.01 µf. (Variable) 1—antenna trimmer (see text); 1—2-gang main tuning capacitor (see text); 2—3-30 µmf trimmers.
Miscellaneous: 1—2.5 mh r.f. choke; 1—2-section, 2-pole, 2-position wafer switch; 8 coil forms (see text); 2—6-pin ceramic sockets; 1—octal socket; wire; chassis, cabinet, dial, knobs, hardware, input and output terminal strips.

Materials for Power Supply

Power transformer—Merit 3045, Thordarson T-22R12, or equivalent; 60-ma filter choke; 75-ma selenium rectifier; 25,000-ohm, 25-watt wire-wound resistor; 2—30-µf, 150-v electrolytic capacitors; 1—0.1 µf, 400-v paper capacitor; s.p.s.t. toggle switch.

COIL TABLE

- 80 METERS**
 L1—15 turns No. 26 enameled, close-wound.
 L2—26 turns No. 24 enameled, close-wound.
- 40 METERS**
 L1—7 turns No. 26 enameled, close-wound.
 L2—19 turns No. 20 enameled, spaced to 1 3/16".
- 20 METERS**
 L1—7 turns No. 26 enameled, close-wound.
 L2—5 turns No. 20 enameled, spaced 3/8".
- 10 METERS**
 L1—2 turns No. 26 enameled, close-wound.
 L2—3 turns No. 20 enameled, spaced 3/16".
- Note: L1 and L2 are separated by 1/8".

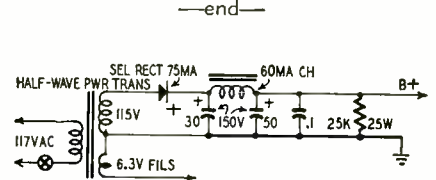

Fig. 2—Power supply recommended for use where preselector operating voltages are not supplied by the receiver.

A description of a photoelectric door-actuating mechanism that can be installed in the home. The system can be adapted to operate gates and garage or barn doors as well.

AUTOMATIC DOOR CONTROLLER

By DON ANGLIN

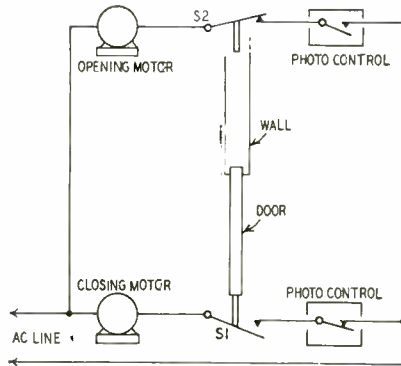

Fig. 1—Basic door-control system.

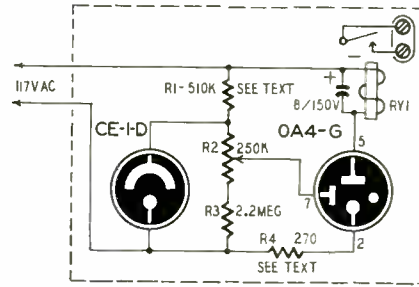

Fig. 2—The electronic control circuit.

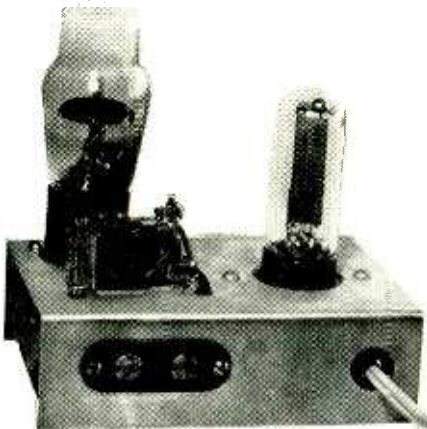

Fig. 3—Top-view photograph of the electronic part of the control system.

DOORS that open automatically when someone approaches, and close after the person has passed through, can be just as useful in the home as in restaurants and railroad stations. The low cost and simplicity of the photoelectric controls and motor drives make it entirely practicable to build your own.

Fig. 1 is a block diagram of a typical installation. When the sliding-type door is closed, limit switch S1 is held open, and breaking either light beam turns on only the "opening" motor. When the

door is open, it opens limit switch S2, and the next interruption of either light beam starts only the "closing" motor. (A single reversing motor can also be used.)

Photoelectric controls

The basic control element is a simple photoelectric relay. Two of these units are required. Fig. 2 gives the circuit, and the layout is shown in Fig. 3 and Fig. 4. The chassis is 3½ x 5 x 1½ inches.

Low-sensitivity phototubes may be used. Mine are Cetron CE-1-D's (Cetron indicates sensitivity by the last letter in the type designation, the CE-1-D being less sensitive than the CE-1-C.)

The values of resistors R1, R2, and R3 in the voltage-divider network are not critical, as long as the proper ratios are maintained. These resistors hold the control anode of the OA4-G at a low voltage to keep it from firing when the phototube is conducting.

When the light beam is interrupted, the resistance of the phototube increases. The voltage across R2 and R3 rises enough to trigger the OA4-G and energize the relay. The plate relay, RY1, may have a resistance of 2,000 to 5,000 ohms. The 8-μf capacitor keeps the relay from chattering. R4 limits the peak current through the OA4-G, and may be from 250 to 1,000 ohms. To check the finished units plug them in and adjust sensitivity control R2 until

Fig. 4—Simplicity of the circuit is evident in this underchassis view of the photoelectric control.

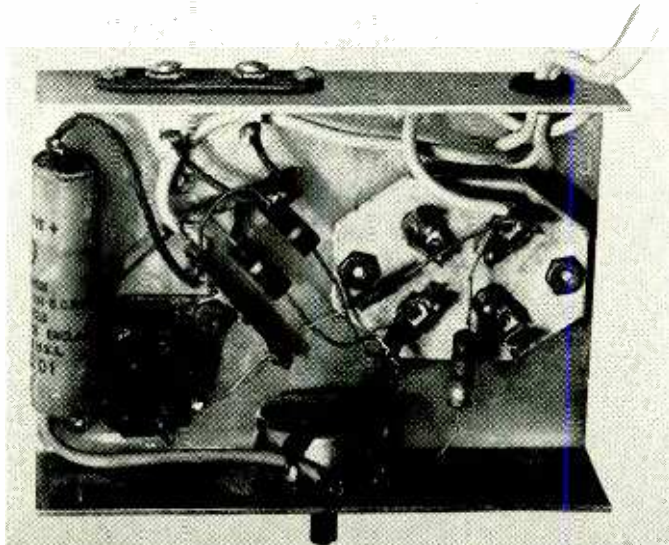

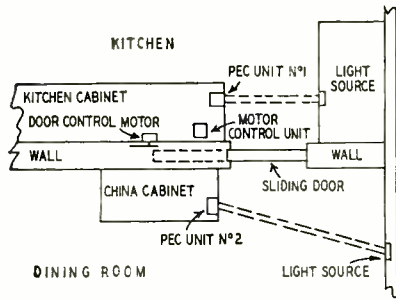

Fig. 5—One form of installation layout.

the 0A4-G ionizes. The glow should be steady and the relay should hold in without chattering. A beam of light on the phototube plate should cut off the control tube. Interrupting the beams should ionize the 0A4-G and pull the relay armature down.

If you cannot adjust R2 to ionize the 0A4-G, check all wiring. R1 may be too large for the phototube you are using. If the 0A4-G will not de-ionize at any setting of R2, increase R1. The photorelay units should be installed in cabinets if possible, with a 1-inch hole in the side to admit the light beam. Keep stray light off the tubes. If you must put the unit where random light can get at it, use a black cardboard shield or black paint on the 0A4-G as well as on the phototube. Leave a window on the phototube for the light beam to enter.

I used separate light sources, placed in the wall in the dining room, and in a convenient cabinet in the kitchen (see Fig. 5). They are auto bulbs fed by a 6.3-v filament transformer. The light source may also be mounted in the relay unit. A mirror reflects the beam back to the phototube.

Driving mechanisms

A sliding type door is easiest to control. Two small motors, or one reversible motor, may be used to pull it in and out of the wall. Swinging doors require relatively expensive solenoids to open and close them. Two motors cost about the same as one motor and a reversing relay. Small a.c. motors such as fan motors, will work fine. A single door, or twin doors going into either side may be controlled with pulleys and ordinary sash cord. Fig. 6 shows the circuit for using two small motors, one for opening and one for closing. The

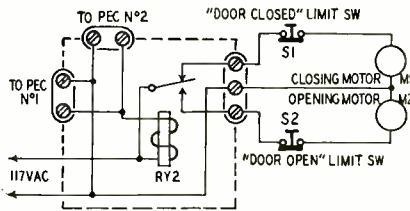

Fig. 6 (above)—Control circuit for two drive motors. Fig. 8 (right)—Two relays can be used to control a single drive motor with reversing winding.

two double terminals on the motor-control unit are tied to the relay contact terminals on the photorelay units.

Relay RY2 is a 110-volt ratchet type such as the Advance model 905. This relay was obtained as surplus, and may be hard to get. The Struthers-Dunn 85AXA (order direct from the manufacturer) can be used in its place. The limit switches are normally-closed microswitches, and are opened by the door as it reaches full open or full closed

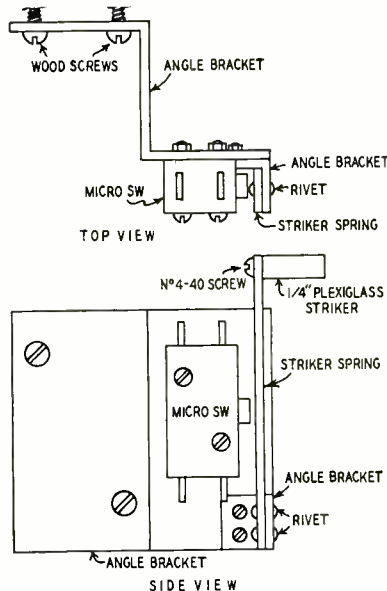
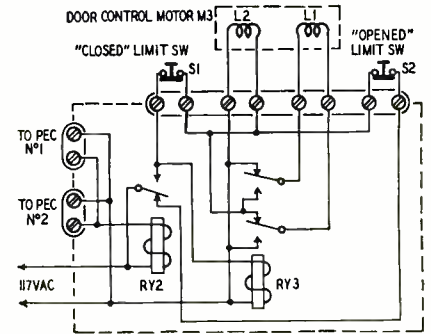

Fig. 7—Construction of limit switches. position. The striker springs may be made of spring brass or steel and assembled as shown in Fig. 7. When the door is closed, limit switch S1 is open. Power must be applied to motor M2 to open the door. When either light beam is broken, the coil circuit of RY2 is completed by one of the plate relays



(RY1) and RY2 turns on opening motor M2. When the door is fully open, it opens limit switch S2. This breaks the circuit to M2 and RY2 must again be energized to close the door. Final adjustment of the door-closing limit switch may be touchy, as the door should close tightly and still open the switch.

A control unit for a reversible motor is shown in Fig. 8. It is for the type of a.c. motor (M3) which is reversed by switching the phase of one of the two windings. Relay RY3 is a Guardian series 200 relay with a 110-volt coil and d.p.d.t. contacts. Operation is similar to the two-motor control unit except that the reversing relay RY3 is pulled in when the impulse-relay contacts are in the door-closing position, and power is applied to both windings in phase until the door is closed and S1 opens. This removes all power from the motor until RY2 is again energized by one of the PEC units and switches to the door-opening position. RY3 is not energized and winding L1 is out of phase with L2, reversing the motor. When the door is open, limit switch S2 removes power from the motor.

Fig. 9 illustrates the motor control unit I used. The motor and gear box are from a surplus antenna reel RL-42-A and operate from 24 volts d.c. I operate the motor on 12 volts from an old battery charger, and with the built-in gear box, the pulley speed is about 75 r.p.m. The motor has an electromagnetic clutch which disengages it from the gear box when power is removed. The pulley is 4½ inches in diameter. A s.p.s.t. switch across the photo-relay control terminals will let you operate the door manually for testing or in case the unit fails.

—end—

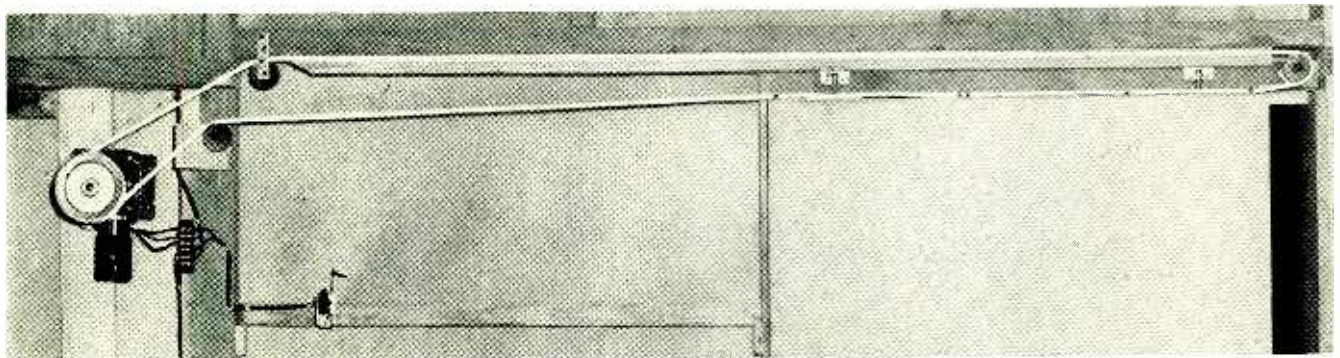
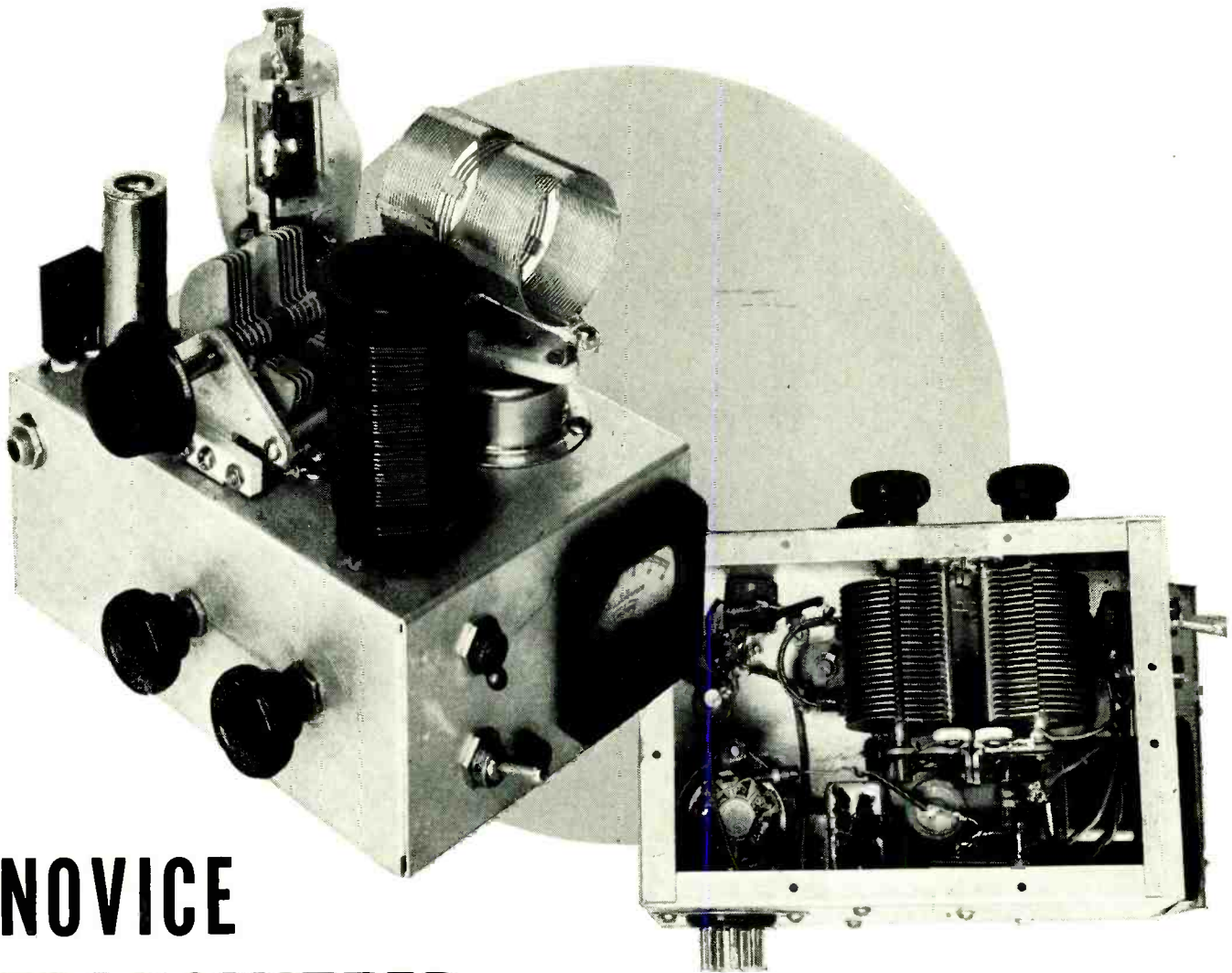

Fig. 9—Wall panels removed to show the sliding door, limit switch, and reversible drive motor with rope drive system.



NOVICE TRANSMITTER

An easy piece of equipment for the beginner to build, adjust and operate

By I. QUEEN, W2OUX

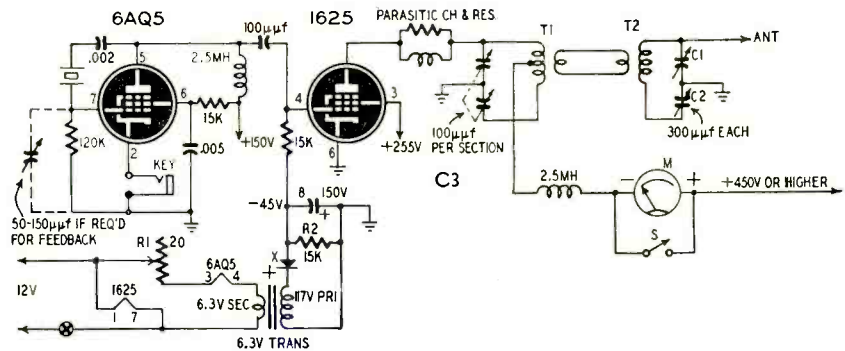

Fig. 1—The schematic. The 12-volt supply can be two 6-volt windings in series.

WE PLANNED this rig to meet the requirements most important to beginners. It features economy, efficiency, circuit protection, and future applicability. It is complete except for A and B power supplies and is built on a 3 x 5 x 7-inch aluminum chassis.

In spite of its small size, the rig includes an oscillator-amplifier circuit, a plate-current meter, antenna-matching

network, and split-stator tank tuning. These features are ordinarily omitted from a small set, but each is desirable and helpful, especially for novice operation.

The circuit is a 6AQ5 Pierce crystal oscillator driving a 1625 class-C final amplifier. (See Fig. 1.) An amplifier is far more efficient than an oscillator and provides high output without endangering the crystal. Like a single-

tube rig, this one has only one tuning control (exclusive of the antenna network). When the novice obtains his general license, the two-stage circuit will be suited for frequency multiplication to cover more bands.

No power supply is shown, as one already on hand may be adapted easily. The 1625 is a 12-volt-heater version of the popular and versatile 807. On the surplus market, you can buy several

1625's for less than the price of one new 807. This may mean buying a small (1/2 amp or more) 6-volt transformer to add in series with an available 6-volt transformer. However, many large power transformers have two separate 6-volt heater windings. Connect these filament windings in series with correct polarity. (Connect the heater of the 1625 across the two windings in series. If the tube fails to light, reverse the leads of one heater winding.) The final plate supply may be anything which will deliver from 400-750 volts, at 180 ma or more. Fig. 2 shows how easy it is to obtain the lower voltages needed for the 6AQ5 plate and screen, and the 1625 screen. The voltage regulation assures better stability even where the rig is crystal controlled. When a higher-class license is obtained, the regulated voltages will come in handy to supply a v.f.o. unit.

The transmitter includes its own C supply. This uses a 50-ma selenium rectifier and a small 6-volt filament transformer for isolation. The 6-v. winding, R1, and the 6AQ5 heater are in series across the 12-v. circuit. R1 is adjusted until the oscillator heater shows about 6 volts. Then about 2.5 volts will appear across the 6.3-v. winding transformer winding. The bias will be about 45 volts. If the bias is too low, increase R2. If too high, reduce this resistance.

This method of obtaining final bias is more efficient than a simple cathode bias resistor. The fixed bias completely blocks the final tube during key-up time. It pays off in power savings and longer tube life. The bias supply requires less space and wastes less power than a clamp tube arrangement. (If an 807 is

used instead of a 1625, the 6-volt winding of the bias transformer and R1 may be connected directly across the 6-volt heater circuit.—Editor)

The parasitic suppressor is made by winding 15 turns of No. 36 enameled wire over a 15,000-ohm 1/2-watt resistor.

The split-stator capacitor minimizes

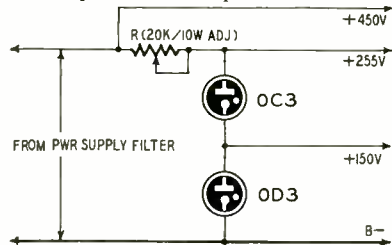

Fig. 2—Voltage divider also regulates.

harmonics. Link coupling between plate tank and antenna network reduces harmonics still further. The antenna network can feed any length antenna efficiently and also helps reduce harmonics. (Don't forget that harmonics of 3.7-3.75 mc do not fall within a ham band.) The antenna matching transformer (T2) is made by winding 30 turns of No. 20 enameled wire on a 1 1/2-inch diameter plug-in coil form. The turns should be spaced to cover a winding length of 2 1/4 inches. The link is two turns of the same wire wound 1/4-inch below the large winding.

If the transmitter is to be used with a dipole antenna, the antenna coupling network (T2, C1, and C2) may be omitted entirely.

Adjustments

If an inexperienced operator is to work the transmitter, it is a good idea

to check whether the final tunes to 7 as well as 3.5 mc. We found that both these bands could be resonated with a National (TMS-100D) capacitor and a standard 80-meter plug-in coil. We eliminated the higher band by shunting a 10-µuf fixed ceramic capacitor across the tank coil.

Tuning is easy enough to satisfy any novice. The oscillator needs no tuning at all. Plug in the proper crystal. Detune the antenna network by setting C1 and C2 to maximum capacitance. Plate current will be high until C3 is tuned to resonance. Tune for the dip. Now tune C1 for maximum current on the meter. For greater power output, reduce C2 and again tune to maximum current with C1. To reduce power, increase C2 and retune C1 for maximum reading.

The meter may be a 100- or 150-ma instrument. If its full-scale reading is lower, it should be shunted by a resistor. To protect the meter, a switch shorts it out when tuning is completed.

This transmitter has given a good account of itself in actual operation. It is used with a single-wire antenna 20 feet long and about 12 feet high.

Materials for Rig

- Resistors:** 3—15,000 ohms, 1—120,000 ohms, 1/2 watt; 1-20 ohms, 10-watts, rheostat; 1—20,000 ohms, 10-watt, adjustable.
- Capacitors:** (Ceramic) 1—10 µuf if needed (see text); 1—100 µuf, (Paper) 1—.002, 1—.005, 400 volts. (Air) 1—split stator variable, 100 µuf each section (C3) 2-300 µuf, variables (C1, C2). (Electrolytic) 1—3 µf, 150 volts.
- Inductors:** 2—2.5 mh r.f. chokes 1—80 meter plug-in coil center-tapped, with link; 6.3-volt transformer.
- Miscellaneous:** Tubes: 1—1625; 1—6AQ5; 1—6C3; 1—6D3; 2—5-pin sockets; 1—7-pin socket; 2—octal sockets; 1—7-pin miniature socket; 1—socket for crystal; 50-ma selenium rectifier; key jack; meter (0-100 or 0-150 ma); s.p.s.t. toggle switches; knobs; hookup wire; aluminum chassis, 3x5x7.

—end—

ALL-CHANNEL RECEIVER FOR WWV

WWV and WWVH are widely used as primary frequency standards and sources of accurate time signals. Since signal strength and readability depend on time of day, season, distance, etc., a multi-channel receiver is desirable. An

eight-channel pre-tuned receiver is shown for selecting any one of WWV's operating frequencies.

The coils are tuned by small trimmer capacitors mounted on the selector switch. Only five of the eight tuning

capacitors are shown in the antenna and oscillator circuits. A small 15-µuf trimmer may be mounted on the front panel and connected across the oscillator circuit to compensate for oscillator drift.

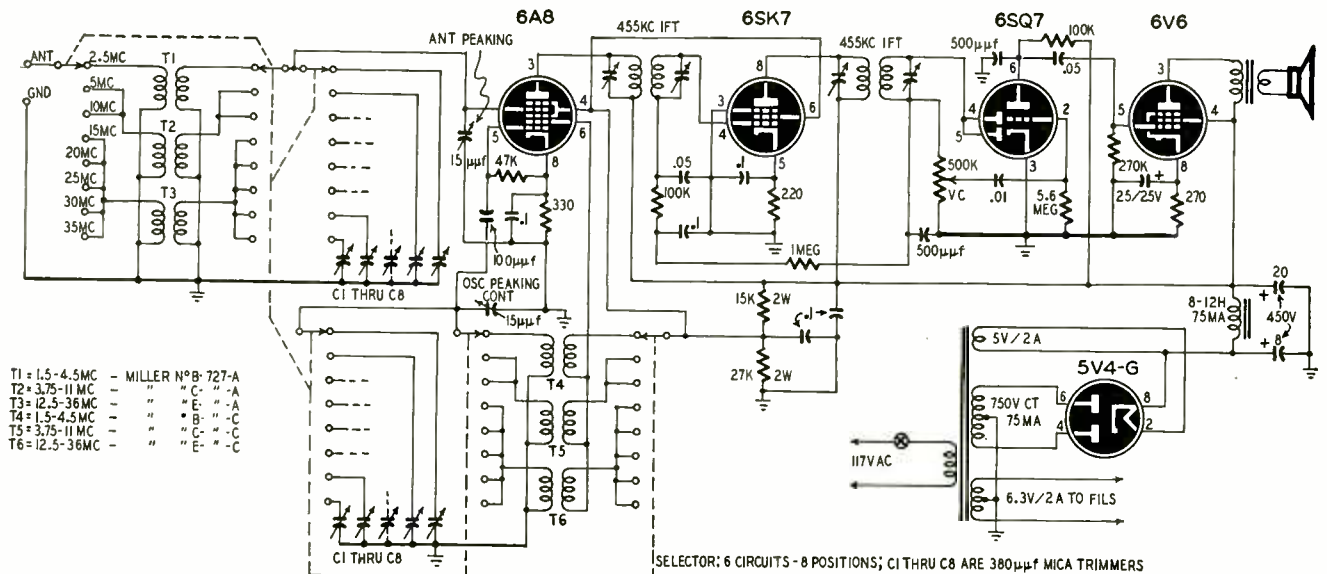

- T1 = 1.5-4.5MC - MILLER N°B-727-A
- T2 = 3.75-11 MC - " " " " -A
- T3 = 12.5-36 MC - " " " " -A
- T4 = 1.5-4.5MC - " " " " -C
- T5 = 3.75-11 MC - " " " " -C
- T6 = 12.5-36MC - " " " " -C

SELECTOR: 6 CIRCUITS - 8 POSITIONS; C1 THRU C8 ARE 380µf MICA TRIMMERS

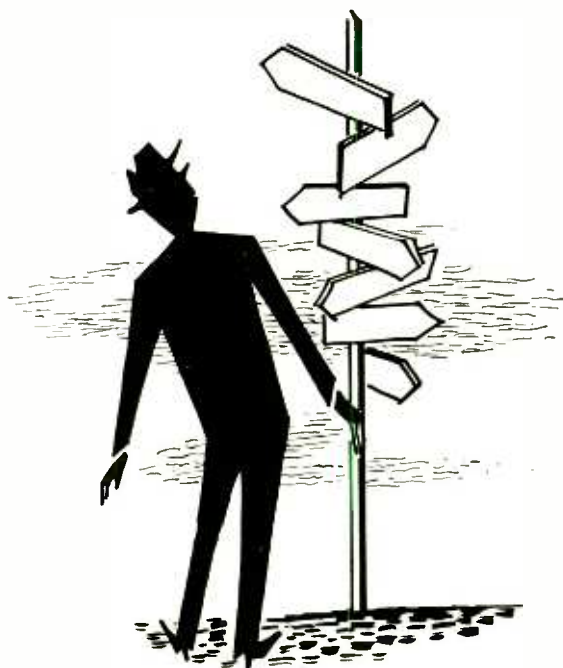

SELECTING THE RIGHT RADIO SCHOOL

By E. H. RIETZKE*

CONGRATULATIONS! The fact that you are reading this article tells us one of two things about you. Either (1) you have decided to enter a radio school, or (2) you are preparing wisely for the day when you will choose a school. In either event, you may look forward to the tremendous opportunities awaiting properly trained men in radio, television, and other electronic pursuits. Your future will be limited only by the extent of your ambition, initiative, and technical knowledge. This is the most rapidly expanding industry in America today. To properly trained men it offers almost unlimited opportunity.

Considering the career you have chosen, you are doubtless equipped with an "engineering" frame of mind. To some extent, you are probably scientific in your approach to problems. You carefully line up all the pros and cons. You match factor for factor, advantage for advantage. This attitude is very valuable to you when you set out to choose the right school.

First, what about yourself?

You must know what you have to offer the world of electronics, before you can determine what electronics can offer you, and what type of school is best for your needs.

Let's start with your schooling. Check yourself on the following subjects: (How much did you have, and what were your grades?)

Algebra	Manual Training
Chemistry	Mechanical Drawing
Electricity	Physics
Geometry	Trigonometry

If you did well in all or most of these subjects, and if you are a high-school graduate with sufficient credits, you should consider a full-fledged college of

engineering. Not every subject mentioned is required, but if you think you qualify, find out the entrance requirements of the school you have in mind. If you lack some subjects, the registrar can advise you how to qualify.

The same qualifications apply for high-level technical schools, except that your background in cultural subjects would not be important and actual practical experience in some phase of electronics often takes the place of a high-school diploma. Some technical schools offer the necessary preparatory courses in mathematics.

At less-advanced levels of training, the qualifications named above become less important. If you attended specialized schools in the service, it should be of great value. If you are a radio amateur, or have any other practical experience in radio, and can handle required assignments, you may be reasonably sure of success. But the better the school, the more stress it places on previous training. Don't approach any level of training without the necessary background.

If you are now in high school, ask your guidance counselor what courses you should take in preparation for further technical training.

Finally, your personal habits have much to do with the case. Can you discipline yourself, or do you find it difficult to set your mind to study? Remember, no "high roads," no magic words will put knowledge in your head and skills at your fingertips.

A word of warning: Do not prejudice yourself too harshly and count yourself out of a radio career too hastily. If you *want* it, half the battle is won. Communicate with, or visit the school and discuss what you have to offer with the registrar.

What type of school?

We are often asked: Shall I go to a

full 4-year engineering school, to a technical institute, or to a trade school? Shall I study at the school or at home?

If you want to be a full-fledged engineer, and if you have the required schooling, ability, and funds (anywhere from \$7,000 to \$10,000), seek admission to an accredited college of engineering.

Not everyone has the time, money, or desire for long-term college study. You may want to get into your chosen field as quickly as possible, in a really technical capacity. There are fine technical institutes offering residence advanced technical training, while omitting the cultural studies. (This does not mean that cultural pursuits are superfluous. If you choose concentrated training, round out your personality with broadening activities. Choose a school where you can devote spare time to music, art, theater, historical appreciation, and so on.)

Such a residence school may cost you from \$750 to \$1,400 for tuition alone, depending on how far you pursue your studies. Although such a school gets you into the market in less than 4 years (about 22 months on the average for the basic course), remember that the study period is continuous, and does not stop for summer vacations, so 22 months is the equivalent of about 3 years of college.

Graduates of good technical institutes usually enter industry as engineering aides. Many, by continued spare-time study and experience on the job, advance to the rank of full-fledged engineer.

If you are already in electronics or radio (or even in some other field) and cannot afford to give up your job for full-time schooling, consider a good correspondence school. Properly administered, correspondence (or home study) schools give you thorough training which takes effect in your work almost immediately. Furthermore, it is a

*Founder and President of Capitol Radio Engineering Institute.

wonderful opportunity to show your employer the interest and ambition you have. He can readily follow your progress, since most correspondence schools, if you wish, furnish progress reports to your employer. In correspondence training, you proceed as rapidly as you wish. You acquire the will-power training so useful in later life. You are your own master. If you invest your free time, you gain. If you hold back, you lose.

Another advantage of correspondence schools is the relatively small cost. A high-level technical home-study course may cost \$200 to \$400, depending, again, on how far you go.

You may not have the educational background for admission to an engineering college or a technical institute. However, because the field of electronics is so vast, there are opportunities for employment at all levels. There are good trade schools offering artisan-level courses, both in residence and by correspondence. The residence trade school offers the advantage of working with equipment while you study. Residence trade schools usually graduate you in less than a year, well-qualified for production assembly work and servicing relatively simple equipment under supervision. Since correspondence study is usually a spare-time activity, it takes longer to reach the same degree of skill. Correspondence schools offering beginners' courses supply kits of parts which give you experience in assembly, testing, and trouble shooting on comparatively simple equipment.

There may be a regular radio school, or a technical institute which offers night classes in your own community. Your city schools may offer trade courses on a basic level. Keep in mind the time and money you have available and the caliber of instruction required to help you attain the level you seek in electronics. You will command respect in industry in proportion to the level of your training and skills.

Now, you may ask, this is all very well, but how do I learn the level of the school I am considering? If you cannot get reliable information from radio-TV electronics people in your city, ask the school for a sample lesson. Though as a beginner, you might more easily understand an "introductory" lesson, you would find it rather unrevealing. Specify Lesson V, for example. Look it over, see if it is geared to your level. Check first before you find yourself enrolled in a course that is too elementary, or, on the other hand, too difficult.

How old is the school?

It is always wise to deal with an established organization. Given two schools equal in all other respects—it would be reasonable to select the older school, for it usually has established the close relations with industry so helpful in placing graduates. Its greater prestige will help you after graduation.

Faculty and facilities

A school stands or falls on the caliber of its teachers and its facilities. Carefully inspect the roster of faculty members listed in a school's catalog. Under each name should be his colleges attended, and his degrees attained. These, together with the indicated industrial experience, serve as a reliable guide. Supplement what you learn from the catalog with information from well-placed electronics people in your city. The chief engineer of a local radio or TV station is a good man to ask. So are other electronics experts. They are better prepared than you to judge some of the faculty and equipment claims in a catalog. Get their opinions on the modernity of the school's facilities and techniques. Is it constantly revising its curricula and equipment as new discoveries appear, or does it still operate as it did back in the days when it was founded, when radio was just a new miracle? If you visit the school, take a good look at its library. Is it large? Are its contents broad and up-to-date? This should not be underestimated.

The courses offered

Study the catalogs of several schools. A complete catalog should list and describe the courses offered. Do they cover the specific fields you are most interested in? Are the specific courses amply treated? What do you know about the caliber of the men who prepared them? Are the courses being constantly brought up-to-date in light of new developments? Will you get personal instruction? Are you permitted to proceed at your own rate of speed? Or are you grouped in heterogeneous classes? Some individuals work better on their own, others may prefer being grouped.

If you are choosing a correspondence school, find out how your lessons will be handled. Will your examination papers come back to you after careful individual servicing, with suggestions for improvement, explanations, advice? Or do they come back after a merely mechanical grading, leaving you still in the dark as to what you have accomplished in a specific lesson? Are the school's examinations sufficiently comprehensive to determine whether or not you really know the subjects studied?

Is school accredited? By whom?

There are educational and technical associations which make studies of schools, their faculties and facilities. For example, the Engineers' Council for Professional Development is the official accrediting agency for engineering colleges and technical institutes. Is the school accredited by E.C.P.D.? Or is it accredited by the National Council of Technical Schools? Or, if a correspondence school, by the National Home Study Council? These are the leading accrediting agencies in their fields.

If not, what groups have accredited the school in which you are interested? You cannot minimize accreditation. Accreditation is one of the most important factors in selecting a school, because it

is a major influence on the thinking of your prospective employer when he evaluates your educational and experience record.

What is industry's opinion?

In the last analysis, industry passes final judgment on the worth of a school in hiring its personnel. What can the school tell you about some of the firms which have hired its graduates? Is there further evidence available, such as the type and size of organizations which use the school's courses for the training of their own personnel?

What about employment aid?

A technical school should be able to offer concrete assistance in finding you employment after graduation. You should look for some form of guidance or placement service in the school's catalog or prospectus. Be wary, however, of wild promises of guaranteed jobs. Ethical schools do not make rash promises of any kind. No school can guarantee jobs to graduates, although at the present time the top schools have more demands for graduates than they can fill.

What about the school's location?

Is it well-situated in its city? Is it convenient to basic needs such as transit, entertainment, shopping, cultural activities (referred to above as so important)? Is it in a quiet area, conducive to undisturbed study? Is it convenient to radio stations and other electronic installations? Is housing readily available, and does the school offer you any assistance in finding housing?

What about tuition fees?

Are fees in line with your ability to pay and the quality of the training you will receive? Fees can be too low—that is, so low that the school cannot possibly offer you the quality of training that will make you really employable. Are extra fees clearly stated? (Books, laboratory fees, student activities, etc.) This should be clearly stated in the catalog.

To sum up

You are headed for a career in which scientific methods are vital, both in work and thought. Just as you apply known laws and principles to solving electronic, television, or radio problems, you should apply fixed rules and techniques in choosing the school which will provide you with thorough professional training. You want a career which will bring you lasting happiness, with financial return in line with your energy, ambition, and ability. Above all, remember that the expanding electronics industry is tremendously complex. No school can turn you out with a few easy lessons or in a few short weeks, truly competent to enter this industry with real hope of success. Get the very best education you can afford and take the time to do it right.

Good luck!

—end—

RECTIFYING without RECTIFIERS

New technique frees a.c. voltage measurements from the limitations of metallic rectifiers.

By H. B. CONANT*

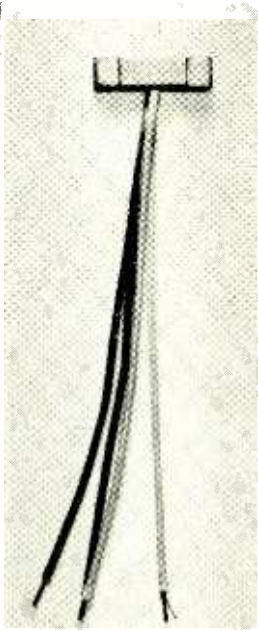

"Translator" assembly.

THE most widely used instrument for measuring low-frequency a.c. voltages is the type that combines a small metallic bridge rectifier and a d.c. meter movement. (See Fig. 1.) Its low cost, simplicity, compactness and ruggedness have made it popular for service instruments. It is used almost universally in broadcasting and sound recording to measure volume levels.

In spite of its advantages and wide range of applications it has two serious drawbacks: (1) The current through a metallic rectifier does not vary in di-

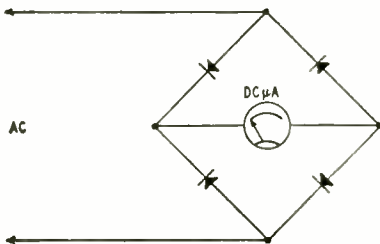

Fig. 1—Standard a.c. voltmeter circuit.

rect proportion to the applied voltage. In other words, the resistance of the rectifier does not follow Ohm's law. The relationship is logarithmic

($R \propto \frac{1}{\log E}$). At very low voltages the resistance of a metallic rectifier is so high that not enough current reaches the meter to give a readable indication. (2) At high audio frequencies the capacitance between the rectifier surfaces allows current to flow in both directions. This effect increases with frequency and makes this type of instrument useless for measuring r.f. voltages.

A third disadvantage, found in multi-range instruments, is also due to the nonlinear resistance of the rectifier.

For maximum accuracy, a separate scale calibration must be made for each range. This is impractical and confusing on service-type instruments, and compromise calibrations are generally used, with an accuracy of about 5%.

The Translator

A new circuit called a *Translator* overcomes these basic limitations. It uses metallic rectifier elements (or nonlinear resistance materials like Thyrite) in the bridge arrangement shown in Fig. 2.

R1, R2, R3, and R4 are the nonlinear elements. R5 is a current-limiting resistor of ordinary permanent-resistance type. Battery E supplies a bias current, and M is a d.c. milliammeter. R6 is a balancing potentiometer for setting the meter pointer to zero. The four bridge arms are closely matched.

The bias current flowing through R5 and the arms of the bridge develops a series of voltage drops in the circuit. With respect to point D, points A and B would have the same negative voltage, and point C would have twice the voltage of A and B. R6 is adjusted to the same voltage as C so that no current flows through the meter. If a.c. is applied across A and B the following ac-

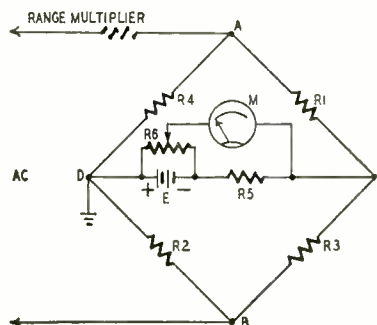

Fig. 2—"Translator"-type a.c. meter.

tion takes place: (See Fig. 3) During the first half-cycle the voltage at point A is increasing and the voltage at point B is decreasing. The resistance of nonlinear arms R1 and R2 decreases, while arms R3 and R4 increase. When point A reaches the same voltage as point D, the voltage at B will equal the voltage at C. At this instant no current can flow through R3 and R4, and these two arms are effectively eliminated from the circuit. The current path under these conditions is shown by the arrows in Fig. 3. The increased current through R1, R2, R5, and R6 changes the voltage at C and unbalances the meter.

As the voltage at point A continues to rise, potential differences again develop across R3 and R4, and their resistance decreases. Only part of the additional current drawn by R3 and R4 flows through the meter circuit. The meter reading increases logarithmically. (This characteristic is highly desirable for many applications. Ordinarily, logarithmic-scale instruments require specially-shaped magnets or complex circuitry.)

On the negative half-cycle the func-

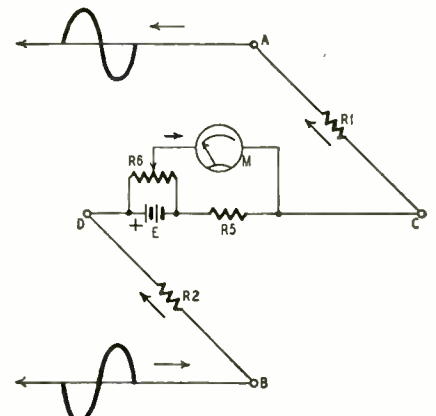

Fig. 3—Current paths in the circuit.

*President, Conant Laboratories.

tions of the opposite arms are reversed. The main current path is now through R3, R4, R5, and R6, but still in the original direction through the meter.

Higher bias current extends the low-voltage sensitivity of the circuit. (Increasing the bias current solely by reducing R5 will decrease the meter response by the greater shunting effect.) Reducing the bias current increases

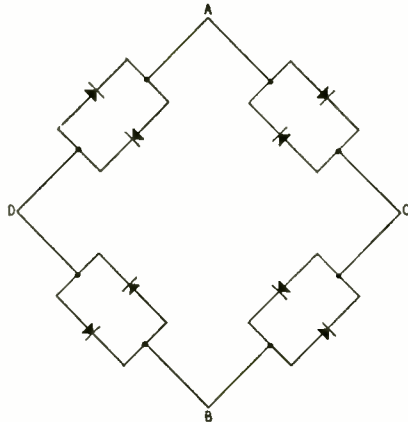

Fig. 4—A two-bridge translator.

the maximum voltage that can be read on any range, at the expense of low-voltage sensitivity.

Circuit variations

Both copper oxide and selenium rectifiers were tried in developing the translator circuit. With copper-oxide units, the low-voltage sensitivity was excellent. Slight instability in the selenium rectifiers caused some drift in readings.

The question of whether or not rectifying action was involved in translator operation was settled by constructing a bridge of nonrectifying Thyrite resistors (G.E. No. 8396839G1). Aside from requiring a higher bias voltage, the Thyrite bridge performed very well, although it was not as sensitive to very low voltages as the copper-oxide bridge.

A translator can be made by connecting two full-wave bridge rectifiers as shown in Fig. 4. An assembled unit is shown on the opposite page.

The frequency response of the translator appears to be perfectly flat up to 20 kc. While conventional rectifier-type instruments indicate the average value of the a.c. voltage, there is some indica-

tion that the translator shows r.m.s. voltages.

Like rectifier-type instruments, the translator does not have uniform scales

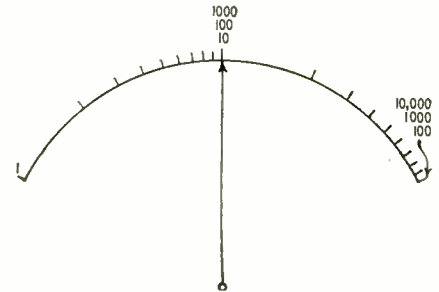

Fig. 5—Logarithmic scale calibration.

on all voltage ranges. The scale uniformity and accuracy are improved by using a different value for R5 as well as a different multiplier on each range.

Logarithmic scale calibration makes it possible to read low and high voltages accurately on a single range. (See Fig. 5.) With the translator circuit an instrument covering 0-10,000 volts in only three ranges can be built without difficulty.

—end—

TRANSISTOR PRODUCTION AT ALL-TIME HIGH LEVEL

The transistor has emerged from the laboratory to become a full-fledged production item. According to reports made at the Symposium on Progress in Quality Electronic Components held in Washington early in May, nearly 8,500 transistors were being produced monthly. Six companies were actually producing transistors in commercial quantities, and two others expected to be ready to manufacture in appreciable quantities within a few months.

Western Electric, with 6,000 transistors per month, was producing the bulk of the output. Raytheon followed with 1,000 per month, with General Electric and RCA making 800 and 400 respectively. RCA expected to up its output to between 2,000 and 3,000 per month by the end of the year, and other companies indicated that sharp increases in production were expected, though the exact quantity to be produced would depend on orders received.

Practically all the transistors now being manufactured or slated for immediate future production are of the contact type. Only Western Electric reported manufacture of junction transistors—on an experimental basis only, with an output of less than 100 per month.

Military procurement accounts for 6,000 transistors per month; the output of Western Electric being allocated as a result of an arrangement between the military departments and the company.

The limited production still hampers widespread use of the transistor, as a manufacturer would be unable to take a contract for equipment requiring a couple of thousand transistors unless

he could obtain the whole unallocated output of the country for a month, or large fractions of it over a proportionally longer time. Price is the other barrier to wider use. The units are listed in mail order catalogs today at \$18 each. Presumably those sold in larger quantities are somewhat—but not greatly—cheaper. At a price so much greater than the vacuum tube,

the transistor becomes practical only when extreme miniaturization or other special necessity disqualifies the tube for the application.

The table below, abstracted from a paper presented by Lt. Colonel W. F. Starr at the Washington symposium, shows the present situation in transistor production.

—end—

AVAILABILITY OF TRANSISTORS

COMPANY	MONTHLY PRODUCTION		DELIVERY TIME		REMARKS
	CONTACT	JUNCTION	CONTACT	JUNCTION	
Federated Semi-Conductor Co., New York, N. Y.	Sample lots available in May, 1952
General Electric Syracuse, N. Y.	800	...	6-8 wks.	Not quoting	Sample lots Junction type Oct.-Nov. 1952
Kemtron Salem, Mass.	Sample lots Point contact Sept. 1952
RCA Harrison, N. J.	400	...	4-6 wks.	...	Sample lots Junction type Oct.-Dec. 1952
Radio Receptor New York, N. Y.	200	...	4-8 wks.	...	
Raytheon Newton, Mass.	1,000	...	4 wks.	Not quoting	Sample lots Junction type Nov.-Dec. 1952
Sylvania Boston, Mass.	Sample lots Point contact Aug. 1952
Western Electric New York, N. Y.	6,000	Less than 100	4-8 wks.	Not quoting	



Learn RADIO TELEVISION

**-New Package Unit Plan- PAY AS YOU LEARN
NO MONTHLY PAYMENT CONTRACT TO SIGN!**

**I Send You
18 BIG
KITS
OF RADIO-
TELEVISION
EQUIPMENT**

**TRAIN IN 10 MONTHS OR LESS
At Home in Your Spare Hours**

Now . . . be ready for Radio-Television's big pay opportunities in a few short MONTHS! Frank L. Sprayberry's completely new "Package" training unit plan prepares you in just 10 MONTHS . . . or even less! Equally important, there is NO monthly payment contract to sign . . . thus NO RISK to you! This is America's finest, most complete, practical training—gets you ready to handle any practical job in the booming Radio-Television industry. In just 10 months you may start your own profitable Radio-Television shop . . . or accept a good paying job in this fascinating expanding field at work you've always wanted to do. Mr. Sprayberry has trained hundreds of successful Radio-Television technicians—and stands ready to train you in less than one year, even if you have no previous experience. You learn by DOING . . . actually working with your hands with equipment of special design to illustrate basic theory instead of relying on books alone.

VALUABLE EQUIPMENT INCLUDED WITH TRAINING

The new Sprayberry "package" plan includes many big kits of genuine, professional Radio-Television equipment. While training you actually perform over 300 demonstrations, experiments and construction projects. In addition, you build a powerful 6-tube standard and short wave radio set, a multi-range test meter, a signal generator, signal tracer, many other projects. All equipment is yours to keep . . . you have practically everything you need to set up your own service shop. The interesting Sprayberry book-bound lessons and other training materials . . . all are yours to keep.

EARN EXTRA MONEY WHILE YOU LEARN!

All your 10 months of training is AT YOUR HOME in spare hours. Keep on with your present job and income while learning . . . and earn EXTRA CASH in addition. With each training "package" unit, you receive extra plans and ideas for spare time Radio-Television jobs. Many students pay for their entire training this way. You get priceless practical experience and earn generous service fees from grateful customers. Just one more reason why the Sprayberry new 10 MONTH-OR-LESS training plan is the best Radio-Television training in America today. If you expect to be in the armed forces later, there is no better preparation than good Radio-Television training.

FREE 3 BIG RADIO-TELEVISION BOOKS

I want you to have ALL the facts about my new 10-MONTH Radio-Television Training—without cost! Act now! Rush the coupon for my three big Radio-Television books: "How to Make Money in Radio-Television," PLUS my new illustrated Television Bulletin PLUS an actual sample Sprayberry Lesson—all FREE with my compliments. No obligation and no salesman will call on you. Send the coupon in an envelope or paste on back of post card. I will rush all three books at once!

SPRAYBERRY ACADEMY OF RADIO
Dept. 20-L, 111 N. Canal St., Chicago 6, Ill.

**APPROVED
FOR VETERANS
UNDER THE
G.I. BILL.**



**IF YOU ARE
EXPERIENCED IN RADIO**

Men already in Radio who seek a short intensive 100% TELEVISION Training with FULL EQUIPMENT INCLUDED are invited to check and mail the coupon at the right.

**Mail
Coupon
Today!**

**NO OBLIGATION
No Salesman
Will Call**

**SPRAYBERRY ACADEMY OF RADIO, Dept. 20-L
111 North Canal St., Chicago 6, Ill.**

Please rush to me all information on your 10-MONTH Radio-Television Training Plan. I understand this does not obligate me and that no salesman will call upon me.

Name..... Age.....

Address.....

City..... Zone..... State.....

Please check Below About Your Experience

Are You Experienced? No Experience



MODEL 680
RF Marker and Crystal Calibrator. Magic-eye provides greatest accuracy \$129.50



MODEL 610A
TV Alignment Generator with strong harmonic output to 900 megacycles for UHF . . . \$219.00

Your need in UHF servicing is an accurate overall response curve through the UHF converter-TV receiver front-end and IF circuits. The HICKOK 680-610A Television combination provides all this. Strong, 610A signals provide clean, sharp IF curve. Strong harmonic signals from the 680 provide clean, sharp marker pips. Engineered by specialists . . . for expert TV technicians. Write today for the new HICKOK Catalog No. 27.

THE HICKOK ELECTRICAL INSTRUMENT CO.
10531 Dupont Avenue • Cleveland 8, Ohio

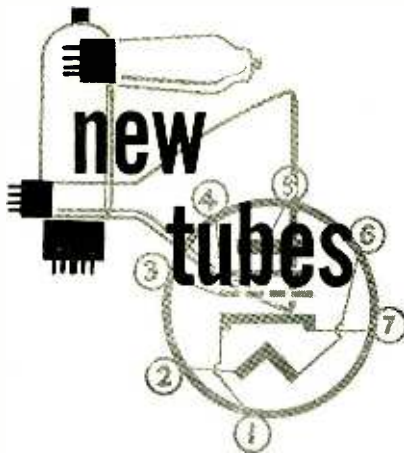

The 1AX2, incorporating several improvements over the 1X2 and 1X2A, has been announced by CBS-Hytron. A heavier filament, reduced interelectrode capacitance, and higher voltage ratings give better regulation and meet the load demands of new large-screen picture tubes. Filament rating is 1.4 v at 650 ma; peak inverse plate voltage 25,000 max.; d.c. load current 1 ma max. Basing is shown in the accompanying diagram.

G-E has developed the 6AM4, a nine-pin miniature grounded-grid triode mixer for u.h.f.-v.h.f. TV receivers. It has a conversion gain of approximately 4 at 900 mc. Average characteristics of the 6AM4 are: Plate volts, 150; plate current, 7.5 ma; amplification factor, 90; transconductance, 9,600 micromhos; cathode resistor, 100 ohms.

Both G-E and RCA are producing the 6AF4 7-pin miniature triode oscillator for u.h.f. TV converter service. Silver-plated base pins and double connections for both plate and grid reduce losses and enable the 6AF4 to be used up to 1,000 mc. The following ratings are for operation at 950 mc: Plate voltage, 100; grid voltage (from a 10,000-ohm grid resistor)—4; plate cur-

rent, 22 ma; grid current (approx), 400 μ a; useful power output, 160 mw. Base connections are given in the accompanying diagram.

Three new 6.3-volt heater-cathode subminiature types have been introduced by Raytheon. All are designed to withstand severe shock and vibration. Type CK6111 is a medium-mu twin-triode for u.h.f. service. Typical operating conditions for each triode unit: Heater current, 0.3 amp; plate voltage, 100; cathode resistor, 220 ohms; transconductance, 4,750 micromhos; amplification factor, 20; plate current, 8.5 ma.

Type CK6112 is a high-mu twin triode with each unit rated as follows: Heater current, 0.3 amp; plate voltage, 100; cathode resistor, 1,500 ohms; transconductance, 1,800 micromhos; amplification factor, 70; plate current, 0.8 ma.

Type CK6152 is a single u.h.f. triode with the following average ratings: Heater current, 0.2 amp; plate voltage, 200; cathode resistor, 680 ohms; transconductance, 4,000 micromhos; amplification factor, 15.5; plate current, 12.5 ma.

The three types have wire leads which may be trimmed to fit subminiature sockets. Connections are given in the accompanying basing figure. Their life expectancy at 30° C ambient temperature is 5,000 hours.

Special purpose types

Raytheon has announced a contact transistor, type CK716, for amplifier or switching applications. The CK716 has the following characteristics in ground-base operation: Collector current, 2.5 ma; emitter current, 1 ma; collector voltage, -15; emitter voltage, 0.5; current amplification (minimum), 1.2; frequency response, 1 kc to 100 kc

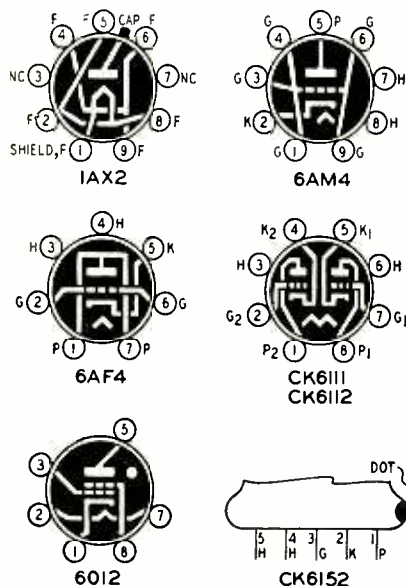

Basing diagrams of some of the recent tube types described in this article.

A Guiding Beacon For
Quality Electronic Parts

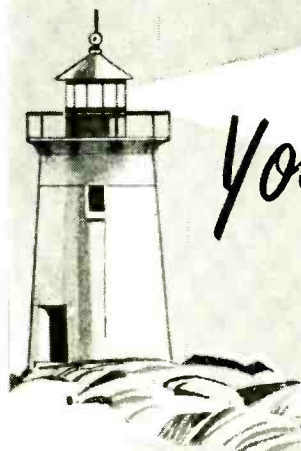

Your Local
RADIART
Distributor

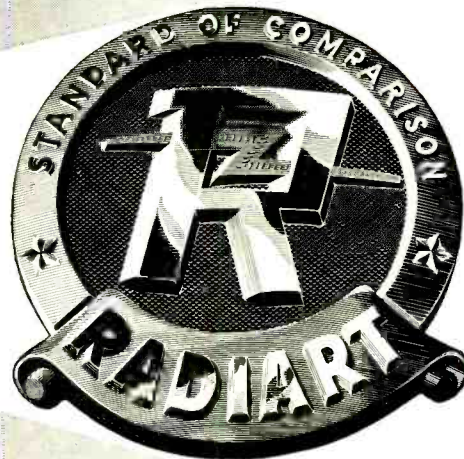

RADIART Sales Offices Across The Nation



These Are The Cities With RADIART Distributors
In Colorado, Montana, Nebraska, New Mexico,
Texas, Utah and Wyoming

COLORADO

- COLORADO SPRINGS
- DENVER
- PUEBLO

MONTANA

- BILLINGS

NEBRASKA

- SCOTTSDUFF

NEW MEXICO

- ALBUQUERQUE
- ROSWELL
- SANTA FE

TEXAS

- EL PASO

UTAH

- OGDEN
- SALT LAKE CITY

WYOMING

- CHEYENNE
- SHERIDAN

BUY OF THE MONTH



RADIART TV SIGNAL AMPLIFIER

☆ Here's the power BOOST needed to get the most from any TV set. Some of its many features are: — low-signal-to-noise ratio for less "snowy" pictures — wide band amplification for sharp pictures free from "smear" — complete neutralization for stable operation — and a handsome cabinet. See them at your jobber — or write for literature.

**FOR NAME OF YOUR NEAREST RADIART DISTRIBUTOR
USE COUPON BELOW**

RADIART SALES CO. 5528 E. Colfax Ave., Denver, Colorado

..... Please send names of the Radiart Distributors in my area stocking the following Radiart products in which I am interested: CDR-Rotors, Vibrators, TV and FM Antennas, "Spee-Dee" Chimney Mounts, Lightning Arresters, Auto Aerials, Power Supplies

..... Please have a Radiart Distributor call on me.

Name

Address

City..... State.....



THE RADIART CORPORATION CLEVELAND 2, OHIO

VIBRATORS • AUTO AERIALS • TV ANTENNAS • ROTATORS • POWER SUPPLIES

10,000,000 Waiting to be SOLD!



**Perma-Power
TV TUBE
BRITENER**



* Over 10,000,000 television sets were purchased prior to 1951. Each of these has a picture tube which is getting dimmer. 10,000,000 set owners need the "TV TUBE BRITENER."

- Prolongs tube brilliance; fully automatic
- Isolates filament; relieves cathode filament shorts
- Eliminates nuisance calls
- Protects tube guarantee
- Made to sell; packaged to sell
- Producing sales everywhere



"TV TUBE BRITENER" was designed by engineers to produce sales for television servicemen. Adds brilliance to any picture tube; extends useful life of tube for year or more; adaptable for all tubes with duodecal base. Write for complete, illustrated literature. SOLD through recognized wholesalers ONLY. ORDER TODAY!

Perma-Power COMPANY

4721 N. Damen Ave., Chicago 25, Ill.

"Manufacturers of electronic equipment since 1928"

within 3 db. The CK716 is enclosed in a small brass shell which forms the base connection. Emitter and collector connections are made to nickel pins which fit a Cinch Exp. 8749 socket or equivalent.

RCA has developed the 6012 hot-cathode thyatron for 60-cycle motor-control and low-power inverter service. Button-stem design gives the 6012 high resistance to shock and vibration, and reduces susceptibility to electrolysis. The 6012 can handle an average load current of 0.5 amp. Socket connections are given in the basing diagram.

A new RCA transmitting tetrode for u.h.f. TV, type 6181, is capable of 1,200 watts sync-level output at 900 mc. The 6181 features coaxial-electrode construction, ceramic-bushing insulation, and an integral radiator for forced-air cooling.

—end—

FREE ELECTRONS SERVE SCIENCE IN NEW WAYS

The Lenard ray, discovered in 1896, is finding new applications in the laboratories of General Electric and other leading research institutions. Electrons, accelerated practically to the speed of light, are allowed to bombard living tissue, biological specimens, and other materials.

Decay-causing molds and microorganisms are destroyed by the beam, indicating possible food preservation without refrigeration, and sterilization of substances such as blood plasma without destructive heating.

Formation of solid plastics from liquid bases through chain-reaction polymerization set off by high-speed electrons is also foreseen.

Deep-seated malignancies and tumors might be treated with less danger by this method, according to Dr. C. G. Suits, G-E director of research.



Common sawdust was converted to digestible cellulose cattle food by bombardment. The photograph shows Elliott J. Lawton of the G-E Research Laboratory placing a specimen in a lead-shielded chamber for bombardment by electrons at an acceleration of 70,000,000 volts.

Fill your parts requirements from a single dependable source

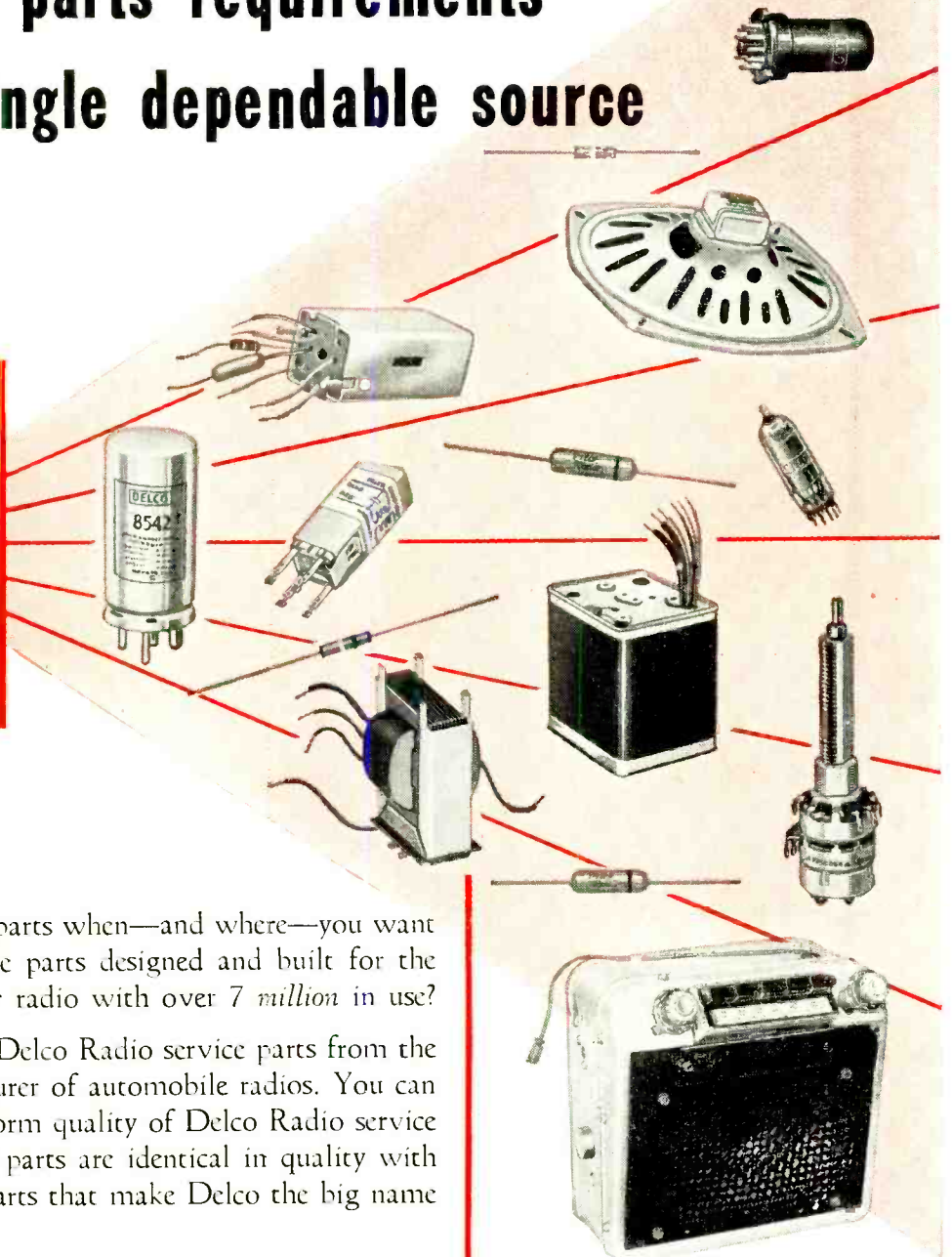

Want *good* radio service parts when—and where—you want them? Want radio service parts designed and built for the world's most popular car radio with over 7 million in use?

If you do . . . you want Delco Radio service parts from the world's largest manufacturer of automobile radios. You can depend on the high, uniform quality of Delco Radio service parts. These replacement parts are identical in quality with the original equipment parts that make Delco the big name in car radios.

Both Delco Radio original equipment and universal service parts are available promptly through United Motors wholesalers.

DELCO RADIO PARTS

A GENERAL MOTORS PRODUCT   A UNITED MOTORS LINE

DISTRIBUTED BY WHOLESALERS EVERYWHERE

DELCO RADIO

DIVISION OF GENERAL MOTORS CORPORATION
KOKOMO, INDIANA

THINGS TO REMEMBER ABOUT DELCO RADIO SERVICE PARTS

- 1 Offer largest market for original-equipment replacement parts.
- 2 Backed by world's largest factory devoted exclusively to automobile radios.
- 3 Designed by one of the largest and most forward-looking engineering groups devoted exclusively to automotive radio.

AMPHENOL
-INLINE*
ANTENNA

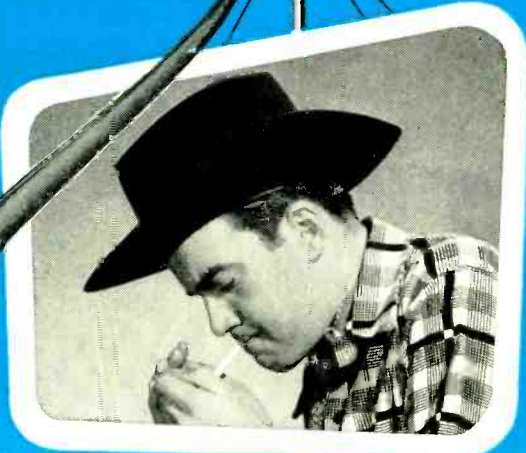

a better picture
with the Amphenol Inline Antenna

Because the Amphenol Inline Antenna operates on a fundamental frequency in both the high and low bands, you get the same steady, uninterrupted picture from channels 2 through 13. Designed by antenna specialists, the Amphenol Inline has consistently proved its superiority through four years of use in the highly competitive television field. The single forward receiving lobe of this broadband antenna literally probes the sky to return with the signal you want, uninfluenced by side radiations and reflected signals.

and the Amphenol Tubular Twin-Lead

Over and over again, the Amphenol Tubular Twin-Lead has been established as the one satisfactory answer to the need for an economical TV lead-in for use in those trouble areas where conventional twin-lead cannot be used. The tubular construction of high grade polyethylene provides a protected area, using air as the dielectric, between the conductors. This provides low-loss and constant impedance at all times, unaffected by any exterior condition.

This book contains . . .

a complete, yet condensed evaluation of the various types of antennas on the market today, graphs and illustrations clarifying their various characteristics, and information on the use of rotators, lightning arresters, etc. Obtain your free copy from your Authorized Amphenol Distributor.

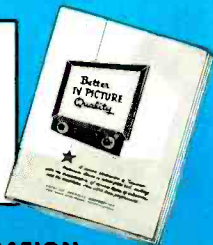

AMPHENOL

AMERICAN PHENOLIC CORPORATION
 1830 SOUTH 54TH AVENUE • CHICAGO 30, ILLINOIS

New Devices

SCOPE TEST PROBES

Scala Radio Co., 2814 19th St., San Francisco 10, Calif., is producing three oscilloscope probe types for radio-TV service applications. Type BZ-1 is a detector probe for signal tracing in video, i.f., and tuner stages at frequen-



cies up to 225 mc. Type BZ-2 is a low-capacitance isolating probe for use in high-impedance circuits. Type BZ-3 is a 100 to 1 voltage-divider probe for observing high-amplitude pulses in horizontal-output and damper circuits.

TV BOOSTER

Turner Company, Cedar Rapids, Iowa, has developed a new TV booster. Model TV-2 combines the cascade circuit with single-knob continuous tuning over TV channels 2 through 13. A three-way switch controls power to the receiver and booster, and allows the receiver to be used alone. The TV-2 input cir-



cuit matches either 72-ohm or 300-ohm transmission line, and is supplied with a 300-ohm ribbon output lead for direct connection to the receiver antenna terminals. The booster is housed in a mahogany-finished plastic cabinet.

HEAVY 300-OHM LINE

Plastoid Corp., 42-61 24th St., Long Island City, N. Y., is producing Synkote heavy 300-ohm ribbon line for TV installations. The new lead-in is 0.1 inch thick, with leads deeply im-



bedded in polyethylene or Dupont Alathon insulation to withstand friction, bending, and weathering.

CATHODE-RAY TUBE TESTER-REACTIVATOR

Electronic Beam Corp., 923 Old Nepperhan Ave., Yonkers 3, N. Y., has introduced the EBCO cathode-ray tube checker-reactivator. This instrument is used to check picture tubes for shorts,

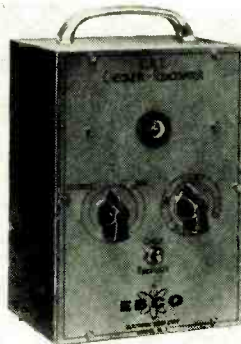

cathode emission and leakage, without removal from the receiver or shipping carton. Picture tubes may also be reactivated in the set. The unit is self-contained and operates on 117 volts a. c.

HIGH-FIDELITY

The Radio Craftsmen, 4401 N. Ravenswood Ave., Chicago 40, Ill., are producing a new 10-watt, high-fidelity amplifier for custom installations. The Craftsmen 400 uses a direct-coupled split-load phase inverter driving push-

pull 6V6's. Power output is 10 watts within 1 db from 15 cycles to 20 kc; total harmonic distortion is less than 1% and inter-modulation distortion is less than 5% at 10 watts output. Overall frequency response is 10 cycles to 30 kc within 1 db, at 1/2 watt output. Hum and noise are 70 db below rated output. Output impedances are 4, 8, and 16 ohms. Inverse feedback of 13 1/2 db around the entire amplifier gives a damping factor of 4 to 1. This is



equivalent to an internal impedance of 2 ohms at the 8-ohm output tap. The amplifier is 14 inches long, 4 1/2 inches wide, and 5 1/4 inches high.

INDOOR ANTENNA

RMS Inc., 1165 Southern Blvd., New York 59, N. Y., has introduced an improved telescoping indoor antenna. The base of the new model T-3 has been specially shaped and weighted to pre-

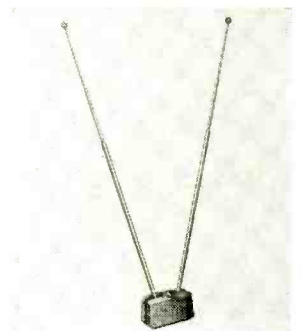

vent accidental tip-over. New phosphor bronze springs assure positive contact between the corrosion-proof aluminum-alloy elements. Internal reinforcements reduce sagging.

TIME-DELAY RELAYS

Amperite Company, Inc., 561 Broadway, New York 12, N. Y., is now producing thermal time-delay relays in standard T-6 1/2 9-pin miniature bulbs. Time delays from 2 to 90 seconds are available. Heater elements can be supplied for all standard voltages, such

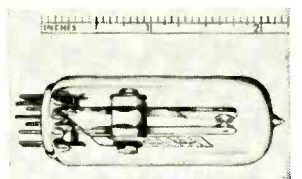

as 6.3, 26, and 117. Heater consumption is approximately 2 watts. The relays are hermetically sealed, and are not affected by altitude, climatic conditions, or vibration. They are compensated for operation in ambient temperatures of minus 50 to plus 70 degrees Centigrade. Contact rating is 115 v, 2 amp, a. c.

A.F. GENERATOR

Precise Development Corp., Oceanside, N. Y., has released its model 635 universal audio waveform generator. A Wien-bridge oscillator produces sine waves covering 20 cycles to 200 kc in 5





10 ELEMENT YAGI

illustrated: JFD No. 10Y2S-10Y6S Low Band Stacked Baline Yagi

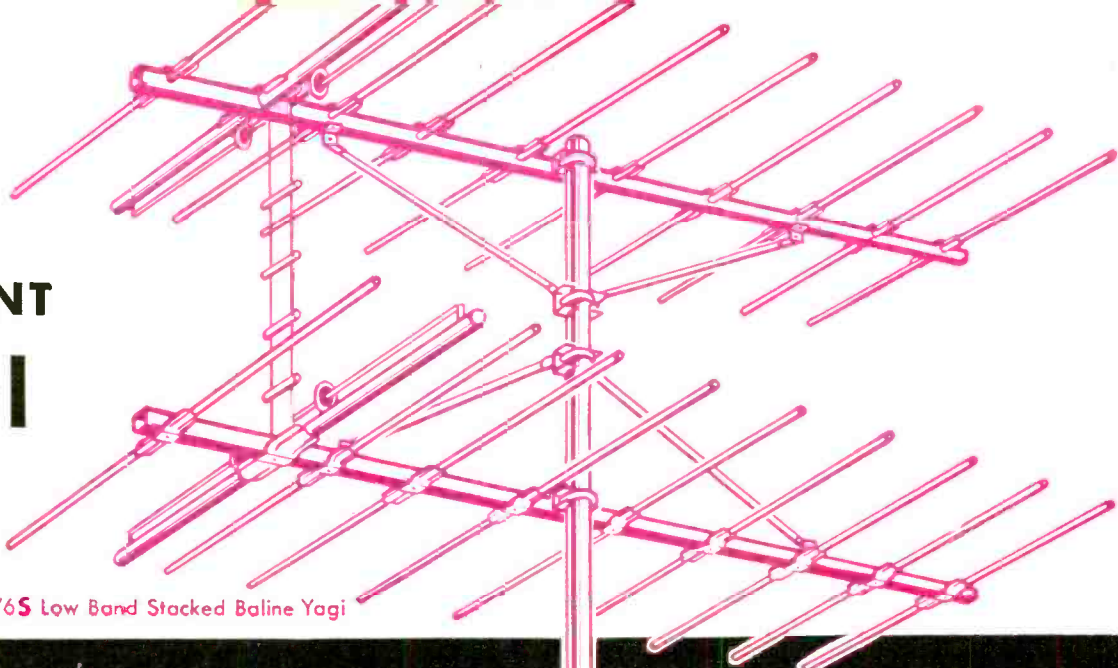

FACTS... not fairy tales

**Performance
is your proof!**

* These figures have been verified by the Hazeltine Corporation, world famous research laboratory. All JFD gain figures are based on a reference folded dipole. Beware of exorbitant gain figures which are not based on any reference level.

It's the GREATEST Yagi Value On the Market!

- Precision-spaced 10-element design packs tremendous signal strength into set. More gain than any 5, 8 or 10-element Yagi in case.
- Unique JFD Baline Impedance Matching Transformers guarantee absolute 300 ohm match in stacking.
- No charge for Baline Matching Transformers... they are free!
- Pre-assembled all-aluminum construction with seamless 1" od aluminum crossarm... not steel.
- One-piece "Quik-Pivot" element design slashes assembly time to seconds on high band only.
- 1 inch square heavy wall aluminum crossarm imparts extraordinary strength and rigidity to construction of low band Baline.
- 12 inch boom jointer speeds and simplifies assembly of 2-piece crossarm on low band.
- Y-type boom support prevents antenna sway, maintains steady non-flickering picture. (low band only) Supports 2/3 of boom length.
- One-piece high band aluminum boom.

Write for form No. 1a3 for full information.

Single JFD High Band BALINE Yagis

Channels	Models	List Price
7-13	10Y7-10Y13	\$13.35

Stacked JFD BALINE Yagis

Channels	Models	List Price
2	10Y2S	} \$63.70
3	10Y3S	
4	10Y4S	} \$3.90
5	10Y5S	
5	10Y6S	51.40
7-13	10Y7S-10Y13S	27.70

Include JFD Baline matching Transformers at no extra charge

Single JFD Low-Band BALINE Yagis

Channels	Models	List Price
2	10Y2	} \$1.85
3	10Y3	
4	10Y4	} 28.45
5	10Y5	
6	10Y6	25.70

10 db* (gain of stacked JFD BALINE over a tuned folded dipole)
7 1/2 db* (gain of single JFD BALINE over a tuned folded dipole)

Best 300 ohm match Yagis ever developed single or stacked

actual field tests prove it!

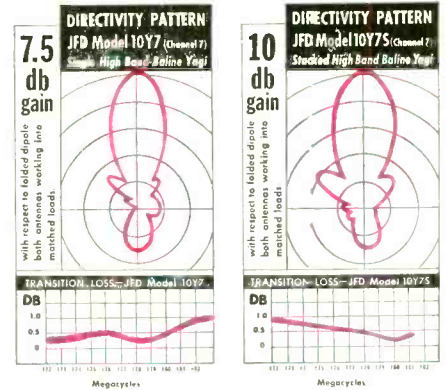

Gain and impedance matching characteristics, tested and attested to by the Hazeltine Corporation, leading electronic research laboratory.



JFD MFG. CO.
BROOKLYN 4
BENSONHURST 6-9200

world's largest manufacturers of TV antennas

ranges. Square waves with minimum overshoot and round-off are available to over 50 kc. Pulse output is available at all frequencies for triggering or re-shaping to any desired wave form. The model 635 features a voltage-regulated power supply, cathode-follower output at four impedance levels, coaxial connectors, illuminated drum dial, and complete shielding.

TESTER-REACTIVATOR

Radio City Products Co., Inc., 152 West 25th St., New York 1, N. Y., has introduced its model 808 combination radio and TV-tube tester-reactivator and v.t.v.m. Model 808 has a burnout-proof meter and tests all standard, miniature, subminiature, and magnetic-deflection cathode-ray tubes. Spare lever switches and blank sockets provide for future types. The reactivator circuit may be used for picture tubes or receiving types.

The balanced-bridge-type v.t.v.m. has an input resistance of 25 megohms, and 17 a.c., d.c., and resistance ranges, including a zero-center scale for discriminator alignment. A multiplier probe is available separately for extending the v.t.v.m. range to 30 000 volts.

Model 808 is 12 1/2 x 12 3/4 x 4 3/4 inches and weighs 12 1/2 lbs.

IMPROVED BRIDGE

Simpson Electric Co., 5200 West Kinzie, Chicago, Ill., has redesigned its model 381 capacitance bridge for greater compactness and ease of application.

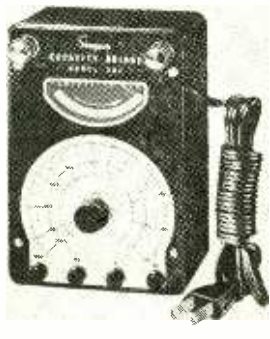

Simplified range selection, with direct correlation between each range button and its associated scale is combined with a high-visibility balance indicator in a pocket-sized bokelite case.

CHANNEL AMPLIFIERS

Blonder-Tongue Laboratories, 38 North Second Avenue, Mount Vernon, N. Y., has announced new TV mixer-amplifier units for master-antenna installations. Mixer-amplifier model MA4-I con-

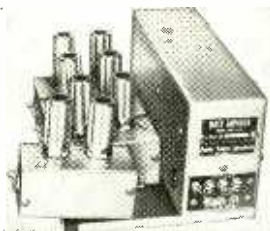

tains a power supply, signal-mixing circuit, and receptacles for up to 4 plug-in strips pretuned to specific channels. It is also provided with a broadband input circuit for cascading with similar units.

Channel strips model CS-1 are 2-tube, plug-in amplifiers, fixed-tuned to individual channels, using a 6AB4 and a 6CB5. Gain of each unit is over 17 db.

U.h.f. converter units, model UC-1, are pretuned, single-channel, plug-in strips, for converting u.h.f. channels to v.h.f. receiver input frequencies.

All units are designed for either 75-ohm or 300-ohm input. Ventilated, gray Hammertone-finished steel enclosures are provided for complete assemblies. Weatherproof housings will be available for outdoor installations.

NEW BEAM ANTENNA

Telrex, Incorporated, Asbury Park, N. J., has announced production of "Fishbone" single-channel, high-gain antennas for TV, FM, amateur, and commercial applications. Two driven ele-

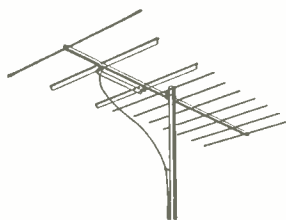

ments, 7 directors, and a single reflector, give over 14 db forward gain, full channel bandwidth, and a terminal impedance of 125 ohms for most effective matching to standard transmission lines. Stacked arrays are available for installations requiring exceptional directivity and gain. Amateur models are stocked for 2 and 6 meters, and are available on order for 10 meters.

NEW HV CORONA DOPE

General Cement Manufacturing Co., Rockford, Ill., has added a new corona dope with superior insulating qualities to its G-C chemical line. Called Red-X Corona Dope, it meets the increased high-voltage requirements of new large-screen TV receivers.



Red-X is easily applied to all solder connections and sharp edges. It is quick-drying, reducing the possibility of circuit fires, and is available in 2-ounce bottles (catalog No. 50-2).

NEW TV CHASSIS

Mattison Television and Radio Corporation, 893 Broadway, New York 3, N. Y., is producing a Silver Rocket 630-type chassis with built-in tunable booster. The Silver Rocket is also equipped with a parallax-corrected yoke, phono-input with automatic h.v. disconnect, front-mounted focus control, and a cascade-amplifier tuner. The booster provides gains as high as 10 on all v.h.f. channels, and may be automatically cut out by the on-off switch. Mattison-built cabinets are available for the Silver Rocket.

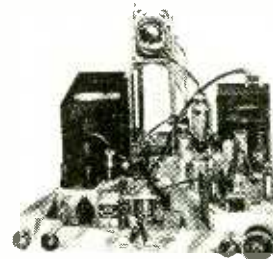

LEARN Practical RADIO AT HOME



COMPLETE ONLY ... **\$19⁹⁵**

BUILD 15 RADIOS

ABSOLUTELY NO PREVIOUS TRAINING NEEDED
EXCELLENT BACKGROUND FOR TELEVISION

10-DAY MONEY-BACK GUARANTEE

WHAT THE 1952 PROGRESSIVE RADIO "EDU-KIT" OFFERS YOU:

This is a practical home radio course. You learn theory, construction, operation, trouble shooting, code. You build RECEIVERS, TRANSMITTERS, AMPLIFIERS, CODE OSCILLATOR, SIGNAL TRACER.

You start with a simple radio circuit, and gradually advance to more complex circuits. No previous background is required. No instructor is needed. All parts and instructions are included and every single step is clearly explained.

All parts are guaranteed, individually packaged, identified, and explained. There is nothing extra to buy. You receive all parts, tools and instructions at once. You keep everything; there is absolutely nothing you return to us.

You can easily pay for the kit in a short time by repairing radios. Use the tester and signal tracer for servicing. The signal tracer alone is worth more than the price of the entire kit.

USED BY RADIO SCHOOLS AND GOVERNMENT AGENCIES!

The Progressive Radio "Edu-Kit" includes tubes, paper condensers, mica condensers, electrolytic condensers, variable condensers, selenium rectifiers, chassis, hardware, tie strips, tube sockets, solder, wire, soldering iron, tubing, coils, instruction book, radio tester, etc.; in brief, everything you need in a practical radio course.

Send for further information and receive FREE Radio & TV Trouble Shooting Guide. Or order direct from this ad and receive FREE Code Oscillator Key (Value \$2.95) in addition to Radio & TV Trouble Shooting Guide.

Postage prepaid on Cash orders—C.O.D. orders accepted in U.S.A.

PROGRESSIVE ELECTRONICS CO.
497 UNION AVE. DEPT. RE-61 BROOKLYN, NEW YORK

FREE RADIO TESTER & SOLDERING IRON

GET A WELL-PAYING JOB



GO INTO A PROFITABLE BUSINESS AND PLAN FOR A FUTURE



RADIO-ELECTRONICS

ANOTHER CBS-HYTRON FIRST YOU'LL BE BUYING SOON



CBS-HYTRON 1AX2

NEW HEAVY-DUTY TV HIGH-VOLTAGE RECTIFIER CAN TAKE IT!

TV high-voltage rectifiers take a beating: Terrific variations occur in applied filament voltage . . . 0.8 to 2.4 volts! Sudden arcs in the rectifying system place destructive electromechanical stresses on the filament. And the increasingly larger TV picture tubes demand peak emission and peak inverse voltage simultaneously. The new CBS-Hytron 1AX2 was especially designed to take such rough treatment and come up smiling.

1AX2 DATA

The CBS-Hytron 1AX2 is a compact, 9-pin miniature TV pulse rectifier. Plate is brought out to top cap and filament is oxide-coated. Absolute maximum ratings are: peak inverse plate voltage, 25,000 volts; d-c load current, 1.0 ma.; and steady-state peak plate current, 11.0 ma.

Typical Operation — TV Pulse Rectifier

Filament voltage	1.4 v \pm 10%
Filament current	650 ma
Positive-pulse plate voltage	20,000 v
Negative-pulse plate voltage	5,000 v
Peak inverse plate voltage	25,000 v
D-c output voltage	20,000 v
D-c load current	300 μ a

BOTTOM VIEW
OF SOCKET

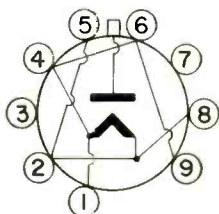

ADVANTAGES OF NEW CBS-HYTRON 1AX2

- 1 Rugged, high-wattage filament of CBS-Hytron 1AX2 has adequate peak emission for the new, larger TV picture tubes. 1AX2 may be run simultaneously at both its peak inverse voltage and maximum d-c current.
- 2 Higher load of 1AX2 filament on transformer tends to regulate filament voltage. Eliminates need for limiting resistor. Yet lower plate-to-filament capacitance (0.7 μ f) of 1AX2 prevents loss of high voltage.
- 3 Insulated tension bar (patent applied for) through center of 1AX2 coiled filament limits destructive movement of filament by electro-mechanical stresses.
- 4 Filament of 1AX2 is located in base and shielded to eliminate bombardment of cool ends of filament by gas molecules.
- 5 An overloaded 1X2A may be replaced with its big brother, the CBS-Hytron 1AX2, by simply removing the limiting resistor. In rare cases, it may be necessary to add another turn to the secondary of the filament transformer to obtain the required 1.4 volts for the 1AX2.



MAIN OFFICE: SALEM, MASSACHUSETTS

TV ARRESTERS

Radion Corporation, 1130 West Wisconsin Ave., Chicago 14, Ill., announced production of two new TV lightning arresters, Champion model QLA2 and Challenger model LA2. Both units will fit any type of 300-ohm lead-in, including standard, oval, jumbo, perforated, or open types, and are designed for indoor or outdoor use. Model QLA2 has a ceramic housing; model LA2 is cased in bakelite. Both types have 4-point mounting brackets.

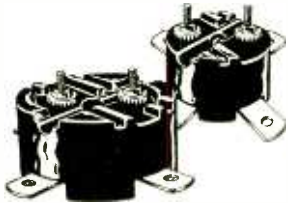

HIGH-GAIN ANTENNA

Technical Appliance Corporation, Sherburne, N. Y., is producing a new high-gain single-channel antenna for fringe areas. The Silver Streak incorporates

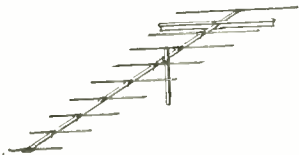

a two-diameter driven element, a single reflector, and eight directors. Gain is 11 db, terminal impedance 300 ohms. Stacked arrays are available. The Silver Streak is factory-assembled for quick installation.

VARIABLE CHOKES

Grayburne Corp., 103 Lafayette St., New York 13, N. Y., has released a line of precision variable r.f. chokes hav-

ing an inductance variation as high as 10 to 1.

Because they incorporate ferrite cores, these high-ratio Vari-Chokes feature compactness, increased Q, and low d.c. resistance.

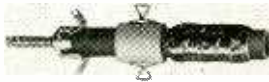

Two standard models are available: model V-6 (0.65 to 6.0 mh) and model V-25 (5.0 to 43.0 mh).

Grayburne Vari-Chokes can be supplied in a wide range of inductances up to 150 millihenries, and in a variety of winding types.

SOLDERING TOOL

Ungar Electric Tools, Inc., Los Angeles, Calif., has added an interchangeable thread-in unit, combining the features and advantages of three separate



soldering tips, to the complete line of Ungar soldering tools.

The new unit, named *Elkaloy tiptlets* is a trio of individual tips designed to thread into a single heating unit, which in turn, fits the Ungar handle. Elkaloy tiptlets consists of No. 535 thread-in heating unit, plus the No. 331 pencil tiptlet, No. 332 offset tiptlet and No. 333 chisel tiptlet.

The lightweight Ungar soldering handle has been redesigned and improved with a new form-fitted streamlined cork bushing, which fits the handle at a 10-degree angle when not in work, thus pointing the hot tip up and away from bench surface. A new protective rubber sleeve has been added to the cord to prevent wear and lengthen cord life.

MOBILE ANTENNA

Ward Products Corp., 1523 East 45th St., Cleveland 3, Ohio, has announced the new model SPPC-88 mobile antenna.

Normally, vehicles operating on 30-50 mc require long vertically-mounted antennas. This length combined with the high mounting found on buses and trucks, leads to excessive breakage from overhead obstructions. This new antenna is designed to reduce this hazard.

The antenna consists of three basic parts. The whip has a coil base serving as both a spring and part of the antenna inductance and capacitance. This section fractures into a friction-free spring, effectively providing two springs for maximum flexibility and permitting a minimum clearance when deflected of only 4 inches. A junction box at the base of the assembly contains a series capacitor to match 50-ohm coaxial cable.



NEW TV BOOSTER

The Astatic Corporation, Conneaut, Ohio, has announced an improved television booster.

Named the *Scanatar*, the new model CT-1 provides a lower noise figure and higher gain with new- or old-style receivers. The circuit is a balanced, cas-



coded type, with a neutralized 6J6 driving a 6BQ7.

Bandwidth is over 7 mc on all channels. One control knob operates as an on-off switch and low- or high-band selector; the other as a fine-tuning control. The metal cabinet is finished in simulated mahogany wood-grain and gold.

TV ANTENNA ASSEMBLY

JFD Manufacturing Co., Inc., 6101 16th Ave., Brooklyn 4, N. Y., has introduced the *JeTenna*, an all-aluminum conical antenna assembly which snaps into place with the flick of a wrist. A single reflector is used, and the dipole ele-

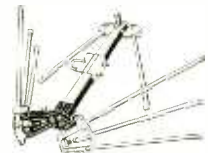

ments have a 35° tilt for higher forward gain. The dipole head insulator is unbreakable. Two- and four-bay arrays are also available.

COLLINEAR ARRAY

Fretco, Incorporated, 1041 Forbes St., Pittsburgh 19, Pa., has introduced the *Fretaray*, a broadband collinear antenna array giving high gain on all

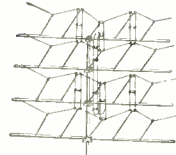

television channels. The antenna is shipped completely assembled and requires only tightening for installation.

**BACK AGAIN!!
BY POPULAR REQUEST
Special Purchase FM Radio Chasis**

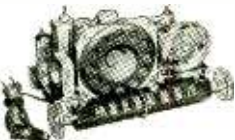

Complete with 6 tubes. Built-in Antenna and Speaker. Products of Patrons Radio & TV Manufacturer whose name we promised not to mention.

TUBE LINEUP
1-12BA7 1-12S8
2-12BA6 1-35W4
1-35B5
May also be used as an FM Tuner by picking signal off detector.

Regularly \$29.95

Brand New

\$16.95

NOW AVAILABLE: Cabinets for above—Maroon Plastic—may be bought separately \$5.95

SPECIAL PURCHASE Record Changer

Gen. Instruments 3-speed Automatic
Reg. \$34.95
Brand New
\$19.97



With all purpose cartridge & needle. Plays 33 1/3-45 RPM records automatically.

TERMS: All items F.O.B., Washington, D.C. All orders \$30.00 or less, cash with order. Above \$30.00, 25 per cent with order, balance C.O.D. Foreign orders cash with orders, plus exchange rate.

SUN RADIO
OF WASHINGTON, D. C.
938 F STREET, N. W. WASH 4, D. C.

HERE'S A REAL BUY!



Less than half the original price. Built for America's leading dept store chain, whose name we cannot mention because of this low price. Consists of master station, remote station and 20 ft. of 3 conductor wire. Can be used as a private or non-private system. 115V AC or DC. Brand New. Now only \$17.95. Additional wire per ft. .05.

Two-Station INTERCOM SYSTEM

BRAND NEW
now only **\$17.95**

LOW FREQ. XTALS-FT 241A

For SSB, lattice filter, etc. 1/2" spc. 54th or 72nd harmonic channels listed by fundamentals. Fractions omitted.

374 407 483 508	400 464	5910	2030 2435
375 408 484 509	440 466	6370	2045 2442
377 409 485 511	441 468	6450	2105 2532
379 411 487 514	442 470	6470	2125 2545
380 412 488 515	446 472	6497	2145 2557
381 413 490 516	447 474	6522	2155 3202
383 414 491 518	450 475	6547	2220 3215
384 415 492 519	452 476	6610	2258 3237
385 416 493 520	461 477	7350	2280 3250
386 418 494 522	462 479	7480	2282 3322
387 419 495 525	463 480	7580	2290 3510
388 420 496 526	7810	2300 3520	
390 422 497 530	7930	2305 3580	
391 423 498 531		2320 3580	
392 424 503 533		2360 3945	
393 425 504 537		2390 3955	
394 426 506 538		2415 3995	
395 427 507			
396 431			
397 433			
398 435			
401 438			
403 437			
404 438			
405 481			

SCR 522 Xtals 1/2" ins 1/2" spc.	BC-61 Xtals 2 banana plugs 3/4" spc.
99c ea. 10 for \$9.00	\$1.29 each
SPECIAL 200 Kc xtals without holders 69c each 3 for \$2.00	\$1.29 each

MANUFACTURER'S CLOSEOUT!

Every reader knows this famous maker of Wire Wound Fixed & Variable Resistors Marked General Electric.

We've bought up a tremendous supply of these and now you can buy them below manufacturer's 5000 lot prices.

10 WATT FIXED	10 WATT ADJ.
1-1000 ~ List .75	1-1000 ~ List 1.47
1100-500080	1250-5000 1.53
6000-10,00092	6000-10,000 1.63
11,000-20,000 1.03	
22,500-25,000 1.08	Your Cost. Each .39
30,000-50,000 1.22	
Your Cost. Each .24	
25 WATT ADJ.	20 WATT FIXED
1-1000 ~ List 1.87	5-1000 ~ List .95
1250-5000 1.88	1200-500097
6000-10,000 2.03	6000-10,000 1.12
12,000-20,000 2.08	12,500-20,000 1.20
25K 2.28	25,000-40,000 1.37
Your Cost. Each .47	45,000-60,000 1.58
	65,000-80,000 1.83
	85,000-100,000 2.11
	Your Cost. Each .36
50 WATT ADJ.	100 WATT ADJ.
1-1000 ~ List 2.37	1-1000 ~ List 3.58
1250-5000 2.47	1500-5000 3.67
6000-10,000 2.63	10,000 3.87
12,000-20,000 2.83	15,000-20,000 4.12
25,000-40,000 3.08	25,000-40,000 4.37
50,000-60,000 3.30	50,000 4.53
80,000 3.67	75,000 4.75
100,000 3.92	100,000 4.95
Your Cost. Each .69	Your Cost. Each .79

Deduct 10%—Lots of 100 or more. Deduct 20%—Lots of 1000 to 10,000. Minimum Order—\$2.00

HAM XTALS-FT 243 HOLDERS—1/2" pin spc.

4190 6773 7873	1015 5800 6366 6573 7506 7673
5030 6873 7906	1129 5806 6325 6575 7540 7706
5485 6906 7940	2045 5825 6340 6600 7573 8240
6040 7240 7973	3735 5840 6373 6606 7606
6073 7273 8273	5305 5850 6406 6625 7640
6106 7306 8306	5677 5873 6440 6640 7650
6125 7840	5796 5875 6450 6673
6140	5725 5906 6473 6706
6173	5740 5940 6475 6740
6175	5760 5973 6506 7440
6206	5773 6273 6540 7473

Code Oscillator Kits—All Parts—Phones, Key Battery—Instructions **\$7.95 COMPLETE**

BUY TEST EQUIPMENT ON THIS RADICALLY NEW TIME PAYMENT PLAN **NO INTEREST!! - NO CARRYING CHARGES!!**

USE CONVENIENT TIME PAYMENT ORDER BLANK BELOW

Superior's New JUNIOR SUPER-METER

MOST COMPLETE AND COMPACT MULTI-SERVICE INSTRUMENT EVER DESIGNED

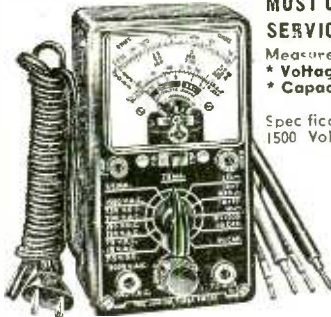

Handsome round cornered molded bakelite case 3 1/4" x 5 7/8" x 2 1/4" complete with all test leads and instructions

\$21.40
NET

Measures:
* Voltage * Current * Resistance
* Capacity * Reactance * Inductance
* Decibels

Specifications: D.C. Volts: 0-7.5/75/150/750/-1500 Volts. A.C. Volts: 0-15/150/300/1500/3000 Volts. Resistance: 0-10,000/100,000 ohms. 0-10 Megohms. D.C. Current: 0-7.5/75 Ma. 0-7.5 amps. Capacity: .001 Mfd.—2 Mfd. .1 Mfd.—20 Mfd. Electrolytic Leakage: Reads quality of electrolytics at 150 Volt test potential. Decibels: -10 Db to +18 Db. +10 Db to +38 Db. +38 Db. to +58 Db. Reactance: 15 ohms—25 K ohms 15 K ohms—2.5 Megohms. Inductance: .5 Henry—50 Henries 30 Henries—10 K Henries. Plus Good-Bad scale for checking the quality of electrolytic condensers.

Superior's New Model TV-11 TUBE TESTER



Operates on 105-130 Volt 60 Cycles A.C. Hand-rubbed oak cabinet complete with portable cover

\$47.50
NET

• Uses the new self-cleaning Lever Action Switches for individual element testing. Because all elements are numbered according to pin number in the RMA base numbering system, the user can instantly identify which element is under test. Tubes having tapped filaments and tubes with filaments terminating in more than one pin are truly tested with the Model TV-11 as any of the pins may be placed in the neutral position when necessary. • Uses no combination type sockets. Instead individual sockets are used for each type of tube. Thus it is impossible to damage a tube by inserting it in the wrong socket. • Free-moving built-in roll chart provides complete data for all tubes. • Phono jack on front panel for plugging in either phones or external amplifier detects microphonic tubes or noise due to faulty elements and loose external connections.

Superior's New Model 670-A SUPER-METER



Comes housed in rugged, crackle-finished steel cabinet complete with test leads and operating instructions. Size 6 1/4" x 9 1/2" x 4 1/2".

\$28.40
NET

A combination volt-ohm milliammeter plus capacity reactance inductance and decibel measurements

SPECIFICATIONS:

D.C. VOLTS: 0 to 7.5/15 75 150 750 1,500/7,500 Volts
A.C. VOLTS: 0 to 15 30 150 300/1,500/3,000 Volts
OUTPUT VOLTS: 0 to 15 30 150 300/1,500/3,000 Volts
D.C. CURRENT: 0 to 1.5/15/150 Ma. 0 to 1.5/15 Amperes
RESISTANCE: 0 to 1,000/100,000 Ohms 0 to 10 Megohms
CAPACITY: .001 to 1 Mfd. 1 to 50 Mfd. (Quality test for electrolytics)
REACTANCE: 50 to 2,500 Ohms 2,500 Ohms to 2.5 Megohms
INDUCTANCE: .15 to 7 Henries 7 to 7,000 Henries
DECIBELS: -6 to +18 +14 to +38 +31 to +58

ADDED FEATURE

The Model 670-A includes a special GOOD-BAD scale for checking the quality of electrolytic condensers at a test potential of 150 Volts.

Superior's New TV BAR GENERATOR



Power Supply: 105-125 Volt 60 Cycles. Power Consumption: 20 Watts. Channels: 2-5 on panel. 7-13 by harmonics. Horizontal lines: 4 to 12 (Variable). Vertical lines: 12 (Fixed). Vertical sweep output: 60 Cycles. Horizontal sweep output: 15,750 Cycles.

THROWS AN ACTUAL BAR PATTERN ON ANY TV RECEIVER SCREEN!!

Two Simple Steps

1. Connect Bar Generator to Antenna Post of any TV Receiver.
2. Plug Line Cord into A.C. Outlet and Throw Switch.

RESULT: A stable never-shifting vertical or horizontal pattern projected on the screen of the TV receiver under test.

TV Bar Generator comes complete with shielded leads and detailed operating instructions. Only ...

\$39.95
NET

New Model 200—AM and FM

SIGNAL GENERATOR

Provides complete coverage for A.M.—F.M. and TV alignment

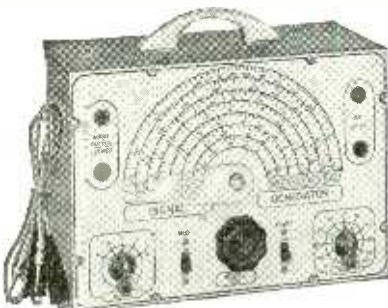

* Tubes used: One 954 as oscillator; one 954 as modulated buffer amplifier; T-2 as modulator; 7193 as rectifier.

The Model 200 comes complete with output cable and operating instructions

\$21.85
NET

NEW TIME PAYMENT PLAN ORDER BLANK

MOSS ELECTRONIC DISTRIBUTING CO., INC.
Dept. B-27, 38 Murray Street, New York 7, N. Y.

Please send me the units checked below. I am enclosing the down payment with order and agree to pay the monthly balance as shown. It is understood there will be no carrying, interest or any other charges, provided I send my monthly payments when due. It is further understood that should I fail to make payment when due, the full unpaid balance shall become immediately due and payable.

- JUNIOR SUPER METER..... Total Price \$21.40
\$5.40 down payment. Balance \$4.00 monthly for 4 months.
- MODEL TV-11..... Total Price \$47.50
\$11.50 down payment. Balance \$6.00 monthly for 6 months.
- MODEL 670-A..... Total Price \$28.40
\$7.40 down payment. Balance \$3.50 monthly for 6 months.
- TELEVISION BAR GENERATOR..... Total Price \$39.95
\$9.95 down payment. Balance \$5.00 monthly for 6 months.
- MODEL 200..... Total Price \$21.85
\$5.85 down payment. Balance \$4.00 monthly for 4 months.

- I enclose \$_____ as down payment.
- Ship C.O.D. for the down payment.

Signature _____

Name _____

Address _____

City _____ Zone _____ State _____

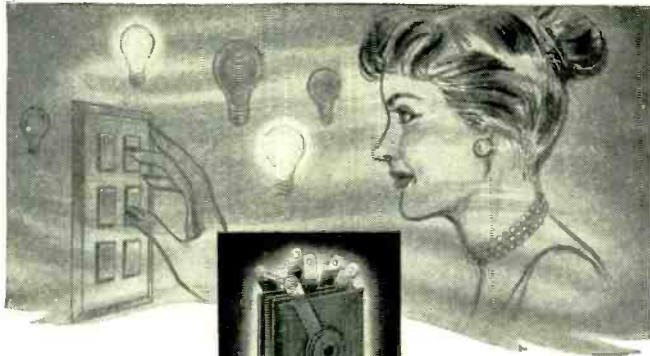

Another Unusual Seletron Application

Touch-Plate Mfg. Co. of Long Beach, Calif. considers the rectifier in each of its control units a highly important "artery" of the system. That's why, after severe tests for temperature, load capacity and longevity, they have chosen SELETRON Selenium Rectifiers.

The rectifier incorporated in "Touch-Plate" (Just touch it and the lights go on anywhere in the house!) is SELETRON's Model P1B1E1C, 1-3/16" cell size, and rated at 26V AC input. It converts A.C. to D.C. for the "Touch-Plate" relay.

SELETRON Selenium Rectifiers are available in ratings from a few mils. up to thousands of amps! New industrial electronic uses are constantly turning up for these versatile and dependable rectifiers—both in miniature sizes and heavy stack assemblies—and of course SELETRON is the choice of a growing list of manufacturers in communications and TV.

Modern new low-voltage remote control light switch systems employs



SELENIUM RECTIFIERS

.....
 May we help with your rectification problems? Write us without obligation. Our engineering department can be of real assistance. And please ask for our helpful Bulletin No. 104-R-3



SELETRON DIVISION
RADIO RECEPTOR COMPANY, INC.

Since 1922 in Radio and Electronics
 SALES DEPT. 251 West 170th Street, New York 31, N. Y. - FACTORY: 84 North 9th Street, Brooklyn 11, N. Y.

Please mention RADIO-ELECTRONICS when writing advertisers

TV REPLACEMENTS

Standard Transformer Corporation, 3580 Elston Ave., Chicago, Ill., has announced 14 new Stancor television replacement components, covering a wide range of applications.

The new components include six power transformers; two filament transformers; two horizontal-deflection and high-voltage transformers; two filter chokes; a vertical-deflection output transformer; and a width control with a.g.c. winding.

Replacement recommendations for these units are listed in the new Stan-

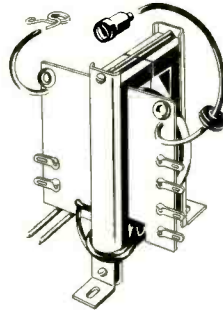

cor TV Replacement Guide and Catalog, which lists 2416 TV models and chassis.

The power transformers are used in over 700 models and chassis built by the major manufacturers of TV sets. Filament transformers, both of which are used in over 80 TV models and chassis, are specifically designed for heating damper-tube filaments where high voltages are required. Both are insulated for 5,000 volt r.m.s. Horizontal-deflection and high-voltage transformers A-8133 and A-8134 are exact replacements for several Admiral sets in 1950-1951. The filter chokes have replacement applications in over 200 models and chassis. The width control with a.g.c. winding (WC-5), because of its extremely wide range of inductances, can be used with the entire Stancor flyback line for both conversion and replacement.

TV BEAMS, ROTATOR

Trio Manufacturing Company, Griggsville, Illinois, announces "Mini-Up" Yagi antennas, designed for assembly in 45 seconds. Color-coded

beam elements match plug-in fittings on the boom, are locked by vibration-proof swaging action with hand-tightened nuts. Two dual-channel models are available: Model 445MU for channels 4 and 5, Model 479MU for channels 7 and 9. A full line of single-channel Mini-Up models is scheduled for early production.

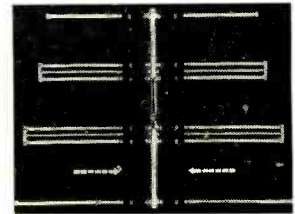

in addition to the Yagi antennas, Trio Manufacturing Company also announces production of an improved 2-motor TV antenna rotator. Extensive field and laboratory tests show that the new rotator operates successfully at 50° below zero, at 15,000-foot altitudes, and can withstand 100-mile gales.

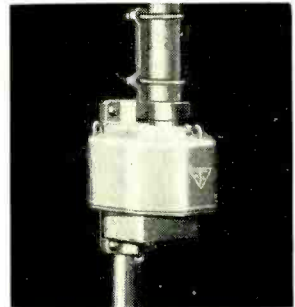

HV CAPACITORS

Sprague Products Co., North Adams, Mass., has developed a complete line of flat-plate high-voltage ceramic capacitors. Known as *Bulplates*, they are available in capacitance values up to 4,700 µmf at 1,000 volts, to 220 µmf at 1,500 volts, and to 470 µmf at 6,000 volts. Bulplates feature an extra-heavy moisture-resistant insulating coating, and are rated for continuous operation at 85° Centigrade.

—end—

All specifications given on these pages are from manufacturers' data.



Regency

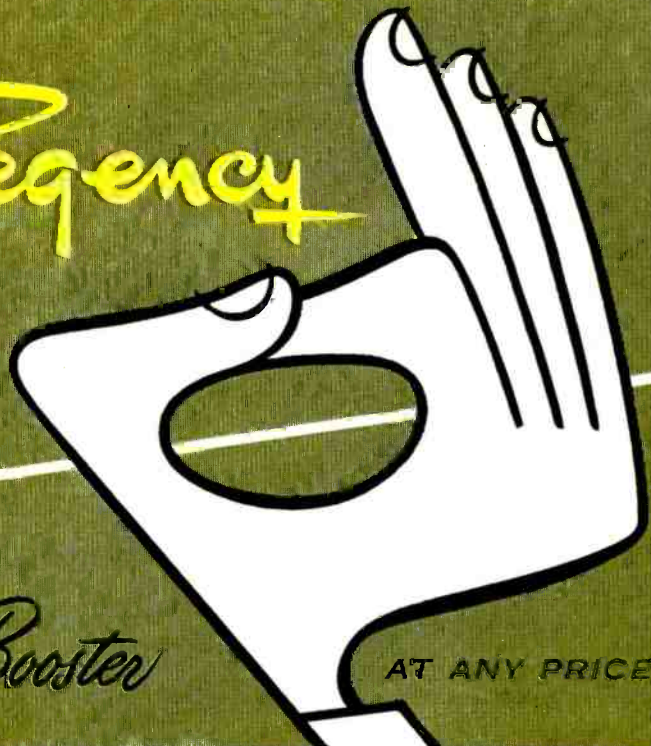

Largest Selling Booster

RADIO-ELECTRONICS

THE ONLY WAY to make tv servicing easy

Here is the key to easy tv servicing... based on practical what-to-do and how-to-do-it information.

Naturally, every set manufacturer wants his receiver repaired correctly. Once he sells a receiver, he'll go to great lengths to keep it operating properly. That's why he prepares such a wealth of servicing data. Data that deals with practical facts... what-to-do and how-to-do-it. It is this data which Rider publishes in complete, unedited form — because it is this data that makes tv servicing easy!

Here's an example: On Hallicrafter receiver models 805, 806, 810 and 810C (chassis number M800S) the manufacturer issued 32, 8½" x 11", pages of servicing data. (We published all 32 pages in Rider TV Manual Vol. 8, and in Rider Tek-File Pack 6.) These models were manufactured in 7 production runs. To give you all the data you need, individual bottom views are given for runs 1, 2, 3 and for 4, 5, 6, 7. To show the difference between the receivers, the manufacturer prepared, and we reprinted, four different schematics. One of these is for run 1; another shows the receiver as produced in runs 2 and 3. Still another schematic shows the runs 4, 5, 6 and 7... but this schematic applies to the receivers using EM (electromagnetic) focus coils. The fourth schematic applies to production runs 4, 5 and 6 for receivers using PM (permanent magnetic) focus coils.

The variations introduced by different runs displayed a major effect on the tube operating voltages. In many instances they varied by as much as 100 per cent. Can you imagine yourself determining whether the operating conditions were right or wrong on these Hallicrafter models without this vital complete data!

This is only one example in thousands of how complete servicing

data makes your job easy. And it is this data which appears in Rider Servicing Data. From large, easy-to-follow schematics... circuit explanations... stage by stage alignment curves... page after page of troubleshooting test patterns... waveforms... clear, enlarged chassis views... circuit changes... to complete unpacking instructions; Rider Data is the only publishing source for complete, factory-issued, official servicing data... in accurate, organized, unedited form. NOW, WITH THESE TWO IMPORTANT FEATURES:

Manufacturers' Trouble Cures

These 3" x 5" standard index cards called Rider Handies contain vital manufacturer-issued permanent trouble cures plus production changes. Each Handy is identified with a manufacturer and a receiver model. With Rider Handies you save countless hours of diagnosis and repair time... because Handies contain the data you must have to make permanent repairs on many manufacturers' models. (Rider Handies information appears in Rider TV Tek-File packs, and Rider TV Manuals beginning with Vol. 9.)

Guaranteed Replacement Parts Listings

Beginning with Rider T.V. Manual 10 and Rider T.V. Tek-File Pack 57, replacement parts listings are included. All the replacement parts listed in Rider tv servicing data meet the physical and electrical performance ratings of the original equipment!

*Rider Servicing Data
available in two forms:*

Rider T.V. Manuals.

Vols. 1 to 9. *Pictured Below*



Each contains full data for manufacturers' receivers produced during a certain period. (The latest, T.V. 9, just published, covers October 1951 through February 1952.) Each manual has over 2,000 (8½" x 11") pages in permanent binder, with an index covering the contents of all manuals. Rider manuals are perfect for shop use and permanent reference. Price — \$24 each.

Rider T.V. Tek-Files. Packs 1 to 60

The contents of a typical T.V. Tek-File pack are shown below. In Rider Tek-File packs you buy complete Rider servicing data for only one, two, or a few manufacturers... according to your needs. Notice that each pack consists of handy, standard file folders for easy use. Only \$2 each pack.

FREE Rider T.V. Tek-File indexes covering the contents of all published packs are at your jobber's. If he's out, write us.

DON'T BE SWITCHED!

Rider Tek-File is DEFINITELY NOT the same as any other publisher's service. If your jobber doesn't carry them, DON'T BE SWITCHED. Write us direct... we'll sell you. (Please include your jobber's name.)

TRY A PACK.

Prove to yourself that Rider Tek-File makes tv servicing easy. Buy one pack for the next receiver you service. If you



don't agree it's better than anything you've ever used, return the pack to us within seven days... we'll send you a full refund!

OUT SOON.

Rider RADIO Tek-Files! Same style as T.V. Tek-Files. Now, get your complete radio servicing data this easy economical package way. Ask your jobber.

John F. Rider Publisher, Inc., 480 Canal St., New York 13, New York.
West Coast Office: 4216-20 W. Jefferson Blvd., Los Angeles, California.

LOOK AT THE BOX



Look at the figures in the charts below. *These figures are taken from current catalogs listing stock distributor items.* Compare Centralab's complete line of temperature compensating capacitors with the four other leading makes. You'll see why more service engineers are standardizing on Centralab wherever capacitors of this type are required.

Remember too — Centralab was the first manufacturer to offer temperature compensating ceramic capacitors to the market.

For r.f. and resonant circuits — where frequency drift is critical — Centralab Temperature Compensating Capacitors are the last word in accurate stabilizing — *safest and best for guaranteed servicing.*

TCZ's SHOW NO CAPACITANCE CHANGE OVER WIDE RANGE OF TEMPERATURE (-20°C to +85°C)

CRL				COMPETITOR A**			COMPETITOR B**			COMPETITOR C**			COMPETITOR D**		
600VDCW		1200VDCT		(tubular) 500 VDCW			Disc. 500 VDCW — 1000 VDCT			(tubular)			(tubular) 500 WVDC		
CRL Part No.	Cap. mmf.	Tolerance	Net Price	Cap. mmf.	Tolerance	Net Price	Cap. mmf.	Tolerance	Net Price	Voltage 500 VDCW			Cap. mmf.	Tolerance	Net Price
										Cap. mmf.	Tolerance	Net Price			
TCZ- .5	0.5	± .25 mmf	.45	*			†			†			†		
TCZ- .68	0.68	± .25 mmf	.45	*			†			.75	± .1 mmf	.45	†		
TCZ- 1.0	1.0	± .25 mmf	.45	*			†			†			†		
TCZ- 1.5	1.5	± .25 mmf	.45	1.0	± 1 mmf	.30	†			1.5	± .5 mmf	.30	1.5	‡	.30
TCZ- 2.2	2.2	± .25 mmf	.45	*			†			†			†		
TCZ- 3.3	3.3	± .25 mmf	.45	3.0	± 1 mmf	.30	†			3.0	± 1 mmf	.30	3.0	‡	.30
				3.3						3.3	± .5 mmf	.30	3.3	‡	.30
TCZ- 4.7	4.7	± .5 mmf	.36	4.7	± 1 mmf	.30	†			4.7	± .5 mmf	.30	4.7	‡	.30
										5.0	± 1 mmf	.30	5.0	‡	.30
TCZ- 6.8	6.8	± .5 mmf	.36	5.0	± 1 mmf	.30	†			6.8	± .68 mmf	.30	6.8	‡	.30
				6.8											
TCZ- 10	10	± .5 mmf	.36	8.2	± 1 mmf	.30	†			10	± 1 mmf	.30	10	‡	.30
				10			10	‡	.30				10	‡	.30
TCZ- 12	12	± .5 mmf	.36	*			†			†			†		
TCZ- 15	15	± .5 mmf	.36	*			†			15	‡	.30	†		
TCZ- 18	18	± .5 mmf	.36	*			†			†			†		
TCZ- 20	20	± .5 mmf	.36	20	± 10%	.30	†			20	± 10%	.30	20	‡	.30
TCZ- 22	22	± 2½%	.30	*			†			22	‡	.30	†		
TCZ- 24	24	± 2½%	.30	25	± 10%	.30	†			25	‡	.30	25	‡	.30
TCZ- 27	27	± 2½%	.30	*			†			†			†		
TCZ- 30	30	± 2½%	.30	*			†			†			†		
TCZ- 33	33	± 2½%	.30	33	± 10%	.30	†			33	‡	.30	33	‡	.30
TCZ- 36	36	± 2½%	.30	*			†			†			†		
TCZ- 39	39	± 2½%	.30	*			†			†			†		
TCZ- 43	43	± 2½%	.30	*			†			†			†		
TCZ- 47	47	± 2½%	.30	*			†			47	‡	.33	†		
TCZ- 51	51	± 2½%	.30	50	± 10%	.33	†			†			50	‡	.33
TCZ- 56	56	± 2½%	.30	*			†			†			†		
TCZ- 62	62	± 2½%	.30	*			†			†			†		
TCZ- 68	68	± 2½%	.30	*			†			68	‡	.33	†		
TCZ- 75	75	± 2½%	.30	75	± 10%	.33	†			†			75	‡	.33
TCZ- 82	82	± 2½%	.30	*			†			†			†		
TCZ- 91	91	± 2½%	.30	*			†			†			†		
TCZ-100	100	± 2½%	.30	100	± 10%	.33	†			†			100	‡	.33
TCZ-110	110	± 5%	.30	*			†			†			†		
TCZ-120	120	± 5%	.30	*			†			†			†		
TCZ-130	130	± 5%	.30	*			†			†			†		
TCZ-150	150	± 5%	.30	150	± 10%	.36	†			†			150	‡	.36
TCZ-160	160	± 5%	.30	*			†			†			†		
TCZ-180	180	± 5%	.30	175	± 10%	.36	†			†			175	‡	.36
TCZ-200	200	± 5%	.30	*			†			†			†		
TCZ-220	220	± 5%	.30	*			†			†			†		
TCZ-240	240	± 5%	.30	*			†			†			†		
TCZ-270	270	± 5%	.30	*			†			†			†		
TCZ-300	300	± 5%	.30	*			†			†			†		

**Name on request.

*Not cataloged item — available on special order.

†Not cataloged

‡Tolerance not listed in literature

SCORE! . . . Of the five leading makes of temperature compensating capacitors – Centralab gives you more values to choose from – closer tolerances you can rely on – at prices that are right!

TCN's VARY CAPACITANCE ACCORDING TO TEMPERATURE															
CRL			COMPETITOR A** (tubular)			COMPETITOR B** (disc)			COMPETITOR C** (tubular)			COMPETITOR D**			
CRL Cat. No.	Cap. mmf.	Toler- ance	Net Price	Cap. mmf.	Toler- ance	Net Price	Cap. mmf.	Toler- ance	Net Price	Cap. mmf.	Toler- ance	Net Price	Cap. mmf.	Toler- ance	Net Price
TCN- 3	3	± .5 mmf	.36	*			†			†			†		
TCN- 5	5	± .5 mmf	.36	5	± 10% or ± 1 mmf	.30	†			5	± 10% or ± 1 mmf	.30	5	‡	.30
TCN- 10	10	± .5 mmf	.36	10	± 10% or ± 1 mmf	.30	10	‡	.30	10	± 10% or ± 1 mmf	.30	10	‡	.30
TCN- 12	12	± .5 mmf	.36	*			†			†			†		
TCN- 15	15	± .5 mmf	.36	*			15	‡	.30	†			†		
TCN- 18	18	± .5 mmf	.36	*			†			†			†		
TCN- 20	20	± .5 mmf	.36	*			†			†			†		
TCN- 22	22	± 2½%	.30	*			22	‡	.30	†			†		
TCN- 24	24	± 2½%	.30	*			25	‡	.30	†			†		
TCN- 27	27	± 2½%	.30	*			†			†			†		
TCN- 30	30	± 2½%	.30	*			†			†			†		
TCN- 33	33	± 2½%	.30	*			33	‡	.30	†			†		
TCN- 36	36	± 2½%	.30	*			†			†			†		
TCN- 39	39	± 2½%	.30	*			†			†			†		
TCN- 43	43	± 2½%	.30	*			†			†			†		
TCN- 47	47	± 2½%	.30	47	± 10%	.30	47	‡	.30	47	± 10%	.30	47	‡	.30
TCN- 51	51	± 2½%	.30	*			†			†			†		
TCN- 56	56	± 2½%	.30	*			†			†			†		
TCN- 62	62	± 2½%	.30	*			†			†			†		
TCN- 68	68	± 2½%	.30	*			68	‡	.30	†			†		
TCN- 75	75	± 2½%	.30	75	± 10%	.30	†			75	± 10%	.30	75	‡	.30
TCN- 82	82	± 2½%	.30	*			†			†			†		
TCN- 91	91	± 2½%	.30	*			†			†			†		
TCN-100	100	± 2½%	.30	100	± 10%	.30	100	‡	.30	100	± 10%	.30	100	‡	.30
TCN-110	110	± 5%	.30	†			†			†			†		
TCN-120	120	± 5%	.30	†			†			†			†		
TCN-130	130	± 5%	.30	†			†			†			†		
TCN-150	150	± 5%	.30	†			150	‡	.30	†			†		
TCN-160	160	± 5%	.30	†			†			†			†		
TCN-180	180	± 5%	.30	†			†			†			†		
TCN-200	200	± 5%	.30	†			200	‡	.30	†			†		
TCN-220	220	± 5%	.30	†			220	‡	.30	†			†		
TCN-240	240	± 5%	.30	†			†			†			†		
TCN-270	270	± 5%	.30	†			†			†			†		
TCN-300	300	± 5%	.30	†			†			†			†		
TCN-330	330	± 5%	.30	†			330	‡	.30	†			†		
TCN-360	360	± 5%	.30	†			†			†			†		
TCN-390	390	± 5%	.30	†			†			†			†		
TCN-430	430	± 5%	.30	†			†			†			†		
TCN-470	470	± 5%	.30	†			†			†			†		
TCN-510	510	± 5%	.30	†			†			†			†		
TCN-560	560	± 5%	.30	†			†			†			†		
TCN-620	620	± 5%	.30	†			†			†			†		
TCN-680	680	± 5%	.30	†			†			†			†		
TCN-750	750	± 5%	.30	†			†			†			†		

Centralab Temperature Compensating Capacitors are available in five body sizes, with most values in the smaller dimensions. For more information, see your Centralab Distributor.



Centralab
A Division of Globe-Union Inc.
922 East Keefe Avenue • Milwaukee 1, Wis.

**Name on request.

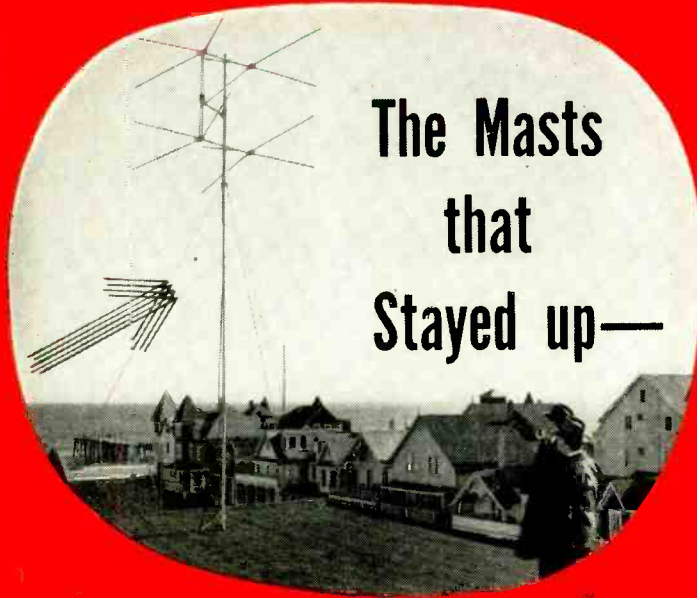

The Masts
that
Stayed up—

when others
went
DOWN!



PERMA-TUBE

... the Steel Television Mast that's UP to STAY!

... it was a *big blow*—the hurricane of November 1950 that hit the New York area with devastating force. Television masts were crumpled and flattened like straws in the path of the wind . . . all but those made of PERMA-TUBE. PERMA-TUBE Masts *Stayed Up!* . . . and why did PERMA-TUBE Masts *stay up?* For the very good reason that they're made of sturdy, corrosion-resistant steel . . . Jones & Laughlin Tele-

vision grade PERMA-TUBE Steel . . . a product that is pre-treated with Vinsynite and coated with a metallic-pigmented vinyl resin base *inside and outside.*

... what's more, they're easily, quickly and economically installed. Their new Fitted Joints can be slipped together in a matter of seconds. And you can obtain PERMA-TUBE in standard lengths, diameters and wall-thicknesses.

FOR COMPLETE INFORMATION—MAIL THIS COUPON TODAY!

**J&L
STEEL**

Jones & Laughlin Steel Corporation
495 Jones & Laughlin Building
Pittsburgh 30, Pennsylvania

Without charge please send me:—

- Name of nearest distributor
 Complete information on Perma-Tube

NAME _____

COMPANY _____

ADDRESS _____

ESFETA MEETS

Thirty delegates and guests attended the annual meeting of the Empire State Federation of Electronic Technicians Associations in Binghamton, N. Y., on April 27. Representatives of seven member associations and one newly formed group, the Southern Tier Television Technicians of Elmira, N. Y., participated in the meeting.

Officers elected for the 1952 term were: O. (Cappy) Capitelli, ARTSNY (New York City), president; Herb Snyder, Binghamton, RSMA, vice-president; Dave Violet, Rochester, RTG, secretary; Charles Kohl, Kingston, UETA, treasurer; and John Hague, Endicott, ERTA, sergeant-at-arms.

The next meeting of ESFETA will be held in Rochester June 15, 1952.

TISA WARS ON RACKETS

The \$3.00-per-call "service technicians" and dishonest repairmen of the Chicago area are the subject of an investigation. A refreshing change from past "exposés" is that this investigation is being carried on by the Television Installation Service Association (TISA) itself. This eliminates dubious gimmicks and controversial practices from the start.

"TISA obtained hundreds of sworn statements from bilked set owners and from past and present employees of the companies involved," states TISA president Frank Moch in a letter recently released. Sets with natural-type, obvious defects were then sent to companies mentioned most often in the statements.

As a result of the investigation, in which TISA and the Chicago Better Business Bureau co-operated, evidence is said to have been collected on at least 6 major and 12 minor offenders. "As a result of the investigations," Mr. Moch says, "Par Television Sales, Alert TV, Halburn TV, and Guarantee TV have closed their doors." The statement is partly metaphorical, since the newspaper *Retailing Daily* says that Alert TV and Halburn TV were operated through telephone answering services, and apparently had no corporate "doors."

TISA has organized a permanent grievance committee to continue the fight against the \$3 operator, whose calls, according to the Chicago organization, usually cost the customer between \$15 and \$20, rather than the \$3 advertised, and cost the Chicago television owners an estimated \$2,500 daily.

Publicity surrounding the investigation has produced gains both in business and membership for the organization. There were 25 articles in Chicago papers, eight telecasts and 25 radio programs, in all of which TISA was given due credit.

As a result, many TV set owners have phoned TISA headquarters for the address of the nearest member. Most said it was the first time they had heard of the association. No less than 60 service firms had applied for membership at the time of writing.



Model 666-R

NOTE the wide ranges of this compact pocket-size instrument. Note controls—flush with panel. Then study the inside view. Nowhere will you find, in design and manufacturing quality, the equal of 666-R.

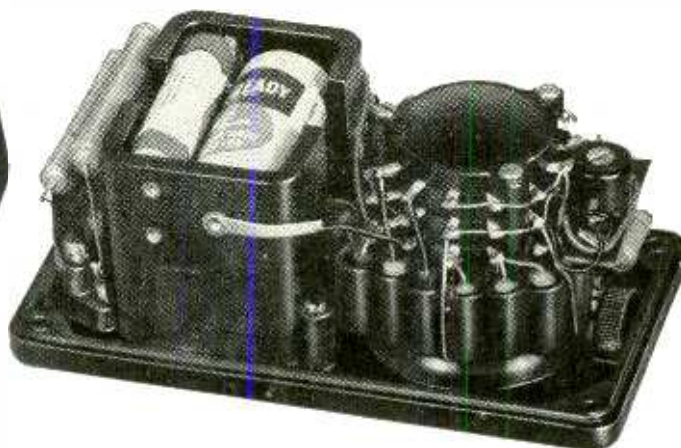

A BASIC TOOL

POCKET-SIZE: VOLT-OHM-MIL-AMMETER

WITH SELF-CONTAINED RESISTANCE RANGES TO 3 MEGOHMS

1. Resistance Ranges from 0-3000 Ohms (.5 Ohm low reading) to 3 Megohms, self-contained. Also A.C.-D.C. Volts to 5000, 10 ranges; and 3 Direct Current ranges.

2. Enclosed Selector Switch, molded construction. Keeps dirt out, and retains contact alignment permanently.

3. Unit Construction—Resistors, shunts, rectifier, batteries, are housed in a molded base integral with the switch. Direct connections without cabling. No chance for shorts.

4. Resistors are precision film or wire-wound types, each in its own compartment.

ONLY \$26.50—at your Distributor

Prices Subject to Change

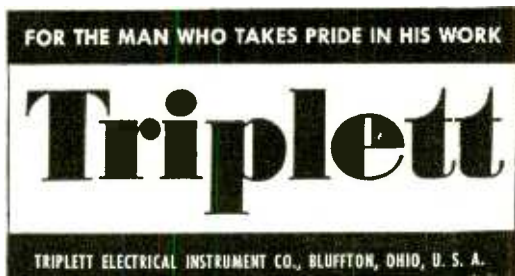

**Put across that
PERSONALITY
WITH AN E-V MIKE**

**Model 950
CARDAX
Crystal
Cardioid
with Dual
Response
List, \$42.50**

**Model 636
Slimair
High Fidelity
Dynamic
List, \$70.00**

**Model 630
High Fidelity
High Output
Dynamic
List, \$42.00**

Authorized
Distributors
Everywhere

REPRODUCE VOICE AND MUSIC . . . ACCURATELY!

The microphone makes a difference in the sound you hear! As a radio ham, sound specialist, or home recording fan, you are certain to reproduce the individual quality and personality of speech or song or orchestral music . . . with a research-engineered E-V mike! Send today for illustrated bulletin.

NO FINER CHOICE THAN **Electro-Voice**

421 CARROLL STREET • BUCHANAN, MICHIGAN
Export: 13 East 40th St., New York 16, N.Y., U.S.A. Cables: Arimb
MICROPHONES • HI-FI SPEAKERS • TV BOOSTERS • PHONO CARTRIDGES



NETSDA'S MAY MEETING

The regular meeting of the National Electronic Technicians and Service Dealers Associations (NETSDA) was held in New York City on May 4. It was the first meeting to take place in the organization's new headquarters at 165 East Broadway, which was put at the disposal of the national organization by the local technicians' association.

After some discussion on recent events in the industry and their impact on the service technician, the meeting was given over to problems of organization, which occupied the delegates till adjournment.

The next meeting was set for June 6, at Trenton, N. J.

WTTM CO-OPERATES

David van Nest, secretary of the Radio Servicemen's Association of Trenton, N. J., reports that its meetings are now being held in quarters provided by the local broadcast station, WTTM.

PENNSYLVANIA TECHNICIANS STUDY STATION OPERATION

The Lackawanna and the Luzerne radio technicians were guests of the Lackawanna County Appliance, Radio, and Television Dealers Association at a joint meeting April 15. The assistant chief engineer of WQAN, Scranton (in whose auditorium the meeting was held) discussed the operation of a TV station and the implications of the unfreezing of the ultra-highs. The total attendance was over 200.

SALT LAKE FIGHTS TVI

A permanent committee, with members representing radio, transportation, and electric power interests, has been formed to handle all complaints of interference made by Salt Lake City television viewers. The committee was first organized through the efforts of William E. Clyne, inspector in the engineering division of the FCC office in Denver, and is headed by Hal Morgan, superintendent of the Salt Lake City police communications department.

The committee started work with ten complaints from viewers on hand, and announced that it would study and put into effect remedies for any TVI caused by transmitters or power devices in the Salt Lake City area.

\$750,000,000 FOR SERVICE

Television set owners are expected to pay 750 million dollars to keep their receivers working during 1952, according to a recent issue of *Electronics*.

The same magazine states most of this money will be paid out on a per-call basis, because only about 5% of the TV receivers now in operation are covered by annual service contracts.

—end—

Industrials

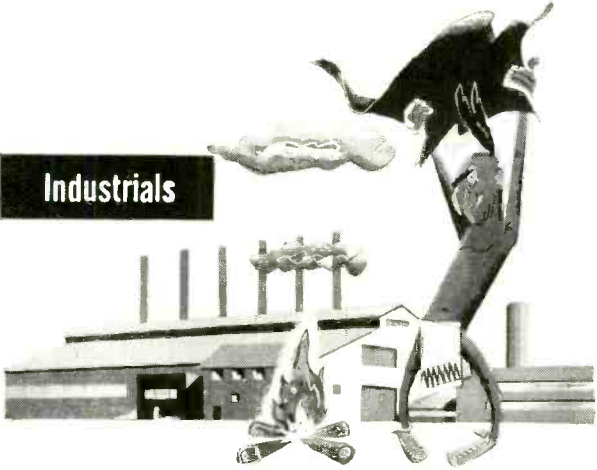

Communications

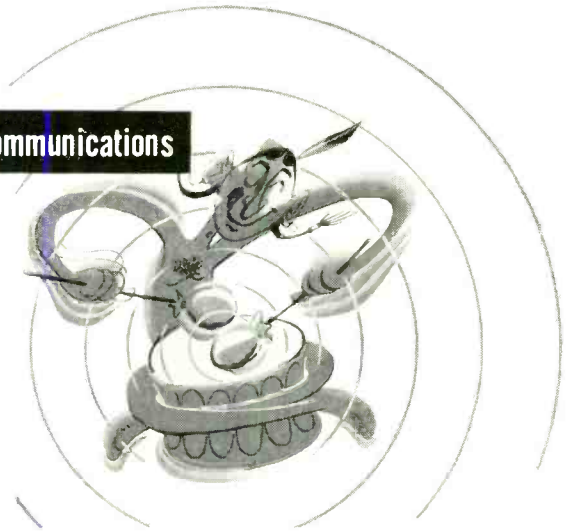

Those who know...choose Sangamo
**for every radio and
electronic application**

SANGAMO Capacitors have been the choice of discriminating users for a quarter of a century. Radio servicemen, amateurs, electronic engineers, the Armed Services—all testify to the design, construction, honesty of characteristics, and conservativeness of ratings of Sangamo capacitors.



SANGAMO
Capacitors

papers 

micas 

buttons 

electrolytics 

Television

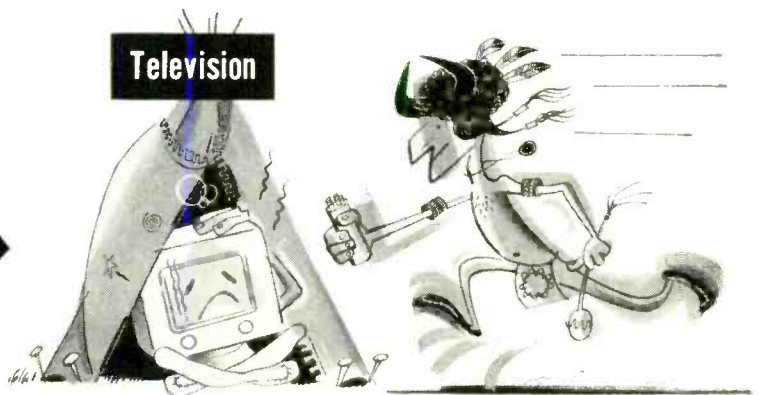

Armed Services

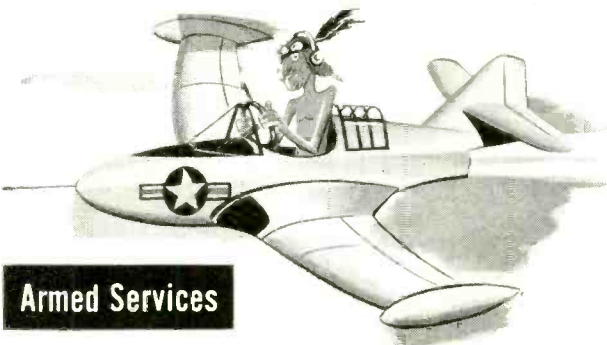

SANGAMO
ELECTRIC COMPANY

MARION, ILLINOIS

IN CANADA

SANGAMO COMPANY LIMITED, LEASIDE, ONTARIO



No Searching

with C-D's line of "UP" electrolytics

... simplifies your TV replacement problems



- The only twist-prong electrolytic line with complete replacement coverage!
- Saves you hours of "hunting time".
- Follow the C-D TV Guide, and you automatically meet and beat the manufacturer's requirements for every TV set.
- See your local C-D jobber today (he's in your local Classified Phone Directory) for C-D's Television Replacement Guide TVR 7A or write to Dept. RC-72, Cornell-Dubilier Electric Corp., South Plainfield, N. J.



CONSISTENTLY DEPENDABLE CORNELL-DUBILIER CAPACITORS

PLANTS IN SO. PLAINFIELD, N. J. • NEW BEDFORD, WORCESTER AND CAMBRIDGE, MASS. • PROVIDENCE, R. I.
INDIANAPOLIS, IND. • FUGUAY SPRINGS, N. C. • SUBSIDIARY, RADIART CORP., CLEVELAND, OHIO



if you service two-way radio

You undoubtedly make frequency and modulation measurements. Will your equipment—present or proposed—handle new accounts on widely spaced frequencies? It will—IF it is Lampkin.

Pictured, the Type 205 FM Modulation Meter measures maximum deviation due to modulation of FM transmitters. Continuously tunable, 25 to 200 Mc.; indicates peaks on voice modulation up to 25 Kc. Meets FCC specifications, weighs 14 lbs., priced at \$240.00.

For center-frequency measurements, use the Type 105-B Micrometer Frequency Meter. Continuous coverage, 0.1 to 175 Mc., accuracy 0.0025%, weighs 13 lbs. Costs \$220.00

WRITE, WIRE OR PHONE TODAY: Sales Department

LAMPKIN LABORATORIES, INC.
BRADENTON, FLORIDA

RADIO POLL DEVICE

Patent No. 2,587,213

Herbert S. Polin, Rio de Janeiro, Brazil
(Assigned to Audience Computing System, Inc. New York, N. Y.)

This device registers the size of a radio or TV audience. Such a count is important for determining which programs are most popular. At present, popularity data is obtained from personal or telephone inquiries, expensive and not highly satisfactory methods. The new method computes the number of sets tuned to a particular program.

Each receiver to be included in the poll is equipped with a 20-cycle vibrator V and a resistor R.

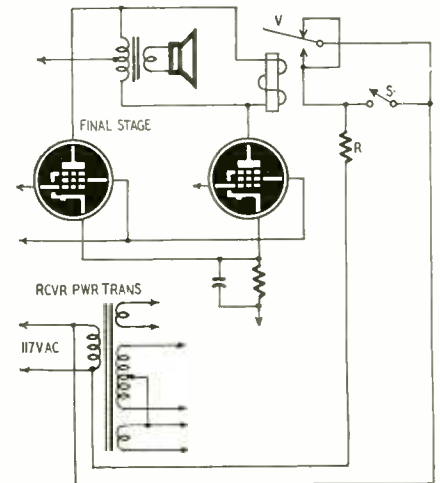

To measure the size of an audience, a 20-cycle signal is superimposed on the program. This low-frequency is inaudible and invisible at the receiver. However, it appears at the output stage and energizes V, which closes its contacts periodically, permitting pulsating current to flow through R. The power substitution measures the pulsating current taken by all equipped receivers. Thus the total number of sets may be computed. The switch S is used for special purposes. For example, listeners may vote for a preferred contest winner by shorting the switch S when requested.

SLOW-RELEASE RELAY CIRCUIT

Patent No. 2,583,328

Thomas L. Dimond, Rutherford, N. J.
(Assigned to Bell Telephone Laboratories, Inc.)

This circuit gives any relay slow-release characteristics. This eliminates the need for copper slugs or special construction where slow release is required. The relay must have two armatures.

With S closed, battery current flows through R2 to energize relay RY. No charge builds up across C because both ends are effectively shorted

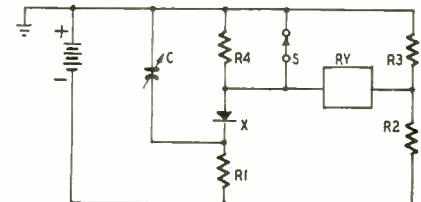

together by the low forward resistance of X. When S is opened, RY remains energized by current through R4, RY and R2. X becomes blocked for a short interval. Its cathode remains at ground potential (since it takes time for C to charge) while its anode goes negative immediately due to current through R4.

The relay holds until C builds up its negative charge through R1. When this charge exceeds the voltage drop across R4, X conducts. This creates a shunt path (through R1 and X) across the relay. It also increases the drop across R4. In time, the resistance of X drops to a relatively low value and the drop across R4 becomes large enough so that the relay drops out. This interrupts its load circuit and ends the timing interval. Release time is controlled by C and R1.

JULY IS HOT... BUT THIS SALE IS HOTTER!

\$55,000.00 Stock of Radio & Television Tubes and Parts — All Standard Makes — All Brand New.
 WE OVERBOUGHT — WE'RE STUCK • • • THE PRICES SPEAK FOR THEMSELVES

<p>RADIO & TV TUBES STANDARD WELL KNOWN BRANDS Some in thousands, others limited, rush your orders in — first come, first served.</p> <p>At 39¢ each, 35Z5, 35W4, 5Y3, 6AL5, 37, 39, 80, 6F5, 6X5, 12SJ7.</p> <p>At 49¢ each, 5U4, 6H6, 6K7, 6SQ7.</p> <p>At 59¢ each, 1LD5, 0Z4, 3V4, 6AT6, 6SA7, 6SK7, 117Z3, 43, 12SF7.</p> <p>At 69¢ each, 1H5, 1Q5, 1T4, 1T5, 6C4, 6C5, 6AB4, 6AU6, 6BE6, 12SK7, 12SA7, 50L6, 6K6, 6BA6, 6AG5, 6SN7.</p> <p>At 72¢ each, 1LE3, 1S4, 1X2, 3Q4, 3Q5, 3S4, 6CB6, 12AT7, 12AU7, 12BE6, 19T8, 35Y4, 25A6.</p> <p>At 98¢ each, 1A7, 1B3, 1LB4, 5V4, 6AC7, 6AK5, 6J6, 6SH7, 6SL7, 6T8, 6AH6, 6SC7, 35A5, 50A5, 117Z6.</p>	<p>100 ASSORTED TUBULAR CONDENSERS All Are Standard Brands All Are Desirable Sizes \$15.00 Value Only \$4.69</p>	<p>100 ASSORTED 1/2 WATT RESISTORS Just what you use in Radio & TV Repairs. \$12.00 Value Only \$3.97</p>
<p>RCA 12" PM SPEAKER only 160 in stock limit 8 to a customer \$3.42 each</p>	<p>15 ASSORTED RADIO ELECTROLYTIC CONDENSERS \$4.74</p>	<p>100 ASSORTED 1 & 2 watt RESISTORS \$5.86</p>
<p>50L6 OUTPUT TRANSFORMERS 2000 in stock first come, first served 29¢ each</p>	<p>15 ASSORTED TV ELECTROLYTIC CONDENSERS \$6.88</p>	<p>100 Assorted PILOT LIGHTS \$4.83 #44, 46, 47 & 51</p>
<p>5" PM SPEAKER (Alnico #5) 3000 in stock case of 30 99¢ each smaller lots \$1.14 each</p>	<p>100 ASSORTED MICA CONDENSERS \$4.99</p>	<p>100 Assorted SOCKETS \$3.92 Octal, Loctal & Miniature</p>
<p>\$5.00 SAPPHIRE PHONE NEEDLE only a few hundred left 46¢ each</p>	<p>100 ASSORTED CERAMIC CONDENSERS \$4.99</p>	<p>100 Assorted KNOBS \$2.97 Screw & Push-on</p>
<p>CUSTOM-BUILT AUTO RADIOS List price \$59.95 Your choice FORD 1949 to 1952 \$36.78 DODGE 1949 to 1952 CHEVROLET 1951 to 1952 complete</p>	<p>8MF-450V CONDENSER made by top mfr.—lists for \$1.35. 12000 in stock 26¢ each in lots of 100 29¢ each in smaller lots</p>	<p>10 ASSORTED VOLUME CONTROLS \$2.94 best sizes, less switch</p>
<p>TV POWER TRANSFORMER 295 ma, enough power for any TV set limit 3 to a customer \$4.99</p>	<p>10 ASSORTED VOLUME CONTROLS \$2.94 best sizes, with switch</p>	<p>1000 ASSORTED TUBE CARTONS 13.98 small peanut, large peanut, GT Small G, Large G, Extra large</p>
<p>TV SAFETY GLASS 13 3/8" x 16 1/4" \$1.16 each in lots of 10 1 for \$1.67</p>	<p>SELENIUM RECTIFIERS 75 mill 57¢ 100 mill 67¢ 300 mill \$1.39</p>	<p>CRT PLASTIC SLEEVES and RINGS 16" RING 49¢ each 10 for \$3.88 16" SLEEVE 49¢ each 10 for 3.88 19" RING 98¢ each 10 for 7.63 19" SLEEVE 98¢ each 10 for 7.63</p>
<p>10" TV COLOR WHEEL \$5.22 only made to sell for \$27.50</p>	<p>4 PRONG AUTO VIBRATOR Non Synchronous type that fits most auto sets 99¢</p>	<p>ONE POUND OF ROSIN CORE SOLDER 56¢</p>
	<p>RCA DEFLECTION YOKE 60° only 99¢ each</p>	<p>\$24.95 AC-DC RADIO 5-Tubes Superheterodyne Built-in Antenna Beautiful Plastic Cabinet \$13.49 complete</p>
	<p>DEFLECTION YOKE BRACKET 100 or over 8¢ each 14¢ each in smaller lots</p>	<p>LATEST DEFLECTION YOKE Cosine type, 70° powers 16" to 24" CRT \$3.98</p>
	<p>LATEST FLYBACK TRANSFORMER for conversions using single 1B3 \$3.98</p>	<p>TV FILTERS IN SMOKE OR BLUE for 17", 19", 20" or 21" TV \$1.87 each in lots of 10 any asst. \$2.09 each in smaller lots.</p>
	<p>TV OPEN MASKS for 16" round or rect. and 19" round 49¢ each in lots of 10 or over 67¢ each in smaller lots</p>	<p>TV COLOR ADAPTER \$5.36 only made to sell for \$26.50</p>
	<p>TV COLOR MOTOR \$5.68 only made to sell for \$29.85</p>	

#630 CHASSIS \$149.18, KIT \$119.44, CABINET \$39.89, 20" CRT \$39.74, BROCHURE ON REQUEST

You ain't heard nothing yet—take off an extra 5% on orders of \$50.00 or over. This sale closes JULY 31st 1952

BROOKS RADIO & TV CORP., 84 Vesey St., Dept. A, New York 7, N.Y.

DON'T GAMBLE WITH LIGHTNING

Be Sure with Vee-D-X Lightning Arresters



A model and mount for every type of installation



RW-200 TWO-WIRE
\$1.25 List

Most popular two-wire arrester. Exclusive saw-tooth point construction assures positive contact without wire-stripping. Highest quality thermo-setting plastic.



RW-204 FOUR-WIRE
\$1.50 List

Accommodates both standard 300 ohm transmission line and four-wire rotator line. Similar in construction to RW-200.

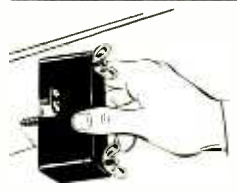

RW-210 TWO-WIRE SCREW-TYPE
\$1.25 List

A new single screw model for fast, easy installation. Appearance and features similar to RW-200. For four-wire rotator line order Model RW-214 (\$1.50 LIST).



RW-200-S TWO-WIRE STRAP MOUNT
\$1.25 List

Has specially engineered strap for non-slip mounting on all size masts or pipes. Similar in construction to RW-200. For four-wire rotator line order Model RW-204-S (\$1.50 LIST).



RW-300 ORIGINAL Heavy Duty TV LIGHTNING ARRESTER
\$2.00 List

First and finest arrester to be introduced to the television trade. A time-accepted standard with TV experts from coast-to-coast. The air gap plus resistors provides double protection. Case of moisture-resistant mica-fill bakelite.



RW-310 NEW OPEN WIRE ARRESTER
\$2.00 List

Similar in construction to RW-300 but designed to accommodate open wire transmission line. Newly designed clips provide positive connections and accurate wire spacing.

VEE-D-X

Makers of the world's most powerful TV antenna systems.

THE LAPOINTE-PLASCOMOLD CORPORATION
Windsor Locks, Connecticut

SEMICONDUCTIVE SWITCH

Patent No. 2,589,704

Wm. E. Kirkpatrick, Chatham, N. J., and Raymond W. Sears, West Orange, N. J. (Assigned to Bell Telephone Laboratories, Inc.)

Germanium and cadmium sulphide crystals can be used as amplifiers and electron switches which are compact, operate instantly, and do not have moving parts.

Drawings a and b (below) show the construction of one of these switches. A thin film of germanium C (only a few microns thick) is evaporated onto an insulating block D. Metal contacts A and B are plated on the semiconductor. The switch is connected in series with a load L and a 10-volt battery (see drawing a). Normally the switch resistance is high, so practically no current flows. Under an electron bombardment, the switch is shorted out and current flows through the load (which may be a relay).

A practical switching arrangement is shown below. Switches S1, S2, S3 are enclosed within an input (collector) cathode-ray tube. An output (distributor) cathode-ray tube contains switches S4, S5, S6. In both tubes the electron beam is con-

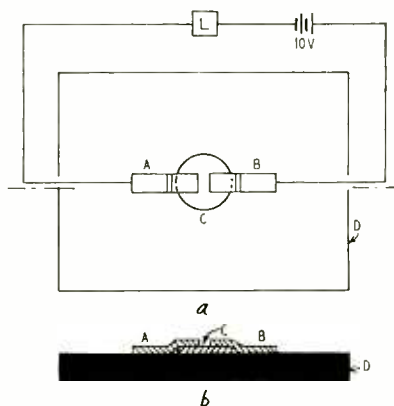

trolled (by deflecting plates) so that it falls on the desired switch. In the illustration the beam from electron gun G1 falls on S2. The distributor beam is shown falling on S5. Under this condition, an input signal at line 2 is passed through S2, T1, transmission line TL, T2, S5, and out through line 5. There is no coupling between any other pair of lines.

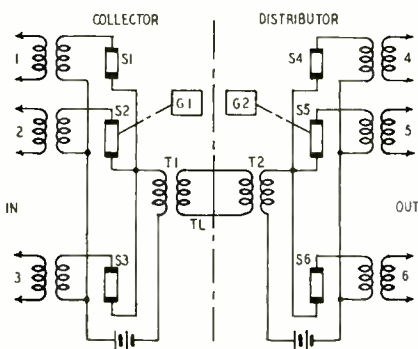

FREQUENCY DIVIDER

Patent No. 2,585,722

Jack A. Baird, Rockaway, N. J.

(Assigned to Bell Telephone Laboratories, Inc.)

Multivibrators are often used to reduce an input frequency by a whole-number ratio like 4, 5, or 6. This new circuit is more stable than a multivibrator because it can divide frequency only by an even integral ratio like 4 or 6. For example, the circuit may be adjusted to divide by 4. Division by 3 or 5 is excluded. The next possible division ratios are 2 and 6. These are so far removed from the desired ratio 4 that even extreme interference cannot upset the divider circuit.

The divider uses two blocking oscillators controlled by a pulse generator G (see diagram). R1, C1 are adjusted so V1 oscillates at slightly less than one-half the pulse frequency. R2, C2 are adjusted for V2 oscillation at about one-fourth

the pulse frequency. The diagram a below shows the positive pulses from G. They occur at times t_0, t_1, t_2, \dots . V1 is triggered at t_0, t_2, t_4, \dots . When this occurs, the tertiary winding T

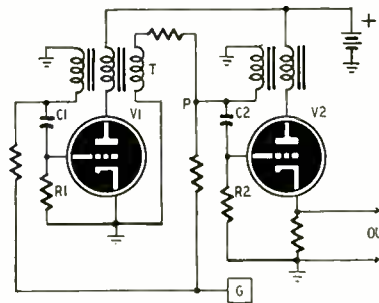

provides a negative pulse which exceeds and overcomes the positive pulse from G.

The pulse voltage at P appears at b. The odd pulses are negative because V1 is triggered at these instants. At other times, the positive pulses from G are unopposed.

The alternate positive and negative pulses at P are impressed upon V2. Waveform c shows how these pulses are superimposed over the grid bias. It is assumed that V2 is triggered at t_1 . Its grid is immediately brought far below cutoff (c.o.) and the voltage rises exponentially as

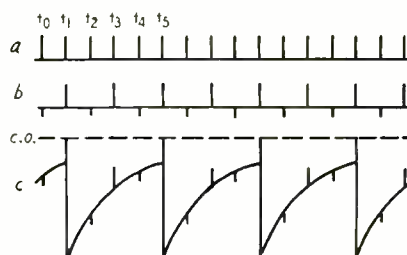

shown. Note that the fourth pulse (at t_5) is sufficient to trigger V2 again. The odd pulses at V2 are negative, so only even pulses can trigger the tube.

METER PROTECTION

Patent No. 2,584,800

George L. Grisdale, Great Baddow, Chelmsford, Eng.

(Assigned to Radio Corp. of America)

This voltmeter circuit protects meter against overload, without effect on the sensitivity or linearity of measurement. The a.c. signal is rectified by X1, filtered, and fed to the tube grid. The meter MA is connected in the diagonal of a bridge network. Two of the bridge arms are formed by the internal resistance of the tube and the adjustable resistor R. The third is R1, R2, and the fourth arm is R3, R4. With no signal at the grid, R is adjusted to balance the bridge.

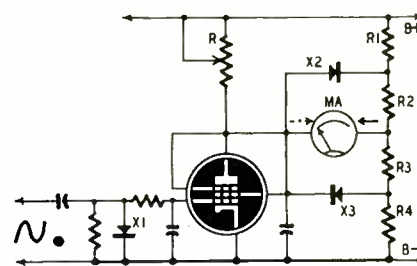

Bleeder current flows through R1, R2, R3, and R4. The drop across R3 blocks rectifier X3. The drop across R2 blocks X2. Normally, therefore, MA is unshunted and sensitivity is not lost.

An overload current may flow through the meter in either direction. For example, a large negative signal at the grid will increase the tube resistance. Then there will be an excessive electron flow through the meter in the direction of the full arrow. On the other hand, too high a value of R or some defect in the bridge circuit may force excessive current through the meter in the direction of the dotted arrow.

In the first case, the overload unblocks X2, and part of the meter current is shunted through this rectifier. In the second case, X3 is unblocked and again the meter is protected by the shunt.

WIDE RANGE A.F. OSCILLATOR

Patent No. 2,583,649

William R. Hewlett, Palo Alto, Calif.
(Assigned to Hewlett-Packard Co.)

This invention deals with a Wien bridge oscillator in which R alone is varied. In a conventional instrument the control element is changed over a 10:1 ratio. This is shown in

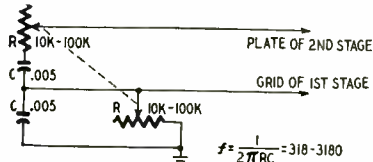

Fig. 1

Fig. 1. The equation given here shows that frequency will vary over a range of 1 to 10. For example, this particular network (followed by the usual two-stage amplifier) provides output from 318 to 3,180 cycles.

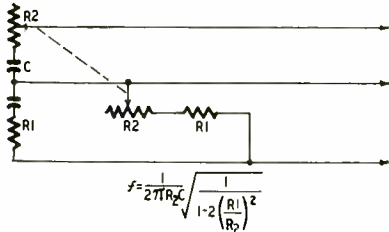

Fig. 2

Fig. 2 is a modified circuit for extended range. R may vary 10:1 as usual, and its minimum value may be 3/2 R1. Under these conditions the lowest frequency will be nearly equal to that of Fig. 1. At the high end, however, frequency is extended by the factor 3.

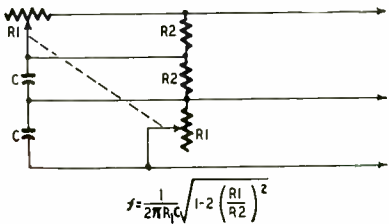

Fig. 3

Another modification appears in Fig. 3. Here the maximum value of R may be 2/3 R2. Using the equation for this figure we find no change at the h.f. end. The low end of the range is extended by the factor 3.

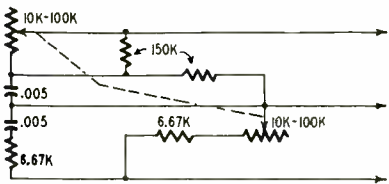

Fig. 4

The two previous circuits are combined in Fig. 4. Frequency range is extended in both directions. With the values given, the coverage is 106-9,540 cycles in a single range and with only 10:1 variation of R.

CORE-LOSS TUNING

Patent No. 2,579,996

Loy E. Barton, Princeton, N.J.

(Assigned to Radio Corp. of America)

This invention discloses an efficient and sharply-tuned i.f. transformer. Its cores are of magnetic ferrite. Considerably power is absorbed by these magnetostrictive cores at their resonant frequencies. The core losses are made to occur at adjacent channel frequencies, thus improving the selectivity of the transformer.

The transformer coils are tuned in the normal manner. In a typical AM receiver, the center i.f. may be 455 kc. The primary core may resonate at 445 kc and the secondary core at 465 kc. The dotted curve shows ordinary i.f. transformer response. The solid curve shows response when the new cores are used.



THOUSANDS ARE RAPIDLY LEARNING ABOUT ITS OUTSTANDING FEATURES SUCH AS: SHARP, CLEAN "SNOW-FREE" PICTURES

And

- Correct impedance for "ghost-free" reception. Nominal 300 ohms.
- Lower in cost than other leadlines purported to accomplish same results.
- Correct spacing for minimum radiation loss. Less than 1% of operating wave length.
- Fully insulated—approved by safety experts.
- Pure, unadulterated polyethylene insulation—specially treated by our chemists for extreme weather.
- High-efficiency conductors: Flexible, stranded—to insure long life.
- Easily installed—with standard insulators.
- Packaged in convenient lengths: 100', 250', 500', 1,000', 2,500'.
- AT YOUR DEALERS, or Write For Free Samples and Literature.

*Patent Pending *Trade Mark U.S. and Foreign Patents Pending
EXCLUSIVE LICENSEE AND SOLE MANUFACTURER

Don Good, INC.

1014 FAIR OAKS AVENUE
SOUTH PASADENA, CALIFORNIA

OTHER OUTSTANDING GOODLINE PRODUCTS:

VARIABLE TELETRAPS-2: Highly effective for eliminating interference from FM STATIONS, and DIATHERMY and AMATEUR SIGNALS within its tuning range.

HI-PASS FILTER: Eliminates or greatly reduces interference picked up by I. F. AMPLIFIER or TV RECEIVER—interference arising from strong, local low-frequency fields: X-Ray, Diathermy Equipment, Neon Lights, Etc., Etc.

So You Want To Be A Writer!

That idea you may have for writing a technical book is absolutely no good unless you do something about it. If you're dying to reveal all you know about TV; if you feel the world is wasted without your words on servicing, or if you nurture a secret ambition to out-theorize all the books on TV theory, then start your writing career by writing to us. Just send us a letter outlining your ideas. Our reply will contain a copy of our author's guide and details of royalty payments.

Book Dept.
RADCRAFT PUBLICATIONS, INC.

25 West Broadway,
New York 7, N. Y.



"CONICAL-V-BEAMS"

*REGISTERED TRADE MARK

"BAT WING"



by *telrex* — the finest TOP-OF-SET antenna ever produced!

SUPER-PERFORMANCE! Beyond a doubt, the finest top-of-set TV antenna ever offered the trade. Outperforms any other indoor type and requires no tuning or pruning. No fuss, bother or time consuming adjustments. **SUPERIOR STYLING!** Featuring modern design that enhances any living room. Rich aluminum elements are mounted on a finely finished, tip-proof base. **WRITE FOR NEW LITERATURE** with complete information on the whole Telrex line for TV, UHF and FM.

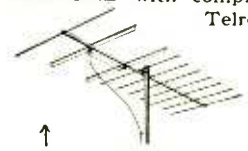

CLOVER-V-BEAM E-Z RIG design. A high gain, compact array for attic or outdoor installation.

NEW! Telrex "FISHBONE". Ten WORKING elements. Guaranteed to outperform any yagi on the market.



NEW! "CONICAL-V-BEAMS" WITH HI-V-REFLECTOR Standard on all Maranch and Universal Series antennas.

"CONICAL-V-BEAMS" are covered by Patent No. 23,346 CANADIAN and FOREIGN PATENTS PENDING



telrex INC.
CONICAL-V-BEAMS

AMERICA'S OUTSTANDING TELEVISION BEAM

ASBURY PARK 9, N. J.

The frequency of maximum loss is determined by the core dimensions. For an i.f. of 455 kc, cores are approximately $\frac{1}{16}$ inch square and $\frac{1}{4}$ inch long. Each is ground to its exact frequency, like a quartz crystal.

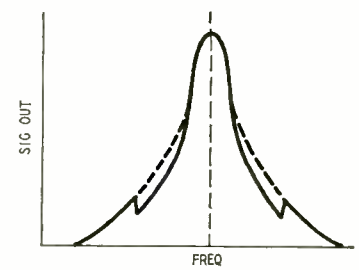

Normally each core would undergo a complete magnetic cycle during each half-cycle of i.f. Thus the core would resonate at twice the i.f. To prevent this, a permanent magnet biases each core.

TRANSIENT CONTROL

Patent No. 2,585,069

Hans K. Ziegler, West Long Beach, N. J.
(Assigned to United States of America as represented by the Secretary of the Army)

This invention absorbs transients which arise when a voltage is switched on and off. Due to resonance effects, the transient may reach a dangerous peak which may break down capacitors and other components. The figure shows the control circuit which includes a rectifier network and a capacitor C2.

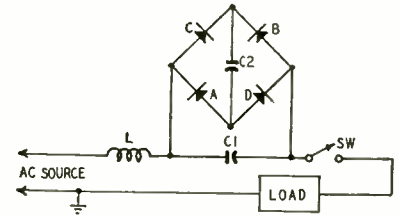

The a.c. source may be a PM generator which feeds a load through a transmission line. To offset the inductance of the generator and line (represented by L) a capacitor C1 is connected in series. This capacitor is endangered when a transient peak is generated.

When SW is closed, a transient may occur. Assume that its first half-cycle is positive. Then it blocks A and B, while permitting C and D to conduct. During this short time, C2 is effectively in parallel with C1, adding to the total capacitance. C2 is large enough to absorb much of the transient charge and prevent it building up a high voltage peak. After a short interval, the transient subsides and the charge on C2 leaks off. Each rectifier normally has high resistance and C2 is effectively isolated from the remainder of the circuit.

When SW is opened, another transient occurs. Again C2 is momentarily shunted across C1 to absorb the charge and prevent a peak from building up across capacitor C1.

WIDE RANGE A.F. OSCILLATOR

Patent No. 2,583,943

William R. Hewlett, Palo Alto, Calif.
(Assigned to Hewlett-Packard Co.)

This invention is similar to the one described in Patent 2,583,649. This one is applicable to Wien-bridge oscillators where C (instead of R) is the control element.

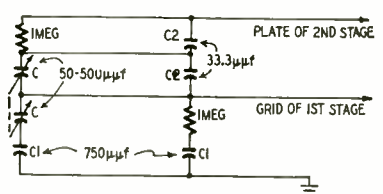

The figure shows a preferred form of the new network. With the values shown, the frequency range is 106-9,540 cycles.

—end—
RADIO-ELECTRONICS

NEW! MOSLEY DUAL-MATCH TV COUPLER . . .

. . . OPERATES 2 TV SETS FROM 1 ANTENNA!

IDEAL FOR:

- Two Family Homes
- Apartments
- Other Multi-Set Installations



Here's a real convenience for folks who have an extra TV set in their play-room, den, or elsewhere. It's the new MOSLEY Dual-Match TV Coupler that permits two TV sets to operate from just one antenna—without one set interfering with the other. The Dual-Match is efficient, compact and low in price. It is easily installed without solder to standard 300 ohm transmission line.

The Dual-Match is available at most TV Dealers and Jobbers. Ask for Catalog Number 902—the New MOSLEY Dual-Match TV Coupler. List Price, only \$3.95

MOSLEY ELECTRONICS
2125 Lackland Road Overland, Missouri

For the **clearest** picture of campaign progress...



Rauland PICTURE TUBES

Man, what a year for TV—and TV service profits! The richest menu of regular attractions ever offered to viewers... PLUS the party conventions, the campaign, the elections and inauguration! When viewers need replacement picture tubes, they'll want them fast—and good.

So remember that Rauland alone

offers these replacement profit advantages:

- The *most complete* line of replacement picture tubes... a far better supplement for your regular tube line than a second line of receiver tubes.
- The faster, *surer* installation adjustment made possible by the patented Indicator Ton Trap.

- The dependable, uniform *extra* quality that so many smart service men depend on for assured customer satisfaction.

Remember, Rauland research has developed more "firsts" in picture tube progress since the war than any other maker. And this leadership pays off... in your customers' satisfaction.

THE RAULAND CORPORATION



Perfection Through Research

4245 N. KNOX AVENUE • CHICAGO 41, ILLINOIS



RCP leads the field
again—with the finest.

MIDGETSCOPE

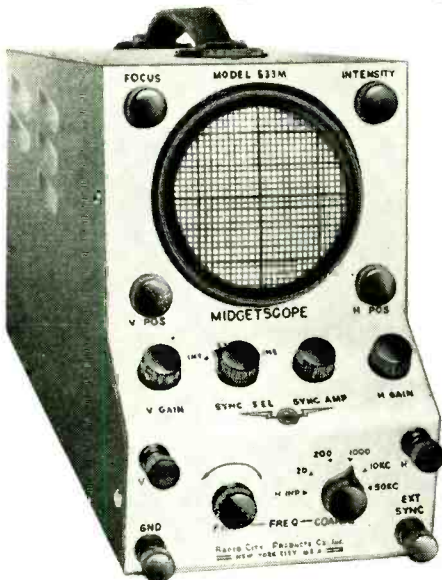

MODEL 533M

THE MIGHTY MIDGET

Here is a truly miniaturized professional oscilloscope with which greater convenience of operation has been accomplished. It is a new concept in electronic oscilloscopes.

This 3" scope packs a high sensitivity, wide band response instrument within its tiny light weight frame.

Check this performance:

SENSITIVITY

Vertical—20 millivolts (.020 volts for 1" rms deflection on CRT face.)
Horizontal—.6 volts.

FREQUENCY RESPONSE

2 db from 20 cycles to 150 kilocycles. Excellent Transient Response.

PUSH-PULL DEFLECTION

For undistorted Response—Eliminates Parallax. Full Vertical and Horizontal Expansion of Trace.

INPUT IMPEDANCE

Vertical—.5 megohms shunted by 50 MMF.
Horizontal—1 megohm shunted by 70 MMF.

TUBE COMPLEMENT

12AT7, 12AU7, 12AX7, 6J6, 11Z76, 3MP1 CRT

In metal case with leather handle—Etched Panel—Smart brushed aluminum face—Fuse protected—for 105-125 volt, 60 cycle AC operation. Size 1 1/4" x 7 3/4" x 5 1/8". Wt. 9 lbs.

MODEL 533M—
ready to operate...
complete,

\$99.50
NET

Write for our latest catalog on the RCP line to Dept. RE-7

RADIO CITY PRODUCTS CO., INC.

152 WEST 25th ST.—NEW YORK 1, N. Y.

Available Now! . . .
The Revolutionary NEW
SONAR SR-9 Receiver
and

SONAR MB-26 Transmitter
Specially designed for today's needs in
CIVIL DEFENSE

and other medium range radio communications.
Not just a monitor, but a compact 9-tube super-heterodyne receiver and a comparably efficient transmitter for dependable 2-way operation.

Write for specifications and prices
IMMEDIATE DELIVERY

WANTED

RADCOM pays highest prices for surplus equipment, parts and tubes. We need TCS-7 and up; SCR 274-N; SCR 399 equipment; BC 312, 342 and 348 Receivers; SCR 522 equipment; SCR 211 frequency meters and RA-34 rectifiers.

Blgelow 3-5434 — Blgelow 3-6610

Always Right With Earl White

RADCOM Engineering Co.

8 Livingston St.
Newark 3, N. J.

Try This One

PRECISION RESISTORS

When winding precision resistors by hand, the usual procedure is to solder the resistance wire to the terminals and then check the resistance on a bridge. We have noticed that thermoelectric effects cause erroneous readings as long as the soldered joints are slightly warm. Instead of waiting for the joints to reach room temperature, we use the following procedure when winding resistors:

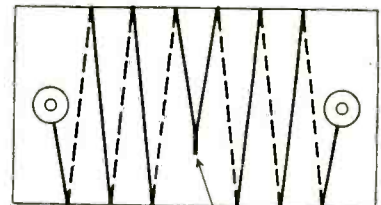

LENGTHEN SOLDER JOINT TO LOWER RESISTANCE

The resistance wire is cut slightly longer than necessary, then it is cut in the middle. The ends of the halves are permanently fastened to the terminals and the inside ends of the wires are then soldered together. The resistance is reduced to precisely the desired value by lengthening the soldered joint as shown in the illustration. With this type of construction, the thermoelectric effects are equal and opposite so they cancel.

If the resistance wire is difficult to solder, try wrapping the joint tightly with No. 30 tinned copper wire before soldering.—Martin J. Brick

SAFETY AND ELECTRIC TOOLS

Portable electric saws, drills, sanders, hedge clippers, and other devices which we use every day are potential killers when we do not take steps to protect ourselves against electrical shock. Most of these appliances have an extra wire protruding from the rear of the line plug. This is a ground wire which is attached to the metal frame of the motor or housing of the equipment. It is a good idea to check this connection with a low-range ohmmeter. The wire is included as a safety measure to protect the operator if one of the power leads should short to the frame.

Never operate such equipment without first grounding the third lead. Solder it to a length of heavy flexible lead which terminates in a large battery clip for connecting to a convenient water pipe or electrical conduit, or a short length of metal rod pointed at one end so it can be pushed into the earth. If the appliance does not have a ground wire, install one. The third wire can be connected to the metal body of the device and taped to the outside of the power cord.

For safety in the household, connect a good ground lead to the motor on the wife's washing machine, ironer, electric mixer, and any other appliance which she uses while standing on a concrete floor or when working near the kitchen sink or wash basin.—Norris C. McKamey

IMPROVED ALARM SYSTEM

Here is an improvement in the circuit of the capacitance relay described by Ernest J. Schulz in RADIO-ELECTRONICS for July, 1950.

By using a commercial 456-kc b.f.o. transformer (Meissner 17-6753 or equivalent) for the oscillator coil, and shunting it with a .002- μ f capacitor as shown below, the oscillator frequency

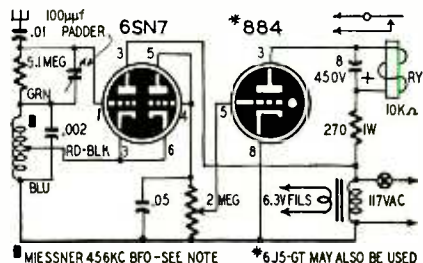

is brought low enough to avoid i.f. or r.f. interference in modern broadcast receivers. The unit shown in the photos uses the chassis and relay from a surplus BC-357-B marker-beacon receiver.

The antenna may be a wire around the object to be protected. A screen door or window screen makes a very sensitive antenna or "feeler."

—J. Francis Nielsen.

SIMPLE TEST FOR METERS

When it is necessary to test an ammeter or voltmeter for burnout, and no battery or other voltage source is available, proceed as follows: In the case of an ammeter, disconnect any shunts connected across the meter coil, whether inside or outside the case. Then, shake the meter sharply and note the pointer deflection. Place a short circuit across the meter terminals. With a voltmeter, be sure to get the short directly across the coil, leaving out any internal or external multipliers. After this is done, shake the meter as before and again note the pointer movement. If the meter coil is good, the deflection will be much less than before. This reduction is caused by electromagnetic damping by currents induced in the coil when the pointer swings. These currents flow through the coil and across the short-circuited terminals. However, if the coil is burned out or otherwise open-circuited, these currents cannot flow, and thus there is no reduction in deflection.—
Charles Erwin Cohn.

—end—



JULY, 1952

**DON'T throw it away...
Weak Picture Tubes CAN
be Saved!**

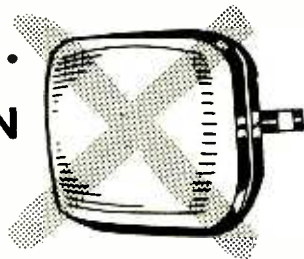

Use a
**Picture Tube
Rejuvenator**

Simple Plug-in Unit
Permanent Hook-up
No Exposed Wires
Usable on All Size Tubes
Automatically Operated
Only \$3.85 Dealer Net
Available at Local Jobbers

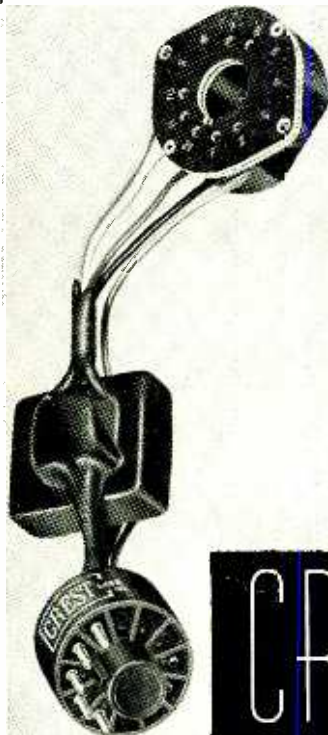

LABORATORIES, INC.

WHITEHALL BUILDING
FAR ROCKAWAY, NEW YORK

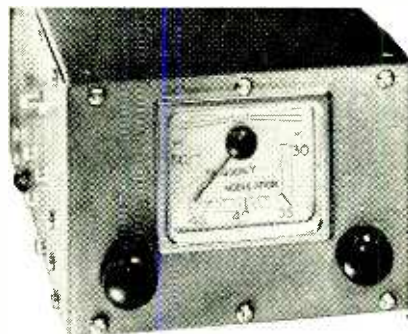

**Model
M-51**

for emergency communications

USED BY HUNDREDS OF MUNICIPALITIES FROM BOSTON, MASS., TO ALHAMBRA, CAL.

POLICALARM MONITORADIO

5 Models For All Systems
6 VOLT MOBILE

M-51
Tunable 30-50 MC
M-101
Tunable 152-163 MC

Says S. L. Grant, City Manager, Winchester, Virginia . . .

"I think you have a receiver that is well built, and I see no reason why it should not be in demand by all public works departments that have a transmitter available."



Users of FM 2-Way Radio Communications equipment throughout the entire nation, find Policalarm and Monitoradio a welcome innovation to low-cost mobile communications radio .

115 VOLT AC-DC
PR-31
Tunable 30-50 MC
PR-8
Tunable 152-163 MC
AIRCRAFT
AR-1
AM Tunable 108-132 MC
115 Volt AC-DC

For Complete Information: See Your Jobber—Or Write Us Today

RADIO APPARATUS CORPORATION

55 N. NEW JERSEY ST., INDIANAPOLIS 4, IND., PHONE: ATLANTIC 1624

110V. AC THYRATRON REMOTE CONTROL

For Less Than Cost of the Relay Alone!

A \$16 Value — Yours For \$3.88

Manufactured by Nationally Famous firm. Sorry, we can not mention name



Size 5 3/4" x 5" x 3 1/4"

Remote Control Unit Contains;
 Plate relay worth.....\$4.00
 Filament Transformer Worth. 2.50
 Controls, Resistors, Sockets,
 Condensers, Chassis Worth. 10.00

Total Value Parts Alone. \$16.50

\$3.88

No C.O.D. Postpaid
 in U.S.A. only

FREE!!

A complete circuit diagram sent with each unit

Here's absolutely the greatest electronic buy in years! We were able to pick up these amazing units at a fraction of the manufacturer's cost and we're passing on this tremendous savings to radiomen who appreciate a genuine bargain. Adapt them for 1,001 uses, or use 'em for parts. Total value of its parts alone is \$16.50—yet for only \$3.88 (less tubes) you get a completely wired and tested 110 volt, 60 cycle AC Thyatron Circuit Remote Control.

These fine Thyatron precision thermostatic controls can be modified by you easily and quickly for electronic remote control of;

Transmitters; Turn Radio or TV on and off; Remote control of Appliances, Machinery, Power Tools; Remote Control for Model Railroads, Planes, Boats, Trucks; Burglar, Fire, Temperature and Rain Alarms; Poultry Brooder Controls; Remote Thermostatic Controls etc. Your own ingenuity can devise many more interesting and practical uses which this remarkable unit can control for you.

No C.O.D. Postpaid in U.S.A. Only 110 Days Net to Rated Firms! Send Check or Money Order Only.

MANUEL KLEIN CO. 94-R CHAMBERS ST. NEW YORK 7, N.Y.

it's the new
TANCO
 twin-driven
Silver Streak

send for complete technical information

TECHNICAL APPLIANCE CORPORATION
 SHERBURNE, N. Y.

In Canada: Stromberg-Carlson Co., Ltd.
 Toronto 4, Ont.

ONE-TUBE INTERCOM

This simple two-station intercom is ideal for use between the kitchen and garage or any other points in the average home. It is easy to build. The parts can be purchased for about ten or twelve dollars.

A 117N7-GT is used as a half-wave rectifier and audio amplifier in the master unit. See Fig. 1. The remote station consists of a small speaker and a 2-position switch connected to the master through 3-conductor cable.

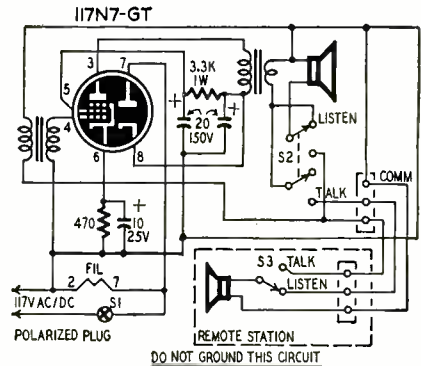

Fig. 1—Circuit of the 1-tube intercom.

S1 is a s.p.s.t. toggle or rotary switch. S2 and S3 are spring-return, nonshorting rotary switches. They are shown in the normal positions in the diagram. The input transformer matches the 4-ohm speakers to a grid and the output transformer matches the 3,000-ohm plate of the output tube to the voice coils.

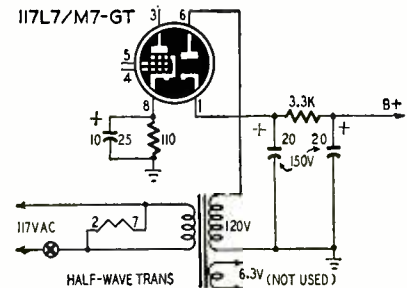

Fig. 2—Safe, more satisfactory hookup.

To minimize shock hazard, all returns should be made to a single B-minus point which is insulated from the chassis. The power cord must be fitted with a plug polarized so the B-minus bus is always connected to the grounded side of the power line.—
 Frank W. Smith

(In cases where the unit will not be operated on d.c. lines, we recommend substituting a 117L7/M7-GT with its heater and rectifier circuit connected as shown in Fig. 2. The transformer isolates the B-minus circuit from the power line, thus eliminating the possibility of a shock from this source. The power transformer may be a Merit P3045, Thordarson T-22R12, or equivalent. Do not attempt to operate the heater from the secondary side of the transformer because most inexpensive units of this type cannot stand the added drain of the 90-ma heater.

SPECIAL!! 6 TUBE AC-DC KIT

At Last! A low-priced kit designed for high sensitivity, excellent selectivity and good tone quality. Uses 25L6, 25Z6, 6SQ7, 6SA7, 6SK7, 6SK7 in an easily constructed circuit. The 6 Tube Kit is shipped with all parts, including punched chassis, resistors, condensers, coil, sockets, PM Speaker, hardware, etc.
And at a closeout price of only **\$6.95**
X182 less tubes and cabinet

X183 Extra for matched set of six tubes for kit **\$3.25**

5 TUBE AC-DC SUPERHET KIT

Five tube superheterodyne kit, A.C.-D.C. contains all components required to construct this latest design, highly sensitive superheterodyne broadcast receiver complete with black bakelite cabinet (excludes wire and solder) Price \$7.95
Extra for a kit of 5 tubes (12A16, 12BA6, 12BE6, 35WA, 50C5). Price \$3.25.

Electronic Code Practice Oscillator & Blinker Kit AC/DC or Battery Operated!

One of the most practical Code Practice Oscillators ever designed, yet one of the simplest to build and operate.
Can be used with any number of headphones.
Adjustable Pitch Control—Any type of headphones can be used.
No warmup time—ready to operate instantly
Simple and safe to operate
Operates anywhere—with AC or DC power, or from a 90 volt Miniature Battery
Learn Blinker Code with flashing light
Blinker can be used as signaling device
International Morse Code included
Kit each **\$2.95** Assembled **\$3.95**

MODEL NFRD—RADIO NOISE FILTER If it doesn't work, send it back!

We absolutely guarantee that our Model NFRD will eliminate all line noises when properly connected to radios, television sets, short wave sets, motors, electric shavers, refrigerators, vibrators, oil burners, transmitters, and all other sources of interference. This unit will carry up to 12 amperes or 1 1/4 KW of power and may be used right at the source of interference or at the radio.
Small size only 2 1/2" x 1 3/4" x 4 1/2". Very low price only
Each **\$1.95**

A SCIENTIFICALLY DESIGNED PHONO SCRATCH FILTER

Resonated at approximately 4500 cycles effectively reducing objectionable needle scratch without altering the brilliancy of reproduction.
Contains a HI-Q SERIES resonated circuit. Tested by means of an audio oscillator and an oscilloscope to give 22 db attenuation with very low signal loss.
EASY TO ATTACH
Just two wires to clip on. Compact
Price **\$1.98**

THREE TUBE PHONO AMPLIFIER

An assembled unit ready for installation using tone and volume control and six feet of rubber cord **\$2.95**
(Not including Tubes)
With Complete Set of Tubes.....\$3.95

PHONO OSCILLATOR

Wireless phono oscillator transmits recording for crystal pick-ups or voice from carbon mike through radio without wires. Can also be used as an intercom by using P.M. speaker as mike.
Price (excluding tubes).....**\$2.95**
With Complete Set of Tubes.....\$3.95

Grab Bag Special, 10 pounds of Misc. Electronic Material—Transformers Condensers, resistor, wire, etc. Price **\$1.95 ea.**

Satisfaction guaranteed on all merchandise
All prices subject to change without notice.

Write for FREE Catalog.

RADIO DEALERS SUPPLY CO.

154 Greenwich St. New York 6, N. Y.

All components and connections not shown in Fig. 2 are the same as in Fig. 1, except that the output transformer should have a 4,000-ohm primary.—Editor)

MONITOR-OSCILLATOR

All amateurs should monitor the phone quality and the keying of their transmitters. A novel phone-c.w. monitor and code-practice oscillator is described in *G-E Ham News*. Its circuit is reprinted here through courtesy of the copyright owners, General Electric Company.

The unit uses a 1N48 germanium diode as the detector and a 6BN6 gated-beam tube with grids 1 and 2 operating as a transatron a.f. oscillator for monitoring code signals and code practice. The whole tube operates as an audio amplifier.

When no r.f. signal is present, the current drawn by grid 2 develops a drop across the 500-ohm cathode resistor producing enough bias on grid 3 to cut off the plate current. The arm of the 500-ohm cathode resistor sets the bias on grid 1 so the circuit oscillates. Although this section of the tube (grids 1 and 2) is oscillating, the signal cannot appear in the plate circuit because plate current is cut off by the bias on grid 3.

When the transmitter is keyed, the detector rectifies a part of the r.f. signal and develops a positive bias for grid 3. The oscillator signal then appears in the plate circuit and at the OUTPUT jack. The unit can be used as a code-practice oscillator by inserting a key in the KEY jack and a pair of phones in the OUTPUT jack. Closing the key connects grid 3 to the cathode, thus removing the bias and permitting the plate to pass current.

For phone monitoring, the cathode switch is closed to disable the oscillator circuit. The 6BN6 now operates as a straight a.f. amplifier for signals detected by the 1N48.

The oscillator uses the primary of a universal push-pull audio output transformer. The resistor and capacitor paralleled across one-half the winding may have to be selected experimentally if the transformer you use is of a type other than a Stancor A-3823. Plug in a key and headphones. Increasing the value of the capacitor lowers the pitch and decreasing the value raises it. Decrease the value of the resistor if you hear a tone in the output with the key open. Try progressively smaller resistors until you hear the tone only with

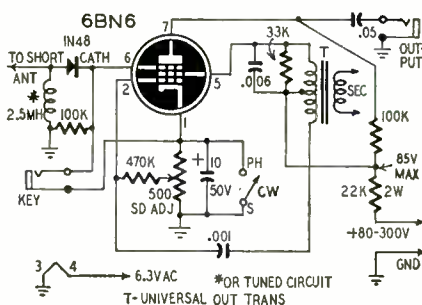

"PACKAGED ENGINEERING"
at Its Best!
For the TV Technician

The B-T MIXER-AMPLIFIER SYSTEM

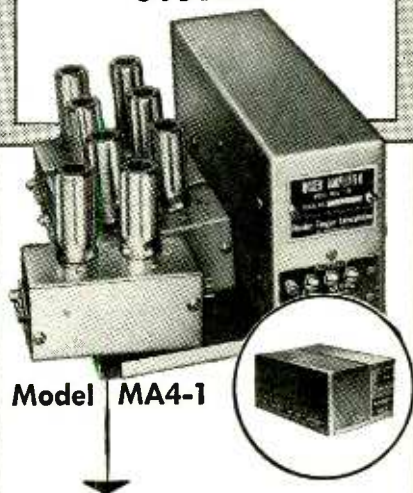

Model MA4-1

For All VHF and UHF Multi-Antenna Problems

Designed for the Service Technician to enable him to plan and make any installation... whether a single receiver or a complete 2000-set Master Antenna System... at lower cost, and without outside engineering.

The B-T MA4-1 is a wide-band, all-channel TV signal mixer for feeding 5 antennas to 1 TV receiver or distribution system. One input is broad-band for signals requiring no pre-amplification, and the remaining 4 accommodate separate plug-in strip assemblies. All terminals have 75 and 300 ohm connections. Several units may be ganged to serve any number of antennas.

B-T PLUG-IN STRIPS

Channel Strip CS-1 is a 2-tube (6AB4-6CB6), single channel, highly selective amplifier with a gain of at least 17 db., one strip for each TV channel.

The UHF Converter, UC-1 is designed for lowering UHF signals to existing TV frequencies, permitting UHF reception on present TV receivers.

Eliminates all need for rotators, separate boosters, converters, and other costly projects.

Once connected the MA4-1 performs without further attention... no switching... no adjustments.

LIST PRICES:

Model MA4-1 (less plug-in strips) **\$52.50**
Channel Strip CS-1 (specify channel) **19.50**
UHF Converters UC-1.....to be announced
Standard RTMA Warranties Apply.



For the Complete "Packaged Engineering" story, ask about B-T Signal Amplifiers and B-T Distribution Amplifiers at your local Distributor, or write to Service Department. F

BLONDER-TONGUE LABS. inc.
Mount Vernon 1, New York

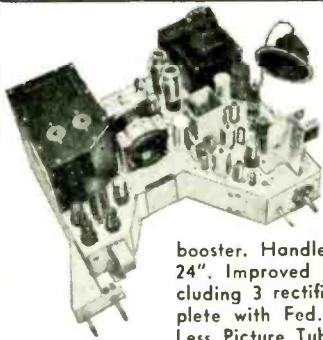

WORLD'S FINEST "630 DX" CHASSIS

Now at New Low Price!

New **CASCADE** tuner assures best reception in fringe areas without a booster. Handles all Cathode Ray tubes from 16" to 24". Improved 30 tube super-quality TV receiver (including 3 rectifiers) mfd. under license by RCA. Complete with Fed. Taxes paid. Less Picture Tube **\$148.50**

- FEATURES:** 4 microvolt sensitivity • Keyed AGC • 3 stage sync. separator and clipper • Automatic brightness control • Mc band width • AFC horizontal hold • Discriminator-type FM Sound system. Stabilized vertical hold • Highest quality parts • Standard brand tubes • Factory wired, aligned and tested.



TRAV-LER 3-WAY PORTABLE

Lots of **\$14.85** ea. of 3

A.C., D.C. or batteries. Built-in loop antenna. Luggage style cabinet. Excellent value.

Less than 3, each \$15.85 Batteries 1.90

STANDARD BRAND TUBES			
Individually Boxed and Guaranteed			
(Manuf. of tubes refuse permission to mention name because tubes are FAIR TRADE)			
1A7	\$0.98	6BG6	\$1.76
1B3	.99	6BH6	.86
1N5	.89	6BK7	1.15
1R5	.87	6BQ6	1.29
IS5	.79	6C4	1.15
1T4	.83	6CB6	.69
1X2A	.78	6CD6	.81
304	.94	6J5	2.39
305	.89	6J6	.98
3V4	.89	6K6	.66
5U4	.63	6K7	.74
5V4	.99	6SA7	.76
5Y3	.47	6S17	.89
6AG5	1.12	6SK7	.76
6AH6	.79	6SL7	.96
6AK5	1.49	6SN7	.89
6AL5	.68	6SQ7	.89
6AQ5	.72	6VGGT	.99
6AT6	.68	6W4	.79
6AU6	.76	6X5	.66
6BA6	.69	7C5	.89
6BC5	.86	7F7	.99
6BE6	.79	7K7	1.19
		7N7	\$0.99
		12AT6	.65
		12AU7	.99
		12AV7	.96
		12AX7	.99
		12BA6	.69
		12BE6	.69
		12SA7	.77
		12SQ7	.99
		14A7	.99
		14B6	.94
		12BQ6	1.29
		25B6	.85
		25W4	.78
		25Z6	.79
		35L6	.86
		35W4	.55
		35Z5	.55
		50A5	.79
		50B5	.96
		50C5	.79
		50L6	.72
		117Z3	.78

Above partial listing only. Send for complete list.

STEVE-EL ELECTRONICS CORP. VISIT OUR NEW STORE

Dept. E-7 61 Reade St., New York 7, N. Y. COrtlandt 7-0086

NEW CONDENSER TESTER



Finds Intermittent Condensers Instantly

Pres-probe's sliding tip with variable resistance prevents condenser heating. Tests with power on. Requires no adjustment. Stops guesswork. Saves time. Convenient probe size (7/8" long). Satisfaction guaranteed.

795 Postpaid U.S.A.

See Your Dist. or Order Direct

PRES-PROBE CO.

4034 N. Sixth St., Milwaukee 12, Wisc.

EASY TO LEARN CODE

It is easy to learn or increase speed with an Instructograph Code Trainer. Aids the quickest and most practical method yet developed. For beginners or advanced students. Available tapes for beginner's alphabet to typical messages on all subjects. Speed range 5 to 40 WPM. Always ready—no QRM.



ENDORSED BY THOUSANDS!

The Instructograph Code Trainer literally takes the place of an operator-instructor and enables anyone to learn and master code without further assistance. Thousands of successful operators have "acquired the code" with the Instructograph System. Write today for convenient rental and purchase plans.

INSTRUCTOGRAPH COMPANY

4701 Sheridan Rd., Dept. HC, Chicago 40, Ill.

Over 43,000 Technicians Have Learned
HOW TO GET THE MOST OUT OF BASIC TEST EQUIPMENT
Why Not You, Too?

SERVICING by SIGNAL SUBSTITUTION

A BEST SELLER FOR OVER 9 YEARS! (NEW, UP-TO-DATE, 12TH EDITION)

The Simple, Modern, Dynamic Speed Approach To Receiver Adjustment and Alignment Problems, AM-FM-TV.

- Nothing complex to learn
- No extra equipment to purchase
- Universal — non-obsolete
- Employs Only Basic Test Equipment

Ask for "S.S.S." at your local Radio Parts Jobber or order direct from factory.

PRECISION APPARATUS COMPANY, INC. 92-27 Horace Harding Blvd., Elmhurst 4, N. Y.

only 40¢

100 pages. Invaluable information that will help you re-double the value of your basic test equipment.

the key closed. Increase the value of the resistor if you don't get a tone when the key is closed.

The monitor-oscillator may be operated from a source delivering 80-300 volts. The 22,000-ohm, 2-watt resistor drops the voltage to a safe value (not more than 85 volts) for grid 2. Higher voltages may damage the tube. Whatever the value of the applied B plus, the dropping resistor must be changed so the voltage at the center-tap on the transformer does not exceed 85. The unit will work when this voltage is reduced as low as 50.

ELECTRONIC FLASHER

The simple electronic flasher shown in the diagram can be used as a flashing danger signal or as a portable stroboscope for timing and checking rotating and reciprocating mechanical parts. Operating voltage is supplied by a 270-volt B battery.

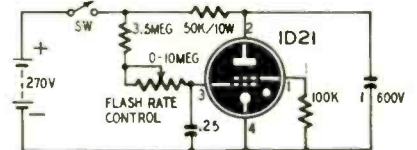

An R-C network consisting of approximately 13 megohms in series with a 0.25- μ f capacitor is connected in parallel with the plate and cathode of the 1D21 Strobotron and the 270-volt supply. The starter anode of the tube is connected to the positive side of the capacitor. When the switch is closed, the 0.25- μ f capacitor starts to charge through the series resistance. When the charge across the capacitor reaches approximately 60 volts, the starter anode ionizes the gas in the tube and causes the 1- μ f capacitor to discharge through the plate-cathode circuit to produce the bright neon-red flash. The flash repeats at a rate controlled by the setting of the 10-megohm potentiometer. — Harry Peach

IMPROVED Q METER

An improved type of Q meter, which eliminates the need for two distinct measurements usually made, has been described in a recent British patent application. The voltage injected into the tuned circuit and the voltage across the tuning capacitor are the separate measurements eliminated, only one null indication being required.

R.f. from the generator is rectified by diode A and a fraction of the rectified output applied through a calibrated

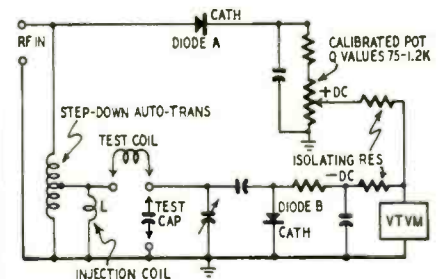

Surplus Outstanding Values



W.E. BREAST MIKE

Single button carbon mike, with breastplate. Very sensitive, complete with 6-ft. plug. **SPECIAL. New \$1.85**

DC AMMETER 0-15 Amps

A terrific buy! 3 1/2" easy reading scale. 75 divisions. Black plastic case 4 1/2"x5 1/4"x2 1/4". Rubber covered test clip leads plus black metal carrying case with hinged cover. Brand new. Wonderful for automotive, battery charging, general test work. Value \$25. All yours for only ... **\$6.95**



SELSYN 2J1G1

Operates from 57 1/2 V 400 cycles. Suggested wiring for 110 V 60 cycle included. Used, tested. Price per pair. **\$6.75**



SCR-274N

COMMAND and ARC-5 Equipment RECEIVERS



	USED	NEW
BC-452-190 to 550KC.....	\$22.95	\$42.50
BC-454-3 to 6 MC.....	11.95	18.95
BC-455-6 to 9 MC.....	11.95	18.95

TRANSMITTERS

BC-457-4 to 5.3 MC.....	12.95	21.95
BC-458-5.3 to 7 MC.....	12.95	21.95
BC-496-3 to 4 MC.....	20.95	39.95
BC-459-7 to 9.1 MC.....	16.95	27.50
BC-456, Modulator.....	3.95	6.95

BC-645 XMTR RECEIVER 15 Tubes 435 To 500 MC



The electronic equipment that saved many lives in the war. Set can be modified to use for 2-way communications, voice or code, on following bands: ham band 420-450 mc, citizens radio 460-470 mc, fixed and mobile 450-460 mc, television experimental 470-500 mc. 15 tubes (tubes alone worth more than sale price!); 4-7F7, 4-7HT, 2-7E6, 2-6F6, 2-6X5 and 1-WE316A. Now covers 460 to 490 mc. Brand new BC-645 with tubes, less power supply in factory carton. Shipping weight 25 lbs. PE-101 DYNAMOTOR for above BC-645\$4.95 UHF ANTENNA ASSY. for above BC-645\$2.45

BRAND NEW \$49.50 each

WILLARD MIDGET 6-V STORAGE BATTERY

3 amp hour rating. Transparent plastic case. Brand new. 3 3/4" x 1 1/8" x 2 3/8", high. Uses standard electrolyte. Each **\$2.85**



WILLARD 2-VOLT STORAGE BATTERY 20 Ampere-Hours



Exact replacement for GE portables for LB-500—BRAND NEW. Each **\$2.69**

GOULD 6-VOLT STORAGE BATTERY

Navy Standard. Black Rubber Case. BRAND NEW. 15 Amp. Hour Rating **\$7.95**



4 VOLT NAVY STORAGE BATTERY 40 amp. hrs. @ 16 hr rate. Plastic case, housed in crackle finished metal case. Brand New. Very special **\$7.95**

ONE-QUART BOTTLE BATTERY ELECTROLYTE

Made by Willard, for above storage batteries. 1 quart sufficient for two 2-volt cells. Hermetically sealed. **SPECIAL. \$1.69** per qt. bottle



7-PRONG 2-VOLT RADIO VIBRATOR for Portable and Farm Sets Replacement for GE. LB 530 **\$1.95**

Please include 25% Deposit with order—Balance C.O.D. MINIMUM ORDER \$3.00. All Shipments F.O.B. Our Warehouse N.Y.C.

GENIE MAJESTIC RADIO PARTS SERVICE
51 VESEY STREET · NEW YORK 7, N.Y.

potentiometer. A known portion of the r.f. is also taken from the auto transformer and injected into the tuned circuit by coil L. (L is very small compared with the test coil). This injected voltage is magnified by the Q of the tuned circuit and rectified by diode B. This second voltage is also fed to the v.t.v.m. through a large isolating resistor.

Note that the first rectified voltage is positive and that the second is negative. When these are made equal by adjusting the potentiometer, the v.t.v.m. indicates a null condition. The circuit Q is then read directly from the calibrated potentiometer dial which covers Q values from 75 to 1,200.

TV ISOLATION AMPLIFIER

The unit shown schematically was designed to permit two TV receivers to be operated from a common TV antenna without interaction between them. Unlike matching pads which are generally used for this purpose, this unit provides appreciable boost in the signal to both sets. It has a built-in a.c. power supply which can be connected across the primary of the transformer in the set so the on-off switch of the receiver controls both units.

The circuit consists of a 12AX7 twin triode, chosen for its high amplification factor and plate resistance. The grid of the input section is fed through a .05-μf capacitor from a balanced or unbalanced transmission line. The grid of the second stage gets its signal from the cathode of the first through a 47-ohm resistor. The output terminals are designed for two TV sets having 72-ohm antenna input terminals. If either set has a 300-ohm antenna circuit, insert a 150-ohm resistor at point X in the grounded side of the amplifier output lead.

The power supply is isolated from the a.c. line by two 6.3-volt filament transformers connected back-to-back. A small half-wave power transformer may

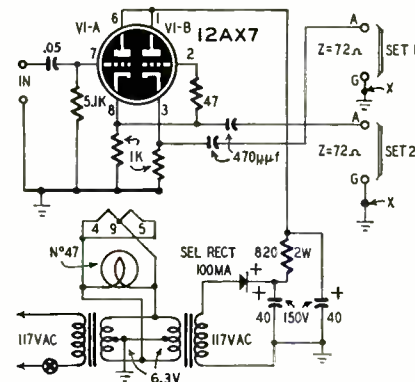

be used instead. We recommend Ohmite resistors for this circuit because we have found that they are more stable and do not develop as much noise as other types.

We have had nearly 200 of these units in service for about two years and have not had a single service call or difficulty with them.—Walt Miller

—end—

ENGINEERS



Make this your home for important work under ideal conditions

- TV Receiver Design Eng.
- Test & Inspection Eng.
- Electronics Eng.
- Field Engineers
- Lab Technicians

TO WORK ON:

Radar, G. C. A., Mobile Radio, Auto Radio, Airborne Communication & Navigation Equipment, Television, Antennas, Microwave Equipment, Servo Mechanisms, Guided Missiles and Test Equipment.

YOU BENEFIT

from high wages, a modern, air-conditioned plant, paid vacations and holidays, group insurance and a good chance for advancement. Housing immediately available in the beautiful suburban and country areas that surround the Bendix plant.

Write Wire, Phone Mr. E. O. Cole, Dept. 5

Bendix Radio

DIVISION OF BENDIX AVIATION CORP.

BALTIMORE-4, MD.

Makers of the World's Finest Electronic Equipment

RADIO-ELECTRONICS is paying good rates on acceptance for original and unusual articles on phonograph, television, FM and AM servicing, as well as articles on industrial electronic equipment and applications. Good constructional stories on receivers or other pieces of electronic equipment can also be used. Send for a copy of our Authors' Guide. Address:

THE EDITOR

RADIO-ELECTRONICS

25 West Broadway
New York 7, N. Y.

You will not require a special adapter for receiving FM signals. You can receive them simply by slightly detuning the converter or the receiver from the signal for best quality. With careful tuning, you will find it difficult to distinguish between AM and narrow-band FM signals.

3FP7 BASING DIAGRAM

? I have a 3FP7 cathode-ray tube and cannot find the base connections for it. Can you help me by showing a drawing of the base connections?—Wm. E., Wheeling, W. Va.

A. The base pin connections of the 3FP7 are shown in the diagram. Since this tube has a long-persistence screen and an intensifier anode, you will find that it is more useful for many applications than the more common types which have P1 or P4 screens. It should serve nicely in an audio analyzer or any other circuit where the sweep is at a comparatively low frequency.

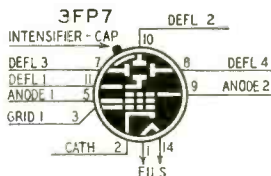

FOREIGN RADIO TUBES

? Are foreign radio tubes available in this country? I am particularly interested in purchasing tube types DAF11, DCH11, DF11, DL11, and UY11. Can you tell me where I can purchase these tubes?—S. S., New York, N. Y.

A. You can purchase many types of foreign tubes from Philips Export Corp., 750 S. Fulton Ave., Mt. Vernon, N. Y. When you write, be sure to give the exact make and model of the set and type numbers of the various tubes.

CONNECTIONS FOR SELSYN

? I have a pair of G-E model 2J1G1 57.5-volt, 400-cycle Selsyns. Can you tell me how to operate them from 117 volts, 60 cycles?—V. M., Federal, Pa.

A. According to information supplied by Harrison Radio Corp., proceed as follows:

1. Connect like-marked terminals of each unit together (R1 to R1, S1 to S1).
2. Connect a step-down transformer delivering 20-35 volts at 60 cycles to R1 and R2. The 117-volt a.c. line with an oil-filled paper capacitor in series with one leg may be used instead of the transformer. If you use a 6-10- μ f capacitor, connect to R1 and R2. For a capacitor from 4 to 6 μ f, break the connection R1-R1 and connect one side of the line to each of these points.
3. To reverse the direction of rotation, interchange S1 and S3.

If you plan to use the Selsyns in a direction-indicating system for a rotary beam type antenna for transmission or reception in the u.h.f. or v.h.f. ranges, you will find details on mechanical and electrical modifications in the *A.R.R.L. Antenna Book* and in a number of articles published in amateur publications during the last six years or so.

TV DIRECT FROM THIS GREAT FACTORY TO YOU
BRINGS YOU
Finest Quality at Lowest Prices



TRANSVISION

TV KITS, WIRED CHASSIS, and SETS
CABINETS, COMPONENTS, INSTRUMENTS, and ACCESSORIES
NEW LOW PRICES
on top quality TV Picture Tubes.

FREE—VALUABLE PREMIUMS:

With every Transvision tube you buy, you get a Merchandise Premium Coupon of real value. Write for list today.

• **TRADE-IN ALLOWANCE** on old tubes: Make from \$2.50 to \$5.00 glass allowance on each "dud."

• **FULL 2 YR GUARANTEE:**

Only Transvision gives you a Guarantee for 24 months.

COMPARE: Get the full details on the Transvision tube deal today.

FREE BOOKLET: "INSIDE CRT, or What You Should Know about Picture Tubes". Written by CRT experts, illustrated. It will **MAKE MONEY FOR YOU. WRITE FOR IT.**



New... TRANSVISION Picture Tube PRICES

Tube Type	Cost WITH GLASS allowance	Cost WITHOUT GLASS allowance
10BP4	\$41.80	\$13.80
12 1/2" Glass (any type)	13.45	15.75
12 1/2" Metal (any type)	13.95	15.25
14RP4	16.50	18.25
16" Metal (any type)	19.90	23.20
16" Round or Rect. (any type)	18.90	22.25
17SP4	18.90	22.25
19" Metal or Glass (any type)	23.95	28.95
20CP4	23.95	31.95

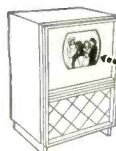

SPECIAL!



REMOTE CONTROL TV CHASSIS

Here's the finest buy in Remote Control TV. Unit is all-electronic; no troublesome mechanical parts. Gives complete operating control of set. Plus—the latest Transvision A-4 Wired TV Chassis; completely aligned; ready to plug in. Has AFC and AGC. Top quality reception, even in fringe areas. 17" A-4 TV Chassis, remote control, and CRT...net \$199. 20" A-4 TV Chassis, remote control, and CRT...net 219. With Du Mont Tuner and FM radio, add... 10

BEAUTIFUL TV CONSOLES

Ideal for Custom-Building or Conversion. Factory prices start from \$49. Send for Cabinet Catalog now.

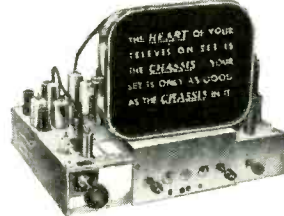

FIELD STRENGTH METER AT NEW LOW PRICE

Improve TV installations; save half the work with the Transvision Field Strength Meter. Especially good for fringe areas—measures field strength as low as 10 microvolts. **\$59 net**
Model FSM-1, complete with tubes.



U. H. F. ADAPTERS

will be available for all Transvision Sets and Kits.

Write for Factory Agent Plan

MULTI-SET CONNECTORS

feed up to 5 TV Sets from 1 Antenna
Prices: Multi-Set Conn. for 2 sets... \$4.95 list*
For 3 or 4 sets... 7.95 list*

*Dealers, write for discounts

FREE: EXTRA INCOME EVERY MONTH from hints in "TV and Electronics Notes." Request sample copy, plate and mailing for FREE Subscription. Monthly issues are gold mines of info on New Products, Sales Service, Conversion, etc. **WRITE DEPT. RE7 TODAY!**

TRANSVISION, INC. NEW ROCHELLE, N. Y.

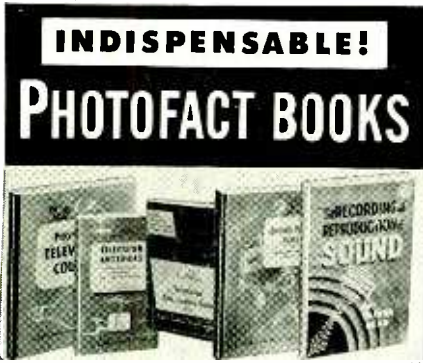

Photofact Television Course. Covers TV principles, operation and practice. 216 pages; profusely illustrated; 8½ x 11". Order **TV-1**.....Only **\$3.00**

Television Antennas. New 2nd edition. Describes all TV antenna types; tells how to select, install, solve troubles. Saves time; helps you earn more. 200 pages; illustrated. Order **TAG-1**.....Only **\$2.00**

Television Tube Location Guide. Volume 2. Accurate diagrams show position and function of all tubes in hundreds of TV sets; helps you diagnose trouble without removing chassis. 224 pages; pocket-size. Order **TGL-2**. Only **\$2.00**

Television Tube Location Guide. Vol. 1. Over 200 pages of TV receiver tube position diagrams on hundreds of models. Order **TGL-1**.....Only **\$1.50**

Making Money in TV Servicing. Tested proved methods of operating a profitable TV service business. Covers all important phases. Authoritative, valuable guide to success. Over 130 pages. Order **MM-1**.....Only **\$1.25**

Servicing TV in the Customer's Home. Shows how to diagnose trouble using capacitor probe and VTVM. Short-cut methods help save time, earn more on outside service calls. Order **TC-1**.....Only **\$1.50**

1949-1950 Record Changer Manual. Vol. 3. Covers 44 models made in 1949, including multi-speed changers and wire and tape recorders. Original data based on actual analysis of equipment. 286 pages; 8½ x 11"; paper-bound. Order **CM-3**.....Only **\$3.00**

1948-1949 Changer Manual. Vol. 2. Covers 45 models made in 1948-49. Paper bound. Order **CM-2**. Only **\$4.95**

1947-1948 Changer Manual. Vol. 1. Covers 40 post-war models up to 1948. Order **CM-1**.....Only **\$3.95**

Recording & Reproduction of Sound. 2nd Edition. New, completely revised and vastly enlarged edition of the outstanding original volume. The most authoritative treatment of all phases of recording and amplification ever written. Over 800 pages. 6 x 9". Order **RR-2**. Only **\$7.95**



Audio Amplifiers. Vol. 3. Clear, uniform, accurate data on 50 important audio amplifiers, plus full coverage of 22 FM and AM tuners, produced during 1950. 362 pages, 8½ x 11". Order **AA-3**.....Only **\$3.95**

Audio Amplifiers. Vol. 2. A complete analysis of 104 well-known audio amplifiers and 12 tuners made 1949-50. 368 pages, 8½ x 11". Order **AA-2**.....Only **\$3.95**

Audio Amplifiers. Vol. 1. 102 amplifiers and FM tuners made through 1948. 352 p. Order **AA-1**.....Only **\$3.95**

Auto Radio Manual. Complete service data on more than 100 post-war auto radio models. Covers over 24 mfrs. 350 pages, 8½ x 11". Order **AR-1**.....Only **\$4.95**

Communications Receiver Manual. Complete analysis of 50 popular communications models. 246 pages, 8½ x 11". Order **CR-1**.....Only **\$3.00**

Radio Receiver Tube Placement Guide. Accurate diagrams show where to replace each tube in 5500 radio models, covering 1938-1947 receivers. 192 pages, pocket-size. Order **TP-1**.....Only **\$1.25**

Dial Cord Stringing Guide. Vol. 2. Covers receivers made from 1947 through 1949. Shows you the one right way to string a dial cord in thousands of models. Pocket-size. Order **DC-2**.....Only **\$1.00**

Dial Cord Guide. Vol. 1. Covers sets produced 1938 through 1946. Order **DC-1**.....Only **\$1.00**

Order from your Parts Jobber or write direct to
HOWARD W. SAMS & CO., INC., 2201 E. 46th St., Indianapolis 5, Indiana
HOWARD W. SAMS & CO., INC.

CRYSTAL PROBES

? Please show circuits of crystal detector probes for use with oscilloscopes and electronic voltmeters.—F. W., Clifton, N. J.

A. Probes for v.t.v.m.'s and scopes are essentially the same. They have a few simple components which can be housed in a shielded can at the end of the cable connected to the instrument for which it is designed.

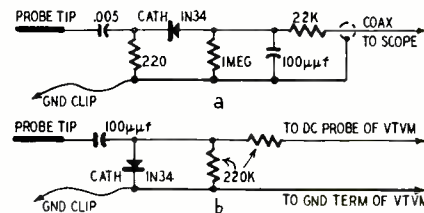

The diagram of a popular detector for a scope is shown at a, and a similar unit for a v.t.v.m. is shown at b. The 220-ohm input resistor shown in a may be increased in value to reduce circuit loading. This will cause some loss in high-frequency response.

YAGI DESIGN DATA

? Please print formulas which I can use to determine element lengths and spacings for a 6-element Yagi antenna for transmitting and receiving in the u.h.f. and v.h.f. ranges.—M. R. S., Memphis, Tenn.

A. The lengths of the elements in inches can be found from the following formulas:

- Reflector = 5880/f
- Radiator = 5544/f
- First director = 5304/f
- Second director = 5256/f
- Third director = 5208/f
- Fourth director = 5160/f

where f is the frequency in megacycles.

The performance of a Yagi antenna depends largely on the spacing between the elements and on the lengths of the parasitic elements. The antenna cannot be simultaneously adjusted for maximum gain and maximum front-to-back ratio. For a good compromise design, space all elements two-tenths wavelength apart. The spacing in inches equals 2361 divided by the frequency in megacycles.

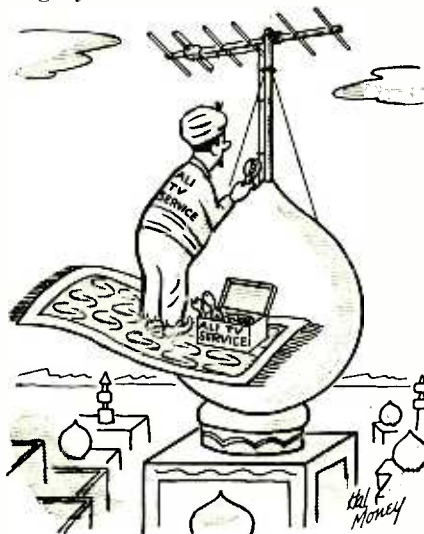

Custom-Quality CR Tubes
 at NEW LOW PRICES!

Ask your Jobber for EBCO Prices

"EBCO" Dual-Purpose CHECKER-REACTIVATOR
 for TV Picture Tubes

A Money Maker For Servicemen:

Check picture tubes for shorts, cathode emission, leakage, etc., without removing tube from TV set. Also PUT NEW LIFE into weak tubes with the REACTIVATING power of this instrument. Lightweight, portable; 110V-60 cycles. Factory-guaranteed.



ASK YOUR JOBBER. net **\$1995**

Dynamic Analyzer
 for TV Picture Tubes

NEW—EBCO Dynamic Analyzer makes your Vacuum Tube Voltmeter the finest CRT Tester. It's the ONLY instrument that performs all vital dynamic tests: checks all socket voltages; checks emission of tube; gives related emission; checks open elements, shorted elements, leakage. Pat. pend. FREE

—Service Engineer's Manual for CRT Testing, with each instrument. **\$7.95** Net



2-SET CONNECTORS

Two-set Connector for TV.....Net **\$2.95**
 Four-set Conn., operates 3 or 4 sets from 1 antenna.....Net **\$4.95**

ASK YOUR JOBBER!

ELECTRONIC BEAM CORP.



RADIO ENGINEERING DEGREE IN 27 MONTHS

Intensive, specialized course including strong basis in mathematics and electrical engineering, advanced radio theory and design, television. Modern lab. Low tuition. Self-help opportunities. Also B.S. degree in 27 months in Aeronautical, Chemical, Civil, Electrical, and Mechanical Engineering. G.I. Gov't approved. Enter September, December, March, June, Catalog.

INDIANA TECHNICAL COLLEGE
 157 E. Washington Blvd., Fort Wayne 2, Indiana

PEN-OSCIL-LITE

Extremely convenient test oscillator for all radio servicing; alignment • Small as a pen • Self powered • Range from 700 cycles audio to over 600 megacycles u.h.f. • Output from zero to 125 v. • Low in cost • Used by Signal Corps • Write for information.

GENERAL TEST EQUIPMENT
 38 Argyle Ave. Buffalo 9, N. Y.

\$3.00 FOR CARTOON IDEAS

RADIO-ELECTRONICS prints several radio cartoons every month. Readers are invited to contribute humorous radio ideas which can be used in cartoon form. It is not necessary that you draw a sketch, unless you wish.

Address
RADIO-CARTOONS, RADIO-ELECTRONICS
 25 West Broadway, New York 7, N. Y.

BLAK-RAY SELF-FILTERING ULTRA VIOLET LAMP



Experimenters have been looking for a reasonably priced Ultra-Violet lamp that would supply a rich quality radiation with minimum power consumption. The BLAK-RAY 4-watt lamp, model X-4, complete with U-V tube, fills these requirements admirably. Over 3000 substances are affected by the so-called "black light" and glow visibly or fluoresce in a weird manner when illuminated by the U-V lamp here illustrated. This lamp gives long-wave ultra-violet radiation having a wavelength of 3654 to 4000 angstrom units. Some of the substances made to fluoresce visibly when illuminated by U-V light are certain woods, oils, minerals, milkstone, cloth, paints, plastics, yarn, drugs, crayons, etc. This lamp is self-filtering and the invisible U-V rays are harmless to the eyes and skin. The lamp is equipped with spectral-finish aluminum reflector. The lamp consumes only 4 watts and can be plugged into any 110 volt 50-60 cycle alternating current outlet. Will give 2000 to 3000 hours of service. It weighs but 1 3/4 lbs. and has a convenient adjustable handle. The lamp is approved by the Underwriters Laboratories and has a built-in transformer so that it may be safely used for long periods when necessary. Extra U-V tubes are available at nominal cost. The outer casing of the lamp is richly finished and very sturdy.

Ship wt. 4 lbs.
ITEM NO. 125
UNUSUAL BUY **\$14.75**

POWERFUL ALL PURPOSE MOTOR



Sturdy shaded pole A.C. induction motor. 15 watts, 3000 rpm. 3"x2"x1 1/4"; 4 mounting studs; 7/8" shaft, 3/16" diameter; 110-120 volts, 50-60 cycles. A.C. only. When geared down, this unit can operate an 18" turntable with a 200 lb. dead weight. Use it for fans, displays, timers and other purposes. Ship. wt. 2 lbs.

ITEM NO. 147
UNUSUAL BUY **\$2.45**

WATTHOUR METER

Leading makes — completely overhauled, ready for service. 100-110 volts, 60 cycles, 2-wire A.C. 5 amp. Heavy metal case 8 1/2" x 6 1/2" x 5". Easy to install. Ship. wt. 14 lbs.



ITEM NO. 33
NOW ONLY **\$4.50**

WESTERN ELECTRIC BREAST MIKE



Lightweight 1 lb. carbon microphone. Aircraft type. Breastplate mounting, adjustable 2-way swivel. Easily fastened straps. For home broadcasts, communications etc. Complete with 6 foot cord, hard rubber plug. Sheradized plate, non-rusting finish. Ship. wt. 2 lbs.

ITEM NO. 152
NEW LOW PRICE **\$1.75**

AMAZING BLACK LIGHT



250-watt ultra-violet light source. Makes fluorescent articles glow in the dark. Fits any lamp socket. For experimenting, entertaining, unusual lighting effects. Ship. wt. 2 lbs.

ITEM NO. 87
A SAVING AT **\$2.45**

HUDSON SPECIALTIES CO.
40 West Broadway, Dept. RE-7-52
New York 7, N. Y.

I am enclosing full remittance for items circled below. (Be sure to include shipping charges.)

OR, my deposit of \$..... Ship balance C.O.D.
MINIMUM C.O.D. ORDER \$5.00.
C.O.D. ORDERS ACCEPTED ONLY WITH 20% DEPOSIT
INCLUDE SHIPPING CHARGES.

Circle Items Wanted
87 147 33 152 125

Name..... Please Print Clearly

Address.....

City..... Zone..... State.....

SINGLE-CONTROL TUNER

? Some time ago you printed a schematic and description of a single-control receiver for the broadcast band. This set has a low-pass filter between the antenna and the grid of the mixer. The only tunable circuit was in the oscillator circuit. Can you tell me where this item appeared?—R. F., Bronx, N. Y.

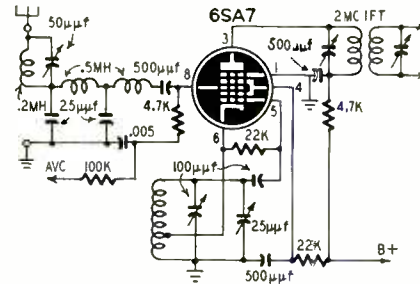

A. The article you are referring to appeared on page 722 of the August, 1945, issue of RADIO-CRAFT. Back copies of this issue are obtainable from this office.

The mixer circuit of this set is shown in the diagram. The low-pass filter in the input circuit passes all frequencies between 100 and 1750 kc. The intermediate frequency is 2 mc. The i.f., second detector, and audio circuits are conventional. The oscillator tunes from 2100 to 3750 kc with a 100-µmf capacitor. The oscillator coil has an inductance of approximately 50µh. A broadcast-band oscillator coil for a 455-kc i.f. system might also be used.

QUERIES ON 16-INCH TUBES

Q. According to the "Picture Tube Replacement Guide" in the January issue, the 16AP4 uses a double-field ion-trap magnet. I have an Admiral 30D1 chassis which has a single-field magnet on this tube. Can you tell me which type beam-bender is correct for this tube?—H. L. H., Van Buren, Ohio.

Q. Your recently published picture-tube guide shows that the 16DP4 uses a double-field ion trap. One manufacturer publishes a folder which recommends a single-field magnet for this tube. Since I am using a 16DP4 in my set, I want to know which is correct.—J. L., Jr., Lorain, Ohio.

A. According to RTMA specifications and to bulletins issued by most picture-tube manufacturers, both these tubes have electron guns designed for use with double-field ion-trap magnets. We have been advised that single-field beam-benders can be used with these and similar tubes, but the magnet strength may be extremely critical on some sets. It may be difficult to get maximum brightness and there may be some difficulty in centering the picture. Similarly, some double-field beam-benders can be used with certain tubes having electron guns designed for single-field magnets.

Manufacturers are probably using single-field magnets whenever possible because of the saving in critical materials.

—end—



Special Offer On This Complete RADIO ENGINEERING LIBRARY

New, Up-To-Date Editions of Famous Library Covers Whole Field of Radio Engineering. Places Latest Facts, Standards, Data, Practice, and Theory At Your Fingertips

The five big volumes of the new edition of the Radio Engineering Library now include the very latest facts, standards, data, and practice. This Library will help solve hundreds of problems for designers, researchers, engineers, and students in any field based on radio.

Written by leading radio engineers, these books cover circuit phenomena, networks, tube theory, vacuum tubes, amplification, measurements, etc.—give specialized treatment of all fields of practical design and application. They provide you with a complete and dependable encyclopedia of facts.

- 5 Volumes, 3872 Pages, 2770 Illustrations
- Eastman's FUNDAMENTALS OF VACUUM TUBES, 3rd Edition.
- Terman's RADIO ENGINEERING, 3rd Edition.
- Everitt's COMMUNICATION ENGINEERING, 2nd Edition.
- Hund's HIGH FREQUENCY MEASUREMENTS, 2nd Edition.
- Henney's RADIO ENGINEERING HANDBOOK, 4th Edition.

SEND NO MONEY

Special Low Price—Easy Terms

On this special offer you get this Library for \$36.50, instead of \$42.50. You save \$6.00 and may pay on easy terms. Mail coupon below to examine the Library FREE for 10 days. No obligation. These books are recognized as standard works; you are bound to need them. So take advantage of this special money-saving offer. Mail coupon at once!

McGraw-Hill Book Co., Dept. RE-7-52
327 West 41st St., New York 18, N. Y.

Send for 10 days' FREE trial, the RADIO ENGINEERING LIBRARY. If not satisfied I will return books. Otherwise I will send \$6.50, plus delivery charges, then; and \$6.00 a month for 5 months. (Reg. price \$42.50; you save \$6.00).

Name.....

Home Address.....

City & State..... RE-7-52

We'll Pay Delivery Charges if you enclose \$6.50 first payment WITH coupon. Same return privilege for full refund.

DRIVING SCREWS INTO PLASTIC

Radio cabinets and similar objects made of thin plastic may be damaged by trying to force a screw into an unthreaded hole. To prevent damage, use the following procedure:

1. Insert the screw into the hole with the fingers.
2. While heating the screw slightly with a soldering iron, turn it slowly clockwise with a screwdriver. Remove the soldering iron when the screw is hot enough to turn easily.
3. Continue to turn the screw in until it is seated in the hole. Turn it back and forth until it has cooled. This prevents the plastic from adhering to the screw when it is finally tightened.—*Crosley Service Dept.*

AIRLINE 84HA-3010A, B, C

A number of circuit changes and improvements have been made since these sets have been in production. Whenever applicable, these changes may be made in sets being serviced.

To improve horizontal sync, install a 47- μ f ceramic capacitor between pins 2 and 4 of V13 (6SN7-GT horizontal oscillator) and change R83 from 5,600 to 6,800 ohms. See circuit at *a*.

For greater white-to-black ratio, add a 2,200-ohm decoupling resistor as shown in circuit *b*, replace R67 (4,700 ohms) with a 2,200-ohm, 1/2-watt resistor. Change connection of C56.

Poor horizontal linearity as indicated by a bulge on the left of the picture may be improved by installing a 20,000-

to 30,000-ohm, 10-watt resistor between pins 4 (or 6) and 8 of damper tube V21.

Definition and focus can be improved by installing cathode bypass capacitor C92—a 470- μ f mica unit, not used in some sets—in the circuit of V10 and by removing R116, the 1,800-ohm, 2-watt resistor in the focus control.

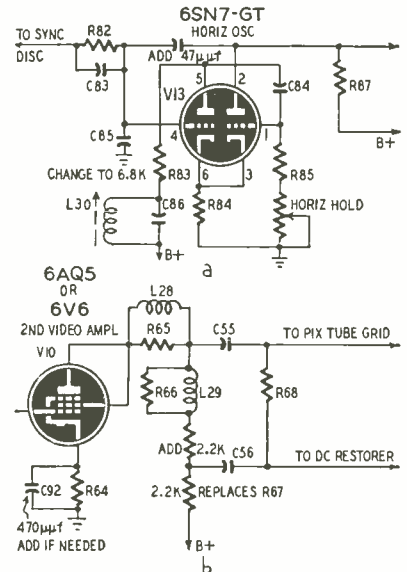

For improved high-band sensitivity, remove the grounding leads from socket terminal 4 of V1 and terminal 7 of V2 and solder these leads directly to the chassis. Remove capacitors C9 and C11.—*Airline Service Manual*

STROMBERG-CARLSON TV SETS

Horizontal pulling in the model 17 series sets may be caused by heater leakage in the 6J6's used as converters in the tuner. Both tubes should be replaced when this condition occurs.

If tube replacement does not help, connect a 50- μ f capacitor between ground and the cathode of the d.c. restorer and sync clipper tube. The cathode of this tube is pin 6 in sets using a 6SN7-GT in this position and pin 3 in sets using a 12AU7.—*Stromberg-Carlson Current Flashes*

WESTINGHOUSE H-338T5U

The set had a bad case of 60-cycle hum which varied with the setting of the volume control and was louder than the audio signal. The trouble was traced to leakage in the 35W4 between the heater pins and pin 2 which is blank. The volume control (see diagram) has a tap for tone compensation. The compensating network consists of a 22,000-ohm resistor and .01- μ f capacitor between the tap and B minus. The junction of the resistor

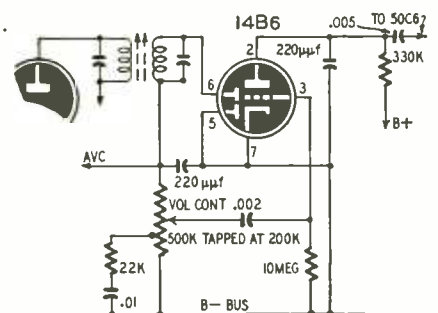

the BIG 10

fabulous
10 element
Yagi

- The highest gain Yagi in TV history: 12 DB single, 14 1/2 DB stacked (78% stacking gain).
- "Boom Braced" (low band) to prevent picture flicker.

600 Series

5 element
Yagi

- Highest gain of any 5 element Yagi: over 9 DB single, 12 DB stacked.
- Full 100% stacking gain!

4

major benefits are provided by Channel Master Z-Match Yagis which are essential to better, more profitable fringe installations. No other Yagi gives you any of them! However, in the Z-Match Yagi, you get all 4 features — at no extra cost.

Write for new catalog

do
you
get
these
Major Benefits

in your present TV installations?

1. Adjustable impedance eliminates mismatch to 300 ohm line in single and stacked arrays.
2. Wider spaced elements, on longer cross-arms, for still higher gain.
3. Up to 100% additional gain in stacking.
4. And you don't pay for stacking bars!

List Prices		
Ch.	600	BIG 10
7-13	7.65	13.89
2-3	17.65	31.94
4-5	16.67	28.47
6	16.67	25.69

MEMBER

CHANNEL MASTER CORP.

ELLENVILLE, N. Y.

ANOTHER NEW
GENSBACK LIBRARY BOOK

Get right
to the heart of
Radio!

RADIO TUBE FUNDAMENTALS

by George J. Christ
Instructor, Div. of General Education,
New York University

Only \$1.00

96 pages
74 illustrations



AT LAST—a complete low-priced
book to increase your understanding
of tubes!

Know tubes and you'll know more about radio! Here's a book that proves it. With a minimum of math, and no engineering jargon, the author, an engineer and instructor, takes you along the road to a clear picture of how and why typical tubes in a modern radio set act as they do. Not just a few isolated paragraphs, but nine big specialized chapters—a complete book—devoted to giving you a sharper and fuller understanding of tubes than you ever thought possible before. Even if you've been servicing sets since neutrodyne days—here's a dollar book that will give you an insight into theory which will actually improve your practical work. And if you're a beginner, RADIO TUBE FUNDAMENTALS is an absolute must! Written for the practical man, it talks about tubes from the standpoint of the technician, not the engineer. It starts with the electron theory and leads you, step by step, from simple diodes to complicated multipurpose tubes. Every rough spot along the way is smoothed out under the clear-cut descriptions of the author. One of the biggest technical book values ever offered for this low price. Order your copy today!

USED AS A REFERENCE TEXT

Radio Course, Div. of General
Education, New York University

Partial list of Contents

- Electrons in motion. Thermionic emission •
- The cathode • Plate current • Space charge •
- Diode load voltage • Ionization • Voltage regulators • The triode • Plate resistance •
- Amplification factor • Oscillation • Gas triodes • Tetrodes • Pentode characteristics •
- Multipurpose tubes • Vacuum and gas phototubes • Vacuum-tube grid bias • Radio Tube applications • Voltage doublers • Detectors •
- Automatic volume control • FM detection •
- Oscillators • Converters • Conversion gain.

Order your copy from your distributor or
MAIL THIS COUPON TODAY

Radcraft Publications, Inc., Dept. 72
25 West Broadway, New York 7, N. Y.
My remittance of \$1.00 is enclosed. Please send me postpaid a copy of RADIO TUBE FUNDAMENTALS, Gernsback Library Book No. 45

Name.....
Street.....
City..... Zone..... State.....

and capacitor is anchored to pin 2 on the socket of the 35W4. Leakage in this tube introduced hum in the grid of the first a.f. tube through the tap on the volume control.

The condition can be cleared up by replacing the 35W4. A permanent cure is to disconnect the components from pin 2 and connect them to an insulated tie-point—Herbert H. Lenk

EMERSON TV SETS

Performance of models 614C, 637A, (chassis 120095B), 650D, 654D, 655B (chassis 120123B), 650F, 654F, and 655F (chassis 120138B) can frequently be improved if the 25.75-mc picture i.f. and the 22.5-mc i.f. bandpass markers are placed at the 50% response points instead of 75% down as shown previously in service notes for these models. The new over-all intermediate frequency response curve is shown in the drawing below.

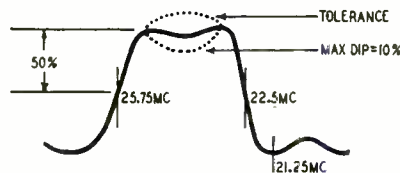

Set the sweep generator for 10 mc sweep width and adjust its output to produce about 0.5 volt d.c. across the 4,700-ohm resistor in the detector load circuit.—Emerson Service Dept.

MICROPHONICS IN RCA 8V151

When shipped from the factory the r.f.-i.f. chassis of this set is clamped to the door of the radio compartment with a shipping bracket. Shipping instructions (packed with each instrument) specify that the bracket should be removed at the time of unpacking. However, since the bracket is not visible from the back of the set, it is generally overlooked. If it is not removed, the rubber chassis mountings will be ineffective and microphonics are likely to occur.

To remove the bracket:

1. Remove the six knobs.
2. Remove the four hex nuts (threaded bushings) which hold the escutcheon in place.
3. Pull off the two push-button knobs which are just above the phono indicator lamp.
4. Remove the phono indicator lamp.
5. Remove the bracket, which is now visible, in the chassis opening for the indicator lamp.
6. Replace the lamp and other parts just removed.—RCA Service Data

WESTINGHOUSE H-242

When the channel selector will not turn beyond a given channel, readjust the oscillator slug for the channel that is opposite it on the front of the tuner. For example: If the selector cannot be turned to any channel higher than 9, reset the oscillator tuning slug on channel 5.—G. N. Manning

—end—

For better, quicker
servicing



USE
Mandl's
Television Servicing

Here are detailed, illustrated instructions for locating and correcting EVERY flaw or failure that may occur in each stage of today's TV receivers. You'll learn simple signal tracing procedures; trade tricks in diagnosing troubles in minimum time; the essentials of successful VHF and UHF servicing; how to trouble-shoot A.G.C. circuits, synchroguide circuits, and all other circuits, including the latest improvements. A complete master trouble index enables you to QUICKLY find the cause of and procedures for correcting any trouble, including those hard-to-find troubles. Hundreds of diagrams, original photographs of flaws as they appear on the TV screen, oscilloscope patterns and other illustrations further aid you in locating trouble, testing, and making adjustments.



Noll's
Television
for Radiomen

Very clear, thorough, non-mathematical explanations of the function and operating principles of every element and circuit in TV reception; how the receiver is constructed; basic principles of transmission; and the techniques of installing, adjusting, and aligning today's receivers, with full instruction on test equipment and its use. Here, in the simplest, clearest terms, is the basic knowledge that is a MUST for good TV work.



AND
Noll & Mandl's
Television
and FM
Antenna Guide

Are fringe area reception, ghost reception, interference your problems? This book shows you how to overcome them—how to improve gain; minimize noise on the transmission line; get the MOST out of the antenna system at any location. It tells how to determine the right type of antenna for the site and the best position for it; gives full data on all types of antennas including those for the new UHF and VHF locations, yagi antennas, stacking, boosters, and other fringe area aids.

NOW MORE THAN EVER, YOU'LL NEED THESE
EXPERT SERVICE AIDS.

SEE THEM ON APPROVAL

The Macmillan Co., 60 Fifth Ave., N. Y. 11 E

Please send me the books checked below. I will either remit in full or return the books in 10 days.

- Mandl's TV Servicing \$5.50 TV & FM Antenna Guide \$6.25
 TV for Radiomen \$7.75

Signed.....
Address.....

(This offer good only within continental limits of U.S.A.)

TEST-ADJUST TELEVISION SETS AT Your CONVENIENCE

Even without station test pattern or in remote, weak signal areas!

A television set will produce a picture only when it is supplied with a COMPOSITE VIDEO SIGNAL. To check any TV set properly, you must have a COMPOSITE VIDEO SIGNAL.

Every TV station sends a COMPOSITE VIDEO SIGNAL when telecasting a program or a test pattern. This COMPOSITE VIDEO SIGNAL is composed of—(1) a synchronizing and blanking signal to lock the free running raster into a frame of two interlaced fields, and—(2) a video signal to control the amount of light and produce the picture (which may be a program scene or a test pattern for analysis purposes).



SUPREME MODEL 665

The SUPREME COMPOSITE VIDEO GENERATOR provides the same type of sync and blanking signal as the TV station—even the equalizing pulses. In addition, it incorporates a video section which generates a special test pattern for analysis and adjustment of TV sets. Other patterns or pictures can be presented by using auxiliary equipment connected to the special "gated" video input section of this versatile instrument. The Model 665 should not be confused with the cross-hatch or bar-pattern generators. The Supreme Model 665 supplies a COMPOSITE VIDEO SIGNAL.

Why lose time and money waiting for that ideal scene or test pattern to check a TV set? In fringe or weak signal areas, you are strictly in the "driver's seat" with a SUPREME COMPOSITE VIDEO GENERATOR. Write SUPREME, Inc., Dept. B-7, GREENWOOD, MISSISSIPPI for descriptive folder.

Our 25th Year

SUPREME

Testing Instruments

"SUPREME BY COMPARISON"

TUBE TESTERS • OSCILLOSCOPES
SIGNAL GENERATORS • MULTI-METERS
FOR RADIO AND TELEVISION

ELECTRONIC LITERATURE

Any or all of these catalogs, bulletins, or periodicals are available to you on request direct to the manufacturers, whose addresses are listed at the end of each item. Use your letterhead—do not use postcards. To facilitate identification, mention the issue and page of RADIO-ELECTRONICS on which the item appears. All literature offers void after six months.

POPULARIZED STORY OF U.H.F. DEVELOPMENT

"U.h.f.—What It Means to Television and to You," is the title of a 24-page history of v.h.f. and u.h.f. telecasting, and RCA's contributions to its development. The behavior of u.h.f. waves is explained in nontechnical language. Many effective illustrations are included.

Available free from the Department of Information, Radio Corporation of America, 30 Rockefeller Plaza, New York 20, N. Y.

LOUDSPEAKER CATALOG AND REFERENCE HANDBOOK

The *Technilog* is a 28-page catalog of University loudspeakers and a handbook on speaker system design and installation. Impedance matching, power requirements and distribution, phasing, acoustics, and baffle construction are covered in the text and in charts and nomographs.

Available free of charge from University Loudspeakers, Inc., 80 South Kensico Ave., White Plains, N. Y.

RACK AND PANEL CONNECTORS

Hugh H. Eby, Inc., has issued an 8-page catalog giving dimensional drawings and detailed descriptions of male and female rack and panel connectors having from 3 to 34 contacts; miniature 5-, 7-, and 9-pin connectors; and watertight and universal binding posts.

A copy of Catalog Supplement No. 1 will be sent on request to Hugh H. Eby, Inc., 4700 Stenton Ave., Philadelphia, Pa.

HIGH-FIDELITY PHONOGRAPH COMPONENTS

A 31-page book "Why Variable Reluctance," describes the construction, characteristics, and use of G-E single-play and triple-play phono cartridges, preamplifiers, styluses, and pickup arms. Schematics, response curves, methods for high- and low-frequency compensation, and full installation data for high-fidelity systems are given. Standard and professional types are covered, and some data on G-E 12-inch speakers is included.

Available at 25 cents per copy from General Electric dealers, or from Electronics Division, General Electric Company, Electronics Park, Syracuse, N. Y.

The Book that takes Drudgery out of Mathematics

Only \$1. postpaid

SOLVES EVERYDAY PROBLEMS HELPS YOU GET AHEAD IN LIFE

How many times have you lost money because of a mistake in figuring? Do you know how to figure quickly and correctly? Can you figure discounts, interest rates, taxes and all the other calculations you meet up with in your daily life?

Are you having trouble qualifying for Civil Service Exams or Armed Services Promotions, because you're not up on mathematics?

ILLUSTRATED

Here is the book that gives you a good background in mathematics; that takes all the irritation and drudgery out of it. You don't need to be scared of mathematics, because here's the subject explained without frills, without useless computations. Here's the book for men in radio jobs; for business men; technicians and craftsmen, explaining and answering everyday mathematic problems in easy-to-understand words and illustrations.

A BOON TO EVERY RADIOMAN

The Radio Technician will find information on the following: Ohm's Law—Resistance—Reactance—Capacities—Inductances.

The valuable tables are multiplication and division table. Squares; Square Roots; Cubes and Cubic Roots Tables. Areas of Circles Table. Common Fractions reduced to Decimal Table. Factors and Prime Numbers Table. Table of Multiples.

Yes, it's the key to a simple understanding of mathematics. It's a real home-study course in mathematics for the man who's alert to its importance in the world today.

ELEMENTARY MATHEMATICS

• EASY — SIMPLIFIED — PRACTICAL •

CONTENTS OF BOOK

- CHAPTER I. Arithmetic—Addition—Subtraction—Multiplication—Division.
- CHAPTER II. Factoring and Cancellation—Fractions—Decimals—Percentage—Ratio—and Proportion.
- CHAPTER III. The Metric System.
- CHAPTER IV. How to Measure Surfaces and Capacity (Geometry).
- CHAPTER V. Powers and Involution—Roots and Evolution.
- CHAPTER VI. Mathematics for the Manual and Technical Craftsman—Thermometer conversions—Graphs or Curve Plotting—Logarithms—Use of the Slide Rule.
- CHAPTER VII. Special Mathematics for the Radio Technician.
- CHAPTER VIII. Commercial Calculations—Interests—Discounts—Short Cut Arithmetic.
- CHAPTER IX. Weights and Measures—Useful Tables.

ONLY \$1. POSTPAID

STAMPS, CASH OR MONEY ORDER ACCEPTED

Send Today for Your Copy of This Indispensable Book. It Can Be Carried Readily in Your Pocket. (Size 6 x 9 in.)

TECHNIFAX,

100 East Ohio St. Chicago 11, Ill.

Enclosed find \$1.00 for which send me ELEMENTARY MATHEMATICS prepaid.

Name _____

Address _____

City & State _____

RE-7-52

Radio Thirty-Five Years Ago
In Gernsback Publications

HUGO GERNSBACK
Founder

Modern Electrics	1908
Wireless Association of America	1908
Electrical Experimenter	1913
Radio News	1919
Science & Invention	1920
Television	1927
Radio-Craft	1929
Short-Wave Craft	1930
Television News	1931

Some of the larger libraries still have copies of ELECTRICAL EXPERIMENTER on file for interested readers.

JULY 1918
ELECTRICAL EXPERIMENTER

Liberty Bell Heard O'er the World Via Radio, by Thomas Reed.

Woman Radio Expert Teaches Draft Men.

Small Portable Radio for Field Work. A Holder for A Tubular Audion.

A Research Type of Detector, by Edward T. Jones.

The How and Why of Radio Apparatus, by H. Winfield Secor.

PLUMBERS' ATOM-SMASHER

Scientific plumbers at Stanford University have laid a thin copper pipeline 220 feet long that carries some of the most extraordinary atom-smashing energy yet created. Stanford physicists, working under an Office of Naval Research contract, designed the pipeline to accelerate electrons to approximately the speed of light.

A large glass cylinder at the base houses a cathode the size of a tomato can. A 400,000-volt, 1-microsecond pulse hits the cathode 60 times a second, starting a beam of electrons down the tube at about 1/3 the speed of light. In the first 12 inches the beam is traveling 180,000 miles per second.

Cavity resonators bunch the electrons, and every 10 feet a Klystron oscillator adds enough accelerating energy to light a city of 35,000.

At 1 billion volts, electrons will hit 99.9999987% the speed of light.

TV ALIGNMENT PRECAUTIONS

Many service technicians disconnect the deflection yoke and disable the high-voltage supply by pulling the horizontal oscillator or output tube when aligning a TV set. Some manufacturers issue warnings against this practice. Pulling the oscillator tube removes the drive from the output tube, with the result that the tube may be damaged.

Disconnecting the deflection yoke from some sets causes the horizontal output tube to draw excessive screen current. This results in damage to the tube, screen-dropping resistor, or both. The boosted voltage may also rise and break down the filter capacitors.

Correct alignment requires that the set be operating under normal voltage conditions. Removing tubes or yoke will cause a change in the bias and plate-supply voltages throughout the set. When a set is aligned under these conditions, the response curves may be far from ideal when the tubes are inserted and the yoke connected.—R.F.S.

TUBES Every Critical Type

Standard Brands • Guaranteed • Individually Boxed

5Y3GT
6AL5
6AR5
6AT6
6AU6
6AV6
6AX5
6C4
6K6GT
12AT6
35Z5GT



1S5
1U5
5U4G
6BA6
6BE6
6CB6
6S4
6V6GT
12BA6
12BE6
25L6GT
35L6GT



1R5
1T4
1U4
3S4
3V4
6AB4
6AG5
6SN7GT
12AT7
12AU7



6AH6—88¢; 6BE6G—\$1.44; 6BQ6—99¢; 6CD6G—\$1.65

Many other types equally low priced—include all your tube needs with your order.

One of the largest stocks in the country!

Min. Order \$25.00. Terms: 25% with order, balance C.O.D. All merchandise subject to prior sale, F.O.E. New York City.

Television Materials Corp.
120 LIBERTY ST., NEW YORK 6, N.Y. • Cortlandt 7-4307

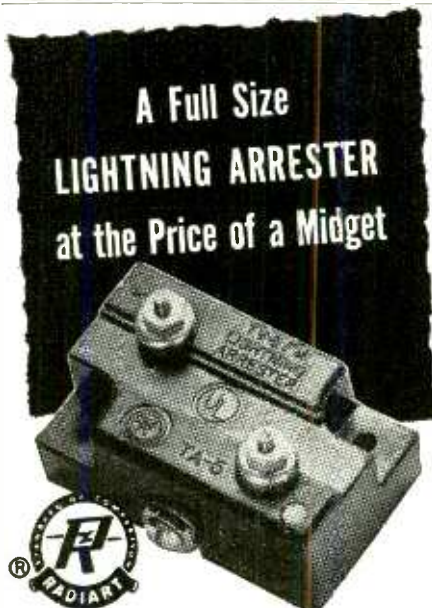

LIGHTNING ARRESTER

MODEL TAs Real protection against lightning and static charges — the RADIART Lightning Arrester has all the features! Fits anywhere... inside or out... handles standard or jumbo leads... no wire stripping necessary... does not unbalance the line... low internal capacity... no loss of signal... internal resistance "leaks off" static discharges! UNDERWRITERS LABORATORIES APPROVED.

THE RADIART CORPORATION
CLEVELAND 13, OHIO

RADIOS 1, 2 & 3 band Electric and gas battery
TELEVISION AC/DC Operation
TEST INSTRUMENTS
Write for FREE Catalog
ARKAY—Radio Kits, Inc.
120 Cedar St., New York 6, N. Y.



OFFICIAL RECORDER OF 1952 OLYMPICS

TWIN-TRAX*

Selected in International Competition by the Olympic Purchasing Commission

Because of their quality, dependability and exceptional value, Twin-Trax* Recorders were selected exclusively for all recording and re-broadcasting of this year's Olympic Games. Engineers of Finland's Purchasing Committee circled the globe while visiting every manufacturer of tape recorders and testing their products. They chose Twin-Trax* to guarantee perfect recording, and give them maximum value for their money.



You, too, can own a Twin-Trax* Recorder, discriminately chosen for the greatest recording project of all time. As a Twin-Trax* owner, you will be in good company — with thousands of government agencies, broadcast stations, schools, and critical music lovers who have also made Twin-Trax* their "official and exclusive" recorder.

*Trade Mark Reg.

Write today for Catalog #5324, containing complete specifications and direct factory prices.

AMPLIFIER CORP. of AMERICA
398 Broadway New York 13, N. Y.

MANUFACTURING FACILITIES OFFERED FOR ELECTRONIC EQUIPMENT—CABLE ASSEMBLIES — LIGHT ASSEMBLY — AND ANTENNA SYSTEMS
BY S/C LABORATORIES, INC.
Call or Write
BENMORE ASSOCIATES
37 George St., Newark 5, N.J. Mitchell 3-3723



FOR ELECTRONIC COMPONENTS

We offer immediate delivery from our vast stock of more than 25,000 items—all standard make, carefully inspected and fully guaranteed. Our prices are below market.

Always Check Wells' Stock First!

Quotations and quantities available will be given immediately upon request.

- ADEL CLAMPS
- ANTENNAS
- Insulators, Mast Sections
- BINDING POSTS
- BLOWERS
- CABLE ASSEMBLIES
- CHOKES
- COILS
- CONDENSERS
- Oil Filled, Bathub, Hearing Aid, Transmitting
- Micas, Silver Micas, Ceramic, Variable, Trimmer
- CRYSTALS
- DYNAMOTORS & BRUSHES
- FILTERS
- FUSES & MOUNTINGS
- GENERATORS
- GROUND RODS
- HEADSETS
- IF COILS
- JACKS
- JACK BOXES
- KEYS, Telegraph
- KNOBS
- LAMPS
- LORD MOUNTS
- LUGS
- MOTORS & BRUSHES
- PLUGS
- RECTIFIERS
- Selenium, Copper Oxide, Meter, Diode
- RESISTORS—All Types
- SELSYNS
- SOCKETS
- SWITCHES
- Aircraft, Micro, Switchettes, Toggle
- TIMERS
- TUBING—Flexible
- TUNING SHAFTS
- TRANSFORMERS—All Types
- VIBRATORS
- WALKIE TALKIES

Available Now!

A complete signal corps stock number listing of items in our stock. Write for listing No. SG-200. (For government agencies and contractors only.)

Manufacturers and distributors—write for Radio-Electronics Catalog No. H 501.

Write, Wire, Phone Your Requirements
all phones: **SEeley 8-4143**



833 W. CHICAGO AVE., DEPT. Y, CHICAGO 22, ILL.

ELECTRONIC BRIGHTNESS METER

A novel electronic meter for measuring the brightness of a surface which is emitting or reflecting light is described in patent No. 2,542,299 issued to Hugh M. Archer and Howard A. Boltz.

The instrument consists of a collimating tube to pick up the light, a phototube, a two-stage direct-coupled amplifier, and a meter to measure the current of the last amplifier stage. The circuit is shown in Fig. 1.

Grid 2—the screen grid—of the first amplifier is used as the signal grid. It is connected to the top of the phototube load resistor. An increase in the output of the phototube causes grid 2 of V1 to go negative and decrease the plate and cathode currents which flow through the 400,000-ohm resistor. As the current decreases, the voltage across the resistor decreases and the control grid of V2 is less negative. This causes increased current to flow through the meter which is calibrated in foot-lamberts or similar light units. Grid 1—the space-charge grid—of V1—is connected to the plate of V2 through 29,000 ohms.

Since the triode is passing current at all times, a bucking circuit is included to zero the meter when no light is being admitted to the phototube. The bucking current is provided by connecting the triode filament battery across the me-

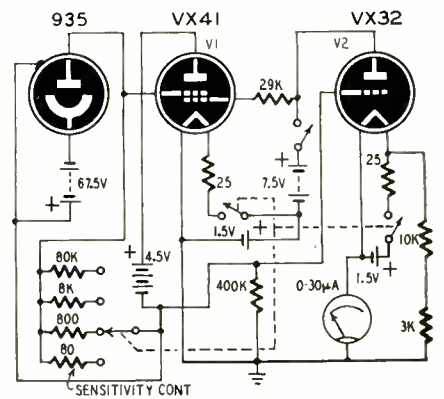

Fig. 1—Circuit of the brightness meter.

ter through a resistance of 13,000 ohms.

The collimating tube shown in Fig. 2 passes a constant amount of radiation to the phototube from a surface having constant and uniform brightness, even when the distance between the surface and the aperture is changed—as long as the viewing angle is intercepted by the surface being measured. The collimating tube consists of a series of metal diaphragms spaced inside a metal tube. The diaphragms have a viewing angle of 1½ degrees. Color filters may be inserted as shown to vary the color sensitivity of the instrument.

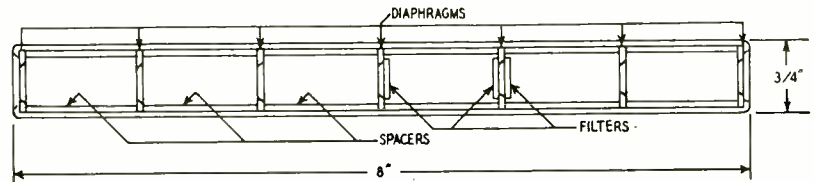
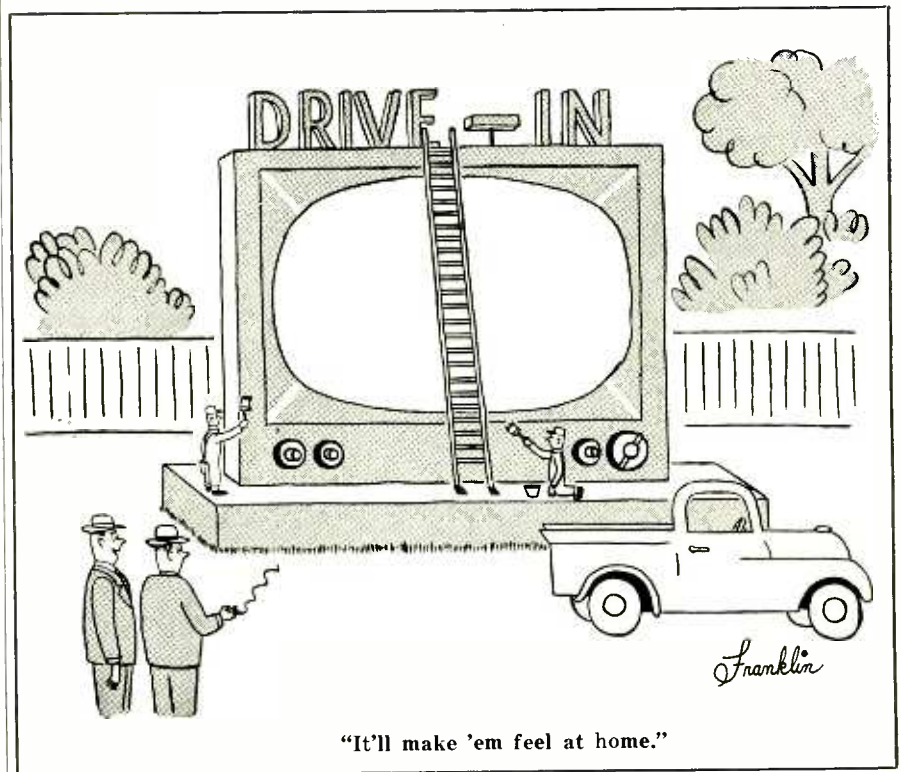

Fig. 2—Construction of the light-collimating tube used with brightness meter.



FLIERS FIGHT TV TOWERS

Ban on "Steel Needles"—fliers' name for 1,000-foot TV antenna towers—near airport control zones and airways is joint demand of Air Line Pilots' and Air Transport Associations. Pilots and industry want the FCC empowered to refuse construction permits where antenna height or location would constitute a flight hazard. Limited antenna heights through use of local TV booster transmitters, and radio warning beacons on all towers are also sought.

CORRECTIONS

There is an error in the drawing of the upper section of relay RY in the schematic in Fig. 1 on page 36 of the April, 1952, issue. The drawing shows a dashed line going to the normally closed contact on the upper section of the relay. This dashed line should connect to the lower of the two supply lines going to the controlled circuit. The normally closed contact of the upper relay section is *not* used.

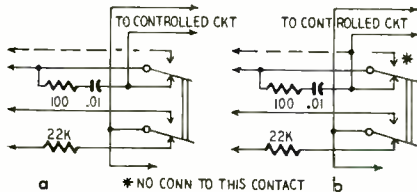

Our thanks to the author, Mr. Rundo, for bringing this error to our attention. The drawing at *a* shows the wiring as it appeared in the original diagram. The drawing at *b* shows the correction.

In the article "Practical TVI Filter" in the May issue, we inadvertently listed a reference to an article in the November-December, 1949 issue of G-E Ham Tips. The correct title of the publication is *G-E Ham News*. The article referred to is the "Harmoniker."

We thank Mr. R. L. Voeller of G-E for calling this to our attention and extend our apologies to G-E, the publishers of *Ham News* and to the staff of *Ham Tips* at RCA.

The map on page 30 of the May issue has white discs in the states of Vermont, Maine, and New Hampshire indicating that these states have v.h.f. TV stations in operation. There are no v.h.f. stations in operation in these areas so blue discs should have been used. This correction is credited to Mr. Wm. C. Larkin, of Delmar, New York.

The following corrections should be made in the article "Transformers", in the April, 1952, RADIO-ELECTRONICS: Total secondary power 63.9 v/amp; primary power 70.3 v/amp; core cross-sectional area 2.8 square inches; primary turns 261; turns-per-volt ratio 2.2; Sec. 1 turns 1,540; Sec. 2 turns 11; Sec. 3 turns 13.9; primary current 0.6 amp.

SPECIALS

BC366 Interphone Jack Box	\$.79
AN 109-A Antenna	1.98
C-30 ARC-5 Control Box	2.35
EE-89A Telephone Repeater	12.50
EE-65A Telephone Test Set	50.00
ID24 ARN-9 Cross Point Indicator	6.95
TU-8 Tuning Unit 6.2-7.7mc	4.95
BC496-A Dual Revr. Cont'l box, 3-6 & 6-9, 1mc	1.75
AN 104-A Antenna, 150mc	1.49
BC734 Indicator, 5" CR Tube, New	22.50
BC929 Indicator, 3BP1, all tubes, New	29.50
Noise Filters, 100 AMP, G.E.	1.39
MC211 Right Angle Drives19
IF Transformers, 112 KC Double Slug Tune69
IF Transformers, 1600 KC Double Slug79
MD 7 Modulator for ARC/5 All tubes	7.95
ARC-5 Xmtrr. Tuning Cond. #5032	1.49
ARC-5 Xmtrr. M.O. Trimmer #4990	1.29
Buffer or Osc. Coil, 160 meters, 50W	
End-Link, 5 pr. STD. Socket, OEL-16079

ARC-5 TRANSMITTER COILS

MASTER OSCILLATOR				
#6029	3-4 MC	\$1.85	#6030 4-5.3 MC	\$1.75
#6031	5.3-7 MC	1.65	#6032 7-9 MC	2.35

POWER AMPLIFIER				
#7247	3-4 MC	\$2.19	#7250 7-9 MC	\$2.98

ANTENNA LOADING				
#6033	3-4 MC	\$1.39	#6034 4-5.3 MC	\$1.25
#6035	5.3-7 MC	1.65	#6035 7-9.1 MC	1.65

SUPERSONIC CRYSTALS, Rochelle salt, \$.50 Ea.
MOTOR, 24 vdc, 3 HP, 3800 rpm, New \$75.00
TV LEAD IN WIRE, 300 ohms, HI-Q, Lo-Loss \$17.50/M FT Roll

GIBSON GIRL, Emerg. Xmtr, 500 kc	\$12.95
BC 306 ANTENNA TUNING UNIT, NEW	\$6.95
R9 APN-4, New, With Tubes and Crystal	\$75.00
ID6-APN-4, New, With Tubes and Crystal	\$75.00
A-62 Phantom Antenna	\$8.50
2 Meter Choke, 1000 MA, 20-144	8/51.00
Supersonic Crystal Head, M-1, 22-27KC HI-2	\$27.45
Underwater Microphone, Model JR, Z-50	\$24.50
Dynamic Mike & Headset Combo, B-19, New	\$3.75
HS-30 inserts, M-300	\$3.50 per M
AN/ARC-4 VHF Trans-Rev	\$75.00
IE 36 Test Set, New	\$37.50
SCR 274 Test Set, I-104	\$12.25
Carbon Pile Reg., 18V-5V #35X025	
ART-13 Driver Trans, 6V6 to P-P 811's	\$1.29
DM 34 Dynamotor, 14V in, 220V, 80 MA out	
Sens. Relay, 3.5MA, 13K ohms, 2PST, 2A	\$1.29
Klixon Breaker, Thermal, 35A69
T-30 Carbon Mikes, New89
Tel. Tape, 3/8" x 8 1/2" Rolls	23¢ ea. 5 \$1.00
Tel. Tape 4" Rolls	12¢ ea. 10 \$1.00

Mail orders promptly filled. All prices F. O. B. N. Y. C. Send M.O. or check only. Shipping subject C. O. D. Rated concerns send P. O. All mdse. subject to prior sale, and prices subject to change without notice.

COMMUNICATIONS EQUIPMENT CO.

131 Liberty St. Dept. C-7 New York City 7, N. Y.

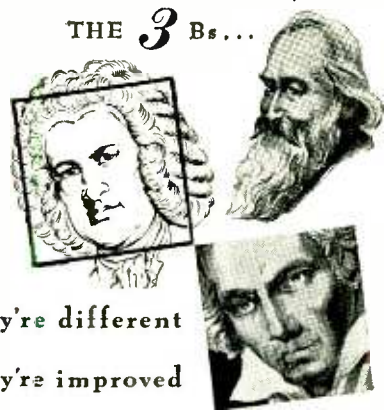

they're different
they're improved

they're better than ever!

Yes, Bach, Beethoven and Brahms are now better than ever—we don't mean we've improved their music, but we do mean we've improved the reproduction of their recorded music.

It's the new, improved Pickering Cartridges that give credence to this claim. Yes, Pickering Cartridges are different. They're improved. They're better than ever. Pickering patented Cartridges are superior in every way, by providing higher frequency response, negligible intermodulation distortion, better tracking characteristics. Pickering diamond stylus cartridges not only wear longer but more important, they preserve the musical quality and prolong the life of your record library.



Oceanside, L. I., N. Y. For details and literature address Department P

STOP! TV INTERFERENCE

Eliminates interference caused by Short Wave... F.M. Hams... Diathermy ... Atmospheric disturbances, etc.

With a **TELEMATIC** Full Range **FILTER KIT**

SIMPLE — SPEEDY — EFFICIENT

- Eliminates antenna-fed interference!
- Covers full-range both I.F. and R.F. Sharper, steadier picture!
- Fewer service recalls!
- Any filter in kit replaceable separately!

FILTER KIT contains 2 Hi-Pass Filters, 4 WAVE TRAPS covering full range of interference signals. Send for **FREE** Booklet on TV-INTERFERENCE

TELE Matic
ONE JORALEMON ST. BROOKLYN 2 N. Y.

LEARN

Television-Radio Electricity

REFRIGERATION-ELECTRONICS

IN THE GREAT SHOPS OF **COYNE**

TRAIN QUICKLY! OLDEST, BEST EQUIPPED SCHOOL of ITS KIND in U.S. Draft Age and Older Men..

Come to the Great Shops of Coyne in Chicago. Get practical training in TELEVISION-RADIO or ELECTRICITY—vital in Defense Program. Prepare now for a better job or better service rating.

START NOW—PAY LATER

You can finance most of your tuition, pay for it later in easy monthly payments. Special plan for men of Draft Age. Part time employment service available.

FREE BOOK Clip coupon for Big Free Illustrated Book. Indicate below, course that interests you. No salesman will call. Act NOW.

COYNE SCHOOL

B. W. Cooke, President
A TECHNICAL TRADE INSTITUTE CHARTERED NOT FOR PROFIT
Established 1899
500 S. Paulina, Chicago

ELECTRICITY ★ TELEVISION RADIO ★ REFRIGERATION ★ ELECTRONICS

B. W. COOKE, Pres.
COYNE School
500 S. Paulina St., Chicago 12, Ill. Dept. B2-81H

Send **FREE** BOOK and full details on:

TELEVISION-RADIO ELECTRICITY

NAME.....
ADDRESS.....
CITY..... STATE.....

Don't worry about CHANNEL CHANGES
Install Rocket ALL CHANNEL CONICALS

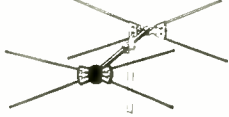

This sturdy, all aluminum constructed TV antenna is designed for broad-band reception on all TV channels, plus 2-13. For use with 72-150-300 ohm lines. Low inception angle. Complete with all hardware—less mast.

NOW AT LOWEST PRICES IN HISTORY
Single Bay \$3.35 Stacked Array with Tie Rods \$7.40

AMAZING ALL CHANNEL Reception
Replace Those Old TV Antennas

with the Famous **Rocket DIRECTRONIC** MOTORLESS TV ANTENNA

- 360° Electronically Switched Beam
- No Motors
- No Roof Orientation
- No Electric Power
- No Ghosts

Flick of Switch Clears Picture Instantly

The Directronic 18-element 360° antenna is the finest for ultra-fringe or metropolitan reception. The Hi-PAC molded insulator is a material of extreme tensile strength not affected by weather or temperature, either mechanically or electrically. Included in the AX-599 "Service-men's Array" are 18 hi-tensile aluminum alloy elements. Universal U Clamps for masts to 1 1/2". Directronic Beam Selector 7.5 feet of Tri-X Cable. AX-599 Directronic, 9-element Single.....\$10.35



AX-599 Directronic, As shown \$16.95

NOW An All Channel Indoor Directronic TV Antenna



360° coverage. Finest reception on all channels. No ghosts. Clearer, sharper pictures. Hidden installation. Steadier focusing. Strongest signal. Minimum noise or interference. Beam selector switch for best picture on every channel. Kit contains three tape elements with insulator mounting fasteners for use if needed. Directronic Beam Selector Switch, 2.5 feet Tri-X Cable, and Twin-X Cable Extension.



CLOSETS \$5.95 Complete Model ID-303 Nothing Else To Buy



Rocket Yagi 5 Element TV ANTENNA
Excellent Pictures in Fringe Areas

High gain. Minimum interference from ghosts and noise due to directive pattern. 5 heavy aluminum elements clamped top and bottom include one folded dipole, one reflector, three directors. Extra strong molded insulator. Special design mast clamp prevents antenna canting or turning. Completely pre-assembled. Prices are less mast. Channels 2 or 3.....\$7.95 each 4, 5 or 6.....\$6.95 each 7 to 13.....\$3.95 each

EACH CHANNEL requires a DIFFERENT Yagi.
When ordering specify exact channel number desired.

- WE WILL NOT BE UNDERSOLD ON TV ACCESSORIES**
- Mast Steel (Dualcoated) 5' Crimped 1 1/4" O.D.....\$1.05
 - Mast Steel (Dualcoated) 10' 1 1/2" O.D.....1.95
 - Mast Steel (Zinc Plated) 10' 1 1/2" O.D.....1.59
 - Mast Connectors for 1 1/4" O.D. Mast—10"......49
 - Chimney Mount Complete with Straps.....1.19
 - Peak Roof Saddle (will take up to 1 1/2" O.D.)......69
 - Lightning Arrestor—TV.....2.45 ft.
 - Galvanized Guy Wire—3 strand #20.....1 1/2 ft. \$2.50
 - Galvanized Guy Wire 7/22 Stranded (#50).....22 ft. \$2.50
 - 300 ohm Open Line Twin Lead—300' Reels.....22.50
 - Mast Stand-off Insulators—3".....8.50 C
 - Stand-off Screw Insulators—3".....2.75 C
 - Stand-off Screw Insulators—7".....5.50

Rocket Products sold only by mail by National Electronics Prices Subject to Change Without Notice ALL PRICES F.O.B. CLEVELAND, OHIO Do not remit more than complete purchase price. Pay shipping charges on receipt of goods. 25% deposit on C.O.D. orders, please. Money-back guarantee.

FREE Catalog of Bargains
TV antennas, accessories at lowest prices. Tells about our fast service, free installation help. Send name, address now.

National Electronics
OF CLEVELAND
THE HOUSE OF TV VALUES
207 Delco Building Cleveland 3, Ohio

THE FUND NEARS \$9,600

HELP-FREDDIE-WALK FUND

This month marks the beginning of the third year of existence for the Help-Freddie-Walk Fund, and we feel that it would be a good idea to review its history for the benefit of not only our newer readers, but also for those who have been following Freddie's progress for so long that the essential facts have



Four-year-old Freddie poses with Dad

become obscure. Little Freddie Thomason was born four years ago, the son of Herschel Thomason, radio technician of Magnolia, Arkansas, but unfortunately, he was born without arms or legs. At the time we learned of his plight, his parents were trying desperately to give him some semblance of a normal life, and the Help-Freddie-Walk Fund was inaugurated BY RADIO-ELECTRONICS in an attempt to aid them in what we knew would be a long and difficult and expensive fight.

That Freddie, at four, is a healthy, happy youngster is a tribute to the faith and courage of his parents and the sincere interest and generosity of our readers. All his life, he will be dependent upon mechanical devices to serve him as arms and legs, and because he is normal in every other respect, these appliances will have to grow as he grows. Among other things, this means periodic trips to the Kessler Institute for Rehabilitation, West Orange, N. J., for checkups and new fittings, but at last report Freddie is learning to walk and it is hoped that in the not-too-distant future it will be possible to fit him with artificial arms, so that he can actually participate in the many activities in which he takes the same interest as any child his age.

It will be a long, up-hill fight to help Freddie become a useful and contributing citizen. Although the Help-Freddie-Walk Fund has reached almost \$9,600, several times that amount will be needed

LOOK! GET THIS STEEL CABINET FREE
With Your Purchase of

KIT OF 103 ASST MOLDED CONDENSERS

YOU GET:
90 Sangamo 600 volt molded condensers inc. 7-.001, 7-.002, 7-.003, 7-.004, 7-.005, 7-.006, 10-.01, 10-.02, 7-.03, 10-.05, 7-.1, 4-.25, 12 - Ceramic discs inc. 3-.001, 3-.002, 3-.005, 3-.01
One mica 500 mmf. 20KV. Erie Universal Hi-voltage cond. with 10 assorted fittings.

COMPLETE \$14.95
You Pay For Condensers Only!

Plus a sturdy steel utility cabinet at no additional cost. All 4 drawers have index card holders and removable compartments. Size: 6" wide, 6 1/2" high, 8" deep, drawers 1 1/2" deep. Ideal for storing condensers and other small parts. Get yours free!

Address Orders To Dept. RE-7
Write For Free FYI Bulletin

WHOLESALE RADIO PARTS CO., Inc.
311 W. Baltimore St.
BALTIMORE 1, MD.

★ **WANTED** ★
★ WE NEED YOUR ★
★ SURPLUS ★
★ ELECTRONIC ★
★ EQUIPMENT ★
★ **WE PAY TOP \$\$\$ FOR:** ★
★ RADIO RECEIVERS ★
★ TRANSMITTERS ★
★ ARC-1 ★
★ ARC-3 ★
★ ART-13 ★
★ CONTROL BOXES ★
★ INDICATORS ★
★ AN CONNECTORS ★
★ CLAMPS ★
★ PLUGS ★
★ CORDS ★
★ RELAYS ★
★ TELEPHONE ★
★ MATERIALS ★
★ **WE BUY ANYTHING!!** ★
★ **Write, Wire Today!** ★
★ Tell us what you have ★
★ **TALLEN COMPANY, INC.** ★
★ Dept. RE, 159 Carlton Ave. ★
★ Brooklyn 5, New York ★
★ *****

PARTS LISTS
Bills of material for most of the pieces of equipment described in RADIO-ELECTRONICS construction articles are on hand at all radio parts jobbers and distributors who sell the magazine. See your dealer for a complete parts list of any of this apparatus you wish to construct.

DYNAMIC POWER TOOL COMBINATION



INCLUDES: Cummins 1/2" Electric Drill; Cummins Saw Attachment; Combination Saw Blade; Set of Drills; Lambs Wool Bonnet; 6 Sanding Disks; Steel Arbor and Attachments; Cloth Buffing Wheels; Grinding Wheel; Wire Wheel Brush; Steel Paint Mixer; Steel Bench Stand; Portable Steel Carrying Case.

Price of Dynamic Power Tool Combination complete is \$26.95

SHIPPED ON APPROVAL
NO MONEY WITH ORDER - NO C. O. D.

If completely satisfied then send \$2.95 and pay balance at rate of \$4.00 per month for 6 months—No Interest or Carrying Charges Added. If not completely satisfied, return to us, no explanation necessary.

KAPNER HARDWARE, INC.
Dept. A-43 2248 Second Ave., N.Y. 29, N.Y.

AUTOMATIC M-90 AUTO RADIO



- Six Tube Superheterodyne • Three Gang Condenser • Powerful, Long-Distance Reception • Fits All Cars, Easy Installation
- Mounting Brackets Included
- 6 Tube model M90 *\$34.97
- 5 Tube Model A-15 \$28.76

*Above price includes Federal Excise Tax
Approx. shipping weight either radio (11) eleven pounds

MAIL US YOUR ORDERS
All orders filled within 24 hours.
Standard Brand tubes 50% off list

Bill Sutton's Wholesale Electronics
Fifth at Commerce Fort Worth, Texas

Easy to make
Saves flash bulb cost
Stops action

Build your own ELECTRONIC FLASH

Sprague booklet C-703 shows you how to build up-to-the-minute Electronic Photo Flash units using the very latest low-voltage circuits. Step-by-step instructions. Send 35¢ today for this invaluable guide for the advanced amateur and professional photographers.



SPRAGUE PRODUCTS COMPANY
81 Marshall St., North Adams, Mass.

500 FORMULAS TO SUCCESS

MANY million dollar firms started with a single formula, for which they paid a big price. Here you have 500—no less—tried and tested formulas, recipes and processes for making things . . . all at the ridiculously low price of 25¢.

Here is your opportunity to start a business with but a few dollars' capital and with undreamed of profits in prospect. You can also use these formulas in your own home to cut household expenses to the bone. Or you can put them to use in your workshop to cut costs as much as 100%.

Quit paying out many dollars in profits to manufacturers, wholesalers, and dealers, when you can make the same thing yourself for a few cents. It's so easy when you follow our simple instructions.

66 PAGES, 47,000 WORDS IN TEXT
Send for "500 FORMULAS AND RECIPES" today. Enclose 25¢, that's all! You won't be asked for another cent now or later. Sold on a money-back guarantee.

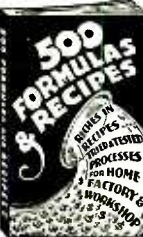

NATIONAL PLANS COMPANY
1966R Broadway, New York 23, N. Y.

before all involved can relax with a job well-done. We therefore urge every reader to send in his contribution—and what's more, to make it a point to donate regularly to this worthy cause. No amount is too small to receive our sincere thanks and acknowledgement, so send in yours—whatever you can afford—today.

We want to take this opportunity to make special mention of a donation of \$55 received from Albert L. Andzik, in the name of the Frigidaire employees of Plant #1, Dayton, Ohio.

Please send your contributions, large or small, from time to time. *Make all checks, money orders, etc., payable to Herschel Thomason.* Address all letters to:

HELP-FREDDIE-WALK FUND
c/o RADIO-ELECTRONICS MAGAZINE
25 West Broadway
New York 7, N. Y.

FAMILY CIRCLE CONTRIBUTIONS
Balance as of April 18, 1952 \$ 550.50
Mrs. Angeline Ash, Yucca Valley, California 1.00

FAMILY CIRCLE Contributions Received to May 19, 1952 \$ 551.50

RADIO-ELECTRONICS CONTRIBUTIONS
Balance as of April 18, 1952 \$8,920.16
Anonymous, Alameda, California .. 3.00
Frigidaire Employees of Plant #1, Dayton, Ohio 55.00
Adam Gretchou, Cleveland, Ohio .. 1.00
Mr. & Mrs. Wallace C. Jensen, West Allis, Wisconsin 10.00
John Larrinaga, Bingham Canyon, Utah 10.00
H. H. Lee, Norfolk, Virginia 2.00
G. E. Paliughi, North Bergen, New Jersey 5.00
Alban J. Petchal, Steubenville, Ohio 3.00
Chester Roxy Stone, Redondo Beach, California 16.00
J. V. Thompson, Inglewood, California 1.00

RADIO ELECTRONICS CONTRIBUTIONS Received to May 19, 1952. \$9,026.16
FAMILY CIRCLE CONTRIBUTIONS 551.50

TOTAL CONTRIBUTIONS to May 19, 1952 \$9,577.66

THEATER TV STANDARDS

The Movie Industry has submitted proposed standards for theater-TV systems to the American Telephone and Telegraph Company. Many of their requirements are far more stringent than those now in force for commercial TV broadcasting. The proposed video-signal bandwidth is 10 mc, more than twice as great as the best commercial circuits' 4.5 mc. Signal-to-noise requirement for the picture signal is at least 46 db for black-and-white, and 42 db for CBS-type color transmissions. This is 6 db higher than broadcast standards. Fading losses must be held to 5 db.

A requirement new to TV transmission is that picture non-linearity shall not exceed 10% of the difference between black and white signal levels. Audio transmission must be flat up to at least 8 kc, with a signal-to-noise ratio of 50 db.

FCC hearings on allocations for theater TV have been postponed indefinitely.

—end—

Compare!

PROVE **EMC** SUPERIORITY!



MODEL 106
Vacuum Tube Voltmeter
✓CHECK THESE FEATURES

Specially designed for field alignment of television and radio sets. Uses dual triode balanced bridge circuit. All functions and ranges completely electronic—meter cannot burn out. Zero center position for FM discriminator alignment. Uses 1% precision resistors for voltage multipliers. 5 DB ranges. Full scale deflection of 1 1/2 volts for both AC-DC volts. Measures resistance in 5 ranges from .2 ohm to 1000 megs. 1 Meg isolating resistor in probe.

SPECIFICATIONS
DC VOLTAGE: Input resistance 16.5 megs or 1 1/2 megohms per volt. Ranges: 0 to 1.5, 10, 100, 300, 1000 up to 30,000 volts (with accessory probe.)
AC VOLTAGE: Input resistance 2 megohms. Ranges 0 to 1.5, 10, 100, 300, 1000. Frequency response flat from: 25-100,000 cycles.
OHMS: 1000—10,000—100,000—10 megohms, 1000 megohms.
Compact portable bakelite case measures 4 1/4" x 5 1/4" x 2 7/8".

MODEL 106..... \$35.90
In Kit form..... \$23.90
MODEL HVP 30,000 Volt Probe for Model 106.... \$8.75

Write Down **IRE 7** for latest **FREE** Catalog and **Jobber Discount** SEE COMPLETE LINE AT YOUR JOBBERS.



EMC Electronic Measurements Corp.
280 Lafayette St., New York 32, N. Y.
Export Dept. 303 W. 42nd St., N. Y. C.

OPEN WIRE

T-V LINE 4.0¢ Per Foot

in 250 ft. rolls boxed in free-flow dispensing boxes. 4.5¢ per ft. in any desired shorter length. #19 solid copper Formvar wire. Pure polystyrene spacers. Very low loss. Send post card for sample section. Order from

SEYMOUR ELECTRONICS
SEYMOUR, MISSOURI

for dependable sound,
INDUSTRY relies on
ATLAS



DR Double-Reentrant Projectors

DEPENDABLE QUALITY:
The latest electro-acoustic research and engineering—and over 20 years of manufacturing know-how—are behind every ATLAS product.

DEPENDABLE SERVICE:
Coast-to-coast and around the world today—in every Industrial, Marine, Railroad, Military, Educational, Civic, U.S. and Foreign Government application—under every kind of climate and noise condition—ATLAS sound equipment is famous for highest efficiency and durability. That's the proof of ATLAS performance dependability.

DEPENDABLE DELIVERY:
Yes, ATLAS gives our Government highest priority. And yes, we too feel the pinch of material shortages. But our customers will continue to get our usual dependable delivery—because we believe in equitable and dependable distribution to all ATLAS users.

DEPENDABLE PROFITS:
Completeness of line, excellence of product, dependable delivery, right prices—that's the ATLAS combination that means high, steady Industrial Sound profits for You!

JUDGE for yourself, COMPARE ATLAS at your local Jobber today. See why ATLAS is the preferred line for utmost dependability. Write NOW for FREE latest Catalog 551.



Paging & Talk-Back Speakers



ALNICO-V-PLUS Driver Units



Dual Speakers



FULL-GRIP, VELVET-ACTION Mike Stands



ATLAS SOUND CORP.

1443-39th Street, Brooklyn 18, N. Y.
In Canada: Atlas Radio Corp., Ltd., Toronto, Ont.

5000 ROLL LABELS
Printed with your copy on white gummed paper in Red or Blue ink 2 1/2 x 4" **\$1.65** Per 1000
Merit Label Co 515 Greene Ave. B'klyn 16, N. Y.

ON-THE SPOT BATTERY RECORDER
WALKIE-RECORDALL 8 lb. miniature BATTERY RECORDER-PLAYBACK
Continuous, permanent, accurate, indexed recording at only 5¢ per hr. Instantaneous, permanent playback. Picks up sound up to 60 ft. Records conferences, lectures, dictation, 2-way phone & sales talks; white walking, riding or flying. Records in closed briefcase with "hidden mike"! Write for details.
MILES REPRODUCER CO., INC.
812 BROADWAY Dept. RE-7 NEW YORK 3, N. Y.

People

Richard M. Purinton, administrator of engineering of the AMERICAN PHENOLIC CORP., Chicago, and William H. Rous, sales manager, both vice-presidents,

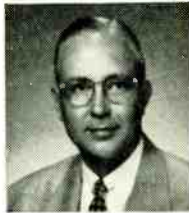

R. M. Purinton



W. H. Rous

were elected to membership on the Board of Directors.

Kenneth C. DeWalt, manager of GENERAL ELECTRIC'S cathode-ray tube operations since 1949, was upped to the position of manager of engineering for the Tube Department. Robert E. Lee, assistant manager of cathode-ray tube operations, succeeds Mr. DeWalt. Another personnel change in the G-E Tube Department promoted Douglas J. Sullivan to the post of manager of Employee and Plant Community Relations.



K. C. DeWalt

Norman Fyler joined HYTRON RADIO & ELECTRONICS CO. as supervisor of Development TV Picture Tubes. He came to the company from Sarks Tarzian, and was previously with the RCA Princeton Laboratories.



N. Fyler

Edmund G. Shower was named to head the newly formed Transistor Division of NATIONAL UNION RADIO CORP., Orange, N. J. Mr. Shower comes to National Union from Bell Telephone Laboratories, where he set up the initial transistor production line. Other personnel changes at National Union placed Kenneth C. Meinken, Jr., in the position of vice-president in charge of equipment sales of cathode-ray tubes, receiving tubes, and Government business. He was formerly midwestern sales manager and will continue to maintain his headquarters in Chicago. F. W. Timmons, formerly with Du Mont, joined National Union as eastern sales manager.



E. G. Shower

Tom White, president of JENSEN MANUFACTURING Co., was elected president of Radio's Old-Timers, an organization of men who have been in the industry for 20 years or more. Earl Dietrich, Cleveland representative, will act as secretary, and Jerry Kahn, president

IT'S NEW!
10-POUND PORTABLE BATTERY-OPERATED TAPE RECORDER

THE MAGNEMITE*
NEW DRY BATTERIES

Inexpensive flashlight-type cells that last 100 operating hours.

NEW SPRING MOTOR

Governor-controlled constant speed motor runs 15 minutes per winding.

NEW PLAYBACK & MONITORING

Feeds directly into headphones or external amplifier and speaker.

NEW SENSITIVITY

Crystal-clear recordings up to 100 feet from the microphone.

4 models available
Priced from **\$225**
Size: 1 1/2 x 8 1/2 x 5 1/2

Field recording is now as easy as studio recording, with the Magnemite* Portable series. There's a midget battery-powered spring-motor Magnemite* model for every recording need — speech, music and sound effects. Write today for descriptive literature and direct factory prices.

*Trade Mark Reg.

AMPLIFIER CORP. of AMERICA
398 Broadway New York 13, N. Y.

!!!SPECIAL!!!—FAMOUS MAKE HI-FIDELITY MIKE

- 30-10,000 cycle response. — 52lb. All-Chrome, Swivel Head (L.P. \$27.35) Now Only \$18.95
- Sound Powered Handset for TV Work, Intercoms. No batteries—No transformers! Pair. 10.95
- 12 1/2' ft. Whip Antenna. 4 steel screw seats. 1.98
- 39' Whip Antenna. 30 extend above. ea. .59
- 39' Whip Antenna. 30 extend above. ea. .59
- "Polystyrene"—12" lgths. Rod. 1/4"—10c; 3/8"—20c; 1/2"—36c; 5/8"—59c; 3/4"—79c; 1"—\$1.29
- Tubing (O.D.). 1/4"—10c; 3/8"—12c; 1/2"—17c; 5/8"—23c; 3/4"—27c; 1"—36c; 1 1/2"—\$1.25

Leotone
A REAL BUY
1/20 h.p. GE Motor. 1725 RPM, 110V. DC. 7 Amp. Dble. 3/8" shaft. 4 3/4" O.D. x 5 1/2" **\$2.95**

- HS-30 Headset. ear-plug type; with cord. \$2.49
- HS-30 Matching Transformer. With cord & PL-54 59
- HS-33 Headset. 10-imped. 2.89
- ANS-H-1 Phone Units. 300 ohm impedance. ea.98
- Crystal Headphones (Brush). 50,000 ohm. ea. 4.95
- Headset with adjustable headband. 3.99
- Sponge Rubber Phone Cushions. pair 1.39
- Portable Metal Utility Box (6"x8"x6"). ea. 69c 3/1.98
- lock hinged lid. With carrying strap. ea. 69c 3/1.98
- "Hook-up Wire Special". Solid & Stranded, ass'd. Colors. 3" to 10" lgths. Stripped, tinned ends. 3 lbs. 1.98
- Midget Plug & Jack. PL-291 JK-48. set 39c 10/3.49
- JK-26 PL-54 Connectors. 12. 1.98
- Cabinet Draw Slides, silent, ball-bearing. 13" (9" ext) —\$2.10 pr.; 15" (11" ext) —\$2.25; 16 1/2" (12 1/2" ext) —\$2.40 pr. pr. 3.25
- Radio Hardware Treasure. Full lb. can of nuts, screws, lugs, washers, etc. 1.99
- Barrier Terminal Strip. 20 brass feet-thru 8/32 holes; moulded bakelite. ea. 69c 3/1.98
- 6V or 4V Pilot Bulbs. min. screw 10/30c 100/3.49
- 100K or 250K Pots. 3/4" shafts. Less sw. ea. 29c 10/2.49
- Hearing Aid Cords. Super-flexible! rubber twisted insul. Outside black silk braid 2 cond (1 1/8" O.D.) 10 ft./49c 100 ft./3.75
- 3 cond (3/32" O.D.) 10 ft./69c 100 ft./5.49

Alnico Magnet Specials U" type. \$1.25
2x1 1/2"x5/8". Poles: 1/2" dia. 1.50
Flat Bar. 1 1/2"x5/16" ea. 79c 3/1.45
Round Bar. 2"x3/8" O.D. ea. 59c 10/5.50
Block Magnet. 1/2" sq. x 9/8" ea. 25c 12/2.50

Alnico Chip Magnets. small irreg. shapes. Approx. 90 pcs/oz. 1.50
Alnico Magnet Kit. Powerful bar, Block "U" Rod, etc. Kit of 10 ass'd. 1.98
(WRITE FOR LATEST "ALNICO" SUPPLEMENT)

Wall Phone Jack. for PL-55e etc. ea. 29c 4/1.00
LOOK FOR SUPER-SAVINGS KIT with the new "Jumbo Radio Parts Kit". 17 lbs. of coils, wire, sockets, controls, resistors, condensers, switches, etc. All for only 3.95
"DIRECT FACTORY SPEAKER REPAIRS SINCE 1927"
Full remittance with foreign orders. Please add sufficient postage—excess refunded.
LEOTONE RADIO CORP.
67 Dey Street New York 7, N. Y.
RADIO-ELECTRONICS

of Standard Transformer Corp., is the new treasurer.

Bert Kohl was promoted to assistant sales manager of PYRAMID ELECTRIC Co., North Bergen, N. J., in line with the company's expansion program. The company also announced the appointment of William P. Levison, Jr., as advertising manager. Levison came to Pyramid from Lewin, Williams and Saylor, advertising agency.



B. Kohl



N. C. Owen

Norman C. Owen was named general sales manager of WEBSTER-CHICAGO. He was previously sales manager of the distribution division. Owen replaces W. S. Hartford, vice-president in charge of sales, who retired.

Hobert M. Murdock, sales manager of the TURNER Co., Cedar Rapids, Iowa, was appointed vice-president in charge of sales. At the same time, Benno Von Mayrhauser was advanced to vice-president in charge of production.



H. M. Murdock



B. Von Mayrhauser

Personnel Notes

Ira Kamen was promoted to vice-president of BRACH MANUFACTURING CORP., Division of General Bronze Corp., Newark, N. J. He will be responsible for organizing the expanded industrial and government sales operations of the Brach organization and will continue to handle contract negotiations for the company's radar antenna, servo and other electronic activities.

... Brig. Gen. David Sarnoff, Chairman of the Board of Directors, RADIO CORPORATION OF AMERICA, received the first Annual Award of the RTMA for outstanding contributions to the advancement of the radio-television industry.

... Fred Voorhaar is the new sales promotion manager of TECHNICAL APPLIANCE Co., Sherburne, N. Y., manufacturer of antennas and allied products. Mr. Voorhaar had been a sales executive with Zenith.

... Jack Poppele, vice-president and chief engineer of STATION WOR-TV, New York City, and a past president of the Television Broadcasting Association, added a new honor, with his election to the Board of Directors of the

Skiatron Electronics and Television Corp.

... Fred A. Lyman, former manager of the New York Factory Distributor Branch, DU MONT LABORATORIES, was promoted to the newly formed post of national merchandise manager of the Receiver Sales Division, Allen B. Du Mont Laboratories.

... N. C. Kirkpatrick now handles the processing and expediting of all Government work for UTAH RADIO PRODUCTS, Huntington, Ind., as the company's defense manager. He had been associated with leading aircraft companies.

... Hugh W. Gaston, formerly with A. D. Juillard & Co., is now southwestern sales manager for KAY-TOWNES ANTENNA Co., Rome, Ga.

... Dr. Newbern Smith, chief of the NATIONAL BUREAU OF STANDARDS CENTRAL PROPAGATION LABORATORY, was awarded the 1952 Harry Diamond Memorial Award for his fundamental work in the field of radio wave propagation. He was recently elected a Fellow of the Institute of Radio Engineers.

... Arthur F. Merrigan succeeds Paul G. Duryea, who retired as president of the WIRT Co., Philadelphia. Other new officers are H. R. D. Biecker, vice president, and Thomas J. Mullaney, secretary and treasurer.

... John H. Beedle, works manager of RAYTHEON MANUFACTURING Co., Waltham, Mass., was elected an assistant vice-president of the corporation.

... Anthony G. Schifino was elected an officer of STROMBERG-CARLSON, Rochester, N. Y., with the title of general manager of the Sound Equipment Division, which he had been managing since 1942.

... Aaron McKay was elected president of KRYLON, INC., Philadelphia manufacturer of acrylic plastic sprays. He joined Krylon after having been general manager of Walker Motors, Detroit.

... A. S. Johnson joined THE RADIO CRAFTSMEN, INC., Chicago, as executive assistant. He had been industrial sales manager and products manager of Webster-Chicago.

... William A. MacDonald was elected president of the HAZELTINE CORP., replacing Jack Binns who assumed the position of chairman of the Board. Fielding S. Robinson is the new president of Hazeltine Electronics Corp., New York City, the manufacturing subsidiary for Government and industrial contracts. Laurence B. Dodds was named president of Hazeltine Research, Inc., Chicago.

... Dr. Allen B. Du Mont, president of Allen B. Du Mont Laboratories, Inc., was awarded the rank of Chevalier in the National Order of the Legion of Honor by the French Government. The honor was bestowed on Dr. Du Mont for services rendered to the Allied cause during World War II and for his contributions to commercial relations between the United States and France.

... William A. Hayes was appointed eastern regional sales manager for the Westinghouse Electronic Tube Division.

—end—

GOING OVER BIG—NEW DAVIS SUPER-VISION

ALL-CHANNEL ANTENNA FOR FRINGE AREA or DX with ELECTRONIC DIAPOLE SEPARATORS

"THE ONLY TV ANTENNA SOLD WITH A MONEY-BACK GUARANTEE"

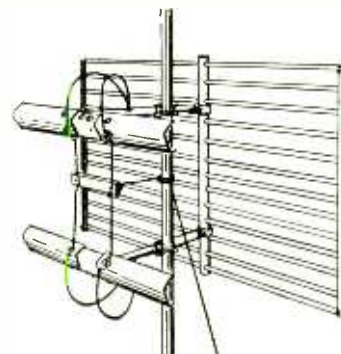

10 OUTSTANDING FEATURES:

1. EXCELLENT FOR FRINGE AREA and DX RECEIVING—and broad band receiving with high gain on all channels—2 through 13.
2. CLEARER PICTURES UP TO 125 MILES OR MORE—from the station.
3. GHOST PROBLEMS REDUCED or eliminated due to excellent pattern.
4. PROVIDES 10 DB OR MORE GAIN ON HIGH CHANNELS where gain is needed most.
5. EXCELLENT FRONT TO BACK RATIO on all channels. Eliminates co-channel interference.
6. MINIMIZES INTERFERENCE: Airplane Flutter—Diathermy and Ignition—F.M.—Neon Signs—X-Ray—Industrial—Etc.
7. ELIMINATES DOUBLE STACKED ARRAYS, and out-performs 2 bay yagis on low band and 4 bay yagis on high channels.
8. ONLY ONE TRANSMISSION LINE NECESSARY.
9. NO WORRY OVER POSSIBLE CHANNEL CHANGES on either high or low channels.
10. CAN BE TIPPED WITHOUT TILTING MAST to take advantage of horizontal wave lengths.

AT YOUR JOBBERS, OR WRITE TO:

DAVIS ELECTRONICS 1-12
 4313 West Magnolia Blvd., Burbank, California
SIRS: RUSH INFORMATION TO ME AS CHECKED BELOW:
 Send Free Technical Data on new SUPER-VISION ANTENNA.
 Send Name and Address of NEAREST JOBBER.
 Name _____
 Street _____
 City _____ State _____

WANTED

BD110 Telephone Switchboards, BD100 Telegraph Switchboards, BD90 Power Boards, EE101 V-F Rings, BE72 Cabinets, FM19 Frames, RA43, REC30, KS5988, RA87, RA37, RA9J Rectifiers, BD101 Test Boards, SB6 Switchboards, Type CF1A, CF3A, CF2B Carrier Equipments. Any condition and quantity.

Box 752-1 Radio Electronics
 25 W. Broadway, New York 7, N.Y.

SENDING RECVG SPEED

Be a "key" man. Learn how to send and receive messages in code by telegraph and radio. Commerce needs thousands of men for jobs. Good pay, adventure, interesting work. Learn at home quickly through famous Candler System. Quality for Amateur or Commercial License. Write for FREE BOOK.
CANDLER SYSTEM CO.
 Dept. 3-H, Box 928, Denver 1, Colo., U.S.A.

ANNOUNCING...

QUAM

Adjust-a-Cone

**REAR SEAT
AUTO SPEAKERS**

Designed by Quam Speaker Engineers after thorough investigation into the installation and performance problems peculiar to this type of speaker . . . the new Quam Adjust-a-Cone models bring you new ease of installation, new superiority of performance! Always specify Quam.

MODEL AS-1—ECONOMY 6½" P.M. SPEAKER KIT

Quam 6½" P.M. Adjust-a-Cone Speaker with ¾" voice coil and capacity to handle full output of any single-ended auto set.

Kit includes 3-position switch for dash mounting, installation cable, flocked grill screen, baffle plate and hardware.



MODEL AS-2—DELUXE 6" x 9" P.M. SPEAKER KIT

Quam heavy duty 6" x 9" P.M. Adjust-a-Cone Speaker with 1" voice coil and capacity to handle full output of the most powerful auto set. Kit includes

3-position switch for dash mounting, installation cable, flocked grill screen, baffle plate, sponge rubber gasket and hardware.

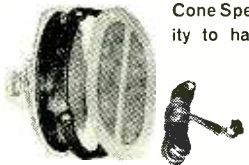

ASK YOUR JOBBER ABOUT QUAM REAR SEAT AUTO SPEAKERS OR WRITE FOR CATALOG

QUAM-NICHOLS COMPANY

ALSO MANUFACTURERS of QUAM ADJUST-A-CONE SPEAKERS
QUAM FOCALIZER UNITS, ION TRAPS and TRU-MATCH OUTPUT TRANSFORMERS
Cottage Grove & 33rd Place, Chicago 16, Illinois

**A WORD TO THE WISE:
Stock Up NOW at**

—LOW SUMMER PRICES—

With credit controls lifted and TV sets available with no down payment at many dealers, it is natural to expect greatly increased sales. Lifting of the freeze on TV stations in many parts of the nation also means more sets sold at dealer level.

300-Ohm TV Lead-In Wire—finest quality J.S.C. Wire—is now at low Summer prices. With prices certain to rise in the Fall, it's WISE TO STOCK UP NOW. . . . Be Protected . . . Stock Up!

SEE YOUR NEAREST J.S.C. DISTRIBUTOR



You Get Highest Quality and Top Efficiency When You Buy Wire Products From the Dealer Displaying the Orange & Blue J.S.C. Disc!!

You can't beat

Radio-Electronics

for complete coverage of

RADIO, TELEVISION and AUDIO

STILL A FREE COUNTRY

Dear Editor:

I've been hearing so much "beefing" about our local part-time service technicians that I feel it my duty to raise my voice in defense of the "little" radiomen. The beef is, of course, that there are too many of us, and that we take work away from the full-time shops.

I know one man who until a year ago was running his own repair shop. But business dropped off to such an extent that he was forced to seek employment, and he eventually landed at the plant where I work. This man harped continually about us "alley mechanics" taking work away from him, and blamed us as 'being the cause of his plight.

Well, there are two sides to most stories, as in this case:

This man had gradually driven his customers away with his complete disregard for others' feelings. If a customer dared venture an opinion about what was wrong with his radio, he was likely to be told he was crazy. What's hard to understand is how this fellow ever built up his business to a full-time job in the first place!

Speaking of people working at two jobs, take a look around. You can buy anything from a box of candy to a pressure cooker at the average drug store, and I've seen some grocery stores stock enough medications to fill a doctor's office. I also know of a few automobile accessory stores where you can buy anything down to a suit of clothes.

So don't rap us part-time radio technicians too hard. This is America, the land of free enterprise and equal opportunity for each and every one of us.

WILLIAM BACON

Springfield, Ill.

LOW-POWER COMMUNITY FM

Dear Editor:

I read with interest R. L. Hawbaker's letter in the April issue of RADIO-ELECTRONICS, and your reply. It seems to me the solution is simpler than you think. At the present time, the FCC permits educational institutions to operate 10-watt FM stations in the lower part of the FM band, with third-class operators; and at least one manufacturer is producing such a system. It would be very simple for the FCC, if they are really interested in community stations, to permit the operation of such low-power stations by small communities on a commercial basis. With such low operating costs, these stations could not fail to prosper. However, even if the FCC did not change its rules, a small town could obtain one of these 10-watters to be operated by its school system. With the exception of advertising, all the advantages of a commercial community station could be obtained, and perhaps operating costs could be kept down by the use of volunteer personnel and limited hours.

RADIO-ELECTRONICS

TUBES Today's Best Buys

Top Quality at Terrific Savings
RTMA Guaranteed

1A7GT	\$.079	6BF5	\$.065	12A6	\$.070
1B3	\$.05	6BF6	\$.070	12A16	\$.40
1L4	\$.80	6B36G	1.48	12A77	\$.35
1L6	\$.60	6B06	\$.94	12A06	\$.55
1L6G	1.05	6BQ7	1.95	12A07	\$.75
1L5	1.05	6C4	\$.60	12A07	\$.95
1N34	\$.69	6CB6	\$.65	12A07	\$.75
1R5	\$.80	6CD6G	1.93	12BA6	\$.48
1S4	\$.85	6E5	1.05	12BA7	\$.50
1S5	\$.85	6F6	\$.95	12B26	\$.55
1T4	\$.85	6H6M	\$.70	12BH7	\$.95
1U4	\$.60	6J5M	\$.65	12J5GT	\$.50
1U5	\$.50	6J6	\$.73	12SA7GT	\$.70
1X2A	\$.85	6K6	\$.65	12SF5M	\$.65
3A4	\$.75	6K7	\$.70	12SG7	\$.90
3Q4	\$.55	6K8	1.35	12SJ7	\$.60
3V4	\$.62	6L6GA	1.05	12SK7	\$.65
3S4	\$.80	6S4	\$.31	12SQ7	\$.70
5U4G	\$.55	6S7M	\$.85	12SN7GT	\$.75
5V4	\$.95	6SA7GT	\$.70	12SR7	\$.65
6Y3GT	\$.39	6SC7	1.10	14B6	\$.95
9Z3	\$.85	6SH7	\$.85	14E6	\$.95
6A7	1.00	6SJ7	\$.70	19T8	\$.86
6AB4	\$.65	6SK7GT	\$.53	25A V5	\$.95
6AB5 6N5	1.25	6SL7GT	\$.65	25BQ6	1.60
6AC7	\$.95	6SN7GT	\$.65	25L6GT	\$.60
6AG5	\$.65	6SN7GT	\$.65	25W4	\$.80
6AG7	1.40	6T8	\$.85	35L6GT	\$.53
6AH6	1.75	6V6GT	\$.89	35W4	\$.47
6AK5	\$.95	6W4GT	\$.49	35Y4	\$.89
6AK6	1.20	6X4	\$.45	35Z5GT	\$.49
6AL5	\$.54	6X5	\$.45	45Z5	\$.80
6AQ5	\$.65	6Y6	\$.85	50B5	\$.53
6AT6	\$.45	7A07	1.25	50C5	\$.53
6AU6	\$.65	7C5	\$.70	50L6GT	\$.53
6AV6	\$.50	7C7	\$.85	59	1.50
6AX5GT	\$.85	7E7	1.30	89Y	\$.75
6B4	1.50	7F7	\$.95	9001	1.25
6BA6	\$.55	7G7	1.30	9002	1.05
6BC5	\$.56	7Q7	\$.99	9003	1.25
6BE6	1.25	7W7	1.25	9006	\$.95

Minimum Order \$15.00

IMMEDIATE DELIVERY!

Write for quotations, many other types available. 20% Deposit with order, balance C.O.D. All tubes subject to prior sale. Prices subject to change without notice.

WRITE, WIRE, CALL—TODAY!
We Buy Anything in Electronics—
large or small quantities!

Nat Adelman

168 Washington St. New York 6, N. Y.
CO. 7-6091

OPPORTUNITY AD-LETS

Rates—35¢ per word (including name, address and initials). Minimum ad 10 words. Cash must accompany all ads except those placed by accredited agencies. Discount for 6 issues, 10%, for 12 issues, 20%. Misleading or objectionable ads not accepted. Copy for September issue must reach us before July 21, 1952.

Radio-Electronics, 25 W. Broadway, New York 7, N. Y.

WANTED: AN/TRC-1 EQUIPMENTS, T14 TRANSMITTERS, R19 RECEIVERS, TS32 TEST OSCILLATORS. Any condition or quantity. Box 752-2, Radio-Electronics, 25 West Broadway, New York 7, N. Y.

SPEAKERS REPAIRED at wholesale prices. Guaranteed workmanship. Fast service. Amprite Speakers Service, 70 Vesey St., New York 7, N. Y.

WILLIAMSON TYPE HIGH FIDELITY AMPLIFIERS. dual chassis, 807 outputs. Stancor Transformers, \$67.50. Partridge, Aerosound transformers, KT66 tubes additional. Operated components used throughout. Write Electronic Wiring, Dept. ET, Selden, L. I., N. Y.

WE REPAIR, CONVERT, SELL, ALL TYPES OF electrical instruments, tube checkers and analyzers. Hazleton Instrument Co. (Electric Meter Laboratory), 128 Liberty Street, New York, N. Y. Telephone—BArclay 7-4239.

WANTED—TOP PRICES PAID—Navy Selsyns IP, IG, IGT, 5F, 5G, 54T and BC-348, BC-221, AN/ART-13, AN/ARC-1, AN/ARC-2, RTA-1B. Lectronic Research, 719 Arch St., Philadelphia.

WANTED: AN/APR-4, other "APR", TS-1, "IE-1", ARC-1, ARC-2, ART-13, BC-348, etc. Microwave Equipment, everything Surplus. Special tubes. Tec Manuals. Lab Quality Equipment, Meters, Fast Action. Fair Treatment. Top Dollar! Littleh, Farhills Box 26, Dayton 9, Ohio.

Five Element TV Yagi Beams, Aluminum Tubing Etc. Write for prices. Willard Radloff, Postoria, Ohio.

INFORMATION \$1.00, 17 yrs. experience. Tubes 50%. Free List Television Radio, 25 N. Sarah St., St. Louis, Mo.

TV AND FM ANTENNAS YAGI, CONICAL BOW-TIE Mounts, accessories. Lowest prices. Wholesale Supply Co., Lunenburg 2, Mass.

JULY, 1952

A large number of such small stations would give FM the shot in the arm which it needs and deserves. The FM band, with as many channels as the AM band, has only one-fourth the number of stations, and is capable of handling many more stations than the AM band due to its noninterference characteristics. The present small number of FM receivers need not be a deterrent, since FM sets are now available at low prices, and if the stations are there, people will buy the sets.

You have had two outstanding series in your magazine recently: that on computers, by Berkeley (including the two articles on Boolean algebra); and the series on the design of feedback amplifiers, by Cooper. In my opinion these should be brought out in book form as part of your book series, as they are too good to be lost in a maze of back issues.

CHARLES ERWIN COHN

Chicago, Illinois

NEAR-FATAL "FIX-IT"

Dear Editor:

Isn't it high time somebody with authority put a stop to these cheap booklets flooding the country informing TV owners they can repair their own TV's and save anywhere from 30 to 100 dollars a year?

A friend of mine has a penchant for poking into things. When he bought a TV set, I cautioned him never to tinker with it, explaining TV was rather complicated compared with radio, and there were dangerous high voltages involved. So, what happens? His set became inoperative; he read one of those "How to Fix It" booklets, and proceeded to test his newly gained "knowledge" on his TV. With the set turned on he thumbed tubes to see if they were warm and lit up, just like the book said.

In the course of this, he came to an innocent-looking tube—one that supplies 15,000 volts. He can only thank kind Providence he is alive today. It so happened the flyback transformer was defective and the tube was delivering only enough voltage to give my friend a pretty fair nip. (He then decided to call a service technician, which he should have done in the first place.) This man is suffering from a heart ailment, and had the flyback system been delivering its normal voltage, I hate to think what the consequences would have been.

It's ironic when a man spends years working and studying the art of television only to have his talents belittled by irresponsible booklets informing TV owners that repair and maintenance of TV's is "duck soup," and, by inference, that the service technician is a "gypper."

"BURNED UP"

St. Louis, Mo.

(While this letter is typical of many received by RADIO-ELECTRONICS on the subject of fix-it-yourself books, the tinkerer in this case deserves at least part of the blame, since he had been warned by the writer of high-voltage hazards.—Editor)

—end—



to the
music lover,
audio hobbyist
or
professional:



PRESENTING
the new Jensen Brochure 1020—
20 comprehensive pages
about high fidelity sound
and its equipment—including
the Jensen Silver Anniversary
line . . . loudspeakers and cabinets
of unprecedented importance to
everyone seeking the finest
quality attainable today.

write for your free copy!

Jensen

JENSEN MANUFACTURING COMPANY
 DIVISION OF THE MUTER COMPANY
 6601 S. LARAMIE AVE., CHICAGO 38, ILLINOIS
 IN CANADA: COPPER WIRE PRODUCTS, LTD., LICENSEE



BURTON BROWN ADVERTISING

Become an Electrical Engineer



MAJOR IN ELECTRONICS



- B. S. Degree in 36 Months
- Radio-Television Technician Certificate in 18 Months

By 1954 there will be at least two positions for every engineering and technician graduate. This College offers a tested plan that permits you to enter these vast employment opportunities at an early date. First — you save a valuable year through optional year-round study. Second — you can receive *advanced credit* for prior training gained in the armed forces, other schools or field experience.

Enter Both Radio and Television Through This Plan

12 months or one-third of the B. S. degree course (Electronics major) — also brings you the *Radio Technician's* certificate. An added 6-month course qualifies you for the *Radio-TV Technician's* Certificate. Recent developments open unlimited opportunities for TV technicians and engineers.

The Proven "UNIT CHASSIS SYSTEM"



of teaching was developed here. It "breaks down" the TV set by stages. You learn every component of all types and makes — and are prepared for future design changes, including the advent of color.

General Preparatory Course

Exclusive 3-month course is tailor-made to help young men fulfill academic deficiencies and meet engineering admission requirements. Terms open October, January, April, July Over 48,000 former students from all states and 23 overseas countries. Faculty of trained specialists. Modern laboratories and equipment. Nonprofit technical institute and college in its 49th year.

MILWAUKEE SCHOOL OF ENGINEERING

FREE — Write for "Occupational Guidance Bulletin," "Your Career" booklet, and catalog.

Milwaukee School of Engineering
Dept. RE 752, 1025 N. Milwaukee
Milwaukee, Wisconsin

Without obligation send Catalog for Electrical Engineering, B. S. Degree, major in Electronics; Power; "Your Career"; Occupational Guidance Bulletin on: Radio-TV; Electrical Power; Welding; Heating, Refrigeration Air Conditioning Mechanical Engineering, B.S. Degree; Preparatory.

Name.....Age.....

Address.....

City.....Zone.....State.....

If veteran, indicate date of discharge.....

RADIO SCHOOL DIRECTORY

Unlimited Opportunities in RADIO ENGINEERING

DEGREE IN 27 MONTHS

Complete Radio Engineering course including Telev., U. H. F. and F. M. Bachelor of Science Degree also in Mech., Civil, Elect., Chem., and Aero. Eng.; Bus. Adm., Acct., Extensive campus, modern buildings, well equipped labs. Low cost. Prep courses. Personalized, practical instruction. Founded 1884. Placement service. Growing shortage of engineers. Prepare now for unlimited opportunities ahead. Enter September, January, March, June. Write for catalog.



TRI-STATE COLLEGE

2472 College Ave. ANGOLA, IND.

RADIO & TELEVISION TRANSMITTERS LAB. WORK EVERY DAY LEARN BY EXPERIENCE

REHRIG SCHOOL

11-13 S. GAY ST.
BALTIMORE 2, MD.
Lex. 3195

BE A RADIO ENGINEER!

You can enter this uncrowded, interesting field. Defense expansion, new developments in electronics demand trained technicians. Study all phases radio & electronics theory and practice: TV; FM; broadcasting; servicing; aviation, marine, police radio. 18-month course equal in radio content to 4 yrs. college. U.S. or equivalent required. Begin Jan., March, June, Sept. Campus life. Catalog. VALPARAISO TECHNICAL INSTITUTE Dept. C Valparaiso, Ind.



RADIO COURSES

- RADIO OPERATING • CODE
- RADIO SERVICING • ELECTRONICS
- F. M. TELEVISION

Preparation for Civilian, Maritime, Army and Navy license requirements.

Write for Catalog TE



TRADE & TECH. SCHOOL 15 W. 63 St., N. Y. 23 ENdicat 2-8117

ROBOTS

MECHANICAL BRAINS • MATHEMATICS
COMPUTERS • LOGIC • OTHER SUBJECTS
PUBLICATIONS & COURSES

EDMUND C. BERKELEY & ASSOCIATES
19 Milk St., R-35, Boston 9, Mass.

Please send me:

- Squee, the Robot Squirrel—Plans—\$4.00
 - Circuit Algebra—Introduction—\$1.50
 - Constructing Electric Brains (reprint of series of 13 articles in Radio-Electronics)—\$2.20
- Returnable in 7 days for full refund if not satisfactory
 Free Catalog of Courses & Publications.
I enclose \$..... in full payment (add 10¢ per item to cover cost of handling and mailing).

Name.....

Address.....

PROVE to yourself in 7 DAYS that you can PASS FCC RADIO EXAMS for AMATEUR and COMMERCIAL

easily, quickly—or NO COST!

Only 15 Minutes A Day With This Amazing New "Hear and See How" Low Cost Home Study Method For Passing Amateur Code and Theory Exams and Commercial Code Exams.....From \$6.95 With this method you ACTUALLY SEND and RECEIVE messages as you practice. You learn code and theory immediately from records and books, at your own convenience. Valuable sturdy Hand Key and High Frequency Buzzer included FREE for practicing. Typical practice FCC code and theory exams included. FREE consultation privileges. Hundreds have received their licenses with these courses.

Write today for FREE information.

AMERICAN ELECTRONICS CO.

Dept. RE-7, 1451 Wilkins Avenue, New York City

FOR THE FIRST TIME!

For several years you've read about the Don Martin School now—for the first time—we are prepared to offer a course by mail. You can obtain your first class radio telephone operator's license from this special course. Operators are desperately needed now by radio and TV stations as well as the aircraft industry. Secure your future.

Be certain that your training is of the best, enjoy the school recognized by the profession. Write today for full information.

THE DON MARTIN SCHOOL OF RADIO AND TELEVISION ARTS AND SCIENCES

Correspondence Section
1655 No. Cherokee, Hollywood 28, Calif. HU. 2-3281.

TELEVISION

Big demand for graduates

B.S. DEGREE IN 27 MONTHS in radio including TV engineering—VHF, UHF, AM and FM. Students use over \$100,000 worth of equipment including 2 large commercial type transmitters in new TV lab. Intense specialized course includes strong basis in mathematics, science and advanced design in radio and TV.

Hundreds of young men each year are earning engineering degrees in this recognized institution. Start any quarter. Many earn a major part of expenses in this industrial center. Low tuition. Competent instruction. Thorough, intense, practical program.

Also B.S. DEGREE IN 27 MO. in Aeronautical, Chemical, Civil, Electrical and Mechanical Engineering. G.I. Gov't approved. Enter Sept., Dec., March, June. Free catalog. ENROLL NOW

INDIANA TECHNICAL COLLEGE

1772 E. Washington Blvd., Fort Wayne 2, Indiana

RADIO and TELEVISION ELECTRONICS

in all Technical Phases

New Classes (Day & Evening)

Start 1st of Dec., Mar., June, Sept.

FREE PLACEMENT SERVICE

for GRADUATES

For Free Catalog write Dept. RC-52

RCA INSTITUTES, INC.

A Service of Radio Corporation of America
350 West 4th St., New York 14, N. Y.

LEARN TELEVISION

ELECTRONICS and RADIO

Engineering Laboratory and Classroom

Training. Day and Evening Classes.

Write for illustrated Catalog

ELECTRONICS INSTITUTE, Inc.

21 HENRY, DETROIT 1, MICH.

TELEVISION-RADIO ELECTRONICS

Training in all branches television, radio and electronics. FCC exam. preparation. Write for free catalog.

COMMERCIAL RADIO INSTITUTE

(Founded 1920)

38 W. Biddle St., Baltimore 1, Md.

Approved by Maryland State Board of Education

COMMUNICATION OF TECHNICAL INFORMATION, by Robert M. Dederich. Published by Chemonomics, Inc., 400 Madison Avenue, New York 17, N. Y. 6 x 8½ inches, 116 pages, offset. Price \$5.00.

The art of communicating technical information is one that needs improvement—nowhere more than among communications engineering writers. Unfortunately, the author of this book seems to have paid too little attention to his own communication skill, with the result that his work is far from being an example of clarity. Possibly one of the reasons is that he seems to think of clarity as a secondary matter—to be mentioned first on page 99—rather than the fundamental objective in improving any and all types of communications. Shorter words, more careful organization, and less involvement of thought and sentence structure, would have produced a more useful book.—FS

SIMPLIFIED RADIO SERVICING BY COMPARISON METHOD, developed by M. N. Beitman. Published by Supreme Publications, 3727 W. 13th St., Chicago 23, Ill. 8½ x 10¾ inches, 92 pages. Price \$1.50.

This is the fourth edition of a practical work familiar to many radio students, beginners, and expert service technicians. It shows the technician how to quickly and accurately diagnose and isolate the most common troubles in radios and in allied home-type electronic equipment without using conventional test equipment.

The first half of the book introduces the beginner to basic practical radio theory. The various components used in modern circuitry are illustrated pictorially and schematically and their purpose is explained. The remainder of

the book goes into actual circuits of typical receivers and explains how such simple devices as a pair of headphones and a couple of resistors and capacitors can be used to quickly locate faulty components in the set.

TEST INSTRUMENT APPLICATIONS MANUAL, by Edward M. Noll. Published by Lecture Bureau Publishing Company, 161 Luckie St., N. W., Atlanta, Ga. 8½ x 11 inches, 50 pages. Price \$1.00.

This is Number 6 in the *Notebook* series issued by Television Technicians Lecture Bureau. It describes the operation and characteristics of the oscilloscope, sweep generator, v.t.v.m., and auxiliary equipment and gives detailed instructions for interconnecting and using them for TV servicing and general applications.

The book gives directions for checking test equipment, suggestions for service-shop layout, and includes a comparative summary of current commercial test instruments.—MB

RADIOTELEPHONE LICENSE MANUAL, by Woodrow Smith. Published by Editors and Engineers, Ltd., Santa Barbara, Calif. 6 x 9¼ inches, 197 pages. Price \$3.75.

This is an up-to-date edition of the license manual covering radiotelephone elements 1-4. The questions are taken from the Government's Study Guide. The answers are clear and complete. Diagrams are given where required.

Several useful appendices complete the manual. Radio formulas, extracts from radio laws and a list of Q signals are included. There is also a short description of artificial respiration.—IQ

FOR TOP QUALITY PICTURES



PERFECTION ION TRAPS

- Simplest to Install
- Stay Put—No Wobble!
- Standard on All Leading Television Sets

Write today for full details!

PERFECTION ELECTRIC CO.

2635 South Wabash Avenue
Chicago 16, Illinois

Makers of Perfection Speakers
and Television Components

New! Up-to-date!



340 pages
170 illustrations



Symptoms of defective operation easily recognized, quickly corrected by illustrations, diagrams and how-to-do-it facts in this new book.

TELEVISION SERVICING

by Walter H. Buchsbaum

Get this brand new, complete handbook for sure-fire working knowledge of TV installation, maintenance and troubleshooting. Tells you step-by-step procedures for audio IF alignment, video IF alignment, aligning RF amplifiers, mixers, oscillators, etc. All possible defects classified for ready reference, thoroughly analyzed to show what is wrong and why . . . and what to do to correct the defect. No mathematical knowledge needed! Practical, authoritative, up-to-the minute, the perfect handbook for set owners, trainees, and repairmen.

USE IT 10 DAYS FREE

Coupon below brings you "Television Servicing" on FREE trial for 10 days, without obligation. Mail it NOW.

PRENTICE-HALL, Inc., Dept. M-RE-752
70 Fifth Ave., New York 11, N. Y.

Send me, for 10 DAYS' FREE TRIAL, "Television Servicing." I will return it in ten days and pay nothing—or keep it and send \$1.35 down (plus postage) and \$2 monthly for 2 months.

NAME.....

ADDRESS.....

CITY.....STATE.....

SAVE! Send \$5.35 with this coupon, and we'll pay postage and packing.

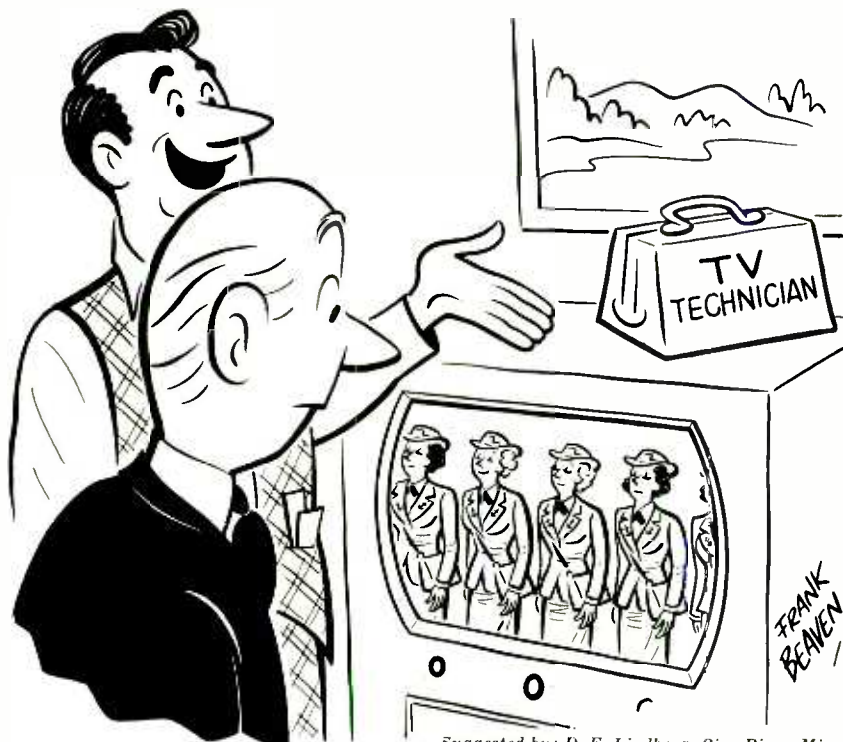

"Your problem is too many standing waves."
Suggested by: D. E. Lindberg, Pine River, Minn.

RADAR AND ELECTRONIC NAVIGATION, by G. J. Sonnenberg. Published by D. Van Nostrand Co., Inc., New York, N.Y. 5 1/2 x 8 1/2 inches, 272 pages. Price \$6.00.

All branches of radiolocation are described here. These include Decca, Loran, Consol, Echo Sounding and Radar. The book gives complete theory, operation and maintenance information on each system. Navigators and communication technicians will appreciate the emphasis put on the practical side of the subject.

The first chapter explains magnetism, time bases, radio propagation characteristics, hyperbolic curves and other basic information. A separate chapter on each system then follows. Numerical examples show how accurate measurements are obtained from available navigation data and from radiolocation information.

Radiolocation can be interesting as well as necessary. One section describes the utility of Loran during an actual ocean voyage. In another place, an echo-sounding shows the Lusitania wreck resting on the ocean floor. Actual PPI and other indicator patterns are interpreted in the chapter on radar.—IQ

FERROMAGNETISM by Richard M. Bozorth. Published by D. Van Nostrand Co., Inc., New York, N. Y. 6 x 9 inches, 968 pages. Price \$17.50.

A complete description of magnetic material and various topics of magnetic theory are presented here in a single volume. It provides data for physicists, practical applications for engineers. Recently developed ferromagnetic materials have found wide application in the field of electronics. They have resulted in more efficient speakers, transformer and h.f.-inductor cores, recording tapes, and measuring instruments.

The book is divided into four parts: Part 1 describes basic concepts of ferromagnetism. It is followed by a full description and numerous diagrams relating to modern high-permeability materials. Composition, methods of heat treatment, and magnetic properties are given. Stress, pressure, heat, and magnetostrictive conditions, magnetic resonance, and aging are discussed. Part 3 details various magnetic theories. Part 4 shows how to measure magnetic forces and fields.

A comprehensive index and a well-arranged list of contents aid in locating a desired subject. The appendix lists known elements and their characteristics, high-permeability materials, permanent-magnet materials, and various physical constants.—IQ

FEEDBACK, by Norman H. Crowhurst. Published by Norman Price (Publishers) Ltd., 283, City Road, London, E.C. England. 5 1/4 x 8 1/2 inches, 64 pages. Price 3 shillings sixpence.

This little book is No. 2 in the author's *Audio Handbook* series. It calls itself "an essentially practical work, explaining clearly what feedback can do, where and how, and what its limitations are." The reviewer can only add that the description is exact, and that the book also acts as an introduction to more complex material. It explains the Nyquist diagram, for example, in terms understandable to the average technician, a new feat in audio literature. The practical technician and semi-technical hi-fi fan will welcome this book.—FS

ADVANCED ANTENNA THEORY, by Sergei A. Schelkunoff. Published by John Wiley & Sons, Inc., New York, N. Y. 6 x 9 inches, 216 pages. Price \$6.50.

This is a rigorous and advanced analysis of antenna theory by an authority in the field. Higher mathematics is used throughout. The author stresses the similarity between antennas and ordinary circuits and transmission lines.

The first half of the book concerns spherical waves and the mode (wave guide) theory of antennas. Subsequent chapters discuss integral equations, natural oscillations, spheroidal and cylindrical antennas. The book ends with several pages of advanced antenna problems (with answers) and various mathematical tables and graphs.—IQ

Send for these Bargains & SAVE MANY DOLLARS



3-TUBE PHONO AMPLIFIER

Designed for use with all types of records. 2 1/2 watt output—completely wired with full range tone control. \$2.95 ea.

ROSE Cash Saver! lots of 3 \$2.49 ea.

- TUBES (for above), set of 3 \$1.95
- 50L6 OUTPUT TRANSFORMER ea. .49
- SPEAKER, 4" P.M. ea. 1.39
- SPEAKER, 5" P.M. ea. 1.49
- SPEAKER, 6" P.M. ea. 1.69
- PHONO PICKUP 78 RPM ea. 1.95
- MOTOR & TURNTABLE 78 RPM, complete 2.89
- MOTOR & TURNTABLE 3-Speed complete 4.95
- HI-FIDELITY PICK UP with turnover cartridge & 2 permanent needles, complete 4.95

Terrific Value! RECORD PLAYER BASE

Teakwood, beautiful leatherette cover with cutout for motor. Can also be used for speaker baffle. Holds 4" to 7" speaker. Size: 13" x 8 1/4" x 3 1/2" SAVE! only 98c ea.



Save More! Order 3 for \$2.49!

Save More Than Half! JEWEL TIPPED PERMANENT NEEDLES Ruby tip, list: \$2.50 ea. \$.98 Sapphire tip, list \$5.00 ea. 1.49 3-Speed jewel tip, list \$2.50 ea. .98

VIBRATORS, 4-Prong, 6 V., Universal type, ea. \$1.29 Save! Get 10 for only \$11.90

Low Priced Sale TUBES

- For Quick Sale Standard Brands—All Guaranteed!
- OZ4 \$.69 6AT6 \$.69 6V6 \$.89
 - 1B3 \$.99 6AU6 \$.70 6X5 \$.69
 - 1X2A \$.99 6CB6 \$.89 12AU7 \$ 1.19
 - 5U4 \$.69 6K6 \$.79 12SA7 \$.79
 - 5V4 \$ 1.09 6SA7 \$.79 12SK7 \$.79
 - 6AC7 \$ 1.19 6SK7 \$.79 35Z5 \$.59
 - 6AG5 \$ 1.09 6SQ7 \$.69 50L6 \$.69
 - 6AL5 \$.99 6SN7 \$.99

MINIMUM ORDER: \$5.00. 25% deposit with order, balance C.O.D. Include postage with order. All merchandise subject to prior sale. F.O.B. New York City. Prices subject to change without notice.

THE ROSE CO. 100 Park Place, Dept. E-7 New York 7, N. Y. COrtlandt 7-6195

STAN-BURN ELECTRONICS

ANTENNAE SPECIALS

- CIRCLE X Limited quantities \$2.98 each
- DOUBLE V 3/8" \$1.11 12 or more
- DOUBLE V 3/8" Dowel \$2.98 \$2.20
- DOUBLE V 1/2" Dowel 3.48 2.95
- 10 Element Conical 3/8" 3.95 2.95
- Folded Hi Straight Low Quick Rig 1/2" elements 4.25 3.25
- WINDOW CONICALS 4.95 3.75
- 5 FOOT SWEDGED MASTS79 .69
- 10 FOOT PLAIN TV WIRE 1.39 1.29
- 55 Mil. 300 OHM \$14.95 M Ft.
- 72 OHM COAXIAL 45.00 M Ft.

CATHODE RAY TUBE SPECIALS

- 10BP4 Zetka. \$14.95 17BP4A Federal. \$23.00
- 10BP4 N.U. 19.95 17BP4A DuMont. 26.00
- 10BP4A N.U. 19.95 19AP4 Sheldon. 29.95
- 12LP4 Zetka. 18.95 19AP4 GE. 39.95
- 12LP4 Thomas. 19.95 19AP4 Thomas. 39.95
- 16AP4 Zetka. 26.00 20CP4A DuMont. 39.95
- 16AP4A G.E. 38.00 20CP4A Snelidon. 37.00
- 16DP4A Thomas. 28.80 21EP4A DuMont. 42.95
- 16GP4A Rauland. 33.00 24AP4A Sheldon. 63.00
- 16GP4 Zetka. 26.00 24AP4A GE. 76.00
- 16FP4A Thomas. 28.80 21EP4A DuMont. 42.95
- 16RP4A GE & NU 26.00 Double ion traps. .59
- 16TP4A DuMont. 26.00

CHASSIS 630 REGAL with Cascade Tuner. \$139.50 211 Tri Fly BNC (similar to RCA). 2.98 OPEN FACE CABINET. 39.00

TRANSFORMERS

- RCA type for 16" to 24" X032 \$3.85
- G.E. Type for 16" to 24" X045 3.85

These are very special prices while they last!

DEFLECTION YOKES

- Cosine Ferrite Todd Yoke 70" \$4.20

SPECIALS

- 4 Prong Vibrators, each \$1.29
- Lots of 12 or more 1.19
- Standard TV Tuners 18.95
- 12" Heavy Slug Speaker Special 4.98

AUDIO DEVICES and TAPE IN STOCK

- Audio Plastic Red Oxide Plastic tape \$2.30
- Half hour spool 3.30
- One hour spool 3.30

WIRE RECORDERS IN STOCK

- WILCOX GAY—Model 2A10 \$89.97
- Model 973C—2 speed Tube Recorder 116.88
- RADIO { Model RC2—Hi-Fi Amplifier, net 42.05
- CRAFTS { Model RC10—AM-PM Tuner, net 128.27
- MEN { Model C5—Williamson Amplifier, net 97.51

CASCADE Guaranteed Tuners (with tubes) Special, while they last. \$21.95

AUTHORIZED DISTRIBUTORS

For: General Electric, Kenrad, Tung-Sol, National Union, Jewel, De Wald, Regal, Automatic and Setchel Carlson.

We carry a complete line of popular makes of radio and TV tubes, at 50% discount. Also many other special purpose and transmitting types, and all electronic parts and equipment at lowest prices.

Send us list of your requirements for prompt quotations.

Terms: 20% with order. Balance COD All prices FOB, New York Warehouse. Minimum order \$5.00

Write for our latest price list to Dept. RE-7

STAN-BURN RADIO and ELECTRONICS CO.
(C.B.S. THEATRE BLDG.)
1697 BROADWAY • NEW YORK 19, N.Y.

The **TURNTABLE** is the **HEART** OF YOUR **HIGH FIDELITY SYSTEM**

Rek-O-Kut's Model T-12H the "CADILLAC"

of the 12" Transcription Turntable Field is again in production and will be available through your regular dealer.

REK-O-KUT offers a complete range of 12" and 16" transcription turntable models to match your present high fidelity equipment. Each REK-O-KUT Turntable carries an engineering specification which enables you to select the appropriate unit to match your other components.

MODEL LP-743 3-Speed 12" Turntable
Induction type motor, designed for smooth, vibration-free operation. Instantaneous speed changes without stopping turntable or removing disc. \$54.95 Net

MODELS T-12H & T-43H — 2-Speed 12" Turntables

Recommended for use with **ULTRA HIGH FIDELITY Amplifiers and Speaker Systems**. The only 12" Turntable that meets N.A.B. specifications for speed regulations and Wow content.

MODELS	MOTOR	DB Noise Level	SPEED	PRICE
T-12 H	Hysteresis Synchronous	-50DB	78-33 1/2	\$119.95
T-43 H	Hysteresis Synchronous	-50DB	45-33 1/2	\$119.95
T-12	4 Pole induction	-40DB	78-33 1/2	\$84.95
T-43	4 Pole Induction	-40DB	45-33 1/2	\$84.95

REK-O-KUT CO.
38-05 Queens Blvd., Long Island City, N. Y.
EXPORT DIVISION, 458 Broadway, New York City, U. S. A.
CANADA: 8745 PACIFIC CORP., LTD., 500 King St. W., Toronto 28, Ontario

PROCEEDINGS OF THE NATIONAL ELECTRONICS CONFERENCE, Volume VII. Published by the National Electronics Conference, Inc., Chicago, Ill. 607 pages, 6 x 9 inches. Price \$5.00.

This volume presents a large group of papers given before the seventh annual conference held in Chicago, October, 1951. A wide variety of subjects is covered. They include servos, tubes, audio, h.f., magnetic amplifiers, micro-waves, circuits. About 80 articles are included.

For the most part the papers are on a high technical level and many articles involve advanced mathematics. A partial list of subjects would include photoforner design, low level magnetic amplifier, economical sync clipper, performance of the Vidicon, X-ray Roentgen ratemeter, charts for coaxial line probe measurements, an electronic music box, pulses and transients in system analysis. —IQ

PRIMER OF ELECTRONICS AND RADIANT ENERGY by Don Caverly (Second Edition). Published by McGraw-Hill Book Co., New York, N. Y. 5 1/2 x 8 inches, 343 pages. Price \$5.50.

This primer will satisfy the curiosity of the layman, provide a good background for the student and serve as a refresher for those who have fallen behind in their knowledge of electronics and physics. The treatment is non-technical. No knowledge of the subject is presumed.

There are four parts: electricity, magnetism, radiation, and tubes. The book starts with elementary concepts of particles, then proceeds to batteries, generators, and transformers. The third part covers the most ground. It contains interesting discussions of subjects such as polarization of light, dielectric heating, ultrasonics, radio, color TV, radar, chain reactions, A and H bombs. The fourth part describes radio and special tubes, including infra-red lamps, orthicons, thyratrons, magnetrons, and cloud chambers.

The author tells an interesting story in a clear and readable manner. Photos and diagrams are included throughout.

—IQ

—end—

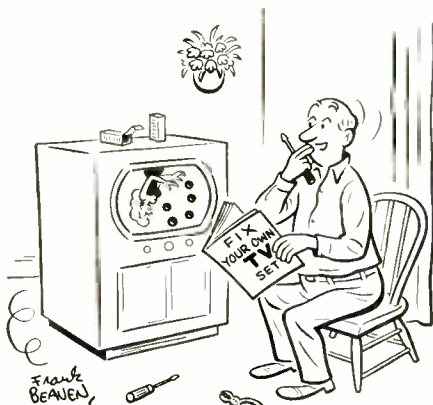

Suggested by: L. Trisner, Chicago, Ill.

"Aha! I seem to have fixed it—or have I?"

JULY, 1952

Cut TV trouble-shooting time with this NEW Gernsback Library Book

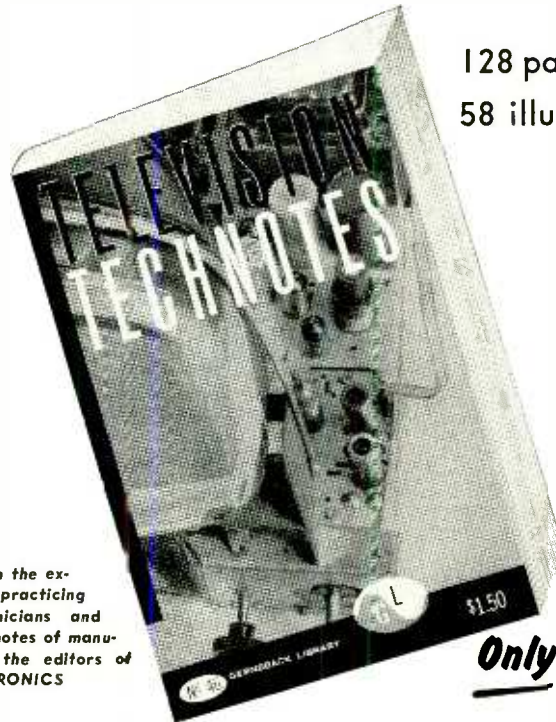

128 pages
58 illustrations

Compiled from the experiences of practicing service technicians and the servicing notes of manufacturers by the editors of RADIO-ELECTRONICS

Only \$1.50

TELEVISION TECHNOTES was specially planned to save you time, money and effort in tracking down the hard-to-find troubles that crop up in TV sets. A collection of 607 actual case histories of persistent and frequent troubles found in models made by 27 manufacturers, it is probably the most valuable practical work book on television ever written! You can save yourself hours of time-consuming routine trouble-shooting by learning from manufacturers' own tips and from the hard-won experience of technicians like yourself who have run into the same bugs. For the amazing low price of only \$1.50, TELEVISION TECHNOTES gives you a priceless collection of servicing data which is bound to help you save time and show up in increased profits. Check this list of helpful features from TELEVISION TECHNOTES—then order your copy today.

Just a few of the troubles TELEVISION TECHNOTES will help you solve!

Adjacent channel interference • Horizontal jitter • Excessive picture height • Horizontal tearing or bending • Veiling • Sync buzz • Vertical foldover • Horizontal sync instability • Vertical bars in picture • Hum • Poor contrast • Insufficient width • Increasing sensitivity in weak-signal areas • Curvature at top of picture • Horizontal wiggle • Vertical roll in fringe areas • Poor vertical linearity • Vertical white bars in picture • Arcing in vertical output stage • Microphonics • Horizontal pulling • Horizontal oscillator radiation • Elimination of retrace lines • Audio buzz • Horizontal foldover • Improving

vertical sync stability • Intermittent picture tubes • Arcing • Ineffective a.g.c. • No vertical sweep • Booming picture • Noise in picture • Loss of vertical and horizontal sync • Insufficient vertical size • No control of horizontal sync • Left-hand bulge • Unstable horizontal sync • Vertical jitter • Blocking on strong signals • Corner-cutting of picture • Improper focus • Intermittent decrease in horizontal scan • White bar at bottom of picture • Black bars at left side of picture • Horizontal drift • Vertical roll • Halo effect • Neck shadow • Intermittent horizontal tear-cut • Critical contrast • Horizontal sweep sing.

Other popular GERNSBACK LIBRARY BOOKS you'll find helpful

Radio Tube Fundamentals • No. 45—\$1.00
Basic Radio Course • No. 44—\$2.25
Model Control by Radio • No. 43—\$1.00
High-Fidelity Techniques • No. 42—\$1.00
The Cathode-Ray Oscilloscope • No. 40—75¢

Practical Disc Recording • No. 39—75¢
Amplifier Builder's Guide • No. 33—50¢
Advanced Service Technique • No. 32—50¢
Radio Questions & Answers • No. 31—50¢
Unusual Patented Circuits • No. 30—50¢
Handy Kinks and Short Cuts • No. 29—50¢

SEE YOUR DISTRIBUTOR OR MAIL THIS COUPON TODAY

RADCRAFT PUBLICATIONS, INC.
25 West Broadway, New York 7, N. Y.

Enclosed is \$..... for which please send me, postpaid, the books checked below:

- 46—Television Technotes
 45 44 43 42 41 40
 39 33 32 31 30 29

Name..... (Please print clearly)

Street.....

City..... Zone..... State..... 72

TAB That's A Buy!

STORAGE BATTERIES

- 36 Volt WILLARD Mini-BRAND NEW! 5 oz. Designed for Portable Equip. Models... 98¢: 4 for \$3.85

INFRARED SNOOPSCOPE

Image-Converter Tube Hi-Sensitivity simplified design 2" dia. Willemite screen—Resolution up to 350 Lines/in. Complete data & tube, each—\$4.98; 2 for \$9.49

CIRCUIT BREAKERS

Heinmann, Magn Bkrs. Amps: 0.22, 2, 3, 5, 7, 9, 12, 15, 20, 30, 35, 40, 80, 180, \$1.69 10 for \$15.98

SELENIUM POWER SUPPLY

0 to 12VDC / 2 Amp. Variable DC supply. Unceasing and completely built-in. 1.5V/60 cy. Usable LAB supply. Filament D.C., plating, battery charging, model railroad, includes voltage or speed control and center off reversing sw. Icc for two "HO" locomotives. "TAB" Special \$10.95 2 for \$20.00

FULL WAVE BRIDGE SELENIUM RECTIFIERS

Table with columns: Current (Cont), 18/14 volts, 26/18 volts, 36/28 volts, 130/100 volts. Rows for 2, 4, 5, 10, 12, 20, 30, 36 amps.

CT Rectifiers 100 amp 10-0-10V... \$44.95 50 Amp 18-0-18V \$29.95 80 Amp 16-0-36V \$33.95

RECTIFIER TRANSFORMERS

18-8-18-2-20-4-21.4 volts / 12 amp 2Kvlns... \$14.98 31-32-31-3-31-31 volts / 12 amp 2Kvlns... 14.98

SOUND-POWERED PHONES

Navy Unit—Cushioned Headsets, Chest Box Mike, Cable & Wpl Plug, Tested Each Unit, \$5.49; Pair \$9.98

NEW THRIFT-LITE LIFETIME PHOTO-FLASH

Not a kit! Incl Pwr pck. Life gtd lamp, 1ftcfr & 15' cord / 11000 Sec flash every 7 sec. True daylight color. Usable all cameras 11/2" x 14" 11/2" x 14" 11/2" x 14"

PHOTOFLASH PWR SUPPLY KIT

1800 V at 35 MA, using doubler circuit. Transformer, rectifiers, sockets, resistors, condensers & diagram. Complete with sunflash tube V-4X4, X400, 200-300 watt sec \$31.98

PHOTOFLASH CAPACITORS

2x.36 MFD, total .72 MFD per unit, 30 units 21.6 MFD / 1800 VDC / 38.8 Watt sec... \$5.95 30 units 21.6 MFD / 300VDC / 64.8 Watt sec... 5.95

SAVE ON REPLACEMENTS, WRITE FOR DETAILS 15MPD 330VAC 1500VDC Intermittent... \$3.98

TELEVISION COMPONENT BUYS

Horiz Def output, & Hivoits xmfr SIM RCA 211T5, for 15"-16" picture tubes... \$1.98

TV PICTURE TUBES

10 inch Round... \$14.95 12 inch Round... 17.95 14 inch Rectangular... 20.95

BLOWERS

40 CFM 28 vacdc... \$5.98 250 CFM 28 vacdc... 59.95 250 CFM with 28 to 115 vac Trans... 11.95

METER SPECIALS

0-1Ma 3" sq. Weston DC MILLIAMMETERS \$7.50 0-10Ma & 0-5KV (Basic 1 Ma) 3 1/2" 4.98

MISCELLANEOUS TYPES

0-50 Micro Ammeter 3" sq. Weston \$16.98 0-500VAC 3 1/2" Rnd Weston \$3.49

WRITE FOR TABS BARGAIN SHEET "THE TABOGRAM"

Prices Subject to Change Dent 7RE, 6 Church Street New York 6, N.Y., U. S. A. Cor. Church & Liberty Sts. Room 200, Phone Worth 2-7230

ADVERTISING INDEX

- Adelman, Nat... 109 Allied Radio Corp... 15 American Electrical Heater Co... 19 American Phenolic Corp... 68 Amplifier Corporation of America... 101, 106

New Listing Every Month TUBES

- Standard R.M.A. Warranty. We endeavor to give you low, low prices, consistent with quality merchandise and service. Here is only a partial listing of our large stocks. You may order popular types not listed at approx. same savings. Note Specials in Light-face Type.

Carter, 6 V. Dynamotors, in original cartons. Brand new—400 VDC @ 375 ma. Only 7" x 4" x 3". Orig. Price \$71.40—Special \$28.00

UNIVERSAL RECTIFIER

The new Directron Universal Selenium Rectifier for the first time permits a single stack to work in a variety of voltages as a half-wave rectifier, full-wave center-tap, or full-wave bridge rectifier merely by proper connections to the contacts. These rectifiers are a must for labs and occasional users of Selenium Rectifiers. Full hook-up information. Designed for AC input voltages up to 20 volts RMS. Order in the following sizes:

SELENIUM RECTIFIERS

Table with columns: Current (Continuous), Volts, 18/14 Volts, 36/28 Volts, 54/42 Volts, 130/100 Volts. Rows for 1 Amp, 2 Amps, 4 Amps, 5 Amps, 10 Amps, 12 Amps, 20 Amps, 24 Amps, 30 Amps, 36 Amps.

New Selenium Rectifier Transformers P-11 115 V, 60 cycles in 4 Amps... \$8.75 P-12 115 V, 60 cycles in 12 Amps... 16.75

BARRY ELECTRONICS CORP.

136 Liberty Street, N.Y. 6, N.Y. Rector 2-2563 Terms: 25% with order, balance C.O.D.—Send a few cents for postage—All merchandise guaranteed. F.O.B. N.Y.C. "Please, min. order \$2"

RADIO SCHOOL DIRECTORY PAGE 110

- American Electronics Co. Berkeley & Associates, Edmund C. Commercial Radio Institute Electronics Institute, Inc. National Technical College

Fast Fit for the Job at Hand . . .

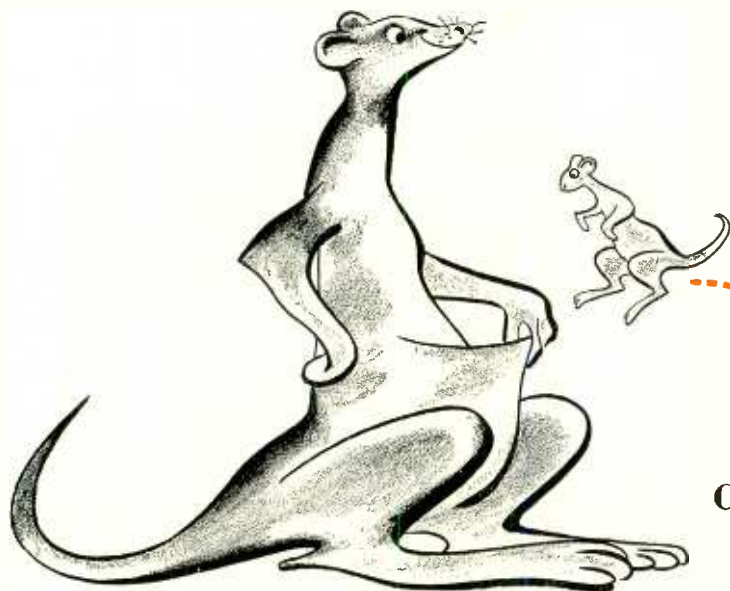

MALLORY MIDGETROL®

Round-Shaft Volume Controls

START FAST . . . FINISH FAST . . .

- Because of the wide and easy adaptability of Mallory Midgetrols, it's easy to stock—or get fast from your distributor—just what you need to do your job.
- Round tubular shaft designed and built for fast, easy and accurate cutting.
- Factory-tested AC switch may be attached instantly without disassembling control.
- Speedy adaptability to both split-knurl and flatted type knobs.

CUSTOMER-PLEASING RESULTS . . .

- Longer lasting resistance elements even in extremes of temperature and humidity.
- Better and more accurate taper curves resulting from precision processing methods.
- No pigtail connections to break—thanks to Mallory's exclusive sliding contact that gives EXTRA quiet operation.
- Minimum wobble with Mallory exclusive two-point shaft suspension.



So Versatile are Mallory Midgetrols—both standard and dual—that they reduce by 40% the cost of inventory needed to service the 10 most popular makes of radio and TV sets.

**Make Sure!
Make it Mallory!**

Every Mallory Midgetrol is packed with two shaft ends to make it easy for you to use either split-knurl or flatted type knobs. The Mallory Midgetrol line, in addition to round shaft standard controls, includes dual concentric controls that offer fast, easy assembly in five steps *without* special tools. Front and rear sections are factory assembled and inspected. AC switch attachment is easy.

P. R. MALLORY & CO. Inc.
MALLORY

CAPACITORS • CONTROLS • VIBRATORS • SWITCHES • RESISTORS
• RECTIFIERS • VIBRAPACK* POWER SUPPLIES • FILTERS

*Reg. U.S. Pat. Off.

APPROVED PRECISION PRODUCTS

P. R. MALLORY & CO., Inc., INDIANAPOLIS 6, INDIANA

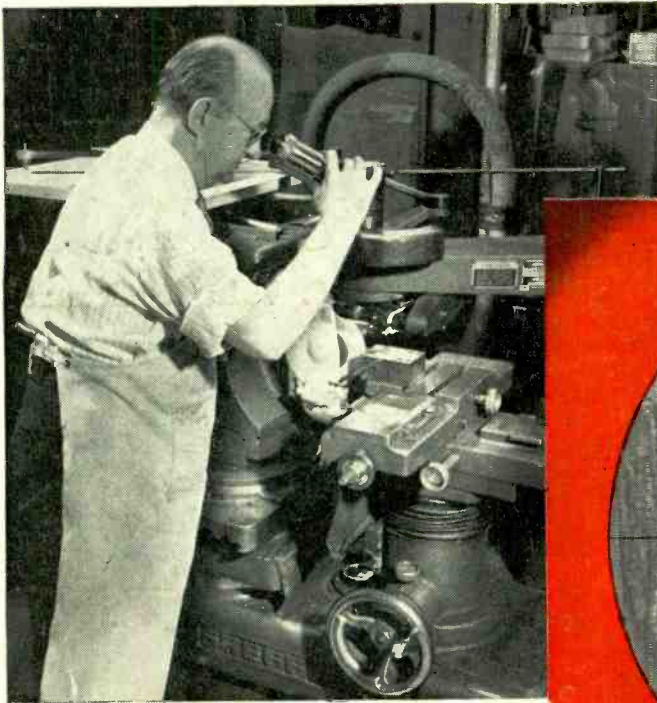

1. The machine that grinds the die.



2. The die that forms the cathode sleeve.



3. The cathode sleeve that helps make the tube.



Take a look at **quality** being born

DIMENSIONAL ACCURACY of the cathode sleeve is a vital factor in providing top-quality tube performance. And cathode-sleeve accuracy begins with the forming die.

What you see above are the two sections of a typical cathode-sleeve forming die, just as it is viewed by the die maker through a 30-power microscope. The die is finished in a

"profile grinder" which employs a 50-to-1 pantograph that traces a template and precisely guides the grinding operation. The result is a die accurate to better than one ten-thousandth of an inch!

Such painstaking precision finishing of dies used to stamp, punch, and form critical tube parts is one more step contributing to the top

quality of RCA Tubes. In this way, RCA closely guards its own reputation for quality ... and yours as well.

With RCA Kinescopes, as well as with RCA Receiving Tubes, **TOP-QUALITY CONTROL** makes the difference.



RADIO CORPORATION of AMERICA
ELECTRON TUBES

HARRISON, N. J.

TMKS. (33)