

DECEMBER 1954

RADIO — ELECTRONICS

TELEVISION • SERVICING • HIGH FIDELITY

HUGO GERNSBACK, *Editor*

In this Issue:

Balanced Modulators
For Low-Level Audio

•
Transistorized
Voltmeter

•
Cathode Followers



Build a Radio for Junior's Car (See page 4)

35¢

U. S. and
CANADA

PROVEN FINEST IN PA

CDP[®]

COMPOUND DIFFRACTION PROJECTOR*

Public Address Loudspeaker System

Sets new standards
for voice penetration
and musicasting

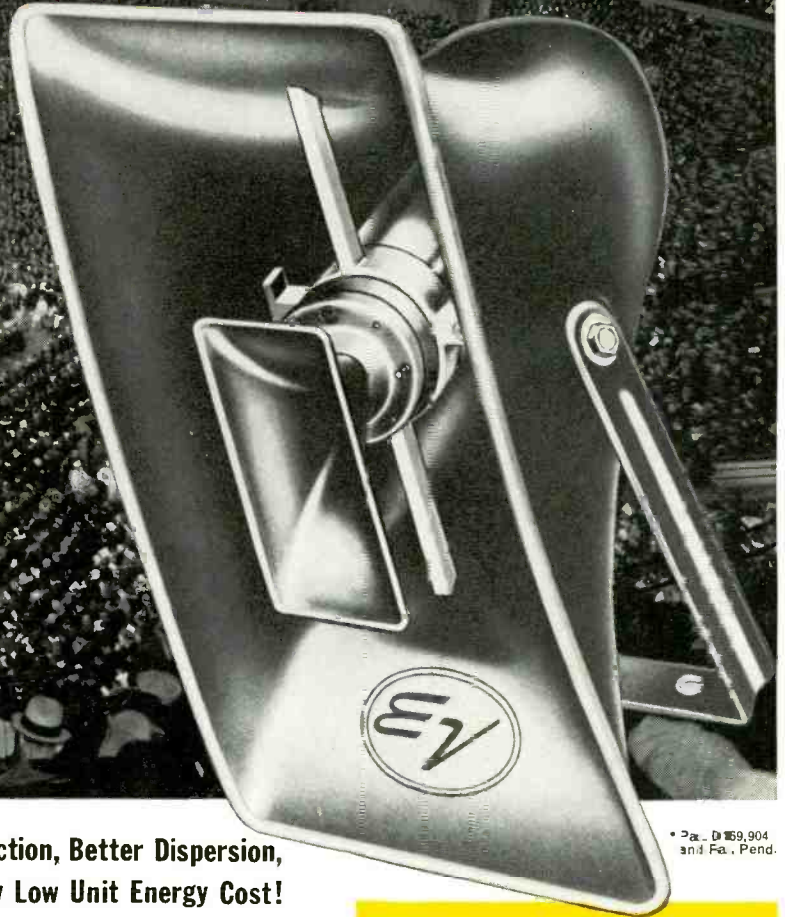

* Pat. D 159,904 and Fa. Pend.

Gives Clearer, Cleaner, Wider-Range Reproduction, Better Dispersion, Greater Penetration and Coverage... at Very Low Unit Energy Cost!

Results are so amazing that the "CDP" is outmoding and rapidly replacing conventional PA re-entrant horns. Exclusive E-V "CDP" utilizes two coaxially mounted diffraction horns working from both sides of a single diaphragm. Each horn is designed for optimum air loading and reproduction within its own range. Also uses the new acoustic application of optical slit diffraction for perfected smooth sound dispersion virtually independent of frequency. Permits use of fewer units at far less cost. Greatly improves public address—in all types of applications—indoors and outdoors. *One test will convince you!*

Model 848 CDP. 25 watts. 16 ohms.
10½" wide, 20½" high, 20" deep over-all.
List Price \$69.50. Net \$41.70

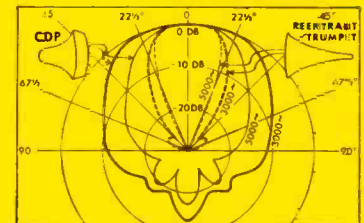

COMPARE POLAR PATTERN

Sound distribution of the E-V "CDP" exceeds 120° at all frequencies up to 10,000 cps.

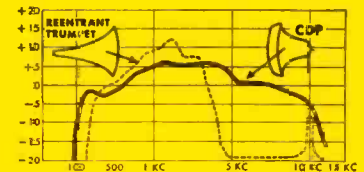

COMPARE RESPONSE AND EFFICIENCY
Note extended high-frequency range of the "CDP." Response is smooth, peak-free 175-10,000 cps.

Acclaimed by Sound Experts Everywhere

- Peak-free response 175-10,000 cps.
- Delivers 2½ octaves more musical range than units of similar size or price.
- Speech articulation index greatly improved.
- Weather-proof, blast-proof, splash-proof. Virtually indestructible.
- Small Size—about ½ the width of re-entrant PA horns of similar power rating. Ideal shape for stacking.
- Provides augmented bass response when stacked in adjacent positions or when mounted singly against wall, in corners or where ceiling joins wall.
- Permits various polar patterns for most effective use.
- Molded of glass fibers for extra strength and improved acoustic properties.

Send Now for Helpful
Bulletin No. 197



Gives complete and helpful information about the performance and application of the "CDP."

NO FINER CHOICE THAN

Electro-Voice

ELECTRO-VOICE, INC. • BUCHANAN, MICHIGAN

Why Guess? There's a Quick, Sure Way to Find TV Set Troubles



The Better Jobs Go to the Men Who Train for Them

PUT YOURSELF IN THIS PICTURE, experimenting at home with equipment we furnish, getting set to go places in TV servicing. Speed in servicing TV sets means stepped up earnings, greater security for you.

ACQUIRE SUPERIOR SKILLS AT HOME IN SPARE TIME

TV Servicing . . . real, professional TV Servicing, pays good money to men with specialized knowledge and training. The exciting, expanding TV industry offers more than just good jobs. It offers success, a career to men qualified to render an essential community service.

Be one of these experienced TV Servicemen. NRI's new course is 100% learn-by-doing, practical training. We supply all the equipment plus comprehensive manuals covering a thoroughly planned program of practice. You learn how experts diagnose TV receiver defects quickly. You learn the causes of defects . . . audio and video . . . accurately, easily. And you learn how to fix them.

ALL LEARN BY DOING

You do more than just build circuits. You get experience aligning TV receivers, isolating complaints from scope patterns, eliminating interference, use germanium crystals to rectify the TV picture signal, adjust the ion trap and dozens of other professional TV Servicing techniques.

Many fellows "go around in circles" trying to isolate TV receiver defects. Don't guess! Learn professional techniques. Take this training now. If you want to go places in TV servicing you will act quickly to find

out what you get, what you practice and how you can advance with better practical knowledge through NRI's new course in Professional Television Servicing. Accept this personal invitation to get a free copy of our booklet which describes this training in detail. Mail the coupon now. Remember, with this course you keep right on working, keep right on earning at your job while you learn through actual practice at home in your spare time.

UHF AND COLOR CREATE GROWING OPPORTUNITIES

To cash in on the present UHF and the coming Color TV boom you'll need the kind of knowledge and experience this Professional Television Servicing

Course gives you. There is no other training like this. Here, condensed into a few months of training at home, is everything that TV servicemen learn in months, even years, of bench work. You get practice installing front-end channel selector strips in modern UHF-VHF receivers. You learn UHF servicing problems and their solution. Mail the coupon below. Discover how this new course meets the needs of the man who wants to get ahead in TV Servicing.

NOT FOR BEGINNERS

NRI's Professional All-Practice Television Servicing Course is for men with some knowledge of Radio and TV fundamentals but who need intensive, practical training and actual experience with TV circuits and professional servicing techniques to be self-reliant, confident, expert TV servicemen. Get this book FREE and judge for yourself how NRI's course will further your ambition to reach the top in TV Servicing. Mail the coupon . . . there is no obligation . . . and it can open the door to a better career for you.

MAIL THIS NOW



NATIONAL RADIO INSTITUTE, Dept. 4NFT
16th and U Sts., N. W., Washington 9, D. C.

Please send my FREE copy of "How to Reach the Top in TV Servicing." I understand no salesman will call.

Name Age

Address

City Zone State

RADIO - ELECTRONICS

Formerly RADIO CRAFT • Incorporating SHORT WAVE CRAFT • TELEVISION NEWS • RADIO & TELEVISION*

Hugo Gernsback
Editor and Publisher
M. Harvey Gernsback,
Editorial Director
Fred Shunaman
Managing Editor
Robert F. Scott
W2PWG, Technical Editor
Jerome Kass
Associate Editor
I. Queen
Editorial Associate
Matthew Mandl
Television Consultant
Angie Pascale
Editorial Production
Wm. Lyon McLaughlin
Tech. Illustration Director
Sol Ehrlich
Art Director

Lee Robinson
General Manager
John J. Lamson
Sales Manager
G. Aliquo
Circulation Manager
Adam J. Smith
Director, Newsstand Sales
Robert Fallath
Promotion Manager
Seymour Schwartz
Advertising Production

Gernsback Publications, Inc.
Hugo Gernsback
Chairman of the Board
M. Harvey Gernsback
President
G. Aliquo
Secretary

ON THE COVER

Dennis Michael, owner of one of the country's few radio-equipped toy automobiles. The radio was made by his father, James S. Michael, and is further described on page 48. Color original by Habershaw Studios

CONTENTS

DECEMBER 1954

RADIO-ELECTRONICS Index Volume XXV January through December 1954 134

Editorial (Page 31)

Our Fabulous Industry.....by Hugo Gernsback 31

Audio—High Fidelity (Pages 32-44)

The Wurlitzer Organ, Part I—Electrical and mechanical construction.....by Richard H. Dorf 32
Balanced Modulators for Low-Level Audio.....by Albert H. Taylor 35
Decibel Measurement With Simple Equipment.....by Hector E. French 37
Servicing High-Fidelity Equipment, Part X—Turntable hum, rumble and wow; record care and storage.....by Joseph Marshall 39
Missing Link in Speaker Operation.....by D. J. Tomcik 41
High-Quality Audio, Part XVI—What price "high fidelity"?.....by Richard H. Dorf 43

Radio (Pages 45-52)

Demonstration Transistor Circuits.....by Edwin Bohr 45
Radio for Junior's Car (Cover Feature).....by James S. Michael 48
Now—the Transistor Pocket Radio.....by Daniel Nof 49
Getting the Cathode Follower Straight.....by Norman H. Crowhurst 50
Novel High-Voltage Supply.....by Harold Pallatz 52

Test Instruments (Pages 53-59)

Dynamic TV Checker.....by H. A. Highstone 53
Transistorized Voltmeter.....by Rufus P. Turner 54
Dual-Feature Capacitor Tester.....by Daniel Nof 56
A.F.-R.F. Tracer Probe.....by John A. Irwin 57
Grid-Dip Adapter Without Tubes.....by Robert H. Mitchell 58
Transistor Overtone Generator.....by I. Queen 59

Television (Pages 60-90)

U.h.f. and V.h.f. Antenna.....by R. F. Kolar 60
Television—it's a Cinch (Fourteenth conversation, first half—The d.c. component and image brightness).....by E. Aisberg 63
Color TV Circuits, Part VII—The 19-inch color tube and associated circuits.....by Ken Kleidon and Phil Steinberg 66
TV Service Notes.....by Dave Gnessin 74
TV Service Clinic.....by Jerry Kass 79
Dogs Without Data.....by Robert G. Middleton 84

Electronics (Pages 94-98)

Electronic Controls.....by J. R. Cornelius 94
Music Into Light.....by C. M. Brainard 98

DEPARTMENTS

Books.....144	Question Box.....120
Business.....123	Radio Month.....6
Correspondence.....12	Radio-Electronic Circuits.....107
Miscellany.....106	Technical Literature.....141
New Devices.....127	Technicians' News.....100
New Tubes and Transistors.....132	Technotes.....114
Patents.....110	Try This One.....116
People.....126	

MEMBER Audit Bureau of Circulation

Vol. XXV, No. 12

Average Paid Circulation over 180,000



RADIO-ELECTRONICS, December 1954, Vol. XXV, No. 12. Published monthly at Mt. Morris, Illinois, by Gernsback Publications, Inc. Entered as Second Class matter June 23, 1954, at the Post Office at Mt. Morris, Ill. Copyright 1954 by Gernsback Publications, Inc. Text and Illustrations must not be reproduced without permission of copyright owners
EXECUTIVE, EDITORIAL and ADVERTISING OFFICES: Gernsback Publications, Inc., 25 West Broadway, New York 7, N. Y. Telephone REctor 2-8630. Hugo Gernsback Chairman of the Board; M. Harvey Gernsback, President; G. Aliquo, Secretary.

SUBSCRIPTIONS: Address correspondence to Radio-Electronics, Subscription Dept., 404 N. Wesley Ave., Mt. Morris, Ill., or 25 West Broadway, New York 7, N. Y. When ordering a change please furnish an address stencil impression from a recent wrapper. Allow one month for change of address.

SUBSCRIPTION RATES: In U. S. and Canada, and in U. S. possessions, \$3.50 for one year; \$6.00 for two years; \$8.00 for three years; single copies 35c. All other foreign countries \$4.50 a year; \$8.00 for two years; \$11.00 for three years.

BRANCH ADVERTISING OFFICES: Chicago: 7522 North Sheridan Road. Tel. ROgers Park 4-8000. Los Angeles: Ralph W. Harker and Associates, 1127 Wilshire Boulevard, Tel. MADison 6-1271. San Francisco: Ralph W. Harker and Associates, 532 Market St., Tel. GARfield 1-2481. FOREIGN AGENTS: Great Britain: Atlas Publishing and Distributing Co., Ltd., London E.C. 4. Australia: McGill's Agency, Melbourne. France: Brentano's, Paris 2e. Belgium: Agence et Messageries de la Presse, Brussels. Holland: Trilectron, Heemstede. Greece: International Book & News Agency, Athens. So. Africa: Central News Agency Ltd., Johannesburg; Capetown, Durban, Natal, Universal Book Agency, Johannesburg. Middle East: Steimatzky Middle East Agency, Jerusalem. India: Broadway News Centre, Dadar, Bombay #14. Pakistan: Paradise Book Stall, Karachi 3. POST-MASTER: If undeliverable send form 3578 to: RADIO-ELECTRONICS, 25 West Broadway, New York 7, N. Y. *Trademark registered U.S. Patent Office.



National Schools brings you a new dimension in training for **TELEVISION-RADIO-ELECTRONICS**

YOU CAN LEARN BY HOME STUDY, IF—

- you are ambitious to increase your earning power.
- you want to broaden your knowledge and skill.
- you choose the school with the most complete training and service.

50 Years of Successful Training

National Schools has been training men for success since 1905. Our graduates are located around the globe, in good-paying jobs in servicing, installation and manufacturing... in public and private industry, or in their own businesses. All this experience and background are your assurance of success.

What This New Dimension in Home Study Means to You

As a National Schools student, with Shop Method Home Training, you master *all phases* of the industry—TV, Radio, Electronics—theory and practice. You learn HOW and WHY, in one complete course at one low tuition.

Because National Schools' world headquarters are in Los Angeles—"capital city" of TV-Radio-Electronics—our staff is in close touch with industry. Our lessons and manuals are constantly revised to keep you up-to-the-minute on latest developments. We show you how to make spare time earnings as you learn, and we give you free placement assistance upon graduation. National Schools is approved for G. I. Training. Both Resident and Home Study courses are offered. If you are of draft age, our training helps you achieve specialized ratings and higher pay grades.

This *new dimension* enables us to train you as you should be trained at home, regardless of your age or previous education.

Your Course Includes Valuable Units

We send you important equipment, including a commercial, pro-

fessional Multitester... plus parts to build Receivers, Oscillators, Signal Generator, Continuity Checker, other units, and Short Wave and Standard Broadcast Superhet Receiver.

Mail Coupon for Complete Information

Get these two free books about this new dimension in Home Training. A comprehensive, illustrated fact-book and a sample National Schools lesson. No obligation, so mail coupon today.

NATIONAL SCHOOLS

TECHNICAL TRADE TRAINING SINCE 1905
Los Angeles 37, Calif. • Chicago: 323 W. Polk St.
In Canada: 811 W. Hastings St., Vancouver, B. C.



MAIL NOW TO OFFICE NEAREST YOU!

(mail in envelope or paste on postal card)

NATIONAL SCHOOLS, Dept. RG-124

4000 S. FIGUEROA STREET
LOS ANGELES 37, CALIF.,

OR 323 W. POLK STREET
CHICAGO 7, ILL.

Rush FREE BOOK, "Your Future in Radio-TV-Electronics," and FREE LESSON. No obligation, no salesman will call.

NAME _____ BIRTHDAY _____ 19__

ADDRESS _____

CITY _____ ZONE _____ STATE _____

Check if interested ONLY in Resident Training at Los Angeles.

VETERANS: Give date of discharge _____

TUNG-SOL TECHNICAL DATA PAYS OFF IN SERVICE!

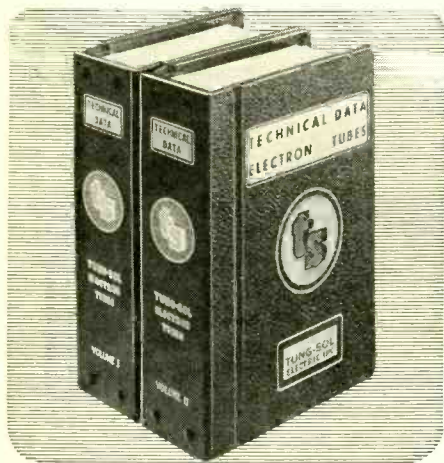

T-58 700 pages—600 tube types



NEW! 1954 Edition! T-70 200 pages of data on CR tubes, receiving and special tubes, dial lamps



T-31 300 blueprint base diagrams for 1100 tube types

Here's the most practical set of tube reference books in the industry—all the information you need for everyday jobs! They're easy to read—easy to use (always lie flat when open). You'll get work done faster with Tung-Sol Technical Data Books. Ask your tube supplier about them.

TUNG-SOL ELECTRIC INC., Newark 4, N. J.
Sales Offices: Atlanta, Chicago, Columbus, Culver City (Los Angeles), Dallas, Denver, Detroit, Newark, Seattle.



TUNG-SOL® easy reference TECHNICAL DATA

Tung-Sol makes All-Glass Sealed Beam Lamps, Miniature Lamps, Signal Flashers, Picture Tubes, Radio, TV and Special Purpose Electron Tubes and Semiconductor Products.



TV PIONEER AND INVENTOR Dr. V. K. Zworykin has been appointed the first honorary vice president in the history of RCA. The appointment was made at a scientific seminar and dinner at which he was the guest of honor, and which marked his retirement as an active vice president of the RCA Laboratories.

David Sarnoff, chairman of the board of RCA, and many of the nation's leading scientists, educators and industrialists paid tribute to Dr. Zworykin for his epoch-making achievements in the fields of television and electronics.

Dr. Zworykin is best known for his



contributions to all-electronic television, including the invention of the iconoscope and development of the kinescope. The electron microscope, developed under his direction, has been acclaimed as one of the most useful scientific tools of this century. He will remain as technical consultant at the RCA Laboratories.

ONE MEGAWATT effective power output will be achieved by a u.h.f. TV station when equipment ordered by WILK-TV (channel 34, Wilkes-Barre, Pa.) is put into operation. The equipment is a 45-kilowatt u.h.f. transmitter, which when used with a new antenna and transmission lines will result in one million watts ERP.

ULTRASOUND may be of considerable value in attacking brain diseases, according to reports by University of Illinois scientists at the recent Madison meeting of the American Physiological Society. The waves of supersound can

be used to eradicate small areas of de-ranged brain tissue, tumors, etc., with less damage to surrounding areas than either the surgeon's knife or other earlier methods. Brain tissue can be destroyed in an area as small as .05 inch across, without affecting areas immediately adjacent.

FREE SERVICE in addition to free replacement of defective parts for a period of 90 days after date of purchase, is being offered by both Westinghouse and General Electric to buyers of their radio receivers.

G-E representatives, meeting with delegates of the Federation of Radio Service Associations of Pennsylvania at Harrisburg, agreed to channel G-E service work to independent shops throughout Pennsylvania. Delegates from the National Electronic Technicians and Service Dealers Association, the Empire State Federation, and from the Eastern Service Conference were present at the meeting. It is expected that General Electric might extend its plan to cover independent service shops in other states.

Westinghouse radio owners should return a new set that needs servicing to the dealer from which it was purchased. The dealer will forward the radio to the nearest authorized Westinghouse radio service station where it will be serviced at no charge to the owner for either parts or labor, and then shipped back, according to the official statement.

NINE NEW TV STATIONS have gone on the air since our last report. These are:

KTIV	Sioux City, Iowa.....	4
KALB-TV	Alexandria, La.....	5
KPLC-TV	Lake Charles, La.....	7
KFVS	Cape Girardeau, Mo.....	12
KETC	St. Louis, Mo.....	9
WLOS-TV	Asheville, N. C.....	13
KTVX	Muskogee, Okla.....	8
WBTW	Florence, S. C.....	8
KUTV	Salt Lake City, Utah.....	2

Two stations, KOPR-TV, Butte, Mont., channel 4 (suspending until March 15), and WTOV-TV, Norfolk, Va., channel 23, have gone off the air.

Four new Canadian stations have gone on the air: CFPA-TV, Port Arthur, Ont., channel 2; CFRN-TV, Edmonton, Alta., channel 3; CJCB-TV, Sidney, N.S., channel 4; CHCT-TV, Calgary, Alta., channel 2.



The Editors wish you a
Happy Christmas and a Prosperous New Year

SURROUND yourself with every major home training advantage to help you earn real money in

TELEVISION

RADIO ELECTRONICS



Established 1931



DTI includes training in **COLOR TV**



You work over **300** Learn-By-Doing projects

ABOVE: You set up your own HOME LABORATORY . . . work with and keep the same type of basic electronic parts used in D.T.I.'s modern Chicago laboratories. Now you can get real Laboratory-type experience—AT HOME.



ABOVE: You receive many well illustrated lessons to provide essential theory.

RIGHT: You use visual training MOVIES at home to help you learn important basic points faster, easier, better—a wonderfully effective, exclusive D.T.I. feature.

- **TOP QUALITY RESULTS!**
- **THOUSANDS OF SUCCESSFUL GRADUATES!**

You have but ONE FUTURE. It deserves EVERY ADVANTAGE. That's why you owe it to yourself to see how you may now receive THE VERY HELP YOU NEED to prepare in your spare time at home for a REAL JOB or your own PROFITABLE BUSINESS.

See how you may prepare to get into work that pays real money . . . that's so interesting . . . that offers an exciting future in one of the MOST PROMISING fields in America—Television, Radio, and Electronics.

EMPLOYMENT SERVICE

See how you may now get ALL of the wonderful home training advantages shown on this page—followed by the same fine EMPLOYMENT SERVICE that has already helped thousands of D.T.I. men start earning good money. If preferred, you can train in our wonderfully equipped Chicago laboratories—one of the nation's finest.



Mail the coupon today. Get the facts. See for yourself. Nothing else like it. And if subject to MILITARY SERVICE, by all means act at once. **MAIL THE COUPON!**

"One of America's foremost Television training centers."

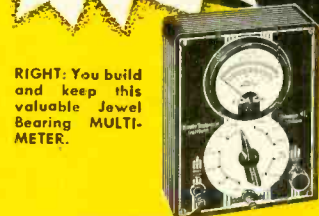

RIGHT: You build and keep this valuable Jewel Bearing MULTI-METER.



ABOVE: You also build and keep this high quality 5 INCH oscilloscope—almost a "must" for TV servicing. Can help you earn money during and after training.

21 INCH

Build and keep this BIG DTI Engineered TV set—easily converted to U.H.F. (DTI offers another home training, but without the TV set.)

Get information packed publication

FREE

89 WAYS TO EARN MONEY

Mail Coupon Today

DeVRY TECHNICAL INSTITUTE

AFFILIATED WITH
DeFOREST'S TRAINING, INC.
CHICAGO 41, ILLINOIS

DeVRY TECHNICAL INSTITUTE

4141 BELMONT AVE., CHICAGO 41, ILL. Dept. RE-12-K

I would like your valuable information-packed publication showing how I may get started toward a good job or my own business in Television-Radio-Electronics.

Name _____ Age _____

Street _____ Apt. _____

City _____ Zone _____ State _____

D.T.I.'s Training is available in Canada

GET OFF THE SPOT



AND
INTO
THE
SPOTLIGHT



WITH THE



BONDED ELECTRONIC TECHNICIAN PROGRAM

Once you gain the confidence of customers, you're on your way to increased volume and profits. The Raytheon *Bonded* Electronic Technician program is designed to help you do just that. The Raytheon Registered Bond Certificate, the Raytheon Creed Display Decal and Identification Cards, featuring your bonded status and the fine Raytheon "Code of Ethics", inspire customer confidence. And a recent survey proved that wherever Raytheon Bonded Technicians took full advantage of their Bonded status — used it to inspire customer confidence — business improved *by at least ten per cent.*

Ask your Raytheon Tube Distributor if you can qualify for this important sales advantage. If you can, the bond is yours *at no cost to you* — it is *Raytheon's investment in your future.*



RAYTHEON MANUFACTURING COMPANY

Receiving Tube Division
Newton, Mass., Chicago, Ill., Atlanta, Ga., Los Angeles, Cal.

RAYTHEON MAKES ALL THESE:

RECEIVING AND PICTURE TUBES • RELIABLE SUBMINIATURE AND MINIATURE TUBES • SEMICONDUCTOR DIODES AND TRANSISTORS • NUCLEONIC TUBES • MICROWAVE TUBES



Excellence in Electronics



Carl E. Smith, E.E.
President

Want To DOUBLE YOUR PAY?

How To Pass FCC COMMERCIAL RADIO OPERATOR EXAMINATIONS FCC LICENSE

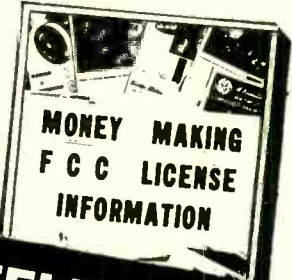

**TELEVISION
ENGINEERING**
Included in our
Training and coaching

GET THIS AMAZING NEW BOOKLET FREE!

TELLS HOW ...

WE GUARANTEE TO TRAIN AND COACH YOU AT HOME IN SPARE TIME UNTIL YOU GET YOUR FCC LICENSE

If you have had any practical experience—Amateur, Army, Navy, radio repair, or experimenting.

HERE IS YOUR GUARANTEE
If you fail to pass your Commercial License exam after completing our course, we guarantee to continue your training without additional cost of any kind, until you successfully obtain your Commercial license, provided you first sit for this examination within 90 days after completing your course.

TELLS HOW ...

Our Amazingly Effective JOB-FINDING SERVICE

Helps CIRE Students Get Better Jobs

Here are a few recent examples of Job-Finding results:

GETS CIVIL SERVICE JOB

"Thanks to your course I obtained my 2nd phone license, and am now employed by Civil Service at Great Lakes Naval Training Station as an Equipment Specialist." Kenneth R. Leiser, Fair Oaks, Md. Del., McHenry, Ill.

GETS STATE POLICE JOB

"I have obtained my 1st class ticket (thanks to your school) and since receiving same I have held good jobs at all times. I am now Chief Radio Operator with the Kentucky State Police." Edwin P. Healy, 264 E. 3rd St., London, Ky.

GETS BROADCAST JOB

"I wish to thank your Job-Finding Service for the help in securing for me the position of transmitter operator here at WCAE in Pittsburgh." Walter Koschik, 1412 Ridge Ave., N. Braddock, Pa.

GETS AIRLINES JOB

"Due to your Job-Finding Service, I have been getting many offers from all over the country, and I have taken a job with Capital Airlines in Chicago, as a Radio Mechanic." Harry Clare, 4537 S. Drexel Blvd., Chicago, Ill.

Your FCC Ticket is recognized by most employers in the electronic field as proof of your technical ability.

TELLS HOW ...

Employers Make JOB OFFERS Like These to Our Graduates Every Month!

Letter from nationally-known Airlines, "We would also appreciate if you would place the following additional advertisement in your bulletin—Wanted—Superintendent of Communications ... Salary \$666.66 per month."

Letter from nationally known airplane manufacturer, "We need men with electronic training or experience in radar maintenance to perform operational check-out of radar and other electronics systems ... starting salary amounting to \$329.33 per month."

Letter from nationally-known Airlines, "We are contemplating placing ... an Airline Ground Radio Engineer." Starting salary \$385 per month.

These are just a few examples of the job offers that come to our office periodically. Some licensed radioman filled each of these jobs ... it might have been you!

HERE'S PROOF FCC LICENSES ARE OFTEN SECURED IN A FEW HOURS OF STUDY WITH OUR COACHING AT HOME IN SPARE TIME

Name and Address	License	Lessons
Lee Worthy 2210 1/2 Wilshire St., Bakersfield, Calif.	2nd Phone	16
Clifford E. Vogt Box 1016, Dania, Fla.	1st Phone	20
Francis X. Foerch 38 Beucler Pl., Bergenfield, N. J.	1st Phone	38
S Sgt. Ben H. Davis 317 North Roosevelt, Lebanon, Ill.	1st Phone	28
Albert Schoell 110 West 11th St., Escondido, Calif.	2nd Phone	23

CLEVELAND INSTITUTE OF RADIO ELECTRONICS
Carl E. Smith, E. E., Consulting Engineer, President
Desk RE-71 4900 Euclid Bldg., Cleveland 3, Ohio

OURS IS THE ONLY HOME STUDY COURSE WHICH SUPPLIES FCC-TYPE EXAMINATIONS WITH ALL LESSONS AND FINAL TESTS.



MAIL COUPON NOW

CLEVELAND INSTITUTE OF RADIO ELECTRONICS
Desk RE-71—4900 Euclid Bldg.
Cleveland 3, Ohio
(Address to Desk No. to avoid delay.)

B I want to know how I can get my FCC ticket in a minimum of time. Send me your FREE booklet, "How to Pass FCC License Examinations" (does not cover exams for Amateur License), as well as a sample FCC-type exam and the amazing new booklet, "Money-Making FCC License Information."
Be sure to tell me about your television engineering course.

Name
Address
City Zone State

Special tuition rates to members of the U.S. Armed Forces. For prompt results, send air mail.

The Sensation of Two Audio Fairs . . .

PERMOFLUX

Largo and Diminnette

2-WAY SPEAKER SYSTEMS

Now Available Under

HTP*

Acclaimed at the Sight and Sound Exposition in Chicago and the Auditorium in New York, these amazing high-fidelity speaker systems are now available under HTP—an exclusive Permoflux insured plan that enables you to try a Largo or Diminnette in the quiet and comfort of your own home for 15 days. See your hi-fi dealer today!

*EXCLUSIVE PERMOFLUX 15-DAY INSURED HOME TRIAL PLAN, INTRODUCED AT THE CHICAGO AND NEW YORK AUDIO FAIRS, OCT., 1954



THE LARGO

Outstanding wide-range speaker system at moderate cost. Uses the famous "Royal Eight" speaker and Super Tweeter. Unique new-type back-loading horn enclosure is matched, octave by octave, to speakers . . . assuring undistorted reproduction from 35-16,000 cps. In selected ¾" Mahogany or Korina veneers. Exclusive: Special connection for headset extension cord. Size: 24" W, 23" H, 14" D. Impedance, 8 ohms. Suggested Audiophile Net . . . **\$99.75**

HEARING IS BELIEVING! Try either system at home under HTP! Read what High-Fidelity Magazine says:

"It's best to try a speaker at home before buying."
—Audio Forum Dept., Oct. 1954 issue

FOR A LIMITED TIME ONLY: Every HTP participant will receive, absolutely FREE, the new Permoflux "Maestro" Speaker-Headset Control Box. See your Permoflux-authorized HTP dealer, or write for full details, to:

Permoflux CORPORATION

4912 West Grand Avenue • Chicago 39, Illinois

West Coast Plant • 4101 San Fernando Road • Glendale 4, California
Canadian Licensee • Campbell Manufacturing Co., Ltd., Toronto, Canada

THE DIMINUETTE

A marvel of compactness featuring "big-system" reproduction over the full audio range and low cost. Ideal for use in a bookcase or as extension speaker. With 2 "Royal 6" speakers and Super Tweeter. In Mahogany or Blonde finish. Size: 23½" W, 11½" H, 12" D. Impedance, 4-8 ohms. Suggested Audiophile Net . . . **\$49.50**

As above, but with selected ¾" Mahogany or Korina veneers. Suggested Audiophile Net . . . **\$64.50**



"George Edward Sterling, during his 31 years of Federal service with this commission and its predecessors, advanced from radio inspector to organizer and director of the FCC wartime radio intelligence activities, chief engineer and, in 1948, to the office of Commissioner. He brought to that office an unprecedented experience in radio which had its beginning in 1908, and as operator, engineer, author and policy maker has played a prominent role in the development of the radio art."

JOHN SCOTT AWARD, presented to ". . . ingenious men and women who make useful inventions," has been made to Marvin Camras, inventor of modern magnetic wire recording. Camras, senior physicist at the Armour Research Foundation of Illinois Institute of Technology, Chicago, will receive the 138-year-old award—consisting of \$1,000, a medal, and a scroll—from the City of Philadelphia, trustee.

KENNETH A. NORTON, chief of the radio propagation engineering division of the Bureau of Standards, has been presented the Stuart Ballantine medal by the Franklin Institute (Philadelphia, Pa.). The award was given for his work in the study and description of propagation phenomena. He is either author or co-author of a long series of papers, all of which contribute to our knowledge of radio propagation or outline methods for making easy engineering calculations in that field.

ELECTRONIC BRAIN designed to simulate aerial fights on a three-dimensional screen and help to solve guided missile problems has been developed in Great Britain. The machine is called the "Tridac" (three-dimensional analogue computer) and uses 8,000 tubes. When the brain calculates what would happen when a fighter chases a bomber, diagrams are automatically drawn showing the sequence of events. END

free

1955 VALUE PACKED ALLIED

308-PAGE CATALOG

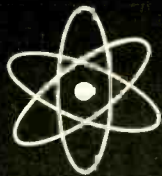

the only COMPLETE
catalog for Everything
in TV, Radio and
Industrial Electronics

SEND FOR IT TODAY

Get ALLIED's 1955 Catalog—308 pages packed with the world's largest selection of quality electronic equipment at lowest, money-saving prices. Select from the latest in High Fidelity systems and components; custom TV chassis, TV antennas and accessories; AM and FM receiving equipment; P.A. Systems and accessories; recorders and supplies; Amateur receivers, transmitters and station gear; specialized industrial electronic equipment; test instruments; builders' kits; huge listings of parts, tubes, tools, books—the world's *most complete* stocks of quality equipment. ALLIED gives you *every* buying advantage: fastest shipment, expert personal help, lowest prices, assured satisfaction. Get the big 1955 ALLIED Catalog. Keep it handy—save time and money on *everything* in Electronics. Send for your FREE copy today.

World's largest Stocks

- All TV and Radio Parts
- All Electron Tube Types
- Test and Lab Instruments
- High Fidelity Equipment
- Custom TV Chassis
- AM, FM Receiving Equipment
- Recorders and Supplies
- P. A. Systems, Accessories
- Amateur Station Gear
- Builders' Kits & Supplies
- Equipment for Industry

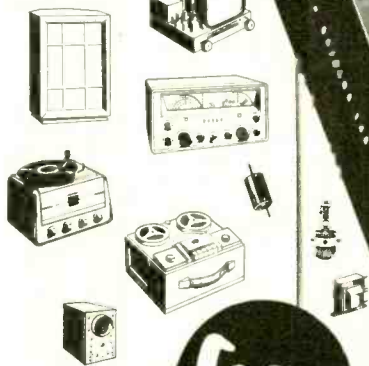

Send for the
leading Electronic
Supply Guide

ALLIED RADIO

free

World's Largest Electronic Supply House

EASY-PAY TERMS

Use ALLIED's liberal Easy Payment Plan—only 10% down, 12 months to pay—no carrying charges if you pay in 60 days. Available on Hi-Fi and P. A. units, recorders, TV chassis, test instruments, Amateur gear, etc.

HI-FI SPECIALISTS

To keep up with the latest and best in High Fidelity, look to ALLIED. Count on us for *all* the latest releases and largest stocks of Hi-Fi equipment. We specialize, too, in TV supply—and are foremost in the field of Builders' Kits.

ultra-modern facilities for the FASTEST SERVICE IN ELECTRONIC SUPPLY

ALLIED RADIO CORP., Dept. 2-M-4
100 N. Western Ave., Chicago 80, Illinois

Send FREE 308-Page 1955 ALLIED Catalog

Name

Address

City Zone State

HERE'S Fast, Easy Picture Tube and Receiver Testing

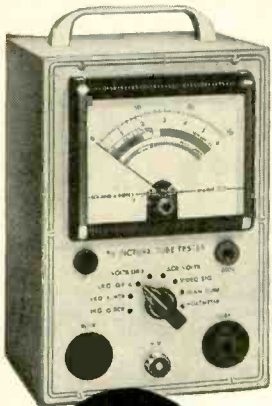

FOR ALL BLACK AND WHITE SETS ADAPTABLE TO COLOR



Take the guesswork out of C-R tube testing and TV troubleshooting! New Boland & Boyce C-R Tube Tester tests all magnetic picture tubes *dynamically*—under the receiver's own power. Tells instantly whether tube or set is at fault. 600 V. d-c range extends to 30 or 60 KV by HV Probe.

BOLAND & BOYCE DYNAMIC C.R.T. TESTER Model 701

Tests tubes in set under receiver's own power or out of set with handy plug-in power supply.

Separate plug-in power supply available for in-carton tube testing. Prices include 2 cabled leads and instruction manual. KIT—\$29.95. FACTORY WIRED & TESTED—\$39.95. Sold by leading distributors.

B&B BIAS BOX—Speeds Alignment and AGC Troubleshooting

Supplies steady, accurately adjustable bias voltages from 0 to 17 volts d-c to substitute for receivers' normal automatic-gain or automatic-volume-control circuits. A "must" for radio and TV alignment. Clips and grounds to chassis apron; powered by receiver's 6.3 v. heater supply. KIT—only \$9.95. FACTORY WIRED & TESTED—\$12.95.

UNIVERSAL HV PROBE for ALL meters, ALL ranges

Extends range of any VTVM, or any multimeter or voltmeter having sensitivity of 10,000 ohms-per-volt or more. Supplied with complete set of plug-in instructions to accurately match any meter... any range—10KV, 30KV, 60KV, and others. Clear, high-dielectric probe body shows resistors in use. Includes shielded cable with Amphenol connectors and phone tips. \$12.95 net.

Write for Brochure Describing B&B Products

BOLAND & BOYCE, INC.
Dept. RE-124, 236 Washington Avenue
Belleville 9, N. J.



WHAT IS CORRECTNESS?

Dear Editor:

This letter is in reference to High-Quality Audio by Richard H. Dorf in the September issue.

Mr. Dorf does not distinguish between impedance and resistance. When speaking of impedance, power is not merely the product of current and voltage; another factor, the phase angle between I and E, must be considered. This is expressed as *cosine theta* and must be included in the formula for power. . . .

Mr. Dorf calculates that to drive a 4-ohm speaker with 8 watts through a 40-1 turns ratio transformer requires what he calls a plate current of 35 ma. . . . I would like to point out that this 35 ma is the r.m.s. value of an a.c. signal with peak values of approximately 50 ma in each direction from the steady-state plate current. Thus the steady-state current must be in excess of 50 ma. . . . After listing some pentode and beam-power tubes (6F6, 6L6, etc.) Mr. Dorf says, "Triodes can pass more current than the others and thus require smaller turns-ratio output transformers. . . ." This statement is in error and is misleading. A 6L6 can pass more plate current for a given plate voltage because its plate dissipation is higher. Yet it should look into roughly twice the load resistance of the 2A3. . . .

I mention these points because I feel RADIO-ELECTRONICS has an obligation to provide accurate information to its reading public.

WILLIAM HOLM

East Lansing, Mich.

(Mr. Holm's attitude is typical of a group whose manuscripts make up nearly 75% of those rejected by this magazine. What these scholars do not understand is that *material must be tailored to its application*. Most of them would consider it insane to design a 10-watt amplifier for use in a hearing aid; yet they do not hesitate at the equal absurdity of firing "cosine theta" at a reader whose Greek has been neglected and whose trigonometry is nil.

Mr. Dorf's articles indicate by their very content—as well as the statement in the opening installment—that they are aimed at the reader who is not already an expert, in fact for "every-one who would like to have a thorough look into the purposes, ingredients and techniques of high-quality home music systems." To reach this group it is necessary to simplify, round off corners,

DON'T THROW OLD RADIOS AWAY!



Let this big handbook show you EXACTLY HOW TO FIX THEM fast and r-i-g-h-t!



A. A. GHIRARDI

Covers every model made by 202 mfrs. from 1925 to 1942

- Airline
 - Apex
 - Arvin
 - Atwater Kent
 - Belmont
 - Bosch
 - Brunswick
 - Clarion
 - Crosley
 - Emerson
 - Fada
 - G.-E.
 - Kolster
 - Majestic
 - Motorola
 - Philco
 - Pilot
 - RCA
 - Silvertone
 - Sparton
 - Stromberg
- and over a hundred more!

THE ONLY GUIDE OF ITS KIND!

There's a "secret" to fixing old radios fast and profitably . . . and Ghirardi's big 744-page, manual-size RADIO TROUBLESHOOTER'S HANDBOOK is it!

No other guide like it! Gives common trouble symptoms and remedies for over 4,800 models of old home receivers, auto radios and record changers. Contains tube and component data, charts, circuits, etc. available from no other source. Even beginners can handle jobs slick as a whistle. Makes it easy to repair old sets for which specifications and how-to-fix-it data are no longer available. Just look up the model you want to fix. Four times out of 5, this giant Handbook leads you right to the trouble . . . shows exactly how to fix it. No useless testing. No guesswork. You repair sets in a jiffy that would otherwise go to the junk pile because no one knows what to do with them.

There are over 400 pages of troubleshooting and service case histories. In addition, you get over 300 pages of helpful I-F transformer data; superhet realignment data and alignment peaks; handy troubleshooting reminder charts; auto radio gear ratios; complete data and characteristics on old tube types and components; tube substitution data . . . and dozens of other invaluable service tips and ideas.

PRACTICE 10 DAYS FREE

Dept. RE-124, RINEHART & CO., INC.,
232 Madison Ave., New York 16, N.Y.

Send Ghirardi's RADIO TROUBLESHOOTERS HANDBOOK for 10-day free examination. If I decide to keep book, I will then send \$6.50 (plus postage) in full payment. Otherwise, I will return book postpaid and owe you nothing.

Name.....

Address.....

City, Zone, State.....

OUTSIDE U.S.A. \$7.00 cash only. Money back if book is returned in 10 days.

DANGER!
CURVES

Don't let any Antenna Manufacturer pitch curves to you!

new **WINEGARD**
INTERCEPTOR

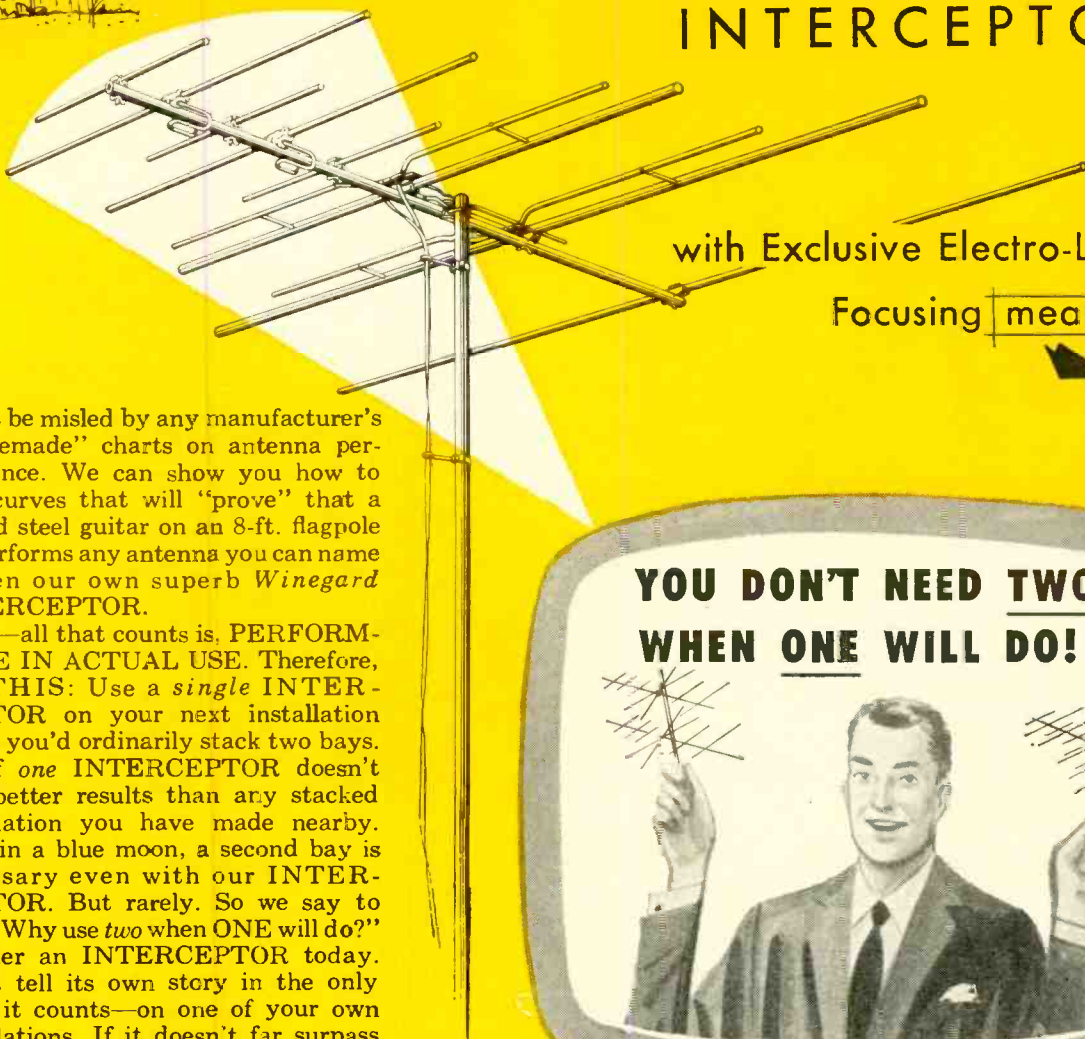

with Exclusive Electro-Lens*

Focusing means...

Don't be misled by any manufacturer's "homemade" charts on antenna performance. We can show you how to plot curves that will "prove" that a busted steel guitar on an 8-ft. flagpole outperforms any antenna you can name—even our own superb *Winegard* INTERCEPTOR.

No—all that counts is, PERFORMANCE IN ACTUAL USE. Therefore, DO THIS: Use a *single* INTERCEPTOR on your next installation where you'd ordinarily stack two bays. See if *one* INTERCEPTOR doesn't give better results than any stacked installation you have made nearby. Once in a blue moon, a second bay is necessary even with our INTERCEPTOR. But rarely. So we say to you, "Why use *two* when *ONE* will do?"

Order an INTERCEPTOR today. Let it tell its own story in the only place it counts—on one of your own installations. If it doesn't far surpass any other antenna you've ever used, fire it back to us! We'll return your money—and we'll still be friends! So . . . order NOW!

**A FAR BETTER PICTURE
OR YOUR MONEY BACK!**

Antenna No.	Winegard Trade Name	List Price
L-4	INTERCEPTOR	\$24.95 a bay
L-5	PIXIE	\$14.95 a bay
Shipped, one L-4 to a carton (stacking bars available)		
Shipped, two L-5's to a carton with stacking bars.		

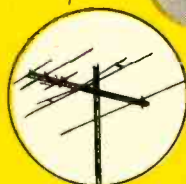

WINEGARD PIXIE
A quality all VHF channel antenna for top performance at a low price.

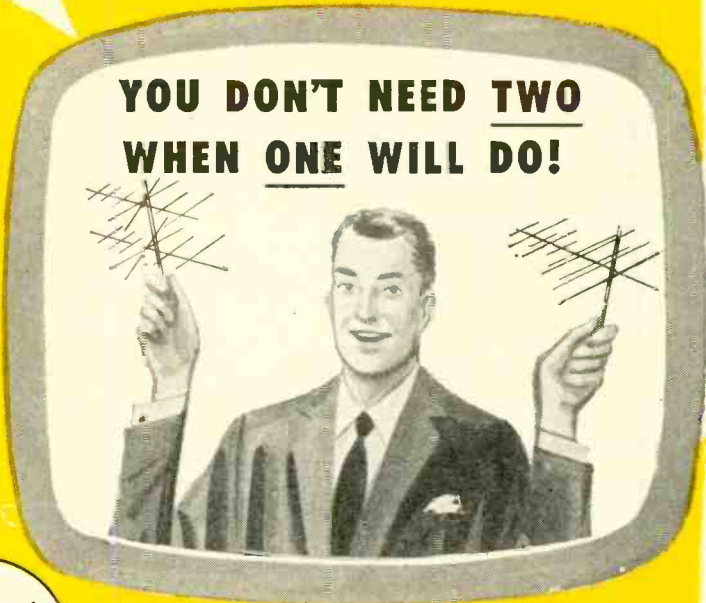

*Patent Pending

THE INTERCEPTOR gives the clearest, sharpest pictures obtainable . . . not just on one or two channels . . . but on all 12 VHF channels.

See your jobber now or write us for complete information.



WINEGARD COMPANY

3000 Scotten Boulevard, Burlington, Iowa

Field Tested and Proven

by Hundreds of Thousands of Satisfied Users

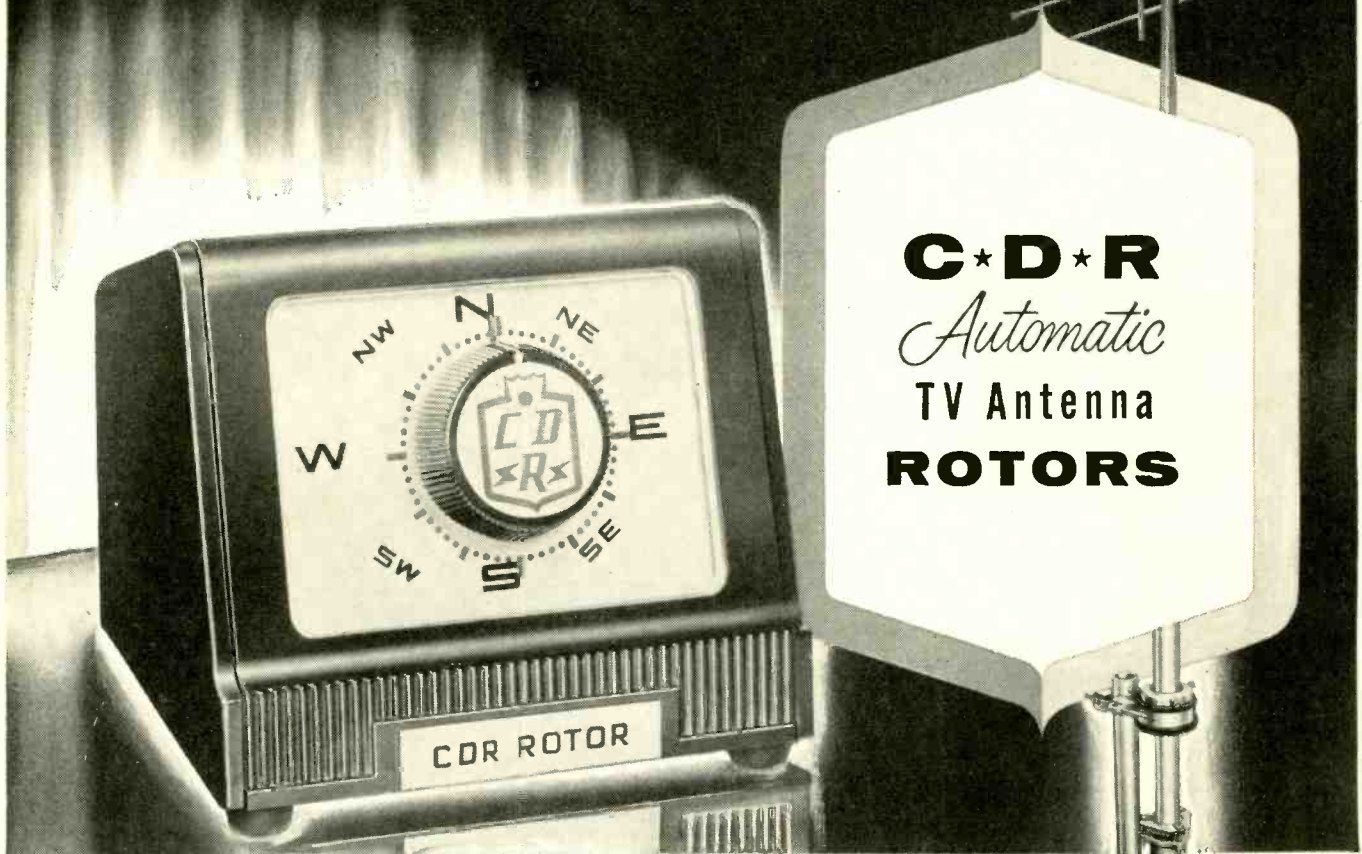

model AR-2... complete AUTOMATIC rotor with thrust bearing... and handsome modern design cabinet, uses 4 wire cable

model AR-1... same as AR-2 without thrust bearing



model TR-12

A special combination value consisting of complete rotor including thrust bearing. Handsome modern cabinet with meter control dial, uses 4 wire cable.

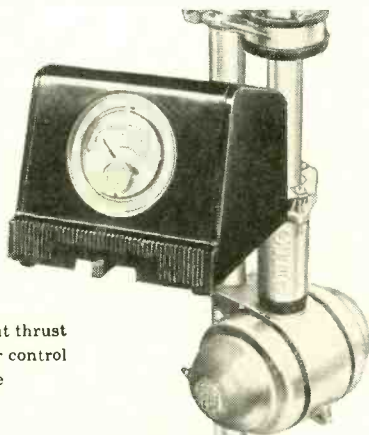

model TR-11

The same as the TR-12 without thrust bearing, complete with meter control dial cabinet, uses 4 wire cable

model TR-2

The heavy-duty rotor with plastic cabinet featuring "Compass Control", illuminated "perfect pattern" dial, uses 8 wire cable

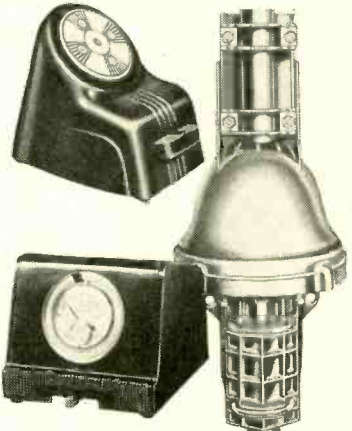

model TR-4

The heavy-duty rotor complete with handsome, modern design cabinet with meter control dial, uses 4 wire cable.



CORNELL-DUBILIER
SOUTH PLAINFIELD, N. J.



THE RADIART CORP.
CLEVELAND 13, OHIO

The One Big Reason Big-Screen Color TV Sets are on the Market Now

It took more than engineering promises before leading set manufacturers invested in production of color TV sets. It took a practical big-screen color picture tube . . . the CBS-Colortron "205."

It took *creative* engineering to conceive this advanced design in color picture tubes. And it took *advanced-engineering* knowledge to produce it.

Today, these set manufacturers are demonstrating their recognition of the leadership of CBS-Hytron. For they are shipping color TV sets *and these sets are equipped with the CBS-Colortron "205."*

There can be no better evidence of the *advanced-engineering* knowledge of CBS-Hytron . . . *Advanced-engineering* knowledge *you* can depend upon to produce the finest in television tubes . . . for color *or* for black and white.



WRITE FOR **FREE BULLETIN E-227** TODAY.
*Four pages of engineering application data
on the "205."*

CBS-COLORTRON PATENT NO. 2,690,518. OTHER PATENTS PENDING



CBS-HYTRON Main Office: Danvers, Massachusetts
A Division of Columbia Broadcasting System, Inc.

A member of the CBS family: CBS Radio • CBS Television • Columbia Records
CBS Laboratories • CBS-Columbia • CBS International • and CBS-Hytron

DECEMBER, 1954

15

Hi-Fidelity dynamic microphone



only
\$57⁰⁰

Quickly converted
for floor stand use

for
Broadcast
Television
Recording
Public Address

NEW TURNER 57

This new dynamic microphone is designed to meet the requirements of TV, broadcasting, PA, high fidelity recording . . . and, at an exceptionally low price. Design is slim and modern, with black satin finish that can't reflect light. Sound characteristics for both voice and music are excellent. Response: 50 to 13,000 cps. Level: -55 db. Has built-in Cannon XL-4 connector, permitting selection of high or low impedance by making connection to proper pair of conductors at terminal end of cable. Matching stand with built-in shock mount priced separately.



Mail the coupon today
for complete information.

THE TURNER COMPANY
933 - 17th Street NE,
Cedar Rapids, Iowa

Please send me complete information on
your new Model 57 Dynamic Microphone

NAME _____
ADDRESS _____
CITY _____
STATE _____

IN CANADA: Canadian Marconi Co.,
Toronto, Ontario and Branches
EXPORT: Ad. Aurelma, 89 Broad Street,
New York 4, N.Y.

CORRESPONDENCE

(continued)

ignore insignificant but very real factors, and otherwise avoid any confusing points which do not aid the reader to grasp the essentials of the matter, but whose inclusion would very effectively prevent him from grasping any of it at all.

The material is correct as far as it goes. All Mr. Dorf's articles were read critically by three persons of different viewpoints and different degrees of audio knowledge, and any doubtful points were discussed with the author and agreed upon before printing. As an example, take Mr. Holm's stand on impedance. No one will deny that X as well as R must be taken into account. But, from a practical point of view, if Mr. Holm's own audio system's output impedance doesn't look pretty much like R over the whole frequency range, he had better look to the quality of his audio! Dorf's equivalent circuit follows the electrical facts of life within all practical tolerances, and has one decisive advantage over conventional equivalent speaker circuits: it's comprehensible!

Again, his reference to plate current, taken out of context, seems a clumsy and "incorrect" way to describe the difference between a triode and pentode. But Dorf has referred to a current ratio four paragraphs before (those 35 ma) and is explaining triode action in terms of the earlier paragraph. Only one thing is incorrect in the paragraph, and the editors apologize for it, since it could have been removed with the stroke of a pencil. That is the reference to "better speaker damping" which is not explained anywhere in the article. We should not glibly have used a term too advanced for the discussion.

On one point we agree heartily with Mr. Holm, that RADIO-ELECTRONICS has an obligation to provide accurate information to its readers. If material is not clear and simple, it is not information. And if it is not information, it cannot be accurate information. If Mr. Holm has overlooked that point, we are sure that he will agree—after looking the articles over again—that they were a correct approach to the job attempted. If, on the other hand, he belongs to the small but widespread group who feel that the would-be learner has no right to knowledge unless he has sufficient mathematical training to take it in "correct" form, we have little sympathy for him.

There remains another possibility—that a series of articles could be written which would suit the purist and yet be useful to the beginner without engineering training. We have not seen such articles, but would love to stand corrected! If any reader can supply articles which would meet all the objections of Mr. Holm, yet be interesting and understandable to the average intelligent radio-TV technician, we can guarantee for them the highest prices we have ever paid, plus a book contract!

—The Editors)

NOW

at last

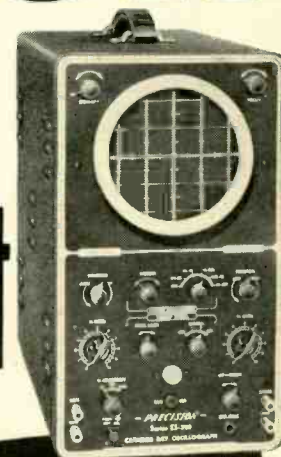

A Reliable, General-Purpose
5" Oscilloscope
Priced at only **\$127⁵⁰**

The **NEW**
PRECISION
MODEL
ES-520

PRECISION-engineered in response to industrial requirements for a reliable, low-cost, FACTORY-wired and FACTORY-calibrated scope for basic production and testing applications.

SPECIFICATIONS INCLUDE . . .

- ★ Push-Pull vertical drive. 20 millivolts per inch sensitivity.
- ★ 3-Step, frequency-compensated, vertical input attenuator.
- ★ Vertical frequency response 20 cycles to 500 KC within 2 DB.
- ★ 1 volt, peak-to-peak, built-in vertical voltage calibrator.
- ★ Excellent vertical square wave response from 20 cycles to 50 KC.
- ★ Push-pull horizontal drive. 50 millivolts per inch sensitivity.
- ★ 'H' frequency response 20 cps to 200 KC within 3 DB (at full gain).
- ★ Internal linear sweep 10 cycles to 30 KC. Neg. and pos. sweep synch.

Plus additional engineering and performance features never before incorporated in an oscillograph designed for such general application and at such economical price!

SERIES ES-520: In black ripple finished, rugged steel cabinet, 8¼ x 14½ x 16½". Complete with all tubes, including 5U1 CR tube. Comprehensive instruction manual.

Net Price: \$127.50

Write directly to factory for complete data and specifications.

PRECISION Apparatus Co. Inc.
70-31 84th Street, Glendale 27, L. I., N. Y.

Export Division: 458 Broadway, New York 13, U.S.A. • Cables—MORHONES
In Canada: Atlas Radio Corp., Ltd., 560 King Street, W., Toronto 28

RADIO-ELECTRONICS

Home Study Courses in TELEVISION SERVICING offered by RCA INSTITUTES



Study Television Servicing—from the very source of the latest, up-to-the-minute TV and Color TV developments. Train under the direction of men who are experts in this field. Take advantage of this opportunity to place yourself on the road to success in television. RCA Institutes, Inc. (A Service of Radio Corporation of America), thoroughly trains you in the "why" as well as the "how" of servicing television receivers.

FIRST HOME STUDY COURSE IN COLOR TV SERVICING

Now you can train yourself to take advantage of the big future in Color TV. RCA Institutes Home Study Course covers all phases of Color TV Servicing. It is a practical down-to-earth course in basic color theory as well as how-to-do-it servicing techniques.

This color television course was planned and developed through the combined efforts of instructors of RCA Institutes, engineers of RCA Laboratories, and training specialists of RCA Service Company. You get the benefit of years of RCA research and development in color television.

Because of its highly specialized nature, this course is offered only to those already experienced in radio-television servicing. Color TV Servicing will open the door to the big opportunity you've always hoped for. Find out how easy it is to cash in on Color TV. *Mail coupon today.*

SEND FOR FREE BOOKLET

Mail coupon in envelope or paste on postal card. Check course you are interested in. We will send you a booklet that gives you complete information. No salesman will call.



RCA INSTITUTES, INC.
A SERVICE OF RADIO CORPORATION OF AMERICA
350 WEST FOURTH STREET, NEW YORK 14, N. Y.

HOME STUDY COURSE IN BLACK-AND-WHITE TV SERVICING

Thousands of men in the radio-electronics industry have successfully trained themselves as qualified specialists for a good job or a business of their own—servicing television receivers. You can do this too.

This RCA Institutes TV Servicing course gives you up-to-the-minute training and information on the very latest developments in black-and-white television.

As you study at home, in your spare time, you progress rapidly. Hundreds of pictures and diagrams, easy-to-understand lessons help you to quickly become a qualified TV serviceman.

There are ample opportunities in TV, for radio servicemen who have expert training. Mail coupon today. Start on the road to success in TV Servicing.

MAIL COUPON NOW



RCA INSTITUTES, INC.
Home Study Dept. RE-1254
350 West Fourth Street, New York 14, N. Y.
Without obligation on my part, please send me copy of booklet on:

- Home Study Course in TELEVISION SERVICING.
- Home Study Course in COLOR TV SERVICING.

Name _____ (please print)

Address _____

City _____ Zone _____ State _____

New
**UHF & VHF
 LEAD-IN**

Thousands of separately sealed tiny cells, filled with inert gas, make this waterproof cable stable and efficient electrically.

ADVANTAGES:

- 1 Lowest losses at UHF and VHF frequencies.
- 2 Great abrasion resistance and mechanical strength.
- 3 No time-consuming end seal required; easy to install.
- 4 No internal moisture to cause signal loss.
- 5 No kinking when used with antenna rotors.
- 6 Resistant to snow, ice, rain, and wind.
- 7 Resistant to ultraviolet rays from the sun.
- 8 Uses Belden Weldahm conductor for long conductor life.
- 9 Can be clamped tightly in stand-off insulators without crushing. No special fittings required.
- 10 Conductor spacing is constant even when the lead-in is transposed.
- 11 No stripping problem for attaching the conductor.

...Cuts
SIGNAL LOSS

This heavy wall of brown virgin polyethylene protects the cable against mechanical abuse and damage from ultraviolet sun rays.

This completely new 300-ohm line results from the development of a new cellular plastic core where each separate cell is filled with an inert gas to make an efficient cable with the lowest possible losses at both UHF and VHF frequencies. With this absolutely waterproof cable, no sealing of the ends is necessary. Celluline cable can be fixed in stand-off insulators without crushing. The thick outer wall of polyethylene serves to protect the cable from abrasion and sun damage.

By using *only* virgin polyethylene, the wall can be made smooth—absolutely free from rough spots—to prevent the adherence of dust and other impurities which would increase the losses.

The copper-covered steel strands, which make up the conductors, assure 49% greater resistance to breaking from flexing or stretching than any all-copper conductor.

8275 CELLULINE[®]
 TRANSMISSION LINE

by **Belden**
 WIREMAKER FOR INDUSTRY

Get this FREE Booklet Today!

LOADED WITH CAREER-BUILDING FACTS — IT CAN LEAD YOU TO A BIGGER JOB, BETTER PAY, SECURITY AND SUCCESS IN RADIO — TV — ELECTRONICS



“YOUR FUTURE IN THE NEW WORLD OF ELECTRONICS”— contains a proved plan for your successful career in:

- ★ BROADCASTING
- ★ MANUFACTURING
- ★ SERVICING
- ★ ARMY, NAVY, AIR FORCE, COAST GUARD ELECTRONICS
- ★ TELEVISION
- ★ COMMUNICATIONS
- ★ AERONAUTICAL ELECTRONICS

A PROVED CAREER-PREPARATION PLAN THAT WORKS!

This free book has brought success home to thousands of men just like you! They are now enjoying responsible jobs, good pay and the good things of life. So can you! In less time than you think! We tell you how you can carve out a bigger better-paying job. Our proved career-preparation plan works because it was written by authorities who know exactly what the varied electronic industries want, need and expect from you!

ELECTRONICS' FUTURE CAN BE YOUR FUTURE

You can't keep up with the tremendous changes in the electronic industries. What's predicted for next year becomes outdated in a few months! All phases of the electronic industries are experiencing phenomenal growth. There are thousands of career openings, big ones. Industry can't find enough trained manpower to fill them—in manufacturing, testing, servicing, broadcasting and telecasting.

TAKE TV FOR EXAMPLE!

Four hundred and six stations are on the air! Many more are building or in

the plans stage; 32,859,915 sets are in use. Color TV is just starting to really come alive! This same phenomenal growth picture is repeated in every phase of business employing electronics—crime prevention, aeronautics, fire-fighting, communications, to name but a few. CREI has the plan to keep you moving upward, to help you assume your rightful place!

CREI GRADS ARE IN DEMAND!

The big companies know CREI men have what it takes! CREI grads are at work in America's biggest corporations, in positions ranging from technicians to engineers to top management. Companies such as United Air Lines, Canadian Broadcasting Corporation, Trans-Canada Airlines, Sears-Roe-

Act Now!

TAKE THAT FIRST BIG STEP!
NO OBLIGATION

buck and Co., Bendix Products Division, All-American Cables and Radio, Inc., and Radio Corporation of America, are now paying for CREI training for their own technical staffs. Our placement bureau has more requests for CREI-trained men than we can presently supply.

CREI GRADS EASILY PASS FCC EXAMS!

You start feeling the benefits of CREI training right away, either with your present connection, or with a future employer. You'll have all the training you need to secure your FCC commercial license.

ACT NOW! TAKE THAT FIRST BIG STEP!

Fill out and mail the coupon. When you do, you'll be on the way to higher pay, a better job and complete career security. Act right away. Send for your free book today.

THOUSANDS LIKE YOU HAVE SUCCEEDED WITH CREI'S PLAN! "CREI TRAINING IS BEST"



“I chose CREI training upon recommendation of two top engineers. Before I had completed the course I became transmitter chief of a 5 KW station. I am now employed as a technician at a 100 KW TV station, and in spare time have a good TV sales and service business. Anyone interested in his electronic future should have CREI training.” . . . —Arlie D. Patton, San Antonio, Texas

“I know of no case in which a man who applied himself and completed the CREI course failed to better himself through promotion and increase in salary.” . . . —Wendell L. Fraser, San Diego, Calif.
“—CREI has raised me to professional status as a radioman. Thanks to your instructors who always gave me needed help.” —Victor Mentzer, Wilmington, Del.
“—I have been in radio and electronics for 24 years. I fully recommend CREI as the best school I have seen.” —L. McManus, Montreal, Canada

CAPITOL RADIO ENGINEERING INSTITUTE

Accredited technical curricula.
Founded in 1927.
3324—16th Street, N.W.
Washington 10, D. C.

CREI also offers resident instruction: at the same high technical level, day or night, in Washington, D.C. New classes start frequently during the year. If this type of instruction meets your requirements, check the coupon for Residence School catalog. Qualified residence graduates may earn the degree of Associate in Applied Science.

INFORMATION FOR VETERANS

If you were discharged after June 27, 1950—let the new G.I. Bill of Rights help you obtain resident instruction. Check the coupon for full information.

MAIL THIS COUPON Today!

CAPITOL RADIO ENGINEERING INSTITUTE

Dept. 1412-A, 3224 16th St., N. W., Washington 10, D. C.

Please send me your course outline and FREE Illustrated Booklet “Your Future in the New World of Electronics” . . . describing opportunities and CREI home study courses in Practical Electronics Engineering.

- CHECK FIELD OF GREATEST INTEREST
- Practical Radio Engineering
 - Broadcast Radio Engineering (AM, FM, TV)
 - Practical Television Engineering
 - Aeronautical Electronics Engineering
 - TV, FM & Advanced AM Servicing

Name.....

Street.....

City..... Zone..... State.....

CHECK: Residence School Veteran

To help you answer your request intelligently, please give the following information:

EMPLOYED BY.....

TYPE OF PRESENT WORK.....

SCHOOL BACKGROUND.....

ELECTRONICS EXPERIENCE.....

IN WHAT BRANCH OF ELECTRONICS ARE YOU MOST INTERESTED?

**BRAND
NEW**

FEATURES

THAT MAKE *TRIO* THE LEADER IN '55



HEAVIEST BOOMS!

Thick-wall, extra-sturdy 1 1/4" diameter Booms. Nothing approaching them for strength! Now used on **ALL** low-band yagis.



New "VARI-CON" HEAD

Four Hi-strength aluminum adjusting arms, Interlocking Butterfly sections, Heavier snap-action spring assembly. The "Vari-Con" is the only antenna with spring dampeners to lessen vibration and breakage. The "Vari-Con" head also used on the popular TRIO 88 Series.



Sensational
INSTA-LOK CLAMP

(Good-Bye Nuts)

This revolutionary clamp permits instant flip-out assembly, permanent alignment with ultra strength. Nothing stronger — nothing faster! Insta-Lok employed on **ALL TRIO** Antennas that have parasitic elements.



New MINIT-UP CONICAL HEAD

Swing out element mounting plates, fan out elements into snap-fastenings and it's set! Used throughout conical line.

New MYCASTYRENE INSULATORS USED THROUGHOUT TRIO LINE

 ZZ12L	 Twin-Six
 C44	 FDLH
 UBT-4	 SQ-1
 SV-2	 44

New TRIO ARISTOCRAT ROTATOR

NOW AVAILABLE IN **FOUR** GLORIOUS COLORS!



TRIO 88

Far superior construction. Rugged, foolproof — easily installed. Parasitic elements supported by TRIO's revolutionary new "Insta-Lok" clamps. Low channel dipoles supported by the strongest conical head made. No vibration — No element shedding. Completely pre-assembled. Available in single or two bay models.

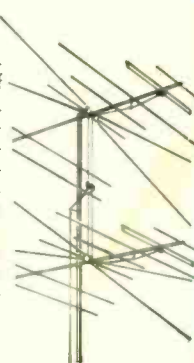

TRIO 66

Three dipoles provide exceptionally high gain on all VHF channels. Exclusive TRIO grid reflector gives improved performance. Extremely rugged yet lightweight. Pre-assembled — simply unfold and tighten reflector and dipole assemblies. Three vertical braces on reflector screen for increased strength. Available in single or two bay models.

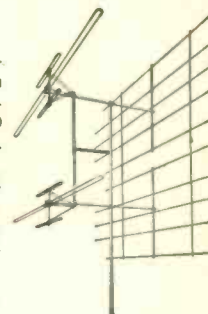

COPYRIGHT 1954 BY TRIO MANUFACTURING CO.

Ask To See America's Most Dependable And Beautiful Rotator:

TRIO
Manufacturing Co.
GRIGGSVILLE, ILLINOIS

 22U	 98-2	 50 Series	 100 Series
---------	----------	---------------	----------------

TRIO Leader in Antenna Development



The New TRIO
"ARISTOCRAT"

Only Rotator Available
in Four Glorious Colors:

Mahogany
Golden Wheat
Decorator's Gray
Broege Marble

AMERICA'S MOST DEPENDABLE ROTATOR

THE TRIO
"ARISTOCRAT"



NOW ...

*America's
most
beautiful!*

The sleek, modern, low silhouette of
the new TRIO rotator control case
marks a new high in styling.

Beauty, here, is more than skin deep since its low
center of gravity makes it tip-proof! Note, too, that
there are NO unsightly control knobs or switches to spoil
its beauty. These are located at top rear of case —
where your hand naturally rests in operation of rotator!

There is no obscuring the easily-read lighted dial.
Available in either blonde or mahogany, the unit with
its graceful flowing lines blends perfectly
with any decor.

Yes, America's most dependable
rotator is now America's most
beautiful as well!

Switch and direc-
tional controls are
located at top rear
of case for most con-
venient manual opera-
tion. Lighted dial
permits operation in
darkened room and
also indicates when
rotator is on. When
on, pointer always
shows exact position
of antenna.



✓ Only Rotator
With Two Motors

✓ Only Rotator
With Two-Year
Guarantee



THE TRIO
"ARISTOCRAT"

... CULMINATION OF
SIX YEARS RESEARCH
AND PRODUCTION

COPYRIGHT 1954 BY TRIO MANUFACTURING CO.



TRIO

Manufacturing Co.
GRIGGSVILLE, ILLINOIS

THIS 980 LINE COMBINATION can save up to 50% of your time

Here are the two famous 980 Line instruments that form the basis of the new Weston simplified method of TV receiver alignment . . . eliminating the troublesome, time-wasting procedures heretofore involved, and enabling servicemen to cut alignment time almost in half. This new method is possible when these two instruments are used with the Weston scope, or scopes with provisions for Z-axis intensity modulation. They also can be used with available test equipment in the conventional method of alignment. For the complete story, write . . . WESTON Electrical Instrument Corporation, 614 Frelinghuysen Avenue, Newark 5, N. J.

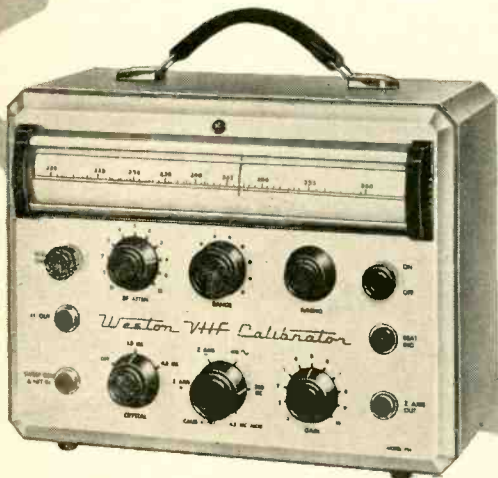

WESTON MODEL 985 CALIBRATOR

FEATURES

SCALE CALIBRATION: Crystal calibrating points are available at 1.5 and 4.5 megacycles throughout the entire scale. A scale shift knob is provided to align the scale with the crystal calibrating dots.

SCALE PRESENTATION: Slide rule type in which one scale is visible at a time. Ten scale range bands available . . . total scale length of 8 $\frac{1}{4}$ ft.

DUAL MARKERS: 4.5 mc side band markers permit simultaneous observation of video and sound carrier.

INTERNAL MARKERS: Special circuitry provides an internal marker of either a positive or negative pulse suitable for Z-axis intensity modulation of the scope pattern. Marker is visible even at the sound trap frequencies.

HETERODYNE DETECTION: With an input sensitivity of 500 microvolts, the local TV receiver-tuner channel oscillator frequency can be determined without tuner disassembly.

BAR PATTERN GENERATOR: Amplitude modulated signals of the band oscillator at 400 cycles and 300 KC are available for linearity checks.

SPECIFICATIONS

Frequency Range (with Variable Frequency Oscillator): 4-110 megacycles in 7 bands. 170-260 megacycles in 3 bands.

Output Attenuator Range: 100% to 1%

Crystal Marker Accuracy: 1.5 mc position \pm 0.01%; 4.5 mc position \pm 0.01%

Internal Modulation Frequencies: 400 cps, 300 KC, 4.5 mc

Heterodyne Input Sensitivity: 500 microvolts (VFO)

Linearity Adjustment: Horizontal—400 cycles, Vertical—300 KC

Dual Markers: video and sound . . . available for either Z-axis intensity modulation of scope or conventional marker pip display.

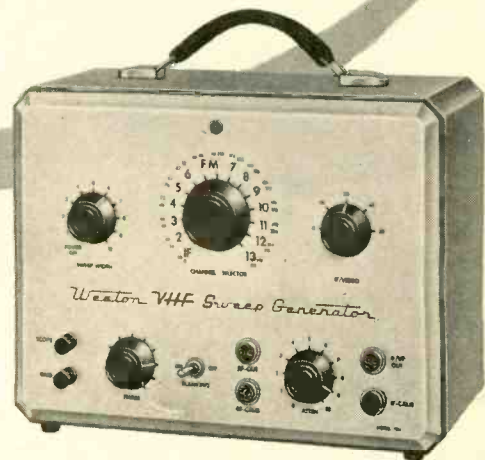

WESTON MODEL 984 SWEEP GENERATOR

FEATURES

BLANKING: Special circuitry produces a zero output reference base which is essential for relative gain measurements.

RF OUTPUT: Frequency modulated signal, TV channels 2 to 13 inclusive, complete FM coverage available by means of two preset selector positions. *Frequencies are fundamentals of the oscillator frequency.*

IF/VIDEO OUTPUT: Frequency modulated signals ranging to 50 megacycles, continuous tuning, signals free from harmonics.

SWEEP WIDTH: Full 10 megacycles on all channels.

Z-AXIS TERMINAL: For use with the Model 985 Calibrator.

SPECIFICATIONS

Sweep Width: 0-10 Megacycles (continuously variable for both IF and RF)

Output Voltage (RMS): 0.1 Volt . . . sweep is linear

RF Output: TV channels 2 to 13 preset. Complete FM coverage available by means of two additional preset selector positions.

IF/Video Output: 50 Megacycles (continuous tuning)

Horizontal Sweep for Oscilloscope: Phase adjustment range . . . 165° Frequency . . . Power Line 60 cycles per second.

WESTON 980 LINE

TV TEST EQUIPMENT

VETERANS . . . NON-VETERANS

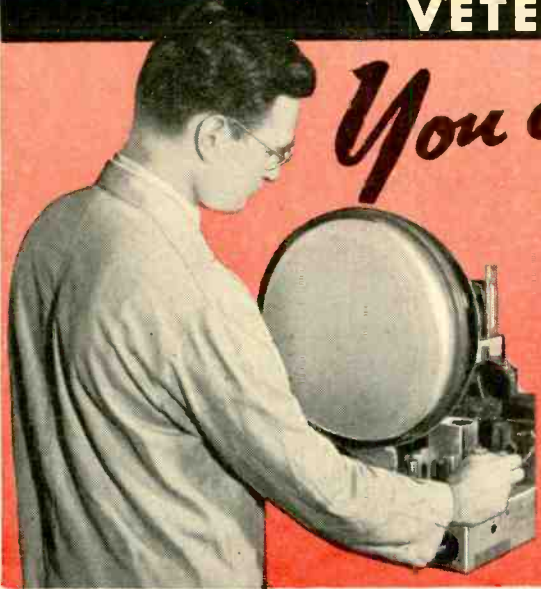

You can be a
**TELEVISION
TECHNICIAN**

**I'LL TRAIN YOU AT HOME IN
YOUR SPARE TIME FOR
BETTER-PAYING JOBS IN THE
DYNAMIC RADIO-
TELEVISION-ELECTRONICS
FIELD.**



L. C. Lane, B.S., M.A.
President, Radio-Television
Training Association, Executive
Director, Pierce School
of Radio & Television.

Not since the beginning of the Industrial Revolution in the 18th Century have there been such amazing technological advances in the wide open Radio-Television-Electronics field. And there's no end in sight . . . FM — UHF — HIGH FIDELITY — COLOR TELEVISION — RADAR — LORAN — all magic words holding out the promise of good-paying jobs with a secure future . . . for qualified men.

NOW, while opportunities for trained men are still increasing, is the time to prepare yourself to advance with the ever-expanding, Radio-Television-Electronics field. You can become a well-paid TELEVISION TECHNICIAN by letting me start your training now!

**YOU GET ALL THIS EQUIPMENT
AND MORE**



VETERANS

My School fully approved to train Veterans under new Korean G.I. Bill. Available only to Veterans discharged after AUGUST 20, 1951. If eligible, CHECK COUPON.

EARN WHILE YOU LEARN. Almost from the very start you can earn extra money while learning by repairing radio-TV sets for friends and neighbors. Many of my students earn up to \$25 a week . . . pay for their entire training from spare time earnings . . . start their own profitable service business.

FREE FCC COACHING COURSE. Important for BETTER PAY JOBS requiring FCC license. You get this training AT HOME and AT NO EXTRA COST. Top jobs go to FCC-licensed technicians.

RADIO-FM-TELEVISION TRAINING

My Radio-FM-Television Technician Course is especially prepared for men with no previous experience or training. I have trained hundreds of men for successful careers in radio-television-electronics. Many of them had only a grammar school education and no previous experience whatsoever in the field.

EXPERT FM-TV TECHNICIAN TRAINING

My FM-TV Technician Course lets you take full advantage of your previous experience — either civilian or Armed Forces. YOU CAN SAVE MONTHS OF TIME . . . complete your training by getting a thorough background in Frequency Modulation and Television Theory and PRACTICE. You "Learn by Doing", working with parts and equipment I send you. YOU BUILD AND KEEP A TV RECEIVER.

EXTRA TRAINING IN NEW YORK CITY AT NO ADDITIONAL COST

You get two weeks, 50 hours, of intensive laboratory work on modern electronic equipment at our associate school in New York City — Pierce School of Radio & Television. I give you this AT NO EXTRA COST whatsoever, after you finish your home study training in the Radio-FM-TV Technician Course or the FM-TV Technician Course. Your home study course is complete without this two-week laboratory session, but it is one of the many Extras available to you from RTTA.

Radio **T**elevision **T**raining **A**ssociation

52 EAST 19th STREET • NEW YORK 3, N. Y.

Licensed by the State of New York • Approved for Veteran Training

DECEMBER, 1954

YOU GET
AS MANY
FREE



**MAIL THIS COUPON TODAY!
NO SALESMAN WILL CALL**

Mr. Leonard C. Lane, President
RADIO-TELEVISION TRAINING ASSOCIATION
52 East 19th Street, New York 3, N. Y. Dept. R-12

Dear Mr. Lane: Mail me your NEW FREE BOOK, FREE SAMPLE LESSON, and FREE aids that will show me how I can make BIG MONEY IN TELEVISION. I understand I am under no obligation and no salesman will call.

(PLEASE PRINT PLAINLY)

Name _____ Age _____
Address _____
City _____ Zone _____ State _____

I AM INTERESTED IN:

Radio-FM-TV Technician Course
 FM-TV Technician Course
 TV Camera and Studio Technician Course

VETERANS!
Check here
for training under NEW
G.I. Bill.

**this great all-channel antenna discovery
is smashing sales and performance records
in every TV area!**

Single bay
SUPER RAINBOW
model no. 331

the
CHAMPION

RAINBOW*

brilliant black-and-white performance —
and really ready for COLOR!

these 3 revolutionary, power-packed
design features — found in no
other antenna today!

- 1. New spacing formula:** Radical new spacing arrangements between the directors and reflectors has, for the first time, extended the full efficiency and high gain of the basic narrow band Yagi over the *full width of an entire VHF band.*
- 2. New "triple power" High Band directors and reflectors:** Three-section directors and reflectors, with insulated segments, provide combined power of three High Band Yagis, operating side by side, in phase.
- 3. New "inter-mix" design:** Combines — into one single antenna — two separate, independent sets of directors and reflectors, one for High Band, one for Low Band. Each parasitic system operates *only* on its own band. Fullest efficiency — no compromise design.

PLUS Channel Master's patented, super-gain TRI-POLE . . . the unique triple-power dipole that made the Champion America's most wanted antenna.

Write for complete technical literature.

Stacked
RAINBOW
model no. 330-2

CHANNEL MASTER creative engineering

Here's how the RAINBOW out-performs the famous Champion:

	CHANNEL	2	3	4	5	6	7	8	9	10	11	12	13
Gain Over	1-Bay RAINBOW	0	0	0	+1	+2	+3	+2.5	+1	+5	+5	+1.5	+2.5
	1-Bay Champion	DB	DB	DB	DB	DB	DB	DB	DB	DB	DB	DB	DB
Gain Over	1-Bay SUPER RAINBOW	+1	+1	+1.5	+2.5	+3.5	+3.5	+3	+2	+1.5	+2	+3.5	+4.5
	1-Bay Champion	DB	DB	DB	DB	DB	DB	DB	DB	DB	DB	DB	DB
Gain Over	Stacked RAINBOW	+1.5	+2	+1.5	+1.5	+2	+5	+5	+0	+0	+0	+1	+1.5
	Stacked Champion	DB	DB	DB	DB	DB	DB	DB	DB	DB	DB	DB	DB
Gain Over	Stacked SUPER RAINBOW	+2	+2.5	+3	+3	+4	+5	+1	+1	+2	+2	+2.5	+3.5
	Stacked Champion	DB	DB	DB	DB	DB	DB	DB	DB	DB	DB	DB	DB

horizontal
polar pattern
(relative
voltage)

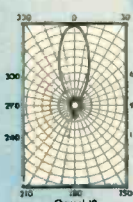

for fringe and super-fringe areas:

Super Rainbow, model no. 331

\$37⁵⁰ list

stacked Super Rainbow,
model no. 331-2

\$75⁷⁰ list

for suburban and near-fringe areas:

Rainbow, model no. 330

\$23⁶⁰ list

stacked Rainbow, model no. 330-2

\$48⁶⁰ list

something new in indoor antennas

for UHF and improved High Band VHF reception

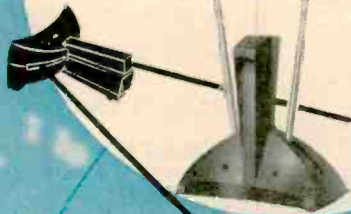

for VHF reception

- features 3 telescoping sections.
- tilt-proof polystyrene base — cannot tip over.
- handsomely packaged for display.

the ALL-VU*

*all VHF . . . all UHF
the only indoor antenna with this "2-Way" feature.

model no. 381 \$6⁹⁵ list

the PRE-VU

for all-channel VHF reception only.

model no. 380

\$5⁹⁵ list

ALUMast

Aluminum Masting.
The new idea in antenna masting—

can never rust!

- in telescoping sections
- in swaged 5, 10, and 14 foot sections

Lightweight ALUMast is 1/3 the weight of steel, making it so easy to install — it swings right up! Stronger than steel, ALUMast is easier to stock and actually more economical.

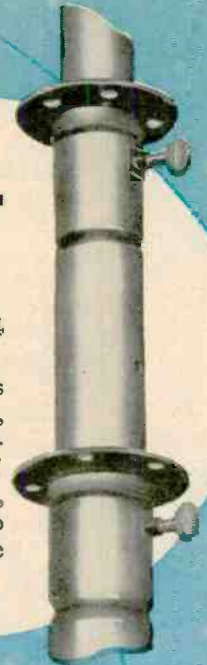

brings you today's **5**
newest installation ideas

for . . . more effective installations
. . . greater customer satisfaction
. . . higher profits for you!

SELECTENNA COUPLING SYSTEM

permits unlimited antenna combinations with only one transmission line!

- for the first time, you can tie together an unlimited combination of antennas, including separate antennas operating on the same band.
- ideal for areas currently using rotators, manually-operated selector switches, and "omni-directional" antennas.

list price:

\$542

each including hardware and wire for joining couplers.

This interlocked stack consists of 4 antenna couplers and 1 Hi-Lo coupler; joins 4 antennas.

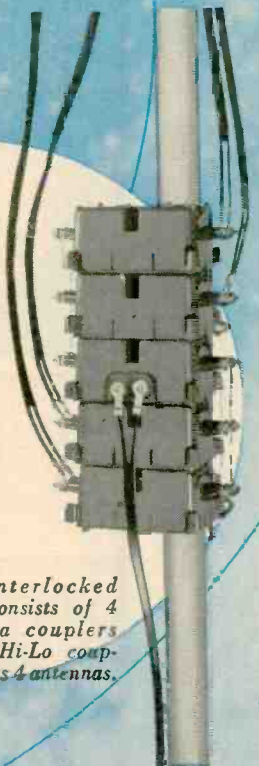

TV ROTATOR

with features found in no other rotator today:

- flexible worm gear, built-in thrust bearing.
- removable motor, electrical and mechanical stops.
- weatherproof, lightweight, strong.
- straight-thru mast mounting, built-in chimney mount.
- extremely high torque.



model no. 9521, \$49⁹⁵ list

model no. 9520, without directional indicator, \$44⁹⁵ list



Beautifully-styled cabinet has great consumer appeal — is smallest on market (2 3/4" x 4"). Finger-tip control bar.



CHANNEL MASTER CORP. ELLENVILLE, N. Y.
WORLD'S LARGEST MANUFACTURER OF TELEVISION ANTENNAS

HEAR THE DIFFERENCE!

Based on the famous University model WLC Theater System used so successfully and extensively in deluxe stadium and outdoor theater installations . . . auditoriums, expositions, concert halls and other important applications where only the highest quality equipment is acceptable—University engineers now bring you a smaller, compact version—the BLC—for general application in public address work. The BLC is the New standard for both voice and music, indoors and outdoors. The BLC is now yours, at the low low price of

ONLY
\$75
LIST

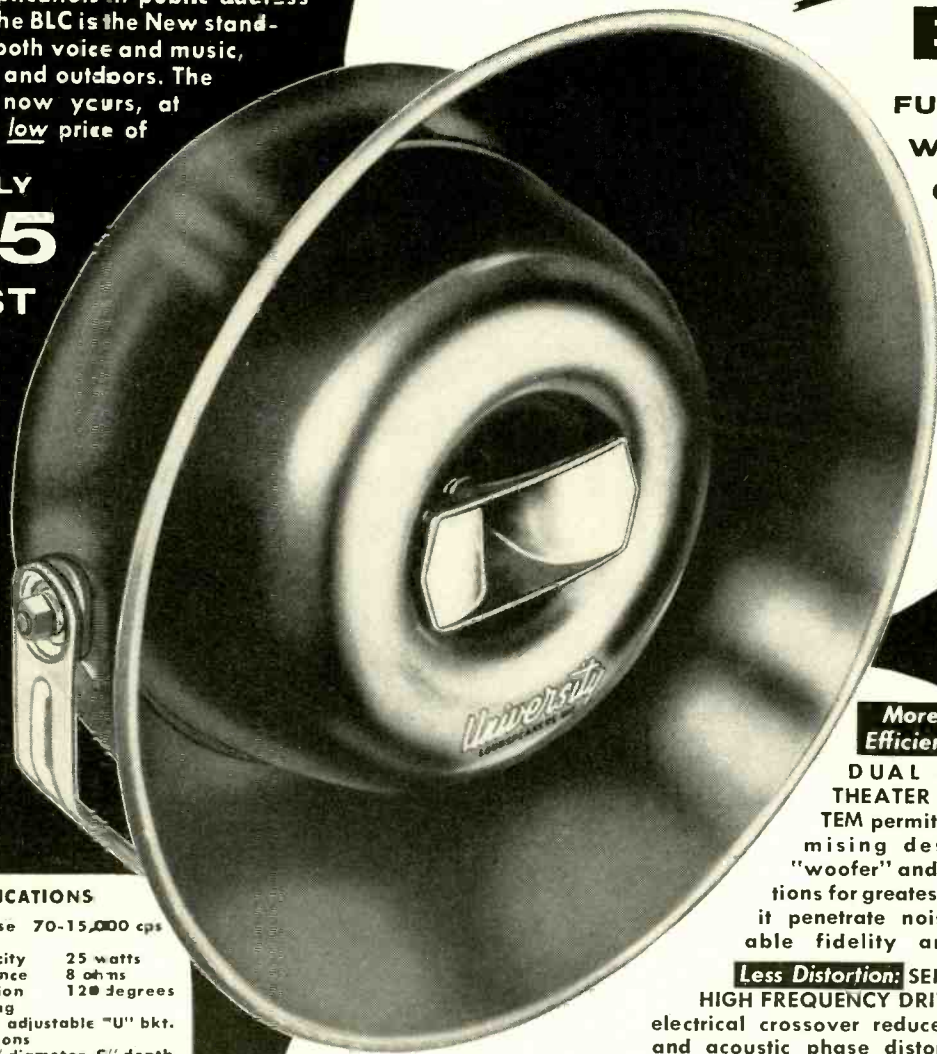

MAKE *Every* P.A.
A HI-FI INSTALLATION
WITH THE *New* MODEL
BLC

FULL RANGE
WEATHERPROOF
COAXIAL
SPEAKER



SPECIFICATIONS

Response 70-15,000 cps
Power Capacity 25 watts
Impedance 8 ohms
Dispersion 120 degrees
Mounting 180° adjustable "U" bkt.
Dimensions 22½" diameter, 9" depth

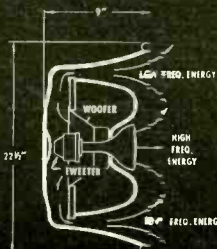

Ask your distributor for a convincing demonstration, and HEAR THE DIFFERENCE!

More Efficient:

DUAL RANGE THEATER TYPE SYSTEM permits uncompromising design of the "woofer" and "tweeter" sections for greatest efficiency. Hear it penetrate noise with remarkable fidelity and intelligibility.

Less Distortion: SEPARATE LOW AND HIGH FREQUENCY DRIVER SYSTEMS with electrical crossover reduces intermodulation and acoustic phase distortions common to other systems which attempt to use two different horns on a single diaphragm.

More Compact: EXCLUSIVE WEATHERPROOF DUAL RANGE COAXIAL DESIGN eliminates wasted space. Depth of BLC is only 9"; can be mounted anywhere, even flush with wall or ceiling.

More Dependable: EXPERIENCED MECHANICAL ENGINEERING AND CAREFUL ELECTRICAL DESIGN meet the challenge of diversified application and environmental hazards. Rugged, and conservatively rated—you can rely on the BLC.

Better Lows: BALANCED "COMPRESSION" TYPE FOLDED HORN, starting with eight inch throat and energized by top quality low frequency "woofer" driver provides more lows than other bulky designs.

Better Highs: DRIVER UNIT TWEETER with exclusive patented "reciprocating flares" wide angle horn transmits more highs with greater uniformity . . . high frequency response that you can hear!

University LOUDSPEAKERS INC.
80 SOUTH KENSICO AVENUE

WHITE PLAINS, N. Y.
RADIO-ELECTRONICS

Write Desk No. 32 for full descriptive literature

I Will Train You at Home

For Good Pay Jobs, Success in

RADIO-TELEVISION

J. E. SMITH
President
National Radio
Institute
Washington, D. C.
40 years of success
training men at
home in spare time.



Practice Broadcasting with Equipment I Send

As part of my Communications Course I send you kits of parts to build the low-power Broadcasting Transmitter shown at the left. You use it to get practical experience putting a station "on the air," performing procedures demanded of Broadcasting Station Operators. An FCC Commercial Operator's License can be your ticket to a better job and a bright future; my Communications Course gives you the training you need to get your license. Mail card below and see in my book other valuable equipment you build.

Practice Servicing with Equipment I Send

Nothing takes the place of PRACTICAL EXPERIENCE. That's why NRI training is based on LEARNING BY DOING. You use parts I furnish to build many circuits common to Radio and Television. With my Servicing Course you build a modern Radio (shown at right). You build a Multitester which you use to help fix sets while training. Many students make \$10, \$15 a week extra fixing sets in spare time starting a few months after enrolling. All equipment is yours to keep. Card below will bring book showing other equipment you build.

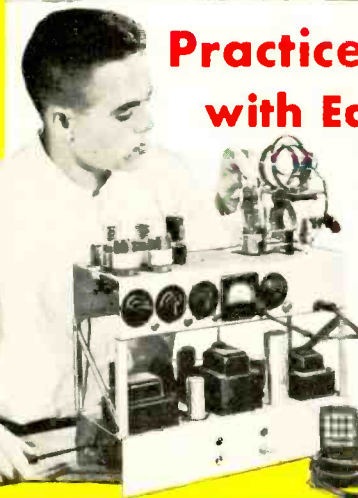

Television is Growing Fast Making New Jobs, Prosperity

More than 25 million homes now have Television sets and thousands more are being sold every week. Well trained men are needed to make, install, service TV sets. About 200 television stations on the air with hundreds more being built. Think of the good job opportunities here for qualified technicians, operators, etc. If you're looking for opportunity get started now learning Radio-Television at home in spare time. Cut out and mail postage free card. J. E. Smith, President, National Radio Institute, Washington, D. C. OUR 40TH YEAR.

AVAILABLE TO
VETERANS
UNDER G.I. BILL

Good Jobs, Good Pay, Success
in Radio-TV! SEE OTHER SIDE

CUT OUT AND MAIL THIS CARD NOW

Sample Lesson & 64-Page Book
Both FREE

This card entitles you to Actual Lesson on Servicing, shows how you learn Radio-Television at home. You'll also receive my 64-Page Book, "How to Be a Success in Radio-Television." Mail card now!

NO STAMP NEEDED! WE PAY POSTAGE

Mr. J. E. SMITH, President,
National Radio Institute, Washington 9, D. C.

Mail me Lesson and Book, "How to Be a Success in Radio-Television." (No Salesman will call. Please write plainly.)

NAME AGE

ADDRESS

CITY ZONE STATE

VETS write in date
of discharge

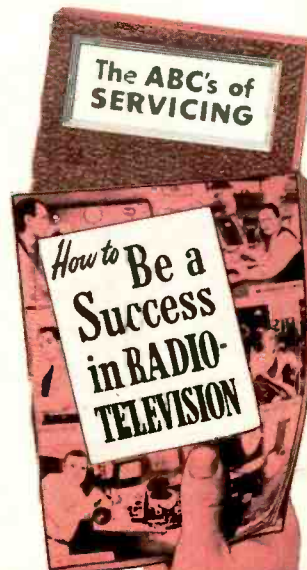

Train at Home to Jump Your Pay as a RADIO-TV Technician



J. E. Smith, President
National Radio Institute

The men whose messages are published below were not born successful. Not so long ago they were doing exactly as you are now . . . reading my ad! They decided they should KNOW MORE . . . so they could EARN MORE . . . so they acted! Mail card below now.

Get a Better Job—Be Ready for a Brighter Future in America's Fast Growing Industry

Training PLUS opportunity is the PERFECT COMBINATION for job security, good pay, advancement. When times are good, the trained man makes the BETTER PAY, GETS PROMOTED. When jobs are scarce, the trained man enjoys GREATER SECURITY. NRI training can help assure you and your family more of the better things of life.

Radio-Television is today's opportunity field. Even without Television, Radio is bigger than ever before. Over 3,000 Radio Broadcasting Stations on the air; more than 115 million home and Automobile Radios are in use. Then add Television. Television Broadcast Stations extend from coast to coast now with over 25 million Television sets already in use. There are channels for 1,800 more Television Stations. Use of

Aviation and Police Radio. Micro-Wave Relay, Two-way Radio communication for buses, taxis, trucks, etc. is expanding. New uses for Radio-Television principles coming in Industry, Government, Communications and Homes.

My Training is Up-to-Date You Learn by Practicing

Get the benefit of my 40 years experience training men. My well-illustrated lessons give you the basic principles you must have to assure continued success. Skillfully developed kits of parts I furnish "bring to life" the principles you learn from my lessons. Read more about equipment you get on other side of this page.

Naturally, my training includes Television. I have, over the years, added more and more Television information to my courses. The equipment I furnish students gives experience on circuits common to BOTH Radio and Television.

Find Out About the Tested Way to Better Pay

Read at the right how just a few of my students made out who acted to get the better things of life. Read how NRI students earn \$10, \$15 a week extra fixing Radios in spare time starting soon after enrolling. Read how my graduates start their own businesses. Then take the next step—mail card below.

You take absolutely no risk. I even pay postage. I want to put an Actual Lesson in your hands to prove NRI home training is practical, thorough. I want you to see my 64-page book, "How to Be a Success in Radio-Television" because it tells you about my 40 years of training men and important facts about present and future Radio-Television job opportunities. You can take NRI training for as little as \$5 a month. Many graduates make more than the total cost of my training in two weeks. Mailing postage free card can be an important step in making your future successful. J. E. Smith, President, National Radio Institute, Washington 9, D. C. OUR 40TH YEAR.

Start Soon to Make \$10 to \$15 a Week Extra Fixing Sets



Keep your job while training. Many NRI students make \$10, \$15 and more a week extra fixing neighbors' Radios in spare time, starting a few months after enrolling. I start sending you special booklets that show you how to fix sets, the day you enroll. The multitester you build with parts I furnish helps discover and correct troubles.

SEE OTHER SIDE

I TRAINED THESE MEN



Consultant on Antenna Systems

"I resigned as Chief Engineer. Now I am on my own as consultant on private and commercial antenna systems." R. J. Bailey, Weston, W. Va.



\$10 a Week In Spare Time

"Before finishing, I earned as much as \$10 a week in Radio servicing, in my spare time. I recommend NRI." S. J. Petrucci, Miami, Fla.



Control Operator, Station WEAN

"I received my license and worked on ships. Now with WEAN as control operator, NRI course is complete." R. Arnold, Rumford, R. I.



Has Own Radio-Television Shop

"Doing Radio and Television servicing full time. Have my own shop. I owe my success to NRI." Curtis Stath, Fort Madison, Iowa.



Radio-Television Service Chief

"Am chief Radio and Television serviceman for large repair shop. Pay very good; working condition pleasant." P. G. Brogan, Louisville, Ky.



Got First Job Thru NRI

"My first job was with KDLR. Now Chief Engr. of Radio Equipment for Police and Fire Dept." T. Norton, Hamilton, Ohio.

My Training Leads to Jobs Like These

- | | | |
|-------------------------------|---|------------------------------------|
| BROADCASTING | Service Manager | AVIATION RADIO |
| Chief Technician | Tester | Plane Radio Operator |
| Chief Operator | Serviceman | Transmitter Technician |
| Power Monitor | Research Assistant | Receiver Technician |
| Recording Operator | | Airport Transmitter Operator |
| Remote Control Operator | | |
| | SHIP AND HARBOR RADIO | TELEVISION |
| SERVICING | Chief Operator | Pick-Up Operator |
| Home and Auto Radios | Assistant Operator | Voice Transmitter Operator |
| P.A. Systems | Radiotelephone Operator | Television Technician |
| Television Receivers | | Remote Control Operator |
| Electronic Controls | GOVERNMENT RADIO | Service and Maintenance Technician |
| FM Radios | Operator in Army, Navy, Marine Corps, Coast Guard | |
| | Forestry Service | POLICE RADIO |
| IN RADIO PLANTS | Dispatcher | Transmitter Operator |
| Design Assistant | Airways Radio Operator | Receiver Serviceman |
| Transmitter Design Technician | | |

FIRST CLASS
Permit No. 20-R
(Sec. 34.9, P.L.&R.)
Washington, D.C.

BUSINESS REPLY CARD

No Postage Stamp Necessary If Mailed In The United States

POSTAGE WILL BE PAID BY
NATIONAL RADIO INSTITUTE
16th and U Sts., N.W.
Washington 9, D. C.

J K L M N O P

CUT OUT—MAIL Postage Free CARD

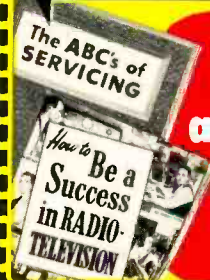

SAMPLE LESSON
and 64-PAGE BOOK
Both FREE

Have Your Own Business

Many NRI trained men start their own successful Radio-Television sales and service business with capital earned in spare time. Joe Travers, a graduate of mine, in Asbury Park, N. J., writes: "I've come a long way in Radio and Television since graduating. Have my own business on Main Street."



BREAK THRU THE FRINGE BARRIERS IN ALL DIRECTIONS

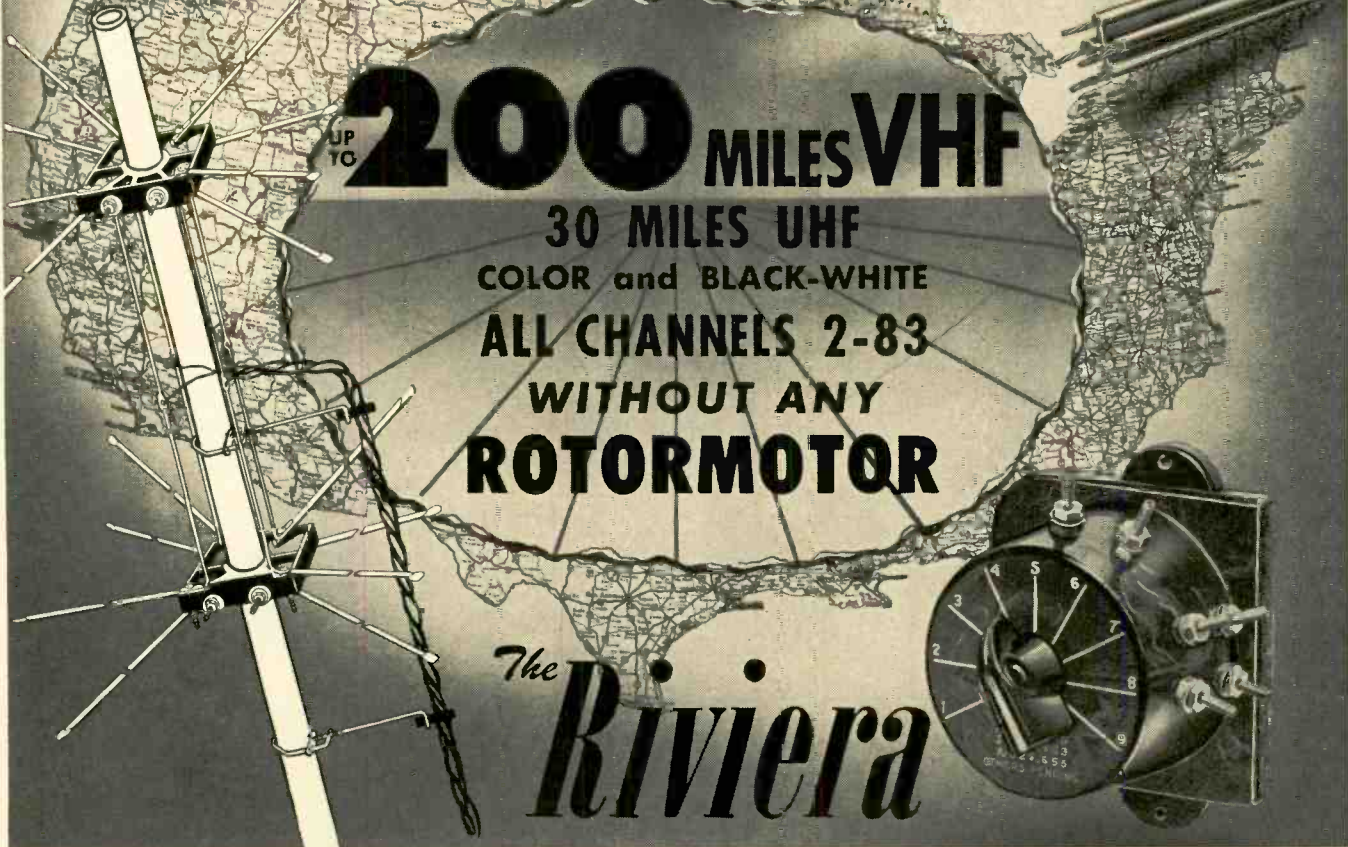

UP TO **200 MILES VHF**

30 MILES UHF
COLOR and BLACK-WHITE
ALL CHANNELS 2-83
WITHOUT ANY
ROTORMOTOR

The
Riviera

NEW PATENTED RADAR ANTENNA

53 CLAIMS GRANTED IN 5 U. S. PATENTS — #2,585,670 — #2,609,503 — #2,625,655 — #2,644,091 — #2,661,423
OPENS NEW HORIZONS TO TV VIEWERS

These are the reasons why the "Riviera" is by far the most powerful VHF antenna on the market today!

1. Utilizes 16 elements 60" long, 1/2" diameter.
2. Utilizes a specially designed, extra low loss four conductor air-dielectric POLYMELENE transmission line which has up to 50% less loss when wet than the finest conventional transmission lines.
3. The "Riviera" encompasses an electro-magnetic capture volume of well over 650 cubic feet, many times more than conventional antennas.
4. The antenna works on the revolutionary principle that the approaching wave front is elliptically rather than horizontally polarized.
5. The new specially designed 9 position electronic orientation switch, aside from changing directivity, maintains a consistently better impedance match over the entire UHF-VHF spectrum.
6. The above features combine to give the "Riviera" antenna greater usable gain at the TV set antenna terminals than the best of any competitive antennas using rotor motors.

This new wonder antenna, called the "Riviera", is already making history. Beyond any question of a doubt, and on an unconditional money back guarantee, it will positively outperform in the field under actual installation conditions, any and all competitive antennas on the VHF channels, with or without rotor motors.

POLAR PATTERNS

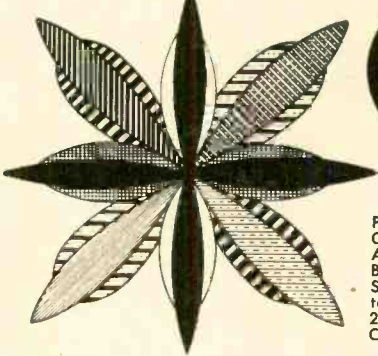

only
\$49.50
LIST PRICE

Price includes:
Complete Stacked Array • Stacking Bars • 9 Position Switch • Switch-to-set Coupler • 2 Stand-offs, 7 1/2" • Complete instructions

The polar directivity response patterns show the major lobes of the "Riviera" antenna on VHF. It shows the fullness of coverage in all directions of this remarkable, patented antenna as it is turned through each of the nine switch positions. Each degree of shading constitutes a different switch position. This excellent directivity response, which can be switched at will, plus the extremely high gains, clearly indicate why the Riviera is such a superior performer.

ALL CHANNEL ANTENNA CORP.
47-39 49th STREET, WOODSIDE 77, N. Y. EXETER 2-1336

IN UHF-VHF DISTRICTS . . . USE
The **NEW Super 60**
100 MILES VHF • 60 MILES UHF

EICO GIVES YOU ALL THREE!

1. LOWEST PRICE

Laboratory Precision at Lowest Cost in the Industry!

425K 5" PUSH-PULL OSCILLOSCOPE KIT \$44.95
WIRED \$79.95

Feature-packed, performance proven, economy-priced — an EICO exclusive! Tens of thousands in use!

- Push-pull Vert. & Hor. amplifiers.
- High V & H sens.: 0.05-0.1 rms v/in.
- V & H response: 5 cps—500 kc.
- Useful to 2.5 mc.
- Sweep: 15 cps—75 kc.
- Z-axis intensity modulation.
- Direct connections to CRT plates.
- Tubes: 2-6J5, 3-6SN7, 2-5Y3, 5" CRT.

470K 7" PUSH-PULL OSCILLOSCOPE KIT \$79.95 WIRED \$129.50
America's greatest big-scope value—sets a new high for sensitivity at wide bandwidth!

- Vert.: flat ± 2 db 10 cps—1 mc, .01 rms v/in.
- Hor.: flat 10 cps—200 kc, —4 db at 500 kc, .3 rms v/in.
- Sweep: 15 cps—100 kc.

NEW! 232K PEAK-TO-PEAK VTVM with AC/DC UNI-PROBE
KIT \$29.95. WIRED \$49.95.



- Measures directly p-p voltage of complex & sine waves: 0-4, 14, 42, 140, 420, 1400, 4200.
- DC/RMS sine volts: 0-1.5, 5, 15, 50, 150, 500, 1500 (up to 30,000 v. with HVP probe, & 250 mc with PRF probe).
- Res.: 0.2 ohms to 1000 megohms in 7 ranges.
- DC Input R: 11 megohms. 1% precision ceramic multipliers. 4 1/2" meter. UNI-PROBE: Only 1 probe performs all functions—a half-turn of probe-tip selects DC or AC-OHMS! (Pat. Pend.)

221K VACUUM TUBE VOLTMETER
KIT \$25.95. WIRED \$39.95.



- AC/DC volts: 0-5, 10, 100, 500, 1000 (up to 30,000 v. with HVP probe, to 250 mc with PRF probe, & peak-to-peak with PTP probe).
- Res.: 0.2 ohms to 1000 megohms in 5 ranges.
- DC Input R: 25 megohms.
- Large 4 1/2" meter, can't-burn-out circuit.
- 1% precision ceramic multipliers.

1050K 6V & 12V BATTERY ELIMINATOR & CHARGER
KIT \$29.95. WIRED \$38.95.



- 2 DC ranges: 0-8V (10A continuous, 20A intermittent); 0-16V (6A continuous, 12A intermittent).
- Continuous voltage adjustment: variac-type transformer.
- Separate voltmeter & ammeter.

OTHER EICO MODELS

- 249K Deluxe PEAK-TO-PEAK VTVM with 7 1/2" METER & UNI-PROBE (Pat. Pend.) (similar to Model 232) KIT \$39.95. WIRED \$59.95.
- 214K Deluxe VTVM with 7 1/2" METER (Similar to Model 221) KIT. \$34.95. WIRED \$54.95.
- 488K ELECTRONIC SWITCH KIT \$23.95. WIRED \$39.95.
- 495K SCOPE VOLTAGE CALIBRATOR KIT \$12.95. WIRED \$17.95.
- 377K SINE & SQUARE WAVE AUDIO GEN. (20-200,000 cps) KIT \$31.95. WIRED \$49.95.
- 950BK R-C BRIDGE & R-C-L COMPARATOR KIT \$19.95. WIRED \$29.95.
- 1171K DECADE RESISTANCE BOX (0-99,999 ohms in 1 ohm steps, 1/2% accuracy) KIT \$19.95. WIRED \$24.95.
- 1180K DECADE CONDENSER BOX (100 mmf—0.111 mf in 100 mmf steps, 1% accuracy) KIT \$14.95. WIRED \$19.95.
- 1100K RTMA RESISTANCE SUBSTITUTION BOX (15 ohms to 10 megohms, $\pm 10\%$ accuracy) KIT \$5.50. WIRED \$9.95.
- 566K 1,000 Ohms/Volt MULTIMETER (Similar to Model 536, but with 4 1/2" Meter and 7 Output Ranges) KIT \$14.90. WIRED \$18.95.
- 556K As above, but with 1% precision resistors. KIT \$16.90. WIRED \$23.50.
- 944K FLYBACK TRANSFORMER & YOKE TESTER KIT \$23.95. WIRED \$34.95.

2. QUALITY

EICO guarantees FINEST QUALITY COMPONENTS, checked by stringent quality control tests.



NEW EICO PROBES

- SCOPE PROBES
- SCOPE DIRECT KIT \$2.75. WIRED \$3.95.
 - SCOPE DEMODULATOR KIT \$3.75. WIRED \$5.75.
 - SCOPE LOW CAPACITY KIT \$3.75. WIRED \$5.75.

- VTVM PROBES
- VTVM PEAK-TO-PEAK KIT \$4.95. WIRED \$6.95.
 - VTVM RF KIT \$3.75. WIRED \$4.95.

HVP-1 \$6.95. HVP-2 \$4.95.
Extends range of VTVMs & voltmeters to 30 KV.

320 SIG. GEN.
KIT \$19.95. WIRED \$29.95.



- Fundamentals 150 kc to 34 mc, calibrated harmonics to 102 mc.
- Pure or modulated RF, & Colpitts oscillator 400 cps sine outputs.
- Vernier knob tuning.

322K SIG. GEN.
KIT \$23.95. WIRED \$34.95.

- As above, plus individual calibration of each of its 5 bands.

625K TUBE TESTER
KIT \$34.95. WIRED \$49.95.



- Tests all conventional and TV tubes.
- Lever-action switches for individual testing of every element.
- PIX TUBE ADAPTER for Tube Testers \$4.50.
- Checks TV picture tubes while in set.

360K TV/FM SWEEP GEN.
KIT \$34.95. WIRED \$49.95.

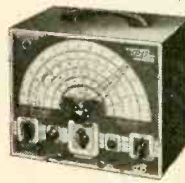

- Covers all VHF TV/FM channels & freqs.: 500 kc—228 mc on fundamentals.
- Continuous sweep width control, 0-30 mc.
- Crystal marker oscillator.
- Variable phasing of 60 cps output.
- Precision 5 mc & 4.5 mc crystals, \$3.95 each.

630K CATHODE RAY TUBE CHECKER
KIT \$17.95. WIRED \$24.95.



- Checks all TV picture & C.R. tubes in set or carton.
- Detects shorted & open elements.
- Measures peak beam current (proportional to screen brightness)—reading directly in terms of tube condition.

145K MULTI-SIGNAL TRACER
KIT \$19.95. WIRED \$28.95.

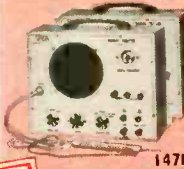

- Audibly signal traces all IF, RF, video & audio from ANT to SPKR or CRT without switching.
- Germanium crystal diode response well over 200 mc.
- 5" test speaker.

565K MULTIMETER KIT \$24.95. WIRED \$29.95.



- 20,000 ohms/v.; 31 ranges.
- DC/AC Output volts: 0-2.5, 10, 50, 250, 1000, 5000.
- DC current: 0-100 ua; 10, 100, 500 ma; 10 A.
- Ohms: 0-2K, 200K, 20 meg.

147K DELUXE MULTI-SIGNAL TRACER
KIT \$24.95. WIRED \$39.95.



- 536K MULTIMETER
KIT \$12.90. WIRED \$14.90
- 1000 ohms/v.; 31 ranges.
- DC/AC volts: Zero to 1, 5, 10, 50, 100, 500, 5000.
- DC/AC current: 0-1, 10 ma; 0.1, 1 A.
- Ohms: 0-500, 100 K, 1 meg.

526K MULTIMETER
KIT \$13.90. WIRED \$16.90.

- As above, but with 1% precision resistors.

315K DELUXE SIG. GEN. KIT \$39.95. WIRED \$59.95.



- 1% accuracy on all 7 ranges.
- Frequency: 75 kc to 150 mc.
- Output: over 100,000 uv.
- Vernier anti-backlash tuning.
- VR tube stabilized power supply, fully shielded chassis.
- 400 cps modulation; provision for ext. mod.

352K BAR GENERATOR
KIT \$14.95. WIRED \$19.95.



- Easy rapid adjustment of TV V & H linearity without station-transmitted test pattern. VHF osc. adj. to any channel between 2 & 6.
- Adj. RF osc. & LF multivibrator generate V & H bars.

Separate Assembly & Operating Manuals supplied with each EICO KIT! SAVE OVER 50% — See the famous EICO line TODAY, at your local jobber. Write NOW for FREE latest Catalog C-12.



Prices 5% higher on West Coast. ©54

ELECTRONIC INSTRUMENT CO. INC., 84 WITHERS ST., BROOKLYN 11, N. Y.

OUR FABULOUS INDUSTRY

... It is difficult to comprehend the vast extent of radioelectronics ...

Back in our November, 1951, issue in the editorial "Radioelectronic Giant," based on an appraisal of the industry, we made the following forecast:

"The war effort has also blurred the picture somewhat, because it is difficult to disentangle war orders from others throughout the industry. One thing is quite certain: even with no war orders it seems likely that annual nonmilitary sales of the entire radioelectronic industry by 1960 should reach no less than \$10 billions."

That figure of \$10 billions will probably prove to be too conservative. It would appear that by 1957 the total sales of the radioelectronics industry will reach \$11.8 billions.

We take pleasure in reprinting here a condensed version of an address by Frank M. Folsom, president of the Radio Corporation of America, who last September, before The Investment Analysts Society of Chicago, gave a highly illuminating talk on "The Business of Electronics." Excerpts from Mr. Folsom's address follow:

Broad Scope of Electronics. The domain of electronics is so vast and so rapid is the rate of development that it seems hard to believe that eight years ago the industry was only one-fifth its present size. Yet that was the case.

In those eight years, electronics has assumed a stature that commands high respect in all branches of finance, trade and industry. It is the vital factor in all forms of modern communications; all modern means of mass entertainment depend upon it—radio, television, talking movies, tape sound systems, and phonograph recording and reproduction; modern transportation must have its controls and communications; the military uses it in myriad ways, and even atomic devices depend on it. Growth of the electronics industry has, of course, accompanied the increased use of many new products and services.

We have recently conducted a survey covering the 12-year period from 1946 through 1957 and analyzing the principal industry components. We believe this survey is the first attempt at so comprehensive a review of the industry.

Facts About Industry Growth. Total annual sales of the electronics industry grew from \$1.6 billions in 1946 to \$8.4 billions in 1953. Further growth is projected, as follows:

1954	\$ 8.8 billions
1955	9.5 billions
1956	10.9 billions
1957	11.8 billions

Our study took into consideration principal components of the electronic industry, as follows:

Home and Portable Radios. This field once represented the chief source of revenue in our business. Today, because of television and changing habits of the people, sales are declining gradually—from a postwar peak of \$600 millions in 1947 to an estimated \$109 millions in 1956.

Auto Radios. Relatively stable sales somewhat in excess of \$100 millions annually.

Black-and-White Television. Postwar growth was spectacular, with sales increasing from \$1 million in 1946 to \$1.4 billions in 1950. Sales in 1953 totaled \$1.2 billions, and nearly \$1 billion is expected in 1954. A drop to \$388 millions is projected by 1957, due to the shifting of the mass market from black-and-white TV to color.

Color Television. Following commercial introduction in 1954, increased volume is expected to more than offset reduced sales of black-and-white television, reaching \$264 millions in 1955, \$767 millions in 1956, and \$952 millions in 1957. This would mean a total of nearly \$2 billions at factory prices during color television's first three years.

Repair Parts (chiefly renewal tubes). Steady growth is expected to continue in support of increased receivers in service. Volume amounted to \$217 millions in 1953, and is estimated at \$454 millions by 1957.

Servicing and Installation. This important element has

grown from \$145 millions in 1946 to \$1.4 billions in 1953. Continued growth to \$2.7 billions by 1957 is indicated.

Industrial and Commercial Equipment. Steady growth is also indicated here, from \$50 millions in 1946 to \$267 millions in 1953, and a projection of \$520 millions by 1957.

Government Electronics Expenditures. Volume totaled \$2.5 billions in 1953 (30% of total electronics industry sales). During the four years 1954-1957, Government electronics expenditures are estimated at \$2.7 to \$2.8 billions annually.

Electricity. Total electricity costs to operate TV and radio instruments are estimated at \$49 millions in 1946, \$354 millions in 1953 and \$634 millions in 1957.

Broadcasting and Communications. Total revenues in 1946 were \$404 millions, or 25% of the total sales by the electronics industry. Revenues increased to \$1.1 billions in 1953. By 1957, total revenues of \$1.5 billions are estimated. Nearly all of this growth is due to TV broadcasting revenue, with radio and communications revenues showing only modest gains.

Television: Black-and-White and Color. Never before in history has a service to the public expanded with such vigor. When the first postwar television sets were introduced in 1946, there were less than 10,000 sets in the entire country and only six TV stations were on the air. Today, there are more than 31 million sets in American homes and 415 stations in operation.

I look upon color television both as a technical marvel and one of the most significant advances in the history of electronics. Its prospects are brighter than the prospects of black-and-white television were eight years ago. We will see a day when virtually every American home will have a color TV set!

During the rest of this year and next year, it is estimated that more than 350,000 color sets will be produced and sold by the industry. During 1956, unit sales should reach 1,780,000; during 1957, 3,000,000; in 1958, about 5,000,000. These annual sales add up to the very satisfactory estimate of more than 10,000,000 color sets in American homes by 1959.

From a standpoint of economic gain, the estimated output would require a mountain of raw materials. Our experts in such matters have informed me that 10,000,000 color sets would use more than 350,000 tons of wood, 175,000 tons of steel, 5,000 tons of brass, 3,500 tons of solder, 3,000 tons of copper, 2,500 tons of zinc, and enough glass, plastics and miscellaneous materials to bring the total well over 1,000,000 tons—or two billion pounds!

Making This Potential Materialize. This great economic potential can and shall be transformed into a reality. It will take a lot of doing, but the foundation is sound.

Our (RCA and NBC's) expenditure in establishing black-and-white television reached \$50,000,000 before a single dollar profit returned. We have already spent another \$50,000,000 in color television research and development, manufacturing and broadcasting.

Because of the compatibility feature, pioneered and developed by RCA, color offers no threat of obsolescence to the millions of black-and-white sets now in American homes. Color augments the black-and-white service and—I would like to re-emphasize—color starts the industry on a new growth curve. From the standpoint of manufacturing alone, it is estimated that in the next five years the American public will invest nearly three billion more dollars in color set purchases than it did in buying black-and-white sets during the past five years.

Beyond this period, the outlook is equally bright for the electronics business. We are far from realizing the full potentialities of this remarkable industry. We have complete confidence in the future of electronics as a science, art and industry.

THE WURLITZER ELECTRONIC ORGAN

Part I—The electrical and mechanical construction of a magnificent musical instrument

By RICHARD H. DORF*

"AND then came a crashing chord from the mighty Wurlitzer!" In the days of our fathers and grandfathers the "mighty Wurlitzer" was as much a byword in the realm of organs as the Hammond is today.

The mighty Wurlitzer is today a streamlined reed organ actuated and heard with the help of electrons, and sounding like a small pipe organ, with nary a reed wheeze to be heard.

The model 44 organ, shown in Fig. 1, is possibly the most interesting for several reasons. As the photo shows, it is a spinet, but has two short manuals in what is coming to be something of a style among modern spinet electronics, each with 44 notes, from F to C. It also has a toe-pedal clavier of 13 notes, C to C. The power amplifier and speaker are built into the console, which is a complete organ with nothing coming out but the a.c. cable and the music.

What particularly distinguishes the model 44, however, is the fact that all reeds are blown all the time at low air pressure. The keying is done entirely electronically, resulting in the elimination of the characteristic slow speaking of reeds which has bothered some people. The system tends to reduce mechanical ciphers, too, because dirt has little chance to accumulate on a reed that is waving in the breeze all the time. Electronic keying also makes the keying much simpler, doing away with both direct action and its Rube Goldberg lever system and electrical keying with its solenoids by the ton. Another advantage is that attacks may be made as sharp or as delayed as the designer wishes.

I have often been asked, "What ever happened to the Everett Organtron?" The answer is that Wurlitzer took it over, refined it, and built it into a line of large electronic organ models. The one pictured in Fig. 2, for instance, is a Wurlitzer series 50, a complete two-



Fig. 1—The Wurlitzer model 44 organ.



Fig. 2—The Wurlitzer series 50 organ.

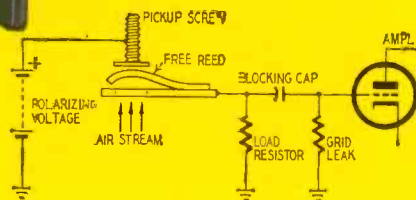

Fig. 3—The basic transducer system.

*Audio Consultant, New York.

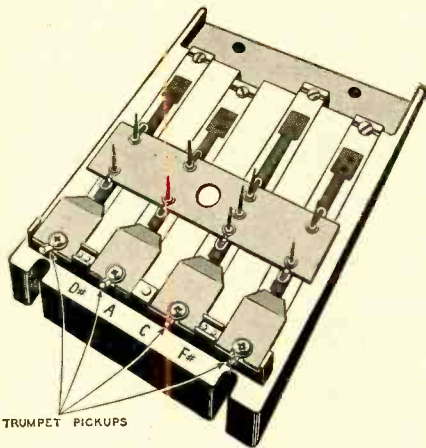

Fig. 4—Reeds with trumpet pickups.

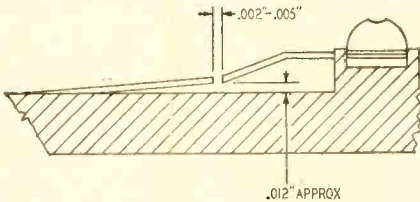

Fig. 5—Trumpet pickup-reed spacing.

manual organ with 32-note radiating pedal clavier, AGO dimensions, and 22 stops. Other more or less elaborate models are made as well.

Principles of operation

The Wurlitzer uses the same basic principle as most other electrostatic transducer devices (Fig. 3). The basic component is the brass reed. A stream of air strikes the reed through a slot in the reed cell. If the stream comes upward, the first breath pushes the outer end of the reed upward. Since the reed is a high-Q mechanical resonator, the burst tends to make it overshoot the point to which the wind pressure would push a nonresonant body. Then the energy stored in the reed because of its elastic properties pushes it down and again it overshoots the initial resting position, after which it springs back up again. The angular velocity of the movement is a function of its resonant frequency and the reed always finds some air pressure at the proper point in its cycle to give it back the energy it expended in the last cycle, thus keeping it moving at its resonant frequency.

The electrostatic transducer system is necessary to convert the reed motion into audio voltage since the reeds themselves are enclosed in a soundproof compartment. The reed and the pickup screw are the two "plates" of a capacitor whose capacitance varies with the position of the reed. With each variation in capacitance there is a rush of electrons from one plate to the other. The electrons pass through the load resistor and create an audio-frequency voltage drop through it that is transferred to the grid of a tube. The model 44 has a bank of 73 reeds that provide all the tones and tone colorings for the organ.

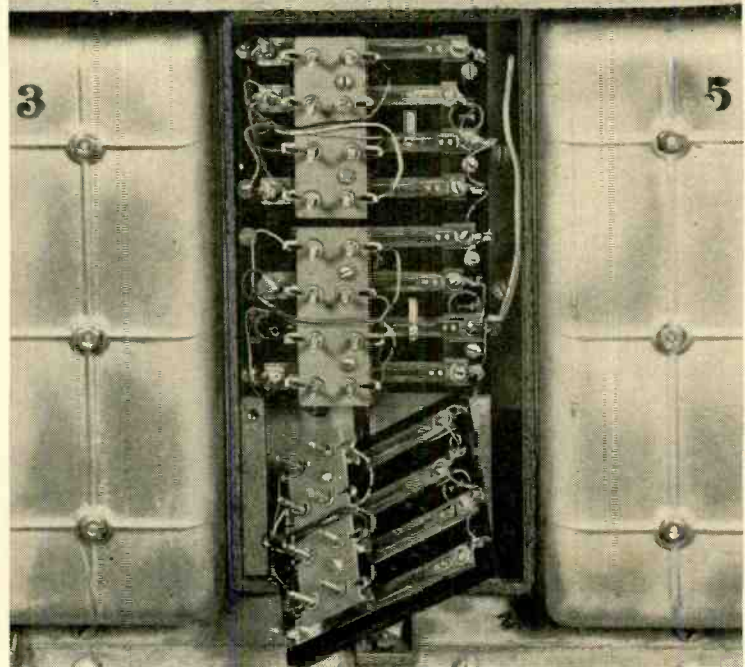
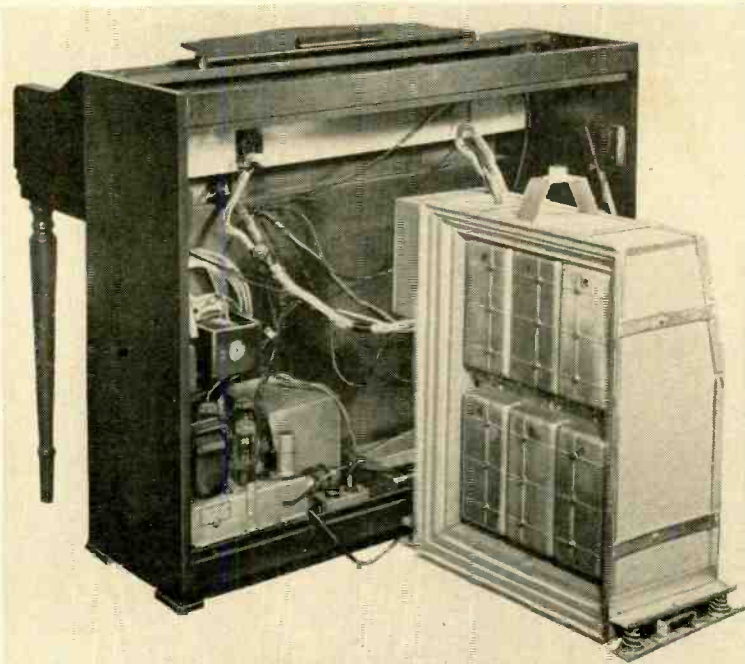

Fig. 6 (top)—Model 44 tone unit. Fig. 7—Reeds and pickup screws.

Two types of tone are available directly from the reed pickups. A flute tone (not a sine wave, but only moderately rich in harmonics) is picked up by the tone screws, directly above the reeds. Most of the reeds have at least two pickup screws. A horn type tone is picked up by special so-called trumpet pickups (bent pieces of sheet metal). A group of four reeds with two tone screws each (except for the C, which has three) and the trumpet pickups are shown in Fig. 4. As Fig. 5 makes clearer, the trumpet pickups are located a very short distance away from the end of the reeds and, as can be imagined, this creates a rather sharply peaked waveform.

The entire tone unit, containing reeds, blower motor, and windchest, is shown

in Fig. 6, as it looks when removed from the organ case with the rear of the tone unit taken off. Each of the six pans can be removed separately to give access to the group of reeds and pickups under it. The tone unit has a soundproofing cover that makes it impossible to hear the reeds acoustically. Fig. 7 shows one of the pans removed to reveal the reeds and pickup screws. The compressor motor is outside the tone unit but attached to it.

Keying system

The basic keying system for the model 44 is shown in Fig. 8. It illustrates keying for one pickup of one reed. The bass end of the upper manual keying and stop mechanism is shown in Fig. 9.

AUDIO—HIGH FIDELITY

The keys are mounted on a strip of spring metal. The rear of the spring metal is screwed down to a transverse rail, a part of the formed metal key support. When the key is pressed, all parts back to the end of the spring holding the assembly to the rail are depressed. The usual bearing and leveling provisions are toward the front of the key to keep it in line and equalize its action with the others.

When the key is pressed it pushes down the activator, a vertical strip of insulating material with a hole for each of the 10 key contacts (9 for stops and the tenth for gating the amplifier). Each key contact is a spring wire fastened at the rear to the key contact mounting block and free at the other end. Since each contact passes through a small hole in the activator, when the key is pressed and the activator lowered, the contacts are pushed downward.

Beneath each contact is a rod of phenolic material with a heavy nichrome wire running its length. The manner in which the nichrome wire is mounted on the rod can be seen in Fig. 9. Each rod is pivoted axially (pivots not shown). Each is controlled by a stop tablet, through the mechanical linkage system. With the tab in the *off* position (face most nearly horizontal) the corresponding phenolic rod is so rotated that the key contact above it strikes the phenolic instead of the nichrome. In the *on* position, the rod is so rotated that the nichrome wire is uppermost and is contacted by the key contact.

A supply of plus 310 volts is fed from the amplifier power supply to the nichrome wire on each of the rods through a 47,000-ohm resistor and a bronze spring that facilitates rod rotation. When the key is played, each contact picks up this positive voltage from its stop rod (assuming the particular stop is pulled) and feeds it through a time-delay filter to the appropriate reed pickup. If the d.c. were suddenly applied to the pickup, there would be a distinct click. The filters allow the d.c. voltage to be built up gradually on the pickup, resulting in a smooth keying characteristic. The filters are printed circuits. There are 165 filters, each going to a pickup screw or strip—73 are for flute-tone pickup screws; 36 for accompaniment pickup screws, similar to the flute pickups but not so close to the reeds and therefore softer; 43 for trumpet pickup strips, and 13 for pedal pickups, similar to the flute-tone pickups for the manuals.

All the reeds for the lowest octave of notes are connected together and through 9.1-megohm and 3,900-ohm resistors to ground. The series combination is the load across which audio is developed. From the top of the load resistor the signal goes through a 0.1- μ f capacitor to the bass input of the amplifier. The remainder of the reeds are connected in common to another 9.1-megohm resistor that goes through the same 3,900-ohm resistor to ground to make up the treble load. The signal

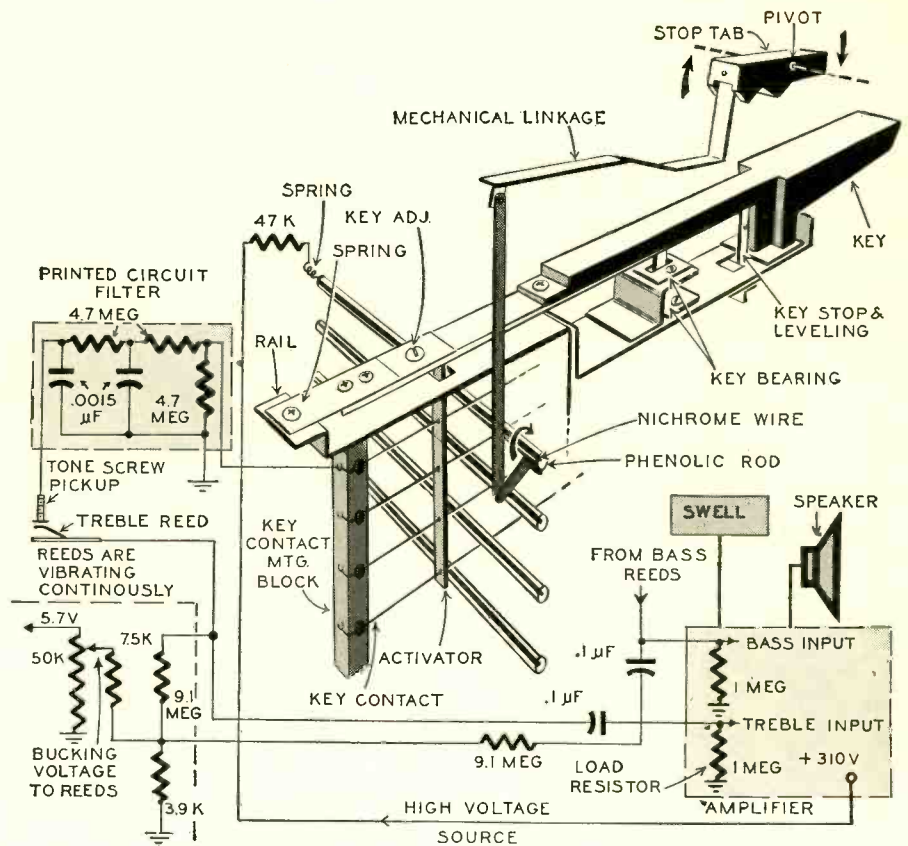

Fig. 8—Diagram shows the basic keying system for the Wurlitzer model 44.

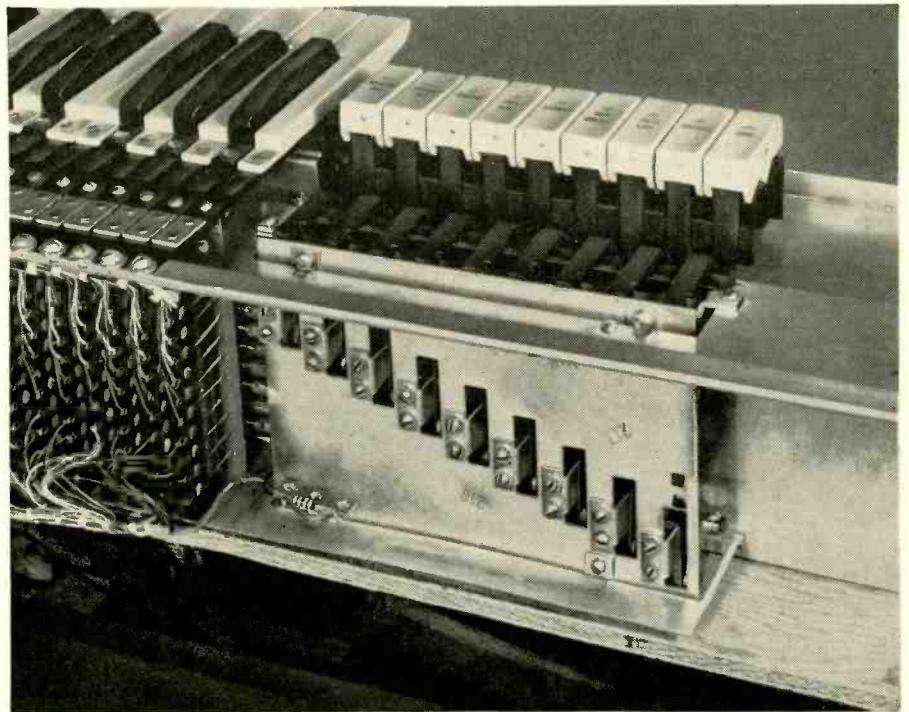

Fig. 9—Section of the keying system.

passes through another 0.1- μ f capacitor to the amplifier treble input. A 50,000-ohm potentiometer with its arm connected to the top of the 3,900-ohm re-

sistor provides 0 to 5.7 volts that polarize the reeds slightly to prevent any signal when there are no keys being pressed.

TO BE CONTINUED

BALANCED MODULATORS for LOW-LEVEL AUDIO

By ALBERT H. TAYLOR

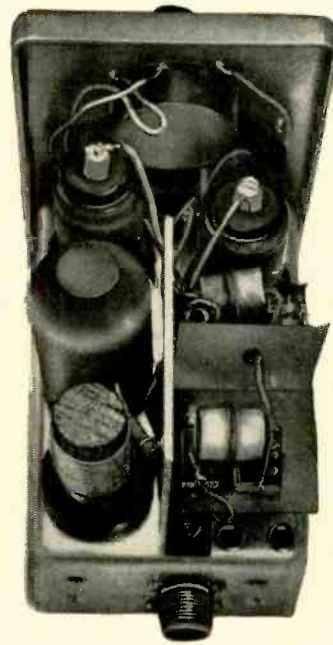

The modulator and band converter.

MODULATED vacuum-tube oscillators have long been used to play phonograph records through radio receivers. The oscillators give adequate volume from pickups delivering a volt or more but not as a rule from low-level pickups which deliver 100 millivolts or less. A recent author reports the same experience with his transistor phonograph oscillator¹.

This is not because the receiver lacks gain. It is probably designed for 100 *microvolts* or less input, but you can't expect much sound from the loudspeaker unless the signal is sufficiently modulated. A low-output pickup produces very weak sideband energy. What happens? The carrier creates a strong a.v.c. voltage, leaving very little gain for the weak sidebands. There are a few ways to overcome this:

1. Preampify the audio signal before modulating. But this presents the usual problems of low-level audio and defeats the purpose of modulating—to

use the high r.f. and i.f. gain of the receiver, though it might well be the best approach from the quality point of view.

2. Reduce the carrier amplitude. This is more difficult with tubes than with transistors.

3. Balance out most of the carrier by a bridge or balanced modulator, as is regularly done in carrier telephony. This (double-sideband reduced-carrier) method has the advantage that while the percentage of modulation in the output can be made high, the individual elements which perform the mixing operate at low percentage modulation, that is, with the carrier very strong compared to the audio. This is accepted as the best condition for low distortion. Of course, if the balance is too perfect, the receiver output will be highly distorted by overmodulation. Hence, with ordinary receivers without carrier re-injection, the modulator must be operated a little off balance. Distortion by the receiver detector will be least with

the lowest percentage modulation (i.e., the most unbalanced carrier) that gives enough volume.

Suppressed-carrier transmission has a number of important applications (as in the carrier telephone systems already mentioned). The circuits are interesting and the technician or experimenter will find the subject one well worth his study.

There are many possible circuits for suppressed-carrier modulation^{2, 3}. All depend on some sort of bridge action and, like other a.c. bridges, most require at least one transformer with an electrostatic shield between its windings. I have built two balanced modulators that work very nicely with low-level pickups and microphones. One is a tube circuit, the other a transistor and varistor circuit. The tube circuit appears in this article.

A practical circuit

This modulator (Fig. 1) operates at 6200 kc because it is also a band converter for my BC-348-P receiver and I have a 6200-kc crystal. To change frequency I just plug in a different crystal and tuned circuit. The modulator is electron-coupled and needs no shielded transformer nor any coil, except a single center-tapped oscillator winding. Output tuning is provided by the receiver without alteration, the modulator being directly coupled to it through a capacitor to avoid misalignment, just as when using a signal generator.

The triode portions of the tubes form a push-pull oscillator controlled by the crystal but will also oscillate without it. It will not oscillate without the neutralizing capacitors. For 6200-kc, tank-coil L has 24 turns center-tapped of No. 22 d.c.c. wire, a single layer 1 inch long on a 3/4-inch wooden dowel set in a tube base. Needless to say, a much

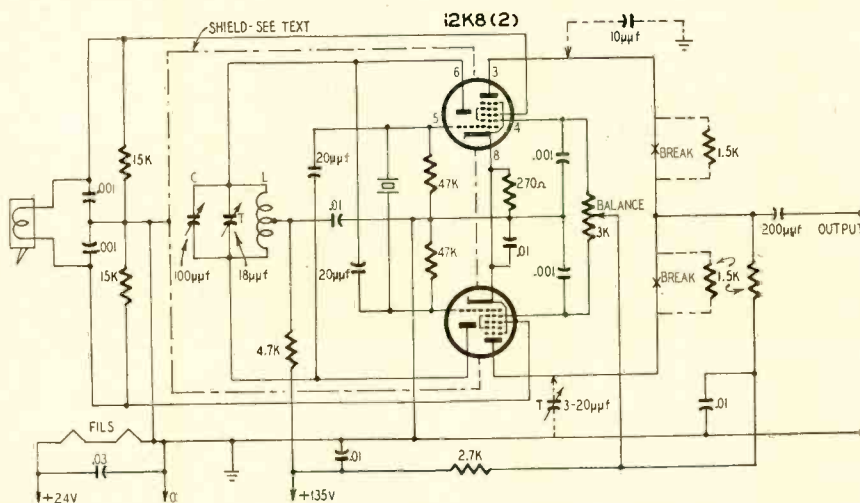
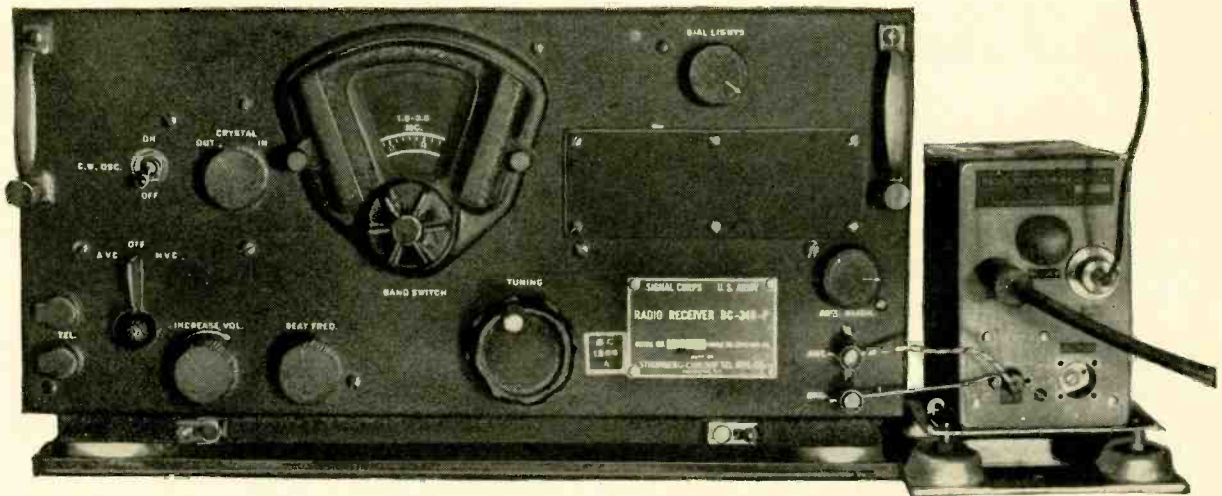

Fig. 1—Electron-coupled modulator—push-pull oscillator, parallel output.



The balanced modulator with receiver.

better and smaller coil could be made. Tank capacitor C is a 100- μf ceramic mounted on the coil. The neutralizing capacitors are 20- μf ceramics mounted on the extra pins of the coil base. An 18- μf trimmer for C is located beneath the chassis and can be screwdriver-adjusted.

To adapt the crystal holder from a 274-N transmitter for push-pull operation, I disconnected the shield cover from pin 7 and connected it to pin 1. Pins 3 and 7 are the crystal electrodes and pin 1 is grounded.

Modulator

The oscillator feeds the hexodes as in ordinary converter circuits, but 180° out of phase in the two tubes. Since the plates are connected in parallel, the oscillator fundamental frequency is cancelled in the output if there is perfect symmetry. Of the many ways of adjusting for symmetry I have chosen the differential screen voltage control because it is bypassed and can be located anywhere. Perfect balance of an a.c. bridge requires reactive as well as resistive balance, but this one balances well enough for the Pickering D-140-S with the screen control alone. In the broadcast band the reactive error should be even less than at 6 mc.

If you need a finer balance for some weaker audio source, one way to get it is to insert an additional impedance (a 1,500-ohm resistor will do) between each plate and the output and hang a trimmer from each plate to ground, as indicated in Fig. 1. The bridge then shows the series of minima typical of a.c. bridges, approaching the true balance by successive adjustments of the screen voltage control and trimmer, and the fundamental output can be reduced to a few microvolts. *Even harmonics* are not balanced but are excluded by the receiver tuning.

The pickup or microphone is connected push-pull to the two signal grids or single-sided to one of them. If it feeds both in parallel, the desired sidebands are cancelled. The r.f. bypass capacitors across it are a precaution only and may not be necessary.

The strong carrier developed by the oscillator must be kept from getting out by any route except the bridge, otherwise it will mask the sidebands. Thus, all leads entering the chassis and especially the oscillator compartment must be filtered and bypassed, and the shielding must be good. My modulator is in a BC-1023-A cabinet and uses some BC-1023-A parts. The under-chassis space is divided into a bridge

no advantage in this application except for receiving such low frequencies—approaching bottom at 10 kc—that the receiver must be tuned very close to the local oscillator frequency and an unbalanced converter might greatly overload it.

With no variable tuning ahead of it, this converter requires no tuning control except that of the receiver, but it is subject to spurious responses. The low-pass filter removes the worst of these, namely the receiver tuning range itself, the image frequencies which lie still higher, and any sums of two transmitter frequencies which might fall into the receiver tuning range. Its elements

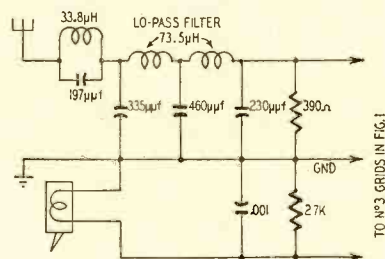

Fig. 2—Circuit for band conversion.

compartment next to the panel and an oscillator compartment at the rear. The copper-shield partition passes across the middle of each tube socket between pins 1 and 8 and pins 4 and 5. Cellulose tape keeps it from grounding the terminals.

Band conversion

With inputs as in Fig. 2, this unit does double duty as a phonograph modulator and band converter. Using the 6200-kc crystal, the BC-348-P covers the missing broadcast band and below when tuned to either 4700–6185 or 6215–6700 kc. The balanced modulator offers

Parts list for modulator

Resistors: 1—270, 1—1,500, 1—2,700, 1—4,700, 2—15,000, 2—47,000, 1/2 watt; 1—3,000-ohm potentiometer.

Capacitors: 2—20 μf , 1—200 μf , ceramic; 4—.001 μf , 4—.01 μf , 1—.03 μf ; 1—18 μf , trimmer; 1—100 μf , variable, ceramic.

Miscellaneous: 2—12K8 tubes; 2—octal sockets; 1—crystal and holder (optional); 1—coil form, winding, base (see text); 1—chassis; 1—power supply.

Parts for band converter

1—390 ohms, 1—27,000 ohms, resistors, 1/2 watt; 1—197 μf , 1—230 μf , 1—335 μf , 1—460 μf , 1—.001 μf , capacitors; 1—33.8 μh , 2—73.5 μh , inductors.

are computed for $f_c = 1730$ kc, $f_\infty = 2070$ kc, $Z_0 = 400$ ohms. They lie within manufacturing tolerances of the nearest stock values. A tuned circuit covering the broadcast band costs less and works better but of course means another tuning control. It can be switched in after searching has been done with the receiver tuning alone.

A later article will deal with a similar unit using transistors. END

References

- ¹Edwin Bohr, "Transistor Phono Oscillator," RADIO-ELECTRONICS, May, 1954.
- ²R. S. Caruthers, "Copper Oxide Modulators in Carrier Telephone Systems," Bell System Monograph B-1140.
- ³R. K. Hellman, "The Modulator Bridge," Electronics, March, 1938.

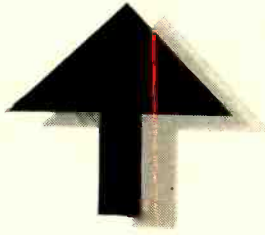

*A painless method
of computing
signal-level ratios*

DECIBEL MEASUREMENTS

with SIMPLE EQUIPMENT

By HECTOR E. FRENCH, W1JKZ

PROBABLY every service technician, radio amateur and audio enthusiast is familiar with decibels. Even the television viewer who watches talent shows sometimes decides that the best performer of the evening is the sound-level meter, which is calibrated in decibels.

Unlike the television viewer, the technician, radio amateur and audio enthusiast should know that a decibel is not primarily a fixed value, like a volt or an ampere, but is a very useful way to compare different sound intensities. For example, two different receivers may be compared in terms of a noise figure stated in decibels, or the response curve of an amplifier at 15,000 cycles may be stated as being a certain number of decibels below the response at 1,000 cycles, or an amateur phone station may be 20 decibels above S9. (I'm usually the same distance below S2.) It's always a *comparison*, no matter what the particular measurement may be.

The values to be compared can usually be measured with very simple equipment; the familiar volt-ohm-milliammeter will often be adequate. The response curve of an audio amplifier, for example, can be found merely by applying a signal of constant strength to the input and measuring the output voltage across the load as the frequency is varied through the audio range.

But when these values of output

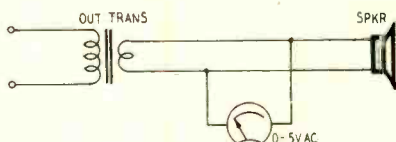

Fig. 1—The standard method of measuring output voltages. A rather wide range of meter types may be utilized.

voltage are converted to decibels, there is usually trouble—complicated mathematics or a confusing decibel chart. Because of this process of measuring in linear values and then converting to decibels, the usefulness of decibel measurement is often cancelled by the labor involved, to say nothing of the possibility of error. Later in this article a simplified conversion method will be shown. But first—how are the measurements made?

No matter how easy or how difficult the conversion to decibels may be, some sort of measurement must be made first. Fortunately, if the readings are to be expressed in decibels an extremely accurate meter is not necessary. A meter accurate to only 10% will be accurate to within 1 db when the readings are converted from linear values.

A meter of only moderate accuracy may be used, with one important restriction. This has to do with the meter resistance. An a.c. meter with an iron-vane magnetic-repulsion movement, for example, can take so much power from the circuit that the readings are completely worthless.

To illustrate, assume that the response of an audio amplifier is to be found by measuring its output voltage as shown in Fig. 1. With a 5-volt meter connected as shown, it is obvious that the meter will show the voltage across the voice coil of the speaker. It also seems obvious that with an 8-ohm speaker, a full-scale reading on the meter should correspond to a little over 3 watts output from the amplifier.

But if this meter is of the iron-vane magnetic-repulsion type, the readings may be completely worthless because such a movement can have a resistance as low as 5 ohms. This would mean that the meter would be drawing more power than the speaker! In this par-

ticular case, full-scale reading indicates 7½ watts, not 3.

Obviously, another type meter must be used. For our purposes either a rectifier type a.c. meter or a v.t.v.m. is indicated. The rectifier type meter can be used because its resistance is usually at least 1,000 ohms per volt. In this circuit, the 5-volt range would have a resistance of at least 5,000 ohms, so much greater than the voice-coil impedance that the effect of adding the meter to the circuit can be ignored.

There is one possible source of error in a rectifier type a.c. meter which cannot be ignored, especially when measuring at the upper audio frequencies. It is the effect of capacitance in the rectifier elements, which reduces the rectification efficiency as the frequency rises and causes the meter to read progressively lower as the frequency is increased. With many instruments an error of 1% per 1,000 cycles is not uncommon. This error will vary from model to model, and the only certain way to find the amount is either to calibrate the meter at different frequencies or to ask the manufacturer for the frequency characteristics.

Another common location for measuring audio voltages is not at the output terminals but at some particular spot inside the amplifier, such as at the plate of one stage. This is usually done as shown in Fig. 2. The signal is being measured at the plate of the output stage, using a rectifier type a.c. meter to avoid loading down the stage and a blocking capacitor to protect the meter from the d.c. component of the plate voltage.

In this case, if a 0-10-volt meter is used, with an effective resistance of 1,000 ohms per volt, the meter resistance will be 10,000 ohms. But if the tube is operating into a plate load of

AUDIO—HIGH FIDELITY

5,000 ohms, adding this meter will drop the loading to 3,300 ohms. Since this change is too great to ignore, it will be necessary either to use a more sensitive meter (one with more ohms-per-volt), or the same meter at a higher full-scale reading. If the meter to be used has a resistance of 50,000 ohms, for example, its effect on the loading is merely to drop it to 4,550 ohms, probably too small a change to cause difficulty.

However, even this particular circuit has a source of error which can sometimes cause puzzling results if not corrected. When the reactance of the blocking capacitor in Fig. 2 starts to approach the resistance of the meter as the frequency is lowered, much of the output voltage is dropped across it. A value of 0.5 μ f or more will be satisfactory down to the lowest frequencies of the audio range when using a 50,000-ohm meter resistance.

This same measurement applied to a voltage amplifier would have the appearance of Fig. 3. In this circuit, most rectifier type a.c. meters cannot be used at all, because of their low resistance compared to the plate load resistance. This problem is made even more troublesome by the low levels of signal voltage usually found in the voltage amplifier stages. Thus, these measurements will almost always require a v.t.v.m. with an effective input resistance of at least a megohm.

Picking the right meter for a particular measurement is only half the job. Even when the measurements are completed, the results are still just a series of readings in terms of voltage or current or power. The question now becomes, how are these measurements converted into decibels?

As previously described, the corresponding values of decibels can be calculated (using a table of logarithms) or the conversion can be made from a table of decibels. And even when a table is right at hand, the ratio of the currents, voltages or powers must be found before the table can be used, since all the values are tabulated with respect to 1.000.

Conversion Scales

To simplify this roundabout process, the set of decibel conversion scales shown in Fig. 4 were designed. These scales could also be called a decibel-conversion nomogram, using the (imaginary) pointer of the meter to indicate the values.

The lower part of each scale is a linear voltage measurement, with one scale

having a range of 0-3, the next 0-12, and the last 0-60. The actual measurements in terms of voltage, current or power are represented along this linear scale, using whichever range is appropriate. The three ranges are chosen to correspond to the most popular scales used in multimeter type instruments.

The upper part of each scale has a series of numbers which are squeezed together at the low end of the range and spread out at the high end. These are the numbers which represent the decibel equivalent of the voltage, current or power being measured.

By using the conversion scales not only can linear measurement be transformed at a glance to decibel measurement, but with a little practice the readings on the meter being used can be converted directly to decibels during the process of making the measurements. The result is that values are found directly in the required terms, with no intermediate steps being required.

To avoid confusion, there are two sets of decibel values for each range of linear values: the large-sized figures used for current and voltage measurements, the smaller figures (in parentheses) for power measurements.

The reason for using two scales lies in the nature of the values being measured. With a given resistance, the power is proportional to either the square of the voltage across the resistance or the square of the current through the resistance. Since the conversion to decibels is being made for some values that are squared (voltage and current) and for some values that are not squared (power or watts), two separate sets of decibel values are required.

For convenience, these scales are all drawn with respect to 1.5 as the reference value, since this permits the number of decibels to be a whole number at full scale. In addition, 1.5 volts of audio applied to the 8-ohm voice coil of a good loudspeaker represents close to $\frac{1}{4}$ watt of electrical power, which corresponds to an average sound level of music reproduction with neither bass nor treble boost in a family-size living room—a convenient basis of comparison. A 1.5-volt signal across a 500-ohm load also represents 4.5 milliwatts of power, which is reasonably close (1.3 db.) to the older standard power reference level of 6 milliwatts.

To use these scales, find the value of current, voltage or power along the bottom of the scale (linear measurement) and read up to the upper scale

which is calibrated in decibels. If the heavy figures directly above the (curved) scale are used for voltage and the small figures in parentheses directly above are used for power measurements, the proper decibel values will be found quickly, with no calculations and no values to extract from a decibel conversion table.

Transforming these measurements, which are given with respect to 1.5, into measurements referred to some other value is very simple. If, for example, the measurements are to be obtained with respect to 10 volts, first perform the conversion in the usual way, with respect to 1.5.

Now operate on the 10-volt value. Referring to the 0-12 range, 10 volts in linear measurement corresponds to 16.5 db, still with respect to 1.5.

To find the final set of values, take each of the decibel values of the measurements (with respect to 1.5) and find the difference between them (subtract 16.5 decibels from each value). This will be in decibels, referred to 10 volts.

Or, for example, if the power readings are to be given with respect to 1 watt, the readings are first converted to decibels by using the values in parentheses. Then, since the 0-3 range shows that 1 watt corresponds to -1.75 db, the difference is found between -1.75 db and the other power readings. (Each value in the measurement has 1.75 decibels added to it.) In this way, the final power measurement is found in decibels, with respect to 1 watt.

There are no doubt other simple ways to arrive at decibels, and some technicians may find the curved meter type scales strange. They are more like a nomogram than a straight graph and easier to read. This may not be the best and simplest approach—merely the nearest thing to it this author has been able to find. END

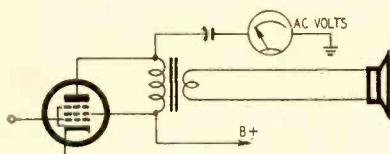

Fig. 2—Another method of measuring output. This has disadvantages, but eliminates output transformer losses.

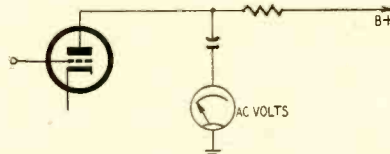

Fig. 3—In a voltage amplifier stage, the method of Fig. 2 would require a very high resistance input voltmeter.

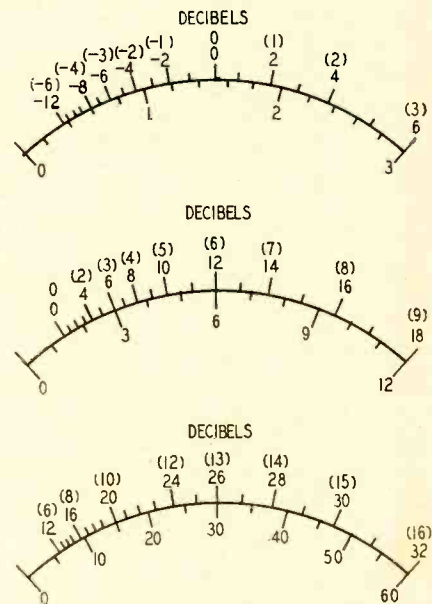

Fig. 4—Lower of these scales is in linear volts, middle a decibel voltage and upper a decibel power scale.

SERVICING

HIGH-FIDELITY

Part X—Turntable hum, rumble and wow; record care and storage

By JOSEPH MARSHALL

EQUIPMENT

THE phonograph turntable or changer affects performance principally by masking portions of music with hum and rumble, and by increasing IM distortion because of the hum, rumble and wow. In one or two turntable models, hum, rumble and wow have been reduced to a point where they have no significant effect on the playback characteristics, but all others have a certain amount of hum and rumble which must be tolerated. When these have increased over their original or design value, the service technician may be able to correct the trouble.

Hum is due to the motor type, its location in relation to the pickup, and the sensitivity of the pickup to hum. In general, the lower the output of a pickup, the more susceptible it is to hum. So, when hum is very annoying, it may be worth while to replace the cartridge with one of higher output and better signal-to-noise ratio. In many cases, the new high-fidelity ceramic cartridges might well be used. Their frequency range and distortion characteristics are scarcely distinguishable from those of the lower-priced magnetics and they are much less susceptible to hum pickup.

Sometimes, a low-impedance magnetic pickup will improve the hum ratio because the hum picked up by the leads is lower in proportion to the desired signal. Such a pickup will require a matching transformer which must be positioned carefully. Incidentally, when hum is bothersome with low-impedance pickups using a transformer, check the orientation of the transformer not only to the phono motor but to any power transformers on the same or adjoining chassis. Such transformers are often triple-shielded and sometimes have two grounding points; it may help to ground the outermost shield to the turntable or motor and the inside shield to the preamp chassis or common ground bus.

More often than not, any increase in hum is due to an increase in the hum

picked up by the cable from pickup to preamp. Check to see that this cable is well grounded on both ends and does not pass close to the motor or a power transformer. Sometimes a considerable improvement can be produced by using a two-conductor shielded cable with the shield grounded only at the preamp (see diagram). Often the hum can be decreased by simply transposing the power-line plug of changer or amplifier; in other cases, it may be worth while to ground the motor frame.

When assembling a single-play turntable and arm, check to see that the arm is positioned so the cartridge is always the maximum distance from the motor.

Short of replacing a turntable or changer with a low-noise model the above are the only steps a service technician can take to improve hum level.

Rumble is produced by motor vibrations reaching the needle by way of the turntable. Ordinarily, the rumble is set by the design and there is little a service technician can do about it. Occasionally one of the rubber mounts of the motor ruptures. This either increases the vibration or decreases the damping—check for it.

Most tables and changers are mounted on springs which not only absorb the external shocks but also damp the motor vibrations. Check to see that the table is actually floating on these springs; often the bolts have been tightened down to such an extent that the cushioning effect has been nullified.

The turntable runs on some sort of bearing requiring grease or oil. The lubricant not only reduces friction but often also serves as a viscous damping element. Check the lubrication as per the manufacturer's recommendations. Be careful not to overlubricate—excess oil may spray the drive wheel, causing slippage; excess grease may increase friction or catch dust and dirt.

The padding of the turntable, whether felt, flocking, rubber or what not, also serves as a damping element. If its

resiliency is gone, the damping is decreased. The new foam rubber turntable cushions may prove a help in reducing rumble.

This thing called wow

Variations in turntable speed, due either to variations in the line voltage or to play and wear in the drive mechanism, produce wow. Check with a stroboscopic disc; wow will be indicated by a more or less rhythmic tendency of the pattern to slip backward or forward one or more times each revolution. A simpler way is to listen to the tones on a test record. If the pitch of the tone is constant, there is very little wow; but if the pitch rises and falls, there is considerable wow.

Most hi-fi changers and turntables are driven by a rubber idler, and wow is almost invariably the result of wear or distortion in this drive wheel. With the table revolving, touch the edge of the turntable to increase the friction

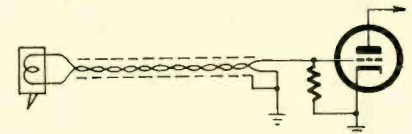

Shield is grounded only at the preamp.

and drag. The turntable will slow down but the pull should remain constant and smooth. If the drag the finger feels is reduced in some portions of the turntable's revolution, the idler is slipping at these points.

If idler and turntable remain in contact in the "off" position, flats may form on the idler, especially if the changer or turntable is used infrequently. Such flats are easily felt when the above test is made. The drive wheel or idler should be replaced whenever the wow increases. In fact, it is probably a good idea to replace the idler every 6 months.

Always examine both the idler and the turntable rim for any evidence of oil or grease. Overoiling sometimes results in the turntable spraying the

AUDIO—HIGH FIDELITY

Emerson 521 single-speed phonograph.



Webster 2-speed phonograph (78-33 1/3 r.p.m.).



The Admiral 3-speed record changer.

rim with oil, causing slippage. The idler can be cleaned with a cloth saturated in either alcohol or cleaning fluid. Unfortunately, there is no telling which should be used except by reading the manufacturer's recommendation. The wrong cleaner may damage the idler. The rim, of course, should also be cleaned thoroughly.

In most cases the idler is held in position against both the turntable rim and the motor shaft by a spring and a slotted mounting. Check to see that this spring is still "alive." Some service technicians like to adjust this spring by cutting off a portion of it to increase the tension. This is not a safe procedure for hi-fi. Though it may temporarily reduce the wow of a worn idler, it is very likely to increase the rumble by reducing the damping the spring provides.

Changers, of course, present many mechanical problems. This magazine published a series on this subject some months ago. The technician who does a lot of audio servicing should obtain service manuals for all the commonly used changers—servicing procedures differ widely from make to make.

Care of records

There is no full agreement on the proper care of records. That may well be an indication that records are more tolerant of mishandling than we have thought. Record problems fall into three categories: reducing wear; reducing noise, and maintaining physical stability or preventing warping, shrinkage, etc.

Wear is a function of use and the condition of the pickup. The best guarantee of long life is to use a pickup with low pressure and to maintain good needle condition, alignment and tracking as detailed previously.

With today's LP plastic records, noise is the result of static electricity or dirt. Since static charges attract dirt, the

two are interrelated. There are methods of reducing the static charge by spraying or wiping the record with special liquids. Both the spray and the special antistatic cloths *do* work. Some say that scratches due to wiping will cause more damage than do the dust particles and static it is supposed to remove; others say that any liquid film sprayed or wiped on the record simply serves as an adhesive and trap for dirt. Some advocate wiping the record occasionally with a damp cloth; others recommend a periodic washing of the record in soap or detergent and water. You pay your money and take your choice.

One procedure is recommended by almost everybody: The needle should be cleaned of dust and lint after every record with a fairly stiff but fine brush.

Good storage conditions are probably the best and least used insurance against deterioration and damage of records. The plastics of which records are made are sensitive to changes in temperature and humidity; they are also very subject to distortion and deformation. A record cabinet with doors is undoubtedly the best. The doors tend to maintain a more uniform temperature and to exclude dust.

When the records are few enough in number so that they cannot fill a shelf snugly, stacking them flat is probably the best insurance against warping.

They can be filed vertically provided they are enclosed in fairly stiff cases which will take up most of the weight and that they stand straight up and down, instead of leaning sideways. If you do not have enough records to fill a shelf snugly, use bookends or some other means to keep them standing straight up and to prevent them from slipping into a leaning position.

Choose a place for record storage that is not overheated or overcooled and maintains a fairly uniform temperature. Usually that means putting the case against an inside partition or wall and well away from radiators, convectors, or air conditioners. Be careful, too, that the case is not in a place where the sun can hit the records. On a warm day the heat produced by this direct radiation may do very great damage. Humidity is also important; a range of from 40 to 60% is best. Since this is also the best for human beings, care in maintaining it will do both you and your records the most good.

Occasionally, despite all precautions, records may acquire a marked wave, warping or dishing. In most cases they can be restored to flatness by placing them between two panes of glass, a little larger than the records, and weighing them down with 10 or 15 pounds of books or whatever. Leave them weighted down for at least a week or, if badly warped, longer. **END**

MISSING LINK IN SPEAKER OPERATION

By D. J. TOMCIK*

Part I—The amplifier damping factor and its application to speaker performance

IN AUDIO reproduction, a subject of considerable importance to the high-fidelity enthusiast is *amplifier damping factor* and its effects on speaker operation. Misconceptions have arisen concerning this subject, and vague and incomplete answers have too often been given to the many questions involved.

Are the high damping factors found in present high-fidelity amplifiers byproducts of high-feedback circuits and, as such, unimportant in the operation of the system? Or is the ultimate, as some loudly proclaim, to have the highest possible damping factor built into the amplifier? Why does a particular speaker sound better with amplifier A than with amplifier B, although both show identical frequency response and power capabilities under bench checks? Why does that \$2 speaker with the 6-ounce magnet (inefficiency and distortion included) seem in some cases to have more bass than the high-fidelity unit with the 5-pound magnet? Why is it that one enthusiast found reproduction more pleasing when he used a little current feedback from the output circuit and another didn't when using the same circuitry?

Some simple laboratory experiments and straightforward analysis can clear the air and answer these questions.

Speaker mechanics

The speaker can be considered, for the moment, a purely mechanical device. As such, the cone with its inherent mass and the cone suspension with its compliance or stiffness make up a resonant system. Some mechanical damping is present but such a slight amount that the system can be considered highly underdamped—if the cone is displaced and then released, it oscillates about its normal resting position for several cycles at its natural resonant frequency. This oscillation decreases in amplitude and finally reaches a state of rest due to the small amount of damping.

If this underdamped speaker is driven by a voltage source having a very high internal impedance so as to maintain the underdamped condition, the cone will vibrate at a greater amplitude at frequencies close to its natural resonance. (This action is similar to pushing a swing or pendulum "in time" with its natural period so as to obtain large amplitudes.) The frequency-response curve of the speaker under these conditions will show a peaked output near cone resonance, usually between 30 and 80 cycles per second. Operation in this manner produces high transient distortion and is undesirable in high-fidelity systems. This can be shown by depressing and then releasing the cone. The oscillation which results is *all* distortion, since the cone does not follow the applied square waveform of depressing and releasing it.

The speaker as a transducer

To reduce the transient distortion as well as the peaked bass response, it is necessary only to damp the cone. If the speaker were purely a mechanical device this would be difficult. But since it is an electromechanical transducer, damping is obtained easily. In analyzing the electrical portion of the speaker we find a coil of wire wound around a form and attached to the cone. The coil is placed in a magnetic field and in this way constitutes a simple motor or generator.

*Chief Electronics Engineer, Electro-Voice, Inc.

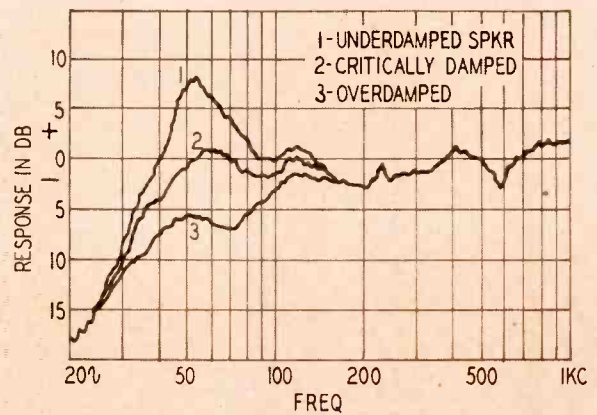

Fig. 1—Effect of various damping values.

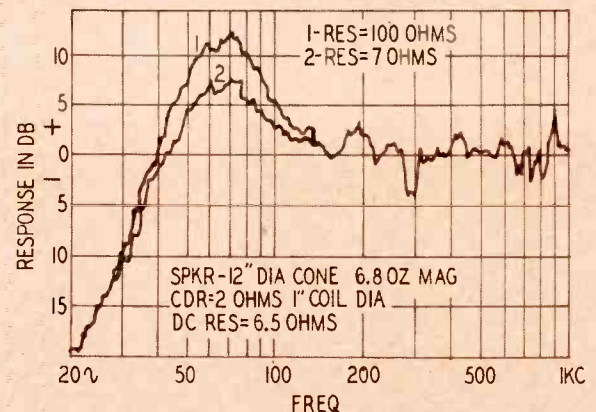

Fig. 2—Curves for inexpensive speaker.

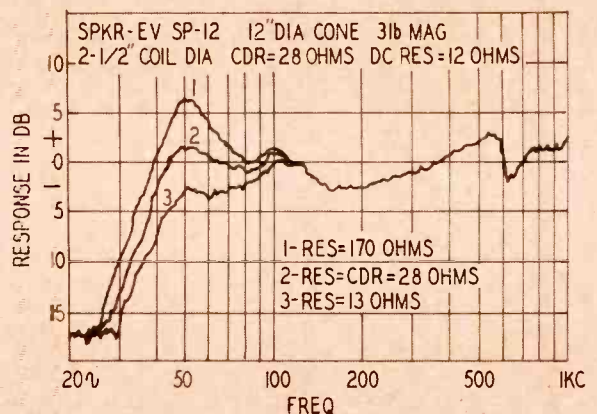

Fig. 3—Curves for a hi-fi speaker.

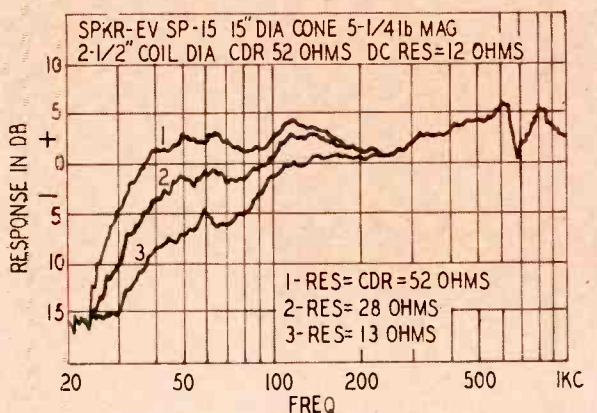

Fig. 4—Curves for 15-inch speaker.

AUDIO—HIGH FIDELITY

If a voltage is applied to the coil, it moves in the magnetic field which in turn moves the cone. If the cone is mechanically moved, the motion of the coil in the magnetic field generates a voltage in the coil. From this it can be seen that cone damping can be obtained by using the magnetic braking action present when the coil terminals are externally closed through a resistance. The motion of the cone in trying to oscillate generates a voltage in the coil. This voltage produces a current flow through the coil and external resistance. The current flow tries to move the cone by motor action, but *opposite* in direction to the motion producing the current. Therefore the cone is damped in its free motion.

For a given speaker, the amount of damping can be varied by changing the value of the external resistance and consequently the value of the braking current. There is one value of damping at which the cone returns to rest in the quickest possible time without going past the rest position. This condition is called the *critically damped state*. Transient distortion is greatly reduced and the low-frequency response is more nearly uniform.

Excessive damping returns the cone slowly to its rest position. If the speaker is driven by a voltage source with very low internal resistance, the low-frequency response lacks intensity. (The action now is similar to pushing a pendulum while it is submerged in grease or heavy oil.)

Fig. 1 shows the extent to which a speaker's output is affected by various damping values. Actual speaker performance is shown for overdamped, critically damped and underdamped conditions. To obtain these curves, the amplifier driving the speaker had means for varying its internal resistance. The method for accomplishing this will be discussed later.

Speaker-damping variables

The easiest method for determining these factors as well as their effect on the damping action is to resort again to the magnetic brake. First, we know that the induced voltage in the coil is directly related to the amount of flux cut by the coil. Therefore a larger magnet or smaller gap volume will induce a higher voltage. As a result, a larger external resistance is needed to limit the current so that the desired braking action is retained.

Second, the amount of induced voltage is directly related to the length of conductor cutting the magnetic field. Since both the coil diameter and the number of turns are directly proportional to the length of wire, we may conclude that these factors also enter into the determination of the critical damping resistance (CDR).

Third, the CDR is made up of two components. The d.c. coil resistance as well as the external resistance limits the amount of braking current. So the CDR is the sum of the coil resistance and

the external, or amplifier, resistance. Conditions might exist, and they surely do, where the d.c. coil resistance of a given speaker *itself* is greater than the resistance necessary to critically damp the cone. Nothing can be done externally to remedy this situation short of using a *negative* resistance amplifier output impedance.

The fourth factor, which is a little more difficult to explain without mathematical illustration, is the effect of the cone mass and suspension stiffness on the value of the CDR. It is logical that to stop a heavier cone from moving in a given time, a greater force in opposition to the motion is required. To increase the opposing force, it is necessary to have a larger braking current, obtainable by lowering the circuit resistance. Also, the stiffer suspension, when displaced, possesses a greater restoring force. The tendency for the cone to overshoot its rest position is increased. Therefore the damping force necessary to overcome this restoring force must be increased proportionately and can be obtained by again decreasing circuit resistance. It must be remembered that the effective mass and stiffness of a speaker are dependent to some extent on the type of enclosure in which the speaker is housed.

To summarize, the factors that determine the CDR can be mathematically expressed as follows:

$$\text{CDR} = C \frac{(Bl)^2}{\sqrt{kM}}$$

where CDR is the critical damping resistance; B, flux density; l, length of conductor in the magnetic field; k, effective stiffness; M, effective mass, and C is a constant.

This formula is not given to encourage experimental calculations—the test equipment necessary is far beyond the means of the average audio enthusiast. Rather, it is used to indicate the relationship of the various factors in determining the critical damping resistance.

Experimental results

Figs. 2, 3 and 4 show actual response curves of three speakers for various values of damping resistance. Infinite baffles were used in obtaining all curves. The speaker whose curves are shown in Fig. 2 is an inexpensive unit with a 6.8-ounce magnet and 1-inch coil diameter. By referring to the equation we can expect the CDR to be low because of the low values of B and l. The curves bear this out since both show the speaker in an underdamped condition. The d.c. coil resistance of this speaker is greater than the CDR and, even though the amplifier resistance is 0.5 ohm for the lower curve, the speaker is still underdamped. Fig. 3 shows curves for a high-fidelity 12-inch speaker with a 3-pound magnet and a 2½-inch voice-coil diameter. As expected, the CDR is much higher than in the first case. The overdamped, critically damped and underdamped curves show plainly that the smoothest response occurs when

the speaker is critically damped. Fig. 4 indicates that this 15-inch speaker with a 5-pound magnet and large voice coil has still a higher CDR. The overdamped curve, No. 3, shows what can be expected from the speaker when the amplifier damping factor is 10 or greater, commonly considered to be the criterion of a good high-fidelity amplifier. However, to obtain critical damping with this particular speaker, the amplifier damping factor had to be adjusted to a value of 0.4—an internal resistance of 40 ohms on the 16-ohm tap! The increase in efficiency by operating this speaker critically damped instead of overdamped is 9 db or 8 times the acoustic power output.

Conclusion

To return to our questions in the early part of this article, let us now see how many can be answered. High damping factors should not be considered byproducts of inverse feedback, *but should be controlled*. They play a very important part in the reproducing chain. Neither should an amplifier be designed with very high damping factors only. A good high-fidelity amplifier demands that the damping factor be variable within wide limits. It is important not only to present the correct load impedance to the amplifier, but also to present the correct load impedance to the speaker. These two load values are seldom the same. The means of true amplifier-to-speaker matching is obtained with the aid of correct amplifier damping factor selection. The answer to the question of why amplifier A works better than amplifier B with a given speaker is that the damping factor of amplifier A more nearly critically damped the speaker than did amplifier B. During the bench test with resistive loads, the two performed in an identical manner. With the variable load of the speaker, the operation was entirely different. The inexpensive speaker seemed to have more bass than the high-fidelity unit because it was working in an underdamped condition, even with a high amplifier damping factor, whereas the hi-fi speaker was heavily overdamped. And finally, the man who improved his speaker performance with current feedback was merely altering his amplifier damping factor to suit his speaker combination. Your speaker, being entirely different, did not perform with that particular value of damping as it would with critical damping. It's all as simple as that.

From the foregoing we see that speakers vary greatly in their requirements of source impedances to critically damp the cone and achieve optimum speaker performance. It also has been conclusively shown with laboratory curves that best speaker performance occurs with critical damping. No one value of amplifier internal impedance can satisfactorily match all speakers and enclosures. The missing link has been found in critically damping the speaker.

TO BE CONTINUED

HIGH-QUALITY AUDIO

Part XVI—Series concluded—
What price “high fidelity”?

By RICHARD H. DORF*



The Bogen model DO10 audio amplifier.

THIS is the final article in this series in which we have tried to show the basic requirements of home music systems and something about their components. The series has been far from encyclopedic and has steered clear of uncompromising engineering discussions and mathematical analyses. This was done in the hope that the hobbyists and service technicians for whom the series was written would gain from it a familiarity with the problems of high-quality sound reproduction.

The title of these articles has been “High-Quality Audio”—not “High Fidelity.” An author does not normally decide the title which will appear in print, but in this case did make a definite point of avoiding “high fidelity” in both title and text for good reasons.

“High fidelity” is a catchword and a slogan today. Like so many words (democracy, for instance) it has come to mean different things to different people. If you make McIntosh amplifiers or sell Altec speakers “high fidelity” means sound as much like the original as possible. If you sell CBS-Columbia model 360 phonographs, you mean sound that is about as good as can be had from a table machine (considerably better than previous table models ever could produce, but not comparable to concert-hall timbre). And if you are a salesman for Acme Phonola† (\$29.95-including-a-spare-permanent-needle) you mean that you have included an extra 95-cent speaker in an exact replica of yesterday’s squawkbox. One manufacturer has come out with a “high-fidelity” piano.

Obviously, the sense has been lost from what started out as a meaningful term, and we are reduced to finding a substitute in “high quality.” But whatever the term we use, its meaning will sooner or later be confused. Industry people here and there have made motions to clean up this nomenclature mess, for example, by placing various

equipments into classes—High-fidelity Class I to, say, High-Fidelity Class VII (which would correspond to no fidelity or pure unintelligibility). Inclusion of the words “high fidelity” in each case would, some innocents assume, satisfy advertising managers whose products fall into Class V or thereabouts, but few companies have yet displayed any inclination to adopt classifications that would tend to indicate its offspring are not as good as somebody else’s. Very little can be done about the situation, other than for the individual to exercise some informed initiative when he buys. This can be done in a few relatively simple steps, especially by readers of this magazine.

The first step is to decide whether a high-quality (or high-fidelity or high-something-else) music system is really a good idea for the individual’s enjoyment of music. To imply that a question exists here is heresy in certain circles, but history’s heretics (Galileo, for instance) are largely responsible for human progress. There are many, including a great number of musicians, who honestly feel that the time, thought, space and money involved aren’t worth while. If you have heard the *Assionata* played 73 times by as many artists, it is very likely that your mind’s ear will supply the missing overtones if you listen to the 74th rendition on a cheap phonograph—which requires no connecting, adjusting or space, is easily portable, and relieves you of a minimum of dollars. But there is no denying that most people—if they will put forth the rather modest effort involved and the (believe it or not) rather modest financial expenditure—will genuinely enjoy music which sounds as much as possible like the original. If you are in this majority, read on.

Step two is to realize that there are different grades of sound reproduction. The aforesaid Acme phonograph may be the lowest quality but the music is generally recognizable, and for the price the instrument may well be a bargain if

we disregard the “hi-fi” claims in its advertising. The two-speaker trend in table models has produced considerably better sound than the same size machine gave in former years. A product like the 360 produces better sound than you have any right to expect in such a small, compact “system,” though it still leaves much to be desired. Most department store type radio-phonograph combinations, even the “console” models, don’t do as well, the money you pay being poured into wood rather than sound.

But from here the next step is an abrupt transition upward in sound quality—when you begin to look in “hi-fi” catalogs for *components*—separate amplifiers, tuners, speakers, turntables, and so on. Even a \$35 amplifier, with other components amounting to perhaps another \$150 or so, gives you a real system, with sound comparable to almost nothing obtainable otherwise. And when you get some of the really first-line components and put them together, you have the kind of sound for which we can no longer find any unabused name.

But even here, let us soft-pedal the extravagant touch with a nice, controversial, flat statement: If you spend more than about \$500 to \$600 for components (with speaker cabinet but no other woodwork), you will have to be extraordinary indeed to hear your money’s worth—and most of those who can are so busy picking apart the sound quality they have no time to hear the music. The quality of components rises much more slowly than their cost. To an Ivory-soap percentage of ears, a \$200 amplifier does not sound anything like twice as good as a \$100 amplifier. There is generally an improvement with higher price, but be very sure you can hear it before you pay for it. The Bogen DO10 amplifier (see photo), for instance, costs only around \$40, but its sound will amaze and delight people who have been used to ordinary instruments. The McIntosh 50-W2 (whose photo also appears here) is a far better performer (at about six times the price)

*Audio Consultant, N. Y. C.
†The name is fictitious.

AUDIO—HIGH FIDELITY

on several counts—but the newcomer to good sound (or even some of the self-styled “golden ears”) won't appreciate it six times as much.

The same is true of other components: You can buy a tuner for \$50 or for \$200, a speaker for \$20 or a speaker system for \$500. If you have the money, by all means buy the better one. But if you can't ascend to the heights, don't think the modest hills aren't worth while.

For a really satisfactory system at any price, certain rules do apply. For instance, a dual speaker system (woofer and tweeter) is almost always more satisfying than a single speaker and is usually worth the extra cost. A tuner with a.f.c. for FM is a very fine thing. A preamplifier or control box with step type equalizers tailored to the various phonograph curves is almost a necessity, while the presence of continuous “tone controls” is less important. A loudness control rather than a simple volume-control potentiometer is a big contributor to good sound.

Magnetic phonograph cartridges are no longer the only choice. There are good crystals and ceramics, though it is true most are not the equals of a good magnetic. Equals do exist, however. Good crystals, and ceramics we predict, will come into strong competition when people learn enough about them to avoid instinctively grouping them with the old-fashioned crystal groove-grinders.

Diamond styli on pickups, at least for LP use, are cheaper in the long run than “precious metal” or sapphire points. True, there is a big difference between their initial prices, but there is a much bigger difference in the length of time they last, and they keep records in good condition right up to the end of their lives. Record changers are not ideal for either record or stylus life because of the constantly changing vertical arm angle as the turntable fills. This is minor and the worst objection

to even good changers is that the pickup arm is rarely if ever correctly made with respect to lack of audible resonance. There is little reason to buy a changer if only LP's are to be played, since they play as long as 20 minutes a side and must be turned over.

Actual choice of components is something that people are too concerned over. Today's audio-components market is a large one, with many manufacturers making equipment in a variety of price ranges, styles and ratings. It is not difficult, therefore, to fill any kind of requirement, and it is rare indeed that any one brand and model of component is very much superior to others in the same price range.

The sound departments of the dealers are there for your use and you should use them. Before the visit, decide on a budget. For about \$200 you can get a system (complete except for cabinetry but including a speaker enclosure). This is about the minimum and will satisfy a very large number of people—and we are *not* speaking in a contemptuous tone about people without discrimination. For \$400, under the same conditions, you may not get a great deal of improvement in sound (except perhaps in the loudspeaker department) but you will have a wider choice of “luxuries,” such as tuners with a.f.c., more flexible control systems, and the like. For \$600 you can buy a system with very good components indeed, and for \$800 you can have the best of amplifiers and an excellent speaker system.

If you spend \$1,000 or more, you are, acoustically speaking, in the yacht-owner's class, with the best of everything. This may satisfy some inner craving but it is hard—at least for this writer—to see how it can be justified in terms of sound—unless, of course, you are doing something fancy like wiring a whole house or installing a binaural system. If you spend more than about \$1,200, you are paying some-

one an annuity and should require an itemized list with prices and compare it with readily available catalogs.

All of this, of course, leaves out cabinetry for containing amplifier, tuner, turntable and controls, but one of the joys of this game is the originality and artistry you can summon forth in making, having made or utilizing existing or antique-shop pieces for this purpose. Costs of cabinetry can range from almost zero for a home-made job to fortunes for converted period pieces.

If you are a technician or skilled hobbyist, you will quickly see how to connect the components together, for manufacturers today usually provide everything—jacks, plugs and full instructions. If not, ask the dealer to furnish cables, with verbal (and drawn) instructions.

One last word, a bit of special pleading occasioned by too many hours of having our ears assaulted by drums, triangles and trumpets, coupled with admonitions to “Just listen to those highs!” and “You really feel that bass, don't you!” There is little point in wasting several hundred dollars and a lot of time and space, followed by nothing but “high-fidelity” demonstrations to yourself and your friends when the local music store can sell you a set of real drums and a couple of triangles for less money. The way to enjoy and demonstrate your system is to play *music*. If you like Eddie Fisher, put on Eddie Fisher records, adjust the equalizer and volume, and let him send you. If you like chamber music, put on a good quartet and allow everyone present to revel in Ravel. But, just as a Parker 51 is useless unless you use it to write intelligibly, the best music system is so much expensive junk if you don't use it to reproduce music.

As Shakespeare used to say, the theatre is beautiful, the air-conditioning perfect, and the costumes magnificent—but, the play's the thing! **END**

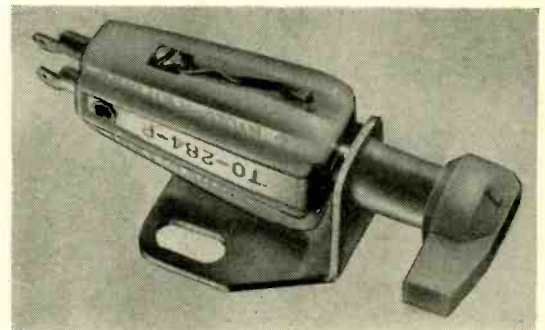
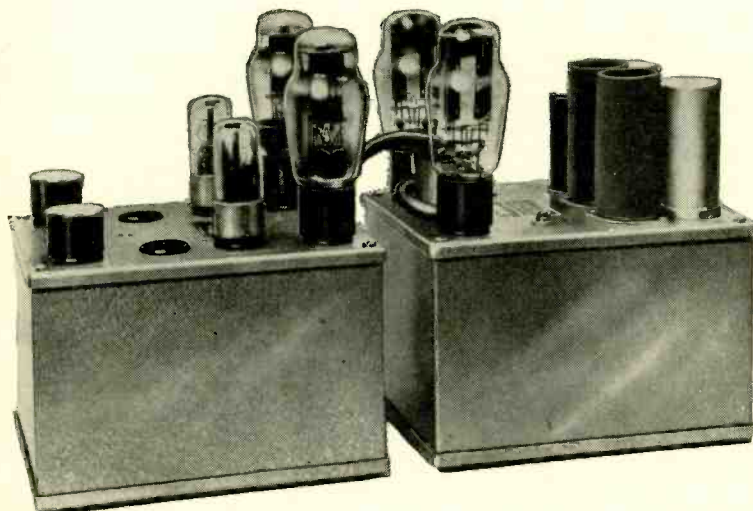

Above—The new Ronette crystal cartridge.

Left—McIntosh model 50-W2 audio amplifier.

DEMONSTRATION TRANSISTOR CIRCUITS

By EDWIN BOHR

Kit for the transistor experiments.

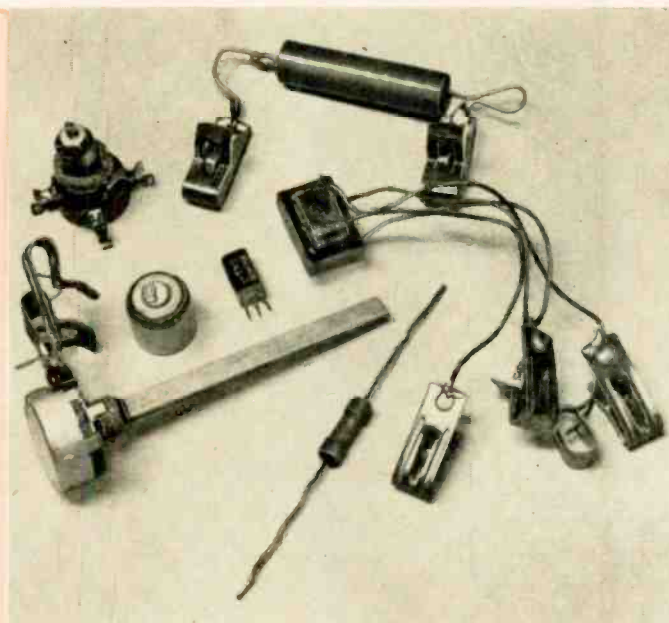

TRY all of these circuits and really get the feel of transistorized equipment. Experiment for personal pleasure or for an audience—the layouts are ideal for club demonstrations.

A single transistor is used in each circuit. Other parts are standard and easily obtained—if not available from the junkbox. Every circuit has been checked out with several CK722 production transistors and found to be fool-proof. (A demonstration circuit must work without embarrassing tinkering and fumbling.)

Components are mounted breadboard style, allowing the individual circuits to be connected or torn down quickly. Since a single transistor is involved in all the circuits, it should be especially protected from continuous handling and soldering.

Two types of breadboard mountings for the transistor are used. In one layout, the leads are run to Fahnestock clips held to a heavy base of clothboard or masonite by 6-32 screws. This base should be heavy and large enough to prevent accidental upsets. The other breadboard model sports a small five-prong hearing-aid tube socket into which the transistor can be plugged. Only the first, third and fifth pins of this socket are used. The other two pins are given a slight twist and pushed out. It is a good idea to mark clearly which lead is the emitter, base and collector. Another suggestion: Slip spaghetti over all wires that might touch or short.

Microwatt oscillator

The most remarkable feature of the transistor is its ability to perform useful electronic tasks with a minimum of power consumption. The first project is an audio oscillator requiring a total power input of 4 microwatts—a perfect example of low power consumption! A simple electrolytic cell, constructed from

a dime and a piece of absorbent paper, supplies the energy.

The circuit (Fig. 1-a) must use transformer feedback to operate at this low power level. For this purpose, and in keeping with the size of the transistor, a tiny U.T.C. SO-3 or SSO-3 subouncer transformer is used. Larger transformers will do, but the data given in this article is for the SO-3.

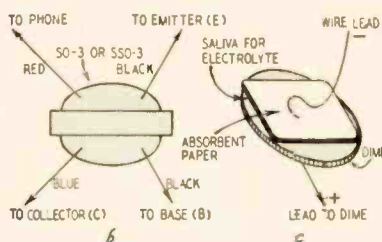
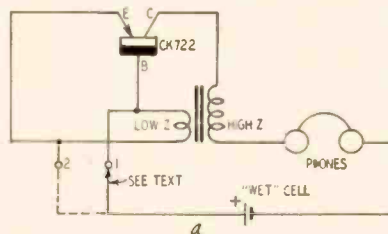

Fig. 1-a—The microwatt oscillator.
Fig. 1-b—Wiring diagram for the SO-3.
Fig. 1-c—Experimental “power supply.”

The exact connections for the SO-3, with the correct feedback polarity, are shown in Fig. 1-b. One wire from the “plate” side of the transformer goes to the collector and the other wire is connected to one side of the headphones. The two low-impedance wires from the transformer are connected to the base and emitter.

Either grounded-emitter (point 2) or grounded-base (point 1) operation is available by switching the wet-cell connection. Operation of the two circuits is essentially the same, but the grounded-base circuit gives a tone of

slightly higher pitch. The frequency of the oscillator changes with the voltage of the wet cell. Increasing the voltage lowers the tone.

Make the wet cell (Fig. 1-c) by placing a piece of absorbent paper moistened with saliva against a dime. The dime forms the positive electrode and a wire lead held against the other side of the moist paper provides the second electrode. A few drops of soft drink also make an excellent electrolyte.

Several of these dime-saliva cells were checked on a potentiometer and the voltage was always around 0.7. When the cell is connected to the transistor oscillator, the voltage drops to about 0.5. With this voltage, the oscillator draws 8 microamps of collector current—a total input power of .000004 watt!

By making a megaphone out of paper and placing it to one of the earphones, the tone can be heard several feet away. For larger groups, an audio amplifier input can be connected directly across the earphones for room volume.

The microwatt oscillator operates from other flea-power sources. Replace the saliva cell with a self-generating photocell and the oscillator will “sing” from the power produced by ordinary room illumination. Automobile headlights at night as far as 30 feet away will give enough light for oscillation. The tone changes with light intensity. This could possibly be used as a blind man’s light meter or in a steering device to bring an electronic animal to its nest.

A peak a.c. output voltage greater than the applied d.c. voltage can be obtained from transistor oscillators. This offers some novel transistor uses. For example, it is often necessary to send small d.c. signals over long-wire distances from remote locations. The microwatt oscillator can operate from these small voltages and, at the point of origin, change them to a.c. for more

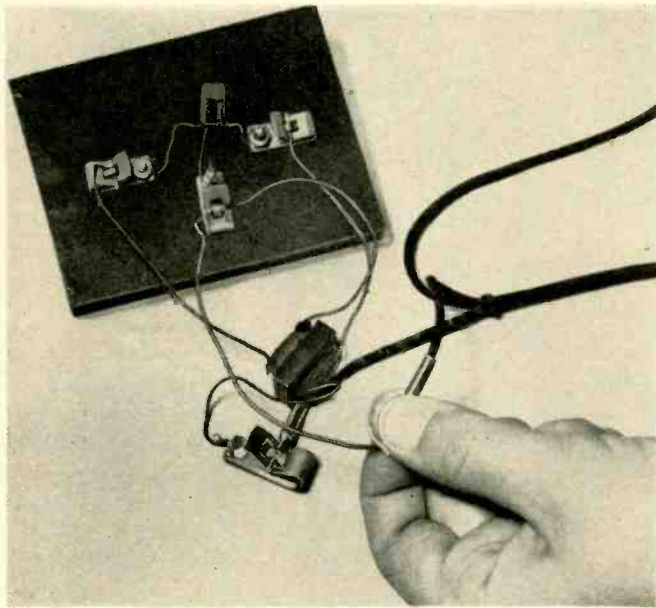

Microwatt oscillator with saliva cell.

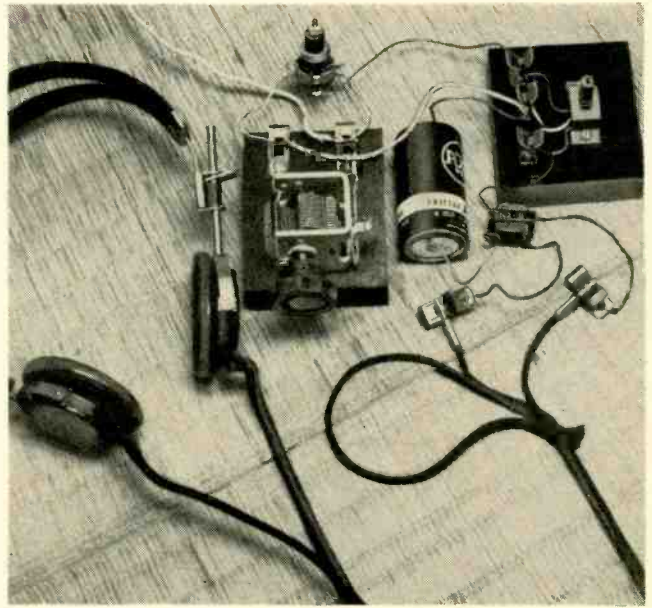

The high-gain radio demonstration.

convenient transmission and amplification.

High-gain radio

Astounding! is the only way to describe the feelings of most people when they first hear this set (Fig. 2) in operation. Only a single tuned circuit, transistor, SO-3 transformer and a battery are used.

The tuned circuit is coupled to the emitter by a tap on the coil, a 6SA7 oscillator type—only here it is used as an antenna coil. A broadcast tuning capacitor (410 μmf) covers the band with perhaps only a few stations missing on the low end of the dial. The tuning is broad enough so these stations will be picked up anyway.

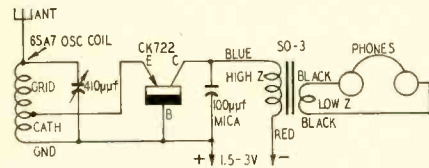

Fig. 2—High-gain transistor radio.

Simply connect the set as shown in the diagram. The grid connection of the 6SA7 coil goes to the tuning capacitor stator plates, the ground side of the coil goes to the frame (rotor) and the cathode tap to the emitter.

The emitter conducts only on the positive half of the carrier swing, like an ordinary diode detector; therefore, the instantaneous emitter current follows the modulation pattern. The emitter thus controls the current in the high-impedance collector circuit, producing amplification.

The secret of the receiver's performance is the SO-3 matching transformer. Ordinary medium-impedance earphones connected directly in the collector circuit do not realize the full gain possible from the transistor. But, with the circuit of Fig. 2, much higher gain is

possible. Even Army type moving-coil (low-impedance) earphones connected across the output winding give very good performance.

A small 0-100-microamp meter connected in series with the collector makes a very good tuning indicator. With a single dry cell for current, and no signal, the collector draws about 10 microamps. As a signal is tuned in, the current increases. A signal producing 20 microamps of collector current is loud enough to be heard faintly 3 or 4 inches from the earphones, while 40-microamp signals are exceedingly loud. Generally, a ground is not needed, but it does eliminate hand-capacitance tuning effects. For demonstrations, just touch the tip of a transformer type instant-heat soldering iron (plugged in but not turned on) to the antenna terminal of the receiver. This makes a very effective antenna with a whopping big signal of over 50 microamps. For even more volume, simply increase the collector supply to 3 volts.

Audio amplifier

The grounded-emitter circuit has become the established transistor audio circuit. There are two reasons for this: First, the gain is highest and, second, the proper bias voltage can be obtained most easily and with the least wasted power by grounding the emitter.

The transistor emitter is basically a rectifier circuit and a bias voltage must be placed on it to cause forward current to flow. For the CK722 this voltage must be positive. Without this bias, any negative swing of the emitter signal would drive the emitter into its "backward" region and produce collector cut-off distortion. In the grounded-emitter circuit, the base is made slightly negative by a series-dropping resistor from the negative collector supply, which is equivalent to making the emitter positive.

Fig. 3 is a typical amplifier circuit of this type. The input impedance being roughly 1,000 ohms, it can be fed from a single magnetic headphone used as a microphone, the transistor radio or a variable-reluctance cartridge.

To try out the circuit, connect a single earphone to the input and another to the output. Place the input earphone (microphone) in one room and the output one in another room. Sounds near the microphone can be heard clearly. The transistor amplifier can be built complete with a mercury-cell power supply in a volume as small as that of the earphone. You can't do this with a vacuum tube! On the debit side, the transistor amplifier has a noise level higher than an equivalent vacuum-tube circuit. This noise, heard as a soft frying sound in the earphones, is not obtrusive.

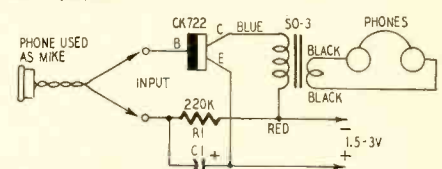

Fig. 3—Transistorized audio amplifier.

A variable-reluctance pickup connected to the input of the amplifier makes a pretty good transistor stethoscope for tracing the source of vibrations in solids and machinery. To detect the vibrations, simply touch the stylus to the vibrating material or machine part.

Capacitor C1 can be any electrolytic with a capacitance larger than 25 μf and a voltage rating of 3 or more. The unit shown in the picture is 200 μf at 3 volts. Resistor R1 can be from 100,000 to 270,000 ohms.

Utility oscillators

The utility oscillator is a demonstration circuit operating from a single-

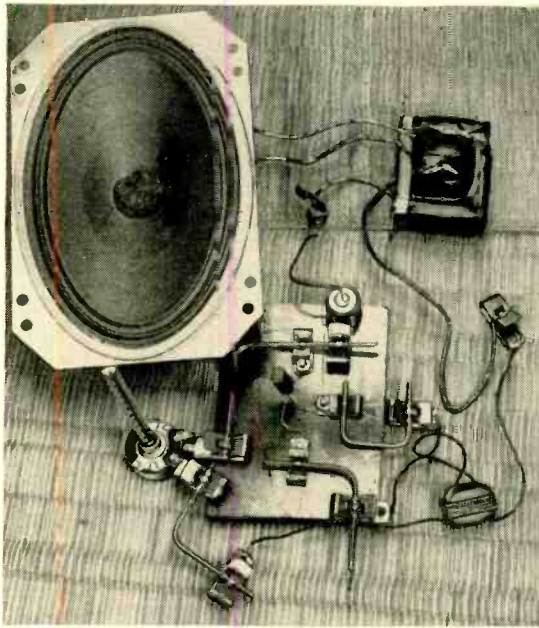

Oscillator of Fig. 4 using mercury cell.

cell. It is useful as a self-contained signal source for Wheatstone bridge circuits, toy musical instruments or an audio test generator. When operating at very low frequencies (60 cycles or less), the output is sufficiently rich in harmonics to radiate signals into the lower end of the broadcast band. The circuit of Fig. 4 is the same as Fig. 1, except for the power source and a variable resistor inserted in the emitter circuit to vary the frequency. Figs. 5-a, b, c and d give the waveshapes and frequencies obtained as the resistance is varied from zero to 7,000 ohms. Notice that the waveshape improves and the harmonic content decreases as the emitter resistance is increased.

Output is sufficient to operate headphones or a speaker at very low volume. Either earphones or the speaker output transformer may be connected to the OUTPUT terminals of the oscillator shown in Fig. 4.

A short antenna can be connected to the collector for signal radiation. The audible tone generated by the oscillator can be heard all across the low end of the band where it is strongest. Just turn on any radio within a few feet of the antenna.

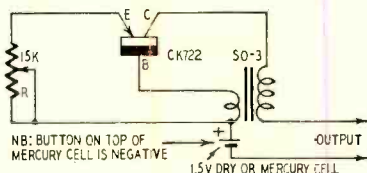

Fig. 4—Variation of Fig. 1 oscillator. Frequency controlled by potentiometer.

Another utility oscillator circuit is shown in Fig. 6. This is an "easier starting" circuit than that of Fig. 4. Some circuit disturbance is always necessary to start an oscillatory circuit in operation. A pendulum or tuning fork, for example, must be given that first push or impact to start it oscillat-

ing at its natural frequency. Vacuum tubes receive this push the instant the plate voltage is applied. When the plate voltage is switched on, the grid has zero bias and heavy plate current flows. This heavy surge of current excites the tuned circuit which oscillates and in turn builds up a grid-leak bias that limits the plate current to a lesser value.

With the transistor, this same situation is not obtained. Like the vacuum-tube grid, the emitter also has zero bias at the instant the collector voltage is switched on. But, conversely, zero

emitter bias allows *very little* collector current to flow, since a positive emitter bias is needed to increase the collector current to a point higher than the normal back current.

The Fig. 4 oscillator develops a starting bias across the variable base resistor. As the collector starting current flows through this resistor, it places a positive bias on the emitter.

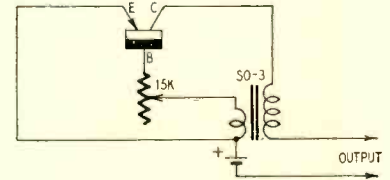

Fig. 6—An "easy start" oscillator.

Loading the circuit with an antenna or hand capacitance changes the waveshape considerably but causes little if any frequency variation.

These circuits will provide plenty of new entertainment and experimental material. You will hate to disassemble some of them—especially the radio.

Parts for transistor demonstration

- 1—CK722 transistor; 1—SO-3 (U.T.C.) transformer;
- 1—6SA7 oscillator coil; 1—1-section tuning capacitor, 410 μf;
- 1—15,000-ohm potentiometer; 1—resistor, any value from 100,000 to 270,000 ohms;
- 1—electrolytic capacitor, 25 μf or greater; 1—mercury or dry cell; several Fahnestock clips.

However, even one transistor is too expensive to limit to any single circuit. Furthermore, the clip-breadboard technique makes it possible to set up any of the other circuits in short order. END

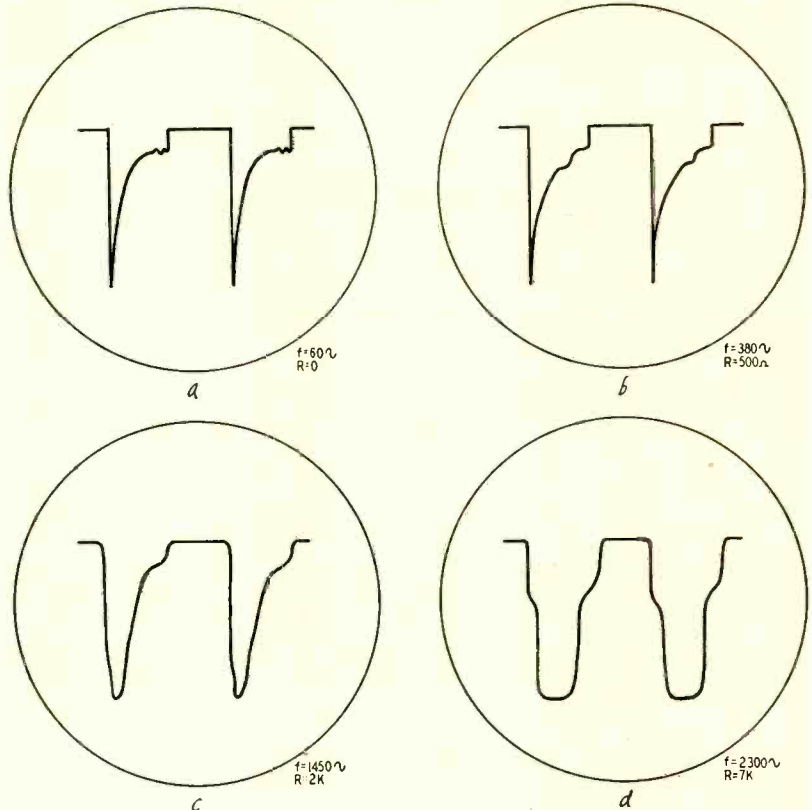

Fig. 5—Waveforms of Fig. 4 oscillator for variations in emitter resistance.

RADIO

RADIO for

JUNIOR'S CAR

A receiver that can be installed conveniently in small-fry vehicle—realism beyond the imagination



By JAMES S. MICHAEL

ONE of the most prized possessions a child can have is his or her own automobile. Unfortunately, manufacturers of these little autos do not provide a line of accessories such as is available for dad's car. To make my little boy's fire engine more realistic, I installed a radio. The result of my trials and tribulations is shown on the front cover.

The first step was to see how much room was available for the installation. In this and just about all other children's vehicles on the market, there is ample room for a decent-sized radio. I decided a 3- or 4-tube circuit would give the desired results.

After some experimentation I settled on the simple 4-tube t.r.f. circuit shown in the schematic. The sensitivity and selectivity of the receiver are about the same as in most t.r.f. circuits without an extra r.f. stage. For my purposes it was very satisfactory.

The circuit is very flexible and can be adapted to almost any installation. Only the usual construction requirements need be followed, such as keeping the plate and grid leads separated.

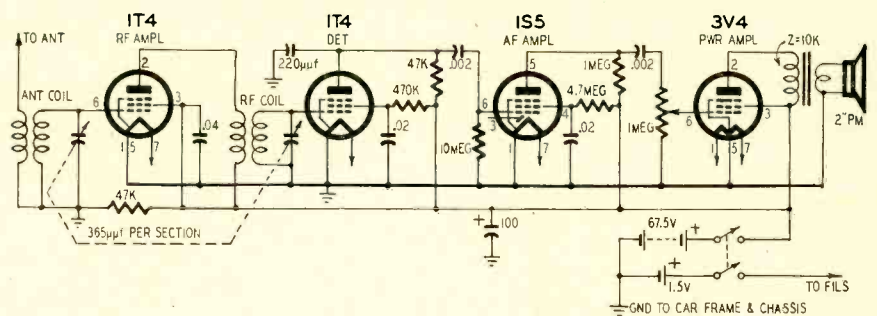

Diagram of Junior's car radio. Unit is not critical—will stand rough treatment.

I used unshielded antenna and r.f. coils because they were on hand. But an improvement could be made by using shielded or iron-core coils.

The unit is powered by a 67.5-volt B battery and two flashlight cells, installed in a separate container. The radio draws very little current, resulting in long battery life.

The r.f. and detector stages (The 1T4 detector circuit is operating without a grid-leak resistor and capacitor in the grid circuit. The author reports

satisfactory detection with the circuit as shown.—Editor) use 1T4's. A 1S5 is used as the first audio amplifier. It drives a 3V4 power amplifier. The speaker is a 2-inch job small enough to install in the dashboard and helps along the realism.

In constructing the unit, one precaution must be observed. Do not use a s.p.s.t. switch in the common negative lead to turn the unit on and off. It will be much cheaper to buy a d.p.s.t. and use it as shown. Or if you must buy a

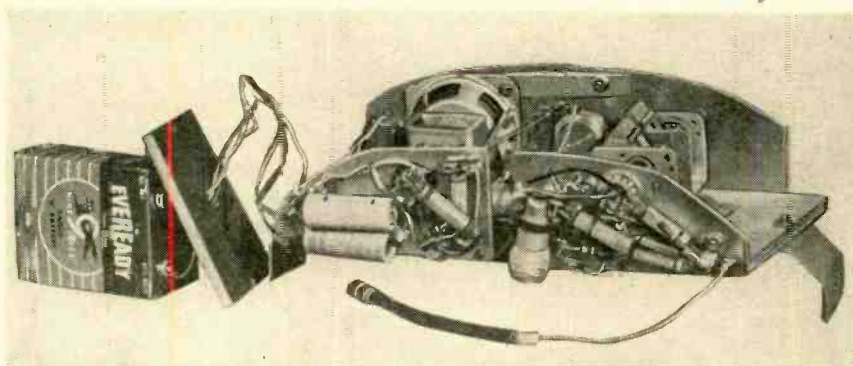

Physical layout of completed chassis.

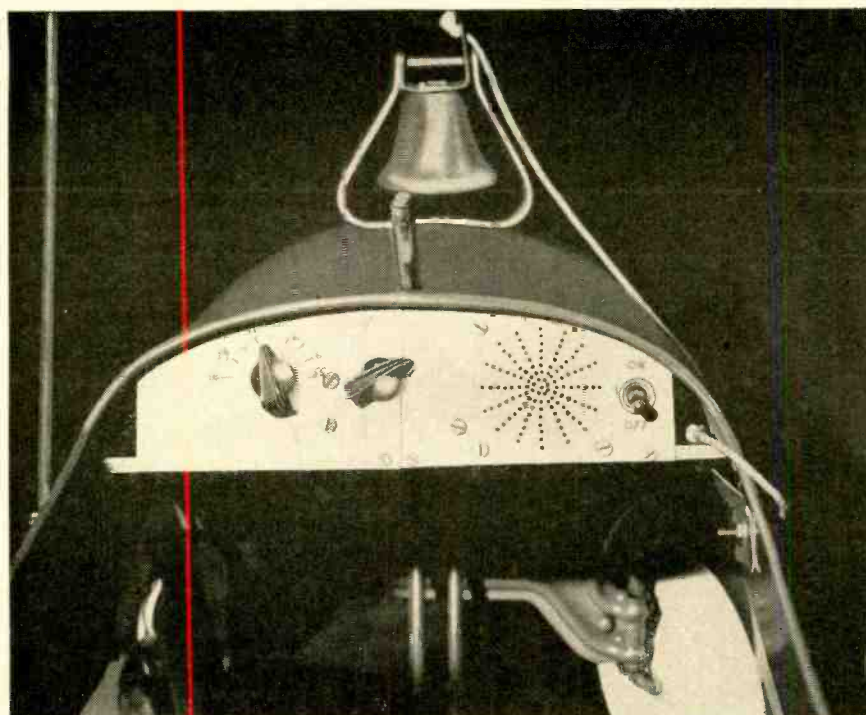

The dashboard—3 simple controls.

new volume control, get one with a d.p.s.t. switch on the rear. One side of all the filaments is grounded, and the negative ends of the batteries are tied together and grounded. The time constant for the 47,000-ohm resistor and 100- μ f capacitor is very long (4-7 seconds). If the single ground lead is opened to turn the unit off, the 100- μ f capacitor will discharge, following a path through the 67.5-volt battery, the 1.5-volt cells and all the filaments in parallel. There is more than enough charge on this capacitor to burn out the filaments of all four tubes.

(When interviewed, the author mentioned that he deviated somewhat from conventional circuitry to use components that were available in the junk-box. Although B batteries last for six months or longer, he agrees that there are some minor changes that may reduce the drain on the batteries and further prolong their life.

Plate and screen current for the 3V4 can be reduced by inserting a resistor of about 500 ohms between the B minus battery terminal and ground and returning the bottom end of the volume control to the battery end of the re-

Parts for Junior's car radio

Resistors: 2—47,000, 1—470,000, 1—1 megohm, 1—4.7 megohms, 1—10 megohms, 1/2 watt; 1—1 megohm, volume control.

Capacitors: 1—220 μ f, 2—.002 μ f, 2—.02 μ f, 1—.04 μ f, 200 volts; 1—100 μ f, 100 volts, electrolytic; 1—2-gang 365 μ f, variable.

Miscellaneous: 2—1T4, 1—1S5, 1—3V4, tubes; 1—output transformer; 1—chassis; 4—7-pin sockets; 1—2-inch speaker; 1—67.5-volt B battery; 2—1.5-volt cell; 1—d.p.s.t., switch; 1—antenna coil; 1—r.f. coil; 1—auto antenna; 2—knobs.

sistor. Select a resistor that provides 3 to 4 volts between the grid and pin 5 of the 3V4. The 47,000-ohm bleeder resistor can be increased to 200,000 ohms or so to reduce the bleeder current. Drain on the A battery can be reduced by using only pins 5 and 7 of the 3V4.—*Editor* END

NOW—THE TRANSISTOR POCKET RADIO



The transistor portable, predicted by many as a certain 1955 development, is now in production. It is a super-

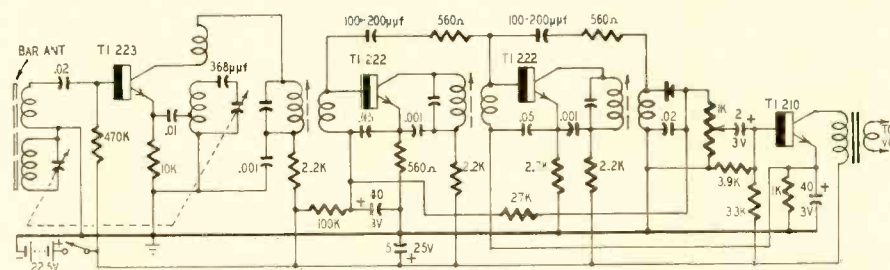

heterodyne and uses four transistors of new design plus a diode detector. The set is only 3 x 5 x 1 1/4 inches in dimensions and weighs less than 12 ounces. Design of such a set is made possible by new high-performance transistors developed by Texas Instruments Inc., Dallas, Texas. Power is supplied by

a single 22.5-volt battery, whose life is naturally expected to be very long.

The little set is made by Regency (a division of Industrial Development Engineering Associates) of Indianapolis, Ind., and is priced at \$49.95. It is expected to be on the market in time for the Christmas trade.

A practical approach to the understanding of this popular circuit

Getting the Cathode Follower Straight

By NORMAN H. CROWHURST

THE well-known cathode follower is a very useful but frequently misunderstood circuit. The commonest misconception concerns its use to produce a low output impedance. It is true the follower circuit *does* produce a low output impedance, but the kind of misunderstanding referred to can be seen in a recent case where the circuit was used as a buffer stage to isolate an oscillator tube. The essential requirements were high stability and good waveform. The circuit designer assured me the follower would feed satisfactorily into a 600-ohm line. I had my doubts, which proved well founded.

Let's not get involved in formulas at this stage. Other articles on cathode followers have done a good job of explanation from this approach. Instead, let's take a diagram of a cathode follower and put some figures in. A cathode follower is essentially a tube in which the *plate* load is connected be-

tween cathode and ground instead of its usual place between plate and B plus (Fig. 1).

Start by assuming that the signal voltage from grid to cathode is, say, 1 volt. This is the tube's viewpoint—it can have no way of knowing what the voltage is from grid to ground, although *we* may prefer that starting point—and it will control the plate-cathode voltage and current. Suppose that, with the plate load chosen (connected in the cathode), the tube has a gain of 20. There will be a signal voltage of 20 across the plate load resistor, in this case from cathode to ground. We find the grid to ground signal voltage by adding these two—21 volts. Not sure of the phase? Well, a positive swing of grid-cathode voltage increases plate current, increasing the drop across the load to produce a positive swing at the cathode. So the two are additive.

Thus, 21 volts input, from grid to ground, will give an output, from cathode to ground, of 20 volts.

What happens when we connect a 600-ohm load (Fig. 2)? Let's take the figuring further: Suppose the tube has an amplification factor of 30, a plate resistance of 15,000 ohms, and the plate load resistor is 30,000 ohms. This works out to give a gain of 20 without feedback. To complete the tube values, its transconductance would be 2,000 micromhos. From the tube's viewpoint,

for signal voltages, its plate load is effectively 30,000 ohms in parallel with 600 ohms—not much less than 600 ohms. The gain of this tube with a 600-ohm load will be $30 \times \frac{600}{15,000} = 1.2$. If the input is still 21 volts, this voltage will divide so that the voltage across the cathode load (11.5) is 1.2 times the voltage from grid to cathode (9.5). Connection of the 600-ohm load has dropped the output voltage from 20 to 11.5.

This drop can be regarded as due to the effective source impedance of the cathode follower. As the drop is $20 - 11.5 = 8.5$ volts, the effective source impedance, calculated by ratio with the load impedance, can be called $600 \times \frac{8.5}{11.5} = 440$ ohms. The accurate value of the cathode follower impedance could be calculated directly from the formula

$$Z_{eff} = \frac{R_p R_L}{\mu R_L + R_p + R_L}$$

Take a look at what has happened to the grid voltage. Before the 600-ohm

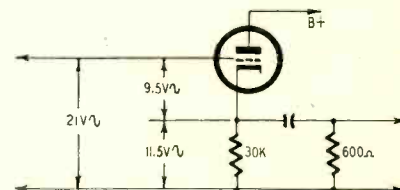

Fig. 2—Circuit addition—600-ohm load.

resistor was connected, the grid to cathode signal voltage was only 1; when the 600-ohm resistor is connected, this signal voltage rises to 9.5. Think a moment and you will realize what the arithmetic failed to tell us. Do you know of a tube with 15,000-ohm plate resistance, 2,000 micromhos transconductance, that will handle 9.5 volts signal on its grid—requiring a grid bias of at least 25 volts? But one to handle 1 volt would be feasible, wouldn't it? So adding the 600-ohm resistor would obviously produce distortion.

At this stage, many people come up with the argument: "But what about the feedback—won't that take care of the distortion?" To which we can imagine our poor little overworked tube squeaking up: "What feedback?" Look again. When the tube works into the changed plate load of 600 ohms, its gain is knocked down to 1.2. Before the load was connected, the tube gain was 20, reduced by feedback to 0.95—a reduction of a little over 26 db; with the load connected the gain is 1.2, reduced by feedback to 0.575—a reduction of a little over 6 db. And a mere 6 db will not do much toward cleaning up a waveform produced by giving an input of 9.5 volts to a tube intended to accept not much more than 1 volt!

All right, someone says, but all you're pointing out is that using a low load on a cathode follower restricts the signal it can handle. But keep within a smaller signal and the cathode fol-

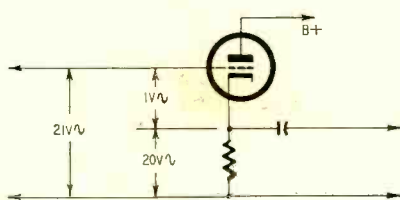

Fig. 1—The basic cathode follower.

lower will still produce lower distortion than other circuits, won't it? To satisfy you, let's go into this a bit further.

Suppose we do turn the input down from 21 volts grid-to-ground to about 2 or 3 volts, so as to keep within the grid-handling capability of the tube. Take a look at the tube characteristics shown at Fig. 3: The load line AB represents a plate load resistance of 30,000

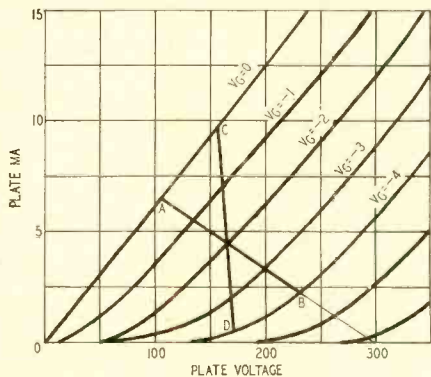

Fig. 3—Load lines for cathode follower.

ohms; assuming the circuit in Fig. 4 provides a bias of 2 volts, the load line CD represents the result of connecting 600 ohms in parallel by a.c. coupling through the capacitor. Notice that the line AB crosses the curves representing successive grid voltages at uniform intervals, while CD cuts at an angle so the spacings taper off noticeably at the bottom end, while the top end extends into high plate current. This means serious distortion, even before full grid

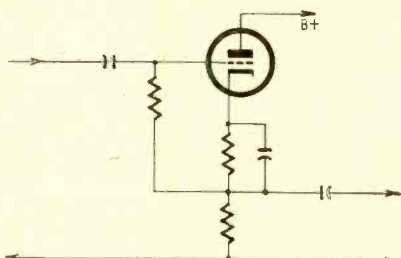

Fig. 4—A practical cathode follower.

swing is reached, and with only 6-db feedback the distortion left will be much more than is expected of a respectable amplifier.

Otherwise expressed, the feedback has been "used up" to provide impedance matching and not enough remains to take care of distortion or for other purposes.

Isn't it surprising how resentful people can get when they think an old favorite is being attacked? So some,

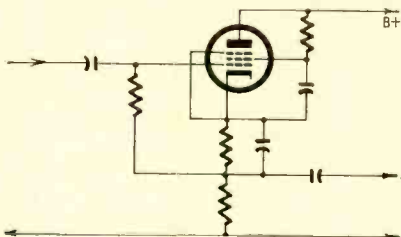

Fig. 5—Cathode follower using pentode.

to whom the cathode follower has seemed to be a valiant knight slaying all the electronic bugs, take a fighting stand. When triodes aren't "good enough" in other circuits we turn to better tubes, such as pentodes; pentodes have been used successfully as cathode followers, the circuit of Fig. 5 being typical. Doesn't this arrangement enable low distortion to be obtained into a low load value, since pentodes "like" working into low impedances better than triodes?

It's not as easy as that. Continuing with the example figures used: With a triode, reduction of the plate load from 30,000 to 600 ohms—a ratio of 50:1—only reduced the gain from 20 to 1.2 because of the triode's relatively low plate resistance. But because of the very high plate resistance of a pentode, the corresponding reduction would be almost in the same ratio as the change in plate load resistance. Even if the pentode had a high gain to start with, loading it down with 600 ohms would reduce the gain as with the triode, so again the effect of feedback in cleaning up waveform would be negligible. In the end, the pentode does no better under these conditions than the same tube used as a triode.

Now don't start throwing out cathode followers everywhere. Let's get things really straight by recounting what they can do: It is true that they reduce output source impedance. Their limitation is that this feature must not be imposed upon by assuming that we can go ahead and use a load impedance much lower than the regular load impedance for the tube used. If we try that, we run into trouble.

Another good use for cathode followers is to obtain a very high input impedance. This they also do very well, provided the plate load (connected in the cathode) is kept high enough to preserve the normal gain of the tube.

Now let's look around to see how all this affects the circuits commonly used. Probably the most frequent everyday application of the cathode follower is in the output of preamplifiers to provide a low source impedance suitable for line-impedance connection between the preamplifier and the main amplifier. But before throwing that poorly operating preamplifier out, check what the main amplifier input impedance does to it. If it has a line-to-grid transformer, the cathode follower is undoubtedly being loaded down too much, and distortion occurs. If the main amplifier is arranged for input direct to grid, the cathode follower will be quite happy, and its low impedance will give the advantage of line impedance coupling between amplifiers, i.e. freedom from loss of "highs" and from "static" pickup.

Summarizing the foregoing further, the right answer works out this way: if the main amplifier uses transformer input, either for phase splitting or to save gain or both, then the preamplifier output should be properly matched down through a transformer, whether plate or cathode coupled. On the other hand, if the input end of the amplifier is all resistance-loaded, with nice high-value resistors, the cathode follower direct is O.K. in the preamplifier output.

So take another look at those circuits: you may rid yourself of an unsuspected source of distortion. END

PHILCO'S NEW EASILY INSTALLED ADAPTER

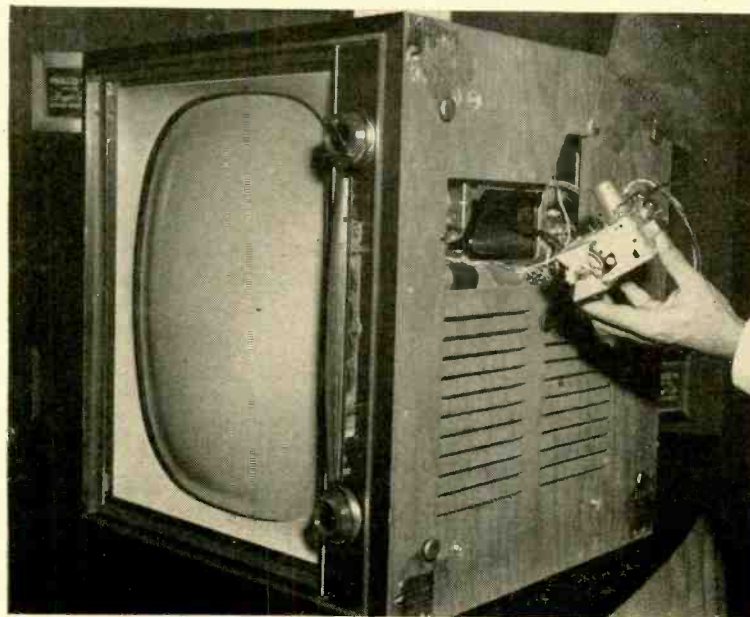

U.h.f. Tuner-Adapter has been announced by Philco (see photo). The unit consists of a u.h.f. tuner, adapter cables and plugs, a planetary tuner driving assembly and mounting hardware. A feature of the adapter is that it can be installed without removing the chassis or cabinet back.

NOVEL HIGH- VOLTAGE SUPPLY

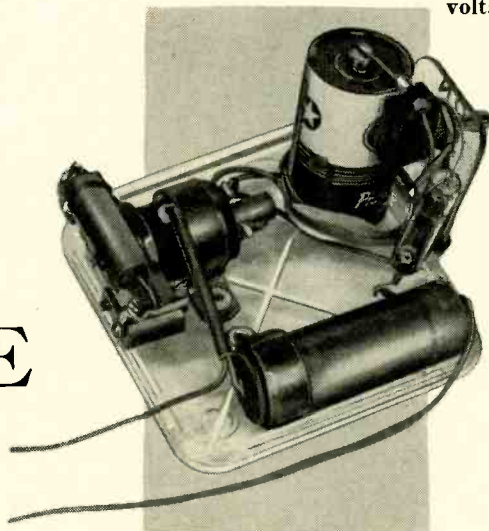

By HAROLD PALLATZ*

THE design and construction of high-voltage, low-current power supplies for portable photoflash units, G-M counters, breakdown and insulation testers, meggers, and similar devices poses a number of problems to the engineer and constructor. The usual solution is to use high-voltage B batteries, r.f. power supplies, hand-cranked generators, or vibrator-type supplies operated from a storage battery. In each of these cases, the supply is bulky, heavy, and inefficient.

This newly developed vibrator converter is designed to be used as the basic component of compact, lightweight, and efficient high-voltage, low-current power supplies. Basically, the unit consists of an efficient step-up transformer with a built-in vibrator. Current flowing in the transformer primary provides the magnetism to operate the vibrator. The secondary output is a series of high-voltage pulses which may be rectified and filtered to provide a constant d.c. voltage. The output can be varied between 500 and 6,000 volts by connecting suitable shunt resistors across the load.

Input voltage is 1.5 to 6 volts d.c. or 60-cycle a.c. at about 300 ma. Standard size-D flashlight cells operate the converter nicely. Cells designed for photoflash service are recommended because of their reserve capacity.

For reliable vibrator operation spring brass is used on the vibrating reeds to provide low-resistance paths. A double leaf-spring arrangement is used to make the contacts self-cleaning. A silver-tungsten alloy is used for the contacts. This produces low-resistance contacts with high resistance to welding and tarnishing.

The circuit and constants

A typical experimental supply delivering up to 6,000 volts d.c. is shown in the photo and in Fig. 1. The rectifier

*Precise Measurements Co., Brooklyn, N.Y.

is a subminiature 5642. Other recommended types are the 1X2-A, 1B3-GT, 1654 and 2X2-A. The latter should be used when power rather than physical dimensions is the determining factor. High-voltage selenium rectifiers may be used when filament connections become complex as in voltage doublers and bridge circuits. Selenium rectifiers for this service should have an inverse rating of at least 10 kv. The CK5517 cold-cathode gas-filled rectifier tube is usable but requires careful circuit design for reliable results.

For most applications, a .005- μ f 6,000-volt filter capacitor will do. Electronic photoflash units require much larger capacitors. Suggested values are 2 to 40 μ f with voltage ratings up to 4 kv. Charging time depends on the size of the capacitor, the final voltage, the primary voltage and current, and the type of rectifier. An 8- μ f capacitor can be charged to 1,000 volts in about 15 seconds using a 2X2-A rectifier and 2.5 volts a.c. on the primary. Charging time with d.c. input is about the same if the battery resistance is low. Fig. 2 shows how the output of the supply in Fig. 1 varies with load resistance and current.

Vibrator hash can be reduced by connecting a buffer capacitor directly across the high-voltage (a.c.) output of the vibrator-converter transformer. The capacitor value depends on the circuit used. About .005 μ f is a good starting point. A buffer that is too large reduces the output voltage.

Voltage-regulator circuits

Various circuits have been used with the supply to stabilize its output voltage. Fig. 3-a shows the circuit for 500 volts output. The regulator consists of a fairly heavy filter capacitor and nine series-connected NE-2 neon lamps shunted across the output. No-load stability is better than 2%. When using a 2X2-A rectifier and 2.5 volts, 60-cycle

The novel high-voltage supply in Fig. 1.

a.c. input, output regulation was better than 4% with a load ranging from 0 to 250 μ a. We haven't tried the neon-lamp regulator above 500 volts but we feel that it will work up to several thousand volts if enough lamps are used in series. Intermediate voltages can be tapped off.

Fig. 3-b is the circuit that we use for high voltages. A capacitor and a CK5517 rectifier are paralleled across the output of the supply. At 2,300 volts output, the regulation is 6% with current drains up to 40 μ a. Note that the tube must be connected with its cathode going to the positive side of the supply and its plate to the negative. If the tube is reversed it operates as a relaxation oscillator and the voltage drops to a low value.

The vibrator unit was one specially developed for the application (Precise Measurements model 5-MVT). Readers who wish to construct their own supply along the lines of the 5-MVT vibrator converter may also try a model aircraft ignition coil as the transformer, with parts from a doorbell or buzzer as the vibrator. Experimenting and careful adjustment may be necessary because it is unlikely that the vibrator will match the coil closely enough for high efficiency. It may also be necessary to raise the battery voltage to 4.5 or 6. END

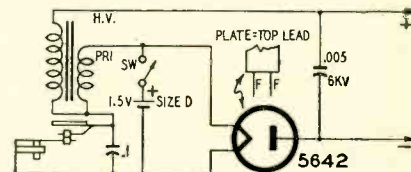

Fig. 1—Typical high-voltage supply.

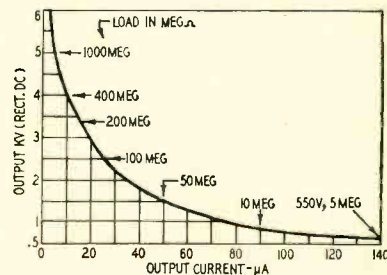

Fig. 2—Graph of output voltage and current with various resistive loads.

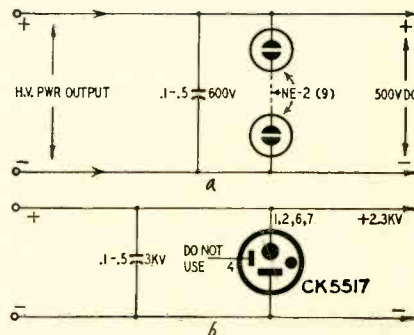
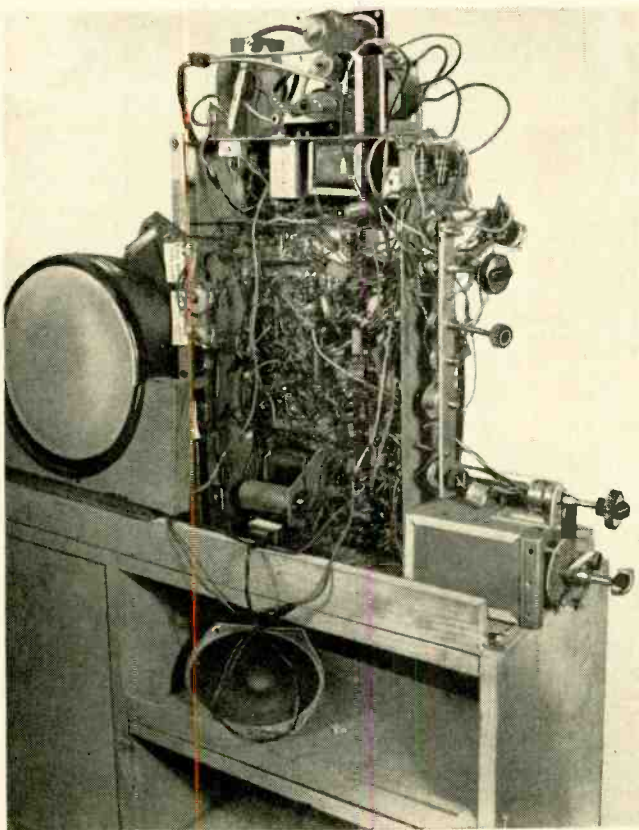

Fig. 3-a—A neon voltage regulator.

Fig. 3-b—Regulator for high voltage.

DYNAMIC TV CHECKER

By H. A. HIGHSTONE



Substitution chassis supplies signals and voltages for checking television receivers.

WHILE self-educating myself in TV, I accumulated a rather large collection of "dogs"—receivers bought for training purposes only. As time passed and it became more and more evident that these 10-inch sets would never be worth repairing, I salvaged what I could, and threw the rest away—except a certain RCA which I converted into about as handy a gadget as a TV student could own. It later became a valuable piece of service equipment.

In the course of time this old RCA 10-incher has been pretty well bread-boarded (see photo). It's mounted on a low (24-inch) table. The chassis is stood up on end and bolted through into the table top. The C-R tube is mounted in a wooden rack alongside. All vital parts not easily accessible have been brought out and draped around the chassis edges in various panels, sets of tie-points, etc. Together with a few patch cords made up from 300-ohm line, some of them broken with decoupling capacitors, the old chassis has become the dandiest little dynamic substitution box a man could want.

With a piece of gear like this it's easy to quickly and accurately double-check the occasional picture tube which is apparently kaput, but where some shadow of doubt still exists. Just roll the box up to the back of the customer's set, plug the C-R tube socket of the former into the C-R tube base of the latter, or vice versa if the situation calls for it. It takes practice. If you are worried about blowing anything up—which is possible, especially where a.c.-d.c. sets are involved, insert 1/8-amp 3AG instrument fuses in the patch cords.

To cite another use, a sure method of checking a suspected video amplifier is by cutting it loose from its detector load resistor and patching in the know-to-be-good video amplifier in your dynamic box. Or vice versa if your angle of attack calls for it.

Need 10 kv to supply another set you're checking, or to flash out a short in a C-R tube? Fire up the substitution box. Running down a toughie in the horizontal oscillator circuit? Just drive the suspected output stage with the 15,750-cycle sawtooth from your substitution box and narrow things down in a hurry. Or vice versa, again. You take it from here.

A chassis like mine is an absolute necessity when the TV student getting his experience at home arrives at the "scope stage." A scope is a fearful piece of machinery for a student working all by his lonesome; it's only human to dodge the issue as long as possible. That's exactly what I did, until I ran into a really rough case of sync separator trouble—and no amount of *static* checking did me the slightest good. It was a job for a scope and nothing else. However when I finally got mine into working condition, I couldn't tell whether those patterns were right, wrong, upside-down, or hind-side-to. Sure, I'd done some practicing with that scope, observing patterns of sets in good working order, but there are quite a few patterns, and I don't have a photographic memory. That's when I "invented" my dynamic substitution box.

It gave me a *standard of comparison*. The instant I got lost in checking a defective set with the scope, or the instant I wasn't sure whether this pat-

tern or that one was good or bad, I could pretty well get an answer by checking a similar part or stage in my box. It's lot like having a TV shark at your elbow all the time, to straighten things out when required.

Similarly, for the student sweating it out all alone, a chassis like this provides the easy way to get a working knowledge of sweep and signal generators in general. Learning this angle is a rough business; merely setting things up properly is a headachy assignment for the solitary novice. The lessons must be rigged so that he learns to walk before he tries to run—and a bread-boarded TV set is just what he needs. You work out on simple things first: an i.f. stage screwed out of alignment and restored; ditto for an adjacent-channel trap, then sound pickup, sound trap, and so on. Try to take notes on symptoms; it might save you hours later on in beating some job in the "stinker" category.

The usefulness of this kind of dynamic substitution box extends in a great many directions for both student and service technician. The moment a meter is suspected of having gone haywire, or whenever the scope seems to be acting abnormally, if what I get through a probe doesn't seem to make sense, I can settle all suspicions within 60 seconds. If for instance, my grid-dip oscillator persists in acting half-witted when I try it out on the box, the answer is obvious. Equally obvious is the answer when a crystal probe behaves normally in the box but plays dead when applied to the customer's set.

Then there are the instances when resort to the substitution box quickly shows I'm the one who's acting half-witted. I recall in particular when—after a particularly long day—the substitution box informed me the reason there was no plate voltage where I *knew* there was plate voltage lay in the fact that the range switch on the v.t.v.m. was in the wrong position! And had been there for about fifteen minutes!

As a final, parting shot of sage advice, I will tell you what I do in a case like this. I forthwith close up shop, go home, and spend the rest of the evening watching the rasslers and the Westerns. If anyone has a better prescription I will be pleased to hear from him. **END**

TRANSISTORIZED VOLTMETER

Operating from a single cell, instrument has an input resistance of a v.t.v.m.

By RUFUS P. TURNER

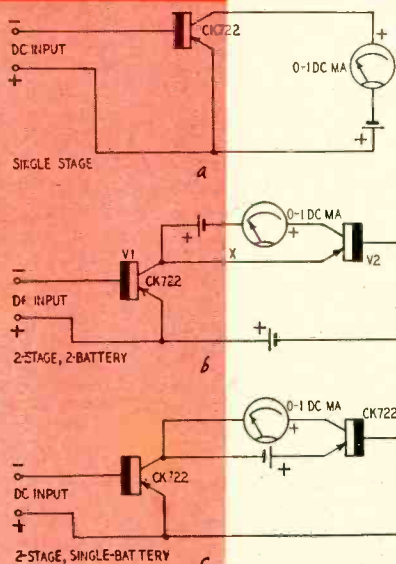

Fig. 1—Evolution of the microammeter.

HIGH values of current amplification are obtained in the grounded-emitter junction transistor circuit by using the base as the input electrode. A small change in base current produces a rather large change in collector current.

Such base-to-collector current amplification is designated by the Greek β (beta), and in commercial transistors has a value many times higher than the familiar emitter-to-collector amplification α (alpha). β is equal approximately to $\alpha/(1-\alpha)$. From this relationship, we see how a junction transistor having an alpha of only 0.909 can give current amplification of 10 in the grounded-emitter circuit. It is clear also that junction transistors with the highest alphas, approaching 1, also show the highest betas.

High-beta performance permits operating the grounded-emitter circuit as a d.c. amplifier with low power drain. The amplifier has a current gain of 10 when alpha is 0.909 and can have a gain of approximately 100 when alpha is very slightly greater than 0.99. Taking advantage of this gain, a d.c. milliammeter in the collector circuit will respond to microamperes applied to the base-input circuit.

Fig. 1-a shows such a simple amplifier type microammeter. Input current of 100 microamperes will deflect the 0-1 d.c. milliammeter to full scale. For simplicity, zero-setting circuits for bucking the static collector current out of the meter have been omitted from each circuit in Fig. 1. In Fig. 1-b, a second common-emitter amplifier stage has been added in cascade for 10-microampere operation of the meter. Note that transistor V2 has been "turned over" so that current flows through its base in the correct direction to increase collector current. The collector current of transistor V1 flows directly through the base-emitter input circuit of V2, so no load resistors are required and inter-stage impedance-matching problems disappear. Inasmuch as current from both batteries flows in the same direction through lead X, a single battery may

be inserted in this lead to supply both transistor stages. This has been done in the final circuit shown in the Fig. 1-c diagram.

It is entirely possible to use low-priced junction transistors, such as the CK722, in this d.c. amplifier circuit. However, for a total current gain of 100, the transistors would have to be selected for a minimum alpha of 0.909 each. There is gain to spare when using a combination of one CK722 and one higher-alpha unit, such as the CK721, in cascade. This combination requires no special picking of transistors.

An interesting and useful application of the transistorized microammeter is as the basis of an electronic d.c. voltmeter—the transistor equivalent of the v.t.v.m.—by adding suitable multiplier resistors to the input of the d.c. amplifier circuit. Since the two junction transistors require only about 2 ma from a 1.5-volt cell for complete circuit operation, the result is a completely portable electronic voltmeter having operating economy not obtainable with conventional battery-operated v.t.v.m.'s.

A 0-10 d.c. microammeter has been shown before as the basis of a d.c. voltmeter having 100,000 ohms-per-volt sensitivity.¹ A 10-microampere d.c. meter is expensive, however, and not obtainable except on special order. The transistorized d.c. amplifier permits use of the more rugged, inexpensive, and readily obtainable 0-1 d.c. milliammeter.

To readers who compare a sensitivity of 100,000 ohms per volt unfavorably with the input resistance of the conventional v.t.v.m., we would like to point out that the 100-volt range has an input resistance equal to that of many v.t.v.m.'s, and on all higher ranges the transistor voltmeter has a higher input resistance than the v.t.v.m.!

Instrument circuit

The complete circuit of the transistorized electronic voltmeter is shown in

¹"New Volt-Ohm Microammeter" RADIO-ELECTRONICS, Sept., 1953, page 80.

Fig. 2. To the simple two-stage transistor microammeter circuit of Fig. 1-c have been added the input multiplier resistors (R1 to R6) and the zero-setting meter circuit (R7 to R10). The zero-setting circuit is of the four-arm-bridge type common in v.t.v.m.'s.

Resistors R1 to R6 must be selected to the exact specified values. The 50-megohm value required for the 500-volt range is obtained by series-connecting one 10- and two 20-megohm resistors. For highest accuracy on the 1-volt range, the input resistance of the CK722 (approximately 2,000 ohms) should be subtracted from the normal 100,000-ohm value of R1, making it 98,000 ohms. If this is not done, the 1-volt range will read 2% low. To check the input resistance of the first transistor in the complete circuit, feed in an input current of 10 microamperes and measure the voltage drop between base and emitter. Determine the resistance by dividing the voltage by .00001.

On all but the last range, the 0-1 scale of the milliammeter can be used by merely adding zeros mentally where necessary. The author found the 1-, 10-, 100- and 500-volt ranges suitable for his purposes. Other ranges may be included if those shown are undesirable. The table shows multiplier resistor values for common voltage ranges other than those shown in Fig. 2.

ADDITIONAL VOLTAGE RANGES	
Range (volts)	Multiplier Resistance (megohms)
2.5	0.25
3	0.3
5	0.5
7.5	0.75
15	1.5
25	2.5
50	5.0
250	25
300	30
750	75
1,000	100

One pole of the range selector switch disconnects the battery. For protection of the instrument, the OFF position is placed after the highest voltage range.

Phone jack J1 is provided for the "high" d.c. input lead which in this circuit is connected to the negative pole of the voltage source under test. A

conventional shielded input lead and probe are advantageous when working around strong fields. The "low" (positive) lead is connected to pin jack J2.

The CALIBRATION control R8 permits the instrument to be standardized initially and provides for its periodic recalibration. This control has a slotted shaft for screwdriver adjustment and is mounted inside the instrument case for protection from disturbance.

Adjusting the ZERO ADJUST rheostat R7 allows the meter to be set to zero against the effects of steady collector current through both transistors. Static collector current in the CK722 is amplified and increases the static collector current of the CK721.

Construction

Being a straight d.c. instrument, the problems of stray coupling and frequency dependence are absent. The model shown in the photos is built in an aluminum utility box 6 inches high, 4 inches wide, and 5 inches deep.

The two transistors and components R8, R9, and R10 are mounted on a 1 3/4 x 4 1/4-inch bakelite board attached to an inner wall of the case with long 6-32 screws. Transistor and resistor leads are pulled through small holes in the board and connections are made underneath.

Resistors R1 to R6 are soldered directly to the range switch. The flashlight cell is held to an inner wall by a curved bracket which does not appear in the photo.

Leads from the meter, battery, zero-set rheostat and battery section of the range switch are cabled together and run to the component board, underneath which connections are made.

The instrument can be built much smaller than shown here. Smaller meter, components, battery and case are entirely feasible.

Initial adjustment

After the wiring has been inspected, make the initial adjustment in the following manner: 1. Set the range switch to the 10-volt position, and set R8 about halfway between its minimum and maximum rotations. 2. Zero the meter by adjusting R7. 3. Apply an accurately known 10-volt d.c. potential to the input terminals. 4. Adjust R8 for exact full-scale deflection of the meter. 5. Remove the voltage. If the meter does not read

exactly zero, reset by adjusting R7. 6. Reapply the voltage and readjust R8, if necessary, for full-scale reading. 7. Repeat steps 4, 5 and 6 until the meter reads full scale when the voltage is applied and falls back to zero when the voltage is removed.

Even when substituting transistors, the author found the circuit response surprisingly close to true linearity. This had made it possible to obtain good accuracy with the regular meter scale. Such operation was not anticipated, since we expected alpha and beta would vary greatly with input current. However, where highest possible accuracy must be insured, the builder should calibrate as many scale points as possible during the initial adjustment. Suggested points would be 1-volt apart from 1 to 10 volts. They should be checked after completing the full-scale adjustment. If the calibration then did not follow the milliammeter scale, a special meter card might be drawn or a calibration chart prepared.

Performance

The transistorized electronic voltmeter will give a good account of itself as a completely portable instrument having high input impedance and excellent economy of operation.

It can be used in place of the v.t.v.m., which it usually will supplement, especially in tests involving voltages which can be read on the 100-volt and higher ranges. The input resistance on these ranges equals or betters that of the tube type d.c. instrument.

Parts for electronic voltmeter

2-500 ohms, 1-100,000 ohms (see text), 1-1 megohm, 2-10 megohms, 2-20 megohms, 1/2 watt, resistors; 1-2,000 ohms, 1-10,000 ohms, potentiometers, wirewound or Ohmite AB composition; 1-0-1 d.c. milliammeter; 1-phone jack; 1-pin jack; 1-1.5-volt flashlight cell; 1-2-pole 5-position single-gang rotary selector switch; 1-CK721; 1-CK722; 1-cabinet; 1-mounting board.

All operating power is furnished by a 1.5-volt cell. Total current drain, at full deflection of the milliammeter, is approximately 2 ma. A jumbo-size flashlight cell will give long life even when the instrument is accidentally left running. A penlight cell will give somewhat shorter service, while a mercury cell will very nearly give its shelf life of several years continuous operation. Operation is instantaneous, without warmup periods, as a result of battery and transistor operation.

With good transistors, zero-setting drift is negligible except during wide changes of temperature—the static collector current increases rather severely with temperature. However, the author finds that resetting zero compensates for this drift. The instrument was kept in continuous operation for 5 hours at a controlled temperature of 30° C with no zero drift.

Other operational features, such as current, resistance, and a.c. voltage ranges, may be added in the conventional manner, borrowing from v.t.v.m. techniques.

END

Fig. 2—The transistorized voltmeter. Instrument has high input resistance.

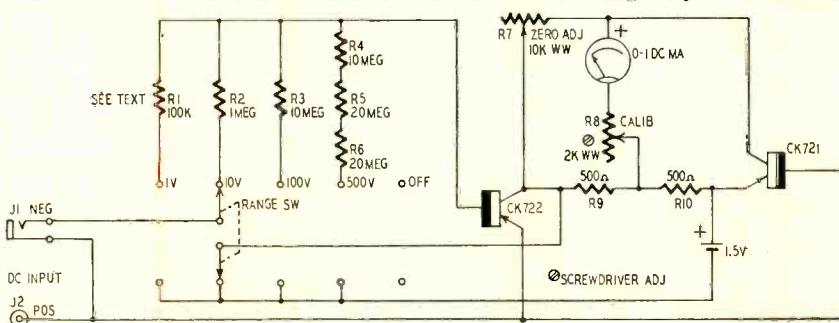

DUAL-FEATURE CAPACITOR TESTER

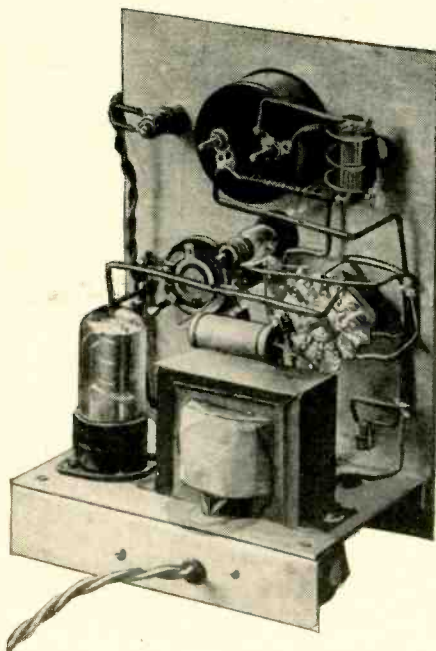

Front and rear views of the capacitor tester and electrolytic film former.

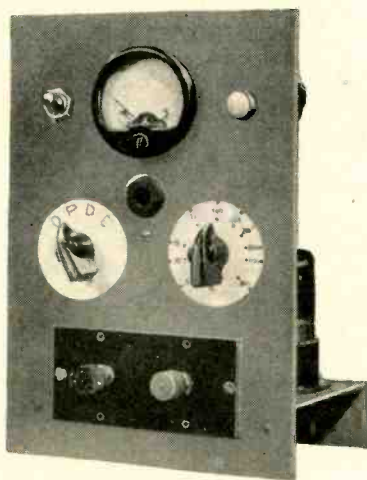

This leakage tester also forms your electrolytics

By DANIEL NOF

HAVING a continuously variable power supply, this tester permits application of the proper d.c. voltages for forming electrolytic capacitors—the leakage current being read on a meter—and testing paper and mica capacitors for opens, shorts, leakage by neon tube indication.

The power supply consists of a grid-controlled rectifier using a 6V6 (6L6, 6F6, 42) with 500–600 volts a.c. on the

The potentiometer controlling the grid bias on the tube is calibrated in d.c. output volts with a high-resistance voltmeter at the output filter capacitor.

Forming electrolytics

It is good practice to form electrolytics before connecting them into a circuit. I use the tester for forming them directly in sets that have been brought in for repairs and have been idle for any length of time. This is done before plugging in the set after preliminary tests for shorts. (The current indicated on the meter might not, in this case, be the true leakage current, depending on the presence of bleeders or voltage dividers.)

This practice has undoubtedly preserved or lengthened the life of rectifiers, especially directly heated ones, by not exposing them to heavy initial surge currents.

For proper forming, gradually increase the d.c. voltage across the electrolytic up to the specified working voltage. For best results the leakage (forming) current should not exceed 10–20 ma during any period in the forming process.

The meter indicating the leakage current has two ranges, 0–10 and 0–100 ma. Always use the 100-ma range first. After the leakage current has dropped to a value lower than 10 ma, switch the meter to the lower range for a more accurate reading.

A maximum value of 0.25 to 0.5 ma per microfarad can be considered normal for a good, fully formed electrolytic capacitor.

Should the forming current increase instead of decrease at a forming voltage much less than the working voltage,

the film is breaking down and cannot be properly formed. Such electrolytics may—after a new forming attempt at a lower voltage—still be used in low-voltage circuits and should be plainly marked as such. It will generally be found that due to the thinner film formed at a lower voltage, the capacitance has increased.

Since a very low leakage current during the forming process might be due to a dried-out electrolytic that has lost most of its capacitance, the formed electrolytic should be measured for capacitance or its action observed in an actual circuit before grading it as good.

Due to rather poor power-supply regulation the tester has an interesting semiautomatic feature, which makes it unnecessary to increase the voltage manually during the forming process.

The initial heavy leakage current causes most of the voltage to be dropped in the tube and filter resistor. The voltage increases automatically—due to voltage division action—to the preset value as the leakage resistance increases while the electrolytic is being formed. The forming d.c. voltage can thus usually be preset to the full value.

As the supply will not deliver more than about 20 ma—or may be adjusted by using higher values for the filter (protecting) resistor—no damage will be caused to the supply or to the electrolytic to be formed.

The following procedure should be used for forming electrolytics:

1. Set FUNCTION switch to DISCHARGE position.
2. Set the forming voltage on the VOLTAGE SELECTOR to the desired value (relying on the semiautomatic feature

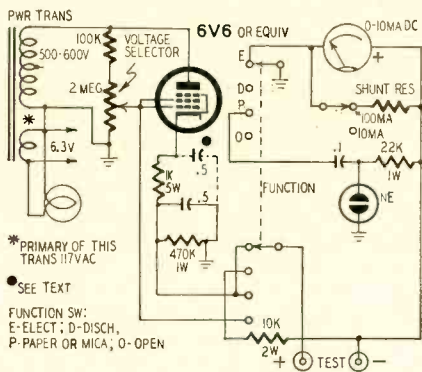

The dual-feature capacitor tester. Capacitor in dotted lines is optional.

plate, supplied by a standard power transformer (center tap not used).

A 1,000-ohm resistor and 0.5- μ f paper capacitor provide ample filtering. The resistor also serves as a protective device if the grid bias is removed or the test terminals shorted. An additional 0.5- μ f input filter capacitor will boost the output d.c. voltage by approximately 50, if necessary.

The high-resistance bleeder is included as a protection against shock. A lower value of bleeder resistance might be used if it does seriously reduce the d.c. output voltage.

A.F. R.F. TRACER PROBE

Much value in little space

By JOHN A. IRWIN

of the supply) or start with a low voltage and gradually increase manually.

3. Make sure meter is in the 0-100-ma position.

4. Connect electrolytic to TEST terminals, observing polarity.

5. Turn power on.

6. After leakage current has dropped below 10 ma, switch meter to the 0-10-ma range for more accurate reading.

7. Increase forming voltage if necessary, always watching meter. Should current begin to increase after application of higher voltage, the film is breaking down and the electrolytic cannot be properly formed to normal working voltage. Try to re-form with lower voltage and use in low-voltage circuit.

8. After forming is complete (leakage current steady at 0.25 to 0.5 ma per microfarad as maximum), discharge electrolytic through resistor by switching to DISCHARGE.

Do not switch power off before disconnecting or discharging the electrolytic, as the discharge current through the bleeder deflects meter backward and may damage it.

Capacitor tests

Leakage in paper and mica capacitors is a constant source of trouble in coupling and high-resistance decoupling circuits. It is important to determine the permissible amount of leakage before connecting a capacitor into a circuit.

The capacitor to be tested is connected by turning the FUNCTION switch to the paper-mica position. This activates the neon-tube relaxation oscillator circuit and puts the leakage resistance of the capacitor under test in place of the series resistor.

Flashes in the neon tube indicate the leakage resistance, the approximate value being found by connecting—for comparison—resistors of 30-200 megohms into the test terminals. A continuous glow indicates a shorted capacitor; rapid flashes, heavy leakage.

Glow on both electrodes of the neon tube indicates that the capacitor is not open. With no glow on the electrodes or with a very weak glow even with comparatively high voltage, the capacitor is open.

Parts for capacitor tester

1—100,000 ohms, 1/2 watt, resistor; 1—22,000 ohms, 1—470,000 ohms, 1 watt, resistors; 1—10,000 ohms, 2 watts, resistor; 1—1,000 ohms, 5 watts, resistor; 1—shunt resistor (for 100-ma meter range); 1—2-megohm potentiometer (with on-off switch); 1—0.1 μ f, paper, capacitor; 1—.5 μ f, 600 volts, capacitor; 1—meter, 0-10 ma d.c.; 1—neon lamp; 1—6V6 (or similar) tube; 1—s.p.d.t. switch; 1—2-pole 4-position rotary switch; 1—pilot light lamp and assembly; 1—power transformer, 500-600 volts @ 40 ma, 6.3 volts @ 2 amps; 1—tube socket; 2—test terminals; 1—chassis and front panel; 1—power cord.

Increase the a.c. voltage enough, approximately 120-150 volts, to ignite the neon tube, but not exceeding the working voltage of the capacitor.

No constructional details are given—the instrument is simple and layout and values are not critical. The only point to observe is to keep the test terminals as far apart as possible, as the tester is very sensitive to leakage. END

HERE is a useful and compact signal tracer that can be constructed for less than \$5. It may be carried in your pocket or in a small toolbox. Its construction is shown in Figs. 1 and 2.

This unit works on either a.f. or r.f. When in use on a.f., the reactance of the r.f. choke is negligible, so R1 becomes the load. With r.f. applied, the choke becomes the load, with R1 being bypassed, as shown in the schematic. A 1N66 germanium diode is used as a detector.

A plastic cigarette case houses the unit. Assemble all the components, except the test probes, outside of the case, using just their own leads for support. Then bring the probe and ground leads through the top cover of the case, and solder them in place. Now slide the assembled unit into the case, and bring the jack out through the hole at the bottom. You can make these holes with ease using the heated tip of a large nail. Have the openings on the top cover large enough to allow sliding the cover off along the wires for possible repairs.

To use, connect the ground clip to the ground side of the receiver, or the chassis on a.c.-d.c. sets. Plug in a pair

of high-impedance phones or feed the probe's output into an audio amplifier. With the receiver tuned to a local station, start at the antenna and pick up the r.f. signal. Then move on to the r.f. amplifier tube (if any) or the i.f. converter. Touch the grid lug and then the plate lug. Do this to each tube in the following order: the i.f. amplifier, second detector, a.f. amplifier, and the power amplifier (output tube). Never apply the probe to the rectifier tube!

Wherever the signal is not heard, you will know that the trouble is in that particular section of the receiver. If the signal is traced from the antenna to the output tube without losing it, check the speaker transformer for a defective winding.

The probe will not show the exact nature of the trouble, but will narrow it down for easier servicing. Then you can use your meter in that particular section for locating the defective component.

The components used in the tracer probe are not critical in value, but they should approximate those shown in the schematic. Since the probe will be applied to the plates of tubes the .05- μ f blocking capacitor should have a voltage rating of about 600. This is especially true when the probe is used to trace the horizontal and vertical sweep voltages in a television receiver. In some sets the boost voltage is used as the plate supply of some vertical and horizontal circuits, and it often exceeds 500 volts. END

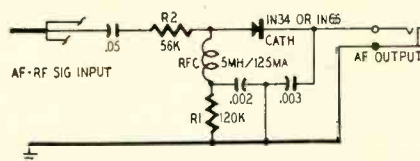

Fig. 1—Schematic of the compact a.f. - r.f. tracer probe.

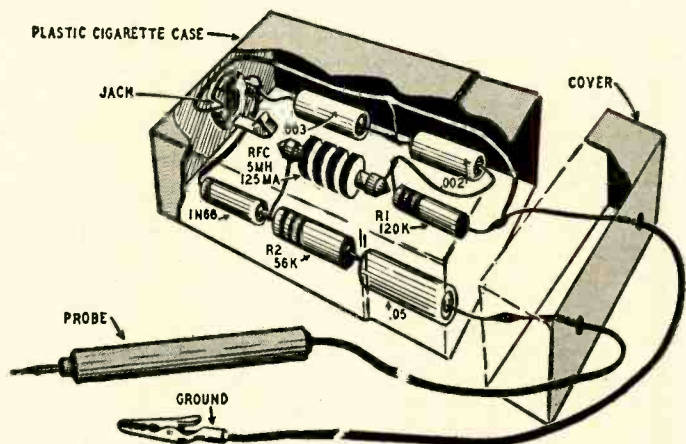
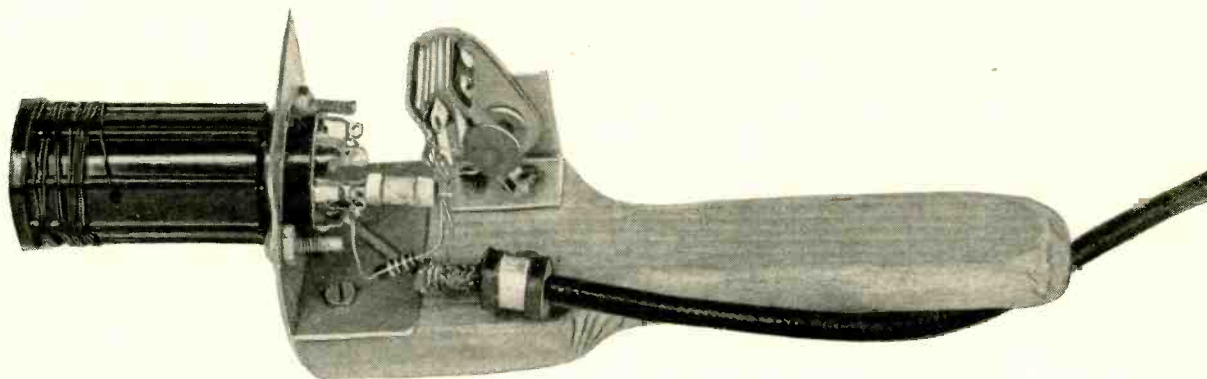

Fig. 2—Physical layout of components.

*Simple junkbox
instrument makes
fine resonance indicator*

GRID-DIP ADAPTER WITHOUT TUBES

By ROBERT H. MITCHELL



Adapter shape makes for easy handling.

HAVE wanted a grid-dip oscillator for several years. Like a lot of other hams, I didn't feel like spending the cash to buy one or expending the effort necessary to build one. Besides, I had a friend who had a grid-dipper that he was willing to part with for a few hours occasionally. Unfortunately one Sunday morning I had to measure the resonant frequency of an inductance-loaded vertical antenna, and neither the friend nor his grid-dipper

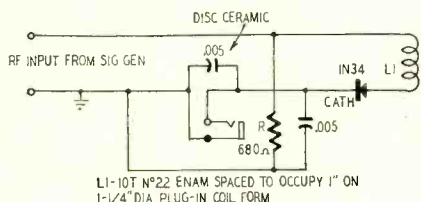

Schematic of the grid-dip adapter.

was available. Then and there I decided to build my own.

Perusing magazines of the past several years, trying to determine just which instrument could be built most easily from the junkbox, I came across an article on a tubeless grid-dip adapter which had been designed and sold by a company which had since gone out of business (McMurdo Silver). This interesting gadget, when inserted between a signal generator and a tuned circuit, indicated the resonant frequency of the circuit by the drop in output when the signal generator was tuned to that frequency. It looked simple and efficient, and I had a signal generator and enough parts in the junkbox for the adapter.

Having no spare 0-1 milliammeter, I used the 0-1-ma range of my multi-

meter as a resonance indicator. The original instrument had two separate components, a coupling head and an indicator. I combined everything but the meter into the coupling head. The resulting circuit is shown in the diagram. A piece of 1 x 2 x 7-inch wood formed a handle and a mounting platform for the components, as shown in the photo. The coil socket was mounted on a piece of 2 x 3-inch aluminum which was bent into an L 2 x 2 inches, with a 1-inch upright. The jack was mounted on a smaller aluminum L. A 4-foot length of RG-59/U coaxial cable was used to connect the adapter to the signal generator. The coil consists of 10 turns of No. 22 enameled wire spaced to cover 1 inch on a 1 1/4-inch diameter plug-in coil form. This permits operation in the range from approximately 5 to 40 mc. Total construction time was less than two hours, and most of that was spent in carving out the handle.

I plugged the multimeter leads into the jack, hooked the RG-59/U to the signal generator and started measuring resonant frequencies. Results were extremely disappointing. The meter indicated a moderate amount of output on the lower frequency ranges of the signal generator, but scarcely moved off the zero position when it was set above the broadcast band. This resulted in a frantic check of the wiring, substitution of a new 1N34 and several coil rewindings. I found the optimum value of R, for maximum meter reading, lay between 600 and 1,000 ohms. That appeared to be the only change that could be made to improve the performance of the gadget. After considerable thought, the obvious became

apparent. The signal generator simply lacked enough output on the higher ranges to drive the adapter.

My signal generator was constructed from an Eico kit, output being taken through a capacitor and isolating resistor. When a jumper was placed across the isolating resistor, the output increased enough to drive the grid-dip adapter on all ranges, and I was in business. Shorting the isolating resistor resulted in some "pulling" of the signal generator when approaching resonance with a tuned circuit. However, the signal generator frequency is checked with a receiver and this is not a serious problem.

The adapter has several uses other than as a resonance indicator. One of the most interesting is checking receiver oscillator frequencies. To do this, plug headphones into the jack, couple the coil loosely to the receiver oscillator and tune the signal generator until a squeal is heard in the phones. This has helped me in the alignment of several receivers in which the oscillators were considerably off frequency.

The ham doesn't need a commercial signal generator to drive this adapter. The station v.f.o. is an excellent signal generator.

After using the circuit for a while, it became apparent that a similar circuit could be used as a tubeless grid-dip adapter with a vacuum-tube voltmeter and a diode probe. All the components in the circuit other than the coil can be omitted. Connect the diode probe across the coil and resonance will be indicated by the drop in signal generator output at resonance. I have tried this circuit and found it effective. END

TRANSISTOR OVERTONE GENERATOR

*Point-contact unit makes
excellent high-frequency
generator*

By I. QUEEN

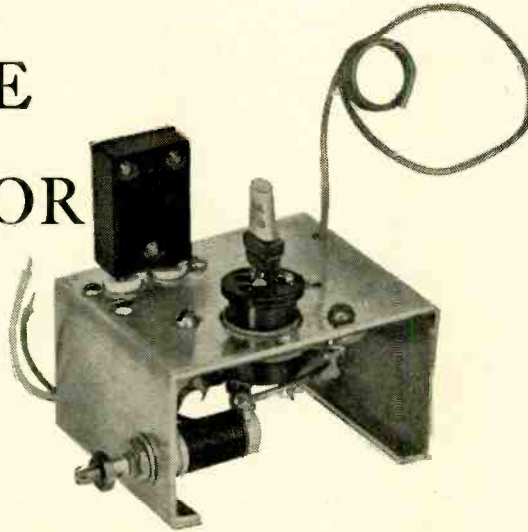

Note special mounting of the transistor.

THE April, 1954, issue of RADIO-ELECTRONICS carried an article on a subharmonic generator which used a CK722 junction transistor to produce low-frequency signals from high-frequency crystals. For instance, a 400-kc crystal acted just like a 100-kc crystal—signals could be heard at 100, 200 and 300 kc, etc. By properly retuning the circuit the 400-kc crystal can be made to behave like a crystal ground for 80 kc, 133 kc, or any other desired subharmonic. Here is a new circuit that does just the opposite: it generates high frequencies from relatively low crystal frequencies. A point-contact transistor of the 2N33 type is used.

The circuit of the new overtone generator is shown. Coil L is tuned to the desired overtone (or multiple) of the crystal frequency. It is *not* tuned to the fundamental frequency. For high-frequency operation near 16 mc, L can be wound on a small slug-tuned ceramic coil form. The instrument shown here uses a CTC coil form, type LS5, 3/8 inch in diameter. It was wound with 23 turns of No. 22 enameled wire. The winding length is about 5/8 inch.

A 3575-kc crystal generated an overtone of about 18 mc. A 3552-kc crystal was heard near 17.9 mc. Both of these are fifth overtones, that is, frequencies five times that of the fundamental. A 4900-kc crystal was heard near 15 mc, the third overtone. These are all ordinary crystals, not special units treated for overtone circuits. All crystals (with third or fifth overtones near 15 mc) that were tried worked perfectly. In each case the slug may be tuned for maximum output and most stable signal. Tuning is *not* at all critical.

Note the difference between a harmonic and an overtone. In the overtone circuit, the 3575-kc crystal actually oscillates at 18 mc. There are no inter-

mediate signals near 3.5, 7 and 10.5 mc, etc. This is a big advantage for the overtone circuit. There are no intermediate harmonics that may confuse identification. Furthermore, there is no progressive weakening from one harmonic to the next. For example, the 18-mc output mentioned above sounds like a fundamental should—very stable and strong. In an ordinary harmonic generator, because this signal would be the fifth harmonic, it would be considerably weakened and perhaps

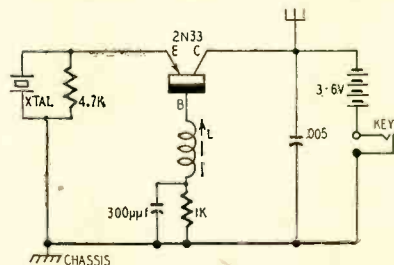

Diagram of overtone generator circuit.

not as stable as a fundamental. Of course, harmonics of the 18-mc signal exist at 36, 54 mc, and so on, well into the u.h.f. and v.h.f. regions. Therefore even 80-meter crystals can generate clear signals, well separated in frequency, deep into the high-frequency spectrum. (Overtone generators do not have even multiples of the fundamental frequency. Only *odd* multiples exist. Also, overtones may not be *exact* integral multiples. They may not be *exactly* three or five or seven times the original frequency, but they are always nearly so.)

Next, a 1-mc crystal was tried in the overtone generator. Tank coil L was a jumble-wound broadcast oscillator coil commonly used for replacement purposes. Its center tap was not used. A strange thing happened when the battery was turned on. The overtone was heard at 2.5 mc! This, of course, is

not the expected odd multiple of 1 mc. On the possibility that the crystal was oscillating at 500 kc, the receiver was tuned to that frequency but nothing could be picked up. The crystal was, in fact, actually oscillating at 2.5 mc and this was the lowest frequency emitted from the transistor circuit. Strong harmonics were present, of course, at 5, 7.5, 10 mc, and so on. This greatly increases the usefulness of a crystal otherwise limited to integral multiples of 1 mc.

The generator is easily assembled and put to work. Components were not critical. The photo shows a special plug and socket used in connection with the 2N33. This was done because the transistor was frequently plugged in and removed during experimental work on the circuit. The pins of a transistor cannot stand too much handling since they are only very thin wires.

The signal generator has a jack in the B plus return for a key or modulation input. This safeguards the transistor by shutting off power when it is not needed. When properly tuned, the circuit could be keyed rapidly. Therefore the overtones are suitable as a signal source for communications purposes.

The power supply may be anything from 3 to 7.5 volts. On most crystals tried, good results were obtained with the lower voltage. The battery drain is approximately 3 ma.

With some crystals, the instrument may seem slow starting and may require touching the base terminal with a finger. This indicates that L is not correctly tuned. Adjust the core while monitoring the signal on a receiver. As you tune the core the output will become louder, but if you go too far the signal will disappear. Back off the slug adjustment slightly from this point for maximum output and optimum stability.

The short piece of wire shown extending from the generator is an antenna. With it, the signal can be heard a short distance from the radio receiver.

Parts for overtone generator

1—1,000 ohms, 1—4,700 ohms, resistors, 1/2 watt;
1—300 puf, mica capacitor; 1—.005 uf, disc ceramic;
1—2N33 point-contact transistor; 1—coil (see text);
1—socket for transistor; 1—3-pin socket and plug;
1—battery, 3 to 6 volts; 1—headphone jack; 1—crystal socket; 1—chassis; 1—length of wire.

There are many applications for this overtone generator. The signals may be used for calibrating and aligning high-frequency receivers and experimental apparatus. Ordinary ham-band and other relatively low-frequency crystals become the source of signals deep into the v.h.f. and u.h.f. regions. The well-spaced frequencies are much easier to identify than if we attempted to use harmonics of low-frequency crystals. The high-frequency signals can serve as markers for TV and high-frequency receivers or to define the upper ham bands. They can even be used for high-frequency communications over short hauls.

END

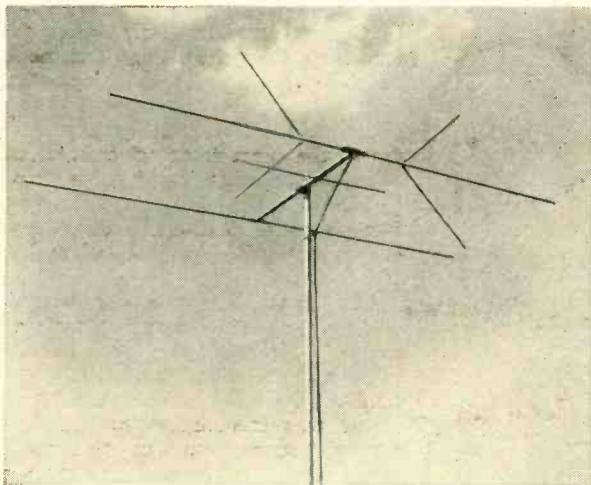

Fig. 1—All-channel v.h.f. TV antenna.

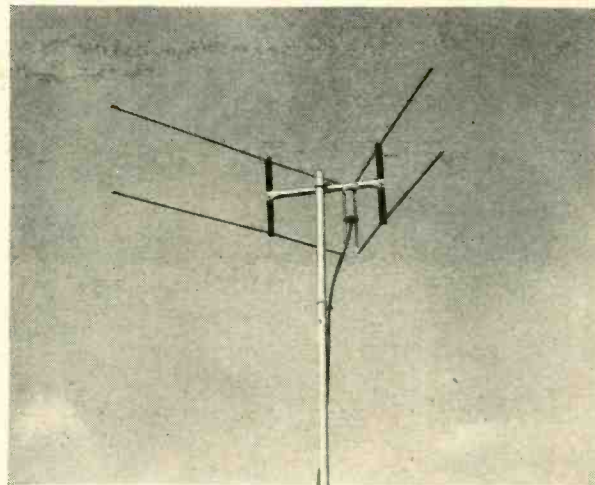
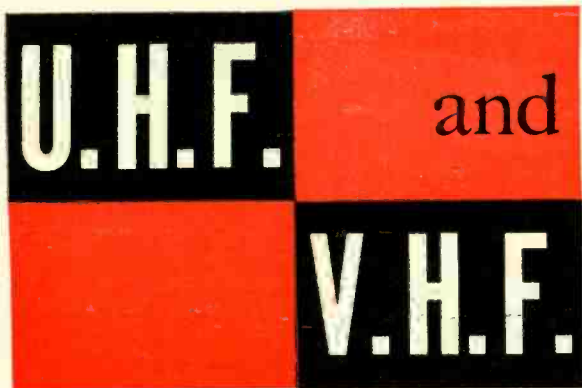

Fig. 2—Stacked V's for u.h.f. channels.



New antennas often evolve from standard types. This all-channel unit is derived from stacked u.h.f. V's and a u.h.f. dipole and reflector

ANTENNA

By R. F. KOLAR*

In recent months, many u.h.f. television stations have gone on the air and an increasing number of areas are being served by both u.h.f. and v.h.f. stations. Separate antennas for each frequency band involve considerable expense which can be reduced by the use of a single low-cost all-channel v.h.f.-u.h.f. television receiving antenna. Such an antenna should give gain and directivity patterns approximately the same as presently acceptable antennas.

A dipole must be about a half wavelength long to operate efficiently, so it should be about 8 feet long for good operation. On channel 2 and other low-channel v.h.f. stations, however, an antenna of such length will develop multilobed field patterns with little radiation at right angles to the dipole on channels 7 to 13. To maintain desirable directivity characteristics on channels 7 to 13, the current distribution along the dipole must be altered. One method of doing this is to add wings to a simple dipole radiator as in Fig. 1. A dipole with properly designed wings displays a horizontal field pattern which is substantially a figure-8 on channels 2 to 13.¹

A u.h.f. antenna providing good gain and directivity is the stacked V's in Fig. 2. Since the dipole and reflector and the stacked V's are adequate in most areas for good signal reception on v.h.f. and u.h.f. respectively, their combination provides desirable performance characteristics over all TV channels. The two antennas are usually combined and connected to a common lead-in by using a crossover network consisting of handpass filters. However, such networks are relatively expensive and necessarily introduce about 1 db loss. Furthermore, when two such antennas are placed near each other, the mutual coupling results in a degradation of the performance of each, particularly the one for v.h.f. Therefore, an array which has gain within one or two db of the individual antennas and eliminates the need for a crossover network would be a valuable addition to currently available antenna types. This article describes a new type of antenna which incorporates the features of the v.h.f. dipole and reflector and the stacked V u.h.f. type in a unique manner.

The impedance between any two points symmetrically placed about the center of a resonant antenna will depend on the distance between them. The greater the separation between the feed points, the higher the impedance. By

using this principle, together with a transmission line of continuously increasing spacing, it is possible to match a resonant dipole to a high-impedance transmission line. Such a system, shown in Fig. 3, is known as a delta-matched antenna.

Design consideration

If the wings on the v.h.f. dipole are modified and the horizontal sections of the wings are extended and connected

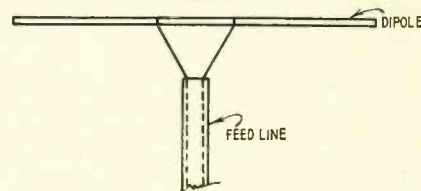

Fig. 3—A delta-matched dipole antenna.

together as shown in Fig. 4, the configuration of the all-channel antenna is complete. The antenna may be considered to be made up of two vertically stacked u.h.f. long-wire V antennas, with a v.h.f. dipole located between the two V's. The two systems are connected electrically as shown.

In the design of the array, primary consideration was given to the u.h.f. section—that is, the stacked V's. Fig. 5 shows that the gain of the V antenna

*RCA Victor, Camden, N. J.
¹O. M. Woodward, "Reversible-Beam Antenna for Twelve-Channel Television Reception." *R.C.A. Review*, Vol. 10, June, 1949, page 224.

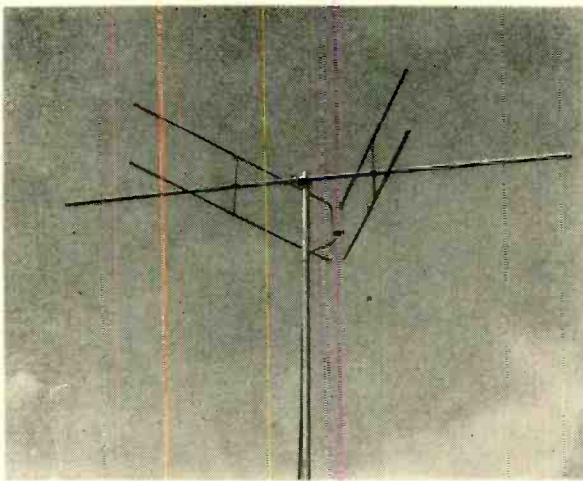

Fig. 4—All-channel v.h.f.-u.h.f. array.

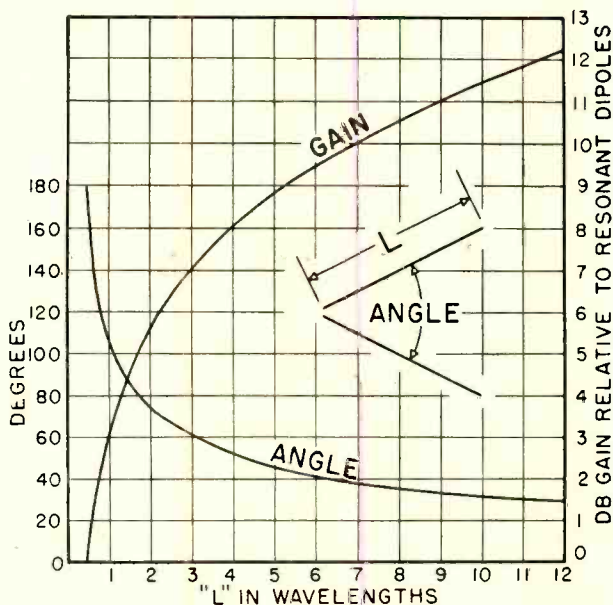

Fig. 5—The gain of a V antenna varies with leg length and the included angle.

increases rapidly with length until the elements are about 3 wavelengths long, thereafter the rate of increase becomes less. At 450 megacycles, 3 wavelengths is approximately 78 inches. This length would be a good choice for high gain and minimum material requirements. However, 55 inches is about the largest practical length which can be supported with sufficient rigidity to prevent wind modulation.

Having established the length of the V elements at 55 inches, which is 4.2 wavelengths at 900 megacycles, Fig. 5 shows that the included angle should be 50 degrees to maintain maximum gain in the forward direction at 900 megacycles. Polar pattern measurements indicate that when a 50-degree angle is selected for 55-inch rod lengths, the field pattern is essentially unidirectional throughout the u.h.f. television spectrum.

With this length and included angle the vertical separation must be between 9 and 13 inches. Less than 9 inches substantially reduces the u.h.f. gain, whereas anything greater than 13 inches causes the vertical polar pattern at 900 megacycles to become too sharp. Twelve inches was selected as a good compromise between high gain and acceptable beam width.

Fig. 6 shows the all-channel v.h.f.-u.h.f. antenna developed by combining stacked u.h.f. V's and a v.h.f. dipole and reflector. Performance on the v.h.f. channels depends on the distance between the dipole and the open ends of the V, measured along the V. The performance of the new array with an 8-foot v.h.f. dipole is shown in Fig. 7. The optimum location for the dipole is 26 inches from the ends of the V. If it is greater than 27 inches from the ends of the V, the horizontal pattern on channel 6 breaks into multiple lobes and the gain decreases. Also if it is located nearer than 24 inches the gain is lowered.

Similar measurements were taken for dipole lengths other than 8 feet. If the dipole is made appreciably longer than 8 feet, the horizontal polar pattern on

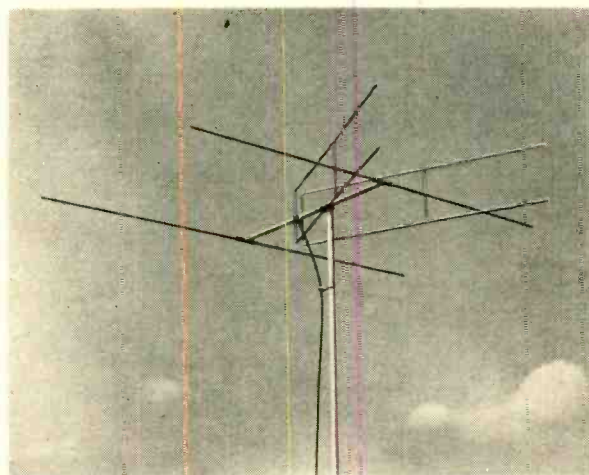

Fig. 6—Delta Vee all-channel antenna. Reflector increases low-channel gain.

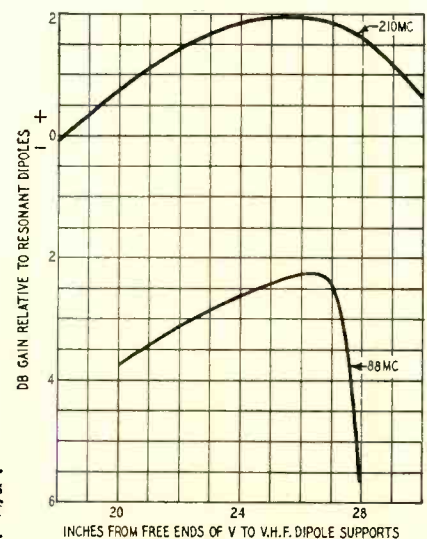

Fig. 7—The v.h.f. power gain varies with position of the dipole radiator.

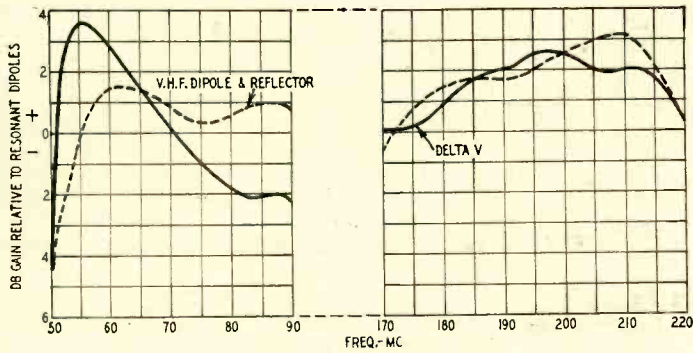

Fig. 8—Power gain of Delta Vee compared to v.h.f. dipole and reflector.

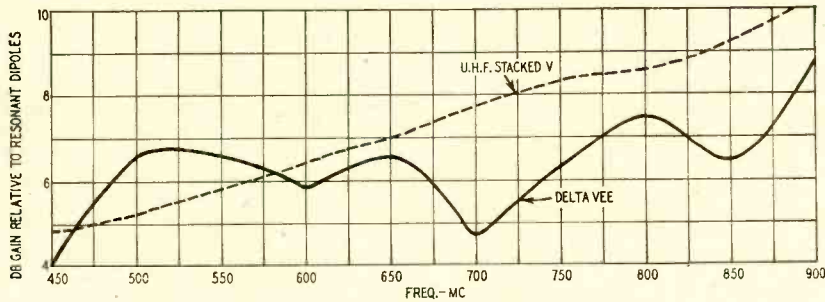

Fig. 9—Delta Vee performance at u.h.f.

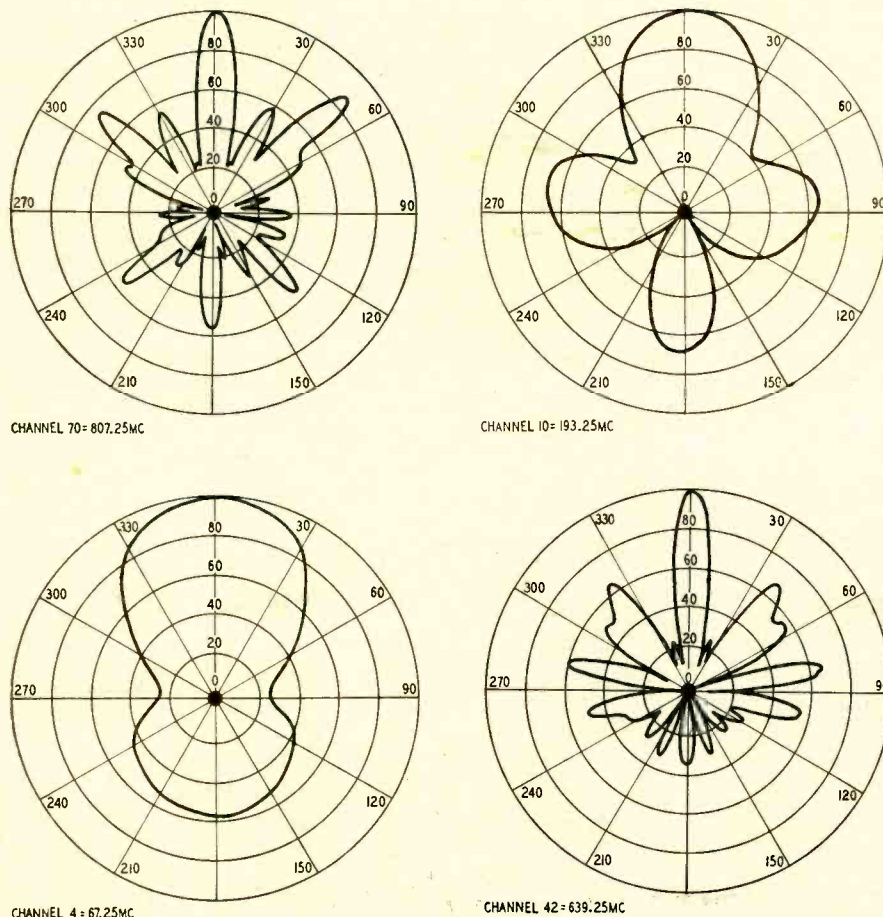

Fig. 10—Horizontal response patterns of the Delta Vee on various channels.

channel 13 breaks up regardless of its position between the V's. If it is shorter than 8 feet, the gain on channels 2 to 6 will be reduced.

The dipole diameter is not critical, but if it is to be used as a support for the array it should be large enough to provide ample strength for mounting. A diameter of $\frac{3}{8}$ inch is adequate for the mounting shown in Fig. 6. The dipole supporting elements must be less than $\frac{1}{2}$ inch in diameter in order to provide sufficient inductance to prevent their presence from impairing the u.h.f. performance of the antenna.

A 106-inch reflector, 46 inches behind the dipole element in Fig. 6, substantially increases the low-frequency gain of the array. Improvement on certain channels may be realized by slightly veeing the v.h.f. dipole element. More than one dipole element can be used, one above and one below the u.h.f. stacked V, with or without one between the V's. However, such improvements at one frequency are invariably accompanied by serious degradation of the gain at other frequencies in the television bands.

Operation and performance

From 54 to 88 megacycles the array operates as a dipole with a delta-matched feed, using the rear portion of the two stacked long-wire V antennas for the delta section. From 174 to 216 megacycles the rear portion of the V again acts as a delta feed, while the forward extensions of the V's produce a current distribution to provide a maximum of gain in the forward direction. On the u.h.f. channels, from 470 to 890 megacycles, the antenna acts as two stacked long-wire V antennas. Since the antenna is a combination of a delta-fed dipole and a u.h.f. V antenna, it is called the *Delta Vee*.

The characteristics of the antenna are given in Figs. 8, 9, and 10. The v.h.f. power gain, shown by Fig. 8, is within 3 db of that of the v.h.f. dipole and reflector of Fig. 1. On channel 2, the gain of the new antenna is substantially greater than that of the dipole and reflector, whereas on channels 5 and 6 the dipole and reflector is 3 db better than the *Delta Vee*. The gain on channels 5 and 6 is no worse than would be expected from mounting the two antennas near each other and combining their outputs with a crossover network. The u.h.f. power gain, shown in Fig. 9, compares very favorably with that of the u.h.f. stacked-V antenna.

The horizontal patterns in Fig. 10, display desirable characteristics. The v.h.f. curves show considerable forward gain. Although there is an indication of some v.h.f. pickup on the u.h.f. elements, the undesired response is small. The u.h.f. patterns have a narrow forward lobe with multiple secondary lobes which are characteristic of long-wire antennas such as the stacked V. It would be necessary to increase the length of the V elements many times in order to reduce the amplitude of the secondary lobes. END

Fourteenth conversation, first half—
The d.c. component and image brightness

WILL—The other day, when we were talking about video frequency, you put in a lot of time on high-frequency problems. But don't you run into difficulties with the other end of the spectrum—the very low frequencies?

KEN—Maybe—but just how does all this come up?

WILL—Well, I began by wondering if—in certain cases—the video signal didn't come down to a simple direct current. For example, suppose the picture has a large horizontal band of one shade. But you can't transmit d.c. through the interstage-coupling capacitors . . .

KEN—You might have a real difficulty there if you didn't have sync pulses at the end of each line. They make a very sudden change in the voltage and prevent it from becoming the simple d.c. you're thinking about. But—as you say—a capacitor can't transmit an unvarying direct current. And that poses some problems—only they're not the ones you're thinking about!

WILL—Suppose you lay off the mystery and give me a line on some of those problems! Who knows—I might understand you!

KEN—O.K. Suppose we start by thinking of the way an alternating voltage is transmitted through a coupling capacitor C with its leak resistor R.

WILL—We did that a long time ago, and nothing could be simpler. Let's say that an alternating voltage is applied to the left-hand plate of the capacitor. During the positive alternation it draws electrons away from that plate. Because the atoms on the left-hand plate are short of electrons, they try to attract a few from the other plate. They can't get them across the dielectric, but a lot of electrons are dragged onto the right-hand plate. Where from? The only place they could come from is the ground, through resistor R. That current flow through R causes a voltage drop across it, and its top end becomes more positive than the bottom. So it's just as if the positive alternation had passed through the capacitor.

KEN—With this one important difference: If an alternating current is superimposed on a direct one (as in a plate circuit where you usually find your high alternating voltage), the d.c. won't be passed through the capacitor. But tell me, what goes on during the negative alternation?

WILL—Much the same thing. The electrons flow into the plate at the left, and of course chase others off the right-hand one, because there's nothing more repulsive to an electron than another electron. The displaced electrons have nowhere to go except to ground through R. That makes its top end negative. So again, it's just as if the negative voltage had gone through the capacitor.

KEN—You're right all the way. The way these electrons rock back and forth balancing themselves so neatly and symmetrically reminds me of children on a seesaw.

Symmetry and equilibrium

WILL—I knew all this a long time ago. Is there some special reason behind this refresher course?

KEN—There is. And the reason is that things are just a bit different for the video signal.

WILL—How come?

KEN—Because—unlike modulated r.f. or sound a.f.—the video-frequency signal is not symmetrical. It isn't made up of equal positive and negative alternations that are exactly like each other—like an object and its reflection in the mirror.

WILL—I see! Once it's detected, our video signal is either all positive or all negative. Only the extreme whites even approach zero. We haven't got that *axis of symmetry* you can always draw on an a.c. waveform.

KEN—Let's take a look at the way those signals are transmitted through the coupling circuits.

WILL—Do you want positive or negative polarity?

KEN—Let's take the commonest case—a set with one video stage and the control voltage to the picture-tube grid.

TELEVISION it's a cinch

By E. AISBERG

From the original "La Télévision . . . Mais c'est très simple!" Translated from the French by Fred Shunaman. All North American rights reserved. No extract may be printed without the permission of RADIO ELECTRONICS and the author.

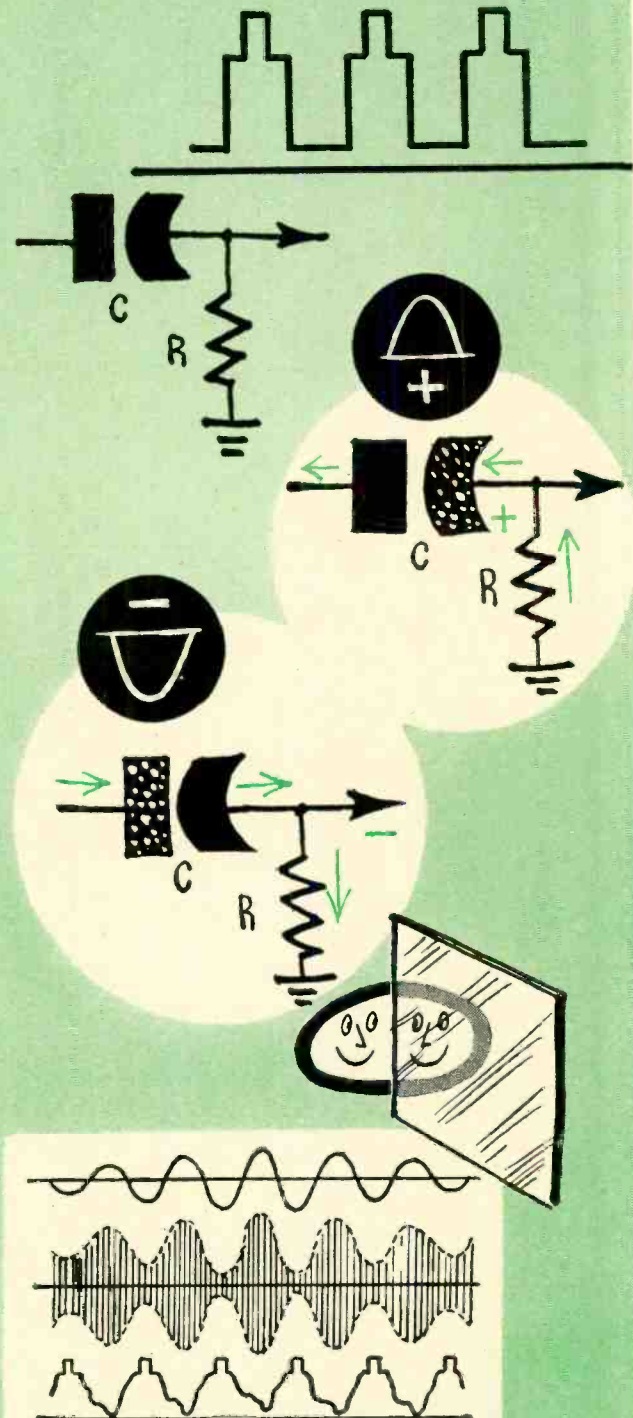

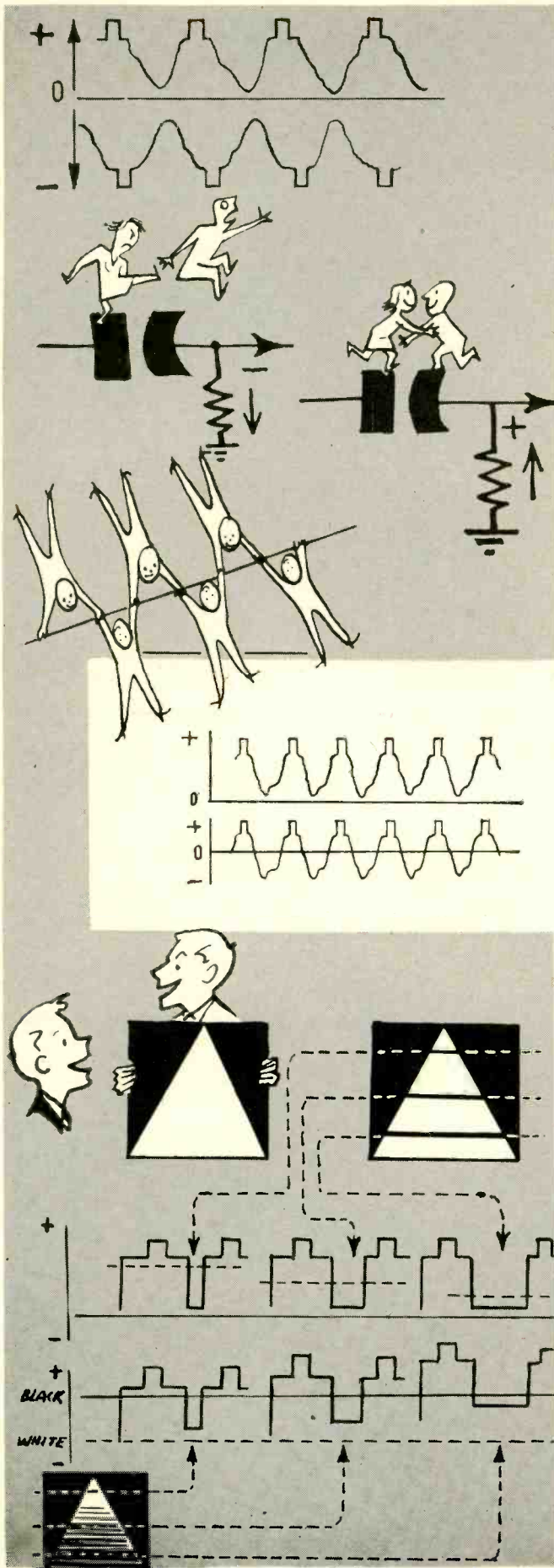

Then the detected signal would, of course, be . . .

WILL—. . . positive-going. Then we'd always have more or less of a shortage of electrons in the left plate of the capacitor, except during the odd periods when we have a "whiter than white" signal. So there'd be a greater or lesser number of electrons crowding into our right-hand capacitor plate.

KEN—That's it. As the positive voltage reaches a peak (during the sync pulses) the largest number of electrons are being dragged from ground through R and to the right-hand plate. So the top of the resistor becomes more positive.

WILL—I think I see what you're driving at. As the signal becomes less positive—for instance during a white patch on the image—some of the electrons in the right-hand plate leave it and try to get back to ground through R. That would make the top of R negative . . . ?

KEN—You see, the signal we get on the right-hand side of the capacitor is a voltage of the same form as the one that came from the detector. But it's no longer entirely positive (or entirely negative if the detection was in that direction). The voltage on the grid of the video amplifier, while not entirely symmetrical, is composed of alternations which are negative and positive as compared to the ground potential, and equitably disposed around it.

WILL—What do you mean "equitably"?

KEN—The number of electrons that leave the plate in a negative alternation is equal to the number that come back into it in a positive one. They're good accountants and always try to even up the receipts and expenses. I think you can realize—without going into integral calculus—that the quantities of electricity are proportional to surfaces inside these curves?

WILL—In other words, to find the point where the curve passes through the zero axis, you have only to cut through it in such a way that you have the same areas on each side?

KEN—At least that would be a way of seeing if the curve is well drawn. . . . You see, in sending your video signal through the coupling capacitor, you have made it alternating—have taken away its polarity. And above all, you have separated the sync pulses from the constant level as compared with zero volt.

More defects of capacitance

WILL—Is that bad?

KEN—It's not as catastrophic as was once thought, but it's not good! For instance, your sync pulses are going to vary in height according to the strength and modulation of the signal. That makes it harder to set the controls for correct synchronization. On top of that, the shade of the picture itself is likely to be altered.

WILL—I don't get that!

KEN—Let's try a simple example to show what the situation really is. Suppose the image is a white equilateral triangle on an even black background. Now try to trace the form of a detected video signal (with positive polarity) for three of the scanning lines: one at the top, the next near the middle, and the third at the base of the triangle.

WILL—Easy! We have the sync pulse at 100% of maximum amplitude, then a black line at about 70%, with the exception of a short point where the amplitude drops down close to zero. The black lines occupy only about half the middle scan, and the white one lengthens out accordingly. And it keeps on lengthening out, till it occupies practically all the bottom line.

KEN—Perfect. Now can you draw me—in dotted lines—the zero axis for each of these signals as it would be situated after passing through a coupling capacitor?

WILL—Nothing simpler. Here are your axes!

KEN—You see now that the sync pulses are all at different voltages. In fringe areas that would mess up synchronization. But that isn't all! If you were to apply signals exactly like these to a picture-tube grid and regulate the brilliancy so as to get a good white for the top line, it wouldn't stay the same for the other two. The middle one would be a decided gray and the bottom one even darker. So our triangle, instead of being a uniform white, would get darker and darker toward the base. TO BE CONTINUED

**It's New! 3 Years in Development
-NOW READY FOR YOU!**

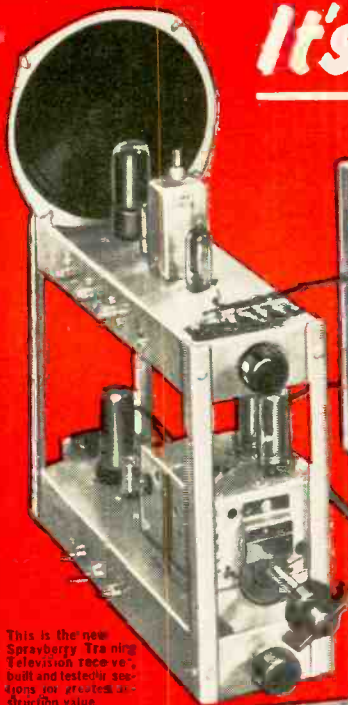

This is the new Sprayberry Training Television Receiver, built and tested in sections in greatest instruction value.

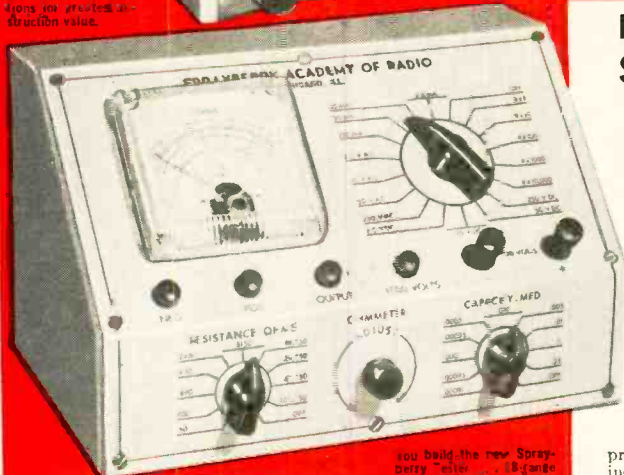
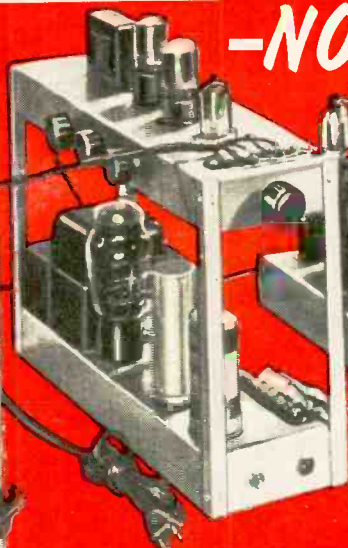

These photos show only a small part of the training equipment I send my students.

You build the new Sprayberry Tester, 18-gauge Volt-Chin. Milliammeter, readings plus output meter and condenser, inc. resistor substitution switch.

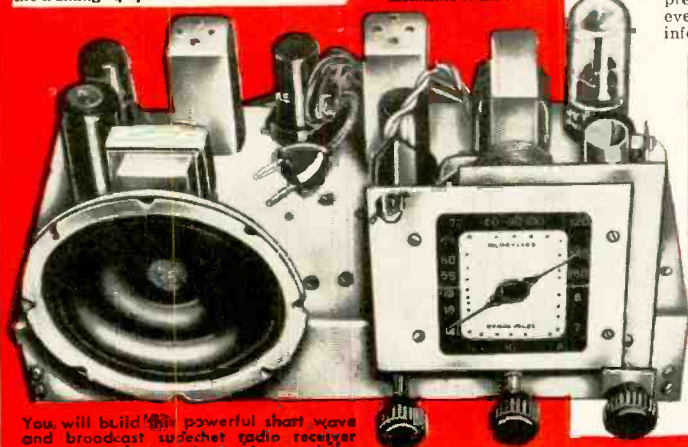

You will build a powerful short wave and broadcast superhet radio receiver for valuable shop instruction practice.

New Equipment! New Lessons! Enlarged Course!
SPRAYBERRY PRACTICAL TRAINING IN

RADIO-TELEVISION

3 NO OBLIGATION TRAINING PLANS



Frank L. Sprayberry
President, Sprayberry
Academy of Radio

**You have NO MONTHLY PAYMENT CONTRACT to sign
... pay for this outstanding training as you learn!**

The complete facts are so big and so important to any man seeking training in Radio-Television that I urge you to mail the coupon below at once for my big all-new 56 page FREE CATALOG and FREE Sample Lesson. Get the full story of this remarkable new and up-to-the-second Training Plan. You'll read about my 3 NO OBLIGATION PLANS or "packaged unit" instruction for both beginners and the experienced man. You'll learn how I can now prepare you in as little as 10 MONTHS to take your place in this fast moving big money industry as a Trained Radio-Television Technician. You'll see that you take no risk in enrolling for my Training because you **DO NOT SIGN A BINDING TIME PAYMENT CONTRACT**. I have been training successful Radio-TV technicians for 22 years. . . I can prepare you, too, to get into your own profitable Service Shop or a good paying job, even if you have no knowledge of Radio-Television. Mail the coupon . . . I rush full information FREE and without obligation. (No salesman will call.)

NEWEST DEVELOPMENTS

Your training covers
**U H F, Color
Television, F.M.,
Oscilloscope
Servicing, High
Fidelity Sound
and Transistors.**

PRACTICE AND TRAIN AT HOME WITH 25 NEW KITS OF EQUIPMENT

You get valuable practical experience in construction, testing and shop practice. You build a powerful 2 band superhet radio, the all-new 18 range Sprayberry multimeter, the new Sprayberry Training Television receiver, signal generator, signal tracer and many other projects. All equipment is yours to use and keep . . . and You have practically everything needed to set up a Radio-Television Service Shop.

All your training is **IN YOUR HOME** in spare hours. Keep on with your present job and income while learning. I help you earn extra spare time money while you learn. If you expect to be in the armed forces later, there is no better preparation than practical Sprayberry Radio-Television training. Rush coupon below for all the facts—**FREE!**

SPRAYBERRY ACADEMY OF RADIO
111 NORTH CANAL STREET, DEPT. 20-S, CHICAGO 6, ILLINOIS

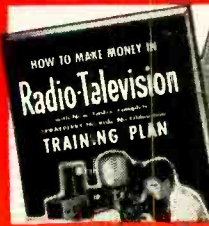

FREE CATALOG AND SAMPLE LESSON

Rush coupon for my catalog "How to Make Money in Radio-Television". PLUS an actual sample Sprayberry Lesson without obligation—**ALL FREE**. Mail coupon **NOW!**

SPRAYBERRY ACADEMY OF RADIO MAIL THIS COUPON FOR FREE
Dept. 20-S, 111 N. Canal St., Chicago 6, Ill. **FACTS AND SAMPLE LESSON**

Please rush all information on your **ALL-NEW** Radio-Television Training Plan. I understand this does not obligate me and that no salesman will call upon me. Include New Catalog and Sample Lesson **FREE**.

Name _____ Age _____

Address _____

City _____ Zone _____ State _____

Progress—the new RCA 21-inch color tube shown alongside old 15-inch tube.



COLOR TV CIRCUITS

Part VII—The 19-inch color tube and associated circuits

By KEN KLEIDON* and PHIL STEINBERG*

THE previous article of this series explained the operation and control adjustment procedure for the three-gun, 15 1/2-inch color picture tube. This article deals with the larger 19-inch three-gun tube and the associated purity, convergence and high-voltage circuitry.

The 19-inch tube is very similar to the 15 1/2-inch color tube in that it contains three electron guns along with a viewing screen composed of red, blue and green phosphor dots. The only major differences between the 15 1/2-inch and 19-inch color tubes are that the convergence electrode is absent in the larger tube and that the three electron guns are mechanically tilted during manufacture so that the beams will converge or come together at the cen-

ter of the tube. Tilting the three guns toward a common axis permits improved d.c. convergence control and makes convergence adjustment easier. Since the 19-inch color tube does not include a convergence electrode, external means are necessary to provide convergence so that each electron beam strikes only its own proper phosphor dot at the correct time. Three convergence coils are placed around the neck of the 19-inch color tube between the deflection yoke and purity coil. The coils, one for each electron gun, deflect the electron beams so that convergence is correct at all times.

Three convergence or beam-position-

ing magnets were required for the 15 1/2-inch tube. Due to the tilted electron guns in the 19-inch tube only one such magnet (blue, in this case) is required. This single magnet is located on the neck of the tube (Fig. 1). To get equal spacing of the three electron beams (to form a triangle) at the center of the phosphor screen, the d.c. through each of the three convergence coils is varied. The effect of the blue-positioning magnet is to move the blue dots at right angles to the direction in which the blue-convergence coil d.c. current would move them. This combined action aids in forming the triangles.

*Raytheon Manufacturing Company Television and Radio Operations.

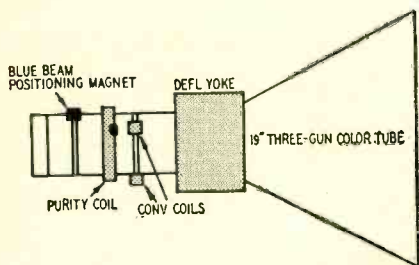

Fig. 1—Components on 19-inch tube.

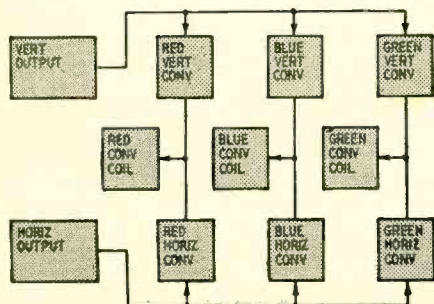

Fig. 2—Horizontal and vertical waveforms are applied to convergence coils.

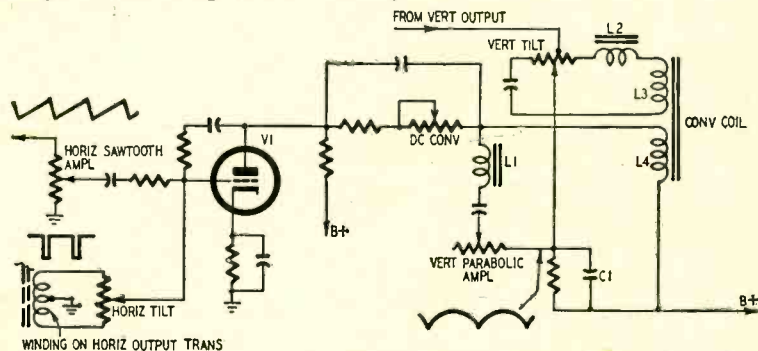

Fig. 3—Schematic diagram of a convergence channel for the 19-inch color tube.

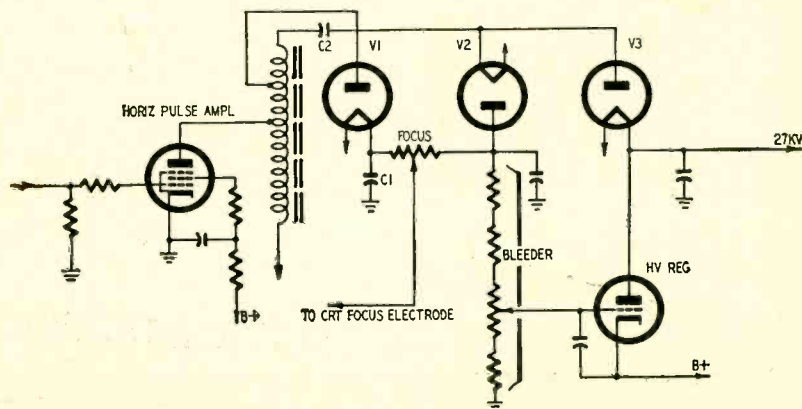

Fig. 4—The high-voltage doubler circuit for second-anode and focus voltages.

NEW 1955

Heathkit

Engineering Features

New PRINTED CIRCUITS

One of the many tremendous improvements in the new 1955 Heathkits is the use of an etched metal process printed circuit board. Printed circuits will be used in Heath kits whenever they will affect construction simplification, performance stabilization, and lend themselves to instrument design. Now for the first time a kit instrument company offers the advantages of modern printed circuit instrument construction technique. For the first time construction has been given toward reducing kit assembly time. Also this is the first time that printed circuit boards have been hand soldered on a volume basis. Offered only by Heathkit, the pioneer and leader in kit instrument design.

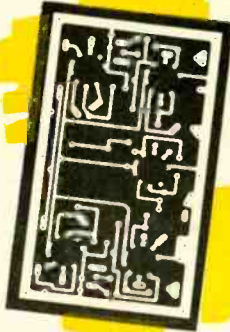

New PEAK-TO-PEAK VTVM CIRCUIT

New 6AL5 full wave rectifier in AC input circuit permits full scale peak-to-peak measurements. Seven ranges—upper limits 4000 volts peak-to-peak. Just the thing you TV servicemen have needed in making TV circuit voltage checks. Precision resistor voltage divider limits AC RMS level to 50 volts. Prevents overloading the rectifier—extends upper limit AC RMS ranges to 1500 volts—further protects meter and circuitry against AC flash-over or arcing. Another definite example of continuing Heathkit design leadership in the kit instrument field.

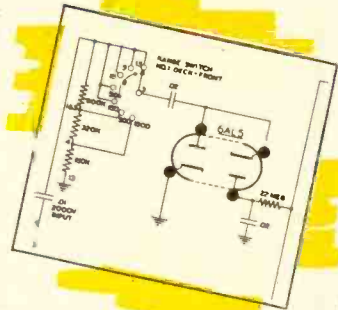

New HIGH READABILITY PANELS

New 1955 Heathkits feature complete panel redesign. Sharp white lettering applied to the beautiful charcoal gray panels, provide a new high in readability. Lettering is easy-to-read open style and panel calibrations are vividly clear against the pleasing soft gray background. New knobs of exclusive Heathkit design.



New 3" UTILITY SCOPE

The new 3" Scope is a "natural" for the well rounded line of Heathkit instruments. Small in size, 11 3/4" deep, 6 1/2" wide, 9 1/2" high, yet big in performance. Just think of the value. An Oscilloscope for \$29.50. Brilliant intensity, sharp focusing, wide positioning range. An ideal portable Scope for the TV serviceman—a second shop scope—modulation monitor for you hams (deflection plate terminals in rear of cabinet). Performance to spare for all general scope applications. See specifications on following page.



New STYLING New COLOR

New styling and coloring is responsible for tremendous improvement in Heathkit appearance. The new instrument panel color combination is high definition white lettering in a soft charcoal gray panel. Cabinet color is a lighter feather gray. The satin gold baked enamel cabinet for the WA-12 Pre-amplifier is further indicative of the modern progressing trend in Heathkit styling.



New SCOPE SWEEP CIRCUIT 10 CYCLES — 500 KC

New 1955 Heathkit Model 0-10 Scope features a new wide frequency range sweep generator covering 10 cycles to 500,000 cycles. This coverage is available in five virtually decade sweep ranges and is five times greater than the sweep frequency range usually available. Excellent retrace time characteristics, actually less than 20% at 500 KC. Use of the free running Heath circuit provides a larger margin of stability and a new high in Heathkit Scope performance.

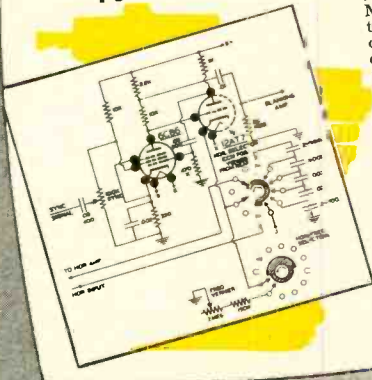

Continuing PROGRESS FUTURE LINE EXPANSION

The outstanding improvements featured in the 1955 Heathkit line are representative of the progress characteristic of the Heath Company operation. Long range planning will provide a continuing succession of new kit releases to further expand the Heathkit line which already represents the world's greatest selection of electronic kits. The innovations in the 1955 line, are representative of additional new models scheduled for release for the coming years.



SEE THE INSTRUMENTS
ON THE FOLLOWING PAGES

HEATH COMPANY • • Benton Harbor 20, Mich.

Heathkit ELECTRONIC SWITCH KIT

Tube complement:
2-6AR7, 2-6SN7,
1-6X5.

Continuously variable
switching rates in three
ranges from less than 10
CPS to over 2000 CPS.

The basic function of the Heathkit Electronic Switch Kit is to permit simultaneous oscilloscope observation of two separate traces which can be either separated or superimposed for individual study. This is accomplished through the use of two individually controlled inputs working through amplifier, multi-vibrator, and blocking stages. The output of the Electronic Switch is connected directly to the vertical input of the Oscilloscope. A typical example of usefulness would be simultaneous observation of a signal or waveform as it appears at both the input and output stages of an amplifier.

APPLICATIONS

An Electronic Switch has many applications to increase the over-all operating versatility of your oscilloscope. It can be used to check amplifier distortion—audio crossover networks—phase inverter circuits—to measure phase shift—special waveform study, etc. The instrument can also be conveniently used as a square wave generator over the range of switching frequencies, often providing the necessary wave form response information without incurring the expense of an additional instrument. Ownership of this instrument will reveal many entirely new fields of oscilloscope application and will quickly justify the modest cost of the Electronic Switch Kit.

Individual input
gain controls, po-
sition control,
coarse frequency
control, and fine
frequency control.

Transformer operated for
safety when used in con-
junction with other equip-
ment.



MODEL S-2

\$23.50

Shpg. Wt.
8 lbs.

Heathkit VOLTAGE CALIBRATOR KIT



MODEL VC-2

\$11.50

Shpg. Wt. 4 lbs.

Another useful oscilloscope accessory particularly in circuit development work and in TV and radio service work. The Voltage Calibrator provides a convenient method for making peak-to-peak voltage measurements with an oscilloscope, by establishing a relationship on a comparison basis between the amplitude of an unknown wave shape and a known output of the voltage calibrator. Peak-to-peak voltage values are read directly from a calibrated panel scale without recourse to involved calculations.

FEATURES:

To off-set line voltage supply irregularities, the instrument features a voltage regulator tube. A convenient "signal" position on the panel switch by-passes the calibrator completely and the signal is applied through the oscilloscope vertical input, thereby eliminating the necessity for constantly transferring test leads.

RANGES:

With the Heathkit Voltage Calibrator it is possible to measure all types of complex waveforms within a voltage range of .01 to 100 volts peak-to-peak. Build this instrument in a few hours and enjoy the added benefits offered only through combination use of test equipment.

Heathkit LOW CAPACITY PROBE KIT



No. 342

\$3.50

Shpg. Wt. 1 lb.

An oscilloscope accessory, the 342 Low Capacity Probe permits observation of complex TV waveforms without distortion. An adjustable trimmer provides proper matching to any conventional scope input circuit. Excellent for high frequency, high impedance, or broad bandwidth circuits. The attenuation ratio can be varied to meet individual requirements.

Heathkit SCOPE DEMODULATOR PROBE KIT



No. 337-C

\$3.50

Shpg. Wt. 1 lb.

Extend the usefulness of your oscilloscope by observing modulation envelopes of RF or IF carriers found in TV and radio receivers. The Heathkit Demodulator Probe will be helpful in alignment work, as a gain analyzer and a signal tracer. Easy construction with the new modern printed circuit board. Voltage limits are 30 volts RMS and 500 volts D.C.

HEATH company

BENTON HARBOR 20,

MICHIGAN

TELEVISION



CBS Colortron 205

The signal currents applied to the three convergence coils come from the vertical and horizontal output circuits and are parabolic in shape, similar to the signal applied to the convergence electrode of the 15½-inch tube. The vertical convergence parabolic signals are derived from the vertical output tube. The same vertical sawtooth waveform that is coupled to the deflection yoke is also coupled to the vertical convergence circuits that change the sawtooth waveform to a parabolic waveform at the vertical frequency. The parabolic signal is then separated into three different channels, the red, blue and green convergence coils mounted on the neck of the tube. Each of the three channels has three controls: one varies the amplitude of the parabolic signal, another changes the shape by tilting the parabola either one way or the other to secure better dynamic convergence, and the third is the d.c. convergence control.

The derivation of the horizontal and vertical convergence signals is similar. A special winding on the horizontal output transformer couples the horizontal flyback pulse to the horizontal convergence circuit. A separate channel is used for each convergence coil and two controls are provided in each channel to vary the tilt and amplitude of the parabolic waveforms. This is similar to the vertical convergence circuit. The horizontal and vertical parabolic waveforms from each channel are added together before being applied to the three separate convergence coils (Fig. 2).

Fig. 3 is one of the three identical convergence channels. The plate circuit of the vertical output tube is in series with C1. This capacitor changes the sawtooth output (same waveform that is transformer-coupled to the vertical winding of the deflection yoke) to a vertical-parabolic waveform as

NEW *Heathkit* 5" PUSH-PULL OSCILLOSCOPE KIT FOR COLOR TV

BRAND NEW DESIGN: The new Heathkit Model O-10 Oscilloscope would be something special at any price, but is almost unbelievable at \$69.50. Completely re-designed scope has broadband amplifiers for color TV work and offers brilliant overall performance. Vertical frequency response within 5 db from 5 cps to 5 mc. Even more astounding, the response is down less than 1 1/2 db at 3.58 mc. the color TV sync burst frequency. It is essential that scopes for color work have these broadband characteristics.

PRINTED CIRCUITS: Two printed circuit boards used in this fine instrument to insure stable, consistent performance. Problems solved by pre-engineering of boards, and their use guarantees completed unit that will have same characteristics as lab development model. Printed circuits simplify construction and save labor.

NEW SWEEP CIRCUIT: Sweep circuit operates with exceptionally good linearity from 20 cps to over 500,000 cps. 5 times the usual range for scopes in this price range. An entirely new circuit introduced for the first time in any Heathkit.

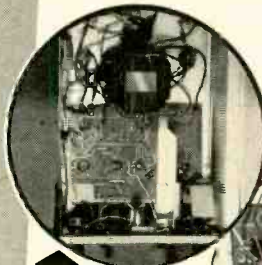

Simplified, standardized construction technique of vertical and horizontal amplifier construction made possible through the use of a single printed circuit board.

Clean, open, under chassis construction and wiring. Possible only through use of pre-cable wiring harness, and simplified printed circuit boards.

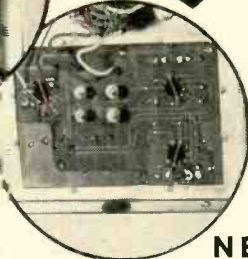

3GP1 CR TUBE

New compact utility Scope—light-weight—portable for service work.

Deflection plate terminals—ideal for ham transmitter modulation monitoring.

EXCEPTIONAL VALUE: The brand new Model OL-1 Utility Oscilloscope is designed especially for portable applications so that outside servicemen or persons performing field tests can have the advantages of a scope available. Then too, it is ideal for home workshop, the ham-shack, or as an "extra" scope for the service shop. It is compact, light in weight, and surprisingly versatile in operation. An outstanding instrument for the price.

Front panel controls are "bench-tested" for ease of operation and convenience. Printed circuit board used for constant circuit performance. Assembly time out in half!

SPECIFICATIONS: Vertical amplifiers feature frequency response within 1 db from 10 cps to 100 kc, and within 5 db from 5 cps to 500 kc. Vertical sensitivity .2 volts per inch at 1 kc, with input impedance of 12 mmfd shunting 10 megohms.

Horizontal response within 1 db from 10 cps to 200 kc, and within 5 db from 5 cps to 500 kc. Hor. sensitivity .25 volts per inch at 1 kc, input impedance of 15 mmfd shunting 10 megohms. Sweep generator covers 10 cps to 100,000 cps with stable positive lock-in circuit. Cathode follower input in both vert. and hor. amplifiers; push-pull vertical and horizontal deflection amplifiers; 3" CRT; electronic positioning controls for wide range of vertical and horizontal spot deflection; provision for internal and external sync; 60 cycle line sweep. New modern color styling and unusual performance make this instrument an outstanding value.

First color television service Oscilloscope with necessary high sensitivity and full 5 megacycle bandwidth.

New printed circuit construction, all components mounted on high insulation surface resulting in uniformly low circuit capacitance.

New type wide frequency range Heath sweep generator, 10 cycles to 500,000



New 5UP1 CR tube

New cabinet styling and color harmony—charcoal gray panel with high readability white lettering.

New electronic positioning controls for instantaneous, definite positioning without bounce or overshoot.

FEATURES: Other outstanding characteristics of this professional oscilloscope are: Built-in 1V peak-to-peak reference for calibration of plastic CRT face-plate; 5" 5UP1 CRT; push-pull hor. and vert. deflection amplifiers; hor. trace width expandable to 3 times diameter of CR tube to allow inspection of any small portion of the signal; deflection sensitivity, .025 volts per inch; wiring harness pre-formed and cabled to save construction time and insure professional appearance and operation. Incorporates efficient retrace blanking. Frequency compensated step attenuator at the vertical input. Entire tube face useable. No foldover on vertical over-load. Performance obtainable only in much more expensive laboratory models.

Uses 5UP1, 6AB4, 6BO7, 12BH7, 6CB6, 12AT7, 2-12AU7, 6X4, 1V2, and 6C4. Quality components used throughout so that outstanding performance characteristics may be maintained for years to come. Plastic molded condensers are used in all coupling and by-pass applications. The "new-look" in Heathkit styling produces professional appearance in keeping with the professional performance of this instrument.

MODEL O-10

\$69.50

Shpg. Wt. 27 lbs.

NEW *Heathkit* 3" PRINTED CIRCUIT OSCILLOSCOPE KIT

MODEL OL-1

\$29.50 Shpg. Wt. 15 lbs.

New easy-to-build printed circuit board with high insulation factor.

New Heathkit instrument styling—charcoal gray panel with high readability white lettering.

New Heath twin triode sweep generator 15-100,000 cycle sweep.

NEW *Heathkit* 5" PRINTED CIRCUIT OSCILLOSCOPE KIT

MODEL OM-1

\$39.50 Shpg. Wt. 24 lbs.

VERSATILE INSTRUMENT: The new Model OM-1 general purpose Oscilloscope represents an outstanding dollar value in reliable test equipment. Full 5 inch CRT. Printed circuit boards for ease of assembly, constant circuit characteristics, and rugged component mounting. Includes all the design features necessary for servicemen, students, experimenters, radio amateurs, etc. Frequency response of amplifiers flat within 1 db from 10 cps to 100 kc, and down only 7 db from 10 cps to 500 kc. Sweep generator range from 20 cps to 100,000 cps. Also features new Heathkit color styling with charcoal gray panel and high definition white lettering for readability even under subdued lighting conditions.

DESIGN FEATURES: A full-size, versatile oscilloscope at a price you can afford. Other features are: adjustable spot shape control; RF connections to deflection plates; direct coupled centering controls; external and internal sweep and sync; 60 cycle line sync; built in 1 volt peak-to-peak panel terminal reference voltage; professional appearance of cabinet, panel, and knob styling.

5BP1 CR TUBE



HEATH company

BENTON HARBOR 20,
MICHIGAN

Heathkit MULTIMETER KIT

The new Heathkit Multimeter is a "must" to complete the instrument lineup of any well equipped service shop. Here is an instrument packed with every desirable service feature, many of which are not found in other Multimeters. All of the measurement ranges you need or want. High sensitivity 20,000 ohms per volt DC; 5,000 ohms per volt AC.

★ ADVANTAGES

Complete portability through freedom from AC line power operation—provides service ranges of direct current measurements from 150 microamps up to 15 amperes—can be safely operated in RF fields without impairing accuracy of measurement.

★ RANGES

Full scale AC and DC voltage ranges are 0-1.5, 5, 50, 150, 500, 1500 and 5,000 volts. Direct current ranges are 150 microamps, 15, 150 and 500 milliamperes and 15 amperes. Resistances are measured from .2 ohms to 20 megohms in 3 ranges and db range from -10 to +65 db.

★ CONSTRUCTION

The Heathkit MM-1 features a unique resistor ring switch mounting assembly procedure. With this method of assembly the precision resistors are wired to the rings and range switch before actual mounting of the switch to the instrument panel. This procedure affords the advantage of simpler construction yet complete accessibility of precision resistors in event replacement is ever required. Ohmmeter batteries were selected for convenience of replacement and only standard commercially available types are used. Batteries consist of 1 type C flashlight cell and 4 Penlite cells. All batteries and necessary test leads are furnished with the kit.

20,000 ohms per volt sensitivity DC; 5,000 ohms per volt AC.

Polarity reversal switch eliminates transferring of test leads.

All 1% precision multiplier resistors—sensitive 50 microamp 4 1/2" Simpson meter.

Total of 35 meter ranges on two color scale.

New modern cabinet styling—attractive appearance.

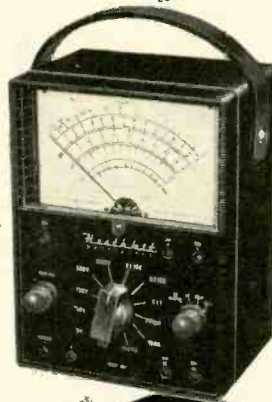

MODEL MM-1

\$26.50

Shpg. Wt. 6 lbs.

Heathkit HANDITESTER KIT



MODEL M-1

\$14.50

Shpg. Wt. 3 lbs.

The Heathkit Model M-1 Handitester readily fulfills major requirements for

a compact, portable volt-ohm milliammeter. The small size of the smooth gleaming molded bakelite case permits the instrument to be tucked into your coat pocket, toolbox or glove compartment of your car. Always the "Handitester" for those simple repair jobs.

RANGES:

Despite its compact size, the Handitester is packed with every desirable feature required in an instrument of this type. AC or DC voltage ranges, full scale, 10, 30, 300, 1,000 and 5,000 volts. 2 convenient ohmmeter ranges 0-3,000 ohms and 0-300,000 ohms. 2 DC milliammeter ranges 0-10 milliamperes and 0-100 milliamperes.

CONSTRUCTION

The instrument uses a 400 microampere meter movement which is shunted with resistors to provide a uniform 1 milliampere load in both AC and DC ranges. This design allows the use of but 1 set of 1% precision divider resistors on both AC and DC and provides a simplicity of switching. A small hearing aid type ohms adjust control provides the necessary zero adjust function on the ohmmeter range. The AC rectifier circuit uses a high quality Bradley rectifier and a dual half wave hookup. Necessary test leads and battery are included in the price of this popular kit.

Heathkit RESISTANCE SUBSTITUTION BOX KIT

MODEL RS-1

\$5.50

36 standard RTMA 1 watt resistor values between 15 ohms and 10 megohms with an accuracy of 10% are at your fingertips in the Model RS-1 Resistance Substitution Box kit. This sturdy and attractive accessory will easily prove its worth many times over as a time saving device. Order several today.



Shpg. Wt. 2 lbs.

Heathkit CONDENSER SUBSTITUTION BOX KIT

MODEL CS-1

\$5.50

18 standard RTMA A values are available from .0001 mfd to .22 mfd. An 18 position switch set in the panel of an attractive bakelite case allows quick changes without touching the test leads. Invest a few minutes of your time now and save hours of work later on.



Shpg. Wt. 2 lbs.

HEATH company

BENTON HARBOR 20,
MICHIGAN

TELEVISION

shown. The parabolic signal is then coupled through the vertical parabolic amplitude control and isolation choke L1 to one winding (L4) of the convergence coil. The other convergence-coil winding (L3)—in conjunction with the vertical tilt control—causes the vertical parabola to lean either left or right. This is done by coupling the vertical sawtooth through the tilt control and isolation choke L2 to the convergence coil. The polarity, or direction, and amplitude of tilt are governed by setting of the tilt control with respect to the tap (point of signal injection).

The horizontal sawtooth, obtained either from a special winding of the horizontal output transformer and a sawtooth generator circuit or any other convenient point in the horizontal circuit, is coupled through the horizontal sawtooth amplitude control to the grid of the amplifier V1. This sawtooth waveform develops a parabolic current through convergence coil L4 in the plate circuit due to the reactance of the coil at the horizontal frequency. The horizontal tilt control varies the polarity and amplitude of the pulse that is also coupled to the grid of the amplifier. Since a pulse voltage is changed to a sawtooth current by the reactance of L4 to the horizontal frequency, the same tilt effect is obtained as for the vertical parabola.

The d.c. convergence control in the plate circuit of V1 varies the d.c. through the convergence coil and therefore permits convergence at the center of the color tube. For each of the three coils, 5 convergence controls are provided, making a total of 15 for a 19-inch color tube. Only one other convergence control is required—the blue beam-positioning magnet mentioned previously. This magnet is a static control and mainly affects convergence at the center of the picture tube.

The function of the purity coil and control for the 19-inch color tube is identical to that of the 15 1/2-inch tube. The purity coil around the neck of the picture tube (Fig. 1) is supplied approximately 225 ma of d.c. that can be varied by the color purity control. The magnetic field of this coil electrically aligns all three electron guns so that each gun strikes only its respective phosphor dot. Three other major components affect color purity: the deflection yoke, blue beam-positioning magnet and convergence coils. The deflection-yoke axial position and rotation affect purity but should not present trouble after the yoke is correctly positioned. As with a 15 1/2-inch color tube the interaction between convergence components and the purity coil may be troublesome. However, due to the smaller d.c. magnetic field of the 19-inch receiver's convergence magnet and coils, less interaction should be experienced.

The high-voltage section of a color receiver is similar to that of a black-and-white set. The only difference is the addition of three tubes to obtain

RADIO-ELECTRONICS

NEW Heathkit VACUUM TUBE VOLTMETER KIT

PRINTED CIRCUIT DESIGN

Another outstanding example of continuing Heath Company pioneering and leadership in the kit instrument field. A new printed circuit VTVM. New peak-to-peak circuit—new styling and new panel design. A prewired, prefabricated printed circuit board eliminates chassis wiring, cuts assembly time in half, assures duplication of Engineering pilot model specifications, and virtually eliminates possibility of construction error.

CIRCUIT:

A 6AL5 tube operated as a full wave AC input rectifier permits seven peak-to-peak voltage ranges with upper limits of 4000 volts P-P. Just the ticket for you TV servicemen. Voltage divider in the 6AL5 input circuit limits applied AC input to a safe level. This circuitry and the isolation of the meter in the cathode of the 12AU7 bridge circuit affords a high degree of protection to the sensitive 200 microampere meter.

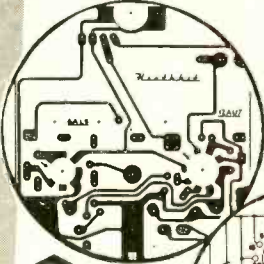

Full wave rectifier in AC input circuit. Read peak-to-peak and RMS volts with upper limit of 4000 P-P and 1500 volts RMS. Voltage divider input circuit.

RANGES:

Seven voltage ranges. 1.5, 5, 15, 50, 150, 500 and 1,500 volts DC and AC RMS. Peak-to-peak ranges 4, 14, 40, 140, 400, 1400, 4600. Ohmmeter ranges X1, X10, X100, X1000, X10K, X100K, X1 meg. Additional features are a db scale, a center scale zero position, and a polarity reversal switch.

IMPORTANT FEATURES:

High impedance 11 megohm input—transformer operated—4% precision resistors, 6AL5 and 12AU7 tube—selenium power rectifier—individual AC and DC calibrations—smoother improved zero adjust control action—new panel styling and color—new placement of pilot light—new positive contact battery mounting—new knobs—test leads included.

The new V-7 also sets the pace as a kit instrument style leader. Smart, good-looking charcoal gray panel and soft feather gray cabinet. High readability panel with sharply contrasting white calibrations. The pleasing, eye catching, modern styling is in harmonious balance with the outstanding circuit design improvements. Easily the best buy in kit instruments.

The first kit instrument to offer a labor-saving, error-free printed circuit board. Your instrument an exact wiring replica of Engineering development model.

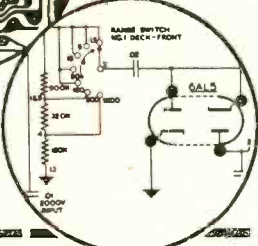

New charcoal gray baked enamel panel with high readability, white lettering, soft feather gray cabinet, subdued pilot light indicator.

New printed circuit board for faster, easier construction—exact duplication of Lab development model.



New easy-to-read open panel switch out. Off-on switch now incorporated in the selector switch.

MODEL V-7

\$24.50

Shpg. Wt. 7 lbs.

New peak-to-peak meter scale—new color harmony—new knobs.

Heathkit AC VACUUM TUBE VOLTMETER KIT

MODEL AV-2



\$29.50

Shpg. Wt. 5 lbs.

Extreme sensitivity has been emphasized in the design of the Heathkit AC VTVM. Ten full scale RMS ranges are .01, .03, .1, .3, 1, 3, 10, 30, 100, and 300 volts. Frequency response is substantially flat from 10 cycles per second to 50 KC with input impedance of 1 megohm at 1 KC. Will accurately measure as low as 1 millivolt at high impedance. Total db range is -52 db to +52 db. An excellent kit for measuring

the output of phono cartridges and the gain of amplifier stages. Use it also to check power supply ripple, as a sensitive null detector, and for compiling frequency response data. Features one knob operation, 200 microampere Simpson meter and precision resistors.

Heathkit 30,000 VOLTS DC PROBE KIT

Measure up to 30,000 volts DC with the Heathkit VTVM and the 336 high voltage Probe. Precision resistor provides multiplication factor of 100. Can be used with any 11 megohm input VTVM. Housed in a Polystyrene two color sleek plastic probe body for safety of operation.

No. 336

\$4.50

Shpg. Wt. 1 lb.

Heathkit PEAK-TO-PEAK PROBE KIT



No. 338-C

\$5.50

Shpg. Wt. 2 lbs.

Peak-to-peak values not exceeding 80 volts at a DC level of not more than 600 volts, can now be read directly by using 338-C Probe with previous model Heathkit VTVM's or any VTVM with 11 megohm input resistance. Probe construction features a modern printed circuit board for easy assembly. Frequency range 5 KC to 5 MC.

Heathkit RF PROBE KIT

The Heathkit RF Probe will permit the measurement of RF voltages up to 250 MC with an accuracy of $\pm 10\%$. The limits are 30 volts AC and a DC level of 500 volts. Designed for any 11 megohm input VTVM. Modern styling, Polystyrene aluminum housing, Polystyrene insulation, and printed circuit board for easy assembly.



No. 309-C

\$3.50

Shpg. Wt. 1 lb.

Heathkit AUDIO WATTMETER KIT



MODEL AW-1

\$29.50

Shpg. Wt. 6 lbs.

Read audio power output directly without using external load resistors with the new Heathkit Audio Wattmeter. Built-in non-inductive load resistors provide impedances of 4, 8, 16, and 600 ohms. Flat response from 10 CPS to 250 KC. Full scale power ranges are 0-5 MW, 0-50 MW, 0-500 MW, 0-5 W and 0-50 W. Model AW-1 will operate continuously at 25 watts and has a duty cycle of 3 minutes at 50 watts. Total db range in five positions is -50 db to +48 db, using the standard 1 milliwatt 600 ohms.

HEATH company
BENTON HARBOR 20,
MICHIGAN

Heathkit 6-12 VOLT BATTERY ELIMINATOR KIT

Here is the new 12 volt Heathkit Battery Eliminator so necessary for modern up-to-date operation of your Service Shop. Furnishes either 6 or 12 volt output which can be selected at the flick of a panel switch. Use the BE-4 to service all of the new 12 volt car radios in addition to the conventional 6 volt models.

RANGES:

This new Battery Eliminator provides two continuously variable output voltage ranges. 0-6 volts D.C. at 10 amperes continuously or 15 amperes maximum intermittent and 0-12 volts D.C. at 5 amperes continuously or 7.5 amperes maximum intermittent. The output voltage is clean and well filtered, as the circuit uses two 10,000 mfd condensers.

The continuously variable voltage output feature is of definite aid in determining the starting point of vibrators, the voltage operating range of oscillator circuits, etc.

OTHER USES:

The controllable low voltage DC supply has many other applications besides primary use in car radio service work. Can be nicely used as a battery charger, or low voltage DC supply for electric trains. Has applications in high gain audio work requiring clean DC filament supply. Can be used for low power electro-plating or as a power supply for battery powered intercommunication systems.

Automatic overload relay—self resetting—fuse protected.

New 18 plate split type, heavy duty rectifier unit.

Continuously variable output voltage, either 6 or 12 volt operation.

Constant ammeter and voltmeter monitoring.

MODEL BE-4

\$31⁵⁰

Shpg. Wt. 17 lbs.



TELEVISION

a regulated 27-kv output and supply a high potential to the focus anode of the picture tube. To obtain 27 kilovolts, a voltage-doubler circuit is used (Fig. 4). A high potential from the output transformer is applied to the plate of V1 and charges C1. The potential across C1 is coupled through the focus control to the plate of V2 (high-voltage coupling diode). Since the plate of V2 is now positive with respect to its cathode, it conducts and charges C2. The charge in C2 adds to the pulse voltage from the

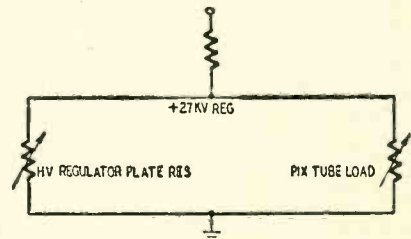

Fig. 5—Equivalent regulator circuit.

high-voltage transformer winding and is sufficient to develop 27 kv at the cathode of V3.

The action of the high-voltage regulator is similar to having two variable resistances in parallel (Fig. 5). For proper operation, the total parallel resistance will always be constant. Thus the total supply current will remain constant and as a result the voltage will also remain constant. One of the variable resistors may be considered the high-voltage regulator, and the other the picture-tube load.

Assume that the picture-tube current increases—effectively, a decrease in picture-tube load resistance. This would cause a decrease in high voltage that would be coupled back by diodes V2 and V3 to the bleeder network and a decrease the positive control-grid bias on the high-voltage regulator. The high-voltage regulator would then conduct less current and have the effect of increasing the regulator plate resistance. The plate of the regulator is connected to 27-kv point and the cathode is tied to B plus, which is, effectively, ground for the high voltage. The high-voltage regulator is therefore in parallel with the picture-tube load resistance. Since the picture-tube load resistance originally decreased and caused the regulator's resistance to increase, the original requirement for constant parallel resistance is maintained. The opposite effect may also occur where the picture-tube load resistance increases and causes the regulator to conduct more current due to its grid going more positive and thereby lowering the regulator's resistance to compensate for the increased picture-tube load resistance.

This article has been particularly related to the 19-inch three-gun color tube and circuitry involving purity, convergence and high voltage. The next installment will discuss circuitry as it applies to a complete color television receiver.

TO BE CONTINUED

Heathkit VIBRATOR TESTER KIT

MODEL VT-1

\$14⁵⁰

Shpg. Wt. 6 lbs.



This time-saving device will quickly pay for itself in your auto radio service shop. 6 volt vibrators can be checked instantly on the Good—Bad type meter scale. Operation requires only a variable DC voltage from 4 to 6 volts at 4 amperes. Model BE-4 Battery Eliminator is recommended for this application.

Five test sockets provide for the testing of hundreds of interrupter and self-rectifier types. Proper starting voltage is determined easily and accurately. Over-all quality is then unmistakably indicated on the panel mounted meter.

Heathkit IMPEDANCE BRIDGE KIT

MODEL IB-2

\$59⁵⁰ Shpg. Wt. 12 lbs.



The new Heathkit Impedance Bridge features built-in adjustable phase shift oscillator and amplifier. This instrument actually represents four instruments in one compact unit. The Wheatstone bridge for resistance measurements, the Capacity Comparison bridge for capacity measurements, Maxwell bridge for low Q, and Hay bridge for high Q measurements.

DESIGN:

Panel provisions for external generator use. A new two section CRL dial, provides ten separate "units." Ten separate units switch settings and fractions of units are read on a continuously variable calibrated control. A special minimum capacity shielded and balanced impedance matching transformer between the generator and bridge circuit is automatically switched to provide correct load operation of the generator circuit. The instrument uses 1/2% precision resistors and condensers in all measurements circuits.

Heathkit VARIABLE VOLTAGE ISOLATION TRANSFORMER KIT

MODEL IT-1

\$16⁵⁰

Shpg. Wt. 10 lbs.

Variable output voltage between 90 and 130 volts AC. Rated at 100 volt—amperes continuously and 200 volt—amperes intermittently. The principle function of the Heathkit Isolation Transformer is to isolate the circuit being tested from line interference being caused by motors, appliances, etc. It works backward too by isolating such devices from the line. Many other uses, especially with AC-DC type circuits. Do not confuse the Heathkit Isolation Transformer with the hazardous auto transformer type line voltage boosters.



HEATH company

BENTON HARBOR 20,
MICHIGAN

NEW *Heathkit* TV ALIGNMENT GENERATOR KIT

Here is the most radically improved Sweep Generator in the history of the TV service industry. The basic design follows latest high frequency techniques which result in a combination of performance features not found in any other sweep generator.

SWEEP:

Sweep action is obtained electronically through the use of a newly developed controllable inductor, thereby eliminating all moving parts with their resultant hum, vibration, fatigue, etc. Frequency coverage entirely on fundamentals, is continuous from 4 MC to 220 MC at an output level well over a measurable .1 volt.

Triple marker system, 4.5 MC crystal controlled marker—continuously variable marker—provisions for external marker.

MARKER:

The same instrument incorporates a triple marker system with a crystal controlled reference. A variable marker provides accurate coverage from 19 to 60 MC on fundamentals, and 57 to 180 MC on calibrated harmonics. A separate fixed crystal controlled 4.5 MC marker can be used for checking IF, band-pass, calibration, reference, etc. Provisions are also made for external marker use. A 4.5 MC crystal is supplied with the kit.

POWER SUPPLY:

The transformer operated Power Supply features voltage regulation for stable oscillator operation. Three sets of shielded cables are furnished with the kit. Sweep range is completely and smoothly controllable from zero up to a maximum of 50 MC, depending upon base frequency.

Here is a TV Sweep Generator that truly no serviceman can afford to be without for rapid, accurate, TV alignment work.

Controllable inductor sweep oscillator with output entirely on fundamentals.

Triple marker system 4.5 MC crystal controlled—3 sets of low loss, low capacity shielded cables included.

Electronically operated smooth continuously variable sweep circuit. No vibration, hum or noise.

Frequency coverage: 4 MC—220 MC continuous including FM spectrum. RF output well over .1 volt.

MODEL TS-3

\$44⁵⁰

Shpg. Wt. 18 lbs.

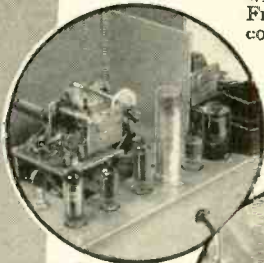

Automatic amplitude control circuit—constant output voltage regulated power supply



NEW *Heathkit* SIGNAL GENERATOR KIT

MODEL SG-8

\$19⁵⁰ Shpg. Wt. 8 lbs.

The new Heathkit service type Signal Generator, Model SG-8 incorporates many design features not usually found in this instrument price range. Frequency coverage

is from 160 KC to 110 MC in five ranges, all on fundamentals, with useful calibrated harmonics up to 220 MC. The RF output level is well in excess of 100,000 microvolts throughout the frequency range. The oscillator circuit consists of a twin triode tube, one-half used as a Colpitts oscillator, and the other half as a cathode follower output which acts as a buffer between the oscillator and external load, thereby eliminating oscillator frequency shift usually caused by external loading.

All coils are factory wound and adjusted, thereby completely eliminating the need for individual calibration and the use of additional calibrating equipment. The stable, low impedance output, features step and variable attenuation for complete control of RF level. A separate 6C4 triode acts as a 400 cycle sine wave oscillator, and a panel mounted switching system permits choice of either external or internal modulation.

Heathkit LABORATORY GENERATOR KIT

The new Heathkit Laboratory type Signal Generator definitely establishes a new performance standard for a kit instrument. An outstanding feature involves the use of a panel mounted 200 microampere meter calibrated both in microvolts and percent modulation, thereby providing a definite reference level for using the Signal Generator in design work, gain measurements, selectivity, frequency response checks.

DESIGN:

Additional design features are copper plated shield enclosure for oscillator and buffer stages resulting in effective double shielding. Fibre panel control shaft extensions in RF carrying circuits, thorough AC line filtering, careful shielding of the attenuator network, voltage regulated B plus supply, selenium rectifier, etc.

RANGES:

Frequency coverage from 150 KC to 30 MC all on fundamentals in five separate ranges. Output voltage .1 volt with provisions for metered external or internal modulation. Output impedance termination 50 ohms. Transformer operated power supply.

Investigate the many dollar stretching features offered by the LG-1 before investing in any generator for Laboratory or Service work.



MODEL LG-1

\$39⁵⁰

Shpg. Wt. 16 lbs.

NEW *Heathkit* BAR GENERATOR KIT



MODEL
BG-1

\$14⁵⁰ Shpg. Wt. 4 lbs.

The Heathkit BG-1 produces a series of horizontal or vertical bars on a TV screen. Since these bars are equally spaced, they will quickly indicate picture linearity of the receiver under test without waiting for transmitted test patterns. Panel switch provides "standby"—horizontal and vertical position. The oscillator unit uses a 12AT7 twin triode for the RF oscillator and video carrier frequencies. A neon relaxation oscillator provides low frequency for vertical linearity tests. The instrument will also provide an indication of horizontal and vertical sync circuit stability as well as overall picture size. Operation is simple and merely requires connection to the TV receiver antenna terminal. Transformer operated for safety.

HEATH company
BENTON HARBOR 20,
MICHIGAN

Heathkit VISUAL-AURAL SIGNAL-TRACER KIT

The new Heathkit Visual-Aural Signal Tracer features a special high gain RF input channel used in conjunction with a newly designed wide frequency range demodulator probe. High RF sensitivity permits signal tracing from the receiver antenna input. Separate low gain channel and probe available for audio circuit exploration. Both input channels are constantly monitored by an electron ray beam indicator so that visual as well as aural indications may be obtained.

NOISE LOCATOR:

A decidedly unusual feature is a noise locator circuit used in conjunction with the audio probe. With this system, a DC potential is applied to a suspected circuit component and the action of the voltage in the component can be seen as well as heard. Invaluable for ferreting out noisy or intermittent condensers, noisy resistors, controls, IF and power transformers, etc.

WATTMETER:

Built-in calibrated wattmeter circuit will prove useful for quick preliminary check of total wattage consumption for substitution under test. Separate panel terminals provide external use of the speaker or output transformer for substitution purposes. Saves valuable service time by eliminating the necessity for speaker removal on every service job. The same panel terminals also provide easy access to a well filtered B plus supply for external use. Don't overlook the many interesting service possibilities provided through the use of this instrument, and let the Signal Tracer work for you by saving time and money.

Substitution test speaker—utility amplifier.
Noise locator circuit—calibrated wattmeter.



RF and audio probes supplied along with necessary test leads.

Visual and aural signal tracing.

MODEL T-3

\$23⁵⁰

Shpg. Wt. 9 lbs.

Heathkit CONDENSER CHECKER KIT



MODEL C-3

\$19⁵⁰ Shpg. Wt. 7 lbs.

Here is a handy test instrument for any Service Shop. Unknown values of capacity and resistance are quickly determined on the direct reading condenser checker dial. Capacity is measured in four ranges from .001 mfd to 1000 mfd. Resistance in the range from 100 ohms to 5 megohms.

DC polarizing voltages of 25, 150, 250, 350, and 450 volts are available for leakage tests on all types of condensers. For electrolytics, a power factor control is provided to balance out inherent leakage and to indicate directly the power factor of a condenser under test. Proper balancing of the AC bridge is reflected in the degree of closure of an electron beam indicator tube.

Model C-3 uses a transformer operated power supply, spring return leakage test switch, and a convenient combination of panel scales for all readings. Test leads are furnished in addition to precision components for calibrating purposes. Quick and easy to operate, the Heathkit Condenser Checker will save valuable time and increase your Shop efficiency.

Heathkit "Q" METER KIT



MODEL QM-1

\$44⁵⁰

Shpg. Wt. 14 lbs.

The Heathkit QM-1 represents the first practical popular priced Q meter available within the price range of schools, laboratories, TV service men, and experimenters. This instrument will enable the operator to simulate conditions encountered in practical circuits and to measure the performance of coils or condensers at the operating frequencies actually encountered. All indications of value are read directly on the 4½" 50 microampere Simpson calibrated meter scale. Measures Q of condensers, RF resistance, and the distributed capacity of coils. Oscillator section supplies RF frequencies 150 KC to 18 MC in four ranges. Calibrate capacity with range of 40 MMF to 450 MMF with vernier of ±3 MMF. Investigate the many services this instrument can perform for you.

Heathkit

AUDIO OSCILLATOR KIT

MODEL AO-1

\$24⁵⁰

Shpg. Wt. 10 lbs.



The Heathkit Audio Oscillator will produce both sine and square waves within the frequency range from 20 CPS to 20 KC in three ranges. Thermistor controlled linearity results in a variation of no more than ±1 db in a 10 volt (no load) variable output level. There will be less than .6% distortion from 100 CPS throughout the audible range. Low impedance 600 ohm output. Precision 1% resistors, used in the range multiplier circuits to provide accurate calibration.

HEATH company

BENTON HARBOR 20,
MICHIGAN

TELEVISION

TV SERVICE NOTES

By DAVID GNESSIN

THESE items from the author's extensive TV trouble-shooting experience should prove helpful to other service technicians. In a few instances the notes apply to specific receivers (the author was servicing Philco and Transvision at the time), but most of them are fundamental suggestions that may help you out of a difficulty with any make set.

Transvision 12-inch kit

If the right side of the picture folds over, check to see if the horizontal hold control is erratic. There may also be insufficient horizontal sweep. Look for a leaky or shorted 150- μ f capacitor in the grid circuit of the 6BG6-G output tube.

This would put a positive d.c. voltage on the grid of the horizontal output tube and upset the horizontal sweep current pattern.

Vertical linearity

Vertical linearity may sometimes be off just enough to be annoying, but not bad enough to warrant tearing the set apart to improve it. In some cases a quick check is simply to reverse the a.c.-line plug.

If this is done while a test pattern is on, a dramatic change in vertical wedge sometimes results. (Of course this may also indicate video-circuit or horizontal sweep troubles.) In any case, the vertical wedges sometimes do show improvement with this simple technique.

AM interference

Complaints turn up in the New York area on channel 4, in the form of parallel vertical lines traveling across the screen. These are produced by beats between the channel 4 picture carrier and an AM station in the immediate vicinity. It generally happens when the 300-ohm lead in—which acts as vertical antenna at low frequencies—is not accurately balanced to ground.

To correct the condition take a 1,000-ohm, ½-watt resistor, wind 15 turns of No. 32 enameled wire over it, and solder this across the antenna-input terminals of the receiver.

Switching 6SN7's

The sync separator and amplifier have to handle both 60-cycle vertical sync and 15,750-cycle horizontal sync. The 6SN7's sometimes used in these circuits may perform better at one frequency than at the other.

These tubes may test O.K. on the tube checker, but because of unequal or excessive internal capacitances, or leakage between triodes, they may not act efficiently in a particular circuit.

In receivers that have more than one 6SN7, try switching them around. You may find your whole service call consists of swapping the vertical oscillator tube with the horizontal oscillator or the sync separator tube.

END

Heathkit TUBE CHECKER KIT

The Heathkit TC-2 Tube Checker was primarily designed for the convenience of radio and TV servicemen and will check the operating quality of tubes commonly encountered in this type of work. Test set-up procedure is simplified, rapid, and flexible. Panel sockets accommodate 4, 5, 6, and 7 pin tubes, octal and loctal, 7 and 9 pin miniatures, 5 pin Hytron, and a blank socket for new tubes. Built-in neon short indicator, individual 3-position lever switch for each tube element, spring return test switch, 14 filament voltage ranges, and line-set control to compensate for supply voltage variations, all represent features of the TC-2.

Illuminated for easy reading and quick identification of chart reference.

Improved smooth running roll chart mechanical action.

Simplified construction—new harness type wiring—closer tolerance resistors.

Smart, professional appearance—available in counter or portable models.



Three color Good—2—B.A.D. 4 1/2" plastic cased meter.

MODEL TC-2

\$29.50

Shpg. Wt. 12 lbs.

Results of tube tests are read directly from the large 4 1/2" Simpson 3-color meter. Checks emission, shorted elements, open elements, and continuity. Wiring procedure has been simplified through the use of multi-wired color coded cable providing a harness type installation between tube sockets and lever switches. This procedure insures standard assembly and imparts a "factory built" appearance to the instrument. New Construction Manual furnishes detailed information regarding tube set-up procedure for testing of new or unlisted tube types. No delay necessary for release of factory data.

Heathkit PORTABLE TUBE CHECKER KIT

The portable model is supplied with a strikingly attractive two-tone cabinet finished in rich maroon proxylin impregnated fabric covering with a contrasting gray on the inside of the detachable cover.

MODEL TC-2P

\$34.50

Shpg. Wt. 15 lbs.

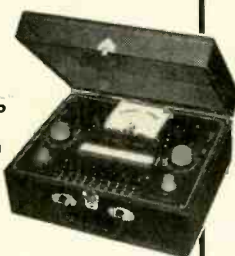

Heathkit REGULATED POWER SUPPLY KIT



MODEL PS-2

\$33.50 Shpg. Wt. 15 lbs.

Here is a source of regulated D.C. voltage for circuit development work. Power supply voltage and current drain to the circuit under test are constantly monitored by the 4 1/2" panel mounted meter. Separate 6.3 volt at 4 ampere A.C. filament source available. The regulated and variable output voltage will be constant over wide load variations, and hum ripple will not exceed .012% at 250 volts under a 50 MA load. Completely isolated circuit, standby switch, and other desirable features, make the Model PS-2 extremely useful in a wide variety of applications.

Heathkit TV PICTURE TUBE TEST ADAPTER

The Heathkit TV Picture Tube Test Adapter used with the Heathkit Tube Checker Kit, will quickly check picture tubes for emission, shorts, etc. and determine tube quality. Consists of standard 12-pin TV tube socket, four feet of cable, octal socket connector, and data sheet.



No. 355

\$4.50 Shpg. Wt. 7 lbs.

Heathkit DECADE RESISTANCE KIT



MODEL DR-1

\$19.50

Shpg. Wt. 4 lbs.

Twenty 1% resistors are decade in 1 ohm steps to provide any value between 1 ohm and 99,999 ohms. Sturdy ceramic switches with silver plated contacts insure reliable service. Use the Decade Resistance in bridge circuits, meter multipliers, calibrations, or any application requiring a wide range of precision resistance values.

Heathkit AUDIO GENERATOR KIT

Here is an Audio Generator with features generally found only in the most expensive instruments. Sine wave coverage from 20 cycles to 1 Megacycle—response flat ± 1 db from 20 cycles to 400 Kc—continuously variable and step attenuated output. Because the output voltage is relatively constant over wide frequency ranges, the AG-8 is ideal for running frequency response curves in audio circuits. Once set by means of the attenuator, this voltage may be relied upon for accuracy within ± 1 db. Instrument features low impedance 600 ohm output circuit and distortion less than .4 of 1% from 100 CPS through audible range.



MODEL AG-8

\$29.50

Shpg. Wt. 11 lbs.

Heathkit DECADE CONDENSER KIT

The Heathkit Decade Condenser provides a ready source of capacity values from 100 mmf to .111 mfd inclusive in capacity steps of 100 mmf. Silver plated contacts on husky ceramic switches, assure positive contact for each switch position. Precision silver mica condensers $\pm 1\%$ accuracy for close tolerance accurate work.

MODEL DC-1

\$16.50

Shpg. Wt. 3 lbs.



HEATH company

BENTON HARBOR 20,
MICHIGAN

NEW *Heathkit* HIGH FIDELITY PREAMPLIFIER KIT

Here is the exciting new Heathkit Preamplifier with all of the features your Audiophiles have asked for and at a down-to-earth price level. Beautiful satin gold baked enamel finish, striking control knobs and arrangement, attractive custom appearance and entirely functional design.

DESIGN:

Uses three twin triode tubes in a shock mounted chassis, 2-12AX7 and 1-12AU7. Features tube shielding, plastic sealed color coded capacitors, smooth acting controls, good filtering, excellent decoupling, low hum and noise level, and all aluminum cabinet. Special balancing control for absolute minimum hum level. Cathode follower, low impedance output circuit for complete installation flexibility.

SPECIFICATIONS:

Provides five switch selected inputs, 3 high level, and two low level, each with individual level controls—4 position LP, RIAA, AES, and early 78 equalization switch—4 position roll-off switch, 8, 12, 16 with one flat position. Separate tone controls, bass 18 db boost and 12 db cut at 50 CPS, treble 15 db boost, and 20 db cut at 15,000 CPS. Power re-

Equalization for LP, RIAA, AES, and early 78.

Separate bass and treble tone controls—special hum control.



Cathode follower low impedance output circuit.

Beautiful, modern appearance, blends with any interior or color scheme.

Five switch selected inputs with individual level controls.

Requirements from Heathkit Williamson Type Amplifier power supply 6.3 volts AC at 1 ampere, and 300 volts DC at 10 MA. Over-all dimensions 12 3/4" wide x 5 3/8" deep x 3 3/8" high.

APPLICATION:

The new Heathkit WA-P2 Preamplifier has been designed to operate with any of the Heathkit Williamson Type Amplifiers and is directly interchangeable with the previous Model WA-P1 Preamplifier unit. Order your kit today and enjoy completely smooth control over the operation of your Hi-Fi system. Obtain the exact tonal balance of bass and treble with the precise degree of equalization you want. Note that the design of the WA-P2 accommodates the newly established RIAA curve.

MODEL WA-P2

\$19.75

Shpg. Wt. 7 lbs.

HAM EQUIPMENT

Single knob band switching—prewound coils.



Crystal or VFO excitation—metered operation.

52 Ohm coaxial output—built-in power supply.

MODEL AT-1

\$29.50

Shpg. Wt. 16 lbs.

filter, good shielding and a 52 ohm coaxial output. The 425 volt, 100 milliampere power supply and 5U4 rectifier are more than adequate for the 6AG7 oscillator multiplier and 6L6 amplifier doubler.

Heathkit

AMATEUR

TRANSMITTER KIT

The Heathkit AT-1 Transmitter has established a high reputation and has been enthusiastically accepted by hundreds of experienced operators as well as beginners. Power input up to 35 watts for the novice and suitable as a standby exciter for your higher powered rig later on.

Model AT-1 can be crystal or VFO excited and operates on 80, 40, 20, 15, 11 and 10 meters. The prewound coils with the oscillator and amplifier are switched simultaneously by the rugged band switch. Meter switch allows a reading of the final grid and plate current on the panel mounted meter. Modulator input and VFO power sockets are provided as well as a key jack for CW operation. Other features include a crystal socket, standby switch, key click filter, AC line meter, and a 52 ohm coaxial output. The 425 volt, 100 milliampere power supply and 5U4 rectifier are more than adequate for the 6AG7 oscillator multiplier and 6L6 amplifier doubler.

Brand NEW

Smooth acting illuminated and precalibrated dial.

Copper plated chassis—aluminum cabinet—easy to build.



HEATHKIT VFO KIT

The new Heathkit VFO is the perfect companion to the Heathkit Model AT-1 Transmitter and it has sufficient output to drive any multi-stage transmitter of modern design. Good mechanical and electrical design insures operating stability. Coils are wound on stable, heavy duty, ceramic forms using Litz or double cellulose wire coated with Polystyrene cement and baked for humidity protection. Variable capacitor of differential type construction, especially designed for maximum bandspread. Kit is furnished with a carefully precalibrated scale which provides well over two feet of scale length. Smooth acting vernier reduction drive and illuminated dial provides easy tuning and zero beating.

Power requirements 6.3 volts AC at .45 amperes, and 250 volts DC at 15 mls. Just plug it into the power receptacle provided on the rear of the AT-1 Transmitter. Seven band coverage 160 through 10 meters with 10 volt average RF output. Uses 6AU6 electron coupled Clapp oscillator and OA2 voltage regulator.

Seven band coverage 160 through 10 meters at 10 volt RF output.

6AU6 electron coupled Clapp oscillator and OA2 voltage regulator.

MODEL VF-1

\$19.50

Shpg. Wt. 7 lbs.

Heathkit

GRID DIP METER KIT

The invaluable instrument for Hams, servicemen and experimenters. Useful in TV service work, for alignment of traps, filters, IF stages, peaking compensation networks, etc. Locates spurious oscillation, provides a relative indication of power in transmitter stages. Use it for neutralization, locating parasites, correcting TVI, measuring CL and Q of components, and determining RF circuit resonant frequencies. The variable meter sensitivity control, headphone jack, 500 microampere Simpson meter, continuous frequency coverage from 2 MC to 250 MC. Prewound coil kit and rack included.

LOW FREQUENCY COILS:

Low frequency range extended to 355 KC by the use of two additional coils. Complete with dial correlation curves. Set 341-A for GD-1B and set 341 for GD-1A. Shpg. wt. 1 lb. Price \$3.00



MODEL GD-1B

\$19.50

Shpg. Wt. 4 lbs.

Heathkit ANTENNA

IMPEDANCE METER KIT

MODEL AM-1

\$14.50

Shpg. Wt. 2 lbs.

Determine antenna resonance and resistance, transmission line surge impedance, and receiver input impedance. Works with one-half and one-quarter wave lines, half wave and folded dipoles, harmonic mobile and beam antennas. Resistance type SWR bridge—100 microampere meter—frequency range 0-150 MC—impedance range 0-600 ohms.



MODEL AC-1

\$14.50

Shpg. Wt. 4 lbs.

Heathkit
ANTENNA COUPLER KIT

For the Heathkit AT-1 Transmitter or any comparable Amateur Transmitter. Will handle power up to 75 watts at its 52 ohm coaxial input. Matches a wide range of antenna impedances with its L type tuning network and neon indicator. A tapped inductance provides coarse adjustment and a transmitting type variable condenser sets it "right on the nose." Will operate on the 10 through 80 meter bands.

HEATH company

BENTON HARBOR 20,
MICHIGAN

New LOW PRICED HEATHKIT SINGLE UNIT Williamson Type High Fidelity AMPLIFIER KIT

Here is the newest Heathkit Hi-Fi Amplifier at the lowest price ever quoted for a complete Williamson Type Amplifier circuit. The W-4 Model has been designed for single chassis construction, and only for the new Chicago Transformer Company Model BO-13 "super range" high fidelity output transformer. This transformer, a new development in the Hi-Fi field, is being offered at substantial saving over transformers of comparable quality. It is outstanding in performance and on the basis of our tests, we find it equal in every respect to transformers used in the W-2 and W-3 Heathkit series.

LOW PRICES:

Through utilization of a single chassis with resultant economy obtained through elimination of duplicate sheet metal fabrication, connecting cables, plugs, sockets, and a new Chicago "super range" output transformer, a 20% price reduction has been made possible without sacrificing kit quality.

COMPONENTS:

The new Heathkit W-4 uses the same heavy duty power transformer and choke. It has all of the features of previous models including individual jacks and a wire wound control to balance the output tubes—plastic high quality capacitors and the exact circuitry previously utilized in Williamson Type Amplifiers. Intermodulation distortion and harmonic distortion are both at the same low level as in the W-2 and W-3 models.

CONSTRUCTION:

Here is the opportunity for even the economy minded Hi-Fi enthusiast to enjoy all of the advantages offered through Hi-Fi reproduction of fine recorded music. Simplified step-by-step Construction Manual completely eliminates necessity of electronic knowledge or special equipment. Assemble this Amplifier in a few pleasant hours.

Rugged, heavy duty,
single chassis con-
struction.

Output impedances
4, 8, and 16 ohms.

Standard
brand com-
ponents used,
no sacrifice of
quality.



Lowest price high quality
Williamson Type Amplifier
ever offered.

Send for
free booklet
"High
Fidelity
Especially
For You."

COMBINATIONS AVAILABLE

W-4M with Chicago "super-range" transformer only. Single chassis main amplifier and power supply. Shipping **\$39.75**
weight 28 lbs. Express only

COMBINATION W-4 with Chicago "super-range" transformer only includes single chassis main amplifier and power supply with W-A-P2 preamplifier kit. Shpg. wt. 35 lbs. Express only **\$59.50**

NEW Heathkit 20 WATT High Fidelity AMPLIFIER KIT



MODEL A-9B

\$35⁵⁰

Shpg. Wt. 24 lbs.

In keeping with the progressive policy of the Heath Company, further improvement has been made in the already famous Heathkit High Fidelity 20 Watt Amplifier. Additional reserve power has been obtained by using a heavier power transformer. A new output transformer designed and manufactured especially for the Heath Company, now provides output impedances of 4, 8, 16 and 500 ohms. The harmonic distortion level will not exceed 1% at the rated output.

FEATURES:

Outstanding features of the Heathkit 20 watt Amplifier include frequency response of ± 1 db from 20 CPS to 20 KC. Separate (boost and cut) bass and treble tone controls. Four switch selected input jacks and a special hum balancing control. Flexibility is emphasized in the input circuits and proper equalization for all input devices is incorporated.

TUBE LINEUP:

12AX7 magnetic preamplifier and first audio amplifier. 12AU7 two stage amplifier with tone controls. 12AU7 voltage amplifier and phase splitter. Two 6L6 push-pull beam power output and 6U4G rectifier.

The Heathkit Model A-9B is excellent for custom installation and is designed for outstanding service at a very reasonable cost.

Heathkit SIX WATT AMPLIFIER KIT



MODEL A-7B

\$15⁵⁰

Shpg. Wt. 10 lbs.

An outstanding value, this economically priced 5 watt Amplifier is capable of performance expected only in much more expensive units. Only 2 or 3 watts output will ever be used in normal home applications and Model A-7B will be more than adequate for this purpose.

SPECIFICATIONS:

Two switch selected inputs are available for crystal and ceramic phono pickups, tuner, TV audio, tape recorder, and carbon type microphone. Model A-7B features separate bass and treble tone controls, push-pull balanced output stages, output impedances of 4, 8, and 15 ohms, and extremely wide frequency range $\pm 1\frac{1}{2}$ db from 20 CPS to 20 KC. Not just a souped up AC-DC job. Full wave rectification, transformer operated power supply and good filtering, result in exceptionally low hum level.

MODEL A-7C

Provides a preamplifier stage and proper compensation for the variable reluctance cartridge and low level microphone. \$17.50

Heathkit WILLIAMSON TYPE AMPLIFIER KIT

Here is the famous kit form Williamson Type high fidelity Amplifier that has deservedly earned highest praise from every strata of Hi-Fi music lovers. Virtually distortionless, clean musical reproduction, full range frequency response, and more than adequate power reserve.

OUTPUT TRANSFORMERS:

This outstanding Williamson Type Hi-Fidelity Amplifier is supplied with the famous Acrosound TO-300 output transformer. This quality transformer features the popular "ultra-linear" output circuit for clean maximum power level. Separate chassis for amplifier and power supply.

SPECIFICATIONS:

Frequency response within 1 db from 10 cycles to 100,000 cycles. Harmonic distortion at 5 watt output less than .5% between 20 cycles and 20,000 cycles. 1M distortion at 5 watts equivalent output .5% using 60 and 3,000 cycles. Output impedances of 4, 8, or 16 ohms. Overall dimensions for each unit 7" high x 5 $\frac{1}{2}$ " wide x 11 $\frac{1}{2}$ " long.

CONSTRUCTION MANUAL:

This fine kit is supplied with a completely detailed step-by-step Construction Manual and the only effort required is the assembly and wiring of the pre-engineered kit. Even the complete novice can successfully construct this Amplifier and have fun building it.

COMBINATIONS AVAILABLE:

W-3 Amplifier Kit (Includes Main Amplifier with Acrosound Output Transformer, Power Supply and WA-P2 Preamplifier.) Shipping weight 37 lbs. **\$69.50**
Shipped express only.....

W-3M Amplifier Kit (Includes Main Amplifier with Acrosound Output Transformer and Power Supply.) Shipping weight 29 lbs. Express only **\$49.75**



HEATH company
BENTON HARBOR 20,
MICHIGAN

Separate BFO oscillator tube and circuit.

Continuous coverage 550 KC-35 MC on 4 Bands.



MODEL AR-2
\$25.50
 (Less Cabinet)
 Shpg. Wt. 12 lbs.

Phone—standby—CW panel switch.

RF gain control with AGC on-off switch.

Electrical band-spread tuning with logging scales.

Receiver employs high gain miniature tubes and IF transformers, chassis mounted $5\frac{1}{2}$ " PM speaker, headphone jack, slide rule dial with Ham Bands plainly identified, and easy tuning with direct planetary drive. Continuous frequency coverage from 550 KC to 35 MC on 4 Bands, with electrical bandspread tuning and logging scales. Other features are RF gain control with AGC on-off switch—phone-standby-CW panel switch—prewound coils in a shielded turret assembly and copper plated chassis and shielding.

Heathkit COMMUNICATIONS RECEIVER KIT

An excellent example of typical Heath Company ability to produce top quality kit merchandise at ridiculously low prices, is the AR-2 Communications Receiver. Here is a transformer operated all-wave receiver with all of the desired features and none of the disadvantages commonly encountered in so-called "economy sets."

Receiver employs high gain miniature tubes and IF transformers, chassis mounted $5\frac{1}{2}$ " PM speaker, headphone jack, slide rule dial with Ham Bands plainly identified, and easy tuning with direct planetary drive. Continuous frequency coverage from 550 KC to 35 MC on 4 Bands, with electrical bandspread tuning and logging scales. Other features are RF gain control with AGC on-off switch—phone-standby-CW panel switch—prewound coils in a shielded turret assembly and copper plated chassis and shielding.

Uses 12BE6 mixer-oscillator, 12BA6 1F amplifier, 12AV6 detector-first audio, 12A6 beam power output, 12BA6 BFO oscillator.

and 5Y3 rectifier. A lettered control plate is provided for the cabinet of your choice or you can order the optional Heathkit cabinet featuring the full size aluminum panel.

RECEIVER CABINETS

Proxylon impregnated fabric covered plywood cabinet available for BR-2 and AR-2 receivers. Includes aluminum panel, floored reinforced speaker grill and protective rubber feet.

For BR-2 Receiver, Cabinet 91-9
 Shipping weight 5 lbs. **\$4.50**

AR-2 Receiver, Cabinet 91-10
 Shipping weight 5 lbs. **\$4.50**

Heathkit FM TUNER KIT

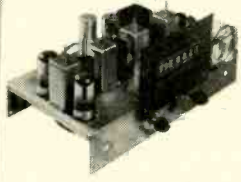

MODEL FM-2

\$22.50

Shpg. Wt. 8 lbs.

Here is an FM Tuner that can be operated with your Hi-Fi Amplifier or through the "phono" section of the ordinary radio. Completely AC operated to eliminate problems usually encountered in "economy type" AC-DC tuner circuits. Features 8 tube circuit with separate mixer and oscillator, 3 double tuned IF stages followed by a limiter discriminator providing maximum sensitivity and selectivity across the full FM frequency band of 88 MC to 108 MC. The tuning unit is factory assembled and adjusted, thus eliminating tedious critical "front end" alignment problems. The attractive slide rule dial and vernier tuning combine to make the Heathkit FM-2 Tuner simple to operate.

Heathkit

BROADCAST BAND RECEIVER KIT



MODEL BR-2

\$17.50

(Less Cabinet)

Shpg. Wt. 10 lbs.

The Model BR-2 Broadcast Band Receiver is designed especially for the beginner without any sacrifice of quality. This receiver features a transformer operated power supply, high gain miniature tubes, sharply tuned IF transformers, new rod type built-in antenna, and a trouble-free planetary tuning system. Exceptional performance with unusually high sensitivity, good selectivity, and excellent tone quality from the $5\frac{1}{2}$ " PM chassis mounted speaker. Can be used either as a receiver, tuner, or phono amplifier. Uses 12BE6 mixer-oscillator, 12BA6 1F amplifier, 12AV6 detector, 12A6 beam power output, and 5Y3 rectifier.

HEATH COMPANY • Benton Harbor 20, Mich.

ORDER BLANK



MAIL YOUR ORDER TODAY TO THE
HEATH COMPANY
 BENTON HARBOR 20,
 MICHIGAN

WALNUT 5-1175

From _____

SHIP VIA

- Parcel Post
- Express
- Freight
- Best Way

(PLEASE PRINT)

QUANTITY	ITEM	MODEL NO.	PRICE

Enclosed find () check () money order for _____ pounds.
 Please ship C.O.D. () postage enclosed for _____ pounds.

On Express orders do not include transportation charges—they will be collected by the express agency at time of delivery.

ON PARCEL POST ORDERS insure postage for weight shown.

ORDERS FROM CANADA and APO's must include full remittance.

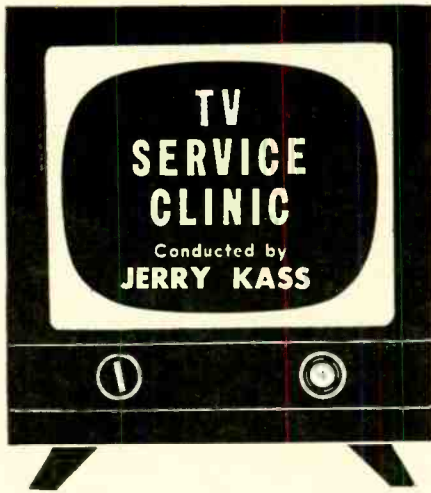

IN trouble-shooting the picture-tube power supply the service technician runs into an ironic situation. Voltages in this circuit are extremely high so the technician has no difficulty determining whether they are present. But just because these voltages are so high conventional trouble-shooting techniques and equipment cannot be used.

The flyback or "kickback" power supply has proved to be the most efficient system and is almost universally used. Technicians will seldom come across an r.f. power supply these days. We will consider only the flyback system.

High voltage is a byproduct of the horizontal deflection circuit. Though many modifications have been made in the design of the horizontal system to improve high-voltage circuit operation, it nevertheless remains true that a properly operating second-anode supply can result only from a properly operating horizontal deflection circuit.

The dependence of the high-voltage circuit on other circuits can be seen in Fig. 1. The a.c. voltage necessary to drive the high-voltage rectifier is generated in the horizontal deflection coils. During each horizontal sweep the current flowing through the deflection coil (Fig. 2-a) increases at a linear rate, causing the electron beam to sweep horizontally across the face of the screen. When the plate current of the horizontal output tube is cut off at the end of each horizontal trace, the magnetic field around the horizontal deflection coil collapses rapidly, generating a large inductive kick. This kick consists of an approximately 1,200-volt negative pulse.

With the horizontal output tube cut off and with the deflection coil connected directly across the secondary (L3 in Fig. 1) of the horizontal output transformer, the deflection coil acts as a generator of large pulses. During this time the output transformer acts in reverse. The usual secondary winding acts as the primary, and the usual step-down function of the transformer becomes one of voltage stepup.

The stepdown ratio in these output

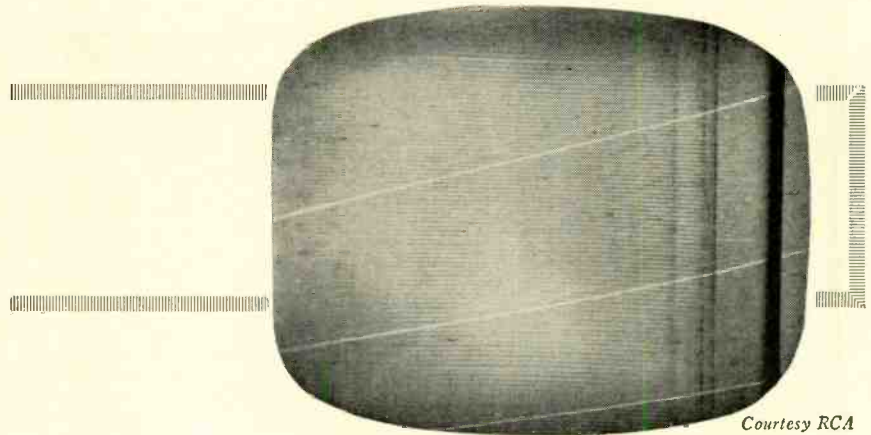

Typical Barkhausen interference bars.

transformers varies—let us assume ours is 5 to 1. Thus we can expect a 1-5

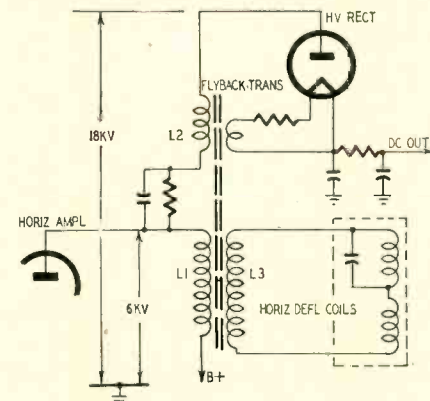

Fig. 1—A typical flyback type power supply and horizontal output circuit.

voltage stepup of the inductive kick, with approximately 6,000 volts appearing across the transformer primary (L1) and at the plate of the output tube (Fig. 2-b). This same transformer action reverses the polarity of the pulse, making the plate of the output tube positive. It is because of this

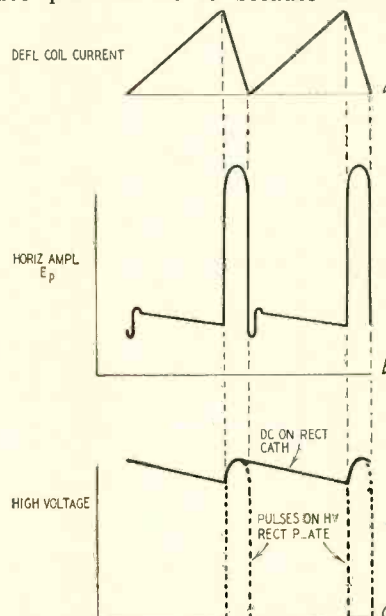

Fig. 2—Waveforms in deflection yoke, output plate and high-voltage rectifier.

enormous pulse voltage that a note appears on almost all TV schematics warning the service technician not to attempt direct voltage measurements at the plate of the horizontal output tube. If measurement is necessary, a high-voltage probe should be used.

There is an additional winding (L2) connected in series with the primary; the two together constitute an auto-transformer. The number of turns in L2 is usually several times that in L1. The exact ratio determines the positive pulse voltage that—increased by auto-transformer action—is fed to the plate of the high-voltage rectifier tube.

The flyback transformer used to create these high potentials has undergone a great deal of modification. Since the development of large-screen tubes, the older powdered-iron units have given way to the present ceramic-core high-efficiency types, making possible the necessary higher voltages.

Rectifier

The high-voltage rectifier does the same job as any conventional rectifier. The high pulse voltage is applied to the plate of the rectifier tube and converted into a d.c. voltage (Fig. 2-c) suitable for second-anode use on a TV picture tube.

Because of the relatively high frequency of the pulse voltages applied to the rectifier tube (15,750 cycles) and the small current drain (approximately 200 μ a), the filtering circuit is simple.

The rectifier is usually a half-wave unit such as the 1B3-GT or 1X2. A high-voltage rectifier tube is unique only in its ability to handle large pulse-shaped a.c. waves, sometimes as high as 20 kv. Since the rectified high voltage is taken from the filament of the tube, heating the filament with a conventional transformer would be impractical. Extremely heavy insulation would be required. So filaments are heated by connecting them to one or two loops of heavily insulated wire wound around a section of the horizontal output transformer. Both the 1B3-GT and the 1X2 draw about 1/4 watt of filament power (1.25 volts, 0.2 amp).

In series with many filaments is a

OUTSTANDING for HIGH FIDELITY!

**BUY DIRECT
AND SAVE**

'PRE-FAB' COLLINS TUNERS and RECEIVERS
AUDIO PRODUCTS CO.

NOW!
with AFC

Collins Audio Products Co., Inc. is not affiliated with Collins Radio Co.

Each Collins Tuner Kit is complete with punched chassis, tubes, power transformer, power supply components, hardware, dial assembly, tuning eye, knobs, wire, etc., as well as the completed sub-assemblies: FM tuning units, AM tuning units, IF amplifiers, etc., where applicable. All sub-assemblies wired, tested and aligned at the factory make Collins Pre-Fab Kits easy to assemble even without technical knowledge. The end result is a fine, high quality, high fidelity instrument at often less than half the cost—because you helped make it and bought it direct from the factory.

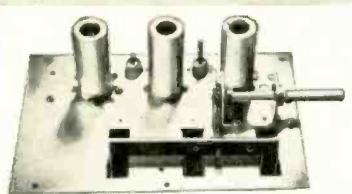

FMF-3 Tuning Unit
\$15²⁵
with AFC \$18.75

The best for FM. The most sensitive and most selective type of "front end" on the market. 6 to 10 microvolts sensitivity. Image ratio 500 to 1. 6J6 tuned RF stage, 6AG5 converter, 6C4 oscillator. Permeability tuned, stable and drift-free. Chassis plate measures 6 1/2" x 4 1/2". In combination with the IF-6 amplifier, the highest order of sensitivity on FM can be attained. Tubes included as well as schematic and instructions. Draws 30 ma. Shipping weight FMF-3: 2 1/2 lbs. Dial available @ \$3.85.

IF-6 Amplifier
\$19⁷⁵
6 Tubes. Shipping Wgt. 3 lbs.

FOR USERS OF COLLINS TUNERS:

Receive \$5.00 credit toward the new FMF-3A front end! Mail us your old front end with \$13.75 and we will send you the new, improved FMF-3A with AFC, or, remit the full amount of \$18.75 and when we receive your old unit in return a check will be mailed you for \$5.00.

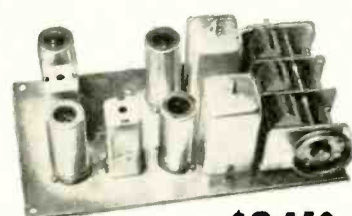

AM-4 Tuning Unit
\$24⁵⁰

Tops in AM superhet performance! A 3-gang tuning condenser gives 3 tuned stages with high sensitivity and selectivity. Assembly is completely wired, tested and aligned ready for immediate use. Frequency coverage 540 KC to 1650 KC at a sensitivity of 5 microvolts. Tubes 6BA6 RF amplifier; 6BE6 converter; 6BA6 IF amplifier and 6AT6 detector. Draws 30 ma @ 220 volts. Mounts on a chassis plate measuring 4" x 7 3/8". Shipping weight 2 1/2 lbs. Dial available at \$3.85.

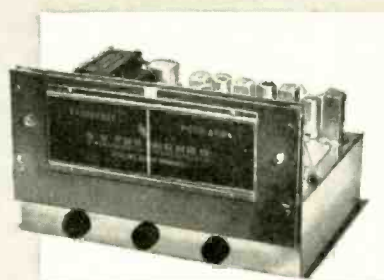

FM Tuner Kit
\$55
with AFC \$58.50

The FM-11 tuner is available in kit form with the IF Amplifier mounted in the chassis, wired and tested by us. You mount the completed RF Tuning Unit and power supply, then after some simple wiring, it's all set to operate. 11 tubes: 6J6 RF amp, 6AG5 converter, 6C4 oscillator, 6BA6 1st IF, (2) 6AU6 2nd and 3rd IF, (2) 6AU6 limiters, 6AL5 discriminator, 6AL7-GT double tuning eye, 5Y3-GT rectifier. Sensitivity 6 to 10 microvolts, less than 1/2 of 1% distortion, 20 to 20,000 cycle response with 2DB variation. Chassis dimensions: 12 1/2" wide, 8" deep, 7" high. Illustrated manual supplied. Shipping weight 14 lbs.

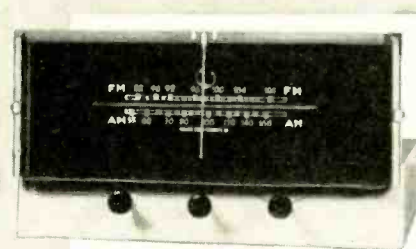

FM/AM Tuner Kit
\$77⁵⁰
with AFC \$81.00

The original 15 tube deluxe FM/AM pre-fab kit redesigned on a smaller chassis. The tuner now measures 14" wide by 12" deep by 7 1/2" high. This attractive new front and dial assembly opens up new applications where space is at a premium. Kit includes everything necessary to put it into operation—punched chassis, tubes, wired and aligned components, power supply, hardware, etc. Kit comprises FMF-3 tuning unit, IF-6 amplifier, AM-4 AM tuning unit, magic eye assembly and complete instructions. All tubes included. Shipping weight 19 lbs.

**MAIL
COUPON
TODAY**

To: Collins Audio Products Co., Inc. RE-12
P.O. Box 368, Westfield, N. J.
Tel. Westfield 2-4290

FM Tuner Kit FM/AM Tuner Kit FMF-3 Tuning Unit
 with AFC with AFC with AFC
 IF-6 Amplifier AM-4 Tuning Unit

NAME _____
ADDRESS _____
CITY _____ STATE _____
Amount for Kit \$ _____ See weights, add shipping cost \$ _____
Total amount enclosed \$ _____ Check Money Order

TELEVISION

current limiting resistor. It is frequently imbedded in high-voltage wax and helps to prevent filament burnout. This resistor requires special attention. Because of the pulsed nature of the filament current, it tends to char.

The filter circuit is usually a simple R-C network. The resistor is generally about 1/2 megohm and the capacitor 500 μf. In some cases even the filter resistor is omitted.

To simplify the circuit further, the 500-μf filter capacitor frequently consists of the capacitance between the Aquadag coating in the picture tube and a second conductive coating on the outside surface of the tube. The glass of the tube acts as the dielectric and has a very high voltage breakdown rating. The outer coating is usually grounded by spring wires connected to the deflection yoke bracket.

Since the capacitor is so small, and the current drain low, a dangerous charge cannot be stored, making this type of power supply relatively safe. Regulation is also very poor, the output voltage decreasing sharply with overload. Conventional high-voltage capacitors used in this circuit are so constructed as to present a high-resistance leakage path to the high voltage.

This type of power supply is referred to as the flyback type because the pulse voltage is developed during the horizontal retrace period. During this time, an action of extreme interest to the service technician takes place. Fig. 2-b shows the falling edge of the inductive kick overshooting its starting position. This makes the plate of the output tube extremely negative with respect to the screen grid. As a result, electrons oscillate around the screen grid, resulting in a light vertical bar at the left edge of the picture tube (see photo). This is the usual symptom of Barkhausen oscillations.

These are radiated from the output tube and frequently picked up by the antenna lead and fed back through the receiver. A strong signal will usually eliminate this interference, because the large a.g.c. voltage developed will make the receiver insensitive to this usually weak signal.

The negative swing is a resonant effect caused by leakage inductance in the flyback transformer. Elimination of this and other defects involving the high-voltage rectifier will be discussed in our next issue.

Any imperfection in the horizontal deflection circuit is bound to reduce the amplitude of the inductive kick and thus the second-anode voltage. This will cause defocusing and a "soft" beam, permitting the deflection voltages to have greater influence and creating an effect known as "blooming."

Many receivers contain an R-C network between the windings of the autotransformer (Fig. 1) They are included as a safety factor to prevent damage in case the plate cap of the high-voltage rectifier tube accidentally touches the chassis. The network will

WHEN YOU THINK OF TUNERS. THINK OF COLLINS AUDIO PRODUCTS

TELEVISION

also provide protection against a burn in case the technician contacts the high-voltage line. It also limits the amount of current flow in short circuits and minimizes shock hazard in transformerless sets.

These components have no effect on circuit operation unless they become defective. Should the capacitor open, the high voltage drops considerably and there will be no brightness. Its value is approximately $.001 \mu\text{f}$, and it provides a path for the 15,750-cycle pulses across the resistor.

Spooks

I have a Sparton receiver, model 24U174, and get a very thin vertical line at the extreme left edge of the raster. At first I took it for Barkhausen oscillations, but I notice it only on the lower channels and it seems thinner and differs in appearance from Barkhausen oscillations. It appears to be the effect of some kind of radiation. I have changed the horizontal oscillator and output tubes, the damper and the high-voltage rectifier. I have also checked the entire output circuit for arcing but there doesn't seem to be any. I would appreciate your help.—A. R., Webster, N. Y.

The probability is that the effect you describe is "spooks." It is seldom troublesome because it generally appears beyond the visible portion of the raster and can be ignored. It is only comparatively recently that particular attention has been paid to this trouble, and it is the effect of radiation.

Many harmonics are generated in the damper circuit as a result of the rapid rise in deflection current. These are radiated, picked up by the antenna, r.f. or i.f. circuits, and appear on the screen. Aside from adjusting the deflection circuit for maximum linearity, there are very few remedies. The most

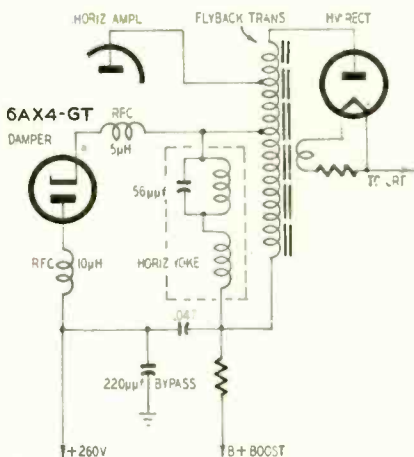
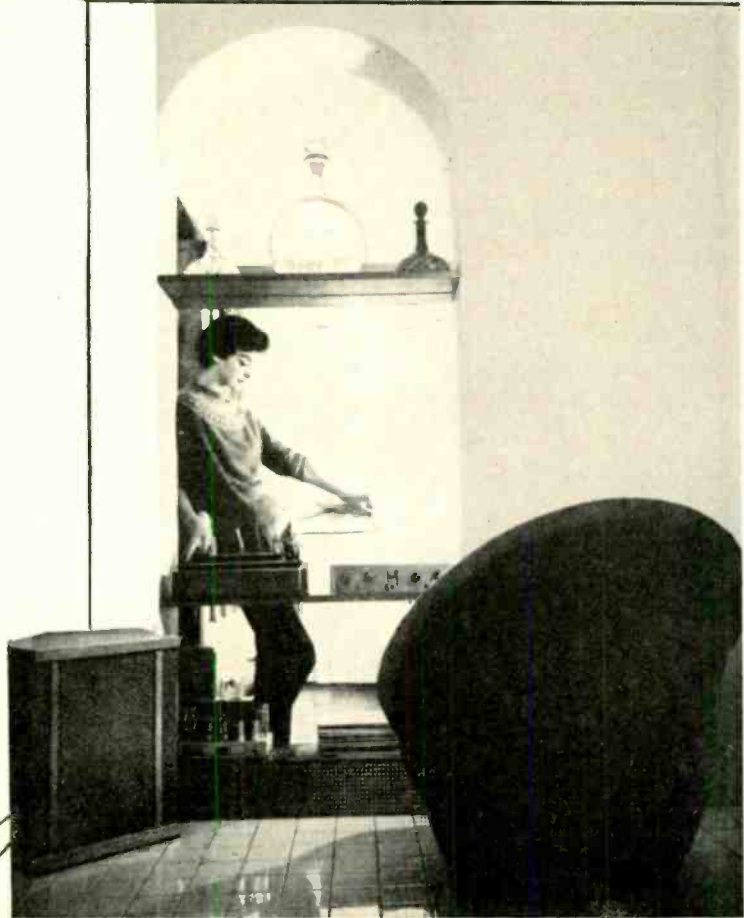

Fig. 3—The two r.f. chokes and bypass capacitor reduce radiation from damper.

effective check on this radiation consists of inserting r.f. chokes of 1–15 μH in the cathode, heater and plate circuits of the damper tube. Small bypass ca-

.. fantastic!



THE

Rebel

KR-5

20" CORNER FOLDED HORN FOR 8" AND 12" SPEAKERS

THE LITTLEST REBEL, The KR-5, approaches Klipschorn performance on light, middle bass. Heavy pipe organ bass is even more amazing with smooth, clean reproduction completely free from unmusical boom and distracting distortion. This latest Klipsch design by Cabinart, fifth in the CABINART-KLIPSCH REBEL series, is available in all fine woods, utility birch and, for portable hi-fi, strikingly smart leatherette.

Wall mount the Rebel 5, hang or set it in a corner. Place it on a table — a bench — a shelf — anywhere! Performance . . . absolutely unbelievable! See your nearest Cabinart hi-fi dealer or write for catalogs.

Finished **\$48.00**

Utility **\$33.00**

Cabinets  by Cabinart

75 North 11th Street, Brooklyn 11, N. Y.

* Trade Mark

**Unique
Centralab plan
provides
4,000 dual-control
combinations**

**And your
Centralab distributor
has them IN STOCK**

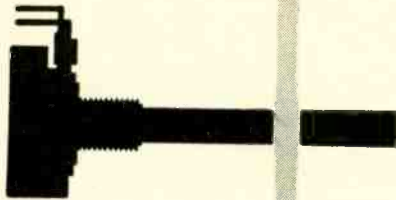

With Centralab's new Fastatch* front and rear units, it's a snap to get the right replacement for practically any dual control, current or future (including color TV)! See for yourself:

Snap front unit . . .

(with outer shaft cut to length)



To rear unit . . .

(with blue shaft cut to length)



Snap on switch

(from Fastatch KB series)



Add the knobs

—and there's your custom dual

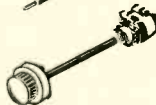

That's all there is to it—sounds easy, doesn't it? It is! There are no loose parts . . . no lugs to bend . . . no tricky assembling. Fastatch front and rear units are completely assembled, tested, and guaranteed by Centralab.

Ask your Centralab distributor to show you Fastatch Duals. And send coupon for bulletin 42-218.

*Trademark

Centralab

Tear out coupon and mail today!

A Division of Globe-Union Inc.
922 E. Keefe Avenue, Milwaukee 1, Wisconsin

Send me free bulletin 42-218.

Name.....

Company.....

Address.....

City..... Zone..... State.....

City..... Zone..... State.....

TELEVISION

capacitors may also be used. See Fig. 3 for a typical circuit.

This effect is most noticeable on the low-band channels because the strength of harmonics decreases with increase in frequency.

Since the vertical line appears on the extreme left edge of the picture, should you have difficulty eliminating this interference, simply increase the width slightly to move the line behind the mask. Most receivers are capable of a little extra width.

Burned plate resistor

I have an Admiral model 21B1 on the bench for the second time. In each case the complaint was the same. No pictures on the weak-signal channels and weak pictures with lots of snow on the stronger ones. The set uses a high-gain cascode tuner. The first time in the shop I replaced a few components in the tuner and that corrected it. Now one of the components I replaced the last time, the cascode plate resistor, is defective. I don't want just to replace it and have another callback. I'd appreciate some help.—C. B., Richmond, Va.

The plate resistor was probably burned out by excessive plate current in the r.f. amplifier. This is especially true in the type 6BK7 that is used in this receiver. The r.f. amplifier circuit is far too critical to attempt reducing the plate current. A more practical approach would consist of replacing the plate resistor with a 1-watt unit. It will easily handle the current flow.

In many cases this failure is the result of a shorted bypass capacitor between ground and the plate end of this resistor. There have been several instances where this capacitor shorted to the cover plate of the tuner. After replacing the resistor, carefully check the bypass capacitor before reassembling the tuner.

Critical focus

I would like some information on a Capehart receiver, chassis CX-33. I have had this set for over two years and cannot find the cause of its critical focus. There is no instability involved. When the focus is adjusted for optimum sharpness, it will stay put for a few weeks. Then it will go out of focus again and I have to readjust the focus control. I have checked every component in the focus circuit and all voltages. Every value, as far as I can determine, is exactly as the manufacturer's schematic.—S. E., Biloxi, Miss.

Check the direction of taper of the focus control. If it is reversed, the focusing point, while obtainable, will be extremely critical—so much so that even the slight aging of any of several tubes will cause defocusing. Set the control at the center of its rotation and measure the resistance between the center terminal and the unused outer terminal—you should get about 3,500 ohms. If the resistance measures about 1,000 ohms, reverse the outer terminal connection.

END



FOR THE LEASTEST . . .

Unlimited thrills from any TV set, new or old. More programs, more variety, more pleasure from a few dollars invested in a Granco converter to tune in those local UHF stations. Install it yourself in a few minutes.

\$24⁹⁵

Granco

MODEL SLU

ASK YOUR DEALER!

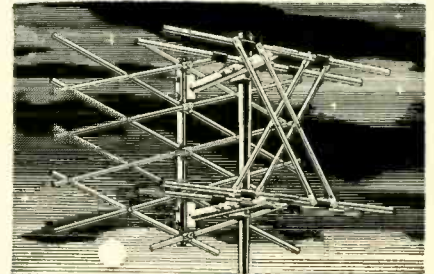

THE NEW RADELCO



ALL-CHANNEL ANTENNA

with the Sensational
Diamond-Back Reflector

UNSURPASSED FOR
FRINGE AND FAR FRINGE
RECEPTION

MODEL DN-2 FOR VHF-UHF

ORDER FROM
YOUR NEAREST **\$34⁹⁵**
PARTS DEALER LIST

● THE ONE INSTRUMENT YOU NEED



FOR

Color

JACKSON COLOR BAR / DOT GENERATOR

Signal Outputs

1. Composite video of either polarity, adjustable amplitude to 2 volts across 90 ohms.
2. Modulated R.F., channels 3 through 5, 0.1 volt across 300 ohms.
3. Horizontal sync., positive polarity, 1 volt across 200 ohms.
4. Color subcarrier, 4 volts across 200 ohms at burst phase.

Synchronizing Signals

1. Horizontal sync. and blanking (F.C.C. standards).
2. Vertical sync., serrated and locked to horizontal.
3. Vertical blanking.
4. Color burst (N.T.S.C. standards).

Video Signals

1. Dots (nominal 108 dots)
2. Crosshatch (nominal 12 by 9)
3. Color bars (5 switch positions)

Position 1—Multi.

8 Bars in the following sequence:

1. White, relative luminance 1.0, chrominance zero
2. Yellow, relative luminance 0.89, chrominance 0.44
3. Cyan, relative luminance 0.70, chrominance 0.63
4. Green, relative luminance 0.59, chrominance 0.59
5. Magenta, relative luminance 0.41, chrominance 0.59
6. Red, relative luminance 0.30, chrominance 0.63
7. Blue, relative luminance 0.11, chrominance 0.44

8. Black, relative luminance zero, chrominance zero

Luminance and chrominance held to 10 percent, phase angles to ± 5 degrees

Position 2—Color Difference.

7 Bars of zero luminance in the following sequence:

1. Black, relative chrominance zero.
2. I, relative chrominance 0.25
3. Q, relative chrominance 0.25
4. Black, relative chrominance zero
5. R-Y, relative chrominance 0.25
6. B-Y, relative chrominance 0.25
7. Black, relative chrominance zero

Phase angles held to ± 2 degrees.

Positions 3, 4 and 5—Single bars, luminance 0.3, chrominance 0.5, occupying approximately 60% of screen width.

1. Red (position 3)
2. Green (position 4)
3. Blue (position 5)

Sound Carrier, approximately 25% of peak picture carrier, placed 4.5 megacycles from picture carrier.

Panel Controls

1. R.F. carrier tuning, channels 3 through 5.
2. Video output amplitude.
3. Horizontal lock.
4. Standby switch (sound on, sound off).
5. Video output polarity switch.
6. Power switch.
7. Function switch (crosshatch — dots — color bars)
8. Color bar switch (Multi, Color Diff., Red, Green, Blue).

Internal Adjustments

1. Burst amplitude.
2. 3.58 frequency vernier.
3. Sync. lock controls.

Tube Complement

12AT7 — 8	6J6 — 10
12AX7 — 4	5U4-G — 1
6AL5 — 1	6BJ7 — 1

Circuit Operation

1. Color sub-carrier and sound frequencies are determined by crystal oscillators.
2. Color phase angles are determined by an accurate, low impedance delay line.
3. Direct gating of proper chrominance phase is employed for each color bar to attain maximum stability and reliability rather than usual methods utilizing quadrature encoders.
4. Serrated vertical sync. is maintained an integral divisor of horizontal rate.
5. Luminance and chrominance levels are reliable and stable. No multivibrators are employed in generating color bars.
6. No internal or external adjustments are necessary for proper bar widths, luminance or chrominance levels. For use on 105-125 volts 60 cycle AC.

Physical Characteristics

Dimensions—16½" wide x 9½" high x 10¼" deep. Designed to match other Jackson TV Equipment, both in styling and exterior dimensions.

Weights—27 net pounds. Shipping 32 pounds.

"Service Engineered" Test Equipment

16-18 South Patterson Boulevard, Dayton 2, Ohio • In Canada: The Canadian Marconi Company

DECEMBER, 1954



Dogs..

without DATA

Servicing the tough ones without voltage and waveform data

By ROBERT G. MIDDLETON*

MERELY because the technician succeeds in localizing the trouble in a "dog" chassis, it should not be assumed that the receiver can be easily restored to normal operation. For example, it may be found that a horizontal output transformer has some shorted turns. But unless a replacement can be obtained, it may be a big job to restore the receiver to normal operation. This situation becomes aggravated when the transformer operates in a complex arrangement, feeding back pulse voltages to the a.f.c., horizontal oscillator, and keyed a.g.c. circuit, as well as to the booster and high-voltage circuits. In some arrangements, pulses are also fed to blanking circuits to eliminate retrace lines and Barkhausen lines, for operation of noise gates, and to peak the horizontal drive voltage.

A big job can be avoided by using a replacement transformer close to the original specifications. But sometimes the remaining differences are sufficient to prevent proper operation. If the operating waveforms and peak-to-peak voltages are available, the technician can sometimes design correcting circuits to compensate for the replacement transformer differences. This procedure comes under the heading of redesign, which most service shops (wisely) do not care to tackle.

In some instances, technicians sug-

gest converting the entire circuit to a standard arrangement. Since this is costly, the customer often refuses to permit it. In such a case it becomes necessary to advise the customer that the receiver is obsolete and no longer worth fixing. Any reasonable customer will accept the logic of the situation.

Sometimes waveforms and peak-to-peak voltage data cannot be obtained for a particular chassis. In a situation of this kind, there are two possible procedures. In some cases, the necessary data can be found for another make of receiver which uses the same circuit arrangement. This requires considerable searching. A great deal of time can be saved if cross-reference data are available to the technician. Since cross-reference data are not published commercially, the technician must build up his own file of pertinent data. These are best filed in card-catalog form for ready reference.

The other procedure involves obtaining another receiver of the same type for comparative measurements of wave shapes and peak-to-peak voltages. If this method is used, the technician should record the peak-to-peak voltages and sketch the waveforms, so that he will have them available if a similar situation arises in the future.

When another receiver of the same type can be obtained, whole sections of the faulty receiver can be checked out. As shown in Fig. 1, the entire sync section of an auxiliary receiver (of the

same type) can be substituted for the sync section of a faulty receiver. The video signal from the cathode of the video amplifier is applied to the grid of the sync separator.

To check the entire sync section by substituting the sync section of an auxiliary receiver, the chassis are grounded together and the signal paths broken at suitable points. Test leads are then used to patch the section; they should be kept reasonably short. If there is trouble in the sync section of the faulty receiver, normal operation will be resumed when the test leads are connected. Various stages in the sync circuit can be eliminated by similar procedure, thus "closing in" on the faulty stage or component.

If normal operation is not resumed, it is apparent that the fault does not lie in the sync section, but in some other section of the receiver. The sweep section or the video section of the receiver can be patched in the same manner.

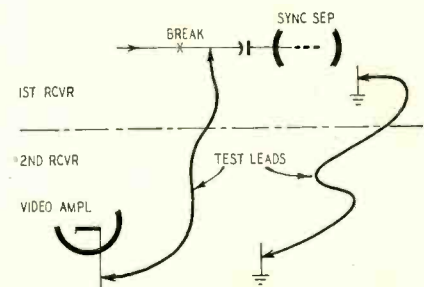

Fig. 1—Substituting the sync section.

*Field Engineer, Simpson Electric Co.

**Fabulous..Revolutionary
..Completely New..**

MIGHTY MO*

*Pat. No. 2680196, others pending.

**the most powerful antenna
ever built, featuring TESCON'S
NEW exclusive DDP (Double Diamond Phasing)**

Tescon's miraculous Mighty Mo will make prime signal areas out of even the deepest fringe sections of the country.

Mighty Mo... complete with DDP, an entirely new and revolutionary concept of phasing, will trap even the weakest signal and perk it up to a clear, brilliantly sharp, deep-toned picture. Tescon absolutely guarantees that each and every Mighty Mo will perform where other antennas have actually failed!

Unshakeable proof, substantiated by exhaustive field tests, definitely shows that Mighty Mo does more than any other antenna manufacturer loudly claims his product will do. Theoretical ratings will never pay off. Rely on tested results... that's your real proof, that's your money in the bank.

**Here's Mighty Mo's proof
...the results of ACTUAL
FIELD TESTS.**

- On channels 2 to 13, Mighty Mo outperforms every other antenna manufactured today.
- Higher uniform gain over all channels. Does not vary more than 1½ D.B. on any channel across band. Perfect on color TV.
- Clearer, sharper, deeper pictures on all channels.
- Higher average gain than 6 of the most advertised antennas

STOCK

**this red-hot, fast moving,
money-making antenna...right now!**

TESCON TV PRODUCTS COMPANY
SPRINGFIELD GARDENS 13, NEW YORK

MIGHTY MO'S FEATURES

- DDP (Double Diamond Phasing) precision-timed phasing regulator enables the weakest of signals to be trapped and then boosted to a clear, magnificently sharp, photo-like picture.
- Flat response... a must for color reception.
- Largest screen area... over 70 sq. ft. Screen elements spaced less than 1/10 wave length apart for maximum reflector efficiency.
- Highest front to back ratio ever achieved.
- Absolutely no rear pick up or co-channel interference... no "venetian blinds."
- ½ wave element spacing on all channels for super-gain.
- Completely preassembled... not an erector set type antenna.
- Uniform gain response... no erratic audio and video patterns.
- Thoroughly tested for mechanical stress and strain... exceptionally rugged.
- Guaranteed to perform where other antennas fail

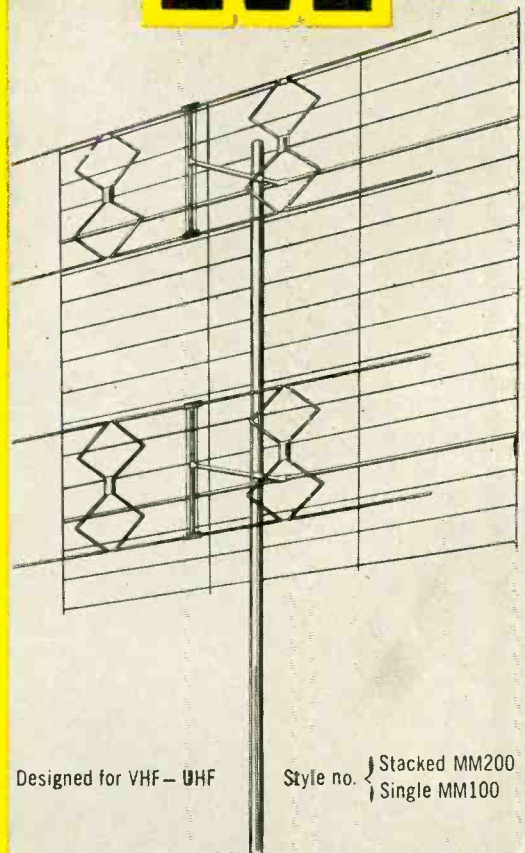

Designed for VHF - UHF

Style no. } Stacked MM200
 } Single MM100

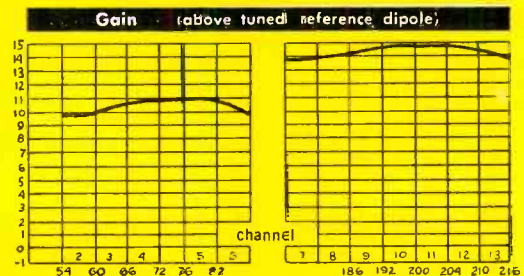

Most uniform gain response ever recorded.
Does not vary more than 1½ D.B. on any channel.
Extremely important for quality color reception.

©NTI

ELECTRICAL ENGINEERS

or

PHYSICS GRADUATES

with experience in

RADAR or ELECTRONICS

or those desiring to enter these areas...

*The time was never more opportune than now
for becoming associated with the field of advanced electronics.*

*Because of military emphasis this is the most
rapidly growing and promising sphere of endeavor for the young
electrical engineer or physicist.*

Since 1948 Hughes Research and Development Laboratories have been engaged in an expanding program for design, development and manufacture of highly complex radar fire control systems for fighter and interceptor aircraft. This requires Hughes technical advisors in the field to serve companies and military agencies employing the equipment.

As one of these field engineers you will become familiar with the entire systems in-

involved, including the most advanced electronic computers. With this advantage you will be ideally situated to broaden your experience and learning more quickly for future application to advanced electronics activity in either the military or the commercial field.

Positions are available in the continental United States for married and single men under 35 years of age. Overseas assignments are open to single men only.



Hughes Field Engineer H. Heaton Barker (right) discusses operation of fire control system with Royal Canadian Air Force technicians. Avro Canada CF-100 shown at right.

Relocation of applicant must not cause disruption of an urgent military project.



Scientific
and
Engineering
Staff

HUGHES

RESEARCH
AND
DEVELOPMENT
LABORATORIES

Culver City,
Los Angeles
County,
California

TELEVISION

Caution must be used in the case of transformerless receivers in which the power plugs may be "crossed," resulting in a short circuit. Transformerless receivers should always be powered by a line isolation transformer. The auto-transformer type of unit is unsuitable and will not isolate the receivers—separate primary and secondary windings must be provided.

Waveforms in faulty receivers

Interpretation of waveforms is not always an easy matter. When an auxiliary receiver is available, comparison checks can be made back and forth between the faulty receiver and the normal receiver. When an auxiliary receiver is not available, the technician may have trouble because of the incompleteness of the published data. In many cases the waveform and peak-to-peak voltage may check out correctly, but the circuit action will still be faulty because of minor spurious components in the waveform. Whether or not such minor spurious components are tolerable cannot be determined when the published waveforms are sketched rather than photographed; the technician making the sketch almost always deletes minor components which may be present in normal operation.

Trouble-shooting a dog

A dog receiver was brought in with the complaint that the picture pulled when the contrast control was set to a normal level. New tubes did not improve the situation and all d.c. voltages and resistances measured correctly. As the contrast control was advanced, the test-pattern circle became distorted. Inspection showed that the picture pulling followed black lettering in the pattern or followed black areas such as the horizontal wedge. This in itself was a clue since it was apparent that the distortion was due to the entry of video signal into the sync circuits.

In cases of this kind it is usually advisable to check the d.c. supply lines for spurious a.c. voltages. Spurious voltages can couple from one receiver section to another in the event of failure or partial failure of decoupling or bypass capacitors. Applying the scope across the B plus supply line to the sync section showed that various spurious a.c. voltages were present, at a level of 0.3 volt peak-to-peak. This level is high enough to cause trouble in some chassis, but not in all. Since the service data for the receiver did not state the normal level of a.c. voltage in this line, it was necessary to regard the spurious voltage with suspicion, and to eliminate the possibility of trouble from this source. Additional filter capacitance was shunted from the B plus line to chassis until the spurious voltage dropped to 0.1 volt peak-to-peak—with no apparent change in the picture pulling. Hence, the B plus line was given a clean bill of health.

Next the waveform at the horizontal phase detector was checked on the

NEW

PHILCO

Super Performance

TV

ANTENNAS

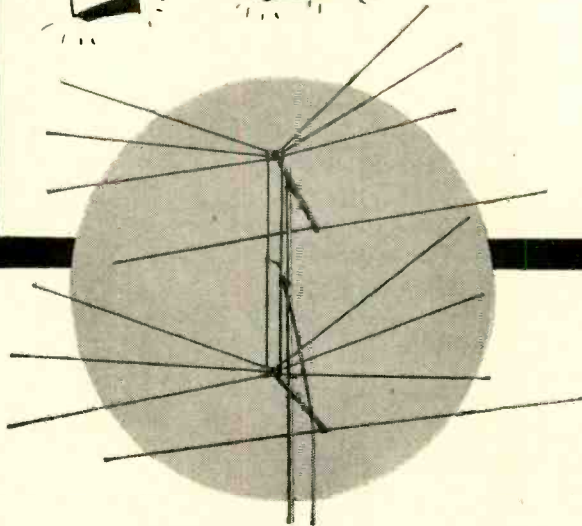

PHILCO TWO-BAY SUPER CONICAL

Strong signal pick-up on all VHF-UHF channels. Ideal for fringe area reception... aluminum construction with dowelled elements: Part No. 45-3096-2. Single bay design: Part No. 45-3096.

BUILD CUSTOMER CONFIDENCE... MORE SALES FOR YOU!

Designed to outperform any equivalent antenna in its class, each Philco Super Performance TV Antenna provides the finest picture possible... long life and ease of installation. Powerful Conical... all-aluminum VHF Yagis, engineered for quick rigging... light weight. Stacked versions provide top-quality fringe area reception. Only six UHF Yagis cover the entire UHF spectrum. Here's powerful reception on all channels... the kind that builds customer confidence... more sales for you!

GET YOUR "PHILCO FREE RIDE"

That's right! Ride any way you like it... or earn all of them! They're yours FREE with PHILCO FREE RIDE TICKETS... and there's no waiting! Collect your selected "ride" as soon as you have the necessary number of tickets. You can enjoy Rollfast Roller Skates; Radio Flyer Coaster Wagon; Rollfast Bicycle; BMC Juvenile Tractor; Airplane Trip for Two; 1/2 Ton Panel Dodge Truck; Plymouth Plaza Sedan. Concentrate your parts and accessories purchases on PHILCO and make double profits... profits through the great ready-made PHILCO market of PHILCO owners and PLUS

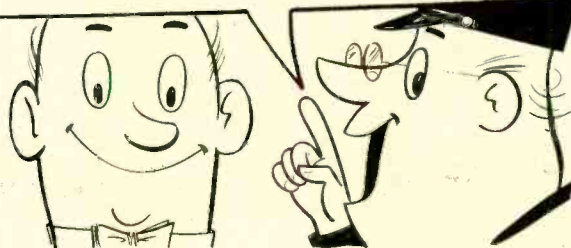

PROFITS with these great FREE RIDES... all at no extra cost to you. Don't wait... register NOW! Get started on your FREE RIDE with PHILCO!

SEE YOUR PHILCO DISTRIBUTOR FOR DETAILS



PHILCO CORPORATION

ACCESSORY DIVISION

"A" AND ALLEGHENY AVE., PHILADELPHIA 34, PA.

Here's how to GET MORE WORK OUT OF YOUR Oscilloscope!



A complete, easy guide to the handiest most profitable service instrument of all
MODERN OSCILLOSCOPES AND THEIR USES

By Jacob H. Ruiter, Jr.

of Allen B. Du Mont Laboratories, Inc.
326 pages, 370 illustrations. Price \$6.

Oscilloscopes are gold mines for servicemen who learn to use them fast, fully and accurately on all types of work—and here at last is a book that really shows you how.

In clear, easily understood terms, it teaches you when, where and exactly how to use the oscilloscope... how to interpret patterns... how to use your 'scope to handle tough jobs easier, faster and better.

It contains no involved mathematics—no complicated discussions. Instead it gets right down to "brass tacks" in explaining how oscilloscopes operate. Then you learn exactly how to use them in lab work and on all types of AM, FM and television service—from locating troubles to handling tough realignment jobs.

Each operation is clearly explained step by step. You learn to determine just where and how to use the 'scope on a specific job; how to make connections and adjust the circuit components; how to set the controls; and HOW TO ANALYZE OSCILLOSCOPE PATTERNS fast and accurately. 370 illustrations including dozens of pattern photos make things doubly clear.

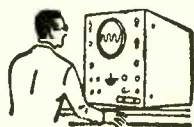

No other type of specific service training can mean so much to you in boosting your efficiency and earning power! Send coupon NOW for 10-day FREE examination!

'SCOPE
EXPERTS get
Better jobs...
bigger pay!

PRACTICE
10-DAYS
FREE!

Dept. RE-124, Rinehart & Co., Inc.
232 Madison Ave., New York 16, N. Y.
Send MODERN OSCILLOSCOPES AND THEIR USES for 10-Day FREE EXAMINATION. If book is satisfactory, I will then send you \$6.00 plus postage promptly in full payment. If not, I will return book postpaid in good condition and owe you nothing.

NAME.....
ADDRESS.....
CITY, ZONE, STATE.....
OUTSIDE U.S.A. \$6.50, cash only. Money back if you return book within 10 days.

TELEVISION

scope with the aid of a low-capacitance probe. The waveform appeared to have the same shape as the published waveform and the peak-to-peak voltage checked within 20%, usually considered satisfactory. However there was evidently some small amount of fuzzy spurious voltage also present, which did not appear in the data. It was questionable whether this spurious voltage was tolerable or not. A check was made to determine whether the spurious voltage was video information because, if the spurious voltage actually was residual video signal, it could easily account for picture pulling at this point in the circuit.

To make the check, the technician touched his finger very lightly to the tip of the low-capacitance probe while also touching the probe tip to the plate of the phase-detector tube (the body always picks up 60-cycle hum around the test bench). This mixed a small amount of 60-cycle hum with the waveform voltage at the phase detector. This type mixture causes a velocity modulation of the waveform, which develops a picture on the screen of the scope if the waveform contains video information. As a result of the test, the technician observed half the test pattern appeared in bas-relief on the scope screen and the suspicion that the spurious voltage consisted of video signal was verified. (See Fig. 2.)

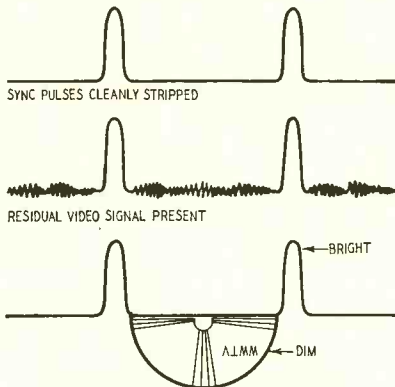

Fig. 2—Testing of spurious voltages.

Only half the test pattern appears because the 60-cycle hum voltage produces a folded-over vertical sweep in the scope, just as a 60-cycle sine-wave voltage produces a folded-over picture when applied to the vertical deflection coils of the picture tube.

The picture on the scope screen appears to be in bas-relief because the picture is being developed by velocity modulation, with the result that the high-frequency portions of the video signal are much more apparent in the reproduced signal than are the low-frequency portions.

Since it was now known that the fuzzy portion of the display consisted of spurious video signal, it was apparent that the trouble was in the sync separator where the camera signal is normally removed from the sync pulses. From this point on, the job was simple enough.

A LONG AND DISTINGUISHED LINE OF CANNON PLUGS

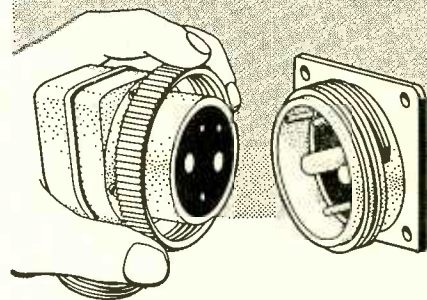

TYPES K AND RK CONNECTORS

for radio, television, instrument and general electrical and electronic circuits

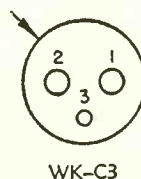
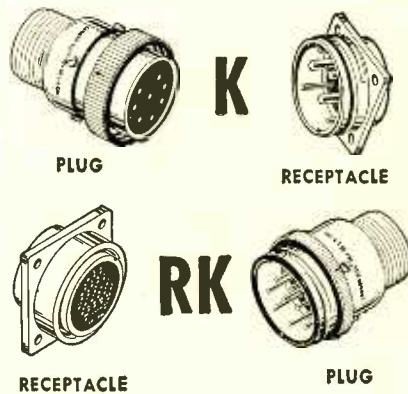

Cannon Electric K and RK plugs and receptacles include 14 shell types in 8 sizes with 199 insert (lay-out) arrangements. The line includes 6 accessory fittings. Contact capacities

include 10, 15, 30, 40, 60, 80, 115 and 200-amperes. Conduit and cable clamp entries accommodate Navy, Air Corps and A-N threads. The special acme thread of the coupling nut assures long service, fewer turns for engagement.

New K5-1954 Bulletin on request.



Since 1915

CANNON ELECTRIC COMPANY,
3209 Humboldt St., Los Angeles,
Calif. • Factories in Los Angeles;
East Haven; Toronto, Canada;
London, England. Representatives
and distributors in all
principal cities.

Please Refer to Dept 144

CANNON ELECTRIC

IT'S NEW! DIRECT to YOU from the manufacturer

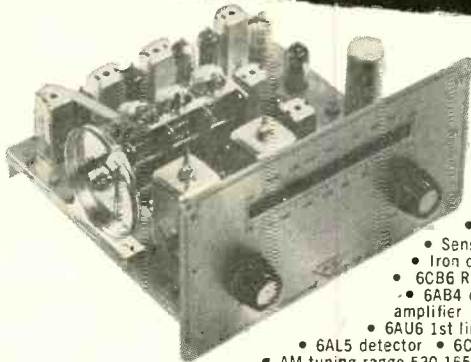

New Imperial V — 12-tube AM-FM Tuner Kit

- Band width—200 kc
- Tuned RF stage
- Tuning Range 88-108 mc
- Sensitivity 5-10 u/v, 20-30 db
- Iron core tuned I.F. disc. trans.
- 6CB6 RF amplifier • 6AB4 mixer
- 6AB4 oscillator • 6AU6 1st I.F. amplifier • 6AU6 2nd I.F. amplifier
- 6AU6 1st limiter • 6AU6 2nd limiter
- 6AL5 detector • 6C4 cathode follower output
- AM tuning range 530-1550 kc • 6BA6 RF amplifier
- 6BE6 converter • 6BA6 1st I.F. amplifier • 1N34 or 1N60 crystal diode detector • Tuned RF stage • Chassis dimensions: 9 3/4" long, 5" high, 8" w.

Complete kit of parts including tubes, pictorial and schematic diagrams **\$3750**

Wired and tested. \$5.00 additional

NEW Approved policy

Now, for the first time you can buy high-quality audio, test, TV, AM-FM receiving equipment at unheard-of low prices!

New Approved policy eliminates percentages to "middlemen"—brings equipment direct from factory to you for buys that can't be beat . . . anywhere!

New

Model A-800 Pre-Amplifier kit

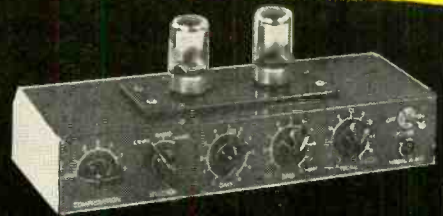

- Floated tubes to prevent tube microphonism
- 3 input connectors—magnetic, crystal, radio
- Input selector switch
- Overall gain control
- 6 position equalizer switch for GE and Pickering cartridges
- High-low tone controls approx. 15 db
- Tubes: 2-7F7
- Power required: 6.3v AC or DC, .6 amp., 180-220v DC at 7 milliamps

Kit with complete, illustrated instruction book **\$1595**

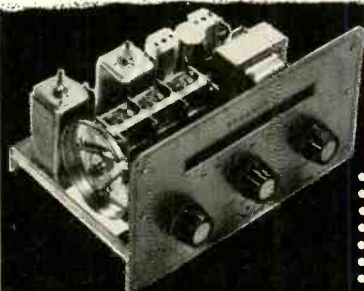

New V-5 AM Receiver Kit

THE BINAURAL TWINS

Start Your Hi-Fi Installation the Economical Way

- Self-contained AC power supply
- Tuning range 530-1650 kc
- 6BA6 RF Amplifier
- 6BE6 converter
- 6BA6 1st I.F. amplifier
- 6AL5 detector
- 6C4 cathode follower output
- Sensitivity 5 microvolts
- Iron core tuned coils throughout
- Dimensions 9 3/4" x 5" x 5 1/8"
- #65 selenium rectifier
- 3 section variable cond.
- Tuned RF stage

Complete kit of parts, including AC power supply, tubes, pictorial and schematic diagrams..... **\$2450**

New V-9 FM Receiver Kit



- Self-contained AC Power Supply
- 3 section variable condenser
- Tuning range 88-108 mc
- Band width 200 kc
- Sensitivity 10 microvolts 20 db
- Tuned RF stage
- Iron core tuned I.F.—disc. trans.
- 6CB6 R.F. amplifier
- 6AB4 mixer
- 6AB4 oscillator (temp. compensated)
- 6AU6 1st I.F. amplifier
- 6AU6 2nd I.F. amplifier
- 6AU6 1st limiter
- 6AU6 2nd limiter
- 6AL5 detector
- 6C4 cathode follower output
- #65 selenium rectifier
- Dimensions 9 3/4" x 5" x 5 1/8"

Complete kit of parts including AC power supply, tubes, pictorial and schematic diagrams..... **\$2950**



New A-465 Field Strength Meter 0-100 Microvolts Full Scale

- 12 Channel High Gain (standard coil) cascade turret tuning front end
- 6BQ7—RF
- 6J6 oscillator-mixer
- 6CB6 high gain 1st I.F.
- 6AU6 high gain 2nd I.F.
- 1N34 crystal diode (meter rectifier circuit) 2nd detector
- 6AU6 amplifier (for earphone or scope use) picture carrier only
- Signal indicator, 6" large face, 0-500 microammeter
- Self-contained power supply 115 volts, 60 cycles
- Calibrated in relative microvolts—2 scales: 0-100 microvolts and 25-30,000 microvolts
- UHF calibrated reference scale
- Panel mounted "Off-On" indicator
- 300 or 72 ohm output
- UHF strips available on order

Wired and tested with tubes and instruction book **\$5950**

New A-900

UHF Signal Generator 450-900 MC on Fundamentals

- Power supply: 115-125v, 60 cycles
- 3" calibrated output meter, 1 volt
- 1 volt minimum across the band
- 50 ohm terminated output cable
- Large 6" dial, accurately calibrated in megacycles and spot channels
- Stable operation—low leakage
- RF attenuator 0-120 db total
- Drift after warmup negligible
- 400 cycle internal modulation
- Separate modulation control
- Cavity tuning system
- Dimensions: 12" x 10" x 8"

Wired and tested with tubes and instruction book **\$5950**

FREE CATALOG OFFER!

Write today for free complete Approved catalog!



order direct from APPROVED

ELECTRONIC INSTRUMENT CORP.
928 BROADWAY NEW YORK 10, N. Y.

THE TAPE THAT MIRRORS THE ORIGINAL SOUND

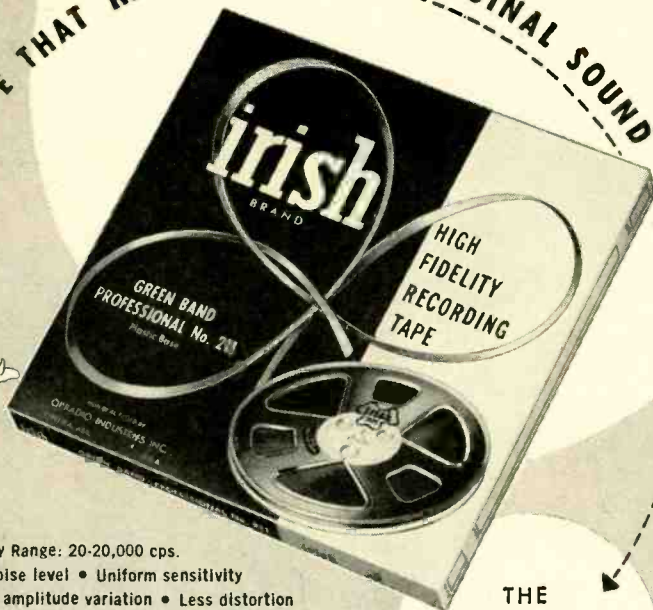

- ▶ Frequency Range: 20-20,000 cps.
- ▶ Lowest noise level • Uniform sensitivity
- ▶ Minimum amplitude variation • Less distortion

600 feet on plastic reel net \$2.10
 1200 feet on plastic reel net 3.30
 2400 feet on plastic reel net 7.71

At All Leading Sound Dealers

ORRADIO INDUSTRIES, INC.
 OPELIKA, ALABAMA

Export Division: Morhan Exporting Corp., New York
 In Canada: Atlas Radio Corp., Ltd., Toronto

THE
FINEST TAPE
 YOUR RECORDER
 CAN USE



TELEVISION

As an illustration of a similar situation, there is a large amount of vertical sync pulse present along with horizontal sync pulse voltage at the grid of various pulse-width a.f.c. arrangements. In case of trouble with the circuit, the presence of this vertical sync pulse, might be a matter for concern, if idealized waveform sketches are referred to. However, the presence of the vertical component is normal and does not disturb satisfactory operation.

Waveform photographs are usually more satisfactory from this point of view if taken in pairs; one photograph should be taken using a 30-cycle scope sweep, another using a 7,875-cycle scope sweep. The reason is that low-frequency spurious voltages may be all but invisible on fast sweep, and vice versa. Some service data are available in which the waveforms are illustrated for half the line and field sweep rates. These will be valuable in servicing "dog" receivers.

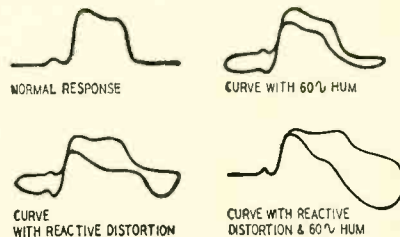

Fig. 3—Trace and retrace scope curves.

The mixing of 60-cycle hum voltage with the input signal to the scope is also useful to determine whether distortion of low-frequency video voltages is being caused by 60-cycle hum or by reactive distortion. For example, when aligning an i.f. amplifier, the technician sometimes observes that the trace and retrace are displaced as shown in Fig. 3. This distortion may be caused by 60-cycle hum or by capacitive reactance. The distortion opens up the base line (when the scope is operating on 60-cycle sine-wave horizontal sweep) and may be caused by heater-cathode leakage in a tube, by a bypass capacitor in circuits carrying the video signal, or by a coupling capacitor having too small a value.

In any case, the technician should determine whether the distortion is hum distortion or reactive distortion. As shown in Fig. 3, this determination is made by injecting a small amount of 60-cycle hum voltage into the scope input circuit by touching the finger lightly to the vertical input post of the scope.

If one end of the display closes up into a straight base line, but the other end of the display opens up into a large loop, reactive distortion is present. But if the display opens or closes equally at both ends, hum distortion is present.

Thus it is seen that hum voltage can be a very useful tool in practical service work, when the operator knows how to use it.

END

New 4-Speed Magnemite*

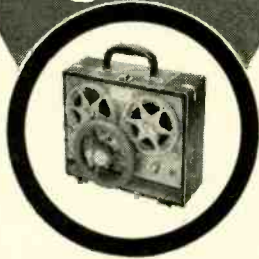

for Unmatched Versatility in Field Recording!

Designed for nature sounds, music, street sounds, interviews, conferences, courtroom reporting, missionary work and field reports. All of these may be recorded on a single 4-speed portable, battery-operated spring-wound tape recorder. Features quick speed change with automatic equalization.

Model 610 EM meets both primary and secondary NARTB standards and operates at tape speeds of 15, 7½, 3¾, 1½ ips. Records and plays back frequencies up to 15,000 cycles. Model 610 DM operates at tape speeds of 7½, 3¾, 1½, 1¼ ips.

These tiny recorders weigh only 17 lbs. with self-contained batteries that last 100 operating hours and include built-in monitoring and headphone playback facilities. Designed for extreme simplicity of operation. Meets the most grueling field tests. May be operated anywhere. Measures only 7 x 10 x 11 inches.

Write for complete technical literature and direct factory prices to Dept. RE:

AMPLIFIER CORP. OF AMERICA
 396 Broadway, N. Y. 13, N. Y.

*T.M. Reg. U.S. Pat. Off.

OUR GREATEST BARGAIN

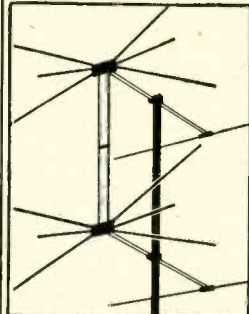

**2-BAY
 16-ELEMENT
 CONICAL ARRAY**
 with Hi-Band
 Adapters
 Sturdy 3/8" Elements

\$4.99 IN LOTS
 OF
 EACH THREE

SINGLE LOTS \$5.30

Never before has National Electronics had a BARGAIN like this. We made a special purchase in order to get these sensational prices. And this array has everything. This conical 2-bay 16-element array provides

ultra-fine fringe reception. Includes sixteen 1/2 inch airplane type aluminum elements, including hi-band adapters for greater gain on the high channels and is complete with one pair of stacking bars to each array. These are packed in cartons of three 16-element arrays per carton, with tie rods at \$14.95 per carton. Money back, if not satisfied.

When purchased in single 16-element arrays, separately boxed—your cost is..... \$ 5.30 each

3 Two-Bay Arrays per carton without Tie Rods..... 13.50 carton

4 Bay Ultra-Fringe Stacking Assembly for Above—Model 4B..... 1.95 set

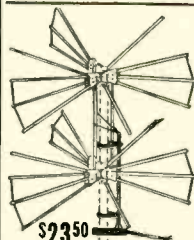

**360° Super Directronic
 Electronically Rotates
 in All Directions VHF-
 UHF CHANNELS 2-83**

Powerful, 24 element 2 bay Directronic antenna is electronically beamed to any transmitter in fringe area by 6-position selector switch. No motors or electricity. Extremely high gain. COMPLETE WITH 6-POSITION DIRECTRONIC BEAM SELECTOR, 75' TUBULAR TRI-X CABLE, UNIVERSAL U-CLAMPS. Order model AX-524. Money back, if not satisfied.

\$2350

NEW CATALOG AVAILABLE

National Electronics
 OF CLEVELAND

THE HOUSE OF TV VALUES

212 Delco Building Cleveland 3, Ohio



for
 SERVICE
 EXPERIMENTAL
 INDUSTRIAL
 and MILITARY
 Applications

NOW!
 Leading Distributors
 Stock Them!

Now, for the first time, you can get these famous original equipment favorites in lots up to 1,000—fast and economically from local parts distributors. Previously sold to the world's leading manufacturers *only*, in huge production quantities, these Stackpole components are now available from selected distributors in the same quality that has made them favorites for over 25 years.

Every Stackpole component is produced under full quality control—from raw material to final test. Each is fully proved through years of field service in the most exacting applications—military, service replacement, and commercial.

Write for bulletin on any type and name of nearest distributor.

STACKPOLE



Iron Cores



Variable Resistors

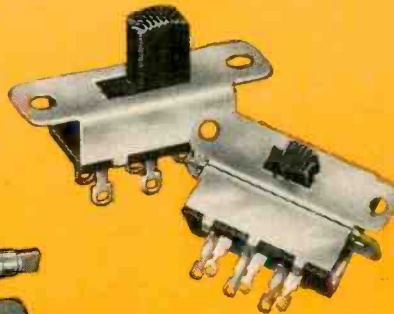

Low Cost Slide Switches

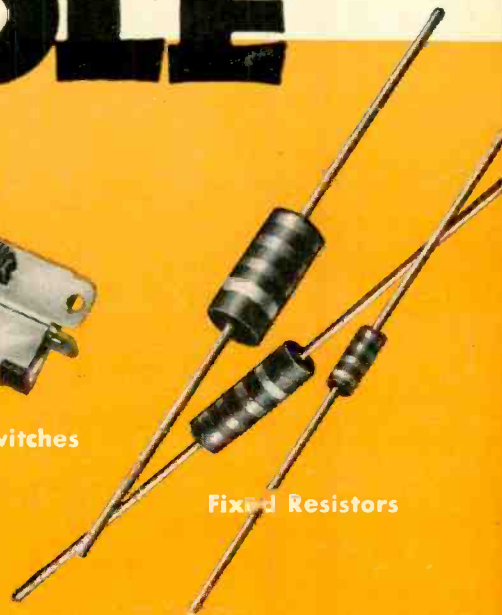

Fixed Resistors

DISTRIBUTORS' DIVISION

STACKPOLE CARBON COMPANY

26 Rittenhouse Place, Ardmore, Pa.

(Plants in St. Marys and Kane, Pa.)

Now...complete
Protection
from the **REAR**...

Now... for the First Time!

A full automatic
snap-out antenna
that is mechanically safe!

Elements are double locked in position
and nested in channel to prevent
drooping or falling apart.

Manufactured and Distributed
in CANADA by
DELHI METAL PRODUCTS, LTD.
DELHI, ONTARIO



*the antenna
for which
all America
has been
waiting...*

**this is the
PROBLEM**

New TV stations by the
score *plus* stepped-up
power on existing
stations is increasing the
difficulty of reception
in many areas.
Co-channel
interferences and the
resulting loss of
reception quality cannot
be overcome by
ordinary antennas
now available.

MODEL	CHANNEL NUMBER
RG-1-L	2-6
RG-1-H	7-13
RG-1-LH	2-13

(RG-1-L and RG-1-H
in combination)

COPYRIGHT 1964

KAY TOWNES REAR GUARD

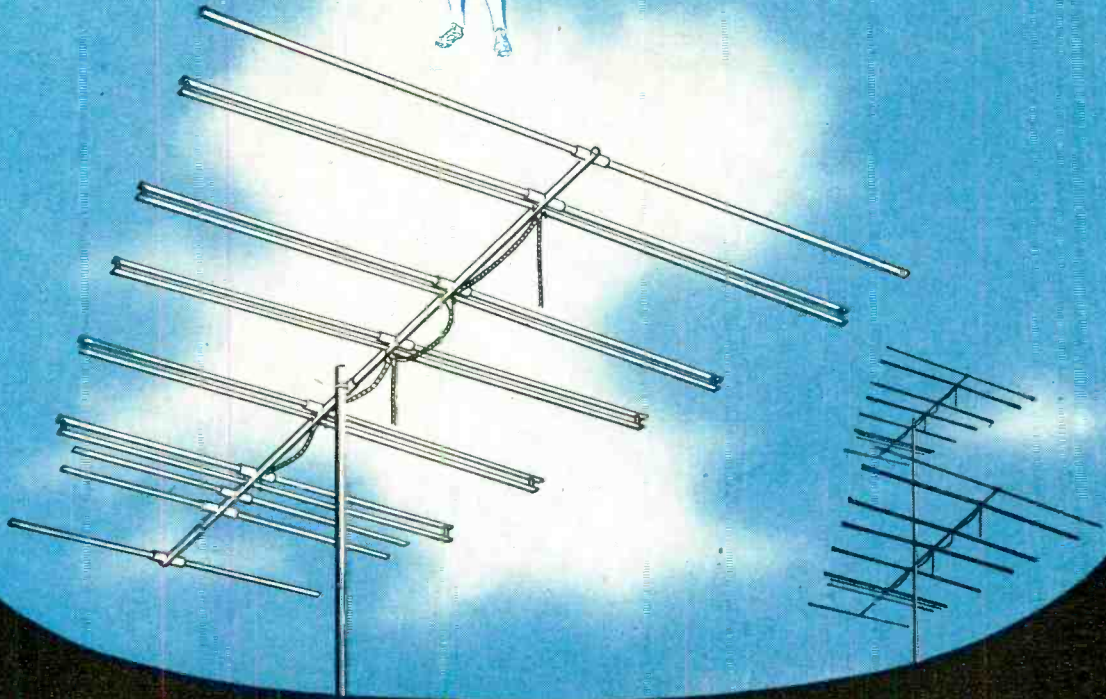

Here is the amazing KAY-TOWNES answer!

Again... KAY-TOWNES is *First* with the answer! The new K-T REAR GUARD completely rejects unwanted signals from the rear and sides to give televiewers the best possible picture and sound reception in areas where co-channel

interferences present difficulties. Yes Sir! The new K-T REAR GUARD is ready for you now in arrays to suit your needs . . . It's a Quality Antenna for Quality Reception. It's a Kay-Townes Antenna!

- *NO interference from the rear*
- *High front to back ratio*

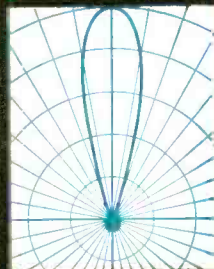

RADIATION CURVE
REPRESENTING ALL VHF CHANNELS

- *Top quality reception*
- *Sharp definition*
- *Primary UHF*

Use the K-T line of television accessories

WRITE TODAY FOR FURTHER INFORMATION AND PRICES

KAY-TOWNES
Antenna Company
Box 593 B, ROME, GEORGIA

ELECTRONIC CONTROLS

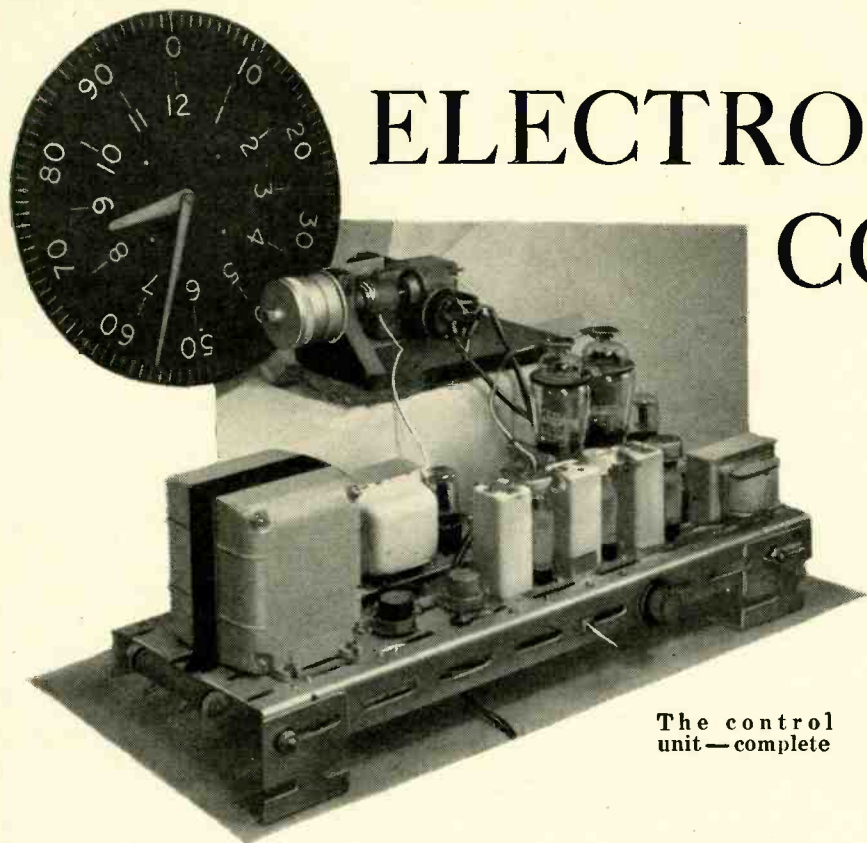

The control unit—complete

To be useful, they must be simple enough to be operated and adjusted by the average plant electrician

By J. R. CORNELIUS*

At a recent exhibition I was taken gently by the hand by a competitor friend and led like a sheep to the slaughter to be shown a most beautifully constructed control panel several yards long that was covered with dials, gauges, switches, knobs and buttons, from real big grandfathers to lovely little babies that simply screamed to be twisted. By inserting a Yale key into a slot somewhere in the side, my friend opened this wonder of wonders. It was a picture to behold. There were rows of tubes from big inverters and rectifiers to tiny little subminiatures that should have been in hearing aids but had been mislaid. The complete chassis layout was a mass of hinged breadboards.

I gasped and held my breath. Here was a masterpiece. Stifling my natural jealousy, I applauded and crawled away, back to my little stand of ordinary sim-

ple meters and controls. My heart was full. This was competition with a capital C.

Three months later I was called north to a large textile plant to fit a control to a calender in a hurry. The job was to fit a continuous thickness gauging unit to indicate automatically the thickness of the linoleum plastic as it left the cylinder and, when a change in thickness occurred, to readjust back to standard within a matter of seconds.

The calender was a massive machine some 80 feet long with two heads raised about 20 feet in the air, each head consisting of three rollers and bearings with the necessary standards to carry them. The width of the machine was about 12 to 14 feet and the calender cylinders measured about 100 inches long, one being 60 inches in diameter and weighing 26 tons, the next or middle 18 inches in diameter and weighing 4 tons, the last or polishing roller 30 inches in diameter and weighing 6 tons.

The polishing roller was fed with freezing brine through the bore to keep it cold, the middle roller was fed through the bore with boiling water to keep it hot. Plastic material of the thermoplastic type was fed between these two rollers and the thickness of the linoleum plastic was controlled by the gap allowed between the two peripheries. Heat and cold from the two cylinders also affected the thickness, as did the speed of each roller, each of which was driven independently by a variable-speed 100-h.p. d.c. motor.

There—covered with a dust sheet in one corner of the shop—was a familiar sight. A control panel several yards long, covered with knobs and meters and a nice little slot where one could insert a key to open the side and see inside. For three months it had stood there coupled to the big calender, and for three months every time one little thing went wrong a specialist had to be called from 200 miles away in London

*Cornelius Electronic Instruments, Ltd., Coventry, England.

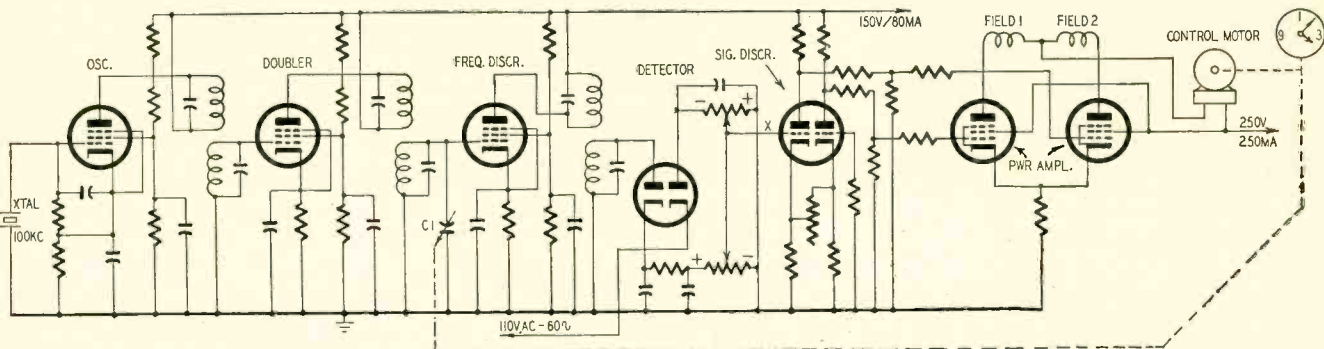

Fig. 1—Schematic of a simple control which gauges the thickness of linoleum strip continuously and automatically.

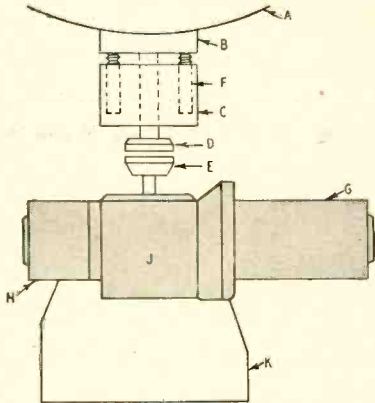

Fig. 2—Drawing shows physical adjustment of the control capacitor.

to open that lock and lift up one or more of those bread baskets until the panel had cost more in spoiled lino than it had cost in cash. Why? It was a beautiful panel for the laboratory where what in this country is called a *boffin* is always available to put it right, but it was too, too complicated for the plant electrician who was supposed to be its day and night nurse.

We want something simple, said the foreman, something that John there can wrestle with in between his motors and lights. Give us something *quick*, said the manager, and it doesn't have to look pretty. Give us something that works, said the president, that's all we want.

This is what I gave them. It fitted into an oblong wood box 20 inches long and 12 inches square. There was not a knob to be seen except one on-off switch. The only adornment was my nameplate and some dirty finger marks, but the unit worked as soon as it was put in, and is working still. It's not pretty, but against the bulk of the whole machine that is not noticed, in fact it's not noticed at all.

That's how electronic instruments should be. Once they are installed, they should be unobtrusively efficient. They can't be continually going wrong and needing a wet nurse night and day. Let us look at this simple job. It combines practically everything in old-fashioned electronics, simple straightforward engineering. The device is covered by British patents and by U.S. patent No. 2,387,946.

The circuit

The general scheme is shown in Fig. 1. There is an oscillator, frequency multiplier, frequency discriminator,

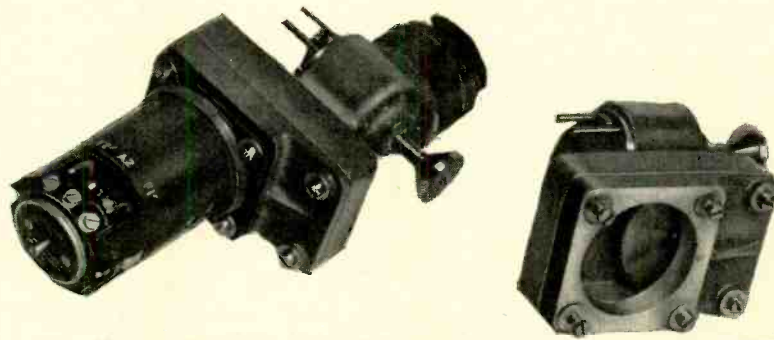
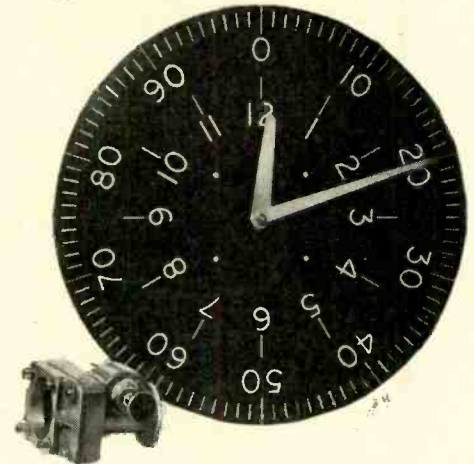

Fig. 3—Mechanical control unit, also a closeup showing the reduction gear.

Fig. 4—The dial indicates thickness of plastic in mm and hundredths.



double-diode detector, signal discriminator, and two power tubes. The d.c. is obtained from metal rectifiers. There are two voltage regulator tubes, not shown.

The oscillator uses a 100-ke X-cut high-quality crystal and is coupled to the amplifier by a frequency-doubling tuned circuit. The second tube amplifies the signal and feeds the discriminator section via a tuned circuit also. The primary is fixed-tuned; the secondary is detuned some 15 kc and includes in its circuit the control capacitor C1. It acts as a frequency discriminator in the manner of the "slope detector."

The signal from the frequency discriminator is fed to the plate of the first half of the double-diode detector and a voltage from the 60-cycle line is fed to the cathode of the other half. The signal from the first half of this tube is positive; that from the second half negative. By adding these two voltages together in the grid resistor of the signal discriminator we have a resultant that varies with the value of the signal fed to the first half of the detector, and can be set to zero with the variable resistors in the cathode circuit of this tube and the grid circuit of the signal discriminator. Now any change in the signal voltage from the frequency discriminator will drive the signal discriminator grid more positive or more negative.

The operation of capacitor C1 is shown in Fig. 2, where A is the middle calender cylinder; B, a shoe pressing onto this cylinder and moving up or down in block C with any movement of the cylinder, and F, springs holding B against the cylinder face. D is one plate of the capacitor C1, and E the

other grounded plate, which is integral with a micrometer screw J operated by the control motor G, which acts through the step-by-step transmitter switch H to change the reading on the indicator dial. Fig. 3 shows the unit (minus the hot plate) complete and also a part view of the reduction gear driving the micrometer and transmitter.

If capacitor C1 is adjusted to a definite value to give, say, zero volts at X, then an increase in the gap between the plates will cause a positive voltage at X and a decrease in the gap will cause a negative voltage.

Since an increase in capacitance causes a negative voltage at X (Fig. 1), and a decrease in capacitance causes a positive voltage, the output of this double triode, if fed correctly to the two power tubes, will cause an unbalance to appear across the plates in one direction or the other. Thus if a gap of 0.1 mm between the control plates gives a balanced pair of power tubes, an increase in this gap will cause a voltage to appear at X which will unbalance the power tubes and cause an unbalance of current in the split fields of the control motor coupled to the micrometer drive. This voltage will persist until the motor has closed the gap to the correct value or until the cylinder control motor closes the cylinder gap, whichever is included in the circuit. A decrease in the gap will unbalance the fields in the opposite direction and cause the coupling to open the gap.

Assume that the equipment is set up for 6-mm thickness and the dial is adjusted to indicate this value. Temperature and other factors affect the characteristics of the raw material and the

Color's bigger than ever! AND THE NEW 2ND EDITION OF

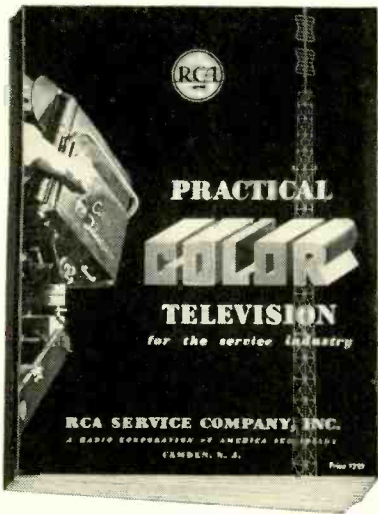

IS MORE THAN EVER A MUST

Color television receivers at much better prices are due to hit dealers' floors any time now. And when color television starts moving in volume . . . every technician must be ready for this new, different, profitable field. There's not a day to lose. Get your copy of the brand new 2nd edition of *PRACTICAL COLOR TELEVISION* . . . and get it right away!

Here is the latest *practical* color service information you can get from any source. Included in its 86 pages are: Principles of Color Television . . . Detailed Circuit Diagrams . . . Operating Instructions . . . Antenna Requirements . . . Test Recommendations . . . and much, much more. Time-tested information . . . brought up to the minute by RCA, pioneer in compatible color television.

\$2.00 a copy . . . and worth far more in future color television profits for you! See your RCA Parts and Tube Distributor, or mail the coupon . . . today.

RCA SERVICE COMPANY, INC.

A Radio Corporation of America Subsidiary
CAMDEN, NEW JERSEY

RCA Service Co., Inc.
Commercial Service Section
Camden, N. J.

Please send me _____ copies of "Practical Color Television" at \$2.00 each.

Check or Money Order for \$_____ enclosed.

NAME _____

COMPANY _____

STREET _____

CITY _____ ZONE _____ STATE _____

ELECTRONICS

thickness of the product passing between the rollers. If conditions change so that the rollers move apart from the present 6-mm spacing to, say, 6.25 mm, the control motor immediately starts and restores C1 to its original value and simultaneously operates the rotary switch to step the pointer around to indicate the thickness of the material at that instant. The roller adjustment screws can then be operated manually to restore the thickness to the desired value.

This system also can be connected (at a little greater cost) so the spacing between the rollers is automatically adjusted to maintain the thickness that is indicated on the manually preset thickness indicator. In this case the dial remains fixed and the correction is applied to the screws controlling roller spacing. There are no tricky circuits. Seven simple tubes and three little potentiometers. It was a masterpiece when I put it in, but—like a good servant—it has already been forgotten. That's how it should be. END

MULTIPURPOSE TOOL



Solderless connections is one of the many functions of a new tool called the Super Champ. An extremely versatile tool, it shears stove bolts and machine screws; cuts wire, sizes 22 to 10; strips wire, sizes 22 to 10; serves as a wire size gauge, and crimps insulated solderless terminals and connectors. This tool should prove especially useful in antenna work where soldering usually requires drawing long power lines. The tool is manufactured by Aircraft-Marine Products, Inc., Cincinnati, Ohio.



"Absolutely all repair work done in the home."

TG-34A KEYS

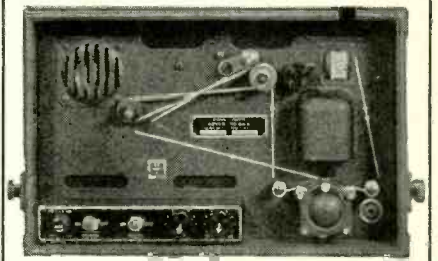

PORTABLE—115 or 230 V. @ 50 to 60 cycles—KEYER TG-34A is an automatic unit for reproducing audible code practice signals previously recorded in ink on paper tape. By use of the self contained speaker, the unit will provide code practice signals to one or more people or provide a keying oscillator for use with a hand key. The unit is compact, in portable carrying case, and complete with tubes, photo cell, and operating manual. Size: 10 1/8" x 10 1/2" x 15 1/8". Shipping weight: 45 lbs.

NEW BOXED: \$21.95 USED TESTED: \$14.95

TG-10 KEYS: Same function as TG-34A, only larger, using 2/6N7—2/6L6—2/6S17—1/5U4G Tubes and 1/923 Photo Cell. Housed in standard Metal Cabinet, can be removed for 19" rack mtg. Size 11" H x 24" W x 18 1/2" D.

— USED, TESTED: \$19.95

PRACTICE CODE TAPES:

Code Training and Practice Inked Paper Tapes on 16 MM 400 ft. Reels for telegraph and radio operation. For use with TG-34A and TG-10 Keyers.

SEPARATE TAPES for following lessons:
Tape #11—Traffic Tape #8—Code Groups
Tape #12—Traffic Tape #2—Receiving

Each on 16 MM Reel, in metal container: \$1.25 Ea.

SOUND POWERED HEAD AND CHEST SET

— Navy Type—No batteries required—Ideal for TV antenna installations and many other uses. 20 Ft. Cord. Used—Tested \$3.95 Ea.

METERS:

WESTON AC AMMETER

(Pictured) in portable leather case, with Test Leads, 2 1/2", 0-15 AC & 0-3 AC Scale **\$5.95**

DC AMMETER HOYT—

in portable metal case, with Test Leads, 4 1/2", Fan, Mirrored Scale 0-15 ADC **\$4.95**

0-3 RF AMMETER IS-128—2 1/2" Jrd., Flush Mtg. Calibrated P/Non Mag. Panel. P/O BC-233 Transmitter. NEW: \$2.95
0-500 MICROAMMETER TRIPLET, 2 1/2" Sq. \$4.95
0-5 MA DC WASTINGHOUSE, 2 1/2" Sq. \$3.95
D-B METER—10 to Plus 6, G.E., 3 1/2" Jrd. \$4.95
TS-291/U VOLTOHMETER—Meter 3" square, 1000 ohms per volt, D'Arsonval Movement—0/300/600 VDC Scale and 0-1 Meg. Case size: 3 1/2" x 5 3/8" x 2 1/4". W/Test Leads P/O 1-56 Test Set. NEW: \$7.95

Address Dept. RE • Minimum Order \$5.00
Prices F.O.B., Lima, O. 25% Deposit on C.O.D. Orders

FAIR RADIO SALES
132 SOUTH MAIN ST. • LIMA, OHIO

HI-GAIN TUNER-BOOSTER
LESS TUBES WITH DIAL

\$ 2.00

COMPLETE WITH TUBES
\$ 2.75

Solve poor TV reception with a Hi-Gain Booster. Banish weak fringe areas, reduce snow. This unit comes to you as a highly serviceable High-Gain Tuner. Uses 6J6 Tubes in very efficient Hi-Q Circuit. Has 8 tuned circuits using pure silver inductances and individual compensation providing high gain on all channels. Built in 5:1 Vernier Drive. All necessary parts and instr. included. Add postage for 5 lb. shipping wt. No C.O.D.'s. Send for TV parts bulletin.

FRANK W. DECRAY & ASSOC.
11842 W. Jefferson Blvd. Culver City, Calif.

RADIO CONTROLLED
Garage Door
Operating Mechanism **\$24.50**

Write for Information
P. E. HAWKINS CO.
631 Prospect Kansas City 24, Mo.

“Sure, we can talk
'height' too...but...”

GENE COX, manufacturer of the new

SPAULDING STRATO-TOWERS

talks about features of far more importance to you.

“Seems to us that height is something you should be able to take pretty much for granted when you talk about a TV antenna tower. We think other points are far more important . . . like a tower's construction, strength, ease of installation, and durability. SPAULDING STRATO-TOWERS challenge comparison on each of these points . . . which you'll find out for yourself when you hear all of our story.”

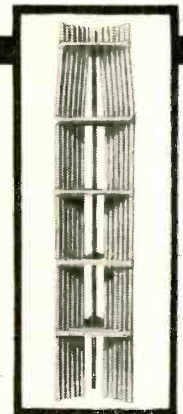

No Concrete Necessary

Time saved is money earned. SPAULDING STRATO-TOWERS—24 ft. to 64 ft.—are entirely self-supporting when used with the specially designed Spaulding base, can thus be installed on one service call.

Installation's Faster . . . Easier

STRATO-TOWER can be assembled by just one man on the ground—complete with rotator, antenna and transmission line—then raised into position from horizontal with a winch in about 5 minutes! Tower can also be raised with block-and-tackle or built adding section upon section, due to its tapered (nesting) section design.

Strato-Tower's Stronger by 50%

STRATO-TOWER tubing is full 1¼" diameter with a tensile strength of 80,000 PSI. Base area is 3 times greater than average, center of gravity is in lower third of tower . . . safer and easier to climb, offering less wind resistance. Aircraft-riveted construction—no welds to rust. Each section heavily galvanized. STRATO-TOWER unconditionally guaranteed for 10 years against rust.

SPAULDING PRODUCTS COMPANY

TIPTON, INDIANA

WRITE . . . WIRE . . . PHONE TODAY for full information on
SPAULDING STRATO-TOWERS. You'll be glad you did!

Remember the name—
SPAULDING
“stairway to superior TV
reception”

MUSIC INTO LIGHT

By C. M. BRAINARD*

WHILE touring one of our local aircraft plants, I noticed a group of men who did little with their time besides replacing spent fluorescent lamps. It seemed to me that a lot of time and money was being wasted. So I set about to develop a method of lighting seemingly dead lamps. I found many different types of devices which would do the trick. Among these were r.f. generators and high-voltage (neon) type transformers. These worked, but it cost approximately 50 times as much as it should to produce enough light to make it worth while.

During the process, I discovered that a standard fluorescent lamp, when connected in various ways across the output of an audio amplifier, would fire when certain frequencies were produced in sufficient strength. With further experimentation I found that all fluorescent lamps did not necessarily light on the same frequencies. Therefore, by connecting a large number of them in parallel, I found that a very unusual and almost hypnotizing transformation of sound into patterns of light could be achieved. The effect was further improved by the use of various colored lamps. They are available commercially in pink, green, blue, white, and "daylight" colors. They all appear white until lighted. The use of lamps with colored glass did not prove too practical because of the reduction of light intensity caused by the coloring of the glass. The length or number of tubes doesn't seem to make a great deal of difference.

We have made small models for the home with as few as 12 18-inch lamps or for giant commercial jobs using as many as 260 4-foot lamps. The arrangement of the lights is up to the builder. We found that mounting them parallel to each other and about one inch apart gives the best results. The tubes are covered with several panels of curved frosted glass mounted about 6 inches in front of the lamps.

Our largest model is located in the auditorium of the North Island Naval Air Station in San Diego, California. It is mounted across the top of the stage, and is 4 feet high and 52 feet long, containing 260 48-inch fluorescent lamps. It has been in use for 7 years, and none of the lamps have ever needed replacement. Since the gas inside these lamps is all that is used and since there are no elements or ballast transformers to worry about, their life, for all practical purposes, is infinite.

Since the efficiency of many things can be improved by a power source with a frequency considerably higher than 50 or 60 cycles, we feel that power

for lighting homes in the future will be in the range of 1 to 10 kc. Of course this would completely eliminate the stroboscopic effect, so annoying with standard fluorescent installations. The intensity of the light will be controlled by the strength of the audio signal. However, for the present, we'll content ourselves with further details on what has come to be known as the "Light Organ".† A few construction hints follow:

Wire all lamps in parallel as shown in Fig. 1. Wrap a fine wire (approximately No. 24) around each of them about 1/8 the distance from either end. Ground this wire to any good ground or the amplifier chassis. Connect one end of the parallel group through a 1-megohm potentiometer, to B minus. Connect the other end of the group through a 0.1-μf 600-volt capacitor to the plate of the output tube. If a conventional amplifier is used, load the secondary of the output transformer with a suitable resistance. Increased variation of light patterns may be obtained by reversing the lamps' terminal connections. The intensity of the light will be controlled by the potentiometer. The input to the output tube should be adjusted for the greatest variation in patterns. If too little volume is used the effect will be weak; if too much volume is used, the lights will fire simultaneously and little or no variation will be obtained.

Do not attempt to run the Light Organ and a loudspeaker from the same output transformer because considerable distortion results from the discharge of the lamps. Fig. 2 shows the diagram of a typical amplifier that can be used to drive the organ. Transformer T1 may be an intercom input transformer or a high-impedance plate-to-voice coil output transformer connected in reverse. The low-impedance winding connects across the loudspeaker voice coil. This input connection loads the output transformer, so it should not be used with a high-quality system. Instead, remove T1 and

†The Light Organ—patented, 1948.



Lamps are mounted behind curved frosted glass.

substitute a 470,000-ohm grid resistor and a .02-μf coupling capacitor. Input can be tapped off at a suitable high-impedance point in the main amplifier.

The effect of the Light Organ, when used in the home for entertainment, is unusual. The startling potentials of creating light from sound are unlimited and provide a vast field for experimentation. END

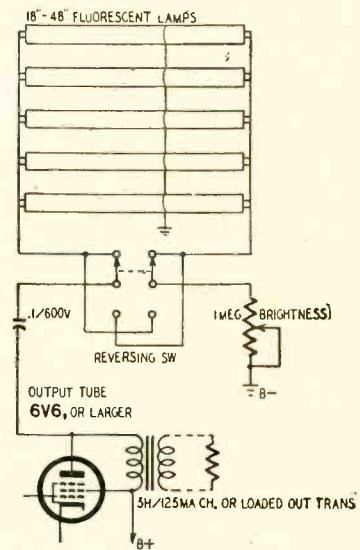

Fig. 1—Fluorescent circuit wiring.

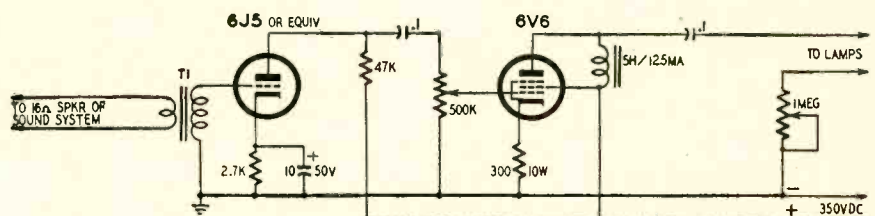

Fig. 2—Schematic diagram of a typical amplifier for driving the organ.

*Master Electronics Co., Hollywood, Calif.

8 ENGINEERING EXCLUSIVES... REASONS WHY...



1 STOP WATCH TUNING ACCURACY
Pinpoint control system is unsurpassed in consistent accuracy of indication. Stops antenna instantly within 1/2 degree of desired position. No drift or ambiguity.

2 SMARTLY STYLED CONSOLE WITH PIANO TUNING

The striking control console is designed for beauty of design as well as ease of operation. Actuates the rotator with the slightest touch. Available in mahogany or ivory cabinet.



3 REPLACEABLE FACTORY SEALED CARTRIDGE UNIT

Sealed power drive unit eliminates the former need of dismantling the antenna when servicing. Simply loosen 3 screws to remove the sealed unit.

4 POWERFUL INLINE DESIGN

Supports direct dead weight load of largest stacked array. Resists downthrust and bending moment. Built-in thrust bearings. No extra parts to buy. No breakable offset bearings.



5 COLORFUL "CARRY-ALL" CARTON

Safely protects Roto-King en route... eases on-the-job carrying of units... comes in handy in the shop or around the home. A JFD merchandising extra at no extra cost.

6 AUTOMATIC VOLTAGE COMPENSATION

Advanced circuitry achieves automatic voltage compensation for stability and exactness of indication despite line voltage fluctuations.

7 BALANCED POWER

Close tolerance 3200:1 reverted gear drive (within .002 in. tolerance) efficiently transmits 100% of developed power. No inherently weak worm gears.

8 390 DEGREE ROTATION

390 degrees — the broadest traverse range now in use — speeds and simplifies station selection beyond standard 360 degree revolution.

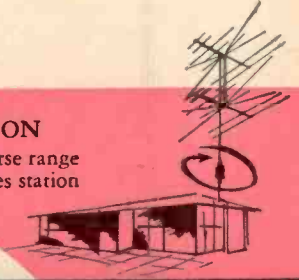

Roto King

is **rocking** the rotator market!

Model	Style	List
RT100-M	Mahogany	\$44.95
RT100-IV	Ivory	\$44.95

Write for 8-page Roto-King engineering brochure No. 288.



Look to JFD for Engineering Leadership!

MANUFACTURING CO., INC.

6101 16th AVENUE, BROOKLYN 4, N. Y.
INTERNATIONAL DIVISION: 15 Moore Street, New York 4, U.S.A.

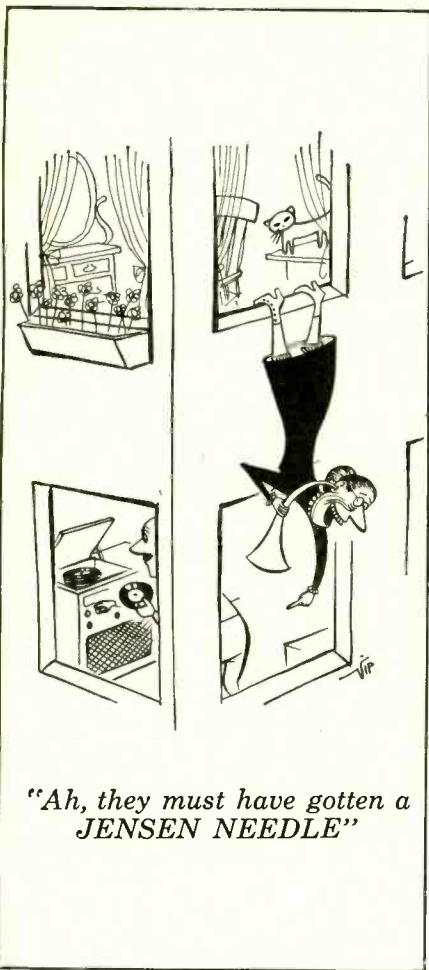

"Ah, they must have gotten a
JENSEN NEEDLE"

NEW! ATLAS CJ-30 COBRA-JECTOR

INDESTRUCTIBLE FIBER-GLASS
ALL WEATHER
WIDE ANGLE DISPERSION



List \$40.00
NET \$24.00
Complete
with Driver.

Weatherproof
Line Matching
Transformer
as shown,
Net \$5.10.

New versatile all-purpose projector—excellent for paging & talk-back, intercom, marine, and industrial voice & music systems. Penetrating articulation assures wide angle intelligible coverage even under adverse sound conditions. "ALNICO-V-PLUS" magnetic assembly. Double-sealed against all weather. Omni-directional mounting bracket. Quick, easy installation. An amazing "power package"—Specify the CJ-30 for the "tough" jobs!

Input Power (continuous).....15 watts
Input Impedance.....8 ohms
Response.....250-9000 cps
Dispersion.....120° x 60°
Dimensions:.....Opening, 14" x 6"
Overall Length, 14"



WRITE FOR COMPLETE CATALOG
ATLAS SOUND CORP.

1443—39 St., Bklyn. 18, N. Y.

In Canada:
Atlas Radio Corp., Ltd., Toronto, Ont.



STUDY COLOR TV

The Associated Radio and Television Servicemen (Chicago) began a series of lectures on color TV in October. Further winter meetings are: Color TV Tubes, Nov. 30; More on Color TV Tubes, Dec. 7; Colorimetry, Jan. 11; and a further series to start at the end of January. Speakers from leading manufacturers have promised their services.

SERVICE TECHNICIAN WEDS MISS EUROPE



Photo Paris-Match

A 23-year-old radio-electrician of Amiens, France, Michael Warembourg, has married Miss Europe of 1953, Sylviane Carpentier, 20 years old, according to news reaching us simultaneously from two sources.

The marriage was due not so much to the glamour surrounding the radio-TV repair business as to the fact that they had been childhood friends, according to E. Aisberg, editor of *Toute la Radio*, the leading radio magazine of France. Instead of movie contracts, Miss Europe is settling down to life in a four-room apartment on a radio-technician's salary of 40,000 francs (about \$114) per month.

The event attracted great attention in France, and the magazine *Paris-Match* (called the *Life of Europe*) printed the young bride's picture on the cover, as well as giving the story two pages of photos and text.

HEAR KCOR PLANS

The San Antonio Radio and Television Association held its first October meeting at Radio Station KCOR to listen to a presentation of KCOR's plans for a u.h.f. TV station and to discuss the problems of u.h.f. conversion and antenna installation that will be faced in the near future.

The second October meeting was scheduled as a Color School, with a buffet supper served at the meeting place. Conductor of the meeting was

IT'S BIGGER AND BETTER THAN EVER!

B-A's NEW 1955

FREE CATALOG

164 BIG PAGES
LOADED WITH SAVINGS
AND NEW ITEMS IN
RADIO, TV, ELECTRONICS



INCLUDES 23 PAGES
OF AMAZING
BARGAINS, NOT FOUND
IN ANY OTHER CATALOG



BURSTEIN-APPLEBEE CO.

BURSTEIN-APPLEBEE CO. Dept. 5,
1012-14 McGee St., Kansas City 6, Mo.

Send Free B-A Catalog No. 551.

Name.....
Address.....
City..... State.....

A COMPLETE BUYING GUIDE FOR EVERYTHING IN—
**RADIO
TELEVISION
ELECTRONICS** } **1955**
ANNUAL CATALOG
NUMBER 551
BURSTEIN-APPLEBEE CO., 1012-14 MCGEE ST., KANSAS CITY, MO.

SEND FOR IT TODAY!

WE ARE SHARING the success of our products WITH YOU

as a CUSTOMER'S DIVIDEND in the most SENSATIONAL PRICE SLASHING EVER!

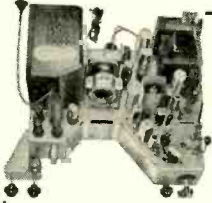

Build your own
SUPER DE LUXE
31-TUBE
#630 TV CHASSIS

#630 SUPER DE LUXE 31-TUBE TV KIT
Engineered in strict adherence to the genuine RCA #630 plus added features • OPERATES 16" to 24" PICTURE TUBES • CASCADE TUNER • COSINE YOKE • LARGER POWER TRANSFORMER • KEYPED AGC • 12" SPEAKER • CONDENSERS and RESISTORS at rated capacities and tolerances. You receive a COMPLETE SET OF PARTS AND TUBES, everything needed is included. You will enjoy building it with "LIFE-SIZE" easy to follow step-by-step ASSEMBLING INSTRUCTIONS" included with each KIT.

slashed to **\$99.99** Less. CRT

#630 SUPER TV CHASSIS DE LUXE

LICENSED UNDER RCA PATENTS
COMPLETE READY TO PLUG IN AND PLAY!
Similar in characteristics and features to the TV KIT at left • Manufactured especially for us by nationally known manufacturers • No efforts or expense have been spared in workmanship or materials, to make this #630 SUPER DE LUXE TV CHASSIS the best obtainable for fringe areas, clarity and all-around performance. Customers report reception better than 300 miles. Each set is factory aligned and air-tested • All parts carry the RMA three month guarantee • Our mass volume of business on this CHASSIS (numbering thousands of pleased customers) now makes it possible for us to reduce the price.

slashed to **\$142.27** Less CRT

We Also Sell The Complete Line of **TECH-MASTER** #630 TV CHASSIS. Catalog mailed on request.

CHRISTMAS SPECIALS

All complete with tubes ready to play
STANDARD RADIOS at almost 1/2 price
5 TUBE SUPER in ivory, ebony, walnut, maroon \$13.58
3 WAY PORTABLE, superb in every detail..... 16.98
5 TUBE CLOCK RADIO, latest sensation..... 16.56
ROUND THE WORLD PORTABLE, 3 Band..... 43.87
Catalog showing these and many others on request

#630 PARTS in COMPLETE SETS

TV WIRE SOLDER KIT, for any Set..... \$.98
VIDEO AND I.F. KIT, 19 items..... 4.99
VARIABLE CONTROL KIT, 9 controls..... 3.97
CARBON RESISTOR KIT, 107 resistors..... 4.98
WIREWOUND RESISTOR KIT, 4 resistors..... 1.76
BRACKET AND SHIELD KIT, 18 items..... 6.44
ELECTROLYTIC CONDENSER KIT, 6 cond..... 4.96
TUBULAR CONDENSER KIT, 38 condensers 3.63
CERAMIC CONDENSER KIT, 28 condensers 1.98
MICA CONDENSER KIT, 11 condensers..... .97
TERMINAL STRIP KIT, set of 30..... .69
COMPLETE SET OF TUBES, 29 tubes..... 24.64

CUSTOM-BUILT CABINETS FOR #630 AND ALL OTHER TV SETS

The VOGUE

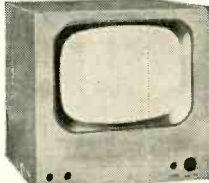

H-25", W-26", D-22"

\$35.91

The FUTURAMIC



H-37", W-28", D-24 1/4"

\$79.34

From Factory to You

4 LEADING STYLES in genuine mahogany or walnut (blond 10% extra)
• Ready drilled for any # 630 TV chassis and cutout for any 16", 17", 19", 20" or 21" picture tube at no extras in price • Also supplied with undrilled knob panel for any other TV set • EVERYTHING NECESSARY for an easy perfect assembly is included • Each cabinet is delivered complete as pictured with mask, safety glass, mounting brackets, backboard, backup, hardware and assembling instructions • Each cabinet is shipped in an air cushioned carton from FACTORY to YOU!

The MAYFAIR



H-40", W-26", D-25"

\$88.70

The MANHATTAN



H-41", W-25", D-23"

\$53.43

#639 TV BASIC PARTS KITS

PUNCHED & DRILLED CHASSIS PAN
BRACKET & SHIELD KIT (18 items)
VIDEO & I.F. KIT (19 items)
POWER TRANSFORMER #201T6 All for
VERTICAL OUTPUT TRANSFORMER only
VERTICAL BLOCKING TRANSFORMER
FLYBACK TRANSFORMER #211T5
FOCUS COIL, 470 ohms #202D2
COSINE DEFLECTION YOKE 70" **\$32.95**
Including LIFE-SIZE TV BUILDER INSTRUCTIONS

BARGAIN CORNER

SELENIUM RECTIFIER 65ma.....	\$.39
SELENIUM RECTIFIER 75ma.....	.54
SELENIUM RECTIFIER 100ma.....	.69
SELENIUM RECTIFIER 150ma.....	.74
SELENIUM RECTIFIER 300ma.....	1.28
SELENIUM RECTIFIER 350ma.....	1.49
SELENIUM RECTIFIER 400ma.....	1.61
SELENIUM RECTIFIER 450ma.....	1.77
SELENIUM RECTIFIER 500ma.....	1.89
4" PM SPEAKER, alnico #5, 1 oz. magnet.....	1.12
5" PM SPEAKER, alnico #5, 1 oz. magnet.....	1.19
6" PM SPEAKER, alnico #5, 1 oz. magnet.....	1.38
AUDIO OUTPUT TRANSFORMER (50L6).....	.29
AUDIO OUTPUT TRANSFORMER (6K6).....	.49
AUDIO OUTPUT TRANS. (universal any tube).....	.79
VOLUME CONTROL, L/S 1/4, 1/2, 1 or 2 meg.....	.22
VOLUME CONTROL, W/S 1/4, 1/2, 1 or 2 meg.....	.42
VARI-LOOPSTICK ANTENNA.....	.39
I.F. TRANSFORMER COIL, 456kc.....	.28
I.F. TRANSFORMER COIL, FM 10.7mc.....	.28
VARIABLE CONDENSER, 2 gang super.....	.39
6-FOOT LINE CORD WITH MOLDED PLUG.....	.14
SAPPHIRE PHONOGRAPH NEEDLE.....	.49
PHONO MOTOR 78 rpm, complete with t.f.....	2.62
PHONO MOTOR 3 speed, complete with t.f.....	4.47
PHONO AMPLIFIER, incl. 3 tubes.....	4.68
FAMOUS MAKE CRYSTAL PICKUP.....	2.42
CRYSTAL PICKUP, 33, 45 & 78 rpm.....	3.99

NATIONALLY KNOWN BRAND PICTURE TUBES

BRAND NEW in Factory Sealed Cartons—With a Full Year Guarantee

17" #17BP4A \$26.66 | 21" #21EP4B Aluminized \$39.21 | 24" #24CP4A Aluminized \$59.99 | 27" #27EP4A Aluminized \$74.31

Brooks LIFE-SIZE Edition

#630 TV KIT BUILDER-SET of INSTRUCTIONS BUILDING YOUR OWN #630 TV CHASSIS is now simplified with this COMPLETE SET OF BUILDING & WIRING INSTRUCTIONS. Covers all #630's, from the RCA 10" SET to the latest SUPER DE LUXE 31-tube 16" to 24" RECEIVER. EVERYTHING AT A GLANCE—LAYOUT CHARTS show chassis and components in actual LIFE-SIZE with instructions alongside the illustrations.

only **\$1.25** postpaid

Brooks CASCODE MANUAL

how to install tuner in any TV SET with easy to follow step-by-step instructions

25¢ postpaid

- HINTS FOR BETTER PICTURES ON 630TV
- 630TV DIAGRAM WITH MODIFICATIONS
- ILLUSTRATED TV CONVERSION MANUAL
- PULSE KEYPED AGC CIRCUIT DIAGRAM
- RMA RESISTOR & MICA CODE CHARTS

All for **50¢** postpaid

STANDARD CASCADE TUNER, w/instructions.....	17.97
AGC KIT, with 6AU6 & instructions.....	2.99
UNIVERSAL CRT MOUNTING BRACKETS.....	4.97
#630 PUNCHED & DRILLED CHASSIS PAN.....	3.96
TV POWER TRANSFORMER, 250ma.....	3.98
RCA FLYBACK TRANSFORMER, doubler type.....	1.17
TV VERTICAL OUTPUT TRANSFORMER 10 to 1.....	.97
TV CONICAL ROOF ANTENNA.....	2.69
TV CONICAL ROOF ANTENNA, double.....	4.88
TV FLYBACK TRANS. single 183.....	2.54
COAXIAL CABLE, #RG59/U, 1,000 feet.....	37.56
COAXIAL CABLE #RG-11U, 1,000 feet.....	87.50
TV 90° deflection yoke.....	5.98
TV FLYBACK TRANS. for 90° TV Chassis.....	4.42
ELECTROLYTIC CONDENSER, 8mfd-450v.....	.22
TV ELECTROLYTIC CONDENSER 1000/250mfd.....	.24
TV PICTURE TUBE BRIGHTENER, complete.....	.79
100—ASSORTED TUBULAR CONDENSERS.....	3.64
100—ASSORTED 1/2 watt RESISTORS.....	2.88
100—ASSORTED MICA CONDENSERS.....	3.72
100—ASSORTED CERAMIC CONDENSERS.....	3.72

BROOKS RADIO & TV CORP., 84 Vesey St., Dept. A, New York 7, N.Y. TELEPHONE Corlind 7-2359

VERSATILE

for
Replacement Use --

78-45-33 1/3 RPM

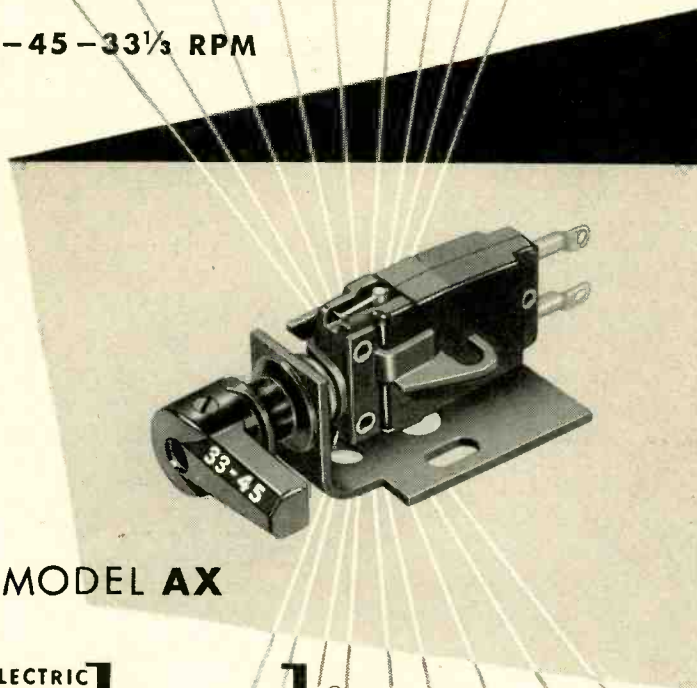

MODEL AX

WEBSTER ELECTRIC

Featheride

CRYSTAL CARTRIDGE

--with twist mechanism

This exceptionally lightweight, two-needle crystal cartridge—MODEL AX, one of the "Famous Featheride Five"—is ideal for fast, easy replacement in literally scores of applications. MODEL AX comes furnished with two needles, removable twist mechanism, terminal lugs and complete installation instructions. It fits any standard RMA 1/2-inch mounting in tone arms with or without twist mechanism.

Write today for full information on the MODEL AX. It will give complete customer satisfaction—and will build sales and profits for you.

SPECIFICATIONS · DATA

TYPE • Two-needle crystal cartridge with twist mechanism
 APPLICATION • For 78, 45 and 33 1/3 rpm use
 OUTPUT (1,000 CPS) • 1.25 volts at 78 rpm—85 volts at 33 1/3 or 45 rpm
 TRACKING PRESSURE
 7 grams (all speeds)
 CUTOFF FREQUENCY
 5,000 CPS
 NET WEIGHT • 13 grams
 NEEDLES • One 1-mil osmium, also one 3-mil osmium furnished

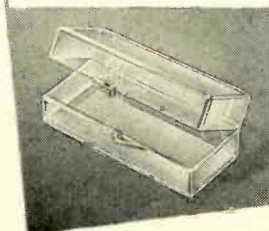

"JEWEL-CASE" PACKAGING

Each MODEL AX cartridge is packed in its own handsome and useful "jewel case" of clear plastic

WEBSTER ELECTRIC
 RACINE WISCONSIN

"Where Quality is a Responsibility and Fair Dealing an Obligation"
 WEBSTER ELECTRIC COMPANY, RACINE, WISCONSIN • EST. 1909

TECHNICIANS' NEWS (continued)

Dave Doss, national sales promotion manager of Hoffman.

NATESA CONVENES

The fifth annual convention of the National Alliance of Television and Electronic Service Technicians took place in Chicago September 24, 25 and 26. Approximately 900 delegates and visitors registered during the convention. More than 60 delegates from 41 localities attended the 24 hours of business sessions that took up a large part of the three days. Exhibitors, 27 in number, included the leading manufacturers and publishers of TV receivers, service materials and servicing books and magazines.

Some excellent information was dispensed during the technical sessions. Unfortunately the competition of business sessions and exhibits kept away some listeners. However, more than 100 technicians attended the final lecture, by Bill Ashby of Magnecord, on tape recorders and the service technician. A number of sessions had nearly as great an attendance.

New affiliates officially voted into membership were: Television Bureau of Elkhart, Ind.; King County Radio and TV Service Association, Seattle, Wash.; TV Technicians Association, Joplin, Mo.; Radio and TV Technicians of Boise, Idaho; Tulsa TV Service Association, Okla.; TV Service Guild, Day-



ton, Ohio, and the Radio and TV Technicians Guild of Alabama. Groups in Canada and Venezuela were also welcomed into the organization.

New officers follow: President, Frank J. Moch, Chicago. Vice presidents: (Eastern) Ferdinand Lynn, Buffalo, N. Y.; (East Central) Fred Colton, Columbus, Ohio; (West Central) Vincent Lutz, St. Louis, Mo.; (Western) Horace Collins, Boise, Idaho. Secretaries: (Eastern) Milton Klarsfeld, Albany, N. Y.; (East Central) Chas. N. Burns, Memphis, Tenn.; (West Central) William Briza, Omaha, Neb.; (Western), Jim Failing, Greeley, Colo. Secretary general: Walt Niswonger, Kansas City, Mo. Treasurer, Bertram Lewis, Rochester, N. Y.

Friends of Service Awards were made to Philco for its great efforts on behalf of independent service through the PFFS plan and the Philco stand on transshipping; Sprague Products for its forthright defense of independent

The **ONLY** Way You Can Get
an **FP** Capacitor is to Specify

P. R. MALLORY & CO. Inc.
MALLORY



Why?

Because Only Mallory Makes FP Capacitors

They were introduced by Mallory. For over 15 years they have set the standard of quality and performance in the industry. And they are available *only* from Mallory.

Imitations are available, of course, but they aren't FP's... and they won't have this combination of features that are exclusively Mallory—

**When you ask for
FP Capacitors...
be sure you get
Mallory, not an
imitation.**

- 85°C construction
- Ability to handle high ripple currents
- Well suited for voltage doubler circuits
- Ideal for use with selenium rectifiers
- Genuine fabricated plate anode
- Corrosive impurities held to less than 7 parts in 10 million
- Long shelf life
- Long service life
- Fast, twist prong mounting
- Standardized can size

P. R. MALLORY & CO. Inc.
MALLORY

CAPACITORS • CONTROLS • VIBRATORS • SWITCHES • RESISTORS
RECTIFIERS • POWER SUPPLIES • CONVERTERS • MERCURY BATTERIES

APPROVED PRECISION PRODUCTS

P. R. MALLORY & CO. Inc., INDIANAPOLIS 6, INDIANA

LEARN MORE - EARN MORE with Rider Books!

FUNDAMENTALS OF TRANSISTORS

by Leonard Krugman, U. S. Signal
Corps Engineering Laboratories

Learn all about the transistor! It's smaller than a jelly bean—it's rugged as they come—and it's the thing in electronics today! With more and more uses for transistors being developed all the time, every service technician, student, engineer, and experimenter . . . must be familiar with transistors—must know their characteristics and operation! Leonard Krugman, who wrote this authoritative book, is one of the pioneers in transistor development and application, and his presentation covers every phase—everything you need to know about this electronic miracle! No complicated mathematics—clearly written so everyone can understand!

CHAPTERS: Basic Semi-conductor physics—Transistors and their operation—The grounded base transistor—Grounded emitter and grounded collector transistors—Transistor amplifiers—Transistor oscillators—Transistor high-frequency and other applications—Appendix—Index.

144 (5½ x 8½") pp., illust., only \$2.70

R-C/R-L TIME CONSTANT

by Alexander Schure, Ph.D., Ed.D.

Time constant is a very deceptive subject! The simplicity of the time constant equation often leads people who've learned it into thinking they've mastered the basic concepts, when actually, they've only scratched the surface! This book, written by one of the leading electronics educators, clearly presents Time Constant in theory and application so that everyone—from student to service technician—can understand! A complete, practical explanation of R-C and R-L Time Constant, and how it affects circuit operation! The first of a new Review Series on important electronics subjects.

CHAPTERS: Capacitance, resistance, and inductance—The development of the charge curve—The development of the discharge curve—The meaning of time constant—Long and short time constant waveforms—Application of the time constant—Index.

48 (5½ x 8½") pp., illust., only 90c

HOW TO LOCATE & ELIMINATE RADIO & TV INTERFERENCE

by Fred D. Rowe, Northern California
Electrical Bureau

Fred Rowe has been an interference investigator for years—he's an expert at tracking down and correcting "sore spots" that create radio and TV interference. In this book, he explains the general theories behind interference, and gives instances of actual cases he's worked on. Illustrated in an easy-to-read cartoon style, with a special section containing more than 65 most-frequently-asked question on interference, and their answers, this book gives you the complete, practical picture on locating and eliminating interference! Actually tells you what to do!

CHAPTERS: The interference problem—Antennas & interference—Basic interference sources and sounds—interference locating equipment—Electrical equipment and appliances as noise sources—Locating the source—Power-line interference—Power-line noise filters—Electrical equipment and appliance interference elimination—Fluorescent lamp interference—TV interference suppression for transmitters—Eliminating interference at the TV receiver—Questions & Answers—Ordinances—Index.

128 (5½" x 8½") pp., illust., only \$1.80

Rider books are available at your parts jobber or book store. If YOUR dealer doesn't have these books, mail this coupon now!

JOHN F. RIDER PUBLISHER, INC.
Dept. RE-1, 480 Canal St., N.Y.C.

Please RUSH me:

- Fundamentals of Transistors
 R-C/R-L Time Constant
 How to Locate & Eliminate Radio-TV Interference

name
address
city & state

TECHNICIANS' NEWS

(Continued)

service people against unfair charges of profiteering; Albert C. W. Saunders for his continuous, tireless and effective work on behalf of the service technician. A continuing award given to Sylvia carried a special commendation for Mr. Walter Biede, field service engineer. Howard W. Sams Co. was cited for its continued support of the independent industry. Special citations were also voted to Mr. Dan Creato, vice president of RCA Service Co., and to Carroll Hoshour and Bill Ashby of Magnecord.

MOVIES AND TV SERVICE

A TV service technician is cast as the hero who saves the life of a U. S. president in the recent *United Artists* film "Suddenly."

Hoodlums conspiring to assassinate the President have mounted a powerful gun on a metal kitchen table in a house on a hill the President is to pass. The members of the household—including a TV service technician who was repairing the set—are held prisoners by the gangsters. While working on the set, the repairman manages to connect the high-voltage lead to the metal table. Then a glass of water is "accidentally" spilled on the floor near the table, making the floor conductive.

Just as the chief gangster sights his gun—moments before the Presidential train arrives—the TV technician makes his fateful contact. The hoodlum "freezes" onto the gun, setting it off. He is killed in the resulting melee.

The back of the set is prominently labeled "5,000 volts." This time the movies *underestimated!*

TV IN DRAGNET?

The television show "Dragnet" will present an exposé of a television service racketeer, according to a report from the National Appliance and Radio-TV Dealers Association. A "gimmicked" TV receiver will apparently be the program's main character.

CETA PLANS MEETINGS

A series of meetings planned by the Certified Electronic Technicians Association of New York City has a feature believed to be new in technical lectures. Instead of asking manufacturers to send guest speakers, CETA members go to the manufacturers. A recent meeting was held at Radio Merchandise Sales, Bronx, N. Y., and future meetings and technical forums will be held at Precise Development, Precision Apparatus, CBS-Columbia and Motorola.

CETA is composed of technicians who have finished the Advanced TV Training Course held under the auspices of the Radio-Electronic-Television Manufacturers Association. Because the pilot courses are being taught in New York City, it is at present a local association, but plans have been made to establish chapters in other localities where the RETMA Advanced TV Training Course is being given.

END

STAN-BURN E-P-A-R-K-E

CATHODE RAY TUBE SPECIALS

ONE YEAR GUARANTEE

G.E.		STAN-BURN	
10BP4A	\$14.95	10BP4	\$10.20
10FP4A	21.10	12LP4A	11.90
12KP4A	24.95	12L4A	13.95
12LP4A	18.75	12QP4	11.90
12QP4A/B1014	21.00	12UP4	11.90
12UP4B	28.75	14CP4	15.60
14CP4	24.50	15DP4	17.50
15DP4/B1014	21.00	16AP4	17.50
Dumont	23.75	16DP4 or A	17.50
16AP4A	30.95	16JP4 or A	17.50
16FP4A (N.U.)	25.25	16CP4 or A	17.50
16GP4 or B	31.25	16FP4	17.50
16KP4/16RP4	24.20	16WP4	17.50
16K4A (Aluminum)	28.35	16AP4A	23.00
16JP4A (N.U.)	25.25	16EP4	19.00
16L4A	26.50	16EP4A	23.50
16WP4A	26.50	16CP4 or A	21.00
16GP4B	31.25	17BP4	18.50
17BP4B	30.30	17CP4A	24.50
17CP4	34.00	17CP4B	22.60
17CP4B (Aluminum)	38.50	19FP4	23.00
19AP4A	41.50	19FP4A	24.00
20CP4	30.00	19AP4	23.90
20LP4	37.50	19AP4A	24.90
21AP4	42.00	20CP4	23.95
21EP4	32.80	21EP4	25.50
21EP4A	37.35	21AP4	26.50
24AP4	78.50	24AP4	49.00

QUANTITY CRT USERS

We will give you DUD allowances if you ship them to us Prepaid. 10 CRT's minimum shipment. WRITE FOR DETAILS.

AUTHORIZED DISTRIBUTORS for: General Electric, Kenrad, Tung-Sol, National Union, De Wald, Regal, Automatic and General Motors.

AUTOMATIC CUSTOM-BUILT RADIOS for Plymouth, Ford, Chevrolet and many others, always in stock. We carry a complete stock of Hi-FIDELITY and SOUND EQUIPMENT. Send us your requests. We also carry a complete line of popular makes of Radio tubes at 50-100% discount. Also many other special purpose and transmitting types, and all electronic parts and equipment at lowest prices. Send us a list of your requirements for prompt quotations. Terms: 20% with order. Balance COD. All prices FOB. NEW YORK Warehouse. Minimum order \$5.00. Write for our latest price list and Hi-Fi Catalog to Dept. RE-12

STAN-BURN RADIO and ELECTRONICS CO.

1697 BROADWAY • NEW YORK 19, N.Y.

Preferred for
Original Equipment
Proven for
Replacement



OXFORD Speakers

Available from leading jobbers!

OXFORD ELECTRIC CORP.
3911 S. Michigan Ave., Chicago 15, Ill.
EXPORT: ROBURN AGENCIES, N.Y.C., N.Y.
In Canada: Atlas Radio Corp., Ltd., Toronto



37C1 or 43C1



37C2 or 43C2

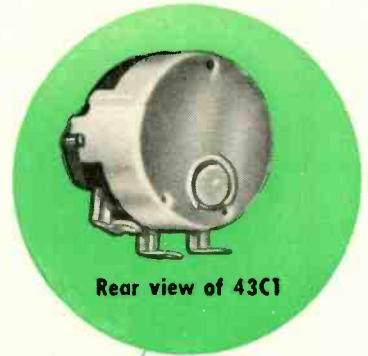

Rear view of 43C1

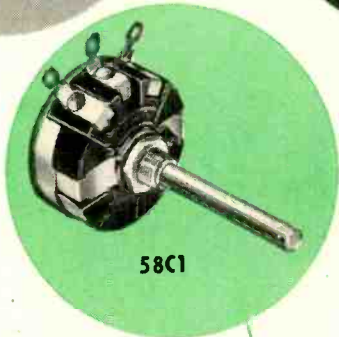

58C1

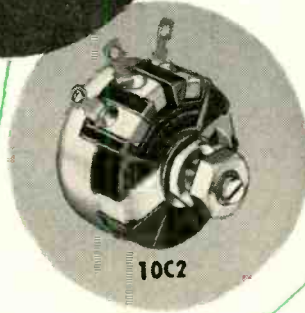

10C2



Where better-than-standard components are desirable...

CLAROSTAT C Line Controls

A new line of composition-element and wire-wound controls designed specifically for custom-built, industrial, laboratory or other semi-critical applications. These controls are *de luxe versions* — mechanically and electrically — of the popular Clarostat standard types widely used in radio-TV sets and for the servicing thereof.

With factory-assembled fixed 1 3/8" round shaft (C1) or 1/8" screwdriver-slot shaft (C2) with split locking bushing. All exposed metal parts have corrosion-resistant finish. Terminals have suitable finish for ease of soldering.

Close-fitting covers — no holes or cut-outs. Maximum protection against dust and dirt.

Ratings: 37C1 and 37C2 composition-element, 1 watt; 43C1 and 43C2 wire-wound, 2 watts; 58C1 and 58C2, 3 watts; 10C1 and 10C2, 4 watts.

Electrical tolerances plus/minus 10% for composition-element controls up to 100,000 ohms; plus/minus 20% from 100,000 ohms to 10 megohms.

Wire-wound controls within plus/minus 5% in all ohmages. Independent linearity to plus/minus 1% for 58C1 and 58C2, and 10C1 and 10C2 controls; for 43C1 and 43C2, plus/minus 2%.

Available with switches on special order.

Units sealed in dustproof plastic bags within standard Clarostat cartons. Factory-fresh appearance and condition, regardless of shelf life.



If you want still better-than-standard quality, performance and life, insist on Clarostat C LINE controls.

CLAROSTAT Controls & Resistors

CLAROSTAT MFG. CO., INC., DOVER, NEW HAMPSHIRE
In Canada: Canadian Marconi Co., Ltd., Toronto, Ontario



EXTRA



NEW IMPROVED JSC STRIPS WIRE EASILY!

Secret Process Plus Pure Polyethylene Guarantees Quality of 300-Ohm Cable

No more complaints when you use newly improved J.S.C. wire. J.S.C.'s secret process plus the use of only pure Polyethylene make this wire the easiest to strip. Compare it with any other on the market; you will find none better.

Compare JSC Quality With Any Higher Priced Make

Choose any other make at any price—J.S.C. wire will stand comparison. Quality-wise and very low in price, J.S.C. wire will win hands down. You be the judge. J.S.C. invites comparison.

Installers Wild About New JSC 300-Ohm Wire

Installers everywhere, now using newly improved J.S.C. wire, term it the easiest stripping cable on the market. Their enthusiastic approval is tangible proof that J.S.C.'s new secret formula is fact, not fiction.

Send For Your Free Sample

Seeing is believing. J.S.C. has so much faith in its newly improved 300-ohm cable they want you to see it with your own eyes. Send for a FREE sample today . . . then compare.



Packed 10 coils to each attractive counter display.



Always look for the Orange and Blue Disc of Quality.

Jersey Specialty Co., Inc.

Burgess Place, Mountain View, N.J.

Phones: Little Falls 4-0784-1404-1405

MISCELLANY



THE FUND REACHES \$11,492.61

HELP - FREDDIE-WALK FUND

IT IS heartening to see that little Freddie, armless and legless son of radio technician Herschel Thomason, Magnolia, Ark., is still remembered by readers of RADIO-ELECTRONICS. From all over the world they continue to send in contributions and messages of encouragement.

It is perhaps even more heartening to know that the \$11,400-plus his friends have donated to Freddie's fund is responsible for the great strides he has been able to take. Not literally, of course, and not yet, but soon. For Freddie has been fitted with artificial legs and is learning to walk with the best of them. Writes his father:

"He is still walking fine. He can go all over the house, and at a fair pace, too. He usually walks all morning and then takes a nap and exercise in the afternoon."

Recently we had the pleasure of meeting Freddie when his mother brought him East to the Kessler Institute for Rehabilitation, and we can happily report that he is so cheerful, so full of fun and the devil, that you almost forget that he is not completely like other children. It is a tribute to his parents and friends that Freddie, young as he is, shows every sign of becoming the contributing, well-adjusted adult we all hope he will be.

However, it is obvious that the special treatments, mechanical appliances, etc., that he will need throughout his life will cost thousands and thousands of dollars. Although RADIO-ELECTRONICS' readers have already contributed almost \$11,500, we can't stop there. We urge each and every reader to send in his contribution whenever and as often as he can. No amount is too small to merit our sincere thanks and appreciation, and every donation is acknowledged. *Make all money orders, checks, etc., payable to Herschel Thomason.*

Address all letters to:

Help-Freddie-Walk Fund
c/o RADIO-ELECTRONICS Magazine
25 West Broadway
New York 7, N.Y.

FAMILY CIRCLE Contributions.....	\$ 602.50
RADIO-ELECTRONICS Contributions as of July 2, 1954.....	10,842.61
Anonymous, San Francisco, Calif.....	5.00
Anonymous, Hartford, Conn.....	1.00
Anonymous, New York, N. Y.....	1.00
Anonymous, Philadelphia, Pa.....	1.00
F. T. Barron, Fontana, Calif.....	1.00
A. H. Danter, St. Louis, Mo.....	5.00
Electro-Scientific, Antwerp, Belgium.....	2.00
Andrew Fyfe, Montreal, Canada.....	5.00
Mary Krull, Passaic, N. J.....	5.00
Morgan Radio Service, Tucson, Ariz.....	1.00
Alexander Rys, Minneapolis, Minn.....	.50
Robert V. Signaigo, Chicago, Ill.....	5.00
Walter Soule, Boston, Mass.....	2.00
Roy Sunday, Camden, N. J.....	1.00
Class BC#19, United Radio Tel-Inst.....	
Newark N. J.....	7.00
W8HOB, Columbus, Ohio.....	5.00

TOTAL CONTRIBUTIONS as of October 15, 1954..... \$11,492.61

GET INTO ONE OF THESE GREATER OPPORTUNITY FIELDS

Electricity or Radio-Television

TRAIN IN THE GREAT SHOPS OF COYNE

OLDEST, BEST EQUIPPED SCHOOL OF ITS KIND IN U. S.

Prepare for your future NOW. Get practical training in TELEVISION—RADIO—ELECTRICITY—ELECTRONICS—all vital in Industry. Prepare now for a better job that also offers a real future in the years ahead. Learn on real equipment at Coyne—no advanced education or previous experience needed.

Approved for Veterans—finance plan—enroll now, pay most of tuition later. Part time employment service while training if needed.

FREE BOOK Clip coupon for Big Free Illustrated Book. No salesman will call. Act NOW.

B. W. COOKE President

COYNE ELECTRICAL SCHOOL

A TECHNICAL TRADE INSTITUTE CHARTERED NOT FOR PROFIT

500 S. Paulina St., Chicago, Dept. 94-81H
ELECTRICITY • TELEVISION • RADIO • REFRIGERATION • ELECTRONICS

B. W. COOKE, Pres.
COYNE ELECTRICAL School
500 S. Paulina St., Chicago 12, Ill. Dept. 94-81H
Send FREE BOOK and details on:
 RADIO-TELEVISION ELECTRICITY

NAME.....
ADDRESS.....
CITY..... STATE.....

CLEAR TV PICTURE

PERMANENT INSTALLATION—

WITH A

WINPOWER TV TOWER

Permanent, one-man tower erection—fewer guy wires—no special tools. Offer better reception at lowest cost—eliminate mounting troubles and service calls.

Adapter locks mast or serves as rotor bracket.

"All-Angle" feet fit any roof.

5' or 10' height.

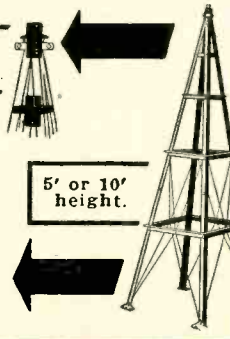

WRITE FOR FREE FOLDER TODAY!

WINPOWER

NEWTON, IOWA

radio-electronic Circuits



HANDY AMPLIFIER KINK

On a recent PA job I used an amplifier designed for high-output crystal phonographs and crystal microphones. In an emergency I had to use a low-output magnetic phono pickup. The amplifier did not have enough volume, even with the gain control set at maximum. No spare parts or tools were available.

The amplifier uses a 6SN7-GT amplifier and split-load phase inverter, a 6N7 push-pull driver, and a 6AS7-G push-pull output stage as shown in the diagram. Using a pair of borrowed scissors, I clipped the 10- μ f capacitor lead running to the cathode of V2, stripped the insulation off one end, and then twisted the lead around the cathode pin of V1-b.

This converted the phase inverter

(V1-b) into a straight amplifier driving the grid of V2-a. The grid of V2-b is now effectively grounded by the 10- μ f capacitor at the cathode of V1-b while the cathode of V2 is now unbypassed. Thus, V2 is converted into a cathode-coupled phase inverter with only half the gain of the original push-pull amplifier circuit. On the other hand, the voltage gain of V1-b as an amplifier is about 20 times that of the original phase-inverter connection. Thus, the over-all gain from the plate of V1-a to the grids of V3 is now about 10 times (20 db) greater than previously. This added 20-db gain was enough to do the job. Naturally, I do not recommend this modification except in emergencies where everything else looks hopeless.—Nathan Sokal

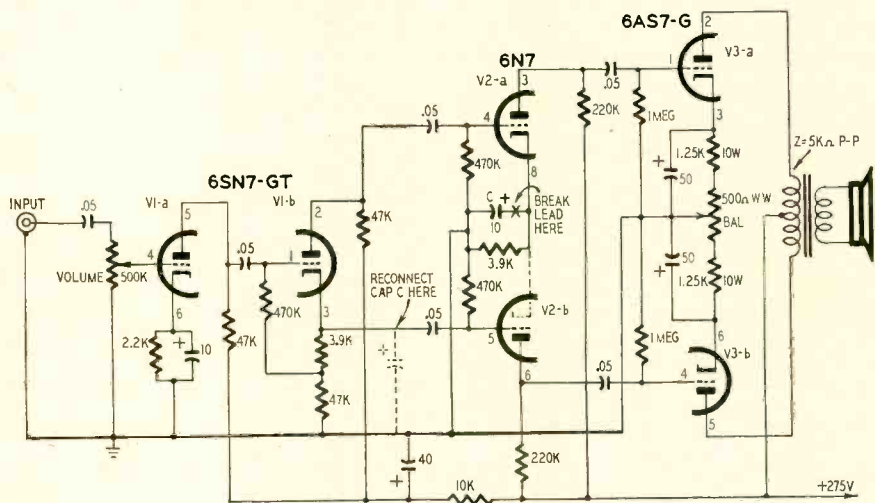

B.F.O. MODIFICATION

Many amateur operators fail to tune their receivers properly for CW signals. They usually tune in a signal and adjust its pitch with the tuning control, using the pitch control only to vary the pitch when fighting QRM. This method of tuning in a CW signal often results in the r.f. and i.f. stages being several kc off resonance.

In *Short Wave Magazine*, G3DXI describes how he modified the b.f.o. in an AR 77 to assure proper CW tuning. His modification, shown in the diagram, can be applied to almost any communications receiver regardless of b.f.o. circuitry.

The original b.f.o. tuning capacitor was removed and replaced with a 3-position rotary switch and a pair of

3-25- μ f trimmers. For CW reception he feeds the output of the receiver through a tuned a.f. amplifier peaked at 1,000 cycles so his switch tunes the b.f.o. to frequencies 1 kc higher and lower than the receiver's i.f.

To align the b.f.o., set the switch to HIGH and feed into the receiver's mixer grid the unmodulated output of a signal generator tuned exactly 1,000 cycles

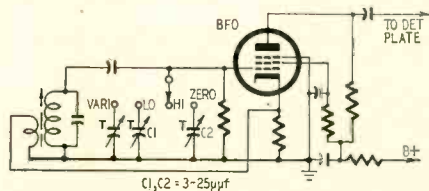

TV SERVICEMEN: here's the help you need

NEW

"TV SERVICE DATA BOOK"

by MILTON S. KIVER



Packed with
facts you'll
use every
single day

**GET IT
TODAY**

**all the data you need
in one handy guide—**

- saves valuable time
- helps you earn more

Instant TV Servicing and Installation Reference: Have at your finger-tips all of the most frequently needed charts, tables and formulas you require in Television servicing and installation. Includes charts on fuses, color codes, attenuator pads, monochrome signal specifications, guy wire lengths, etc.—all the data you'll ever want in your daily work. Save valuable time on calculations by quick reference to the tables of mathematical constants and electrical formulas. Speeds your work for greater earnings.

Trouble-Shooting Guide: Includes section on TV trouble-shooting. Lists common trouble symptoms and tells how to locate defective components. Recommends most effective methods for use of test probes and other accessory equipment. You'll want to keep it handy in your tube caddy for quick reference at the bench or in the field. It pays for itself in a single day's work. Over 100 pages. 5½ x 8½".

ORDER JB-1. \$150
Only

**ORDER
TODAY**

HOWARD W. SAMS & CO., INC.

Order from your Parts Jobber today, or write to Howard W. Sams & Co., Inc., 2205 East 46th St., Indianapolis 5, Ind.

My (check) (money order) for \$..... enclosed. Send.....copy (ies) of "TV Service Data Book" (JB-1, \$1.50).

Name.....

Address.....

City..... Zone..... State.....
(outside U.S.A. priced slightly higher)

EDLIE
says

"HUGE HOLIDAY SAVINGS"

TERRIFIC VALUE!

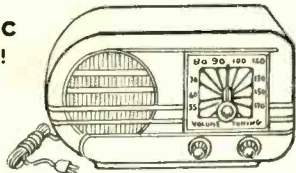

5 TUBE AC/DC Superhet Kit

Kit #1: 5 tube superhet kit. AC/DC includes all quality components required to construct this latest design, highly sensitive superhet broadcast receiver, complete with black glistening bakelite cabinet (excludes wire & solder). Kit of 5 tubes. 12AT6, 2/12BA6, 12BE6, 35W4, 50B5.

Price, Less Tubes..... **\$7.95**
Extra for Tubes..... **\$3.25**

3-Way Portable RADIO KIT AC/DC Batteries



NEW, compact, lightweight portable radio kit with the very latest supersensitive superhet. circuit. Wonderful reception from either batteries, or 115 V., 50-60 cycle AC or DC. Includes all complete parts (except wire & solder) necessary to build a Great sounding tuner. Also includes circuit diagrams and simplified, complete step-by-step instruction folder which makes assembling easy. Housed in a beautifully high-glossed Catalin cabinet in two delightful and distinctive colors: maroon or ivory. Size: 9 1/4" x 5 7/8" x 4 3/4". Includes tubes..... **\$13.95** (maroon or ivory)

BATTERY KIT: add..... \$2.59

AM/FM TUNER with BUILT-IN 10 WATT HI-FI AMPLIFIER

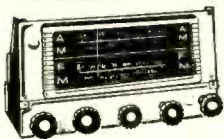

117 V., AC. 60 cycles, using an oversized power transformer. Includes push-pull audio output providing for 10 watt undistorted output, full range Bass & Treble control, built-in powerful antenna for FM, plus hi-gain Ferrite antenna for AM. Provision for phono input, and an additional audio amplifier.

Tubes: 6BE6, 2-6AV6, 6CB6, 6BA6, 6AL5, 2-6V6, 5Y3. Completely shock mounted chassis: 12 1/2 x 5 1/2 x 7 1/2". 11 Lbs.

If tuner is to be used for a reluctance pick-up, a pre-amplifier will be contained. Add.....\$6.75

Now Only **\$48.75**

3-SPEED PORTABLE PHONOGRAPH

The Ideal Gift

Plays all speed records (33 1/3, 45 & 78 RPM) with a new, all purpose permanent needle. Complete with excellent amplifier and speaker for unusual fine tone. Luggage type carrying case, durable and long lasting. 12 1/2" x 10" x 5 1/4". 8 1/2 lbs.

Christmas Special **\$14.75**



3-TUBE PHONO AMPLIFIER NOT A KIT

An assembled unit ready for installation using tone and volume control and 6 ft. rubber cord. (less tubes)..... **\$2.95**

Lowest Price! With complete set of tubes..... **\$4.45**

Great Savings! 6-TUBE RADIO KIT

Kit #2: Low priced 6-tube kit designed for extra high sensitivity, excellent selectivity and good, rich tone quality. Uses 25L6, 25Z6, 6SQ7, 6SA7, 2/6SK7 in an easily constructed circuit. Includes all parts: pinched chassis, resistors, condensers, coils, sockets, PM speaker, hardware, etc. Special closeout price. (Less tubes & cabinet)..... **\$6.95** Matched set of 6 tubes for kit **\$3.25**

Phone Oscillator NEW SAVINGS! NOT A KIT!

Wireless phono oscillator transmits recording for crystal pickups of voice from carbon mike through radio without wires. Can also be used as an intercom by using PM speaker as mike (less tubes)..... **\$2.95** With complete set of tubes **\$3.95**

NEW KIT SUPERSENSITIVE 2-STATION INTERCOMMUNICATIONS SYSTEM—Kit..... \$12.95



This fine unit is suitable for use in home, office, factory, nursery, or sick room. So sensitive it will pick up baby's whimper. Operates from 115 V. AC/DC. Both stations housed in compact, handsome, plastic cabinets: 6" x 6" & 3 1/2". Requires only 2 wires to connect for quick installation. Complete with 50 ft. of twin conductor wire. Factory Wired..... **\$16.95**

Newest Flashlight

BROW-LITE

Frees Both Hands for Repair Work



Just out! Brow-Lite gives you the third-hand you've always wished for when using a flashlight. Indispensable to servicemen—excellent for night work. Safer and quicker than flashlight. Fits easily on your head like a pair of glasses yet can be worn comfortably with or without glasses. Adjustable to any angle.

WORLD'S MOST USEFUL FLASHLIGHT. Uses standard penlite batteries & bulb.

Complete with btry. & bulb. **\$1.98**

Just Out! First Time Anywhere

Larrel's E-Z TV REPAIR GUIDE

The only Fix-It-Yourself guide made expressly for YOUR TV SET! Save costly TV repairs with this new, simplified method which includes all necessary data for just your set. No confusing, unimportant information applicable to hundreds of different makes. Simplifies detection of faulty tubes in your TV receiver. It's a great idea—It's a great guide! Order today and have your set back in perfect condition at once. Send us make and model of your set when ordering. **50¢**

E-Z TV REPAIR GUIDE

save costly TV repairs... FIX IT YOURSELF

This simplified method of repairing your own TV set... Yarnall

PREPARED EXPRESSLY FOR YOUR SET

No confusing, unimportant information applicable to hundreds of different makes.

This Guide Has Been Prepared Only For
Your Set
Larrel Electronics, Inc.

RADIO-ELECTRONIC CIRCUITS (continued)

(1 kc) higher than the i.f. Adjust the b.f.o. tuning slug (or padder capacitor) for zero beat.

Tune the signal generator to the i.f., set the switch to ZERO, and adjust C2 for zero beat. Throw the switch to LOW, tune the signal generator 1 kc below the i.f., and adjust C1 for zero beat.

To operate, set the b.f.o. switch to ZERO and adjust the tuning controls to zero-beat the desired signal. This assures that the r.f. and i.f. circuits are peaked on the incoming signal. Now, flip the switch to LOW or HIGH, and you are ready to copy. In QRM, you can simply flip the switch to the other side rather than tune the variable control and take the chance of losing the station. Of course, if you want to keep the variable pitch control for optional use, you can use a 4-position switch and connect the original variable pitch control as shown.

SHORT-PULSE GENERATOR

Multivibrators, sine-wave clippers, and differentiators are generally used to produce sharp unidirectional pulses for timing, triggering, and gating applications. The circuits are usually complex and component values are critical. In *Electronic Engineering* (London, England) F. A. Benson and G. V. G. Lusher review the use of a simple shock-excited LCR circuit as a source of sharp unidirectional pulses.

The oscillator circuit consists of inductor L tuned by stray and distributed capacitance C_s. When a positive-going pulse is applied to the input, the L-C circuit is shocked into producing a chain of damped oscillations. Resistor R damps out the oscillations after two or three cycles. The diode clips off most of the unwanted negative portion.

With a 6,500-cycle, 20-volt peak positive pulse applied to the input and a

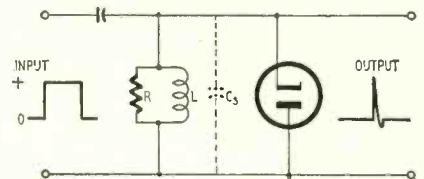

damping resistor of 3,000 ohms, a 400-μh coil produces an output signal with a rise time of 0.8 μsec and amplitude of 1.6 volts. With 180- and 33-μh coils, rise times are 0.6 and 0.5 μsec and output pulse amplitudes 1.35 and 0.3 volts, respectively. With a 250-μh coil and 2,000-ohm damping resistor, a 6,500-cycle, 60-volt input pulse produces a 10-volt output pulse with a rise of 0.7 μsec and a width of 2 μsec.

For negative output pulses, reverse the diode polarity and use negative-going input pulses. When a negative pulse of greater amplitude is needed, replace the diode with the grid-cathode circuit of a triode and take the output from the plate. END

TERMS: All mdse shipped FOB New York City, prices subject to change without notice, include 20% deposit for COD's. WRITE TODAY FOR NEW FREE CATALOG!

EDLIE Electronics 154 Greenwich St
DI 9-3143
New York 6, N.Y.

Giving coils a high IQ*



**DELCO RADIO CAREFULLY CONTROLS THE PRODUCTION
OF ORIGINAL AND REPLACEMENT RF AND IF COILS**



Each RF and IF coil is wound under the supervision of a skilled operator, and each is tested at several points along the production line. This painstaking care is what gives a high IQ to Delco Radio Coils.



A GENERAL MOTORS PRODUCT   A UNITED MOTORS LINE

***INBUILT QUALITY.** The "Q" of a coil affects its performance in the circuit, and is of vital importance to the radio engineer. The "IQ" of all RF and IF coils used for servicing is of equal importance to you, and can mean real customer satisfaction. To assure high IQ, Delco Radio carefully controls the production of all RF and IF coils—both original equipment and replacement coils.

If you could visit the Delco Radio plant, you would see skilled operators sitting at expensive specially designed machines winding high-quality coils. On the production line, these coils are assembled with their powdered iron cores and shield cans. By controlling all steps of the production, Delco Radio gives its coils not only the required Q, but also the highest possible IQ—*Inbuilt Quality*. Delco Radio parts are available through your UMS Delco Electronics Distributor.

DISTRIBUTED BY ELECTRONIC PARTS DISTRIBUTORS EVERYWHERE

DELCO RADIO

DIVISION OF GENERAL MOTORS CORPORATION, KOKOMO, INDIANA

THIS professional TRAINING IS THE KIND THAT Really Pays Off!

... and it costs only a fraction of what you might expect to pay!

FIX ANY RADIO OR TV SET EVER MADE...easier...better...faster

Backed by the how-to-do-it methods so clearly explained in this one big 822-page book, you'll be prepared for fast, accurate service on any radio or television receiver ever made.

Best of all, the cost is only \$6.75 (or see money-saving combination offer in coupon).

Radio & Television TROUBLESHOOTING AND REPAIR by Ghirardi & Johnson is far and away the world's most modern, easily understood guide. Step by step, it takes you through each service procedure... from locating troubles with less testing to repairing them by professional methods... the kind that let you handle tough jobs as slick as you do the easy ones.

COMPLETE SERVICE TRAINING

For beginners, this giant book is a complete service training course. For experienced service-

men, it is a quick, easy way to "brush up" on specific jobs; to develop better methods and shortcuts and to find fast answers to tough jobs.

Here are just a few of the subjects covered: Components and Their Troubles; Basic Troubleshooting Methods; "Static" and "Dynamic" Testing; Practical Troubleshooting Tips and Ideas; AC/DC, 3-way Portable and Battery Set Troubleshooting Problems; Servicing Communications Receivers; a Complete Guide to Television Service; AM, FM, and TV Realignment Made Easy; Resistor, Capacitor, Inductor and Transformer Problems; Servicing Tuning, Selector and Switching Mechanism; Loudspeakers; Servicing Recorders and Record-playing Equipment... and dozens more... 417 illustrations. Read TROUBLESHOOTING AND REPAIR for 10 days AT OUR ISK!

LEARN BASIC CIRCUITS FULLY... and watch service "headaches" disappear

It's amazing how much easier and faster you can repair radios, television sets and even industrial electronic equipment when you know all about circuits and what makes each one "tick."

You locate troubles in a jiffy because you know what to look for and where to look.

You make repairs lots faster, better and more profitably!

Actually, there are only a comparatively few BASIC circuits in modern equipment. Radio & Television RECEIVER CIRCUITRY AND OPERATION by Ghirardi and Johnson gives you a complete understanding of these as well as their variations. It teaches you to recognize them... to understand their peculiarities and likely "troubleshooting"... and shows how to eliminate useless testing and guesswork in making repairs.

LEARN MORE—EARN MORE!

Throughout, this 669-page book with its 417 clear illustrations gives you the kind of above-average professional training that fits you for the better, big pay jobs in either servicing or general electronics. Covers all circuits in modern TV and radio receivers, amplifiers, phono-pickups, record players, etc. Price only \$6.50... or see money-saving offer in coupon. Examine it 10 days at our risk!

FREE EXAMINATION...easy terms!

Dept. RE-124, RINEHART & CO., INC.
232 Madison Ave., New York 16, N. Y.

Send books indicated for FREE EXAMINATION. In 10 days, I will either remit price indicated plus postage or return books postpaid and owe you nothing.

- Radio & TV TROUBLESHOOTING AND REPAIR (Price \$6.75)
- Radio & TV CIRCUITRY AND OPERATION (Price \$6.50)

COMBINATION OFFER... Both books only \$12.00 (Regular price separately \$13.25... you save \$1.25)

(Combination offer is payable at rate of \$3 (plus postage) after 10 days if you decide to keep books, and \$3 a month thereafter until \$12 has been paid.)

Name _____
Address _____
City, Zone, State _____

OUTSIDE U.S.A. . . . \$7.25 for TROUBLESHOOTING & REPAIR; \$7.00 for CIRCUITRY & OPERATION; \$13.00 for both books; Cash with order, but money refunded if you return books in 10 days.



SAVE \$1.25

Make your training library complete! Get both these big books at the low price of only \$12.00 for the two (you save \$1.25).

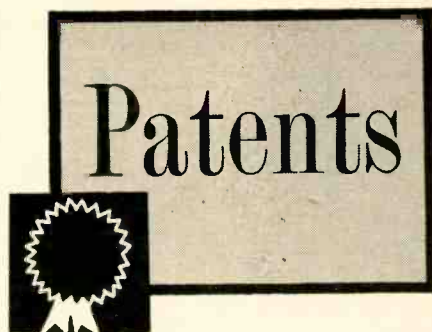

VOLUME LIMITER

Patent No. 2,679,626

Edwin C. Miller, Havre, Mont.

(assigned to Northwest Radio Consultant Service, Hill County, Mont.)

This is a constant-output amplifier suitable for recording, ham and commercial broadcasting, etc. When properly adjusted, the output remains constant to within 1.5 db, even though the input may vary over a range of 20 db or more. The

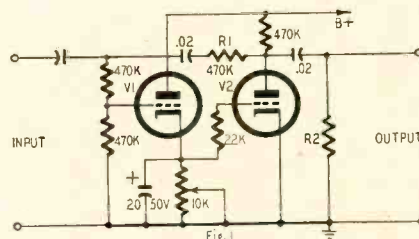

circuit is essentially an electronic potentiometer. The input appears across both sections (R1, R2) of the potentiometer. Output is taken across R2, which is shunted by the plate-cathode resistance of V2. This resistance varies considerably with signal input.

In Fig. 1, the triodes are a 6SL7-GT tube. Triode V1 is a cathode follower, biased to respond primarily to a positive input. Negative swings are less effective since V1 goes into cutoff.

If the input voltage increases, the cathode of

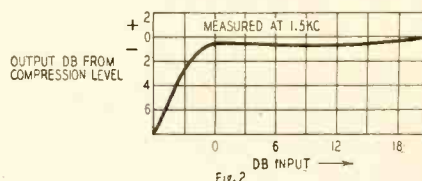

V1 goes more positive, as does the grid of V2. Therefore the internal resistance of V2 is reduced. Of course, a smaller fraction of the total signal is available at the output. On a weaker signal, V2 shows a higher internal resistance, and therefore supplies a greater percentage of the input to the next stage.

The remarkable leveling characteristic is shown in Fig. 2. Once full input is obtained, further increase (even as much as 20 db) does not produce greater output.

INFRARED GENERATOR

Patent No. 2,683,794

Howard B. Briggs and James R. Haynes, Chatham, and William Shockley, Madison, N.J. (assigned to Bell Telephone Labs., Inc.)

The operation of a transistor is known to be affected by heat and light. Now it has been determined that semiconductors can radiate energy when large currents flow through them. This invention shows how a p-n junction transistor generates infrared energy.

In Fig. 1, C charges through R when the key is left up. When the key is depressed, C discharges through the p-n junction. Positive charges are injected into the n region of the semiconductor, preferably at a rate exceeding 10

amps per sq. cm. These holes recombine with excess electrons in the n region, giving a pulse of infra-red rays.

Fig. 1 also shows how the radiation is detected. A lead sulphide photocell (PC) is energized by a battery. When radiation strikes the cell, electricity is generated. After amplification, it is fed to an oscilloscope with a synchronized sweep. The visible pattern indicates energy amplitude vs. wavelength.

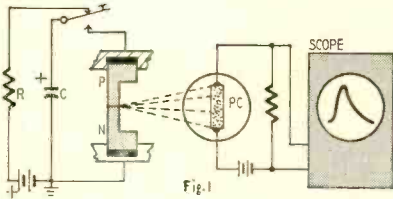

Fig. 1

The wavelength of the energy varies with junction temperature. (See Fig. 2.) Curve A shows energy distribution at room temperature (295° K). Curves B and C are drawn at the temperatures of liquid nitrogen (77.4° K) and liquid

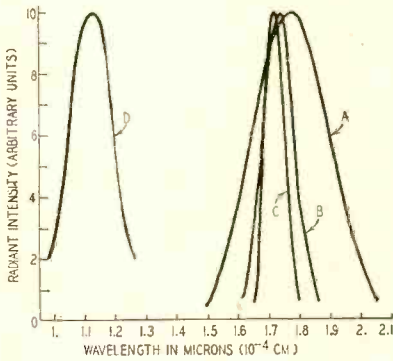

Fig. 2

hydrogen (21.5° K), respectively. Note that wavelength drops as temperature decreases. Bandwidth also becomes narrower. Curve D is for room temperature but with a silicon junction instead of germanium.

Because infra-red rays easily pierce fog and haze, these pulses of energy are useful for short-distance signaling and communication.

The primary object of this invention is the creation of a readily controllable source of infra-red energy. A more specific object is to enable infra-red energy to be generated in narrow frequency bandwidths. This makes it particularly suitable as a radio-frequency carrier. END



For monochrome and color...

TACO

TWIN DRIVEN

Shark

12 Channel VHF Antenna

Another winner by Taco! Full 12 channel reception with emphasis on channels 2 through 6, plus full color reception.

Make your installations right... right from the start. Install the new Taco Twin-Driven Shark and assure full color saturation for your customer when he "switches" over, and provide unparalleled black and white reception immediately.

Designed for single bay, 2-Bay Stacked (2 Models) or 4-Bay Stacking, depending upon gain required.

Look at the gain curve below - it will tell you why you should try the Shark and use the Shark.

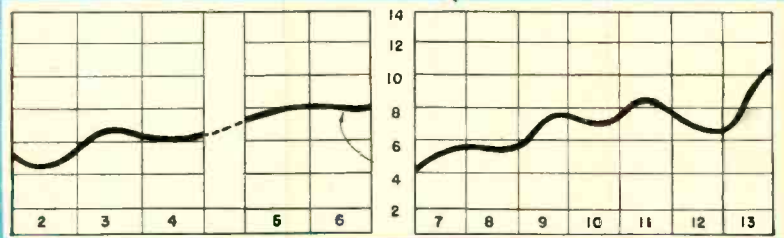
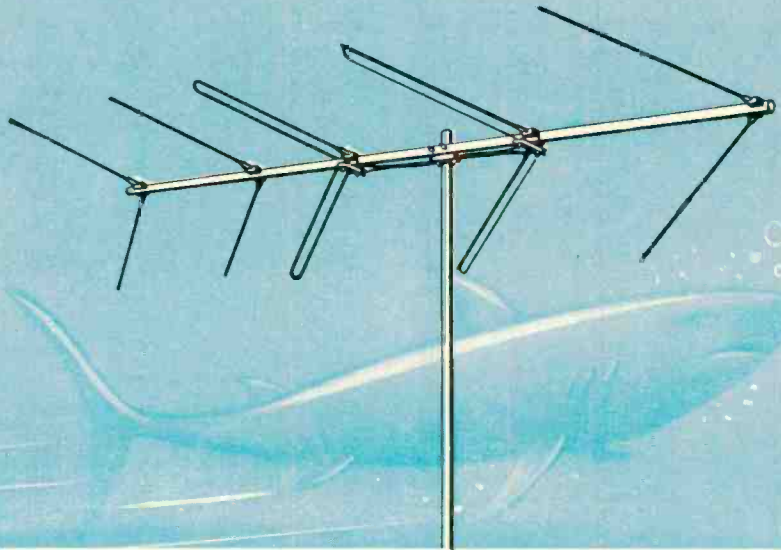

Measured voltage gain in DB for No. 1845 single bay Shark compared to reference dipole.

TECHNICAL APPLIANCE CORPORATION SHERBURNE, N. Y.

In Canada: Hackbusch Electronics, Ltd., Toronto 4, Ont.



Measures 6 1/4" x 9 1/2" x 4 1/2"

Superior's new
Model 670-A

SUPER METER

A COMBINATION VOLT-OHM MILLIAMMETER PLUS
CAPACITY REACTANCE INDUCTANCE AND DECIBEL MEASUREMENTS

SPECIFICATIONS:

D.C. VOLTS: 0 to 7.5/15/75/150/750/1,500/7,500 Volts
A.C. VOLTS: 0 to 15/30/150/300/1,500/3,000 Volts
OUTPUT VOLTS: 0 to 15/30/150/300/1,500/3,000 Volts
D.C. CURRENT: 0 to 1.5/15/150 Ma. 0 to 1.5/15 Amperes
RESISTANCE: 0 to 1,000/100,000 Ohms 0 to 10 Megohms
CAPACITY: .001 to 1 Mfd. 1 to 50 Mfd. (Good-Bad scale for checking quality of electrolytic condensers.)
REACTANCE: 50 to 2,500 Ohms 2,500 Ohms to 2.5 Megohms
INDUCTANCE: .15 to 7 Henries 7 to 7,000 Henries
DECIBELS: -6 to +18 +14 to +38 +34 to +58

ADDED FEATURE:

Built-in ISOLATION TRANSFORMER
reduces possibility of burning out meter through misuse.

The Model 670-A comes housed, in a rugged crackle-finished steel cabinet complete with test leads and operating instructions.

\$2840
NET



Superior's new
Model TV-11

TUBE TESTER

SPECIFICATIONS:

- ★ Tests all tubes including 4, 5, 6, 7, Octal, Lock-in, Peanut, Bantam, Hearing Aid, Thyatron Miniatures, Sub-miniatures, Novals, Sub-minars, Proximity fuse types, etc.
- ★ Uses the new self-cleaning Lever Action Switches for individual element testing. Because all elements are numbered according to pin-number in the RMA base numbering system, the user can instantly identify which element is under test. Tubes having tapped filaments and tubes with filaments terminating in more than one pin are truly tested with the Model TV-11 as any of the pins may be placed in the neutral position when necessary.
- ★ The Model TV-11 does not use any combination type sockets. Instead individual sockets are used for each type of tube. Thus it is impossible

to damage a tube by inserting it in the wrong socket.

- ★ Free-moving built-in roll chart provides complete data for all tubes.
- ★ Newly designed Line Voltage Control compensates for variation of any Line Voltage between 105 Volts and 130 Volts.
- ★ **NOISE TEST:** Phono-jack on front panel for plugging in either phones or external amplifier will detect microphonic tubes or noise due to faulty elements and loose internal connections.

The model TV-11 operates on 105-130 Volt 60 Cycles A.C. Comes housed in a beautiful hand-rubbed oak cabinet complete with portable cover

EXTRA SERVICE—The Model TV-11 may be used as an extremely sensitive Condenser Leakage Checker. A relaxation

type oscillator incorporated in this model will detect leakages even when the frequency is one per minute.

\$4750
NET



SUPERIOR'S NEW MODEL TV-40

C.R.T. TUBE TESTER

A complete picture tube tester
★ for little more than the price of a "make-shiff" adapter!!

★ Tests all magnetically deflected tubes . . . in the set . . . out of the set . . . in the carton!!

The Model TV-40 is absolutely complete! Self-contained, including built-in power supply, it tests picture tubes in the only practical way to efficiently test such tubes: that is by the use of a separate instrument which is designed exclusively to test the ever increasing number of picture tubes!

EASY TO USE:

Simply insert line cord into any 110 volt A.C. outlet, then attach tester socket to tube base (Ion Trap Need Not Be on Tube). Throw switch up for quality test . . . read direct on Good-Bad scale. Throw switch down for all leakage tests.

SPECIFICATIONS:

- Tests ALL magnetically deflected picture tubes from 7 inch to 30 inch types.
- Tests for quality by the well established emission method. All readings on "Good-Bad" scale.
- Tests for inter-element shorts and leakages up to 5 megohms.
- Tests for open elements.

Model TV-40 C.R.T. Tube Tester comes absolutely complete—nothing else to buy. Housed in round cornered, molded bakelite case. Only.....

\$1585
NET

**SHIPPED ON APPROVAL
NO MONEY WITH ORDER — NO C.O.D.**

Try any of the above instruments for 10 days before you buy. If completely satisfied then send down payment and pay balance as indicated on coupon. No Interest or Carrying Charges Added! If not completely satisfied return unit to us, no explanation necessary.

MOSS ELECTRONIC DISTRIBUTING CO., INC.
Dept. D-83, 3849 Tenth Ave., New York 34, N.Y.

Please send me the units checked. I agree to pay down payment within 10 days and to pay the monthly balance as shown. It is understood there will be no carrying, interest or any other charges, provided I send my monthly payments when due. It is further understood that should I fail to make payment when due, the full unpaid balance shall become immediately due and payable.

Model 670-A.....Total Price \$28.40
\$7.40 within 10 days. Balance \$3.50 monthly for 6 months. Model TV-11.....Total Price \$47.50
\$11.50 within 10 days. Balance \$6.00 monthly for 6 months. Model TV-40.....Total Price \$15.85
\$3.85 within 10 days. Balance \$4.00 monthly for 3 months.

Name

Address

City..... Zone..... State.....

The Model
TV-50

GENOMETER

A versatile all-inclusive GENERATOR which provides ALL the outputs for servicing:

A. M. Radio F. M. Radio Amplifiers Black and White TV Color TV

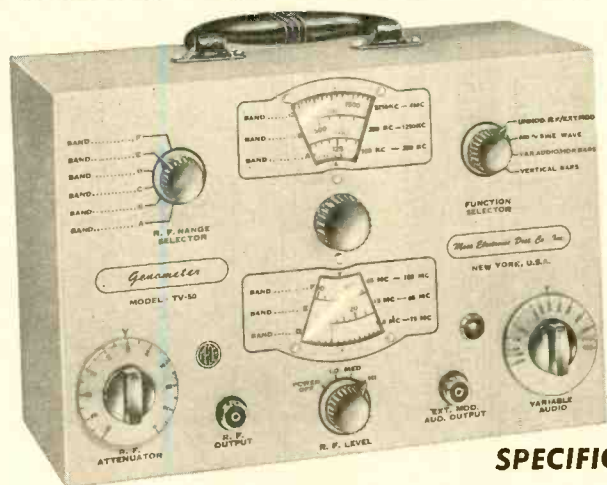

7 Signal Generators in One!

- ✓ R. F. Signal Generator for A.M.
- ✓ R. F. Signal Generator for F.M.
- ✓ Audio Frequency Generator
- ✓ Bar Generator
- ✓ Cross Hatch Generator
- ✓ Color Dot Pattern Generator
- ✓ Marker Generator

SPECIFICATIONS:

R. F. SIGNAL GENERATOR:

The Model TV-50 Genometer provides *complete* coverage for A.M. and F.M. alignment. Generates Radio Frequencies from 100 Kilocycles to 60 Megacycles on fundamentals and from 60 Megacycles to 180 Megacycles on powerful harmonics. Accuracy and stability are assured by use of permeability trimmed Hi-Q coils. R.F. is available *separately*, modulated by the fixed 400 cycle sine-wave audio or modulated by the variable 300 cycle to 20,000 cycle variable audio. Provision has also been made for injection of any external modulating source.

VARIABLE AUDIO FREQUENCY GENERATOR:

In addition to a fixed 400 cycle sine-wave audio, the Model TV-50 Genometer provides a variable 300 cycle to 20,000 cycle peaked wave audio signal. This service is used for checking distortion in amplifiers, measuring amplifier gain, trouble shooting hearing aids, etc.

BAR GENERATOR:

This feature of the Model TV-50 Genometer will permit you to throw an actual Bar Pattern on any TV Receiver Screen. Pattern will consist of 4 to 16 horizontal bars or 7 to 20 vertical bars. A Bar Generator is acknowledged to provide the quickest and most efficient way of adjusting TV linearity controls. The Model TV-50 employs a recently improved Bar Generator circuit which assures stable never-shifting vertical and horizontal bars.

CROSS HATCH GENERATOR:

The Model TV-50 Genometer will project a cross-hatch pattern on any TV picture tube. The pattern will consist of non-shifting, horizontal and vertical lines *interlaced* to provide a stable cross-hatch effect. This service is used primarily for correct ion trap positioning and for adjustment of linearity.

DOT PATTERN GENERATOR (For Color TV)

Although you will be able to use most of your regular standard equipment for servicing Color TV, the one addition which is a "must" is a Dot Pattern Generator. The Dot Pattern projected on any color TV Receiver tube by the Model TV-50 will enable you to adjust for *proper color convergence*. When all controls and circuits are in proper alignment, the resulting pattern will consist of a sharp white dot pattern on a black background. One or more circuit or control deviations will result in a dot pattern out of convergence, with the blue, red and green dots in overlapping dot patterns.

MARKER GENERATOR:

The Model TV-50 includes *all* the most frequently needed marker points. Because of the ever-changing and ever-increasing number of such points required, we decided against using crystal holders. We instead adjust each marker point against precise laboratory standards. The following markers are provided: 189 Kc., 262.5 Kc., 455 Kc., 600 Kc., 1000 Kc., 1400 Kc., 1600 Kc., 2000 Kc., 2500 Kc., 3579 Kc., 4.5 Mc., 5 Mc., 10.7 Mc. (3579 Kc. is the color burst frequency.)

The Model TV-50 comes absolutely complete with shielded leads and operating instructions. Only

\$47⁵⁰
NET

SHIPPED ON APPROVAL
NO MONEY WITH ORDER — NO C.O.D.

Try it for 10 days before you buy. If completely satisfied then send \$11.50 and pay balance at rate of \$6.00 per month for 6 months. No Interest or Carrying Charges Added! If not completely satisfied return unit to us, no explanation necessary.

MOSS ELECTRONIC DISTRIBUTING CO., INC.
Dept. D-83, 3849 Tenth Ave., New York 34, N. Y.

Please rush one Model TV-50. I agree to pay \$11.50 within 10 days and to pay \$6.00 per month thereafter. It is understood there will be no carrying, interest or any other charges, provided I send my monthly payments when due. It is further understood that should I fail to make payment when due, the full unpaid balance shall become immediately due and payable.

Name

Address

City..... Zone..... State.....

COMPLETELY SERVICE... COLOR TV with only two NEW instruments!



RAINBOW GENERATOR
Model 150
Patent Pending

NEW CIRCUITS incorporated in this instrument greatly simplify the TEST and ALIGNMENT of color TV circuits. NEW LINEAR PHASE SWEEP produces the COMPLETE PHASE RESPONSE CURVE, assuring greater accuracy with faster alignment and elimination of color bar drift problems.

APPLICATIONS

- MASTER PHASE CONTROL test and alignment
- CHROMA DEMODULATOR test and alignment (either I/Q or R-Y/B-Y)
- QUADRATURE TRANSFORMER test and alignment
- MATRIX CIRCUIT test and alignment
- BURST AMPLIFIER test and alignment
- PHASE DETECTOR CIRCUIT alignment for reference oscillator
- REACTANCE CONTROL and REFERENCE OSCILLATOR adjustment
- 3.58 MC TRAP alignment
- TROUBLESHOOTING and PHASE ALIGNMENT in the home by picture patterns.



WHITE DOT GENERATOR
Model 160

THE WHITE DOT GENERATOR ENABLES COMPLETE ALIGNMENT OF ALL COLOR CONVERGENCE CIRCUITS PLUS SWEEP CIRCUIT LINEARITY AND SIZE, AS WELL AS GENERAL TROUBLESHOOTING BY SIGNAL TRACING.

APPLICATIONS

- DYNAMIC CONVERGENCE—vertical and horizontal test and adjustment
- DC CONVERGENCE—test and adjustment
- DEFLECTION COIL—positioning for best convergence
- BEAM MAGNETS—alignment for best convergence
- DYNAMIC PHASE ADJUSTMENT—vertical and horizontal
- FOCUS—test and adjustment of DC and dynamic focus
- TROUBLESHOOTING of all circuits affecting convergence
- LINEARITY—test and adjustment of horizontal and vertical sweep linearity

FREE Literature on Request

WIN-TRONIX

WINSTON ELECTRONICS, INC.

Dept. 102, 4312 Main Street
Philadelphia 27, Pa.

Technotes



CROSLY 115 CHASSIS

To improve stability at the upper end of the shortwave band, a 15,000-ohm, ½-watt resistor has been added across the shortwave r.f. coil of late

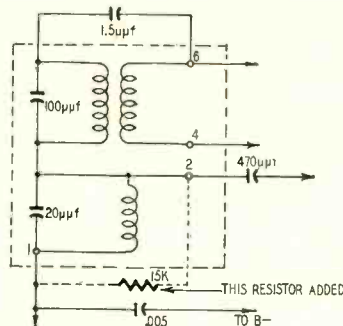

production sets, as shown in the diagram. Chassis containing this change are marked with code letter B (or higher). This resistor is not found in code A (early production) chassis.—*Crosley Service Department*

RECORD PLAYERS

Many children's record players use 117-volt rectifier-pentode tubes such as the 117L7-GT in the amplifier circuit. Failure of the input filter capacitor usually burns off the cathode connection and makes it necessary to replace the tube. The high list price of the tube plus the cost of replacing the

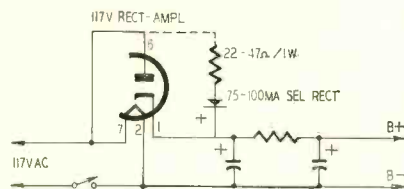

capacitor discourage some parents from having the player repaired.

When the pentode section of the tube checks O.K., you can greatly reduce the cost of the repair job by using the original tube and substituting a selenium rectifier for the defective diode section. Replace the capacitor, then connect a 22-47-ohm, 1-watt resistor and a 75-100-ma selenium rectifier between rectifier plate and cathode pins as shown. Be sure to paste a circuit-change label on the chassis.—*Albert L. Sohl*

GASSY TUBES

When confronted with the complaint that the set "uses too much battery" or "doesn't pick up stations on the low-frequency side of the dial," check the oscillator tube carefully. Failure of the oscillator in battery sets and portables is often caused by a gassy oscillator-mixer tube. The most effective check is to replace with a new one—a gassy tube is not readily detected on the average tube tester.

Occasionally this defect can be detected by visual examination of the tube filament while under test. A flaring up of the filament glow together with the appearance of a bluish fluorescence around it is a good indication of gas. This is common in 1A7-GT and 1R5 types.—*V. F. Woychoski*

MUNTZ TV-16A1

A customer brought in a Muntz TV-16A1 TV chassis with a burned-out a.c. line choke used with the built-in antenna. (See *a* in the illustration.) A replacement choke not being avail-

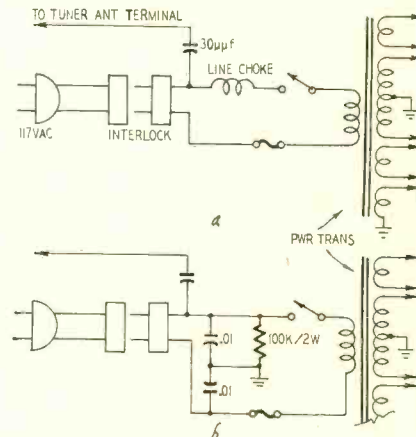

able, I studied the diagrams of various sets with power-line antennas and decided on the arrangement used in some RCA sets. The modified circuit is shown at *b*. It worked satisfactorily and kept the set in operation until a new part was obtained from the manufacturer.—*Leroy Brown*

JEWEL MODEL 920

Greater sensitivity can be had in this model by taking the resistor out of the cathode circuit of the i.f. amplifier and grounding the cathode directly to the chassis.—*Ross Harris*

TECHNOTES

FM AND TV AUDIO HISS

A high hiss level may be heard in the output of some TV and FM sets with ratio detectors. This is usually caused by insufficient AM rejection. When the usual corrective measures do not work, try placing a variable resistor of about 150 ohms across resis-

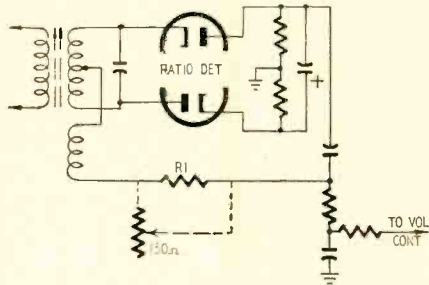

tor R1 in series with the tertiary winding on the ratio-detector transformer as in the illustration. Mount the control on the chassis or cabinet with short leads and set it for minimum hiss and maximum AM rejection.

The usual value of R1 is between 200 and 400 ohms. Smoother balance-control action can be obtained by changing R1 to between 100 and 150 ohms.—*Lyle Briggs*

(This method of balancing ratio detectors reduces the circuit sensitivity, so take care when the set is installed

in a fringe area or is used for dx'ing. —*Editor*)

G-E 16C113 DIAL CORD

I ran into a difficult repair situation recently when I had to replace the dial cord (fine tuning) on this receiver. I simplified the job by installing a General Cement phono-drive rubber belt. It made a friction drive tight enough to prevent slipping, and there is no danger of ever breaking the dial cord again.

There are numerous other applications where a phono-drive rubber belt can be used to replace a broken dial cord, and this procedure is becoming more and more popular among service technicians. It also eliminates duplicating complicated restringing jobs.—*Hyman Herman*

ZENITH MODEL 9S263

An open speaker voice coil is a common complaint on this model. Before replacing the speaker, remove the two 3/8-inch paper tabs near the apex of the cone and you will probably find the open circuit. You can save the speaker by resoldering the connection and then recementing the tabs.—*Harold J. Weber*

CAPEHART CX-33

Insufficient width in these chassis gave us lots of trouble because tubes

and all components checked O.K. While studying the circuit of a later model I noticed an additional 30-μf, 6,000-volt capacitor connected between ground and the plate of the 6W4-GT damper tube. Adding this capacitor to earlier models clears up complaints of insufficient width.

There are other ways of increasing width such as varying output-tube screen voltage, but they usually vary the high-voltage output.—*Carl Hennig*

RINGING COILS

Ringings coils, found in the multi-vibrator circuits of horizontal sweep systems, may be tested without pulling the chassis. Merely tune in a station and rotate the horizontal hold control toward the low-frequency (greater-resistance) side of synchronization. If the ringing circuit is working properly, the picture will slip into a number of stationary patterns as the control is rotated.

Each pattern will slip abruptly into the following pattern, remaining for a short time in each position. However, if the ringing circuit is not working properly, there will be no stable patterns. Each pattern will appear briefly and intermittently. Of course, this technique will not work if the hold control is part of the ringing circuit itself, as is the case in some sets.—*Charles Erwin Cohn*

COYNE offers LOW COST TELEVISION RADIO-ELECTRONICS Training in Spare Time AT HOME



The future is YOURS in TV-RADIO!
A fabulous field—good pay—fascinating work—a prosperous future! Good jobs galore, or independence in your own business!

Coyne brings you the first *truly lower cost*, MODERN—QUALITY Television Home Training; training designed to meet Coyne standards. Not an old Radio Course with Television "tacked on". Here is MODERN TELEVISION TRAINING including working knowledge of Radio. Includes **UHF AND COLOR TV**. No Radio background or previous experience needed. Personal guidance by Coyne Staff. **Practical Job Guides** to show you how to do actual servicing jobs—*make money early in course*.

With Coyne Television Home Training you pay only for your training, **No Costly "Put together kits"**.

COYNE ELECTRICAL SCHOOL
A TECHNICAL TRADE INSTITUTE OPERATED NOT FOR PROFIT
500 S. Paulina Street, Chicago 12, Dept. 94-HT4

B. W. COOKE, President



Coyne—the Institution behind this training... the largest, oldest, best equipped residential school of its kind. Established 1899. Send coupon for details.

SEND COUPON FOR FREE PICTURE FOLDER

and full details, including easy Payment Plan. No obligation, no salesman will call.



COYNE ELECTRICAL SCHOOL
Television Home Training Div.
500 S. Paulina St., Chicago 12, Ill., Dept. 94-HT4

Send Free Picture Folder and details on Television Home Training. This does not obligate me and no salesman will call.

Name _____
Address _____
City _____ State _____

POWERS • FLYBACKS • YOKES • WIDTH
STANCOR
 YOUR MOST COMPLETE SOURCE OF
**EXACT REPLACEMENT
 TV TRANSFORMERS**
 ● Designed from original manufacturers specifications, STANCOR exact replacement transformers faithfully duplicate the ratings and mounting styles of the original unit.
 There is no skimping on wire, insulation or laminations. They will equal or better the performance and quality of the original and every STANCOR transformer is individually tested before packaging.
 LINEARITY CONTROLS • VERTICAL OUTPUTS • BLOCKING-OSCILLATORS



NEW... and typical of STANCOR exact replacements is the DY-13A Deflection Yoke, exact replacement for all Muntz 24" and 27" sets. There are no leads to solder—the DY-13A plugs into the set. Bulletin 495 listing models using this yoke is available from your distributor or from STANCOR.

Stancor transformers are listed in:
 Photofact Folders
 Counterfacts
 Radio's Master
 File-O-Matic



CHICAGO STANDARD TRANSFORMER CORPORATION

3592 ELSTON AVENUE • CHICAGO 18, ILLINOIS
 EXPORT SALES: Roburn Agencies, Inc., 431 Greenwich Street, New York 13, N. Y.

SUBSCRIBERS

If you're moving, please don't forget to send us your address as it appears on the copy of the magazine, including the numbers shown beside your name, as well as your new address.

If we receive this information before the 20th of the month, you will continue getting the magazine without interruption.

Your cooperation will be most helpful and greatly appreciated.

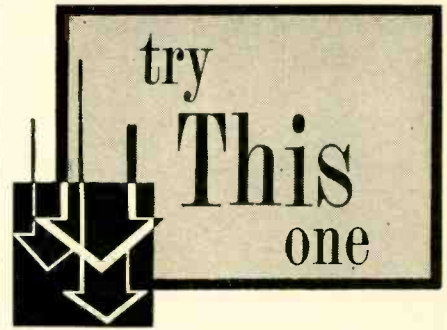

NOVEL TV ANTENNA

This simple TV antenna costs not more than 50 cents and can be constructed in about 20 minutes. It is strictly an indoor affair particularly suited for attic installation, but, it will often outperform roof-top antennas costing many times more. I call it the Supermarket antenna because its bill

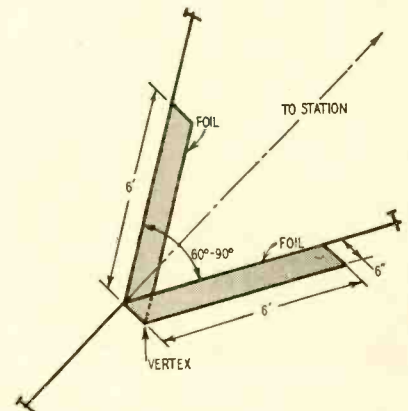

of material consists of a roll of aluminum foil and a length of stout twine.

Refer to the diagram and proceed as follows: Select two points—suitable for attaching strong twine—of equal height on a line at right angles to the direction of the TV station. Tie a 14-foot piece of twine between the two points. Tie a second piece of twine to the center of the first piece, pull it taut in the direction opposite the TV station and tie it to a third point at the same height as the other two. The results should be an arrow-shaped framework pointing away from the station. Next, cut two 6-foot lengths from a 12-inch roll of aluminum foil. Fold one piece lengthwise over each leg of the V and slide them to within 1 inch of each other at the point. You now have a nonresonant 90° V antenna with each leg 6 inches high and 6 feet long.

Use 300-ohm ribbon for the lead-in. Connect a conductor to each sheet at the vertex. Because the foil tears easily and is not readily soldered, make the connection with paper clips.

The antenna has relatively high gain and sharp directivity so some orientation may be necessary in suburban areas. Handling and orientation will be easier if you use two lightweight sticks for the supporting framework. Performance can be improved for weak-signal areas by lengthening the legs

Sensational Low Price!

COMPLETE HI-FI SYSTEM

- VM Changer
- Regal FM-AM Tuner & 10 W. Hi-Fi Amp.
- G.E. 12" Speaker

\$98⁵⁰



You get famous VM 951 record-changer. Has 4 pole motor, muting switch. Completely automatic.

You get famous Regal AM-FM tuner Model T-9753 with built-in hi-fidelity 10 watt amplifier. Full bass control. Full treble control. Ten tubes for high efficiency. FM band 88 to 108 mc.

You get famous G.E. 1203A speaker. 50 to 13,000 cycle frequency range. Alnico 5 magnet. For quality high fidelity installation.

BASS REFLEX CABINET KITS

By Cabinart

- Build 'em yourself and save!
- Model 80 equipment cabinet \$27
 - Model 8112 12" speaker cabinet \$18

Write for FREE "FYI" Bulletin No. 200

WHOLESALE
RADIO PARTS CO., Inc.
311 W. Baltimore St.
BALTIMORE 1, MD.

AUDELS TV-RADIO SERVICE LIBRARY

HERE IS LATE INFORMATION IN A HANDY FORM FOR RADIO AND TELEVISION REPAIRMEN, SERVICEMEN AND STUDENTS



2 VOLS. 6 COMPLETE \$ A PAY ONLY 1 MO.

AUDELS T.V.-RADIO SERVICE LIBRARY—Highly Endorsed—1001 Facts—Over 1552 Pages—625 Illustrations, Diagrams of Parts. Presents Important Subjects of Modern Radio, Television, Industrial Electronics, F.M., Public Address Systems, Auto, Marine & Aircraft Radio, Phonograph Pick-Ups, etc.

IT PAYS TO KNOW!

The Basic Principles—Construction—Installation—Operation—Repairs—Trouble Shooting. Shows How to get Sharp, Clear T.V. Pictures. Install Aerials—How to Test. Explains Color Systems, Methods of Conversion, Terms, etc. Includes Ultra High Frequency (U.H.F.)—Valuable for Quick Ready Reference & Home Study. Tells How to Solve T.V. & Radio Troubles—Answers Your Questions.

Get this Information for Yourself. 7 DAY TEST—ASK TO SEE IT!

MAIL ORDER

AUDELS Publishers, 49 W. 23 St., N.Y. 10, N.Y.
Mail AUDELS T.V. RADIO SERVICE LIBRARY 2 Vols. \$6 on 7 days free trial. If O. K. I will remit \$1 in 7 days and \$4 monthly until \$6 is paid. Otherwise I will return them.

Name _____
Address _____
Occupation _____
Employed by _____ RE

DECEMBER, 1954

TRY THIS ONE

(continued)

of the V and slightly reducing the angle at the vertex of the antenna.—Harry W. Lawson

CLEANING TUBE SOCKETS

Tube sockets and similar components that are used frequently in experimental circuits soon become caked with rosin flux. This should be removed for appearance and for better performance at high frequencies.

An easy and effective way to do this is to first scrape away as much dirt as possible with the blade of a small screwdriver. Then, the remainder can be brushed off with an artist's brush dipped in acetone. Acetone is safe for ceramics but other materials should be checked to make sure that it does not attack them.—J. Sareda

TV ANTENNA HINT

Some of the better TV antennas are made of anodized aluminum to resist corrosion. Anodizing coats the aluminum with a "skin" that has a high r.f. resistance. Use emery cloth to remove it at all points of electrical contact to get maximum transfer of energy from the antenna to the lead-in.—Gerold Macheak

HANDY CHASSIS SUPPORT

When test instruments such as v.t.v.m.'s and oscillators are removed from their metal cases, it is often difficult to balance the delicate exposed chassis on the bench for convenient servicing. Those instruments with one or more screws securing the back of the case to the chassis rear skirt can

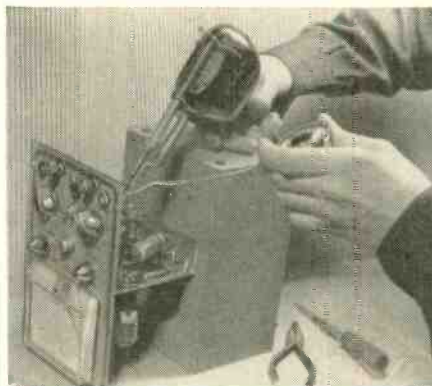

be supported conveniently in any position without using the usual books or blocks.

Remove all screws attaching the chassis to the case, place the instrument face down on the bench, protecting it of course with some cloth or corrugated cardboard. Lift the case off the instrument, reverse it, and place it back to back with the instrument rear skirt. Replace the screws from the inside of the case into the chassis. The case now supports the instrument chassis in any position.

The photograph shows the simplicity and reliability of this method.—C. F. Pocius

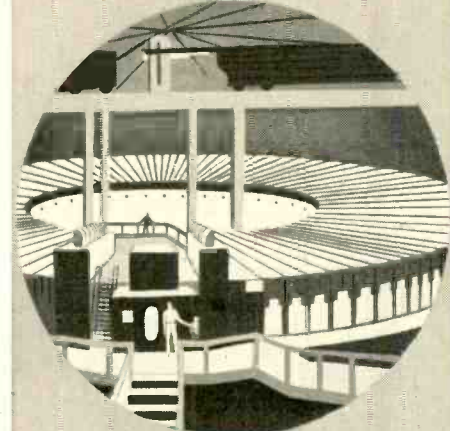

"To find and follow the better way" ... Gigantic offspring of the cyclotron, the Bevatron—world's greatest magnet—can send masses of protons hurtling around its 135'-diameter race track at almost the speed of light. "Idea", to penetrate deep into the atomic nucleus, where lie secrets of matter and energy. With us, the "American Idea" is, by directed effort and applied know-how, to continue to lead in bringing you electronic products of the highest quality.



Complete line of "Full Vision" Microphones
D-33 Broadcast
D-22 Public Address
Replacement Phonograph Cartridges

INSIST ON AMERICAN FOR QUALITY
Send for FREE Catalog 47



370 South Fair Oaks Ave. • Pasadena, 1, Calif.

Compare! Lowest Prices Anywhere!

FREE BONUS
of tubes with every order.
Cash in on this sensational
gift offer!

all TUBES

- Individually boxed
- Guaranteed for 1 Year

0B3 / VR90S.75	3E5	.46	6AV6	.37	6F5GT	.39	6U4	.60	12BD6	.45	25W4	.56	
1A5GT	.46	3Q4	.49	6AX4	.53	6F6	.37	6U5	.44	12BE6	.39	26	.45
1A6	.59	3Q5GT	.49	6B4C	.64	6G6G	.52	6U6	.63	12BF6	.39	27	.39
1A7GT	.47	3S4	.46	6B5	.64	6H6GT	.41	6U8	.61	12BH7	.63	35R5	.40
1A85	.59	3V4	.47	6BA6	.39	6J5GT	.37	6V3	.93	12J5GT	.42	35C5	.39
1B3	.65	5U4G	.41	6BA7	.57	6J6	.52	6V6GT	.39	12Q7G	.39	35L6GT	.41
1B5	.59	5V4	.73	6BC5	.44	6K6GT	.37	6W4GT	.44	12S8	.70	35W4	.37
1B7GT	.59	5X4	.40	6BC7	.71	6J7G	.43	6W6GT	.44	12SA7GT	.44	35Z4	.39
1C5GT	.43	5W4	.50	6BD5GT	.59	6J8	.69	6X4	.37	12S7GT	.52	35Z5GT	.37
1E7	.29	5Y3G	.32	6BD6	.45	6K5	.47	6X5GT	.37	12SJ7	.44	36	.60
1H4G	.48	5Y3GT	.32	6BE6	.39	6K7	.44	6V6G	.48	12SK7GT	.48	42	.42
1H5GT	.40	5Y4G	.35	6BF5	.41	6L6	.63	7A4	.47	12SL7GT	.47	43	.55
1G6	.60	5Z3	.46	6BF6	.37	6Q7	.45	7A7	.53	12SN7GT	.52	45	.55
1L4	.46	6A3	.59	6BG6G	1.19	6S4	.38	7E7	.44	12SQ7	.42	50R5	.39
1L5	.51	6A7	.59	6BH6	.46	6S8	.53	7G6	.40	12SR7	.49	50C5	.39
1N5	.46	6A8	.62	6BJ6	.39	6SA7GT	.43	7E6	.49	12S7	.50	50C6	.59
1P5	.57	6AB4	.44	6BK7	.59	6SD7GT	.41	7F7	.59	14A7	.60	50L6GT	.40
1Q5	.58	6AG5	.43	6BL7	.59	6SF5GT	.46	7X7	.70	14J7	.60	50Y6	.46
1R5	.45	6A25	.70	6BQ6GT	.65	6SH7	.73	12AL5	.37	14K7	.60	50Y7	.50
1S5	.39	6AK5	.72	6BY5	.65	6SG7GT	.41	12AT6	.37	19B6G6	.95	50Y7	.50
1T4	.45	6AL5	.38	6BQ7	.90	6S7GT	.41	12AUG	.38	19C8	.70	70L7GT	1.09
1T5	.53	6AQ5	.39	6BZ7	.90	6SK7GT	.41	12AU7	.43	19T8	.79	75	.41
1U4	.45	6AQ6	.37	6C4	.37	6SL7GT	.48	12AV6	.39	19V8	.89	76	.44
1U5	.39	6AR5	.37	6C5GT	.39	6SN7GT	.49	12AV7	.59	25AV5	.83	78	.47
1X2	.60	6AS5	.50	6C6	.44	6SQ7GT	.37	12AX4	.48	25BQ6GT	.62	80	.35
2A3	.70	6AT6	.37	6CD6G	1.29	6SR7GT	.60	12AX7	.48	25L6	.39	117Z3	.37
2X2	1.50	6AU6	.38	6D6	.45	6S7	.60	12AZ7	.69	25Z5	.40	117L7	.39
3A4	.45	6AV5	.83	6E5	.48	6T8	.56	12BA6	.38	25Z6GT	.37	807	1.20

TERMS: A 25% deposit must accompany order, balance C.O.D. Shipments F.O.B. Irvington, N.J. Orders under \$10.00: \$1.00 handling charge. Merchandise subject to prior sale.

HI-LITE
ELECTRONIC SALES CO.
837A 18th Avenue • Irvington 11, N. J.

SAVE MONEY ON INSTRUMENTS!



- How to test better with fewer instruments . . .
- How to use old instruments in new ways . . .
- How to select the instruments you need . . .
- How to evaluate instrument readings and put them to practical use.

BASIC ELECTRONIC TEST INSTRUMENTS

by Rufus P. Turner

254 pages, 171 illus., Price \$4.00

Written especially for servicemen, amateurs and experimenters, this new book is a complete training course in instruments. Over 60 instruments—from the most modern TV pattern generators to grid-dip oscillators and special-purpose bridges—are fully explained. Work-saving short cuts are outlined. You learn how to put your old instruments to new uses and thus avoid buying costly new ones. Tells all about current and voltage meters; ohm-meters and V-O-M's; V-T rollimeters; power meters; oscilloscopes; r-f test oscillators; signal tracers; tube testers; TV linearity pattern generators; sweep and marker generators; sulfate-wave generators; distortion meters and dozens more.

READ IT 10 DAYS . . . at our risk

Dept. RE-124, Rinehart & Co., Inc., 232 Madison Ave., New York 16, N.Y.

Send Turner's BASIC ELECTRONIC TEST INSTRUMENTS for 10-day examination. If I decide to keep book, I will then remit \$4.00 plus postage in full payment. Otherwise, I will return book postpaid and owe you nothing.

Name: _____
Address: _____
City, Zone, State: _____
OUTSIDE U.S.A.—Price \$4.50, cash with order. Same return privilege with money refunded.

“FREE”

PERMO DIAMOND NEEDLES

for DEALERS and DEALER Personnel

Sell 4 Permo Diamond Needles and get one “free.” Send postal card for complete details.

Special promotion for September, October and November

PERMO, INC.
6415 Ravenswood Avenue
Chicago 26, Illinois

TRY THIS ONE (Continued)

MEASURING METER RESISTANCE

Many technicians and experimenters have surplus microammeters and milliammeters that they would build into multimeters if the internal resistances of the meters were known so they could calculate shunt resistances.

Internal resistance cannot be measured with an ohmmeter without damaging the meter movement.

Here is a quick and simple method of finding the internal resistance of a meter. Suppose that the instrument to be measured has a full-scale deflection of 50 μ A. Connect the meter in series with a 2-megohm potentiometer across a 45-volt battery. Make sure

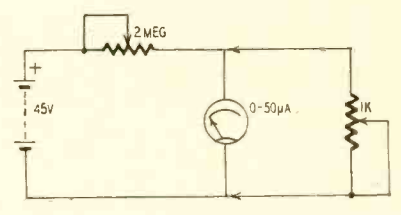

that the resistance is fully in the circuit before making the connection to the battery. Carefully reduce the resistance until the meter deflects to full scale (50 μ A). Next shunt a 1,000-ohm variable resistor across the meter as shown in the diagram and adjust its value until the meter reads exactly half scale.

Remove the 1,000-ohm resistor from the circuit and measure its resistance with an accurate ohmmeter or a resistance bridge. Its measured resistance will be equal to the internal resistance of the meter. For a 200- μ A movement, a 200,000-ohm resistor may be used in place of the 2-megohm unit.

Other values of series resistance and voltage may be used if the resistor is large enough to limit the current to a value less than the full-scale deflection with the applied battery voltage.—P. E. Clement

INSTRUMENT COVERS

Quite a lot of dust accumulates on test instruments that are not used often. While sitting in the kitchen a few weeks ago I noticed the neat plastic covers on the toaster, mixer and other kitchen accessories. After a talk with the Little Woman I went out and purchased a few yards of transparent plastic and some colored piping. My wife used this material to make instrument covers that she stitched together on her sewing machine. These covers now protect my equipment from dust and moisture.—Albert Zanelli

BENDING LIGHT METALS

Wide-jawed canvas or webbing pliers, available from dealers in artists' and upholsterers' supplies, are handy tools for making neat bends in sheet metal used for shields, partitions, brackets, and chassis.—Van H. Ferguson END

WARD Antenna Rama

... means a complete merchandising and profit building program for TV antenna dealers ... antennas designed to meet any installation requirement ... in every price range ... smartly styled ... precision engineered ... and backed by dynamic advertising ... all designed to make WARD your most profitable line!

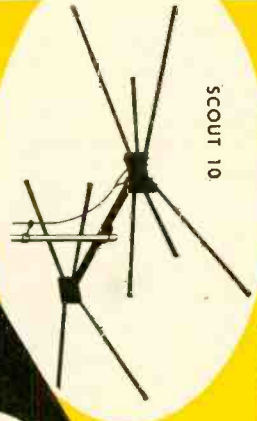

SCOUT 10

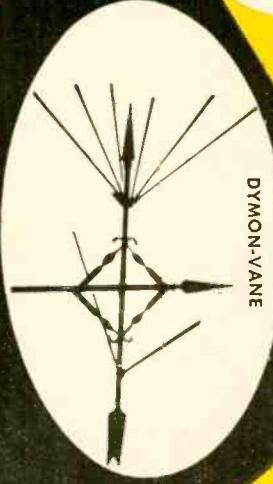

DYMON-VANE

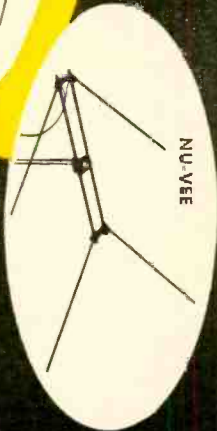

NU-VEE

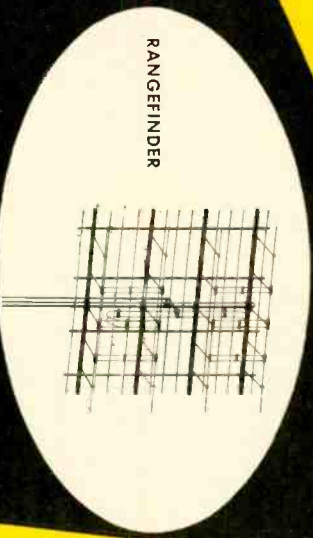

RANGEFINDER

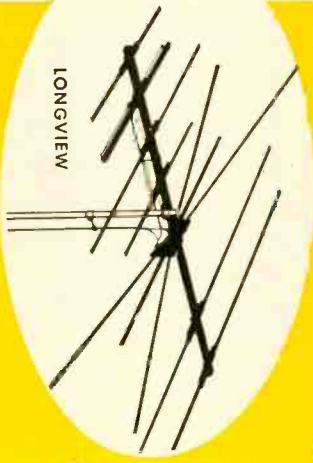

LONGVIEW

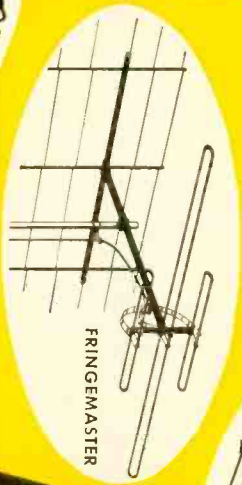

FRINGEMASTER

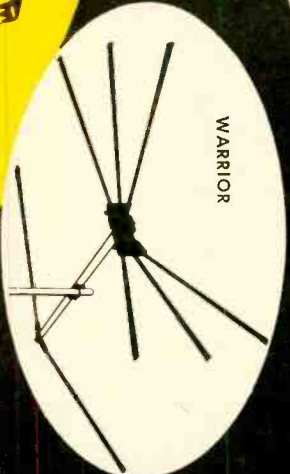

WARRIOR



TROMBONE

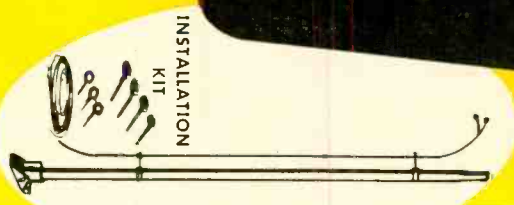

INSTALLATION KIT

WARD PRODUCTS CORP.

1148 EUCLID AVENUE, CLEVELAND 15, OHIO

Canadian Distributor: Atlas Radio Corp., Ltd., Toronto, Canada



Let SAM work for you...

- S**ales promotion — Eye catching displays, mailing pieces, catalog sheets.
- A**dvertising — Effective national advertising plus local tie-in.
- M**erchandising — Quality products, attractive prices, and actual sales leads for you.

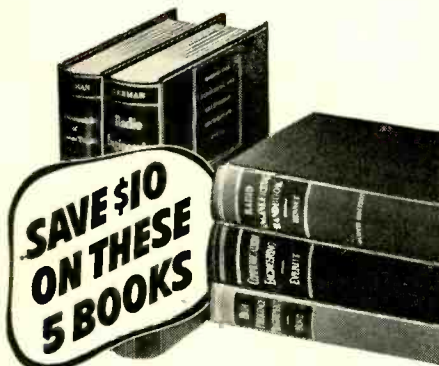

Special Offer On This Complete RADIO ENGINEERING LIBRARY

The Famous Library that Brings High-powered Help on the Whole Field of Radio Engineering. Places Authoritative Facts, Standards, Data, Practice, and Theory At Your Fingertips.

Now offered at a special low price, the Radio Engineering Library brings you almost 4000 pages of tested methods, standards, data and accepted practice. This Library will help solve hundreds of problems for designers, researchers, engineers, and students in any field based on radio.

Written by leading radio engineers, these books cover circuit phenomena, networks, tube theory, vacuum tubes, amplification, measurements, etc.—give specialized treatment of all fields of practical design and application. They provide you with a complete and dependable encyclopedia of facts.

5 volumes, 3872 pages, 2770 illustrations

- Eastman's FUNDAMENTALS OF VACUUM TUBES, 3rd Edition
- Terman's RADIO ENGINEERING, 3rd Edition
- Everitt's COMMUNICATION ENGINEERING, 2nd Edition
- Hund's HIGH FREQUENCY MEASUREMENTS, 2nd Edition
- Henny's RADIO ENGINEERING HANDBOOK, 4th Edition

SEND NO MONEY
Special Low Price—Easy Terms

On this special offer you get this Library for \$38.00, instead of \$48.00. You save \$10 and may pay on easy terms. Mail coupon below to examine the Library FREE for 10 days. No obligation. These books are recognized as standard works; you are bound to need them. So take advantage of this special money-saving offer. Mail coupon at once!

McGraw-Hill Book Co., Dept. RE-12
327 West 41st St., New York 36, N. Y.
Send for 10 days' FREE trial, the RADIO ENGINEERING LIBRARY. If not satisfied I will return books. Otherwise I will send \$8.00 plus delivery charges then; and \$6 a month for 5 months. (Reg. price \$48.00, you save \$10.00.)

Name
Home Address.....
City & State.....

Employed by.....
 We'll pay Delivery Charges if you enclose \$8.00 first payment WITH coupon. Same return privilege for full refund.
For prices and terms outside U.S. write McGraw-Hill Int'l., NYC RE-12

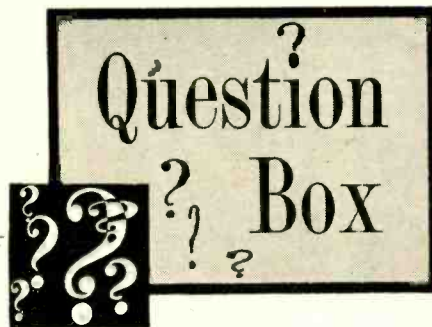

S-METER FOR S-40B

I want to add an S-meter to a Hallcrafters S-40B receiver. Can I use a 1-ma meter in a bridge circuit to measure plate current of the i.f. tubes on the a.v.c. line?—F. H. B., Brooklyn, N. Y.

Several circuits in which a meter

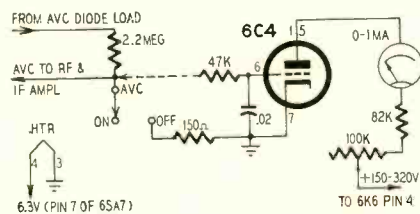

indicates signal strength by changes in i.f. plate current will be found in

the 1953 and earlier editions of *The Radio Amateur's Handbook*. These circuits are sometimes difficult to adjust and stabilize. You are less likely to have trouble with a v.t.v.m. type of indicator like that shown in the diagram. The grid of the 6C4 S-meter (v.t.v.m.) tube connects to the a.v.c. line in the receiver. Probably the most convenient spot for this connection is at the terminal of the movable arm of the a.v.c. switch. However, other points on the a.v.c. line can be used.

To adjust the meter, short-circuit the antenna posts and set the variable resistor for full-scale deflection. The needle should fall to zero on a strong local signal. If it does not, try different values in place of the 82,000-ohm resistor.

TRAPS FOR BCI

I live about a half mile from the broadcasting towers of KMPC (50,000 watts, 710 kc). This station is the only one that I can receive on table model radios. It comes in all over the dial. On two large console models I can tune in other stations, but KMPC and a loud whine can always be heard in the background. Is there any way that I can eliminate this trouble?—T. P., Van Nuys, Calif.

BCI (broadcast interference) of this type is usually fairly easy to eliminate with tuned traps. The diagram at a shows the connections for a series-tuned trap in the grid circuit of the r.f. amplifier or mixer in a receiver using a loop antenna. When the set uses an outside antenna, you can use either a series-tuned trap across the antenna and ground terminals or a parallel-tuned trap in series with the lead-in close to the set's antenna post. In some cases, you may have to use both types of traps for complete elimination of interference (b). Shielded traps are more effective than unshielded types. On a.c.-d.c. sets ground the shield to the chassis. On other types, connect the shield and chassis to a good outside ground.

Tuned circuits L-C in the traps should resonate at the frequency of the interfering station. You can use the secondary of a small broadcast antenna or r.f. coil and a mica trimmer with a maximum capacitance around 380 μmf and a minimum of not more than about 50 μmf. J. W. Miller Co. has a series

of series-tuned traps designed especially for receivers using tuned loops. The type 816-BC2 tunes from 500 to 900 kc and the 816-BC1 from 900 to 1,800 kc. Others in the series are available for amateur, i.f. and commercial frequencies.

Note well that you will not be able to tune in the station causing the inter-

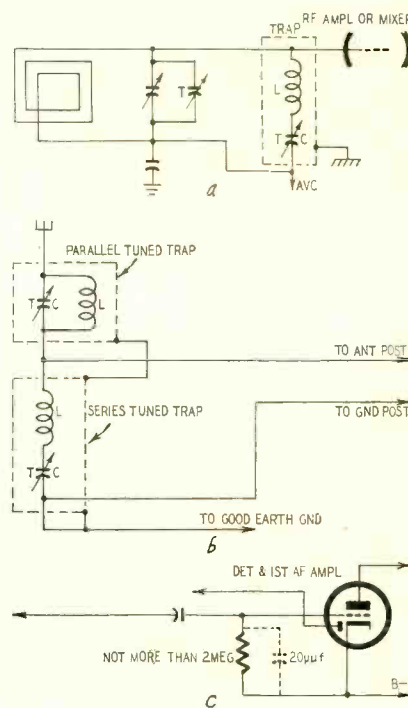

HERE'S WHY!

ALLIANCE develops and markets NEW OUTSTANDING ANTENNA

After staying out of the antenna business these many years...
Alliance has now entered the field because...

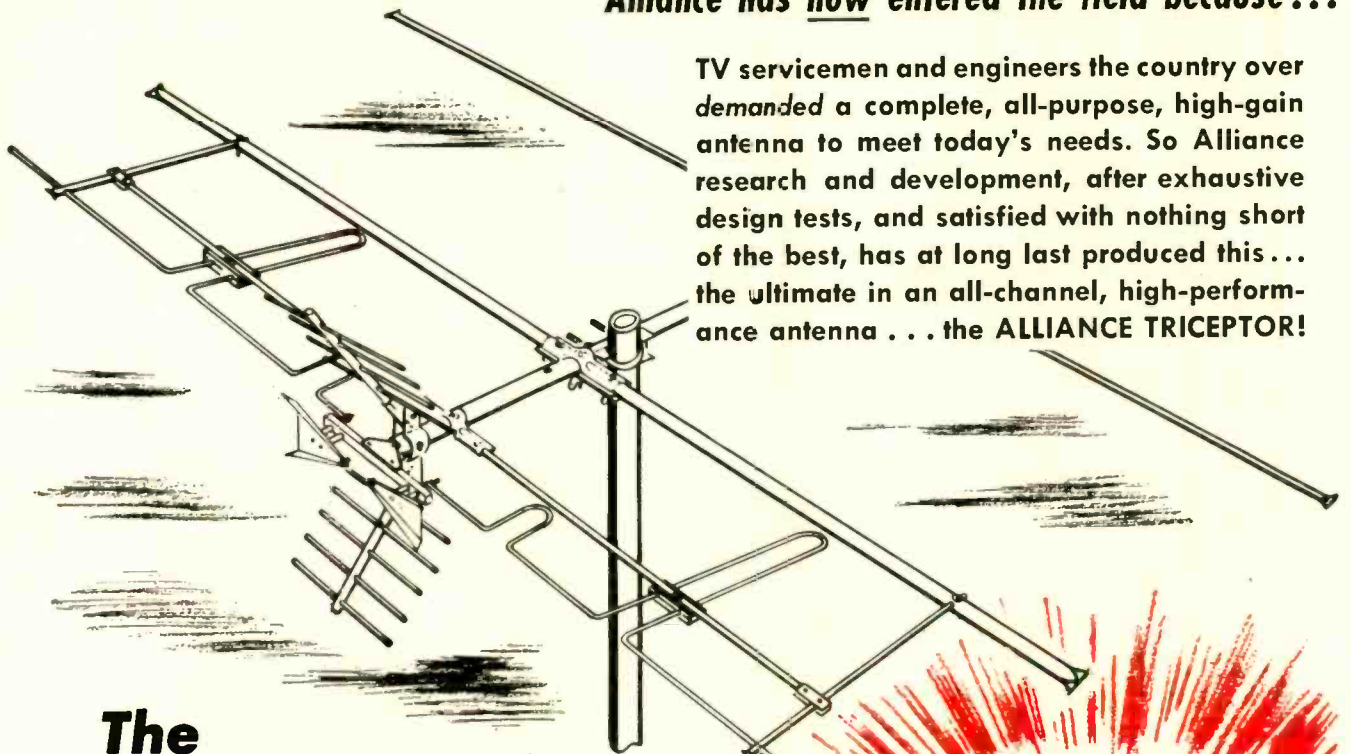

TV servicemen and engineers the country over demanded a complete, all-purpose, high-gain antenna to meet today's needs. So Alliance research and development, after exhaustive design tests, and satisfied with nothing short of the best, has at long last produced this... the ultimate in an all-channel, high-performance antenna... the ALLIANCE TRICEPTOR!

The ALLIANCE TRICEPTOR

**The Antenna you asked for—
ALL VHF UHF CHANNELS
A Revolution in Design!**

A totally new and different UHF-VHF all channel antenna. Adds gain of VHF antenna to UHF antenna for unusually high, uniform gain and top performance on all channels!

Where the ultimate in directivity is required, especially in fringe, multiple station and overlapping areas, the famous Alliance Tenna-Rotor used as an accessory with the Alliance Triceptor, makes the ideal combination for 'peak' reception.



HIGH UNIFORM GAIN on all UHF-VHF channels. No dropouts—no channels sacrificed to improve others.

MINIMIZES OR ELIMINATES INTERFERENCE. Co-channel interference, ghosts, airplane flutter, auto ignition, neon, etc., greatly reduced or eliminated!

HIGH DIRECTIVITY with a MONOLOBE pattern.

PRE-ASSEMBLED "SNAP-OUT" DESIGN units for fast easy installations.

NO SPARE PARTS BAG!

ALL-WEATHER CONSTRUCTION—structurally sound, rigid, sturdy, compact and lasting. Wind tested, light weight, no tying needed.

Meet the changes in Television with Alliance Triceptor antennas.

THE
Monolober
(Model TC-2 single bay UHF-VHF)
New Alliance Antenna designed for
all channel reception.

ORDER TODAY

THE ALLIANCE MANUFACTURING CO., Alliance, Ohio
MAKERS OF THE FAMOUS ALLIANCE TENNA-ROTOR

1 Hot Ham News from hallicrafters

CHICAGO 24, ILLINOIS

IN CANADA: BOX 27
TORONTO 17, ONTARIO

Model SX-96 SELECTABLE SIDEBAND RECEIVER

- Covers Broadcast 538-1580 kc plus three S/W 1720 kc—34 Mc.
- Full precision gear drive dial system.
- Double conversion with second oscillator crystal controlled.
- Selectable side band reception of both suppressed carrier and full carrier transmissions.
- Mixer type second detector.
- CW operation with AVC on.
- Delayed AVC.
- Calibrated bandspread — "S" meter — double superhet.
- 10 tubes, 1 rectifier and voltage regulator.

HALLIDAY & WATSON

Model SX-96

Bud

Echel

For many happy years

FOR FROM

HALLIDAY & WATSON

QUESTION BOX

ference as long as the traps are in the circuit. Series-tuned traps can be disabled by a switch that disconnects one end, and parallel-tuned traps by a switch that shorts the tuning capacitor C.

Traps are not effective when the interference is due to direct pickup in the audio circuit of the set. This usually occurs in the first audio-amplifier stage. Most sets subject to this type of interference have high- μ triodes with grid-leak bias. In this case, the trouble can be eliminated by shielding the tube or replacing it with its metal equivalent. If this does not help, try reducing the grid resistor—often as large as 10 megohms—to not more than about 2 megohms and bypass it with a mica capacitor of about 200 μf as in the drawing at c.

SENSITIVE R.F. INDICATOR

I am often called on to construct small transmitters, boosters, converters, and similar devices. I frequently have trouble that I believe to be due to spurious oscillations and incomplete neutralization but I have no way of checking it. How can I detect oscillations in an r.f. stage? Is there any indicator that I can use?—F. R., Memphis, Tenn.

The simplest way to detect oscillation is to measure the grid current or check for the presence of r.f. voltage on the grid with a v.t.v.m. Grid current can be checked with a microammeter shunted by a capacitor of 50–100 μf . The bypass capacitor should be connected directly across the meter termi-

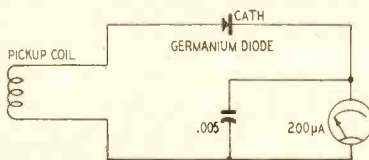

nals. If the meter leads are long, shunt another capacitor directly across the points where they connect into the circuit. In some cases it may be necessary to use a meter with a sensitivity of 100 μa or less. Sometimes inserting the meter changes the circuit configuration so it won't oscillate or the strength of oscillation varies.

A simple r.f. detector probe like that shown in the diagram is useful in detecting weak r.f. oscillations in some circuits. The probe circuit is untuned so it will be easier to use but less sensitive than a wavemeter. The pickup coil may be three or four turns of self-supporting wire with an inside diameter of about 1 inch. Smaller diameter coils may be wound to meet the needs of the application. A wavemeter can be used to identify the frequency of the spurious oscillations.

Wavemeters and grid-dip oscillators working in the u.h.f. range are useful in detecting spurious oscillations well above the working range of the equipment under test. Such oscillations are often caused by inefficient bypassing, excessive lead lengths and poor choice in capacitor types.

(Continued)

TELEPHONE RECORDING

Can you tell me how to connect a tape recorder to a telephone line so I can record conversations. I would also like to have construction details on an automatic answering device using either tape or disc recorders. This will enable me to take incoming calls while I am out of the shop.—E. O. C., Mamaroneck, N. Y.

Any device, circuit, apparatus or equipment not supplied by a telephone company but connected electrically, mechanically or by induction to its lines, equipment or facilities is a "foreign attachment."

The "foreign attachment" clauses of FCC regulations and the Communications Act of 1934 make it illegal for any person to use or permit the use of any attachment, accessory or other device in connection with the services or facilities of a telephone company without the company's written permission. The FCC regulations also state that no direct recording of a telephone conversation shall be made unless a periodic "beep" is transmitted to inform the party at the other end that his remarks are being recorded. The "beep" is an audio tone of about 1,400 cycles transmitted for about $\frac{1}{5}$ second at intervals of 12 to 18 seconds.

Since telephone companies are bound by regulations to provide certain services in a satisfactory manner, they retain the right to discontinue service or to remove any foreign attachment used without their approval.

Although a phone company is not likely to permit direct connection of a foreign attachment to its facilities, it will supply a "recorder connector"—a device for coupling your recording device to the line and for generating the beep of the required frequency, duration and interval. The recorder connector also equalizes the levels of speech fed into the recorder and feeds the beep into the phone circuit so it is about level with an average phone conversation. In many areas the recorder connector can be rented for about \$2 per month, after an installation charge of around \$5.

The regulations against the use of foreign attachments also apply to telephone answering devices not supplied by the company. You can probably obtain a type 1A telephone answering set from your phone company. The 1A is about the size of a portable typewriter. It connects to the line so the subscriber can have normal phone operation when he desires. When he is away, the instrument—automatically started by an incoming call—gives the caller a pre-recorded message, records a 30-second message and then disconnects to await the next call. Twenty 30-second incoming calls can be recorded. The device gives a "don't answer" signal if it is improperly adjusted or its recording time (10 minutes) is used up.

The outgoing announcement and the incoming messages are recorded on magnetic drums and can be erased at will.

END

Business

Merchandising and Promotion

Astron Corp., East Newark, N. J., is promoting its Blue Point capacitors by offering \$64.70 worth of the capacitors



plus a free "Swing Bin" plastic and metal container for \$29.95. The company is making the offer for a limited time only.

CBS-Hytron, Danvers, Mass., introduced a series of sales aids for service technicians, including two illuminated signs—a weatherproof outdoor sign and



a jumbo illuminated clock sign. Other items include two-color stationery, which may be imprinted with the technician's or distributor's name, and a Certified Quality Service Repair sticker which may be affixed to sets serviced. The company also brought out indoor and outdoor illuminated signs for distributors.

JFD Manufacturing Co., Brooklyn, N. Y., is packaging its Roto-King rotator in a new "Valet" pack which serves both as a handy suitcase type package for carrying the rotator and as an attractive window or counter display. JFD also announced that it is

DECEMBER, 1954

select
RCP...
for best
test
performance

modern
designs
to
maintain
modern
circuits



5 Instruments in 1 Performs 62 Individual Electronic Measurements

RCP ELECTRONIC DO-ALL Model 657

Never before has there been engineered one instrument to sell for under \$100 that can possibly match the versatility, efficiency and speed of measurement built into this latest RCP design. Here are combined in one instrument five independent instruments—capacity meter, high range ohmmeter, RMS VT voltmeter, peak-to-peak VT voltmeter, inductance meter (by ref. to charts).

Features: 8 1/2" easy-to-view meter—Simplified controls save time, illuminated individual settings of function and range—carrying handle serves as inclinable rest—tilts the instrument for maximum readability.

Only \$99.85 Net



For Fast, Reliable Testing of Flyback Transformers and Yokes

ORIGINAL RCP FLYBACKER Model 123

Extremely sensitive, the Model 123 Flybacker immediately shows up a single shorted turn in a flyback transformer or yoke. Its light, portable design serves to advantage in the shop and in the home. All tests can be carried out with the components in place in the TV receiver.

Features: Three Good-Bad Scales—One Scale for Yokes—Tests Low and High Impedance Yokes—Pilot Light illuminates meter when "on." Only RCP makes the Flybacker—accept no substitutes.

Only \$39.75 Net

See your local parts distributor or WRITE RE-12 FOR LATEST RCP CATALOG

RADIO CITY PRODUCTS COMPANY
EASTON, PENNSYLVANIA

Concord's BUY OF THE MONTH

Never Before at This LOW PRICE!!

U.S. GOVT. COMMAND RECEIVER 6 to 9.1 Megacycles

\$6.95



One of the most Sensational money saving values that Concord Radio has ever been able to offer. Famous U.S. Govt. SCR 274 Command Receivers designed to operate on the 40 meter band (6 to 9.1 Mc.). Extensively used on the armed forces in the last war and just as extensively used today by Airlines, Trucking Companies, Taxicabs, Hams, etc. Uses 12SK7 E.F. Amp., 12K8 Mixer, 2-12SK7 I.F. Amp., 12SR7 Det. CW Amp., and 12A6 Audio Amp. Designed to operate from 28V DC, but easily converted to 110 Volt 60 Cycle operation. All units are Guaranteed Operative, complete with tubes. Removed from airplanes in almost the same excellent condition as when installed. Shpg. Wt. 10 lbs. \$6.95

28 Volt Dynamotor for above Used \$3.95
SURPLUS RADIO CONVERSION MANUAL Vol. 1 \$2.50

CONCORD RADIO 54 Vesey St., N. Y. 7.
Dept. C12
20% deposit with C.O.D. MINIMUM ORDER \$5.00
 Please send NEW 1955 CONCORD Catalog!

NAME _____
ADDRESS _____
CITY _____ ZONE _____ STATE _____

CONCORD RADIO • 54 VESEY ST. NEW YORK 7, N. Y. • Digby 9-1132

2 Hot Ham News from hallicrafters

CHICAGO 24, ILLINOIS

IN CANADA: BOX 27
TORONTO 17, ONTARIO

Model HT-30 SINGLE SIDEBAND TRANSMITTER/EXCITER

- Highly stable VFO with full 100:1 ratio gear drive system built-in.
- Stability comparable to most crystals .01%.
- Ample gain for 55 db microphone with hum and noise 40 db down.
- Full 40 watt lineal peak power output.
- Unwanted sideband at least 40 db down.
- Undesired beat frequency down 60 db or more.
- T. V. I. suppressed.
- Provisions for coaxial output fitting.
- Built-in voice control circuit with bias switching for final amplifier.
- AM-CW-SSB-19 tubes plus voltage regulator and 2 rectifiers.



Model HT-30
Coming Soon

For many happy years

GIFT CERTIFICATE

FOR.....
FROM.....

Hugh
Alice

HALLIGRAMMERS

BUSINESS

planning the biggest advertising campaign in its history for its antennas and



accessories. The company is also mailing "ad paks"—including a window streamer featuring a picture of Imogene Coca—to dealers and service technicians across the country.

Electronic Measurement Corp., New York, is now packaging its test equipment in a display box with picture of the actual instrument on the cover. Copy on the package highlights the instrument's features.



Erie Resistor Corp., Distributor Division, Erie, Pa., is now packaging its disc ceramicons in a cardboard "Pallet-Pak."

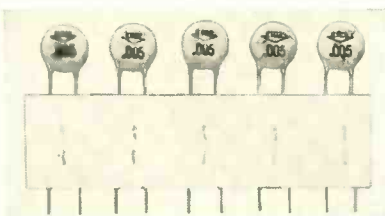

National Company, Malden, Mass., developed a new hi-fi sales promotion kit for distributors. It includes current advertising, catalogs, advertising mats, window streamers, etc.



(continued)

Jensen Industries, Forest Park, Ill., introduced a new needle-threader gimmick to help service technicians promote the sale of its phonograph needles to their housewife customers. The company has also developed a new white leatherette display kit which holds 64 different types of needles.



Alliance Manufacturing Company, Alliance, Ohio, has budgeted better than \$500,000 for promotion of its Tenna-Rotor and other TV accessories, according to John Bentia, executive vice president.

Channel Master Corp., Ellenville, N. Y., was featured in a story in the October issue of Coronet Magazine. The company has built a promotional campaign around the story.

Simpson Electric Company, Chicago, announced that its chief field service engineer, Bob Middleton, had resumed his color and black-and-white TV service demonstrations. The most recent series was held throughout the Pacific Northwest.

Allen B. Du Mont Laboratories' Public Relations Department, Clifton, N. J., has produced a documentary motion picture, "A Story of Television," available to Du Mont distributors, dealers and service organizations.

Walsco, Los Angeles, Calif., introduced a new merchandising display for its "99" line of hardware and chemicals.

American Screen Products Company, Miami, Fla., is promoting its Unicorn TV antenna by field demonstrations in a ranch wagon on which the antenna is mounted.

The Winegard Co., and its advertising agency, Henry M. Hempstead Co., advise us they did not intentionally mean to illustrate in their advertisement in the November issue of RADIO-ELECTRONICS any competitive antenna, and in particular an antenna that looks like the one manufactured by the JFD Mfg. Co., Inc. The advertisement, they state, merely attempted to illustrate any stacked antenna versus any

BUSINESS

(continued)

unstacked antenna. Steps have been taken to correct the illustration in all future advertising.

H. G. Cisin, Amagansett, N. Y., publisher, announced the 50 winners in the recent contest for selecting the title of his forthcoming television service book. Ralph L. White, Springfield, Mass., won \$100 in cash as first prize.

Finney Co., Cleveland, held a series of TV antenna clinics throughout Texas and the Midwest, co-sponsored by local distributors. The company also demonstrated its products at the Ohio State Fair in Columbus.

Production and Sales

RETMA reported the production of 3,785,519 TV receivers and 6,110,119 radios during the first eight months of 1954. This compares with 4,754,285 TV sets and 8,932,638 radios during the same period in 1953.

RETMA reported the record retail sale of 3,174,394 TV sets during the first seven months of 1953 as against 3,116,306 in the 1953 period. Retail sales of radios excluding auto sets reached 2,822,090 for the first seven months of 1954 as against 3,383,862 in 1953.

Calendar of Events

Eastern Joint Computer Conference and Exhibition, December 8-10, Bellevue-Stratford Hotel, Philadelphia, Pa.

Symposium on Printed Circuits sponsored by RETMA Engineering Department, January 20-21, University of Pennsylvania, Philadelphia.

New Plants and Expansions

Rohn Manufacturing Co., Peoria, Ill., has considerably enlarged its facilities for the manufacture of TV towers, masts and accessories, through the acquisition of a new plant which will provide an additional 20,000 square feet of factory and office space to the two plants it already owns. The company's general offices have been relocated in the new plant at 116 Farmington Road, Peoria, Ill.

CBS-Columbia opened a new headquarters building at 48-50 34th St., Long Island City, N.Y., which will contain a complete color TV service training school.

Permosflux, Chicago, officially opened a new plant in Bradford, Tenn.

Simpson Electric Co., Chicago, purchased the complete plant facilities of O. D. Jennings & Co., at 4307 W. Lake St., Chicago. The new plant will be used for production of new color TV test equipment and the company's new suspension type meter.

Clear Beam Antenna Corp. has combined operations with Tempo TV Sales Corp. and is now located in Canoga Park, Calif. Clear Beam also opened a new plant in Chicago. END

OHMITE®

REPLACEMENTS
INSURE CUSTOMER
SATISFACTION



Little Devil!®
COMPOSITION RESISTORS

Tiny, yes . . . but what dependability, ruggedness, and stability! Rated at 70C rather than 40C. Completely sealed and insulated by molded plastic, they meet all MIL-R-11A requirements. Available in 1/2, 1 and 2-watt sizes in all RETMA values.

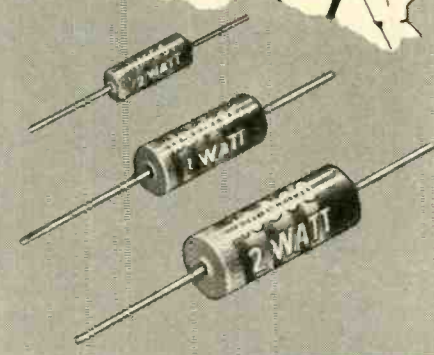

TYPE AB NOISE-FREE POTENTIOMETERS

Because the resistance material in these units is solid-molded—*not* sprayed or painted on—continued use has practically no effect on the resistance. Often, the noise-level decreases with use . . . and they give exceptionally long service. Rated at 2-watts.

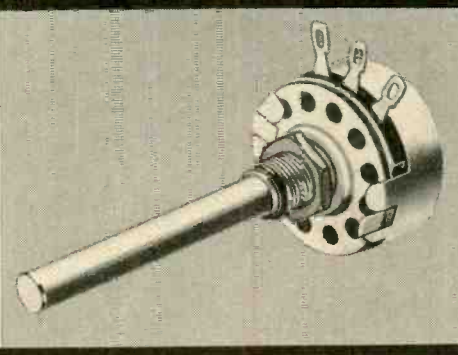

BROWN DEVIL® AND DIVIDOHM® RESISTORS

BROWN DEVIL fixed resistors and DIVIDOHM adjustable resistors are favorite vitreous-enamelled units! Resistance wire is welded to terminals. DIVIDOHM resistors are available in 10 to 200-watt sizes; BROWN DEVILS in 5, 10, and 20-watt sizes.

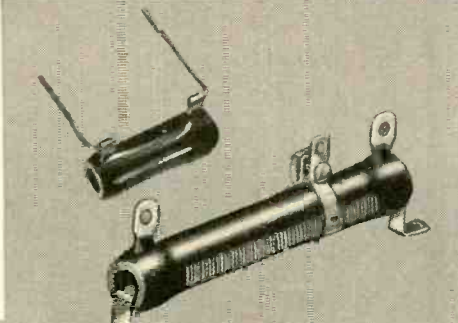

PROVIDE AN "EXTRA MARGIN OF SAFETY"

Using Ohmite replacements in your repair work is like having insurance against call-backs. The reason is, of course, the "extra margin of safety" engineered into Ohmite products. The prevention of just one call-back can save your profit on the entire job. So order a supply today, and use them on your next job.

Be Right with

OHMITE®

DEPENDABLE RESISTANCE UNITS



Write for Stock Catalog

OHMITE MANUFACTURING CO.
3646 Howard St., Skokie, Ill.
(Suburb of Chicago)

3 Hot Ham News from hallicrafters

CHICAGO 24, ILLINOIS

IN CANADA: BOX 27 TORONTO 17, ONTARIO

Model SX-99 RECEIVER

Here is everything you could wish for in a DX receiver. Covers Broadcast Band 540-1680 kc plus three short-wave bands 1680 kc-34 Mc calibrated for the 10, 11, 15, 20, 40 and 80 meter amateur bands over a large easy-to-read dial. Features for the amateur—"S" meter, separate bandspread tuning condenser, crystal filter, antenna trimmer, one r-f, two i-f plus 3.2 and 500 ohm speaker terminals.

Gray-black steel cabinet with brushed chrome trim and piano hinge top, 18 $\frac{3}{8}$ " x 8 $\frac{1}{2}$ " x 11". Shipping weight 36 lbs.

Seven tubes plus rectifier. 105/125 V. 50/60 cycle AC. \$149.95 (less speaker). Use Hallicrafters R-46A Speaker.

HALLIDRUMMERS

Model SX-99

For many happy years

GIMMICKS

FOR JACK DAD

People

Brig. Gen. James S. Willis, U. S. Army (ret.), joined Hallicrafter, Chicago, as coordinator of research and development. He was most recently commanding general of the Signal Corps Supply Agency in Philadelphia.



Nathaniel B. Nichols, manager of the Raytheon Manufacturing Co.'s research division, Waltham, Mass., was named assistant vice president. He is an international authority on servomechanisms and electronics automation. Raytheon also announced that Dr. K. C. Black, formerly business manager of Polytechnic Research and Development Co., had joined the company as head of the Communications Engineering Department.



Eugene E. Broker was named manager of Sylvania Electric Products, Shawnee, Okla., Tube Plant, succeeding Chas. W. Hosterman, who was recently appointed assistant general manager of the Electronics Division. Broker was formerly manufacturing superintendent of the Sylvania Radio Tube Plant in Burlington, Iowa.



Jack Moore joined Skyline Manufacturing Co., Cleveland, Ohio, as sales manager. He has long been active in West Coast electronics sales.



Bruce E. Vinke mulder joined Carter Parts Co., Chicago, as sales manager of the Electronics Division. He was formerly a sales executive with the Capacitor Division of Sangamo Electric. The Carter Co., organized by Nick Carter in 1922, was formerly a division of Utah Radio Products. The company is presently expanding its nonautomotive



line of potentiometers, plugs, resistors and other electronic components.

Jack E. Wilson was appointed audio products manager of National Co., Malden, Mass. He was formerly with the Collaro Division of Rockbar Corp.



John J. Traviesas was promoted to general service manager of United Motors Service, Division of General Motors, Detroit, Mich. He was formerly assistant general service manager.



Obituary

Bertram J. Grigsby, co-founder of the old Grigsby-Grunow Co., a director of Grigsby Allison Co., Arlington Heights, Ill., and a well known pioneer in the radio industry, died early this fall at his home in Barrington, Ill.

Personnel notes

... Elmer W. Engstrom was elected a member of the Board of Directors of RCA, filling the vacancy caused by the retirement of Walter A. Buck. Dr. Engstrom is executive vice president, research and engineering; head of RCA Laboratories and a director of RCA Victor, Ltd., Canada.

... O. O. Schreiber, assistant to the president of Philco Corp., Philadelphia, was named vice president of the corporation. He will continue to handle special assignments for the president and chairman of the board of Philco and act as secretary of the Policy and Management Committees and chairman of the Coordinating Committee of Philco, Inc.

... H. G. Cheney was appointed Midwestern regional sales manager for the Westinghouse Electronic Tube Division with offices in Chicago. He joined the Electronic Tube Division in 1951 as sales manager.

... A. Raymond Bermond, previously radio advertising manager of Hallicrafters, Chicago, was promoted to the post of advertising manager of the company, succeeding John S. Mahoney who left the company to join Sheriff-LeVally, Chicago advertising agency, as account executive on Hallicrafters' account. END

new Devices



CIRCLOTRON high-fidelity amplifier (Electro-Voice) includes new design principles. No d.c. in output transformer, less than quarter the plate circuit

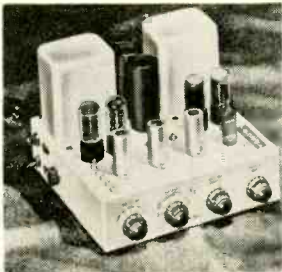

impedance of conventional output circuits. Damping factor control permits perfect match of amplifier output impedance to loudspeaker's critical damping resistance. Output 20 watts rated, 40 watts on peaks. Frequency response ± 0.1 db, 20-20,000 cycles at 20 watts.

Circlotron has necessary controls for handling complete high-fidelity system. Inputs are Ultra-Linear phono, magnetic phono, tape or television, tuner or television, and high-impedance microphone. Controls consist of function selector, record compensation, level, loudness, bass, treble, damping factor, and two hum adjustments on chassis.

Electro-Voice, Inc., Buchanan, Mich.

10-WATT AMPLIFIER, Freed-Eisemann *model 910*, Williamson type. Frequency response 20-30,000 cycles at ± 1 db. Total harmonic distortion less than 0.5% at full rated output. Hum and noise level 80 db below rated output.

Freed-Eisemann, 200 Hudson St., New York 13, N. Y.



HI-FI EQUIPMENT. Espey *model 710* (not illustrated) single chassis mounted receiver incorporating 12-watt Williamson type amplifier with integral control panel for ease of installation. *Models 700* (tuner) and *501* (amplifier) designed for use together or with any standard audio system. The 700 and 710 use limiter-discriminator cir-

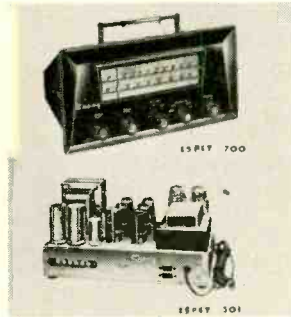

uits. 501 is 24-watt Williamson type audio amplifier.

Espey Manufacturing Co., Inc., 528 E. 72nd St., New York 21, N. Y.

12-WATT AMPLIFIER, Rauland *model 1811* 12-watt output at 0.6% harmonic and 2% IM distortion (60 and 7,000 cycles, 4-1). Response ± 0.5 db, 20 to 20,000 cycles. Hum and noise 75 db below 12 watts on tape and tuner inputs, 55 db below on mike and phono inputs. Controls: Separate bass and treble; volume, input (provides RIAA, frr, and "quiet" record com-

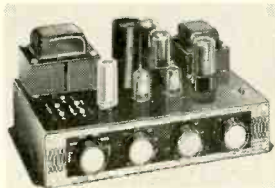

pensation). Rauland-Borg Corp., 3515 W. Addison St., Chicago 18, Ill.

ANTENNA, CBS-Columbia *Delta-V-Reflector*, designed for color TV reception, provides minimum of dips and peaks, maintaining flat response within 2 db across entire v.h.f. and u.h.f. spectrum. Average gain about 7 db relative to resonant dipole at u.h.f. and approximately 3 db over the v.h.f. range.

CBS-Columbia, Inc., 34-00 47th Ave., Long Island City 1, N. Y.

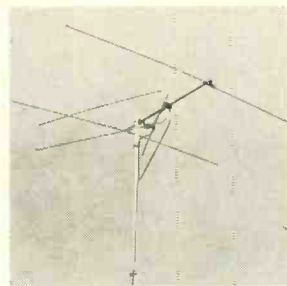

Compare... prove EMC superiority

model 206 MUTUAL CONDUCTANCE TUBE TESTER

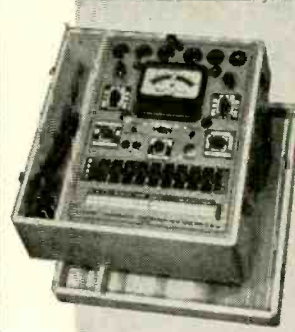

- Checks mutual conductance on calibrated microhmo scale • Checks tubes for gas content • Detects both shorted and open elements • Tests all tubes from .75V to 117 filament volts • Tests all octal, octal and miniature tubes • Checks individual sections of multi-purpose tubes • Built-in roll chart • Uses lever type switches.

MODEL 206P—With hand-rubbed oak carrying case (illustrated)

\$83.50

MODEL 206C—Slipping counter case
\$79.50

model 205 TUBE TESTER

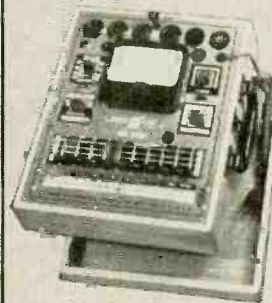

- Tests all tubes including Noval and sub-miniatures • Completely flexible lever type switching arrangement • Tests all tubes from .75 volts to 117 filament volts by standard emission test • Tests all cold cathode, magic eye, voltage regulator and ballast tubes • Has pilot light indicator • Line voltage control compensates for line variations between 105 and 135 volts • Checks for shorts and leakages • Three-color hammertone panel.

MODEL 205P—with hand-rubbed oak carrying case (illustrated)

\$47.50

MODEL 205C—Slipping counter case
\$46.50

model 204 TUBE-BATTERY-OHM CAPACITY TESTER

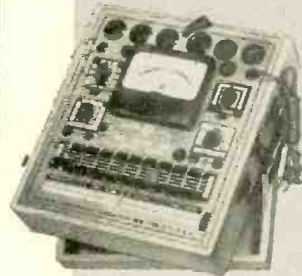

- Tests all tubes including Noval and sub-miniature • Tests all batteries under rated load • Emission testing method gives easy, direct readings • Tests resistance to 4 megohms • Tests condensers from .01 to 1 mfd • Uses four-position lever type switches • Checks condenser leakage.

MODEL 204P—Portable oak case, removable cover (illustrated)

\$55.90

MODEL 204C—Slipping counter case
\$54.90

EMC

Write Dept. RE-12
for Free Complete
Catalogue
of these and other
Instruments.

ELECTRONIC MEASUREMENTS CORPORATION
280 LAFAYETTE STREET • NEW YORK 12, N. Y.

EXPORT DEPARTMENT 136 LIBERTY STREET, N.Y.C. 6, N.Y.

A Star Is Born...

Only EICO #232 Peak-to-Peak VTVM has all these Advanced Features

- ★ FOR THE FIRST TIME ALL CALIBRATION IS DONE WITH INSTRUMENT IN CABINET.
- ★ 7 non-skip ranges on every function — DC/RMS sine volts: 0-1.5, 5, 15, 50, 150, 500, 1500. (To 30 kv with HVP probe.) Res.: 0.2 ohms to 1000 meg. — Uniform 3 to 1 scale ratio assures extreme wide-range accuracy.
- ★ Flat freq. response 30 cps to 3 mc.
- ★ Measures directly peak-to-peak voltage of complex & sine waves: 0-4, 14, 42, 140, 420, 1400, 4200. Vital for TV servicing. Saves the cost of separate Peak-to-Peak Probe.
- ★ Modern styling, etched panel; compact, easily portable. Size: 8½" x 5" x 5".
- ★ No annoying lead toggle, no back-and-forth prod changing. Positive-action, super-rugged!
- ★ Terrific time and trouble-saver! One probe for all functions—in a "twist of the wrist" it selects DC or AC (Peak-to-Peak & RMS)/OHMS!
- ★ (not. pend.)

NEW PEAK-to-PEAK VTVM AT LOWEST COST

With Exclusive **Uni-Probe**

KIT \$29.95

Factory Wired \$49.95

Complete with UNI-PROBE at no extra cost

Excellent for your bench
Model 249 Peak-to-Peak VTVM with Giant 7½" Meter
KIT \$39.95 **Wired \$59.95**
Complete with UNI-PROBE

See this amazing engineering achievement at your jobber today. Write now for FREE latest catalog **CV-12**

EICO ELECTRONIC INSTRUMENT CO. INC.
84 Withers Street
Brooklyn 11, N. Y.
Prices 5% higher on West Coast. © 54

WATCH FOR OUR SPECIAL JANUARY TELEVISION ISSUE

DEVICES

(continued)

ANTENNA, Taco Trapper Jr., available as single, two- and four-stacked array. Good gain on v.h.f. TV and FM. Covers u.h.f. band in medium signal areas. Driven element with wave traps backed by high- and low-frequency reflectors providing six working elements on high band. Fiberglass insulators on antenna sections.

Technical Appliance Corp., Sherburne, N. Y.

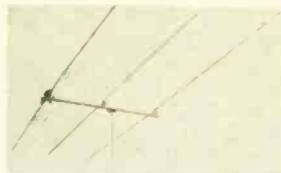

V.H.F. ANTENNA, Winegard Pixie model L-5, constructed for streamlined appearance and low resistance to wind.

Winegard Co., 3000 Scotten Blvd., Burlington, Iowa.

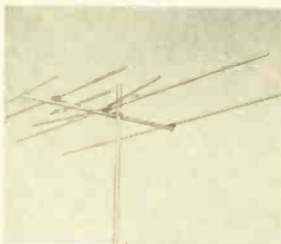

TOWER, Rohn No. 6, for home TV installation and communication requirements. Self-supporting to 50 feet. Features 12½-inch triangular design

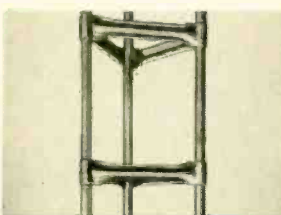

with heavy-duty corrugated cross bracing.

Rohn Manufacturing Co., 116 Limestone, Bellevue, Peoria, Ill.

ANTENNA ROTATORS, CAR6-B deluxe model and **CAR6-A** standard model (both called *Tenn-a-liner*). Finger-tip control, constant directional indication, illuminated dial.

Crown Controls Co., Inc., New Bremen, Ohio.

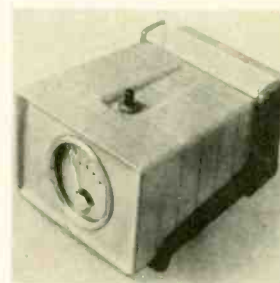

COAXIAL SPEAKER, University model BLC, 22½ inches in diameter, 9 inches deep, 8-inch throat. Separate high-frequency tweeter, coaxially mounted, with its own driver unit coupled to wide-angle horn. Built-in frequency dividing network, crossover at 2,000 cycles. Rated frequency response 70-15,000 cycles. 25-watt rating.

University Loudspeakers, Inc., 80 So. Kensico Ave., White Plains, N. Y.



Invisible hands make light work...

of faraway TV tuning with Regency model RT-700... based on an entirely new principle in remote control devices. Now it's possible to change channels, sharpen contrast, brighten the picture, control the volume, and most important—adjust the picture from where it is seen. So simple to install, that a service man can do it in minutes. Handsome cabinet design complements any decor... blond or mahogany finish.

Regency, world's leading manufacturer of TV accessories including VHF boosters, FM boosters, voltage boosters, UHF converters, chair side TV control, high pass filters and a complete line of high fidelity equipment.

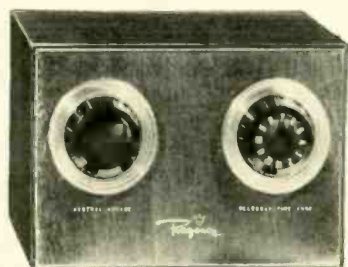

Regency
List Price \$69.95

REGENCY DIVISION, I.D.E.A., INC. INDIANAPOLIS 26, INDIANA

www.americanradiohistory.com

Burton browne advertising

BAR GENERATOR, portable TV color, model 655XC produces fully saturated color-bar pattern on picture tube of any color TV receiver. Creates color bars on TV screen in following order (left to right): green, yellow, red, magenta, white, cyan, blue, black. Output either r.f. or video. Video output is 0-2 volts, peak-to-peak open circuit 0-1 volt, peak-to-peak across 100 ohms, either positive or negative output. R.f. output modulated with color-bar pattern available through channels 4, 5, 6.
 Hickok Electrical Instrument Co., 10531 DuPont Ave., Cleveland 8, Ohio.

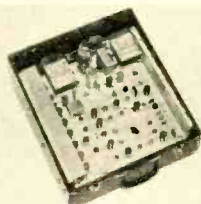

TRUKARADIO, an auto receiver suspended from car roof. Antenna and shockmount made under patents of King Mfg. Co. (Dubuque, Iowa). Radio manufactured by Eckstein Radio & TV Co., Minneapolis.
 Trukaradio, 228 E. Park Ave., Wheaton, Ill.

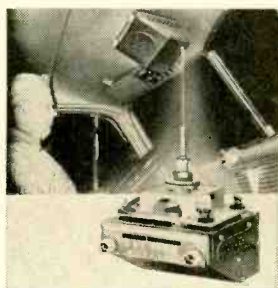

MIXER-SEPARATOR, Blonder-Tongue model MMS, requires no a.c. power. Capable of mixing and equalizing signals from any number of v.h.f. antennas. Can separate individual channels being transmitted in single cable. U.h.f. signals handled by converting to unused v.h.f. channel at antenna. Includes complete series of plug-in pads to supply up to 24-db attenuation on any one channel.
 Blonder-Tongue Laboratories, Inc., 526 North Ave., Westfield, N. J.

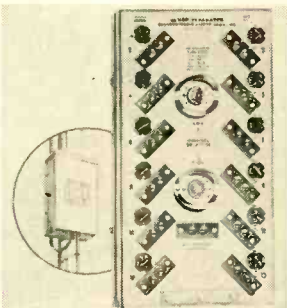

THE TELE-PAL, Tele-Matic's external speaker for remote-controlled TV listening. Has switch for shifting from remote unit to TV speaker, and remote volume control. Easily connected to speaker in TV set.
 Tele-Matic Industries Inc., 16 Howard Ave., Brooklyn 1, N. Y.



BRITENERS, Perma-Power model C201 C-Brite for picture tubes in parallel-wired sets and model C202 for series-wired sets. Both are 6-wire autoformers.
 Perma-Power Co., 4727 N. Damen Ave., Chicago 25, Ill.



HI-FI MICROPHONE, Shure Concert-Line 333, is unidirectional. Extended frequency response 30-15,000 cycles, ± 2.5 db.
 Shure Brothers, 225 W. Huron St., Chicago 10, Ill.



OSCILLOSCOPES, Electromec large-screen, available with 17- and 21-inch rectangular tubes, designed for data plotting, production test, waveform analysis, education and display uses. Features are: high resolution, $\pm 1\%$ linearity, stable d.c. amplifiers, calibrated time base (from 10 microseconds to 1 second per inch), gain controls calibrated in two peak-to-peak voltage ranges (10 millivolts or 1 millivolt per inch peak-to-peak sensitivity), low drift rate and long-term stability. Performance not affected by line-voltage changes from 105 to 125 volts.
 Electromec Inc., Oscilloscope Dept., 3200 N. San Fernando Blvd., Burbank, Calif.

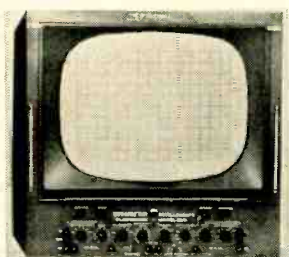

MAIL TODAY LEARN RADIO AT HOME WITH THE PROGRESSIVE RADIO "EDU-KIT"

BUILD 15 RADIOS ONLY AT HOME \$19.95

With the New Improved 1955 Progressive Radio "EDU-KIT"

NOW INCLUDES HIGH FIDELITY, SIGNAL TRACER, and CODE OSCILLATOR

- ATTRACTIVELY GIFT PACKED
- FREE SOLDERING IRON
- NO ADDITIONAL PARTS NEEDED
- EXCELLENT BACKGROUND FOR TV
- 10 DAY MONEY-BACK GUARANTEE
- SCHOOL INQUIRIES INVITED
- ABSOLUTELY NO KNOWLEDGE OF RADIO NECESSARY

WHAT THE PROGRESSIVE RADIO "EDU-KIT" OFFERS YOU

The Progressive Radio "Edu-Kit" offers you a home study course at a rock bottom price. Our Kit is designed to train Radio Technicians, with the basic facts of Radio Theory and Construction Practice expressed simply and clearly. You will gain a knowledge of basic Radio Principles involved in Radio Reception, Radio Transmission and Audio Amplification.

You will learn how to identify Radio Symbols and Diagrams; how to build radios, using regular radio circuit schematics; how to mount various radio parts; how to wire and solder in a professional manner. You will learn how to operate Receivers, Transmitters, and Audio Amplifiers. You will learn how to service and trouble-shoot radios. You will learn code. You will receive training for F.C.C. license. You will learn High Fidelity. In brief, you will receive a practical basic education in Radio, worth many times the small price you pay.

THE KIT FOR EVERYONE

The Progressive Radio "Edu-Kit" was specifically prepared for any person who has a desire to learn Radio. The Kit has been used successfully by young and old in all parts of the world. It is not necessary that you have even the slightest background in science or radio.

The Progressive Radio "Edu-Kit" is used by many Radio Schools and Clubs in this country and abroad. It is used for training and rehabilitation of Armed Forces Personnel and Veterans throughout the world.

The Progressive Radio "Edu-Kit" requires no instructor. All instructions are included. All parts are individually boxed, and identified by name, photograph and diagram. Every step involved in building these sets is carefully explained. You cannot make a mistake.

PROGRESSIVE TEACHING METHOD

The Progressive Radio "Edu-Kit" comes complete with instructions. These instructions are arranged in a clear, simple and progressive manner. The theory of Radio Transmission, Radio Reception, Audio Amplification and servicing by Signal Tracing is clearly explained. Every part is identified by photograph and diagram. You will learn the function and theory of every part used.

The Progressive Radio "Edu-Kit" uses the principle of "Learn by Doing". Therefore you will build radios, perform jobs, and conduct experiments to illustrate the principles which you learn. These radios are designed in a modern manner, according to the best principles of present-day educational practice. You begin by building a simple radio. The next set that you build is slightly more advanced. Gradually, in a progressive manner, you will find yourself constructing still more advanced multi-tube radio sets, and doing work like a professional Radio Technician. Altogether you will build fifteen radios, including Receivers, Transmitters, Amplifiers, Code Oscillator and Signal Tracer. These sets operate on 105-125 V. AC/DC. An Adaptor for 210-250 V. AC/DC operation is available.

THE PROGRESSIVE RADIO "EDU-KIT" IS COMPLETE

You will receive every part necessary to build 15 different radio sets. Our kits contain tubes, tube sockets, chassis, variable condensers, electrolytic condensers, mica condensers, paper condensers, resistors, line cords, selenium rectifiers, Ris strips, coils, hardware, tubing, etc.

Every part that you need is included. These parts are individually packaged, so that you can easily identify every item. A soldering iron is included, as well as an Electrical and Radio Tester, complete, easy-to-follow instructions are provided. In addition, the "Edu-Kit" now contains lessons for servicing with the Progressive Signal Tracer, F.C.C. instructions, quizzes, high fidelity instructions. The "Edu-Kit" is a complete radio course, down to the smallest detail.

TROUBLE-SHOOTING LESSONS

Trouble-shooting and servicing are included. You will be taught to recognize and repair troubles. You will build and learn to operate a professional Signal Tracer. You receive an Electrical and Radio Tester, and learn to use it for radio repairs. While you are learning in this practical way, you will be able to do many a repair job for your neighbors and friends, and charge fees which will far exceed the cost of the "Edu-Kit". Here is your opportunity to learn radio quickly and easily, and have others pay for it. Our Consultation Service will help you with any technical problems which you may have.

FREE EXTRAS

- ELECTRICAL & RADIO TESTER
- ELECTRIC SOLDERING IRON
- TV BOOK
- RADIO TROUBLE-SHOOTING GUIDE
- CONSULTATION SERVICE
- QUIZZES
- F.C.C. TRAINING

Progressive "Edu-Kits" Inc., 497 Union Ave., Dept. RE-99, Brooklyn 11, N.Y.

MAIL TODAY—Order shipped same day received.
 10-Day Money-Back Guarantee. Include ALL FREE EXTRAS

Send "Edu-Kit" Postpaid. I enclose full payment of \$19.95 (U.S.A. only).

Send "Edu-Kit" Postpaid. I enclose full payment of \$20.95 (Outside U.S.A.).

210-250 V. Adapter for "Edu-Kit"—\$2.50.

Send "Edu-Kit" C.O.D. I will pay \$19.95 plus postage (U.S.A. only).

I wish additional information describing "Edu-Kit". No Obligation.

Send me FREE Radio-TV Servicing Literature. No Obligation.

Name.....
 Address.....

PROGRESSIVE "EDU-KITS" INC.
 497 UNION AVE., Dept. RE-99, Brooklyn 11, N.Y.

BUILD 15 RADIOS AT HOME WITH THE PROGRESSIVE RADIO "EDU-KIT" MAIL TODAY

VHF, UHF, VHF / UHF, FM...

AMPHENOL

new **TELE-COUPLER**

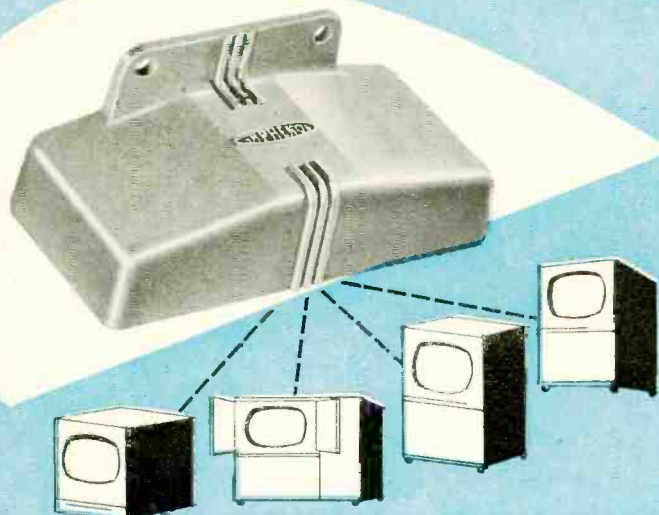

up to 4 TV SETS —
only 1 antenna!

TV or FM set owners can now operate up to 4 sets with a single antenna!—with the easy installation of an AMPHENOL Tele-Coupler. This ingeniously designed accessory will work equally well for VHF, UHF and FM, or any of these combined provides good picture/sound reception between each set without annoying interference. The heart of the Tele-Coupler is a specially designed bifilar network which combines a high isolation factor for VHF, UHF and FM sets with a low insertion loss factor. The network is weather-protected both at the top and at the sides by a sturdy and attractive grey plastic case—protection which makes the outdoor installation of the Tele-Coupler completely dependable. The Tele-Coupler is available in four models: two and four set couplers, with and without grounding lugs.

PRICES:

- 114-088 Two Set \$3.75
- 114-089 Same, with grounding lug 4.75
- 114-090 Four Set 5.75
- 114-091 Same, with grounding lug 6.75

AMPHENOL

AMERICAN PHENOLIC CORPORATION Chicago 50, Illinois
In Canada: AMPHENOL CANADA LTD., Toronto

NEW DEVICES

(continued)

TV TESTER, Seco *FB-4* checks flyback interval and inductance at a glance. No disconnecting of parts necessary. Reveals condition of coil components as connected group, from the standpoint of self-resonant frequency established with distributed capacitance in coils and circuit. Verifies transformer and yoke matching, also tests flyback transformer and yokes individually. Checks linearity and ringing coils by comparison. Seco Manufacturing Co., 5015 Penn. Ave. So., Minneapolis, Minn.



V.V.M., Sylvania *302 Poly-meter*, has subminiature vacuum tube r.f. probe, peak-to-peak scale, 7-inch meter movement, lighted scale, linearity circuit shielded a.c. and r.f. leads, and screw-on connectors. Input impedance: 17 megohms.

Voltage Ranges: Peak-to-peak, 200 millivolts to 2,800 volts; d.c., 200 millivolts to 2,800 volts; d.c., + or - 50 millivolts to 1,000 volts; a.c., 50 millivolts to 1,000 volts; r.f., 100 millivolts to 300 volts (10 kc to 300 mc).

Resistance: 0.5 ohm to 1,000 megohms.

Decibels: -20 to +61.4.

D.C. voltage range may be extended to 30,000 with type 225 (30 kv) d.c. voltage multiplier probe.

Sylvania Electric Products, Inc., 1221 W. 3rd St., Williamsport, Pa.

sensitivity, a.v.c. on r.f., mixer and i.f. FM sensitivity 5-10 μ v for 20-30-db quieting, bandwidth 200 kc, two limiters and discriminator. Tuned r.f. stages on both AM and FM. Chassis dimensions 5 x 9 $\frac{1}{4}$ x 8 inches.

Approved Electronic Instrument Corp., 928 Broadway, New York 10, N. Y.

ADAPTER, makes Audax tone arms usable with all cartridges. Compass-pivoted construction—no springs and only three parts; frontal oscillation nil. Easy to use with any cartridge, by just inserting into the Audax tone arm.

Audax Co., 500 Fifth Ave., New York 36, N. Y.



4-WAY TOOL (CBS-Hytron) has three parts: slotted steel barrel with hex sockets ($\frac{1}{4}$ inch at one end, $\frac{5}{16}$ inch at other); double-ended screwdriver blade (one end with Phillips head; other with hollow-ground standard head which slides inside barrel); knurled setscrew to lock sliding blade into any one of three recessed positions within

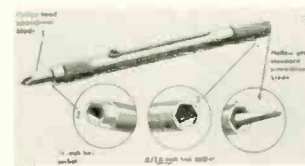

slotted barrel. When sliding blade is centered with the barrel, either hex socket can be used or either screwdriver head, Phillips or standard, may be drawn out of barrel and locked into position for use.

CBS-Hytron, Danvers, Mass.

CAPACITORS, Cornell-Dubilier tubular subminiature. Require no voltage derating even at +130°C. Maximum moisture resistance (exceeding MIL-C-91 requirements). Noninductively wound extended foils soldered to wire leads for low r.f. impedance. Mylar polyester dielectric, tubular steatite cases. Ends sealed with Polykane fill.

Cornell-Dubilier Electric Corp., South Plainfield, N. J.

RESISTOR, Sprague subminiature 3-watt wirewound. 13/64-inch diameter by 17/32-inch

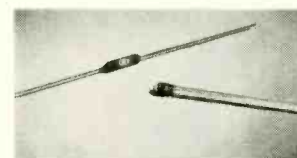

long (same size as conventional $\frac{1}{2}$ -watt carbon). Maximum resistance, 10,000 ohms. Blue vitreous enamel coating. Sprague Electric Co., North Adams, Mass.

12-TUBE AM-FM TUNER. Approved *Imperial V*, kit form. AM tuning range 530-1650 kc, 6- μ v

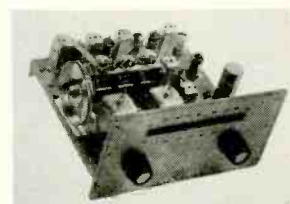

All specifications given on these pages are from manufacturer's data.

He's using the telephone that lends an extra hand



"Sure . . . I'm looking up the figures right now!" From busy executives to clerks, people in business can work more easily and efficiently with Bell's new Distant Talking Telephone. Small white rectangle is the loudspeaker.

For people who want to keep *both* hands free when they telephone, Bell Telephone Laboratories engineers have devised a new telephone with a sensitive microphone in its base.

To use it, simply press a button. The microphone picks up your voice and sends it on its way. Your party's voice comes to you through a small loudspeaker. Both hands are left free.

The volume can be adjusted to suit yourself. If privacy is needed, you simply lift the handset; this shuts off the microphone and loudspeaker and you talk just as you would on a regular telephone.

This new development of Bell Laboratories increases the number of ways your local Bell telephone company can serve in businesses and homes.

Bell Telephone Laboratories

*Improving telephone service for America provides careers
for creative men in scientific and technical fields.*



Pencil points to microphone in base of new telephone. Left-hand button controls volume, center one turns set "on" and lights up while in use. The third is an "off" button.

TRANSVISION

COMMUNITY AND MASTER TV Antenna Systems

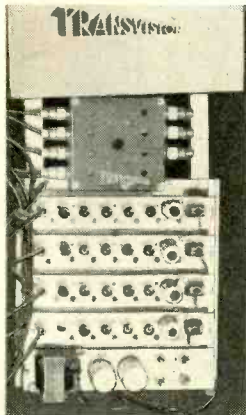

Type shown here is a 4-Channel System.

Larger systems with any number of Channels are available to order.

CUSTOM-DESIGNED for your individual needs

Lowest Installation and Maintenance Cost of all Systems.

In the difficult Metropolitan New York area, more TRANSVISION Master Antenna Systems were selected and proven out than any other system.

Features: 1. Highest power output allows longest cable runs . . . 2. Central system with only 1 point of service . . . 3. Operates up to 500 TV sets from 1 amplifier . . . 4. Lowest cost per outlet . . . 5. Maximum signal to each set with minimum interference . . . 6. Standard units are provided . . . but they may be modified to meet your special reception problems and layout. We also offer you:

FREE: Engineering advice. Send us your problem for quick solution.

FIELD STRENGTH METER

For 110V AC, and Battery Operation

Saves 50% of installation cost . . . Measures pic signal strength directly from antenna . . . Identifies TV, FM, TVI signals . . . Has 12 channel selector; multiplier switch for weak signal areas . . . Range, 10-50,000 microvolts . . . A must in fringe areas, UHF or VHF . . .



Money Back Guarantee

Model FSM-5, for 110V AC only, complete with tubes. Weight 13 lbs. . . . net \$79.
Model FSM-5B, for Battery Operation and 110V AC. Weight 22 lbs. . . . net \$89.

TRANSVISION, Inc., New Rochelle, N. Y.
JOBBER INQUIRIES INVITED

new Tubes & Transistors

DU MONT has joined the contest for bigger and better color TV picture tubes with what is claimed to be the first 21-inch rectangular shadow-mask tube. The unit is of metal cone construction and provides approximately 225 square inches of picture area. Du Mont announced it expects to make quantity deliveries in 1955.

To improve performance in TV receivers using a single series-connected heater string, including the heater of the picture tube, RCA has announced the 6CG7, a 9-pin miniature version of the popular 6SN7-GT. The tube is intended for use particularly as a vertical and horizontal deflection oscillator, and is designed with a 600-ma heater having a controlled warm-up time.

The medium-mu twin-triode contains an internal shield to prevent coupling between the triode units. It may also be used as a phase inverter, sync separator and amplifier, and resistance-coupled amplifier.

RCA has announced an addition to its line of short, wide-angle picture tubes—the 21AMP4-A, a 21-inch, 90° deflection type using magnetic focus and deflection. Measuring 20 3/8 inches in length, the 21AMP4-A is a rectangular glass tube with an aluminized screen measuring 19 1/8 by 15 inches. It has a screen area of 263 square inches, an external conductive bulb coating, and uses a single-field ion-trap magnet.

Two 70° TV picture-tube types have been placed on the market by RCA: the 14HP4 and 21YP4-A. Both have been used as initial equipment in numerous brands of TV receivers and are now available for general replacement service.

The 14HP4 is a rectangular glass tube with a screen size of 11 3/8 by 8 1/2 inches. It uses low-voltage electrostatic focus and magnetic deflection, and has a maximum high-voltage rating of 14,000.

The 21YP4-A, an aluminized glass picture tube with a screen size of 19 1/8 by 14 3/8 inches, has a spherical filter-glass faceplate. It uses low-voltage electrostatic focus and magnetic deflection, and has a maximum high-voltage rating of 18,000. The tube has an external conductive bulb coating, and uses a single-field ion-trap magnet.

RCA has announced 20 new series-string tubes, not including the 6CG7 mentioned. They have 600-ma heaters designed to operate in a single series-connected circuit. These are in addition

6 VOLT BATTERY SOLDERING IRON AND WELDER

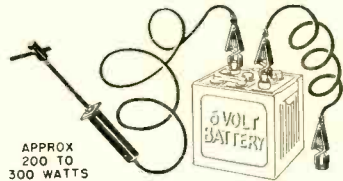

APPROX 200 TO 300 WATTS

U.S. Army release. Brand New—Never Used. Fully Guaranteed. This soldering iron can be used to solder or weld when connected to any six-volt storage battery. Uses approximately 200 to 300 watts. The high intensity arc created between the metal to be soldered and the carbon electrode (carbons supplied free with iron) can be used to heat tin or aluminum solder. Suitable also for light brazing and spot welding. Arc can be used for melting metals, cutting holes and soldering seams in chassis. Also useful for analyzing metals and minerals.

Battery soldering iron outfit includes 2 carbons, 3 heavy duty spring clips, 2 pieces 5 ft. heavy duty wire cable. (Battery not included.) Ideal for use where current is not available. Ship wt. 4 lbs.

\$1.95
ITEM NO. 126
UNUSUAL BUY (Shp. Chgs. 40c)

POWERFUL ALL PURPOSE MOTOR

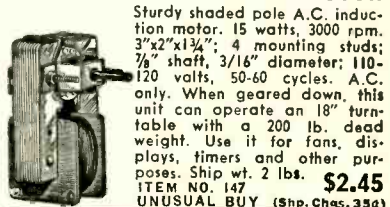

Sturdy shaded pole A.C. induction motor. 15 watts, 3000 rpm. 3"x2"x1 1/4"; 4 mounting studs; 7/8" shaft, 3/16" diameter; 110-120 volts, 50-60 cycles. A.C. only. When geared down, this unit can operate an 18" turntable with a 200 lb. dead weight. Use it for fans, displays, timers and other purposes. Ship wt. 2 lbs.

\$2.45
ITEM NO. 147
UNUSUAL BUY (Shp. Chgs. 35c)

WATTHOUR METER



Leading makes—reconditioned. Ideal for trailer parks. 100-110 volts, 60 cycles, 2-wire A.C. 5 amp. Heavy metal case 8 1/2" x 6 1/4" x 5". Easy to install. Ship. wt. 14 lbs.

\$4.50
ITEM NO. 33
NOW ONLY (Shp. Chgs. \$1.25)

WESTERN ELECTRIC BREAST MIKE



Lightweight 1 lb. carbon microphone. Aircraft type. Breastplate mounting, adjustable 2-way swivel. Easily fastened straps. For home broadcasts, communications etc. Complete with 6 foot cord, hard rubber plug. Sheradized plate, non-rusting finish. Ship. wt. 2 lbs.

\$1.98
ITEM NO. 152
NEW LOW PRICE (Shp. Chgs. 32c)

AMAZING BLACK LIGHT



250-watt ultra-violet light source. Makes fluorescent articles glow in the dark. Fits any lamp socket. For experimenting, entertaining, unusual lighting effects. Ship. wt. 2 lbs.

\$2.45
ITEM NO. 87
A SAVING AT (Shp. Chgs. 35c)

250 POWER TELESCOPE LENS KIT



Make your own high powered 6 ft. telescope! Kit contains 2" diam., 75" focal length, ground and polished objective lens and necessary eye pieces. Magnifies 50x to 250x. Full instructions. Ship. wt. 1 lb.

\$2.95
ITEM NO. 123
YOU SAVE AT (Shp. Chgs. 10c)

HUDSON SPECIALTIES CO.
25 West Broadway, Dept. RE-12-54
New York 7, N. Y.

I am enclosing full remittance for items circled below. (Be sure to include shipping charges.)
OR, my deposit of \$ Ship balance C.O.D.
MINIMUM C.O.D. ORDER \$5.00.
C.O.D. ORDERS ACCEPTED ONLY WITH 20% DEPOSIT
INCLUDE SHIPPING CHARGES.

Circle Items Wanted
87 147 33 152 126 123

Name Please Print Clearly
Address
City Zone State

These new books can help you get ahead in electronics

The new Gernsback Library books are the only technical books in the field dedicated to supplying technicians with a constant source of up-to-the-minute technical information at low cost. New titles are continually being added. These are the latest. Pick out the books you want and order them from your distributor today.

THE OSCILLOSCOPE—No. 52



A practical book that tells you how to use the scope to best advantage in all types of servicing. Gives you tips on use and warns about pitfalls to avoid. 192 Pages. Over 100 illustrations.

\$2.25

TRANSISTORS—THEORY AND PRACTICE—No. 51

Rufus P. Turner explains transistors for the practical man. Gives applications in well-known circuits. Contains guide to characteristics of commercial transistors. 144 Pages.

\$2.00

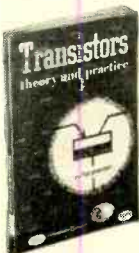

TY REPAIR TECHNIQUES—No. 50



Top technician-writers tell you how to recognize and correct quickly the tough servicing problems which stump even the experts. Will help you do a better job faster. 128 Pages.

\$1.50

RADIO & TV TEST INSTRUMENTS—No. 49

How to build just about every modern TV-radio-audio servicing instrument, plus unique chapters on service bench and carrying case construction. 128 Pages. Over 100 illustrations.

\$1.50



See coupon on page 140

Gernsback Publications, Inc.

Publishers of RADIO-ELECTRONICS

25 West Broadway

New York, N.Y.

NEW TUBES

(Continued)

to the seven series-string tubes announced in the October issue. Except for changes in heater design, these new receiving tubes correspond electrically and mechanically to prototypes widely used in home TV receivers.

The tubes, followed by their prototypes, are: 2AF4-A (6AF4), 3AL5 (6AL5), 3AU6 (6AU6), 3AV6 (6AV6), 3BY6 (6BY6), 3CF6 (6CF6), 4BQ7-A (6BQ7-A), 4BZ7 (6BZ7), 5AQ5 (6AQ5), 5AS8 (6AS8), 5X8 (6X8), 6AU7 (12AU7), 6S4-A (6S4), 6SN7-GTB (6SN7-GT), 12AX4-GTA (12AX4-GT), 12BH7-A (12BH7), 12BQ6-GTB (6BQ6-GT), 12BY7-A (12BY7), 12W6-GT (6W6-GT), 25CD6-GA (25CD6-G).

A new line of subminiature germani-

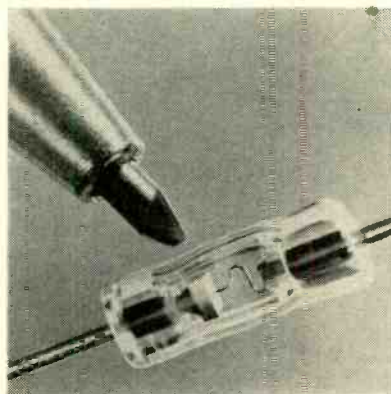

um diodes, using a miniature gold junction, has been announced by Hughes Aircraft, Culver City, Calif. The diodes have a high forward and high back resistance, making them particularly suitable for use in magnetic amplifier circuits, clamps and d.c. restorers.

These gold-junction diodes are made with a fusion-sealed, one-piece glass body (see photo). They are 0.265 inch long and 0.130 inch wide. END

Radio Thirty-Five Years Ago In Gernsback Publications

HUGO GERNSBACK Founder

Modern Electronics	1908
Wireless Association of America	1908
Electrical Experimenter	1913
Radio News	1919
Science & Invention	1920
Television	1927
Radio-Craft	1929
Short-Wave Craft	1930
Television News	1931

Some of the larger libraries still have copies of ELECTRICAL EXPERIMENTER on file for interested readers.

In December, 1920 Science and Invention (formerly Electrical Experimenter)

The Nauen Radio Station
Eilvise Radio Station
Transmitting Photographs by Radio, by Pierre H. Boucheron
Light Ray Phonograph, by Eric A. Dime
Automatic Indicator for Storage Cells
New Precision Condenser and Wave-meter
Magnitude of Tesla High Frequency Currents

NEW! EICO FLYBACK & YOKE TESTER KIT

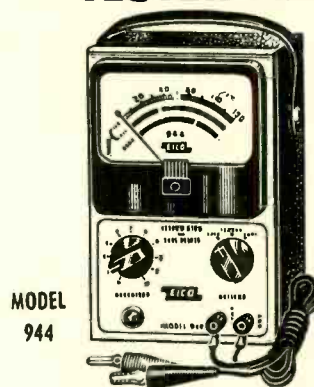

MODEL 944

LOWEST PRICED KIT

\$23.95

Wired \$34.95

Checks all flybacks & yokes instantly—in or out of set!

- Detects even 1 shorted turn!
- Exclusive separate calibration for air & iron-core flybacks for accurate testing of all types.
- Tests continuity of coils, speakers, switches, etc.
- Large 4 1/2" meter, 3 colored scales.
- Complete with easy instructions.
- Compact, rugged, smartly styled.

See it at your jobber today. Write for FREE Catalog CF-12 describing EICO's 38 Kits and 42 Wired Instruments. Prices 5% higher on West Coast.



ELECTRONIC INSTRUMENT CO., Inc.
84 Withers Street, Brooklyn, N. Y.

BRAND NEW TUBES FAR BELOW WHOLESALE

Steve-El brings you Fully Guaranteed tubes for one year at Below Wholesale Prices. All tubes individually boxed.

1B3	.52	6SL7	.49	12BE6	.41
1S5	.46	6SN7	.54	12SL7	.49
1T4	.46	6T8	.56	12SN7	.51
1X2A	.61	6Y6	.39	19T8	.64
6AG5	.51	6W4	.44	25BQ6	.66
6AK5	.66	6X4	.36	25L6	.38
6AC7	.73	7C4	.49	25W4	.47
6AL5	.39	12A6	.46	50B5	.47
6AT6	.37	12AT7	.56	57A5	.49
6AU6	.43	12AV7	.58	57S	.49
6BC5	.47	12AX4	.52	117Z3	.39
6BG6	1.19	12BA6	.43	807	.99
6BQ6	.81				
6CB6	.44				
6J6	.51				
6L6	.86				

Write Dept. RE-12 for complete list of tubes and other bargains.

Minimum order \$5.00

FREE 1955 Catalog!

STEVE-EL Electronics Corp.
61 Reade St. New York 7, N. Y.

For **QUALITY - PERFORMANCE - DEPENDABILITY**

Rad-Tel Tubes Guaranteed 1 FULL YEAR



**70% to 90%
OFF**

- Same Day Service
- All Tubes Individually Boxed
- 300 Types Always in Stock

Type	Price	Type	Price	Type	Price	Type	Price	Type	Price	Type	Price
OA2	.74	5U4G	.55	6C4	.40	7A4	.47	12B6	.45	25L6GT	.51
OA4	.68	5W4GT	.50	6C5	.39	7A5	.59	12BE6	.51	25V4GT	.59
OB2	.81	5Y3GT	.37	6C6	.58	7A6	.69	12BF6	.39	25Z5	.66
OC3	.72	5Y4	.51	6CB6	.54	7A7	.69	12BH7	.63	25Z6	.49
OD3	.70	5Z3	.45	6CD6	1.11	7A8	.68	12BY7	.65	26	.45
OZ4M	.65	6A6	.51	6CF6	.64	7AD7	.79	12BZ7	.65	27	.39
1A5	.49	6A7	.69	6CS6	.51	7AF7	.53	12C8M	.34	32L7	.89
1A7GT	.47	6AB4	.44	6D6	.59	7AG7	.69	12H6	.56	35	.58
1A2	.52	6AC5	.69	6E5	.48	7AH7	.79	12J5	.42	35A5	.58
1B3GT	.73	6AC7M	.86	6F5GT	.39	7B4	.44	12J7	.49	35B5	.52
1C5	.43	6AF4	.90	6F6	.59	7B5	.45	12K8	.59	35C5	.51
1E7	.29	6AG5	.56	6G6	.42	7B6	.69	12Q7	.59	35L6GT	.51
1G6	.24	6AH4	.99	6H6GT	.41	7B7	.49	12S8GT	.62	35W4	.47
1H4	.30	6AM4	.73	6J5GT	.43	7C4	.59	12SA7GT	.65	35Y4	.54
1H5GT	.49	6AH6	.73	6J6	.52	7C5	.69	12SC7M	.63	35Z3	.59
1L4	.46	6AJ5	.65	6J7	.43	7C6	.59	12SF5	.50	35Z4	.47
1LA4	.59	6AK5	.55	6K5	.47	7E5	.59	12SG7	.51	35Z5GT	.47
1LA6	.69	6AK6	.59	6K6GT	.45	7E6	.30	12SJ7M	.67	36	.39
1LB4	.69	6AL5	.42	6K7	.44	7E7	.59	12SK7GT	.63	45	.55
1LC5	.59	6AM8	.78	6L6	.64	7F7	.79	12SL7GT	.57	45 (Spec)	.27
1LC6	.79	6AO5	.50	6L7M	.68	7F8	.79	12SN7GT	.52	45Z5	.49
1LD5	.59	6AF6	.37	6N7M	.63	7G7	.89	12SQ7GT	.56	46	.69
1LE3	.59	6AQ7	.70	6P7	.45	7H7	.79	12SR7M	.49	50A5	.55
1LG5	.69	6AR5	.45	6R7	.69	7J7	.59	12V6GT	.46	50B5	.52
1LH4	.69	6AS5	.50	6S4	.48	7K7	.69	12X4	.38	50C5	.51
1LN5	.59	6AS6	1.49	6S7M	.79	7L7	.59	14A4	.69	50L6GT	.61
1N5GT	.67	6AT6	.41	6S7B	1.90	7M7	.69	14A5	.59	50X6	.49
1P5GT	.57	6AU4GT	.68	6S8GT	.53	7Q7	.66	14A7	.63	50Y6	.49
1Q5GT	.58	6AU5GT	.82	6SA7GT	.55	7R7	.89	14AF7	.59	50Y7	.50
1R5	.62	6AU6	.46	6SD7GT	.47	7S7	.79	14B6	.63	55	.49
1S4	.59	6AV5GT	.83	6SF5GT	.46	7V7	.89	14B8	.63	56	.49
1S5	.51	6AV6	.40	6SG7GT	.41	7X6	.54	14C5	.79	57	.58
1T4	.58	6AX4GT	.65	6SH7GT	.49	7X7	.70	14C7	.79	58	.60
1U5	.57	6B4	.54	6SJ7GT	.41	7Y4	.69	14E6	.75	70L7	.97
1U5	.50	6BA6	.49	6SK7GT	.53	7Z4	.59	14E7	.88	75	.49
1V	.43	6BA7	.57	6SL7GT	.48	12A6	.54	14F7	.65	76	.44
1X2A	.63	6BD5	.59	6SN7GT	.59	12A8GT	.61	14F8	.69	77	.57
2A3	.30	6BD6	.45	6SQ7GT	.46	12AL5	.37	14H7	.59	78	.47
2W3	.38	6BE6	.51	6SR7GT	.45	12AQ5	.52	14J7	.30	80	.43
2X2	.49	6BF5	.41	6S7GT	.42	12AT6	.41	14N7	.84	83V/6Z4	.68
3A4	.45	6BF6	.37	6T8	.80	12AT7	.72	14R7	.79	84/6Z4	.46
3B7	.27	6BG6G	1.25	6U5	.57	12AU6	.46	14S7	.89	85	.59
3D6	.27	6BH6	.53	6U6	.59	12AU7	.60	14W7	.30	117L7	.99
3E5	.46	6BJ6	.49	6U8	.78	12AV6	.39	14X7	.69	117P7	.99
3LF4	.69	6BK5	.80	6V6GT	.50	12AV7	.73	14Y7	.62	117Z3	.37
3Q4	.48	6BK7	.80	6W4GT	.57	12AX4	.67	19B6G	1.39	117Z6	.69
3Q5GT	.69	6BL7GT	.83	6W6GT	.47	12AX7	.63	19T8	.69	807	.99
354	.58	6BN6	.59	6X4	.37	12AY7	.69	19V8	.79	866A	1.39
3V4	.58	6BQ6GT	.98	6X5GT	.37	12AZ7	.59	24A	.39	1274	.30
5AZ4	.59	6BQ7	.90	6Y8	.75	12BA6	.60	25AV5GT	.83	HI-PO	.30
5T4	.79	6BZ7	.90	6Y6G	.48	12BA7	.49	25BQ6GT	.98	#567	1.39

TERMS:
A 25% deposit must accompany all orders—balance C.O.D. All shipments F.O.B. Irvington warehouse. **ORDERS UNDER \$10-\$1.00 HANDLING CHARGE** Subject to prior sale.

PLEASE:
Send full remittance allow for postage and C.O.D. charges! We refund all unused money! Dept. RE-12.

Tubes in bold Type Cover 90% of Demand
Phone: Essex 5-2947

JAN TUBES
1619 .27
1626 .27
1629 .27
615 .27
7193 .27
954 .27

Rad-Tel TUBE CO. 'Integrity Is Our Chief Asset'
115 COIT ST., IRVINGTON II, N. J.

TELEVISION Big demand for graduates

B.S. DEGREE IN 27 MONTHS in radio including TV engineering—VHF, UHF, AM and FM. Students use over \$100,000 worth of equipment including 2 large commercial type transmitters in new TV lab. Intense specialized course includes strong basis in mathematics, science and advanced design in radio and TV. Hundreds of young men each year are earning engineering degrees in this recognized institution. Start any quarter. Many earn a major part of expense in this industrial center. Low tuition. Competent instruction. Thorough, intense, practical program. Also **B.S. DEGREE IN 27 MO.** in Aeronautical, Chemical, Civil, Electrical and Mechanical Engineering. G.I. Gov't approved. Enter Dec., March, June, Sept. Free catalog. **ENROLL NOW.**

INDIANA TECHNICAL COLLEGE
1712 E. Washington Blvd., Fort Wayne 2, Indiana

EASY TO LEARN CODE

It is easy to learn or increase speed with an Instructograph Code Teacher. Affords the quickest and most practical method yet developed. For beginners or advanced students. Available tapes from beginner's alphabet to typical messages on all subjects. Speed range 5 to 40 WPM. Always ready—no QRM.

ENDORSED BY THOUSANDS!

The Instructograph Code Teacher literally takes the place of an operator-instructor and enables anyone to learn and master code without further assistance. Thousands of successful operators have "acquired the code" with the Instructograph System. Write today for convenient rental and purchase plans.



INSTRUCTOGRAPH COMPANY

4701 Sheridan Rd., Dept. RC, Chicago 40, Ill.

RADIO-ELECTRONICS

ANNUAL INDEX

1954 Vol. XXV
Jan-Dec 1954

(Key to abbreviations on pg 140)

A

AMATEUR

- Antenna Relay, Electronic* (REC) Feb 128
- B.f.o. Modification (REC) Dec 107
- Bandspread, Tailor-made (TTO) Aug 110
- Code-Practice Oscillator, Transistor* (Cleland) Mar 78
- Keying Monitor, Transistor* (Queen) Jan 124
- Modulator, Suppressor-Grid (REC) Jun 111
- Junction Transistors for High-Frequency Oscillators (Queen) Aug 87
- Multipurpose Instrument for Novice* (REC) Jul 112
- Receivers, Improving All-Wave (QB) Aug 106
- Regenerative Set, Sensitive All-Wave* (REC) Mar 130
- S-Meter Circuit* (REC) Sep 141
- Watch That Signal* (Minor) Jun 83
- Swinging Chokes & Power-Supply Regulation (Crowhurst) Nov 59
- AMPLIFIERS**—(See Audio, Television)
- ANTENNAS**—TV (See Television)
- ATTENUATORS**
More About (Crowhurst) Jan 116
- Transmission Set, Economical* (Maxwell) Feb 34
- Volume Controls, Push-Pull (Taylor) Feb 36
- AUDIO**
- Amplifiers**
Bogen HO10t Oct 60
- Cascade (Pat) Jan 161
- Compression Audio-Frequency (Pat) Jun 104
- Crossover Network for (Rogers) Nov 63
- D.c. (Pat) Jan 156
- D.c. to A.c. (Pat) Apr 108
- Golden Knight† May 58
- High-Fidelity (Pat) Mar 129
- Kink (Rec) Dec 107
- Low-Cost* (Montgomery) Aug 72
- Low-Frequency Narrow-Band* (REC) Feb 126
- Milady's Golden Ear* (Marshall) Apr 50
- Power (Dorf) Sep 44
- Push-Pull Volume Controls (Taylor) Feb 36
- Tape-Recording* (Augsburger) Jul 56
- Triode and Pentode Resistance-Coupled (Dorf) May 61
- Ultra-High-Gain Starved-Current* (Lederer) Mar 45
- Without Frills* (Drenner) Feb 33
- Cathode Followers, High-Quality Audio** (Dorf) Jun 45
- Getting the Cathode Follower Straight (Crowhurst) Dec 50
- Control Unit**
For Golden Ears* (Marshall) Mar 32
- General**
Decibel Measurements (French) Dec 37
- Gate, Selective Audio (Pat) Jun 98
- Headphone Circuit* (Philpott) Nov 52
- Intercom, Quick-Heating* (QB) Nov 138
- Load, Optimum (Crowhurst) Mar 38
- Phono Connection to A.c.-D.c. Set (QB) Jun 118
- Relay Switching for TV* Aug 62
- Sound Destroys Sound Aug 70
- Swinging Chokes & Power-Supply Regulation (Crowhurst) Nov 58
- Turntable, D & R† Nov 59
- Visual Volume Control Indicator for Hard-of-Hearing Jun 41
- Hearing Aids,**
Low-Drain (Zenith Royal-T) Sept 36
- High-Quality Audio** (Dorf)
Part V—Pickups Jan 106
- Part VI—Pickups, Preamps, Recording & Playback Feb 40
- Part VII—Bass & Treble Equalizers Mar 40
- Part VIII—Tuners Apr 63
- Part IX—Triode & Pentode Voltage Amplifiers May 61
- Part X—Cathode-Followers Jun 45
- Part XI—Phase Splitters Jun 62
- Part XII—Cross-Coupled Inverter Aug 54
- Part XIII—Power Amplifiers Sep 44
- Part XIV—Negative Feedback Oct 58
- Part XV—Tape Recorders Nov 79
- Part XVI—Conclusion Dec 43
- Loudspeakers**
Baruch-Lang System† Mar 59
- High-Fidelity (Hartley)
Part I—Design Tangibles & Intangibles Mar 35
- Letter (Messner) May 138
- Part II—Voice-Coil Design Apr 60
- Part III—Horns & Multiple-Speaker Systems Jun 42
- Part IV—Enclosures, Baffles, Cabinets Aug 60
- Part V—Room Acoustics; Testing, Response Curves Oct 62
- Improving† (Dewar) Sep 43
- Kingdom-Lorentz† Jul 60
- Permolux-Diminuette Oct 55
- R-J Type 12† Speaker Enclosure (Korte) May 68
- Correction Jun 92
- Missing Link in Operation (Tomcik) Dec 41
- Recovering (Sorenson) Feb 86
- Space Sound (Klein system) Aug 69
- Modulators, Balanced for Weak Audio (Taylor) Dec 35
- Musical Instruments,**
Music into Light* (Brainard) Dec 98

27" Wired CHASSIS FOR CUSTOM BUILDING

27 TUBES, including CRT
with or without REMOTE CONTROL



CHASSIS and CRT—\$239
plus 10% Tax
In Kit Form . . . \$199

This *De Luxe Transvision Chassis* is ideal for fringe area, UHF-VHF reception. . . Has super-sensitivity and stability. . . Keyed AGC . . . 27 tubes, including CRT and 3 rectifier tubes. Also available with Remote Control and dual sound system for \$69 additional. *Order today, direct from:*

TRANSVISION
THE OLDEST NAME IN TV KITS
NEW ROCHELLE, N. Y.



ONLY \$495 Ppd. or C.O.D. + Chgs.

THE NEW TV DYNATRACER

- TRACES TV SIGNALS AND VOLTAGES
- LOCATES DEFECTIVE COMPONENTS
- REQUIRES NO ADDITIONAL EQUIPMENT

This sensationally new piece of test equipment is ideal for trouble-shooting television sets in the home or in the shop. The "DYNATRACER" will outperform more expensive testers and should pay for itself on the very first repair.

A Must for Every TV Technician

SPECIFICATIONS: The "DYNATRACER" is a self-powered quality test instrument designed to trace TV signals through any Video, Sound, Sync, AFC, Horizontal or Vertical Sweep Circuit—will isolate trouble to a stage or component.

ADDED FEATURE: The "DYNATRACER" will also trace voltages (50/100 V. AC-DC) and instantly locate open, shorted, intermittent or leaky condensers, resistors, coils, transformers, etc. Complete with 16 page step-by-step instruction and repair guide. See your local distributor—or if he can't supply you, clip a \$5.00 bill, check or money order to this ad. 100% absolute satisfaction guaranteed or money back within ten days.

Century ELECTRONICS CO.
211-04 99th Ave., Dept. 120
Queens Village, N. Y.

OSCIL-O-PEN

Extremely convenient test oscillator for all radio servicing: alignment • Small as a pen • Self powered • Range from 700 cycles audio to over 600 mc/cycles u.h.f. • Output from zero to 125 v. • Low in cost • Used by Signal Corps. • Write for information.

GENERAL TEST EQUIPMENT
38 Argyle Ave. Buffalo 9, N. Y.

ANNUAL INDEX

(Continued)

Music Pickup*, String (QB)	Jul	110
Organ, Wurlitzer, Part I (Dorf)	Dec	32
Organs, Tuning Electronic (Dorf)	Jun	40
Ukulele, Transistorized* (Herzog)	Feb	30
Oscillators, Phase-Shift (Harris)	Jan	136
Phono Pickups		
Ferranti†	Sep	37
High-Quality Audio, Part VI (Dorf)	Feb	40
Magnetic†	Jan	110
Titone Ceramic Cartridge†	Jul	60
Preamplifiers		
A.f., from Radio (Pat)	Jun	100
Childs 352 Control†	Mar	42
Phono, for Golden Ears (Marshall)	Jun	32
Pickering 230H†	Mar	41
Transistor, Low-Noise*	Aug	64
Recording		
Controlling Tape-Head High-Frequency Supply (Pat)	Jun	104
Curve, New Standard	May	63
Tape-Recorder Equalizer (Pat)	May	112
Record Player, Mobile* (REC)	Nov	127
Record Review, for Golden Ears Only (Monitor) May 59, Jul 61, Sep 59, Nov		88
Servicing		
Distortion Totalizer* (Palmer)	Aug	39
Ground Loops & Hum (French)	Apr	56
High-Fidelity (Goldstick & Peikes)	Jun	37
High-Fidelity Audio Equipment (Marshall)		
Part I—High-quality Equipment	Feb	38
Part II—Balance, Feedback & Hum	Mar	43
Part III—Measurements with Special Test equipment	Apr	58
Part IV—Frequency Test Records, Audio Test Instruments	May	64
Part V—Checking Distortion	Jul	69
Part VI—Oscilloscope Patterns as Trouble Locators	Aug	56
Part VII—Checking Phono Needles	Sep	42
Part VIII—Tracking Angle & Needle Pressure	Oct	82
Part IX—Equalization & Frequency Response	Nov	66
Part X—Turntable Hum, rumble and wow	Dec	39
Reconing Speakers (Sorensen)	Feb	86
Tools for Audio Technician (Scott)	Sep	46
Speaker Matching, Easy Way (Houston)	Sep	34
Tape Recorders		
High-Quality Audio, Part XV (Dorf)	Nov	79
Servicing (Smollin)	Sep	40
Video (RM)	Jan	10
Tuners—See Tuners under Radio		

B

BROADCASTING & COMMUNICATIONS		
Cable Break, Locating (Lineback)	Apr	112
Circuit, New Lockout*	Sep	41
Intercom, Quick-Heating* (QB)	Nov	138
Noise-figure (QB)	Sep	142
Radio, Low-Cost CD Mobile (Nannis)	May	78
Signaling, Transistor (Pat)	May	114

C

CAPACITORS		
Low-Value (Pat)	Oct	110
Ceramic (Dines)	Jun	78
Correction on above	Aug	16
Ceramic, More on (Dines)	Oct	94
Electrolytics, Reforming (REC)	May	132
Electrolytic (Deutsch)	Feb	69
Cathode Follower, Crowhurst	Dec	50
Commercial Killer, Transistor*	Jul	93
CONSTRUCTION [See individual heads: Receivers, etc. Construction articles are designated with an asterisk (*) after title of article.]		

E

EDITORIALS (H. Gernsback, unless otherwise noted)		
Automation	Sep	33
Color TV Problems	Jan	33
Decomplexity, Age of	Jun	31
Letter by De Forest	Aug	16
Letter by Ritchey	Aug	18
Electronics, Atom	May	31
Electrons, Hot or Cold?	Nov	31
Industry, Our Fabulous	Dec	31
Insurance, Service	Oct	31
Radio-Electronics in 1980	Jul	29
Specialization	Apr	31
Success, Rocky Road to	Aug	29
Technicians, Wanted	Feb	29
Transmitters, 600,000 U.S. (Federal Communications Commission)	Mar	31

ELECTRONICS

Amplifiers		
Smallest (Wallace)	Feb	95
Dielectric, Introducing (Fink)	Feb	92
Magnetic (Sands)	Nov	103
Astronomy and Electronics (Slaughter)	Oct	52
Audiometer, Controlled Output (Pat)	Jun	102
Battery, Atom (RM)	Mar	6
Battery Powers Transmitter, Solar* (Chapin & Thomas)	Aug	76
Blinking, Periodic (Pat)	Mar	126
Burglar Alarms, Alertronic†	Jun	47
High-Voltage Supply, Novel* (Pallatz)	Dec	52
Control Circuit, Punch-Press* (Stevenson)	Nov	62
Controls, Simple, for Industry (Cornelius)	Dec	94
Control Unit, Versatile* (Sandretto)	Jun	51
Diodes Amplify!	Nov	94
Electropilot (Shunaman)	Feb	96
Electrotherapeutics, Display in (Van den Bosch)	Mar	97
Flip-flop, 3 state (REC)	May	134
Geiger Counter, Transistorized* (Sokal & Resnick)	Jul	82

arkay kits

world's finest radio, phono, TV, and test kits

hi-fi ac/dc amplifier kit

arkay kit model A-5: A high-fidelity AC/DC amplifier kit featuring a new, improved push-pull output circuit plus a specially designed output transformer utilizing 2 speakers for the new 3d-dimensional qualities of audio reproduction. New engineering developments give you hi-fi at the lowest possible price. Kit is complete, except for speakers. **\$9.95**



hi-fi pre-amp kit

arkay kit model PA-3: Complete compensation for LP, NARTB, AES and early 78 RPM records. Kit also may be used as a control unit for custom hi-fi installations. Includes bass and treble control and contains 5 turnover and roll-off switch positions; 3 dual triode tubes are used to give maximum performance always. **\$16.95**



10 watt hi-fi amplifier kit

arkay kit model A-10: Complete with built-in pre-amplifier for magnetic cartridge, mike, crystal phono or radio tuner. Frequency response ± 1 db., 20 to 20,000 cps. with wide response bass and treble controls. Speaker output inductance: 4, 8, 16 ohms; negative feedback; hum: 70 db below rated output. **\$21.95**
Complete with tubes!



hi-fi amplifier with built-in pre-amp

arkay kit model FL-10: A striking new design with physical dimensions and style for use on a shelf or corner without elaborate or expensive enclosures. Specifications: same as model A-10 (above). **\$27.95**



3-way portable radio kit

arkay kit model 3W10-P: A smartly styled portable radio kit that operates on AC/DC or self contained batteries. Has 4 tubes and selenium rectifier with a fine quality Alnico V speaker, built-in loop antenna and hi-gain coils. Includes pictorial and schematic diagrams that are easy to follow. Colorful plastic cabinet. **\$18.95**



ac/dc radio kit

arkay kit model S-5E: New, 5-tube superhet. kit designed for radio students and hobbyists. Includes new 3D color instruction book, 550-1600 kc, complete with glistening walnut bakelite cabinet. **\$14.95**



Write today for new catalog including complete arkay line of radio, TV, phonograph, amplifier and test equipment kits.

the world's finest kits

arkay RADIO KITS, INC.
120 Cedar Street
BEekman 3-6686 New York 6, N. Y.

Coming next month

RADIO - ELECTRONICS 8th Annual

TV ISSUE

This, big 50c January issue is a year-round reference of important technical information on the latest developments in modern TV. A big oversize issue devoted to vital facts on:—

Color • UHF • Transistors • Servicing

PLUS A feature on color servicing in FULL COLOR

On sale December 28th

If you don't subscribe

If you act now, we will reserve a copy of the big 50c January 1955 TV issue for you.

You need the information RADIO-ELECTRONICS gives you to get ahead in electronics. Make sure you get it next month, and every month. Fill in the coupon below and mail it in to us today. **YOUR TV ISSUE IS WAITING.**

You Save on a
RADIO-ELECTRONICS
Subscription

3 YEARS \$8.00
Saves you \$5.05 over the newsstand rate.

2 YEARS \$6.00
Saves you \$2.70 over the newsstand rate.

1 YEAR \$3.50
Saves you 85c over the newsstand rate.

RADIO-ELECTRONICS, Dept. 124

25 West Broadway
New York 7, N.Y.

Please enter my subscription as indicated, to begin with the 50c January TV issue.

3 YEARS \$8.00 1 YEAR \$3.50
 2 YEARS \$6.00 \$.....enclosed. Bill me.

Name

Please print clearly

Street

City..... Zone..... State.....

**SAVE
UP
TO
\$5⁰⁵**

STATEMENT OF THE OWNERSHIP, MANAGEMENT, AND CIRCULATION REQUIRED BY THE ACT OF CONGRESS OF AUGUST 24, 1912, AS AMENDED BY THE ACTS OF MARCH 3, 1933, AND JULY 2, 1946 (Title 39, United States Code, Section 233) of RADIO-ELECTRONICS published monthly at Mt. Morris, Illinois, for October 1, 1954.

1. The names and addresses of the publisher, editor, managing editor, and business managers are: Publisher, Gernsback Publications, Inc., 25 West Broadway, New York 7, N. Y.; Editor, Hugo Gernsback, 25 West Broadway, New York 7, N. Y.; Managing Editor, Fred Shunaman, 25 West Broadway, New York 7, N. Y. Business Manager, none.

2. The owner is: Gernsback Publications, Inc., 25 West Broadway, New York 7, N. Y.; H. Gernsback, 25 West Broadway, New York 7, N. Y.

3. The known bondholders, mortgagees, and other security holders owning or holding 1 percent or more of total amount of bonds, mort-

gages, or other securities are: None.

4. Paragraphs 2 and 3 include, in cases where the stockholder or security holder appears upon the books of the company as trustee or in any other fiduciary relation, the name of the person or corporation for whom such trustee is acting; the affiant's full knowledge and belief as to the circumstances and conditions under which stockholders and security holders who do not appear upon the books of the company as trustees, hold stock and securities in a capacity other than that of a bona fide owner.

H. GERNSBACK, Publisher

Sworn to and subscribed before me this 15th day of September, 1954. [Seal] Irving Abramson, Notary Public. (My commission expires March 30, 1956.)

ANNUAL INDEX (Continued)

Generator, Solar (Cadmium Sulphide) (RM)	Aug	8
IRE Shows Electronic Progress (Shunaman)	Jun	47
Nim Computer, Digital* (Schlang)	Jun	49
Musical Instruments (See Audio)		
Nomograph, Distributed Capacitance (Sodaro)	Oct	57
Parallel-T Use, Novel (REC)	Sep	140
Photo-Flash System* (Hedge)	Sep	98
Phototransistor (Mileaf)	Nov	96
Radiometers, Microwave (Harris)	Feb	104
Relay, Capacitance, Uses Balanced Lines* (TTO)	Jun	116
Reverberation, Artificial (Pat)	Sep	116
Sound Destroys Sound	Aug	70
Switch, Electronic (REC)	Oct	134
Thermometer, Electric	Sep	112
Transistors, What's New in (Queen)	Jun	75
Volscan Speeds Air Traffic (Pascale)	Jul	75
Volume Indicator, Visual, Aids Hard-of-Hearing	Jun	41
Wire Tester, Insulated* (REC)	Feb	124
X-Ray Tube, Smallest	Mar	106

F

FICTION, Cosmic-Generator (Fips)	Apr	48
FREQUENCY MODULATION		
A.f.c., Adding, to FM Tuner* (Ringel & Gunny)	Nov	61
Booster, Electro-Voice FM†	Sep	38
Generator Based on Multivibrator* (REC)	Jul	112
Tuning Indicator, Adding* (QB)	Aug	106
(See also Tuners, under RADIO)		

G

Geiger Counters, Transistorized* (Sokal & Resnick)	Jul	82
--	-----	----

H

Hearing Aid (Zenith Royal-T)	Sep	36
------------------------------	-----	----

M

Measurements, Decibel (French)	Dec	37
Music into Light (Brainard)	Dec	98

P

Phono Oscillator, Transistor (Bohr)	May	74
Photo-Flash System* (Hedge)	Sep	98
PRINTED CIRCUITS		
I.f.'s for Hi-Fi Tuners (Grodinsky)	Aug	80
Servicing Techniques (Ricketts)	Oct	88
TV Receiver (Bonhomme)	Mar	55

R

RADIO		
Cathode Followers (Crowhurst)	Dec	50
Communications Radio—Citizens Band (RM)	Feb	10
Converter, V.h.f., 110—235 Mc* (QB)	Jun	118
Power Supplies		
Auto Radio (REC)	Oct	133
Voltage Regulators, Selenium (Cataldo)	Jul	84
Receivers		
Converter, Low-Frequency (QB)	Oct	126
Detector, Efficient CW (Cohn)	Oct	103
Headphone, Electronic* (Irwin & Queen)	Nov	56
High-Gain, Low-Drain Portable* (Queen)	Mar	84
More Compact Battery Portable* (Queen)	Sep	90
Correction on	Dec	140
Radio for Junior's Car (Michael)	Dec	48
Squelch (Pat)	Oct	108
Transistor Pocket Radio	Dec	49
Servicing		
Card-File System (Johnson)	Jul	90
Marine Radio (Robberson)	Apr	78
Tubes with Damaged Etchings, Identifying (French)	May	96
Wave Trap, High-Efficiency (TTO)	Apr	113
Whistlers (Darr)	Jul	86
Tuners		
Bogen R701 FM-AM†	Apr	66
Craftsman C900	Aug	80
Fisher 70-RT†	Nov	86
Radio Craftsman 800†	Apr	63

S

SERVICING		
Audio—See Audio		
Bandwidth, Variable* (REC)	Sep	139
Best Teacher (Farad)	Mar	58
Capacitors		
Ceramic (Dines)	Jun	78
Correction on above	Aug	16
More on (Dines)	Oct	94
Electrolytic (Deutsch)	Feb	69
Dummy Tubes Good for Tests (TTO)	Jun	116
FCC Boosts Marine Radio (Robberson)	Sep	82
Filament Checker* (REC)	Jun	114
Ground Loops & Hum (French)	Apr	56
High-Fidelity Audio (Goldstick & Peikes)	Jun	37
High-Fidelity Equipment (Marshall) See Audio		
Save Time with Test Equipment (Noll)	Nov	48
Signal Tracer, Phonic* (Richard)	May	52
Tape Recorder (Smolin)	Sep	40
Tech-Tricks (Leeper)	Jun	70
Tools for Audio Technician (Scott)	Sep	46
Transformers, Protecting I.f. (TTO)	Feb	132
Vertical Interlace & Instability (Mandl)	Sep	55
Yankee Repairman in England (Burke)	Jun	64

T

TAPE RECORDERS—See Audio		
TELEVISION		
Amplifiers, Video (Waner)	Jan	53
Antennas		

ANNUAL INDEX

Corner Reflector* (QB)	Feb	135	Problems (Editorial)	Jan	33	Hum in TV Receivers (Clinic)	Sep	66
Delta-Match System (QB)	Jan	178	Receiver, Adjustment	May	35	Instruments for Better Servicing (Scott)	Jul	51
G-line	Mar	57	Receiver Circuits	Jan	66	Intermittents, Locating (Clinic)	Jun	62
Helical (Clinic)	Oct	45	Conversion, 630 Circuitry (Scott)	Feb	56	Linearity Circuit (Clinic)	Oct	44
Novel (TTO)	Dec	116	Converters			Linearity Generator (Dunscombe)	Oct	35
Rabbit Ears (Frieborn)	Mar	56	U.h.f. (Tabulation of Manufacturers)	Jan	78	Horizontal Sweep (Clinic)	Oct	44
Receiving v.h.f. and u.h.f. (Kolar)	Dec.	60	U.h.f. Lines & Converters (Mandl & Noll)	Jun	60	Markers & Alignment Bugs (Scala)	May	32
Repairs (Sobel)	Sep	63	U.h.f., Home-Built* (Lederer)	Feb	52	Math & Servicing (Clinic)	Aug	51
U.h.f., Improving Performance (Noll & Mandl)	Jan	74	Diagrams (see under "Schematics")			Mechanical Bugs Deadliest (Lowens)	Nov	41
V.h.f. Element Sizes	Nov	38	DX			Notes (Gnessin)	Dec	74
Yagi, 10-Element, for 7 & 9 (QB)	Apr	114	1953 (Tilton)	Jan	68	Picture Tubes, Reconditioning (Ledbetter)	May	34
Attenuator, Ghost (Warriner)	Apr	47	TV DX in February, Feb 53; Mar, Mar 54; Apr-Jun, Apr 47; July-Sep, Jul 35; Oct.-Dec. Oct 41			Picture-Tube Replacement Guide (Scott)	Jan	76
Boosters			European			Printed Wiring (Ricketts)	Oct	88
U.h.f., Electro-Voice 3400 (Hagey)	Jan	40	British Standards (Bradley)	Oct	49	Selenium Rectifiers (Clinic)	Mar	60
U.h.f. (tabulation of manufacturers)	Jan	79	Eurovision (RM)	Jul	16	Spot Blanking (REC)	Jan	169
Cabinet Work, Installation, Custom (Wisniewsky)	Oct	72	Interference			Superunusual Case (Anglado)	Sept	74
Channels & Frequencies	Jan	39	Caused by Nearby TV Sets (Clinic)	May	45	Test Probes* (REC)	Mar	131
Circuitry			U.h.f. Design Promotes TV?	Jan	71	Tester for TV Tubes (REC)	Oct	131
630 Chassis (Scott)	Jan	63	Interface, Vertical & Instability (Mandl)	Sep	55	U.h.f. Snow (Frier)	Feb	58
630 Chassis—Conversion to Larger Tubes (Scott)	Feb	56	Oscillators, Blocking (REC)	Nov	126	Vertical Hold, Loose (Lemons)	Jun	61
Color Receiver	Jun	66	Power Supply & Voltage Multipliers (QB)	Apr	114	Vertical Sweep Troubles (Glickstein)	Jan	48
Noise Immunity (Scott)	Jun	56	Receiver			Video Amplifier Problems (Waner)	Jan	53
Sync, Noise-Free (Scott)	Apr	35	Buzz Rejection Filter* (Gottlieb)	Aug	53	Video Amplifiers (Scala)	Mar	49
Unusual (Scott)	Nov	32	Duoscopic (RM)	Mar	10	Video Amplifiers (QB)	Mar	138
Color			Printed Circuit (Bonhomme)	Mar	55	Video I.F.'s, Understanding (Matsinger)	Jan	46
Basic Color TV (Newman & Roche)			Schematics (see under Schematics)			Schematics		
Part I—Principles of Color & Vision	Jan	58	Vertical Chassis, first (RM)	Apr	8	Admiral 19P1 V.h.f.-U.h.f.	Jan	84
Part II—Mixing & Transmitting Colors—Bandwidth Reduction	Feb	43	Recording on Tape*	Jun	48	Emerson 120185-B, 120190-D, 120191-D, 120192-B, D.	Jan	90
Part III—Color Subcarrier, Color Difference Signal	Mar	52	Remote Controls			G-E S-21C225-B	Jan	92
Part IV—Interference Elimination; NTSC System	Apr	37	TV, New	Nov	39	Motrola TS-292A-00, TS-324A-00	Jan	86
(contd)—I & Q Signals, NTSC	May	40	TV, Two Remote (Scott)	Mar	46	RCA 21-S-348KU to 21-S-369KU	Jul	44
Color TV Circuits (Kleidon & Steinberg)			Servicing			RCA 21-S-354U and 21-S-362U	Jan	82
Part I—Reception Problems	Jun	53	Adjusting Color TV Receiver	May	35	Stromberg-Carlson Series 21T-22T	Jul	42
Part II—Luminance & Bandpass Circuits	Jul	33	Afterglow (Clinic)	Jul	38	Sylvania J-518.1, 2, 3 (TV Chassis C03)	Jul	46
Part III—Burst Amplifier, Color Oscillator & Control Circuits	Aug	45	A.g.c. in TV Receivers	Nov	44	Westinghouse Chassis V-2243-4 & V-2263	Jul	40
Correction on above	Nov	114	A.g.c., Keyed (Lemons)	Apr	39	Zenith 19L26-19L28-19L30-19L33-19L34	Jan	88
Part IV—Demodulator & Matrix Circuits	Sep	60	Alignment Bugs, Killing (Scala)	Apr	32	Stations		
Part V—I-Q Color Demodulation	Oct	42	Alignment Bugs, Markers & (Scala)	May	32	List as of Nov. 23, 1953	Jan	80
Part VI—3-Gun Picture Tube; Its Control Circuitry	Nov	40	Alignment Generator, Improving (DiEisi)*	Aug	33	(with supplements: Feb. 8; Mar. 6; Apr. 6; May. 6; Jun. 10; Jul. 16; Aug. 6; Sep. 8; Oct. 10; Nov. 10; Dec. 10)	Apr	6
Part VII—19-Inch Color Tube & Associated Circuits	Dec	66	"Blood and Tears"	Aug	127	New Stations, Jan-Jul, 1954	Aug	44
Components	May	39	Coils, Peaking (REC)	Jan	170	... in the Americas	Feb	53
CRT (Lieberman)	Jul	30	"Dog", Receivers, (Middleton)	Nov	34	Subscription—Pay as You Go (Kamen)	Feb	46
Past, Present & Future (de Forest)	Jan	34	"Dogs" without Data, (Middleton)	Dec	84	Telephone (RM)	Nov	6
			Dynamic TV Checker* (Highstone)	Dec	53	Theory		
			High-Voltage Loss (Clinic)	Feb	54	Television—It's a Cinch (Aisberg)	Jan	56
			Horizontal Instability, Tracking (Glickstein)	Aug	42	8th Conversion, 1st half—Sawtooth Action	Jan	56
			Part I—Analysis & Location	Sep	62	2nd half—Horizontal retrace	Feb	49
			Part II—Tracing Sync Pulses	Jan	51	9th, 1st half—Electron Image	Mar	62
			Horizontal Sweeps (Smith)	Jan	51	2nd half—Icoscope	Apr	41

(Continued)

Get This Valuable Book

Just for Examining COYNE'S New 6-Volume Set

FREE



Applied Practical Radio-Television

Yes, you get this big, new 1954 book, "150 Radio-Television Picture Patterns and Diagrams Explained", absolutely FREE! Just off the press! Gives complete 11x22" Schematic Diagrams on leading models Radio and Television Sets. Easy-to-read, large 8 1/2 x 11" pages, with full instructions on how to read and use the diagrams. A "must" in every Radio and Television service-man's repair kit. You get this valuable book as a FREE Gift for asking to see Coyne's great new 6-book set, "Applied Practical Radio-Television"!

ON 7 DAY FREE TRIAL!



At Last! Money-Making "Know-How" on Transistors, Color TV and Servicing

Coyne's great new 6-volume set gives you all the answers to servicing problems—quickly! For basic "know-how" that is easy to understand, you'll find everything you want in volumes 1 to 5 which contain over 5000 practical facts and data. They cover every step from principles to installing, servicing, trouble-shooting and aligning all types of radio and TV sets. So up-to-date it includes COLOR TV and UHF, adapters, converters. Also covers latest data on TRANSISTORS.

Extra! 802-Page Television Cyclopeda Included

And then, for speedy on-the-job use, you get volume 6—the famous Coyne TELEVISION CYCLOPEDIA. It answers today's television problems on servicing, alignment, installation and others. In easy-to-find ABC order, cross indexed. Use this 6 volume TV-RADIO LIBRARY free for 7 days; get the valuable Servicing Book ABSOLUTELY FREE!

SEND NO MONEY! Just mail coupon for 6-volume set on 7 days free trial. We'll include book of 150 TV-Radio Patterns & Diagrams. If you keep the set, pay \$2 in 7 days and \$2 per month until \$22.50 plus postage is paid. (Cash price \$20.95). Or you can return the library at our expense in 7 days and owe nothing. **YOU BE THE JUDGE. Either way, the book of TV-Radio Patterns is yours FREE to keep!** Offer is limited. Act NOW!

FREE BOOK—FREE TRIAL COUPON!

Educational Book Publishing Division
COYNE ELECTRICAL SCHOOL, Dept. C4-T1
500 S. Paulina St., Chicago 12, Ill.

YES! Send 6-volume "Applied Practical Radio-Television" for 7 days FREE TRIAL per your offer. Include TV-Radio Patterns & Diagram Book FREE.

Name _____ Age _____
Address _____
City _____ Zone _____ State _____

Where Employed _____
() Check here if you want library sent COD. You pay postman \$20.95 plus COD postage on delivery. 7-day money-back guarantee.

Educational Book Publishing Division
COYNE ELECTRICAL SCHOOL
500 S. Paulina St., Dept. C4-T1, Chicago 12, Ill.

NEW STOCK OF FIRST QUALITY TELTRON TUBES GUARANTEED! . . . LOWEST PRICES EVER!

All tubes individually boxed . . . unconditionally guaranteed for one year!

GIFT OFFER!
One 6BG6G tube will be shipped FREE with any order accompanying this ad.

Type	Price	Type	Price	Type	Price	Type	Price	Type	Price
1A7GT53	6A840	6BF648	6Q740	12A7637
1B3GT62	6K740	6BG6G . . .	1.18	6S141	12A7771
1H5GT51	6AB143	6BK575	6S8GT65	12A7843
1L451	6AC765	6BJ651	6SA7GT45	12A7958
1L651	6AG552	6BH651	6SK7GT45	12A8058
1LC649	6AH4GT65	6BK778	6SL7GT60	12AV773
1NSGT51	6A1596	6BN690	6SN760	12AX4GT60
1T451	6AK596	6BQ785	6SQ7GT38	12AX761
1U451	6AL543	6BY5G60	6TB71	12AZ765
1U543	6AQ548	6C441	6V365	12B172
2A335	6AR548	6CB651	6V6GT48	12BA646
2A735	6AT637	6CD6G . . .	1.63	6W4GT43	12BA758
3Q453	6AU5GT60	6CU695	6W6GT53	12BE646
3Q5GT61	6AV5GT60	6F642	6X437	12BH761
3S448	6AV637	6F5GT44	6X880	12BY765
3V448	6AX5GT60	6H650	6Y880	12C763
5V3GT30	6BC548	6J661	7F849	12K740
5V4G40	6BE646	6J5GT49	7N749	12L740
5Z342	6BF548	6L678	12AL543	12SA745
								12SK740
								12SL7GT60
								12SN7GT56
								19BG6G . . .	1.48
								19T871
								25Z555
								25Z6GT36
								35B548
								35C548
								35W433
								35Y442
								35Z5GT33
								50A549
								50B548
								50C548
								TYPE 8040
								117Z333
								117Z6GT65

FREE \$7.20 list value Bonus Box of three 6SN7 tubes and 25 assorted resistors with each order of \$25 or more.

SAME DAY SERVICE

48 Hour Postal Delivery To West Coast

TERMS: Save all freight and postage charges. All orders accompanied by full remittance will be shipped POSTAGE PAID anywhere in the continental U.S.A.
25% deposit required on C.O.D.'s. Minimum order \$10.00. Open accounts to rated firms only.

Send for Free complete tube listing and monthly specials! Get on our mailing list.

SPECIAL!—till JAN. 1

Type	Price	Type	Price
1R544	6BQ6GT73
1X257	6BZ783
5U4G40	6K6GT34
6A4F89	6SN7GT48
6AU636	6U865
6AX4GT49	12SQ734
6BA648	25BQ6GT75
6BA749	25L6GT37
6BL7GT65	50L6GT44

TELTRON ELECTRIC COMPANY

428 Harrison Ave.,

Harrison, N. J.

Dept. RE-12

Phone HUmboldt 4-9848

the ENCYCLOPEDIA of SWEEP CIRCUIT

NEW!

SERVICING AND REPLACEMENT



- 64 pages, 37 "Pix-A-Faults", 67 schematics, 34 "Trouble-Facts" — no other Manual comes anywhere near such completeness!
- Shows you how to find and replace faulty flybacks, yokes, vertical output transformers, vertical blocking oscillators, linearity and width coils — of every type and brand — fast and accurately.
- Latest field-gathered experience — saves you loads of time, money, labor.



Write for it now.
Ask for Ram Manual RE-12
RAM ELECTRONICS SALES CO.
Irvington-on-Hudson, New York

ANNUAL INDEX (Continued)

10th, 1st half—Composite Video Signals	May	42
2nd half—Vertical Sync & Blanking Signals	Jun	58
11th, Heterodyning	Jul	36
12th, 1st half—R.f., Visible Noise, Selectivity vs Bandpass	Aug	48
2nd half—Contrast Controls, Mixer Methods	Sep	58
13th, 1st half—Positive & Negative detection	Oct	46
Correction on above	Nov	114
2nd half—High-Frequency Compensation	Nov	42
14th, 1st half—D.c. Component and Image Brightness	Dec	63
Transmitters		
Boosters, Increases Station Range	Jan	61
Tiny Transistor	Sep	8
Tuners, Cascode, U.h.f.-V.h.f., 82-Channel (Lucas)	Jan	43
U.h.f.		
Converter, Home-built* (Lederer)	Feb	52
Converters & Boosters	Jan	78
Converters, Installing (Clinic)	Jan	72
Installations (Mahler)	Oct	40
Lines & Converters	Jun	60
Line Lead-in, Transmission (Richards)	Jan.	37
Performance, Improving (Noll & Mandl)	Jan.	74
Tuner, 82-Channel Cascode (Lucas)	Jan	43
V.h.f. comes on U.h.f. Area (Mahler)	Apr	44

TEST INSTRUMENTS

See also AUDIO, Servicing; SERVICING, and TELEVISION, Servicing

Bridge Test Unit, R-C* (Sorensen)	Mar	94
Capacimeter (Klemm)	Jun	67
Capacitor Checkers		
Bridge* (Sorensen)	Mar	94
With Dual Feature* (Nof)	Dec	56
Tester (Sprague KT-1)†	Jul	53
Continuity Checker* (REC)	Nov	125
Continuity Tester	Sep	54
Dynamic TV Checker (Highstone)	Dec	53
Distortion Totalizer* (Palmer)	Aug	39
Eico 425, Modifying (Burstein)	Feb	60
Field-Strength Meter, Relative* (Remley)	May	56
Voltmeter, Microvoter* (REC)	Aug	109
Frequency Meters		
Frequency Standard* (Frye)	Feb	63
U.h.f. (Pat)	Oct	108
Gain Set* (Maxwell)	Feb	34
Grid-Dip Meters		
Easily Built* (REC)	Jun	111
Novel, Uses 6E5* (McCready)	Jun	68
Spot-Checking (Reed)	Sep	51
Tubeless* (Mitchell)	Dec	58
IM Analyzer, Using†	Jul	69
Intermodulation Analyzer (Scott)	Sep	46
Linearity Generators		
Cross-Dot (Phico) (Lerner & Starks)	Jul	48
Do-All (Radio City 750)†	Jul	52
Improving* (DiElsi)	Aug	33
Plug-in Bar (Crest)	Feb	65
TV (Dunscombe)	Oct	35
Marker Adder (Hickok 691)†	Oct	33
Marker Injector (Scala)†	Apr	34
Meter-Protection Circuit (REC)	Oct	131
Modulation Monitor, C-R (Minor)	Jun	83
Multimeter, Pin-Jack* (Queen)	Sep	49
Neon-Lamp Test Set*	Nov	54
New Instruments for Better Servicing (Scott)		
Ohmmeter, High-Accuracy (Crowhurst)	Jul	51
Aug	36	
Oscilloscopes		
Beam Positioning, C-R Tube (REC)	Apr	111
Frequency Compensation* (McCready)	Aug	35
Heathkit O-8, Stabilizing (REC)	May	133
Switch for Double-Beam* (Dresser)	May	54
Power Supply, High-Voltage* (Pallatz)	Dec	52
Probes		
A.F.-R.F. Tracer	Dec	57
Oscilloscope HF3 LO-Ct	Oct	32
Q Meter (Pat)	Feb	119
Records, Test†	May	64
Resistor Checker, Bridge (Sorensen)	Mar	94
Signal Generators (all types)		
Audio Oscillator, Miniature (Queen)	Aug	38
Dot Maker, Transistor*	Aug	86
I.f.-R.f., Uses Transistor (Queen)	May	92
Multipurpose* (Galoire)	Nov	53
Noise, Transistor*	Jul	85
Overfone, Transistor* (Queen)	Dec	59
Oscillator, Phase-Shift (Harris)	Jan	136
Oscillator, Phase-Shift (Laikin)	Oct	37
Sine- & Square-Wave (Eico 377)		
(Markantes)	May	50
Sine-Wave Square-Wave* (DiElsi)	Nov	46
Square Waves—\$1.00* (Ketchum)	Nov	55
Subharmonic Oscillator* (Queen)	Apr	97
Transistor AM Test Oscillator* (Bohr)	Sep	52
U.h.f.-V.h.f. (Radio City 750)†	Jul	52
Wide-Range* (Graham)	Jul	54
Signal Tracers		
A.f. & R.f.* (REC)	Jul	113
AM, FM & Intercarrier TV (REC)	Feb	126
Utility Amplifier and (Sorensen)	Oct	38
Substitution Box, Capacitor (TTO)	May	126
Transformer Checker, Flyback (Kirby, 68)†	Jul	52
Transistor, Tube Testers		
For A.c.-D.c. Sets* (Kaufman)	Jun	66
Junction Transistor* (Bohr)	Aug	30
VR* (Sodaro)	Nov	51
Transmission Set* (Maxwell)	Feb	34

Lafayette's CHRISTMAS GIFTS



Collaro
THE WORLD'S FINEST 3 SPEED
AUTOMATIC RECORD CHANGER
SPECIAL 29.50 LIST PRICE 54.50

Lafayette scores again with an almost unbelievable price on the Collaro 3-speed automatic record changer. We made a spectacular buy and we are passing the savings on to you. Here's the finest changer made. Manufactured in England—with a world-wide reputation. It plays all sizes and all speeds automatically. It's packed with quality features that the Hi-Fidelity enthusiast will appreciate: Jam-proof ball-bearing mounted tone arm; automatic shut-off after last record; powerful fan-cooled hum-shielded 4-pole motor with self-aligning oilite bearings; automatic muting switch; weighted ball-bearing mounted constant speed turntable; rubber drive couplings—and more! Base size 14 1/2" x 12 1/4". Depth below base 2 1/4". Shpg. Wt. 19 lbs. Available either less cartridge with plug-in shell, or with famous turnover Ceramic or G.E. Triple-Play cartridge. **Net 29.50**
COLLARO Model 3/531 changer.....**Net 29.50**
COLLARO Model 3/531 with Turnover Ceramic cartridge.....**Net 31.50**
COLLARO Model 3/531 with G.E. Triple Play RPN-050 cartridge installed.....**Net 32.50**
45 RPM SPINDLE
 Slips on in place of regular spindle, eliminating use of center inserts on 45 RPM records. **Net 3.23**
GSA Spindle.....

NEW POCKET AC-DC VOM MULTITESTER 9.95



This instrument is one of the best buys that Lafayette has ever offered in a Wide Range AC-DC MULTITESTER. An ideal portable unit that meets the need for a compact, yet rugged test instrument. Has ease of operation usually found ONLY IN MORE EXPENSIVE INSTRUMENTS. Has 1000 ohms/volt sensitivity on both AC or DC. Uses full 3" rectangular meter with large, easy to read scale. Uses 1% precision resistors. Jeweled D'Arsonval meter movement. Ranges: AC-DC and output volts 0-5, 0-25, 0-250, 0-1000V; DC current 0-1, 0-10, 0-100 D.C. mA; Resistance 0-10K and 0-100K ohms. In handsome sturdy bakelite case. Size: 1 3/4" x 3 3/4" x 1 3/8". Supplied Complete with test leads and batteries. A Must for every serviceman, Shop, Laboratory or experimenter—and at Lafayette's Price you can afford to own one. Shpg. Wt. 2 1/2 lbs.
MODEL RW-27C—Complete.....in Lots of 3 **9.45**
 Single, ea. **9.95**

Greatest Tape Buy Ever!

1200 FT. REEL
Genuine Plastic Base
RECORDING TAPE
 Shpg. Wt. 14 oz.
LAFAYETTE made a terrific deal with one of the leading manufacturers of recording tape to supply us with their regular tape which sells for almost twice our price. WE GUARANTEE ABSOLUTE SATISFACTION OR YOUR MONEY BACK. The finest, professional quality recording tape obtainable. Highest performance for thousands of playings. Red Oxide Base in a smooth, uniform coating; greater signal strength; with maximum fidelity; uniform frequency response from 40-15,000 cps.
\$1.89 per roll plus postage

CARDWELL UHF CONVERTER SALE!

List **42.50**
Net 13.95 ea.
 Lots of 3
Singly 14.45 ea.
 Outstanding Value! The Cardwell ES-1 UHF converter covers the entire UHF spectrum—channels 14-53. Has 6AF4 oscillator, 6CB6 IP amplifier and 1N75 crystal diode. Features printed circuit oscillator, high overall gain (3 to 4 times), high sensitivity, constant L/C ratio tuner, 25-1 gear drive. Has AC cord and plug, 3-pos. switch for UHF, VHF and OFF. Handsome wood cabinet 8 1/2" x 6 1/2" x 3 1/4" with easy reading dial. Shpg. Wt. 4 1/2 lbs.
CARDWELL ES-1 Converter—Lots of 3 each.....**13.95**
 Singly each.....**14.45**



WESTERN ELECTRIC HEARING AID

Reg. price **\$185.00** Our price **\$14.95**
 Brand new, in original Western Electric's jeweler's case. Supplied with receiver, receiver cord, battery cord and plug (less batteries). Money back guarantee. Act now while they last! Uses Burgess 2X30Z and 8R batteries at \$1.55 per set.



3 LENS TURRET MICROSCOPE 100X-200X-300X

7.45
 Precision built for accuracy and long lasting service. Triple position turret holds 3 achromatic color-corrected objectives for magnification of 100X, 200X and 300X power! Heavy base and stand—inclines through 90°. Dual knob focusing by rack and pinion. Adjustable plano sub-stage mirror. High-grade microoptics used throughout! Complete with fitted wooden carrying case and slides. Shpg. Wt. 4 1/2 lbs.
F-10 NET 7.45



SARKES TARZIAN VHF TUNER Latest Type Complete With 2 Tubes

Brand new—covers entire VHF spectrum. It is an exact duplicate of thousands now in use in many chassis including the Sylvania 510 and 520 series. Has 7" long concentric shafts. Excellent gain, noise factor, image and I.F. rejection. For 40 mc. systems. Complete with 6BC5 and 6X8 tubes and shields. Shpg. Wt. 4 lbs. Worth 3 times the price!
TL-24—In lots of 3 each.....**4.45**
 Singly each.....**4.95**

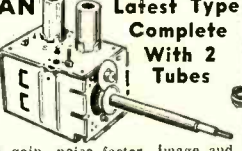

WESTERN ELECTRIC MICROPHONE

3.95
 A terrific value! High impedance mike with —55 db output level. Compact, modern, slim styling. Contains W.E. 253A magnetic head and UTC uncser. Silver plastic casing with detachable desk stand. Lightweight—only 11 ounces. Complete with 6 ft. cable.
PA-23.....Net 3.95



HIGH FIDELITY AMPLIFIER KIT 10 WATT — BUILT-IN PREAMPLIFIER For G.E. Reluctance Cartridge

11.95
 Replacement for All G.E. RPN-050 Triple-Play Cartridges!
 Stock No. PK-29 Net **11.95**
30 POWER TELESCOPE
 Weighs only 8 ounces! All metal—chrome trimmed! Precision machined body. Hand ground, hard coated, achromatic lenses. Sharp, clear, brilliant images in the same manner as fine binoculars. Used in hunting—sports—vacationing. For long distance or close up views. Brings objects 30 times closer! Highly polished, plated tubes for smooth, easy sliding focusing. Collapses to 7"—extends to 14 1/2". Not a cheaply made toy telescope. But one of Lafayette's finest optical bargains. As always you must be satisfied—or return for immediate refund. Shpg. Wt. 1 lb.
F-59.....Net 7.50
NEVER BEFORE AT THIS PRICE
IMPORTED DIRECT PRISM-COATED LENSES BINOCULARS
 ALL-METAL CONSTRUCTION
 INDIVIDUAL FOCUS
 COMPLETE WITH LEATHER CASE & STRAPS
F-15, 7 x 35 with case.....Net **22.50**
F-103, 7 x 50 with case.....Net **24.95**
F-104, 12 x 50 with case.....Net **32.50**
 with order, Add 10% Fed. Tax

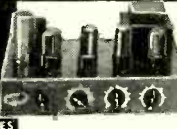

DUAL STYLUS — TRIPLE PLAY DIAMOND and SAPPHIRE

11.95
 Replacement for All G.E. RPN-050 Triple-Play Cartridges!
 Stock No. PK-29 Net **11.95**

30 POWER TELESCOPE

7.50



PRECISION DRAFTING SET 11 Pieces—Fitted Felt-Lined Case

Made in Germany, of heavy brass, nickel plated and polished. Instruments include 3 1/2" Compass with pencil and pen points and lengthening bar, 5 1/2" Divider, three 3 1/2" sidwheel bow dividers with needle point, pen point and pencil point, 5" Ruling pen, extra handle for pen or pencil, capsule with extra leads. Interchangeability of these many parts makes this an exceptionally versatile set. Your money back—if this set is not worth twice our price!
F-13.....Net 2.75
\$2.75



GERMAN ARMY KNIFE First Time At Under \$8

Made in Solingen, West Germany, of super fine steel. Sharp enough to shave with! Finest all round sporting AID made! Includes a 2 3/4" sabre type blade, 1 3/4" utility blade, standard screw driver, Phillips screw driver, 3" compound toothed saw blade, reamer-punch-awl blade, can opener, and bottle opener. Withstands the roughest treatment. Shpg. Wt. 1 lb.
F-61.....Net 3.95
3.95

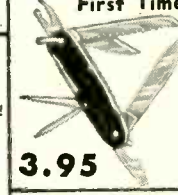

REGAL UNIVERSAL UNDERDASH AUTO RADIO

This universal mounting auto radio fits under the dash of most cars and trucks. Has a 4 tube plus rectifier circuit using one each 6BB, 6BA6, 6AT6, 6AS5 and 6X3. This superhet circuit has fine sensitivity and very low battery drain. Complete with very high gain ferrite antenna, double tuned antenna coil and Alnico V PM speaker. Outstanding performance. For 6V operation. Size 5 1/4" W x 8 1/4" D x 1 1/4" H. Shpg. Wt. 11 lbs.
IL-583.....Net 24.95
24.95



TWIN LENS IMPORTED CAMERAS 2 1/4 x 2 1/4 NEGATIVES With F3.5 Coated Lens A 69.50 VALUE!

only at Lafayette
Stock No. F-32 Net 29.95
 Shpg. Wt. 7 lbs.
 Built-in Flash Synchronization
 Fingertip Focusing
 Sportsfinder
 9 Speed Shutter 1 to 1/200 Sec.
 Double Exposure Prevention
 Matched Coated Lenses are Coupled in Helical Mount
 Accepts 120 Roll Film

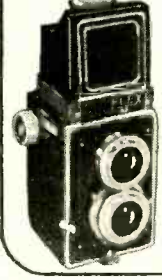

Lafayette Radio
DEPT. JL
 Include postage with order.
NEW YORK, N.Y. 100 Sixth Ave.
BRONX, N.Y. 542 E. Fordham Rd.
NEWARK, N.J. 24 Central Ave.
PLAINFIELD, N.J. 139 West 2nd St.
BOSTON, MASS. 110 Federal St.

The new Gernsback Library helps you learn more—earn more!

The Oscilloscope—No. 52.

A practical book that gives you full details on how to use the scope for more efficient TV, radio or audio-high fidelity servicing. You'll be amazed at all the new scope applications this book opens for you. 192 pages. Fully illustrated. **\$2.25**



TV Repair Techniques—No. 50.

Top technician-writers tell how to recognize, find and correct quickly, the tricky TV servicing problems which stump even the experts. A few minutes reading this book can save you hours of servicing time. 128 Pages. Over 100 Illustrations. **\$1.50**



High-Fidelity—Design, Construction, Measurements—No. 48.

An audio man's audio book. How to get top performance from a high-fidelity system. New 3-way approach. 21 top audio men wrote this book. 128 Pages. Over 100 Illustrations. **\$1.50**



Television Technotes—No. 46.

Cut routine trouble shooting to the bone in TV servicing. Here are the symptoms, causes and cures of over 600 troubles which occur in scores of sets made by leading manufacturers. 128 Pages. **\$1.50**



5 CLASSICS ON RADIO AND AUDIO

- Radio Tube Fundamentals—No. 45**
Theory of receiving tubes from the technician's viewpoint. **\$1.00**
- Model Control By Radio—No. 43**
Theory and practical construction for beginner and expert. **\$1.00**
- High-Fidelity Techniques—No. 42**
A common-sense guide to getting the most out of your equipment. **\$1.00**
- Public-Address Guide—No. 41**
Shows you how to make extra money in profitable PA work. **75c**
- Practical Disc Recording—No. 39**
Theory and practical techniques. Full chapter on each component. **75c**

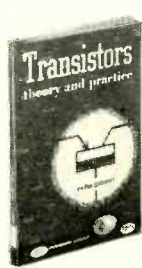

Transistors—theory and practice—No. 51.

Rufus P. Turner talks transistors from the viewpoint of the practical man. Transistor applications in well-known circuits! Complete guide to the characteristics of commercial transistors. 144 Pages. 135 Illustrations. **\$2.00**



Radio & TV Test Instruments—No. 49.

How to build just about every instrument required for modern TV-radio servicing. Plus chapters on constructing a practical servicing bench and carrying case. 128 Pages. Over 100 Illustrations. **\$1.50**



Radio & TV Hints—No. 47.

Offers over 300 sure-fire hints, gimmicks, and short cuts on radio, TV and audio. Gathered from the hard-earned experience of experts. Grouped in seven sections. 112 Pages. 132 Illustrations. **\$1.00**



Basic Radio Course—No. 44.

John T. Frye's classic on fundamentals! For the practical man who wants to learn theory. Covers everything from Ohm's Law to advanced servicing in a style which makes learning fun. 176 Pages. Cloth cover. **\$2.25**

From the publishers of RADIO-ELECTRONICS

See your distributor—or mail this coupon

GERNSBACK PUBLICATIONS, INC., Dept. 124
25 West Broadway
New York 7, N.Y.

Enclosed is my remittance of \$.....

Please send me the following books postpaid.

- 39 41 42 43 44 45 46
 47 48 49 50 51 52

Name
(Please print clearly)

Street

City Zone State

ANNUAL INDEX

(Continued)

Voltmeter	
Audio Microvoltmeter (REC)	Aug 109
Supersensitive*	Aug 41
Transistorized D.c.* (Turner)	Dec 54
V.f.v.m.'s	
Antenna Tuning*	Nov 127
TV Servicing (Middleton)	May 47
Voltage Breakdown Tester* (REC)	Apr 110
Wave-Shaping Device (Berkshire Labmarker)*	Oct 34
Wow & Flutter Meter†	Sep 46
THEORY & ENGINEERING	
Amplifiers, Dielectric (Fink)	Feb 92
Amplifiers, Magnetic A.f.	Mar 126
Flip-Flop, 3-Stage (REC)	May 134
Frequency Measuring Method (Appleby)	Sep 48
Load? What is Opifum (Crowhurst)	Mar 38
Multivibrators (Bukstein)	May 84
Parallel Resistors & Series Capacitors (Crowhurst)	Feb 66
Power From Sun (RM)	Jun 6
Space Sound (Klein system)	Aug 69
Transistors from N to P (Cooper)	Jul 77
Tracking, Improved (Erb)	Feb 84
Univibrators & Flip-Flops (Bukstein)	Oct 50
TRANSISTORS	
Amplifiers	
Preamp, Low-Noise* (Turner)	Aug 64
Smallest (Wallace)	Feb 95
Two-Way (Pat)	Sep 117
Bias Circuit (Pat)	Nov 119
Checker, Junction* (Bohr)	Aug 30
Code-Practice Oscillator* (Cleland)	Mar 78
Commercial Killer, Transistorized* (Reed)	Jul 93
Demonstration Circuits* (Bohr)	Dec 45
Dot Maker*	Aug 86
Follower (Pat)	May 114
Four-Terminal (Rhita)	Sep 108
Geiger Counter* (Sokal & Resnick)	Jul 82
Headphone, Electronic* (Irwin & Queen)	Nov 56
Keying Monitor* (Queen)	Jan 124
Layout Board* (Steen)	Mar 96
Microphone (RM)	May 6
Phono Oscillator* (Bohr)	May 74
Phototransistor (Mileaf)	Nov 96
Rate-Grown (RM)	Nov 6
Regenerative Receiver* (Bohr)	Apr 71
Receiver* (Grace)	Aug 84
Signal Generators, Oscillators	
A.f. Miniature* (Queen)	Aug 38
AM Test* (Bohr)	Sep 52
High-Frequency (Queen)	Aug 87
I.f.-R.f. (Queen)	May 92
Noise Generator (Queen)	Jul 85
Overtone Generator* (Queen)	Dec 59
Sawtooth, Controlled (Pat)	Jun 98
Subharmonic (Queen)	Apr 97
Signaling (Pat)	May 114
Surface-Barrier (RM)	Feb 8
Theory, from N to P (Cooper)	Jul 77
Thimble-Size (RM)	Jan 10
Tiny (RM)	Sep 8
Trigger (Pat)	Jan 161
Trigger (Pat)	Mar 128
Voltmeter, D.c. (Turner)	Dec 54
Wrist-Radio	Mar 82
What's New in (Queen)	Jun 75
U.h.f. (RM)	Nov 12
Ukulele, Transistorized* (Herzog)	Feb 30
Transmitter—Jim Creek Valley (RM)	Jan 6

TUBES & TRANSISTORS—Jan, 150; Feb, 117; Mar, 119; May, 104; Jun, 94; Jul, 98; Aug, 92; Sep, 124; Oct, 119; Nov, 110; Dec 132

Wire-Tester* (REC)	W	Feb 124
X-Ray Tube, Smallest	X	Mar 106

KEY TO SYMBOLS & ABBREVIATIONS

*Construction Articles
†Section of a full length article
ClinicTelevision Clinic
QBQuestion Box
RECRadio-Electronic Circuits
RMRadio Month
TTOTry This One
Items as marked above appeared monthly. Regular departments not indexed are Radio Business, With the Technician, New Devices, Technotes, People, Electronic Literature, Book Reviews. In most entries the author's name is included.

CORRECTION

There is an error in the diagram of the portable receiver in the article "A More Compact Battery Portable" on page 90 of the September issue. The 15,000- and 120,000-ohm resistors in the last two audio stages should return to the *negative* side of the 4.5-volt battery—not the positive side as in the diagram.

technical Literature

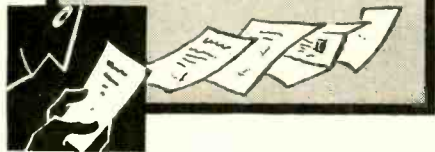

REPLACEMENT GUIDE

An 8-page bulletin "TV Replacement Transformer Popularity Tables," No. 469, lists 100 major set manufacturers and replacements for their components. These manufacturers produce over 90% of the sets listed in the Stancor TV Guide.

Chicago Standard Transformer Corp., Standard Division, Addison and Elston, Chicago 18, Ill.; or any Stancor distributor.

Any or all of these catalogs, bulletins, or periodicals are available to you on request direct to the manufacturers, whose addresses are listed at the end of each item. Use your letterhead—do not use postcards. To facilitate identification, mention the issue and page of RADIO-ELECTRONICS on which the item appears. UNLESS OTHERWISE STATED, ALL ITEMS ARE GRATIS. ALL LITERATURE OFFERS ARE VOID AFTER SIX MONTHS.

MINIATURE CONNECTORS

Bulletin SR-KM1 on miniature connectors gives in 4 pages test data on thermal shock, humidity, corrosion, contact resistance, insulation resistance, vibration, physical shock, durability, air leakage, moisture resistance, immersion, high temperature, arcing resistance, dielectric strength, and other pertinent information.

Cannon Electric Co., 3209 Humboldt St., Los Angeles 31, Calif.

HI-FI CABINETS

A 20-page colorful catalog on the Cabinart line of high-fidelity equipment cabinets, speaker enclosures and kits embodies all the pertinent information relating to cabinet design. All of the Cabinart models are fully illustrated to define clearly the period and styling. Individual specifications and spot illustrations highlight each cabinet's layout and equipment requirements. Many ways to mix and match the models to fit any interior requirements are explained.

G & H Wood Products Co., 75 No. 11th St., Brooklyn 11, N. Y.; or local parts distributors.

CAPACITORS

A 24-page capacitor catalog is put out by Pyramid Electric Co. Electrolytic, paper, oil-paper and metallized-paper capacitors are described. The catalog is well illustrated with photos.

Pyramid Electric distributors.

DECEMBER, 1954

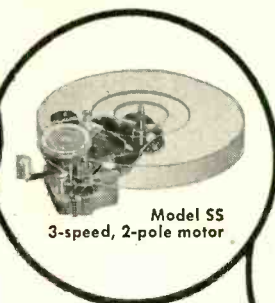

Model SS
3-speed, 2-pole motor

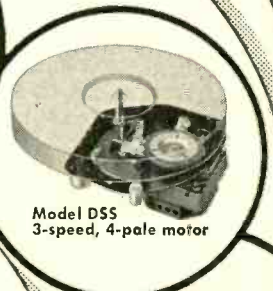

Model DSS
3-speed, 4-pole motor



Model DR
2-speed, 4-pole motor

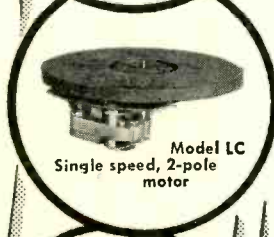

Model LC
Single speed, 2-pole motor

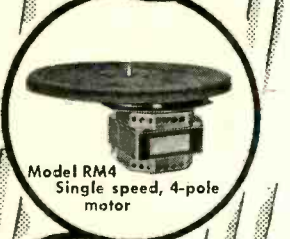

Model RM4
Single speed, 4-pole motor

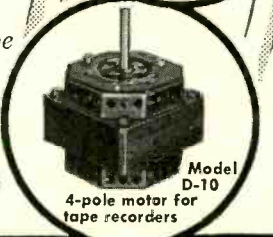

Model D-10
4-pole motor for tape recorders

The ONE Source for EVERY Phonomotor Need!

First choice of America's Leading Manufacturers

Any speed, any type — no matter what your phonomotor requirements may be, you'll always be right if you follow the lead of America's foremost manufacturers and choose from the GI "Smooth Power" line.

Specified as original equipment for many years on the finest recording and play-back devices, GI motors have built up an unmatched record of trouble-free performance and dependability.

When you need phonomotors . . . any speed, any type . . . remember that the greatest names in the industry rest their reputations on "Smooth Power" quality . . . remember to "Specify GI"

Write today for quantity-price quotations and specifications.

GI Phonomotors for: *Portable Phonos • Tape Recorders • Record Changers • Hi-Fi Units • Combinations • Replacement*



THE GENERAL INDUSTRIES CO.

DEPARTMENT ME • ELYRIA, OHIO

OVER 97,000 TECHNICIANS HAVE LEARNED HOW TO GET THE MOST OUT OF BASIC TEST EQUIPMENT for AM FM-TV

'Servicing by Signal Substitution'

A BEST SELLER FOR OVER 13 YEARS!
(NEW, UP-TO-DATE, 14th EDITION)

The Modern, Simplified, Dynamic Approach to all Receiver Adjustment & Alignment Problems

- ★ Nothing complicated to learn
- ★ No extra equipment to purchase
- ★ Universal . . . non-obsolete
- ★ Employs only Basic Test Instruments

Ask for "S.S.S." at your local Radio Parts jobber or remit 40¢ in small stamps or coin directly to factory.



ONLY 40¢
103 pages. Invaluable information that will help you redouble the value of your basic test equipment.

PRECISION APPARATUS COMPANY, INC.
70-31 84th STREET, GLENDALE 27, L. I., N. Y.

OPPORTUNITY ADLETS

Rates—45c per word (including name, address and initials). Minimum ad 10 words. Cash must accompany all ads except those placed by accredited agencies. Discount, 10% for 12 consecutive issues. Misleading or objectionable ads not accepted. Copy for Feb. issue must reach us before Dec. 15, 1954.

Radio-Electronics

25 W. Broadway, New York 7, N. Y.

SPEAKER REPAIRS ON ALL MAKES. 8" & 12" HI-FI speakers for sale. Amprite Speaker Service, 70 Vesey St., New York 7, N. Y.

TEST EQUIPMENT REPAIR—Kit construction. Free information. Bigelow Electronics, Pioneer Road, Beulah, Michigan.

SPEAKER RECONING: Guaranteed workmanship. C&M Recone Co., 255 Tioga St., Trenton 9, N. J.

PRINTED CIRCUITS made to order. James Devlin, Trucksville, RD, Penna.

RADIO DIAGRAMS \$1.00. Television \$2.00. Give make model. Diagram Service, 672-RE, Hartford 1, Conn.

CUSTOM BUILDING AND CALIBRATION OF STANDARD kit test equipment. Heath, Elco, etc. Write for price list. C. Duval, Linlier, Va. Beach, Va.

NOW AT LAST. A pocket P-M radio self-contained tunes 87.5 to 108.5 MC. plans \$1.00 and self-addressed envelope. 6000 mile range subminiature set 535 kc to 16 meters plans 50c and self-addressed envelope. Beginners broadcast kit with subminiature tube, less batteries and phone. \$5.95 postpaid. U.S. Only. 25% deposit on all C.O.D. orders. Ekeradio, 646 N. Fair Oaks Ave., Pasadena, California.

HI FI BARGAINS COLLARO 3-532 INTERMIX 45 Spindle-dual ceramic cartridge-mounting board—\$36.95 PREPAID. CRESCENT TRIOMATIC-dual cartridge-automatic shut-off-mounting board \$24.95 PREPAID. LOW PRICES—Cartridges, tuners, etc. WRITE TODAY. FIDELITY UNLIMITED, 63-03 39 Ave., Woodside, N. Y.

TUBES—TV, RADIO, TRANSMITTING, AND SPECIAL PURPOSE TYPES BOUGHT, SOLD AND EXCHANGED. Send details to B. N. Gensler W2LNI, 136 Liberty, N. Y. 6, N. Y.

TEST EQUIPMENT REPAIRED—New modern lab equipped to handle all makes and types of meters and testers. Free estimates. Catalogue available. General Electronic Dist. Co., 100 Park Place, N. Y. 7, N. Y.

PUT THE HIGH IN HIGH FIDELITY!



Whether you specialize in high fidelity service, custom building or simply want to build a top-notch outfit for yourself, this big 512-page book will guide you every step of the way.

Helps you get better results at less cost. Shows what to do . . . what mistakes to avoid. Gives you a full understanding of the many different methods, circuits, designs, equipment, components and other subjects that are debated whenever hi-fi fans get together.

A COMPLETE GUIDE TO BETTER RESULTS

Written by one of the nation's leading experts, High Fidelity Techniques is complete, authentic and easy to understand. From beginning to end, it is chock full of how-to-do-it tips, service hints, custom-building ideas and data, charts and diagrams of the most helpful sort.

High Fidelity Techniques
by John H. Newitt
The book that says goodbye to guesswork in choosing, building and servicing hi-fi equipment.

512 pages
203 pictures
Price \$7.50

10-DAY FREE EXAMINATION!

Dept. RE-124, RINEHART & CO., INC.
232 Madison Ave., New York 16, N. Y.

Send HIGH FIDELITY TECHNIQUES for 10-day FREE EXAMINATION. If I like book, I will then promptly send \$7.50 (plus a few cents postage) in full payment. Otherwise, I will return book postpaid and owe you nothing!

Name _____
Address _____
City, Zone, State _____

OUTSIDE U.S.A.—Price \$8.00 cash with order only. Money back if book is returned in 10 days.

TOP DOLLAR paid for ART-13s, dynamoters, parts racks and all other component parts. Write: Harjo Sales Company, 4109 Burbank Blvd., Burbank, Calif.

ALL MAKES OF ELECTRICAL INSTRUMENTS AND TESTING equipment repaired. Write for free catalogue on new and used instruments at a savings. Hazleton Instrument Co., 128 Liberty Street, New York, N. Y.

HEPNEI'S NOTES. \$1.00 per copy. Write to Edward K. Hietner, 3648 E. Walnut Ave., Pomona, Calif.

TELEVISION SETS \$18.95 up. Jones TV, 1115 Rambler, Pottstown, Pa.

BUILD YOUR OWN ELECTRONIC ORGAN. Sample Circuit 25c. Jim Kirk, W6JKX, 1552 Church Street, San Francisco 14, Calif.

WANTED: AN/APR-4, other "APR.", "TS.", "TE.", ARC-1, ARC-3, ART-13, BC-348, etc. Microwave Equipment. Everything Surplus. Special tubes. Tee Manuals. Lab Quality Equipment, Meters. Fast Action. Fair Treatment. Top Dollar Little, Fairhills Box 26, Dayton 9, Ohio.

MATHEMATICS SERVICE. problems solved, calculations, computations. Electronics, physics, mathematics. Reasonable rates. Mathematics Service, Box 6671, Orlando, Fla.

SPEAKER RECONING: 25 years experience. Michigan Speaker Reconing Service, 930 Metropolis, Marine City, Michigan.

Power Transformers Rebuilt: all makes. Victor R32—\$12.95. Red Arrow Radio, 924 Metropolis, Marine City, Michigan.

25-50% DISCOUNT, guaranteed Factory Fresh LP records: 69c and up; pre-recorded tapes. Send 20c for catalogue. SOUTHWEST RECORDS, 4710 Caroline, Houston 4, Texas.

TELEVISION RECEIVERS \$30 UP. W4API, 1420 South Randolph, Arlington 4, Virginia.

CODE PRACTICE ELECTRONIC OSCILLATORS, new. Guaranteed \$4.00. Keys \$2.00 Postpaid. Details free. C. Stout, 2241 E. Broadway, Muskegon, Michigan.

TV Trade-In Sets. Philco—Emerson—GE—Admiral—Motorola—Tele-King—Others. List Available. 10"—\$17, 12"—to 17"—\$20 up. Washtek Service, 1501 Boston Road, Bronx, N. Y. DA 5-9281.

TV FM ANTENNAS. ALL TYPES INCLUDING UHF. Mounts, accessories. Lowest prices. Wholesale Supply Co., Lunenburg 2, Mass.

FREE! REQUEST PORTFOLIO 200
TO EVERY TV SERVICEMAN
GET IT TODAY!
TV accessories and parts catalogs, literature, data sheets, etc. Yours for the asking!
Vidaire ELECTRONICS MFG. CORP.
Main Office & Plant
576 WEST MERRICK ROAD LYNBROOK, N. Y.

ENJOY 3 COLOR TELEVISION FILTER SCREEN NOW
Changes dull eye-straining black and white pictures into beautiful color tones. Seconds to attach. No tools used. Helps eliminate glare and snow in fringe areas. Order direct. Send \$1 for screen size up to 16", \$1.25 size 17", \$1.50 size 20", \$2 size 21", \$2.50 size 24", \$3 size 27". We pay postage except on C.O.D. orders. Satisfaction guaranteed. Inquiries from dealers also welcomed.
Zingo Products, Johnstown 13, New York



BUY AND USE

CHRISTMAS SEALS

FIGHT

TUBERCULOSIS

TECHNICAL LITERATURE (Continued)

AUDIO EQUIPMENT

An 8-page catalog, No. 54A gives descriptions, specifications, performance, and replacement data on pickup cartridges. Also described are converters, boosters, recording heads, phonograph pickups, microphones, stands and microphone cartridges.

The Astatic Corp., Conneaut, Ohio.

1955 CATALOG

Allied's 1955 catalog No. 140 contains 308 pages and lists over 25,000 items. Among the products described are the latest high-fidelity components, television chassis, professional and home recording equipment, amateur receivers, transmitters and other gear, and industrial v.h.f. radio and radiotelephone equipment.

Allied Radio Corp., 100 No. Western Ave., Chicago 80, Ill.

STEPPING RELAYS

Booklet P-84 (12 pages) contains illustrations, dimensional drawings, technical chart data and general information on 12 new steppers, including midjet, high-speed, vibration-resistant and interlock types for add-subtract, continuous rotation, electrical reset and other applications.

Guardian Electric Manufacturing Co., 1621 W. Walnut St., Chicago 12, Ill.

DATA SHEETS

Five data sheets, 1801 to 1805, give detailed descriptions on industrial relays, inspection, servicing and maintenance. Dimensional drawings, wiring diagrams and specifications are provided for plug-mounted classes A, B, F, S and Z relays.

Automatic Electric Sales Corp., 1033 W. Van Buren St., Chicago 7, Ill.

DELAY LINES

No. 54, a 12-page brochure, gives illustrations, descriptions and technical data covering the lumped constant, distributed constant and ultrasonic delay lines. Also of special interest is a description of the test procedure used by the company as part of their strict quality control. Design, engineering and manufacturing facilities are described.

Richard D. Brew and Co., Inc., Airport Road, Concord, N. H.

TEST EQUIPMENT

Hickok's 4-page brochure describes a TV color-bar generator, white-dot generator, 5-inch oscilloscope, sweep-alignment generator, oscilloscopes and tube testers.

Hickok Electrical Instrument Co., 10519 Dupont Ave., Cleveland 8, Ohio.

RADIO SHACK CATALOG

Radio Shack's 1955 224-page catalog lists and illustrates 30,000 radio, TV and electronic products. It includes a manufacturers' index on the front cover, an 18-category thumb index and a product index.

Radio Shack Corp., 167 Washington St., Boston 8, Mass. END

RADIO SCHOOL DIRECTORY

GET INTO ELECTRONICS

You can enter this uncrowded, interesting field. Defense expansion, new developments demand trained specialists. Study all phases radio & electronics theory and practice: TV; FM; broadcasting; servicing; aviation, marine, police radio. 18-month course. Graduates in demand by major companies. U.S. or equivalent required. Begin Jan., March, June, Sept. Campus life. Write for catalog.

VALPARAISO TECHNICAL INSTITUTE
Dept. C Valparaiso, Ind.



TV REPAIRMEN EARN TOP MONEY!

IN JUST 12 MONTHS, COMPLETE TV SERVICE TRAINING, INCLUDING COLOR TV. Streamlined course gives you all essentials for a good job as service technician. Graduates in great demand; jobs are plentiful in this growing field. Other electronic courses in radio operation and maintenance. Day or evening classes. Opportunity for employment in local industry. Approved for Korean veterans.

Write for Catalog 111 Today

INDIANAPOLIS ELECTRONIC SCHOOL
312 E. Washington, Indianapolis 4, Ind.

TELEVISION

PREPARE FOR A GOOD JOB!

BROADCAST ENGINEER
ELECTRONICS
RADIO SERVICING

Television Servicing

(Approved for Veterans)

SEND FOR FREE LITERATURE

BALTIMORE TECHNICAL INSTITUTE
1425 EUTAW PLACE, BALTIMORE 17, MD.

LEARN TV AT HOME

Here is your opportunity to learn TV servicing at home . . . a simple 14-week course written so you can understand it, priced so you can afford it.

This well-established, reputable TV and electronics school will send you complete lessons, tests and give you individual consultation, by correspondence.

The complete course costs only \$25.00. This is a limited offer so write today for information to:

VIDEO SPECIALTIES, INC., Dept. 616A
4508 E. Firestone Blvd., South Gate, Calif.

F.C.C. LICENSE

Get your FCC commercial operator license quickly

We specialize in rapid and thorough preparation for FCC examinations. Correspondence or resident training. Results guaranteed. Write for free booklet.

GRANTHAM School of Electronics
Dept. 101-C, 6064 Hollywood Blvd.,
Hollywood 28, Calif.
(Phone HO 2-1411)

RCA INSTITUTES, INC.
A service of Radio Corporation of America
350 West 4th St., New York 14, N. Y.

OFFERS COURSES IN
ALL TECHNICAL PHASES OF
RADIO, TELEVISION, ELECTRONICS
Approved for Veterans
Write Dept. RE-54 for Catalog

MORE JOBS

than graduates

Demand for our engineering graduates exceeds supply. *Effective placement.* Study in this world-famed college established 1884. Quarters start January, March, June, September. *Approved for Korean Vets.*

Bach. Sc. degree in 27 months

Complete Radio Eng. courses . . . TV, UHF and FM. Also Mech., Civil, Elec., Chem., Aero. and Adm. Eng.; Bus. Adm., Acct. Small classes. Well-equipped labs. Modest costs. Prep. courses. Write *Jean McCarthy, Director of Admissions,* for Catalog and Campus View Book.



TRI-STATE COLLEGE

24124 College Avenue, Angola, Indiana

RADIO ENGINEERING DEGREE IN 27 MONTHS

Intensive, specialized course including strong basis in mathematics and electrical engineering, advanced radio theory and design, television. Modern lab. Low tuition. Self-help opportunities. Also B.S. degree in 27 months in Aeronautical, Chemical, Civil, Electrical, and Mechanical Engineering. G.I. Gov't approved. Enter December, March, June, September. Catalog.

INDIANA TECHNICAL COLLEGE

1512 E. Washington Blvd., Fort Wayne 2, Indiana

CODE SENDING RECEIVING SPEED

Be a "key" man. Learn how to send and receive messages in code by telegraph and radio. Commerce needs thousands of men for jobs. Good pay, adventure, interesting work. Learn at home quickly through famous Candler System. Qualify for Amateur or Commercial License. Write for FREE BOOK.
CANDLER SYSTEM CO.
Dept. 3-0, Box 928, Denver 1, Colo., U.S.A.

EARN MORE MONEY— BE A PROFESSIONAL

TELEVISION SERVICE TECHNICIAN

GET DOWN-TO-EARTH PRACTICAL TV TRAINING WITH WTI EXPERTS FOR THE TOP PAYING \$5,000-\$10,000 PER YEAR JOBS.

UHF—COLOR—VHF

Master the latest, up-to-the-minute TV and Color TV developments QUICKLY.

WESTERN TV offers real experience on live equipment in our BIG SHOPS AND LABORATORIES in the shortest practical time under expert instructors. Graduates are in big demand because they have the "field experience" necessary for immediate "bench" or supervisory positions. You learn every phase of Radio and TV servicing (AM, FM, VHF, UHF). WTI men win fast promotion . . . can demand better pay . . . develop highly profitable businesses of their own with the latest and most PRACTICAL PERSONALIZED TRAINING BEHIND THEM. You concentrate all your time on being a PROFESSIONAL TV SERVICE TECHNICIAN — non-essential math and engineering theory omitted. YOU CAN EARN WHILE YOU LEARN. Special Finance Plan.

APPROVED FOR VETERANS. Find out how you can get into the TOP PAY GROUP — Send for this fact-packed book NOW!

WESTERN TELEVISION INSTITUTE

America's Leading Television Servicing School

Western Television Institute Dept. E-124
341 W. 18th St., Los Angeles 15, Calif.
Without obligation, please send FREE fully illustrated booklet. (No salesman will call.)

NAME _____ AGE _____
ADDRESS _____
CITY _____ ZONE _____ STATE _____

Become an

ELECTRICAL ENGINEER

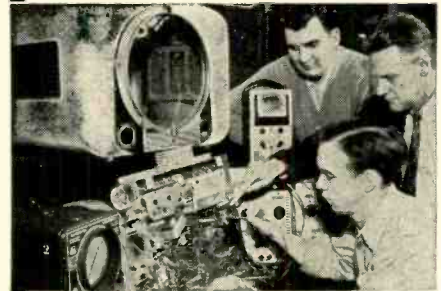

Major in Electronics or Power BS Degree in 36 months

Prepare now for a career as an electrical engineer or engineering technician — and take advantage of the many opportunities in these expanding fields.

You can save a year by optional year 'round study. Previous military, academic, or practical training may be evaluated for advanced credit.

Enter Radio and Television — courses 12 to 18 months

You can be a radio technician in 12 months. In an additional 6-months you can become a radio-television technician with Associate in Applied Science degree. Color television instruction is included in this program.

These technician courses may form the first third of the program leading to a degree in Electrical Engineering. Twenty-one subjects in electronics, electronic engineering and electronic design are included in these courses.

Courses also offered: radio-television service (12 mos.); electrical service (6 mos.); general preparatory (3 mos.).

Terms — January, April, July, September

Faculty of specialists. 50,000 former students—annual enrolment from 48 states, 23 foreign countries. Non-profit institution. 51st year. Courses approved for veterans. Residence courses only.

MS-6A

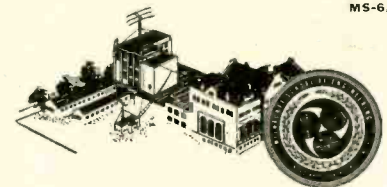

MILWAUKEE SCHOOL OF ENGINEERING

MILWAUKEE SCHOOL OF ENGINEERING
Dept. RE-1254, 1025 N. Milwaukee Street
Milwaukee 1, Wisconsin

Send FREE illustrated booklets
 Career in Electrical Engineering.
 Career in Radio-Television.

I am interested in _____ (name of course)

Name _____ Age _____

Address _____

City _____ Zone _____ State _____

If veteran, indicate date of discharge _____

TOP QUALITY TUBES ONE YEAR GUARANTEE BELOW MFRS' PRICES!

A WORD TO THE WISE: "JUNK is the MOST EXPENSIVE Thing You Can Buy!"
 Junk is NEVER a Bargain. . . . Price alone is not enough . . . a REAL Bargain is a combination of Price AND Quality: LOW Price and HIGH Quality! On the basis of QUALITY and DEPENDABILITY, Electron Tube Wholesalers offer the **LOWEST TUBE PRICES** on the market today!

We want your business now, of course. We also want it for the future. That's why we make absolutely certain that every tube shipped has first been carefully tested in our laboratories, for optimum performance. And we guarantee every ELECTRON TUBE, NOT for THREE Months—NOT for SIX Months—but for ONE FULL YEAR!

As Tube Specialists for many years, we carry one of the Largest Tube Stocks in the whole wide world—more than 3000 different types—Receiving, Transmuting, Special Purpose—all in stock in substantial quantities, for IMMEDIATE DELIVERY. All ELECTRON TUBES individually boxed in handsome three-color cartons.

Type	Price	Type	Price	Type	Price	Type	Price	Type	Price
0A2	.89	3Q5GT	.69	6B27	.92	6SF7	.59	7B7	.59
0A3 VRT5	.99	3A	.56	6C4	.41	6SG7GT	.49	7B8	.83
0B2	.79	3V4	.58	6C5	.39	6SH7	.60	7C4	.58
0B3 VR90	.95	5T4	1.28	6C6G	.57	6SH7GT	.50	7C5	.49
0C3 VR105	.98	5U4C	.85	6D6	.85	6S17	.50	7D5	.49
0D3 VR150	.89	5V4	.82	6C8B	.57	6SK7	.49	7C7	.65
0Z4	.54	5Y3GT	.39	6C8D	.57	6SL7GT	.59	7E5	.59
1A5GT	.43	6A3	.89	6CF6	.64	6SN7GT	.59	7E6	.59
1A7	.53	6A3	.89	6CF6	.64	6SQ7	.45	7E7	.65
1A85	.39	6A6	.51	6C56	.51	6SR7	.45	7F8	.95
TAX2	.59	6A7	.55	6D6	.69	6SS7GT	.60	7H7	.59
1B3	.69	6A8	.69	6D8G	.98	6GT7	.49	7J7	.75
1D8GT	.77	6A8	.69	6E5	.48	6SV7	.99	7L7	.59
1G6GT	.54	6A8	.69	6F5	.48	6T7	.95	7M7	.62
1HG5T	.43	6A8	.69	6F6	.45	6T7G	.79	7R7	.65
1J6	.53	6A8	.69	6F7	.45	6T8	.79	7S7	.85
1L4	.49	6A8	.69	6G7	.45				
1LA4	.59	6A8	.69						
1L4S	.71	6A8	.69						
1L84	.79	6A8	.69						
1L85	.59	6A8	.69						
1L86	.71	6A8	.69						
1L87	.79	6A8	.69						
1L88	.59	6A8	.69						
1L89	.71	6A8	.69						
1L90	.79	6A8	.69						
1L91	.59	6A8	.69						
1L92	.71	6A8	.69						
1L93	.79	6A8	.69						
1L94	.59	6A8	.69						
1L95	.71	6A8	.69						
1L96	.79	6A8	.69						
1L97	.59	6A8	.69						
1L98	.71	6A8	.69						
1L99	.79	6A8	.69						
1L100	.59	6A8	.69						

THIS MONTH'S SPECIALS

Our new policy brings you greater tube savings than you thought possible! As a GOODWILL offering, we are giving, each month, a number of popular tube types (listed in extra bold) — AT PRICES BELOW OUR OWN COST! Look for these terrific offers of different types each month, in industry-wide publications!

6A8	.69	6U7G	.45	7V7	.91
6A85	.39	6V3	1.02	7X7	.70
6A85	.45	6V6GT	.41	7Y7	.44
6A85	.48	6W4GT	.39	7Z7	.85
6A85	.41	6X5GT	.29	12A6	.69
6A85	.41	6X8	.79	12A7	.68
6A85	.41	6Y7	.54	12A8GT	.63
6A85	.41	7A4	.54	12A15	.49
6A85	.41	7A5	.59	12A16	.35
6A85	.41	7A6	.69	12A17	.53
6A85	.41	7A7	.69	12A18	.44
6A85	.41	7A8	.59	12A19	.44
6A85	.41	7A9	.56	12A20	.44
6A85	.41	7B5	.59	12A21	.44
6A85	.41	7B6	.59	12A22	.44

EXPORT INQUIRIES INVITED! New Complete Listing—Send For Free Copy!

ELECTRON TUBE WHOLESALERS, INC.
 140 DUANE STREET • NEW YORK 13, N. Y. • Phone: BArlay 7-7616

FREE OFFER!
 7 Assorted 12, 7, 6, 1 and 2-volt type tubes. List Value a p p r o x . \$23.00. FREE with every order for \$25.00 or more!

35W4	.43	12A27	.89	12B7	.49
35Y4	.45	12A28	.39	12B8	.49
35Z3	.43	12A29	.59	12B9	.49
35Z5GT	.47	12A30	.59	12BD6	.49
41	.41	12A31	.59	12B7G	.39
42	.41	12A32	.59	12B8G	.39
43	.41	12A33	.59	12B9G	.39
45	.41	12A34	.59	12C7	.65
46	.49	12A35	.59	12C8	.65
47	.49	12A36	.59	12C9	.65
48	.49	12A37	.59	12D7	.65
49	.49	12A38	.59	12D8	.65
50A5	.55	12A39	.59	12D9	.65
50B5	.49	12A40	.59	12E6	.45
50C5	.49	12A41	.59	12E7	.45
50L6GT	.61	12A42	.59	12F7	.45
50X6	.64	12A43	.59	12G7	.45
50Y6GT	.59	12A44	.59	12H7	.45
50Z6	.49	12A45	.59	12I7	.45
50Z7	.49	12A46	.59	12J7	.45
50Z8	.49	12A47	.59	12K7	.45
50Z9	.49	12A48	.59	12L7	.45
50Z10	.49	12A49	.59	12M7	.45
50Z11	.49	12A50	.59	12N7	.45
50Z12	.49	12A51	.59	12O7	.45
50Z13	.49	12A52	.59	12P7	.45
50Z14	.49	12A53	.59	12Q7	.45
50Z15	.49	12A54	.59	12R7	.45
50Z16	.49	12A55	.59	12S7	.45
50Z17	.49	12A56	.59	12T7	.45
50Z18	.49	12A57	.59	12U7	.45
50Z19	.49	12A58	.59	12V7	.45
50Z20	.49	12A59	.59	12W7	.45
50Z21	.49	12A60	.59	12X7	.45
50Z22	.49	12A61	.59	12Y7	.45
50Z23	.49	12A62	.59	12Z7	.45
50Z24	.49	12A63	.59	13A7	.45
50Z25	.49	12A64	.59	13B7	.45
50Z26	.49	12A65	.59	13C7	.45
50Z27	.49	12A66	.59	13D7	.45
50Z28	.49	12A67	.59	13E7	.45
50Z29	.49	12A68	.59	13F7	.45
50Z30	.49	12A69	.59	13G7	.45
50Z31	.49	12A70	.59	13H7	.45
50Z32	.49	12A71	.59	13I7	.45
50Z33	.49	12A72	.59	13J7	.45
50Z34	.49	12A73	.59	13K7	.45
50Z35	.49	12A74	.59	13L7	.45
50Z36	.49	12A75	.59	13M7	.45
50Z37	.49	12A76	.59	13N7	.45
50Z38	.49	12A77	.59	13O7	.45
50Z39	.49	12A78	.59	13P7	.45
50Z40	.49	12A79	.59	13Q7	.45
50Z41	.49	12A80	.59	13R7	.45
50Z42	.49	12A81	.59	13S7	.45
50Z43	.49	12A82	.59	13T7	.45
50Z44	.49	12A83	.59	13U7	.45
50Z45	.49	12A84	.59	13V7	.45
50Z46	.49	12A85	.59	13W7	.45
50Z47	.49	12A86	.59	13X7	.45
50Z48	.49	12A87	.59	13Y7	.45
50Z49	.49	12A88	.59	13Z7	.45
50Z50	.49	12A89	.59	14A7	.45
50Z51	.49	12A90	.59	14B7	.45
50Z52	.49	12A91	.59	14C7	.45
50Z53	.49	12A92	.59	14D7	.45
50Z54	.49	12A93	.59	14E7	.45
50Z55	.49	12A94	.59	14F7	.45
50Z56	.49	12A95	.59	14G7	.45
50Z57	.49	12A96	.59	14H7	.45
50Z58	.49	12A97	.59	14I7	.45
50Z59	.49	12A98	.59	14J7	.45
50Z60	.49	12A99	.59	14K7	.45
50Z61	.49	12A100	.59	14L7	.45
50Z62	.49	12A101	.59	14M7	.45
50Z63	.49	12A102	.59	14N7	.45
50Z64	.49	12A103	.59	14O7	.45
50Z65	.49	12A104	.59	14P7	.45
50Z66	.49	12A105	.59	14Q7	.45
50Z67	.49	12A106	.59	14R7	.45
50Z68	.49	12A107	.59	14S7	.45
50Z69	.49	12A108	.59	14T7	.45
50Z70	.49	12A109	.59	14U7	.45
50Z71	.49	12A110	.59	14V7	.45
50Z72	.49	12A111	.59	14W7	.45
50Z73	.49	12A112	.59	14X7	.45
50Z74	.49	12A113	.59	14Y7	.45
50Z75	.49	12A114	.59	14Z7	.45
50Z76	.49	12A115	.59	15A7	.45
50Z77	.49	12A116	.59	15B7	.45
50Z78	.49	12A117	.59	15C7	.45
50Z79	.49	12A118	.59	15D7	.45
50Z80	.49	12A119	.59	15E7	.45
50Z81	.49	12A120	.59	15F7	.45
50Z82	.49	12A121	.59	15G7	.45
50Z83	.49	12A122	.59	15H7	.45
50Z84	.49	12A123	.59	15I7	.45
50Z85	.49	12A124	.59	15J7	.45
50Z86	.49	12A125	.59	15K7	.45
50Z87	.49	12A126	.59	15L7	.45
50Z88	.49	12A127	.59	15M7	.45
50Z89	.49	12A128	.59	15N7	.45
50Z90	.49	12A129	.59	15O7	.45
50Z91	.49	12A130	.59	15P7	.45
50Z92	.49	12A131	.59	15Q7	.45
50Z93	.49	12A132	.59	15R7	.45
50Z94	.49	12A133	.59	15S7	.45
50Z95	.49	12A134	.59	15T7	.45
50Z96	.49	12A135	.59	15U7	.45
50Z97	.49	12A136	.59	15V7	.45
50Z98	.49	12A137	.59	15W7	.45
50Z99	.49	12A138	.59	15X7	.45
50Z100	.49	12A139	.59	15Y7	.45
50Z101	.49	12A140	.59	15Z7	.45
50Z102	.49	12A141	.59	16A7	.45
50Z103	.49	12A142	.59	16B7	.45
50Z104	.49	12A143	.59	16C7	.45
50Z105	.49	12A144	.59	16D7	.45
50Z106	.49	12A145	.59	16E7	.45
50Z107	.49	12			

SELL MORE TUBES! SAVE SERVICE TIME!

INDISPENSABLE
ON EVERY
SERVICE
CALL



STORE
IN
TUBE
CADDY

PORTABLE
SECO
GRID
CIRCUIT
TUBE
TESTER

MAKE THIS 4 WAY CHECK:

1. Control grid emission (Exclusive Feature!)
2. Grid to cathode shorts.
3. Gaseous condition in tube.
4. Cathode to heater shorts.

See your Jobber or write for literature
and prices.

SECO MFG. CO. 5015 PENN. AVE. S.
MINNEAPOLIS, MINN.

KITS!! KITS!! KITS!!

Whopping Values for Everyone!!

Relays . . . incl. multi-contact & midket keying types. Kit of 5 assorted	\$2.49
R.F. ANT-Oscillator Coils 10 stand. 5'ncst & S.W. incl. shielded Kit of 10 asstd.98
Moulded Bakelite Condensers 50mmf. to 2mfid., 200-600VW. 50 asstd. \$1.98; 100/ Radio-TV Builders Library for Students Hams, Servicemen, Radio & TV schematics. incl. Photofacts. Kit of 25 asstd.98
Rotary Selector Switches incl. multi-deck. 1/4" shafts. Kit of 6 assorted	1.75
Tube Sockets wafer: 4 to 8 pin. 12 asstd. Radio Hardware Treasure Full lb. can of: Nuts, Screws, Washers, Lugs, etc. 3 lbs. / Carbon Resistors 1/2-2 Watt. 100 asstd. Electrolytics can & tubular. 5 asstd. Oil Condensers05 to 2 mfd. incl. dual section. Kit of 5 asstd.98
Potentiometers 1/4" shafts. Kit 6 asstd. Knobs & Plastic Kit 25 asstd. Dial Windows acetate & glass. Kit 12 asstd. 1% Precision Resi tors incl. IRC & Weston. Most are wire-wound. Kit 10 asstd.	1.98
Alnico Magnets Powerful Bar, Block, U. Rod, etc. Kit of 10 asstd.	1.98

(Write for Latest "Alnico Magnet Supplement")

!! Repair Your Own Speakers !!

SAVE TIME—SAVE MONEY. Clear, simple instructions supplied with every cone or repair kit order.
Kit "A"—SPEAKER CONES, etc. An assortment of popular sizes 4" to 12", incl. oval. Less voice coils. Kit of 12 asstd. \$1.98
Kit "B"—DE LUXE CONES, etc. Same as above, but containing a larger variety of 20 asstd. cones \$2.98
Kit "C"—SPEAKER REPAIR KIT A professional assortment of: Voice Coil Forms, Rings, Spiders, Felt, Chamois Lthr, Shim Kit, Cement & Instructions \$2.49

!!SPECIAL!!—BOTH KITS "A" & "C"
FOR ONLY \$3.95

!! Over 10,000 Kits Already Sold !!

And more "JUMBO RADIO-ELECTRONICS PARTS KITS" are going out every day. Why? WHY PAY MORE FOR PARTS? Here's a kit with 17 LBS. of: SWITCHES, CONTROLS, WIRE, SOCKETS, CAPACITORS, RESISTORS, CHILDS, KIT PARTS & DIAGRAMS, PHOTOFACTS, PLUS DOZENS OF OTHER ITEMS (shpg. wt. 20 lbs.) \$3.95



Last Minute Special!... 1/10 H.P. AC Motor

(Oster Type KS-687) 115VAC, 1725 RPM, 2.8 Amps. Shaft 1 7/8" O.D. Fully enclosed; 4 threaded mtr. holes. 7 1/2" x 4 1/2" O.D. with starting condenser. (shpg. wt. 14 lbs.) \$7.95

"DIRECT FACTORY SPEAKER REPAIRS SINCE 1927" Min. Order \$3.00. 20% deposit req. on all C.O.D.'s. Full remittance with foreign orders. Please add sufficient postage—excess refunded.

LEOTONE RADIO CORP.
67 Dey Street
New York 7, N. Y.

BOOKS

(Continued)

GRAPHICAL SYMBOLS FOR ELECTRICAL DIAGRAMS (American Standard Y32.2-1954). Sponsored by American Society of Electrical Engineers and American Society of Mechanical Engineers. American Standards Association, New York, N. Y. 58 pages. \$1.25.

This new standard is a complete revision and coordination of five American Standards for graphical symbols. The document contains single-line diagrams and simplified symbols for radio, electronics, telegraph, telephone and power. It is prepared for engineers, designers, manufacturers and installers of equipment to show interconnection and functions of electrical circuits.

PICTURE BOOK OF TV TROUBLES, Vol. 1, Horizontal a.f.c.-Oscillator Circuits, by John F. Rider Laboratories Staff. John F. Rider Publisher, Inc., 480 Canal St., New York 13, N. Y. 5 1/2 x 8 1/2 inches, 70 pages. \$1.35.

This book, the publisher states, represents the first of a series reporting the results of trouble-shooting a large number of television receivers in the John F. Rider Labs. No attempt is made to explain circuit operation in detail or to analyze the results from a theoretical standpoint. The book covers the four most popular horizontal a.f.c.-oscillator circuits.

They include the pulse-width a.f.c. oscillator (Synchroguide); phase detector-stabilized multivibrator a.f.c. oscillator; phase discriminator-sine wave oscillator (Synchrolock), and phase detector-sine wave oscillator.

For each circuit there is a typical schematic diagram showing the waveforms at various key points in the circuit. Following this, the most common faults in each circuit are described, together with their abnormal patterns and distorted waveforms.

In addition, at the rear of the book is a long fold-out page containing the schematic diagrams and waveforms of each of the four a.f.c.-oscillator circuits discussed. This permits the reader to have the schematic before him while leafing through a chapter.

The book does a very good job for the service technician interested in a study of cause and effect.—JK END

CORRECTION

The parts list for the transistor oscillator on page 54 of the September issue specifies three .01-μf capacitors. The correct value is, as you have no doubt guessed, .01 μf.

The formula for distributed capacitance, in the middle column of page 57 of the October issue, is incorrect. Its correct form is

$$C = \frac{C1 - 4C2}{3}$$

We thank William Pickering of Vancouver, B. C., and Walter Planker of Camden, N. J., for bringing these corrections to our attention.

The Quickest Way to the Best Jobs

for • TV TECHNICIANS
• SERVICEMEN
• STUDENTS

Have the **ESSENTIAL**
math at your finger-
tips



Essentials of Mathematics for Radio, TV & Electronics

You'll EASILY gain FULL COMMAND of the most important rock-bottom requirement for TV from this book. You'll learn every step in the math you need and how to USE it for all such calculations as voltage drops, frequency resolutions, decibels, thousands of others. Thoroughly explains the slide rule, useful rule-of-thumb short-cuts. Very clear and practical. NO mathematical smog!

Over 3000
examples and
problems for
practice

Radio & Television Mathematics

Whatever your problem—to correct the power factor of a motor, find the impedance and length of matching stub between antenna and transmission line, convert from polar to j-notation in a matter of seconds—you'll find the complete worked-out solution here. Fully indexed for quick reference on all common problems requiring math in radio & TV.

Complete
quick-reference
handbook of
problems and
SOLUTIONS

Learn the **SURE, QUICK**
methods of installation
and servicing



Mandl's Television Servicing

The NEW printing of this famous service guide includes all latest improvements, full section on color. Clear, specific instruction on ALL techniques of efficient installation and servicing. Practical aids for locating trouble quickly and FULLY correcting it. Excellent material on antennas; improving reception in difficult areas.

Unique
Master Trouble
Index
Complete
Color Section

10-day FREE TRIAL

The Macmillan Co., 60 Fifth Ave., New York 11

Please send me the books checked below. I will remit full price plus small delivery charge, or return books in 10 days. (Save: Send check or money order and we pay delivery charge)

- Elements of Mathematics by Fischer & Jacobs \$7.20
- Radio & Television Mathematics by Fischer \$6.75
- Mandl's Television Servicing \$5.75

Signed _____

Address _____

This offer good only within continental limits of U.S.A.

TERADO



Trav-Electric CONVERTERS

provide *House Current*

Anywhere

—from battery in car, truck, boat. At the beach—picnic grounds—at cabin—on trips—anywhere! Easy! No installation! Just plug Trav-Electric into cigar lighter on dash.

Trav-Electric Operates:

- Tape Recorders
- Electric Shavers
- Radios
- Soldering Irons
- Dictating Machines
- Small Electric Drills
- Portable Photographs
- Etc. etc. etc.

6 Models 10 to 100 Watts
—a size for every need.

"Midget"

Model 6-11160
10-15 Watts



About as small as a pack of cigarettes.

\$11.95 LIST

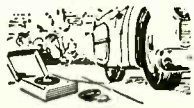

PORTABLE PHONOGRAPH



Dictating Machine



ELECTRIC SHAYER

"JUNIOR"

Model 6-110
115 Cycle
30-40 Watts
\$12.95 LIST

"SENIOR"

Model 6-1160
Size 2 1/2"x2 1/2"x4 1/2"
35-40 Watts
\$15.95 LIST

"MASTER"

Model 6-51160
40-50 Watts
Size 4"x5"x6"
\$27.50 LIST

"SUPER"

Model 6-71160
(Shown at top of ad)
60-75 Watts
Size 4"x5"x6"
\$37.95 LIST

—and now, the **"CHIEF"**
NEW—JUST OUT—Model 6-81160—75-100 Watts—automatic on-off switch—**\$49.95 LIST**

See your Electronic, Hardware, or Automotive Jobber or Dealer

Terado Company

Designers and Mfrs. of Electronic Equipment
1057 Raymond Ave., ST. PAUL 14, MINN.

In Canada Write: Atlas Radio Corp., Ltd.
560 King St. West, Toronto 28, Ont.
Export Sales Division: Scheel International, Inc.
4237 N. Lincoln Ave., Chicago 18, Ill. U.S.A.
Cable Address—Harshheel

ADVERTISING INDEX

Radio-Electronics does not assume responsibility for any errors appearing in the index below.

All Channel Antenna Corp.....	29
Alliance Mfg. Co.....	121
Allied Radio Corp.....	11
American Microphone Co.....	11
American Phenolic Corp.....	130
Amplifier Corporation of America.....	90
Approved Electronics.....	89
Arkay Radio Kits Inc.....	135
Atlas Sound Corp.....	100
Audel Publishers.....	117

Barry Electronics Corp.....	146
Belden Mfg. Co.....	18
Bell Telephone Labs.....	131
Boland & Boyce, Inc.....	12
Brooks Radio & TV Corp.....	101
Burstein Applebee Co.....	100

Cabinart.....	81
CBS Hytron (Div. of Columbia Broadcasting System).....	15
Cannon Electric Co.....	88
Capitol Radio Engineering Institute.....	19
Centralab—Division of Globe-Union.....	82
Century Electronics Co.....	135
Channel Master Corp.....	24
Chicago Standard Transformer Corp.....	116
ClaroSTAT Mfg. Co., Inc.....	105
Cleveland Institute of Radio Electronics.....	9
Collins Audio Products Co., Inc.....	80
Concord Radio.....	123
Coyne Electrical & TV Radio School.....	106, 115, 137

Decray, Frank W.....	96
Delco Radio (Division of General Motors Corp.).....	109
DeVry Technical Institute.....	7

Edie Electronics.....	108
Electro-Voice, Inc.....	Inside Front Cover
Electron Tube Wholesalers, Inc.....	144
Electronic Measurements Corp.....	127
Electronic Instrument Co.....	30, 128, 133

Fair Radio Sales.....	96
-----------------------	----

General Industries Co.....	141
General Test Equipment.....	135
Granco Products.....	82

Hallcrafters Co.....	122, 124, 126
Hawkins, P. E., Co.....	96
Heath Co.....	67-78
Hi-Lite Electronic Sales Co.....	118
Hudson Specialties Co., Inc.....	100
Hughes Research & Development Labs.....	86

Indiana Technical College.....	134
Instructograph Co.....	134

JFD Mfg. Co., Inc.....	99
Jackson Electronic Instrument Co.....	83
Jensen Industries Co.....	106
Jersey Speciality Co.....	106
Kay-Townes Antenna Corp.....	92, 93

Lafayette Radio Corp.....	139
Leontone Radio Corp.....	145

Macmillan Co., The.....	145
Mallory & Co., Inc., P. R.....	103
McGraw-Hill Book Co., Inc.....	120
Moss Electronic Distributing Co.....	112, 113

National Electronics of Cleveland.....	90
National Radio Institute.....	3, 27, 28
National Schools.....	5

Ohmite Mfg. Co.....	125
Opportunity Adco.....	103
Or-Radio Industries, Inc.....	90
Oxford Electric Co.....	104

Permo, Inc.....	118
Permotlux Corp.....	87
Phileo Corp.....	101
Precision Apparatus Co., Inc.....	16, 141
Progressive "Edu-Kits", Inc.....	129

RCA Institutes, Inc.....	17
RCA Service Company.....	96
RCA Victor Division (Radio Corp. of America).....	Back Cover
Rad-Tel Tube Co.....	134
Radelco Mfg. Co.....	82
Radiart Corp.....	14
Radio City Products.....	123

RADIO SCHOOL DIRECTORY PAGE 143

Baltimore Technical Institute.....	9
Candler System Co.....	148
Grantham School of Electronics.....	14
Indiana Technical College.....	146
Indianapolis Electronic School.....	14
Milwaukee School of Engineering.....	14
RCA Institutes, Inc.....	9
Valparaiso Technical Institute.....	14
Western Television Institute.....	14

Radio Television Training Association.....	23
Ram Electronic Sales Co.....	138
Raytheon Mfg. Co.....	8
Regency Division (I.D.E.A.).....	138
Rider, Inc., John F.....	104
Rinehart & Co., Inc.....	12, 88, 110, 118, 142

Sams, Howard W. & Co., Inc.....	107
Seco Mfg. Co.....	145
Spaulding Products Co.....	97
Spraberry Academy of Radio.....	85
Stackpole Carbon Co.....	91
Stan-Burn Radio & Electronics.....	104
Stev-EI Electronics Corp.....	134

T. V. Products Co.....	85
Tab.....	146
Technical Appliance Co.....	110
Teltron Electric Co.....	138
Terado Co.....	146
Transvision, Inc.....	132, 135
Trio Mfg. Co.....	20, 21
Triplett Electrical Instrument Co.....	Inside Back Cover
Tung-Sol Electric Co.....	6
Turner Co.....	16

University Loud Speakers, Inc.....	26
Vidaire Electronics.....	142

Ward Products Corp.....	119
Webster Electric Corp.....	102
Westco Mfg. Co.....	146
Weston Electrical Instrument Co.....	22
Wholesale Radio Parts.....	117
Windward Co.....	118
WinPower Mfg. Co.....	106
Winston Electronics.....	114

Xcelite, Inc.....	144
Zingo Products.....	142

STANDARD BRAND TUBES AT THE NEW LOW PRICES

- Individually boxed.
- Only list quality
- Latest Dating—
- No private label, electrical or mechanical rejects.
- No rebrands or reworked "bargains."

AUTHORIZED DISTRIBUTORS CBS-HYTRON—EIMAC—WESTINGHOUSE AND OTHERS

Tube Orders Over \$25.00, with full remittance, PREPAID to you in U.S.A.

Type	Net	Type	Net	Type	Net
02A	.50	6BF5	.70	7B7	.95
1A5GT	.80	6BF6	.80	7C7	1.00
1A7GT	1.00	6BG6G	1.80	7R7	1.30
1B3GT	.85	6BH6	.80	7S7	1.25
1HS6T	.80	6B4G	.70	8A7	1.30
1L4	.85	6BK5	.90	7W7	1.30
1L6	1.10	6BK7A	1.10	7X6	.85
1L4A	1.00	6B7C	1.20	8L7	.70
1LA6	1.00	6BN6	1.15	7Y4	.70
1L8A	1.00	6BQ6GT	1.20	7Z4	.70
1LC5	1.00	6B27	1.20	6D6GT	1.20
1LD5	1.00	6BK7GT	1.25	12A7G	.50
1LE2	1.00	6BY5G	1.30	12A7T	1.00
1L6G	1.00	6G6	1.25	6E7	.60
1LM4	1.00	6C4	.50	12A7U	.80
1LN5	.95	6CB6	.70	12A7V	.55
1N5GT	.90	6C6G	1.25	12A7W	.60
1Q5GT	1.15	6CF6	1.00	12A7X	.85
1R4	1.00	6CL6	1.10	12A7Y	.80
1S4	.70	6C8	.90	6G6	.65
1S4	.90	6CS6	.70	12A7Z	.90
1S5	.70	6CU6	1.70	12B27	.90
1T5GT	1.05	6E5	1.00	12B27	1.00
1U4	.70	6F6M	1.00	12B46	.95
1U5	.65	6FG6	.80	12B47	.95
1V	.85	6H6	1.20	12B77	.95
1V2	.70	6J4	4.95	12B77	.95
1X2B	.85	6J5	.50	12B77	1.00
2X1	.80	6J6	.75	12C5T	.70
2X2	.50	6J7	.95	12K7GT	.90
3A4	.55	6K6GT	.60	12K8GT	1.10
3A5	.90	6K7M	.60	12L7GT	.80
3L4	1.15	6K8	1.20	12S47GT	.65
3Q4	.90	6L6G	1.15	12S6GT	.90
3L6	1.00	6L6G	1.30	12S7GT	.95
3S4	.85	6L6M	.80	12S7GT	.70
3V4	.75	6L7G	1.25	12SK7GT	.65
5AW4	1.35	6N7	1.15	12SL7GT	1.00
5R4GY	.85	6Q7M	.80	12S7GT	.90
SU4G	.55	6Q7G	.80	14A4	1.00
SU4	.90	6Q7GT	.80	14A4	.75
SW4GT	.70	6R6	1.10	14A7	.85
SX4G	.80	6S8	.65	14B6	.70
SY3GT	.45	6SA7GT	.65	14F8	1.20
SZ	.85	6S7	.75	14F8	1.20
SZ3	.80	6SF5	.75	14F8	1.20
SZ4	1.25	6SG7	.70	14J7	1.35
G8M	1.05	6S7G	.70	14K7	1.00
G8GT	1.05	6S7M	.70	14Q7	.95
G8B4	.65	6SK7GT	.65	14R7	1.30
G8C5G	.85	6SL7GT	.65	14S7GT	1.00
GAC5GT	1.15	6SN7GT	.75	14W7	1.30
GAC7	1.10	6SQ7GT	.60	1986GG	2.00
G1D7G	.85	6T4	1.30	25A5V	1.20
6AF4	1.30	6T4	1.30	25A5V	1.20
6AF6	1.20	6T8	.95	25BQ6GT	1.30
6A7	.85	6U5	.75	12L6GT	.55
6AG7	1.20	6U8	1.00	25A4GT	.90
6AH4GT	.85	6V3A	1.30	25Z5	.70
6AH5	.90	6VE6T	.65	25Z6GT	.65
6AJ5	1.75	6V6M	1.30	6S7GT	.65
6AK5	.75	6W4GT	.60	35S5	.65
6AK6	.80	6W6GT	.80	35C5	.70
6AL5	.60	6X4	.50	35LGT	.65
6AL7	1.50	6X5GT	.50	35W4	.45
6AM8	1.25	6X8	.95	35Z5GT	.45
6AN6	1.00	6Y6G	1.00	50A4GT	.65
6AN5	3.50	7A4	.80	50B5	.70
6AN8	1.20	7A5	.95	35C5	.70
6AQ6	.65	7A6	.75	807GT	.65
6AQ6	.55	7A7	.80	50X6	.90
6AQ7	1.20	7A8	.85	70L7	1.55
6AR6	.65	7B4	.85	81	.60
6AR6	2.75	7B5	.70	7B7	1.15
6AS6	2.50	7B6	.75	117L7GT	2.50
6AT6G	3.75	7B7	.80	117R7GT	1.95
6AT6	.55	7C4	1.25	117P7GT	1.15
6AU4GT	.95	7C5	.80	117Z3	.70
6AV5GT	1.10	7C6	.70	117Z4GT	1.00
6AU5	.50	7C7	.85	117Z6GT	1.00
6AV5GT	1.05	7E5	1.10	5642	1.00
6AV6	.55	7E6	1.15	5654	1.75
6AX4G	.80	7E7	1.10	182A	3.80
6AX5GT	.75	7F7	.90	58P1	3.00
6BA6	.65	7F8	1.20	211	1.75
6BA5	.90	7G7	1.15	807GT	1.90
6BC5	.70	7H7	.75	866-A	1.25
6BD5	1.40	7J7	1.35	872-A (E)2	75
6BD6	.75	7K7	1.20	1520	.65
6BE6	.70	7L7	1.15	—AND OTHERS	

3,000 VOLT MULTITESTER

AC: 0-15, 150, 750, 3000 volts.
DC: 0-15, 75, 300, 750, 3000 volts.
DC MA: 0-15, 150, 750 ma.
Resistance: 0-10,000, 100,000 ohms.
Complete with battery, test leads. Only 3 1/2" Wx 4 1/4" Hx 1 3/4" deep. Brand new. Only \$9.95

Write for latest 1955 Handy-Order Form showing new low price levels. Remember, we are the originators of the Handy-Order Form. Don't be misled by imitators of this form who sell "bargain" tubes. Tubes as well as this Handy-Order Form are being initiated. Buy with confidence from Barry.

SPECIAL-PURPOSE TUBES

Write for our complete listing of XMTG, Industrial, Special-Purpose and Crystal Diodes. We stock over 2,000 types at excellent prices.

TWO-COLORED TUBE CARTONS, with new Safety Partitions, Prevents Tube Breakage. This Super-Gloss Red and Black Carton is the Most Durable and Available Today! Minimum: 100 any one size. Quantity prices on request. Boxes F.O.B. N.Y. N.Y.

SIZE	Miniature (6AU6, 6AL5, etc.)	EACH
GT	(6SN7, 6W4, etc.)	\$.01
LARGE GT	(1B3, 6BQ6GT, etc.)	0.125
LARGE G	(5U4G, 6BG6G, etc.)	.02

Terms: 25% with order, balance C.O.D. All merchandise guaranteed F.O.B., N.Y.C.

PHONE: Rector 2-2562

Barry ELECTRONICS CORP.

136-B LIBERTY ST. N. Y. 6, N. Y.

Introducing...



SABRE *with exclusive*

a Masterpiece of Advanced Engineering . . .

Welco's exclusive Miracle Phase is now added to a truly great fringe area antenna, the Sabre Senior — Here's a television antenna with extremely high gain on all VHF channels — Its sharp forward pattern offers the maximum in sparkling picture quality and the minimum in noise and picture wrecking co-channel interference — For new picture life and uninterrupted enjoyment of favorite black and white or color programs — Use a Sabre Senior — The antenna that can prove by comparison superior performance.

What you have always wanted now comes true — One antenna that works like two — Completely assembled — Ready for mounts — For sharp clear pictures — That's what counts.

Use one Sabre Senior — Or two stacked, which is rarely necessary — For complete satisfaction. A completely assembled antenna in a small, smartly styled, easy-to-handle carton — For quick installation.

See your Welco Jobber or write direct.

WELCO MFG. CO.

Leaders in Electronic Design

225 S. Third Street

P.O. Box 110

Burlington, Iowa

SENIOR *Miracle Phase*

Patent Applied For

*there's a Sabre Model
with Miracle Phase
for every area*

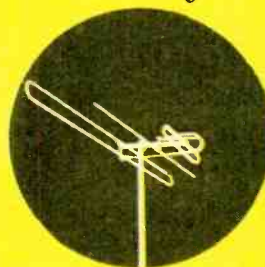

PRIMARY
Sabre Junior
\$8.75 list

MEDIUM FRINGE
Sabre 100
\$14.95 list

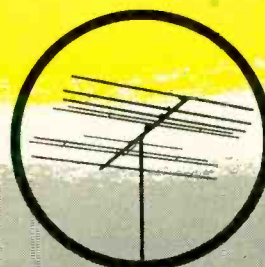
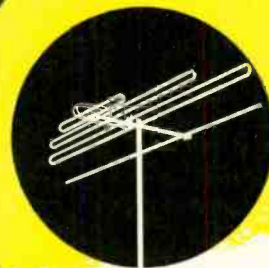

FRINGE
Sabre Senior
\$22.50 list

As a



is 2 a



or a



is 2 a



or a



is 2 a

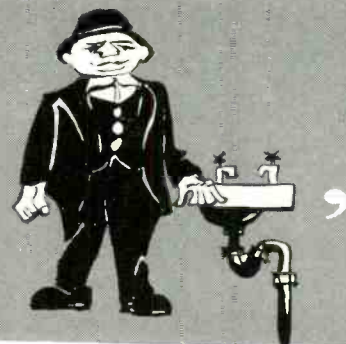

the



is 2 U!

MODEL 631 VOM-VTVM \$59.50 NET

Because—it's TWO-in-One for the price of one! It's a VTVM—It's a VOM with just the flip of a switch!

This one combination instrument will be the serviceman's most frequently used piece of test equipment. No need to invest in two separate testers when one will do his work at half the price—\$59.50 net.

Flip the switch, it's a **V T V M** (completely portable; battery operated—VTVM accuracy not subject to line voltage fluctuations — Input Impedance of 11 megohms).

Flip the switch and it's a **V O M** (with the sensitivity to match readings in all the service manuals—20,000 ohms per volt DC, 5,000 ohms per volt AC).

Ranges entirely adequate for servicing needs. All 34 ranges selected by one knob control—minimizes incorrect settings and burnouts. Unbreakable clear plastic meter case front floods light on long, readable scales.

Triplet Model 631 is sold by leading distributors everywhere.



TRIPLETT ELECTRICAL INSTRUMENT CO., Bluffton, Ohio

BRUNO MATAS 3-56
 20 EVERETT ST
 LAWRENCE MASS

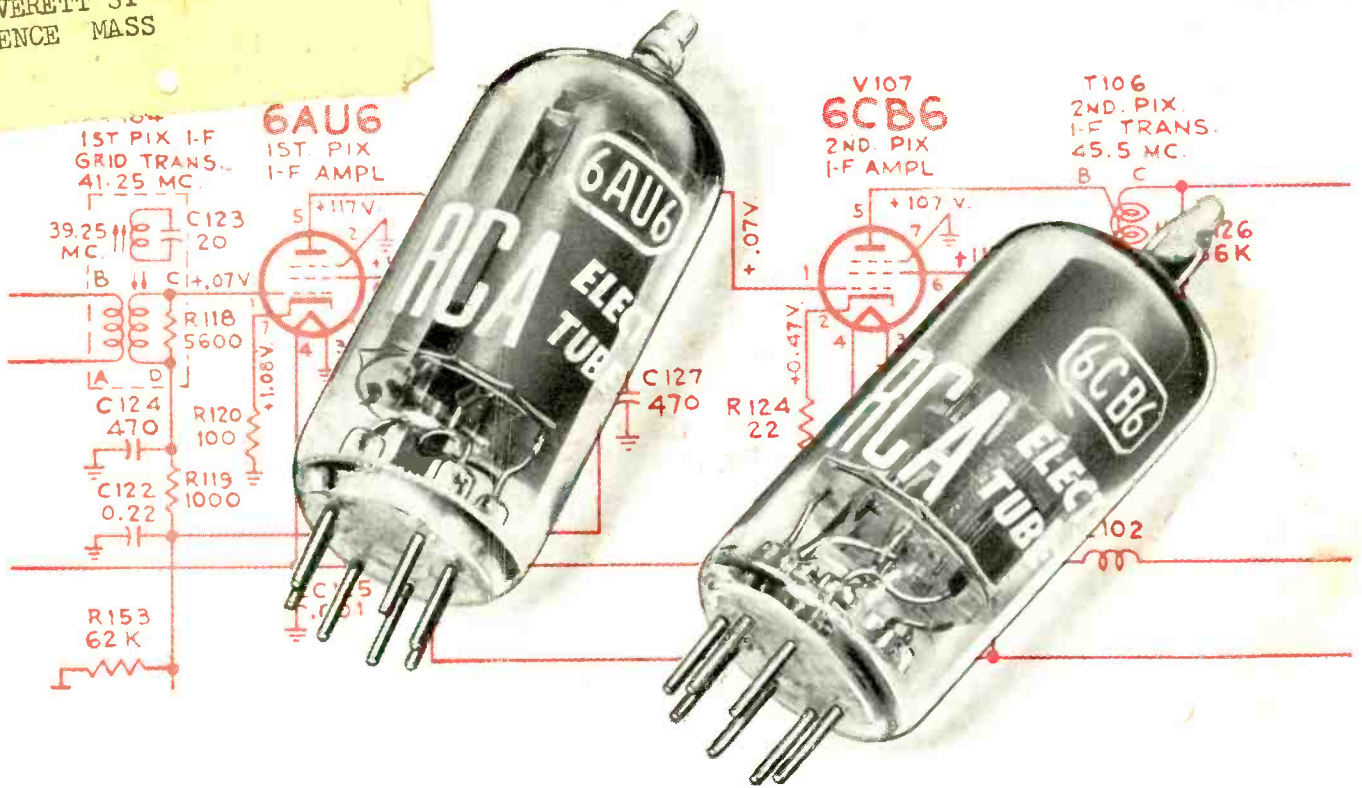

SAVE TIME IN REPAIRING TV IF CIRCUITS!

Use RCA Tubes with built-in quality!

HERE'S WHY . . . Strict quality control in manufacturing RCA Tubes assures consistent uniformity of characteristics. For example, careful control of transconductance, plate-current cutoff, and tube capacitances in RCA Tubes for TV IF Circuits is your assurance of quick servicing without quality difficulties.

In circuits so vital to the production of sharp pictures and strong signals—be sure, use RCA Tubes!



RADIO CORPORATION of AMERICA
 ELECTRON TUBES
 HARPISON, N.J.

Your First Choice for TV circuits . . . dependable RCA Tubes.