

HIGH-QUALITY 3-CHANNEL MIXER EQUALIZER

NOVEMBER 1955

RADIO - ELECTRONICS

TELEVISION • SERVICING • HIGH FIDELITY

HUGO GERNSBACK, Editor

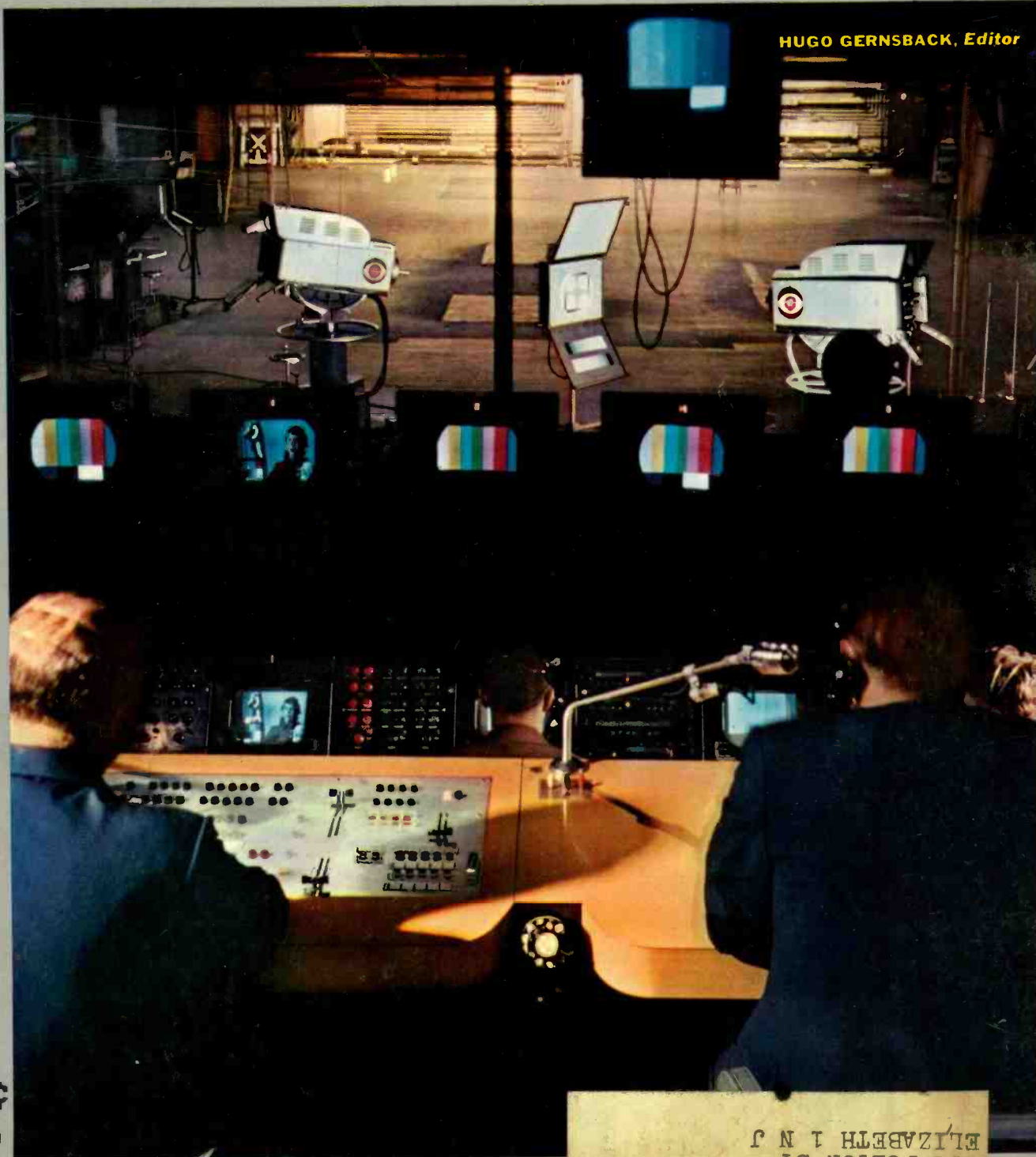

In this issue:

**Use Small Speakers
for
High-Power Work**

How the 6BN6 Works

**Make an Intercom
From Your
A.C.-D.C. Radio**

**The Composite
Video Signal**

**How to Use
the VU Meter**

35¢
U. S. and
CANADA

Control Room—CB
(See page)

FULTON T V 3-57
% PAUL S BOLLARO
434 FULTON ST
ELIZABETH 1 N J

Costs no more than ordinary
Aluminized Picture tubes...



Your best buy in television picture tubes is the Du Mont Twin-Screen Hi-Lite. It offers you greater brilliance, clarity and sharpness that makes your best work better.

The Twin-Screen Hi-Lite is a product of cathode-ray tube specialists. All engineering talents and knowledge at the Du Mont Tube Division are devoted

solely to the design and development of superior cathode-ray tubes.

Use a Du Mont Twin-Screen Hi-Lite picture tube on that next replacement job and see for yourself why leading TV receiver manufacturers specify them. They are available in all popular types for all popular sets.

DU MONT®

Cathode-ray Tube Division, Allen B. Du Mont Laboratories, Inc., Clifton, N. J.

Here's a NEW Way to Reach the Top in TV SERVICING

**All-practice method—
professional techniques,
skills, knowledge of
circuits, etc.**

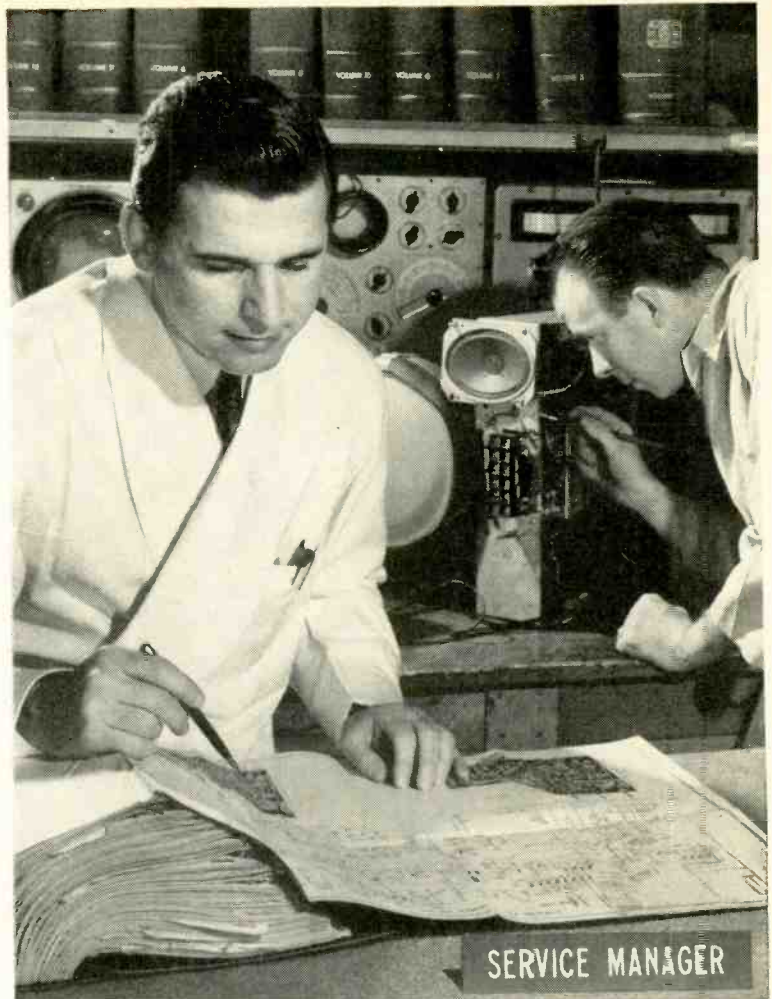

**Includes 17" picture tube, all other
tubes, components for a TV Receiver,
Scope, Signal Generator, HF Probe.
Low Introductory price under \$200,
on easy terms. Mail Coupon today.**

IF YOU HAVE some Radio or Television experience, or if you know basic Radio-Television principles but lack experience—NRI's new Professional Television Servicing course can train you to go places in TV servicing. This advertisement is your personal invitation to get a free copy of our booklet which describes this training in detail.

LEARN-BY-DOING "ALL THE WAY"

This is 100% learn-by-doing, practical training. We supply all the components, all tubes, including a 17-inch picture tube, and comprehensive manuals covering a thoroughly planned program of practice. You learn how experts diagnose TV receiver defects quickly. You see how various defects affect the performance of a TV receiver—picture and sound: learn to know the causes of defects, accurately, easily, and how to fix them. You do more than just build circuits. You get practice recognizing, isolating, and fixing innumerable TV receiver troubles.

You get actual experience aligning TV receivers, diagnosing the causes of complaints from scope patterns, eliminating interference, using germanium crystals to rectify the TV picture signal, obtaining maximum brightness and definition by properly adjusting the ion trap and centering magnets, etc. There isn't room on this or even several pages of this magazine to list all the servicing experience you get.

UHF AND COLOR TV MAKING NEW BOOM
Installing front-end channel selector strips in modern UHF-VHF Television receivers and learning UHF servicing problems and their solution is part of the practice you get if you live in a UHF area. To cash in on the coming color TV boom you'll need the kind of knowledge and experience which this training gives.

GET DETAILS OF NEW COURSE FREE

Once again—if you want to go places in TV servicing, we invite you to find out what you get, what you practice, what you learn from NRI's new course in Professional Television Servicing. See pictures of equipment supplied, read what you practice. Judge for yourself whether this training will further your ambition to reach the top in TV servicing. We believe it will. We believe many of tomorrow's top TV servicemen will be graduates of this training. Mailing the coupon involves no obligation.



National Radio Institute, Dept. 5MFT
16th and U Sts., N.W., Washington 9, D. C.

Please send my FREE copy of "How to Reach the Top in TV Servicing." I understand no salesman will call.

Name _____ Age _____

Address _____

City _____ Zone _____ State _____

Approved Member National Home Study Council

RADIO - ELECTRONICS

Formerly RADIO CRAFT • Incorporating SHORT WAVE CRAFT • TELEVISION NEWS • RADIO & TELEVISION*

Hugo Gernsback
Editor and Publisher
M. Harvey Gernsback
Editorial Director
Fred Shunaman
Managing Editor
Robert F. Scott
W2PWG, Technical Editor
Jerome Kass
Associate Editor
I. Queen
Editorial Associate
Matthew Mandl
Television Consultant
Elizabeth Stalcup
Production Manager
Angie Pascale
Editorial Production
Wm. Lyon McLaughlin
Tech. Illustration Director
Sol Ehrlich
Art Director

Lee Robinson
General Manager
John J. Lamson
Sales Manager
G. Aliquo
Circulation Manager
Adam J. Smith
Director, Newsstand Sales
Robert Fallath
Promotion Manager

GERNSBACK PUBLICATIONS, INC.

Executive, Editorial and Advertising Offices, 25 West Broadway, New York 7, N. Y. Telephone REctor 2-8630.

Hugo Gernsback
Chairman of the Board
M. Harvey Gernsback
President
G. Aliquo
Secretary

ON THE COVER

(Story on page 39) Control room of the CBS color studio in New York City. Two rows of monitors are ahead of the control desk and the color stage is visible through the wide window ahead.

Color original by Dan Rubin



NOVEMBER 1955

Vol. XXVI, No. 11

Editorial (Page 33)

Television for Deaf Children..... 33

Television (Pages 34-44)

Again—the Matrix.....by Robert G. Middleton 34
The Little Things that Count.....by Art Margolis 36
Control Room (Cover Feature).....by John Koushouris 39
Composite Video Signal.....by Jesse Dines 40
TV Service Clinic.....Conducted by Jerry Kass 42

Radio (Pages 45-53)

Leave 'Em in or Take 'Em Out.....by Jack Darr 45
Adapting the A.C.—D.C. for Intercom Operation.....by Ralph T. Guarente 48
Gated-Beam Discriminator.....by Sol Heller and Irving Shulman 50
Improved Transistor Regenerator.....by Joseph Amorose 52
An Improvement in AM-FM Tuners.....by D. L. Stoner 53

Technical Reports (Pages 54-57)

What's New..... 54
The Technical Reporter.....by Sol Heller 56

Electronics (Pages 58-60)

Traffic Control System.....by Roy R. Newsom 58
Magnetic-Induction Flowmeter.....by Theodore C. Jay, Jr. 60

Test Instruments (Pages 61-64)

Squitch-Panel.....by H. A. Highstone 61
Build This Ultra-Sensitive Transistorized Meter.....by I. Queen 63

Audio—High Fidelity (Pages 77-122)

The VU Meter and its Uses.....by John T. Frye 77
Variable Damping . . . How Good Is It?.....by Norman H. Crowhurst 82
3-Channel Mixer Equalizer.....by George L. Augspurger 87
High Power With Small Speakers.....by H. L. Matsinger 98
For Golden Ears Only: The Pentron HFP-1 preamplifier; National Horizon 20 amplifier; National Horizon 5 preamp; new records review.....by Monitor 104

DEPARTMENTS

| | | | |
|--------------------------------|-----|--------------------------------|-----|
| Books..... | 161 | Question Box..... | 143 |
| Business..... | 155 | Radio Month..... | 6 |
| Correspondence..... | 10 | Radio-Electronic Circuits..... | 140 |
| New Devices..... | 126 | Technical Literature..... | 159 |
| New Tubes and Transistors..... | 132 | Technicians' News..... | 136 |
| Patents..... | 134 | Technotes..... | 146 |
| People..... | 153 | Try This One..... | 150 |

Average Paid Circulation over 175,000

RADIO-ELECTRONICS, November, 1955, Vol. XXVI, No. 11. Published monthly at Mt. Morris, Ill. by Gernsback Publications, Inc. Second-class mail privileges authorized at Mt. Morris, Ill. Copyright 1955 by Gernsback Publications, Inc. Text and illustrations must not be reproduced without permission of copyright owners.

SUBSCRIPTIONS: Address correspondence to Radio-Electronics, Subscription Dept., 404 N. Wesley Ave., Mt. Morris, Ill., or 25 West Broadway, New York 7, N. Y. When ordering a change please furnish an address stencil impression from a recent wrapper. Allow one month for change of address.

SUBSCRIPTION RATES: U. S., U. S. possessions and Canada, \$3.50 for one year; \$6.00 for two years; \$8.00 for three years; single copies 35c. Pan-American countries \$4.00 for one year; \$7.00 for two years; \$9.50 for three years. All other countries \$4.50 a year; \$8.00 for two years; \$11.00 for three years.

BRANCH ADVERTISING OFFICES: Chicago: 7522 North Sheridan Road, Tel. ROgers Park 4-8000. Los Angeles: Ralph W. Harker and Associates, 600 South New Hampshire, Tel. DUmkin 7-2328. San Francisco: Ralph W. Harker and Associates, 582 Market St., Tel. GARfield 1-2481. **FOREIGN AGENTS:** Great Britain: Atlas Publishing and Distributing Co., Ltd., London E.C. 4. Australia: McGill's Agency, Melbourne. France: Brentano's, Paris 2e. Belgium: Agence et Messageries de la Presse, Brussels. Holland: Trilectron, IJckenstede. Greece: International Book & News Agency, Athens. So. Africa: Central News Agency Ltd., Johannesburg. Capetown, Durban, Natal. Universal Book Agency, Johannesburg. Middle East: Steimatzky Middle East Agency, Jerusalem. India: Broadway News Centre, Dadar, Bombay #14. Pakistan: Paradise Book Stall, Karachi 3. **POSTMASTER:** If undeliverable send form 3578 to: RADIO-ELECTRONICS, 25 West Broadway, New York 7, N. Y. *Trademark registered U. S. Patent Office.

ADVANCE! Raise your earning power—learn RADIO-TELEVISION-ELECTRONICS by SHOP-METHOD HOME TRAINING

GOOD JOBS AWAIT THE TRAINED RADIO-TV TECHNICIAN

There is a place for *you* in the great Radio-Television-Electronics industry when you are trained as National Schools will train you at home!

Trained technicians are in growing demand at good pay—in manufacturing, broadcasting, television, communications, radar, research laboratories, home Radio-TV service, and other branches of the field. National Schools Master Shop-Method Home Training, with newly added lessons and equipment, trains you in your spare time, right in your own home, for these fascinating opportunities. **OUR METHOD IS PROVED BY THE SUCCESS OF NATIONAL SCHOOLS TRAINED MEN, ALL OVER THE WORLD, SINCE 1905.**

EARN WHILE YOU LEARN

Many National students pay for all or part of their training with spare time earnings. We'll show you how you can do the same! Early in your training, you receive "Spare-time Work" Lessons which will enable you to earn extra money servicing neighbors' and friends' Radio and Television receivers, appliances, etc.

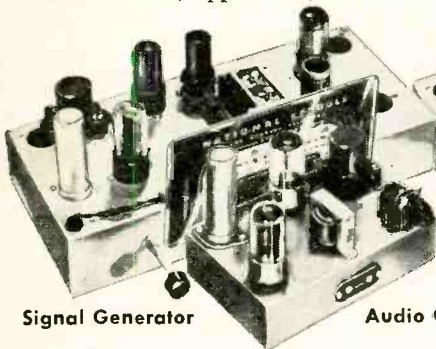

Signal Generator



T. R. F. Receiver

Audio Oscillator

National Schools Training is All-Embracing

National Schools prepares you for your choice of many job opportunities. Thousands of home, portable, and auto radios are being sold daily—more than ever before. Television is sweeping the country, too. Co-axial cables are now bringing Television to more cities, towns, and farms every day! National Schools' *complete* training program qualifies you in all fields. Read this partial list of opportunities for trained technicians:

Business of Your Own • Broadcasting
Radio Manufacturing, Sales, Service • Telecasting
Television Manufacturing, Sales, Service
Laboratories: Installation, Maintenance of Electronic Equipment
Electrolysis, Call Systems
Garages: Auto Radio Sales, Service
Sound Systems and Telephone Companies, Engineering Firms
Theatre Sound Systems, Police Radio
And scores of other good jobs in many related fields.

TELEVISION TRAINING

You get a complete series of up-to-the-minute lessons covering all phases of repairing, servicing and construction. The same lesson texts used by resident students in our modern and complete Television broadcast studios, laboratories and classrooms!



MASTER ALL PHASES!

Get Master Shop-Method Home Training from an Established Practical Resident School with its own Training with its own Training — almost 50 Years of Successful Experience in Training Ambitious Men.



Shops, Laboratories, Studios — almost 50 Years of Successful Experience in Training Ambitious Men.

We Bring National Schools To You!



You also receive this Multitester

Superheterodyne Receiver

LEARN BY DOING

You receive and keep all the modern equipment shown above, including tubes and valuable, professional quality Multitester. *No extra charges.*

FREE! RADIO-TV BOOK AND SAMPLE LESSON!

Send today for National Schools' new, illustrated Book of Opportunity in Radio-Television-Electronics, and an actual Sample Lesson. No cost—no obligation. Use the coupon now—we'll answer by return airmail.

APPROVED FOR
VETERANS
AND
NON-VETERANS
Check coupon below

Both
Resident and
Home Study
Courses Offered!

NATIONAL SCHOOLS

TECHNICAL TRADE TRAINING SINCE 1905
Los Angeles 37, California • Chicago: 323 W. Polk Street, In Canada: 811 West Hastings Street, Vancouver, B. C.



GET FACTS FASTEST! MAIL TO OFFICE NEAREST YOU!

(mail in envelope or paste on postal card)

NATIONAL SCHOOLS, Dept. RG-115

4000 S. Figueroa Street or 323 West Polk Street
Los Angeles 37, Calif. Chicago 7, Ill.

Send FREE Radio-TV Electronics book and FREE sample lesson. No obligation, no salesman will call.

NAME _____ BIRTHDAY _____ 19 _____

ADDRESS _____

CITY _____ ZONE _____ STATE _____

Check here if interested ONLY in Resident Training at Los Angeles. VETERANS: Give Date of Discharge _____

Audio Powerhouse

MEETS THE HIGH POWER
DESIGN REQUIREMENTS
OF HIGH FIDELITY
AUDIO AMPLIFIERS

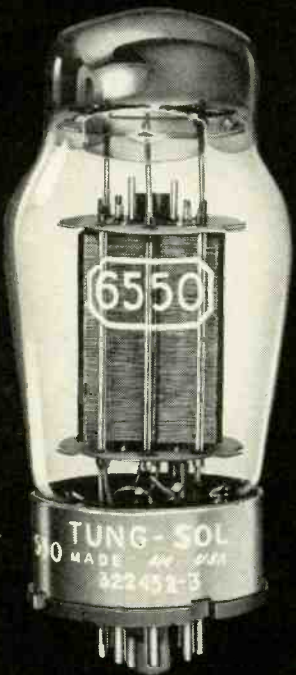

For outputs up to 100 watts, two 6550's in push-pull will provide the same power now attained in most existing designs by the use of four or more tubes. Reduction in the number of tubes means simplified electrical balance, reduced maintenance and over-all lower cost. With proper circuitry, the 6550 will provide full power output with approximately the same grid voltage drive as the 6L6, 5881 or KT66 types. The 6550 is produced under laboratory conditions with exhaustive quality control to assure premium performance and long life. Ask your tube supplier for it.

TUNG-SOL ELECTRIC Inc., Newark 4, N.J.
Sales Offices: Atlanta, Chicago, Columbus,
Culver City, Dallas, Denver, Detroit,
Newark, Seattle

TUNG-SOL
6550
BEAM POWER AMPLIFIER

the Radio month



MONAURAL DELAY, a system in which a sound is received by one ear .06 second before it reaches the other ear, produces better hearing. Tests conducted by Ohio State University's Speech and Hearing Clinic showed that radio messages received under noisy conditions were 22% clearer when they were heard by one ear before the other. The delayed signal sounded "louder, fuller and farther away." The delay was produced with a tape recording device that split the signal fed to headphones.

The reason monaural delay produces better hearing is not clearly understood. However, Ohio State University scientists state that the .06-second delay, which gives the best results, corresponds with estimates of the time required for the discharge of a signal from the auditory nerve. "What may be happening," they report, "is that the listener is getting two complete and distinct presentations of the signal, one through each ear, with no interference."

JOHN V. L. HOGAN, pioneer radio engineer, has been awarded the IRE Medal of Honor, the highest technical award in the radio engineering profession. The award was presented "for his outstanding contributions to the electronic field as a founder and builder of the Institute of Radio Engineers, for the long sequence of his inventions and for his continuing activity in the development of devices and systems useful in the communications art." The award will be presented during the IRE convention in New York next March.

Mr. Hogan began his radio career in 1906 as a laboratory assistant to Lee de Forest. From 1910 to 1921 he held important posts with the National Electric Signaling Co. and the International Radio Telegraph Co., then became a

consulting engineer in New York City. He is responsible for many inventions in radio, television and especially facsimile. His inventions include the ganged variable capacitor. He was the founder and owner of the first high-fidelity station, WQXR (New York City), which he sold to *The New York Times*. At present he is president of Hogan Laboratories, Inc., of New York City.

In 1912 he helped found the Institute of Radio Engineers, which has since grown to be one of the largest engineering societies in the world, with an international membership of over 43,000. He served as vice president of the IRE from 1916 to 1919 and president in 1920. He has also served frequently as a member of the board of directors and on many IRE committees.

ELECTRONIC EYES have been developed for the Ground Observer Corps for use during periods of darkness or poor visibility. The device is a lightweight portable detector mounted on a hat (see photo).

The receiver operates on the basis that any enemy aircraft penetrating our defenses would be forced to use nonoptical methods of navigation and bombing during conditions of poor visibility. The radar from this aircraft



would radiate strong bursts of high-frequency energy, easily detected by Ground Observer Corps personnel equipped with the detector.

Signals are picked up by the horn antenna and fed to a crystal detector. The output of the crystal is fed, by way of a coaxial choke assembly, to a transistorized, printed-circuit pulse amplifier. The choke assembly has a filtering action that delivers sharp pulses to the amplifier which in turn feeds lightweight earphones.



Prepare Now... in spare time at Home... for a New,

PROFITABLE, INTERESTING FUTURE



in
TELEVISION
RADIO - ELECTRONICS

RADIO CHIEF OF ILE DE FRANCE
FRENCH LUXURY LINER PRAISES D. T. I.

Radio Chief—Jean Desmas Says:

"Your Training Organization in Chicago is known not only throughout Europe, but also in many parts of the world as one of America's finest Television, Radio and Electronics training centers."



JACK DEMPSEY

Former World's Heavyweight Champion
TELLS WHY HE'S PROUD
TO BE
WITH **D.T.I.**

- I have been greatly impressed with D.T.I.'s wonderful spirit of friendliness and sincere determination to help its students make good in Television-Radio-Electronics.
- I admire its remarkable 24 year record of helping men build brighter futures.
- I also admire the business policy of its management and the thoroughness of its large faculty of instructors.
- Never have I heard young men praise a school as enthusiastically as do the students and graduates of D.T.I. They are its best boosters.

Prepare At Home Or In Our Chicago Laboratory!

See for yourself how readily you may prepare at home, or in our modern Chicago laboratories, for a good job or business of your own in one of America's most promising, fast-growing fields—TELEVISION-RADIO-ELECTRONICS.

If you train at home you get (1) the use of a 16-mm. movie projector and 16 reels of animated movies to help you learn important points faster... easier, (2) modern, well illustrated lessons and (3) sixteen shipments of electronic parts enabling you to get valuable practical experience from over 300 projects—including building and keeping the electronic equipment shown below. And upon completing training, you have the optional privilege of building and keeping a big 21 INCH TV Set. (D.T.I. offers another home training in Television-Radio-Electronics, but without the TV set.) Get the full story. Mail coupon today!



HOME MOVIES

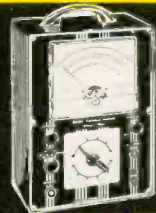

VACUUM TUBE
VOLTMETER



OSCILLOSCOPE



Build and keep this BIG DTI
Engineered TV set—easily
converted to U.H.F. (DTI offers
another home training, but
without the TV set.)

**LAUD D.T.I.'s
HOME MOVIES
IN CONGRESS**

D.T.I.'s remarkable home training benefit of visual training MOVIES has been praised from the floor of the House of Representatives in Washington, D.C. and recorded in the Congressional Record.



If subject to military service, the information we have for you should prove very helpful. Mail coupon today.

"One of America's Foremost
Television Training
Centers"



**89 WAYS
TO
EARN
MONEY
IN TELEVISION
RADIO
ELECTRONICS**

MEMBER OF NATIONAL HOME STUDY COUNCIL
MAIL COUPON TODAY!

DeVRY TECHNICAL INSTITUTE
4141 BELMONT AVE., CHICAGO 41, ILL.

Dept. RE-11-L

I would like your valuable information-packed publication showing how I may get started toward a good job or my own business in Television-Radio-Electronics.

Name _____ Age _____
(PLEASE PRINT)
Street _____ Apt. _____
City _____ Zone _____ State _____

D. T. I.'s Training is Available in Canada

DeVRY TECHNICAL INSTITUTE

CHICAGO 41, ILLINOIS

FORMERLY

DeFOREST'S TRAINING, INC.



ACTUAL SIZE

TURNER MODEL 58

New high fidelity dynamic miniature

VERSATILE MODEL 58, a superior lavalier microphone, meets TV, broadcasting, recording, PA requirements for performance, durability, compactness and adaptability. High fidelity Model 58 has the sensitive-but-rugged new Turner Dynaflex diaphragm, designed to resist shock, temperature extremes, moisture. Response: 60 - 13,000 c.p.s. Level -57 db at high impedance. Write today for more information.

- | | | |
|--|--------------|--------|
| MODEL 58 (high & low impedance) | } List Price | \$5700 |
| MODEL 58A (50 or 200 ohms impedance) | | |
| Support clip, neck cord, 25-ft. cable | | |
| MODEL G-4 Swivel Desk Stand | List Price | \$5.75 |

THE TURNER COMPANY
933 17th Street N.E.
Cedar Rapids, Iowa

IN CANADA:
Canadian Marconi Co., Toronto, Ont. & Branches.
EXPORT:
Ad. Auriema, Inc., 89 Broad St., New York 4, N. Y.

THE RADIO MONTH

NINE NEW TV STATIONS have gone on the air since our last report:

| | | |
|---------|--------------------|----|
| WKRG-TV | Mobile, Ala. | 5 |
| KCRA-TV | Sacramento, Calif. | 3 |
| KTVU | Stockton, Calif. | 36 |
| WCTV | Thomasville, Ga. | 6 |
| WTTW | Chicago, Ill. | 11 |
| KARD-TV | Wichita, Kan. | 3 |
| KTBS-TV | Shreveport, La. | 3 |
| WTVS | Detroit, Mich. | 56 |
| KTRE-TV | Lufkin, Tex. | 9 |

WWOR-TV, Worcester, Mass., channel 14, has gone off the air.

Calendar of Events

High-Fidelity Show, Nov. 4-6, Benjamin Franklin Hotel, Philadelphia, Pa.
Atomic Exposition, Dec. 10-16, Cleveland Public Auditorium, Cleveland, Ohio.

NEW COLOR TV tube now in General Electric laboratories combines advantages and eliminates disadvantages of existing types. Tube has vertical color stripes on screen, ahead of vertical grill which acts as electron-optical mask or lens and permits 90% of beam to reach screen (shadow-mask tube passes only 15% of beam). In-line three-gun assembly halves number of convergence controls and eliminates switching and gating difficulties of one-gun tube. G-E hopes to get tube into production in about a year. Complete story on the tube is scheduled for next month.

TACAN (TACTical Air Navigation radio aid), an electronic system that instantly and automatically informs a pilot of his distance and bearing from a fixed ground station, was unveiled to the public recently by Federal Telecommunication Laboratories, research division of International Telephone and Telegraph. The distance facility gives a meter indication, in nautical miles, from a ground beacon tuned in by the pilot. The bearing facility gives a meter indication, in degrees, with respect to the beacon. It is expected to replace the present VOR-DME system now used in commercial American air navigation.

(Continued)

The TACAN system (see illustration) was originally developed by the Armed Forces. It operates in the u.h.f. band with an airborne multichannel receiver-transmitter providing both the distance and bearing information. The ground installation consists of a receiver-transmitter. Spaced 1 mc apart, 126 two-way operating channels are available for assignment. Accuracy of the system is extremely high, with the distance accurate to within 1/2 mile at 100 miles and proportionately less at lower ranges. Average bearing errors are about 3/4°.

STRANDED AIRMEN can now direct their own rescue with the aid of a miniature emergency radio developed by the Air Research and Development Command. The new radio (shown in photo to the right of the battery) weighs only 15 ounces and has a volume of 20 cubic inches. It replaces the older and heavier unit shown at the left.

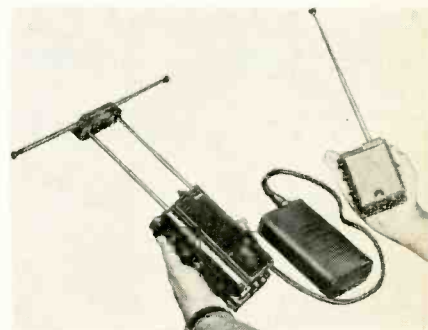

The transmitter-receiver will be included in survival kits carried by Air Force personnel when flying over water or wilderness areas. The unit can also be set to broadcast a continuous tone to provide a fix for rescue aircraft. It contains six subminiature tubes and under normal conditions will transmit from 50 to 100 miles. Power is supplied by a battery of mercury cells. END

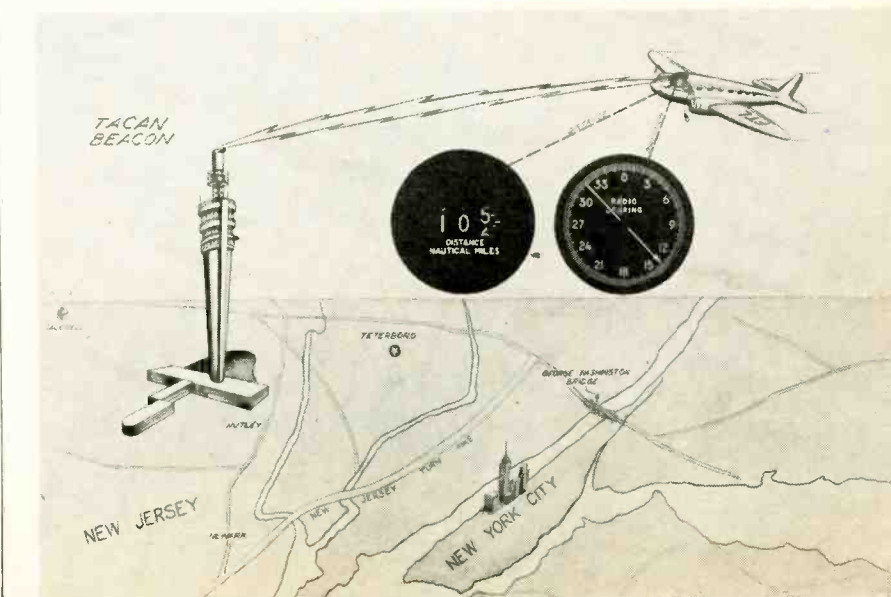

Let me send you FREE
the entire story

Just fill out the coupon and mail it. I will send you, free of charge, a copy of "How to Pass FCC License Exams," plus a sample FCC-type Lesson, and the amazing new booklet, "Money-Making FCC License Information."

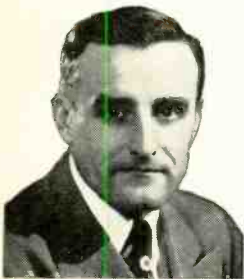

CARL E. SMITH, E.E.
President

I can train you to pass your FCC License Exams in a minimum of time if you've had any practical radio experience—amateur, Army, Navy, radio servicing, or other. My time-proved plan can help put you, too, on the road to success.

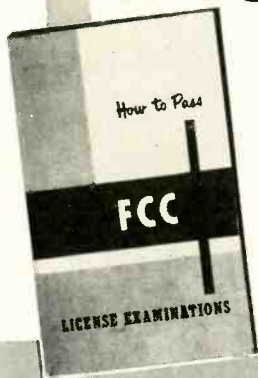

How to Pass FCC COMMERCIAL Radio Operator License Exams

FREE

Tells where to apply and take FCC examinations, location of examining office, scope of knowledge required, approved way to prepare for FCC examinations, positive method of checking your knowledge before taking the examination.

GET YOUR FCC TICKET IN A MINIMUM OF TIME

Get this Amazing Booklet FREE



TELLS HOW

HERE IS YOUR GUARANTEE

If you fail to pass your Commercial License exam after completing our course, we guarantee to continue your training without additional cost of any kind, until you successfully obtain your Commercial license.

WE GUARANTEE

TO TRAIN AND COACH YOU AT HOME IN SPARE TIME UNTIL YOU GET

YOUR FCC LICENSE

If you have had any practical experience—Amateur, Army, Navy, radio repair, or experimenting

TELLS HOW

TV ENGINEERING INCLUDED IN OUR TRAINING & COACHING

Our Amazingly Effective JOB-FINDING SERVICE

Helps CIRE Students Get Better Jobs

Here are a few recent examples of Job-Finding results

BROADCASTING

"Your 'Chief Engineer's Bulletin' is a grand way of obtaining employment for your graduates who have obtained their 1st class license. Since my name has been on the list I have received calls or letters from five stations in the southern states, and am now employed as Transmitting Engineer at WMMT."

Elmer Powell, Box 274, Sparta, Tenn.

CIVIL SERVICE

"I have obtained a position at Wright-Patterson Air Force Base, Dayton, Ohio, as Junior Electronic Equipment Repairman. The Employment Application you prepared for me had a lot to do with my landing this desirable position."

Charles E. Loomis, 4516 Genessee Ave., Dayton 6, Ohio

AIRLINES

"Due to your Job-Finding Service, I have been getting many offers from all over the country, and have taken a job with Capital Airlines in Chicago as Radio Mechanic."

Harry Clare, 4537 S. Drexel Blvd., Chicago, Ill.

Your FCC ticket is recognized by employers as proof of your technical ability.

TELLS HOW

Employers make

An Approved Member



JOB OFFERS Like These to Our Graduates Every Month

Letter from nationally-known Airlines,

"Radio Operators and Radio Mechanics are needed for our company. Periodic wage increase with opportunity for advancement. Both positions include many company benefits such as paid vacations, free flight mileage allowance and group insurance."

These are just a few examples of the job offers that come to our office periodically. Some licensed radioman filled each of these jobs . . . it might have been you!

HERE'S PROOF FCC LICENSES ARE OFTEN SECURED IN A FEW HOURS OF STUDY WITH OUR COACHING AT HOME IN SPARE TIME

| Name and Address | License | Time |
|--|-----------|----------|
| Harry G. Frame, Box 429, Charleston, W. Va. | 2nd Class | 13 Weeks |
| Charles Ellis, Box 449, Charles City, Iowa | 1st Class | 28 Weeks |
| Omar Bibbs, 1320 E. 27th St., Kansas City, Mo. | 1st Class | 34 Weeks |
| Kenneth Rue, Dresser, Wisconsin | 2nd Class | 20 Weeks |
| B. L. Jordan, Seattle, Washington | 1st Class | 20 Weeks |

CLEVELAND INSTITUTE OF RADIO ELECTRONICS
CARL E. SMITH, E. E., Consulting Engineer, President
Desk RE-82, — 4900 Euclid Bldg., Cleveland 3, Ohio

OURS IS THE ONLY HOME STUDY COURSE WHICH SUPPLIES FCC-TYPE EXAMINATIONS WITH ALL LESSONS AND FINAL TESTS.

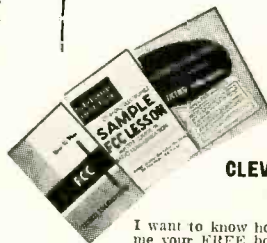

Get All 3 FREE MAIL COUPON NOW

CLEVELAND INSTITUTE OF RADIO ELECTRONICS

Desk RE-82, 4900 Euclid Bldg., Cleveland 3, Ohio
(Address to Desk No. to avoid delay)

I want to know how I can get my FCC ticket in a minimum of time. Send me your FREE booklet, "How to Pass FCC License Examinations" (does not cover exams for Amateur License), as well as a Sample FCC-type lesson and the amazing new booklet, "Money-Making FCC License Information." Be sure to tell me about your Television Engineering course.

NAME..... AGE.....

ADDRESS.....

CITY..... ZONE..... STATE.....

FOR PROMPT RESULTS SEND AIR MAIL
Special tuition rates to members of the U. S. Armed Forces
Electronic Training Available to Canadian Residents

INTERNATIONAL'S

**NEW
TV RECTIFIER
REPLACEMENT
BONUS
PACK!**



**FREE!
NYLON TV TOOL**

**With every pack of 4 TV
Selenium Replacement Rectifiers...
A PAIR and a SPARE PAIR!**

You can't miss with International's New "BONUS PACK"! You'll get the *best* in TV replacement rectifiers. Each BONUS PACK contains a pair for immediate use, and a spare pair for your next job—PLUS a Nylon TV Alignment Tool worth \$1.00—ABSOLUTELY FREE!

SPECIFY INTERNATIONAL RECTIFIERS for long, dependable performance—the Widest Range in the Industry! Best for you... Best for your service customers!



Ask your distributor
for details about
"Bonus Pack" today!

**International
Rectifier**
CORPORATION

1521 East Grand Avenue, El Segundo, California • Oregon 8-6281
IN CANADA: Atlas Radio Corp., 50 Wingold Ave. W., Toronto, Ontario

**WORLD'S LARGEST SUPPLIER
OF INDUSTRIAL METALLIC RECTIFIERS**



RESISTOR RATINGS

Dear Editor:

A few days ago I received from you a letter written by Mr. Henry Chu of Los Angeles who referred to my July article "How Much Can a Resistor Take?" and brought up a number of excellent points on the difference between nominal and practical wattage ratings of resistors. He also suggested further clarification on characteristics and tolerances of resistors and other components.

A resistor may be used at its full rated wattage provided certain limits of ambient temperature are not exceeded. For ordinary composition resistors the actual wattage may be 100% of the rated value when ambient temperature does not exceed 104° F, and may be as much as 83% when ambient does not exceed 122° F. Many resistors commonly used for service replacements are so conservatively rated that these temperature limits may be exceeded.

Measurements of temperature underneath the chassis of typical receivers, while in their cabinets, seldom show much if anything in excess of 110° F, with outside air temperature at 75° F. Such measurements are made here with extended-stem expansion thermometers and with extended elements of temperature bridges. The thermometer must not be subjected to either radiant or convection heating on top of the chassis, where temperatures are much higher than underneath because of tube heat retained within the cabinets of small sets.

Ratings for high-wattage resistors, which usually are the wirewound vitreous-enamel types, are based on operation in free air. Such units are not harmed by surface temperatures as high as 400° to 500° F. Actual dissipations must be reduced when operation is in confined spaces, to avoid hot spots on the resistors.

Mr. Chu brings out a matter which should have been emphasized in the article. It certainly is desirable to use resistors of higher wattage rating than absolutely necessary, thus avoiding small areas or regions of temperature high enough to affect nearby components even though resistors are unharmed.

The article mentions that resistors should not be pushed tightly together to shut off part of their area if the resistor surfaces are to dissipate heat to surrounding air.

It must be remembered, however, that actual heating in BTU's per minute or

NOW... model SX-100

Selectable side band receiver

**BUILT TO THE SPECIFICATIONS OF
1,000,000 FIELD EXPERTS**

See it at your Jobber—only \$295.00



Model SX-100, Amateur Net \$295.00
Matching R-46B Speaker \$17.95
Frequency Range 538kc-1580kc
1720kc-34mc

Hallicrafters 22 years of production know-how, the engineering experience of developing over 100 different major receiver designs, plus the advice of over 1,000,000 field experts operating Hallicrafters receivers all are combined to bring you this outstanding new receiver—the SX-100! Hallicrafters alone, long recognized as the leading designer and manufacturer of quality communications equipment, can offer you the dependability and performance of this great new SX-100 at the amazingly low price of just \$295.00

Look at these features you enjoy with the SX-100... before, they were available only on receivers costing a great deal more!

1. SELECTABLE SIDE BAND OPERATION.
2. "TEE-NOTCH" FILTER—This new development provides a stable non-regenerative system for the rejection of unwanted heterodyne. The "Tee-Notch" also produces an effective steepening of the already excellent 50 K.C. i.f. pass band (made famous in the SX-96) and further increases the effectiveness of the advanced exalted carrier type reception.
3. NOTCH DEPTH CONTROL for maximum null adjustment.
4. ANTENNA TRIMMER.
5. PLUG IN LABORATORY TYPE EVACUATED 100 KC QUARTZ CRYSTAL CALIBRATOR—included in price.
6. LOGGING DIALS FOR BOTH TUNING CONTROLS.
7. FULL PRECISION GEAR DRIVE DIAL SYSTEM.
8. SECOND CONVERSION OSCILLATOR CRYSTAL CONTROLLED—greater stability through crystal control and additional temperature compensation of high frequency oscillator circuits.

CONTROLS

Pitch Control
Reception
Standby
Phone Jack
Response control (upper and lower side band selector)
Antenna Trimmer
Notch Frequency
Notch depth
Calibrator on/off
Sensitivity
Band Selector
Volume
Tuning
AVC on/off
Noise limiter on/off
Bandspread
Selectivity

hallicrafters
CHICAGO 24, ILLINOIS

RADIO-ELECTRONICS

MEN 17-45!
HERE'S A NEW
OPPORTUNITY
FOR YOU!



PREPARE AT HOME FOR A
PROFITABLE CAREER IN
AUTOMATION
ELECTRONICS*

Get in on the Ground Floor of this
Fast-Moving Field

Want a better job? . . . more money? . . . better working conditions? These are the things that can come to a man when he has a *skill* to offer . . . especially when that skill is in a newer field where ground floor opportunities often lead to well-paying positions. Such a field is the Electronic applications to **AUTOMATION** — and *what a field!*

Many plants, large and small, in various parts of the country are looking for ways of using automatic electronic control equipment to help turn out a better product and at lower cost. This equipment must be designed, installed and maintained — calling for well trained men. That's where **YOU** may come in!

You need no special technical experience . . . no previous knowledge of Automation Electronics . . . to prepare for a future that can be bright and more secure. For now there is a proved way to get this important know-how. Mail coupon for complete details. Men 17 to 45 preferred.

***WHAT IS AUTOMATION ELECTRONICS?**

Simply stated, this refers to the marvelous electronic controls that will help regulate the much talked about "automatic factory"—as well as other amazing automatic equipment in plants, offices and elsewhere. It is a gateway to some of the most desirable opportunities in the amazing, newer field of Automation.

ONE OF AMERICA'S
FOREMOST ELECTRONICS
TRAINING CENTERS



DEVRY TECHNICAL INSTITUTE
CHICAGO 41, ILLINOIS
 FORMERLY
DEFOREST'S TRAINING, INC.

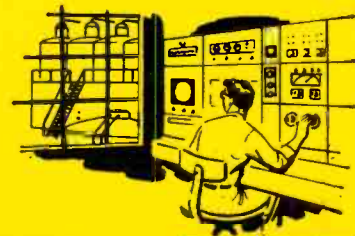

Industrial Processing

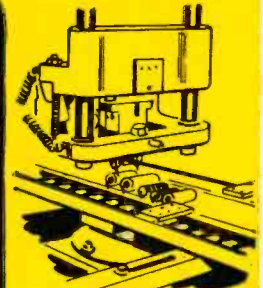

Making Electronic devices



Recording and billing



Anti-aircraft gun control

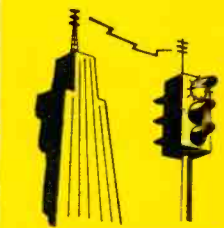

Traffic control signals

A New Training Program!

As one of the leading organizations of its kind, the DeVry Technical Institute has years of experience in teaching Electronics, Television and Radio. So it is only natural for this training institute to develop a new program to prepare men for good jobs in instrumentation — as well as in the design, installation and maintenance of Electronic controls — as applied to Automation.

EMPLOYMENT SERVICE

Following the same proved method used to train thousands of other men, you get valuable practical experience from actual electronic equipment. You also receive well-illustrated texts and effective moving pictures to show important basic principles—a wonderful home training advantage! To top that off, D.T.I. provides actual employment help when you have completed the training—all of which can open the way to many new and exciting opportunities.

Member of
 National Home Study Council

MAIL THIS COUPON TODAY!

DEVRY TECHNICAL INSTITUTE, Dept. RE-11A-L
 4141 Belmont Avenue, Chicago 41, Ill.

I would like further information about the newer Electronic opportunities in **AUTOMATION**, also facts on how you may help me to prepare.

Name _____ Age _____
 Please Print
 Street _____ Apt. _____
 City _____ Zone _____ State _____

5 **DTI's training is available in Canada**

The Only COMPLETE Line...



Smooth Power
PHONOMOTORS

- FOR PORTABLE PHONOS • FOR HI-FI UNITS • FOR COMBINATIONS • FOR RECORD CHANGERS • FOR TAPE RECORDERS • FOR REPLACEMENT USE • FOR EVERY PHONO APPLICATION

Follow the lead of America's foremost manufacturers — Specify GI for all your phono-motor needs. A complete range of speeds and types to meet every requirement — backed by over half a century of design leadership!

Model D-10
4-pole, shaded pole A.C.
Induction type for
tape, wire, or disc
recorders

Model RM 4
Single speed,
4-pole motor



THE GENERAL INDUSTRIES CO.

DEPARTMENT GE • ELYRIA, OHIO

NEW! For the First Time!

CHECK CAPACITORS UNDER WORKING CONDITIONS!

CAPACITEST

Quickly, Accurately checks:

- PAPER, MICA, CERAMIC CAPACITORS
- ELECTROLYTICS
- CONTINUITY
- AC/DC VOLTAGES
- FLASHBULBS



SATISFACTION
GUARANTEED
OR RETURN WITHIN
TEN DAYS FOR REFUND

\$9.95 postpaid
Dir. Net
complete,
ready for
operation

CAPACITEST, the result of months in development.

FREE Special Introductory Offer for limited time only: Set of test leads Free with each CAPACITEST.

ment is a new, compact checker that does a giant job to save you time and money. It will check condensers at 150 Volts, which is approximately the working voltage in a radio or TV set. Meters will not give this type of check since the applied voltage is 20 Volts or less. Avoid call-backs by using CAPACITEST. Accurately, quickly, it shows open, shorted, or intermittent capacitors and leaky electrolytics. Compact: 4"x4"x2"—lightweight, for bench or tool kit.

Order direct from manufacturer — include \$3 deposit with C.O.D.'s. Save PP & COD fees, send \$9.95 & we'll pay postage.

BAR JAY The Barjay Co. 145 West 40 Street New York 18, N.Y.

CORRESPONDENCE (Continued)
hour depends on resistance and current. There would be the same total heat production with given resistances and currents regardless of size or rating of resistors. It is total heat production that determines ambient temperature underneath a chassis, and it is ambient temperature that determines the relation between ratings and actual dissipations of the resistors.

H. P. MANLY
Wilmette, Ill.

PRAISES INTERFLEX

Dear Editor:

I have recently built Dr. Grace's Interflex transistor set described in the August issue of RADIO-ELECTRONICS. For volume, this one-transistor circuit beats anything I have ever tried—and I have tried many transistor hookups. The set will operate a speaker with more than adequate volume from the signals of two 5-kw transmitters about 10 miles away. It outperforms many one-tube sets I have built through the years.

The selectivity of the set is something to write about, too. With the two-coil version I can get five of the six locals fine. Station separation is excellent. On phones, the volume is too loud on most stations, and I had to replace the 25,000-ohm volume control with a 50,000-ohm unit.

I've never seen a one-transistor set that could approach this one in volume and selectivity with so few parts. Dr. Grace's Interflex should occupy the center of the stage for a long, long time.

J. AMOROSE
Richmond, Va.

ABANDON V.H.F. TV?

Dear Editor:

Present TV frequency allocations are a mess. Direct responsibility for the mess cannot be fixed, but everybody knows it exists. The best brains in Government and industry study the problem, but no practical solution has been found. Nor is there evidence one is in the making.

One satisfactory to everyone will never be found. Whatever is done will hurt somebody; some, probably, more than others. Yet, it is abundantly clear present chaotic conditions cannot be tolerated indefinitely. The longer they continue the harder the solution.

Present v.h.f. channels are inadequate. There can be no argument about that. Yet, experience shows v.h.f. and u.h.f. do not intermix. Whether we like it or not, common sense warns that sooner or later TV will be forced to abandon v.h.f. and concentrate on u.h.f.

The question is how to abandon v.h.f. without wrecking the TV industry. Billions are invested in v.h.f.; they cannot be arbitrarily destroyed.

The FCC can make a start by gradually withdrawing low-band channels from TV service. Withdraw channel 2 the first year, channel 3 the second

A dramatic demonstration of a new idea to help you understand music better and enjoy it more...

MUSIC-APPRECIATION RECORDS



Will you accept
WITHOUT CHARGE

A COMPLETE PERFORMANCE—WITH AN ILLUMINATING
ANALYSIS ON A SEPARATE RECORD—OF

Tchaikovsky's FIFTH SYMPHONY

MAX RUDOLF, *conducting*

THE STADIUM CONCERTS SYMPHONY ORCHESTRA

NOTE: Because of the unusual length of the symphony, the Tchaikovsky recording is on two records—a 12" disc with the performance on both sides, and a 10" disc with the analysis on both sides.



ON ONE SIDE there is a full performance of a great musical work. The records feature orchestras and soloists of recognized distinction in this country and abroad. You listen to this performance first, or afterward, as you desire, and then...



ON THE OTHER SIDE is an illuminating analysis of the music, with the themes and other main features of the work played separately with running explanatory comment, so that you can learn *what to listen for* in order to appreciate the work fully.

SPONSORED BY THE BOOK-OF-THE-MONTH CLUB, this new idea is designed for those who enjoy good music but who are aware, too often, that they do not listen to it with complete understanding and appreciation. There is no doubt about the reason: most of us are not properly primed about *what to listen for*. MUSIC-APPRECIATION RECORDS meet this need—for a fuller understanding of music—better than any means ever devised. This enjoyable form of self-education can be as thorough as the Music Appreciation courses given in many universities.

YOU SUBSCRIBE BUT TAKE ONLY THE RECORDS YOU WANT... A new MUSIC-APPRECIATION RECORD will be issued—for subscribers only—every month. Ultimately, all the great masterpieces of music will be included. The announcement about each forthcoming record will be written by the noted composer and music commentator Deems Taylor. After reading this descriptive essay you may take the record or not, as you decide at the time. *You are not obligated to take any specified number of records.* And you may stop the subscription at any time you please!

TWO TYPES OF RECORDS... All MUSIC-APPRECIATION RECORDS are high-fidelity, long-playing records of the highest quality—33 $\frac{1}{3}$ R.P.M. on Vinylite. They are usually of two kinds: first, a so-called Standard Record—a twelve-inch disc which presents the performance on one side, the analysis on the

other. This is sold at \$3.60, to subscribers only. The other is an Analysis-Only Record—a ten-inch disc—priced at \$2.40. The latter is made available each month for any subscriber who may already have a satisfactory long-playing recording of the work being presented. (A small charge is added to the prices above to cover postage and handling.)

TRY A ONE-MONTH SUBSCRIPTION—WITH NO OBLIGATION TO CONTINUE... Why not make a simple trial, to see if these records are as pleasurable and as enlightening as you may anticipate? The Tchaikovsky recording will be sent to you at once—without charge. You may end the subscription immediately after hearing this recording, or you may cancel any time thereafter. In any case, the gift recording is yours to keep.

* * * * *

TYPICAL COMMENT: "Music has been my whole life—but not until I heard my first MUSIC-APPRECIATION RECORD did I realize how much I had been missing when I listened to orchestral music. I subscribed originally for my son, but quickly found that my own enjoyment of orchestral music was increased far beyond what I dreamed possible."

—Jarmila Novotna

STAR OF THE METROPOLITAN OPERA



YOU WILL RECEIVE SEPARATELY A GLOSSARY OF MUSICAL TERMS

PLEASE RETURN ONLY IF YOU HAVE A RECORD PLAYER WHICH CAN PLAY 33 $\frac{1}{3}$ R.P.M. LONG-PLAYING RECORDS

MUSIC-APPRECIATION RECORDS

R39-11

c/o Book-of-the-Month Club, Inc., 345 Hudson Street, New York 14, N. Y.

Please send me at once the Music-Appreciation recording of Tchaikovsky's Fifth Symphony, without charge, and enroll me as a Trial Subscriber to MUSIC-APPRECIATION RECORDS, with the privilege of canceling at any time. I understand that, as a subscriber, I am not obligated to buy any specified number of records, but may take only those I want. Also, I may cancel my subscription after hearing the first recording, or any time thereafter at my pleasure, but the gift offer is free in any case.

Mr. }
Mrs. }
Miss } (PLEASE PRINT)
ADDRESS.....
CITY..... Postal Zone No. STATE..... MAR 40
(if any)

Gives your customers brilliant results ...pays off for you!

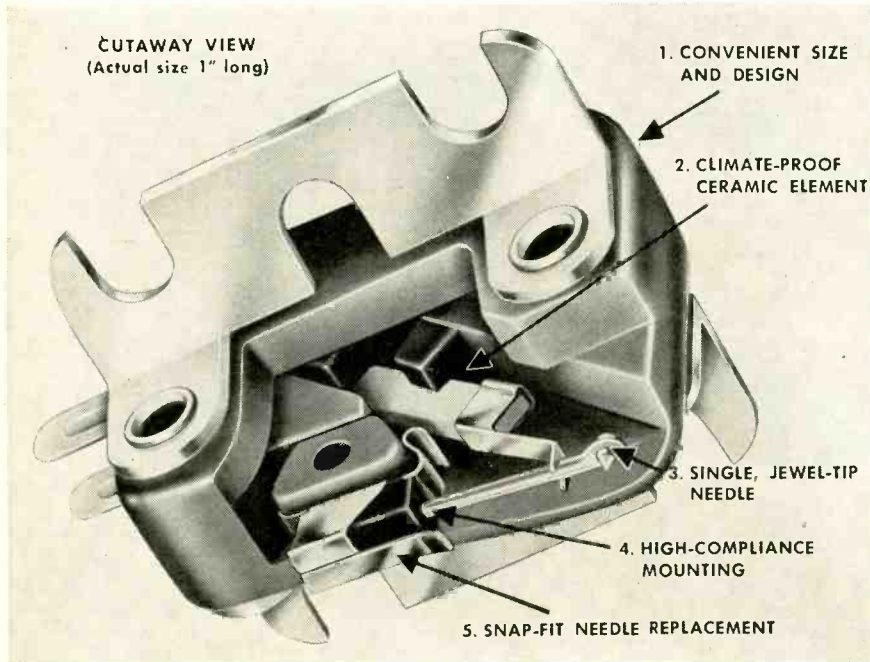

New Sonotone 1P Cartridge

1. Easy to install. Just two models fit most arms now in use. Cartridge is less than 1" long, 8/10" wide with bracket. Time-saving hardware included.
2. Ceramic element gives flat response (see curve) — requires no preamplification or equalization. No deterioration problems as with other types...virtually immune to hum pickup.
3. Replaceable needle, diamond or sapphire. Models for 33-45 rpm, or 78 rpm.
4. Extreme lateral compliance and low-mass design give superior tracking, low wear.
5. Needles snap in, snap out easily.

Tap the Huge 45 RPM Changer Market!

Install this new Sonotone 1P, and give your customers exciting, true, wide-range response. At one stroke, you make a good sale, cut installation time, avoid problems found with other types of cartridges...and build your reputation for quality work and professional advice. No other cartridge has all the advantages this 1P gives you! With sapphire, \$7.50; with diamond, \$25.00.

RESPONSE 30-15,000 ± 3 DB!

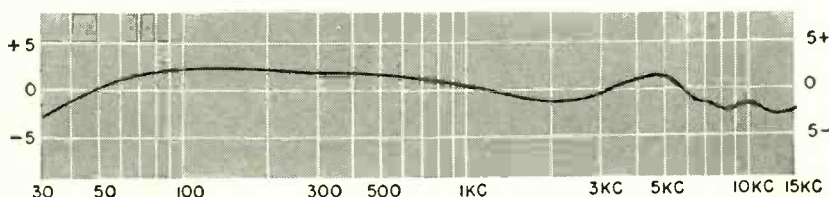

SONOTONE CORPORATION

ELMSFORD, N. Y.

Write Dept. CE-115 for free Phono Modernization Manual

CORRESPONDENCE (Continued)

year and so on until all low-band channels are abandoned, frequency reassignments to be made in the u.h.f. band.

After 5 years abandon the high-band v.h.f. channels. That can probably be done abruptly. With 5 years' warning the change should not be prohibitively expensive to anyone. The plan can be modified where the only station uses a low-band channel. The changeover need not be a shock.

LEE WILCOXON

Des Plaines, Ill.

LOWTHER SPEAKER DESIGN

Dear Editor:

I was surprised to see in your July issue (page 16) that the proprietor of Lowther denied any credit for their speaker design to P. G. A. H. Voigt. I wonder if he would care to repeat his statement in England where Mr. Voigt's name is so much more widely known.

M. O. FELIX

Hamilton, Ontario
Canada

TRAINING BETTER TODAY

Dear Editor:

I read Mr. Perkinson's letter on progressive education in the August issue. I started in radio 12 years ago in a night trade school taking electronics, math, electricity and servicing, and I agree with Mr. Perkinson that the teaching was thorough. But if he considers the radio-TV technicians of today of a lower quality than those of 10 to 15 years ago, he is wrong.

Years ago there were plenty of screwdriver repairmen with only a soldering iron and ohmmeter for test equipment. Most of these overcharged often and their work was inferior. When TV came along, they closed down in droves. The technician of today is better informed and better equipped.

G. P. OBERTO

Richmond, Va.

SIMPLIFIED CONVERSION

Dear Editor:

I have read the article on converting 630 type receivers (September, 1955) and cannot see how you justify such a complicated conversion when the job can be done so much easier. I have converted several of these circuits in the following, much simpler, manner:

1. Remove V104, T111, V105, T112 and associated circuitry.
2. Install a pickoff coil from the 6AL5 video detector to the grid of V106 (Meissner 20-1004 or equivalent).
3. Install a 4.5-mc coil in grid circuit of V106 (Meissner 16-3445 or equivalent).
4. Replace T113 with a 4.5-mc unit (Meissner 17-1023 or equivalent).
5. Align sound channel for 4.5 mc.

FREDERICK J. NORVIK

Albany, N. Y.

(This will work in medium and strong signal areas with resulting loss in sensitivity and noise rejection.—
Editor) END

free

1956 VALUE PACKED ALLIED

324-PAGE ELECTRONIC SUPPLY CATALOG

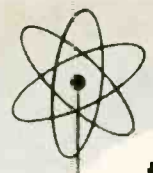

the only COMPLETE catalog for everything in TV, Radio, Hi-Fi and Industrial Electronics

send for it today

Get ALLIED's 1956 Catalog—it's complete, up-to-date—324 pages packed with the world's largest selection of quality electronic equipment at lowest, money-saving prices. Select from the latest in High Fidelity systems and components; P.A. systems and accessories; recorders and supplies; TV tubes, antennas and accessories; Amateur receivers, transmitters and station gear; specialized industrial electronic equipment; test instruments; new build-your-own kits; huge listings of parts, tubes, transistors, tools, books—the world's most complete stocks of quality equipment. Get every buying advantage at ALLIED: fastest shipment, expert personal help, lowest prices, assured satisfaction. Send today for your FREE copy of the big 1956 ALLIED Catalog.

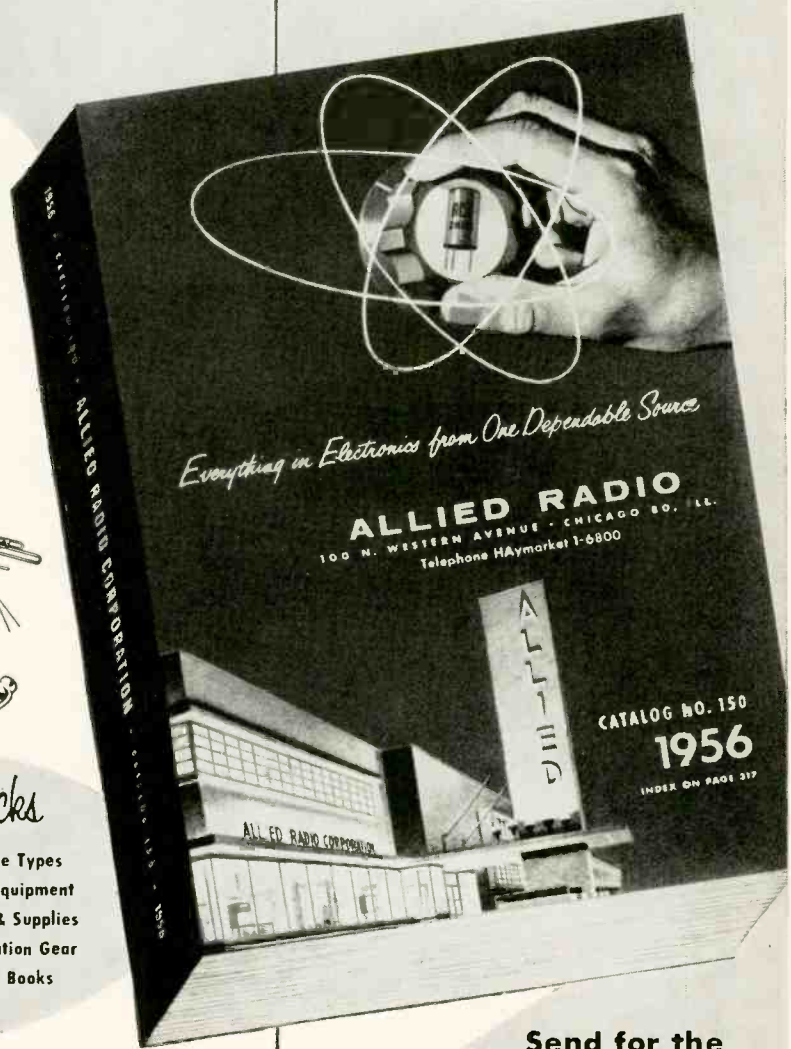

World's largest Stocks

- All TV & Radio Parts
- All Electron Tube Types
- Test & Lab Instruments
- High Fidelity Equipment
- Latest Build-Your-Own Kits
- Recorders & Supplies
- P.A. Systems, Accessories
- Amateur Station Gear
- TV Antennas, Accessories
- Tools and Books
- Equipment for Industry

ALLIED RADIO

World's Largest Electronic Supply House

EASY-PAY TERMS

Use our liberal Easy Payment Plan—only 10% down, 12 months to pay—no carrying charges if you pay in 60 days. Available on Hi-Fi and P.A. units, recorders, TV chassis, test instruments, kits, Amateur gear, etc.

HI-FI SPECIALISTS

To keep up with the latest and best in High Fidelity, look to ALLIED. Count on us for all the latest releases and largest stocks of Hi-Fi equipment. We specialize, too, in TV supply—and are foremost in the field of Builders' Kits.

ultra-modern facilities for the FASTEST SERVICE IN ELECTRONIC SUPPLY

free

Send for the leading Electronic Supply Guide

ALLIED RADIO CORP., Dept. 2-L-5
100 N. Western Ave., Chicago 80, Illinois

Send FREE 324-Page 1956 ALLIED Catalog

Name

Address

City Zone State

Introducing



THE *fluxvalve* PICKUP

the first really new pickup in a decade

The FLUXVALVE is made by perfectionists — for perfectionists. Literally the cartridge of the future, its unique design meets the demands of all presently envisioned recording developments, including those utilizing less than 1 mil styli.

There is absolutely nothing like it!

The FLUXVALVE Turnover Pickup provides the first flat frequency response beyond 20kc! Flat response assures undistorted high frequency reproduction—and new records retain their top “sheen” indefinitely, exhibiting no increase in noise. . . . Even a perfect stylus can't prevent a pickup with poor frequency characteristics from permanently damaging your “wide range” recordings.

With this revolutionary new pickup, tracking distortion, record and stylus wear are reduced to new low levels. The FLUXVALVE will last a lifetime! It is hermetically sealed, virtually impervious to humidity, shock and wear . . . with no internal moving parts.

The FLUXVALVE has easily replaceable styli. The styli for standard and microgroove record-playing, can be inserted or removed without use of tools.

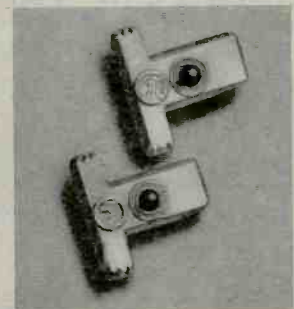

For a new listening experience, ask your dealer to demonstrate the new FLUXVALVE
... words cannot describe the difference... but you will hear it!



PICKERING & CO., INC. Oceanside, N.Y.

PIONEERS IN HIGH FIDELITY

“For those who can hear the difference”

... Demonstrated and sold by Leading Radio Parts Distributors everywhere. For the one nearest you and for detailed literature, write Dept. W-9

Never before — an antenna
with such utterly . . .

Fantastic

front-to-back ratios

Low Band: from 20:1 to 50:1 relative VOLTAGE
(2500:1 relative power)

High Band: up to 13:1 relative VOLTAGE
(169:1 relative power)

"Super-sembled"
— with
Channel Master's
trigger-fast
Snap-Lock Action.

CHANNEL MASTER'S

new
"K.O."
all-channel antenna

Available 3 ways!

Broad Band model—model no.1023
(includes HI-LO Matching Harness)

Low Band only—model no.1026

High Band only—model no.1073

Full descriptive literature available from your
Channel Master distributor.

Knocks out venetian blinds and co-channel interference!

Channel Master's new "K.O." has the highest front-to-back ratios ever recorded for any TV antenna! The sensational "K.O." actually sets up an INVISIBLE BARRIER to signals coming in from the rear. Working with supreme efficiency on both VHF bands, it totally REJECTS rear signals, preventing venetian blinds and other picture problems caused by co-channel interference.

Spectacular High Gain!

Low Band, 7 to 9 DB, single bay; High Band, 8.5 to 10.5 DB, single bay. True Yagi performance, combined with completely independent High and Low Band operation for maximum efficiency.

LICENSED BY KAY-TOWNES ANTENNA CO., ROWE, GA.



CHANNEL MASTER CORP.

The World's Largest Manufacturer of TV Antennas and Accessories

ELLENVILLE, N. C.

Copyright 1955, Channel Master Corp.

A GIANT FOR ITS SIZE!

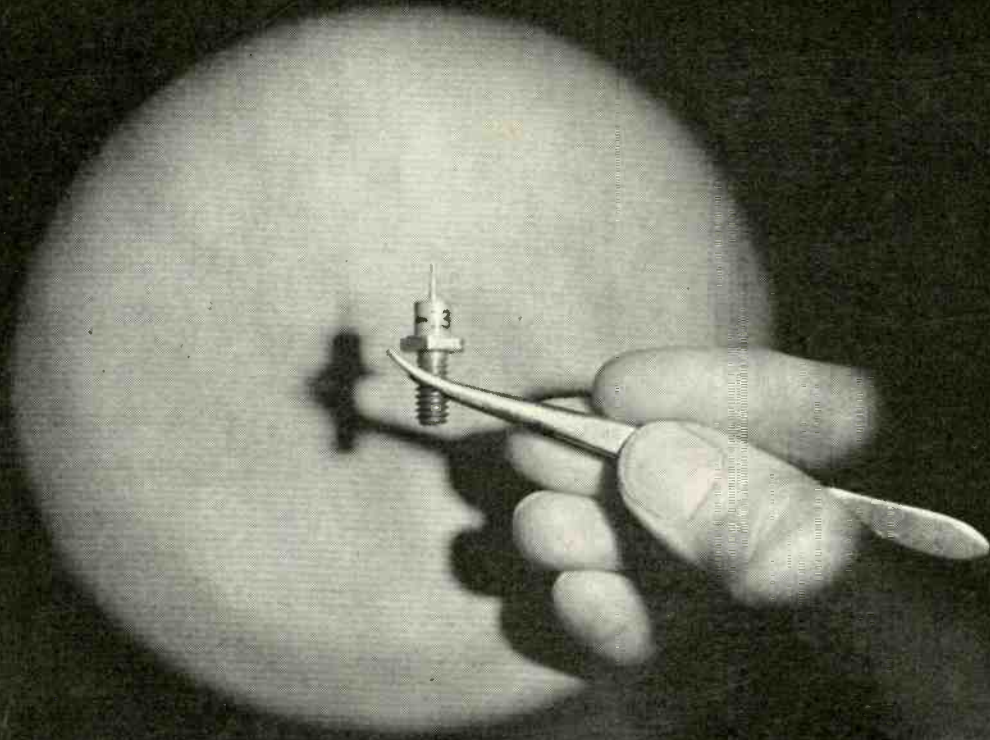

Telephone science produces an important new rectifier

At Bell Laboratories one line of research is often fruitful in many fields. Latest example is the silicon power rectifier shown above.

Product of original work with semiconductors—which earlier created the transistor and the Bell Solar Battery—the new rectifier greatly reduces the size of equipment needed to produce large direct currents. It is much smaller than a tube rectifier of equal performance and it does not require

the bulky cooling equipment of other metallic rectifiers.

In the Bell System the new rectifier will supply direct current more economically for telephone calls. It can also be adapted to important uses in television, computers, industrial machines, and military equipment. Thus, Bell Telephone Laboratories research continues to improve telephony—while it helps other fields vital to the nation.

BELL TELEPHONE LABORATORIES



IMPROVING TELEPHONE SERVICE FOR AMERICA PROVIDES
CAREERS FOR CREATIVE MEN IN SCIENTIFIC AND TECHNICAL FIELDS



Above, new rectifier (held in pliers) is contrasted with comparable tube rectifier and its filament transformer, rear. Mounted on a cooling plate, lower center, the new rectifier can easily supply 10 amperes of direct current at 100 volts, that is 1000 watts—enough to power 350 telephones.

I Will Train You at Home

For Good Pay Jobs, Success in

RADIO-TELEVISION

J. E. SMITH
President
National Radio
Institute
Washington, D. C.
40 years of success
training men at
home in spare time.



I'll Prove It Is Easy And
Practical To Learn At Home.
Sample Lesson FREE.



To See Equipment I Send You
For Practical Experience...
Get Illustrated Book FREE.



Practice Broadcasting with Equipment I Send

It's practical to train at home for good Radio-TV jobs and a brighter future. As part of my Communications Course I send you kits of parts to build the low-power Broadcasting Transmitter shown at the left. You use it to get practical experience performing procedures demanded of Broadcasting Station Operators. An FCC Commercial Operator's License can be your ticket to a better job and a bright future; my Communications Course gives you the training you need to get your license. Mail card below and see in my book other valuable equipment you build. Get FREE sample lesson.

Practice Servicing with Equipment I Send

Self-confidence, security, earning power come from knowing-how and from experience. Nothing takes the place of PRACTICAL EXPERIENCE. That's why NRI training is based on LEARNING BY DOING. You use parts I furnish to build many circuits common to Radio and Television. With my Servicing Course you build a modern Radio (shown at right). You build a Multitester, use it in conducting experiments, fixing sets in spare time starting a few months after enrolling. All equipment is yours to keep. Card below will bring book showing other equipment you build. Judge for yourself whether you can learn at home in your spare time.

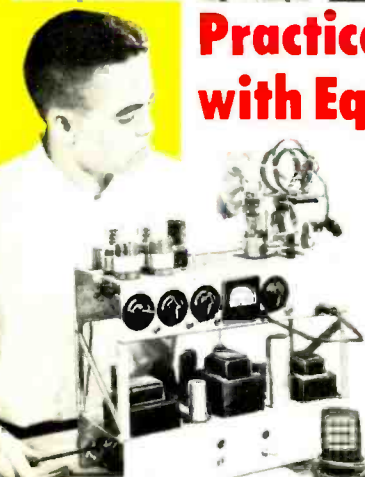

Television Is Growing Fast Making New Jobs, Prosperity

More than 30 million homes now have Television sets and thousands more are being sold every week. Well trained men are needed to make, install, service TV sets and to operate hundreds of Television stations. Think of the good job opportunities here for qualified technicians, operators, etc. If you're looking for opportunity, get started now learning Radio-Television at home in spare time. Cut out and mail postage-free card. J. E. Smith, President, National Radio Institute, Washington, D. C. Over 40 years' experience training men at home.

AVAILABLE TO
VETERANS
UNDER G.I. BILL

Good Jobs
Good Pay **See Other Side**

Get My **SAMPLE LESSON** and
64-Page Illustrated Book
BOTH FREE

Cut out and mail
card NOW!

This card entitles you to Actual Lesson on Servicing, shows how you learn Radio-Television at home. You'll also receive my 64-page Book, "How to Be a Success in Radio-Television." Mail card now!

NO STAMP NEEDED! WE PAY POSTAGE

Mr. J. E. SMITH, President
National Radio Institute, Washington 9, D. C.

Mail me Lesson and Book, "How to Be a Success in Radio-Television." (No Salesman will call. Please write plainly.)

NAME AGE.....

ADDRESS.....

CITY.....ZONE.....STATE.....

VETS write in date of discharge.....

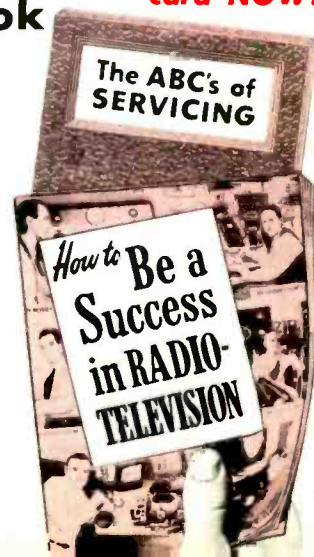

Train at Home to Jump Your Pay as a RADIO-TV Technician



J. E. Smith, President
National Radio Institute

The men whose messages are published below were not born successful. Not so long ago they were doing exactly as you are now . . . reading my ad! They decided they should **EARN MORE . . .** so they acted! They **EARN MORE . . .** so they acted! Mail card below now.

Get a Better Job—Be Ready for a Brighter Future in America's Fast Growing Industry

Training PLUS opportunity is the PERFECT COMBINATION for job security, good pay, advancement. When times are good, the trained man makes the BETTER PAY, GETS PROMOTED. When jobs are scarce, the trained man enjoys GREATER SECURITY. NRI training can help assure more of the better things of life.

Radio-Television is today's opportunity field. Even without Television, Radio is bigger than ever before. Over 3,000 Radio Broadcasting Stations on the air; more than 115 million home and Automobile Radios are in use. Television Broadcast Stations extend from coast to coast now with over 30 million Television sets already in use. Over 400 Television stations are on the air and there are channels for hundreds more.

Use of Aviation and Police Radio, Micro-Wave Relay. Two-way Radio communication for buses, taxis, trucks, etc., is expanding. New uses for Radio-Television principles coming in Industry, Government, Communications and Homes.

My Training Is Up-to-Date You Learn by Doing

Get the benefit of our 40 years' experience training men. My well-illustrated lessons give you the basic principles you must have to assure continued success. Skillfully developed kits of parts I furnish "bring to life" the principles you learn from my lessons. Read more about equipment you get on other side of this page.

More and more Television information is being added to my courses. The equipment I furnish students gives experience on circuits common to BOTH Radio and Television.

Find Out About this Tested Way to Better Pay

Read at the right how fellows who acted to get the better things of life are making out now. Read how NRI students earn \$10, \$15 a week extra fixing Radios in spare time starting soon after enrolling. Read how my graduates start their own businesses. Then take the next step—mail card below.

You take absolutely no risk. I even pay postage. I want to put an Actual Lesson in your hands to prove NRI home training is practical, thorough. I want you to see my 64-page book, "How to Be a Success in Radio-Television," because it tells you about my 40 years of training men and important facts about present and future Radio-Television job opportunities. You can take NRI training for as little as \$5 a month. Many graduates make more than the total cost of my training in two weeks. Mailing postage-free card can be an important step in becoming successful. J. E. Smith, President, National Radio Institute, Washington 9, D. C. Training Men for Over 40 years. Approved Member, National Home Study Council.

I TRAINED THESE MEN



Lots of Spare-Time Jobs

"I do a lot of spare-time Radio and TV servicing. It was fun learning and I don't know how to thank you." B. Goede, Plainview, Minn.



Now TV Trouble Shooter

"I had only gone to 7th grade when I started course. Now have job as TV trouble shooter, also fix sets spare time." M. R. Lindemuth, Fort Wayne, Ind.



Engineer with WHPE

"Thanks to NRI, I operated a successful Radio repair store. Then I got a job with WPAQ and now am an engineer for WHPE." V. W. Workman, High Point, N. C.



NRI Course Can't Be Beat

"Am with WCOB. NRI Course can't be beat. No trouble passing 1st class Radio-phone license examination." Jesse W. Parker, Meridian, Mississippi.



Quit Job for Own Business

"I decided to quit my job and do TV work full time. I love my work and I am doing all right financially." William F. Kline, Cincinnati, Ohio.



Extra Money in Spare Time

"I am a police captain and also have good spare-time service business. Just opened my new showrooms and shop." C. W. Lewis, Pensacola, Fla.

Start Soon to Make \$10 to \$15 a Week Extra Fixing Sets

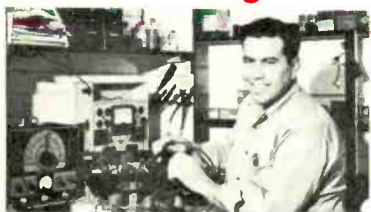

Keep your job while training. Many NRI students make \$10, \$15 and more a week extra fixing neighbors' Radios in spare time, starting a few months after enrolling. The day you enroll I start sending you special booklets that show you how to fix sets. The multimeter you build with parts I furnish helps discover and correct troubles.

SEE OTHER SIDE

My Training Leads to Jobs Like These

BROADCASTING: Chief Technician, Chief Operator, Power Monitor, Recording Operator, Remote Control Operator. **SERVICING:** Home and Auto Radios, P.A. Systems, Television Receivers, Electronic Controls, FM Radios. **IN RADIO PLANTS:** Design Assistant, Transmitter Design Technician, Service Manager, Tester, Serviceman, Research Assistant. **SHIP AND HARBOR RADIO:** Chief Operator, Assistant Operator, Radiotelephone Operator. **GOVERNMENT RADIO:** Operator in Army, Navy, Marine Corps, Coast Guard, Forestry Service Dispatcher, Airways Radio Operator. **AVIATION RADIO:** Plane Radio Operator, Transmitter Technician, Receiver Technician, Airport Transmitter Operator. **TELEVISION:** Pick-Up Operator, Voice Transmitter Operator, Television Technician, Remote Control Operator, Service and Maintenance Technician. **POLICE RADIO:** Transmitter Operator, Receiver Serviceman.

FIRST CLASS
Permit No. 20-R
(Sec. 34.9, P. L. & R.)
Washington, D. C.

BUSINESS REPLY CARD

No Postage Stamp Necessary If Mailed In The United States

POSTAGE WILL BE PAID BY

NATIONAL RADIO INSTITUTE

16th and U Sts., N. W.

Washington 9, D. C.

K L M O P R S T

SAMPLE LESSON and 64-Page BOOK BOTH FREE CUT OUT AND MAIL POSTAGE-FREE CARD

Have Your Own Business

Many NRI trained men start their own successful Radio-Television sales and service business with capital earned in spare time. Joe Travers, a graduate of mine, in Asbury Park, N. J., writes: "I've come a long way in Radio and Television since graduating. Have my own business on Main Street."



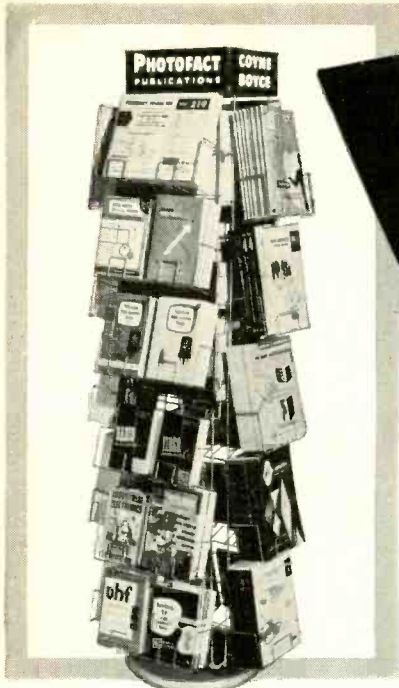

STAY AHEAD IN ELECTRONICS!

these **SAMS BOOKS** show you how
look for them on the Howard W. Sams "Book Tree"
displayed at your Electronic Parts Distributor

POPULAR BASIC MANUALS

Basic Radio Manual. A comprehensive training guide, outlining step-by-step a 36-Lesson Course on Basic Radio accompanied by a practical Shop Project section devoted to actual job projects that implement the lessons and clearly translate theory into practice. 248 pages, 8 1/2 x 11", illustrated. Order ED-1 \$5.00

Basic Electricity Manual. A complete training course covering basic theory, terms, laws, circuits; includes magnetism, motors, transformers, lighting and many other subjects, supplemented by inexpensive projects which demonstrate theory in action. 264 pages, 8 1/2 x 11". Order ED-12 \$5.00

HANDY SERVICE GUIDES

Radio Receiver Servicing. A book on practical radio receiver servicing covering such basic troubles as dead set, weak set, intermittent and noisy sets, etc. 192 pages, 5 1/2 x 8 1/2". Order RS-1 \$2.50

AM-FM Servicing Short-Cuts. Describes actual AM and FM service case histories; shows practical ways to solve similar troubles in any AM or FM receiver. 152 pages, 5 1/2 x 8 1/2". Order RK-1 \$1.50

Radio Receiver Tube Replacement Guide. Shows where to replace each tube in 5500 receivers made from 1938 to 1948. 196 pages, 5 1/2 x 8 1/2". Order TP-1 \$1.25

Dial Cord Stringing Guide, Vol. 4. Shows correct way to string dial cords in radio receivers made from mid-1951 through 1953. With index. 96 pages, 5 1/2 x 8 1/2". Order DC-4 \$1.00

Vol. 3. Covers receivers produced from 1950 through mid-1951, and TV-radio receivers from 1946 through mid-1951. 96 pages, 5 1/2 x 8 1/2". Order DC-3 \$1.00

Vol. 2. Covers receivers produced from 1947 through 1949. 96 pages, 5 1/2 x 8 1/2". Order DC-2 \$1.00

Vol. 1. Covers receivers produced from 1938 through 1946. 112 pages, 5 1/2 x 8 1/2". Order DC-1 \$1.00

AUTO RADIO SERVICE MANUALS

Vol. 4. Covers 41 chassis (48 models) produced during 1953. 288 pages, 8 1/2 x 11". Order AR-4 \$3.00

Vol. 3. Full service data on 47 chassis (80 models) used in 1950, 1951 and 1952 auto radio receivers. 288 pages, 8 1/2 x 11". Order AR-3 \$3.00

Vol. 2. Covers 60 chassis (90 models) used in 1948, 1949 and 1950 auto radios. 288 pages, 8 1/2 x 11". Order AR-2 \$3.00

Vol. 1. Covers 100 auto radio models made from 1946 to 1949 by 24 manufacturers. 396 pages, 8 1/2 x 11". Order AR-1 \$4.95

COMMUNICATIONS RECEIVERS

Vol. 2. Full analysis of 26 popular communications receivers made during recent years. 190 pages, 8 1/2 x 11". Order CR-2 \$3.00

INVALUABLE, AUTHORITATIVE TELEVISION BOOKS

Color Television for the Service Technician. Written to prepare the service technician for the day when he will be installing and servicing color TV equipment. 116 pages, 8 1/2 x 11". Order SC-1 \$2.50

Analyzing and Tracing TV Circuits. A book which presents a new approach to the problems of television servicing. 168 pages, 8 1/2 x 11". Order JA-1 \$3.00

TV Service Data Handbook. A compilation of the most frequently needed charts, tables, and formulas as required in TV servicing and installation work. 112 pages, 5 1/2 x 8 1/2". Order JB-1 \$1.50

TV Servicing Timesavers. This handy reference summarizes many service techniques found profitable from actual servicing experience. 124 pages, 5 1/2 x 8 1/2". Order JC-1 \$1.50

Fundamentals of Color Television. A complete and up-to-date explanation of Color TV written in a simple style to give the reader a clear understanding of the subject. 224 pages, 8 1/2 x 11". Order BA-1 \$2.00

Teletesting Operations. The only complete coverage of every phase of Teletesting, from theory through equipment, operation, maintenance, production—indispensable to anyone interested in Teletesting. 600 p., 6 x 9". Order OH-1 \$7.95

Photofact Television Course. Gives a clear, complete understanding of TV principles, operation and practice. 208 pages, 8 1/2 x 11". Order TV-1 \$3.00

TV Servicing Short-Cuts. Describes actual TV service case histories; shows how to solve similar troubles in any receiver. 100 pages, 5 1/2 x 8 1/2". Order TK-1 \$1.50

TV Test Instruments. Tells how to operate each test instrument used in TV service work. 175 pages, 8 1/2 x 11". Order TN-1 \$3.00

UHF Antennas, Converters & Tuners. Covers all antenna types, transmission lines and matching networks. UHF converters and tuners, 136 pages, 5 1/2 x 8 1/2". Order UHF-1 \$1.50

Servicing TV in the Customer's Home. Short-cut methods for repairs in the field. 128 pages, 5 1/2 x 8 1/2". Order TC-1 \$1.75

Making Money in TV Servicing. Tells how to set up and operate a profitable TV service business. 136 pages, 5 1/2 x 8 1/2". Order MM-1 \$1.25

Pay As You See TV. A clear exposition of the facts that are of vital interest to everyone connected with the television industry. Four informative chapters present the case for this significant new development in TV entertainment. 96 pages, 5 1/2 x 8 1/2". Order KA-1 \$1.50

TV Tube Location Guides: Vol. 5. Shows tube positions and functions in hundreds of TV receivers. Helps quickly locate faulty tube. 200 pages, 5 1/2 x 8 1/2". Order TGL-5 \$2.00

Vol. 4. Covers receivers produced in 1952-1953. 192 pages, 5 1/2 x 8 1/2". Order TGL-4 \$2.00

Vol. 3. Covers receivers produced in 1951-1952. 192 pages, 5 1/2 x 8 1/2". Order TGL-3 \$2.00

Vol. 2. Covers receivers produced in 1950-1951. 208 pages, 5 1/2 x 8 1/2". Order TGL-2 \$2.00

Vol. 1. Covers receivers produced in 1948, 1949, 1950. 208 pages, 5 1/2 x 8 1/2". Order TGL-1 \$2.00

Atomic Radiation, Detection and Measurement

This book covers the information necessary for a basic understanding of nuclear science and its applications. The service technician will be particularly interested in those chapters dealing with the circuitry and operation of the many types of detection devices, in case he is called upon to service these units. 200 pages, 5 1/2 x 8 1/2". Order ADR-1 \$3.00

AUDIO PUBLICATIONS

Recording & Reproduction of Sound. Oliver Read's biggest selling volume on all aspects of Audio; fully covers recording and amplifying methods and equipment. Authoritative, complete, 810 pages, 6 x 9". Order RR-2 \$7.95

Audio Amplifier Service Manuals, Vol. 5. Covers 37 amplifiers, 12 preamplifiers and 14 custom tuners made during 1952 and 1953. 352 pages, 8 1/2 x 11". Order AA-5 \$3.95

Vol. 4. Covers 75 amplifiers and tuners made during 1951 and 1952. 352 pages, 8 1/2 x 11". Order AA-4 \$3.95

Vol. 3. Covers 50 amplifiers and 22 tuners made during 1950. 352 pages, 8 1/2 x 11". Order AA-3 \$3.95

Vol. 2. Covers 104 amplifiers and 12 tuners made during 1949. 368 pages, 8 1/2 x 11". Order AA-2 \$3.95

RECORD CHANGER MANUALS

Vol. 6. Covers 14 different tape recorders and 6 changers manufactured during 1953 and 1954, with complete index covering all six manuals of the Series. 288 pages, 8 1/2 x 11". Order CM-6 \$3.00

Vol. 5. Covers 32 different basic units manufactured during 1952-53. 288 pages, 8 1/2 x 11". Order CM-5 \$3.00

Vol. 4. Full service data on 38 changers and recorders made during 1951. 288 pages, 8 1/2 x 11". Order CM-4 \$3.00

Vol. 3. Covers 44 changers made in 1949 and 1950. 288 pages, 8 1/2 x 11". Order CM-3 \$3.00

Vol. 2. Covers 45 models made in 1948 and early 1949. 432 pages, 8 1/2 x 11". Order CM-2 \$4.95

COYNE AND BOYCE BOOKS

Distributed by Howard W. Sams & Co., Inc.

BB-1 Radio & Electronics Handbook \$4.95
 BB-2 Video Handbook 5.95
 CTB-1 TV Servicing Cyclopedic 5.95
 CTB-2 Industrial Electronics 3.75
 CTB-3 Latest Testing Instruments for Servicing Radio-Television 3.25
 CTB-4 Practical Television Servicing and Trouble-Shooting Manual 4.25
 CTB-5 Television and Radio Handbook 2.75
 CTB-7 Transistors & Their Applications in Radio-Television-Electronics 1.50
 CTB-8 Bigger Profits in TV 1.50
 CTB-11 Application of Radio & TV Principles 3.25
 CTB-12 Radio-TV and FM Receivers 3.25
 CTB-13 Radio and TV Circuits 3.25
 CTB-50 5 Volume Set Complete of Applied Practical Radio-Television 15.00
 CTB-100 Technical Dictionary 2.00
 CTB-101 Electrical Trouble Shooting Manual 6.95
 CTB-102 Electrician's Handbook 2.75

HOWARD W. SAMS & CO., INC.

Order from your Parts Jobber today, or write to Howard W. Sams & Co., Inc., 2205 East 46th St., Indianapolis 5, Ind.

My (check) (money order) for \$ enclosed.

Send the following books:

.....

.....

Name

Address

City Zone State

(outside U.S.A. priced slightly higher)

SAMS' PUBLICATIONS HELP YOU LEARN MORE AND EARN MORE

BLACK AND WHITE TV
 COLOR TV
 TRANSISTOR RADIOS
 FM RADIOS
 AM RADIOS
 AUTO RADIOS
 AMPLIFIERS AND TUNERS
 RECORD CHANGERS



WHAT'S YOUR SERVICE PROBLEM?

PHOTOFACT HELPS YOU SOLVE IT

FASTER, EASIER, BETTER, MORE PROFITABLY!

THE WORLD'S FINEST SERVICE DATA **THESE GREAT FEATURES ARE EXCLUSIVE IN PHOTOFACT—THEY HELP YOU EARN MORE DAILY, HELP INSURE CUSTOMER SATISFACTION**



PHOTOFACT Service Data is the *only* service information based upon first-hand examination of the actual production-run receivers and equipment. It is authentic, uniform data developed through actual study and analysis by service engineers in the Howard W. Sams Laboratories. PHOTOFACT is the *only* data prepared from the practical point of view of the Service Technician.

Thousands of Service Technicians use PHOTOFACT daily for time-saving, profit-boosting service operations. If you've never used PHOTOFACT, you've never realized your full earning power—you've never given such complete customer satisfaction. So get the proof for yourself. Try PHOTOFACT—use it on any job. Your Parts Distributor has the Folder Sets you need for any of the 17,000 TV and radio receivers, changers, recorders, etc., covered in PHOTOFACT. Once you use this great service, we know you'll want the complete PHOTOFACT Library.

FREE Send for the PHOTOFACT CUMULATIVE INDEX IT'S VALUABLE!

Send for it! Your guide to virtually any model ever to come into your shop; helps you locate the proper PHOTOFACT Folder you need to solve any service problem on any model. Once you have the make and chassis number, it takes just 60 seconds to find the applicable PHOTOFACT Folder. Send coupon now for your FREE copy of the valuable Cumulative Index to all the PHOTOFACT Folders you need.



FREE

FULL SCHEMATIC COVERAGE

1. Famous "Standard Notation" uniform symbols are used in every schematic.
2. The same standard, uniform layout is used for each schematic.
3. Diagrams are clear, large, easy to read, easy to handle.
4. Wave forms are shown right on the TV schematics for quick analysis by 'scope.
5. Voltages appear on the schematics for speedy voltage analysis.
6. Transformer lead color-coding is indicated on the schematic.
7. Transformer winding resistances appear on the schematic.
8. Schematics are keyed to photos and parts lists.

FULL PHOTOGRAPHIC COVERAGE

9. Exclusive photo coverage of all chassis views is provided for each receiver.
10. All parts are numbered and keyed to the schematic and parts lists.
11. Photo coverage provides quicker parts identifications and location.

ALIGNMENT INSTRUCTIONS

12. Complete, detailed alignment data is standard and uniformly presented in all Folders.
13. Alignment frequencies are shown on radio photos adjacent to adjustment number—adjustments are keyed to schematic and photos.

TUBE PLACEMENT CHARTS

14. Top and bottom views are shown. Top view is positioned as chassis would be viewed from back of cabinet.
15. Blank pin or locating key on each tube is shown on placement chart.
16. Tube charts include fuse location for quick service reference.

TUBE FAILURE CHECK CHARTS

17. Shows common trouble symptoms and indicates tubes generally responsible for such troubles.
18. Series filament strings are schematically presented for quick reference.

COMPLETE PARTS LISTS

19. A complete and detailed parts list is given for each receiver.
20. Proper replacement parts are listed, together with installation notes where required.
21. All parts are keyed to the photos and schematics for quick reference.

FIELD SERVICE NOTES

22. Each Folder includes time-saving tips for servicing in the customer's home.
23. Valuable hints are given for quick access to pertinent adjustments.
24. Tips on safety glass removal and cleaning.

TROUBLE-SHOOTING AIDS

25. Includes advice for localizing commonly recurring troubles.
26. Gives useful description of any new or unusual circuits employed in the receiver.
27. Includes hints and advice for each specific chassis.

OUTSTANDING GENERAL FEATURES

28. Each and every PHOTOFACT Folder, regardless of receiver manufacturer, is presented in a standard, uniform layout.
29. PHOTOFACT is a *current* service—you don't have to wait a year or longer for the data you need. PHOTOFACT keeps right up with receiver production.
30. PHOTOFACT gives you *complete* coverage on TV, Radio, Amplifiers, Tuners, Phonos, Changers.
31. PHOTOFACT maintains an inquiry service bureau for the benefit of its customers.

HOWARD W. SAMS & CO., INC.

Howard W. Sams & Co., Inc., Dept. 2-L5
 2201 E. 46th St., Indianapolis 5, Ind.

Send FREE Photofact Cumulative Index.

Name.....

Address.....

City.....Zone...State.....

EASY-PAY PLAN TO FIT YOUR BUDGET

Ask your PHOTOFACT Distributor... he'll show you how you can now own the PHOTOFACT Library through a unique Easy-Pay Plan that exactly fits your needs. Pays for itself as you EARN MORE.

HELPS YOU EARN MORE DAILY
 RADIO-ELECTRONICS

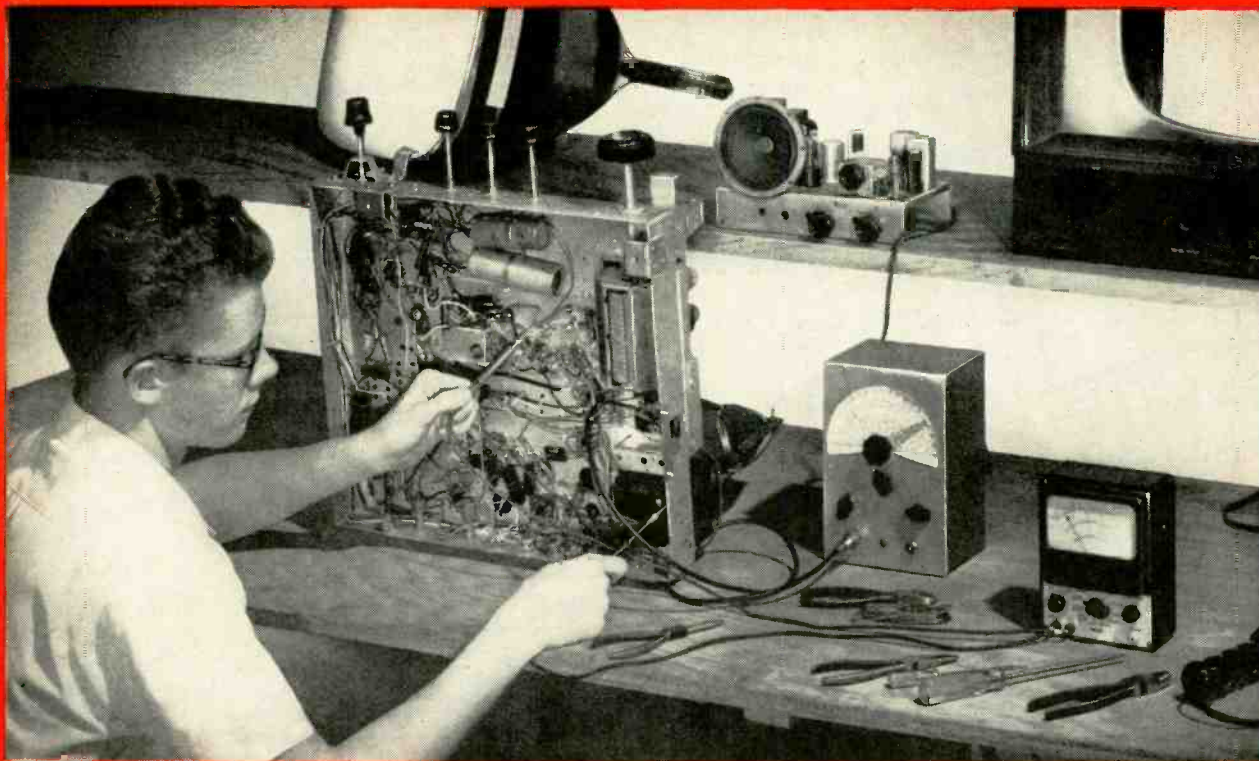

NOW... RCA trains you at home to be an expert technician in...

RADIO-TV ELECTRONICS

TV SERVICING

COLOR TV SERVICING

NOW THREE HOME STUDY COURSES... prepared by instructors of RCA Institutes, engineers from RCA Laboratories, and training experts of the RCA Service Company. Clearly written... easy to understand... the same high caliber instruction as given in the resident classrooms of RCA INSTITUTES.

● **COURSE I—RADIO-TELEVISION ELECTRONICS**—starts you from the ground up to a solid working knowledge of electronics. Without any previous experience, you get a thorough training in radio theory and servicing techniques for AM, FM, home and car radios... plus an introduction to the fundamental theory and practices of television.

● **COURSE II—TELEVISION SERVICING**—prepares you to advance from radio into the expanding field of television servicing as a well-trained service technician. If you have completed Course I or are now working in

the field of radio or TV, Course II will show you the many special techniques of troubleshooting, aligning, checking, and repairing modern black and white TV sets.

● **NEW TV KIT AVAILABLE WITH COURSE II**—there is no better way to learn than by *doing* and RCA Institutes has developed a large-screen TV KIT available to home study students to build while taking Course II. It has the most modern up-to-date circuitry, actually enabling you to apply at home all the latest servicing techniques.

● **COURSE III—COLOR TELEVISION SERVICING**—covers all phases of color servicing techniques. It is a practical, down-to-earth course in color theory as well as how-to-do-it servicing procedure. A natural move "up" from Course II or for those now employed in TV.

SINCE 1909, RCA INSTITUTES has trained thousands for successful careers in elec-

tronics. Many graduates have established their own paying business. Now this opportunity is available to you at home.

● **"PAY-AS-YOU-LEARN" PLAN**... you pay for one study group at a time, as you progress through the course. Tuition costs are amazingly low. For full details, mail coupon.

A SERVICE OF RADIO CORPORATION OF AMERICA—RCA INSTITUTES is licensed by the N. Y. State Education Department... recommended by radio and television service organizations.

**SEND FOR
FREE
CATALOG
NOW**



RCA INSTITUTES, INC.
A SERVICE OF RADIO CORPORATION of AMERICA
350 WEST FOURTH STREET, NEW YORK 14, N.Y.

RCA Institutes, Inc., Homes Study Dept. RE-115
350 West Fourth Street, New York 14, N. Y.

Without obligation, send me FREE CATALOG on Home Study Courses in Radio, TV and Electronics. No salesman will call.

Name _____ Please Print

Address _____

City _____ Zone _____ State _____

What is the best amplifier?

THAT'S simple. The one that gives you the least distortion at high frequencies. Or put it this way: an amplifier with Unity Coupling. Because with Unity Coupling, transformer-caused impulse distortion just can't happen. And which amplifiers *have* Unity Coupling? That's simple, too. National's Horizon 10 and Horizon 20.

You know what makes a conventional amplifier sound "raw"—especially at higher frequencies—even though its *harmonic* distortion may be rated low? It's because the output transformer has to function as a coupling device between output tubes.

But with a National Horizon, no rawness—ever. Unity Coupling takes over. Output transformer merely provides an impedance match between tubes and load.

So, impedance ratio of output transformer is lowered, leakage inductance cut way down.

Power bandwidth naturally increases. More distortion-free power becomes available at higher frequencies. Which, of course, is exactly what you're after.

That's the logic of it . . . but even more convincing is the listening. National's Horizon amplifiers can be found only at authorized National Company full-line distributors.

| — SPECIFICATIONS — | | |
|----------------------------|---|---|
| | HORIZON 20 | HORIZON 10 |
| Harmonic Distortion | Less than .3% at rated output of 20 watts | Less than .5% at rated output of 10 watts |
| Intermodulation Distortion | Not more than 1% at 20 watts | Not more than 2% at 10 watts |
| Frequency Response | 20 cps—20 kc ± .1 db; 10 cps—100 kc ± 1 db | 20 cps — 20 kc ± 1 db |
| Power Response | 20 cps—20 kc ± .15 db; 10 cps—60 kc ± 1 db at 20 watts | 20 cps — 20 kc ± 2 db |
| Sensitivity | 1.6 volts for 20 watts output | .5 volts for 10 watts output |



Horizon 10, 10 watt amplifier-preamp

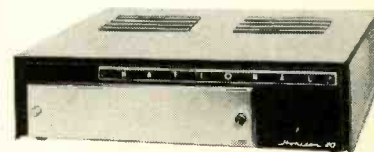

Horizon 20, 20 watt amplifier

tuned to tomorrow

Authorized full line National Company distributors are identified by this sign

National

Manufacturers of high-fidelity record changers, AM/FM tuners, preamplifiers, amplifiers, and speaker systems.

www.americanradiohistory.com

Write to Dept. RE-113
for full specifications
NATIONAL COMPANY, INC.
61 SHERMAN ST., MALDEN, MASS.

Learn **PRACTICAL RADIO-TV**
with **25 BIG KITS**

of equipment I send you while
you train with me . . . for valuable
shop bench experience . . .

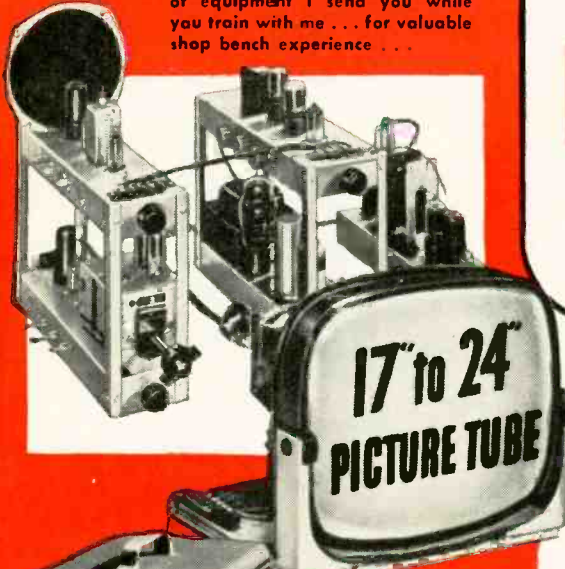

This is the new Sprayberry Training Television receiver, built and tested in sections for greatest instruction value.

I now offer this fine modern oscilloscope to help you learn practical Television servicing.

You will build this powerful short wave and broadcast superhet radio receiver for valuable shop instruction practice.

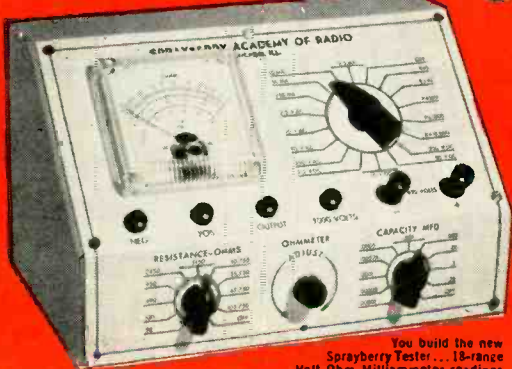
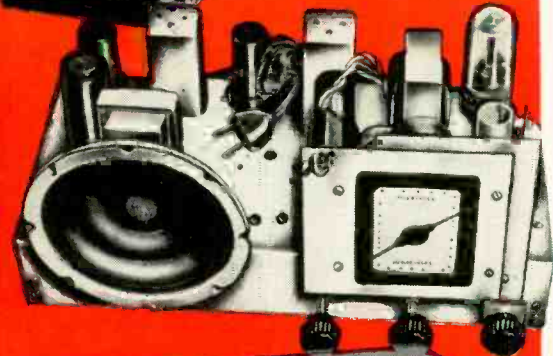

You build the new Sprayberry Tester . . . 18-range Volt-Ohm-Millammeter readings plus output meter and condensator and resistor substitution selector.

In addition to modern lesson training, I also give you plenty of home practice on actual Radio-Television equipment . . . you will build and use the units shown here plus many more. All this equipment is yours to keep . . . keep everything you need to set up your shop.

Prepare for a Good Paying Job — Or Your Own Business

"I Will Train You at Home in
RADIO-TELEVISION
On Liberal No Obligation Plan!"

New Equipment! New Lessons! Enlarged Course! The true facts are yours in my big new catalog . . . **YOURS FREE . . .**
JUST MAIL COUPON!



Frank L. Sprayberry
President, Sprayberry
Academy of Radio

I can train and prepare you in as little as 10 months to step into the big opportunity Radio-Television service field. Train *without* signing a binding contract . . . without obligating yourself to pay any regular monthly amounts. You train entirely at home in spare hours . . . you train as fast or as slowly as you wish. You'll have your choice of **THREE SPRAYBERRY TRAINING PLANS** . . . planned for both beginners as well as the more experienced man. Get the true facts about the finest most modern Radio-Training available today . . . just mail the coupon for my big new 56 page fact-filled catalog plus sample lesson—both **FREE**.

Train the Practical Way—with Actual Radio-Television Equipment

My students do better because I train both the mind and the hands. Sprayberry Training is offered in 25 individual training units, each includes a practice giving kit of parts and equipment . . . all yours to keep. You will gain priceless practical experience building the specially engineered Sprayberry Television Training Receiver, Two-Band Radio Set, Signal Generator, Audio Tester and the new Sprayberry 18 range Multi-Tester, plus other test units. You will have a complete set of Radio-TV test equipment to start your own shop. My lessons are regularly revised and every important new development is covered. My students are completely trained Radio-Television Service Technicians.

NEWEST DEVELOPMENTS

Your training covers U H F, Color Television, F M, Oscilloscope Servicing, High Fidelity Sound and Transistors.

See for Yourself . . . Make Your Own Decision . . . Mail Coupon Today!

The coupon below brings you my big new catalog plus an actual sample Sprayberry Lesson. I invite you to read the facts . . . to see that I actually illustrate every item I include in my training. With the facts in your hands, you will be able to decide. *No salesman will call on you.* The coupon places you under no obligation. Mail it now, today, and get ready for your place in Radio-Television.

SPRAYBERRY ACADEMY OF RADIO
111 North Canal Street, Dept. 20-E Chicago 6, Illinois

Mail This Coupon For Free Facts and Sample Lesson

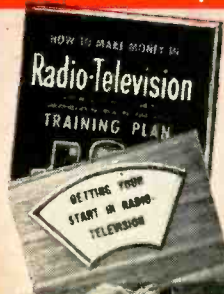

SPRAYBERRY ACADEMY OF RADIO
Dept. 20-E, 111 N. Canal St., Chicago 6, Ill.

Please rush all information on your **ALL-NEW** Radio-Television Training Plan. I understand this does not obligate me and that no salesman will call upon me. Include New Catalog and Sample Lesson **FREE**.

Name _____ Age _____

Address _____

City _____ Zone _____ State _____

setting new selling records everywhere

C·D·R
TV antenna
ROTORS
the COMPLETE line
A Model for Every Need

AR-1

The completely **AUTO-**MATIC rotor, powerful and dependable, with a modern design cabinet. Uses 4 wire cable.

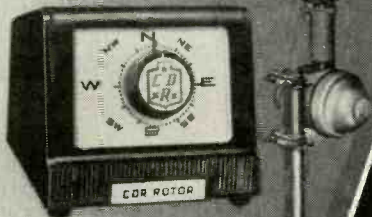

AR-2

Completely **AUTOMATIC** rotor with thrust bearing. Handsome cabinet, uses 4 wire cable.



TR-4

The heavy-duty rotor complete with modern cabinet with **METER** control dial. Uses 4 wire cable.



AR-22

Here is the completely **AUTOMATIC** version of the famous TR-2 with all the powerful features that made it so famous.



TR-11

The ideal budget all-purpose rotor with new, modern cabinet featuring meter control dial. Uses 4 wire cable.

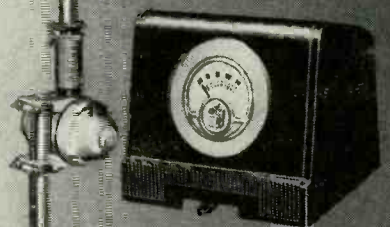

TR-2

The heavy-duty rotor with plastic cabinet featuring "compass control" illuminated perfect pattern dial. Uses 8 wire cable.



TR-12

A special combination value consisting of complete rotor with thrust bearing. Handsome modern cabinet with meter control dial, uses 4 wire cable.

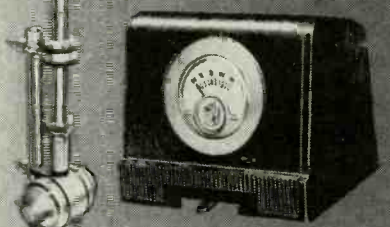

CORNELL-DUBILIER
SOUTH PLAINFIELD, N. J.



THE RADIART CORP.
CLEVELAND 13, OHIO

ALLIED'S own KNIGHT ELECTRONIC KITS... better by far...and you SAVE MORE

Get the most for your money in ALLIED'S KNIGHT Test Instrument Kits. Have the lab precision quality, the dependable accuracy, the professional styling you want—and SAVE MONEY. KNIGHT Kits are the last word in electronic design and the easiest to build. Instruction manuals are a marvel of simplicity and clarity for quick assembly without guesswork. You need only a soldering iron, screwdriver and pliers to assemble and own these professional quality instruments. Build one and you'll want to own more of these fine matched units.

SAVE! ALLIED—the reliable name in Electronics—gives you the greatest value for your best instrument dollar in KNIGHT Kits.



**NEWEST
PRINTED CIRCUITS**

KNIGHT PRINTED CIRCUIT 5" OSCILLOSCOPE KIT

Model F-144 New wide-band, full-size 5" Oscilloscope; equals or betters the performance of commercially-wired scopes costing several times the price. Two printed circuit boards and exclusive laced wiring harness cuts assembly time to minimum. Ideal for the professional Laboratory, for color TV servicing and high frequency applications. Has 6 times the usual sweep range—from 15 to 600,000 cps. Locks in frequencies as high as 9 mc. Vertical response from 5 cycles to 5 mc. Response: ± 1 db at 3.58 mc; ± 3 db at 5 mc. High vertical sensitivity of 25 rms millivolts/inch. Input capacitance 20 mmf. Outstanding features: cathode-follower vertical and horizontal inputs; 2nd anode provides 1400 volts for high-intensity trace; push-pull vertical and horizontal amplifiers; positive and negative locking; faithful square wave response; frequency-compensated input attenuator; Z-axis input for high-intensity modulation; one volt peak-to-peak voltage calibration; internal astigmatism control; blanking circuit to eliminate retrace lines; DC positioning control. Complete with all tubes and parts, ready for easy assembly. Handsome professional case finished in blue, with gray control panel. Shpg. wt., 40 lbs.

Model F-144. Knight Printed Circuit 5" Oscilloscope. Net only \$69.00
Model F-148. Demodulator Probe. Net \$3.45
Model F-147. Low Capacity Probe. 12 mmf. Net \$3.45

BUY WITH CONFIDENCE BUILD WITH CONFIDENCE

KNIGHT Kits are engineered to bring you the latest advances in electronic instrument design. The use of premium quality components assures absolute dependability.

KNIGHT Kits are designed for easiest assembly. It's just like having a good instructor at your side.

You and ALLIED are a team. ALLIED stakes its 30-year reputation in the Electronics field on your complete success and satisfaction.

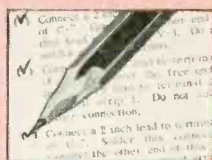

EXCLUSIVE ALLIED "STEP-AND-CHEK" ASSEMBLY METHOD

You just follow each step and check it off as you complete it. You always know where you are and what to do next with the wonderfully clear KNIGHT Manuals.

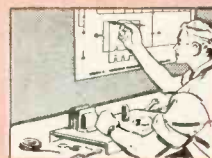

EXCLUSIVE ALLIED "KING-SIZE" DIAGRAMS

Diagrams are duplicated in large wall size to hang conveniently over your work. Helps you see and understand the finest details clearly and easily.

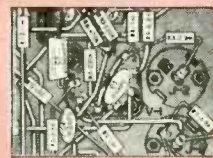

EXCLUSIVE ALLIED "SPOTLIGHT" PICTORIALS

Special two-tone treatment makes it easy for you to spot the circuit you're working on, separates it from work you've already completed. "You always know where you are."

NEWEST PRINTED CIRCUIT

All Prices Net
FOB Chicago

EASY PAYMENT TERMS

If your total Kit order is over \$45, take advantage of our liberal Time Payment Plan—only 10% down, 12 full months to pay. Write for application form.



KNIGHT PRINTED CIRCUIT VTVM KIT

Model F-125 New extremely stable, highly accurate VTVM. Greatly simplified wiring—entire chassis is a printed circuit board. Features maximum convenience in arrangement of scales and controls. With peak-to-peak scale for FM and TV work. Ranges: AC peak-to-peak volts, 0-4-40-140-1400-4000; AC rms volts and DC volts, 0-1.5-5-15-50-150-500-1500; ohms, 0-1000, 10K, 100K; 1-10-100-1000 megs; db scale, -10 to +5. Uses low-leakage switches and 1% precision resistors. Balanced-bridge, push-pull circuit permits switching to any range without adjusting zero set. $4\frac{1}{2}$ " meter, 200 microamp movement. Polarity reversing switch. Input resistance, 11 megs. Complete kit, ready to assemble. Shpg. wt., 6 lbs.

Model F-125. Knight Printed Circuit VTVM Kit. Net only \$24.95
Model F-126. Hi-Voltage Probe; extends DC range to 50,000 Volts. Net \$4.50
Model F-127. Hi-Frequency Probe; extends AC range to 250 mc. Net \$3.45

order from **ALLIED RADIO**

100 N. Western Ave., Chicago 80, Ill.

SEE FOLLOWING PAGES

ALLIED'S own **KNIGHT** ELECTRONIC KITS....



PORTABLE
TUBE TESTER

Model F-143
\$29⁷⁵

BUY WITH CONFIDENCE

- Advanced Electronic Design
- New Printed Circuits
- Easy-View, Hi-Legibility Panels
- Professional Streamlined Styling
- Matched Instruments
- Premium Quality Components

All Prices Net
FOB Chicago



Model F-119
\$11⁶⁵

KNIGHT EASY-TO-BUILD TUBE TESTER KIT—OUTSTANDING VALUE

Expertly designed, up-to-date, ideal for the laboratory or service shop. Remarkably low priced, yet it offers high accuracy, top versatility and convenience. Features provision for testing 600-ma tubes; roll-chart data for all popular series-string types. Tests 4, 5, 6 and 7-pin large, regular and miniature types, octals, loctals, 9-pin miniatures and pilot lamps. Tests for open, short, leakage, heater continuity and quality (by amount of cathode emission). 4 1/2" square meter with clear "GOOD-?-REPLACE" scale. With line-voltage indicator and line-adjust control. Choice of 14 filament voltages from .63 to 117 volts. Blank socket for future type tubes. Universal-type selector switches for any combination of pin connections. Single-unit, 10-lever function switch simplifies assembly. Illuminated roll chart lists over 700 tube types. Complete kit, ready for easy assembly. Shpg. wt., 14 lbs.

Model F-143. Counter type Knight Tube Tester Kit. Net only \$29.75
 Model F-142. As above, but with carrying case. Net only \$34.75
 Model F-141. TV Picture Tube Adapter for above. Net only \$3.75

KNIGHT CAPACITOR CHECKER KIT

Tests capacitors while they are still wired in the circuit! Saves time and trouble. Just press a button and the "magic eye" instantly shows opens and shorts. Checks by-pass, blocking, coupling and filter condensers from 20 mmf to 2000 mfd, even when the capacitor under test is wired with a resistance as low as 60 ohms. Capacitors between .1 mfd and 2000 mfd may be tested even when in parallel with resistance as low as 2 ohms. Housed in the professionally styled Knight Kit case, sturdy steel in blue wrinkle finish with gray control panel. Complete kit, ready for easy assembly. Shpg. wt., 5 lbs. Model F-119. Knight Capacitor Checker Kit. Net only \$11.65



KNIGHT 20,000 OHMS/VOLT VOM KIT

Model F-140 Outstanding quality and performance at extremely low cost. Features 32 ranges; full vision 4 1/2" meter; ± 2% full scale deflection; 50 microampere sensitivity for 20,000 ohms/volt input resistance on DC; front panel "zero adjust". Single switch selects function and range. Range: AC, DC and output volts, 0-2.5, 10-50-250-1000-5000; Resistance, 0-2000-200,000 ohms and 0-20 meg.; DC ma, 0-1-10-100; DC amps, 0-1-10; Decibels, -30 to + 63 in 6 ranges. Uses precision 1% multipliers. Complete kit with bakelite case, batteries and test leads. Shpg. wt., 5 lbs. Model F-140. Knight 20,000 ohms/volt VOM Kit. Net \$26.50



KNIGHT 1,000 OHMS/VOLT VOM KIT

Model F-128 Exceptional accuracy and versatility at amazing low cost. Ideal for service shop, lab and Amateur use. Uses 4 1/2" meter (400 microamp movement) with separate scales for AC voltage and current, DC voltage and current, decibels and resistance. 38 ranges include: AC, DC and Output volts, 0-1-5-10-50-100-500-5000 (1000 ohms/volt sensitivity); Resistance, 0-1000-100,000 ohms and 0-1 meg.; Current, AC or DC, 0-1-10-100 ma and 0-1 amps; Decibels, -20 to + 69 in 6 ranges. Uses 1% precision resistors. 3-position function switch and 12-position range switch. Complete kit with bakelite case, battery and test leads. Shpg. wt., 2 1/2 lbs. Model F-128. Knight 1,000 ohms/volt VOM Kit. Net \$14.25

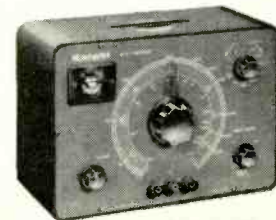

KNIGHT RESISTOR-CAPACITOR TESTER KIT

This new highly accurate tester meets the critical requirements of lab and service shop. Measures capacitance and resistance; checks for opens and shorts in paper, mica and ceramic capacitors; shows power factor of electrolytics. Large dial shows capacitance and resistance at a glance; balanced-bridge circuit with "magic eye" for correct dial setting. Measures power factor from 0-50%. Tests capacitors with rated voltages applied. 5 test voltages: 50, 150, 250, 350, 450. Capacity ranges: 10 mmf to .005 mfd, .001 to .5 mfd, .1 to 50 mfd and 20 to 1000 mfd. Resistance ranges: 100 to 50,000 ohms and 10,000 ohms to 5 megs. Accuracy, ± 10%. Automatic discharge feature prevents after-test shock. Complete kit with Knight professional portable case. Shpg. wt., 8 lbs. Model F-124. Knight Resistor-Capacitor Tester Kit. Net only \$18.75

Model F-124
\$18⁷⁵

EASY PAYMENT TERMS: If your total kit order comes to over \$45, take advantage of our liberal Time Payment Plan—only 10% down, 12 full months to pay. Write for application form.

USE HANDY ORDER FORM
ON NEXT PAGE

order from **ALLIED RADIO**

310 N. Western Ave., Chicago 80, Ill.

Everything in Electronics
from One Reliable Source

better by far...easiest to build...and you **SAVE MORE**

KNIGHT LOW-COST RF SIGNAL GENERATOR KIT

An extremely popular kit, noted for its wide range and exceptional stability—saves you two-thirds the cost of a comparable wired instrument. Delivers output on fundamentals from 160 kc all the way out to 110 mc; useful harmonic output to 220 mc. Ideal for aligning RF and IF stages and for audio equipment troubleshooting. Also serves as TV marker generator when used with any sweep generator. Features the famous Colpitts circuit for high accuracy with negligible drift. RF output rated over 100,000 microvolts. Output can be modulated at 400 cycles. Has built-in sine-wave audio oscillator with output jack for 400 cycle output. Maximum audio output, 10 volts. Jack for external modulation; step and continuous-type output attenuators. Complete kit with professional portable case. Shpg. wt., 10 lbs.

Model F-145
\$19⁷⁵

Model F-145. Knight RF Signal Generator Kit. Net only. \$19.75



All Prices Net FOB Chicago

BUILD WITH CONFIDENCE

- Crystal-Clear Instruction Manuals
- Exclusive "Step-and-Chek" Building Method
- Exclusive "King-Size" Diagrams
- Exclusive "Spotlight" Pictorials

SAVE MONEY! Depend on ALLIED—the world's largest Electronic Supply House—get the most for your test instrument dollar.



Model F-137
\$31⁵⁰

KNIGHT AUDIO GENERATOR KIT

Save money—have performance equal to instruments at many times the price! Provides an ideal audio frequency source for checking audio circuits of amplifiers and other hi-fi equipment; also checks speaker response. Frequency range: 20 cps to 1 mc in 5 ranges. Output voltage: 10 volts to high imp., ± 1 db to 200 kc. Generator imp., 600 ohms. Less than .25% distortion from 100 cps through the audible range; less than .5% when driving 600 ohm load at maximum output. Continuously variable step-attenuated output. Circuit as developed by U. S. Bureau of Standards. Complete kit with professional portable case, ready to assemble. Shpg. wt., 17 lbs.

Model F-137. Knight Audio Generator Kit. Net. \$31.50



HAM SPECIAL!

Model S-725
\$27⁵⁰

KNIGHT SELF-POWERED VFO KIT

Complete with built-in power supply! Careful design and voltage regulation assure high stability. Excellent oscillator keying characteristic for fast break-in without clicks or chirps. Full TVI suppression. Has plenty of bandspread: separate scales for 40, 20, 15 and 10 meters (11 and 80 meters have combined scale); vernier drive mechanism. 2-chassis construction keeps heat from frequency determining circuits. Output cable plugs into crystal socket of transmitter. Output on 80 and 40 meters. With Spot-Off-Transmit switch for "no swish" tuning. Extra switch contacts for operating relays and other equipment. Complete kit for easy assembly. Shpg. wt., 8 lbs.

Model S-725. Knight Self-Powered VFO Kit. Net. \$27.50

KNIGHT VISUAL-AURAL SIGNAL TRACER KIT



A remarkable value in a kit which permits visual and aural signal tracing of RF, IF, video and audio circuits—costs no more than an audio signal tracer alone. Traces the signal from the antenna to the speaker. Reproduces signal at plate or grid connection of any stage. Identifies and isolates "dead" stages. Features: high usable gain of 50,000; "magic eye" with calibrated attenuators for signal presence indication and stage-by-stage gain measurements; built-in 4" PM speaker; RF probe for checking all stages; special audio probe tip included; provides noise test; built-in watt meter calibrated from 25 to 1000 watts; provision for external scope or VTVM. Complete kit with portable case. Shpg. wt., 13 lbs.

Model F-135
\$23⁷⁵

Model F-135. Knight Visual-Aural Signal Tracer Kit. Net only. \$23.75

KNIGHT AMPLIFIER KITS FOR HI-FI BUILDERS



10-WATT HI-FI AMPLIFIER KIT

Model S-234 Famous for wide response and smooth reproduction at low cost. Only 0.5 volt drives amplifier to full output. Frequency response: ± 1 db, 30-20,000 cps at 10 watts. Harmonic distortion less than 0.5% at 10 watts. Intermod. distortion less than 1.5% at full output. Controls: on-off, volume, bass, treble. Input for crystal phono or tuner. Chassis punched to accommodate preamp kit. Matches 8 ohm speakers. Shpg. wt., 14 lbs.

Model S-234. Amplifier Kit. Net. \$20.95
Model S-235. Preamp Kit for above. Net. \$2.75

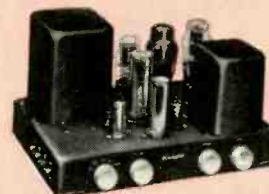

20-WATT HI-FI AMPLIFIER KIT

Model S-750 True hi-fi for less! Frequency response, ± 1 db, 20 to 20,000 cps at 20 watts. Distortion, 1% at 20 watts. Hum and noise level: tuner input, 90 db below 20 watts; phono, 72 db below 20 watts. Sensitivity: tuner input, 0.6 volt for 20 watts output; magnetic phono, .007 volts. 4 inputs: magnetic phono, microphone, crystal phono or recorder, and tuner. Controls: Bass, Treble, Volume, Selector. With compensation positions for 78 and LP records, controlled from front panel. Shpg. wt., 23 lbs.

Model S-750. 20-Watt Hi-Fi Amplifier. Net. \$34.75

ALLIED RADIO

Allied Radio Corp., Dept. 2-L-5, 100 N. Western Ave., Chicago 80, Ill.

Ship me the following KNIGHT Electronic Kits:

| Quantity | Description | Model No. | Price |
|----------|-------------|-----------|-------|
| | | | |
| | | | |
| | | | |

\$.....enclosed. For parcel post include postage (express is shipped collect).

Name _____

Address _____

City _____ Zone _____ State _____

ORDER TODAY

ROHN NO. 6 TOWER "All-Purpose" Tower

Self-supporting to 50 ft., or guyed to 120 ft. Utilizes mass production techniques to give you lowest prices, yet highest profits for a tower of this type. Ideal for home and industrial requirements. Permanent hot-dipped galvanized coating inside and out. Dependability — a feature customers demand — is assured with the Rohn No. 6 Tower . . . designed to "stand up" for years to the rigors of weather and climatic conditions. Easy to climb for fast, efficient servicing. In 10 ft. sections.

ROHN PACKAGED TOWER "Space Saver" cuts storage space 300% or more!

Popular PT-48 has almost 50' of sturdy tower within a compact 8' x 20" package! "Magic Triangle" design is adapted to a pyramid shape using a wide 19" base with progressively decreasing size upward. Decreases your overhead . . . easy to transport and assemble; cuts shipping costs! Galvanized throughout. Available in heights of 24', 32', 40', 48', 56' and 64'.



Both Towers Feature . . .

1. MAGIC TRIANGLE CONSTRUCTION

Famous wrap-around design with full 2½" corrugated cross-bracing welded to tubular steel legs.

2. INTERLOCKING JOINTS

. . . formed by swaging tower ends so that they overlap each other, becoming a single unit in structure. Proved by tests to be superior.

3. WEATHER SEALED

. . . against condensation and moisture.

4. HOT DIPPED GALVANIZING

. . . both inside and out gives the finest protective coating known. This sales point is one of the best you can offer . . . the finest quality and at lower than competitive prices!

these two **HOT DIPPED GALVANIZED**
Rohn Towers
will satisfy 90% of your TV tower needs!

HEAVY DUTY NO. 30 TOWER

Heights up to 200' or more when guyed
Self-supporting up to 60'

Sturdy communication or TV tower that will withstand heavy wind and ice loading. Heavy gauge tubular steel, electrically welded throughout.

Weather resistant, non-corrosive double coating provides durable finish.

All sections in 10' lengths. Only 2-4 manhours required for installing 50' tower! Tremendous sales potential for you in this tower!

SPECIAL INSULATOR SECTIONS are available to permit the Rohn No. 30 Tower to be used as guyed "series fed" radiators for amateur and commercial uses.

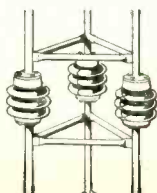

NEW LINE OF ROHN ROOF TOWERS



Four superior designed "Roof Towers" are available for inexpensive, yet sturdy roof installations. 3', 5' and 10' sizes are available. These completely galvanized Rohn Towers have unbeatable sales appeal when this type installation is desired.

for • larger profits • customer satisfaction • greater ease in ordering, handling and shipping

HANDLE THE COMPLETE LINE OF ROHN GALVANIZED ACCESSORIES

. . . house brackets, special bases, peak and flat roof mounts, instant drive-in bases, telescoping masts with matching bases, special Rohn Fold-Over Tower, guying brackets, UHF antenna mounts, erection fixtures, variety of mounts and supports for masts or tubing, tower installation accessories, TV service tables, mast and TV hot dipped galvanized tubing, guy rings, etc.

CALL YOUR ROHN REPRESENTATIVE
FOR COMPLETE CATALOG, SALES
LITERATURE AND PRICES — OR WRITE —
PHONE — WIRE DIRECT

GET ALL YOUR REQUIREMENTS
FROM ONE RELIABLE SOURCE

ROHN Manufacturing Company

116 Limestone Avenue, Bellevue, Peoria, Illinois

RADIO-ELECTRONICS

L. C. Lane, B.S., M.A.
President, Radio-Television Training Association. Executive Director, Pierce School of Radio & Television.



VETERANS--NON-VETERANS TRAIN NOW FOR A TOP-PAY JOB IN TELEVISION



No Experience Needed—I train you AT HOME in your SPARE TIME

NOW — while the Television-Radio-Electronics industry is expanding at the fastest rate in history — is the time for you to prepare for a top-pay lifetime job . . . or your own profitable business.

New TV stations are going up constantly . . . sales of TV sets are breaking all past records . . . new products are being announced almost every day . . . new plants are

springing up to meet the heavy demand for these products.

Trained men are needed urgently. The head of CBS-Columbia product service department estimates that the industry will need 200,000 service men by 1959. The best jobs will go to the men who are ready for them. *Right now* is the time for you to prepare yourself. Delay can be costly.

LEARN BY DOING

As part of your training I give you the equipment you need to set up your own home laboratory and prepare for a **BETTER-PAY TV JOB**. You build and keep an Electromagnetic TV RECEIVER designed and engineered to take any size picture tube up to 21-inch, (10-inch tube furnished. Slight extra cost for larger sizes.) . . . also a Super-Het Radio Receiver, AF-RF Signal Generator, Combination Voltmeter-Ammeter-Ohmmeter, C-W Telephone Transmitter, Public Address System, AC-DC Power supply. Everything supplied, including all tubes.



STUDY NEWEST DEVELOPMENTS

My training covers all the latest developments in the fast-growing Television-Radio-Electronics industry. You learn about FM — RADAR — COLOR TV — TRANSISTORS — PRINTED CIRCUITS, etc.

CHOOSE FROM THREE COMPLETE COURSES covering all phases of Radio, FM and TV

1. Radio, FM and Television Technician Course — no previous experience needed.
2. FM-TV Technician Course — previous training or experience in radio required.
3. TV Cameraman and Studio Technician Course — advanced training for men with Radio or TV training or experience.

EXTRA TRAINING IN N.Y.C. AT NO EXTRA COST!

After you finish your home study training in Course 1 or 2 you can have two weeks, 50 hours, of intensive Lab work on modern electronic equipment at our associate resident school, Pierce School of Radio & Television. **THIS EXTRA TRAINING IS YOURS AT NO EXTRA COST WHATSOEVER!**

FCC COACHING COURSE

Important for **BETTER-PAY JOBS** requiring FCC License! You get this training **AT NO EXTRA COST!** Top TV jobs go to FCC-licensed technicians.

FREE! I'll send you my new 40-page book, "How to Make Money in Television - Radio - Electronics," a Free sample lesson, and other literature showing how and where you can get a top-pay job in Television.



EARN WHILE YOU LEARN

Almost from the very start of your course you can earn extra money by repairing sets for friends and neighbors. Many of my students earn up to \$25 a week . . . pay for their entire training with spare time earnings . . . start their own profitable service business.

VETERANS

My School fully approved to train Veterans under new Korean G. I. Bill. Don't lose your school benefits by waiting too long. Write discharge date on coupon.

MAIL THIS COUPON TODAY!

Mr. Leonard C. Lane, President
RADIO-TELEVISION TRAINING ASSOCIATION
Dept. R-11C, 52 East 19th Street, New York 3, N. Y.

Dear Mr. Lane: Mail me your **NEW FREE BOOK, FREE SAMPLE LESSON**, and **FREE** aids that will show me how I can make **BIG MONEY IN TELEVISION**. I understand I am under no obligation and no salesman will call.

(PLEASE PRINT PLAINLY)

Name _____ Age _____

Address _____

City _____ Zone _____ State _____

I AM INTERESTED IN:

- Radio-FM-TV Technician Course
- FM-TV Technician Course
- TV Cameraman & Studio Technician Course

VETERANS!

Write discharge date

NO SALESMAN WILL CALL!

Radio **T**elevision **T**raining **A**ssociation

52 EAST 19th STREET • NEW YORK 3, N. Y.

Licensed by the State of New York • Approved for Veteran Training

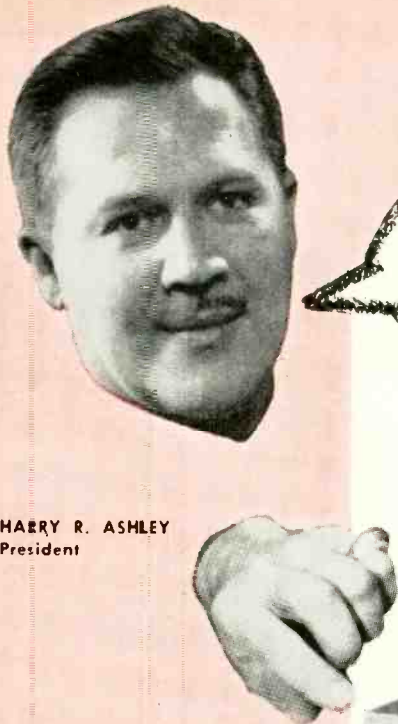

HARRY R. ASHLEY
President

**DO YOU OVERPAY
FOR QUALITY INSTRUMENTS
LIKE THESE?**

EICO's mass purchasing and world-wide distribution, together with advanced electronic design, produce values never before possible . . . to give you **LABORATORY PRECISION AT LOWEST COST!**

You build **EICO KITS** in one evening — but . . . **THEY LAST A LIFETIME!**

GET THE MOST FOR YOUR MONEY! Don't buy ANY test instrument until you put the **EICO INSTRUMENT** (kit or wired) equivalent before you — and . . .

★ Compare **ADVANCED ELECTRONIC DESIGN**

★ Examine the **QUALITY PARTS**

★ Notice ease of construction

★ Check **EICO's 5-WAY GUARANTEE** on components, instructions, performance, lifetime service and calibration

★ Compare **FEATURE** for **FEATURE, DOLLAR** for **DOLLAR**

Then **YOU** decide who's giving you the **MOST** for **YOUR MONEY**.

46 KITS and Instruments to choose from!—an instrument for every purpose.

You'll **SAVE 50%** and more . . . when you **BUY EICO!**

In stock at local parts distributors from coast to coast.

Write for **FREE CATALOG C-11**



84 Withers St. • Brooklyn 11, N. Y.

Prices 5% higher on West Coast



KIT \$26.95
Wired \$39.95
Range: 150 KC to 435 MC



NEW DC WIDE BAND 5" OSCILLOSCOPE #460
KIT \$79.95
Wired \$129.50



5" PUSH-PULL OSCILLOSCOPE #425
KIT \$44.95
Wired \$79.95



7" PUSH-PULL OSCILLOSCOPE #470
KIT \$79.95
Wired \$129.50



VACUUM TUBE VOLTMETER #221
KIT \$25.95
Wired \$39.95



DELUXE VTVM #214 (7 1/2" METER)
KIT \$34.95
Wired \$54.95



#232 Peak-to-Peak VTVM with DUAL-PURPOSE AC/DC UNI-PROBE (pat. pend.)
KIT \$29.95
Wired \$49.95



TUBE TESTER #625
KIT \$34.95
Wired \$49.95



Pix Tube Test Adapter \$4.50



#944 FLYBACK TRANSFORMER & YOKE TESTER
KIT \$23.95
Wired \$34.95



TV/FM SWEEP GENERATOR #360
5MC-4.5MC CRYSTAL \$3.95 ea.

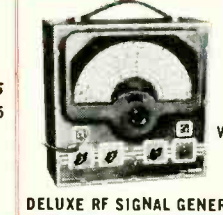

DELUXE RF SIGNAL GENERATOR #315
KIT \$39.95
Wired \$59.95

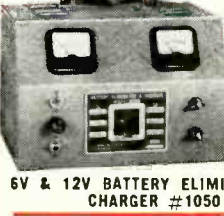

6V & 12V BATTERY ELIMINATOR & CHARGER #1050
KIT \$29.95
Wired \$38.95



DELUXE MULTI-SIGNAL TRACER #147
KIT \$24.95
Wired \$39.95



R-C BRIDGE & R-C-L COMPARATOR #950B
KIT \$19.95
Wired \$29.95



20,000 Ohms/Volt MULTIMETER #565
KIT \$24.95
Wired \$29.95



1000 Ohms/Volt MULTIMETER #536
KIT \$12.90
Wired \$14.90

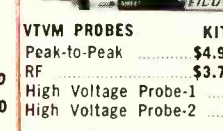

| VTVM PROBES | KIT | Wired |
|----------------------|--------|--------|
| Peak-to-Peak | \$4.95 | \$6.95 |
| RF | \$3.75 | \$4.95 |
| High Voltage Probe-1 | | \$6.95 |
| High Voltage Probe-2 | | \$4.95 |

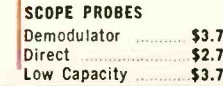

| SCOPE PROBES | KIT | Wired |
|--------------|--------|--------|
| Demodulator | \$3.75 | \$5.75 |
| Direct | \$2.75 | \$3.95 |
| Low Capacity | \$3.75 | \$5.75 |

TELEVISION FOR DEAF CHILDREN

... *What has television done for our deaf children?* ...

Television for deaf children is now routine in England. We publish below an article by Ursula Eason, producer of the British Broadcasting Company's Children's Television Program. It is hoped that it will interest our television broadcasters sufficiently to produce such programs in the United States in the future:

THE first regular series of television programs for deaf children was started in June, 1952, and has continued monthly.

The idea of the programs for deaf children had long been in the mind of the head of BBC Children's Programs, Miss Freda Lingstrom, but it was not until a regular daily program for children had been established for some time that she felt justified in giving part of the time to a section of the audience.

Before the regular series began there was an experimental program which was generally agreed not to have been very successful. It consisted of a story told in pictures with the spoken words of the story repeated in running captions like subtitles. The words were too small for easy reading on small television screens and went too fast for children whose chief difficulty is words. So for the regular series we sought further advice and asked for the cooperation of the National Institute for the Deaf, the largest society in England dealing with the welfare of deaf people. The editor of the Institute's magazine "The Silent World" was appointed adviser and scriptwriter for the program, and his cooperation has proved invaluable. The institute gets reactions from schools and from members of the institute on the program's presentation and content.

We realize that deaf children can get a lot of pleasure from watching normal programs, but many of these must be puzzling to those to whom words are a constant difficulty. We know that deaf children are the same as any other children in their interests and in their intelligence, and superior to many in their quickness in taking in pictures and in their powers of concentration.

Where programs for deaf children should specialize is, we feel, in the presentation of words. Our formula has been very simple: never show on the screen words—either spoken for lip reading or written—at the same time as movement. Our plan is to tell children beforehand what they are going to see and then to show the action. They cannot watch lips and action simultaneously.

In England the teaching of deaf children in schools is purely oral. All teaching is done by lip reading and children are discouraged—in some cases punished—for using finger spelling or signing. It is for this reason that we have adopted lip reading in program announcements. But some teachers feel that finger spelling may be used to help give a wider background and knowledge to deaf children out of the classroom. To meet the views of these teachers we have occasionally included items which show finger spelling, but we do not use the sign language which, it is felt by many teachers and workers for the deaf, only increases the isolation of deaf children from the normal community.

The aim of the program for deaf children is *entertainment*. If in the course of the program the children get something of educational value or are helped with their lip reading, then

we are very glad, but this is a secondary consideration.

I have mentioned the opinions of teachers because it is through them and the schools that I have received valuable comments on children's reactions to the program. Also, many of the residential schools in this country have television sets and the children do their main viewing in the schools.

At first, action was always shown with no sound at all. Many people suggested that normal sound should be included, so our plan has been changed. We now include sounds that would normally accompany the action and we have musical backgrounds to mime, comedy and film. But we never use sound to make movement clear as normal television programs do. In other words, the vision in all these programs is complete and self-contained and sound is only supplementary to sight. Explanation is given by an announcer speaking in closeups with the mouth as near as possible in the center of the picture. This is followed by a repeat in written caption form of what has been said and then comes the action. This method of presentation has been generally well received and seems to be the most satisfactory form.

We have experimented with stories for lip reading only. We have shown pictures only without explanation and sometimes this is successful. But on the whole we feel that the formula of explanation followed by movement is the right one.

What we are trying to do in these programs is to present the same kind of material as in normal children's programs, but made explicit through sight alone. There are many limitations, the most serious being lack of time—*only fifteen minutes a month* [the italics are ours.—Editor]—and I am afraid that with [England's] television at its present stage it is not possible to increase this.

The content of the programs takes the form of a short "magazine" presentation. Comedy, usually in mime, conjuring and magic without patter, knockabout clowning—these we know the children enjoy. How to do and make things—shown visually with a minimum of written captions at key points—and natural history are other ingredients. We show information films of industrial processes, other countries and so on and "break" them at key points to include captions explaining what is to follow. Perhaps the most popular items are films made in schools for the deaf or of some activity in which deaf children themselves are taking part. We try also to reflect the work of clubs and societies. For instance the National Institute for the Deaf sponsors an annual show of paintings and handicrafts by deaf children, and we borrow the prize-winning entries to show on the screen.

We have also attempted an explanation of news events. For instance, before the coronation we showed—by means of film, animated diagrams and a working model of the procession from the Abbey—exactly what the Queen would be doing on Coronation Day, in the hope that the television program would be clearer for children who could not hear the commentary. Similarly after the climbing of Mount Everest, we broadcast a program explaining the difficulties of mountaineering.

Specially made films, which would be particularly valuable, are used rarely because of their cost. (*Continued on p. 124*)

By ROBERT G. MIDDLETON*

again... the



The color circle: matrix response to faulty color detector

READERS will remember from the earlier articles that the matrix system does not operate correctly unless the color subcarrier frequency is injected in the proper phase. We now ask and answer the question, "How is the simple matrix affected by incorrect adjustment of the color phase control?"

Fig. 1 shows a color circle. These are the colors developed by the matrix sys-

*Chief field engineer, Simpson Electric Co.

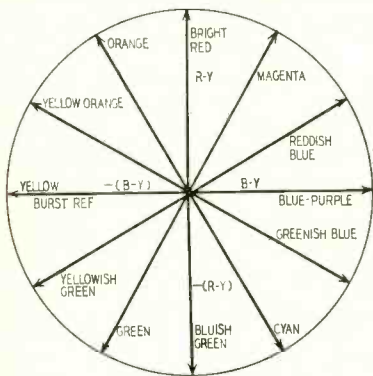

Fig. 1—Circle shows chrominance voltages with proper color phase adjustment.

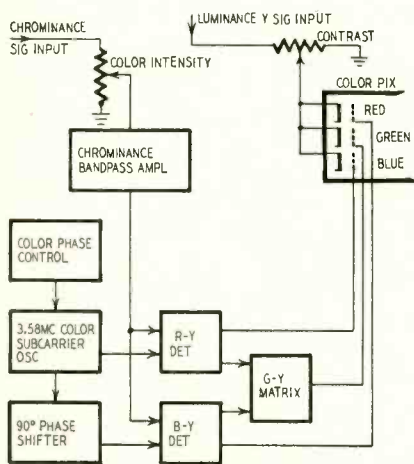

Fig. 2—Matrix system—subcarrier must be fed to detectors in proper phase.

tem (Fig. 2) when the color subcarrier voltage is introduced correctly with respect to the burst phase which is the same as the $-(B-Y)$ phase as shown in Fig. 3. Now, let us investigate the effect of misadjusting the color phase control in such a manner that the color subcarrier voltage is injected with reference to the $R-Y$ phase instead of the $-(B-Y)$ phase. This misadjustment has the effect of rotating the color circle shown in Fig. 1 through an angle of 90° counterclockwise: red becomes yellow, blue becomes red, yellow bluish-green, etc.

In similar manner, let us investigate the effect of misadjusting the color phase control so that the color subcarrier voltage is injected with respect to the $-(R-Y)$ phase, instead of the $-(B-Y)$ phase. This misadjustment has the effect of rotating the color circle through an angle of 90° clockwise: red becomes blue, yellow red, blue bluish-green, etc.

If the color subcarrier voltage is injected with reference to $B-Y$ phase, blue becomes yellow, red bluish-green, yellow blue, etc.

It might be supposed that the matrix might develop a pure red signal when energized by an $R-Y$ signal from a rainbow generator or other signal source. This is not so and the red hue will be diluted. Fig. 4 shows why this is so. An $R-Y$ signal produces output

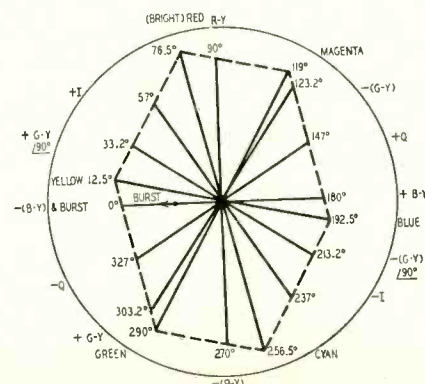

Fig. 3—The colors of the NTSC system.

from the $R-Y$ detector and applies it to the red grid of the color picture tube. But the $R-Y$ detector also supplies -0.51 of the signal to the green grid via the green matrix. The green grid is thus energized also and a pure red output is not obtained—the red hue appears mixed with green.

Let us observe what happens when a signal is applied which does not energize the $G-Y$ matrix. Such a signal is $(G-Y) / 90^\circ$, as shown in Fig. 3. But it is evident from Fig. 3 that $(G-Y) / 90^\circ$ has components along both the $R-Y$ and $B-Y$ axes. Hence, when a $(G-Y) / 90^\circ$ signal is applied to the chrominance amplifier, there is no output from the $G-Y$ matrix, but there is output from both the $R-Y$ and $B-Y$ detectors, energizing both the red and blue grids in the color picture tube. The red hue which appears is diluted with blue.

Thus, a simple chrominance or rainbow signal is incapable of energizing the matrix so as to produce output from either the $R-Y$, $B-Y$ or $G-Y$ matrix alone. For this reason, pure saturated primaries cannot be obtained from the matrix with rainbow input.

Let us now distinguish between chrominance and NTSC signal input. Fig. 5 shows $R-Y$ input as the signal appears on the screen of a wide-band

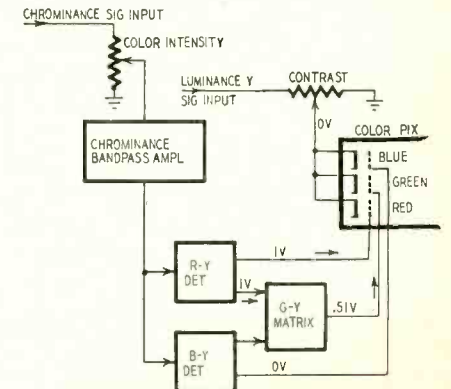

Fig. 4—Diagram shows how output from $G-Y$ matrix prevents pure red hue.

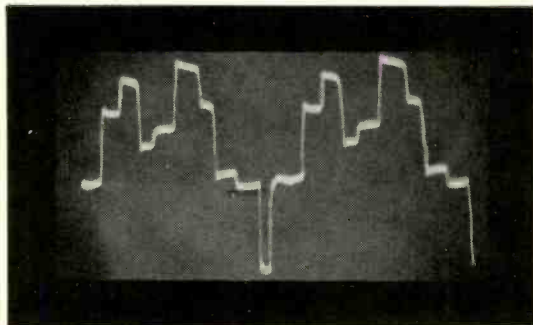

Fig. 5—Appearance of R - Y signal.

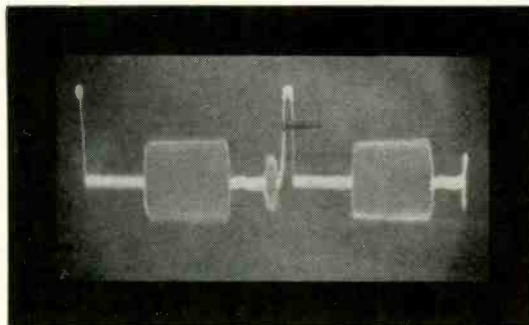

Fig. 6—Luminance component on scope.

scope. Note that this chrominance signal is centered on black level—the signal has no Y voltage. Fig. 6 shows a Y signal as it appears on the screen of a scope. When luminance (Y) and chrominance voltages are added, the result is a complete (NTSC) color signal as shown in Fig. 7.

The complete color signal produces pure primary colors on the screen of the picture tube because, when a saturated red is being reproduced (the Y signal on the cathode adds to the signal on the red grid to produce full output from the red gun), the Y signal on the cathode simultaneously cancels the signals on the blue and green grids, eliminating the source of contamination of the saturated red color. The outputs from the luminance and chrominance channels must be set to proper levels to obtain this condition.

Before proceeding with the fundamentals of matrix action, we should emphasize a point illustrated in Fig. 8. The *input* to the color detectors, as seen on the screen of a wide-band scope, is a 3.58-mc sine wave; the *output* from the color detectors is a video-frequency signal having the appearance of a square wave (envelope of the 3.58-mc signal). When the bandpass amplifier applies a 3.58-mc signal in the R-Y phase to the color detectors, the R-Y detector will produce an output signal, but the B-Y detector will not. As shown in Fig. 9, the G-Y matrix responds to the R-Y signal by developing negative output (remember, the G-Y matrix develops -0.51 of R-Y).

Faulty color detector

Now let us see what happens in the matrix system when the B-Y detector goes dead. Where a saturated red signal is being transmitted, the 30% Y component proceeds to the cathodes of the picture tube as usual. The R-Y detector develops its normal output of 70% and the red gun is energized fully. But, the B-Y detector does *not* deliver $-30%$ of B-Y as it should, hence the blue gun in the picture tube is not cut off—instead, the blue gun develops a

very noticeable blue cast in the red hue. Furthermore, the G-Y matrix receives the R-Y signal, *but the matrix receives no B-Y signal*. The matrix responds to the situation by developing -0.51 (R-Y), and this signal is applied to the green grid where the cathode voltage is more than cancelled by the grid voltage. The end result is a red hue rather badly contaminated with blue.

The same process can be followed through for other hues—green, blue, yellow, etc. A saturated green hue becomes diluted with blue; a saturated blue hue with red and blue. But, suppose that the R-Y detector fails and the B-Y detector continues to operate. In such a case, this line of reasoning shows why all colors then appear as greenish-yellow or reddish-blue on the screen of the color picture tube.

Thus, the service technician who has a good working knowledge of matrix action can often glance at the image and realize immediately that either one or the other of the color detectors is faulty. Finally, let us consider the

case in which the G-Y matrix is faulty. A tube is used in the matrix for inverting the R-Y and B-Y signals, since $G-Y = -0.51(R-Y) - 0.19(B-Y)$. When the G-Y matrix tube goes dead, there is no driving voltage to the green grid, and the green gun is operated only by the Y voltage on the cathode. For colors such as saturated red and blue which have no green content, the reproduced colors become contaminated with green—30% contamination in the case of red and 11% contamination for blue.

In the case of a green signal the output from the green gun is only 50% (of the Y signal) instead of 100%. But there is no contamination of the green with red or blue since the R-Y and B-Y detectors are operating normally. Thus, the Y signal on the red and blue cathodes are properly cancelled by the R-Y and B-Y detector outputs at the red and blue grids. However, due to failure of the green matrix tube there is no additive signal on the green grid to boost the 59% Y voltage on the green cathode to 100% output from the green gun. END

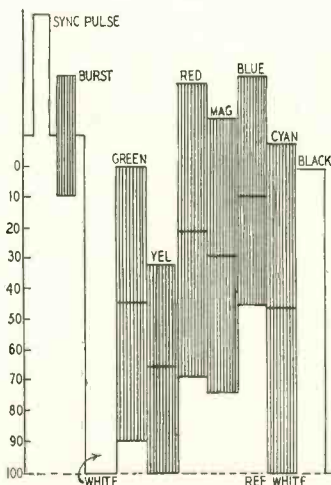

Fig. 7—Standard NTSC color-bar signal, obtained by superimposing the chrominance signal on the luminous signal.

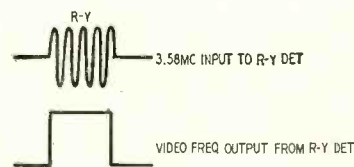

Fig. 8—Input and output of color detector energized by sine-wave signal.

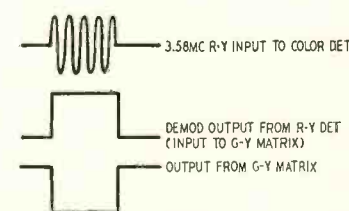
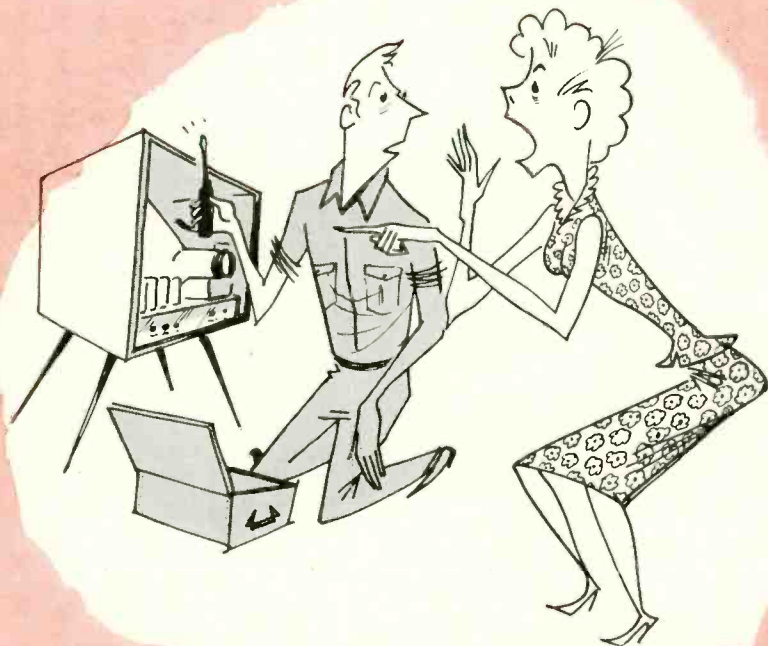

Fig. 9—G - Y matrix takes R - Y detector output—develops negative output.

THE LITTLE THINGS THAT COUNT

By ART MARGOLIS



IMAGINE this situation. A gigantic nation-wide TV manufacturer decides to cut expenses. By an odd quirk of ill planning he comes to the conclusion that he no longer needs a production line test setup. All testing is abolished and the testers fired. The production line continues and untested receivers are boxed and shipped. Do you think any confusion would result? Which do you think would cause more consternation, this situation or a carefully placed hurricane? Getting back to reality, do you think anyone would ever let a predicament such as this occur? Of course not! Not for all the white collars on Wall street.

But consider this set of circumstances. A 19-inch RCA chassis is pulled into the shop. The benchman takes a fast gander at the complaint tag. "Fixed brightness and loss of sync." From long experience he turns the chassis on its side and quickly locates a .02- μ f capacitor connected from the sync separator to the picture-tube grid. As expected, the suspicious roll of foil measures 3 ohms. Since capacitors were not made to measure 3 ohms, he replaces it with a more normal one. As an added precaution he checks for a possible resistor that might have received too much current flow due to the short, but he finds none. With a triumphant smile he lifts the chassis high and puts it on the rack labeled "Repaired Sets." Casually he turns to his next job.

Do you think anyone would ever let a situation like this occur? Of course, it happens all the time. The TV receiver is repaired just as those mythical untested TV sets were manufactured. The repairs consisted of locating the defective part, and replacing it. Then the set was declared ready for delivery. No further testing or checkout was even considered, especially with this chassis, since it arrived at the shop in three sections, minus the picture tube, and it would have been a full 5-minute job to hook everything up.

You will shrug your shoulders and murmur that there is a big difference between making a set and repairing one. O.K. Naturally there is hardly a comparison. A checkout procedure for TV repair need not be anywhere near as complex as a manufacturer's test of a receiver. The entire affair can be taken care of in a few minutes, but these minutes can reduce dollars lost in call-backs.

The reminder chart

The factory, in its engineered test setups, uses all sorts of sheets and charts. Some resemble the tube voltage and resistance tables found on some schematics. These are necessary for a successful high-speed production line. But all we need is a reminder card (see chart). It can be attached to each chassis or simply tacked to the wall.

After we clean the chassis and tuner of dirt and corrosion, we invest in a few drops of solvent and swish a bit in

each pot. A dirty control, especially volume or contrast, can result in an annoying callback.

A 12-inch Artone came into the shop a while back. The complaint read, "No nothing." The service technician was not quite accurate—the filaments still lit. A shouted hallelujah was heard from the benchman as he located a burnt focus pot. This restored raster and video to the screen, but it was way out of horizontal sync. After about 20 minutes, more laughter was heard together with the clicking of the solder-gun trigger. He had found that a horizontal multivibrator grid resistor measured 500,000 ohms—it should have been 270,000. Changing this resistor brought back horizontal sync. Then, another discovery—no audio. Another hour of exploratory surgery uncovered two open 1,000-ohm resistors in the B plus feed line and a shorted .02- μ f capacitor in the grid circuit of the audio output tube. After that the set seemed in good shape and was delivered.

I got the report from the technician who delivered the set. The owner was satisfied with the picture but when she found the volume control scratchy, she hit the ceiling. Upon her return to the hardwood floors, she told the technician, in true customerlike fashion, that we hadn't done anything, because the volume control was just as noisy as when the set was pulled. A few drops of solvent were all that was needed to bridge the gap between a satisfying expensive repair job and the unlucky results of this one.

A somewhat parallel case—a 19-inch Crosley—went swiftly through the shop. The complaint was picture shrinking. The service technician had suspected weak selenium rectifiers but instead the horizontal output screen-grid resistor, when heated, went from 4,700 to about 900 ohms. This short lowered the screen resistance on the horizontal output, ran the tube hotter, drew more screen current and lowered the B plus voltages throughout the set—four-sided shrinking resulted. The resistor was changed, the set delivered and the technician received a large tip. The customer was more thrilled with the volume control that no longer grated than the repair. The repair was taken for granted, but the few drops of suitable solvent constituted the little extra that gave us a satisfied customer.

Insufficient width occasionally is pooh-poohed over lightly in the shop. The customer usually has a different opinion of it. We make a very definite width check in the shop and we don't settle for anything but the best. Typically, a 10-inch Motorola stared blankly up at me the other day. The complaint read simply, "No B plus." Checking revealed a leaky 140- μ f filter capacitor in the B plus line. This restored the missing B plus and all was well with the receiver—that is, all but the width. Try as I might, I could not get enough width. After playing with adjustments for 15 minutes I broke down and in-

stalled two new gayly colored selenium rectifiers. The picture seemed to grunt as it came on and then confidently pushed its way outward till it crept around either side of the tube. Then the delivery man went forth bravely.

Insufficient width can be corrected rather easily with new rectifiers, horizontal output tubes, dampers or even by juggling the screen and cathode resistors in the horizontal output stage. But no matter how, it must be done for satisfied customers and repeat business.

Checking sweep circuits

Vertical sweep headaches, though not as constant a pest as horizontal sweep problems, occur frequently. A 10-inch Admiral arrived for care. There was no vertical sweep. An open primary in the vertical output transformer was quickly located. Upon replacement the picture blossomed out once more, top and bottom. However, to center the picture properly and spread it to fill the entire screen, the vertical linearity pot had to be opened all the way.

The actors on the TV screen had pointy heads and stumpy legs. Further research showed that the vertical output cathode resistor had changed tremendously in value. Inserting the correct resistance restored the maligned TV performers to their normal proportions.

Another time a 16-inch set was brought into the shop. Like a mongrel, it resembled three or four brands, but there was no name on the cabinet and none on the chassis. The customer confessed she did not know the name of IT either.

There was very little vertical sync. The picture would, upon ticklish manipulation of the vertical hold control, lock in; but even walking past the set rapidly would kick it off. A 6SN7 tube was located acting the dual role of vertical oscillator and vertical output. The last of the three legs in the integrator was a .05- μ f capacitor that had the audacity to measure about 500,000 ohms. We all breathed a sign of relief as a new .05 "boiynge" in the picture to stiff attention.

Once more our lips trembled, for there was not enough vertical sweep. Scouring the circuit revealed no other bad parts. Then, miraculously, we were delivered in our hour of need by a stroke of genius. One of the outside service technician pulled out the 6SN7 tube, winked at us once and inserted a 6BL7. We all witnessed the expansion of the picture with lots of leeway on both of the vertical sweep controls.

Another must on our list is a horizontal frequency stability check. For circuits such as the Synchrolock, a fast scope alignment doesn't do any harm. A 21-inch Muntz was brought into the shop. The complaint was no sound, no video and, though only a 6-months old infant, the set was smoking. Somehow the raster remained during the melee. After a fast check through the tuner and i.f. sections, hot on the

trail of a couple of hundred ohms between B plus and ground, the trouble was naturally located in another section of the receiver. The 6W6 audio output tube had a screen-to-cathode short that killed B plus to the tuner and i.f. stages. The 6W6 screen grid dropping resistor was mercilessly having heavy current pumped through it, and it was doing the underage smoking. A new 6W6 and 5U4 in addition to the damaged resistor had the TV pumping along nicely once more. The set was returned.

A day or two later brought a frantic plea for assistance from the proud owner. She told us the picture was going off again, but this time the sound remained. Further questioning revealed it was horizontal sync trouble this time. As an added attraction, it was intermittent. The little monster was brought back to the shop once more and the oscilloscope showed in bright chartreuse that the horizontal alignment of the Synchrolock circuit was not all it should be. About 45° rotation on the underside of the Synchrolock can make the scope form identical with the picture on the alignment notes. Needless to say, the set has lived happily ever after. Also, needless to say, horizontal alignment became a 3-minute must on every chassis that runs through our shop.

The audio system is another circuit that we give a quick check. A 12-inch Admiral, brought in for bench repair, had high voltage arcing all over everything. The picture tube was arcing to the chassis. This was successfully shielded with some plastic sheets. Then just as we began to pat ourselves on the back, the second-anode lead began to arc to the high-voltage cage. Gobs of high-voltage tape straightened that out, but there was no rest for the weary. The IB3 socket began to spit miniature lightning into the metal frame of the flyback transformer.

Somehow at this point we began to

REMINDER CHART

- Clean chassis and tuner
- Clean all controls
- Width and blooming
- Vertical sweep
- Horizontal frequency
- Sound clarity
- Picture—all channels
- Shadows
- Cook

Remarks:.....

.....

TELEVISION

suspect there just might be something causing it. A few fast resistance checks revealed the 470,000-ohm limiting resistor in the lead from the IB3 cathode to the picture tube open. With no place special to go the high voltage was spilling onto everything! Replacing the resistor eliminated the trouble.

Congratulations were passed around freely and without further fanfare the set was returned from whence it came. However, we were not off the hook so easily, for the customer called back promptly. She told me that after about a half-hour the sound became garbled. Her complaint was justified. We went out and found the TV performers speaking excellent Martian. A new 6AL5 and some discriminator trimming brought the set back to this world. An audio check could have easily bypassed this expensive interplanetary episode.

Here in Philadelphia we have channels 3, 6 and 10. It follows then that it might be sensible to see whether all three are coming in properly. We weren't always that sensible. For example: a 10-inch Motorola came in with no sound, no raster and the distinct odor of rotten eggs. Following the plot I substituted my nose for my trusty v.t.v.m. and tracked the odor to shorted selenium rectifiers. They were replaced, the picture popped back on and the sound rallied loud. Everything looked pretty good and the malingering smell of hydrogen sulfide was gone. Then with a glance at the checkout chart, I went through the routine.

I cleaned all the controls and the tuner. There was no width problem and no blooming, the vertical sweep was doing an excellent broomlike job and the horizontal frequency was performing in stellar fashion. Then I checked for all three channels. Number 6 was there but, try as I might, neither 3 nor 10. But good fortune was riding at my side—I discovered a 12AU7 acting the role of local oscillator and mixer. It was a poor substitute for the 12AT7 that the set had been designed for. The tube swap restored the missing channels and we had saved a costly callback.

If possible we find it a good idea to adjust the yoke, focus magnet and ion-trap magnet in the shop to remove all corner shadows. One of the boys delivered a 12-inch Muntz that had received a new yoke in our shop. The set got the usual checkout procedure, but this was done while it was lying on a metal bench. After the delivery I heard some mumbling from the technician about some difficulty he had in centering the picture, but I didn't pay too much attention.

A few months later I returned to our customer's home on another service call. The horizontal output tube had passed away and a new replacement soon had the set working again. Before I put the back on I noticed a screwdriver carefully balanced on top of the focus coil. I thought it was a good thing my technician was not a surgeon. He'd leave a scalpel inside someone's kidney. Right-

eously I removed the implement. I might have taken it from the customer's kidney, from the howl she let out. Removing the screwdriver shifted the picture about 4 inches, leaving a most remarkable black margin.

Then I invested 20 minutes of attempted centering. I ended up balancing the screwdriver in the same precarious perch, and silently blessed my service technician for his ingenuity. Evidently the tool channeled some of the magnetic lines of force from the focus magnet, enabling the electron beam to shift to the correct position. As far as I know the screwdriver is still acting as part of that focus magnet. If we had caught the condition in the shop, a more professional approach could have been used.

Cooking

The last thing we do to a completed chassis, after all else is done, is play it for at least 3 or 4 hours. This is intimately called cooking. Cooking has saved us much money on callbacks.

For instance, a 16-inch Philco was tagged: "Arcing in the picture and then

loss of raster entirely." Quickly we located an arcing 2-megohm high-voltage resistor and changed it. The arcing stopped. The set was put through the usual routine and then set on the shelf to cook. About 2 hours later the raster disappeared with a pop. An hour or so of circuit scouring uncovered a cold solder joint. It was on the cathode of the 12AU7 horizontal multivibrator. When the tube got really hot the cathode bias resistor went out of action.

When the chassis is removed to the shop, the TV service technician is under a much heavier obligation than when it is repaired in the home. The customer has all kinds of wondrous ideas about the miracles that are going to be performed on her TV receiver in the "factory." It is not good to encourage the idea that a complete overhaul is going to be performed but it is a definite asset to have her feel that it is your automatic practice to clean and check along with the repair. A spotlessly clean chassis with an X'ed-in checkout card hanging from it will never permit a TV set owner to say, "Why, you didn't do anything!"

END

EASY SERVICE FEATURE ON NEW TV

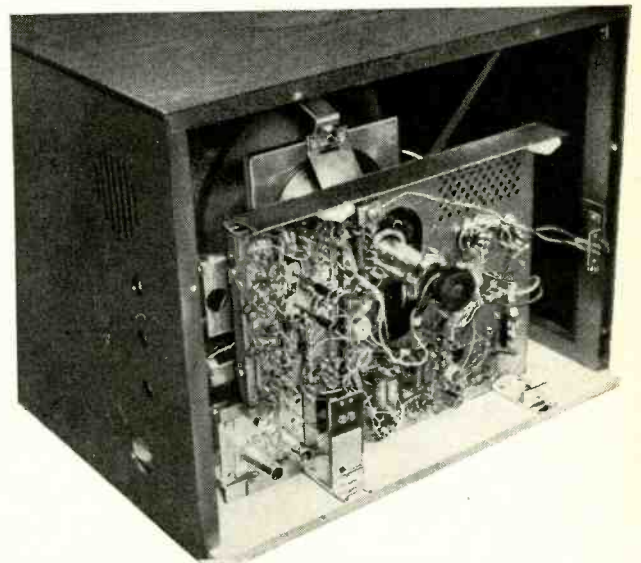

A TV chassis recently introduced by the Canadian Marconi Co. of Canada features a tilt-back arrangement for simplified servicing. The chassis is of the vertical type and is conventional in all other respects. A similar chassis was announced later by CBS-Columbia. Fastened to the base by two hinged brackets (top photo), the service technician can work on the chassis underside and, when desired, lower the unit to a horizontal position (bottom photo) for topside servicing.

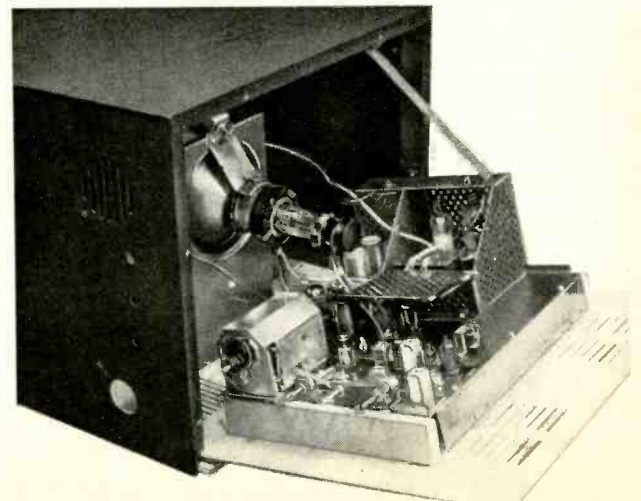

*The scene behind
the scene; operating
facilities in a CBS
color television studio*



Similar to the cover illustration, this photo gives a more detailed view of control room.

CONTROL ROOM

By JOHN KOUSHOURIS*

THE cover photo, taken from the rear of the control room in CBS color Studio 72, gives a bird's-eye view of the technical operating and staging areas.

On the upper level, the technical director (left) is seated at the switching console. He can select a camera or film chain, test signal, remote feed or a special effects feed by depressing buttons. To his right is seated the show director who issues orders to the camera men and boom operators via an intercom system. Instructions are issued to the operating personnel on the stage by the show director, technical director and audio engineer via microphones.

The equipment below is the color video console. To the left are the controls for all telecine facilities which include 35- and 16-mm film, and 35-mm slide transparencies. To the right are control units for cameras 1 through 4.

There is a color control technician seated at each camera position to set up each camera electronically so that a high-quality color reproduction or picture is produced. The major part of his setup work is concerned with viewing the camera picture on a black-and-white video monitor. A final check-out of the camera chain is made by viewing respective color monitors located above the operating position.

Seated at the center of this video console is the color technical director who is concerned with color match between cameras as viewed on the color line monitor, adequate lighting for good-quality pictures and correct choice of colors for good color reproductions.

On the left side of the video console is a black-and-white slide reproduction of a young lady and directly above it can be viewed the same picture in color. On both sides of this color picture is a color bar display used primarily as a test signal in matching both encoders and individual monitors. Above these color monitors, within the control room,

is located a black-and-white presentation of the color test bars on a black-and-white client's monitor. It is important today, since the majority of the viewing audience has black-and-white receivers, that we be concerned with the black-and-white reproductions as well as color.

The three-tube color cameras and test pattern can be seen through the control-room windows on the studio stage floor. Between the cameras is a gyrating test pattern. The upper chart is used in registering the three color channels in the three-tube color cameras. In the center is a standard black-and-white RETMA test chart. Linearity and resolution are adjusted when the camera is focused on this chart. In the lower portion is a gamma chart consisting of a series of 10 steps in the gray scale from what we consider white to black in television. Each channel is electronically adjusted so that the red, green and blue Image Orthicons track uniformly from the black through the intermediate grays to white. This is done by turning a knob on a selsyn

motor which rotates a remotely located selsyn-motor-controlled iris. The lens can be closed down or opened from the video console and this is carried out when the camera is trained on the gamma chart. By making electronic adjustments while we open and close the camera iris, we correct any tracking errors.

The audio facilities in a color studio are identical with those in monochrome operations. The audio console (not shown) is located to the left of the technical director.

The audio racks are located behind the audio console and they house the audio amplifiers and jackfields. Adjacent to the audio console, two record turntables are installed for playing back records and transcriptions. Directly behind the turntables is an announcer's booth with excellent visibility of the production console and video monitors. Just as the video control technician works with a camera man on stage, so the audio engineer works with boom operators and pushers in the staging area.

END



Technicians adjusting the color cameras.

* Engineer in charge of color, CBS Television, New York.

COMPOSITE



SIGNAL

*Analyzing the blanking, sync
and video portions of the
transmitted TV signals*

By JESSE DINES

UNDoubtedly, you have read a number of explanations of how the composite video signal gives us a normal television picture, but how many of you have felt you really understood any of those explanations? The conventional method consists of showing the entire signal and then breaking it down into its components. This leaves many questions unanswered. A clearer and more complete analysis can be made by building up the signal from ordinary blanking pulses.

When the sawtooth voltages are applied across the horizontal and vertical deflection plates of a C-R tube, a pattern or raster results because of the constantly varying voltage between each pair of plates. The height and width of the pattern depend on the amplitude of the sawtooth voltages; the number of lines in the pattern is determined by the sawtooth frequency.

And so it is with television—a sawtooth voltage (A in Fig. 1) with a frequency of 15,750 cycles is applied to the horizontal deflection plates of a C-R tube. Its peak-to-peak voltage is high enough to cover the entire width of the screen. At the same time that the 15,750-cycle sweep is applied to the horizontal deflection plates, a 60-cycle sawtooth voltage (B in Fig. 1) is applied to the vertical plates. The resulting raster (pattern) is shown at D in Fig. 1. The waveforms in A and B are applied to the left and top plates, respectively. The right and bottom plates are grounded. Or you may have a push-pull circuit with voltages applied to both plates and a center point grounded or brought to the high-voltage supply.

Forming the raster

Point *a* is positive with respect to ground, causing the electron beam

to be pulled to the extreme upper left corner of the screen (*a'* at D). When the sawtooth signal becomes negative, at *b*, the beam is pulled toward the extreme upper right corner of the screen. At the same time, the negative-going signal shown at B moves from point *q* to *p*, causing the raster line to be gradually pulled down to *b'*. The time it takes the beam to go from *a'* to *b'* is known as the trace time. From points *b* to *c*, the beam returns very quickly to the extreme left-hand side of the screen (*b'* to *c'*). Because of this speed, its effect on the formation of the raster is negligible. The time it takes the beam to go in a leftward direction from *b* to *c* is known as the horizontal retrace time.

It is not desirable to see this retrace since it would only interfere with the picture. For this reason a horizontal blanking pulse, applied to either the grid or cathode of the picture tube is used to cut off the tube during this time. This blanking pulse is shown at C.

Each succeeding line of the raster is formed in the same manner until point *h* is reached. At this point there is zero potential on the left horizontal deflection plate with the top vertical deflection plate at its most negative potential (point *t* on line B). This causes the electron beam to be at the bottom center of the screen.

After point *h* the vertical sweep goes in a positive direction at a relatively rapid rate, causing the beam to go from the bottom to the top of the screen (vertical retrace) during which time the horizontal sweep performs as usual. The dashed lines at D represent the vertical retrace. Just as the horizontal retrace is not desired, so too with the vertical retrace. It is eliminated by a vertical blanking pulse (line C). Note the extended duration of this pulse

compared to a horizontal blanking pulse.

Actually vertical blanking starts at point *f* or *s*. This is done to make absolutely certain that the vertical retrace lines are not seen. Vertical blanking always occurs a short time before retrace. The beam starts its climb to the top of the screen after about 250.5 lines have been scanned. As a safety factor vertical blanking continues (to point *o* or *v*) even after the beam returns to the top of the screen (point *k* or *u*).

It takes 262.5 lines to make the beam travel from the top of the screen (point *a*) to the bottom (point *h*) and then to the top again (point *k*). This is known as the first field. The second field begins at point *k'* because *k* is at zero potential at the same time *u* starts going in a negative direction. Since the second field starts at the top center of the screen, line *m'-n'* must fall midway between lines *a'-b'* and *c'-d'*. The reason is that the distance between all horizontal lines is equal. The falling of one line between two others is called interlacing—hence the term “interlaced scanning.”

The completion of two fields is a *frame*. Therefore, one frame equals 262.5 (first field) plus 262.5 (second field) or 525 lines (including retrace periods which do not appear as lines on the raster). The vertical frequency is 60 cycles. Thus 60 fields are produced every second to correspond to the 60-cycle line frequency. The 15,750-cycle horizontal sweep frequency is obtained from $262.5 \times 60 = 15,750$ lines per second.

The groundwork for the formation of the composite video signal has been established—and that is the explanation of the waveform on line D in Fig. 1. Various other pulses and signals are added to form the final signal.

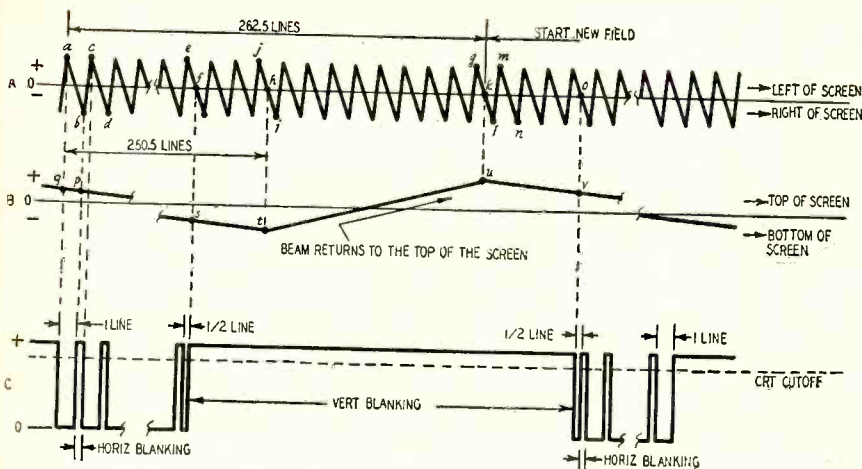

Fig. 1, above and left—Formation of the television raster.

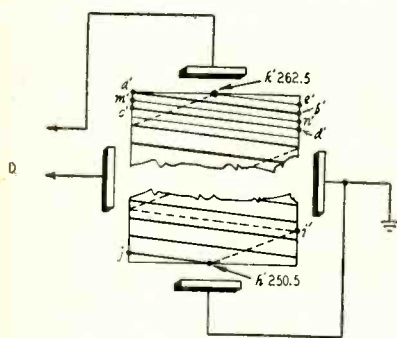
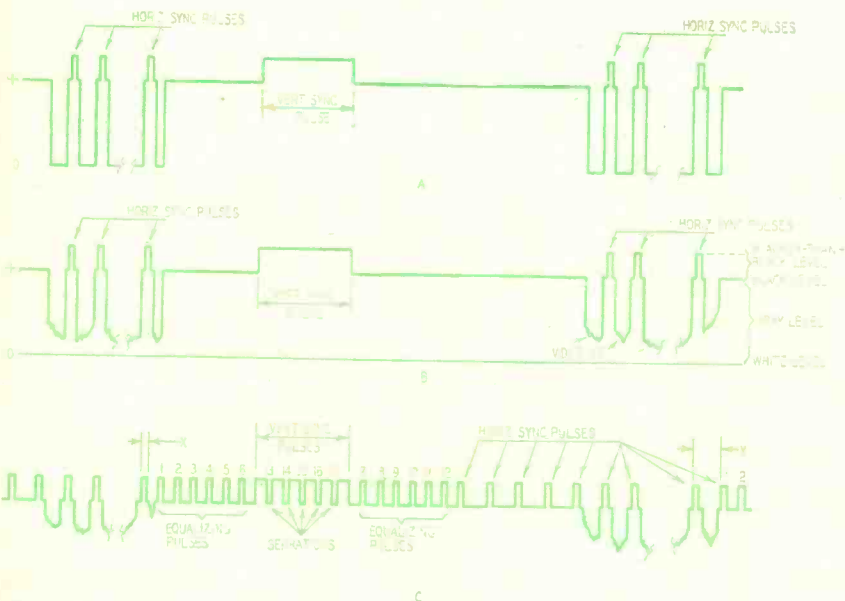

Fig. 2, below—The composite video signal. Blanking period greatly exaggerated.



No horizontal sync pulses occur during the vertical pulse. Thus, to maintain horizontal synchronization the vertical sync pulse is separated or serrated (Fig. 2-c). The addition of the serrations does not impair the normal activities of the vertical blanking and sync.

Horizontal sync pulse α (Fig. 2-c) is the last sync pulse to occur before vertical blanking takes place one-half line later. Since the horizontal oscillator of a television receiver is designed to operate at 15,750 cycles, it cannot be triggered by pulses occurring at $2 \times 15,750$ or 31,500 cycles. Therefore, when the oscillator is triggered by pulse α , it will also be triggered by equalizing pulses 2, 4 and 6 and serrations 14 and 16 and equalizing pulses 7, 9 and 11; thereafter it is triggered by the normal run of horizontal pulses.

During the second field horizontal pulse y occurs before the vertical blanking pulse appears. Because the distance between pulse y and the first equalizing pulse 1 will trigger the horizontal sweep. From this we can see that equalizing pulses 3 and 5, serrations 13, 15 and 17 plus equalizing pulses 8, 10 and 12 also trigger the horizontal sweep. The third field is the same as the first, and the fourth the same as the second etc.

The chart indicates the durations of all pulses. The equalizing pulses are

| Wave Form | Time Duration in μsec |
|---|----------------------------------|
| Equalizing pulse | 2.54 |
| Vertical serrations | 4.44 |
| Horizontal sync pulse | 5.08 |
| Horizontal blanking pulse | 10.0 |
| Distance between serrations | 27.3 |
| Distance between horizontal sync pulses | 31.7 |
| Vertical sync pulse | 190.5 |
| Vertical blanking pulse | 833-1,333 |

Sync and video signals

The composite video signal keeps both the television transmitter and receiver in synchronization, thereby preventing picture rolling and tearing. This is done by horizontal and vertical synchronizing pulses shown on line A in Fig. 2. The horizontal pulses are placed closer to the left side of their blanking pulse than to the right. This is done to make sure that the horizontal retrace ends before unblanking takes place.

The next step is the addition of video intelligence to the composite TV signal (Fig. 2-b). Video signals of vary-

ing amplitudes appear between the horizontal blanking pulses. By applying the composite signal in the form it now has to the grid or cathode of the picture tube, intensity modulation of the beam will occur, producing video intelligence on the raster. This intelligence is at four color levels: white, gray, black and blacker-than-black. Small-amplitude video signals occur near the white level, medium ones at the gray and large signals toward the black. Video signals never appear in the blacker-than-black area which is used solely for establishing synchronizing level.

one-half the width of the horizontal sync pulses. The reason for this is two fold: first, power output is saved at the transmitter; second, separation of the equalizing pulses from the vertical sync pulse becomes comparatively easy since the vertical integrator, which is used to separate them, is a relatively long-time-constant network. The serrations—which are about twice the width of the equalizing pulses—although narrower than the horizontal sync pulses do not substantially affect the integrator network.

The exact width of the vertical blanking pulse is not critical. The difference between the value of 833 or 1,333 μsec is only a few horizontal lines which are blanked out. The vertical blanking pulse is about 100 times longer than the horizontal blanking pulse, for it takes about 100 times longer for the electron beam to travel from the bottom of the screen to the top than from the right side to the left.

END

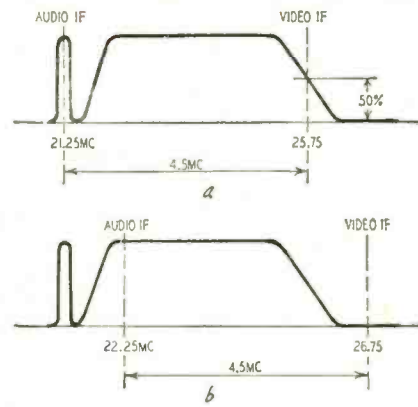
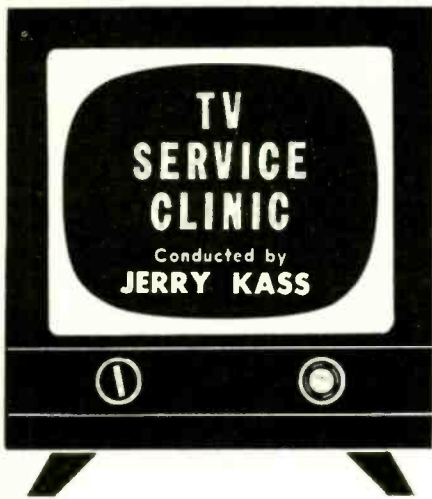

Fig. 1—Video and sound i.f. response. Curve at *a* shows correct oscillator tuning; *b* shows oscillator too high.

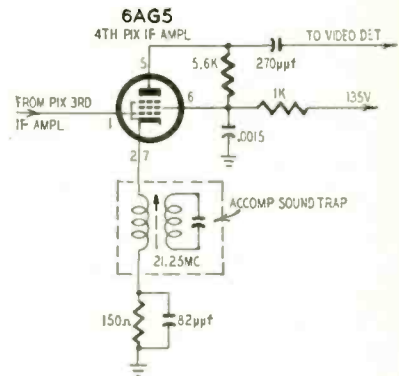

Fig. 2—Trap in video i.f. amplifier cathode attenuates the sound carrier.

SOUND bars, as distinguished from hum bars, are easily identified because they vary in number and intensity in step with the modulation of the audio signal received. Hum from the heater filament or half-wave B supply (60 cycles) will produce one horizontal bar; hum from a full-wave B supply produces two. The number of horizontal sound bars appearing on the picture tube screen is equal to the frequency of the incoming audio signal at that instant divided by 60, the field frequency. Thus, 10 horizontal bars indicate an audio frequency of 600 cycles. It follows that no sound bars appear when no audio signal is being received.

Sound bars can usually be seen by varying the fine tuning control thus detuning the oscillator. This leads us to one of the most common causes of this trouble, incorrect oscillator alignment. We can examine this more closely by assuming a TV set is tuned to channel 2. At this setting the received picture carrier will be at 55.25 mc and the sound carrier at 59.75 mc. With normal operation the oscillator frequency will be 81 mc (in a 25-mc i.f. receiver). This produces two difference frequencies, the sound i.f. at 21.25 and the video i.f. at 25.75 mc, appearing as shown in Fig. 1-a in the i.f. response curve.

If, however, the oscillator is at some other frequency, say 82 mc, the sound and video i.f.'s will each be 1 mc higher, falling on the receiver's i.f. response curve as shown in Fig. 1-b. With the i.f. carriers shifted, the sound carrier falls within the passband of the video signals and is amplified, producing horizontal sound bars on the screen. A secondary effect of this defect is a loss of amplification of low-frequency video signals, causing a deterioration of the picture's background appearance.

In most receivers a slight oscillator drift can be corrected by varying the fine tuning control, usually capable of varying the oscillator frequency through a 2-mc range. When the oscillator cannot be corrected by the fine tuning control or when correction occurs at the extreme end of this adjustment, the tuner should be carefully realigned. If

oscillator drift occurs on only one channel of a turret type tuner, the correction can usually be made by adjusting the oscillator slug for that channel.

Sound traps

Another common source of sound bars is misaligned sound traps—video i.f. (Fig. 2) or 4.5 mc (Fig. 3). Adjacent-channel sound interference is easily recognized since the bars do not follow the sound accompanying the picture on the screen. In addition, adjacent-channel audio will usually cause trouble on only one channel and even then not all the time. However, interference from the 21.25-mc sound i.f. (of the above example) will usually be seen on all channels all the time.

A sound trap can be quickly checked by varying its resonant frequency while observing the picture. Try placing a single shorted turn of wire around or over the trap. This raises the trap's resonant frequency. Place your hand near the coil. This adds capacitance to the circuit and lowers the frequency. If all traps are properly aligned, doing this will in each case increase the sound-bar interference. If, however, one of these tests improves picture appearance, the traps should be aligned. In most cases traps can be aligned by varying the slug and observing the picture.

Microphonics

This effect produces sound bars on the screen as a result of mechanical vibration of components. Tubes in the

tuner, video i.f. or video amplifier are frequently at fault. Vibrations set up by the loudspeaker cause tube elements to move, producing variations in inter-electrode capacitances. Changes in capacitance cause shifts in frequency (FM) which might appear harmless, the video detector being fairly insensitive to variations in frequency. However, in many receivers the response of the video i.f. amplifiers and detector is such as to produce slope detection of the FM signal, permitting audio voltages to enter the video amplifier. Because microphonics are the result of mechanical vibration, the intensity of the sound bars in the picture will vary with setting of the volume control.

A quick check for this trouble is to remove the loudspeaker from the chassis or disconnect the loudspeaker voice coil from the output transformer and substitute a suitable load resistor—5 ohms at 10 watts is about right for most sets. If the loudspeaker vibrations were at fault, the sound bars should disappear even at high volume settings. Tube vibration is not the only cause of this trouble. Others are vibrations between leads, plates of capacitors and changes in spacing between coil turns.

In cases of microphonics, substitute a less microphonic oscillator tube, strengthen the mechanical layout of loose coils and capacitors—use coil cement, rubber damping pieces and other means of increasing mechanical stability where possible. Keep all wires in and around the oscillator circuit short

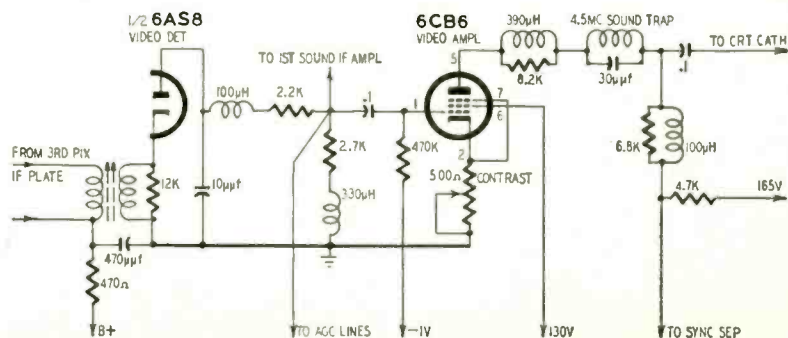

Fig. 3—Sound trap in intercarrier set.

and separated. Some manufacturers install a heavy lead shield around the oscillator tube, especially sensitive to microphonics.

Defective filtering

Another possibility occurs when the audio voltage modulates the B supply to the video circuits, causing variations in brightness. This is generally caused by poor filtering of the plate and cathode circuits of the receiver's audio output stage.

At high volume there are large swings in the plate current drain from the B supply. If the plate and cathode supply circuits are not properly filtered, the B supply becomes "amplitude-modulated." Here again the intensity of the bars will vary with volume control settings. However, with the speaker disconnected and the amplifier working into a dummy load, microphonic troubles will disappear—filter troubles will remain.

Horizontal instability

A Capehart television set has been giving a great deal of trouble. According to my schematics, part of the set follows the circuitry of the 3002 chassis and the rest follows the 3007. The trouble is general sync instability and results in horizontal tearing. I have checked just about every component in the horizontal circuit. I realize that this defect is very broad in nature and could be caused by any of many things. However, I would appreciate your opinion on this trouble.—N. B., Brooklyn, N. Y.

There has been considerable trouble with sync stability in this chassis, (CX-30) and many changes have been made during the various production runs. Since most of these changes dealt with horizontal instability, check to see that your circuitry (Fig. 4) contains the following changes:

Remove the 1-megohm resistor between the picture tube grid and B minus and connect it from pin 3 to pin 4 of the 6H6 d.c. restorer.

Disconnect pin 3 from B minus and insert a 470,000-ohm resistor between pin 3 and B minus.

Disconnect the .05- μ f capacitor from the junction of the 3,900- and 1,000-ohm resistors in the 12AU7 (second video amplifier) plate load circuit and connect it to pin 3 of the 6H6.

Change the coupling capacitor from

pin 2 to pin 4 of the 12SN7-GT sync amplifier and clipper from 600 to 100 μ f and remove the 350 μ f bypass capacitor from pin 6 of this tube to B minus.

From the junction of the 240- μ f and the .002- μ f capacitors between pin 6 of the same tube and pin 1 of the 12SN7-GT horizontal oscillator and a.f.c. tube, connect a 100- μ f capacitor to B minus. Increase this capacitor to 200 μ f if instability persists.

In most cases this should clear up the trouble. If not, you will have to check all components in the horizontal oscillator and a.f.c. circuits and replace any that are off-value by more than 10%. Check the output of the sync amplifier for possible poor clipping. If the sync output is weak or contains traces of video, replace this tube and check all voltages and resistance values in this circuit. Sync compression could very easily be causing the trouble.

Critical horizontal oscillator

A Motorola TS-118 has come in with a very critical horizontal oscillator. The very slightest rotation of the horizontal hold control throws the horizontal oscillator off frequency and the picture breaks up. I have replaced all tubes in the horizontal circuits and have made a thorough check of all components in these circuits. I was doubtful about several resistors and capacitors and changed them. In addition, I replaced various filter capacitors in the B supply to these circuits but have not been able to come up with the trouble. Please advise me what to do to locate and correct this trouble.—W. S., Detroit, Mich.

The first order of business is to determine whether the defect is due to faulty circuit adjustment or to component failure. This chassis has been unusually troublesome in the field with respect to critical oscillator adjustment. Try the following:

1. Short out the horizontal oscillator coil. This can be done by shorting the two pins of the receptacle on top of the chassis. In some sets there will be a terminal strip in place of the receptacle.

2. With the centering lever, move the picture to the left so that the right edge of the raster can be seen. Then adjust the horizontal hold control to about the middle of its range and note the width of the blanking pulse—it

will appear as a gray bar at the right edge of the picture.

3. Remove the short from the horizontal oscillator coil.

4. Adjust the horizontal oscillator coil until the same amount of blanking pulse can be seen as in step 2.

With proper adjustment the horizontal hold control should have a sync range of approximately 180°. Should the adjustment fail to improve the situation, you will have to check the horizontal oscillator circuit carefully. This circuit uses a multivibrator with a 14-volt peak-to-peak signal on the input grid and a 40-volt signal on the plate. You should measure 10 volts d.c. on the input cathode and 11 volts on the output cathode. The input grid should read 2 volts, the output grid -12 volts. If any of your measurements are radically different from these, check that circuit carefully.

Weak sound

A model 9T147 RCA receiver on my bench produces weak and slightly distorted sound. All tubes from the sound takeoff coil to the loudspeaker have been replaced and are known to be good. In addition, the sound i.f. transformer and the sound discriminator transformers have been aligned following the instructions in the RCA service notes.

The customer complained that the defect developed over a period of time and is now intolerable. I may have missed a few components, but I believe I have checked just about every resistor and capacitor in the sound section. The voltages check reasonably close to those specified in the manufacturer's notes. Yet despite all this checking I have been unable to come up with the cause of the weak sound. Would appreciate any ideas you can give toward locating the trouble.—J. G., Orlando, Fla.

Considering the extensive checks you have made on the sound section of this set, a good possibility is that the trouble lies in the two 94- μ f capacitors in the sound discriminator transformer. They are connected in series across the secondary and when defective will reduce the sound output and cause slight distortion. Also check carefully for loose slug adjustment in the discriminator transformer. When a slug is out of line, it may be impossible to get optimum adjustment. If you find any loose slugs, align that coil very carefully and cement it against detuning through vibration.

One other common cause of the trouble you describe is defective capacitors in the screen grid circuit of the second sound i.f. transformer. They are .0015- μ f capacitors and part of the screen decoupling network. When defective, these capacitors introduce degeneration in this circuit lowering the gain of the stage and thus the sound volume.

Static discharge

This may not be a servicing problem, but I am having a great deal of trouble

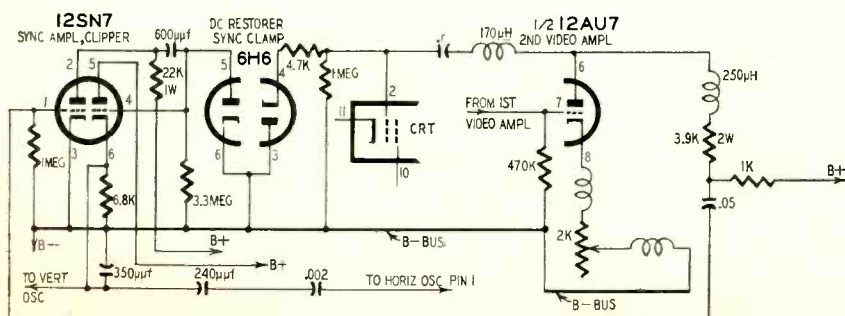

Fig. 4—Sync circuit in Capehart set.

TELEVISION

from shocks when near any of several spots on the front of my television set. These shocks are usually accompanied by a popping sound in the loudspeaker. My receiver is a Silvertone chassis 100.208 and the shocks are similar to those received when walking across a rug and then touching a metal object. The shocks come from the speaker mounting bolts and from the picture bezel. Although this trouble does not affect the operation of the set, it is extremely annoying and I would like to get rid of it. Please advise.—P. R., Louisville, Ky.

I believe you can consider your problem of a servicing nature, and fortunately the solution is comparatively simple. The simplest method is to cover all points that produce shock with any of the various high-voltage or anti-corona dopes on the market. However this cure is not always lasting nor completely effective because of insulation breakdowns due to moisture and dirt. A much more effective solution is to connect all troublesome points together and ground to some common point. In your case connect a wire from the picture-tube bezel bolt to the speaker frame and from the frame to the ground side of the speaker voice coil.

Audio tube failure

A Sentinel model 401 came in with a cracked 6AR5, the audio output tube. I replaced it with a new tube and the set worked perfectly. After about a week I was called back by the customer and found the tube I installed was cracked. At that time I recalled that the shield over the tube was extremely tight, so I replaced the 6AR5 again but left the shield off. This was several months ago and I have received no further complaints. Now another set has come in with the same trouble, a cracked 6AR5. It appears that leaving the shield off and simply installing a new tube is the solution. What I would like to know is the importance of leaving the shield off on the operation of the set.—L. R., Alameda, Calif.

The tube shield over the 6AR5 in some sets does fit very snugly, and even the slightest of flaws in the glass envelope will cause the tube to crack when it expands, due to the heat generated by the 6AR5 elements. When replacing this tube, leave off the tube shield. It has virtually no effect on the sound, and is used to hold the tube firmly in the socket during shipment.

Defective damping

A model 17T4 G-E receiver has the following defects: white vertical lines at the left side of the screen, extreme squeezing at the right side, very poor linearity. I have checked the video amplifier for ringing, but the components and peaking coils appear in good order. All voltages in the video amplifier seem normal and the waveforms show no sign of anything wrong. I have also checked all tubes in the horizontal

sweep circuit including the damper tube without success. Have I overlooked something in the video amplifier or could the trouble be in some other circuit?—F. C., Houston, Tex.

The symptoms you describe indicate a case of defective damping and poor linearity. The trouble is most likely caused by a defective 0.1- μ f capacitor in the damper circuit. To be more exact, it is probably the capacitor in the cathode circuit. There is a remote possibility that the defective capacitor is the unit on the horizontal output tube side of the linearity coil; however, this would usually cause a reduction in width. One other check would be in testing the horizontal linearity coil and the 470-ohm resistor shunting it.

Poor contrast

A Du Mont RA-166 has very poor contrast and weak sound. Tube substitutions have not helped but I noticed the voltage at the cathode of the audio amplifier is low, measuring about 40. For a voltage distribution of this type I think it should be about 100 volts; however I am unable to locate the trouble. Everything checked in the low-voltage power supply checks out O.K.—M. P., Scranton, Pa.

It seems that you may have hit the nail on the head with your theory about the voltage of the cathode of the audio amplifier. This voltage should be 150 or very close to it. Since you measure about 40 volts at this point, it would certainly result in poor picture contrast and weak audio. The voltage at the cathode of the 6W6-GT supplies the plate and screen of the 6AU6 sound i.f. amplifier, the tuner, bias to the sync phase inverter and the screens of the 6CB6 fourth video i.f. amplifier and the 12BY7 video amplifier. Most prob-

ably you will find a leaky .02- μ f coupling capacitor between the 6AT6 and 6W6-GT audio amplifiers. This will lower the voltage to the points mentioned above and reduce the contrast and volume. If this capacitor is not defective, check for interelectrode shorts in the 6W6, 6AU6, 6CB6 and 12BY7 by substitution and check all resistors and capacitors in or associated with the cathode circuit of the 6W6-GT.

Rebuilt picture tube

A Sentinel receiver came in with a complaint of a very weak picture. A check revealed that the cathode emission was low and I replaced the tube, a 21MP4. In about 2 weeks the customer called and said the focus control was defective. I found the screen to be completely blurred and checked the focus circuit. All voltages were in order and further checks showed that the picture tube was gassy. I then noticed that there was a large bulge on the neck of the tube. The tube was apparently rebuilt but the distributor insisted it wasn't. The tube was a G-E and I would like to know if G-E would sell a rebuilt tube as new.—M. M., Hempstead, N.Y.

Most probably this tube was renecked rather than rebuilt. In many cases it is necessary to use different type glass in the bell or flare and in the neck. In this case the joint is made at the glass manufacturer even before the tube is shipped to the tube manufacturer. There are many instances where necks are broken in the production line either at the glass or electronic manufacturer. Here again the annealing process will leave a bulge or indentation. This probably happened if your tube was factory-sealed from G-E. These renecked tubes must meet all quality control tests at the factory. END

FLAT TV PICTURE TUBE

This recent development was the subject of much discussion by spokesmen for Willys Motors and Hoffman Electronics at the recent Western Electronics show and convention in San Francisco. Ross Aiken, developer of the flat TV tube for Willys Motors, stated that his tube, only a few inches thick, worked on an electrostatic principle and would use far fewer components in its circuitry than present-day picture tubes. The Willys' flat TV tube makes use of parallel transparent deflection plates. By controlling the voltage on these plates, a very small focus area can be achieved with high definition and considerable brightness. Mr. Aiken refused to comment on when the tube will be ready for commercial television.

Leslie Hoffman, president of Hoffman Electronics, confirmed that his company was experimenting with the flat tube for application in color TV. Hoffman has developed a two-gun color tube for military use having red and blue guns

and is currently preparing a three-gun tube. The new flat tube works on a principle originally developed by Baird in Britain. The new three-gun tube would add principles developed by Geer, who is now working with Hoffman.

A thin transparent screen is mounted just behind the clear face plate of the tube. The green phosphor is coated on the front of the screen. The rear surface is composed of a series of ridges (like pitch roofs, too small for the human eye to view, running up and down the screen). One side of each of these ridges is coated with the blue phosphor, the other with the red. The red and blue guns are placed slightly behind and at the sides of the screen so that the electrons from the red gun strike only one side of the ridges; those from the blue strike the other. The green gun projects its beam on the front of the screen from a point slightly ahead and up, or from the side. The tube would probably be less than 6 inches deep.

LEAVE 'EM IN . . .



. . . OR TAKE 'EM OUT

The Old-Timer passes out plenty of hot tips to his young helper on the art of servicing radios on the back of his neck

By JACK DARR

THE Old-Timer snapped the case of the portable shut, tuned in a station and ran the dial of his auto-transformer up and down one last time. Noting that the set still played at a line voltage of 100, he turned it off with a grunt of satisfaction. As he wrote out the job ticket, a noise from outdoors made him look up. He grinned at the sight which met his eyes. In front of the shop sat a sedan, and visible above the seats were two very loud socks, topped by a pair of laceless loafer shoes, one of which was threatening to come adrift entirely from its wild gyrations. Shelving the portable, the Old-Timer sauntered to the door.

Peering into the car, he inquired, "Having difficulties, Junior?" From under the instrument panel emerged the red, perspiring face of the Young Ham, his assistant. Running grimy fingers through his crew-cut hair, he gasped, "I can't get this blamed radio out! It's jammed up there!"

"Wait a minute. Lemme in there," said the Old-Timer. As the Young Ham managed to attain an upright position, the Old-Timer slid under the dash with the ease of long years of practice. There was a muffled grunt, and he came out with the set.

"How in the dickens did you get that stubborn thing out?" asked the Young Ham. "I couldn't get it past that heater."

"Takes both brains *and* experience, m' boy," grinned the Old-Timer. "No,

lemme show you. Y' don't even have to go downstairs to get this one. Look here." He sat upright in the center of the seat, reached under the dash and easily slipped the set back into place, then removed it again. "See? Just push it back, turn it on edge, raise it up past the holes, then drop it down and out. Simple."

"I get it now. Whew! Wish you'd come out quicker. I thought it was stuck there for good!" puffed the Young Ham.

"Well," said the Old-Timer, "It's mostly experience. I was just kiddin' you about the brains. Howsoever, there is a lot you can do with a little brains, and maybe save yourself a lot of work, takin' 'em out. The question is whether to leave 'em in an' try to fix 'em or take 'em out right away. That's where the brains come in."

"What do you mean?" asked the Young Ham. "I thought you told that guy the other day that there wasn't much you could do to a set, while it was still in the car."

"Yep, I did," admitted the Old-Timer. "However, if you'd heard all the conversation, you'd have known I was talkin' about a complete alignment job. He wanted to know if I could 'tune a set up' without takin' it out of the car. Told him no, I'd have to take it out. Y' see, I know that bird. He'd been workin' on th' i.f. trimmers. Reason I say that, he never had a radio that *he* didn't try to align at one time

or another. I've made more money off of him realignin' sets he's messed up! Whoo! I'm just waitin' for him to get a TV set!"

"That'll break him, won't it?" laughed the Young Ham.

"Well, I doubt it," said the Old-Timer. "It's hard to break that kind of guy, but let him alone. He's a good source of service income. More power to him. I sent him a set of little screwdrivers for Christmas last year! That ain't fixin' this set, though. Gimme the symptoms again."

Case of the local receiver

"Well, it gets KENA fine. It won't get any out-of-town station, and it doesn't have enough 'blow.'"

"Hmmm. Lessee here." The Old-Timer removed the lid of the set as it lay in his lap. Consulting a small diagram pasted insecurely to the cover, he selected a small tube. "Here. Take this in and test it."

"O.K." The Young Ham galloped into the shop, clutching the tube. He returned in a minute, carrying a new tube in its bright box. "It was dead. How'd you know?"

"Just a minute," said the Old-Timer, inserting the tube, and pulling the hot lead and antenna far enough out to connect the set, still in his lap. He turned it on and, when it warmed up, it roared loudly. He turned the dial from one end to the other, picking up several stations.

RADIO

The Young Ham replaced the set, sitting upright in the seat as the older man had done. He grinned. "That's a lot easier. Why didn't you show me this long ago?"

"Did. Several times, as a matter of fact. You just didn't remember it. You got a man-sized forgettery, young feller!" said the Old-Timer. "Where the brains come in in this part of it is in figurin' out just how to take 'em out, and what you're gonna have to do. Take a minute or two to look 'em over, careful, and most of 'em will come out pretty easy."

"That's just one man's opinion," sourly said the Young Ham. "They're all hard, for me, seems like." He paused. "Hey, wait a minute. How did you know that tube was dead?"

"Didn't," grinned the Old-Timer. "Just thought it might be. You see, the set *was* playing, at least on that one station. That cleared the power supply, speaker and almost everything

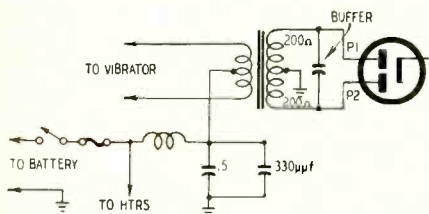

Resistance from P1 to P2 should be sum of P1 and P2 to ground, if buffer is good.

else, including the oscillator tube. The very low volume, and the fact that it wouldn't get anything but local made me suspect the r.f. amplifier was dead. That was the tube you checked. See, there was just enough signal leaking through the dead stage to let it play on that one. Anything else wouldn't have come through. Catch?"

Antenna possibilities

"I catch, now," said the Young Ham. "If one acts like that, check the r.f. tube."

"First," said the Old-Timer, "there's several other things that could cause that, like a leaky antenna, open antenna coil, mistuned antenna trimmer and so forth. Anything that will kill all the gain of the r.f. stage. The tube was the easiest thing to check. Actually, you might have checked the antenna trimmer to see if it had a peak; a flat trimmer means trouble, like a bad antenna or open lead-in cable. Now, how about checkin' for some of those other troubles, if that tube had turned out all right?"

"Well, I could pull the antenna plug and check it with the ohmmeter." He looked up at the top of the car and recited, "Very low resistance from pin of plug to antenna rod itself; very high resistance or absolutely open from antenna to chassis; dead short from plug-shell to chassis."

"Correct, turn the page," said the Old-Timer. "Now, give me some other troubles that you might find in the

antenna and what would you do about 'em."

"A leakage in the antenna insulators will cause a loss in volume—"

"And also, believe it or not," interrupted the Old-Timer, "added pickup of engine noise in some cases. So, if you get a hard case of engine noise, try a new antenna temporarily."

"Yeah, you mean hold it by the insulators and stick the rod out of the window. That'll tell you for sure if it's the antenna."

"Right," said the Old-Timer. "Best thing for any trouble like that, leaks and so forth is to replace the antenna. Your customer will be a lot better pleased in the long run. Besides, it's dern near impossible to make a satisfactory repair to a leaky antenna, that is, make it cheaper than a new antenna, as cheap as they are nowadays. Good antennas, too, I mean."

Check list for auto radios

The Young Ham had pulled out his little loose-leaf notebook and was busily writing down his own brand of shorthand notes as the Old-Timer talked. Finishing with "sub. ant if trim no pk," he closed the book.

"Wait a minute," said the older man. "If you're gonna write this down, let's do it right. Make a check list of things to do, before you pull a car radio. Head it—let's see—diagnosis of trouble in car. Ready?" The Young Ham nodded. "First, see that the set lights up. Look at the pilot light, or the tubes if you can see 'em. If it isn't getting power, check the fuse, fuse lead and holder, and the connections. See that it's clean, too. Found a fuse once so dirty that it actually had 4 volts drop *across* it. Set was a little weak, too. So, be sure you've got your 6 volts to the set, as the first test of all. Next, if she lights up and you can't hear the vibrator buzzin', what's wrong?"

"Vibrator dead," stated the Young Ham, confidently. "Replace it."

"Maybe," said the Old-Timer, "maybe not. Most of the time, yes; but not always. There's no such thing as a sure thing in radio. Remember that. What we do is figure out where the trouble's at, then check things 'til we locate it. You might have a bad socket or even a bad switch; some sets use a double-pole switch, one side of which switches the vibrator."

"So, you have to know which switch is which?" asked the Young Ham solemnly.

"I'll smack you!" warned the Old-Timer. "One more corny and you've had it." The Young Ham elaborately straightened his face and poised the pencil. "Yes, Master."

"Sometimes you get a loose lead on the vibrator 'A' choke," explained the Old-Timer. "They almost all use a heavy choke in the vibrator lead for hash filtering, and a bad joint there will heat up and break loose. Then sometimes you get a bad fuse socket for the same reason. Dirty. Lots of

the older sets like Buick, Olds and some Chevrolets have trouble with that. Them's shop jobs, though. We're talkin' about troubles you can spot in the car. All right, you've found a dead vibrator and replaced it. If it works, fine. If it sounds funny, like it was laborin' or runnin' on an overload, shut it off and get the bench multitester. It's got a 10-amp range, so check the current drain. If you're pulling more than 7 or 8 amps, better pull the set; chances are you've got a bad buffer condenser. If you want to make a diagnosis in the car, while you've got the meter out here, pull the rectifier tube and check from plate to plate on the rectifier tube socket then from each plate to chassis. You see, your buffer is connected right across the secondary winding on almost all sets and, if you get a reading of 200 or 300 ohms from each plate to ground, each half of the transformer, and then get a reading of only a few ohms from plate to plate, you've got a shorted or leaky buffer. In fact, your plate-to-plate reading should equal the sum of the other two readings. See here." And he sketched rapidly on the back of an envelope. "Here's your secondary, and here's the buffer. You can see how those readings should be. Now! Your vibrator's buzzin', but still no sound. You can see the tubes lighting up. You reach in and pull the audio output tube out. If you get a 'pop' in the speaker, O.K. If not, you might take the volt-ohm-milliammeter and check to see if you've got any plate or screen voltage on it. If not, look and see if there's an 0Z4 rectifier tube in it. If there is, check it and probably change it. If you get plate voltage and you've got a pop in the speaker, then go back to the antenna, pulling each tube in turn; the second detector, the i.f. amplifier, the mixer and finally the r.f. amplifier. Somewhere along the line you'll find one that won't pop, and there's your trouble. Check or replace the tube and, if that doesn't get it, pull the set."

"I had one the other day with a fuse blown. When I put in a new one, it went to playing all right," said the Young Ham. "What blew the fuse? I checked for shorts and couldn't find any. I let the man go with the set and only charged him with the fuse."

"That's right," approved the Old-Timer. "What that probably was, when a vibrator gets a little age on it, enough to let the points get a little dirty, sometimes they'll stick momentarily and blow a fuse. Then, when you put in a new fuse, they'll go right off like nothing had ever happened. Only way you can catch them is to take 'em in on the bench and put the oscilloscope on 'em. That'll show anything like that up right away."

"What if they don't want to wait?" asked the Young Ham. "Most all car-radio customers seem to be in a terrible hurry, anyhow."

"Well, there's nothing you can do, then. Just tell 'em you think it's their

vibrator, sell 'em a full box of fuses and send 'em on their way. Explain to them that the vibrator will probably start to blowing fuses pretty fast and then's the time to replace the vibrator."

"You can see that on a 'scope pattern?" asked the Young Ham.

"Sure can," replied the Old-Timer. "In fact, we ought to take a 'scope check of every auto radio that gets to the bench, just for luck. You can sure spot a lot of trouble before it happens, that way. Likewise, you can sell a lot of badly needed vibrators, too. Customers mostly think that if a vibrator's buzzin', it's all right. If you can show 'em what a ragged, jumpy pattern their old vibrator makes and what a nice clean square-wave pattern a new one makes, lots of times you'll get to replace one—and save them a service charge and you a service job. Takes a little diplomatic explainin', though."

"What else can you do in the car? Isn't that about all?"

"Gosh, no," said the Old-Timer. "There's a mess of things you *can* do if you want to. Now, about these newer sets, the two-piece jobs, like the gals' bathin' suits, except they're bigger. Sometimes you can get by only pullin' one unit, except when the dead part is on top. One thing you want to watch, though, if you do pull half of one of them, watch those 'ambiguous plugs.'"

"Huh?"

"An ambiguous plug, Junior, is one you can insert into its socket just as easy right or wrong! In fact, it seems to be a little *easier* to get 'em in wrong than right! They put 'em in some of the dernedest places, too. Does look like they'd put 'em where you could see 'em when the set's in the car, but they don't, so we've got to look out for 'em. One way and about the easiest, I guess, is to plug 'em in before you slide the unit up into place. That way you can at least see what you're doing."

"Plugs, look out for. Anything else?"

"Yes, there's speakers. Car-radio speakers are subject to lots of troubles, being exposed to all the dust, dirt and vibration that they are. Dragging cones and sometimes even stuck voice coils, open voice coils and the like are common troubles. Lots of sets mount the speakers above the set, in a dash grille like this one, and you have to pull the set to get it out. Good idea to check the tone of the speaker before you put the set back in, if it's at all possible. Might get to replace the speaker, too. Lots of times if you can show the customer what a heck of a difference a new speaker will make he'll buy it right away. 'Nother thing; on these little underdash sets, like we've got in the truck, those little 4-inch speakers give quite a bit of trouble and they're pretty tinny to start with. If you find one of them in a car like this, for instance, try sellin' him a new 7 x 9 oval speaker to mount in the regular place in the dash. No trouble to hookin' 'em up and they'll sure make a big difference in the tone of the set."

"Speakers—check. Now, what else is there about car radios that I ought to have in my book?"

Off-the-list items

"Lots of things, Junior, lots of things, but that's just about enough for the present. After you get 'em on the bench, that's a different story. A car radio is just about the same as any other when you come down to it. If you know your circuits, you won't have too much trouble. One thing you want to look for, when you're testing 'em, current drain. That's what that little ammeter on the car-radio test panel is there for, and it'll tell you more about a car radio in a minute than you could find out any other way in two hours. If you see a drain of around 10 amps, for instance, on a set that shouldn't draw but 8, look out for a leaky buffer or filter condenser or maybe a shorted last audio coupling condenser or a shorted tube. Turn one on and it draws only 3 amps, and there you are again. Probably a bad rectifier tube or open choke.

"Also, remember the other day I fussed at you for hookin' up the outside antenna to that car radio you were checkin'? I took it off and made you use that little 4-foot piece of wire with the antenna plug on the end? Reason was, like I told you, a car radio has to be awful dern sensitive and, if you check it on a long antenna, it'll give you all kinds of false indications. The thing has to work on a tiny little 3-foot rod. If you can get it to play O.K. on that, it'll play fine in the car.

"Another thing, you've gotta be *very* careful of your alignment work on car radios. Most of 'em are pretty high-gain stuff, around the i.f.'s and r.f. coils and so forth, and they've got to be very carefully tuned up. If you're gonna get the most out of 'em, you've really got to be on the ball with your alignment. Watch out for 'flat' trimmers in the i.f., too. A trimmer without a peak means trouble and loss of gain in that stage somewhere, and you'd better find it if you want the set to play at all when you put it back in the car."

"And I might say that there are few things that make me any madder than putting a car radio back in the car and then finding out that it won't play!" said the Young Ham.

"'Tis true, 'tis true," smiled the Old-Timer. "I remember what a fizz you got in when you had to pull that Buick set last week twice! That was the result of a little lack of checkin' up on i.f. intermediate frequencies, wasn't it?"

"I guess so," admitted the Young

Ham. "Who ever heard of a radio with a 370-kc i.f. stage?"

"You have, right now," said the Old-Timer, "and let that be a lesson to you. Never take an i.f. for granted! Look it up in the book before you start. That's what we got all those manuals for, by gosh. Car radios will run mostly to 455- or 262-kc i.f.'s, but once in a while you'll come across a different one, so watch out. Be dern sure you're using the right one. Well, come on. I've got to go out to Dyas Barry's and see what's makin' his TV picture wiggle sideways. Better gitta cuppa cawfee before we go, hadn't we? Huh? I said—" He looked out the car door to where the Young Ham was, standing near the corner, motioning for him to hurry. He relit his pipe, and ambled off up the street. END

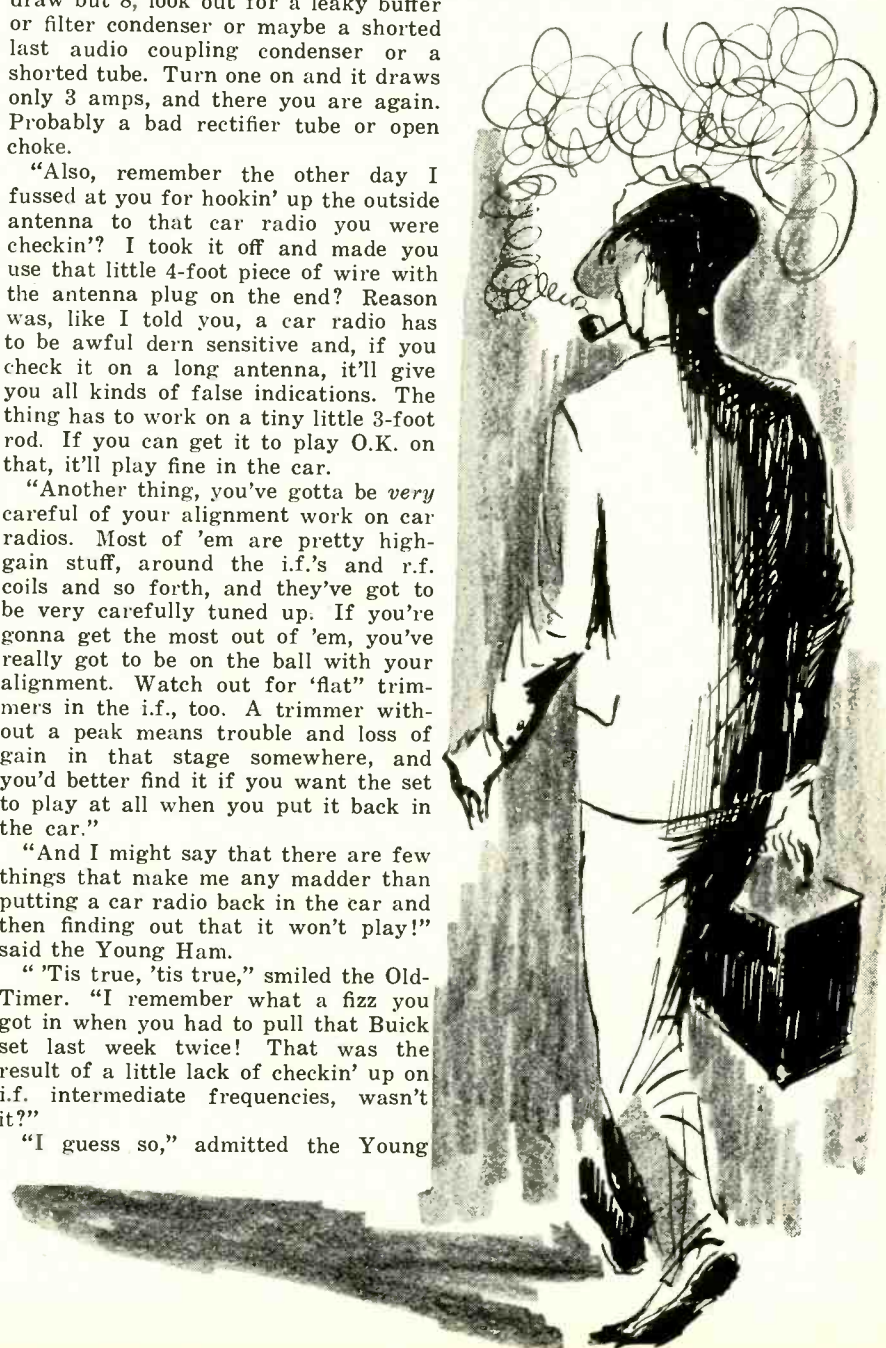

Adapting the AC-DC for INTERCOM operation

*Putting that table model to work
as a radio, radio with remote
speaker, intercom*

By RALPH T. GUARENTE

THE two-way intercom is daily finding a place in more homes as new uses are found for this handy electronic gadget. It is ideal for short-distance communication and monitoring work such as remote-control baby sitting.

This two-station system consists of a remote station containing a PM speaker connected by cable to the master station which has its own PM speaker, a power supply and two or more stages of amplification. The master station accounts for most of the cost of buying or building the system, but we can eliminate this expense by taking advantage of the fact that all a.c.-d.c. radios contain in slightly different form the necessary items for a master station. With some added wiring and a three-position switch, we can change the a.c.-d.c. radio into a versatile instrument that gives us a choice of radio, intercom or remote-speaker radio operation.

Fig. 1 is a partial schematic of a 1946 Admiral table radio that has been converted for use as a radio-intercom

combination. Except for tube types and capacitor and resistor values, it may be adapted for changing any modern a.c.-d.c. set since they all use basically the same circuit. The wide variety of makes and models makes the proposition an interesting one since it offers wide latitude for individual design.

Intercom circuitry

The only requirements for the input transformer are that it match the voice coil impedance and have a turns ratio of at least 1 to 50. An ordinary single-ended output transformer from an old radio may be used. Components C1 and R1 are used to match the secondary impedance to the grid of the input tube.

All necessary changes in the original circuit are made in the first i.f. stage. Here we interrupt the radio signal and inject the intercom voltage on the grid of the i.f. tube. Doing this involves changing the i.f. tube into an audio amplifier. It is possible to inject the input directly on the grid of the first audio tube; however, due to the low input level from the PM speaker,

a stage of preamplification is usually necessary.

The type tube used as the i.f. amplifier will greatly affect the gain obtainable. In general, i.f. amplifiers are of two types—the remote-cutoff pentode such as the 12SK7 or 12BD6, the sharp-cutoff pentode of the 12SJ7 type. The 12SJ7 is preferable because of its small-signal amplifying qualities.

In either case, the problem is to select the correct value for R2, the plate load resistor, to obtain maximum gain. Careful consideration should be given to this problem. Since the rest of the circuit is fixed, any additional gain required must come from this first stage. An approximate value of the load resistor may be obtained from the RCA tube manual. This value will not be exact because the primary of the i.f. transformer is connected from plate to screen on the tube, causing it to act as a triode at audio frequencies. Once an approximate value has been established, the trial-and-error method may be used to obtain optimum performance.

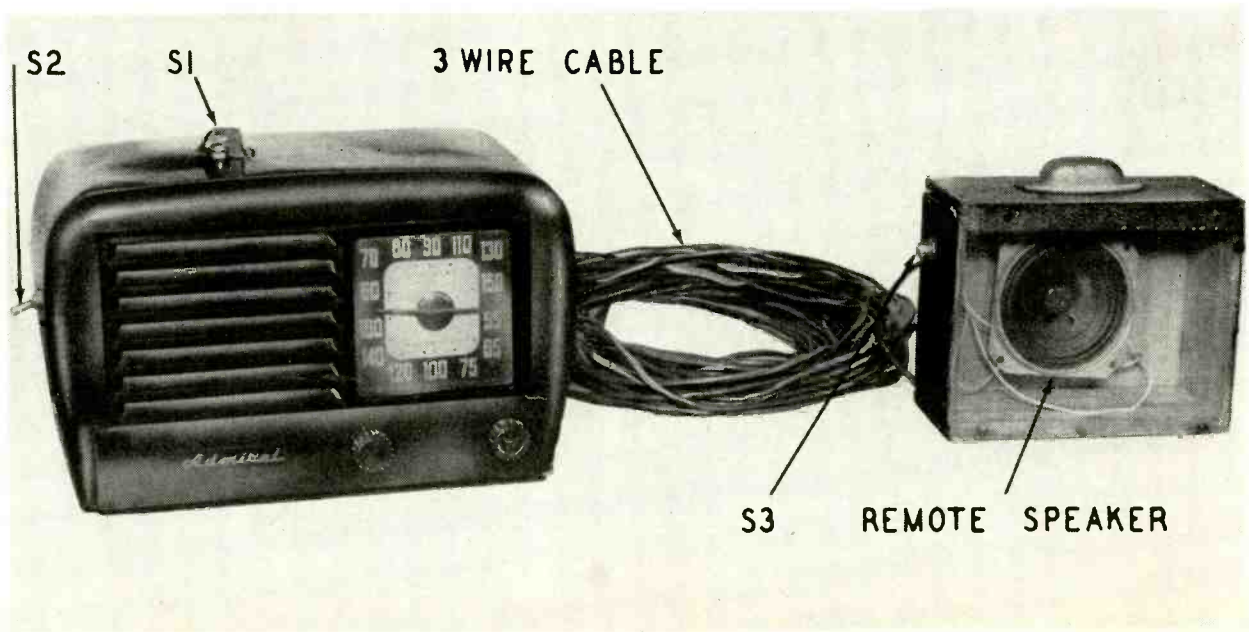

The speaker and remote station.

Function switch S1 controls which of the three modes of operation is to be used. The first and third positions of S1 have been shorted in all but one section. This section connects the radio output directly to the remote station when in the third position. If the remote-speaker feature is not desired, simply omit all wiring to the third position of the switch in each section. Switch S3 (Fig. 2) is a pushbutton type and is normally in the listen position. This arrangement permits control of the system at the master station. When S2, a d.p.d.t. toggle switch, is thrown to the talk position, the master station may be used for straight monitoring from the remote location. Placing S2 in the listen position, we can call from either station. Other systems may be used and additional speakers may be brought into the system if desired. The three-wire plastic-covered cable in Fig. 2 is relatively inexpensive and has a low loss at 150 feet.

Mechanical layout

Like the set shown here, most five-tube table radios are mounted in plastic cabinets. They are generally large enough to mount the selector switch and talk-listen switch conveniently. If possible, they should be mounted on the top or side as far from the converter as possible to avoid pickup. To anchor the rotary selector switch, it is best not to tighten the shaft nut against the plastic. A better arrangement is to remove one of the assembly screws and replace it with one long enough to protrude through a hole in the cabinet. This will keep the switch from slipping.

It is always a good idea to keep lead wires as short as possible. If there are no openings on the chassis near the switches, drilling a few holes under the selector switch will provide a direct path for most of the wires. The remote-speaker housing does not have to be an elaborate affair if it is mounted

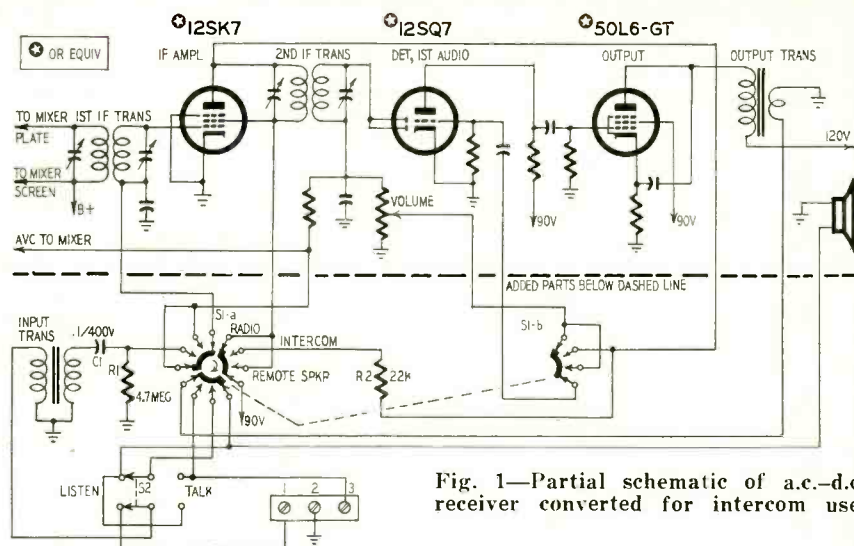

Fig. 1—Partial schematic of a.c.-d.c. receiver converted for intercom use.

Parts for intercom operation

- 1—5-megohm resistor; 1—R2 (see text); 1—0.1-μf 400-volt capacitor; 1—4-section 3-position rotary switch; 1—d.p.d.t. switch; 1—pushbutton switch; 1—input transformer, 1:50 turns ratio (Stancor A-4744 or equivalent); 1—4-inch PM speaker; 1—150-foot length of 3-wire cable.

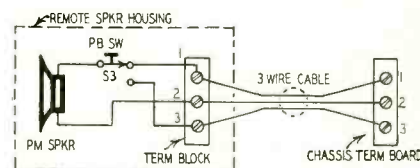

Fig. 2—Remote-speaker circuitry.

in an inconspicuous spot. The one illustrated here was made for outdoor use. It has plywood sides and back, with copper screening in front. It is usually a good idea to clamp the cable to the cabinet to avoid pulling the terminal connections loose when moving the station.

Bear a couple of points in mind when converting a set for intercom work. If the output transformer has been mounted on the speaker, as it was in the set used here, there is a good chance the voice coil will interact with the transformer winding, setting up feedback. To avoid this, file the rivets holding the transformer to the speaker and remove it. There is usually a convenient spot on the chassis top where it can be remounted. When

wiring S1, the wiper for the input contacts *must* be wired to the *ground side* of the secondary on the first i.f. transformer. Any direct connections to the grid of the tube will ground the i.f. signal in the radio position.

Performance data has been omitted, since they will vary with different models. In some cases, it may be desirable to have a less sensitive device. A potentiometer connected across the secondary of the input transformer may then be used in place of R1, as a volume control. For monitoring work it is necessary to keep a constant check on the system. For this purpose, an ordinary clock placed near the input speaker will provide a constant source of signal to check operation. END

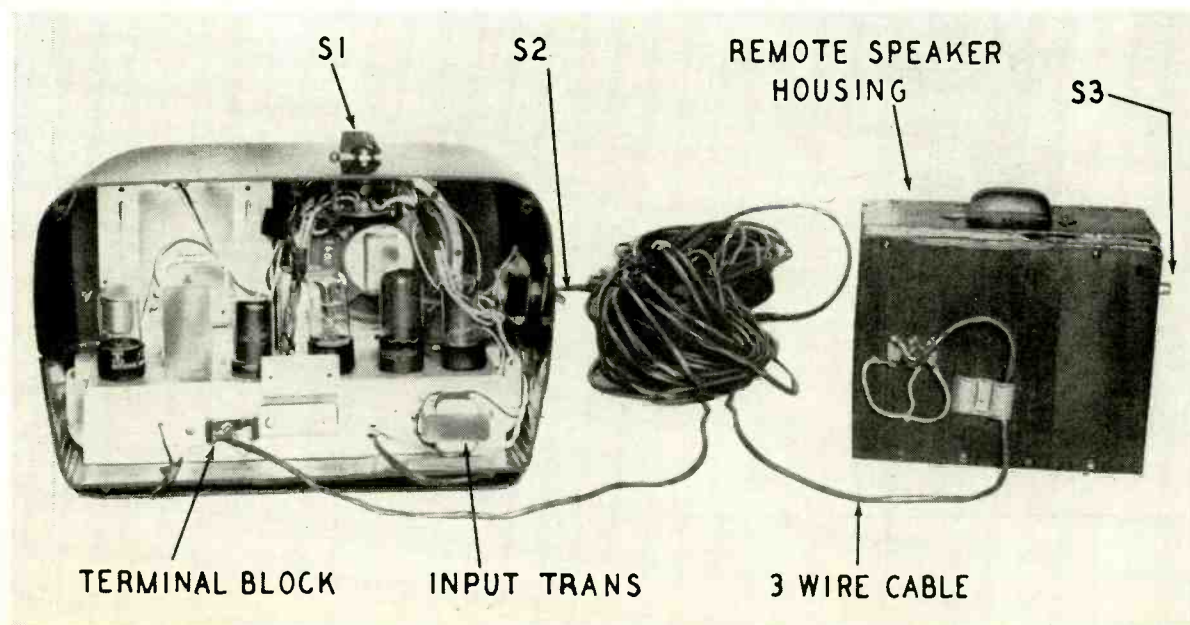

Rear view shows interconnections.

THE GATED-BEAM DISCRIMINATOR

By SOL HELLER and IRVING SHULMAN

Action and application of the 6BN6

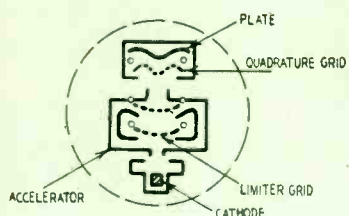

Fig. 1—Construction of the 6BN6.

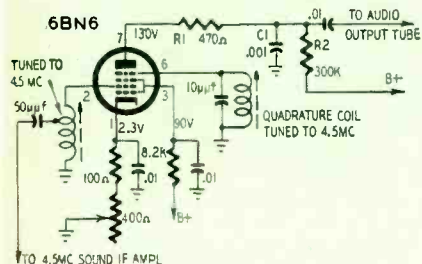

Fig. 2—Schematic diagram of the 4.5-mc gated-beam discriminator circuit.

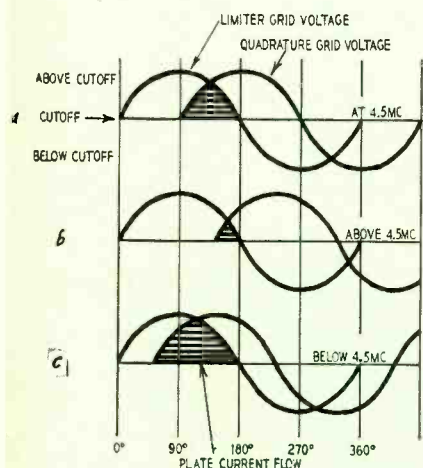

Fig. 3—The phase relationship of the limiter and quadrature grid voltages.

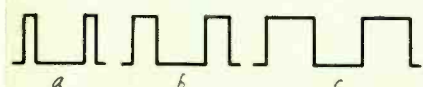

Fig. 4—6BN6 plate current pulses.

THE 6BN6 gated-beam discriminator, now widely used in the sound sections of TV sets, is not as widely understood.

The 6BN6 is generally used as an FM detector, the discriminator action being based on the unique properties of this vacuum tube. The circuit provides a number of advantages: it permits a reduction in the number of tubes (and associated circuit components) in the sound section of the TV receiver; no detector transformer is needed, reducing costs and simplifying alignment; it provides good noise rejection—pulse type noise is minimized since the time constant in the grid circuit of the discriminator can be made very small.

A sketch of the 6BN6 is shown in Fig. 1. The tube contains a cathode, two grids, an accelerator element and a plate. A circuit using the 6BN6 is shown in Fig. 2.

The incoming frequency-modulated signal is applied to both grids. The construction of the tube is such that the phase of the FM signal on one grid is different from the phase of the signal on the other grid. The phase difference—measured in degrees—varies with the frequency deviation of the FM signal at that instant. The amount of plate current that flows in the 6BN6 depends on the two grids. The frequency deviations of the incoming signal are thus converted into corresponding amplitude variations in the plate current, restoring the original audio signal. The frequency characteristic of the audio signal needs no restoration since it was never lost—i.e., the rate of change of the frequency deviations of the incoming signal is the same as the rate of change of the amplitude variations in the 6BN6 plate circuit.

6BN6 discriminator action

Let's consider the circuit action more closely. The plate and accelerator elements are operated at a positive potential with respect to the cathode. The grids are known as the *limiter* and *quadrature* grids and function somewhat like the control and suppressor grids, respectively, of a pentode. Both

are connected to tuned circuits resonant at 4.5 mc.

Electrons leaving the cathode are attracted to the positive accelerator. Whether or not some of the electrons will pass on through the accelerator to the anode depends on the signal voltage on the limiter grid. If this grid is a few volts negative, electrons will be repelled toward the cathode and will fall onto the inner surface of the accelerator, returning to the cathode by way of the B supply. If the grid potential is less than a few volts negative, electrons will pass through the accelerator and head for the plate.

On its way to the anode, the electron stream encounters the quadrature grid. If the negative potential at this grid is above cutoff, the electrons will pass through it and strike the plate; if the negative potential is at or below cutoff, the electrons will be repelled to the accelerator anode. Thus, for plate current to flow, both limiter and quadrature grids must be above cutoff. The two grids can thus be considered as gates. Both gates must be open if electrons are to reach the plate.

Before we consider this gating action in greater detail, we should discuss the nature of the plate current flow in the 6BN6. The cathode bias developed by the 6BN6 sets the operating point of the tube midway between plate current cutoff and saturation. The negative and positive swings of the relatively small 4.5-mc signal applied to the limiter grid drive the tube alternately to plate cutoff and saturation. The electron stream flowing past the limiter grid is, as a result, virtually a square wave. The repetition rate of these current pulses is the same as that of the incoming FM signal.

The length of time that plate current flows—and it is this time duration on which the width of the square-wave pulses depends—varies in accordance with the phase difference of the signals on the limiter and quadrature grids.

A time or phase lag exists in a tuned circuit between the voltage applied to the circuit and voltage built up in the circuit. In the case of the quadrature

grid tuned circuit, the applied voltage is the one fed from the limiter. (This voltage is transferred to the quadrature grid by space-charging coupling between the grids. Such coupling is similar to the coupling that would exist if a small capacitor was connected between the grids.) The voltage built up in the quadrature grid tuned circuit lags the applied voltage by 90° (at resonance). It therefore lags the limiter grid voltage by 90°.

The varying phase relations of the signals on the two grids are indicated in Fig. 3. When the incoming signal is exactly 4.5 mc, the signal on the quadrature grid lags the limiter grid signal by approximately 90° (Fig. 3-a). The addition of the signal voltages on both grids is such, at this time, that the 6BN6 will conduct only during the interval of the cycle indicated by the shaded area. During the rest of the input signal cycle, the sum of the two signal voltages produces too negative a net bias to permit plate current flow. Approximately 50% of each square-wave pulse of current (Fig. 4-b) that flows past the limiter grid will actually reach the plate under these conditions.

When the frequency of the incoming signal goes above 4.5 mc, the quadrature grid parallel-tuned circuit becomes capacitively reactive and the signal voltage on this grid lags the limiter grid signal by less than 90° (Fig. 3-b). The time interval during which plate current will flow becomes smaller since the addition of the grid waveform voltages at this time is such that the bias is brought out of cutoff during a smaller part of the incoming signal cycle. As a result, the width of the current pulse decreases (Fig. 4-a) and the average plate current drops. Less than 50% of the current flowing between cathode and limiter grid reaches the plate at this time.

When the frequency of the incoming signal drops below 4.5 mc, the quadrature grid signal voltage lags that on the limiter grid by more than 90° (Fig. 3-c). The addition of the grid waveform voltages now brings the bias above cutoff for a larger part of the incoming signal cycle, permitting plate current to flow for a longer time. The width of the current pulse waveform therefore widens (Fig. 4-c) and more than 50% of the square-wave current flowing between cathode and limiter grid reaches the plate.

The relation between the frequency deviation of the incoming signal and the average plate current is fairly linear—that is, the change in average plate current is proportional to the frequency deviation of the incoming signal. The modulation content of the FM signal is thus detected.

The discriminator circuit

The varying plate current flows through R2, the plate load resistor (Fig. 2). The resultant audio signal produced across R2 is usually of suffi-

cient amplitude to be applied directly to a power amplifier stage. The audio amplifier stage needed when a ratio detector or Foster-Seely discriminator is used may thus be dispensed with.

R1 and C1 (Fig. 2) in conjunction act like an R-C filter, eliminating the 4.5-mc i.f. signal. The two units make up an integrating network. The i.f. signals have a duration insufficient to charge C1 appreciably due to the relatively long time constant of R1 and C1; they are therefore unable to get through the circuit. The average voltage produced by these i.f. pulses of current appears across C1, reproducing the original audio signal (Fig. 5).

While plate current in the 6BN6 is intermittent or pulse type, accelerator current is continuous. The major portion of the tube's space current is accelerator current. Typical current values are 10 ma for the accelerator and 0.5 ma for the plate. The cathode current, made up of the sum of the two currents, is fairly independent of the plate current since the latter is so small as compared with the accelerator current. An apparently correct cathode voltage, therefore, does not necessarily mean that plate current is flowing—a point to be kept in mind during service work.

The limiter grid has approximately twice the effect upon plate current (for a given voltage swing) as the quadrature grid. Both grids are of the very sharp cutoff type. Grid currents are limited to small values in the 6BN6. This is advantageous since the tuned circuits the grids are connected to will not be heavily loaded down should the grids be driven positive by large signal inputs.

Potentiometer R3 in the cathode circuit is adjusted for minimum buzz (maximum AM rejection). This potentiometer is sometimes called the buzz control. Its adjustment is usually made on the channel on which the strongest signal is received.

Resistor R1 improves the gated-beam

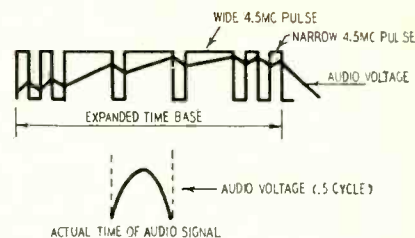

Fig. 5—Integrating the output of the 6BN6 into an audio-frequency signal.

detector's linearity. Its value may range between 470 and 1,000 ohms. The voltage drop across R1 is fed back from the plate circuit to the quadrature grid circuit through the coupling provided by tube interelectrode and wiring capacitances. It is important for the service technician to realize that the lead dress in the 6BN6 circuit must not be changed since this may affect the coupling just referred to, possibly causing distortion and poor AM rejection due to nonlinear discriminator operation. In some sets a shield may be across the bottom of the 6BN6 socket to prevent excessive coupling between the plate and the limiter or quadrature grid.

The limiting of noise pulses is inherent in the design of the 6BN6. A signal of 1.5 volts r.m.s. is all that is needed to drive the limiter grid from saturation to cutoff. Enough amplification must be provided by stages preceding the 6BN6 to bring the weakest received signal (minus noise) to this voltage level at the limiter grid. Signals greater in amplitude than 1.5 volts will be limited to this level; the limiting is applied to noise pulses as well.

Noise limiting is aided by the low value of d.c. resistance in the limiter grid circuit. Since this is only a few ohms (the resistance of the coil in the tuned circuit) the grid-circuit time constant is very short. The developed grid-leak bias can therefore "follow" noise pulses. The AM rejection properties of the circuit are good because of this feature. END



"Honey, will you call the kids in for supper."

IMPROVED TRANSISTOR REGENERATOR

By JOSEPH AMOROSE

EDWIN BOHR'S regenerative transistor set (Fig. 1) described in the April, 1954, issue of RADIO-ELECTRONICS was built and found to be a most interesting and extremely efficient receiver. Robert A. Rogers, a fellow transistor set enthusiast, also built this set and found it good, after which he carried on extensive experiments with the circuit. His plan was to simplify and, at the same time, improve performance. Recently he brought his latest product (Fig. 2) to me for testing and comparison with the original Bohr circuit. I found the improvement in performance striking. Perhaps other transistor hobbyists might like to try their hand at Rogers' improved version of the original Bohr receiver.

The most impressive feature is the increase in sensitivity, brought about by the change in the tuning system. Where Bohr's version brought in stations consistently over a 100-mile radius, Rogers' set will pull in with ease signals from transmitters 500 to 600 miles distant. Too, in Rogers' version sensitivity is better on the low-frequency end of the dial. The principal features of Rogers' modified circuit are: elimination of the tickler coil; use of a variable capacitor to control feedback more effectively than was possible with potentiometer R2 originally used for this purpose—R2 is retained, however, and functions as an additional volume booster; the Ferris-Loopstick is used "as is" with no alteration required; hand-capacitance effect is negligible; transistor noise is reduced to a practically inaudible level; control of regeneration is smoother—it can be set closer to the

most sensitive (critical) point without spilling over, resulting in utmost sensitivity; better selectivity, because both the primary and secondary circuits are tunable by C1 and C2; only one tuning coil is used.

The dashed line in Rogers' circuit encloses the changes made; only a slight change is made in the wiring. Specifically, the tickler coil is removed. Bohr's C1, C2, C3 and C4 capacitors are taken out and replaced by capacitors C1, C2, C3 and C4 shown in Rogers' diagram. A two-gang TRF type variable capacitor, 365 μmf in each section, acts as C1 and C2. C3 is a 5- to 50- μmf variable

capacitor used to control regeneration and takes over the function performed by R2 in the Bohr circuit. R2 controls the emitter bias and r.f. gain and functions as an additional volume booster. It increases sensitivity sharply and proves invaluable when tuning in weak dx stations.

An insulated shaft coupling should be used on C1-C2 to eliminate hand-capacitance effects. (Rogers uses a drum and dial cord running to a separate shaft—it is very effective.)

The regenerative ability of the CK722 transistors varies widely. If more than one unit is at hand, try all and choose the CK722 that oscillates best.

Use headphones of at least 2,000 ohms resistance; phones with an impedance of 24,000 ohms worked best of all.

Left — Improved regenerative transistor set.

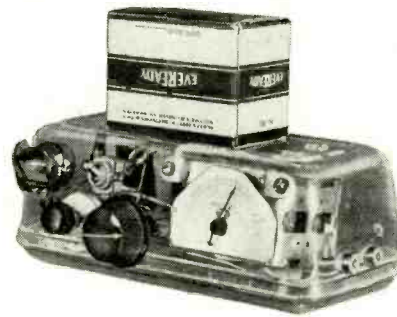

Below — Under-chassis view shows parts layout.

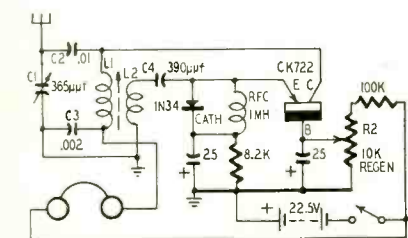
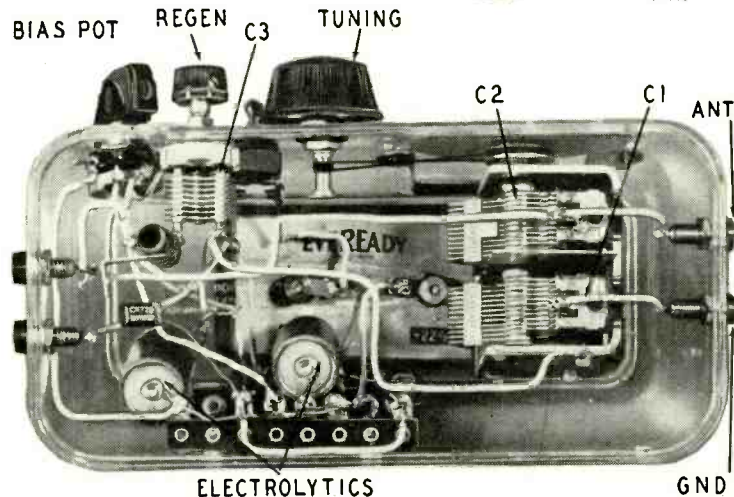

Fig. 1—Schematic diagram of Bohr's regenerative transistor receiver.

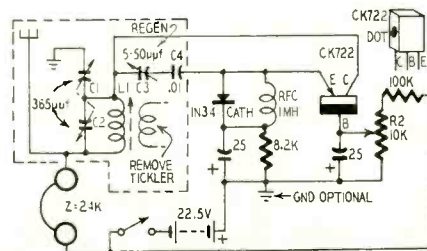

Fig. 2—Schematic diagram of Rogers' revised regenerative transistor set.

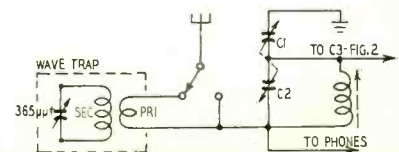

Fig. 3—Typical absorption wave trap.

Adjusting the revised set

Turn C1-C2 to the wide-open position. Then adjust L1 to peak on a station around 1600 kc and cement it in place. Next, set C3 just under the squealing stage. Finally, adjust R2 for best overall response—this is near the halfway point. Controls R2 and C3 can be left “set” for local reception; on dx, a slight adjustment will increase sensitivity sharply. Reverse the leads of C3 if any hand capacitance effect is noticed. With R2 and C3 set, all locals should come in easily by tuning C1-C2.

Connections to the antenna and ground are made in the conventional manner. If hand-capacitance effect is troublesome, reverse the antenna-ground connections. Should strong locals interfere over any part of the band, use an absorption type wavetrap and switch (Fig. 3) in the antenna lead. This not only eliminates the trouble but also permits tuning in dx stations over that part of the band.

Numerous types of traps were experimented with. The most effective was one made up of an S-645 Carron (Carron Manufacturing Co., Chicago, Ill.) antenna coil (low-impedance primary) and a 365- μmf trimmer—both very inexpensive units. Set the trimmer to attenuate the most interfering station; then no further attention is required.

Construction and performance

Use only new, fresh batteries. Just as important use fresh electrolytics that have *NOT* been shelf-stored. Keep leads short and well separated. Place the battery as far as possible from other components—sensitivity was found to decrease sharply the closer the battery was to other parts. (Rogers has his battery on top of the set—see photo—to get the most possible oomph.) Use the best antenna possible, plus a ground to a cold water pipe. A short antenna will give good local reception; for dx use 50 to 100 feet placed high and well insulated.

A 3-foot antenna and ground brought in 5 of the 6 local stations well. A 15-foot antenna brought in all locals well. With an antenna 75 to 100 feet long, stations about 100 miles away could be picked up in the daytime. At night, stations within a 600-mile radius are frequently tuned in. On locals, the set is much more selective if no ground is used; bias and regeneration must be set to their most sensitive point.

Experimenters often wonder, “How does a set built on a metal chassis compare with one built on a chassis of insulated material?” Mr. Rogers (an industrious fellow) built two identical sets to find out. He used his revised version of Bohr’s circuit in both receivers and these were the results:

The set with the metal cabinet produced slightly more volume on all stations, but selectivity was poorer; only five of the six local stations could be tuned in—the weakest, the sixth, could not be heard. Too, the hand-capacitance

effect was much worse in the set on a metal chassis. It was hard to eliminate it to a satisfactory degree even when an insulated shaft was used on the tuning capacitor.

The other set was built in a Lucite 8 x 4 x 3-inch box and results were vastly better. All six locals could be tuned in easily; tuning was much sharper with almost hairline selectivity. Volume was very nearly as loud as the set in a metal cabinet. Most important, however, was the decrease of hand-

capacitance effect; it was practically negligible. No trouble whatever existed in tuning; stations could be brought in easily and quickly with no noticeable detuning effect as was experienced on the set with the metal cabinet. Another advantage of using Lucite is that it is easier to work and makes a much neater-looking job. A note of caution: drill holes slowly when working with Lucite and don’t press more than is necessary when drilling—it will crack. Improved results justify the use of Lucite. END

AN IMPROVEMENT IN AM-FM TUNERS

By D. L. STONER

WHILE installing and servicing AM-FM tuners, obtaining satisfactory reception on the AM band is sometimes difficult. This is particularly true of tuners using ferrite antennas. Broadband intermediate-frequency amplifiers usually require more signal strength than ordinary sharp-tuned circuits.

After purchasing an AM-FM tuner, I really came face to face with the problem. The tuner was installed inside an all-metal house trailer and AM stations were nonexistent. An outside antenna was the only answer. The problem was to connect the AM section of the tuner to the FM antenna without affecting the performance of either AM or FM sections.

Fig. 1 shows the original circuit. It is found often in present-day AM-FM tuners. The FM antenna coil presents an impedance of 300 ohms to the antenna. By disconnecting the center tap of the antenna coil, a capacitor can be inserted that will have a low reactance at the FM band but a high reactance at the broadcast band. With a low reactance at this point, performance of the FM section will not be impaired.

Because of the impedance of the ferrite antenna, which is extremely high, impedances must be matched carefully. This is done by C2 (Fig. 2) and the capacitance ratio between C1 and C2. It provides an impedance ratio of 80.

Do not change the value of C2 to obtain more signal strength. If the impedance ratio is less than 50, image rejection will be impaired by lowering the Q of the ferrite antenna. Instead, reduce the value of C1. If the value of C1 is reduced too much, a slight loss of signal strength may be noticed on the FM band. The values shown are about optimum, and no change can be detected in FM signals by shorting out C1.

Fig. 3 shows another type of antenna input circuit and the method of match-

ing the ferrite antenna to the lead-in. Modified connections and parts are shown in dashed lines.

The circuits have been tried in many different makes of tuners and each has provided an improvement. It will work equally well if the cold end of the ferrite antenna goes to the a.v.c. circuit. Also, it will improve tuners using spiral loop antennas and antenna coils. If your tuner uses an antenna coil, disregard the primary winding and connect C2, the 5- μmf capacitor, to the end of the secondary coil connected to the tuning capacitor. If it uses a spiral loop antenna, wire it just as you would with a ferrite antenna. END

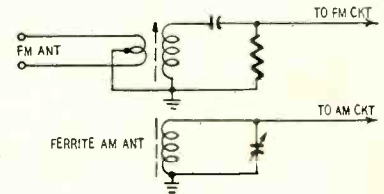

Fig. 1—Original AM-FM antenna circuit.

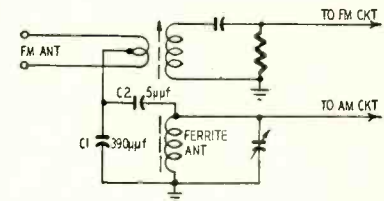

Fig. 2—The modified tuner circuit.

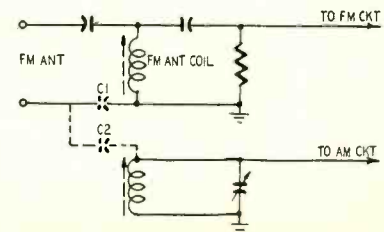

Fig. 3—An antenna input circuit.

what's

new

?



Miniaturization

Four transistors are packed into this hearing aid, which the manufacturer (Sonotone) says is the smallest and lightest the company has ever made. Measurements are $1\frac{1}{8}$ inches long, $1\frac{3}{8}$ inches wide and a little less than $\frac{1}{2}$ inch thick. Only control is the volume control plus switch seen at the top. The microphone is behind the six small holes, the grill at the top being ornamental etching on the metal. An earpiece and plug-in cord complete the unit.

Micro-cell

This button-size cell has been developed by the Elgin Watch Co. with the idea of future use in an electric wrist watch. It delivers an open-circuit voltage of 1.15, and models have been made with a theoretical capacity of 130 milli-ampere-hours, of which at least 85% is realizable. Voltage remains practically constant during discharge, and life is long—at least one year of shelf life prior to being placed in service, plus up to two years of service life.

Tape Phonograph

The Ampex 612 stereophonic tape phonograph is designed solely to play prerecorded tapes in home music systems. Intended for stereophonic (binaural, bi-fi, etc.) tapes, it will also play full- or half-track tapes. Each of the two 620 speakers has its own 10-watt amplifier to amplify the signals from its own half of the tape. The player itself operates at $7\frac{1}{2}$ inches per minute and on Ampex standard tape No. 5563 has a response within ± 2 db from 40 to 15,000 cycles. The 612 will also be sold without its case, for inclusion in custom-built systems.



Communications

Smallest two-way field portable ever built is this 12-transistor-plus-1-tube v.h.f. radiophone transceiver. It operates on preset frequencies in the 45-50-mc band, has only two controls (push-to-talk and volume control with switch). The receiver, an all-transistor superhet, uses 10 transistors; the transmitter, 2 transistors and a tube. The receiver is a true vest-pocket unit and could be built independently for use as a listening-only device, to link a soldier with his platoon, for example. It was developed for the Signal Corps by RCA.

RADIO-ELECTRONICS

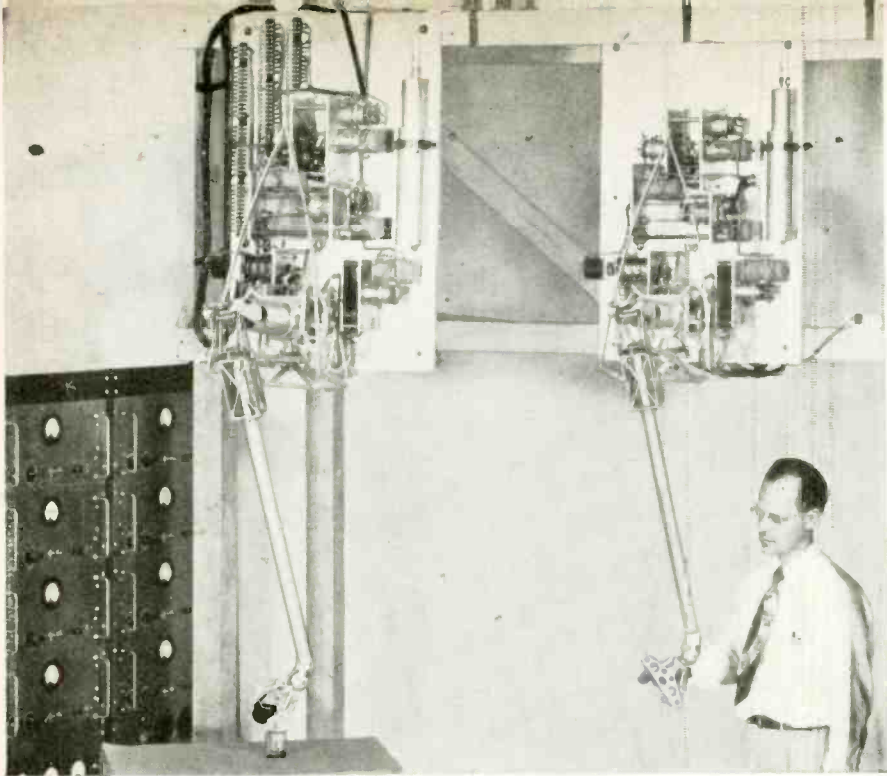

Electronics

This electronic manipulator reflects to the operator the forces felt by the "slave arm," giving the "feel" necessary when performing delicate operations with sensitive or fragile equipment.

It reproduces the seven basic motions employed in grasping, lifting and turning objects. Two master handles are connected to two slave hands by electrical cables. Earlier manipulators connected slaves to masters by mechanical linkages, limiting the distance between them to about 12 feet. This system increases the distance to several hundred feet and can be modified for even greater separation. The operator watches the hands' action with three-dimensional television. An important feature is the servo-mechanism system to reflect work loads and resistances to the operator. Without it, it is nearly impossible for him to know and control the forces applied at the slave arm. It was developed by the Argonne National Laboratory to handle radio-active materials.

To operate the manipulator, the scientist grasps the master handles, moves and turns them exactly as the robot hands are to move.

Visual Tone Controls

Tone control curves you can see are featured by European and American audio equipment.

In the Bell & Howell phonograph-radio-tape recorder control panel the visual tone control consists of a rubber or plastic strip mechanically linked to the LEVEL, BASS and TREBLE controls so that it moves up or down a scale, showing the level at bass, middle and high ranges in the form of a smooth curve (photo right). Once the treble and bass controls are set, the curve may be moved up or down by the LEVEL control, increasing or decreasing volume without altering frequency response.

An auxiliary loudness control protects against high or low tonal loss at decreased volume levels, and pushbuttons are used to equalize the circuits for the various recording curves. An additional feature of a number of the new Bell & Howell models is the oscilloscope seen at the right in the photo. It acts as a tuning indicator for AM and FM radio, makes a convenient recording level indicator for tape and may be adapted to a number of other applications.

The ReVox preamplifier (ELA A-G, Zurich, Switzerland) has a less direct system. Bass and treble curves are printed on the panel and these are continued to coincide roughly with various positions of the step type bass and treble controls. Thus the user can see an approximation of the response curve. The bass curve is calibrated from 50 to 500 cycles and the treble from 1 to 10 kc, with extrapolations to 20 kc.

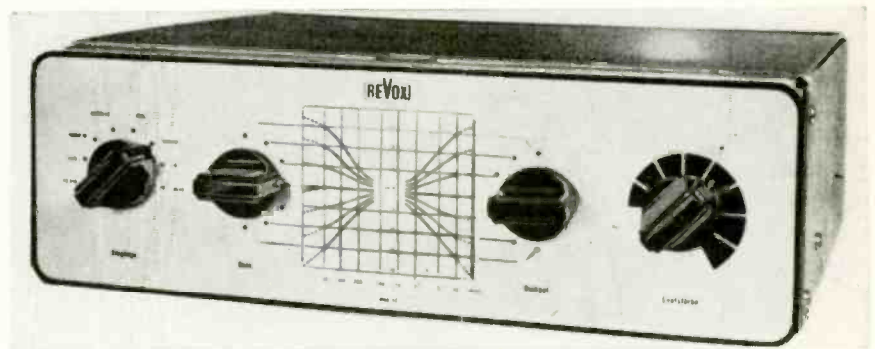
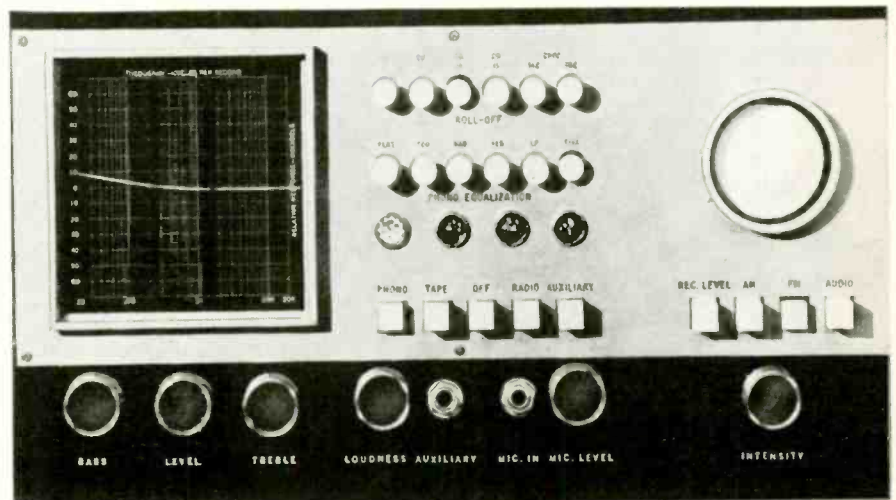

Transistor Portables

This seven-transistor receiver has power and volume comparable to small line-operated radios. Using seven transistors, it plays 2,500 hours on one set of batteries. This represents about 2 years for an average set. Made by Raytheon, the set is the second transistor portable put out by that company.

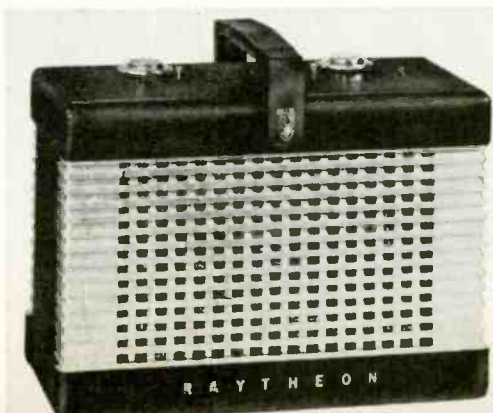

The

Technical reporter

*Stringing beads to reduce feedback:
an interesting frame-lock circuit;
electronics and the dairy herd*

By SOL HELLER

Courtesy Ferroxcube Corp. of America

**Ferroxcube beads
strung on a wire.**

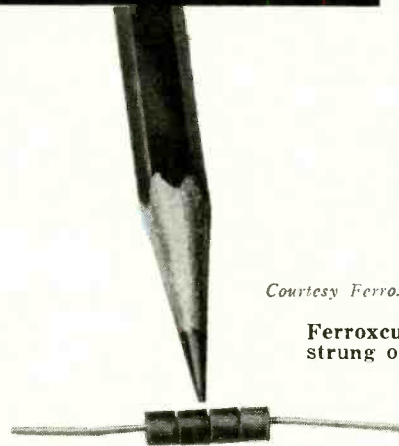

REMEMBER in the old Westerns how the hero drew a bead on the villain? Well, you may be drawing a bead pretty soon, too, if you're a service technician. The Ferroxcube Corp. of America has developed beads for reducing high-frequency feedback. The beads (see photo) are threaded onto wires.

Supply leads in radio and TV sets form a path along which high-frequency signals can go astray. Instead of traveling the straight and narrow path to the speaker or cathode-ray tube, r.f. and i.f. signals can feed back to input stages. Regeneration or degeneration may result, impairing set performance.

So why not decouple the leads? Why string along with beads?

Well, simple decoupling with capacitors may not be satisfactory because parasitic resonance can be set up by the combination of lead inductance with the circuit capacitance. Adding series inductance to choke out the offending feedback is, for the same reason, an uncertain remedy.

Ferroxcube's solution is to thread shielding beads onto supply leads that may introduce trouble. The permeabil-

ity of these beads is high. As a result, the inductance of the lead is greatly increased—so much so that the lead now functions as a choke for high-frequency signals.

Furthermore, high losses take place in the beads at frequencies exceeding 500 kc. Any r.f. or i.f. oscillations set up in the leads despite this choke action will be severely damped by the losses in the beads.

An example of how the beads may be used practically is illustrated in Fig. 1. The sketch shows part of a heater line in an AM-FM receiver using a three-section decoupling network. The resistor in the first section acts as a voltage-dropping as well as a filter unit. The two other sections each consist of a piece of hookup wire with three beads positioned at either end. The leads are shunted to ground .0015- μ f capacitors. Thus, the choke action of the beads is supplemented by the filtering action of the capacitors. Feedback by way of the filaments is thus suppressed.

Ferroxcube beads are likely to be

used for decoupling supply leads from the power supply to the front end. These are long leads that often pick up i.f. signals. The more beads used, the greater the choking and damping effect.

Motorola Frame-Lock circuit

The problem of noise in weak signal areas is one that has been separating the men from the boys among TV engineers for some time. Horizontal pulling, vertical roll and related symptoms are often produced under such conditions, substantially lowering set owners' pleasure-to-pain ratio.

Special noise inverters and noise canceller circuits have been included in various receivers to prevent noise from upsetting receiver performance. A new kink in noise cancellation, used by Motorola in its late-model TV sets (chassis TS-525, 528, 603 and others), is worthy of honorable mention.

The principle of feeding oppositely phased noise pulses to the plate circuit of the video amplifier, causing them to cancel, is not new; the means used to

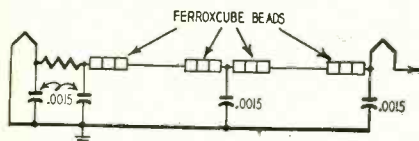

Fig. 1—Diagram of part of heater circuit showing use of Ferroxcube beads.

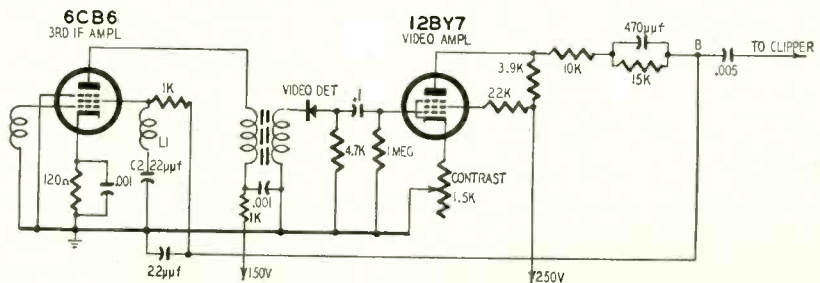

Fig. 2—Schematic diagram shows circuitry of the Motorola Frame-Lock.

Courtesy Motorola

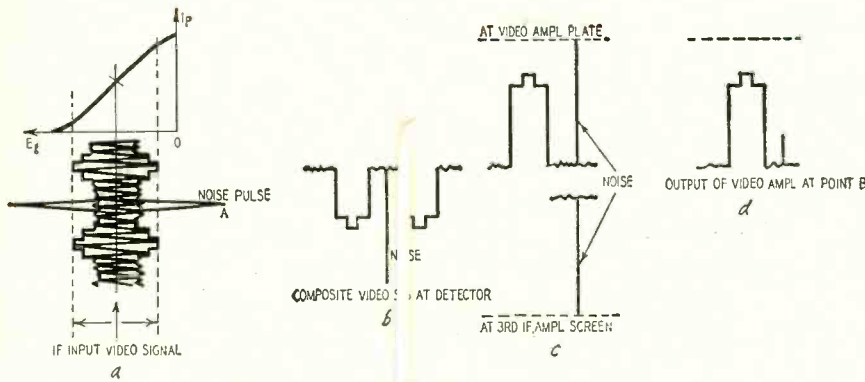

Fig. 3—Action of Frame-Lock circuit.

achieve this in Motorola sets is. Motorola obtains this noise reduction without using a special noise canceller or inverter tube, which in itself is interesting.

The circuits in the anti-noise battle are shown in Fig. 2. The third i.f. amplifier operates class A for video i.f. signals, passing them on to the video detector and video amplifier without even inspecting their credentials. When a noise pulse comes along, however, the circuit becomes less amiable. Let's analyze it a bit.

The i.f. signals that reach the screen grid of the 6CB6 are bypassed to ground through L1 and C2, series-resonant to these frequencies. The L1-C2 network, however, offers a high impedance to noise signals. Unbypassed noise currents thus flow, developing noise voltages in this circuit.

Noise appearing at the control grid of the third video i.f. tube momentarily drives the tube to zero bias (Fig. 3-a), causing the screen voltage to rise and the screen current to fall. This drop in screen voltage, occurring at the noise frequency, is a negative-going pulse.

Noise pulses get to the video amplifier plate circuit (point B) via two paths. One is conventional, through the video detector (Fig. 3-b) and video amplifier, and appears as a positive-going pulse at point B.

The noise signal is also fed to point B through the third i.f. tube's screen circuit (Fig. 3-c); the noise signal taking this route is negative-going. The two opposite-going signals are almost equal in size, and cancel out (Fig. 3-d). Long-duration noise pulses are particularly subdued in this electronic harakiri circuit, eliminating vertical picture flopping.

Recording cattle behavior

The behavior of cattle can now be electronically recorded, according to an article in the English magazine *Electronic Engineering*. Which brings up the question: Who cares how cattle behave? Ranchers who raise them do! A knowledge of their behavior can provide the basis for improved techniques of grazing management.

Portable recording equipment is strapped to the animals to be studied. Basically, the equipment consists of a

recording box and switches. These units are mounted on a leather harness. The animal can wear the harness for several weeks without noticeable discomfort.

Information needed includes how

much time the animal spends walking, standing, lying down, grazing and chewing the cud; also, the total number of his leg and jaw movements.

Every time the animal takes a step, one type of switch is activated. When he lies down, the pressure of his body actuates another switch. Jaw movements operate a jaw switch; corresponding electric impulses are set up by each such jaw movement. One switch is activated by head-up and head-down movements. The head-down motions are recorded as grazing, head-up as cud-chewing. An electronically energized pen traces on paper the various symbols corresponding to the different movements of the animal and records them for future study.

Comparison tests made with unharnessed cattle show that the harnessed animals do not mind this invasion of their liberties. END

AUTO RECORD PLAYER

The record fan can now take his music with him on the road. A record player (see photo) that goes mobile has been announced as an accessory for Plymouth, Dodge, DeSoto, Chrysler and Imperial 1956 cars. The numerous problems of a mobile record player—one that would not be affected by sudden starts and stops, curves and rough roads—were solved by CBS Laboratories with a unit that plays 7-inch records, transcribed on both sides. The records turn at 16 $\frac{2}{3}$ r.p.m. and give up to 45 minutes of music or an hour of speech on each side. Thus the difficulties of record changing (nearly impossible with an automatic changer under road conditions and dangerous if frequent manual changing is necessary) are overcome. Records can be changed during stops at filling stations or lunch counters, or the canned-music addict can pull to the side of the road

when he needs to change records.

The *Highway Hi-Fi* plays through the speaker of the car radio and uses its amplifier. The turntable—built by CBS-Columbia—is mounted in a shock-proof case, installed just below the center of the instrument panel. The pickup is a ceramic unit with a sapphire stylus. Tests have demonstrated that it is extremely difficult to jar the arm off the record—or even make it jump a groove—under rough road conditions.

The special records already include selections from the classics, such as Tchaikovsky, Borodin and Ippolitov-Ivanov, jazz music rendered by the orchestras of Andre Kostelanetz, Percy Faith and Paul Weston, a series of dramatic readings and—for the younger passengers—Gene Autry and Davy Crockett. Six discs are given to the customer with each player. END



*A novel method of
synchronizing traffic
lights with a tape
recorder and
radio control*

By ROY R. NEWSOM*

FOR many years radio and traffic engineers have been working with the idea of regulating traffic lights by wireless radio control. The first successful effort known was in France in 1937 where they had a surprisingly efficient microwave system for turning traffic lights red to give fire trucks and the like the right-of-way in emergencies. Their activities were reported in the Dec. 2, 1937, issue of *Wireless World* magazine.

But a system of continual integrated cycling of all the lights in an entire traffic system by radio is a different matter. A number of companies conducted experiments in that direction over a period of years, but until recently no one evolved a control system capable of transmitting the necessary hundreds of switching functions and separating them at the intersections. The Colorado Electronics Corp. has installed a successful system at Greeley, Colo. This project revived interest in the idea and it is again getting considerable attention.

Of the several possible approaches to synchronizing traffic lights by radio control, two are currently receiving most consideration. One method is to

*President, Colorado Electronics Corp., Greeley, Colo.



switch the lights with a conventional intersection controller, using a synchronous or clock type motor with attached switches and reset this controller periodically by transmitting an impulse to throw a reset switch in the controller mechanism. This is comparable to the system of resetting electric clocks by timed pulses. It requires a minimum of radio transmission and is the easiest and simplest approach to exerting a limited control over the lights from a central control point. With this method cycling flexibility is limited to that of the controller, but the controller retains its timing relationship with controllers of other intersections.

The other approach is to eliminate the old type controller altogether and use an intersection control unit motivated entirely by radio transmission.

The first method largely eliminates the problem of cabling the old type controllers together for synchronization.

Traffic engineers have been much concerned with the cost of cabling their controllers. But they have become accustomed to the old controller, have accepted its limitations and have been interested only in eliminating the cable often used to interconnect them to retain their scheduled timing cycles.

Our survey, however, indicated a definite need for an improvement over the old controller as well as the elimination of cable. And most students of traffic conditions are in full agreement with our conclusion in this respect.

Actually, the traffic engineer needs more control over his traffic lights than he now has. He needs more flexibility in setting traffic patterns, but even more he needs more controllers than he can purchase at present market prices. The average city wants the maximum control over traffic for maximum safety and convenience, but in practice can afford controllers for only a minimum amount of regulation. The situation calls for a controller which will give efficient regulation at a price which will permit cities to install them in sufficient numbers to achieve real traffic safety. We felt that there was a pressing need to build a completely new product, and that is what we did!

In a typical installation for a small city such as Greeley, we used a tape recorder as the storage mechanism for coded signal voltages recorded on the tape and then reproduced continually for broadcast. The signals are processed through a premodulation unit and then fed into a conventional transmitter much the same as ordinary microphone output.

At each intersection is a conventional receiver. The receiver output is fed into a decoder unit which decodes the signals and selects those intended for that particular intersection. The signal pulses activate mercury switches and the switches handle the lamp load. The intersection unit includes a synchronous motor which is turned on and off by radio. In the event of a radio failure at the base station or in the intersection unit, this motor automatically assumes cycling of the traffic lights and a small red light on the controller box signals that the intersection is on what we refer to as "manual" control.

Left—An intersection unit installed on a conventional traffic-light fixture. Bottom—Technician checks intersection unit.

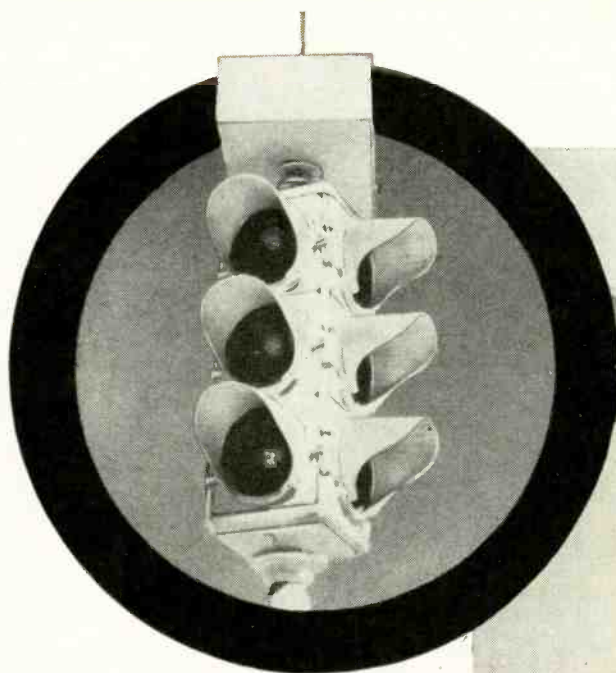

The transmitter used in the Greeley project is a standard Motorola type PA-9355 designed for FM mobile communications in the u.h.f. band. (Our operations are at 454.15 mc.) It is rated at 18 watts output and designed for a 30-kc bandwidth.

Our receivers are also standard Motorola units, model PA-9344, designed for mobile use with the PA-9355 base station transmitter. In spite of the relatively narrow-band design of the equipment, we can put several systems in this band with overlapping radiation patterns and operate without interference between systems. This feature was necessary to accommodate systems in neighboring cities.

Receiver sensitivity is not critical when relatively high transmitter power is used and field strength is high. Conversely, some receivers with high sensitivity will operate well from a weaker field. Our operation requires that the radiated field be sufficient for the design of the receiver used.

For average installations a bandwidth of 30 kc is sufficient; for a more complex system in a larger city desiring several independent systems, 60 kc might be required to insure that one system does not interfere with another.

The novel modulating, filtering and decoding circuitry of our units gives maximum protection against interference from other transmissions, screens out "skip" interference and permits operation with a signal-to-noise ratio far below that required for conventional communications. This permits maximum use of radio spectrum.

We cannot detail the tape-making process, the premodulation circuitry or the decoding action, but the system is capable of transmitting hundreds of switching functions simultaneously with maximum integration and control. It

is capable of handling the traffic system of any American city.

The tape mechanisms are our own design and construction. They are conventional units, dual-track recording at a speed of 1.875 inches per second. All switching functions of the tape mechanisms and other base station components are entirely automatic. The system is designed for unattended operation.

Magnetic drums or other storage methods may be used in lieu of the tape mechanisms if individual installation requirements so indicate.

Our system is very simple to install. A qualified electrician can install six intersection units per day. Maintenance is simplified by unitized assembly; the intersection unit consists of four plug-in subunits and may be exchanged and taken to a shop for repair.

There are many advantages to our

system: it lowers costs per intersection; no ditching or expensive cabling; maximum flexibility of control; simple and economical maintenance; portability; units along a highway or traffic route can be removed and plugged in at new locations should it become necessary to reroute traffic or change the course of a highway. Little features, such as automatic control over fire routes or other specific traffic lanes, may be easily included. Mercury switching helps prevent fires or explosions from sewer gas or other explosive vapors. Many of our switches with several years' service show no sign of wear. The flexibility of the system permits the controlled variation of the cycling of one light, any group of lights or the entire city traffic pattern as many times per day as is desired. The controllers may be used in conjunction with other types of controls or may replace them.

END

MAGNETIC INDUCTION FLOWMETER

*Device measures rate of flow
of liquid metal through pipe*

By THEODORE C. JAY, JR.

IN chemical process work, it is often necessary to measure the velocity or rate of flow of liquid metals or electrically conductive fluids through a pipe. Various mechanical devices have been used for this type of measurement, but their accuracy and speed of response are not satisfactory for many applications. A new instrument called a magnetic-induction flowmeter has been developed which measures the fluid velocity electronically. It is more accurate and responds faster than the mechanical devices.

A simplified magnetic-induction flowmeter circuit is shown in the diagram. A portion of an insulated pipe is suspended within the air gap of an electromagnet. The winding of the electromagnet is excited with d.c. supplied from a d.c. magnet power supply. When a liquid metal such as mercury passes through the pipe, the moving mercury cuts the magnetic lines of force set up across the air gap of the electromagnet. Consequently, a voltage proportional to the rate of flow of the mercury is induced in the mercury and appears across the electrodes. This voltage is fed into a d.c. amplifier. The output is measured with a d.c. voltmeter. When the voltmeter is properly calibrated, the rate of flow is directly indicated on the meter scale.

The operation of this flowmeter is similar to that of a transformer. When a.c. is applied to the primary winding of a transformer, the constantly changing magnetic flux in the core sets up constantly changing lines of force around the core. These lines cut the turns of the secondary winding and induce a.c. voltages in it. If d.c. voltages are applied to the primary winding, the magnetic flux in the core will not change and no voltage will be induced in the secondary winding. However, if the secondary winding can be rotated with respect to the primary as in a synchro or a generator, the constant lines of force set up around the

A cylindrical bore in a rectangular block forms the flow tube of the unit.

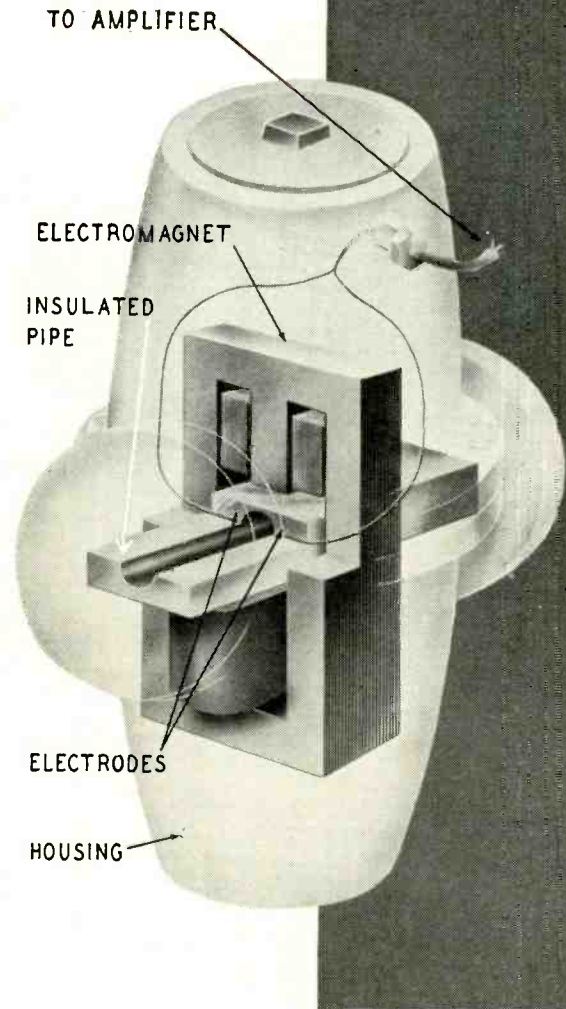

core will be cut by the moving turns of the secondary and an a.c. voltage proportional to the speed of rotation will be induced in the secondary winding. In other words, when an electrical conductor is moved in a magnetic field in a direction cutting the lines of force, a voltage proportional to the velocity of the conductor is induced in this conductor. This is the principle of the magnetic induction flowmeter.

The d.c. flowmeter circuit is not satisfactory for very low flow rates because the induced voltage is too small for stable d.c. amplification. Therefore, for these flow rates an a.c. flowmeter circuit is used. The circuit shown in the diagram can be converted to a.c. operation by replacing the d.c. magnet power supply, the d.c. amplifier and the d.c. voltmeter with similar a.c. units. However, since the magnetic flux within the air gap of the electromagnet will now be constantly changing, an a.c. voltage called the no-flow voltage will be induced in the mercury even though the mercury is standing still. This situation is similar to that of the transformer with fixed primary and secondary windings in which an a.c. voltage

is induced in the secondary because of the changing flux in the transformer core.

Therefore, when the mercury flows in the pipe, two a.c. voltages will be induced in the mercury and will appear at the electrodes. The first voltage is proportional to the rate of flow; the second is the no-flow voltage.

To eliminate the effect of the no-flow voltage, the a.c. voltmeter can be provided with a manual zeroing adjusting screw. The voltmeter can then be calibrated by setting the needle to a zero reading when only the no-flow voltage is present. Afterwards, very small rates of flow can be read directly on the voltmeter. The calibration must be made very carefully. The rates of flow are sometimes so small as to make accurate reading difficult. **END**

Bibliography

- A. Kolin, "An Alternating Field Induction Flowmeter of High Sensitivity," *Review of Scientific Instruments*, May, 1945.
 J. S. Arnold, "An Electromagnetic Flowmeter for Transient Flow Studies," *Review of Scientific Instruments*, January, 1951.
 W. B. James, "An Induction Flowmeter Design Suitable for Radioactive Liquids," *Review of Scientific Instruments*, December, 1951.

SQUITCH PANEL

By H. A. HIGHSTONE

*A component substitution unit
that will solve those really
tough ones*

SOME refer to it as "squegging." Others call it "ringing" in the horizontal sweep circuit. "Squitching" is the one I'll buy. It was invented by a nice old lady TV customer of mine to describe that rough, beaten-up raster shot through with bright horizontal streaks which every TV repairman has encountered.

Squitching is easily stopped—in most cases. Simply replacing the horizontal oscillator or output tube often cures it. Sometimes readjusting the locking-range trimmer or horizontal-frequency slug can be the answer. Again, a loused-up Synchronguide waveform may be causing the trouble.

However, to every TV bench there eventually comes a squitcher which continues to squitch—often intermittently—in spite of everything. Mass replacement of parts or some similar brute-force technique is the only means of subduing it. Chassis such as these frequently account for that vacant stare and twitching facial muscles (squitching) one notes in certain TV repairmen.

Stubborn squitchers lost me a lot of hours. But no longer; not since I contrived my Squitch Panel (Pat. Not Pending). A squitch panel is cheap and easy to construct, screwdriver-simple to use and tells its operator in words of one syllable exactly why some chassis persist in squitching and exactly how to stop it.

My squitch panel is a bare 3 months old, but already it has taken on three rough squitchers and nailed them in an average of 20 minutes per chassis. Cost of parts used totaled less than 50c, net.

The panel is a piece of heavy sheet metal 8 x 12 inches, flanged at the bottom to stiffen it. (Having gained hindsight, I would now suggest making the chassis of the squitch panel from insulating material, rather than metal—reduces shock hazard. I've had several minor but unpleasant bites which would never have occurred had my panel been a nonconductor.) It mounts a dozen potentiometers ranging from 500 ohms

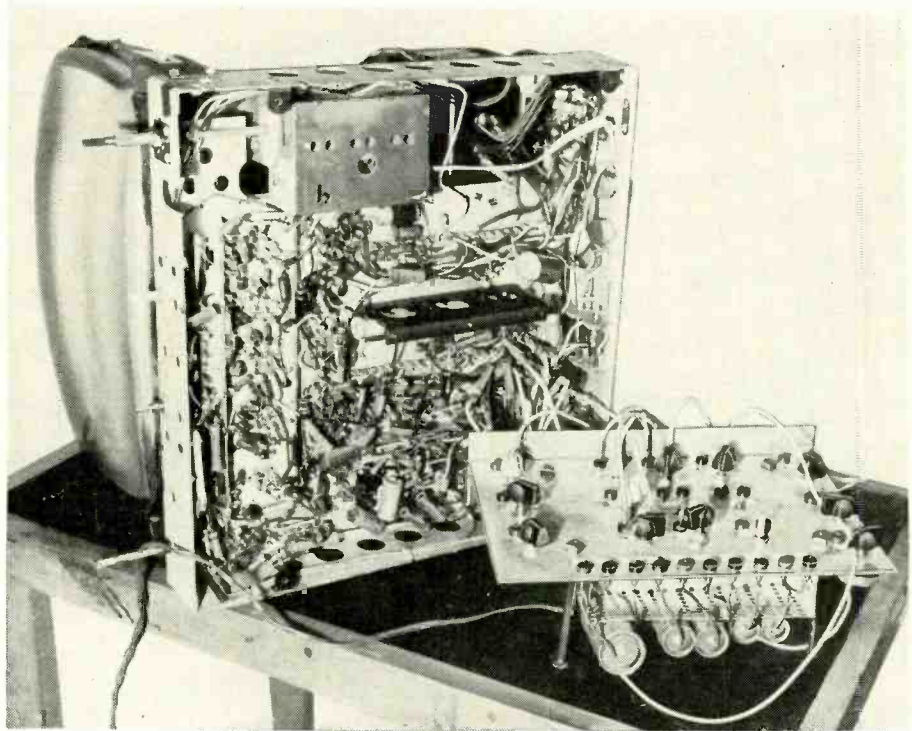

Partial rear view of squitch panel.

to 5 megohms. Each is used as a rheostat, two leads from each being brought to insulated telephone tip jacks mounted under each pot. Two dozen patch-cords, each with a phone tip at one end and an alligator clip at the other, complete the squitch panel.

How to use it? Clamp the panel to the afflicted chassis via two small C-clamps permanently bolted to the panel. Next, lift one side of each significant resistor in the horizontal oscillator circuit and replace it with a suitable pot on the squitch panel. (To prevent errors when later reconnecting, color-code each lifted resistor and the point from which it was lifted. I use various shades of nail polish for this purpose: green, blue, purple, yellow, etc.) Set each pot to the value of the lifted resistor it replaces. Now fire up your TV set and you are in business.

Operating the panel is pure cut-and-try. It's a matter of changing the value of the pots, singly and in combination, until a setting or settings are found which stop the squitching. Then simply measure the value of each pot and reach

for the resistor barrel. I've nailed three rough chassis in a row—just as simply as that.

Admittedly, this is TV servicing on a really by-guess-and-by-gosh level. But if one can get an answer fast by using a stone hatchet, why snootily stick to slide-rule approaches?

To cite a case in point, a stubbornly squitching Admiral 19B1 was kyoed instantly by taking the advice of my squitch panel and replacing R428 (150,000 ohms) with a 390,000-ohm resistor—in the grid circuit of the horizontal oscillator. Then there was another mean squitcher which instantly straightened out and flew right after a 5,600-ohm 6SN7 plate load resistor had been replaced by 7,800 ohms, as the squitch panel dictated. This latter chassis had obviously given someone a very, very bad time, judging by evidence of wholesale component lifting in the horizontal oscillator section. Anyway I will pay a substantial sum for just a quick look at the slide-rule approach which would have set me right on chassis such as these.

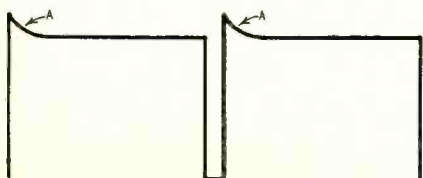

Output from a sync separator circuit. Panel quickly straightened it out.

TEST INSTRUMENTS

Another toughie was a Packard-Bell chassis 2201-4, about 4 years old, which would no longer hold vertically for longer than 2 or 3 minutes at a time. Routine investigation dug up nothing. Neither substitution, use of the scope nor voltage and resistor checking bought me anything. (I forgot to mention that the focus of this set was impaired also and that no amount of resistor juggling across the focus coil did the slightest good.)

While I idly clipped resistors and

many times over, and even so it represents only a start toward a gadget of much greater value and far wider scope. For instance, my panel now mounts an assortment of 450-volt capacitors, each provided with its pair of tip jacks, polarized plus and minus. This little addition enables me to substitute every major filter and decoupling capacitor in a chassis in bare minutes. All at once, too—not one at a time.

Also tacked onto my now-crowded squitch panel are a couple of mica

some R-C, R-L or L-C network; that changing R428 exerted enough electrical leverage to cancel out the upset. But I still don't care, and neither does your customer, whether you use a bow and arrow or a water-cooled electronic computer to get his magic lantern working again. Speed is the essence, and that's exactly the category in which the squitch panel gets straight A's.

The squitch panel has further demonstrated its value in the matter of horizontal pulling, or bending if you prefer. Only once, true, but only one opportunity has presented itself. This instance involved an ancient 12-inch Westinghouse which had developed about a 45° bend in the top 15 or 20 lines. If you chose to believe that set, a wind of supersonic velocity was blowing from right to left in the top ½ inch of the picture, bending heads, scenery, door jambs, etc. indiscriminately to the left, but good. The customer did not like it. That is what he said, anyway.

Investigation with my scope soon revealed a peculiar pattern (see diagram) coming out of the sync separator (heading for the 6AL5 a.f.c. diodes). Note arrows pointing to areas A-A and the reason behind the big wind.

This was an interesting discovery; it was also informative—it localized the cause. But what to do? How to level off that pattern? All components measured out right on the nose; substituting tubes brought me absolutely nothing.

What to do? I'm no engineer. So I put the question to my squitch panel and it supplied the answer immediately and painlessly. Change such-and-such resistors, it stated dogmatically, and you have it, Buster! I don't recall the values of the resistors, I didn't then even know their exact location in the sync separator region. I was flying blind, strictly.

I changed the resistors, though, and the door jambs thenceforth were straight up and down, exactly as the carpenters had built them. The supersonic wind fell off to a dead calm. Screwdriver technique? Well, how do you want to live anyway? Hard or easy?

It's not hard to see that the squitch panel will not supply easy answers indefinitely just by swapping resistors. That's one of the reasons for the compression trimmers on my panel and why I plan to expand this section further sometime while I'm resting. Even with this bit of business attended to, the squitch panel still will not be complete. R and C will have been supplied as variables, but where's L? And L as a variable we must have if the squitch panel is to become a really competent instrument. Take a snafu in a video amplifier for instance; a variable L or L's in substitution might easily come up with an answer in minutes. All one needs to fill in this department are a few tapped inductances and multipoint switches. END

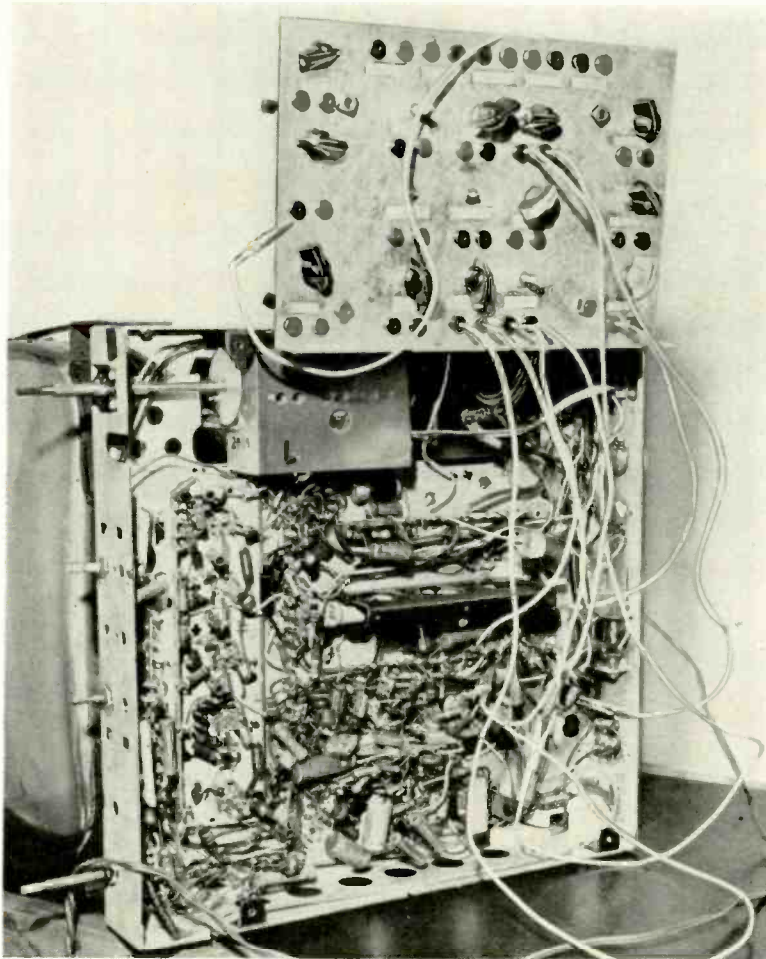

Squitch panel in operation—several components are being substituted.

capacitors hither and yon in the vertical section, my squitch panel suddenly informed me that connecting an 18,000-ohm resistor between the cathode of the vertical output tube and the height-control pot arm would make the set hold, but good. It also restored the picture to proper focus! That cure-all resistor had to be 18,000 ohms, too. Less resistance clobbered the picture, a greater amount put things right back to where I'd started.

This yarn makes little if any sense electrically. Anyway, I can't make any even after staring at the schematic from every angle, including upside down. Drawing a long bow, one might come up with something halfway sensible regarding the vertical hold, but the focus . . . !

My squitch panel has paid for itself

compression trimmers in the 40–600- μf range. They will be brought into action the next time I tackle one of those Packard-Bells or Spartons with a hair-trigger horizontal hold—one of those dogs which refuse to hold even though every component in the area is quite within factory limits, all waveshapes and voltages right on specs. I have a strong suspicion that juggling the values of those .0015- μf capacitors tacked onto pins 5 and 7 of the 6AL5 a.f.c. tube, plus juggling resistance values in the vicinity, might quickly straighten out such cases.

Why? I'm no more interested in the why than I'm interested in why changing R428, aforementioned, made a Christian out of that squitching 19B1. Oh sure, it's easy to deduce owlshly that a shift in value somewhere upset

BUILD THIS...

ULTRA-SENSITIVE TRANSISTORIZED METER

By I. QUEEN

MANY writers point out the similarities between tubes and transistors. Few mention their differences or the problems that must be solved in designing new transistor circuits. Problems relating to measuring circuits were discussed in RADIO-ELECTRONICS, February, 1955 (Transistor Voltmeter Design Problems).

After many experiments these problems were finally overcome and a highly practical meter constructed. Its features are:

- high sensitivity—2.5 megohms per volt;
- compensation for temperature changes and variations in input resistance;
- use as a microammeter as well as a voltmeter (previous instruments could not measure current);
- stability like that of a v.t.v.m.—no zero resetting over wide temperature ranges.

In a simple transistor measuring circuit there are two problems that don't appear in a v.t.v.m.

1. Temperature effects are serious. They may be noticed just by working

with a transistor near an open window. In one experimental voltmeter a special switch was required for warm and cool weather in addition to a normal temperature control. The static current of a transistor may change by as much as 9% per degree Centigrade! Unless your room is temperature-controlled, a transistor meter may be impractical.

2. While frequent zero resetting due to temperature change may be annoying, there is one problem even worse. Note the following measurements made on different transistors used in a circuit like Fig. 1. Resistor R represents resistance of the signal source and was varied as shown. Readings are in μ a.

| | | R (ohms) | | |
|------------|---|----------|----|---------|
| | | ∞ | 0 | 100,000 |
| Transistor | A | 55 | 18 | 52 |
| | B | 40 | 14 | 37 |
| | C | 78 | 26 | 71 |

This circuit is useless for measuring low currents because the current varies with changes in source resistance. For example, in a practical circuit using transistor A, we would need 55 μ a through the meter in a reverse direction to zero it with input terminals open. Now what happens when a measurement is made? If the source resistance is very small, the meter will read too low by 37 (55 - 18) μ a. Even with a source resistance as large as 100,000 ohms, the error would still be 3 (55 - 52) μ a. These are considerable errors on a 0-50 or 0-100 microammeter. We can't get around the problem by using a 0-1 milliammeter aided by a high-gain amplifier. The amplifier will boost the error as much as it does the gain. We can't always tell when this error is present and it cannot be easily corrected like resetting a zero reading.

The above problem is minimized in the voltmeter of Fig. 2 by adding multiplier resistance R1 in series with source R2. When R1 is large enough, it masks out errors due to changes in R2. However, even a multiplier equal to 100,000 ohms may give considerable error. You can test your transistor voltmeter as follows: Zero it with terminals open. Now short them. There should be no shift.

These problems can be overcome in a simple way by using a balanced two-transistor arrangement (Fig. 3). Two high-gain transistors are connected in series, back to back. The input current flows through each. It affects them equally but oppositely so far as collector flow is concerned. Therefore *sensitivity*

is increased, temperature effects cancel out.

The microammeter was tested as follows: After chilling for a few minutes in a refrigerator, it was placed alongside a warm radiator. The pointer remained substantially at zero in both cases without need for adjustment. Then the balanced instrument was tested for zero change with variation of input resistance. After carefully setting zero with the terminals open, they were shorted out—no perceptible change in meter reading! This test was carried out across the microampere terminals! If you compare these results with those shown above, you will agree that they are remarkable. The balanced circuit is, in fact, a stable *microammeter* for it will measure without regard to the *resistance* of the source.

Constructing the voltmeter

Having thus designed a sensitive and stable microammeter, it is very easy to add the voltmeter feature. All we need is to add multiplier resistors for each desired range. Fig. 3 shows three voltage ranges: 0.2, 2 and 20 volts. Others may be added as desired. The balanced circuit assures linearity across the scale (just as it does in a v.t.v.m.).

Here is the procedure for balancing the transistor measuring set:

1. Short-circuit the current terminals. The balance control will have no effect now but the zero adjustment may be set to zero.

2. Remove the short. Set the balance control to zero the meter again. Now it should make no difference whether the current terminals are shorted, left open or terminated with *any resistance*. This may be done after the instrument is left on 2 or 3 minutes to minimize drift.

In designing the meter I first determined that about 0.35- μ a input is needed to produce full-scale deflection. This is about 3 megohms per volt. To allow a margin of loss, a somewhat smaller figure, 2.5 megohms per volt, was chosen. A shunt (gain control) across the meter reduces the sensitivity as required (from 3 to 2.5 megohms per volt). Now the multipliers may be calculated. At 2.5 megohms per volt this amounts to 5 megohms for the 2-volt scale. The resistance of the transistors is taken as 30,000 ohms and must be subtracted from the multipliers.

Here is how the gain is calibrated. Connect a known voltage like a mercury cell (1.345 volts) across the 2-volt

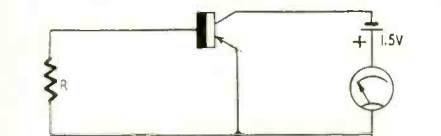

Fig. 1—Experimental transistor circuit.



Fig. 2—Multiplier resistance R1 is in series with source resistance R2.

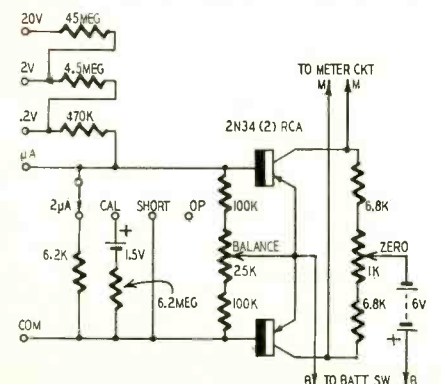
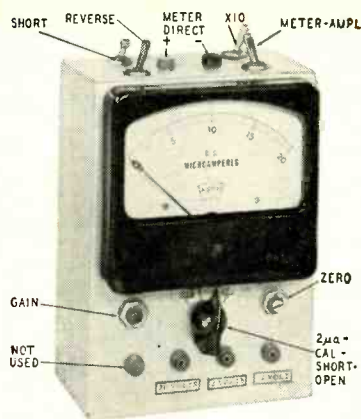

Fig. 3—Schematic diagram of balanced transistor circuit used for meter.

TEST INSTRUMENTS



The transistor microammeter.

terminals. Adjust gain (Fig. 4) as required. Now all other scales should be correct. For high precision you may calibrate each range individually just as for the 2-volt scale. Gain may need *slight* correction if room temperature is subject to considerable variation from time to time. It will not have to be touched very often.

To avoid rechecking with a standard voltage from time to time, a calibration network is included (Fig. 3). After the instrument is correctly calibrated gain-wise (as with a mercury cell) note the calibration reading. Next time you question the gain calibration, simply switch to CAL and see if the standard value is obtained. If not, adjust the gain till it is. The calibration network is powered by a small penlight cell that will last its shelf life.

The panel switch is provided with positions to short and open the input terminals. These are convenient for initial zeroing of the microammeter.

The most remarkable feature of this measuring circuit is that it indicates such low-current signals. The low scale measures only $0.4 \mu\text{a}$ full scale! Since the meter movement is $0-20 \mu\text{a}$, this represents a gain of 50. Yet the input resistance is only 30,000 ohms. Compare this with the input resistance of a vacuum-tube microammeter. One commercial unit, selling for about \$100, can measure as low as $.01 \mu\text{a}$ full scale. However, like all tube circuits, it measures current by forcing it through a high grid leak. Actually it is measuring *voltage drop* across the high resistance. Naturally this means a large voltage drop. In this particular commercial meter there is a loss of 0.5 volt at full scale. The transistor microammeter drops voltage only about .01 volt, a considerable improvement!

This instrument uses a highly sensitive $0-20$ -microammeter movement. Each transistor passes less than $75 \mu\text{a}$, so this is practical and safe. The safety factor is about the same as with a v.t.v.m. using a $0-200$ - μa meter movement. If lower sensitivity can be tolerated, you may use a $0-50$ - or $0-100$ - μa basic movement. The $0-20$ costs only a few dollars more than a $0-50$ and is recommended. Some instruments use a low-sensitivity meter (for ex-

6 VOLT BATTERY

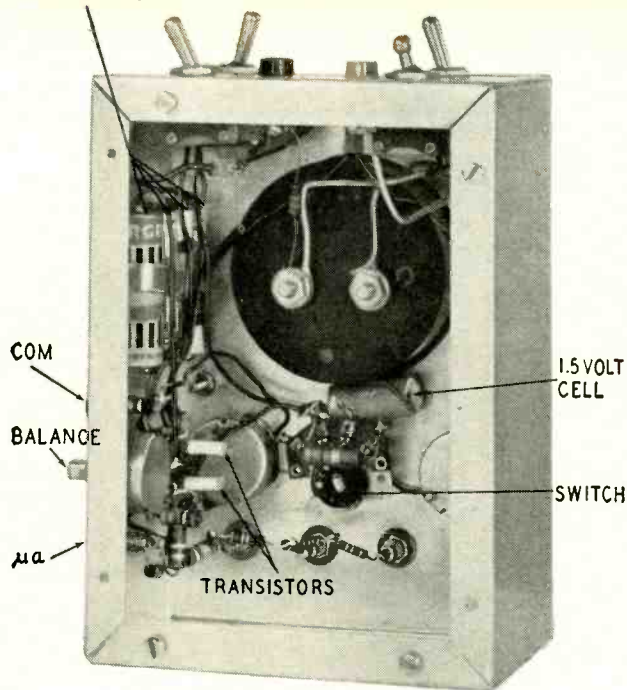

An inside view of the microammeter.

ample, $0-1 \text{ ma}$) and an added transistor amplifier. There is little if any saving in money for a high-gain transistor costs a few dollars, too. In addition there will probably be complications due to drift and error of the second transistor.

The meter circuit is drawn separately in Fig. 4 for convenience, but the entire instrument is housed in a $7 \times 5 \times 3$ -inch aluminum chassis box with back cover (see photos). Voltage terminals are more commonly used so they are on the front panel. The current terminals are at the side of the box. Normal operation is with the switch at OP which signifies both "operate" and "open circuit."

Several interesting features appear in Fig. 4. The "short" switch damps the meter and prevents bouncing the pointer while the instrument is carried. The " $\times 10$ " switch converts the meter to read $0-200 \mu\text{a}$ and may be used before applying unknown currents or voltages which may overload the meter. This switch also permits extending the voltage range up to 200. The sensitive $0-20$ - μa itself is available for external measurements through pin jacks.

This instrument is useful wherever

a low-reading v.t.v.m. can be used. The 2 - μa range can indicate weak grid currents, phototube output, discriminator or bridge balance. The basic 0.4 - μa range permits supersensitive indications. It was tried in connection with an inexpensive photovoltaic cell. On a rather dark day the cell could not be brought near a window without overloading the microammeter. Only by closing the venetian blinds almost completely could the pointer be brought to a readable value. In another experiment, the meter was used to measure the output of a crystal set. With only a hand for antenna, the needle went past full scale.

This instrument is so sensitive that the pointer may be driven off scale just by touching the test clips or plugs. For example, the leads may have a phone tip plug at one end, a battery clip at the other. When the leads are plugged into the instrument, touching the clips may produce negligible deflection. However, if you touch the *plug* of one lead and the *clip* of the other, the needle may deflect violently in one direction or the other. This will occur if the clip is made of a different metal than the plug, and is due to contact potential. Remember that only .01 volt is sufficient for full deflection.

Construction is simple, with no critical wiring involved. The unused pin jack on the front panel can be omitted or used as a terminal for a possible 200-volt range. END

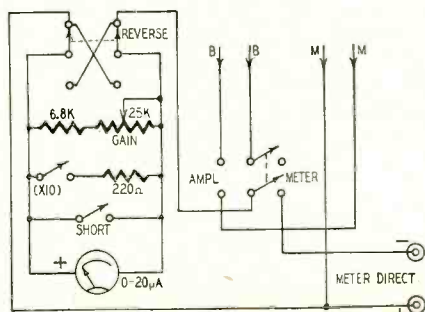

Fig. 4—Schematic of meter circuit.

Parts for transistor microammeter

Resistors: 1—220, 1—6,200, 3—6,800, 2—100,000, 1—470,000 ohms, 1—4.5, 1—6.2, 1—45 megohms, $\frac{1}{2}$ watt; 1—1,000, 2—25,000 ohms, potentiometers.

Miscellaneous: 2—2N34 transistors; 1— $0-20$ - μa meter movement (Triplett 420 or equivalent); 5—1.5-volt cells; 1—single-pole 4-position switch; 2—s.p.s.t. switches; 2—d.p.d.t. switches; 7—pin jacks; 1— $7 \times 5 \times 3$ -inch cabinet.

Heathkits

FOR THE ENTIRE ELECTRONICS INDUSTRY

more than 65 top-quality models to choose from, including such outstanding kit designs as

V-7A VACUUM TUBE VOLTMETER: Easily the world's largest selling VTVM. Features peak-to-peak scales—etched metal circuit board—1% precision resistors—full wave rectifier and AC input circuit—reads rms and peak-to-peak AC, DC, and ohms.

O-10 LABORATORY TYPE OSCILLOSCOPE: The world's largest selling oscilloscope kit, and the most successful oscilloscope in history. Designed especially for color and black-and-white TV service work. Its 5 megacycle bandwidth and new 500 Kc sweep generator readily qualify it for laboratory applications. Features easy-to-assemble etched metal circuit board construction.

WA-P2 HIGH FIDELITY PREAMPLIFIER: This is the world's largest selling hi fi preamplifier kit. Features complete equalization, 5 separate switch-selected inputs with individual pre-set level controls, beautiful modern appearance, high-quality components.

HIGH FIDELITY AMPLIFIERS: Five Heathkit Models to choose from at prices ranging from \$16.95 to \$59.75. Power output range from 7 to 25 watts.

DX-100 TRANSMITTER: A 100 watt phone and CW ham transmitter, offering the greatest dollar value available in the ham radio field today.

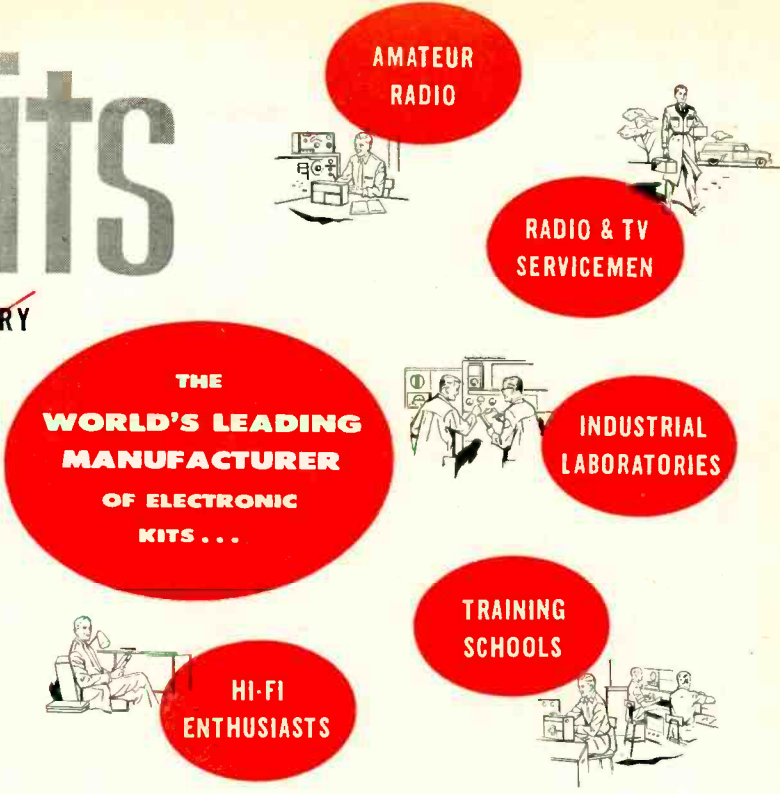

Greatest Dollar Value Through Factory-To-You Selling!

Heathkits

ONLY CAN GIVE YOU ALL OF THESE DISTINCTIVE ADVANTAGES!

- *The Most Complete Construction Manuals for Easy Assembly.*
- *Originality of Design—Developed Through Pioneering in the Kit Instrument Field.*
- *Greatest Dollar Value—Finest Quality with Real Economy.*
- *Direct Contact with Manufacturer—Lower Price, Guaranteed Performance.*
- *Etched Metal, Prewired Circuit Boards—Save Construction Time, Improve Performance.*
- *High Quality Standard Components for Long-Life Service.*

HEATH COMPANY A Subsidiary of Daystrom, Inc. **BENTON HARBOR 20, MICHIGAN**

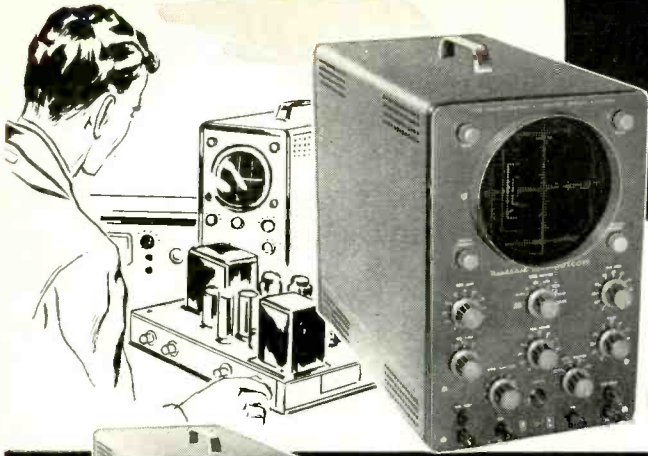

there is no substitute for HEATHKIT QUALITY

YOU GET MORE: All first-run, top quality parts—the latest in electronic design—complete and comprehensive step-by-step assembly instructions with large pictorial diagrams and assembly drawings. Proven performance through the production of thousands of kits.

MODEL
O-10
1

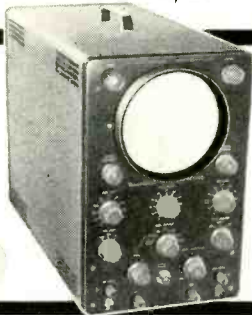

2

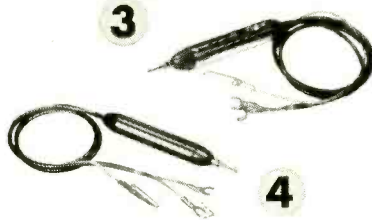

3

4

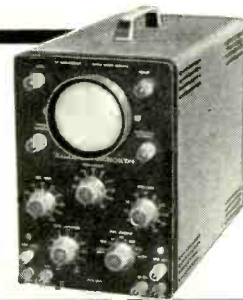

5

1 *Heathkit* ETCHED CIRCUIT
COLOR-TV
5" OSCILLOSCOPE KIT

This deluxe quality oscilloscope has proven itself through thousands of operating hours in service shops and laboratories. Features the best in components—and the best in circuit design.

Features amplifier response to 5 Mc for color TV work, and employs the radically new sweep circuit to provide stable operation up to 500,000 cps. In addition, etched metal, pre-wired circuit boards cut assembly time almost in half, and permit a level of circuit stability never before achieved in an oscilloscope of this type.

Vertical amplifiers flat within +2 db -5 db from 2 cps to 5 Mc, down only 1½ db at 3.58 Mc. Vertical sensitivity is 0.025 volts, (rms) per inch at 1 Kc. 11 tube circuit employs a 5UP1 CRT.

Plastic molded capacitors used for coupling and bypass—preformed and cabled wiring harness provided.

Features built-in peak-to-peak calibrating source—retrace blanking amplifier—push-pull amplifiers and step-attenuated input.

MODEL O-10
\$6950
Shpg. Wt. 21 lbs.

2 *Heathkit* ETCHED CIRCUIT
5" OSCILLOSCOPE KIT

This is a general purpose oscilloscope for the more usual applications in the service shop or lab, yet is comparable to scopes costing many dollars more.

Features full size 5" CRT (5BP1), built-in peak-to-peak voltage calibration—3 step input attenuator—phasing control—push-pull deflection amplifiers—and etched metal pre-wired circuit boards.

Vertical channel flat within ±3 db from 2 cps to 200 Kc, with 0.09 V. rms/inch, peak-to-peak sensitivity at 1 Kc. Sweep circuit from 20 cps to 100,000 cps. A scope you will be proud to own and use.

MODEL OM-1
\$4950
Shpg. Wt. 21 lbs.

3 *Heathkit* LOW CAPACITY
PROBE KIT

Scope investigation of circuits encountered in TV requires the use of special low capacity probe to prevent loss of gain, circuit loading, or distortion. This probe features a variable capacitor to provide correct instrument impedance matching. Also the ratio of attenuation can be controlled.

NO. 342
\$350
Shpg. Wt. 1 Lb.

4 *Heathkit* ETCHED CIRCUIT
SCOPE DEMODULATOR PROBE KIT

Extend the usefulness of your Oscilloscope by observing modulation envelope of R.F. or I.F. carriers found in TV and radio receivers. Functions like AM detector to pass only modulation of signal and not signal itself. Applied voltage limits are 30 V. RMS and 500 V. DC.

NO. 337-C
\$350
Shpg. Wt. 1 Lb.

5 *Heathkit* ETCHED CIRCUIT
3" OSCILLOSCOPE KIT

This compact little oscilloscope measures only 9½" H. x 6½" W. x 11¾" D., and weighs only 11 lbs! Easily employed for home service calls, for work in the field or is just the ticket for use in the ham shack or home workshop. Incorporates many of the features of the Model OM-1, but yet is smaller in physical size for portability.

Employing etched circuit boards, the Model OL-1 features vertical response within ± 3 db from 2 cps to 200 Kc. Vertical sensitivity is 0.25 V. RMS/inch peak-to-peak, and sweep generator operates from 20 cps to 100,000 cps. Provision for r.f. connection to deflection plates for modulation monitoring, and incorporates many features not expected at this price level. 8-tube circuit features a type 3GP1 Cathode Ray Tube.

MODEL OL-1
\$2950
Shpg. Wt. 14 lbs.

HEATH COMPANY A Subsidiary of Daystrom, Inc. **BENTON HARBOR 20, MICHIGAN**

fill your test requirements WITH HEATHKITS

DESIGNED FOR YOU: Heath Company test equipment is designed for the maximum in convenience. Besides being functional, Heathkits represent the very latest in modern physical appearance, and incorporate all the latest circuit design features for comprehensive test coverage.

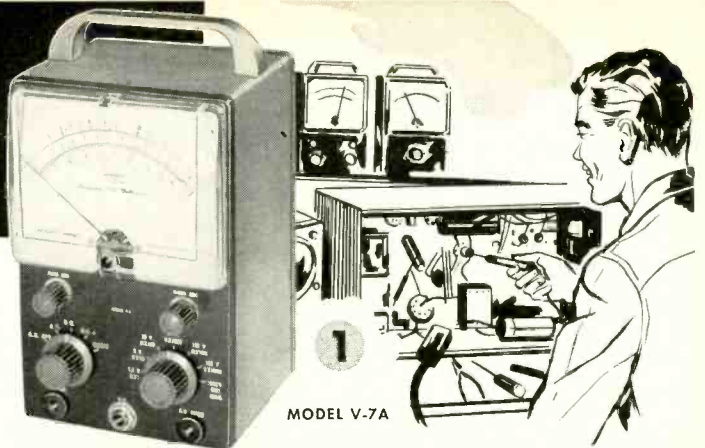

MODEL V-7A

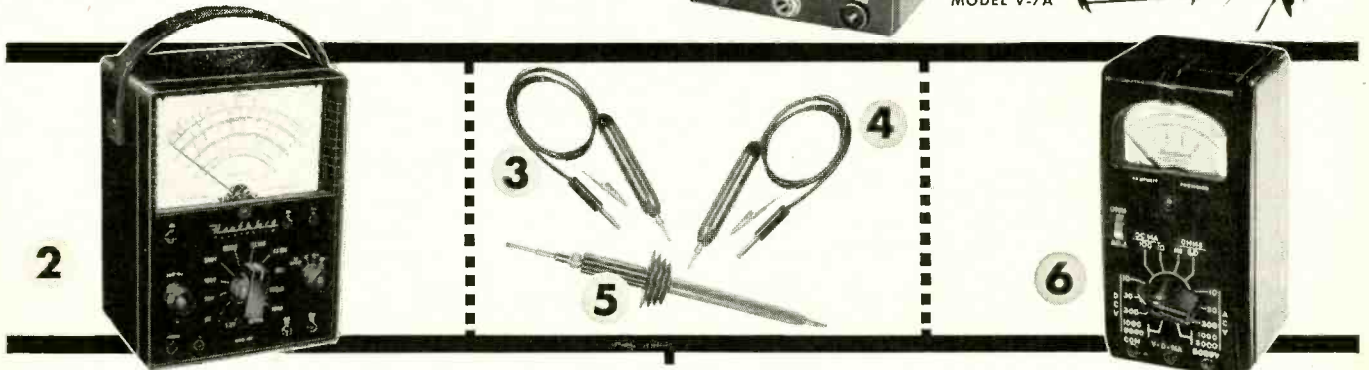

1 Heathkit ETCHED CIRCUIT VACUUM TUBE **VOLTMETER KIT**

Besides measuring AC (rms), DC and resistance, the modern-design V-7A incorporates peak-to-peak measurement for FM and television servicing.

AC (rms) and DC voltage ranges are 1.5, 5, 15, 50, 150, 500, and 1500. Peak-to-peak AC voltage ranges are 4, 14, 40, 140, 400, 1400, and 4000. Ohmmeter ranges are X1, X10, X100, X1000, X10K, X100K, and X1 megohm. Also a db scale is provided. A polarity reversing switch provided for DC measurements, and zero center operation within range of front panel controls. Employs a 200 μ a meter for indication. Input impedance is 11 megohms.

Etched metal, pre-wired circuit board for fast, easy assembly and reliable operation is 50% thicker for more rugged physical construction. 1% precision resistors for utmost accuracy.

MODEL V-7A
\$24⁵⁰
Shpg. Wt. 7 lbs.

2 Heathkit 20,000 OHMS/VOLT **MULTIMETER KIT**

The MM-1 is a portable instrument for outside servicing, for field testing, or for quick portability in the service shop. Combines attractive physical appearance with functional design. 20,000 ohms/v. DC, and 5000 ohms/v. AC. AC and DC voltage ranges are 0-1.5, 5, 50, 150, 500, 1500 and 5000 volts. Direct current ranges are 0-150 μ a., 15 ma., 150 ma., 500 ma., and 15 amperes. Resistance ranges are X1, X100, X10,000 providing center scale readings of 15, 1500 and 150,000 ohms. DB ranges cover -10 db to +65 db.

Features a $4\frac{1}{2}$ " 50 μ a. meter. Provides polarity reversal on DC measurements. 1% precision resistors used in multiplier circuits. Not affected by RF fields.

MODEL MM-1
\$29⁵⁰
Shpg. Wt. 6 lbs.

3 Heathkit ETCHED CIRCUIT **RF PROBE KIT**

The Heathkit RF Probe used in conjunction with any 11 megohm VTVM will permit RF measurements up to 250 Mc with $\pm 10\%$ accuracy. Uses etched circuits for increased circuit stability and ease of assembly.

NO. 309-C
\$3⁵⁰
Shpg. Wt. 1 lb.

4 Heathkit ETCHED CIRCUIT **PEAK-TO-PEAK PROBE KIT**

Now read peak-to-peak voltages on the DC scale of any 11 megohm VTVM with this new probe, employing etched circuit for stability and low loss. Readings made directly from VTVM scales, from 5 Kc to 5 Mc. Not required for Heathkit Model V-7A VTVM.

NO. 338-C
\$5⁵⁰
Shpg. Wt. 2 lbs.

5 Heathkit 30,000 VOLT D.C. **HIGH VOLTAGE PROBE KIT**

For TV service work or similar application for measurement of high DC voltage. Precision multiplier resistor mounted inside plastic probe. Multiplication factor of 100 on the ranges of Heathkit 11 megohm VTVM.

NO. 336
\$4⁵⁰
Shpg. Wt. 2 lbs.

6 Heathkit **HANDITESTER KIT**

The Model M-1 measures AC or DC voltage at 0-10, 30, 300, 1000, and 5000 volts. Measures direct current at 0-10 ma. and 0-100 ma. Provides ohmmeter ranges of 0-3000 (30 ohm center scale) and 0-300,000 ohms (3000 ohms center scale). Features a 400 μ a. meter for sensitivity of 1000 ohms/volt. Because of its size, the M-1 is a very handy portable instrument that will fit in your coat pocket, tool box, glove compartment, or desk drawer. Makes a fine standby unit in the service shop when the main instruments are in use, or is ideal for the hobbyist or beginner. An unusual dollar value.

MODEL M-1
\$14⁵⁰
Shpg. Wt. 3 lbs.

HEATH COMPANY A Subsidiary of Daystrom, Inc. **BENTON HARBOR 20, MICHIGAN**

Heathkit TV ALIGNMENT GENERATOR KIT



1



2



3



4

HEATH COMPANY

A SUBSIDIARY OF DAYSTROM INC.

The Model TS-4 features a controllable inductor for all-electronic sweep, improved oscillator and automatic gain circuitry, high RF output, center sweep operation, and improved linearity. It sets a new high standard for sweep generator operation, and is absolutely essential for the up-to-date service shop doing FM, black-and-white TV, and color TV work.

Voltage regulation and effective AGC action insure flat output over a wide frequency range. Electronic sweep insures complete absence of mechanical vibration. Sweep deviation controllable from 0 up to 40 Mc, depending upon base frequency. Effective two-way blanking.

Fundamental output from 3.6 Mc to 220 Mc in 4 bands. Crystal marker provides markers at 4.5 Mc and multiples thereof. Crystal included with kit. Variable marker covers from 19 Mc to 60 Mc on fundamentals, and up to 180 Mc on harmonics. Provision for external marker.



MODEL TS-4
\$4950
Shpg. Wt. 16 lbs.

1

Heathkit LINEARITY PATTERN GENERATOR KIT

The new-design Model LP-1 produces vertical or horizontal bar patterns, a cross-hatch pattern, or white dots on the screen of the TV set under test. No internal connections required. Special clip is attached to the TV antenna terminals. Instant selection of the pattern desired for adjustment of vertical and horizontal linearity, picture size, aspect ratio, and focus. Dot pattern presentation is a *must* for color convergence adjustments on color TV sets.

Extended operating range covers all television channels from 2 to 13. Produces 6 to 12 vertical bars or 4 to 7 horizontal bars.

MODEL LP-1
\$2250
Shpg. Wt. 7 lbs.

2

Heathkit LABORATORY GENERATOR KIT

The Heathkit Model LG-1 Laboratory Generator is a high-accuracy signal source for applications where metered performance is essential. It covers from 100 Kc to 30 Mc on fundamentals in 5 bands. Modulation is at 400 cycles, and modulation is variable from 0-50%. RF output from 100,000 μ v. to 1 μ v. 200 μ a. meter reads the RF output in microvolts, or percentage of modulation. Fixed step and variable output attenuation provided.

Features voltage regulation, and double copper plated shielding for stability. Provision for external modulation. Coaxial output cable (50 ohms).

MODEL LG-1
\$3950
Shpg. Wt. 16 lbs.

3

Heathkit CATHODE RAY TUBE CHECKER KIT

This new-design instrument holds the key to rapid and complete picture tube testing, either in the set, on the work-bench, or in the carton. Tests for shorts, leakage, and emission. Features Shadow-graph test (a spot of light on the screen) to indicate whether the tube is capable of functioning.

The Model CC-1 tests all electromagnetic deflection picture tubes normally encountered in television servicing. Supplies all operating voltages to the tube under test, and indicates the condition of the tube on a large "GOOD-BAD" scale. Features spring loaded test switches for operator protection.

The CC-1 is housed in an attractive portable case and is light in weight — ideal for outside service calls.

MODEL CC-1
\$2250
Shpg. Wt. 10 lbs.

4

Heathkit DIRECT READING CAPACITY METER KIT

Not only is this instrument popular in the service shop, but it has found extensive application in industrial situations. Ideal for quality control work, production line checking, or for matching pairs.

Features direct reading linear scales from 100 mmf to .1 mfd full scale. Necessary only to connect a capacitor of unknown value to the insulated binding posts, select the correct range, and read the meter. The CM-1 is not susceptible to hand capacity, and has a residual capacity of less than 1 mmf.

MODEL CM-1
\$2950
Shpg. Wt. 7 lbs.

BENTON HARBOR 20, MICHIGAN

RADIO-ELECTRONICS

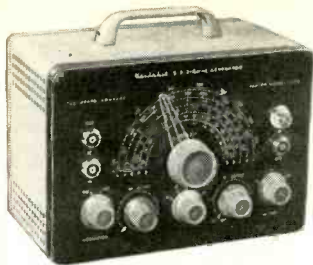

MODEL SG-8 **\$1950**
Shpg. Wt. 8 Lbs.

low price deceive you. This is a professional type service instrument to fulfill the signal source requirements in the service lab.

This is one of the biggest signal generator bargains available today. The tried and proven Model SG-8 offers all of the outstanding features required for a basic service instrument. High quality components and outstanding performance.

The SG-8 covers 160 Kc to 110 Mc on fundamentals in 5 bands, and calibrated harmonics extend its usefulness up to 220 Mc. The output signal is modulated at 400 cps, and the RF output is in excess of 100,000 uv. Output controlled by both a continuously variable and a fixed step attenuator. Also, audio output may be obtained for amplifier testing. Don't let the

Heathkit SIGNAL GENERATOR KIT

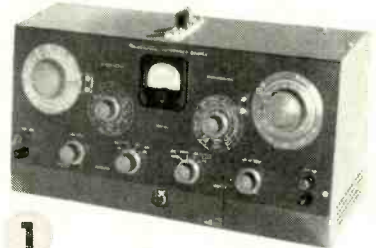

1

1 Heathkit . . . IMPEDANCE BRIDGE KIT

The IB-2 features built-in adjustable phase shift oscillator and amplifier, and has panel provisions for external generator. Measures resistance, capacitance, inductance, dissipation factors of condensers, and storage factor of inductance.

D, Q, and DQ functions combined in one control. 1/2% resistors and 1/2% silver-mica capacitors especially selected for this instrument. A 100-0-100 microammeter provides null indications. Two-section CRL dial provides 10 separate "units" with an accuracy of .5%. Fractions of units read on variable control.

MODEL IB-2
\$5950
Shpg. Wt. 12 lbs.

2 Heathkit "Q" METER KIT

The Heathkit Model QM-1 will measure the Q of inductances and the RF resistance and distributed capacity of coils. Employs a 4 1/2" 50 microampere meter for direct indication. Will test at frequencies of 150 Kc to 18 Mc in 4 ranges. Measures capacity from 40 mmf to 450 mmf within ± 3 mmf. Indispensable for coil winding and determining unknown condenser values. A worthwhile addition to your laboratory at an outstandingly low price. Useful for checking wave traps, chokes, peaking coils, etc. Laboratory facilities are now available to the service shop and home lab.

MODEL QM-1
\$4450
Shpg. Wt. 14 lbs.



2

3 Heathkit 6-12 VOLT BATTERY ELIMINATOR KIT

This modern battery eliminator will supply 6 or 12 volt output for ordinary automobile radios as well as 12 volts for the new models in the latest model cars. Output voltage is variable from 0-8 volts DC, or 0-16 volts DC. Will deliver up to 15 amperes at 6 volts, or up to 7 amperes at 12 volts. Two 10,000 microfarad filter capacitors insure smooth DC output. Two panel meters monitor output voltage and current. Will double as a battery charger. Definitely required for automobile radio service work.

MODEL BE-4
\$3150
Shpg. Wt. 17 lbs.



3

4 Heathkit DECADE RESISTANCE KIT

Twenty 1% precision resistors provide resistance from 1 to 99,999 ohms in 1 ohm steps. Indispensable around service shop laboratory, ham shack, or home workshop. Well worth the extremely low Heathkit price.

MODEL DR-1
\$1950
Shpg. Wt. 4 Lbs.

5 Heathkit VIBRATOR TESTER KIT

Tests vibrators for proper starting and indicates the quality of the output on a large "GOOD-BAD" scale. Checks both interrupter and self-rectifier types in 5 different sockets. Operates from any battery eliminator delivering variable voltage from 4 to 6 volts DC at 4 amps. Ideal companion to the Model BE-4.

MODEL VT-1
\$1450
Shpg. Wt. 6 Lbs.



5

6 Heathkit DECADE CONDENSER KIT

Provides capacity values from 100 mmf to 0.111 mfd in steps of 100 mmf. ± 1% precision silver-mica condensers used. High quality ceramic switches for reduced leakage. Polished birch cabinet. Extremely valuable in all electronic activity.

MODEL DC-1
\$1650
Shpg. Wt. 3 Lbs.

4

6

HEATH COMPANY

A SUBSIDIARY OF DAYSTROM INC.

BENTON HARBOR 20, MICHIGAN

Heathkit TUBE CHECKER KIT

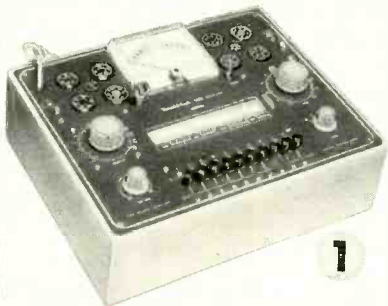

1

1 The Heathkit Model TC-2 is an emission type tube tester that represents a tremendous saving over the price of a comparable unit from any other source. At only \$29.50, you can have a tube tester of your own, even if you are an experimenter, or only do part time service work. Extremely popular with radio servicemen, it uses a 4½" meter with 3-color meter face for simple "GOOD-BAD" indications that the customer can understand. Will test all tubes commonly encountered in radio and TV service work.

Ten 3-position lever switches for "open" or "short" tests on each tube element. Neon bulb indicates filament continuity or short between tube elements. Line adjust control provided. The roll chart is illuminated.

Sockets provided for 4, 5, 6, and 7-pin, octal, and loctal tubes, 7 and 9 pin miniature tubes, and the 5 pin Hytron tubes. Blank space provided for future socket addition. Tests tubes for opens, and shorts, and for quality on the basis of total emission. 14 different filament voltage values provided.

MODEL TC-2
\$29.50

Shpg. Wt. 12 Lbs.

2 Heathkit PORTABLE TUBE CHECKER KIT

The Model TC-2P is identical to the Model TC-2 except that it is housed in a rugged carrying case. This strikingly attractive and practical two-tone case is finished in proxylin impregnated fabric. The cover is detachable, and the hardware is brass plated. This case imparts a real professional appearance to the instrument. Ideal for home service calls, or any portable application.

MODEL TC-2P
\$34.50

Shpg. Wt. 15 Lbs.



3

2

3 Heathkit TV PICTURE TUBE TEST ADAPTER

The Heathkit TV picture tube test adapter is designed for use with the Model TC-2 Tube Checker. Test picture tubes for emission, shorts, and thereby determine tube quality. Consists of 12-pin TV tube socket, 4 ft. cable, octal connector, and necessary technical data. (Not a kit.)

MODEL 355
\$4.50

Shpg. Wt. 1 lb.

4 Heathkit . . . CONDENSER CHECKER KIT

Use this Condenser Checker to quickly and accurately measure those unknown condenser and resistor values. All readings taken directly from the calibrated panel scales without any involved calculation. Capacity measurements in four ranges from .00001 to 1000 mfd. Checks paper, mica, ceramic and electrolytic condensers. A power factor control is available for accurate indication of electrolytic condenser efficiency. Leakage test switch—selection of five polarizing voltages, 25 volts to 450 volts DC to indicate condenser operating quality under actual load conditions. Spring-return test switch automatically discharges condenser under test and eliminates shock hazard to the operator.

Resistance measurements can be made in the range from 100 ohms to 5 meg-ohms. Here again, all values are read directly on the calibrated scales. Increased sensitivity coupled with an electron beam null indicator increases overall instrument usefulness.

For safety of operation, the circuit is entirely transformer operated. An outstanding low kit price for this surprisingly accurate instrument.

MODEL C-3
\$19.50

Shpg. Wt. 7 Lbs.



4

5 Heathkit VISUAL-AURAL SIGNAL TRACER KIT

This signal tracer is extremely valuable in servicing AM, FM, and TV receivers, especially when it comes to isolating trouble to a particular stage of the circuit under test.

This visual-aural tracer features a high gain RF input channel to permit signal tracing from the receiver antenna input clear through all RF, IF, detector, and audio stages to the speaker. Separate low-gain channel provided for audio circuit exploration. Both visual and aural indication by means of a speaker or headphone, and electron beam "eye" tube as a level indicator. Also incorporates a noise locator circuit for DC noise checks, and a built-in calibrated wattmeter (30-500 watts). Panel terminals provided for "patching" output transformer or speaker into external circuit for test purposes. Designed especially for the radio and TV serviceman. Cabinet size: 9½" wide x 6½" high x 5" deep. A real test equipment bargain.

MODEL T-3
\$23.50

Shpg. Wt. 9 Lbs.



5

HEATH COMPANY

A SUBSIDIARY OF DAYSTROM INC.

BENTON HARBOR 20, MICHIGAN

RADIO-ELECTRONICS



MODEL HD-1

Shpg. Wt. 13 Lbs. **\$4950**

Used with a sine wave generator, the Model HD-1 will check the harmonic distortion output of audio amplifiers under a variety of conditions. Reads distortion directly on the meter as a percentage of the input signal. Operates between 20 and 20,000 cps. High impedance VTVM circuit for initial reference settings and final distortion readings. Ranges are 0-1, 3, 10, and 30 volts full scale. 1% precision resistors. Distortion scales are 0-1, 3, 10, 30 and 100% full scale. Requires only .3 volt input for distortion test.

Heathkit HARMONIC DISTORTION METER KIT

1 Heathkit AUDIO ANALYZER KIT

This instrument consists of an audio wattmeter, an AC VTVM, and a complete IM analyzer, all in one compact unit.

Use the VTVM to measure noise, frequency response, output gain, power supply ripple, etc. Use the wattmeter for measurement of power output. Internal loads provided for 4, 8, 16, or 600 ohms. VTVM also calibrated for DBM units. High or low impedance IM measurements made with built-in 6KC and 60 cps generators. VTVM ranges are .01, to 300 volts in 10 steps. Wattmeter ranges are .15 mw. to 150 w. in 7 steps. IM scales are 1% to 100% in 5 steps.

MODEL AA-1

\$5950

Shpg. Wt. 13 lbs.



2 Heathkit AUDIO GENERATOR KIT

This new Heathkit Model features step-tuning from 10 cps to 100 Kc with three rotary switches that provide two significant figures and multiplier. Less than .1% distortion. Frequency accurate to within $\pm 5\%$.

Output monitored on a large $4\frac{1}{2}$ " meter that reads voltage or db. Both variable and step-type attenuation provided. Meter reads zero-to-maximum at each attenuator position. Output ranges (and therefore meter ranges) are 0-.003, .01, .03, .1, .3, 1, 3, 10 volts. Step-tuning provides rapid positive selection of the desired frequency, and allows accurate return to any given frequency.

MODEL AG-9

\$3450

Shpg. Wt. 8 lbs.



3 Heathkit AUDIO OSCILLATOR KIT

(SINE WAVE — SQUARE WAVE)

The Model AO-1 features sine wave or square wave coverage from 20-20,000 cps in 3 ranges. It is an instrument specifically designed to completely fulfill the needs of the serviceman and high fidelity enthusiast. Offers high level output across the entire frequency range, low distortion and low impedance output. Features a thermistor in the second amplifier stage to maintain essentially flat output through the entire frequency range. Produces an excellent sine wave for audio testing, or will produce good, clean, square waves with a rise time of only 2 microseconds.

MODEL AO-1

\$2450

Shpg. Wt. 10 lbs.

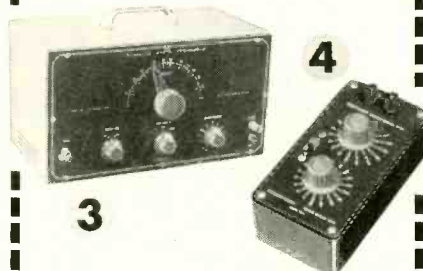

4 Heathkit RESISTANCE SUBSTITUTION BOX KIT...

Provides switch selection of 36 RTMA 1 watt standard 1% resistors ranging from 15 ohms to 10 megohms. Numerous applications in radio and TV work, and essential in the developmental laboratory.

MODEL RS-1

\$550

Shpg. Wt. 2 lbs.

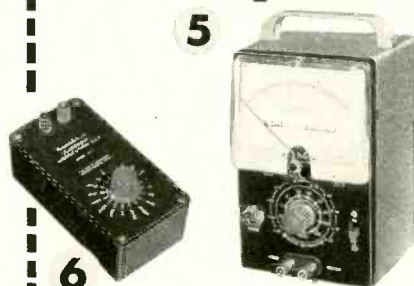

5 Heathkit AC VACUUM TUBE VOLTMETER KIT...

The Heathkit AC VTVM features high impedance, wide frequency range, very high sensitivity, and extremely wide voltage range. Will accurately measure a voltage as small as 1 mv. at high impedance. Excellent for sensitive AC measurements required by laboratories, audio enthusiasts and experimenters. Frequency response is substantially flat from 10 cps to 50 Kc. Ranges are .01, .03, .1, .3, 1, 3, 10, 30, 100, and 300 v. RMS. Total db range -52 to + 52 db. Input impedance 1 megohm at 1 Kc.

MODEL AV-2

\$2950

Shpg. Wt. 5 lbs.

6 Heathkit CONDENSER SUBSTITUTION BOX KIT...

Very popular companion to Heathkit RS-1. Individual selection of 18 RTMA standard condenser values from .0001 mfd to .22 mfd. Includes 18" flexible leads with alligator clips.

MODEL CS-1

\$550

Shpg. Wt. 2 lbs.



BENTON HARBOR 20, MICHIGAN

**HEATH
COMPANY**

A SUBSIDIARY OF DAYSTROM INC.

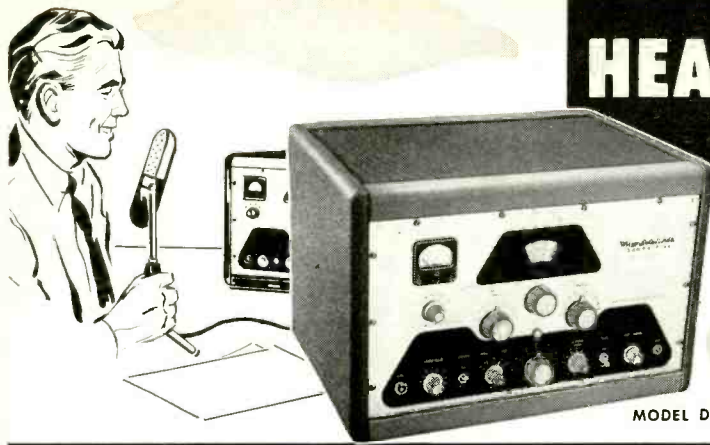

HEATHKIT HAM GEAR

for high quality at moderate cost

DOLLAR VALUE: You get more for your Heathkit dollar because your labor is used to build the kit instead of paying for someone else's. Also, the middleman's margin of profit is eliminated when you deal directly with the manufacturer.

1

MODEL DX-100



2



3



4

1 Heathkit DX-100 PHONE & CW TRANSMITTER KIT

The reception given this amateur transmitter has been tremendous. Reports from radio amateurs using the DX-100 are enthusiastic in praising its performance and the high quality of the components used in its assembly. Actual "on the air" results reflect the careful design that went into its development.

The DX-100 features a built-in VFO, modulator, and power supplies, and is completely bandswitching for phone or CW operation on 160, 80, 40, 20, 15, 11, and 10 meters. All parts necessary for construction are supplied in the kit, including tubes, cabinet, and detailed step-by-step instructions. Easy to build, and a genuine pleasure to operate.

Employs push-pull 1625's modulating parallel 6146's for RF output in excess of 100 watts on phone and 120 watts on CW. May be excited from the built-in VFO or from crystals (crystals not included with kit). Features five-point TVI suppression: (1) pi network interstage coupling to reduce harmonic transfer to the final stage; (2) pi network output coupling; (3) extensive shielding; (4) all incoming and outgoing circuits filtered; (5) inter-locking cabinet seams to eliminate radiation except through the coaxial output connector. Pi network output coupling will match 50 to 600 ohm non-reactive load. Illuminated VFO dial and meter face. Remote control socket provided.

The chassis is made of extra-strong #16 gauge copper-plated steel. It employs potted transformers, ceramic switch and variable capacitor insulation, solid silver loading switch terminals, and high-grade well-rated components throughout. Features a pre-formed wiring harness, and all coils are pre-wound.

High-gain speech amplifier for dynamic or crystal microphones, and restricted speech range for increased intelligence. Plenty of audio power reserve. Measures 20 7/8" W. x 13 3/4" H. x 16" D. Schematic diagram and complete technical specifications on request.

MODEL DX-100

\$189⁵⁰

Shpg. Wt. 120 Lbs.

Shipped Motor Freight Unless Otherwise Specified
\$50.00 Deposit Required on C.O.D. Orders

2 Heathkit VFO KIT

The Model VF-1 covers 160-80-40-20-15-11 and 10 meters with three basic oscillator frequencies. Better than 10-volt average RF output on fundamentals. Features illuminated and pre-calibrated dial scale. Cable and plug provided to fit crystal socket of any modern transmitter.

Enjoy the convenience and flexibility of VFO operation at no more than the price of crystals. May be powered from plug on the Heathkit Model AT-1 transmitter, or supplied with power from most transmitters. Measures: 7" H. x 6 1/2" W. x 7" D.

MODEL VF-1

\$19⁵⁰

Shpg. Wt. 7 Lbs.

3 Heathkit CW AMATEUR TRANSMITTER KIT

The Model AT-1 is an ideal novice transmitter, and may be used to excite a higher power rig later on.

This CW transmitter is complete with its own power supply, and covers 80, 40, 20, 15, 11, and 10 meters. Features single-knob bandswitching, and panel meter indicates grid or plate current for the final amplifier. Designed for crystal operation or external VFO. Crystal not included in kit. Incorporates such features as key click filter, line filter, copper-plated chassis, pre-wound coils, 52 ohm coaxial output, and high quality components throughout. Instruction book simplifies assembly. Employs a 6AG7 oscillator, 6L6 final amplifier. Operates up to 35 watts plate power input.

MODEL AT-1

\$29⁵⁰

Shpg. Wt. 15 Lbs.

4 Heathkit . . . ANTENNA COUPLER KIT

The Model AC-1 will properly match your low power transmitter to an end-fed long wire antenna. Also attenuates signals above 36 Mc, reducing TVI. 52 ohm coax. input—power up to 75 watts—10 through 80 meters—tapped inductor and variable condenser—neon RF indicator—copper plated chassis and high quality components. Ideal for use with Heathkit AT-1 Transmitter.

MODEL AC-1

\$14⁵⁰

Shpg. Wt. 4 Lbs.

HEATH COMPANY A Subsidiary of Daystrom, Inc. **BENTON HARBOR 20, MICHIGAN**

"AMATEUR-ENGINEERED"

Equipment For The Ham

MODERN DESIGN: You can be sure of getting all the latest and most desirable design features when you buy Heathkits. Advanced-design is a minimum standard for new Heathkit models.

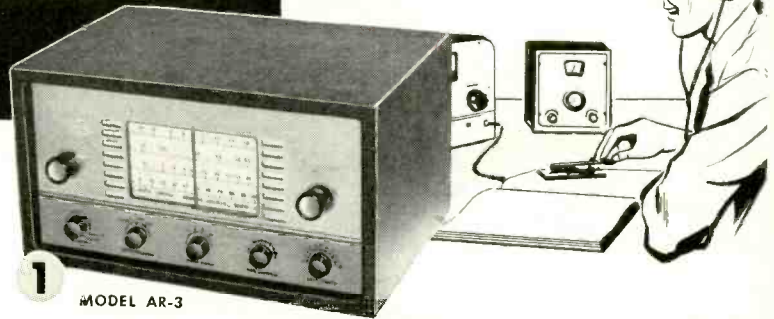

1 MODEL AR-3

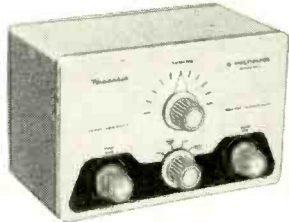

2



3



4



5

1 Heathkit COMMUNICATIONS-TYPE ALL BAND RECEIVER KIT

The new Model AR-3 features improved IF and RF performance, along with better image rejection on all bands. Completely new chassis layout for easier assembly, even for the beginner.

Covers 550 Kc to 30 Mc in four bands. Provides sharp tuning and good sensitivity over the entire range. Features a transformer-type power supply—electrical bandspread—separate RF and AF gain controls—antenna trimmer—noise limiter—AGC—BFO—headphone jacks—5½" PM speaker and illuminated tuning dial.

CABINET: Fabric covered cabinet with aluminum panel as shown. Part No. 91-15, shipping weight 5 lbs. \$4.50.

MODEL AR-3
\$27⁹⁵

Shpg. Wt. 12 lbs.
(Less Cabinet)

2 Heathkit "Q" MULTIPLIER KIT

Here is the Heathkit Q Multiplier you hams have been asking for. A tremendous help on the phone and CW bands when the QRM is heavy. Provides an effective Q of approximately 4,000 for extremely sharp "peak" or "null." Use it to "peak" the desired signal or to "null" an undesired signal, or heterodyne. Tunes to any signal within the IF band-pass of your receiver. Also provides "broad peak" for conditions where extreme selectivity is not required.

Operates with any receiver having an IF frequency between 450 and 460 Kc. Will not function with AC-DC type receivers. Requires 6.3 volts AC at 300 ma. and 150 to 250 VDC at 2 ma. Derives operating power from your receiver. Uses a 12AX7 tube, and special High-Q shielded coils. Simple to connect with the cable and plugs supplied. Measures only 4-11/16"H.x7 7/8"W.x4 1/8"D. A really valuable addition to the receiving equipment in your ham shack.

MODEL QF-1
\$9⁹⁵

Shpg. Wt. 3 lbs.

3 Heathkit VARIABLE VOLTAGE REGULATED POWER SUPPLY KIT

Provides well filtered DC output, variable from zero to 500 volts at no load and *regulated* for stability. Will supply up to 10 ma. at 450 VDC, and up to 130 ma. at 200 VDC. Voltage or current monitored on front panel meter. Also provides 6.3 VAC at 4A. for filament. Filament voltage isolated from B+, and both isolated from ground. Invaluable around the ham shack for supplying operating potentials to experimental circuits. Use in all types of research and development laboratories as a temporary power supply, and to determine design requirements for ultimate power supply.

MODEL PS-3
\$35⁵⁰

Shpg. Wt. 17 lbs.

4 Heathkit ANTENNA IMPEDANCE METER KIT

Use in conjunction with a signal source for measuring antenna impedance, line matching, adjustment of beam and mobile antennas, etc. Will double as a phone monitor or relative field strength indicator. 100 µa. meter employed. Covers the range from 0-600 ohms. An instrument of many uses for the amateur.

MODEL AM-1
\$14⁵⁰

Shpg. Wt. 2 lb.

5 Heathkit GRID DIP METER KIT

This is an extremely valuable tool for accomplishing literally hundreds of jobs on all types of equipment. Covering from 2 Mc to 250 Mc, the GD-1B is compact and can be operated with one hand. Uses a 500 µa. meter for indication, with a sensitivity control and headphone jack. Includes prewound coils and rack. Indispensable instrument for hams, engineers, or servicemen.

MODEL GD-1B
\$19⁵⁰

Shpg. Wt. 4 lbs.

HEATH COMPANY

A Subsidiary
of Daystrom, Inc.

BENTON HARBOR 20, MICHIGAN

Heathkits
 PROVIDE THE
 "CONSTRUCTIVE"
 APPROACH TO
HIGH-FIDELITY



EASY TO BUILD: *The assembly instructions supplied with Heathkits are so complete and detailed that anyone can assemble the kits without difficulty. Plenty of pictorial diagrams and step-by-step instructions. Information on resistor color codes, soldering, use of tools, etc. Build-it-yourself with confidence!*



1

1 *Heathkit* **ADVANCED-DESIGN**
HIGH FIDELITY **AMPLIFIER KIT**

The 25 Watt Model W-5 is one of the most outstanding high fidelity amplifiers available today—at any price. Incorporates the very latest design features to achieve true "presence" for the super-critical listener.

Features a new-design Peerless output transformer, and KT66 output tubes handle power peaks up to 42 watts. The unique "tweeter-saver" suppresses high frequency oscillation. A new type balancing circuit results in closer "dynamic" balance between output tubes. Features improved phase shift characteristics and frequency response, with reduced IM and harmonic distortion. Color styling harmonizes with the Heathkit WA-P2 Preamplifier and the FM-3 Tuner.

Frequency response—within ± 1 db from 5 cps to 160 Kc at 1 watt. Harmonic distortion only 1% at 25 watts, 20-20,000 cps. IM distortion only 1% at 20 watts, using 60 and 3,000 cps. Output impedance 4, 8, or 16 ohms. Hum and noise—99 db below rated output. Uses two 12AU7's, two KT66's and a 5R4GY.

KIT COMBINATIONS:

W-5M Amplifier Kit: Consists of main amplifier and power supply, all on one chassis. Complete with all necessary parts, tubes, and comprehensive manual. Shpg. Wt. 31 lbs. Express only.

\$59⁷⁵

W-5 Combination Amplifier Kit: Consists of W-5M Amplifier Kit listed above plus Heathkit Model WA-P2 Preamplifier Kit. Complete with all necessary parts, tubes, and construction manuals. Shpg. Wt. 38 lbs. Express only.

\$79⁵⁰

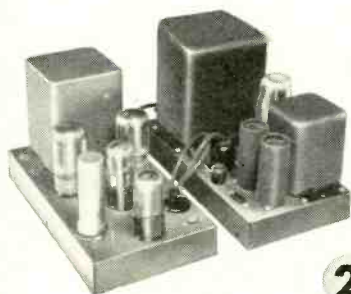

2

2 *Heathkit* **DUAL-CHASSIS WILLIAMSON TYPE**
HIGH FIDELITY **AMPLIFIER KIT**

This is a very popular high fidelity amplifier kit that features dual-chassis type construction. The resulting physical dimensions offer an additional margin of flexibility in installation. It features the famous Acrosound TO-300 "ultra-linear" output transformer, and has a frequency response within ± 1 db from 6 cps to 150 Kc at 1 watt. Harmonic distortion only 1% at 21 watts. IM distortion at 20 watts only 1.3% at 60 and 3,000 cps. Rated power output is 20 watts. Output impedance 4, 8, or 16 ohms. Hum and noise—88 db below 20 watts. Uses two 6SN7's, two 5881's, and a 5V4G.

KIT COMBINATIONS:

W-3M: Consists of main amplifier and power supply for separate chassis construction. Includes all tubes and components necessary for assembly. Shpg. Wt. 29 lbs., Express only.

\$49⁷⁵

W-3: Consists of W-3M Kit listed above plus Heathkit Model WA-P2 Preamplifier described on opposite page. Shpg. Wt. 37 lbs., Express only.

\$69⁵⁰



3

3 *Heathkit* **SINGLE-CHASSIS WILLIAMSON TYPE**
HIGH FIDELITY **AMPLIFIER KIT**

This is the lowest priced Williamson type amplifier ever offered in kit form, and yet it retains all the usual features of the Williamson type circuit. Main amplifier and power supply combined on one chassis, and uses a new-design Chicago output transformer. Frequency response—within ± 1 db from 10 cps to 100 Kc at 1 watt. Harmonic distortion only 1.5% at 20 watts. IM distortion at rated output, 2.7% at 60 and 3,000 cps. Rated power output is 20 watts. Output impedance 4, 8, or 16 ohms. Hum and noise—95 db below 20 watts. Uses two 6SN7's, two 5881's, and one 5V4G.

Instructions are so complete that the kit may be assembled successfully even by a beginner in electronics.

KIT COMBINATIONS:

W-4AM: Consists of main amplifier and power supply for single chassis construction. Includes all tubes and components necessary for assembly. Shpg. Wt. 28 lbs. Express only.

\$39⁷⁵

W-4A: Consists of W-4AM Kit listed above plus Heathkit Model WA-P2 Preamplifier described on opposite page. Shpg. Wt. 35 lbs. Express only.

\$59⁵⁰

HEATH
COMPANY

A SUBSIDIARY OF DAYSTROM INC.

BENTON HARBOR 20, MICHIGAN

RADIO-ELECTRONICS

ATTRACTIVELY STYLED: Heathkit high fidelity instruments are not only functional, but are most attractive in physical design. Such units as the preamplifier and the W-5 main amplifier are designed for beauty as well as performance. They blend with any room decor and are the kind of instruments you will be proud to own.



enjoy....
**THE VERY BEST
 IN AUDIO WITH
 "BUILD-IT-YOURSELF"
 HEATHKITS**

1 *Heathkit* HIGH FIDELITY
PREAMPLIFIER KIT

This outstanding preamplifier is designed specifically for use with the Heathkit Williamson type amplifiers. It completely fulfills the requirements for remote control, compensation and preamplification, and exceeds even the most rigorous specifications for high fidelity performance.

Features five separate switch-selected input channels (2 low level and 3 high level), each with its own input control. Full record equalization with four-position turnover control and four-position rolloff control.

Output jack for tape recorder — separate bass control with 18 db boost and 12 db cut at 50 cps. — treble control offering 15 db boost and 20 db cut at 15,000 cps — special hum control to insure minimum hum level — and many other desirable features. Overall frequency response (with controls set to "flat" position) is within 1 db from 25 cps to 30,000 cps. Will do justice to the finest available program sources. Beautiful satin-gold finish.

Power requirements from the Heathkit Williamson type high fidelity amplifier — 6.3 VAC at 1 amp., and 300 VDC at 10 Ma. Uses two 12AX7's and one 12AU7.

MODEL WA-P2
\$1975
 Shpg. Wt. 7 Lbs.

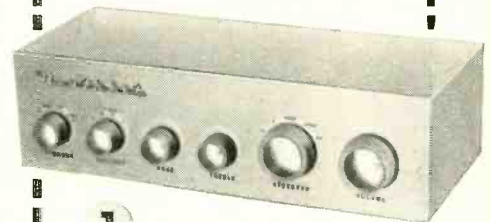

1

2 *Heathkit* 20-WATT HIGH FIDELITY
AMPLIFIER KIT

This Heathkit Model offers you the least expensive route to high fidelity performance. Frequency response is ± 1 db from 20-20,000 cps. Features full 20 watt output using push-pull 6L6's, and incorporates separate bass and treble tone controls. Preamplifier and main amplifier are built on the same chassis. Four switch-selected compensated inputs and separate bass and treble tone controls provide all necessary functions at minimum investment. Features miniature tube types for low hum and noise.

Uses 12AX7, two 12AU7's, two 6L6's and a 5V4G. A most interesting "build-it-yourself" project, and an excellent hi-fi amplifier for home use. Well suited, also, for public address applications because of its high power output and high quality audio reproduction. Another Heathkit "best-buy" for you!

MODEL A-9B
\$3550
 Shpg. Wt. 23 Lbs.



2

3 *Heathkit* 7-WATT
AMPLIFIER KIT

The redesigned Model A-7D features a new type output transformer for tapped screen operation, and provides improved sensitivity, reduced distortion, and increased power output.

The full 7-watt output of the Model A-7D is more than adequate for normal home installations. Frequency characteristics are $\pm 1\frac{1}{2}$ db from 20 to 20,000 cps. Potted output and power transformers employed. Push-pull output — detailed construction manual — top quality parts — high quality audio without great expense. Output transformer tapped at 4, 8, and 16 ohms. Bass and treble tone controls provided on the front chassis apron.

MODEL A-7D
\$1695
 Shpg. Wt. 10 Lbs.

Model A-7E: Provides a preamplifier stage with two switch-selected inputs and RIAA compensation for variable reluctance or low level cartridges. Preamplifier built on same chassis as main amplifier. Model A-7E. Shipping weight 10 lbs. \$18.50.



3

**HEATH
 COMPANY**

A SUBSIDIARY OF DAYSTROM INC.

BENTON HARBOR 20, MICHIGAN

NOVEMBER, 1955



Brand New **HEATHKIT HIGH-FIDELITY FM TUNER KIT**



MODEL FM-3
 Shpg. Wt. **\$24.50**
 7 lbs.
 (with cabinet)

The new Heathkit Model FM-3 features tremendous circuit improvements and brand new physical design. Sensitivity is better than 10 uv. for 20 db of quieting, and it employs a completely modern tube line-up for high gain and stable operation. Incorporates its own power supply, and has provision for low-level or high-level output at low impedance.

The attractive Model FM-3 matches the WA-P2 Pre-amplifier in color, styling, and physical size.

Incorporates automatic gain control, a highly stabilized oscillator, and illuminated tuning dial. Educational treatment of construction manual simplifies assembly for the newcomer to electronics. IF and ratio transformers are pre-aligned, and the front-end tuning unit is pre-assembled and aligned. Uses 6BQ7A as a cascode type RF stage, 6U8 oscillator-mixer, two 6CB6's as IF amplifiers, a 6AL5 ratio detector, a 6C4 audio amplifier, and 6X4 rectifier.

Features

- ▶ Brand New, Modern FM Circuit Using Latest Type Miniature Tubes.
- ▶ Low-Noise Cascode RF Stage—Two IF's—Ratio Detector—Stage of Audio.
- ▶ Extremely Good Sensitivity and Band-Pass for Outstanding Performance.
- ▶ Strikingly Attractive Satin-Gold Finish to Match Heathkit Model WA-P2 Pre-amplifier.
- ▶ Compact Physical Dimensions for Most Pleasing Appearance and Increased Circuit Efficiency.

HEATHKIT BROADCAST-BAND RECEIVER KIT

Build your own radio receiver with confidence, even if you are a beginner. Complete instructions supplied.



Features transformer-type power supply, high-gain miniature tubes, built-in antenna, 5 1/2" speaker, and planetary tuning from 550 Kc to 1500 Kc. Adaptable for use as AM Tuner and phono amplifier. Educational treatment of the construction manual helps the beginner learn about radio circuits and parts as he builds.

CABINET: Fabric covered plywood cabinet with aluminum panel as shown. Part 91-9, Shpg. Wt. 5 lbs., \$4.50.

MODEL BR-2
\$17.50 Less Cabinet
 Shpg. Wt. 10 lbs.

Are you on our mailing list? If not—how about sending us your name?

Phone
WALNUT
5-1175

to **HEATH COMPANY**
 A Subsidiary of Daystrom, Inc.
 BENTON HARBOR 20,
 MICHIGAN

ORDER BLANK

from _____

(PLEASE PRINT)

SHIP VIA

Parcel Post

Express

Freight

Best Way

| QUANTITY | ITEM | MODEL NO. | PRICE |
|----------|------|-----------|-------|
| | | | |
| | | | |
| | | | |
| | | | |
| | | | |
| | | | |
| | | | |
| | | | |
| | | | |
| | | | |

NOTE: ALL PRICES SUBJECT TO CHANGE WITHOUT NOTICE.

Enclosed find () check () money order for _____ . Please ship C.O.D. () postage enclosed for _____ pounds.

On Express orders do not include transportation charges—they will be collected by the express agency at time of delivery.

ON PARCEL POST ORDERS include postage for weight shown. ORDERS FROM CANADA and APO's must include full remittance.

HEATH COMPANY A Subsidiary of Daystrom, Inc. **BENTON HARBOR 20, MICHIGAN**

the VU METER

and its uses

Circuitry, operation and practical applications of this sensitive audio-frequency instrument

By JOHN T. FRYE

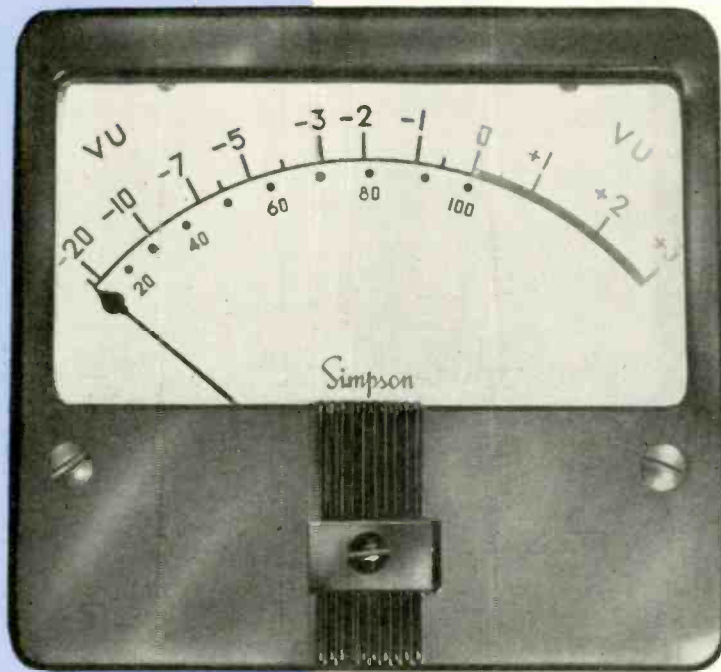

Typical VU meter with A card scale.

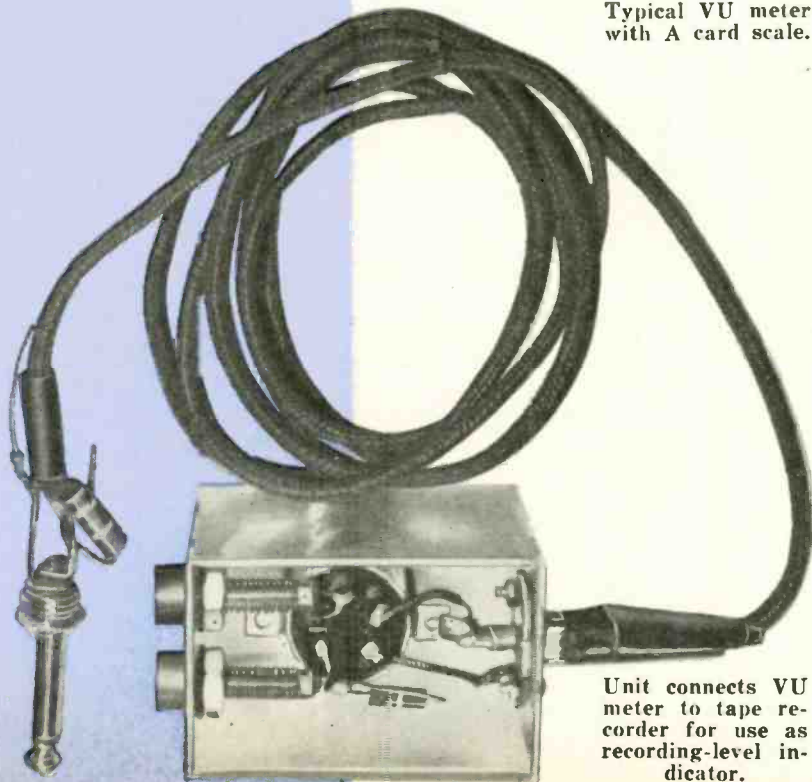

Unit connects VU meter to tape recorder for use as recording-level indicator.

ANYONE who has ever watched Arthur Godfrey's *Talent Scout* program or Edward R. Murrow's *See It Now* has seen a VU or volume unit meter in action. This is the meter you see registering applause on the Godfrey program and kicking up with every word the announcer speaks at the beginning of the Murrow show. It is an indispensable tool for the broadcast engineer, the recording engineer or anyone else who has occasion to measure the audio voltages produced by music and voice; yet its characteristics are not too well known.

It is NOT, as some may think, just an ordinary a.c. meter with a special scale. The standard VU meter was developed through the joint efforts of Bell Labs, CBS and NBC to provide a means of measuring accurately and continuously the volume level of voice or music fed into a transmitter, telephone line or recording device.

There was a serious need for such an instrument, for the power-level meter previously in use had several serious shortcomings: its impedance of 5,000 ohms was too low for bridging across a standard 600-ohm line, since devices so bridged should have an impedance of at least 10 times the line impedance; its sensitivity, requiring 6 mw across 500 ohms to make the meter read 0 db, was too low; it was good only for steady-state sine-wave measurement because its damping allowed it to overshoot badly on program material and thus give false readings.

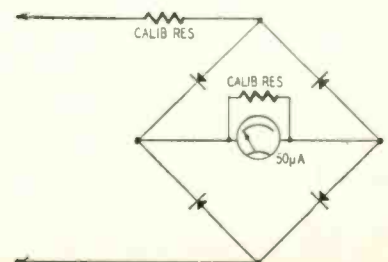

Fig. 1—Diagram of standard VU meter.

AUDIO—HIGH FIDELITY

The new VU meter (see photo) designed to overcome these shortcomings consists essentially of a 50- μ amp d.c. D'Arsonval movement meter (Fig. 1), a noncorrosive, full-wave, copper-oxide rectifier and two calibrating resistors. The complete self-contained impedance of the VU meter is 3,900 ohms. A full-wave rectifier is necessary to insure that human voice, which generates peaks of greater amplitude for one polarity than the other, will read the same no matter how the microphone is polarized through its connector.

Two scales are used on VU meters. The A card scale shown in the photo has a -20 to +3 VU scale above the line. The negative figures are in black while the positive figures and the heavy line beneath them are in red. Below the line is a percent voltage scale from 0 to 100. The 100% mark corresponds with 0 VU. These numbers are black. This scale is used on meters intended for laboratory and general test work.

On the B card scale the percent-of-voltage numbers are above the line and are printed in large black numerals. The same VU scale as on the A card is printed in smaller letters, and in red, below the line. This scale is used in broadcasting and recording where it is necessary to know the percentage of modulation or maximum recording level produced by the signal being measured. However, the markings of either scale are actually present in both. The choice is simply which scale you prefer to have accented. The 0 VU or 100% mark is located to the right of center, approximately 71% of the full-scale arc.

Volume units indicated on this scale are actually numerically equal to decibels above or below the zero reference level of 1 mw of power across 600 ohms when measuring a sine-wave signal. This is the reference level used in telephone work. The expression "dbm," meaning "decibels above or below 1 mw," signifies exactly the same thing as volume units only when measuring steady-state sine-wave signals. Plain "db," when used in reference-level discussion, ordinarily refers to decibels above or below the old reference level of 6 mw across 500 ohms. VU's applied to the measurement of program material indicate volume level and not actual power.

The frequency response of the VU meter is very good. To pass inspection it must be flat within 0.5 db between 25 and 16,000 cycles and within 0.2 db between 35 and 10,000 cycles. And when this meter is bridged across a 600-ohm line, the harmonic distortion produced in the line by the connection of the meter is less than 0.3%.

The damping of the meter is designed to allow it to handle the abrupt changes in level found in program material. When it is connected across a 600-ohm external resistance and a sine-wave voltage sufficient to give a steady-state deflection of 0 VU is suddenly applied, the pointer will not overshoot less

than 1% nor more than 1.5%. Still, that pointer is no laggard for it must be able to reach 99 on the percent scale in 0.3 second.

Sooner or later most audio signals in radio and TV work pass through a telephone line, and the VU meter was particularly designed to measure the signal fed into a telephone pair. A series resistor of 3,600 ohms is always used with a VU meter across a 600-ohm telephone line. The combination of this resistor and the 3,900-ohm impedance of the meter produces a total of 7,500 ohms, well above the "10 times" minimum bridging impedance previously mentioned.

A 4-db drop occurs across this resistor so that a 0-VU reading on the meter represents a power level of 4 dbm in the line itself. And it just so happens, by no mere coincidence, that it is a practice of the telephone company to allow signal levels of from 4 to 8 dbm to be transmitted over the average cable pair! When the VU meter pointer touches 0 VU or the 100% mark, the level will be precisely the maximum that should be sent into the line. If the transmitter being fed at the other end of the line is adjusted so this signal produces 100% modulation, the operator at the remote pickup can tell by glancing at his VU meter the percentage of modulation.

Fig. 2 shows the diagram of an at-

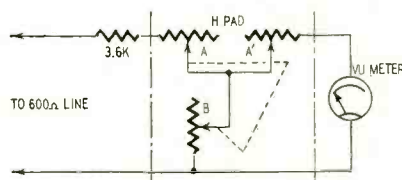

Fig. 2—Attenuation network for use with VU meter across a 600-ohm line.

tenuation network used with a standard volume unit meter. The 3,600-ohm series resistor mentioned above is used ahead of an H-pad. Arms A and A' of this pad are identical and increase or decrease in step. When they are increasing in resistance, arm B is decreasing, and vice versa. Resistance values are such that the source voltage always "sees" 7,500 ohms impedance, no matter where the attenuator is set. The impedance of the attenuator as seen from the meter side likewise remains unchanged. The attenuator dial starts at 4 dbm and goes up in steps of 2 dbm to a maximum of 44 dbm. There is no 0-db setting of the attenuator, for the series resistor producing a 4-db attenuation is always in use. The 0-VU point on the meter automatically indicates the level to which the attenuator dial is set. For example, if the attenuator is set for 10 db, the VU meter will indicate from -10 to +13 VU, with 0 VU on the dial actually being 10 VU. These attenuators are precision equipment and are expensive. Fig. 3 shows the distribution of voltage and impedance across a VU meter and its attenuator when the meter is reading 0 VU.

VU meter applications

It might be thought so sensitive a meter would be too delicate for practical use, but this is not so. A VU meter is designed to take a reasonable amount of abuse. It is built to withstand voltage peaks 10 times those necessary to produce a 0-VU reading for a period of 0.5 second or a continuous voltage overload of 5 times the 0-VU level. In neither case should there be any injury to the meter nor any effect on its calibration. Incidentally, VU meters are calibrated at the 0-VU point and have their greatest accuracy when the pointer is reading between points -1 and +1 VU.

As a tape recording fan I have never been completely satisfied with the neon-bulb recording-level indicator on my otherwise highly prized home tape recorder. The trouble with the neon lamp is that it gives a positive indication only at one level, that at which the lamp just lights. When the level is either above or below this point, there is no way of telling how far that level is exceeding or falling short of the proper value. A meter, with its continuous indication, would correct this. Finally, the fact that all high-quality professional tape recorders use a VU meter as a level indicator clinched the argument in favor of trying to marry my VU meter to my tape recorder.

This took a surprising amount of experimenting before a satisfactory ar-

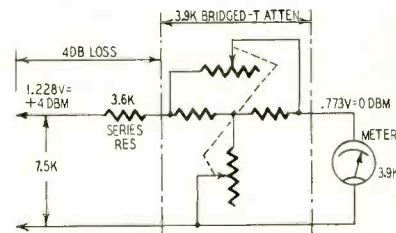









Fig. 3—Voltage and impedance distribution across attenuating network.

angement was worked out. Two things contributed to the difficulty: first, it was resolved the meter connection must be made to existing outlets of the recorder without tampering with the amplifier wiring. Had it not been for this restriction, the example described in the excellent article "Improving Low-Priced Tape Recorders" by Herman Burstein in the April, 1955, issue of RADIO-ELECTRONICS could have been followed and a meter amplifier tube added to the instrument. Second, my recorder had no 500- or 600-ohm outlet as do some home recorders. If it had, the meter in series with a level-setting variable resistor could have been connected across this outlet. The only outlet on my recorder is one for use with an external speaker with a 3.2-ohm voice coil. As is usually the case, this outlet could be activated while recording for monitoring purposes.

The first attempt was merely to connect a 3.2-ohm resistor across a phone plug in this outlet jack and then to

| | | | |
|---|---|--|---|
| <p>SYLVANIA</p> <p>6SN7GTB</p> <p>ELECTRONIC TUBE</p> |  | <p>SYLVANIA</p> <p>6AU6</p> <p>ELECTRONIC TUBE</p> |  |
|  | <p>SYLVANIA</p> <p>6BQ6GTA</p> <p>ELECTRONIC TUBE</p> |  | <p>SYLVANIA</p> <p>5U4GB</p> <p>ELECTRONIC TUBE</p> |
| <p>SYLVANIA</p> <p>6GT</p> <p>ELECTRONIC TUBE</p> |  | <p>SYLVANIA</p> <p>6CB6</p> <p>ELECTRONIC TUBE</p> |  |
| | <p>SYLVANIA</p> <p>1B3GT</p> <p>ELECTRONIC TUBE</p> |  | |

How to get the jump on call-backs in 6 easy moves

Here are six tube types called for most in your daily service work. Eliminate the call-backs from these types and your biggest share of headaches is over. It's easy to do just that, too, simply by getting into the habit of using only Sylvania tubes . . . in the familiar yellow and black carton.

These 6 types alone incorporate over 14 design and production improvements to eliminate the most common causes for "quick failures" and costly call-backs. It's no wonder more and more servicemen consider the yellow and black carton their "calling card of top quality service."

 **SYLVANIA**

SYLVANIA ELECTRIC PRODUCTS INC.
1740 Broadway, New York 19, N. Y.
In Canada: Sylvania Electric (Canada) Ltd.
University Tower Building, Montreal

AUDIO—HIGH FIDELITY

connect the meter across this resistor. This would not work because the voltage developed across the resistor at optimum recording level was only about one-fifth the 0.773 volt necessary to make the meter read 0 VU. I tried to step up this voltage by using a line-to-voice-coil transformer backward. That is, I plugged the voice coil winding into the external speaker jack and connected a 600-ohm resistor across the line winding. The meter, in series with

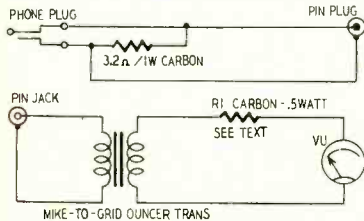

Fig. 4—VU meter connection to tape recorder to indicate recording level.

a variable resistor, was connected across the line winding. This arrangement yielded plenty of voltage for the meter, but tests run with an audio signal generator and an a.c. v.t.v.m. soon revealed the voltage developed across the recording head and that indicated by the VU meter varied widely for different frequencies being recorded. Scratch one bright idea!

Finally I hit upon the method shown in Fig. 4. The 3.2-ohm resistor is used in the external speaker jack as before, but the voltage developed across it is stepped up by a microphone-to-grid Uncer transformer and applied through a series resistor to the meter. Many tests with the equipment and a Dubbings test tape reveal that the level indicated by the meter is practically identical with that appearing across the recording head for all frequencies between 50 and 15,000 cycles. The measured impedance across the microphone winding of the transformer when the meter and resistor are connected across the grid winding is around 350 ohms—more than 100 times the load resistor being bridged—so the connection of the meter has no noticeable loading effect.

The actual connecting equipment is shown in the photo. The 3.2-ohm 1-watt carbon resistor can be seen connected across the plug. A shielded lead goes from this to a phono jack on the side of the plastic dial cord box and then to the microphone winding of the Uncer transformer inside the box. Also inside the box can be seen the ½-watt carbon resistor used in series with the meter across the grid winding of the transformer. A pair of tip jacks in the side of the box receive the phone tip leads of the meter.

The value of R1 in Fig. 4 sets the response of the meter to the proper recording level. I adjusted this value in accordance with instructions in the booklet accompanying the Dubbings test tape, but it could just as well have been done by temporarily connecting a variable resistor of 100,000 ohms or so in place of R1. While recording a musical

program from the radio or TV set, vary this resistor until the pointer just barely reaches 0 VU when the recorder's neon lamp flashes. This is a starting point. Now you can adjust the resistor either side of this point until you feel that the 0-VU level indicated on recording peaks is the best one to use for your purposes. Lowering the value of the resistor will make the meter read higher on the same recording level, increasing the resistance will make it read lower. When you are satisfied, measure the resistance of the variable resistor with an ohmmeter and replace it with a fixed, carbon, ½-watt resistor of this value.

A nice thing about using the meter is that you do not have to have the meter kicking up to 0 VU on maximum peaks on all types of recorded material unless you wish. You may find, for example, that piano music sounds better if the meter kicks up only to -3 VU. If so, simply use the -3-VU point as your maximum level for piano recording. This flexibility is the main advantage of the VU meter indication. However, the meter no longer indicates true volume units in this application. It reads volume units only when across a 600-ohm line. Now it is simply a level indicator, but a change of so many volume units still indicates a change of that many decibels in the voltage applied to the meter.

Another "natural" use for the VU meter is as a modulation-level indicator on a ham transmitter. Here at W9EGV this is done in the following manner:

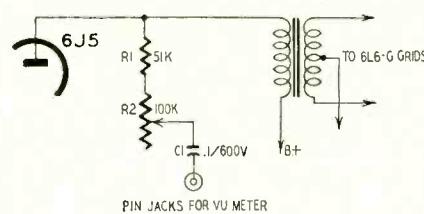

Fig. 5—VU meter connection to amplifier for modulation-level indicator.

The speech equipment consists of a 6SJ7, 6J5 and a pair of 6L6-G's running in class-AB₁ as modulators. The VU meter is connected between the plate of the 6J5 and ground (Fig. 5), with C1 blocking d.c. from the meter rectifier. Resistor R1 provides enough fixed resistance to protect the meter from damage if R2 is reduced to zero while the transmitter is being fully modulated; R2 permits adjustment of the meter to read 100% modulation when the transmitter is being fully modulated.

The resistance values given apply just to this transmitter. The value of the resistance in series with the meter will depend, of course, upon the voltage developed at the point where it is connected. It should be connected across as low an impedance point in the audio amplifier as is available. If the speech amplifier feeds the modulator through a 500-600-ohm line, across this line

would be the ideal place for the meter, and in this case no blocking capacitor would be necessary.

To adjust R2, connect a scope or other percentage-of-modulation indicator to the transmitter and carefully adjust the rig for what you consider normal loading, excitation, etc. Now speak into the microphone in tones that just produce full modulation. Slowly decrease the resistance of R2 until the meter pointer is just touching the 100% mark when the scope is showing full modulation. Put a drop of sealing wax on the shaft of R2 or take other precautions to see that its setting cannot be accidentally changed. Now you can return the scope to your service bench or to its rightful owner—if it is borrowed—and you can depend upon the VU meter to indicate faithfully your percentage of modulation as long as you do not change the operating parameters of the transmitter. At rare intervals you can make checks with the scope just to make sure the VU meter is still giving you a true picture, but you will find it highly reliable and virtually free from troubles.

Finally, anyone using a phone patch should have a VU meter to guard against feeding too much signal into the telephone lines. Since these patches are used purely through the sufferance of the telephone companies, anyone who takes a chance on overloading a telephone line is threatening the phone-patch privileges of all of us who make use of them.

Whatever kind of patch you use, it likely terminates in a pair of blocking capacitors feeding into the line as shown in Fig. 6. The VU meter is simply connected across the line on the patch side of these capacitors. The 3,600-ohm resistor in series with the meter provides a 4-db drop as explained; so when the meter pointer touches the 0-VU point on the signal being fed

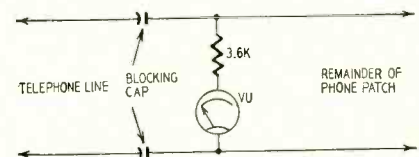

Fig. 6—VU meter connection to phone patch to indicate level fed into line.

from the receiver into the line, this actually means that the signal level is 4 db, the maximum permitted. If you make sure the pointer of the meter, connected as shown, never goes past 0 VU, you may be confident you are not jeopardizing our valuable phone-patch privileges.

These examples should help point out that the VU meter is not just a delicate laboratory instrument but a sturdy, reliable and versatile tool for anyone who works with audio frequencies. Once you have used a VU meter and come to depend upon its un-failing accuracy, you wonder how—and why!—you ever got along without this instrument. END

She: *But, how do I know this is a good tube?*

You: *Because, this is a CBS aluminized Mirror-Back picture tube. There aren't any better.*

She: *And I see it has the Good Housekeeping Guaranty Seal, too. That's proof enough for me.*

Customer confidence really counts when it comes to the big tube. That's when CBS tube advertising helps you most. For CBS tubes have the Good Housekeeping Guaranty Seal and are nationally advertised to 76.9% of your customers . . . the women of America. And 53% of these women are influenced in their purchases by that seal of approval. You protect yourself and gain your customer's good will when you install a new CBS aluminized Mirror-Back picture tube.

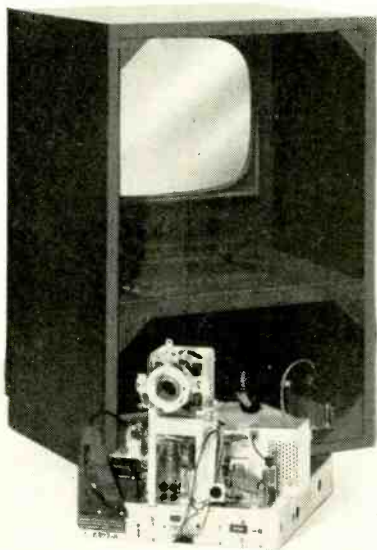

Show her the CBS carton with the Good Housekeeping Guaranty Seal.



CBS-HYTRON, Danvers, Massachusetts . . . A DIVISION OF COLUMBIA BROADCASTING SYSTEM, INC.

VARIABLE DAMPING

The importance of mechanical or acoustical damping on the loudspeaker

...How good is it...

By
NORMAN H. CROWHURST

MANY of the latest amplifiers incorporate variable damping as a feature. Various statements about the value—or otherwise—of this new device have been made. To evaluate some of these, let's first see what damping can do for loudspeakers.

Development of variable damping has led to the introduction of a new term—*ultimate damping*—meaning that the loudspeaker is completely damped by neutralizing the voice coil resistance. This assumes that the acoustical resonance of the loudspeaker is 100% damped by the electrical circuits.

Let us examine this hypothesis more closely. Fig. 1 shows the basic equivalent of a loudspeaker, even a very poor one. It consists of an electro-acoustical resonant system in which the inductance is made up of the mass of the diaphragm (together with various other little bits of mass attached to it); the capacitance is composed of the compliance of the centering spider, of the surround and of the air inside the loudspeaker enclosure, and the resistance is due to the energy radiated in the form of sound. If energy is radiated there *must* be a component of resistance.

The nearest possible approach to a resistance-less mechanical-acoustical system would be obtained by putting the loudspeaker in a double enclosure where the diaphragm is on a baffle between two equal enclosures (Fig. 2). If the enclosure were sealed off so that no sound escaped, the mass of the diaphragm tuned with the two bodies of air as compliances could make a fairly efficient resonant system, although even then some energy would be lost due to the viscosity of the air and mechanical resistive losses in the diaphragm movement itself.

But in a practical loudspeaker and its enclosure, some steps at least are taken to reduce the efficiency or Q of this resonant system. Also the fact that most of the acoustic energy developed is radiating into a room, rather than building up a resonance in the

enclosure, means that only a fraction of the energy reaching the diaphragm of the loudspeaker is used in building up an acoustical resonance.

The series circuit (Fig. 1-a) in the acoustical part, represented as an inductance, capacitance and resistance, is transferred by the electromechanical coupling of the loudspeaker to appear like a parallel resonant circuit (Fig. 1-b) in series with the voice coil resistance and inductance. This electro-mechanical transfer is not very efficient—an efficiency of 20% is regarded by loudspeaker manufacturers as high, most commercial units will be nearer to 10%, while some are as low as 5%. This fact too has some significance on the question of damping.

Assuming that the coupling is complete or 100%, note that there is already some resistance in the damping of the circuit and so 100% electrical damping would never be necessary to damp out the resonant effect. On this basis, we need never completely neutralize the voice coil resistance.

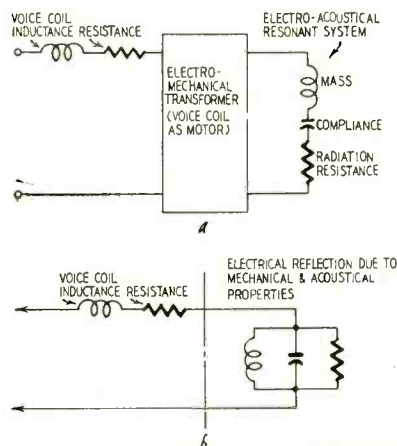

Fig. 1—Basic equivalent loudspeaker circuits: a, acoustical; b, electrical.

Aperiodic damping of the "tuned circuit" is reached when the resistance applied to the circuit is such as to give the values equivalent to a Q of unity. Ideally, the damping should be applied to the acoustical part of the circuit. This means that the resistance due to the mechanical and acoustical effects in the loudspeaker's radiation of sound into the room, as well as into its enclosure, should produce the critical damping mentioned above.

This objective is not achieved in a poor loudspeaker design. So some attempt may need to be made to transfer some damping from the electrical circuit because electrical circuit damping does affect the loudspeaker diaphragm behavior, particularly at its resonant point. This can be checked by "plonking" the diaphragm of a speaker without its being connected to an amplifier. Do it first with the voice coil terminals short-circuited, and then with them open-circuited. It will be found that the movement of the diaphragm is appreciably easier when the voice coil terminals are open-circuited. This means that any tendency of the diaphragm to vibrate at its resonant frequency will be damped by feeding it from a low source resistance. Neutralizing the voice coil resistance will damp the movement of the diaphragm even more than short-circuiting the coil.

Now let's see what the efficiency—or coupling factor—of the loudspeaker's electromechanical system means to damping. There are two equivalent

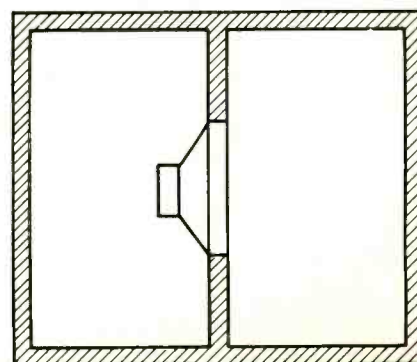
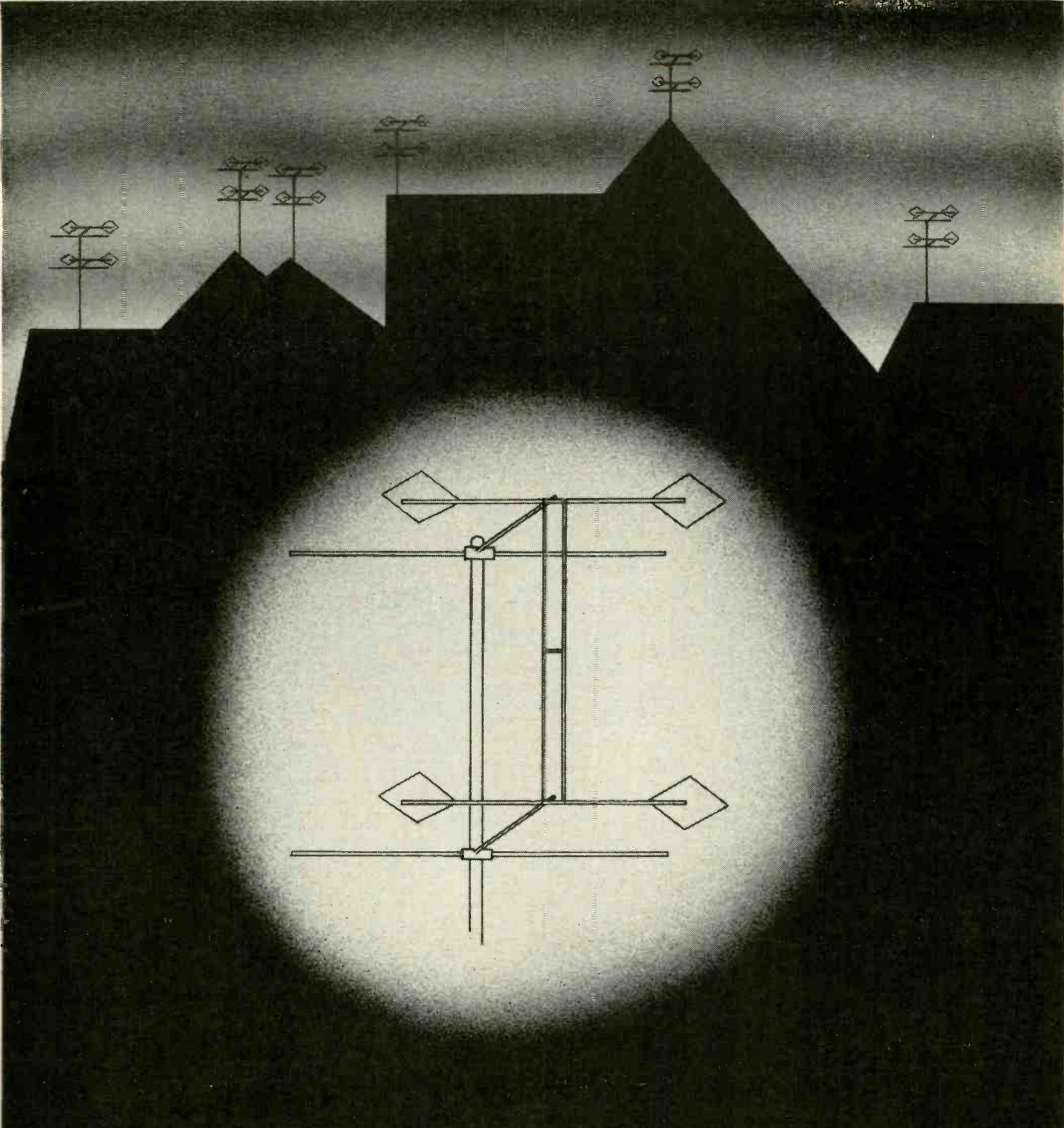

Fig. 2—Diagram shows loudspeaker unit housed to make it into a high-Q mechanical-acoustical resonant system.



ONLY ANTENNA WITH A FULL FIVE-YEAR GUARANTEE

End replacement problems. Guaranteed to be the most efficient all channel antenna available on a performance versus cost basis. Rugged all aluminum construction; heavy seamless tubing with stainless steel hardware.

PATENT PENDING

WAYCO Inc.

WAYCO manufactures a full line of antennas and towers
P.O. BOX 115 • WAYNESBORO, TENNESSEE

AUDIO—HIGH FIDELITY

resonant circuits: the acoustical one (Fig. 1-a), which is the cause of both, but which itself consists of a mechanical-acoustical resonance damped to some extent by the electrical circuit as well as by the resistance elements in its mechanical-acoustical makeup; the impedances reflected through the electro-mechanical coupling from the acoustical resonance, which produce an equivalent electrical resonant circuit Fig. 1-b.

Because the coupling of a loudspeaker is relatively poor, damping that effectively eliminates ringing effects in one circuit is different from the damping required to eliminate the same effects in another. Ringing effects can be produced either in the mechanical-acoustical resonant system—because it has a tendency to continue oscillating after the driving force has ceased—or in the electrical circuit because the impedance reflected by the mechanical-acoustical system causes the electrical circuit to ring.

It is possible, by applying a negative resistance to the voice coil circuit, to short-circuit the effective resonant circuit reflected into the voice coil circuit. This must completely damp any tendency to ring electrically. But assume the Q of the mechanical-acoustical system is relatively high so that even a short-circuited zero-resistance voice coil will fail to damp out completely the mechanical tendency to ring. After all, this is the best contribution to damping that can be achieved electrically. Such a complete neutralization of the voice coil resistance will still fail to damp the mechanical system of the loudspeaker 100%, although it is actually overdamping the electrical circuit.

This brief introduction to the electro-mechanical aspects of a loudspeaker has brought to light an important fact: *basically there is no satisfactory substitute for applying damping to the mechanical-acoustical resonance in a mechanical or acoustical fashion* because this is the only place at which 100% coupling to the mechanical-acoustical resonant system can be achieved. If the loudspeaker with its enclosure is satisfactorily damped, then its effective resonance reflected into the electrical circuit will be very small—negligible—so no steps are specifically necessary to damp the electrical circuit. It will have no tendency to ring unless the amplifier itself is extremely susceptible to the small degrees of reactance reflected into the circuit from the electromechanical coupling.

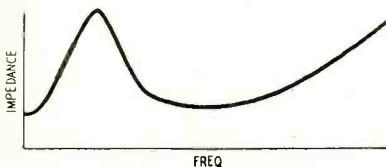

Fig. 3—Typical impedance-frequency characteristic of a speaker enclosure.

Without going any further into the consideration of amplifier design we can now realize that damping factor control is not so important to the correct performance of a loudspeaker and enclosure as is attention to correct acoustical and mechanical damping of the loudspeaker's resonant system. In the best loudspeakers this has been taken care of by the designer. For this reason when using an amplifier equipped with variable damping with a well designed loudspeaker system it will be practically impossible to detect any effect from changing the variable damping control. It is almost impossible to detect any difference in reproduction if the control is moved from one extreme end of its setting to the other.

This rather surprising fact suggests that variable damping control may be somewhat overrated when any reasonably good type of loudspeaker and enclosure is used. The only time variable damping can be used to improve the performance of a loudspeaker would seem to be when the design of the loudspeaker itself or its enclosure could be improved. In such cases, variable damping may be inadequate to damp the mechanical-acoustical system sufficiently. Although it may stop the apparent ringing measured in the electrical circuit across the voice coil, it will not be able to prevent mechanical-acoustical ringing of the loudspeaker itself—even with "ultimate" damping.

But some amplifiers containing this feature have given impressive demonstrations of variable damping. "How is this, if the feature is really as ineffective as you say?" some of you will ask. The answer to this question is that some of the amplifiers featuring variable damping also do something else that needs a little more explanation.

You are told that the variable damping feature is confined to the low-frequency end of the response, because this is where loudspeaker damping needs be varied. In other words, the resonance of the loudspeaker mechanical-acoustical system is at the low-frequency end of the scale, and hence this is where attention to damping is necessary. Accordingly some manufacturers have introduced frequency-selective variable current feedback which varies the damping at the low-frequency end only.

This is true, but the fact that seems to have escaped attention is that varying current feedback from positive to negative at one end of the frequency

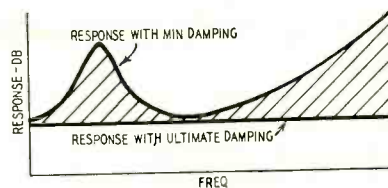

Fig. 4—Change in electrical response produced by an amplifier with variable damping on speaker with Fig. 3 response.

response also varies the frequency response of the amplifier, entirely independent of what kind of loudspeaker it is feeding. It will vary the response of the amplifier *even if a resistance load is connected*. Turning the variable damping control changes the basic frequency response of the amplifier, quite apart from its direct effect on damping.

The change in frequency response caused by the control can be far more noticeable to the ear than any change of damping independent of this change in the amplifier's basic frequency response. This kind of amplifier can give spectacular demonstrations with any loudspeaker, quite apart from its control on damping. The change in effect noticeable to the ear is due, not to a change on the damping applied to the loudspeaker, but to the change in frequency response produced in the amplifier itself. Because this kind of control produces a change in frequency response bigger than its effect on damping, it becomes impossible for the ear to detect the effect on damping—even if the effect were audible.

This may seem a little complicated, and in the confusion some will be thinking, "But doesn't variable damping inherently change frequency response? This guy is telling us nothing new." Let's separate the effects we are talking about.

It is true that, especially with inexpensive loudspeakers, a true variable damping control will change frequency response because of the impedance-frequency characteristic of the loudspeaker (Fig. 3). This means damping control will affect response as shown in Fig. 4. But a frequency-selective damping control, connected to a resistance load, will change response as in Fig. 5.

Where a frequency-selective damping control is used, the two effects shown in Figs. 4 and 5 will be added together. The combination is not shown here, because the effect in any individual case is not predictable.

The general trend of this article may seem to be on the negative side as regards the application of variable damping. However, there are many cases where application of variable damping can be an advantage and in which the user may find it useful to have an amplifier with variable damping control. In a further article I will discuss variable damping in a little more detail from the aspect of amplifier circuitry. END

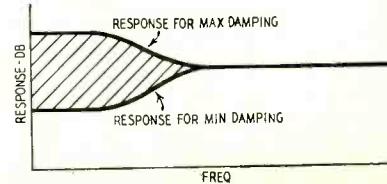

Fig. 5—Change in electrical response of amplifier using frequency-selective variable damping—measured with amplifier working into resistance load.

Get this FREE Booklet Today!

Loaded with career-building facts — it can lead you to a bigger job, better pay, security and success in radio — TV — electronics

"YOUR FUTURE IN THE NEW WORLD OF ELECTRONICS"—

Contains a proved plan for your successful career in:

- ★ BROADCASTING
- ★ MANUFACTURING
- ★ SERVICING
- ★ ARMY, NAVY, AIR FORCE, COAST GUARD ELECTRONICS
- ★ TELEVISION
- ★ COMMUNICATIONS
- ★ AERONAUTICAL ELECTRONICS

A PROVED CAREER-PREPARATION PLAN THAT WORKS!

This free book has brought success home to thousands of men just like you! They are now enjoying responsible jobs, good pay and the good things of life. So can you! In less time than you think! We tell you how you can carve out a bigger better-paying job. Our proved career-preparation plan works because it was written by authorities who know exactly what the varied electronic industries want, need and expect from you!

ELECTRONICS' FUTURE CAN BE YOUR FUTURE

You can't keep up with the tremendous changes in the electronic industries. What's predicted for next year becomes outdated in a few months! All phases of the electronic industries are experiencing phenomenal growth. There are thousands of career openings, big ones. Industry can't find enough trained manpower to fill them—in manufacturing, testing, servicing, broadcasting and telecasting.

TAKE TV FOR EXAMPLE!

Four hundred and six stations are on the air! Many more are building or in the plans stage; 32,859,915 sets are in use. Color TV is just starting to really come alive! This same phenomenal growth picture is repeated in every phase of business employing electronics—crime prevention, aeronautics, fire-fighting, communications, to name but a few. CREI has the plan to keep you moving upward, to help you assume your rightful place!

CREI GRADS ARE IN DEMAND!

The big companies know CREI men have what it takes! CREI grads are at work in America's biggest corporations, in positions ranging from technicians to engineers to top management. Companies such as United Air Lines, Canadian Broadcasting Corporation, Trans-Canada Airlines, Sears-Roebuck and Co., Bendix Products Division, All-American Cables and Radio, Inc., and Radio Corporation of America, are now paying for CREI training for their own technical staffs. Our placement bureau has more requests for CREI-trained men than we can presently supply.

THOUSANDS LIKE YOU HAVE SUCCEEDED WITH CREI'S PLAN! "CREI TRAINING IS BEST"



"I chose CREI training upon recommendation of two top engineers. Before I had completed the course I became transmitter chief of a 5 KW station. I am now employed as a technician at a 100 KW TV station, and in spare time have a good TV sales and service business. Anyone interested in his electronic future should have CREI training."
—Arlie D. Patton, San Antonio, Texas.

"I know of no case in which a man who applied himself and completed the CREI course failed to better himself through promotion and increase in salary."
—Wendell L. Fraser, San Diego, Calif.

"CREI has raised me to professional status as a radioman. Thanks to your instructors who always gave me needed help."
—Victor Mentzer, Wilmington, Del.

"I have been in radio and electronics for 24 years. I fully recommend CREI as the best school I have seen."
—L. McManus, Montreal, Canada.



Act Now!

TAKE THAT FIRST BIG STEP!
NO OBLIGATION

Fill out and mail the coupon. When you do, you'll be on the way to higher pay, a better job and complete career security. Act right away. Send for your free book today.

CREI GRADS EASILY PASS FCC EXAMS!

You start feeling the benefits of CREI training right away, either with your present connection, or with a future employer. You'll have all the training you need to secure your FCC commercial license.

MAIL THIS POSTAGE-FREE POSTCARD TODAY

CAPITOL RADIO ENGINEERING INSTITUTE

Accredited Technical Institute Curricula

Dept. 1411-B 3224 16th St., N.W., Washington 10, D. C.

Please send me your course outline and FREE Illustrated Booklet "Your Future in the New World of Electronics"... describing opportunities and CREI home study courses in Practical Electronics Engineering.

- CHECK FIELD OF GREATEST INTEREST
- Practical Radio Electronics Engineering
 - Broadcast Radio Engineering (AM, FM, TV)
 - Practical Television Engineering
 - Aeronautical Electronics Engineering
- CA**

Name.....

Street.....

City..... Zone..... State.....

Check: Home Study Residence School Korean Veteran

To help us answer your request intelligently, please give the following information:

EMPLOYED BY.....

TYPE OF PRESENT WORK.....

SCHOOL BACKGROUND.....

ELECTRONICS EXPERIENCE.....

IN WHAT BRANCH OF ELECTRONICS ARE YOU MOST INTERESTED?

MAIL THIS POSTAGE-FREE POSTCARD TODAY

See Our Ad On The Next Page

CREI prepares you quickly for success in

The future is in your hands!

The signs are plain as to the future of the trained men in the electronics industry. It is a tremendous industry, and—at the *present time* there are more jobs than there are trained men to fill them. But—when there's a choice between a trained and untrained applicant, the trained man will get the job. Your biggest problem is to decide on—and begin the best possible training program.

CREI Home Study . . . The Quick Way to Get There.



Since 1927, CREI has given thousands of ambitious young men the technical knowledge that leads to more money and security. The time-tested CREI procedure can help *you*, too—if you really want to be helped. CREI lessons are prepared by experts in easy-to-understand form. There is a course of instruction geared to the field in which you want to specialize. You study at *your* convenience, at *your* rate of speed. Your CREI instructors guide you carefully through the material, and grade your written work personally (not by machine).

Industry Recognizes CREI Training.

CREI courses are prepared, and taught with an eye to the needs and demands of

industry, so your CREI diploma can open many doors for you. Countless CREI graduates now enjoy important, good-paying positions with America's most important companies. Many famous organizations have arranged CREI group training for their radio-electronics-television personnel. To name a few: All America Cables and Radio, Inc.; Canadian Aviation Electronics, Ltd.; Canadian Broadcasting Corporation; Columbia Broadcasting System; Canadian Marconi Company; Hoffman Radio Corporation; Machlett Laboratories; Glenn L. Martin Company; Magnavox Company; Pan American Airways, Atlantic Division; Radio Corporation of America; Technical Appliance Corporation; Trans-Canada Air Lines; United Air Lines. Their choice for training of their own personnel is a good cue for *your* choice of a school.



***Benefits Felt
Right Away.***

- BROADCASTING
- TELEVISION
- MANUFACTURING
- COMMUNICATIONS
- SERVICING
- AERONAUTICAL ELECTRONICS

Almost immediately you feel the benefits of CREI training. Your employer, when informed of your step toward advancement (only at your request), is certain to take new interest in you and in your future. What you learn in CREI Home Study can start helping you do a better job immediately.



CREI also offers Resident Instruction

at the same high technical level—day or night, in Washington, D. C. New classes start once a month. If this instruction meets your requirements, check the coupon for Residence School catalog.

PAYS FOR ITSELF QUICKLY. Your very first raise could repay your investment in CREI training, and leave you a profit the very first year. Your increases in pay thereafter are all pure profit, and you'll be prepared for many more promotions and pay raises in the future years of your life.

KOREAN WAR VETERANS

If you were discharged after June 27, 1950, let the new G.I. Bill of Rights help you obtain resident instruction. Check the coupon for full information.



***Get this fact-packed
booklet. It's free.***

Called "Your Future in the New World of Electronics," this free illustrated booklet gives you the latest picture of the growth and future of the gigantic electronics world. It includes a complete outline of the courses CREI offers together with all the facts you need to judge and compare. Take 2 minutes to send for this booklet right now. We'll promptly send your copy. The rest—your future—is up to you.

1st Class

Permit No. 288-R

Sec. 34.9 P.L.R.

Washington, D. C.

BUSINESS REPLY CARD

No Postage Stamp Necessary If Mailed in United States

3c Postage Will Be Paid By

CAPITOL RADIO ENGINEERING INSTITUTE

3224 16th Street, N.W.

Washington 10, D. C.

3-CHANNEL MIXER EQUALIZER

By GEORGE L. AUGSPURGER

BY now anyone who makes even a passing pretense of being a hi-fi bug has tried at least a half-dozen preamplifier and tone control circuits. In addition, he has been bombarded with magazine articles such as the "Ultra-Simplified No-Control Automatic Equalizing Preamp" or its complement, "The Ultrex Limitless Silent Compensator Featuring Separate Level Controls for Each Discrete Frequency in the Entire Listening Spectrum." One deficiency in all these circuits—regardless of their respective merits—is that none of them provide for mixing more than one input at a time. This may be fine for the fellow who listens to nothing but LP's, but for those of us who include recording facilities in our sound system a more flexible input system is desirable. Certainly no one with a tape machine at his disposal can resist the temptation to make like a broadcast station and try a little live dramatic effort now and then.

Since I do this sort of thing a good deal I set about to devise a companion unit to the tape recording amplifier described in RADIO-ELECTRONICS (July, 1954). This master control unit was to include pickup preamplifier and tone control circuits and have provisions for low-impedance broadcast microphone as well as a utility channel for tuners and whatnot. Furthermore, all chan-

nels were to maintain the bandwidth and low distortion normally achieved in single-channel hi-fi preamps. The unit finally built works so well that I'm not ashamed to recommend it to anyone who wants the flexibility of multiple-channel mixing in his audio system without degradation in quality.

The microphone preamplifier

The schematic of the whole mixer preamplifier is shown in Fig. 1. The microphone preamplifier section is conventional enough except that the first stage uses a 6AU6 with the plate and suppressor grounded. The circuit is one used in broadcast equipment and described by F. Langford Smith in the fourth edition of *Radiotron Designer's Handbook*. The idea is to reduce heater-to-plate hum leakage by interposing grounded pins between the heater terminals and the screen, which acts as the plate of the tube in this circuit. To reduce hum leakage further the tube socket of this stage should be of ceramic rather than the usual molded composition material. High-frequency hiss is kept to a minimum by making all resistors carrying audio currents in this stage low-noise deposited-carbon units. Feedback is applied around the first stage as an additional precaution against noise and distortion.

Excellent decoupling of the B plus

supply is important if the microphone and phonograph low-level stages are not to amplify ripple voltage or oscillate at subsonic frequencies. A 0D3/VR150 voltage regulator tube decouples these two stages. The use of VR tubes in this manner gives better filtering and decoupling than the usual capacitor.

The 6AU6 is followed by a 6C4 voltage amplifier having an unbypassed cathode resistor to provide negative feedback in this stage. The number of different types of tubes used in the design could have been reduced by using a triode-connected 6AU6 in this and the other two 6C4 stages, but a 6AU6 draws twice as much heater current as a 6C4. With seven tubes in the control unit drawing power from the main amplifier, it was felt best to keep the current requirements as low as possible.

The phono preamplifier

This section is also a two-stage design with a loss type R-C equalizer between stages to provide proper compensation for various recording curves. A 6AU6 connected in the normal manner is used here although a 5879 would have been a better choice. The 6AU6 was used to find out if it was as good a performer in low-level stages as some writers have indicated. If a selected tube is used in this stage, the results

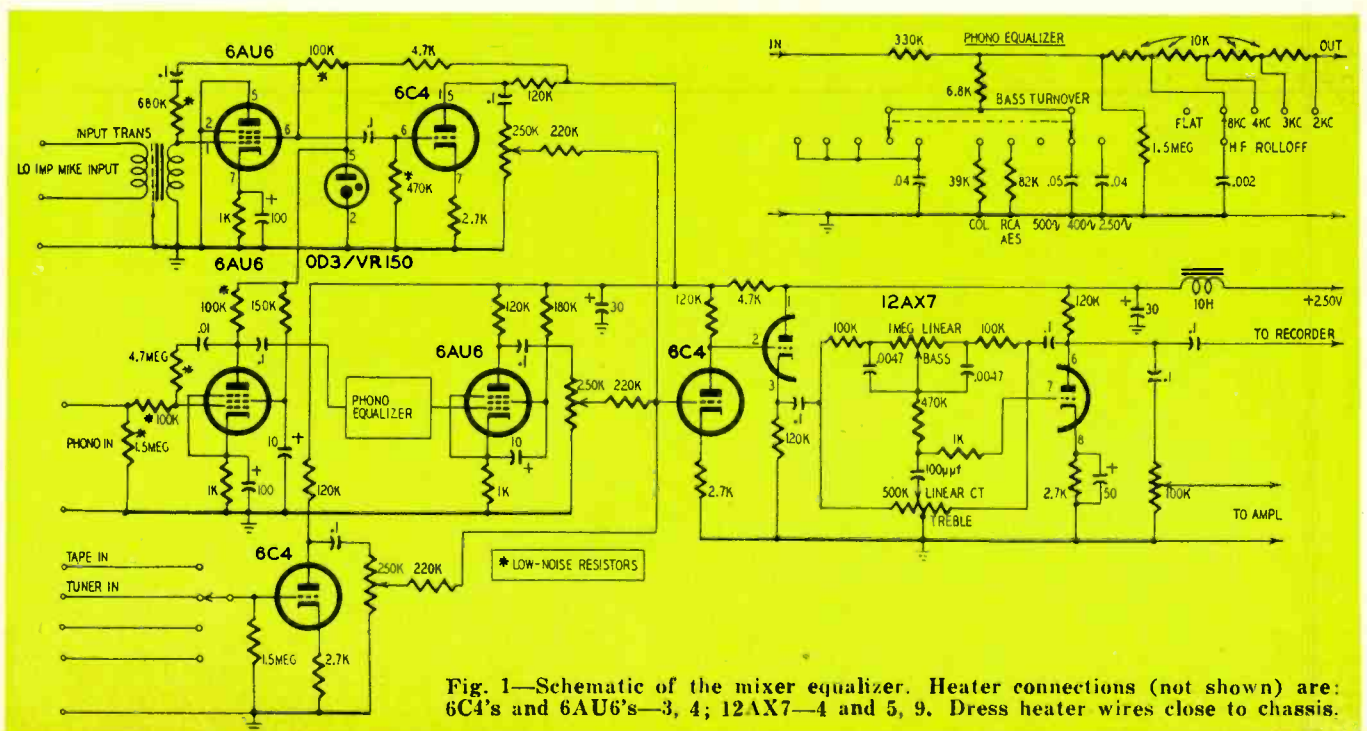

Fig. 1—Schematic of the mixer equalizer. Heater connections (not shown) are: 6C4's and 6AU6's—3, 4; 12AX7—4 and 5, 9. Dress heater wires close to chassis.

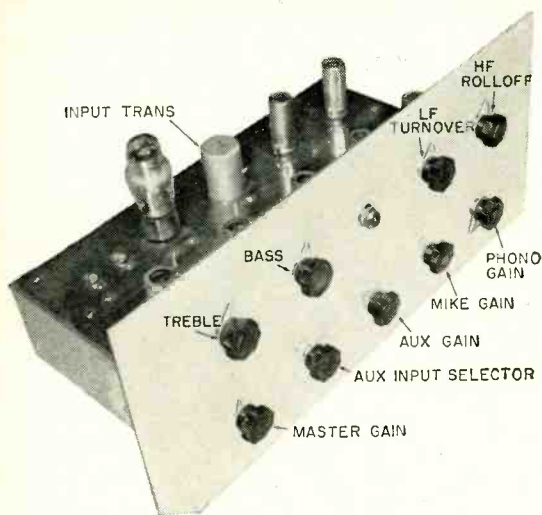
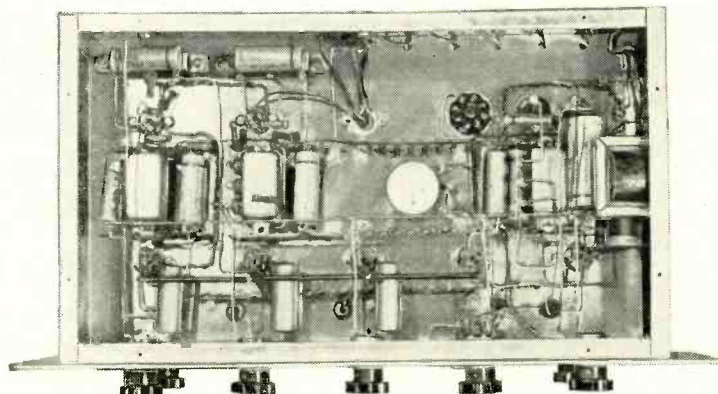

Fig. 2—Front view of instrument shows the layout of all panel controls.

The arrangement of components can be seen from this under-chassis photograph.



are excellent. Although the hum level is higher than that of the microphone channel due to the bass boost in the equalizer section and the difference in the way the two input 6AU6's are connected, hum is still not audible at normal volume settings.

Low hum and noise levels can only be achieved if 6AU6's are selected from a batch of a dozen or so. If the builder doesn't want to go to this trouble, 5879's can be substituted with minor circuit changes. If this change is made, however, a small loss in gain will result due to the difference in transconductance between the two tube types.

Following the initial 6AU6 is the equalizer section. Loss type filters are used in preference to feedback networks because of the difficulty in obtaining satisfactory low-frequency response with feedback circuits. Separate switches were used for low- and high-frequency equalization to provide sufficient flexibility to match any recording curve without the multitude of resistors and capacitors needed when a separate equalizer section is used for each curve. The high-frequency rolloff is adjustable from flat response to 2,000 cycles in five steps and the bass turnover to any of the standard recording curves.

The two switches should be set by ear rather than by formula. Since all of the settings are used at one time or another, and this circuit uses such a small number of parts, it is probably worth the trouble to provide all 25 possible equalization curves.

A great deal of loss is introduced in the equalizer circuit to allow bass boost to continue to 20 or 30 cycles, so the second stage of the phono preamplifier is a pentode-connected 6AU6. With the usual unbypassed cathode providing negative feedback, this stage brings the level of the phonograph channel up to that of the other two mixing channels.

A selector switch enables the third channel to be used for tape, tuners and various other medium-level inputs. An input resistor of 1.5 megohms prevents undue loading of any high-impedance circuits that may be connected to this

Rear view of equipment indicates position of tubes and other parts.

Photos by Dick Bell, staff photographer, KVAR

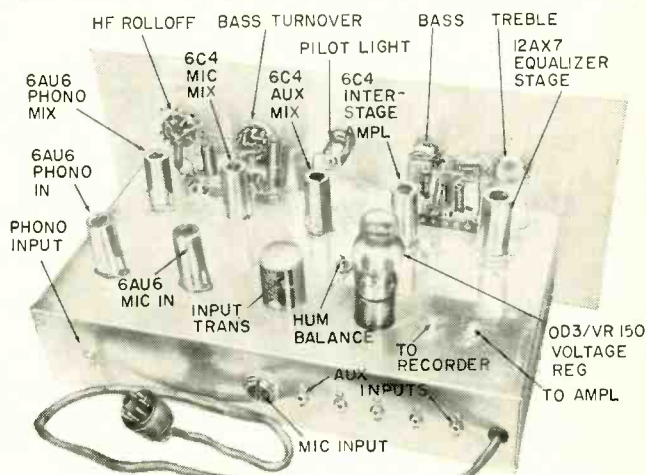

stage. Also, the negative current feedback developed in the cathode of the 6C4 results in low input capacitance which keeps high-frequency losses exceptionally small.

The volume controls for the three channels are bridged together through isolating resistors into the grid of another 6C4. In most amplifier designs considerable variation in high-frequency response is encountered at different settings of the volume control. However, the cathode feedback in the 6C4 neutralizes the Miller effect to a considerable extent and the frequency response of the system is flat to 20,000 cycles even with volume controls set at mid-position.

The 6C4 is direct-coupled to the first half of the 12AX7 tone control stage, eliminating a coupling capacitor and resulting in a little less bass phase shift. The tone control stage is the Baxendall circuit which has recently achieved great popularity. The big feature of this design is that it provides continuously variable turnover frequencies for both bass and treble rather than varying the amount of boost or cut from a certain fixed frequency. The circuit—first introduced in

Wireless World, October, 1952—is fully described in the September, 1953, issue of *Audio Engineering*. Joseph Marshall also praises it in the March, 1954, *RADIO-ELECTRONICS*.

The Baxendall circuit

Most recent adaptations of this circuit eliminate the cathode follower input to save one stage. However, to obtain the full high-frequency compensation of which the unit is capable, it is necessary that it be driven from a source impedance of no higher than 10,000 to 15,000 ohms. Since the direct-coupled arrangement in our design uses no more components than would be associated with a single triode driving the tone control circuit, the cathode follower was retained.

The Baxendall circuit gives high-frequency boost or cut starting at a frequency which can be varied from 1,000 to 8,000 cycles. The low-frequency turnover can likewise be varied from 100 to 800 cycles.

Thus, the circuit can be used to compensate for certain deficiencies which the usual tone control curves are unable to correct. For example, some noisy record surfaces require a sharp high-

All New!
RCA WO-91A
5" 'SCOPE FOR
BLACK and WHITE
and COLOR TV

Only \$229⁵⁰
 User Price (Optional)

RCA WO-91A 5" OSCILLOSCOPE
 Complete, ready-for-use, including new
 WG-300A low-capacitance, dual-purpose
 probe, shielded input cable and
 instruction book.



NOW—AN ALL-NEW OSCILLOSCOPE with features usually found only in more expensive instruments. It has all the 'scope functions you need to do both black-and-white and color TV service work . . . speedily and with top-grade results! Check a few of these work-simplifying features . . . "low-capacitance/direct" probe . . . preset "V" and "H" sweep positions . . . automatic probe-disconnect calibration control. And look at the added features of this instrument:

- Dual-band response. Response flat to 4.5 Mc in wide-band position.
- Voltage-calibrated, frequency-compensated, 3-to-1 step attenuator for "V" amplifier.
- Simplified, semi-automatic voltage calibration for simultaneous voltage measurement and waveshape display.
- VTVM-type graph scales marked in peak-to-peak volts—read voltage amplitude directly from screen.
- Vertical-polarity reversal switch for "upright" or "inverted" trace display.
- Sturdy one-piece low-capacitance/direct probe minimizes circuit loading.
- Z-AXIS input facilities permit direct modulation of the cathode-ray tube grid.
- Preset "V" and "H" sweep positions for speedy, automatic lock-in at "vertical" and "horizontal" frequencies.
- "Plus" or "minus" internal-sync selector.
- Shielded vertical-input connector and shielded cable for minimizing hum and stray field pick-up.
- Positive-lock internal sync.

FREQUENCY RESPONSE: Wide-band position, within-1 db from 10 cps to 4.5 Mc; Narrow band position, within-1 db from 10 cps to 0.5 Mc; within-6 db at 1.5 Mc.

SENSITIVITY: 0.05 volt peak-to-peak per inch (0.018 volt rms) in narrow-band position;
 0.15 volt peak-to-peak per inch (0.053 volt rms) in wide-band position.



RADIO CORPORATION of AMERICA
 TEST EQUIPMENT

HARRISON, N. J.

See the ALL-NEW
 WO-91A at your
 RCA Distributor.
 Order now for
 early delivery.



BUT ONLY ONE QUALITY....THE BEST!

AMERICAN BEAUTY makes the finest of Soldering Irons. No second or third grade bears the name which is still the standard of top performance — sixty-one years of it!

DEPENDABLE • DURABLE • EFFICIENT
American Beauty Soldering Irons are doing fast, precision, production soldering on leading radio, TV, electronic and aviation equipment.

[We also manufacture and stock a wide variety of soldering iron tips in special shapes and sizes. Tell us your requirements.]

American Beauty

ELECTRIC SOLDERING IRONS

Write for Descriptive Literature

AMERICAN ELECTRICAL HEATER COMPANY

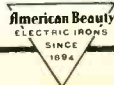

DETROIT 2, MICHIGAN

AUDIO—HIGH FIDELITY

frequency cutoff. In more elaborate amplifiers this is obtained by a separate adjustable-tuned filter. A good compromise can be made by setting the phonograph high-frequency rolloff control and the treble control to the same frequency. A curve of approximately 12 db per octave is thus obtained with the controls operating in cascade.

A close setting can be made easily by ear and the noise level is effectively reduced without the necessity of another control and its associated components. Similarly, bass response can be boosted below the fundamental resonance of unpretentious speaker systems, giving partial bass compensation without the boominess that results if this is tried with conventional tone control designs.

Both potentiometers used in the circuit have linear tapers and the 0.5-megohm treble control must be tapped at mid-rotation. When wiring, note that the tapped control is the high-frequency control. When wiring my chassis I didn't bother to examine the operation of the circuit and took it into my head

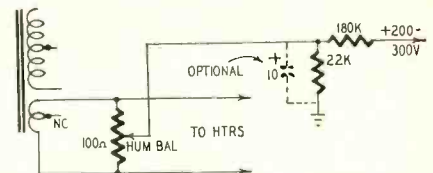

Fig. 3—Hum balance control circuit.

that the 0.5-megohm control was the bass equalizer. The controls for the phono preamp are reversed from the tone control knobs which is confusing to anyone not familiar with the history of the unit.

[The tone-control components—dual concentric-shaft potentiometers and a printed-circuit RC Couplate—are available in one compact unit. This special tone control (Centralab C3-300) is available for \$4.50 from Centralab distributors only.—Editor]

Since the Baxendall circuit is a feedback network, the output impedance is about a few thousand ohms. This is almost as good as a cathode follower, so a reasonable length of cable can be used between the control unit and the main amplifier without concern about high-frequency losses. In my design only about 18 inches of wire connect the two units, so a 100,000-ohm master gain control feeds the Ultra-Linear power amplifier, while the tape recorder is connected directly to the output of the tone control amplifier. This arrangement allows the speaker volume to be adjusted independently of the recording level, but the tone controls still operate during both recording and playback.

If it is desirable to isolate the recorder from the tone compensation circuits, simply bridge the tape recorder across the cathode follower output of the first 12AX7 section. At either place the impedance is low enough that the recorder will not load the circuit, and

MERIT

THE most complete
replacement line

*a transformer or coil
for every TV-radio need.*



Power transformers

P-3059 this and 57 others.



Vertical output transformers

A-3035 with 6 companion types

MERIT

COIL AND TRANSFORMER
CORPORATION

4427 N. Clark Street, Chicago, Ill.



Line voltage regulators

P-3138 and P-3139

**CIRCUIT DESIGN
ENGINEERS**

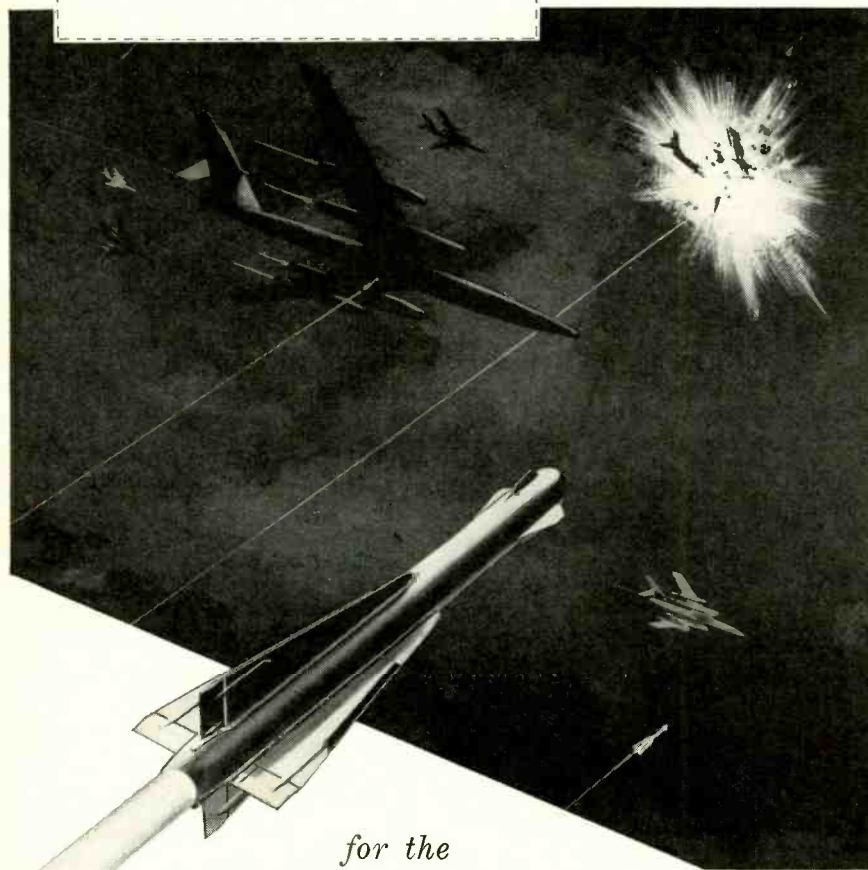

for the
FALCON
GUIDED MISSILE

So accurate and deadly is the Hughes Falcon guided missile produced in Tucson, Arizona, for the U.S. Air Force, that it has knocked maneuvering drone bombers out of the air even without an explosive warhead. Although its electronic brain can outwit any enemy bomber, it is the smallest guided missile in production.

Because of this small size and consequent extreme miniaturized packaging, new production techniques have had to be conceived. This leads to production testing of individual parts, small integrated units, self-contained components, complete integrated systems, and simulated environmental performance.

The development of equipment for producing and testing of such a missile provides a continuous challenge to engineers experienced in electronic circuit design including the following:

Pulse—Power Supply—Transistor—IF and RF—Clamping—Wave Shaping—Switching—Phase Shift—Input—Output—Modulator—Discriminator—Feedback—Video Circuits.

Write to

ENGINEERING
STAFF RELATIONS

HUGHES

Aircraft Company

Tucson, Arizona

AUDIO—HIGH FIDELITY

the signal level is the same at either stage.

Note that feedback of some sort is applied around every stage of the three-channel unit. This is absolutely necessary if performance is to compare with that of a good power amplifier. With new amplifier designs such as the Williamson and the Ultra-Linear, feedback loops can be applied over several stages. But in preamplifier circuits, tone and gain controls isolate various stages and it is difficult to incorporate negative feedback without adding a great many extra tubes that contribute no gain to the basic circuit. Eliminating bypass capacitors to provide negative current feedback around individual stages seems the best solution for uncomplicated designs.

Mechanical design

The photographs show the mechanical layout of the chassis to be perfectly straightforward. A 16 x 9-inch aluminum chassis was used since that amount of space had originally been set aside for a control unit in the installation. Using a large chassis leaves plenty of room to wire neatly without crowding parts or worrying about stray coupling effects. Fig. 2 shows the layout of the panel controls. The two first 6AU6 sockets are shock-mounted; a ground bus connected to the chassis at only one point is used for all ground

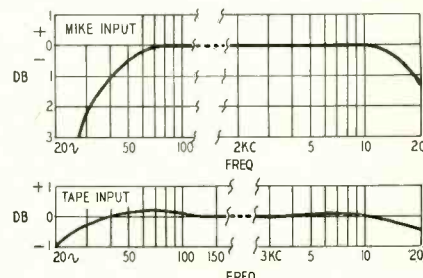
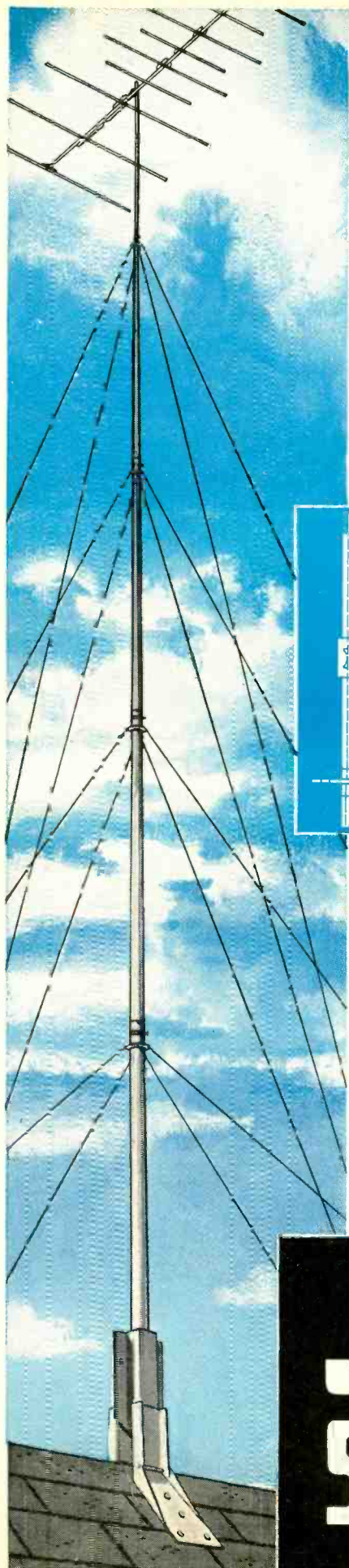

Fig. 4—Tape and mike amplifier response.

connections; all heater leads are tightly twisted and kept separated from audio leads. These are all important features of any good design which aims to keep noise and hum to an absolute minimum.

Another important feature for hum reduction is some means of balancing the heaters to ground. If a hum-balancing potentiometer is not included in the associated power amplifier it can be added without difficulty. Disconnect the heater center tap from the power transformer and connect the 6.3-volt leads through a balancing potentiometer to a source of about 20 volts above ground as shown in Fig. 3. With these precautions the hum level will be no higher than if a d.c. supply were used for the heaters. Langford Smith goes into this thoroughly in *Radiotron Designer's Handbook*.

These precautions paid off when I first listened to the completed unit. In attempting to make accurate checks, however, I ran into difficulties. There wasn't a good scope or square-wave



New concept in telescoping TV masting
 ... utilizes J & L Perma-Tube

REDUCE YOUR TV MAST COST OVER 20%

Use high-strength, corrosion-proof J & L Perma-Tube 10-foot telescoping sections to easily construct 30 to 50-foot masts

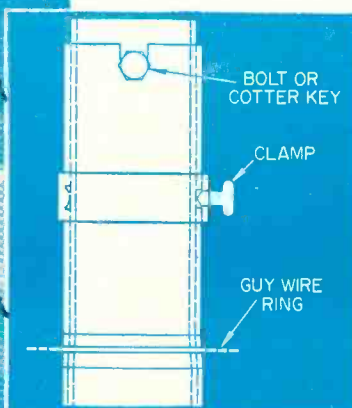

Only J&L Telescoping Perma-Tube offers:

- Joint design which provides instant field assembly
- Machine-fitted joints that insure close tolerance for high strength and rigidity
- Guy wire ring position that eliminates all binding and guy wire interference

No longer is it necessary to buy expensive, ready-made masts. Now you can "tailor-make" your own with standard 10-foot lengths of 16-gage J&L Perma-Tube—and save money.

It's available in cartons from your local distributor in five diameters. The largest base section OD is 2¼ inches and each telescoping section is ¼-inch smaller, the smallest section having an OD of 1¼ inches.

J&L Perma-Tube in the 1¼-inch size can be used interchangeably as a fitted-joint section for smaller masts or as the smallest and topmost piece of longer telescoping masts.

Corrosion-proof J&L Perma-Tube is treated with Vinsynite—then coated both inside and outside with a metallic vinyl resin base. It successfully passes ASTM's 500-hour-minimum salt spray test—which guarantees Perma-Tube's longer life on the job.

Sturdy J&L Perma-Tube is made of a special, high-strength, J&L-produced steel. A 10-foot section of 1¼-inch diameter by 16 gage can support a weight at its center point of 200 pounds with a minimum of deflection and permanent set.

Order these new telescoping sections along with your regular 1¼-inch J&L Perma-Tube. Hardware—cotter keys or bolts, clamps and guy rings—may also be secured from your local distributor. For more information write J&L direct.

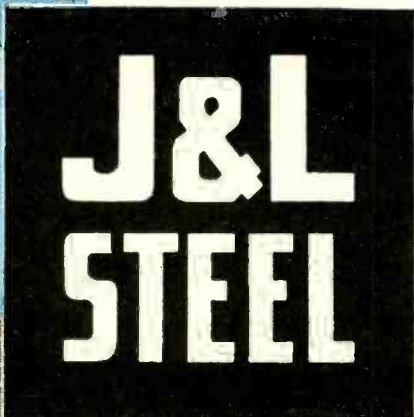

Jones & Laughlin
 STEEL CORPORATION — Pittsburgh

**NO SPEAKER
INSTALLATION
PROBLEMS**

with

QUAM

Adjust-a-Cone[®]

SPEAKERS

QUAM speakers have transformer mounting brackets welded to the baskets.

There is a universal mounting bracket packed with every QUAM 3 1/2", 4", 5", 5 1/4", 6 1/2", 4" x 6" and 5" x 7" Adjust-a-Cone speaker, AT NO EXTRA COST.

In addition there are four threaded mounting holes in the pot . . . besides the usual mounting holes in the speaker basket.

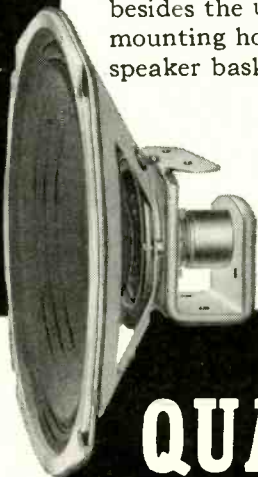

**QUAM
HI-FI
SPEAKERS**

for fine audio
reproduction
at low cost

A good hi-fi speaker need not be expensive. Prove it to yourself by listening to QUAM extended range and coaxial speakers. They can't be beat for small budget hi-fi installations. Write for QUAM Hi-Fi Catalog No. 69.

ask for QUAM, the quality line for all your speaker needs

QUAM-NICHOLS COMPANY

236 EAST MARQUETTE ROAD • CHICAGO 37, ILLINOIS

LEARN TV in KC

UNIVERSAL TV FAMOUS FOR 24 YEARS
1,000's OF SUCCESSFUL GRADS COAST TO COAST



Easy, quick, fascinating. Learn TELEVISION in 36 short weeks of enjoyable companionship in shop training. Wonderful job opportunities. Graduates have choice of many jobs or can establish their own TV repair shop.

YOU CAN START EARNING AS MUCH AS \$150 PER

WEEK. NO limit as time goes on. U.S. is an old established school (TV exclusive for 24 years) staffed by expert instructors, headed by one of America's first TV broadcasters. Costs so little to prepare yourself for life. No previous experience needed. Fully approved for Korean Veterans. Also fully approved course in color TV (1st in U.S.) Send coupon now for FREE BOOK on TV and Electronics opportunities.

WRITE FOR
FREE CATALOG

FILL OUT COUPON

UNIVERSAL TV SCHOOL
1220R Admiral Boulevard, Kansas City, Missouri

PLEASE SEND ME INFORMATION FREE. Age _____

Name _____

Address _____

City _____ State _____

Check here if Korean veteran

RADIO-ELECTRONICS is paying good rates on acceptance for original and unusual articles on audio, television, FM and AM servicing, as well as articles on industrial electronic equipment and application. Send for a copy of our Authors' Guide. Address:

**THE EDITOR
RADIO-ELECTRONICS**

25 West Broadway, New York 7, N. Y.

AUDIO—HIGH FIDELITY

generator available and there was no means of testing intermodulation. It was finally decided that since it is the entire system that counts after all, what measurements could be made would be done through the entire system. Consequently the frequency-response tests (Fig. 4) were made from the output of the power amplifier with a loudspeaker load!

Under these conditions, the response of the system from the tape recorder input to the speaker with all gain controls at mid-setting is within 1 db from 20 to 20,000 cycles. The response from the low-impedance microphone input is flat within 2 db from 30 to 20,000 cycles. The harmonic distortion at any frequency within this range measured at

Parts for mixer equalizer

Resistors: 4—1,000, 4—2,700, 2—4,700, 1—6,800, 4—10,000, 1—39,000, 1—82,000, 3—100,000, 6—120,000, 1—150,000, 1—180,000, 3—220,000, 1—330,000, 1—470,000, 2—1.5 megohms, 1/2 watt; 3—100,000, 1—470,000, 1—680,000, 1—1.5 megohms, 1—4.7 megohms, 1/2-watt low-noise units; 1—100,000, 3—250,000, 1—500,000 (linear), 1—1 megohm, linear, center-tapped potentiometers.

Capacitors: 1—100 µf, 1—.002 µf, 2—.0047 µf, 1—.01 µf, 2—.04 µf, 1—.05 µf, 10—0.1 µf; 2—10 µf, 2—30 µf, 300 volts, electrolytics; 1—50 µf, 2—100 µf, 25 volts, electrolytics.

Miscellaneous: 3—6AU6, 3—6C4, 1—12AX7, 1—OD3/VR-150, 1—octal socket, 6—7-pin miniature sockets, 1—9-pin miniature socket, 1—input transformer; line to grid, 600-ohm center-tapped primary, 60,000-ohm secondary, electrostatic shield (Triad A-10J or equivalent); 7—shields for miniature tubes; 1—10-h choke, 75 ma; 1—1-pole 4-position switch, rotary; 1—2-gang 5-position rotary switch; 1—1-pole 5-position switch, rotary; 1—power cord; 1—chassis; 8—jacks; 9—knobs; 1—pilot light and assembly.

1-watt output at the voice coil is less than 1%.

If intermodulation test equipment is available, the cathode bias resistors could be adjusted for minimum distortion, and with a little trial and error work the distortion in the mixer pre-amplifier could probably be reduced to one-tenth the preceding figure. Even as the unit stands it is good by commercial high-fidelity standards. These results are achieved with a circuit not at all tricky or erratic. Anyone building it without test equipment available can be sure that his unit will perform at least as well as this one if good layout and wiring is practiced.

The mixer equalizer will deliver about 1 volt from normal microphones or long-playing records. This may not be enough for some low-sensitivity power amplifiers. If more gain is needed, the 6C4 preceding the tone control stages can be changed to a 6AU6. If this change is made, it will probably not be possible to retain the direct coupling to the tone control amplifier, but it is about the easiest way to increase the gain of the design and still retain feedback around each stage.

The mixer equalizer has performed extremely well. I use a speaker system with a range of 50—15,000 cycles, and also tried hooking up the control unit to a friend's ultra-ultra installation. It sounded noticeably better than the well-known commercial preamp he was using.

END

NEW!

NOISELESS!

ELECTRONIC!



Thompson Products

Automatic

Superotor.

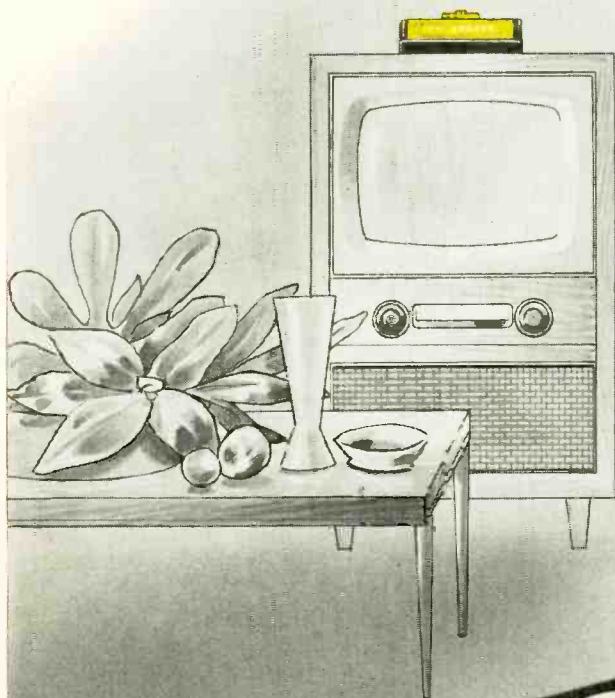

INTERCHANGEABLE ROTORS

Famous time-proved Superotor models "100" and "500" have both been adapted for automatic operation!

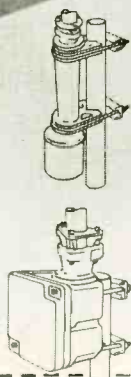

World's only *silent* automatic antenna rotator! No gears, no click, no clatter. Electronic fingertip VP* tuning. Antenna rotation and control is smooth, not in "steps" like ordinary automatics — provides a new standard of tuning accuracy for Fringe, UHF and Color reception. Write today for specifications.

*VP (Vernier Precision)

**OTHER THOMPSON PRODUCTS
ELECTRONIC AFFILIATES**

- Bell Sound Systems • Dage Television • Ramo-Wooldridge Corp. • Pacific Semi-Conductors, Inc.

ELECTRONICS DIVISION

Thompson Products, Inc.



2196 CLARKWOOD ROAD • CLEVELAND 3, OHIO

Available in Canada thru Atlas Radio Corp., Ltd., 50 Wingold Ave., Toronto



Measures 6 1/4" x 9 1/2" x 4 1/2"

Superior's new
Model 670-A

SUPER METER

A COMBINATION VOLT-OHM MILLIAMMETER PLUS
CAPACITY REACTANCE INDUCTANCE AND DECIBEL MEASUREMENTS

SPECIFICATIONS:

D.C. VOLTS: 0 to 7.5/15/75/150/750/1,500/7,500 Volts
 A.C. VOLTS: 0 to 15/30/150/300/1,500/3,000 Volts
 OUTPUT VOLTS: 0 to 15/30/150/300/1,500/3,000 Volts
 D.C. CURRENT: 0 to 1.5/15/150 Ma. 0 to 1.5/15 Amperes
 RESISTANCE: 0 to 1,000/100,000 Ohms 0 to 10 Megohms
 CAPACITY: .001 to 1 Mfd. 1 to 50 Mfd. (Good-Bad scale for checking quality of electrolytic condensers.)
 REACTANCE: 50 to 2,500 Ohms 2,500 Ohms to 2.5 Megohms
 INDUCTANCE: .15 to 7 Henries 7 to 7,000 Henries
 DECIBELS: -6 to +18 +14 to +38 +34 to +58

ADDED FEATURE:

Built-in ISOLATION TRANSFORMER
reduces possibility of burning out meter through misuse.

The Model 670-A comes housed, in a rugged crackle-finished steel cabinet complete with test leads and operating instructions.

\$28⁴⁰
NET



Superior's new stream-lined Model TC-55

TUBE TESTER

QUICKLY AND EFFICIENTLY TESTS RADIO AND TV TUBES INCLUDING: SEVEN PIN MINIATURES; EIGHT PIN SUBMINARS, OCTALS AND LOCTALS; NINE PIN NOVALS
YOU CAN'T INSERT A TUBE IN THE WRONG SOCKET.

It is impossible to insert the tube in the wrong socket when using the new Model TC-55. Separate sockets are used, one for each type of tube base. If the tube fits in the socket it can be tested.

"FREE-POINT" ELEMENT SWITCHING SYSTEM.

The Model TC-55 incorporates a newly designed element selector switch system which reduces the possibility of obsolescence to an absolute minimum. Any pin may be used as a filament pin and the voltage applied between that pin and any other pin, or even the "top-cap."

CHECKS FOR SHORTS AND LEAKAGES BETWEEN ALL ELEMENTS.

The Model TC-55 provides a super sensitive method

The Model TC-55 comes complete with operating instructions and charts. Use it on the bench—use it for field calls. A streamlined carrying case, included at no extra charge, accommodates the tester and book of instructions.

of checking for shorts and leakages up to 5 Megohms between any and all of the terminals.

ELEMENTAL SWITCHES ARE NUMBERED IN STRICT ACCORDANCE WITH R.M.A. SPECIFICATIONS.

One of the most important improvements, we believe, is the fact that the 4 position fast-action snap switches are all numbered in exact accordance with the standard R.M.A. numbering system.

Thus, if the element terminating in pin No. 7 of a tube is under test, button No. 7 is used for that test.

\$26⁹⁵
NET



About Testing Picture-Tubes . . .

Of course you can buy an "adapter" which theoretically will convert your standard Tube Tester into a picture-tube tester. Sounds fine—but—it simply doesn't work out that way!

We do not make nor do we recommend use of C.R.T. adapters because a Cathode Ray Tube is a very complex device and to properly test it, you need an instrument designed exclusively to test C. R. Tubes and nothing else. As compared to a make-shift adapter, which sells for about five dollars, our Model TV-40

C.R.T. Tube Tester sells for \$15.85. But, if you believe that Television is here to stay, then you must agree that the difference in price is more than justified by the many years of valuable service you will get out of this indispensable instrument.

Incidentally, the Model TV-40 is the ONLY low-priced C.R.T. Tube Tester, which includes a real meter. Neons are fine for gadgets and electric-line testers, but there is no substitute for a meter with an honest-to-goodness emission reading scale.

Superior's
New Model
TV-40

C.R.T. TUBE TESTER

Tests ALL magnetically deflected tubes . . . in the set . . . out of the set . . . in the carton ! !

- Tests all magnetically deflected picture tubes from 7 inch to 30 inch types.
- Tests for quality by the well established emission method. All readings on "Good-Bad" scale.
- Tests for inter-element shorts and leakages up to 5 megohms.
- Test for open elements.

EASY TO USE: Simply insert line cord into any 110 volt A.C. outlet, then attach tester socket to tube base (Ion trap need not be on tube). Throw switch up for quality test . . . read direct on Good-Bad scale. Throw switch down for all leakage tests.

Model TV-40 C.R.T. Tube Tester comes absolutely complete—nothing else to buy. Housed in round cornered, molded bakelite case. Only

\$15⁸⁵
NET

**SHIPPED ON APPROVAL
NO MONEY WITH ORDER — NO C. O. D.**

Try any of the above instruments for 10 days before you buy. If completely satisfied then send down payment and pay balance as indicated on coupon. No Interest or Finance Charges Added! If not completely satisfied return unit to us, no explanation necessary.

MOSS ELECTRONIC DISTRIBUTING CO., INC.

Dept. D-180 3849 Tenth Ave., New York 34, N. Y.

Please send me the units checked. I agree to pay down payment within 10 days and to pay the monthly balance as shown. It is understood there will be no finance, interest or any other charges, provided I send my monthly payments when due. It is further understood that should I fail to make payment when due, the full unpaid balance shall become immediately due and payable.

Model 670-A.....Total Price \$28.40
\$7.40 within 10 days. Balance \$3.50
monthly for 6 months.

Model TC-55.....Total Price \$26.95
\$6.95 within 10 days. Balance \$5.00
monthly for 4 months.

Model TV-40.....Total Price \$15.85
\$3.85 within 10 days. Balance \$4.00
monthly for 3 months.

Name

Address

City..... Zone..... State.....

The Model
TV-50

GENOMETER

A versatile all-inclusive GENERATOR which provides ALL the outputs for servicing:

A. M. Radio F. M. Radio Amplifiers Black and White TV Color TV

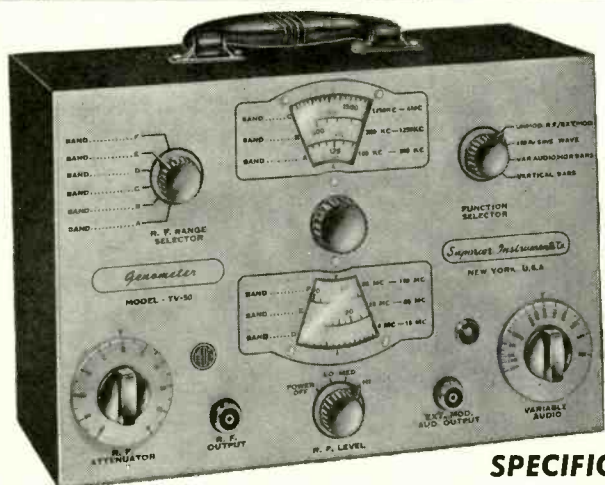

7 Signal Generators in One!

- ✓ R. F. Signal Generator for A.M.
- ✓ R. F. Signal Generator for F.M.
- ✓ Audio Frequency Generator
- ✓ Bar Generator
- ✓ Cross Hatch Generator
- ✓ Color Dot Pattern Generator
- ✓ Marker Generator

SPECIFICATIONS:

R. F. SIGNAL GENERATOR:

The Model TV-50 Genometer provides complete coverage for A.M. and F.M. alignment. Generates Radio Frequencies from 100 Kilocycles to 60 Megacycles on fundamentals and from 60 Megacycles to 180 Megacycles on powerful harmonics. Accuracy and stability are assured by use of permeability trimmed Hi-Q coils. R.F. is available separately, modulated by the fixed 400 cycle sine-wave audio or modulated by the variable 300 cycle to 20,000 cycle variable audio. Provision has also been made for injection of any external modulating source.

VARIABLE AUDIO FREQUENCY GENERATOR:

In addition to a fixed 400 cycle sine-wave audio, the Model TV-50 Genometer provides a variable 300 cycle to 20,000 cycle peaked wave audio signal. This service is used for checking distortion in amplifiers, measuring amplifier gain, trouble shooting hearing aids, etc.

BAR GENERATOR:

This feature of the Model TV-50 Genometer will permit you to throw an actual Bar Pattern on any TV Receiver Screen. Pattern will consist of 4 to 16 horizontal bars or 7 to 20 vertical bars. A Bar Generator is acknowledged to provide the quickest and most efficient way of adjusting TV linearity controls. The Model TV-50 employs a recently improved Bar Generator circuit which assures stable never-shifting vertical and horizontal bars.

CROSS HATCH GENERATOR:

The Model TV-50 Genometer will project a cross-hatch pattern on any TV picture tube. The pattern will consist of non-shifting, horizontal and vertical lines interlaced to provide a stable cross-hatch effect. This service is used primarily for correct ion trap positioning and for adjustment of linearity.

DOT PATTERN GENERATOR (For Color TV):

Although you will be able to use most of your regular standard equipment for servicing Color TV, the one addition which is a "must" is a Dot Pattern Generator. The Dot Pattern projected on any color TV Receiver tube by the Model TV-50 will enable you to adjust for proper color convergence. When all controls and circuits are in proper alignment, the resulting pattern will consist of a sharp white dot pattern on a black background. One or more circuit or control deviations will result in a dot pattern out of convergence, with the blue, red and green dots in overlapping dot patterns.

MARKER GENERATOR:

The Model TV-50 includes all the most frequently needed marker points. Because of the ever-changing and ever-increasing number of such points required, we decided against using crystal holders. We instead adjust each marker point against precise laboratory standards. The following markers are provided: 189 Kc., 262.5 Kc., 456 Kc., 600 Kc., 1000 Kc., 1400 Kc., 1600 Kc., 2000 Kc., 2500 Kc., 3579 Kc., 4.5 Mc., 5 Mc., 10.7 Mc. (3579 Kc. is the color burst frequency.)

The Model TV-50 comes absolutely complete with shielded leads and operating instructions. Only _____

\$47⁵⁰
NET

SHIPPED ON APPROVAL NO MONEY WITH ORDER - NO C.O.D.

Try it for 10 days before you buy. If completely satisfied then send \$11.50 and pay balance at rate of \$6.00 per month for 6 months. No Interest or Finance Charges Added! If not completely satisfied return unit to us, no explanation necessary.

MOSS ELECTRONIC DISTRIBUTING CO., INC.
Dept. D-180, 3849 Tenth Ave., New York 34, N.Y.
Please rush me one Model TV-50. I agree to pay \$11.50 within 10 days and to pay \$6.00 per month thereafter. It is understood there will be no finance, interest or any other charges, provided I send my monthly payments when due. It is further understood that should I fail to make payment when due, the full unpaid balance shall become immediately due and payable.

Name _____
Address _____
City _____ Zone _____ State _____

High power

with

SMALL SPEAKERS

By H. L. MATSINGER

MANY technicians, when considering a PA or other sound reproduction system using an amplifier of more than 10 watts, immediately visualize trumpets, folded horns or other high-power sound projectors. Few realize that the 6-inch speaker—properly baffled—can be used in multiple for a wide range of normal or casual applications. With an ordinary 8-inch bench saw, a couple sheets of plywood, a can of Casco casein glue, some 6-inch speakers, assorted hardware and a little common sense, one can devise a sound projector for almost every moderate-fidelity requirement: a reproducer which will not only be cheaper than the commercial variety, but which can be tailored to a specific need.

In most cases, such as for indoor use, the speaker units can be used just as they are purchased. However, if you feel that you would like to improve the highs to some extent, you can replace the felt dust cap with an aluminum dome easily fashioned from the material of which plates and the containers of many frozen dinners and the like are made. Simply lay a flat portion of the material on a bald, inflated tire or a flat piece of thick rubber, then strike it sharply with a ball-peen hammer. If you make a good strike, the result will be a perfect dome. Trim off the excess metal so that the dome is of the proper size, remove the old felt, then cement the dome to the center of the speaker cone with an air-drying thermoplastic, Ambroid or Akryloid.

Speaker resonance can be lowered slightly by brushing a mixture of castor oil and acetone on the edge compliance. A half-and-half mixture is most commonly used for this purpose. You can

also waterproof the speaker cones for outdoor use by brushing on a mixture of acetone and Ambroid—one part Ambroid to three parts acetone. The acetone will evaporate, leaving the Ambroid impregnated in the felted fibers of the cone. Normally, weatherproofing will raise the resonant frequency, but a prior treatment with the acetone-castor oil solution will minimize the change. Waterproofing is required only in those cases where the cones are directly exposed to the elements.

Most important in the construction of any baffle is rigidity. We must not permit any false vibrations or rattles to occur in the baffle setup: Rattles are unpleasant to the ear and detract from the quality of the reproduced sound; spurious vibrations tend to cancel or exaggerate certain portions of the range, causing improper balance.

Plywood is very satisfactory for the construction of baffles; it has greater rigidity per unit of thickness than natural wood boards. For small single-unit baffles of limited size, 1/4-inch plywood works well; for larger multiunit jobs, 1/2- or 3/4-inch board may be required. (When in doubt, always use the heavier board.) All contact surfaces except the access opening should be glued as well as nailed. On a long unbroken run, glue blocks are a practical necessity; these are small triangular strips about 3/4 inch on each face, about 1 inch long.

To prevent reflections, the inner surfaces of all enclosed baffles are usually covered with Ozite, Kimpac or some other sound-absorbing material about 3/4 to 1 inch thick. A notable exception to this rule is the pentagon-shaped speaker enclosure to be described later. If you study the sketch of this enclosure,

you will find that the rear of each speaker works into an angle formed by two sides, resulting in dispersion of the sound waves and preventing objectionable reflections into the speaker. All square or rectangular enclosures should, however, be treated to avoid direct reflections.

No one article can possibly cover every contingency or situation involving sound propagation or reproduction but we hope, by presenting three basic forms of baffle, to highlight the principles and techniques. The prime considerations are angular coverage, sound level, distribution and, in some instances, weatherproofing.

Baffle construction

The simplest of all enclosed baffles is the single-unit wall cabinet. Shown in Fig. 1, this enclosure is made from 1/4-inch plywood throughout. Nominal dimensions are 12 by 16 inches, with a depth of 6 inches at the top and 4 inches at the bottom. The hole for the speaker is drilled on the vertical center line, about 6 inches from the top. The hole may be round or square; but if

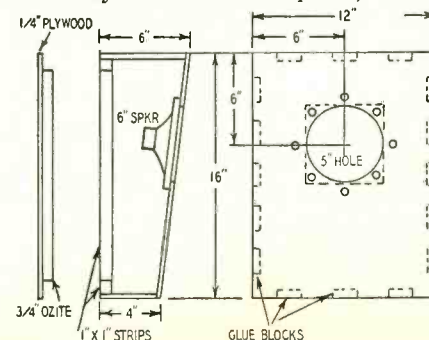

Fig. 1—Diagram shows the front and side view of single-unit wall baffle.

EXCLUSIVE "PHASE-REVERSER" GUARANTEES

THE NEW WALSCO WIZARD

THE MOST ADVANCED, MOST POWERFUL

SUPER FRINGE ANTENNA

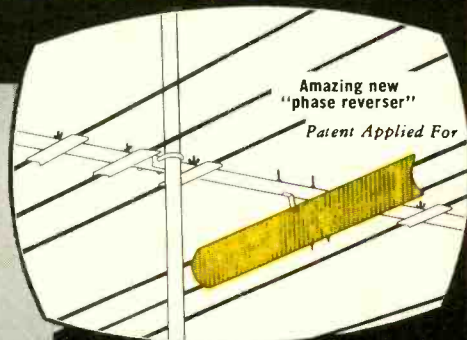

Amazing new "phase reverser"
Patent Applied For

here's positive proof!

IN THE WORLD

The new Walsco Wizard performs as 3 separate antennas combined in one to give the very finest, all-channel picture reception ever seen on any television screen. Extra dipoles, complicated harnesses, or phasing stubs are completely eliminated. And the Wizard is the easiest to assemble and install.

Walsco guarantees the Wizard for 3 years.

| Model | Price |
|-----------------------|--------------|
| Wizardette #4110 | \$14.90 list |
| Wizard #4220 | 19.50 list |
| Wizard Imperial #4230 | 34.90 list |

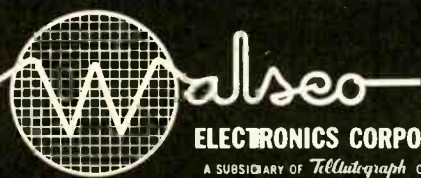

ELECTRONICS CORPORATION
A SUBSIDIARY OF *Tellitograph* CORPORATION

3602 Crenshaw Blvd.,
Los Angeles 16, California

IN CANADA: Atlas Radio Corp., Ltd.

Actual comparison
of fringe antenna performance

| Channels | Gain (db) Single Bay | | | | | | | |
|--|----------------------|-----|-----|------|------|------|------|--|
| | 2 | 4 | 6 | 7 | 9 | 11 | 13 | |
| Walsco Wizard Imperial | 6.1 | 6.9 | 8.2 | 11.9 | 11.6 | 10.8 | 12.6 | |
| Antenna "A" With 3 Phase Reversing Dipoles | 6.3 | 6.6 | 8.1 | 10.5 | 10.2 | 10.6 | 12.4 | |
| Antenna "B" Yagi Type with Phasing Loops | 5.1 | 5.5 | 6.8 | 7.5 | 9.6 | 8.8 | 11.2 | |
| Antenna "C" Yagi Type with Loading Coils | 5.9 | 6.9 | 8.6 | 9.1 | 8.6 | 9.6 | 7.8 | |

ASK YOUR JOBBER FOR FULL INFORMATION AND TECHNICAL BROCHURE ... OR WRITE DIRECT TO WALSCO.

A Patent-Protected Instrument

Good Service Companions
the miniaturized durable
portable electronic instruments
you've waited for . . .

UNITED STATES
ELECTRONIC

REN-O-LYZER

**Electronically Analyzes, CORRECTS
Picture Tube Trouble in 2 Minutes!**

Cleans Picture Tube elements, burns off oxygen, welds open cathodes and filaments . . . automatically and electronically! The TV Serviceman can now RESTORE picture tubes IN THE HOME! Service Charge just \$9.95 to customer—may be sold with minimum guarantee! 7"x9"x4" 6½ lb. steel-cased kit.

REN-O-LYZER
F.O.B. Detroit
\$115.00

UNITED STATES
ELECTRONIC

TUBE-CHECKER

**MUTUAL CONDUCTANCE
AND EMISSION CHECKER**

Accurately checks Picture and Circuit Tubes for filament continuity, emission, gas, shorts and leakage under actual load conditions—in 20 seconds! 7"x9"x4" 7 lb steel-cased kit.

TUBE-CHECKER
\$98.50

Prices slightly higher
west of Rockies

ONLY THE REN-O-LYZER FORECASTS REPAIRABILITY!

Increase your customer-confidence—increase your sales amazingly with these "ON THE JOB" quality-built, electronic companions! You can restore dark, fuzzy pictures to full, bright contrast with the revolutionary REN-O-LYZER! Surveys prove that 90.1% of picture tubes Ren-O-Lyzed are still in use after 1 year's time! Each Ren-O-Lyzing job at \$9.95 is creating an average \$120.00 weekly increased income for every Ren-O-Lyzer unit in use. The TUBE-CHECKER eliminates all guesswork, proving to the customer IN THE HOME, the need for replacement of defective tubes. Order today . . . don't delay this opportunity for increased income. Instruments extremely simple to operate.

**UNITED STATES ELECTRONIC
RESEARCH & DEVELOPMENT CORP.**

1605 W. Lafayette Detroit, Mich. Woodward 3-4498

Send me name of nearest dealer and further details.

11/55 R-E

Name _____

Address _____

City _____

Zone _____ State _____

AUDIO—HIGH FIDELITY

square, you must supply an auxiliary cardboard baffle to prevent leakage at the corners. The opening may be covered with grille cloth or a thin silk supported on a piece of screening. Since any cloth is primarily decorative and may attenuate the highs, you can protect the cone just as well with a plain piece of metal or plastic screening.

No port is provided in this wall cabinet; the cubical content of the enclosure is sufficient to permit unrestricted speaker-cone excursions. An important factor is the Ozite pad on the back panel which prevents reflections. The front panel is strengthened with the glue blocks, while the 1 x 1-inch strips provide secure anchorage for the back panel. Means for hanging the baffle are left to your own imagination; use screw eyes, brackets or even overhead wires. Just be certain that the support does not vibrate.

The multiunit baffle (Fig. 2) designed for 360° coverage is more complex. Although ¼-inch plywood might be used in its construction, a safer bet would be to use ⅜- or ½-inch stock throughout. Actual size is not critical, but for good operation the minimum should be about 36 x 36 x 9 inches, which will permit the centers of the speaker holes to be 9 inches from each end and have a spacing of 18 inches between centers. The two cross braces are made from 1 x 2-inch strips, notched in the center, and 1 x 1-inch strips support the top and bottom panels. All points of contact are coated with a thin layer of Casco casein glue. The assembly is made, except for the top panel, using ¾-inch brads to hold the parts in place. Then let the entire assembly sit for 24 hours while the glue hardens. Note that the bottom panel contains four 2-inch ports on 9-inch centers. After the glue hardens, you may tack in the 4-inch strips of Ozite, install and wire the speakers, then screw on the top panel. Protection for the speaker cone can be the same as

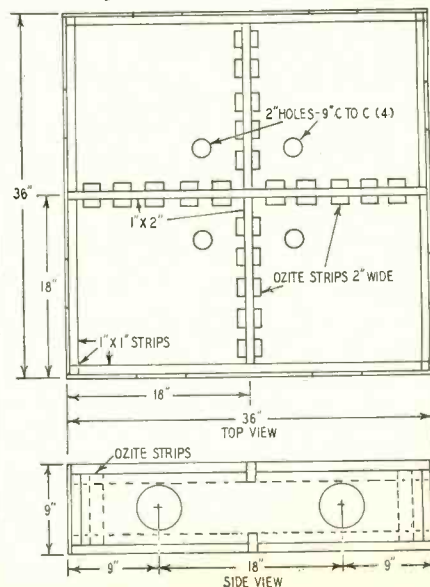

Fig. 2—Diagram shows layout for a car-top or suspended speaker baffle.

AUDIO—HIGH FIDELITY

that used in the small single-unit speaker. Further, if this baffle is going to be used for car-top mounting, the cones should be waterproofed—or else stay out of the rain.

When using this type baffle on a sound truck or car, some means must be provided for fastening. The simplest and perhaps the most satisfactory way to do so is to purchase a couple of suction-cup cross members of the type formerly called ski carriers from your local auto accessory store. These relatively cheap carriers come complete with straps to prevent shifting when the car is in motion. Just mount the baffle on the cross members with screws, moisten the cups and adjust the straps for a satisfactory holddown. Speeds in excess of 50 miles per hour will not dislodge a tight job, although the wind pressure may be a little tough on the speaker cones. This speaker cluster will handle 20 to 25 watts without laboring.

Heavy-duty baffle

Because of the stresses and forces involved, a heavy-duty installation must necessarily contain all the essentials that go to make a good sound reproducer. A steeple speaker installation made in a church about 2 years ago has been proven by that most stringent of all tests—*time*. We can feel pretty certain that what worked well in this case will perform equally well in a similar application.

From the start, our foremost consideration was tonal quality. This was a new church in a new community, and the pastor was a young man with the old-fashioned idea that no church is complete without a belfry. But bells are expensive and the steeple was small, so the only answer seemed to be electrical reproduction. There came the rub.

Like many of us, this pastor had heard many steeple installations which gave out much sound, which did *not* sound natural. He said emphatically, "I want it to sound like bells." Now bells have, among other qualities, a nondirectional effect, since they vibrate around their entire periphery. It was up to us to duplicate this action. A cluster of trumpets, alternately stacked, might have done the trick in the horizontal plane, but this meant at least eight, and we still had to consider matters from the vertical standpoint. Worse yet, the job had to be done on a "satisfaction-guaranteed" basis, so that we couldn't take too many chances.

As a result, we came up with the pentagon-shaped enclosure shown in Fig. 3. This is an enclosed baffle 4 feet high. The sides are just a shade less than 2 feet so that we could be certain of getting them out of a 10-foot sheet of plywood. On the center line of each side, 5-inch holes were cut, starting 6 inches from the top and allowing 1 foot between holes. With the bench saw, each side was trimmed with a 36° bevel, and 25 pieces of 1 x 2-inch strips were



*Opens as easily
as an
umbrella*

ALL-ALUMINUM Conical ANTENNAS

WITH THE NEW AND AMAZING

"Presto"

INSTANT MOUNT ASSEMBLY

Complete line of 16 full size, completely pre-assembled conical antennas with doweled elements and molded plastic insulator of high impact polystyrene. See new Tenna catalog.

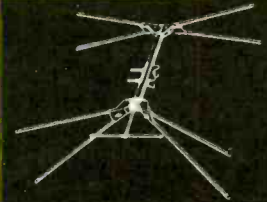
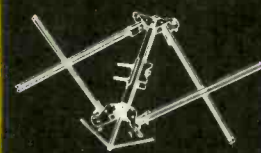

REMOVE FROM BOX • OPEN ELEMENTS • AND PRESTO, IT'S READY!



MODEL T-801
\$417

LIST

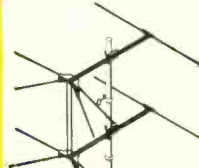

MODEL T-802
\$875

LIST

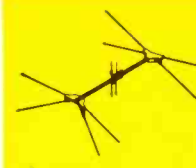

MODEL T-811
\$500

LIST



MODEL T-812
\$1042

LIST



MODEL T-791
\$444

LIST



MODEL T-792
\$931

LIST

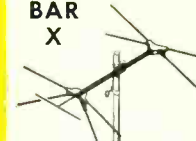

BAR X
MODEL T-751
\$556

LIST



BAR X
MODEL T-752
\$1153

LIST

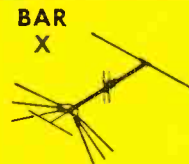

MODEL T-781
\$556

LIST



BAR X
MODEL T-782
\$1153

LIST

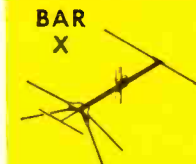

BAR X
MODEL T-851
\$472

LIST



BAR X
MODEL T-852
\$986

LIST

Tenna Manufacturing Co.

7580 GARFIELD BLVD. • CLEVELAND 25, OHIO

in ceramics

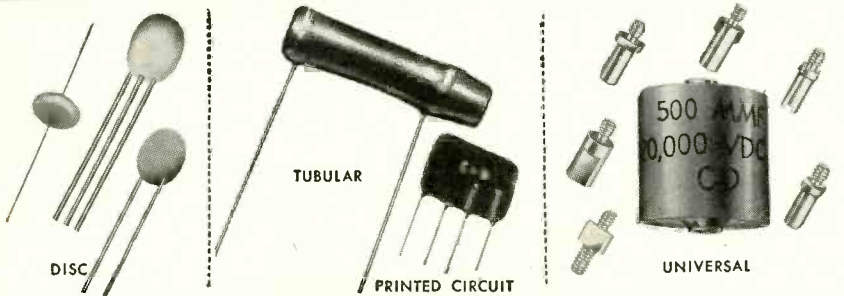

you can see why C-D is always the leader

THE ONLY CERAMIC WITH THE MILLION-DOLLAR BODY

C-D Ceramic Capacitors are made from beginning to end under one roof in a huge plant devoted completely to ceramic capacitor production. Every process . . . every ingredient is under constant control. You can see the reasons for C-D's outstanding superior quality.

And to help you, C-D Ceramic Capacitors are packaged in compact, crystal-clear, easy to handle and always usable plastic boxes (no extra charge). That's why Distributors *who know* carry the complete C-D line. See your C-D Distributor today. He's listed in your local Classified Telephone Directory.

There are more C-D capacitors in use today than any other make.



CONSISTENTLY DEPENDABLE CORNELL-DUBILIER CAPACITORS

PLANTS IN SOUTH PLAINFIELD, N. J.; NEW BEDFORD, WORCESTER AND CAMBRIDGE, MASS.; PROVIDENCE AND HOPE VALLEY, R. I.; INDIANAPOLIS, IND.; SANFORD AND FUGUAY SPRINGS, N. C.; SUBSIDIARY: THE RADIART CORPORATION, CLEVELAND, O.

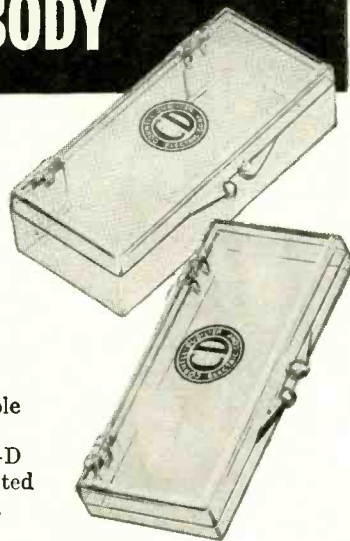

AUDIO—HIGH FIDELITY

cut in the same manner. These strips had an overall maximum dimension of approximately 10 3/4 inches. The angle was cut along the 2-inch dimension. These are the inner-braces and must be cut with extreme accuracy so that the edges of the plywood will butt together. We made up our inner braces first, glued them, used saddle staples to secure them and let them dry for 24 hours. When they were dry, we glued on the sides, using No. 16 1-inch brads to hold them in place. Then we glued and nailed on the bottom, using fourpenny finishing nails.

The bottom and top are cut from 3/4-inch plywood to insure rigidity, and the top has cut in it a 10-inch port. This port is not extremely critical so, if the circle cutter only goes to 4 1/2 inches, don't worry too much. The top piece is secured with screws to provide access to the wiring. However, the speakers were mounted on the face of the panels, rather than inside, to permit rapid servicing whenever needed. The screws used to mount the speakers were No. 6 1/2-inch, and the starter holes were drilled with a No. 34 drill. All the speakers of a tier were wired in series. Since the admittance curves of several random speakers showed about 6 ohms at 1,000 cycles, we paralleled series-connected lines 1 and 3 (60 ohms) with series-connected lines 2 and 4 (60 ohms) to give us a calculated impedance of

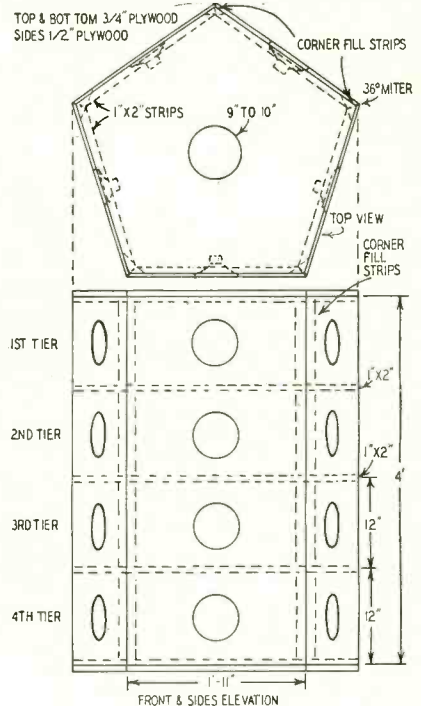

Fig. 3—Diagram shows layout of the heavy-duty steeple reproducer.

ALMO'S ONE TIME SPECIAL FOR MUSIC LOVERS



Meissner

FM RECEPTOR

(with cabinet) adds frequency modulation to any regular AM set . . .

This model is a precision built instrument, designed for simple connection to your present AM radio . . . instantly converting it to a thrilling new AM-FM set, full-scale fidelity, sensationally free from static, station interference and fading.

MODEL 8C WITH CABINET

~~\$60.00~~ Now Only

\$39.50

Come in, Call or Write to the

Almo RADIO CO.

509 ARCH ST., PHILA., PA. • WA 2-5153

Branches: CAMDEN, N.J. • ATLANTIC CITY, N.J.
NORRISTOWN, PA. • WILMINGTON, DELAWARE
SALISBURY, MARYLAND

AUDIO—HIGH FIDELITY

about 30 ohms, just right for the output of our amplifier. Further, since the line from the amplifier was only about 25 feet, we had no worries about line drop.

There was a certain element of danger in having so many speakers in series, since a single failure would put 10 units out of business. At first we considered putting a 15-ohm resistor across each speaker so that if one went out it wouldn't take the whole string. But on second thought we ruled out this drastic move on the grounds that each speaker was conservatively rated at 3 watts, a total of 60 watts, while our amplifier was rated only at 50 watts.

Fewer tiers of speakers could be used with a reduced power input. Each tier of speakers is complete in itself, identical in form, so that you could make it one, two or three high, without altering the basic design in any way except for the height of the sides. The tiers are rated at 15 watts input, so that for a 25-watt amplifier two tiers would be sufficient. With the removal of a tier, a reduction of 1 inch in the size of the port is permissible, so that for a single tier the port would be 7 inches in diameter.

Speaker phasing

Attach a couple of leads about 6 inches long to a 4.5-volt battery. Then, holding the negative lead to one terminal of the speaker, touch the positive lead to the other terminal. The speaker cone should move outward; if it does not, reverse the battery leads to the speaker, then mark with some quick-drying paint, lacquer or nail polish the terminal to which you applied the positive lead. Do this to all the speakers you intend to use. Then, when you come to connect them, just remember that when in *series*, the unmarked terminal of one will go to the marked terminal of the other; in *parallel*, all marked terminals are wired together.

Ordinary loudspeakers in projector type baffles can be used to advantage in almost any application which does not call for sound to be projected over a great distance in a straight line. For use in skating rinks, dance halls, juke boxes and wherever it is desirable to cover a large area at a rather high sound level, we can almost always use a projector type baffle.

Sound attenuates 6 db each time the distance from the source is doubled. Thus, in a noisy location where it is desired to have the sound level at an average of 75 to 80 db, we may find that when we use only two trumpets, we will have some spots where the sound is uncomfortably loud—and which will therefore be avoided by the clientele. Conversely, if we operate the trumpets at a level low enough for a comfortable approach, we will find that in the more remote spots the sound is masked by the noise level. By contrast, a multiple arrangement of small speakers will give a uniform level of sound throughout the hall and the initial cost will be the same, or lower, for better-quality sound. END



A. A. Ghirardi

J. R. Johnson



...here's how to LEARN SERVICING R-I-G-H-T!

Complete training in modern professional methods . . . only \$12 . . . 3 months to pay!

FIX ANY RADIO OR TV SET EVER MADE...easier...better...faster

Radio & TV Receiver TROUBLESHOOTING AND REPAIR

by Ghirardi & Johnson

822 pages, 417 illustrations
Price \$6.75

(See special offer in Coupon)

This big, 822-page book brings you the kind of PROFESSIONAL training that helps you handle the toughest radio-television-electronic service jobs as slick and as accurately as you now do the easy ones!

For service beginners, Radio & Television Receiver TROUBLESHOOTING AND REPAIR is a complete, easily understood professional training course. For experienced servicemen, it is the ideal way to "brush up" on specific jobs; to develop better troubleshooting methods and shortcuts; and to find quick answers to puzzling service problems.

Step by step, it takes you through each service procedure . . . from locating troubles quicker and with less testing to repairing them faster and better.

You learn to deal with any kind of trouble in any kind of receiver. No guesswork. No aimless testing.

Here are just a few of the subjects covered: Components and Their Troubles; Basic Troubleshooting Methods; "Static" and "Dynamic" Testing; Practical Troubleshooting Tips and Ideas; AC/DC, 3-way Portable and Battery-set Problems; Servicing Communications Receivers; A Complete Guide to Television Service; AM, FM and TV Realignment Made Easy; Resistor, Capacitor, Inductor and Transformer Problems; Servicing Tuning Selector and Switching Mechanisms; Loudspeakers; Servicing Recorders and Record-playing Equipment . . . and dozens more. Use coupon. Read it for 10 days at our risk.

LEARN BASIC CIRCUITS...and watch service "headaches" disappear!

Radio & TV Receiver CIRCUITRY AND OPERATION

by Ghirardi & Johnson

669 pages, 417 illustrations
Price \$6.50

(see special offer!)

It's amazing how much easier you can repair radio and television sets and even industrial electronic equipment when you know all about their circuits. You locate troubles in a jiffy because you know what to look for and where to look. You handle jobs lots faster, better . . . and more profitably.

Radio & Television Receiver CIRCUITRY AND OPERATION gives you a complete understanding of basic circuits as well as their variations. It teaches you to recognize them . . . to understand their peculiarities . . . to

know their likely "troublespots" . . . and how to eliminate guesswork and useless testing.

Throughout, this new book brings you the kind of above-average professional training that fits you for the bigger, better-pay jobs. Covers all circuits used in modern television and radio receivers, amplifiers, phono pick-ups, record players, etc.

Price only \$6.50 . . . or see money-saving combination offer in coupon. 10-day FREE examination.

Save \$1.25!

Make your training library complete. Have ALL the latest data at your fingertips. Get both these books at only \$12.00 for the two . . . YOU SAVE \$1.25.

RINEHART BOOKS ARE SOLD BY LEADING BOOK STORES

FREE EXAMINATION . . . easy terms!

Dept. RE-115, RINEHART & CO., INC.
232 Madison Ave., New York 16, N.Y.

Send books indicated for FREE EXAMINATION. In 10 days, I will either remit price indicated plus a few cents postage or return books postpaid and owe you nothing.

Radio & TV CIRCUITRY AND OPERATION (Price \$6.50) Radio & TV TROUBLESHOOTING AND REPAIR (Price \$6.75)

COMBINATION OFFER . . . Both books only \$12.00 (Regular price separately \$13.25 . . . you save \$1.25)

(Combination offer is payable at rate of \$3 (plus postage) after 10 days if you decide to keep books, and \$3 a month thereafter until \$12 has been paid.)

Name _____

Address _____

City, Zone, State _____

OUTSIDE U.S.A. . . . \$7.25 for TROUBLESHOOTING AND REPAIR; \$7.00 for CIRCUITRY AND OPERATION; \$13.00 for both books; Cash with order, but money refunded if you return books in 10 days.

FOR GOLDEN EARS ONLY

*Pentron HFP-1 preamplifier;
National Horizon 20 amplifier;
National Horizon 5 preamp; new
records review*

THE audiophile with a thin wallet and a desire for a high-fidelity recorder is faced with a real Hobson's choice. The performance of several professional and semiprofessional recorders fully lives up to high-fidelity standards, but their prices, beginning at around \$300 and averaging closer to \$400, are far beyond his purse. On the other hand, the "home type" equipment, selling for around \$100, misses high-fidelity standards rather widely. Accordingly, when he looks in the catalogs and notes the Pentron 9T-3M basic tape transport mechanism and the companion HFP-1 high-fidelity preamplifier, which together run to about \$125 and are claimed to provide high-fidelity performance, he is inclined to ask himself: "Can you really buy high fidelity in a tape recorder at that price?"

Fig. 1 gives the frequency response of a sample unit submitted by Pentron and tested in my laboratory. Curve A is the response of the preamp alone, with and without the compensator. In the flat position, the greatest departure is +2½ db at 70 cycles and -5 db at 20,000 cycles. The compensator yields a boost of around 5 db above 8,000 cycles and is used normally when recording and playing back at the slow

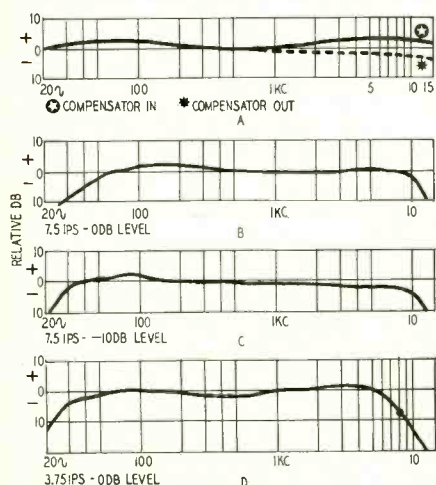

Fig. 1—Various frequency response curves of the Pentron HFP-1 preamp.

speed. Curve B is the response of the outfit when used for recording at 7½ inches per second. It was obtained by feeding constant-amplitude sine waves from an audio oscillator into the mike channel, recording them and then measuring the output when the tape is played back. The curve is within 2 db from 50 to 10,000 cycles. Curve C is a similar curve recorded at a level of -10 db.

These are very creditable curves and high-priced equipment surpasses them only at the two extremes, below 50 and above 10,000 cycles. Curve D was made at the slow 3¼-inch-per-second speed and is within 2 db between 50 and 6,000 cycles, down 8 db at 8,000 cycles. To eliminate the possibility of tape imperfections showing up in these measurements, a brand-new reel of Irish Sound Plate professional tape, a top-quality line, was used.

The signal-to-noise ratio fell between 40 and 45 db. Flutter is low—audible only when considerable bass boost is used in playback. The mechanism tested was not in optimum adjustment when received and had a pronounced wow. Readjustment reduced it to a tolerable level, even with piano music. The timing accuracy was within 4 seconds in 15 minutes.

The recorder sounded even better than it measured. To provide an A-B comparison the following test was set up: Portions of the RCA-Victor record *An Adventure in High Fidelity* were recorded on tape directly from the output of an equalizer adjusted to give a flat response with a Pickering cartridge and pickup within 1½ db to 15,000 cycles. The recorded tape was fed into one input of a control unit, and the output of the record player with the same equalizer and pickup into another

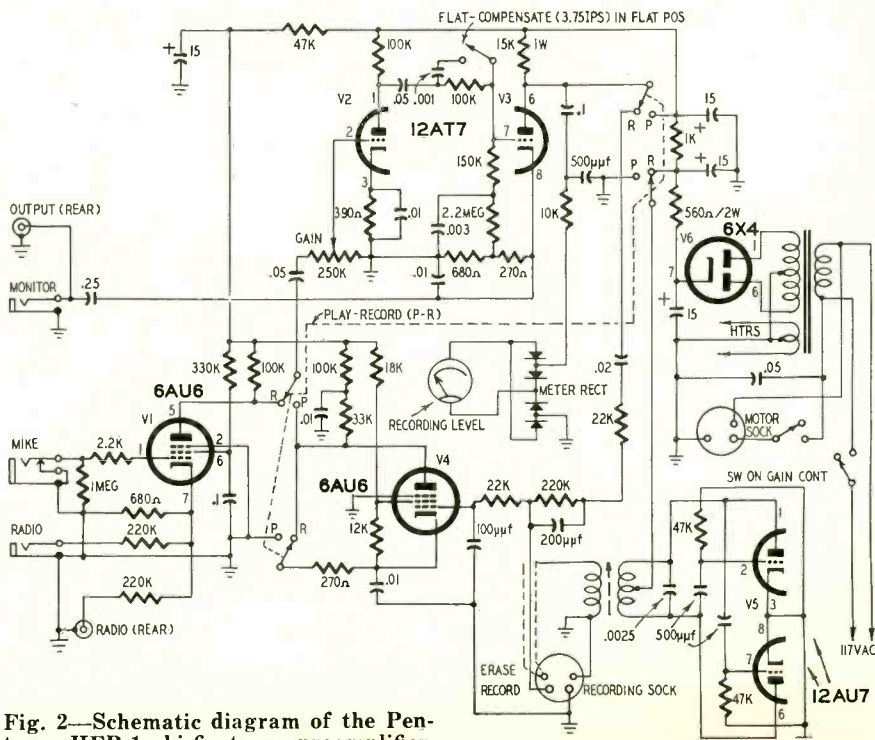
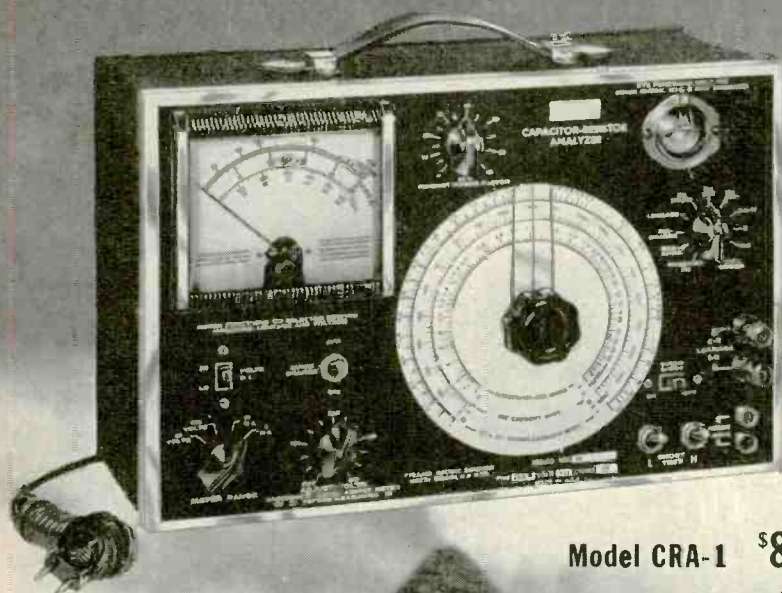

Fig. 2—Schematic diagram of the Pentron HFP-1 hi-fi tape preamplifier.

NEW Capacitor Resistor-Analyzer AND Quick Capacitor Checker

another
Pyramid
first



Model CRA-1 \$82⁹⁵
user net price

This fine double duty instrument provides you not only with the complete setup for checking and analyzing all types of capacitors and resistors, but also the "Quick Check" feature enables you to test capacitors while they are wired in a set.

With the Pyramid analyzer there is no need to remove capacitors from the circuit to determine if they are open, shorted or intermittent.

This new development that saves time in servicing and production testing serves the function that required two instruments previously, actually costs less than the older type analyzer plus a separate "quick" capacitor checker.

PYRAMID ELECTRIC CO.

1445 Hudson Blvd., North Bergen, N. J.

2 in 1

BURTON BROWNE ADVERTISING

PYRAMID

AUDIO—HIGH FIDELITY

channel. The pickup was set down on the record about a measure behind the tape. By operating the selector switch

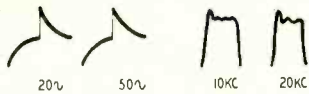

Fig. 3—Horizon 20 square-wave response.

on the control unit the same passage could be heard first as recorded on the tape and then directly off the record.

It took critical listening to discern any difference, and the difference consisted almost entirely of a slight loss of high-high shimmer and sharpness of high-high transients. Most of this could be corrected by cracking the

Baxendahl type treble tone control about a quarter-turn. The tape clearly revealed the differences between the three switch bands on the record. Even the contrast between the full range (30-18,000 cycles) and the restricted range (100-8,000 cycles) was plainly audible.

I judge that the response of the recorder is better than that of all but the very finest high-fidelity recordings pressed today when those are played with the very few pickups flat to 15,000 cycles or beyond. The response is equal to or better than that of most recordings played with typical high-fidelity cartridges.

I was amazed by the excellent quality of the recordings made at the slow speed. To be sure, even an uncritical ear can tell that the high-speed recordings are superior. But the slow-speed quality is acceptable and good enough to provide high musical enjoyment, though not complete realism. For off-the-air recordings of almost all AM stations and all chain broadcasts the bandwidth is entirely adequate, and the higher speed would add very little real quality. It is completely adequate for most voice work. Pre-recorded tapes using either the Ampex or NARTB curves are reproduced very well.

The recorder comes in two units (see photos): the transport mechanism and the preamplifier. The transport mechanism is made of stampings rather than castings, has several adjustments to take up wear and tear and should give good service. The preamp (Fig. 2)

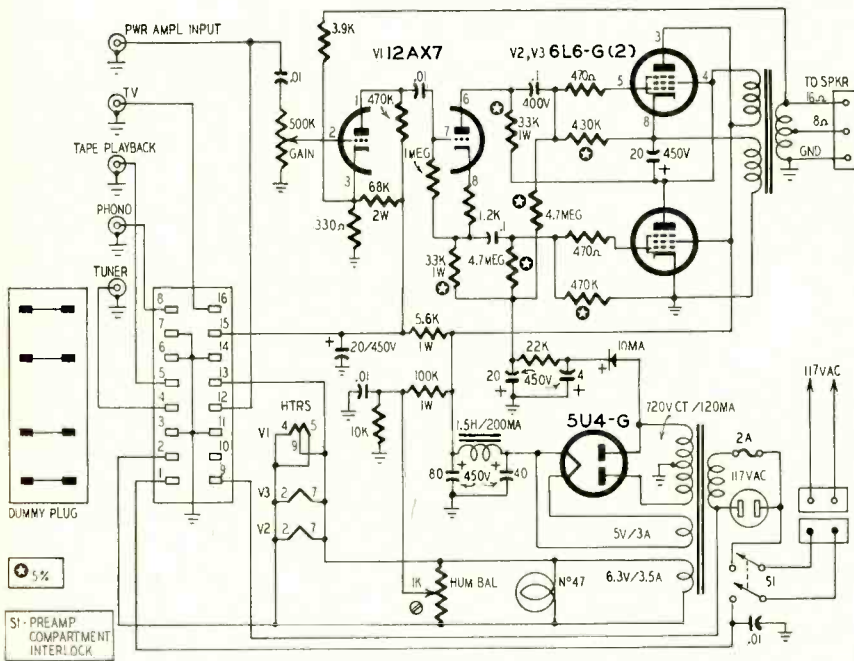

Fig. 4—Schematic of the Horizon 20—uses single-ended push-pull output.

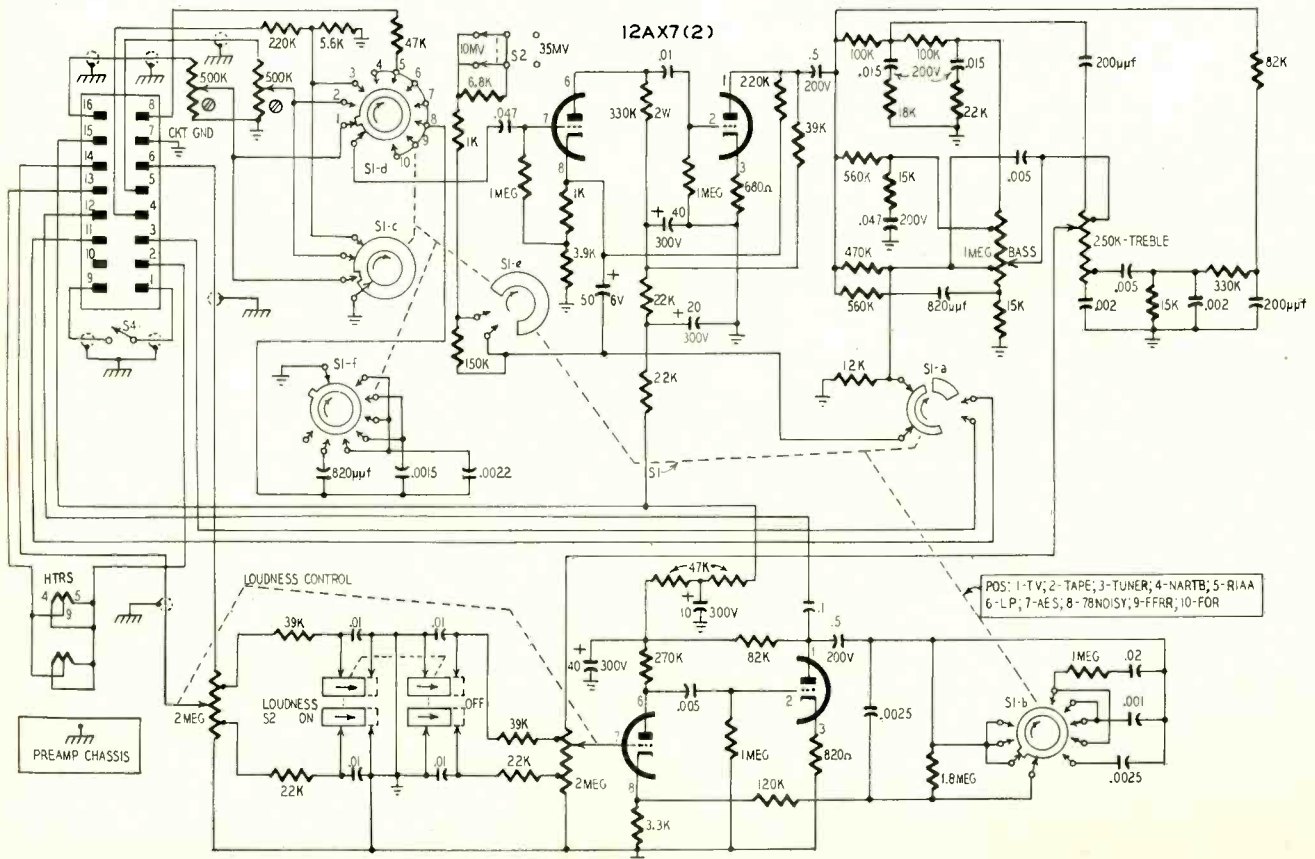

Fig. 5—Diagram of the Horizon 5 preamp—requires external power supply

**AN OPEN LETTER TO
THE
SERVICE TECHNICIANS
OF AMERICA**

**B-T
LABS**

BLONDER-TONGUE LABORATORIES, INC.

526-536 NORTH AVENUE • WESTFIELD, NEW JERSEY • WESTFIELD 2-7032

Dear Friend:

A great deal has been said and written about the advances in TV receiver design over the past 10 years. But too little has been said about the TV Service Technicians - the installers and service men - who put these receivers into operation and kept them going.

To you TV 'doctors' there is a special debt of gratitude due. Without you, the American consumer might have been quickly discouraged - for he was helpless without your knowledge and your aid.

We, too, wish to express our appreciation. You so defined your needs as to make it possible for us to fill them with new products. And you rewarded our efforts by acknowledging the merit of these products and adopting them in your work. You turned to B-T wherever the need arose for effective TV signal amplification, conversion and distribution, and there are today more than 500,000 TV sets in homes, communities, schools, hotels, institutions, etc. being served and operating by virtue of B-T units.

We, for our part, have done everything in our power to justify your confidence. Intensive research has kept us ahead in latest developments and has enabled us to devise new equipment to help you deal with your problems. We have striven always to widen your market - without ever entering into competition with you. All in all, it has been a relationship which we feel should not go by unnoticed or unmentioned.

We are now working to open up the new Industrial TV market for you. We believe that Industrial TV - closed circuit TV - is right in line with your kind of work. And we have developed a new TV camera to help you cash in on the profit opportunities offered by this market.

If you will drop me a note, I'll be glad to send you our Sales and Installation Manual on Master TV and Industrial TV Systems - together with a complete description of the new TV camera.

Cordially,

Joe Kerner

Joe Kerner
Sales Manager

JK:c

TV AMPLIFIERS • CONVERTERS

**UHF
VHF**

TV DISTRIBUTION SYSTEMS

**how many of
these important
Rider Books
have you read?**

Rider books give you a *wealth* of information on electronics! Whether it's hi-fi, radio and tv servicing, theory, or beginner's books . . . whether you're a student, technician, ham, or experimenter . . . you're sure to find a Rider book on the subject that interests *you!* Listed below are just a few of the informative books we've published recently. How many have *you* read?

Picture Book of TV Troubles

Each volume in this series covers a different receiver section! Based on troubleshooting done right in the Rider labs, each shows you almost 50 typical troubles, their symptoms (picture tube patterns & waveforms) and their causes. There's also a handy pull-out section in each book that shows you what the *right* waveforms should look like! Actually does your troubleshooting for you!

- Vol. 1: Horiz. afc-osc. circuits.....only \$1.35
- Vol. 2: Vert. sweep-defl. circuits...only \$1.80
- Vol. 3: Video i-f & amp. circuits...only \$1.80
- Vol. 4: AGC circuits.....only \$1.80

Fundamentals of Transistors

A clear, authoritative explanation of this new electronic miracle, showing transistor characteristics and operation. Written by one of the pioneers in transistor development. \$2.70

High Fidelity Simplified

The complete hi-fi story: how to get top-quality reproduction in your own home! Answers questions about tuners, amplifiers, speakers, tape recorders, record players & changers. Only \$2.50

Basic Vacuum Tubes & Their Uses

A simplified introduction to the basic types of vacuum tubes, starting with a brief history of their development, and following an easy-to-understand, step by step examination of each of the basic types and their applications. Many illustrations. Paper bound: only \$3.00. Cloth: only \$4.50

Handbook of 630-type TV Receivers

Covers all 630 types—from the earliest to the latest! Gives the "whys" and "hows" of each section; analyzes and explains the many changes and modifications made by various manufacturers. Complete schematics of the original "630" . . . plus typical revisions. 26 pages of troubleshooting charts. A *must* for every technician! Only \$3.50

Obtaining and Interpreting Test Scope Traces

A complete explanation of waveforms appearing on the 'scope screen, with over 800 waveform illustrations to show the *ideal, practical, and distorted* versions of the most commonly encountered 'scope traces: am & fm radio receivers, tv receivers, audio amplifiers, power supplies, test equipment. Tells and shows how to apply the 'scope! Only \$2.40

Order today!

Rider books are sold by electronics parts jobbers and book stores throughout the country. If your dealer doesn't have them, mail this coupon for prompt delivery. Add state and city sales tax where applicable. In Canada, prices approx. 5% more.

JOHN F. RIDER PUBLISHER, INC.

Dept. RE-11, 480 Canal St., N.Y. 13, N.Y.
Enclosed is \$..... Please rush the books I've circled above.

Name.....
Address.....
City & State.....

AUDIO—HIGH FIDELITY



The Pentron preamplifier and the model 9T-3M tape transport mechanism.

includes a meter for monitoring, has two inputs on the panel (one for mike and one for high-level inputs) plus another high-level input on the back of the chassis. These inputs can be mixed only if the sources have gain controls, since the preamp has only a single gain control. Like the pro and semipro outfits, it does not contain a power amplifier or speaker and must be monitored either with headphones or an external sound system.

One feature I don't like at all: *Two* switches must be thrown to change from RECORD to PLAY—one on the transport panel and one on the preamp panel. If the transport is thrown into REWIND after recording and one forgets to throw the switch on the preamp into the PLAY position, the recording will be ruined because the high-frequency bias will beat with the recorded signal to produce squeals and whistles. I imagine, however, that it wouldn't take long to build up habits of operation which would minimize that possibility. The units are available without a case for panel or cabinet mounting, or a separate case can be bought for portable use.

[The reader will note differences between the performance data and curves on Pentron equipment obtained by Mr. Herman Burstein in "Improving Low-Priced Tape Recorders" (April and May, 1955) and those given by Monitor. Aside from the fact that different individuals may arrive at slightly different results in testing the same product, checkup with Monitor and Pentron reveals that the instrument used by Mr. Burstein and that used by Monitor were manufactured more than 1 year apart and that continuous changes and improvements in components were taking place in the interim.—Editor]

Horizon 20 amplifier; 5 preamp

Square-wave traces of amplifiers offer important clues to amplifier behavior, especially as to feedback stability and ability to handle transients. But they can be misleading and fail to tell the whole story. This is evidenced sharply by the low-frequency square waves

**Of this
you can be sure...**

there is no finer

**Record
Changer
than the**

Collaro

RC-54

Automatic Intermix

- + Supplied with pre-cut Mounting Board, Power Cord and Audio Cable.
- + Automatically Intermixes All Size Records without Presetting.
- + Rapid, 7-second Change-over Cycles . . . and other outstanding features.



You can SEE it at your Sound Dealer.
You can READ about it in our Folder.

Mail This Coupon Today

ROCKBAR CORPORATION, Dept. WL-16
215 East 37th St., New York 16, N. Y.

Please send Literature describing the Collaro RC-54 Record Changer.

NAME.....
ADDRESS.....
CITY..... ZONE..... STATE.....

P. R. MALLORY & CO. INC.
MALLORY
APPROVED PRECISION PRODUCTS

P. R. MALLORY & CO. INC.
MALLORY
APPROVED PRECISION PRODUCTS

P. R. MALLORY & CO. INC.
MALLORY
APPROVED PRECISION PRODUCTS

Don't be fooled by **OUTSIDE** similarity . . .

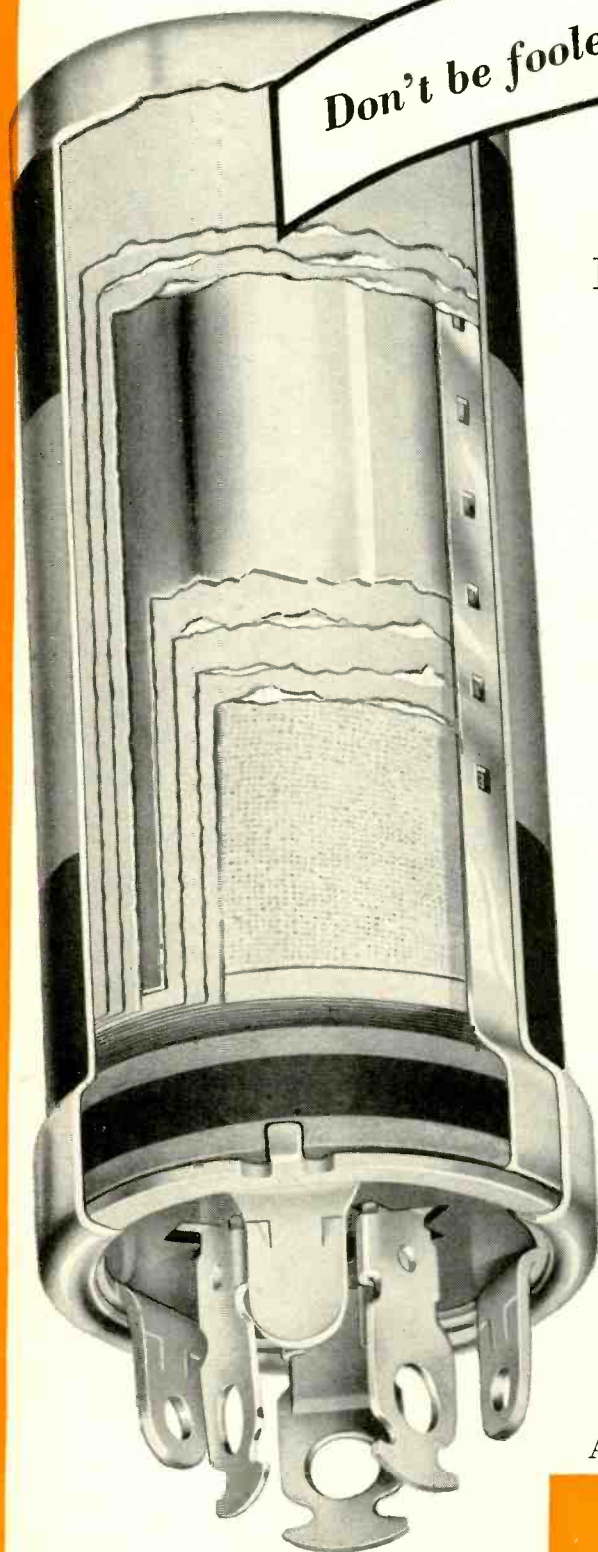

What's **INSIDE** makes the difference

in **MALLORY FP** Capacitors

To see what makes Mallory FP electrolytics superior in performance, take a look at what's inside the can. You'll find—

GENUINE FABRICATED PLATE ANODE . . . originated by Mallory, and available for replacement work *only* in the Mallory FP . . . gives excellent heat dissipation, low impedance, low inter-section coupling.

ETCHED CATHODE . . . prevents capacitance loss, reduces RF impedance.

85° C. CONSTRUCTION . . . standard in FP's for years, at no extra cost . . . eliminates need for voltage de-rating, even for 450-volt units.

LEAKPROOF SEAL . . . prevents loss of electrolyte . . . withstands high temperatures . . . and still retains the venting feature.

There are other features, too . . . and many you can't see, such as the hospital-like sanitation maintained in the Mallory plant to guard against impurities which could shorten capacitor life. Add all these up, and you'll appreciate why FP capacitors are the *standard of performance* for replacement and for use in original equipment.

Order your stock of FP capacitors today, from your nearby Mallory distributor. They lead the field, yet cost no more.

Another *Service-Engineered* Product by . . .

P. R. MALLORY & CO. INC.
MALLORY

CAPACITORS • CONTROLS • VIBRATORS • SWITCHES • RESISTORS
RECTIFIERS • POWER SUPPLIES • FILTERS • MERCURY BATTERIES

APPROVED PRECISION PRODUCTS

P. R. MALLORY & CO. Inc., INDIANAPOLIS 6, INDIANA

P. R. MALLORY & CO. INC.
MALLORY
APPROVED PRECISION PRODUCTS

P. R. MALLORY & CO. INC.
MALLORY
APPROVED PRECISION PRODUCTS

P. R. MALLORY & CO. INC.
MALLORY
APPROVED PRECISION PRODUCTS

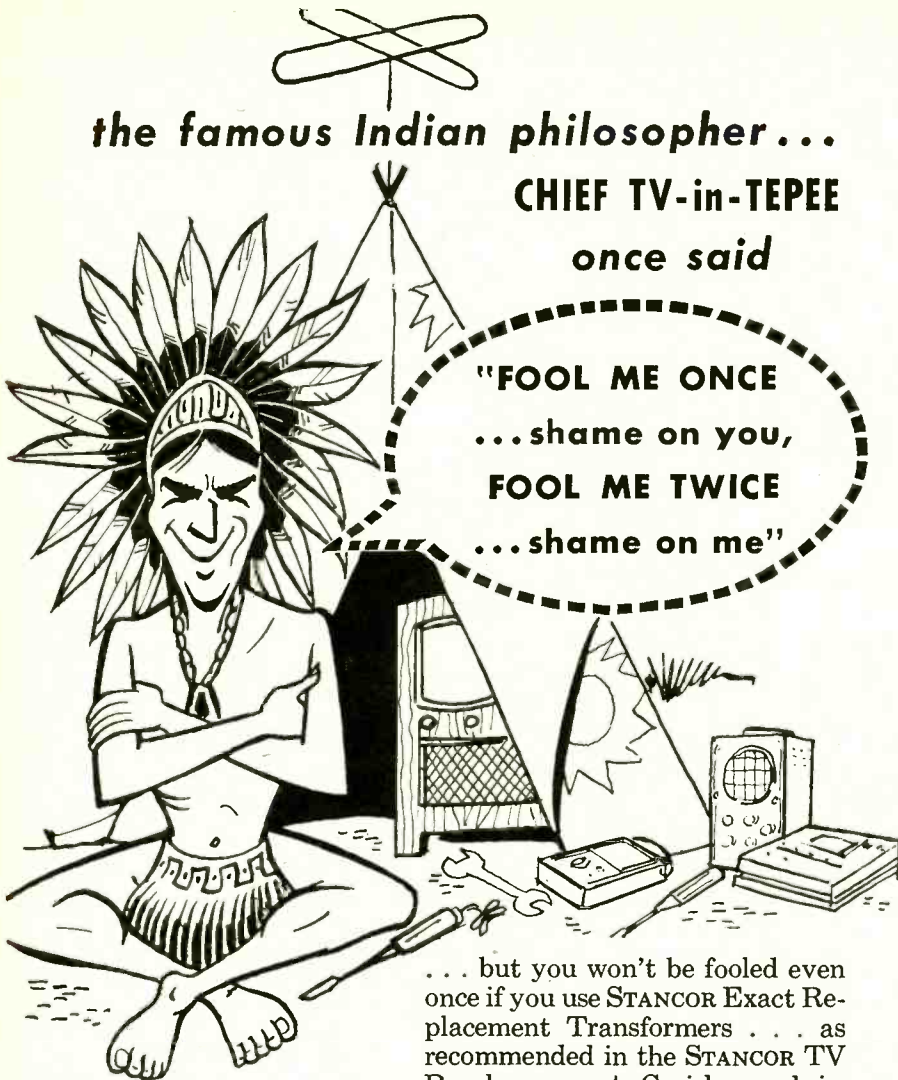

the famous Indian philosopher...
CHIEF TV-in-TEPEE
 once said

"FOOL ME ONCE
 ...shame on you,
 FOOL ME TWICE
 ...shame on me"

... but you won't be fooled even once if you use STANCOR Exact Replacement Transformers . . . as recommended in the STANCOR TV Replacement Guide and in Counter-Facts . . . because every unit is a VERIFIED exact replacement, designed from the original manufacturer's specifications and tested by actual installation and operation in the recommended chassis.

FREE—54 page STANCOR TV GUIDE. Lists over 8000 TV models and chassis and over 150 exact replacements. Available from your STANCOR distributor or from Chicago Standard.

EXPORT SALES:
 Roburn Agencies, Inc.
 431 Greenwich St.
 New York 13, N. Y.



**CHICAGO
 STANDARD
 TRANSFORMER
 CORPORATION**

3592 ELSTON AVENUE • CHICAGO 18, ILLINOIS

AUDIO—HIGH FIDELITY

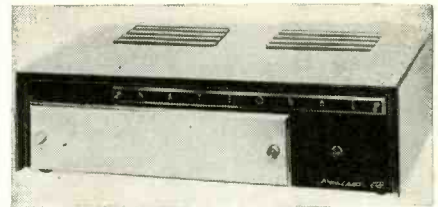

The National Horizon 20 amplifier.



The National Horizon 5 preamplifier.

(Fig. 3) of the National Horizon 20 amplifier. The traces do not indicate a faulty unit and will be more or less duplicated with any specimen; they are the result almost entirely of the .01- μ f coupling capacitor in the input. And the slope it produces is intended to provide a degree of filtering of rumble, flutter and subsonic transients. This slope, however, has no more effect on the performance of the amplifier than a similar slope would have in the control unit, preamp, rumble filter or the bass attenuation provided by bass tone controls. In fact, the quality of reproduction is especially good on the bass end, possibly because the filter permits the amplifier to handle high-amplitude bass—even the extreme 33-db boost of the loudness control of the Horizon 5—with greater freedom from momentary instability, motorboating or breathing.

Other characteristics of the Horizon 20 are excellent, especially the power output capabilities. Although rated at only 20 watts and although the breakup point of the model tested was approximately 32 watts, the amplifier will deliver 35 watts or more with not over 3 or 4% harmonic and 10-12% IM distortion. Its output stage permits operation into the cutoff region without the switching transients which occur when such operation is attempted with conventional circuitry. Therefore, while intended primarily for home use, the Horizon 20 has applications in hi-fi PA systems and represents an unusual bargain in watts per dollar.

The circuit operates just like that of the Horizon 10 analyzed in "Circuit Features in Hi-Fi Power Amplifiers" in the September issue of RADIO-ELECTRONICS. It has a single-ended push-pull output stage. The principle, however, is simple. The output tubes are in series so far as the current swing is concerned. The grids, however, are supplied a push-pull signal. When the current in the upper tube rises, the current in the lower tube falls. The result is exactly the same kind of doubling of the total current swing as obtained in conventional push-pull circuitry. The output is taken off in the middle of the circuit at the junction of

DeRO Latest in *ELECTRONIC Equipment*

The Famous DeRO-JUVENATOR CRT BOOSTER

New compact design features one-piece construction. No loose ends. No hanging weights. Attractive Counter Display box of 12.

90c net



The PERSONNA-TONE EXTENSION SPEAKER

Long range, hi-quality sound for chair-side listening. No disturbance to others. Select either speaker and control volume in comfort of easy chair.

\$697 net



Pic-TEST CRT SUBSTITUTION TESTER

A "must" for all servicemen. Miniature design—only 1 1/2x3 1/2". Determine if CRT is bad without removing from set. With genuine GAF66 twinning indicator Electron Ray tube

\$997 net



NOW AT YOUR JOBBER
 If he cannot supply, write to

Write for FREE Folder

DeRO ELECTRONICS 63 GILROY AVE. UNIONDALE, N. Y.

from

DELCO RADIO...

One of the Largest Makers
of High Quality

SPEAKERS

for Home and Auto Radios,
Phonographs and Television

Product of combined Delco Radio and General Motors engineering skills, manufactured in plants devoted exclusively to electronic parts, the Delco speaker line embraces 14 standard models for home and auto radios, phonographs, and television—plus the model 8007, a superior Hi-Fi dual-purpose speaker for replacement in AM, FM, TV and phonograph sets, and for use with custom-built high-fidelity audio systems. It's plain to see that here's the speaker line to fill your needs...products of uniformly fine design and construction, *all* of them competitively priced!

Standard Speaker Features: Designed and built to R.E.T.M.A. standards; cones uniform in response over operating frequency range; fully dustproofed with drawn brass magnet covers and felted cones; Alnico-V magnets; heavily plated metal parts.

Model 8007 Hi-Fi Speaker Features: Size 8"; 50 to 12,500 CPS frequency range; Alnico-V magnet; 10-watt power rating; 4.1 input impedance; $1\frac{3}{16}$ " voice coil.

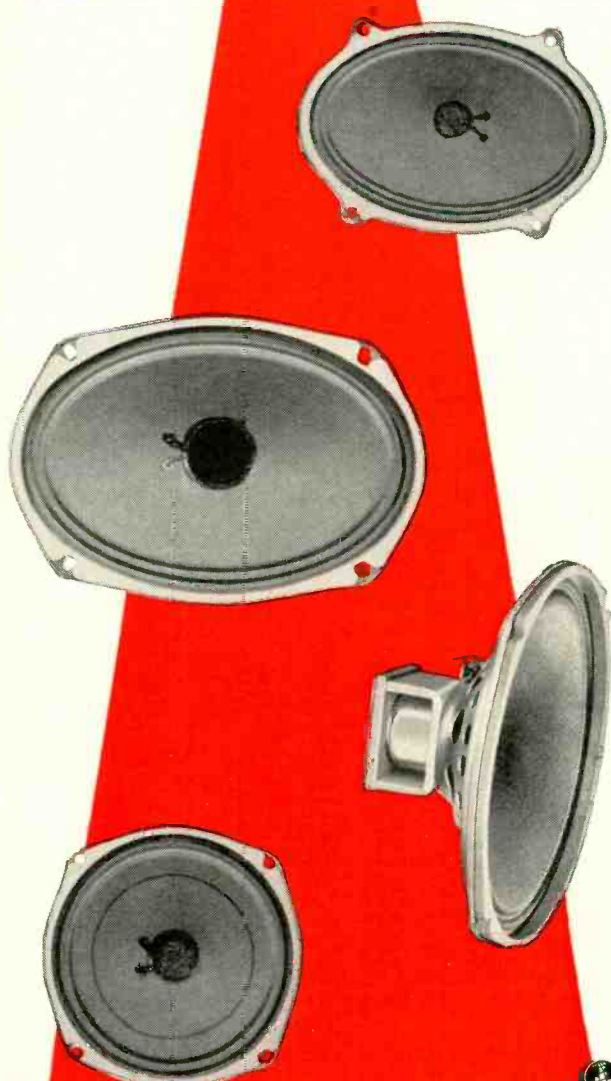

DELCO RADIO

DIVISION OF GENERAL MOTORS, KOKOMO, INDIANA

A GENERAL MOTORS PRODUCT  A UNITED MOTORS LINE

DISTRIBUTED BY ELECTRONICS DISTRIBUTORS EVERYWHERE

Order these quality products of a volume electronics manufacturer through your UMS Electronic Parts Distributor today.

NEW

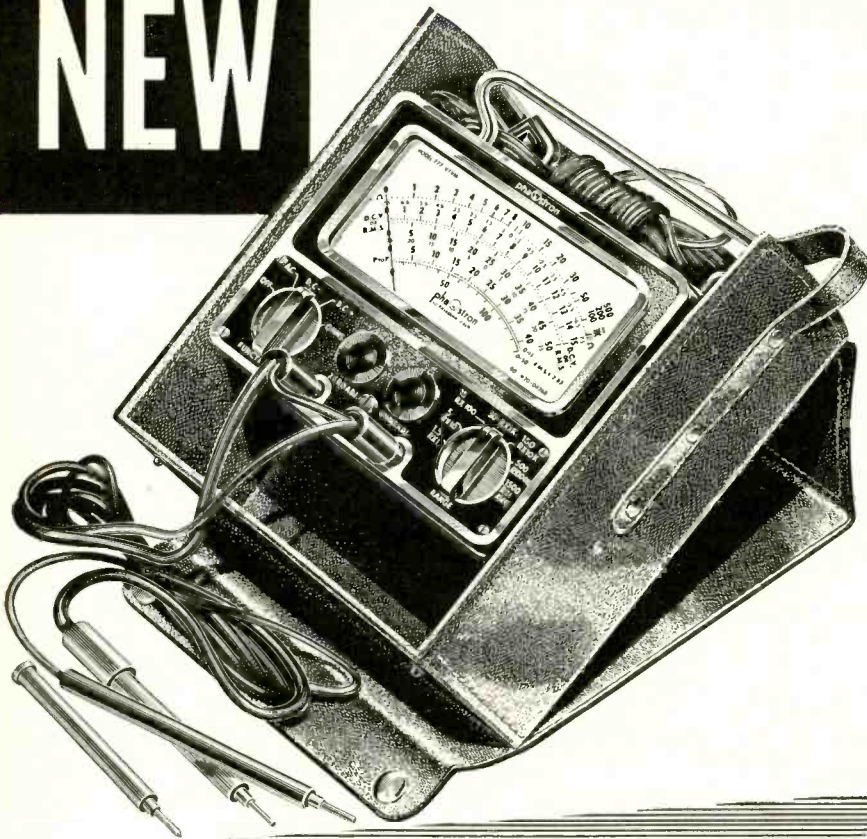

PHAOSTRON

NONE FINER

"777"
V. T. V. M.
 (VACUUM TUBE VOLTMETER)

The MODEL "777" V.T.V.M. is a completely self-contained, ready-to-use test instrument. Its accessories and the HF co-ax cable, DC Probe, AC line cord and instruction book all fit in the genuine California Saddle Leather carrying case that is furnished with the instrument.

- 42 Unduplicated Ranges
- Illuminated Dial (5000 hour self-contained lamps)
- Die Cast Chrome Finished Bezel
- Metal Case, unbreakable, ultra compact
- Doubly Shielded, time proven 200 microamp movement
- Permanent Accuracy . . . 3% DC, 5% AC
- Large, Easy to Read Scales 4 7/8" Long
- Color Coded Scales: green—ohms; black—AC, DC; Red—P. to P.
- 2 Zero Center Scales for FM Discriminator Alignment
- Separate Range and Function Switches
- Only 2 Jacks for All Measurements
- New, High Style, Easy-to-Use Chrome Bar Knobs
- Dual Purpose Handle also serves as AC line cord reel

YOUR KEY TO EXCELLENCE



"777" V.T.V.M. complete with Coaxial Cable, DC Probes and Leather Case at your PARTS DISTRIBUTOR

\$69⁹⁵

PHAOSTRON COMPANY
 151 PASADENA AVE. • SOUTH PASADENA, CALIF.

AUDIO—HIGH FIDELITY

plate and cathode. There are several ways of doing this and National uses an output transformer with two unity-coupled primaries; one in the plate circuit of the lower tube, the other in the cathode circuit of the upper tube. Though it is not obvious to the eye, there is a common load and therefore there is cancellation of hum and distortion.

Circuits of this general type usually require two power supplies plus a lot of juggling of voltage parameters, bootstrapping of the inverter-driver, etc. The advantage of all this complication is simply this: it permits class-AB or even class-B operation and considerable swing into the cutoff region without the switching transients which occur when this is attempted with ordinary circuitry. True, these switching transients are not likely to be bothersome in home listening since they occur only near full output, and the occasion when a home system requires or even permits output in excess of 30 watts is extremely rare and perhaps almost nonexistent.

However, it has secondary benefits in providing a much higher power safety factor and reserve at normal listening levels, and in lower power input at low levels. While this may not reduce the electric bill significantly it does reduce the heat problem in the pancake form of construction used here. In any event, the result is a very different and ingenious circuit which only a staff of good engineers could have made work at all. I caution amateurs and home builders not to attempt to duplicate—let alone adapt—it. The Horizon 20 passes listening tests with excellent marks, especially in the bass end.

The only fault I find with the Horizon 5 preamplifier (Fig. 5) is that it would be rather difficult to adapt it for use with some other amplifier. It plugs into either the Criterion tuner or the Horizon 20 amplifier and is supplied both with operating voltages and with input and output interconnections by these "mother" units. Despite its very small size and moderate price it provides a higher-than-average degree of versatility, flexibility and quality of performance. In one aspect the model tested was downright astonishing: with gain control full on, loudness off and bass and treble both "flat" the distortion, at the 2-volt output needed to drive a modern amplifier, was virtually unmeasurable, though National claims only a level of 0.3%. The distortion varied with various combinations of loudness and tone controls, but was insignificant in every combination measured. This is the effect of feedback loops around all amplifying stages.

The selector switch offers a choice of seven phono equalizations and three inputs: tuner, tape and TV. When used with the Criterion tuner, the switch removes plate and filament voltages from the tuner in all positions except TUNER. The TV and tape inputs have level controls; there is also a switch

ALLIANCE TENNA-ROTOR

beats the biggest drum!

**30,000,000
TV VIEWERS**

week after week



New

MODEL U-98—fully automatic—incorporates 32 distinct improvements—eliminates all arcing and consequent picture distortion—points directly, positively, instantly to target station—“just set it and forget it”! List Price, **\$39.95**

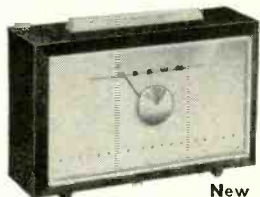

New

MODEL T-12—fingertip electrical operation. Rocker switch on top controls turning. Has direction indicator dial. Compact and smartly styled. Highly accurate! List Price, **\$29.95**



You can't miss with the "leader"!

Seven years of continuous TV advertising pays off!

Millions know about Alliance . . . more users have Alliance Tenna-Rotor.

Millions of sales impressions in hundreds of TV markets week after week—year after year—give you the solid backing that no other TV accessory has even approached!

Nearly two million Alliance Tenna-Rotors are in use!

The
ALLIANCE MANUFACTURING COMPANY, INC.

Alliance, Ohio

World's most adaptable replacement cartridge!



Model AX with complete turn-over mechanism

• The new MODEL AX is a *universal* turn-over replacement cartridge in the highest sense! Lightweight, compact, beautiful in playing qualities, it can be used to replace all standard automatic changer turn-over cartridges.

Unequaled versatility is only one of the advantages of the MODEL AX. In addition, it has high compliance, excellent tracking, fine response at all speeds—and a wholly new, advanced design. Illustrations show how it can be quickly adapted to virtually any type of turn-over arm.

Model AX with knob and bracket removed, for installation in arms with built-in front mounting bearing

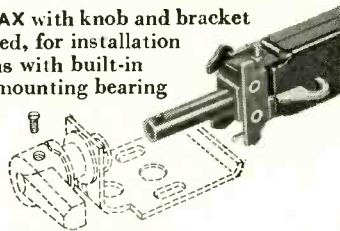

Model AX with scored shaft snapped off, for installation in arms containing complete turn-over mechanism with 1/2" standard mounting

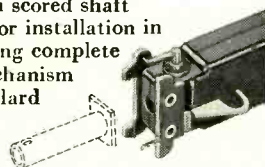

specifications • data

Output • (1000 CPS): 0.7 volt at 33 1/3-45 rpm; 1.5 volts at 78 rpm

Tracking pressure • 7 grams

Cut-off Frequency • 10,000 cycles

Mounting • Standard 1/2", either with or without turn-over mechanism or front mounting as shown above

Needles • 3 mil osmium for 78 rpm (WE 52)
1 mil osmium for 33 1/3-45 rpm (WE 52 LP)

WEBSTER ELECTRIC
RACINE WISCONSIN

AUDIO—HIGH FIDELITY

for equalizing the level of high- and low-output pickups. All of these are accessible through holes provided for that purpose in both the Criterion tuner and Horizon amplifier.

The phono equalization is within 2 db except at the extremes of some curves (Fig. 6). The slope in the high end, however, indicated in the curves is probably accounted for by the likeli-

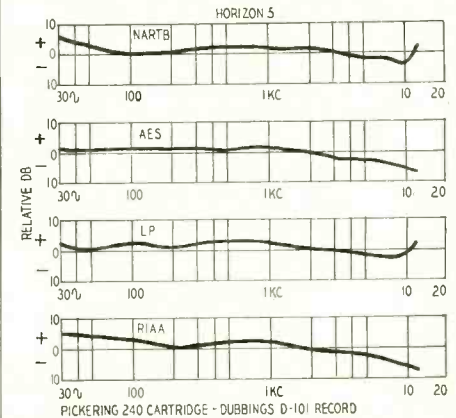

Fig. 6—Phono equalization curves.

hood that the "flat" position of the treble actually produces a small slope and can be corrected by slightly advancing the treble control. Besides the curves shown, there is provision also for frrr, European and noisy 78-r.p.m. records.

The loudness control, which provides 33 db of boost at 20 cycles (Fig. 7)

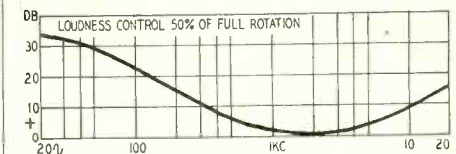

Fig. 7—Loudness control gives boost.

with the volume control half on, ought to correct the Fletcher-Munson curve even of some hard-of-hearing listeners and produce a spectacular bass even with inexpensive speaker systems. The bass and treble tone controls are excellent. The curves (Fig. 8) are for

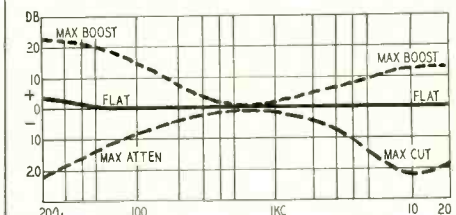

Fig. 8—The bass and treble range.

the extreme positions only; in intermediate positions the crossover as well as the boost or attenuation vary and produce highly satisfying control of response and noise.

New records review

Note: Records below are 12-inch LP and play back with RIAA curve unless otherwise indicated.

Glockenspiel, Traps and Pipes (Vol. 3)
Leon Barry at the Wurlitzer
Replica 33x505

Here is a sure-fire demonstration and showoff

BUY BY MAIL Direct From Manufacturer AND SAVE

NEW Approved policy ...

eliminates percentages to "middlemen"—brings equipment direct from factory to you for buys that can't be beat... anywhere! Approved kits are NOT AVAILABLE FROM DISTRIBUTORS OR JOBBERS.

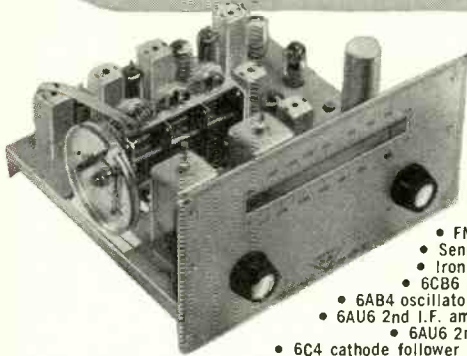

New Imperial V— 12-tube AM-FM Tuner Kit

- Band width—200 kc
- Tuned RF stage
- Frequency Response FM-20-20,000 CPS ± .5DB
- FM Tuning Range 88-108 mc
- Sensitivity 5-10 u/v, 20-30 DB
- Iron core tuned I.F. disc trans.
- 6CB6 RF amplifier • 6AB4 mixer
- 6AB4 oscillator • 6AU6 1st I.F. amplifier
- 6AU6 2nd I.F. amplifier • 6AU6 1st limiter
- 6AU6 2nd limiter • 6AL5 detector
- 6C4 cathode follower output • AM tuning range 530-1650 kc • Frequency response AM-20-7,500 CPS ± 3DB
- Iron core tuned coils throughout • 6BA6 RF amplifier • 6BE6 converter
- 6BA6 1st I.F. amplifier • IN34 crystal diode detector • Tuned RF stage
- Chassis dimensions: 9 3/4" long, 5" high, 8" wide.

Complete kit of parts including tubes, step by step, pictorial and schematic diagrams, less power supply **\$37.50**
Wired and tested extra **\$10.00**
Power Supply—5.3V-4 Amp., 190 Volts 55 MA—117V. 50-60 cycles **\$12.00**
Tuning Eye Kit **\$ 2.95**
Shipping Weight 10 lbs.

New Binaural Twin Channel Amplifier Kit Channel 1 and 2



- 1-6SC7-Pre Amp. Common to both Chan.
- 2-6F5—1st Stage Amp.
- 2-6F5—Voltage Amp.
- 2-6V6—Power Amp.
- 1-5Y3—Rectifier Amp.
- 2-Cathode Ray Output Indicators
- Individual Channel Volume controls
- Individual Bass control boost 12DB
- Individual Treble control boost 12 DB
- Inputs for Radio, Tape, Crystal, GE Reluctance
- Chrome plated chassis

Complete kit of parts including AC power supply, tubes, step by step pictorial and schematic diagrams **\$39.95**
Shipping Weight 18 lbs.

- Hum levels—78 DB below full output
- Frequency response each Channel ± 1 DB 40-12,000 CPS
- Maximum power output each channel, 4 Watts
- Output, 4-8-16 ohms
- Size 13" Long x 9" Wide x 8 1/2" High

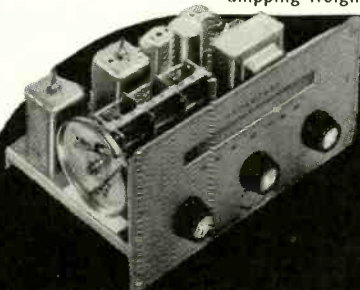

New V-5 Am Tuner Kit

THE BINAURAL TWINS

Start Your Hi-Fi Installation the Economical Way

- Self-contained AC power supply
- Tuning range 530-1650 kc.
- 6BA6 RF Amplifier
- 6BE6 converter
- 6BA6 1st I.F. amplifier
- 6AL5 detector
- 6C4 cathode follower output
- #65 selenium rectifier • Sensitivity 5 microvolts
- Frequency response 20-20,000 CPS ± .5DB
- 3 section variable cond. • Tuned RF stage
- Iron core tuned coils throughout • Dimensions 9 3/4" x 5" x 5 7/8"

Complete kit of parts, including AC power supply, tubes, step by step, pictorial and schematic diagrams **\$24.50**
Wired and tested extra **\$5.50**
Tuning Eye Kit **\$2.95**
Shipping Weight 9 lbs.

New V-9 FM Tuner Kit



- Self-contained AC Power Supply
- 3 section variable condenser
- Tuning range 88-108 mc
- Band width 200 kc
- Sensitivity 10 microvolts 20 DB
- Tuned RF stage
- Iron core tuned I.F.—disc trans.
- 6CB6 R.F. amplifier
- 6AB4 mixer
- 6AB4 oscillator (temp. compensated)
- 6AU6 1st I.F. amplifier
- 6AU6 2nd I.F. amplifier
- 6AU6 1st limiter

Complete kit of parts including AC power supply, tubes, step by step, pictorial and schematic diagrams **\$29.50**
Wired and tested extra **\$7.50**
Tuning Eye Kit **\$2.95**
Shipping Weight 10 lbs.

- 6AU6 2nd limiter
- 6AL5 detector
- 6C4 cathode follower output
- 65 MA selenium rectifier
- Dimensions 9 3/4" x 5" x 5 7/8"
- Frequency response 20-20,000 CPS ± .5DB

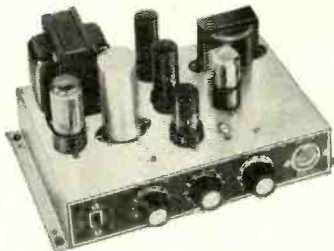

New Push Pull 6 Watt Amplifier Kit

- 1-12J5—1st stage Amp.
- 1-12SL7—Phase Inverter
- 2-12A6—P.P. Beam Power
- 1-5Y3—Rectifier
- 1-Cathode Ray Output Indicator
- Tapped outputs, 4-8-16 ohms
- Volume, Continuously variable
- Chrome plated chassis
- Bass Control Boost 12 DB • Treble Control Boost 12 DB • Hum level—78 DB below full output • Frequency response ± 1.5 DB 20-20,000 CPS
- Size 5 1/2" high x 5 1/2" wide x 11" long

Complete kit of parts, including AC power supply, tubes, step by step pictorial and schematic diagrams **\$15.45**
Shipping Weight 13 lbs.

New 20 Watt Williamson Type Hi-Fi Amplifier Kit



- New Chicago Kit of transformers
- Chrome plated chassis
- 1-6SN7—1st stage Amp.
- 1-6SN7—Phase inverter
- 2-5881—Push Pull Power Output
- 1-5V4G—Rectifier
- Frequency Response ± 1 DB, 10-100,000 CPS
- Output 4-8-16 ohms
- Volume control
- On-off power switch

Complete kit of parts, including AC power supply, tubes, step by step pictorial and schematic diagrams **\$39.55**
Shipping Weight 32 lbs.

- IM Distortion—1% using 60 and 3000 cycles sine wave output, at 12 watts indicated
- Hum Level—78DB below full output
- Pre Amp. Voltage supply outlet
- Size 15" Long x 9" Wide x 7" High

ORDER DIRECT FROM APPROVED ELECTRONIC INSTRUMENT CORP.

928 BROADWAY, NEW YORK 10, N. Y. • AL 4-7266

FREE CATALOG AVAILABLE!

APPROVED ELECTRONIC INSTRUMENT CORP. 928 Broadway, Dept. E, N. Y. 10, N. Y.

NAME
ADDRESS CITY STATE

Downtown Sales Office
51 Vesey St., N.Y.C. CO 7-4605

Hi-Fi and Hi-Price aren't Siamese Twins!

The new imported *Fer-tone*^{Hi-Fi} is out to prove this to you. Now you can get professional features you always wanted—at prices you will gladly pay.



THE NEW *Fer-tone*^{DO-350} Lo-Z PROFESSIONAL MAGNETIC CARTRIDGE. Works on any load over 1000 ohms. 30 mV/4.4 cm/sec. output, due to 8-poles. Highest 5×10^{-6} cm/dyne lateral compliance. Response 20—16,000 cps flat ± 2 db then gradually rising to over 20,000 cps.

Audiophile Net:
B&O Reversible, Silver Label (2 sapphire jewels).....\$7.95
B&O Reversible, Gold Label (1 diamond, 1 sapphire).....\$19.95

THE NEW MINIATURE *Fer-tone*^{DO-50} BLUE RIBBON STUDIO TYPE VELOCITY MIKE. Its exceptional great sensitivity, low (1.3 mg) mass and novel three-way "Close Talk", "Music" and "Off" switch make it the ideal tool for the sound engineer. Impedance 50 ohms. Frequency Range: 30—15,000 cps ± 2 db. Sensitivity: "T" position — 59 db; "M" position — 55 db. Size: $7\frac{3}{4}$ " x $1\frac{3}{16}$ ". Weight: under 15 oz. Shipped with 20' shielded 3-conductor cable.

Audiophile Net: \$48.95

REX Perpetuum-Ebner

THE MOST PERFECT CHANGER EVER BUILT
A truly mechanical brain, plays any odd size record between 6" and 12". Long professional type pick-up arm with plug-in shell to American standards. World's best shaded 4-pole phono motor. Factory tuned spring suspension double chassis. Practically free of rumble and acoustic feedback. Muting switch. Automatic shutoff. Two spindles—long for changer and short for manual player use. Many other features and models.
Audiophile Net: Model Rex AA \$59.50
45 rpm Automatic Spindle (Add.) Net \$3.50



THE MINIATURE *Fer-tone* RESLO "BLUE RIBBON" STUDIO-TYPE VELOCITY MIKES

• Dual Impedance. • Shipped with two 18' cables—proper impedance selected by plugging in proper cable. • Shock-mounted miniature duraluminum ribbon with no audible re-sonance. • Frequency range 20-15000 cps ± 2 db. • Sensitivity — 53 db. • Bi-directional pattern easily changed to directional or close talk by use of internal pads (supplied). • Triple blast screening for outdoor use.

MODELS

Iteso-Celeste 30/50 ohms & Hi-Z with muting switch; Iteso-Symphony 250/600 ohms. no switch; Audiophile Net: \$48.95 each.

NEW P-12 EXTENDED RANGE HIGH FIDELITY CARTRIDGE.

made by Perpetuum-Ebner. • Highest $2\frac{1}{2}$ x 10^{-6} cm/dyne lateral compliance and lowest 1M distortion ever achieved with crystal cartridges. • Hermetically sealed. • Fullest bass and treble reproductions: 20-16000 cps conforming to IIAA curves. • 500 mV output at 1 megohm. • With 100 K load, can be fed into a magnetic input resulting in response curve and characteristics equal to best magnetic cartridges. • Ideal as a replacement cartridge.

Models: P-12/RS (2 sapphire jewels) \$ 6.25
P-12/RG (1 diamond, 1 sapphire) 19.95



SYMPHONY

CELESTE

Literature on request. Sold through better audio distributors

FENTON COMPANY 15 MOORE STREET NEW YORK 4, N.Y.

Look what RADIO-ELECTRONICS has in store for you in the months ahead . . .

- BUILD THIS MINIATURE RECEIVER FOR MODEL CONTROL
By Rufus Turner
- CONVERTING TABLE RADIOS INTO HI-FI TUNERS
By Joseph Marshall
- THE FIRST DECADE OF RAILROAD RADIO
By Leo G. Sands
- TREMOLO CIRCUITS FOR ELECTRONIC MUSIC INSTRUMENTS
By Thomas Jaski
- TRANSISTOR OPERATED GEIGER COUNTER
By Thomas G. Knight
- GETTING FEEDBACK STRAIGHT
By Norman H. Crowhurst
- MAKING PHOTOETCHED CIRCUITS IN YOUR OWN WORKSHOP
By Richard H. Dorf
- A LOW-COST HIGH-QUALITY AUDIO AMPLIFIER
Roland Jordan, Jr.
- LOSS OF SYNC IN DC RESTORERS
By James A. McRoberts
- HIGHER POWER WILLIAMSON AMPLIFIER FOR HIGHER FIDELITY
By David Haffer

The DECEMBER issue of RADIO-ELECTRONICS goes on sale November 24th at better parts distributors and newsstands.

SUBSCRIPTION RATES

One year \$3.50 Two years \$6.00 Three Years \$8.00
25 WEST BROADWAY NEW YORK 7, N.Y.

AUDIO—HIGH FIDELITY

record guaranteed to sound stunning to most people on practically anything called (or even miscalled) high fidelity and to please or at least amuse with its music. This particular Wurlitzer is almost a travesty of its type: the drums and traps are really loud, the tuba has a nice rough growl and there are plenty of all sorts of highs. Moreover, though the bass is really big and has a nice natural roughness, I don't think there is much of anything in the grooves below 40 cycles and any system which goes down to there will do the bass nearly full justice. Even the very cute little small-speaker enclosures which achieve their bass mostly with mirrors give out a very gratifying bass. The drums will make your jaw drop and Leon Barry manipulates the keys, pedals and stops with an ironic good humor which makes the effect delightful. I recommend especially *Our Director March* as the best medicine for those friends and relations who may wonder what high fidelity is all about; if after that they don't concede you've got something, maybe you haven't!

Pipe Organ at the Chicago Stadium Al Melgard, organist

Replica 33x504

Here is another unique record but of an entirely different type. The organ in the Stadium is the mightiest of the mighty with no fewer than 6 manuals, 883 stops and 40,000 pipes. It can imitate anything from a loaded freight train (which it does on this disc) to the squeaks of the lady wrestlers who occasionally infest the Stadium ring. Unfortunately, the Stadium is the world's largest cavern under one roof and its reverberation period makes the sharpest staccato passage sound like a Swiss yodeler in the Simplon tunnel. Apparently it was impossible to mike it closely enough to escape the reverberation. In any case this record is a unique example of "fatigue factor." If you do not know the ill effects of hangover and excessive reverberation, this is very likely to give you an example of a fatigue-factor headache before the end of either side. If playing it gives you or the family no headaches except those you normally experience or have learned to live with, there is a strong presumption that instead of a hi-fi set you are operating a first-class torture device.

Replica records, like Audiophiles, are the hobby of an enthusiast and the recording quality is extremely good; they are available from many parts jobbers as well as hi-fi and music stores.

JOHANN STRAUSS and JOSEF LANNER

Waltzes, Polkas, Marches and Galops
Anton Paulik conducting
Vienna State Opera Orchestra
Vanguard VRS-458

If the Replica record reviewed above is the ideal record for demonstrating almost any hi-fi system, this is the ideal record for demonstrating and showing off those ultimate systems which go all the way down to 30 cycles or lower. I have said often that a system which cuts off at 45 or 50 cycles loses little musical value but a lot of realism. If you don't think there is anything in normal musical material worth listening to below 45 or 50 cycles, play this first on a system with such a cutoff and then on one that goes all the way down.

Listen especially to the *Loveli-Rheinlage Waltz* on side 1; note how the big bass drum practically disappears on the cutoff system and how awesomely real its dull beat with no boominess whatever sounds on the ultimate system. The shimmer of the cymbals in these selections is also extremely real and clean. Vanguard makes the extraordinary guarantee that the sound on the disc is identical to the sound on the master tape and I'm willing to believe it.

All Vanguard records I have heard are remarkably clean and one reason for this is how low the needle chatter is even in the peaks. Clearly, Vanguard is keeping its maximum peaks below the zero level when making tapes and patiently resists every temptation to overcut the master discs. On the proudest hi-fi systems this always pleasant music produces one of the most gorgeous sounds I have ever had the pleasure of hearing. This is one record your wife may enjoy even when you play it as loud as you need to get the most out of it.

Hycon

...where
accuracy
counts

MODEL 617 3' OSCILLOSCOPE

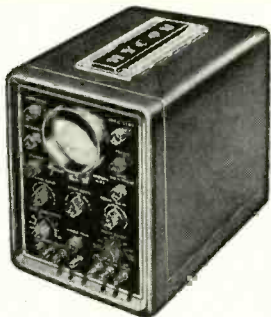

The general purpose scope that gives you most for your dollar... has *flat face* CRT for usable trace edge to edge. It combines laboratory accuracy with ruggedness and compactness that makes it ideal for field service...

VERTICAL AMPLIFIER
Frequency Response: 6 cps to 4.5 mc ± 1 db
Sensitivity: .01 v/in rms
Input Impedance: 1 megohm, 35 mmf (± 2 mmf) over entire range of attenuator

HORIZONTAL AMPLIFIER
Frequency Response: 6 cps to 500 kc ± 3 db
Sensitivity: .075 v/in rms
Input Impedance: 1 megohm

SWEEP RANGES
15 cycles to 100 kc

Television V & H frequencies
60 cycle, variable phase

CALIBRATION
Internal 60 cps square-wave 0.05 to 150 volts peak-to-peak $\pm 5\%$

SYNCHRONIZATION
Internal, external, positive, negative or AC line

POWER REQUIREMENTS
115 volts, 60 cycles, 100 watts

SIZE...WEIGHT
8½" x 11" x 10¾" ... 22 lbs.



MODEL 616 COLOR BAR/DOT GENERATOR

...for adjusting and testing color receivers and transmitting equipment by manufacturer, station or serviceman. Features: Seven output forms of bars, dots, cross-hatch, phase and color-difference

signals, including NTSC color bars. Panel presentation shows actual color and sequence of generator output...

SIGNAL OUTPUTS:

Composite video... either phase... adjustable 0 to 1.5 volts peak-to-peak across 75 ohms
RF... 10,000 microvolts fixed level... optional channel 3 or 4... crystal controlled... modulated sound carrier
Sync in or out

TYPES OF SIGNAL:

Vertical bars... variable from 15 to 20
Horizontal bars... variable from 10 to 15
Cross-hatch... variable as above

Dots... variable as above
Color Bars:
"A"... NTSC colors (Phase accuracy $\pm 5^\circ$... luminance and chrominance amplitude held to $\pm 10\%$)
"B"... G-Y at 90° ... R-Y... B-Y... Black... R-Y and B-Y within $\pm 1^\circ$ of quadrature
"C"... Black... I... Q... Black... I and Q within $\pm 1^\circ$ of quadrature

PHYSICAL CHARACTERISTICS:
Power: approximately 125 watts
Size: 8½" x 11" x 10¾"
Weight: approximately 22 lbs.



MODEL 622 5' OSCILLOSCOPE

A new oscilloscope concept... *automatic triggered sweep*. Simplifies adjustments, makes synchronization positive. Special CRT has flat face for usable trace edge to edge. One of today's most advanced TV servicing aids...

VERTICAL AMPLIFIER
Frequency Response: 6 cps to 6 mc ± 3 db; down less than 0.5 db @ 4 mc
Sensitivity: 10 mv rms (28 mv peak-to-peak) per inch
Input Impedance: 1 megohm, 40 mmf (± 2 mmf) over entire attenuator range

HORIZONTAL AMPLIFIER
Frequency Response: 1.5 cps to 500 kc ± 3 db
Sensitivity: 75 mv rms (210 mv peak-to-peak) per inch
Input Impedance: 100k, 25 mmf

SWEEP CHARACTERISTICS
Usable writing speed... 0.03 sec/in to .3 μ sec/in

Ranges...
a. 10 cps to 300 kc
b. Preset V & H television @ 7875 and 30 cps
c. 60 cps, variable phase line Type... automatic triggered or straight triggered (by switching)

SYNCHRONIZATION
Internal, external, positive, negative or AC line

CALIBRATION
Internal 60 cps square-wave .05 volts peak-to-peak $\pm 3\%$

POWER REQUIREMENTS
115 volts, 60 cycles, 175 watts

SIZE...WEIGHT
13¾" x 10½" x 18¾" ... 32 lbs.

MODEL 614 VTVM

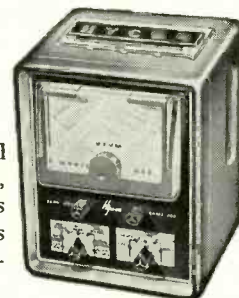

Convenience at unprecedented low cost sums up this rugged, serviceable instrument. It's lightweight, versatile. Probes stow inside case, ready for instant use...

RANGES
DC: 0-1.5, 5, 15, 50, 150, 500, 1500 volts
AC: 0-1.5, 5, 15, 50, 150, 500, 1500 volts rms (with associated peak-to-peak scales)
Ohms: 0-1000 megohms in seven ranges

INPUT IMPEDANCE
11 megohms

FREQUENCY RESPONSE
Direct Probe: 30 cps - 3 mc

Crystal Probe: 50 kc - 250 mc

INDICATOR
6½" meter

ACCURACY
DC and ohms: 3% ... AC: 5%

POWER REQUIREMENTS
115 volts, 60 cycles, 6 watts

SIZE...WEIGHT
8½" x 11" x 7½" ... 10 lbs.

"Where accuracy counts"
Hycon Electronics, Inc.

321 SOUTH ARROYO PARKWAY
PASADENA, CALIFORNIA

A Subsidiary of Hycon Mfg. Company

Be one of the few experts on Audio and Hi-Fi... Cash in on This Money-Making Field

Be prepared! Know how to service the thousands and thousands of dollars worth of Audio equipment the growing army of Hi-Fi enthusiasts is buying. Know all about the different kinds and makes of turntables, pickups, speakers, amplifiers, cartridges, housing, etc. Know how audio circuits work, how to use them properly—how to tell which parts work best in which systems. Have at YOUR fingertips the FIRST and ONLY COMPLETE library of practical, detailed Audio and Hi-Fi know-how ever assembled!

THE GERNSBACK AUDIO AND HIGH-FIDELITY LIBRARY— WRITTEN BY THE WORLD'S FOREMOST AUTHORITIES

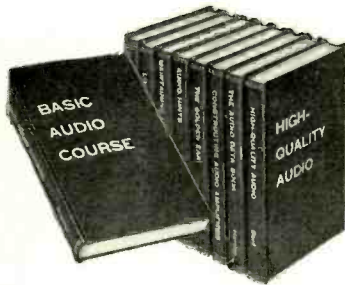

All 9 of the important and valuable books in this library were ordered to the specifications of the Editors of RADIO-ELECTRONICS—Written by the top-notch men in the field. You get complete diagrams and the most expert, detailed and thorough information available. Nothing has been left out . . . everything about Hi-Fi is included . . . practical, condensed, RIGHT TO THE POINT! Now you will have the latest tips, the inside dope—in 9 handsomely bound books. Everything you need to know *where* and *when* you want it!

THE FIRST BOOK IS READY NOW

BASIC AUDIO COURSE, by Donald Carl Hoefler, explains the WHY and HOW of music and electronics in Audio—gives you the complete lowdown on what audio systems must do—tells you all about the new words that make the “language of audio.” Written by a well-known RCA recording engineer, this is an extremely important, easy-to-read basic book you will use again and again.

AND YOU CAN SAVE 25%

You may buy any or all of the nine books at the low retail price of \$5.00 each. OR you may become a member of the GERNSBACK AUDIO AND HIGH-FIDELITY LIBRARY PLAN and SAVE 25%.

Here Is How The Library Plan Works

- 1) You only have to take four out of the nine books in the complete library to get each one at the special low member's price. As a member you pay only \$3.75 per copy—you can save \$11.25 on the whole library! The additional books you will be entitled to receive include: *High Quality Audio*; *Maintaining High Fidelity*; *The Golden Ear*; *Audio Hints*; *Constructing Audio Amplifiers*; *The Audio Data Book*; *Loudspeakers And Speaker Systems*; *Loudspeaker Enclosures*.
- 2) You will receive the very latest books every three months as they come off the press.
- 3) You may examine each new book IN YOUR OWN HOME FOR 10 FULL DAYS AT OUR RISK. If you don't like it, return it.

FILL OUT THIS NO-RISK COUPON TODAY!

All you have to do is fill out this coupon and mail it today. Just check the box next to the plan that suits you best. Start cashing in on this money-making specialty NOW.

NO-RISK COUPON

GERNSBACK PUBLICATIONS, INC.
DEPT. 11-55A, 25 West Broadway, New York 7, N. Y.
Gentlemen:

Please send me postpaid a copy of the deluxe, hard cover edition of BASIC AUDIO COURSE. My remittance of \$5.00 is enclosed.

Enroll me now as a member of the GERNSBACK AUDIO AND HIGH-FIDELITY LIBRARY. Send me postpaid the deluxe, hard cover edition of BASIC AUDIO COURSE. If satisfied I agree to remit the special member's price of \$3.75 and will take at least 4 books.

I would like to know about the GERNSBACK AUDIO AND HIGH-FIDELITY LIBRARY. Send full information.

NAME Please Print
STREET
CITY STATE

AUDIO—HIGH FIDELITY

Out of This World

Earthquake, Ionosphere Noise

Cook 5012

Voice of the Sea

Cook 5011

These records will not bring any joy to the long-suffering wives of audiophiles who like to demonstrate and show off with thunderstorms, pile drivers and similar natural noises. For that matter, the audiophile himself may not be quite as happy with his equipment when he finishes playing the *Earthquake*. Cook says the record will play back without damage on “most good equipment.” I strongly recommend, however, that before you play it you check and adjust pickup tracking and pressure. If the pickup has shown any tendency to skip or jump grooves on ordinary records, you are practically certain to hear more skip than earthquake. Just for consolation let me report that I tried a half-dozen arms and another half-dozen pickups in various combinations, all carefully adjusted, and only the Ferranti, despite its 3-gram pressure, tracked section 11 without skipping or having the jitters. Indeed it continued to be indifferent even to the damage done when other pickups skipped. Section 11 is recorded with something less than 5 cycles in a tremendous swing, presenting the most extreme test of needle compliance and arm resonances I know of.

The peaks on this record rival and possibly exceed those on Audiophile's thunderstorm in amplitude and have much sharper rise and decay times with the beautiful (to the audiophile's ear) dullness of real, natural low-frequency transients. Many good amplifiers can be entirely excused for blocking on one or more of the peaks and extremely good speaker systems need no alibi for suffering some hangover. Certainly, any system which can go through the *Earthquake* side blithely and without causing any trouble anywhere in the chain belongs in the gold-medal class. In other words, this is for those who have the courage to submit their systems (and their families) to just about the ultimate indignity and final test.

The *Ionosphere* side offers no such problems in tracking but it is excellent material for testing high-frequency transient response since a good portion of the sound is similar to white noise and presumably includes components at least to 15,000 cycles. Both sides have a lot of commentary which will bore almost everybody. The actual usable sound could have been put on a 7-inch record and—considering that in at least 50% of the cases the record will be damaged by skipping—such a presentation would have been a lot cheaper way to find out that your system isn't as good as you thought.

The *Voice of the Sea* puts out more familiar noises. Not being an expert on the sea I don't know whether they missed anything. Here are fog horns; the whistle of the Queen Mary; the chugging, clanking, roaring, bellying and grinding of ship machinery, plus one whole side of waves from *Quiet Lapping* to *Pounding Storm*. This stuff needs a system capable of going down at least to 30 cycles.

The Zither

Ruth Welcome

The Cimbalon

Dick Marta

Cook 1032 (10-inch LP)

Pedal Harpsichord

Bruce Prince-Joseph

Cook 1131

I love recordings of strange and out-of-the-way instruments not only for musical reasons but also because their special tonal qualities are most evident on systems which possess a high degree of realism. The first disc will be a treat to the whole family and I recommend it especially as a peace offering if you buy the *Earthquake* and *Voice of the Sea*. The difference between plucked and struck strings is nowhere more sharply defined. The plucking and striking transients as well as the strange harmonic relationships which give these instruments their individual quality are beautifully reproduced. Your wife will like the fact that it should be played at relatively low volume (neither the zither nor cimbalon is capable of much over 100 mw) and everybody will enjoy the lovely music.

The *Pedal Harpsichord* is an astonishing

LEARN MORE! EARN MORE!

WITH H. G. CISIN'S TV SERVICE BOOKS

FACTS ABOUT THE AUTHOR

H. G. Cisin, technical author and publisher, is also well-known as a radio and television inventor, electronic consulting engineer and educator.

Considered to be one of the foremost electronic engineers in the country, Mr. Cisin has the unique ability to translate complex technical subjects such as television, into simple everyday language and this has made him the most popular author in the field of television and radio servicing.

Holder of six U.S. patents, perhaps the most famous of his inventions is the basic AC-DC circuit which makes present-day small radios possible. Among the concerns he has licensed under his patents are: RCA, AT&T, W.E. Co., Bell Telephone Co., and many others. He is also the inventor of the 3-way portable radio and of other important television and radio devices. He is the author of many technical books and also of hundreds of technical articles on radio and TV.

Mr. Cisin learned practical television servicing the hard way by actually working at a test bench on hundreds of faulty TV sets. He has trained thousands of technicians, many now owning their own prosperous TV service concerns, or holding highly paid TV positions. A graduate of Cornell University, he has concentrated on teaching television and radio to men with little formal education. His years of study, practice and experience are embodied in his radio and television service books.

WHAT TV SERVICEMEN & TECHNICIANS SAY ABOUT CISIN BOOKS

Your TV servicing book is much more valuable than your advertisements would indicate.

H. Duloss, RMC, U.S. Naval Radio Station, c/o First Post Office, San Francisco, Cal. So good I am sending for a second copy. I use it to shoot those tough bench jobs. It's a life saver believe me.

Joe F. Clay, Cleveland, Ohio. All you claim. Best investment in my life.

Raymond Dodge, Brighton, Mass. Very ingenious in its logical presentation of cause and effect. Should be in every TV serviceman's tool kit.

George E. Hirsch, Jamaica, N.Y. Thank you for a job very well done. First book of any kind I have ever endorsed.

Robert E. Mays (Bob's Radio Service), Salineville, Ohio. Best book on TV servicing—yet lowest in price. No other book gives the facts like yours.

Anthony Martine, Philadelphia, Pa. Easy to understand and complete. Don't know why you sell it at such a low price.

G. A. Nelson, Seattle, Washington. Send another copy. Have one, but am afraid I might mislay it. Can't afford to be without it.

Edward Danks, Chicago, Illinois. As TV instructor, writer and technician, I can fully appreciate this fine book.

Nicholas B. Cook, Paterson, N. J. Enormously pleased with results obtained by using your book. Hasn't failed me yet.

Joseph B. Seiler, Chicago, Illinois. Your book has taken the mystery out of TV servicing. Better than any book on the subject I have ever seen, but still the lowest priced.

John B. Kleisen (Jack's Radio Hospital), Chicago, Illinois. Your book has helped me tremendously. Hold a top bench job with one of the largest servicing organizations here.

A. J. Thornton, Kalamazoo, Michigan. Please send me another book. Lent my copy to a friend, also a TV serviceman, and can not get it back. We both think it's great.

E. L. Coleman, Youngstown, Ohio. Unable to see how you can give so much for so little. Paid three times as much for other TV service books which didn't contain 1 percent of the information in your book.

Frank Stuppich, Detroit, Michigan. Clear, concise handling of a complicated subject in a way the average serviceman can easily grasp it.

Thomas E. Denton, East Orange, N. J. The above are just a few of the hundreds of similar letters in our files.

TV CONSULTANT

NEW, easy to use way to solve toughest TV troubles. UHF and COLOR TV sections included. Modern alignment methods clearly shown, tell exactly WHAT to do and HOW to do it. Practical pointers on the use of all TV TEST INSTRUMENTS. Over 300 pix, raster and sound symptoms. Detailed directions tell where and how to find faulty parts. Over 135 RAPID CHECKS, many using pix tube as trouble locator. 125 illustr. of scope wave forms, diagrams, station patterns, show various defects. NO THEORY—NO MATH—NO FORMULAS—just practical service info covering all types of TV sets.



TV Serviceman's Silent Partner
No. L1.....Only \$2

RCA TV MODELS



1947 to 1955 TUBE LOCATION GUIDES

Most complete compilation of RCA Trouble Indicating Tube Location Guides ever produced. Contains hundreds of RCA models from earliest 1947 sets to latest 1955 models including Color TV. Each guide shows positions of all tubes and also by a copyrighted method indicates effect of each tube on operation of TV set. Scraps old-style fine-print function names such as AGC Gate, Sync Clip, Vert. Mult., etc. Instead tells plainly what each tube actually does. Tubes affecting picture are marked "P," sound "S," contrast "C," horizontal sweep "H," etc.

Fits Every Tube Caddy—No. A1....\$1

SHOOT TV & RADIO TROUBLE FAST



NEW! A complete section on Rapid Trouble Shooting of AC-DC radio sets combined with new edition of Rapid TV Trouble Shooting Method. Enables you to locate radio & TV faults in record-breaking time, regardless of make or model.

QUICKEST RADIO & TV TROUBLE SHOOTER—No. T2.....\$1.50

TV TUBE LOCATOR

TROUBLE INDICATING TUBE LOCATION GUIDES over 3000 most popular models. Admiral to Zenith. Shows PIX tubes used in many models. Covers products of over 110 different TV manufacturers. Over 135 common TV troubles are listed with explicit directions for locating defective tubes which cause each fault.



SPEED SERVICING—No. K1.....\$1

TV DOCTOR



How to Diagnose and Remedy TV Troubles; Useful Info About TV Sets; Easy Trouble Checks; UHF Servicing; Antenna Know-How; Servicing Hints; Color TV; Troubles Due to Defective Tubes; How to Read Schematic diagrams. Practical hints for prospective TV servicemen.

BEGINNER'S BEST BUY—No. D5....\$1

NEW! TROUBLE SHOOTING PIX GUIDE incl. TV TERMS EXPLAINED

Sect. 1 is a fully illustrated Guide to oft-recurring picture faults. Causes and cures explained. Copyrighted illustrated CHART tells where troubles start in typical TV sets. Illustrations show resulting faulty TV pictures. Sect. 2 explains hundreds of TV terms in non-technical language.



PIX SHOW FAULTS—No. G1.....\$1

NEW! TV & RADIO TUBE SUBSTITUTION GUIDE



Contains tube replacements for TV sets, radios and other electronic devices. All fit same socket and NEED NO CHANGES IN WIRING. Also contains complete data on

TV PICTURE TUBE

replacements, many directly, others with only slight changes.

Substitute with Certainty

No. S1.....Only 50c

TV TROUBLE TRACER

Each vol. has different TROUBLE INDICATING TUBE LOCATION GUIDES of hundreds of popular TV models. Each has over 70 illustr. & Guides. 40 most common pix troubles illustrated.



Vol. 1 (No. TT1) older models;
Vol. 2 (No. TT2) 1952-1953 sets;
Vol. 3 (No. TT3) 1953-1954 sets;
Vol. 4 (No. TT4) 1954-1955 models.

Find It & Fix It.....Each Vol. 50c

ABC OF COLOR TV

Takes mystery out of Color TV. Explains this fascinating new TV development in simple down-to-earth manner. Translates technical descriptions of research scientists into plain language. Covers basic color principles, color signal, transmission, color TV reception, plus practical pointers on color pix tubes, tests, etc.



COLOR TV SIMPLIFIED—No. R1....\$1

RAPID TV TROUBLE SHOOTING METHOD

This unique servicing method has helped thousands to become expert TV diagnosticians. Pix, raster & sound troubles are listed and given code numbers. When these are combined they tell exactly where trouble exists. Then step-by-step directions enable you to find faulty part.

EASY TO USE—No. T1.....\$1

FREE: TV & RADIO TUBE SUBSTITUTION GUIDE

with every purchase of \$5 or over

FREE: TV & RADIO TUBE SUBSTITUTION GUIDE

plus TV TROUBLE TRACER, Vol. 4
with every purchase of \$8 or over

IF JOBBER IS OUT OF STOCK MAIL "NO RISK" TRIAL ORDER COUPON
5-day Money Back Guarantee!

H. G. CISIN, Dept. E-36 AMAGANSETT, N. Y.

Enclosed find \$..... RUSH POSTPAID following books:

L1—\$2 D5—\$1 T2—\$1.50 TT2—50c
 A1—\$1 G1—\$1 T1—\$1 TT3—50c
 K1—\$1 R1—\$1 T1—50c TT4—50c

S1—50c Order \$5 or over SEND BOTH
INCLUDE FREE \$1 FREE BOOKS

Name

Address

City

Zone.....State.....

LOWEST PRICES HIGHEST QUALITY

100 TUBES \$49.50

TUBES—PREMIER Unconditionally Guarantees All Tubes For One Full Year. Very Best Brands Available for Immediate Delivery, Individually Boxed.

| | | | |
|--------|--------|---------|---------|
| 1A5GT | 6AL5 | 6V7 | 12SN7GT |
| 1A6 | 6AQ5 | 6W4GT | 12SQ7GT |
| 1A7GT | 6AU5GT | 6W6GT | 12X3 |
| 1B3GT | 6AU6 | 6X5GT | 12Z3 |
| 1D8GT | 6AV5 | 7A5 | 14B6 |
| 1F4 | 6AV6 | 7A5 | 14B8 |
| 1F5GT | 6AX4GT | 7A7 | 14Q7 |
| 1H5GT | 6AX5GT | 7A8 | 14W7 |
| 1H6G | 6B4G | 7AD7 | 14X7 |
| 1L4 | 6BA6 | 7B6 | 24A |
| 1LA4 | 6BD6 | 7B7 | 25A6 |
| 1LA6 | 6BE6 | 7B8 | 25AC5GT |
| 1LC5 | 6BF6 | 7C4 | 25B06GT |
| 1LC6 | 6BG6G | 7C5 | 25C6G |
| 1LD5 | 6BQ6GT | 7C6 | 25W4GT |
| 1LH4 | 6BY5G | 7C7 | 25Y5 |
| 1LN5 | 6C4 | 7E5 | 25Z5 |
| 1NS5GT | 6C5GT | 7E6 | 26 |
| 1P5GT | 6C6 | 7E7 | 27 |
| 1Q5GT | 6C6 | 7J7 | 32L7GT |
| 1R5 | 6C8G | 7J7 | 35F1 |
| 1S5 | 6C8G | 7N7 | 35A5 |
| 1T4 | 6CD6G | 7Q7 | 35B5 |
| 1U4 | 6D6 | 7V7 | 35C5 |
| 1V | 6D8G | 7W7 | 35L6GT |
| 1V4 | 6F6GT | 7X7 | 35Y4 |
| 1X2A | 6G6G | 12A7 | 35Z5GT |
| 2A7 | 6J6 | 12AU6 | 39/44 |
| 2X2 | 6K6 | 12AU7 | 41 |
| 3A4 | 6L6G | 12AV7 | 42 |
| 3B7 | 6P5GT | 12AX4GT | 43 |
| 3C6 | 6Q7GT | 12AX7 | 45 |
| 3Q4 | 6S4 | 12AY7 | 45Z5GT |
| 3Q5 | 6SA7GT | 12BA7 | 46 |
| 5U4G | 6SD7GT | 12BD6 | 47 |
| 5Y3GT | 6SF5 | 12BE6 | 50AX6 |
| 5Z3 | 6SJ7GT | 12BH7 | 50L6GT |
| 6A7 | 6SH7GT | 12F5GT | 56 |
| 6AB4 | 6SK7GT | 12J7GT | 57 |
| 6AB7 | 6SL7GT | 12J7GT | 58 |
| 6AC5GT | 6SN7GT | 12S8GT | 70L7GT |
| 6A7 | 6SQ7GT | 12SA7GT | 77 |
| 6A7 | 6SS7 | 12SC7 | 78 |
| 6AG5 | 6U7GT | 12SG7 | 117L7GT |
| 6AK5 | 6U8 | 12SK7GT | 117Z3 |
| 6AK6 | 6V6GT | 12SL7GT | 117Z6GT |

ANY ASSORTMENT—TAKE WHAT YOU WANT
5c per tube extra FOR ORDERS LESS THAN 100 TUBES

NEW PICTURE TUBES

| SIZE | PRICE | SIZE | PRICE |
|--------|---------|--------|---------|
| 10BP4B | 11.95 | 17LP4 | \$21.95 |
| 12LP4A | 13.95 | 17TP4 | |
| 12UP4A | | 19AP4B | \$27.95 |
| 14BP4A | \$18.95 | 19DP4B | |
| 14CP4 | | 20CP4 | \$26.95 |
| 16AEP4 | 17.95 | 20DP4 | |
| 16AP4A | | 20HP4 | \$28.95 |
| 16DP4A | | 21AP4 | |
| 16EP4A | \$19.95 | 21EP4 | 27.95 |
| 16GP4A | | 21FP4 | 28.95 |
| 16JP4A | | 21MP4 | 29.95 |
| 16KP4 | 17.95 | 21WP4 | 27.95 |
| 16LP4A | 19.95 | 21YP4 | 28.95 |
| 16RP4 | \$17.95 | 21ZP4 | 27.95 |
| 16TP4 | | 24CP4 | 49.95 |
| 16W4A | 19.95 | 27EP4 | |
| 17BP4A | 17.95 | 27GP4 | |
| 17CP4 | \$21.95 | 27LP4 | \$59.50 |
| 17GP4 | | 27MP4 | |
| 17HP4 | | 27NP4 | |
| | | 27RP4 | |

ALL TUBES THROUGH 21" GUARANTEED 1 YEAR
24" AND 27" GUARANTEED 6 MONTHS

One Hundred Assorted RESISTORS

\$1.49 PER HUNDRED
200 FOR \$2.50

All good values, sizes and types 1/2-1.2 watts—
2%—5%—10%—20%, Precision—Carbon Insulated—
Carbon—Deposited Carbon



10 lbs. Net of Rej-able Radio and T. V. Parts—Each Kit includes a new Radio Cabinet—Good for 5 to 8 Tube Chassis. **All for \$1.98**

QUALITY CLEAR-BEAM ANTENNA KIT 10 ELEMENT CONICAL

Complete with Mast, 300 OHM Lead in Wire, Guy Wire, Mount, Stand-Off Insulators and Hardware. **\$6.95**

TERMS: 25% DEPOSIT with order, balance C.O.D. All shipments F.O.B. Chicago. ORDERS LESS THAN \$5.00—\$1.00 SERVICE CHARGE. These prices supersede all previous advertised prices, subject to change.

PREMIER

TV Radio Supply

3241 W. North Ave.

Chicago 47 • ARmitage 6-5550

Write for FREE Bargain Catalog

AUDIO—HIGH FIDELITY

beast: it differs from the normal harpsichord because in addition to the two upper manuals it has a pedal manual flat on the floor. For the hi-fi man it offers the most remarkable concatenation of low-frequency transients I can recall hearing. Indeed, most of the sound below 50 cycles consists of the noises as feet actuate pedals and they in turn actuate levers which pluck the strings. And these noises are probably little softer than the music they are supposed to produce. These unique transients fall mostly in the bottom two octaves and provide excellent measures of transient response in this region. If the bass is boosted rather violently, portions of this will in fact sound like a bit of *Earthquake* with the music. As for the music it consists of the Vivaldi-Bach *Concerto No. 2 for Organ*, Mozart's *Sonata in C Major* and Bach's *Prelude in G Major* and *Bouree* from *The 2nd English Suite*. All very pleasant despite the noises.

PROKOFIEFF: *Concerto No. 1 in D Major*

LALO: *Symphonie Espagnole*
Nathan Millstein, violin
St. Louis Symphony Orchestra
Capitol P-8303

Excellent demonstration and showoff material for that clean high end. In the Prokofieff concerto the fiddle is continually being called upon to supply beautiful birdlike or piccololike notes in the very high register. Millstein produces them superbly and this recording reproduces them cleanly. If as you play them back they have any edge, fuzziness, sharpness or stridency—if they're anything less than birdlike—your system needs attention and replacement. There is also some heavy bass under the fiddle in portions which provides a good check for IM. At the high end the birdlike note is sustained for several measures, a severe test for wow. As a dividend the Lalo work has some of the loveliest melodies written for the fiddle. The recording is slightly marred by touches of distortion in the peaks, but no worse than most.

MacDOWELL: *Woodland Sketches* GRIEG: *Holberg Suite*

Richard Ellsasser at Baldwin
Electronic Organ

MGM E-3182

The Baldwin electronic organ sounds a good deal more like a pipe organ than some others. The pedals don't go down as far, or at least not with as much volume, presumably because Baldwin has had no better luck covering this range with loudspeakers than the rest of us. But down to about 35 cycles the bass is deep and with the round quality of a pipe bass rather than the percussive quality of most electronic organs. The music will make sophisticates squirm but most people will love it. The record will produce a sound to be proud of on any really good hi-fi system.

HONEGGER: *Pacific 231*

DEBUSSY-RAVEL: *Danse*

BARBER: *Adagio for Strings*

Willis Page conducting New

Orchestral Society of Boston
Cook 1068 (10-inch LP)

None of the three selections has any affinity for the others but the very diversity makes this a good demonstration and showoff record. *Pacific 231* was a famous tour de force in the Twenties and has not been much recorded because it really demands high fidelity and here receives it. Though not meant to be an exact imitation it provides a colorful and real impression of a train with all its huffing and puffing, clanking, rattling, hissing and roaring and clacking. Played at a loud level and with some bass boost to bring up the lowest octave, the effects are startling and spectacular. I would say that here is a record for those who want some music with their noises, but I'm afraid most wives will not hear much music in it. The *Danse*, though, is very musical and has some fine high-highs, while the *Adagio for Strings*, played with \$100,000 worth of rare fiddles, sounds like it. The recording quality is very fine throughout.

Incidentally, Cook records, too, are sold by many parts distributors as well as music stores.

a HIT in High Fidelity with COLLINS

AUDIO PRODUCTS CO. 'PRE-FAB' TUNERS

Collins Audio Products Co. is in no way affiliated with Collins Radio Co.

Each Collins Tuner Kit is complete with punched chassis, tubes, power transformer, power supply, components, hardware, dial assembly, tuning eye, knobs, wire, etc., as well as the completed sub-assemblies: FM tuning units, AM tuning units, IF amplifiers, etc. All sub-assemblies wired, tested and aligned at the factory make Collins Pre-Fab Kits easy to assemble even without technical knowledge. The end result is a fine, high quality, high fidelity instrument at often less than half the cost—because you helped make it AND BOUGHT IT DIRECT FROM THE FACTORY.

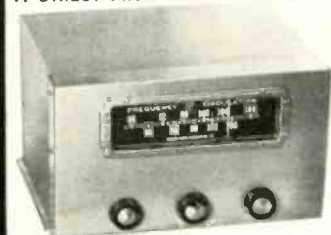

NEW FM TUNER KIT

New decorative gold front. New cascade front end—3 mv sensitivity. 1F amplifier mounted, wired and tested in the chassis. You mount completed RF tuning unit and power supply. 11 tubes, 20 to 20,000 cycle response. A.F.C. and switch. Size: 12 1/2" x 9 1/2" x 7". High. Shipping weight: 15 pounds. Manual supplied. Gold screen cover available at \$3.50 extra. PRICE: **\$59.50**



NEW FM-AM TUNER KIT

New, decorative gold front like FM tuner above. New cascade front end on FM—3 mv sensitivity. 15 tubes. Comprises chassis, amplifier, all wired and tested, ready for mounting in chassis. A.F.C. with switch. Kits include all parts and hardware. Size: 14 1/2" x 12" x 7 1/2" high. Shipping weight: 19 pounds. Manual supplied. Gold screen cover available at \$3.75 extra. PRICE: **\$82.50**

FMF-3B Tuning Unit with Cascade

Permeability tuned, 3 tubes. A.F.C. 3 microvolts sensitivity. May be used with any 10.7 MC IF amplifier such as our IF-6. **\$19.50**

AM-4 Tuning Unit

3-gang tuning condenser. Unit covers 530 to 1600 KC. Completely wired and tested with tubes. 4 tubes. Chassis plate measures: 4" x 7 3/8". 2 1/2 pounds. **\$24.50**

IF-6 Amplifier

6 tubes. 10.7 MC. Low distortion, high gain. 3 pounds. **\$21.50**

--- MAIL COUPON TODAY! ---

To: Collins Audio Products Co., Inc.
P. O. Box 368
Westfield, N. J.
Tel. Westfield 2-4390

- RE-11
- FM Tuner Kit
 - FM-AM Tuner Kit
 - FMF-3B Tuning Unit
 - IF-6 Amplifier
 - AM-4 Tuning Unit
 - COVER

Name _____
Address _____
City _____ State _____
Amount for KIT \$ _____
See weights, add shipping cost \$ _____
Total amount enclosed \$ _____
 Check Money Order

WHEN YOU THINK OF TUNERS,
THINK OF
COLLINS AUDIO PRODUCTS

GUIDE

AUTRONIC-EYE[®]

TRAINING COURSES

MEAN MORE

BUSINESS FOR YOU!



Courses for experienced service technicians provide latest repair information—enable you to do the job faster and more efficiently.

Quick, accurate circuit diagnosis and repair to factory specifications boosts your profits. That's why so many qualified auto technicians attend these Guide training courses at no cost other than transportation and living expenses.

The Guide Lamp diploma, awarded only to those who successfully complete the course, is proof that you're equipped to give more and better service to more people—and that means business.

If you're an auto radio service dealer, come yourself, or send your technicians. There's one of 30 GM Training Centers near you. Apply through your local United Motors Service Division Distributor or write

GUIDE LAMP DIVISION • GENERAL MOTORS CORP. • ANDERSON, INDIANA

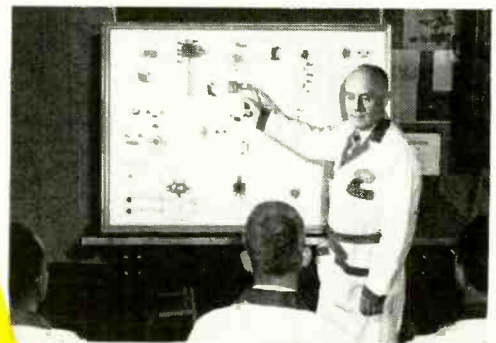

Jumbo-size operational panel of Guide's Autronic-Eye Circuit puts all parts out front for better, more efficient instruction.



Thirty modern GM Training Centers offer newest equipment and latest service techniques. There's one nearby . . . no matter where you live.



POWERAY

new
antenna
development

AMPHENOL

114-096
Four Bay
List 69.75

new FRINGE AREA antenna features revolutionary SLEEVE DIPOLE principle

The reason for the outstanding performance of the new AMPHENOL VHF POWERAY is a new design variation of the sleeve dipole principle. The POWERAY provides better pictures in fringe and deep-fringe areas because *only this new design* properly balances the three important reception factors: high gain, directivity and *exact impedance match* between antenna, lead-in and TV set.

new PRINCIPLE: how it works

The sleeve dipole principle of the POWERAY is based upon resonance of the overall length at a low frequency and resonance of a 3-wire transmission line section at a higher frequency. The result is ideal broadband performance and *proper balance* of very high gain, sharp directivity and exact impedance match.

PREASSEMBLED

The POWERAY is preassembled for less installer-time on the job. All long elements swing out and are held securely in place with a new, positive spring-locking device. The two and four bay models in which the POWERAY is available are quickly connected with one piece stacking harnesses.

performance proves SUPERIORITY

The POWERAY'S superior design is proved by its superior performance. *Try* the POWERAY for fringe area reception—and *see* for yourself why the POWERAY is the finest antenna ever built for fringe areas!

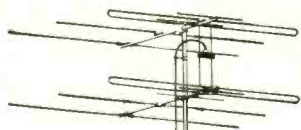
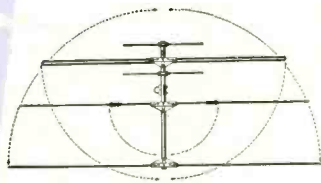

114-095
Two Bay
List 34.75

AMPHENOL

AMERICAN PHENOLIC CORPORATION
chicago 50, illinois

In Canada: AMPHENOL CANADA LIMITED, Toronto 9, Ontario

See Your AMPHENOL Distributor

AUDIO—HIGH FIDELITY

Pop Concert Favorites (Vol. 5):

Pinocchio, Funeral March of Marionette, Suite Primeval, Cortège from Queen of Sheba, Phaeton, Pacific 231

Philharmonia Orchestra of Hamburg, conducted by Hans-Juger Walther
MGM E-3144

Another well recorded potpourri of the popular type of classical music. This is from the same tapes used for the Musical Sound Book records and it is interesting to note that there is practically no difference in quality between these and the 78-r.p.m. MSB versions. *Pacific 231* sounds different than in the Cook record, largely because the interpretation and even the instrumentation is a little different. What with *Pacific 231* and the drums of the *Primeval Suite* and the high bouncing strings of *Phaeton*, this should please many both for the music and as showoff material.

Cool Europe

Jutta Hipp and Her German Jazzmen
Mike Nevada and His British Jazzmen
MGM E-3157

Of the current crop of pops this one might be of greatest interest to jazz people. Personally I'm strictly from Dixie and especially N'Awlins and these attempts by the brassy jazz brethren overseas really leave me very cool indeed; but there's some excellent sound in this and those who aren't as provincial and reactionary will probably enjoy knowing what's happening to jazz over there.

Jimmy Rushing Sings the Blues

Vanguard VRS-8011

They say that for blues Jimmy Rushing is the greatest since Bessie Smith; all I can say is that it's too bad Bessie was never presented in sound as fine as this. Allowing for some Count Basie type modernisms, especially in the orchestral accompaniment, I'll grant he does sing the blues with some of that primitive feeling they need and his voice has the right touch of whiskey in it. The sound is absolutely top-notch.

Burlesque Uncensored

Cook 1071

I usually go along with Emory Cook's tour de forces but I find nothing of hi-fi value here—after all even a lousy TV sound is capable of getting burlesque jokes across and does every day. But it might possibly be an interesting thing to bring home as evidence that what the maiden aunts and the cops say about burlesque just ain't so. END

Names and addresses of manufacturers of any items mentioned in this column may be obtained by writing Monitor, RADIO-ELECTRONICS, 25 West Broadway, New York 7, N. Y.



"And just as a suggestion—kicking your set will do little to bring back the picture."

NOVEMBER, 1955

NOW... the Service Dealer can make

HI-FI PROFITS

ONLY
TRANSVISION
OFFERS THIS
4-POINT PROGRAM
to the
**SERVICE
DEALER**

1. FULL PRICE PROTECTION.
2. NEGLIGIBLE INVENTORY INVESTMENT. A Sales Kit* gets you started!
3. FINEST MATCHED HI-FI UNITS for custom-building or complete in beautiful furniture cabinets.
4. PRICES THAT ENABLE YOU TO UNDERSSELL COMPETITION.



You sell the Finest Matched Hi-Fi Components such as these:

RC101

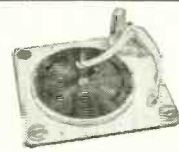

RECORD CHANGER (Famous English Collaro) with **D AMOND NEEDLE** and **RELUCTANCE PICKUP.**

A102



AMPLIFIER: Superb Transvisior 10 watt unit with built-in Pre-Amp.

S101

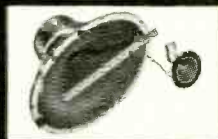

15" Transvisior **DUAL SPEAKER SYSTEM** with cross over network.

The Service Dealer sells the above complete system for only \$153!

*SALES KIT for \$4.95 gets you started. Rush coupon for full details.

BEAUTIFUL FURNITURE plus SUPERB HI-FI:

You can offer Hi-Fi quality equal to many \$1000 jobs on the market—for as little as \$159 to \$299. In component form for custom-building, or in complete "package" including fine furniture as shown above. (Bass reflex corner cabinet and lovely chairside end table.)

**SOLD ONLY THRU
SELECTED DISTRIBUTORS**
Write for name of the one in your area.

DISTRIBUTORS: Some areas still available. Write, wire, phone for complete program.

TRANSVISION, INC. • NEW ROCHELLE, N. Y.

TRANSVISION, INC., NEW ROCHELLE, N. Y. RE-11

- Please send name of your nearest Distributor.
 Rush full details on your Hi-Fi Dealer Program.

Name _____

Address _____

City _____ State _____

NEWEST ELECTRONIC SENSATION!



the SUPERKIT TRANS-ATOMIC
TRANSISTOR RADIO \$8.95

(completely wired \$9.95)

Enjoy your favorite programs wherever you may be! Be prepared for Conelrad emergency broadcasts. The amazing Trans-Atomic featherweight Transistor Radio brings in all stations loud and clear . . . is so small that it fits easily into pockets, your palm or your purse. Smartly packaged in an unbreakable case, it actually works for months on 10c flashlight batteries!

Real quality thru & thru . . . features the miracle Germanium Transistor and Germanium Diode, a Slide Rule Dial for precision tuning, and the world-famous Loopstick for unsurpassed reception. Prepunched for quick, easy assembly . . . only a screwdriver is needed. Comes complete with batteries, parts, instructions.

Superkit GERMANIUM DIODE RADIO



\$5.95

list Complete with DeLuxe Sensiphone Earphone and Antenna

Features

- World-famous Loopstick
- Professional Metal Chassis
- Slide Rule Dial for Precision Tuning

Assures loud, clear reception even without a long aerial. Easily assembled . . . only a screwdriver is needed. Complete with illustrated, step by step instructions.

DeLuxe Sensiphone EARPHONES

HERE'S SENSATIONAL RECEPTION FROM

- Transistor Sets
- Crystal Sets
- Battery Sets
- Monitor Tape Recordings
- ANY instrument needing earphones!



Single Phone (1,000-ohm) List 1.98
Double Phone (2,000-ohm) List 3.49

IDEAL FOR CHRISTMAS! Give it as a gift for boys and girls. Perfect for Boy Scouts and similar organizations.

At your Dealer, or write Dept. E-11

SupereX CORP. 4 Rodford Pl., Yonkers, N.Y.

(Continued from Page 33)

Plays we would like to present specially for deaf children are almost impossible, except in mime. Many have suggested running subtitles to cover dialogue, but it is surely too much to ask children to watch dramatic action and at the same time read captions which may contain unfamiliar words. Screen size is another limitation. To have all the words spoken in closeup would almost certainly ruin dramatic action. Mime plays seem the answer and we are experimenting with these.

On the whole, reactions to the program have been very favorable. At first this may have been due to the fact that there was a program specially for deaf children. A sense of isolation and of indifference to their needs is, we know, felt by many deaf people. The general public remains very ignorant of the difficulties of the deaf. We know from letters from normal-hearing children that these programs have helped to bring their needs to more general notice. And the deaf are delighted to have a special program of their own.

This however is not sufficient justification for a series, and we apply exactly the same standards of performance and interest as to similar normal-hearing children's programs. Inevitably presentation method slows the tempo of programs. And some older deaf children feel the contents are babyish and too "easy."

We are now experimenting with another series designed for normal-hearing children but considered suitable for the deaf. We try to justify the label by including only material so visually clear that words spoken out of vision do not mean any loss of understanding for the deaf. The programs are aimed at older children. We occasionally include a caption but we do not caption all words spoken in vision. Anything spoken in vision is shown in closeup and in simple words spoken slightly more slowly and deliberately than normal. The first two programs have been generally well received.

One secondary result of both series is, we hope, to make deaf children feel more a part of the general community. In "Wednesday Magazine" we will include deaf as well as normal-hearing children in the programs. In the series for the deaf, we include deaf children wherever possible. They are found very cooperative, very quick to realize what is happening and remarkably free from self-consciousness. They do need a good deal of rehearsal and must know exactly what is expected of them. Once they have grasped this they do not forget and carry through with charming spontaneity.

Quizzes are popular. In lip-reading quizzes we ask the children to illustrate a sentence spoken to them. We have had visual quizzes showing two photographs one after the other. Both show a number of objects, but the position of one object has been changed. The children are extremely quick at this kind of question, which depends on observation. Their answers (and the correct answer) are shown in writing in case deaf children at home have not been able to lip-read the child's answer.

Whenever possible we get deaf children to speak, although the born-deaf child's voice may come as rather a shock to the normal-hearing.

Deaf children are very fond of sports. Well known sportsmen have taken part in programs and discussed various games. Usually we invite deaf youngsters to take part in the demonstration.

We also include as often as possible adult deaf who can entertain by drawing or conjuring, acting, etc. or can explain their jobs. We hope their appearance may encourage those deaf children who may be beginning to be aware of their handicap. The programs have won their place in the general output for children. Audience reaction figures show that children generally appreciate them as much as similar programs for hearing children in spite of the slower tempo.

We are constantly experimenting—trying to brighten the lives of this small but important section of the child audience. —By arrangement with European Broadcasting Union Bulletin

See What's New in ELECTRONICS Radio • TV • High Fidelity



FREE!

Send for NEWARK'S 1956 CATALOG

See the latest and finest equipment ever offered in High-Fidelity, Radio, TV, Amateur and Electronics. Select the fast, dependable way, from this new 260-page catalog.

NEWARK ELECTRIC COMPANY

Dept. RE-11, 223 W. Madison, Chicago 6, Ill.

WEST COAST BRANCH
4736 W. Century Blvd., Inglewood, Calif.

PERMO'S SALES INDEX

A factor of the relative national rate of movement of each type of needle to other types

| Permo Needle Number | Reg. Price | Rate Per 100 | Index | % of Needle Played | Permo Tip Material & Size |
|---------------------|------------|--------------|--------|--------------------|---------------------------|
| A-300 | \$7.50 | \$1.50 | \$1.47 | 7.9 | Shirred Jewel 001 |
| A-304 | 1.50 | .30 | .88 | 2.3 | Shirred Jewel 001 |
| B-210 | 1.00 | .50 | .49 | 136.3 | Permo Metal 001 |
| A-316 | 1.50 | .90 | .86 | 1.3 | Permo Metal 001 |
| C-320 | 1.50 | .90 | .88 | 17.9 | Shirred Jewel 002 |
| B-334 | 2.50 | 1.50 | 1.47 | 1.3 | Shirred Jewel 002 |
| B-334D | 25.00 | 15.00 | 14.70 | 1.3 | Shirred Jewel 002 |
| C-360 | 2.50 | 1.50 | 1.47 | 1.3 | Shirred Jewel 002 |
| C-360D | 25.00 | 15.00 | 14.70 | 1.3 | Shirred Jewel 002 |
| A-311 | 1.50 | .75 | .73 | 30.2 | Permo Diamond 78 |
| C-312 | 1.50 | .75 | .73 | 14.70 | Permo Diamond 78 |
| C-312D | 25.00 | 15.00 | 14.70 | 1.3 | Permo Diamond 78 |
| AC-313 | 3.00 | 1.80 | 1.76 | 4.7 | Permo Diamond 78 |
| AC-313D | 26.50 | 15.90 | 15.98 | 1.4 | Permo Diamond 78 |
| A-314 | 2.00 | 1.20 | 1.18 | 1.4 | Permo Diamond 78 |
| A-314D | 25.00 | 15.00 | 14.70 | 1.3 | Permo Diamond 78 |
| AC-315 | 2.50 | 1.50 | 1.47 | 6.7 | Permo Diamond 78 |

DEALER PRICE

Keeps you from being "STUCK" with once-a-year sellers . . .

PERMO PHONO NEEDLES

PERMO, INC. CHICAGO 26

CABINART '56 - HI FI CABINET KITS

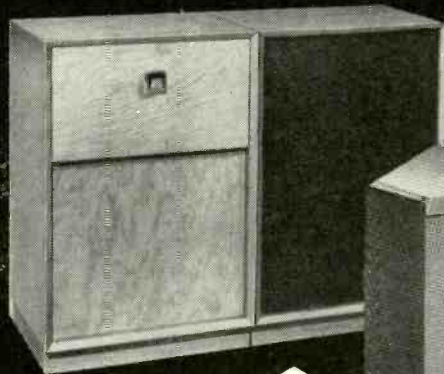

**MODEL 27K
MODEL 28K**
matched equipment
and speaker
cabinets

HI Fi
wall storage
units

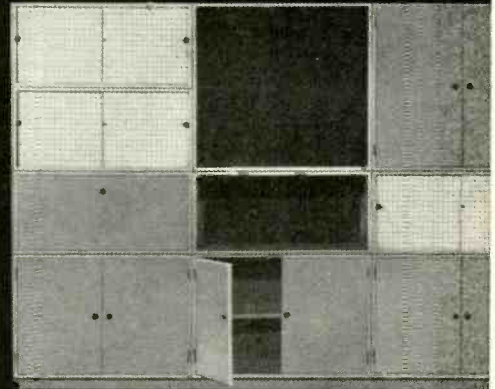

Model K-3
newest Rebel*
corner folded horn kit



... all you need is a screwdriver!

Machined wood pieces key exactly to each other! Pre-shaped, pre-drilled, pre-engineered and not a scrap of sawdust left over!

THE REBEL K-3

Identical acoustically with the KR-3, first and largest of the Klipsch-designed Rebel series of corner folded horns. Using the mirror images of room walls at a corner, the K-3 extends bass down nearly to 30 cycles! Two companion Rebel kits are more economical but only in price and size.



K-3 . . . \$54.00

Prices slightly higher west and south

THE "ST" SERIES

Wall storage units . . . ten basic Cabinart designs in kitform or assembled, ready to finish. Each is tailored to the needs of hi-fi installations. The Series includes a *nine cubic foot bass reflex cabinet*.

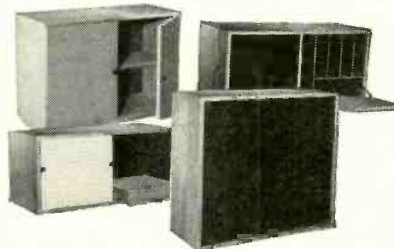

**Prices from
\$21.00 to \$36.00**

FURNITURE KITS

The new 27K and 28K typify Cabinart kit utility and economy. Both point up the unique design functions necessary to the correct hi-fi installation.



**Equipment Cabinet
\$51.00**



**Bass Reflex
\$39.00**

WRITE FOR THE NAME OF YOUR NEAREST DEALER AND MAIL ORDER HOUSE.

kits by **cabinart**

...the pioneers in radio furniture
for high fidelity.

99 NORTH 11th STREET, BROOKLYN 11, NEW YORK

*Trademark

WRITE

1. Equipment Storage
2. Equipment/Speaker Enclosure Kits
3. The Rebel Speakers
4. Wall Storage Cabinets
5. Accessories By Cabinart

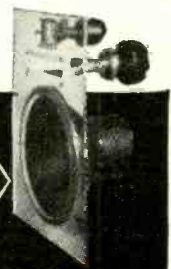

LEARN RADIO AT HOME WITH THE PROGRESSIVE RADIO "EDU-KIT" MAIL TODAY.

BUILD 16 PRINTED CIRCUIT and METAL CHASSIS RADIO CIRCUITS

With the New Deluxe 1956 Progressive Radio

ONLY **\$19.95** Complete

"EDU-KIT"

NOW INCLUDES RECEIVER, TRANSMITTER, CODE OSCILLATOR, SIGNAL TRACER, SIGNAL INJECTOR, CIRCUITS

- ATTRACTIVELY GIFT PACKED
- FREE SOLDERING IRON
- NO ADDITIONAL PARTS NEEDED
- EXCELLENT BACKGROUND FOR TV
- 30 DAY MONEY-BACK GUARANTEE
- SCHOOL INQUIRIES INVITED
- ABSOLUTELY NO KNOWLEDGE OF RADIO NECESSARY



WHAT THE "EDU-KIT" OFFERS YOU

Our Kit is designed to provide a fundamental background in radio, with the basic facts of Radio Theory and Construction Practice expressed simply and clearly. You will gain a knowledge of basic Radio Principles involved in Radio Reception, Radio Transmission and Audio Amplification. You will learn how to identify Radio Symbols and Diagrams; how to build radios, using regular radio circuit schematics; how to mount various radio parts; how to wire and solder in a professional manner. You will learn proper chassis layout. You will learn printed circuitry. You will learn how to service and trouble-shoot radios. You will learn code. You will receive training for F.C.C. Novice License. You will learn High Fidelity. In brief, you will receive a practical basic education in Radio, worth many times the small price you pay.

THE KIT FOR EVERYONE

The Progressive Radio "Edu-Kit" was specifically prepared for any person who has a desire to learn Radio. The Kit has been used successfully by young and old in all parts of the world. It is not necessary that you have even the slightest background in science or radio. The Progressive Radio "Edu-Kit" is used by many Radio Schools and Clubs in this country and abroad. It is used by Armed Forces Personnel and Veterans throughout the world. The Progressive Radio "Edu-Kit" requires no instructor. All instructions are included. All parts are individually boxed, and identified by name, illustration and diagram. Every step involved in building these sets is carefully explained.

PROGRESSIVE TEACHING METHOD

The Progressive Radio "Edu-Kit" comes complete with instructions. These instructions are arranged in a clear, simple and progressive manner. The theory of Radio Transmission, Radio Reception, Audio Amplification and servicing by Signal Tracing is clearly explained. Every part is identified by illustration and diagram. You will learn the function and theory of every part used. The Progressive Radio "Edu-Kit" uses the principle of "Learn by Doing". Therefore you will build radio circuits, perform jobs, and conduct experiments to illustrate the principles which you learn. These circuits are designed in a modern manner, according to the best principles of present-day educational practice. You begin by building a simple radio. The next set that you build is slightly more advanced. Gradually, in a progressive manner, you will find yourself constructing still more advanced multi-tube radio sets and doing work like a professional Radio Technician. Altogether you will build Receiver, Transmitter, Code Oscillator, Signal Tracer, Signal Injector Circuits—16 in all. These sets operate on 105-125 V. AC-DC. For use in Foreign Countries having 210-250 Volt Source, an Adaptor for 210-250 V. AC-DC operation is available.

THE PROGRESSIVE RADIO "EDU-KIT" IS COMPLETE

You will receive every part necessary to build 16 different radio circuits. Our "Edu-Kit" contains all tubes, tube sockets, variable, electrolytic and paper condensers, resistors, tie strips, coils, hardware, tubing, instruction manuals, printed circuit materials, etc. No solder or wire included. These parts are individually packaged, so that you can easily identify every item. A soldering iron is included, as well as an Electrical and Radio Tester. Complete, easy-to-follow instructions are provided. All parts are guaranteed, brand new, carefully selected and matched. In addition, the "Edu-Kit" now contains lessons for servicing with the Progressive Signal Tracer and Signal Injector. F.C.C. instructions, quizzes, High Fidelity instructions.

TROUBLE-SHOOTING LESSONS

Trouble-shooting and servicing are included. You will be taught to recognize and repair troubles. You will build and learn to operate a professional Signal Tracer and Signal Injector. You receive an Electrical and Radio Tester, and learn to use it for radio repairs. While you are learning in this practical way, you will be able to do many a repair job for your neighbors and friends, and charge fees which will far exceed the cost of the "Edu-Kit". Here is your opportunity to learn radio quickly and easily, and have others pay for it.

FREE EXTRAS

- ELECTRICAL & RADIO TESTER
- TV BOOK
- QUIZZES
- FREE CONSULTATION SERVICE
- HI-FI GUIDE
- TESTER INSTRUCTION MANUAL
- ELECTRIC SOLDERING IRON

Progressive "Edu-Kits" Inc. 497 Union Ave., Brooklyn 11, N.Y.

MAIL TODAY—Order shipped same day received. 30-Day Money-Back Guarantee. Include ALL FREE EXTRAS

- Send "Edu-Kit" Postpaid. I enclose full payment of \$19.95 (U.S.A. only).
- Send "Edu-Kit" Postpaid. I enclose full payment of \$20.95 (Outside U.S.A.).
- 210-250 V. Foreign Line Voltage Adapter for "Edu-Kit"—\$2.50.
- Send "Edu-Kit" C.O.D. I will pay \$19.95 plus postage (U.S.A. only).
- I wish additional information describing "Edu-Kit". No Obligation.
- Send me FREE Radio-TV Servicing Literature. No Obligation.

Name.....
Address.....

PROGRESSIVE "EDU-KITS" INC.

497 Union Ave., Room 110-G, Progressive Bldg., Brooklyn 11, N. Y.

BUILD 16 RADIO CIRCUITS AT HOME WITH THE PROGRESSIVE RADIO "EDU-KIT" MAIL TODAY.



BROAD-BAND ANTENNAS, Fireball, for deep fringe v.h.f.-u.h.f. **FB500S-68** (2-bay model) incorporates reverse-phase multiplex dipole system of **Fireball FB500**. Custom-tailored for co-adjacent-channel interference. Wide stacked at spacing of 68 inches and coupled with 68-inch high-band rejection stack-

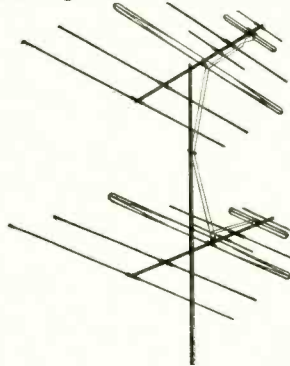

ing transformer; increases back rejection on high channels by 8 db.

Model FB500S-96 (illustrated) with 96-inch low-band boost stacking transformers increases gain on channels 2 to 6. Stacking gain of 15% over standard stacking configuration.—**JFD Mfg. Co., Inc.**, 6101 16th Ave., Brooklyn 4, N. Y.

TV ANTENNA, Little Jim, models LJ-1 and LJ-2. High gain on v.h.f. channels. New type director increases gain directivity on high and low bands, permits close coupling of directors with-

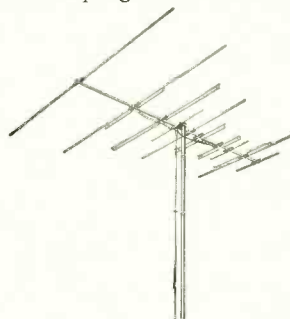

out sharp decrease in radiation resistance. Mounts on 96-inch crossarm.—**Kay-Townes Antenna Co.**, Rome, Ga.

AUTOMATIC ANTENNA ROTATOR, Superotor, completely



electronic. Eliminates spring or gear mechanisms in control unit. Dimensions 2½ x 7½ x 4½ inches. Automatically illuminated dial. Perfect synchronization between control and rotor units; smooth rotation without steps or jumps. Fingertip vernier precision tuning. Removable power unit. Choice of two interchangeable rotor units.—**Thompson Products Inc., Electronics Div.**, 2196 Clarkwood Rd., Cleveland 3, Ohio.

SUPER-FRINGE ANTENNA, Wizard, features phase reverser—specially shaped metallic shield

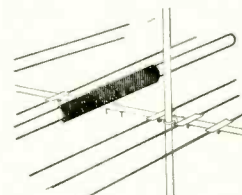

in front of receiving element. Functions as three separate antennas in one for high and low channels. Phase reverser eliminates complicated harnesses, phasing stubs, extra dipoles.—**Walsco Electronics Corp.**, 3602 Crenshaw Blvd., Los Angeles 16, Calif.

12-WATT AMPLIFIER, Knight Bantam: 3.3-megohm input for ceramic phono cartridges, level control on tuner input, variable damping control. Frequency response ±0.5 db, 20-20,000 cycles; total harmonic distortion 1%; IM distortion less than 2%; hum down 75 db. 6 inputs for



G-E and Pickering magnetic, ceramic, radio tuner or crystal cartridges, tape recorder and microphone.

Knight FM-AM Bantam Tuner for Bantam Amplifier: 2 front-panel controls, tuning and function selector and output level on rear panel prevent overdriving amplifier; 7-tube-plus-rectifier circuit. Sensitivity on FM: 5 µV for 20-db quieting; AM: 20 µV for 1-volt output. FM, frequency response 20-20,000 cycles ±0.5

SELLING OUT!

REGARDLESS OF COST.
Prices Reduced Up to 80%

COMPLETE STOCK OF NATIONALLY ADVERTISED
RADIO & TELEVISION TESTING INSTRUMENTS,
PARTS AND ELECTRICAL APPLIANCES TO BE SOLD
This is the opportunity of a lifetime!

Below mentioned units are not kits, but all factory wired and brand new. Some models have been discontinued by the manufacturer, but every one is factory sealed and carries a one year factory guarantee. Satisfaction or money refunded within 10 days.

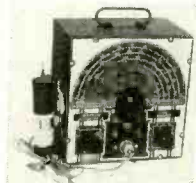

Model 999 Combination
F.M., A.M. and Television

SIGNAL GENERATOR

A.C. operated, generates R.F. frequencies from 150 kc. to 50 mc. Positive action attenuator provides effective output control

at all times. R.F. is obtainable separately or modulated by the Audio Frequency. Complete with test leads, instructions. Reg. \$39.50; **now only \$19.50**



TEST CRAFT

Model TC-10 Quality Multitester

AC and DC Voltage Ranges: 0-5/15/150/-1500/3000 Volts. DC Current Ranges: 0-5/50 ma. 0-1.5 Amps. Resistance Ranges: 0-100 ohms. 0-100 K.

Complete with batteries, instructions: **Reg. \$16.85 now only \$9.85**



TEST CRAFT

Model TC-75
Combination Test Speaker and Signal Tracer

plus resistor tester plus field substitutor plus condenser tester plus voice coil substitutor plus output indicator

Complete with full instructions **Reg. \$39.50 now only \$24.50**



Famous-Make OHMMETER

Has a double range of 0-10 and 0-1000 ohms for accurate measurement of low resistance. Widely used for production testing, armature and field resistances of small motors relay and coil testing transformer winding tests, etc.

Complete with test leads, instructions, leather case.

Reg. \$36.50 now only \$14.95



SUPREME

Model 543-S
Multimeter

1% WIRE WOUND PRECISION RESISTORS

D.C. Volt Ranges: 0-150-300 D.C. Ma: 0-60-120-300-600. AC Volt Ranges: 0-150-300. Ohm Ranges: 0-1000/100,000. Complete with instructions.

Reg. \$24.50 now only \$9.95



SUPERIOR

Model PB-100
Volt-Ohm-Milliammeter

Measures DC Voltages to 2500 Volts, AC Voltages to 1000 Volts. Resistance to 1 Megohm, 1000 Volts. Decibels to plus 55 D.B. Push Button Operation. Complete with instructions and test leads.

Reg. \$28.40 now only \$15.00

| Supplier | Model | Description | Dealers Net Price | Selling-Out Price |
|--|-----------|--|-----------------------|-------------------|
| SUPERIOR METROPOLITAN GENERAL ELECTRONICS | 660-A | Signal Generator | \$42.50 | \$29.50 |
| | 111 | Quality Multitester | 21.50 | 9.95 |
| | 200 | AM-FM & Television Signal Generator, AC operated | 39.50 | 24.50 |
| REINER ELECTRONICS | 333 | DC Volt-Ohm-Milliammeter | 26.95 | 9.95 |
| RADIO CITY PRODUCTS | 668 | Electronic Multitester | 74.50 | 39.50 |
| | 665 | AC-DC Volt-Ohm Capacity, VTVM | 95.40 | 49.50 |
| | 630 | Wheatstone Resistance Bridge | 145.00 | 75.00 |
| SHALLCROSS ELECTRONIC MEASUREMENTS CORPORATION | 102 | Voltmeter | 14.90 | 11.90 |
| | 103 | " | 18.75 | 15.00 |
| | 104 | " | 26.95 | 21.50 |
| | 106 | Vacuum Tube Voltmeter | 35.90 | 28.75 |
| | 107 | " | 48.90 | 39.00 |
| | 205-P | Tube Tester | 47.50 | 37.50 |
| | 206-P | Mutual Conductance Tube Tester | 83.50 | 67.50 |
| | 600 | Oscilloscope | 99.50 | 79.50 |
| GRUEN | 2 1/2" | DC, D'Arsonval Type, 1 Milliammeter, Meter | 9.95 | 2.95 |
| WESTON | Model 507 | F.S. 1, 2 Milliam. Meter | 12.95 | 3.95 |
| TRIPLETT | 331-JP | 30 Amperes, Meter | 12.95 | 4.95 |
| MARION | 3" | D'Arsonval Type, 1 Milliam. with calibrated Volt-Ohm Current Scale, Meter | 12.95 | 3.95 |
| ACRO | | Radio & Phonograph Chassis Cradles | 6.95 | 2.95 |
| GRAF-O-TONE | 8" | Glass Recording Discs, sold only in cartons of 24 discs | .75 each | .15 |
| MELODISC | 12" | Metal Recording Discs, sold only in cartons of 50 discs | 1.50 each | .30 |
| HOLYOKE | | 180 Ohm resistance line cords, 6 foot with plug | 1.25 each | .35 |
| | | Electrical Iron Cords, 6 foot with plug | .95 each | .25 |
| | | Extension line cords, 9 foot with plug | .75 each | .30 |
| | | Extension line cords, 12 foot with plug | .95 each | .40 |
| | | Electrical Iron Cords, 6 foot with plug and on and off switch | 1.25 each | .45 |
| | | No. 22, stranded, tinned, copper push-back wire, on 500" spools | 5.75 ea. spool | 2.50 |
| SUPREME | | 3 speed recordplayers, with life time needle portable case, speaker and amplifier | Reduced to 14.95 each | |
| DUOSONIC | | MODEL CAPRI, 3 speed recordplayers, with life time needle, plastic case, speaker and amplifier | Reduced to 16.95 each | |
| WEBSTER-CHICAGO | | Model Webcor, 3 speed recordplayers, with life time needle, portable case, speaker and amplifier | Reduced to 19.95 each | |
| MAGUIRE | | Automatic Recordchanger | Reduced to 9.95 each | |
| TELE-TONE | | Table Radio, all colors | Reduced to 9.95 each | |
| MOTOROLA | | Table Radio, 5 tubes, all colors | Reduced to 12.95 each | |
| | | Clock Radios, all colors | Reduced to 18.95 each | |
| NELSON | | Electrical Waffle Iron | Reduced to 4.95 each | |
| | | Electrical Mixer | Reduced to 4.95 each | |
| CUCKOO CLOCK | | Genuine, imported Black Forest, hand-carved, cuckoos every 15 minutes | Reduced to 4.95 each | |
| GLO | | Electronic, oscillating massager with infra-red heat combined | Reduced to 3.95 each | |
| BRIL-QUICK CHEF | | Fully automatic rotisserie and broiler combination, 7 way, with time clock, 3 heat element, double powered | Reduced to 24.50 each | |
| CAPITOL | | Infra-red heat, automatic broiler | Reduced to 9.95 each | |

All prices are f.o.b. New York, 20% deposit with order, balance C.O.D., or full remittance with order.
QUANTITIES ARE LIMITED. WRITE, PHONE OR WIRE FOR IMMEDIATE DELIVERY.
METROPOLITAN ELECTRONICS & INSTRUMENT CO.

106 Fifth Ave., New York 11, N.Y. Telephone: Oregon 5-1707 Cable Address: METRONICS



SUPERIOR

Model 1553
Volt-Ohm-Milliammeter

Meets U.S. Army requirements for accuracy and durability. Measures AC Voltages: 0-7.5/15/150/-750. D.C. Voltages: 0 to 2.5/15/150/750. D.C. Current: 0 to 7.5/75 ma. Resistance: 0 to 5,000/500,000 Ohms. Complete with leather case, instructions.

Reg. \$29.25 now only \$14.50

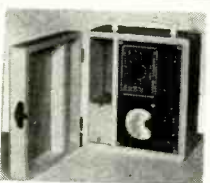

SUPERIOR

5,000 ohms per Volt,
Volt-Ohm-Milliammeter

D.C. Voltages to 1500 Volts. Resistance to 2 Megohms, Output Volts to 1500 Volts, D.C. Current to 150 Ma., Decibels to plus 58 D.B. Complete with instructions and test leads.
Reg. \$27.65 now only \$14.50



TEST CRAFT

Model TC-50
TUBE AND SET TESTER

Test all tubes up to date, incl. 4, 5, 6, 7L, octals, locals, television, magic eye, thyrators single ended floating filament, mercury vapor, new miniatures, etc. Multi-tester Specifications:

AC and DC Voltage Ranges: 0-1-100-1000-5000. DC Current Ranges: 0-10-100-1 Amp. Low Res. Range: 0-10,000 Ohms. Medium Re. Range: 0-100,000 Ohms High Res. Range: 0-1 megohm. Complete with test leads and instructions. **Reg. \$49.50 now only \$29.50**



**THE
"EYES"
HAVE
IT!
SEE THE**

**FEATURE-BY-FEATURE
SUPERIORITY OF
EMC TEST EQUIPMENT**

**NEW RF
SIGNAL GENERATOR
EMC Model 501**

With leads—
\$37⁹⁰ (Wired & Tested)
\$24⁹⁰ (Kit Form)



A professional, 6-band (115 KC to 220 MC) generator • produces dependable signals for precision alignment, tuning and adjustment of all types of circuits including COLOR TV.

**NEW COMBINATION RESISTANCE—
CAPACITY SUBSTITUTION BOX
EMC Model 900**

\$19⁹⁰ (Wired & Tested)
\$10²⁵ (Kit Form)

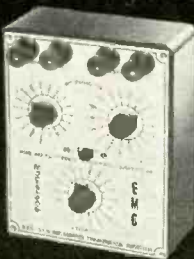

World's first combination substitution box • quickly determines exact values • provides 18 RETMA Capacity Values and 36 RETMA Resistance Values.

**NEW WHITE DOT—CROSS HATCH
—BAR GENERATOR
EMC Model 800**

With leads—
\$39⁹⁰ (Wired & Tested)

Lowest priced, quality color and monochrome generator available • easily adjusts color convergence, width, linearity, ion trap and yoke, etc.



FREE!

Yes, I want to see for myself, send me—FREE—a detailed catalog of the complete EMC line of precision test equipment.

NAME _____ RE-11
STREET _____
CITY _____ STATE _____

EMC

ELECTRONIC MEASUREMENTS CORPORATION
280 LAFAYETTE STREET, NEW YORK 12, N. Y.
EXPORT DEPT. - 370 BROADWAY, N. Y. 13, N. Y.

NEW DEVICES

db; AM, 20-5,000, ± 4 db.—Allied Radio Corp., 100 N. Western Ave., Chicago 80, Ill.

3-SPEED DECK, Fen-Tone Brenell Hi-Fi; independent capstan, feed and takeup motors—with instantaneous mechanical braking. Braking, switching and pinch-roller operations positively interlocked in two control knobs—left, fast forward and rewind within 45 seconds; right, for record-playback and off. 2:1 ratio screw-on sleeve permits 3 $\frac{3}{4}$ - and 7 $\frac{1}{2}$ - or 7 $\frac{1}{2}$ - and 15-i.p.s. operation. Rubber belt can be placed

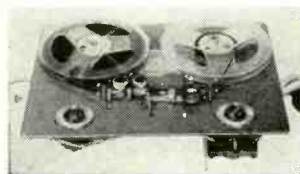

on slow or fast grooves of double-stepped flywheel and motor pulley assembly.

Wow and flutter under 0.2%; frequency response 50-12,000 cycles at 7 $\frac{1}{2}$; 30-15,000 cycles at 15 i.p.s.—Fenton Co., 15 Moore St., New York 4, N. Y.

2 $\frac{1}{2}$ -INCH LOUDSPEAKER, model 25A07, replacement speaker for personal portable radios, intercom equipment and other applications needing very small rugged speakers. 1 $\frac{1}{4}$ inches deep; maximum input, 2 watts;

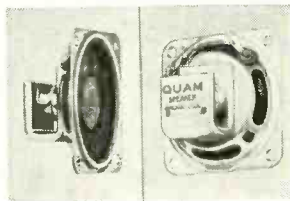

voice coil impedance, 3.2 ohms. 0.65-ounce Alnico-V magnet and 4 mounting holes on rim.—Quam-Nichols Co., 236 E. Marquette Rd., Chicago 37, Ill.

RECORD PLAYER UNITS feature Collaro RC-54 record changer make it possible to enjoy high-quality components without extensive carpentry and wiring.

Series C units: RC-54 on oversized, laminated $\frac{5}{8}$ -inch mounting board. Can be installed like a shelf hanging or included in



custom-built equipment. Series M and B: RC-54's with hardwood bases (M, mahogany; B, blond). Can be placed on table tops, con-

(Continued)

soles or shelves. Furnished with power cords and audio connecting cables; ready to use by simply plugging in. Automatic 45-r.p.m. adapter spindles.—Rockbar Corp., 215 E. 37th St., New York 16, N. Y.

DOUBLE-PLAY TAPE, Irish (2400 feet) plays up to 4 hours single track without reel change at 1 $\frac{1}{8}$ i.p.s., 8 hours dual-track; 2 hours at 3 $\frac{3}{4}$, 4 hours dual-track; 1 hour at 7 $\frac{1}{2}$, 2 hours dual-track. 0.5-mil Mylar tape

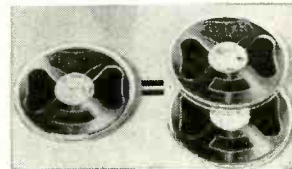

base.—OR Radio Industries, Inc., Shamrock Circle, Opelika, Ala.

3-WAY SPEAKER SYSTEM, Forester, with 5 $\frac{1}{2}$ -foot curled-horn cabinets. Based on principle of complete acoustical and electrical isolation of each of three specially designed speakers (12, 8 and 5 inches). 0.6%

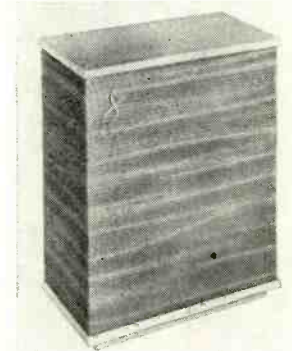

IM distortion at 10 watts. Individual speakers and 12-db-per-octave electrical crossover for 300 and 5,000 cycles available in separate do-it-yourself kits for modernizing existing systems or new installations.—Sherwood Electronic Labs., Inc., 2802 W. Cullom Ave., Chicago, Ill.

SPEAKERS, Utah Fabulous G series, in 8-, 12-, 15-inch sizes in single-cone models; 12- and 15-inch sizes in coaxials. Have heavy Alnico V magnets; spring clip; solderless terminals; rugged, seamless cones. Marine-resistant, sea-froth green finish over heavy cadmium plating.—Utah Radio Products Co., Inc., 1123 E. Franklin St., Huntington, Ind.

TAPE DECK, FF75, capable of 40-14,000-cycle frequency response at 7.5-i.p.s. tape speed. Has 1 $\frac{1}{2}$ -lb capstan fly wheel, belt-driven from floated motor platform. Dynamu head (flux gap .00015 inch). Designed for extended-range prerecorded music tapes. Monaural and binaural adaptations available. Can be used with temporary, standup mounting brackets provided; in accessory portable case or conventional cabinetry. 45-db signal-to-noise ratio; less than 0.2% flutter or wow; less than 1% total harmonic distortion with NARTB recorded tape and equalized V-

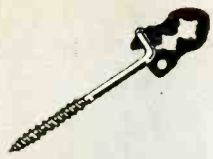

TELCO E-Z "SWING IN" STAND-OFF

Wood screw type, 3 1/2"; UHF-VHF
No. EZ-8027 \$4.80 / C

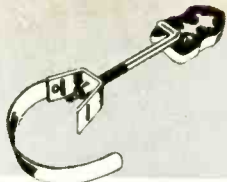

TELCO E-Z "KANT-STRIP" STAND-OFF

"Swing In" type, 3 1/2", 9" strap
No. EZ-8253 \$0.13

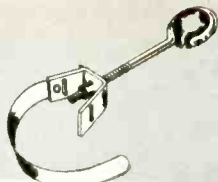

TELCO "KANT-STRIP" STAND-OFF

Round insulator, 3 1/2" 9" strap
No. 8253 NET \$0.11

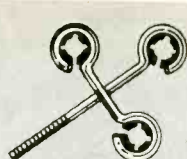

TELCO 3-WAY STAND-OFF

For 3-line use, 7 1/2" wood screw
No. 8397 NET \$0.21



TELCO NUT-TYPE STAND-OFF

Welded 10-23 nut, 3 1/2", 9" strap
No. 8253-N \$0.12

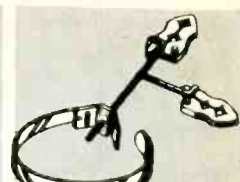

TELCO E-Z NUT-TYPE STAND-OFF

Tougher, inline duplex, 7 1/2", 9" strap.
No. EZ-8258-N \$0.24

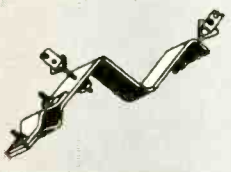

TELCO CHIMNEY QUICK MOUNT

Easy to install, complete

No. 8005 NET \$1.35

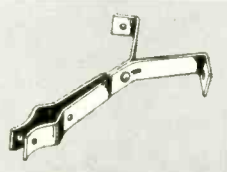

TELCO SNAP-IN CHIMNEY MOUNT

Fits masts to 1 3/4" complete

No. 8610 NET \$1.71

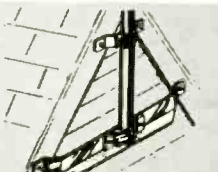

TELCO PEAK MOUNT

Masts to 1 3/4" 30" lower support

No. 8625 NET \$2.37

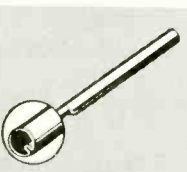

TELCO GALVANIZED ANTENNA MASTS

1 1/4" OD x 5', crimped end

No. 9013 NET \$0.78

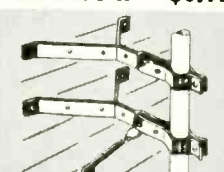

TELCO DELUXE SNAP-IN WALL MOUNT

Extra sturdy, 12" clearance

No. 8312 NET \$2.10



TELCO UNIVERSAL LIGHTNING ARRESTOR

Easy to install; UL approved

No. 8642 NET \$0.75



TELCO UHF-VHF GLOBE-TENNA

Handsome 12" globe plus built-in antenna

No. A-9265 \$11.97

Ask For These

TELCO SERVICE AIDS

...at Your Jobber



TELCO UHF-VHF LIGHTNING ARRESTOR

Universal type, UL approved

No. 9242 NET \$0.42

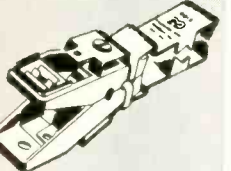

TELCO 3-WAY TV LINE KLIP

For straight side or plug-in

No. 9015 NET \$0.12

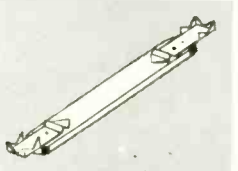

TELCO LOW-LOSS LINE KLIP

All one piece, plastic, metal ends

No. 9055 NET \$0.15

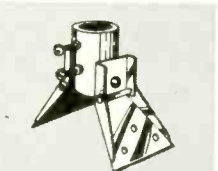

TELCO HINGED TYPE RIDGE MOUNT

Fits masts to 1 1/2" assembled

No. 9021 NET \$1.17

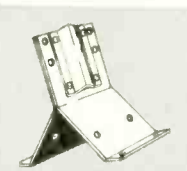

TELCO ALL-PURPOSE MAST BRACKET

Fits masts to 1 3/4" use every where

No. 8575 NET \$1.65

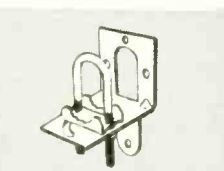

TELCO MAST HANDY MOUNT

For masts to 1 1/2", extra support

No. 8800-U \$0.33

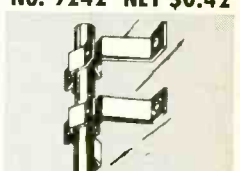

TELCO SPECIAL WALL MOUNT

For close-in (4") mounting.

No. 9241 NET \$0.45

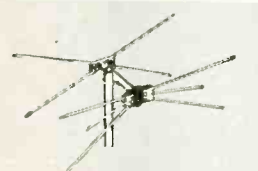

TELCO MASTER-LINE VHF CONICAL ANTENNA

Single bay, 10 element; all-channel

No. A-8700 \$4.20

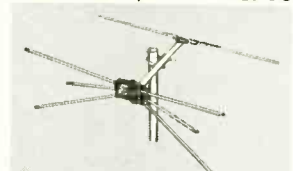

TELCO RANGER COLOR CONICAL ANTENNA

Single bay, 8 element, VHF-UHF.

No. A-110 NET \$3.45

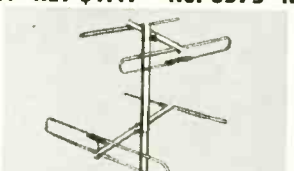

TELCO HI-LOW DIPOLE ANTENNA

VHF, covers channels 2 to 13

No. A-250 NET \$4.41



TELCO 5 ELEMENT VHF YAGI ANTENNA

12 models, custom cut to each.

No. A-302 Ch. 2 \$7.35
No. A-313 Ch. 13 4.35



TELCO UHF-VHF DOUBLE V ANTENNA

Covers channels 2 through 83.

No. A-9017 \$3.15

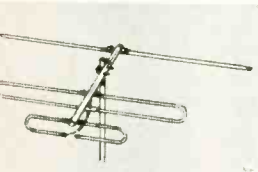

TELCO VHF INLINE ANTENNA

Channels 2-13, 1/2" seamless elements

No. A-9046 NET \$5.97



TELCO INDOOR UHF-VHF ANTENNA

DeLuxe brass, nickel-plated elements

No. A-8160-TP \$2.97

FREE!

Your copy of the complete, illustrated TELCO Catalog. Send postcard today.



TELEVISION HARDWARE MFG. CO.

Division of General Cement Mfg Co.

910 TAYLOR AVENUE • ROCKFORD, ILLINOIS

Now... Save ON QUALITY RCP TEST EQUIPMENT

Here are three instruments that are "musts" for efficient service operation... and they are now available at prices lower than ever before. Don't pass up this opportunity to equip your operation with these extremely valuable instruments.

Model 453—New Master Multitester

The One Great 20,000 Ohms Per Volt Multitester

A super-sensitive, self-contained multimeter with $4\frac{1}{2}$ " rectangular, long scale D'Arsonval meter. Designed for direct metering—eliminates warm-up time, grounding, etc. Assures accurate dependable measurements for TV, FM, AM and industry.



RANGES:
DC VOLTS: 0-2.5-10-50-250-500-1000-5000 at 20,000 ohms per volt.
AC VOLTS: 0-2.5-10-50-250-500-1000 volts.
DC MICROAMPS: 0-100—DC MILLIAMPS: 0-10-100-500.
OHMS: 0-2000-200,000—MEG OHMS: 0-20-20 Meg.
DECIBELS: -12 to 3, -3 to 15, 14 to 29, 28 to 43, 34 to 49, 40 to 55.
 Multiplier and shunts selected within 1% accuracy. Handsome with deeply etched brushed aluminum panel mounted in hand-rubbed, shock resistant oak case. Size $10\frac{1}{4}$ " x $6\frac{7}{8}$ " x $3\frac{7}{8}$ ". Wt. $4\frac{1}{4}$ lbs. Complete ready to operate at

\$34.95 Net

HVMP-20
High Voltage Probe \$8.95

Extends range to 25,000 volts.

HFP-20
High Frequency Probe \$7.95

Increases Range to 400 Mc.

Model 730—Universal Signalizer

AF-AM (RF)-FM SIGNAL GENERATOR. Simplicity, speed and accuracy is accomplished by fixed frequency points at which circuits are calibrated. Broadcast Band Alignment is provided by fixed frequencies of 1500 KC and 550 KC. Intermediate frequencies of 455 KC and 465 KC are also supplied. Calibration also provides for alignment of 460 KC IF systems. **FM BAND ALIGNMENT** is provided for by fixed frequency signals of 88 MC and 108 MC which are the ends of the band. Fixed frequencies of 10.7 MC and 9.1 MC provide for IF alignment. The FM section is frequency modulated for use with ratio detectors. RF frequency deviation is plus and minus 500 KC. **AUDIO FREQUENCY MODULATION** is provided for AM at 400 cycles. A separate audio output of 400 cycles is also provided. Calibrated trimmers to be accurate within 1%. Suitable trimmers to permit recalibration. Perfect operation from either AC or DC lines with equally high accuracy and stability. Entirely safe as the chassis and case are completely isolated from the line. Attenuator provides smooth control from high signal level to a high degree of attenuation. Complete with tubes, shielded output cable, line cord and plug, ready to use on 105-125 V, 50-60 cycle AC. Attractively finished panel and case.

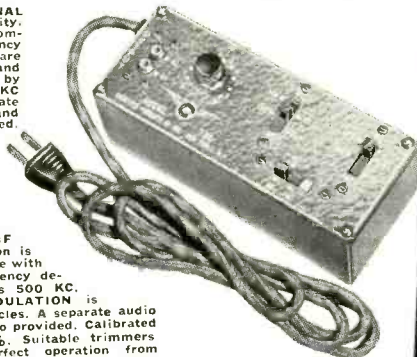

\$27.75
 formerly \$32.95

Model 463—New 20,000 ohms per volt Multitester



Low enough in cost so that no one should be without one. Ultra compact V.O.M. for this high sensitivity 20,000 ohm per volt meter. Performance accuracies and tolerance same as that of higher price units. Has full wave bridge rectifier—deposit type of multiplier resistors, accurate within one per cent. AC sensitivity 10,000 ohms per volt with one per cent tolerance deposit type of resistors. All Bakelite molded panel, case and battery holder. Battery immediately replaceable—no soldering.

RANGES:
D.C. Volts: 0-5-50-250-500-1000 V. D. C. Milliampere: 0-1-10-1000 Mils.
A.C. Volts: 0-10-100-500-1000 V. Ohms: 0-10,000-100,000 ohms. 0-1-10 meg.
Output Volts: 0-10-100-500-1000 V. DB: -82 +55 DB. Complete with batteries.

formerly \$26.95 **\$24.95**

Write for complete information to Dept. RE-11

RADIO CITY PRODUCTS CO., INC.
 EASTON, PENNSYLVANIA



Manufacturers of quality Laboratory and Service Test Equipment Since 1932

NEW DEVICES

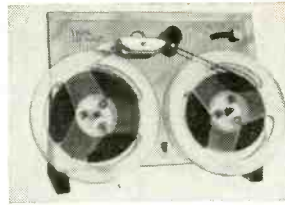

Viking PB60 preamplifier.—Viking of Minneapolis, 3520 E. 43rd St., Minneapolis, Minn.

TUBE TESTER, Dyna-Quik model 500, dynamic mutual-conductance type has plastic

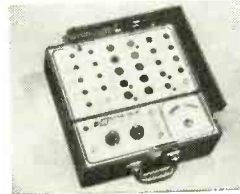

meter with 2 scales: 0-6,000 and 0-18,000 μ mhos. Automatic line compensation maintained by special bridge that continuously monitors line voltage. 7-pin and 9-pin straighteners mounted on panel.—B & K Mfg. Co., 3726 N. Southport Ave., Chicago 13, Ill.

PAPER-DIELECTRIC CAPACITORS, Royal Cub, general-purpose units where high-temperature operation, high stability, smallest possible sizes are required. Polykane-impregnated



capacitors operate from -55° to +100° C at full rated voltage. Average capacitance-temperature variation 5% from 25° C value. Available in 100, 200, 400, 600, 1,000 volts d.c.; capacitances from .001 to 1.0 μ f, depending on voltage.—Cornell-Dubilier Electric Corp., S. Plainfield, N. J.

D.C. POWER SUPPLY, model GF, converts a.c. to 125 volts d.c., continuously variable. For loads to 10 amps continuous, 20 amps intermittent. 115-volt

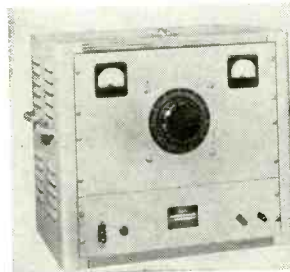

50-60-cycle input (available for 230-volt input). Filtered to less than 1% a.c. ripple at 10 amps. **Electro Products Labs.**, 4501 N. Ravenswood Ave., Chicago 40, Ill.

(Continued)

DO-IT-YOURSELF K-D KITS, 7 models for high-fidelity speaker enclosures—corner and wall types for full-range loud-speaker or separate 2-, 3- and



4-way speaker systems. Available for Patrician, Regency, Baronet, Aristocrat, and new Empire and Centurion. Kit includes glue, screws, nails and book with step-by-step instructions, diagrams and photos.—**Electro-Voice, Inc.**, Buchanan, Mich.

NONTOXIC CLEANER, Electro-Tet, replaces carbon tetrachloride. Made of Chlorothene. Nonflammable, fast drying,



safe for bench use. Cleans chassis, controls, switches, motors, vacuum cleaners, etc.—**General Cement Mfg. Co.**, 919 Taylor Ave., Rockford, Ill.

WALL-PLATE SOCKETS, Mosley AC-TV, fit standard double type electrical outlet boxes; provide dual a.c. outlet plus any of 9 combinations of TV line and rotator cable outlets. Plug-in connections for 1, 2 or 3 300-ohm TV lines or combinations such as one 300-ohm line plus 4-, 5- or 8-wire rota-

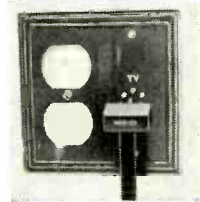

tor cable outlet. Matching plugs polarized to prevent plugging into a.c. outlets. Barrier plate isolates outlet box halves.—**Mosley Electronics, Inc.**, 8622 St. Charles Rock Rd., St. Louis 14, Mo.

9-INCH TOOL, TrolMaster, cleans and lubricates single or dual TV or radio controls. Adapter for auto radio controls. **Kleontrol Magic Solvent**, for use with TrolMaster, is



nonflammable, will not harm wood, metal or acetate surfaces or finishes.—**R-Columbia Products Co., Inc.**, 305 Waukegan Ave., Highwood, Ill.

NEW DEVICES

FOUR RESISTOR KITS, axial-Blue Jacket wirewound resistors: 3-watt units no larger than conventional 1/2-watt composition resistors. Kit RK-1: 10 values from 3-, 5- and 10-

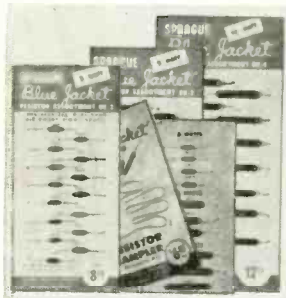

watt lines. RK-2: 15 30-watt values. RK-3: 15 5-watt values. RK-4: 15 10-watt values.—Sprague Products Co., 81 Marshall St., North Adams, Mass.

PORTABLE TUBE TESTER, model 750, tests germanium diodes and selenium rectifiers. Short test shows up heater cathode leakages. Ranges: 0-1,500, 0-3,000, 0-6,000, 0-15,000, 0-30,000 μmhos.

Tests voltage-regulator tubes—d.c. voltmeter readings to 200, d.c. milliammeter to 100 ma. 2 d.c. plate and screen voltages—normal and low—controlled by selector switch. Low range for subminiature tubes and others requiring low plate and screen voltages. 4 a.c. signal voltages, as low as 0.25. Tests for gas content and tube noise.—Hickok Electrical In-

All specifications on these pages are from manufacturers' data

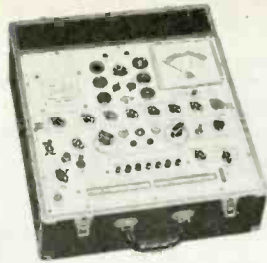

strument Co., 10531 Dupont Ave., Cleveland 8, Ohio.

IN-CIRCUIT CAPACITOR TESTER, model 383, checks capacitors from 1 μf to 0.25 μf for leakage from few ohms to hundreds of megohms. Detects breakdowns, shorts, intermittents. Checks coupling, variable tuning and trimmer

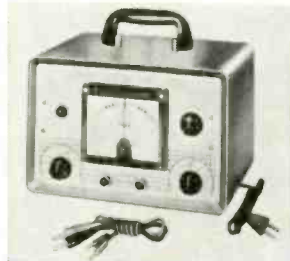

capacitors; wiring harnesses, coil winding-to-core leakage, winding breakdowns to 900 volts peak. Detects unstable resistors while in circuit.—Simpson Electric Co., 5200 W. Kinzie St., Chicago 44, Ill.

CRT REJUVENATOR TESTER, Golden Vitalyzer, model RT-1 has automatic neon indicator to show completion of rejuvenation process. Used to analyze performance character-



istics of cathode-ray tubes, locate and eliminate interelement shorts, repair open elements, weld open filaments, rejuvenate tube without removing from set.—Tescon, Inc., Springfield Gardens, N. Y.

ANTENNA CONNECTOR, Kwik-On. Stainless steel mobile device to protect antenna and coil against theft and for storage. Fits standard whip antennas, antenna loading coils, mast sections. One Kwik-On is required to disconnect whip. With two Kwik-Ons both antenna and coil can be stored in trunk of parked car. Noise-free; positive electrical connection.—Vaaro Electronics Div., Davis Electronics, 4002 W. Burbank Blvd., Burbank, Calif.

(Continued)

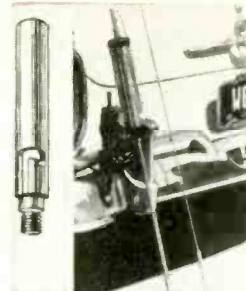

TWIN ANTENNA UNIT, Double Header: contains two 26 1/2-inch (extended) telescopic antennas, complete with leads. Triple-plated chrome finish or choice



of 6 baked-on colors—red, blue, green, yellow, white, brown. Double Header also available as dummy set without leads for decorative purposes only.—Antenna Specialists Co., 12435 Euclid Ave., Cleveland, Ohio. END

Just Out

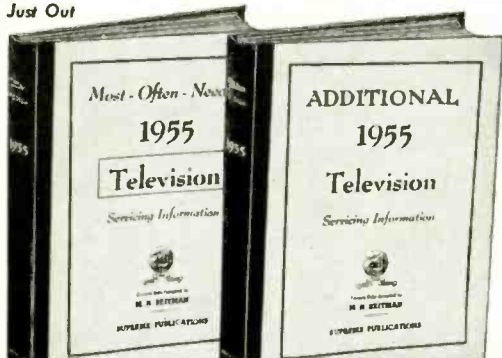

These twin 1955 TV volumes cover practically all sets of all makes. The new ADDITIONAL 1955 TV manual includes material almost to the minute. Each giant manual has 192 large pages of service data, changes, double-size circuits, service hints. Special price, each manual only

\$3

New ADDITIONAL 1955 TV Volume LARGE MANUAL COVERS NEWEST 1955 TV SETS EARLIER TV VOLUMES STILL SOLD AT ONLY \$3

AMAZING BARGAIN

Supreme twin 1955 TV manuals are the scoop of the year. Cover all sets of all important makes. New ADDITIONAL 1955 TV volume gives you the very latest material. Your price for this mammoth manual is only \$3. Supreme super values defy competition. Each prior-year manual (at only \$3) has a whole year of service material. Each volume covers different material, from 1947 to latest 1955 sets. Include circuits, alignment, waveforms, voltage charts, service hints, changes, and double-spread diagrams.

Practically tell you how to make every repair. More pages, more diagrams, more service data per dollar of cost. Get the best for less. Get SUPREME.

ALL NEEDED TV DATA

Supreme TV manuals supply all needed service material on every TV set of every important manufacturer. Here is helpful, practical, factory-prepared data. It will really make TV servicing and adjustment easy for you. Join 146,000 servicemen who use, benefit, and save with SUPREME service manuals. In these manuals you get correct factory-checked circuits, alignment procedure, response curves, service hints, recommended changes, voltage charts, waveforms, and dozens of double-page diagrams. Here is your TV service material to help you do expert work double-quick: and priced at only \$3 per annual volume. Be ready to repair any model by carrying in your car all ten TV volumes listed in coupon below. Or try one of the new 1955 TV manuals to see what an amazing bargain you get for only \$3. Send coupon for prompt shipment or ask your jobber.



TELEVISION SERVICING COURSE
Let this new course help you in TV servicing. Amazing bargain, complete, only \$3, full price for all lessons. Giant in size, mammoth in scope, topics just like a \$200.00 correspondence course. Lessons on picture faults, circuits, adjustments, short-cuts, UHF, alignment facts, hints, antenna problems, trouble-shooting, test equipment, picture analysis. Special, only

\$3

Newest



RADIO DIAGRAMS

Here is your complete source of all needed RADIO diagrams and service data. Covers everything from most recent radios to pre-war old-timers: home radios, auto sets, combinations, changers, and portables. Sensational values. Still sold at pre-Korean prices. Only \$2 for most volumes. Every Radio manual contains large schematics, all needed alignment facts, parts lists, voltage values, trimmers, dial strings, and helpful service hints. All volumes are large in size, 8 1/2 x 11 inches, about 190 pages. See coupon at right for a complete list of these low-priced manuals.

NO-RISK TRIAL ORDER COUPON

SUPREME PUBLICATIONS, 1760 Balsam Rd., Highland Park, ILL.

| | | |
|--|---|--|
| <p>Radio Diagram Manuals</p> <ul style="list-style-type: none"> <input type="checkbox"/> New 1955 Radio Manual, \$2 <input type="checkbox"/> 1954 Radio Manual, \$2.50 <input type="checkbox"/> 1953 Diagrams <input type="checkbox"/> 1952 Radio <input type="checkbox"/> 1951 Diagrams <input type="checkbox"/> 1950 Manual <input type="checkbox"/> 1949 Radio <input type="checkbox"/> 1948 <input type="checkbox"/> 1947 <input type="checkbox"/> 1946 <input type="checkbox"/> 1942 <input type="checkbox"/> 1941 <input type="checkbox"/> 1940 <input type="checkbox"/> 1939 <input type="checkbox"/> 1926-1938 Manual, \$2.50 <input type="checkbox"/> Radio and TV Master Index, 25c | <p>Radio Manuals</p> <p>PRICED AT ONLY \$2 EACH</p> | <p>Rush today TV manuals checked <input type="checkbox"/> below and Radio manuals at left. Satisfaction guaranteed.</p> <ul style="list-style-type: none"> <input type="checkbox"/> Additional 1955 TV, \$3. <input type="checkbox"/> 1954 TV Manual, \$3. <input type="checkbox"/> 1952 Television Manual, \$3. <input type="checkbox"/> 1950 Television Manual, \$3. <input type="checkbox"/> 1948 TV, \$3. <input type="checkbox"/> New Television Servicing Course, complete... \$3. <ul style="list-style-type: none"> <input type="checkbox"/> Early 1955 TV, \$3. <input type="checkbox"/> 1953 TV Manual, \$3. <input type="checkbox"/> 1951 TV, \$3. <input type="checkbox"/> 1949 TV, \$3. <input type="checkbox"/> 1947 TV & FM, only \$2. <p><input type="checkbox"/> I am enclosing \$..... Send postpaid. <input type="checkbox"/> Send C.O.D. I am enclosing \$..... deposit.</p> <p>Name:</p> <p>Address:</p> |
|--|---|--|

Supreme Publications
Sold by All Leading Parts Jobbers

WANTED

ELECTRONIC Technicians

**TO BE TRAINED
for NEW
Nation-Wide Service Program!**

CAREER OPENINGS

Await Qualified Technicians

... at BOTH the Junior and Senior Level, in the installation and maintenance of Electronic Equipment.

These are definitely of interest to exceptionally capable men of above average intelligence who are anxious to PROVE their capacity to advance to posts of greater responsibilities in the e-x-p-a-n-d-i-n-g, challenging field of electronics.

Salaries commensurate with your experience plus liberal per diem living costs & travel allowances, plus these company benefits: Cooperative Educational Aid - Liberal Pension Plan and all the usual Health and Hospitalization Benefits for YOU and your Family.

BURROUGHS MEANS BUSINESS!

Get The Details Now. Call or Write The Burroughs Placement Manager For An Appointment.

Burroughs

RESEARCH CENTER

Paoli, Pa. • Suburban Philadelphia • Paoli 3500

OPPORTUNITY ADLETS

\$500 MONTHLY addressing POSTCARDS. Instructions \$1. ADELE'S, 739M Marshall, Rochester 11, N.Y.

PASS Amateur Theory Exams. Check yourself with sample FCC type questions and novice and general class examinations. All for only 50c. American Electronics, 1263R Bryant Ave., New York 59, N.Y.

COMPLETE HIGH SCHOOL at home in spare time with 58-year-old school; texts furnished; diploma; no classes; booklet free. Write American School, Dept. X89, Drexel at 58th, Chicago 37, Ill.

HIGH-FIDELITY SPEAKERS REPAIRED. Ampitro Speaker Service, 70 Vesey St., New York 7, N.Y.

TELEVISION COMMUNITY ANTENNA System, Ohio new homes fringe area; installation charges, monthly rentals, write for details. APPLE CO., 1836 Euclid Ave., Brokers, Cleveland, Ohio.

TAPE RECORDERS, ACCESSORIES, BEST BUYS. Boynton Studio, 10 E. Pennsylvania, Tuckahoe, N.Y.

BUY Surplus Radio, Electronic Equipment direct from Government. List \$1.00. Box 169RAC, East Htfd 8, Conn.

BUY GOVERNMENT SURPLUS radios, receivers & electronic equipment. Bulletin \$1. Box 1842N, Hartford 1, Conn.

EXPERIMENTERS-HOBBYISTS-BUILD PROJECTS IN THIS MAGAZINE. Parts available for most articles. Free Price List of our Part-Paks. Write Box 481, Camden, N.J.

\$200 WEEKLY CLEANING Venetian Blinds. Free book, Hurtt, 2434BX, Wichita 13, Kansas.

SPEAKER RECONING: Guaranteed workmanship. C&M Recone Co., 255 Tioga St., Trenton 9, N.J.

FOR SALE: Electric guitars, amplifiers, parts; wholesale. Free Catalog. CARVIN RE, Covina, Calif.

RCA, Motorola, Link, GE and Kaar new and used two-way radio equipment bought and sold. Communications Associates, 138-17 Springfield Blvd., Springfield Gardens, N. Y. Phone LA 7-2727.

TELEVISION Tuner Repairs. DAN'S Television Laboratory, 2 West 183 St., N.Y. 53, N.Y.

DIAGRAMS FOR REPAIRING RADIOS \$1.00. Television \$2.00. Give Make, Model. Diagram Service, Box 672-RE, Hartford 1, Conn.

USED Correspondence Courses and Educational books bought, sold, rented. Catalog free. Educational Exchange, Menlo, Ga.

NEW printed circuit Television antenna, Ekerator Electronic Developments, 646 N. Fair Oaks Ave., Pasadena, Calif.

TUBES-TV, RADIO, TRANSMITTING, AND SPECIAL PURPOSE TYPES BOUGHT, SOLD AND EXCHANGED. Send details to B. N. Gensler W2LNI, 512 Broadway, N.Y. 12, N.Y.

new

Tubes &

Transistors



6CH7

A new twin-triode has been developed by G-E for use as a cascode r.f. amplifier in TV receivers. The 6CH7 is designed to give considerably more gain and a better noise factor on the higher v.h.f. channels than previous cascode tubes.

The increased gain is obtained by a basing connection having two cathode leads for the driven-grid section, with the shield between sections internally connected to the grid of the grounded-grid section. The improved shielding and lower cathode lead inductance thus attained contribute both to higher gain and improved noise factor on the high v.h.f. channels.

Operating as a typical class-A₁ amplifier with a plate voltage of 150 and a cathode bias resistor of 220 ohms, each section has an amplification factor of 36, plate resistance of 5,300 ohms and transconductance of 6,800 micromhos.

3BZ6

A semiremote-cutoff pentode of the seven-pin miniature type, the 3BZ6 is intended for use particularly in the gain-controlled video i.f. stages of TV receivers. Announced by RCA, the tube has a 600-ma heater having a controlled warmup time for series-string operation.

The semiremote cutoff of the 3BZ6 reduces cross-modulation effects in the video i.f. stages and minimizes distortion resulting from high signal levels and automatic gain control time delay. The tube's high transconductance of 6,100 micromhos contributes to high gain per stage. Except for its heater voltage of 3.15 and heater current of 600 ma, the 3BZ6 is identical to the 6BZ6.

2N107

Announced by G-E, this transistor is designed to meet the demands of radio amateurs, hobbyists and experi-

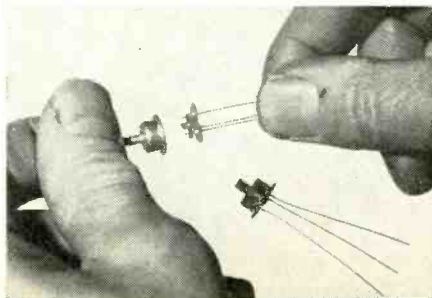

menters for a stable, inexpensive transistor. Carrying a suggested distributor price of "well below \$2," the 2N107 is a p-n-p audio unit produced by a fused-junction process.

The 2N107 (see photo) has an all-metal case and is hermetically sealed. In a typical common emitter circuit, this transistor has a power gain of 38 db. Its maximum frequency cutoff is 2.5 mc with the design center at 1 mc. The alpha design center is 0.95. Maximum collector voltage is -12 and maximum junction temperature is 60°C. The 2N107 can dissipate 50 mw in 25°C free air.

5563-A

A three-electrode mercury-vapor thyatron designed primarily for high-voltage d.c. power-control applications has been announced by RCA. The thyatron, the 5563-A, supersedes the 5563 and has greater power-handling capability.

In power-control use the tube is operated so that its d.c. output voltage to the load is controlled by changing the time of firing during the a.c. input cycle. With this arrangement three 5563-A's connected in a half-wave three-phase circuit are capable of handling up to 45 kw at d.c. output voltages to about 9,500. The tube is 2 7/8 inches in diameter and 10 3/32 inches long. END

Radio Thirty-Five Years Ago
In Gernsback Publications

HUGO GERNSBACK
Founder

| | |
|---------------------------------|------|
| Modern Electrics | 1908 |
| Wireless Association of America | 1908 |
| Electrical Experimenter | 1913 |
| Radio News | 1919 |
| Science & Invention | 1920 |
| Television | 1927 |
| Radio-Craft | 1929 |
| Short-Wave Craft | 1930 |
| Television News | 1931 |

Some of the larger libraries still have copies of ELECTRICAL EXPERIMENTER on file for interested readers.

In November 1921 Science and Invention
(formerly Electrical Experimenter)

Electric Trouble Detector for Autoists
Home-Made Electrical Stethoscope, by Harold Lawson
A Yacht Radiophone, by C. Golden
Arc Welding of Audion Parts, by F. A. Anderson

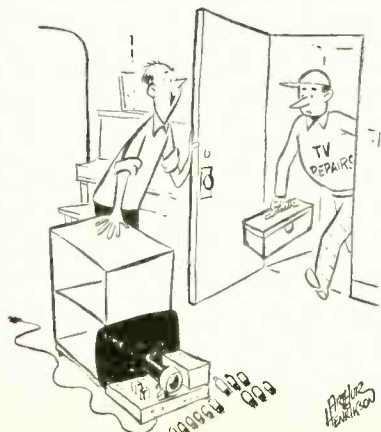

"I've got it all ready for you!"

Servicemen everywhere are saying...

MOST VALUABLE TV SERVICE INSTRUMENT EVER MADE!

\$181 in INSTRUMENTATION FUNCTIONS \$49⁹⁵ for only

7 Performs these VITAL FUNCTIONS

COMPLETELY CHECKS:

- ← Flybacks and Yokes
- ← Selenium Rectifiers
- ← Continuity
- ← Condensers
- ← Picture Tubes
- ← Series Filament Tubes
- ← Reactivates Picture Tubes

TV COMPONENT TESTER
by **TRANSVISION**

SOLD ONLY THRU SELECTED DISTRIBUTORS
Write for name of the one in your area.

Other TRANSVISION Instruments
— finest in their field in every way:

- FIELD STRENGTH METERS
- CRT Tester-Reactivator-Sparker
- Flyback-Yoke-Continuity Tester
- Master Antenna Amplifiers, etc.

TRANSVISION, INC., NEW ROCHELLE, N. Y.

DISTRIBUTORS:

Some lucrative areas are still available. Write, wire, phone today for details on Transvision's powerful new *Exclusive Distributor Program*. It's a sure-fire sales and profit builder for you.

TRANSVISION, INC., NEW ROCHELLE, N. Y. RE-11

Rush name of your nearest Distributor

Send _____ TV Component Testers. Enclosed find \$_____ deposit; balance C.O.D.

Name _____

Address _____

City _____ State _____

OPPORTUNITY ADLETS (Continued)

SPECIAL: New English COLLARO RC-54 changer, mounting board, plug-in-head, \$38.75 prepaid. Guaranteed: DIAMOND-SAPPHIRE Sylvania RFX-050, \$10.75. Stimulated base-cover for all changers, \$9.75. 3 3/4" - 7 1/2" - 15 lbs Dual Tracks, 30-15,000 cps English High Fidelity Tape Deck Three 4 pole motors. Best buy \$79.50 prepaid. WRITE TODAY. Dept. RE, FIDELITY UNLIMITED, 63-03 39th Ave., Woodside 77, N.Y.

ALL MAKES OF ELECTRICAL INSTRUMENTS AND TESTING equipment repaired. Write for free catalogue on new and used instruments at a savings. Hazelton Instrument Co., 123 Liberty Street, New York, N. Y.

WANTED: AN/APR-4, other "APR" "TS", "IE", "ARC-1, ARC-3, ART-13, RC-348, etc. Microwave Equipment. Everything Surplus. Special tubes. See Manuals. Lab Quality Equipment. Meters. Fast Action. Fair Treatment. Top Dollar! Littell, Fairhills Box 26, Dayton 9, Ohio.

BUY WHOLESALE. 25,000 Items. Catalog 25c. Matthews, 1472-P1, Broadway, N.Y.C. 36.

YOUR choice \$1.35 postpaid: T49C radiosonde transmitter less tube, 25 assorted mica capacitors, 100 insulated carbon resistors, 10 assorted switches or 20 wirewound resistors. All fire for \$4.95; bargain list on request. PALMER, 1440 Las Salinas Way, Sacramento 21, Calif.

DIAGRAMS: Professional Model Timers, Counters, Intercoms, Organs, etc. \$1.00 each. List free. Parks, 101 S.E. 57th, Portland 15, Oregon.

SPLICES in a wink! **NO SCISSORS! NO RAZOR BLADES!** with GIBSON GIRL TAPE SPLICERS. Diagonal cuts tape ends and trims splice edges with the "Gibson Girl" shape. Model TS-4 \$8.50 list, Model TS-4 Deluxe \$11.50 list. At your dealer or write: ROBINSON INDUSTRIES (CORP.), Dept. RE, 41-08 Bell Blvd., Bayside 61, N. Y.

RADIO & TV TUBES. Now, Net up to 70% off. Details 10c. Sonoret Box C. 36 Woodbury St., Wilkes-Barre, Pa. 25-50% DISCOUNT guaranteed. Factory Fresh LP records; 69c and up; pre-recorded tapes. Send 20c for catalogue. **SOUTHWEST RECORDS**, 1108 Winburn, Houston, Texas.

TV FM ANTENNAS. ALL TYPES INCLUDING GHP. Mounts, accessories. Lowest prices. Wholesale Supply Co., Lunenburg 2, Mass.

Rates—45c per word (including name, address and initials). Minimum ad 10 words. Cash must accompany all ads except those placed by accredited agencies. Discount, 10% for 12 consecutive issues. Misleading or objectionable ads not accepted. Copy for January issue must reach us before Nov. 15, 1955.

Radio-Electronics
25 W. Broadway, New York 7, N. Y.

NOW 2 B&K CRT Money-Makers

TEST and REPAIR TV PICTURE TUBES



NEW DELUXE CRT 400 with 4 1/2" Plastic Meter

This portable Cathode Rejuvenator Tester quickly locates and corrects picture tube troubles in a few minutes, right in the home, without removing tube from set! Restores emission, stops leakage, repairs inter-element shorts and open circuits. Life-test checks gas content and predicts remaining useful tube life. Grid Cut-Off reading indicates picture quality customer can expect. Earns servicing dollars in minutes. Cuts operating costs, eliminates tube transportation. Saves money on TV set trade-in reconditioning. Pays its way from the very first day.

Weights only 5 lbs. mounted in rugged, luggage style, carrying case covered with handsome, durable leatherette. Size: 11 x 7 1/2 x 5".

Model 400. Net \$5495

Over 20,000 CRT'S NOW IN DAILY USE ACROSS THE NATION



NEW ECONOMY CRT 200

A quick profit maker priced low enough for every serviceman to cash in on picture tube repairs. Performs most of the functions of the CRT 400. Has 3" meter. In leatherette carrying case. Size: 11 x 7 1/2 x 5". Weighs 5 lbs.

Model 200. Net \$3995

Send for Bulletin 104-E

B & K MANUFACTURING CO.

3726 N. Southport Ave. • Chicago 13, Illinois



WHY...

subscribe to RADIO-ELECTRONICS? After all a subscription only saves you up to \$5.05 over the newsstand price, assures you of getting every issue every month and protects you against price rises. But after all it's only money—and convenience. So why take advantage of these low subscription rates?

3 Years \$8.00—Saves you only \$5.05 over the newsstand price

2 Years \$6.00—Saves you only \$2.70 over the newsstand price

1 Year \$3.50—Saves you only 85c over the newsstand price—hardly worth it, better subscribe for three years.

RADIO-ELECTRONICS

Dept. 115 25 West Broadway New York 7, N.Y.

Patents

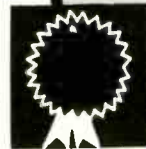

TRANSISTOR CONVERTER

Patent No. 2,709,787

Raymond J. Kircher, Summit, N. J. (Assigned to Bell Telephone Labs., Inc.)

Transistors are now available for nearly every radio receiver function. There are class-B audio units, detectors and i.f. amplifiers. The missing element is a mixer. The transistor disclosed here is a new type designed especially for modulation or frequency conversion. For example, a local oscillation frequency may be mixed with an r.f. signal to produce i.f. The new transistor is a n-p-n type with five contacts—an extra base contact and an auxiliary point contact.

The n-p-n unit (see diagram) operates like any conventional junction transistor. Carrier voltage E1 is injected at the emitter. The normal base contact (B1) is grounded. Output may be taken from the collector. Base contact B2

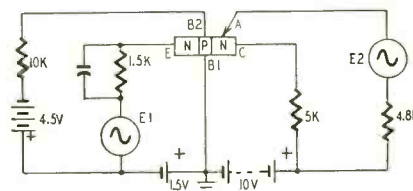

has a negative bias that produces flow within this element. It reduces internal base resistance and increases high-frequency efficiency.

A local oscillator E2 injects holes at contact A, which may be beryllium copper if the N region is germanium. A is placed only .001 inch from the p region, so any holes injected at the point can pass into the base where they are attracted to B2. Note that the point contact A, the collector and the base form an auxiliary p-n-p transistor. Holes flowing into the base (from A) combine with electrons injected at the emitter. Thus E2 modulates E1. The output, which may be an intermediate frequency, is available in the collector circuit.

Typical values are given in the diagram. The voltages are approximately: collector, 5; point A, 5.2; upper base contact, -1.

RAPID SWITCH

Patent No. 2,706,756

Sherman T. Brewer, Chatham Township, Morris County, N. J. (Assigned to Bell Telephone Labs., Inc.)

A switch that opens and closes almost instantly has many useful applications in modern control circuits. This one operates much more rapidly than a conventional relay, yet it retains the advantage of an all-metal path for the current. It is made up of two U-shaped elements in a glass tube. A coil (about 100 ampere-turns) surrounds the tube.

Normally the U-shaped elements do not touch. When the coil is energized, however, a magnetic field is generated within the tube. The flux flows through the wires and, as it tends to shorten its path, the two forked ends attract each other. When they touch, a reliable contact is made. With 1-mil spacing between contacts the switch operates in approximately 0.3 millisecond.

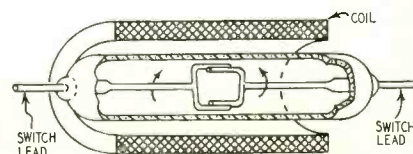

RADIO-ELECTRONICS

PATENTS

(Continued)

Switch efficiency is high because there are actually two gaps in series.

When the coil is de-energized, the contacts spring back to their normal positions and the circuit is interrupted. This switch opens in less than 0.1 millisecond and operates without chatter.

X-RAY DETECTION

Patent No. 2,706,792

John E. Jacobs, Milwaukee, Wis. (Assigned to General Electric Co.)

Many semiconductors are sensitive to visible light or ultra-violet but few are affected by X-rays. This inventor has discovered that cadmium selenide is very sensitive to X-rays as well as light. Radiation on the selenide frees trapped electrons, making them available for current flow. The diagram shows the basic X-ray detector.

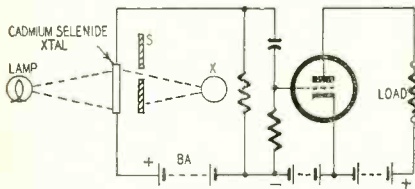

Battery BA polarizes the cadmium selenide. X-rays from source X are controlled by a suitable shield and allowed to fall on the crystal. The inventor finds that sensitivity is greatly increased if visible light falls on the crystal at the same time. Preferably this should be green light (approximately 5,200 angstrom units).

The X-ray machine (X) is energized by the a.c. line so its output is modulated at the line frequency or a multiple thereof. The current flow through the selenide crystal is modulated by this a.c. component. A triode amplifies the a.c. and the voltage across its load indicates the intensity of radiation. The crystal output varies with the square of the X-ray intensity.

TV PROMPTER

Patent No. 2,711,667

Luther G. Simjian, Riverside, Conn. (Assigned to Reflectone Corp.)

TV commercials, speeches and announcements are often delivered by an announcer who reads them from large "prompting cards" held alongside the camera. This produces a bad effect on the viewers, since the speaker cannot look directly at them, but turns his eyes to one side.

This invention permits the announcer to read his notes while looking directly at the camera. A transparent reflecting screen (a glass plate in this case) is placed at a 45° angle between the

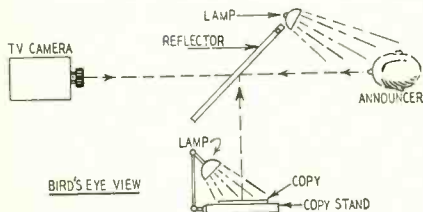

announcer and camera. The surface facing the camera is coated with fluoride or other reflection-preventing material. The surface toward the announcer has a thin metallic reflecting coating.

The material to be read is so placed on an illuminated stand or projected from a film projector at one side of the stage that the message is reflected back to the announcer, as shown in the figure.

The message can be placed on a moving roll or fed into the machine to keep pace with the speaker's delivery as is done with present prompting devices. END

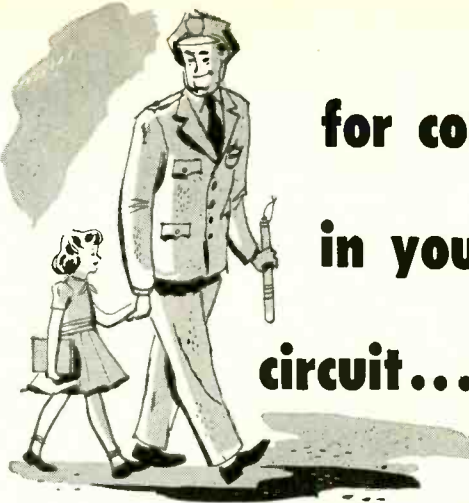

for complete protection

in your

circuit...

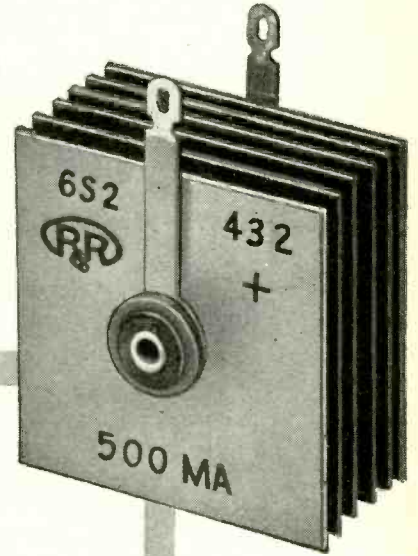

SELENIUM RECTIFIERS

with

"SAFE CENTERS"

The rectifier center is a real trouble zone. That's why all Radio Receptor selenium rectifiers are specially built and tested to eliminate arc-over danger, short circuits and heating at the center contact point. Even assembly pressure, or pressure applied in mounting the rectifier cannot affect its performance.

This "Safe Center" feature of RRco. rectifiers is accomplished by deactivating the area of the plate under the contact washer... An added safety factor that gives protection during mounting and when the rectifier is in use.

No wonder RRco. selenium rectifiers are preferred by leading manufacturers of radios, TV and other electronic equipment. Millions in use under all conditions—including high humidity—give eloquent testimony to their dependable service. Next time you need rectifier replacements demand the bright green RRco. units with "Safe Centers."

For latest information of the Radio Receptor rectifier line write today to Dept. R-2.



RADIO RECEPTOR COMPANY, INC.

In Radio and Electronics Since 1922

SALES DEPT.: 251 West 19th Street, New York 11
WAtkins 4-3633 • Factories in Brooklyn, N. Y.

NOW! PASS FCC LICENSE EXAMS!

easier... faster!

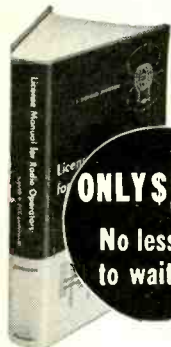

ONLY \$5.00
No lessons
to wait for

Answers
almost 2200
typical FCC
examination
questions

A complete guide
for getting
your license as
a commercial
operator in

**RADIO OR
TELEVISION
STATIONS
SHIP OR MARINE
RADIO
AIR LINE RADIO
COMMUNICATIONS,**
etc.

Whether you plan to take the Federal Communications Commission examination for either your 1st, 2nd or 3rd class 'phone or telegraph license, this big book will guide you ALL of the way!

EXTRA "BONUS"!



At not one cent of extra cost you also get a 32-page Supplement. This brings all parts of Johnson's LICENSE MANUAL FOR RADIO OPERATORS fully up to the minute as regards the recent changes in Examination Elements 1 and 2. Many people are not even aware that these changes exist!

10-DAY FREE EXAMINATION

Dept. RE-115, RINEHART & CO., INC.
232 Madison Ave., New York 16, N. Y.

Send Johnson's LICENSE MANUAL FOR RADIO OPERATORS (including the new 32-page supplement on Elements 1 and 2) for 10-day FREE EXAMINATION. If I decide to keep them, I will promptly send you \$5.00 (plus a few cents postage) in full payment. Otherwise I will return book postpaid and owe you nothing.

Name

Address

City, Zone, State.....

OUTSIDE U.S.A.—Price \$5.50 cash with order. Money back if book is returned in 10 days.

RINEHART BOOKS ARE SOLD BY LEADING BOOK STORES



NATESA'S ANNUAL MEET

Coming from 44 states, Hawaii, Canada, Cuba and the Philippines, 1,580 service technicians registered at the NATESA convention held in Chicago Aug. 19, 20 and 21. Four prizes, totaling \$450 in cash, were given.

Delegates from 38 affiliates laid plans for new districts, district governors, state chairmen and a new advisory council, completing the plan of organization all the way down to the town level.

A TV-radio week or month was planned and proposed to RETMA, a new dues structure was voted and awards made to P. R. Mallory Co., Technician magazine, Paul Wendell, Howard Sams, RCA and G-E tube divisions, Sylvania and Sprague. Dan Creato of RCA Service Co. was awarded a continuing citation.

It was voted to standardize on one name for locals: Television Electronic Service Association. Thus each local would be TESA, and the national organization NATESA. A target date of 1 year was set for making the change complete.

Officers elected for the 1955-56 term are Frank J. Moch, Chicago, president; Robert Hester, Mission, Kan., secretary-general; Bertram Lewis, Rochester, N. Y., treasurer. The following were elected district vice presidents: Harold Eskin, Rochester, N. Y., Eastern; Russ Harmon, East Central; Vince Lutz, St. Louis, West Central; Jim Failing, Greeley, Colo., Western. Others elected were P. P. Pratt, Buffalo, N. Y., Eastern secretary; L. C. Stallcup, Nashville, Tenn., East Central secretary; Joe Driscoll, St. Paul, West Central secretary; Albert C. W. Saunders, Boston, Mass., educational director.

The spring board of directors' meeting was voted to Omaha and tentatively set for April 22, 1956. The proposed dates for the 1956 annual convention was Aug. 19 at Chicago.

U. S. ACTS ON BAIT ADS

The struggle against unethical service practices has reached the Federal level. The Federal Trade Commission has issued a complaint against the Mayflower Television Co., Inc., Washington, D. C., charging it with misrepresenting basic facts about its television repair service.

The complaint alleges that the company has misrepresented—in TV, newspaper and other advertising—the cost of servicing TV sets, the services per-

New Gift Suggestions at Special Holiday Low Prices

Newest Phonographs!

The Ideal Gift!

3-Speed Portable Phonograph

Plays all speed records (33 $\frac{1}{3}$, 45 & 78 RPM) with a new, all purpose permanent needle. Complete with excellent amplifier and speaker for unusual fine tone. Luggage type carrying case, durable and long lasting. 12 $\frac{1}{2}$ " x 10" x 5 $\frac{1}{4}$ ", 8 $\frac{1}{2}$ lbs.

Unusual Value

\$14.75
Special



AUTOMATIC RECORD PLAYER



Now
only **\$39.75**

3-Speed, fully automatic phono with the latest VM record changer; twist dual-needle pick-up arm, tamproof, intermix (plays 7", 10" & 12" records in same stack), heavy duty 6" speaker for true fidelity sound. Sturdy, portable case covered with duPont tu-tone material. 18" x 14 $\frac{1}{2}$ " x 8 $\frac{3}{4}$ "; 22 lbs. Model 1404.

AUTOMATIC RADIO-PHONO COMBINATION

Same as above but in a combination that includes a well engineered, hi-powered, 5-tube superhet. radio of the latest circuit. Model 1405. **Reduced to \$49.75**
Terrific Values....

3-SPEED AUTOMATIC RECORD CHANGER



Limited quantity! Famous make automatic changer plays all 3 speeds (33 $\frac{1}{3}$, 45 & 78 RPM) and all size records (7", 10" & 12"), intermixes records of same speed. Automatic shut off after last record. 1955 model **Reduced to \$22.50**

3-TUBE PHONO AMPLIFIER



NOT A KIT
An assembled unit ready for installation using tone and volume control and 6 ft. rubber cord (less tubes)..... **\$2.95**
Lowest Price!
With complete set of tubes..... **\$4.45**

PHONO OSCILLATOR

NEW SAVINGS! • NOT A KIT!
Wireless phono oscillator transmits recording for crystal pickups or voice from carbon mike through radio without wires. (Can also be used as an intercom by using PM speaker)..... **\$2.95**
as mike. (less tubes)..... **\$3.95**
With complete set of tubes.....

Write today for FREE Catalog. All mdse. shipped F.O.B. New York City, prices subject to change without notice. Include 20% deposit with C.O.D.'s.

EDLIE Electronics

154 Greenwich St., New York 6, N.Y.
DI 9-3143

formed on those sets and the number of instances sets can be repaired in the home. A typical ad is an offer to send a service technician, "each a specialist for a different make," to the home "to fix your TV set for only a \$1.50 service charge." Other ad claims were that 9 times out of 10 a set can be repaired in the home.

In the vast majority of cases, sets were removed from the home and the costs were far in excess of the \$1.50 service charge; the "specialists" were found to have no more than a limited knowledge of TV servicing. In addition, it was stated, the company declared that only needed parts would be replaced and that, if any were replaced, there would be no service charge. In fact, according to the complaint, parts not needed were replaced and a service charge was included in those instances.

NEW CONSTITUTION

A new constitution, giving the association powers to move speedily when circumstances dictate, was adopted by the Television Service Dealers Association of Philadelphia. It sets up a five-man advisory board having powers to appoint committees to work on certain projects without first receiving the approval of the full membership. The board will consist of the president, a past president, one elected officer and two TSDA members. It will handle all urgent business arising between membership meetings.

Arrangements were also made for appointing committees with a 1-year life, to handle all phases of association business. An editorial committee which will publish a bi-weekly newspaper was also set up under the leadership of Charles Knoell, past president.

TSDA officers for the 1955-56 term are Harrison Neel, president; Walker H. Prager, vice president; Elmwood S. Walker, corresponding secretary; Richard Schofield, recording secretary; Harry J. Yust, treasurer.

DEVANEY PRSMA PRESIDENT

Richard G. Devaney was elected president of the Philadelphia Radio Service Men's Association for the 1955-1956 season. Devaney is one of the oldest workers in the Pennsylvania service association field and had previously served two terms as PRSMA vice president.

Samuel M. Brenner—the past president—was elected vice president; James T. Daly, recording secretary; William P. Humes, corresponding secretary; Stanley W. Myers, treasurer.

ABOLISH LIST PRICES

An original proposal to eliminate the evils of off-list and "wholesale to everybody" selling is made by Chris Stratigos, secretary of the Long Island Radio-Television Guild, writing in the August Guild News.

"The very existence of list prices has (Continued on page 139)

10 Masterpieces

Advertisement for 10 Masterpieces recordings, listing composers like BACH, CHOPIN, BEETHOVEN, MUSSORGSKY, VIVALDI, MOZART, BRAHMS, BERLIOZ, WAGNER, and DUKAS. Includes pricing: "COMPLETE TO THE LAST NOTE! \$1.10 for just one dollar!"

try them FREE Don't pay until AFTER you've heard them. No Strings Attached! No purchase obligation ever Full membership privileges

Performed by world-famous artists and orchestras. Custom recorded on quiet vinylite with full range high-fidelity—50 to 15,000 cycles. Now, take all these 10 Masterpieces for free home trial! After 5 days send only \$1 as payment in full for all 10, or return them. We make this amazing offer to show you the quality of our recordings and acquaint you with our no obligation Membership Plan. See coupon for details and mail today - without money - for your 10 Masterpieces.

The Musical Masterpiece Society, Dept. 52-11 43 West 81st Street, New York 23, N.Y. Rush 10 Masterpieces for free trial... Address... City... State... Canada: 105 Bond Street, Toronto 2, Ont.

LIFETIME GUARANTEED TUBES

BRAND NEW PICTURE TUBES

RCA Licensed One Year Unconditional Guarantee

Table of Picture Tubes with columns for TYPE, PRICE, TYPE, PRICE. Includes models like 10BP4, 12LP4, 14BP4, etc.

Picture Tubes shipped F.O.B. Harrison, N. J. Above types are most popular. However, you may order any equivalent size at the same price.

LOOK WHAT YOU GET FREE!

- FREE BONUS BOX With Every \$25 Order: 1 RCA Cheater Cord, 10 Assorted resistors, 10 Assorted 2-Color "blank" tube cartons, 1 6BQ4GT tube, 1 6AU6 tube, 1 6CB6 tube

FREE CLOCK RADIO

Wakemaster clock radio with famous Sessions clock movement wakes you to music or alarm. May be purchased outright from MAJOR BRAND for \$17.95. In ivory or rust.

FREE GIFT CERTIFICATE*

worth \$5 toward the purchase of any of our merchandise on future orders will be sent with any order of \$50 or more.

*Free Gift Certificate cannot be used to obtain another certificate unless order is \$55 or more. WE PAY ALL POSTAGE on orders shipped in U.S.A., Territories and APO's. Send only purchase price of merchandise. Please include approximate postage on foreign shipments. All orders subject to prior sale. 25c Handling Charge on Orders under \$5. Quantity users Write For Special Discounts. Write For FREE Tube List-Order Blank-and FREE Sample Tube Carton. We want Y-O-U On Our Mailing List!

NEW INDOOR ANTENNA

Both UHF and VHF. Brings better reception than most outdoor antennas. Use on top of TV.

List Price \$9.95

YOUR PRICE \$3.29 Lots of 3 \$3.99 each

THIS AD IS WORTH M-O-N-E-Y

Clip out this ad and attach it to your order. Three 6SN7GT's will be shipped FREE with any order of \$10 or more.

- Top Branded Tubes and Our Own MAJOR BRAND Label Each Tube Individually Boxed and Guaranteed for Life Over a Half Million Tubes Always in Stock Immediate Shipment Free Postage On All Orders With Full Remittance

Here's How LIFETIME GUARANTEED TUBES SAVES YOU PLENTY! There are fewer "call backs" There are no "out of date" tubes "Peak Performance" testing in our fully equipped Testing Department before shipment guarantees quality

Table of various vacuum tube types and prices, such as 02A, 1A4P, 1A7GT, etc.

MAJOR BRAND TUBE CO. Romano Bldg. ESsex 4-1106 Harrison, N. J. Write Dept. 11-RE

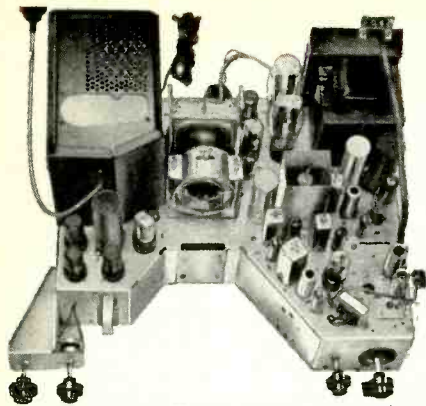

Build your own #630 Super De Luxe TV CHASSIS

With a

#630 SUPER DE LUXE 31-TUBE TV KIT

OPERATES 16" to 21" PICTURE TUBES • Engineered in strict adherence to the genuine RCA #630 plus added features • **FULL 4MC BANDWIDTH** • **CASCADE TUNER** • **COSINE DEFLECTION YOKE** • **LARGER POWER TRANSFORMER** • **KEYED AGC** • **12" SPEAKER** • **CONDENSERS** and **RESISTORS** at rated capacities and tolerances. You receive a **COMPLETE SET** of **PARTS** and **TUBES**, everything needed is included (less CRT & wire). All I.F. Coils and Transformers are factory pre-aligned and tuned. You will enjoy building it with "LIFE-SIZE" easy to follow step-by-step **ASSEMBLING INSTRUCTIONS**" included with each KIT.

is included (less CRT & wire). All I.F. Coils and Transformers are factory pre-aligned and tuned. You will enjoy building it with "LIFE-SIZE" easy to follow step-by-step ASSEMBLING INSTRUCTIONS" included with each KIT.

slashed to **\$99⁹⁹**

Same KIT for 27" and ALL 90° CRT's **\$110³⁹**
Slashed to

CUSTOM-BUILT CABINETS for #630 and all Other TV SETS—from FACTORY to YOU

5 NEW 1956 STYLES in genuine mahogany or walnut (blond 10% extra) • Ready drilled for any #630 TV chassis and cutout for any 16", 17", 19", 20" or 21" picture tube at no extras in price • Also supplied with undrilled knob panel for any other TV set • **EVERYTHING NECESSARY** for an easy perfect assembly is included • Each cabinet is delivered complete as pictured with mask, safety glass, mounting brackets, backboard, backcup, hardware and assembling instructions • Each cabinet is shipped in an air cushioned carton from **FACTORY to YOU!**

The GEM
Popular Table Model



H-25", W-26", D-22"

\$35⁹¹

GEM also available for 24" or 27" picture tube.
H-31", W-27", D-23"

\$59⁵⁴

The FUTURAMIC
Latest sensation in styling with tambour roll-in door.



H-37", W-28", D-24 1/4"

Underneath mounting for 12" speaker

Slashed to **\$79³⁴**

The MANHATTAN
Style, Quality, Price



H-39", W-25", D-23"

\$53⁴³

MANHATTAN for 24" or 27" CRT \$79²²
H-46", W-27", D-23"

The WESTCHESTER
Choice of Interior Decorators, truly superb in every detail.

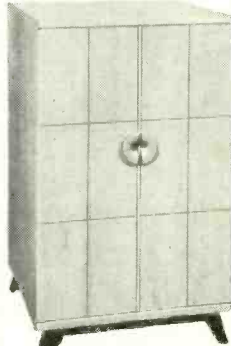

H-41", W-26", D-25"

\$88⁷⁰

The TOWN & COUNTRY
Patterned after the popular credenza. Available for all size picture tubes 14" to 27"

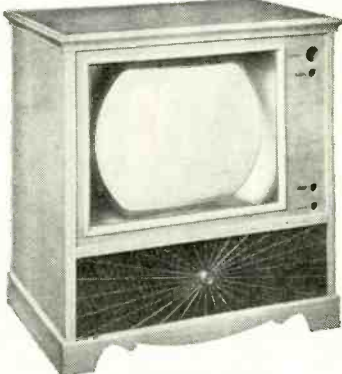

H-42", W-36", D-24"

Slashed to **\$98⁶⁵**

#630 SUPER DE LUXE TV CHASSIS

LICENSED UNDER RCA PATENTS
COMPLETE READY TO PLUG IN AND PLAY
Similar in features to the 16" to 21" TV KIT above.
Slashed to **\$142²⁷** (less CRT)

DUMONT OR THOMAS PICTURE TUBES

BRAND NEW in Factory Sealed Cartons — With a Full Year Guarantee

17" #17BP4A \$22.66 | 21" #21EP4B Aluminized \$32.21 | 24" #24CP4A Aluminized 90° \$48.99 | 27" #27EP4A Aluminized 90° \$74.31

#630 B Y TECH-MASTER

COMPLETE LINE AT SPECIAL PRICES
Catalog mailed on request

Modernize a #630 or any TV Set

STANDARD CASCADE TUNER

with a #630
For better all around performance
Complete with tubes and Brooks CASCADE MANUAL with step-by-step instructions and all extra parts needed. **\$15⁹⁷**

PULSE KEYED AGC KIT

Finest, most accurate and the easiest Kit to install in any make TV RECEIVER including the No. 630. Improves performance and insures a steady picture on all channels.
COMPLETE SET OF PARTS \$2⁹⁹
Including 6AU6 tube & Instructions

UNIVERSAL Picture Tube MOUNTING BRACKETS

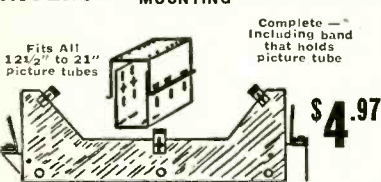

Complete — including band that holds picture tube

\$4⁹⁷

27" TV CONVERSION KIT

Convert ANY MAKE TV RECEIVER including #630 to operate the 27" or ANY 90° PICTURE TUBE
COMPLETE SET OF ESSENTIAL PARTS includes matched set of Todd 90° COSINE DEFLECTION YOKE and TODD 18KV FLYBACK TRANSFORMER
List Price \$39⁷⁵

Your price... **\$15⁹⁸**
Incl. CONVERSION MANUAL with Step-By-Step Instructions & Diagrams.

21" TV CONVERSION KIT

Convert ANY MAKE TV RECEIVER including #630 to operate the 21" or ANY 70° PICTURE TUBE
COMPLETE SET OF ESSENTIAL PARTS includes matched set of Todd 70° COSINE DEFLECTION YOKE and TODD HV FLYBACK TRANSFORMER
List Price \$33⁵⁰

Your price... **\$13⁹⁷**
Incl. CONVERSION MANUAL with Step-by-Step Instructions & Diagrams.

BROOKS RADIO & TV CORP., 84 Vesey St., Dept. A, New York 7, N.Y.

been the prime reason for the growth of the discount house," he says. "When one is eliminated the other may die out . . . The manufacturer's accounting system sets the price at which the product will be sold to the retailer. Shouldn't the retail shop owner consult his accountant to determine what his selling price should be?"

"The simplest way out is for the manufacturer to stop making list prices and let the retailers set a price through competition. As it stands now the manufacturer makes the profit he wants and the retailers battle their way downward from the list price to some ridiculous figure which is hopefully rationalized by the word 'turnover.' In other words list prices, originally intended to prevent underselling are used to foster underselling. Isn't it logical that they be abandoned? . . ."

"The first step," Stratigos believes, "is for the manufacturer to stop telling the retailer what he should charge the customer while knowing full well that by doing so he is merely setting a bargaining point from which one can only go downward."

DON'T TALK TOO MUCH!

Charles Golenpaul, vice president in charge of distributor sales, Aerovox Corp., in expressing hearty sympathy with organizations trying to eliminate the evils of indiscriminate over-the-counter selling, and especially with a

resolution to that effect passed by the Associated Radio & Television Servicemen (Chicago), presents some practical points:

He stresses that the ethical distributor may be recognized by his shop-front. Many distributors, he says, are even painting their windows so that from the outside there is no indication of the nature of the business other than a sign and the words "Wholesale Only."

"It stands to reason," says Mr. Golenpaul, "that just so long as the distributor dresses up his store windows with a lot of consumer goods such as tape recorders, phonographs, radios, hi-fi equipment and similar merchandise, the public is going to barge into the store—and the serviceman is going to barge out!"

The technician is often his own enemy—telling the customer how to compete with him, declares Mr. Golenpaul. "He often tells the set owner just what is wrong with the inoperative set, after a time-consuming diagnosis. 'You need a new 8-mike 450-volt electrolytic—this one,' or 'This resistor is shot—it's a 3,300-ohm carbon,' or 'This tube is gone—it's a 6AL5.' . . . I don't believe the general public purchases a capacitor or resistor or transformer . . . unless the serviceman has talked too much."

He sums up: "Servicemen talk too much; distributors lack the guts to send anyone away; manufacturers do

not try to limit their distribution to strictly legitimate wholesalers."

FRISCO SETS STANDARDS

First action of the new Television Service Guild of San Francisco was to establish a set of standards, including minimum charges for service calls and guarantees on parts and labor.

The group, organized with Lyle Dennis as president and Al Braunberg as secretary-treasurer, credits the San Francisco Better Business Bureau with much of the inspiration for organizing the new association.

The new guild has already adopted an emblem to identify member shops and is supplying it in badge form to identify members to the customer. Committees have been formed and techniques adopted to improve customer relations.

NEW JERSEY GROUP

The New Jersey TV and Electronic Technicians Association, with headquarters at 1113 Raritan Road, Clark Township, N. J., announces that regular meetings will be held the last Wednesday of each month during the winter.

The association, recently incorporated, is headed by Richard Scholl. William Marbach and Harry Miller are first and second vice presidents respectively; Arthur Riley, secretary, and William Hanson, treasurer. END

| | | |
|---|--|--|
| <p>BROOKS LIFE-SIZE TV INSTRUCTIONS for building any #830 TV Receiver from the original 10" to the latest 27" \$1.25 postpaid</p> | <p>HINTS FOR BETTER PERFORMANCE on your # 630 TV receiver. Also useful on all other makes of TV Sets. 50¢ postpaid</p> | <p>BROOKS CASCADE MANUAL how to install Cascade Tuner in any make TV Set. 25¢ postpaid</p> |
| <p>90° TV CONVERSION MANUAL how to convert any TV SET to 24", 27", etc. with illustrations of wall-type TV Mountings. 50¢ postpaid</p> | <p>70° TV CONVERSION MANUAL how to convert any TV SET to 17", 21", etc. instructions for boosting HV on any TV Set. 50¢ postpaid</p> | <p>A.G.C. STEP-BY-STEP INSTRUCTIONS how to add A.G.C. to any make TV Receiver. 25¢ postpaid</p> |
| <p>REGULAR BUS TYPE #3AG QUARTER AMP FUSE Regular price 10c, only 1¢ each as long as supply lasts</p> | <p>ONE POUND OF ROSIN CORE SOLDER 56¢</p> | <p>NEW SENSATIONAL \$1.00 HANDY WRENCH 39¢ For 10 Hex Nut Sizes</p> |
| <p>SELENIUM RECTIFIERS 75ma . . . \$.49 250ma . . . \$1.08 100ma62 350ma . . . 1.26 150ma74 500ma . . . 1.49</p> | <p>5" PM SPEAKER (Alnico #5) case of 3099c each smaller lots . . . \$1.14 each</p> | <p>SAPPHIRE PHONO NEEDLE Best made 46¢ each Lists for \$2.00</p> |
| <p>TV PICTURE TUBE BOOSTER Lists for \$3.75 69¢</p> | <p>THREE SPEED WEBSTER CHANGER Intermixes all records Complete with flip-over cartridge \$24.19</p> | <p>FLYBACK TRANSFORMER <small>RCA #218T1</small> List Price \$10.00 Doubling type for 70° C.R.T. incl. schematic diagram. . . . only 99¢</p> |
| <p>100 ASSORTED TUBULAR CONDENSERS \$3.64</p> | <p>15 ASSORTED RADIO ELECTROLYTIC CONDENSERS \$3.49</p> | <p>15 ASSORTED TV ELECTROLYTIC CONDENSERS \$4.97</p> |
| <p>100 ASSORTED 1/2 WATT RESISTORS \$2.88</p> | <p>100 ASSORTED 1 & 2 watt RESISTORS \$4.62</p> | <p>100 ASSORTED MICA CONDENSERS \$3.72</p> |
| <p>10 ASSORTED VOLUME CONTROLS \$1.66 best sizes, less switch</p> | <p>10 ASSORTED VOLUME CONTROLS \$2.63 best sizes, with switch</p> | <p>100 ASSORTED CERAMIC CONDENSERS \$3.72</p> |
| <p>100 ASSORTED KNOBS \$2.84 Screw & Push-on</p> | <p>100 ASSORTED SOCKETS \$2.79 Octal, Loctal & Miniature</p> | <p>100 ASSORTED PILOT LIGHTS \$4.43 #44, 46, 47 & 51</p> |

Brooks Radio & TV Corp., 84 Vesey St., Dept. A, New York 7, N.Y.

Small
in size and cost
Big
in performance



American's NEW TAPE RECORDER MICROPHONE

Here's a new standard for high fidelity convenience . . . for the home or small studio. Attractively styled, and available in matching colors, this sensational new lightweight champ delivers a heavyweight performance throughout the entire tone range. Omni-directional pick-up pattern provides uniform fidelity when more than one performer or participant is being recorded at one time.

Versatility underscores the modern functionalism of this new design. It weighs only 2 ounces, only $3\frac{1}{2}$ x $2\frac{1}{4}$ x $\frac{1}{4}$ inches in size . . . can be easily handled and used by standing persons, or it can be rested on a flat surface for conference type pick-up such as conference recording.

Quality in construction means quality in tonal reproduction. The microphone element is shielded, with very low hum pick-up. Model B-203, ceramic type, and Model X-203, crystal type are both available with RCA type or miniature phone plugs.

For high fidelity sound that is reproduced to last, use American tape recorder microphones.



full vision . . .
full sound . . .
where fidelity
speaks for itself!

American
microphone
company

370 South Fair Oaks Ave., Pasadena 1, Cal.

AN ELGIN NATIONAL WATCH
COMPANY AFFILIATE

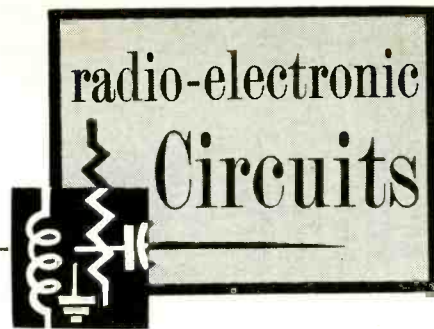

D.C. TO A.C. INVERTER

From time to time we receive requests for variable-frequency power supplies for varying the speed of small a.c. motors and for inverters for operating small a.c. motors from d.c. lines. This circuit, taken from *The Radio Constructor* (London, England), can be adapted to fill both these needs. It was designed to operate 50-cycle phono and magnetic recorder motors drawing around 25 watts from 220-volt d.c. lines.

TV horizontal output tube that will deliver the required power output. In this case, plate and screen voltages are taken from suitable power supplies.

The center-tapped output inductor must be able to handle the current drawn through it on alternate half-cycles and its resistance should be less than 20% of the load (motor) it supplies. The author recommended using the primary of a 110-220-volt power transformer.

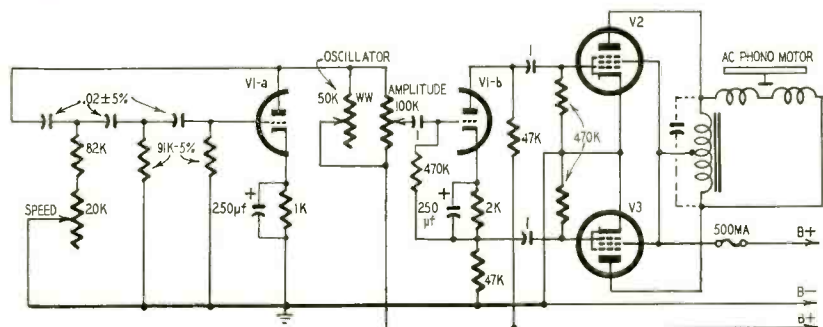

The circuit consists of a variable-frequency phase-shift oscillator (V1-a); phase inverter V1-b and output pentodes V2 and V3. The output tubes are biased to cutoff by grid-leak bias developed across the 470,000-ohm grid resistors. V1 may be a 6SN7-GT, 12AU7 or any similar twin triode. V2 and V3 are preferably beam-power output tubes having high power sensitivity.

Output frequency is controlled by the 20,000-ohm SPEED (frequency) control in the grid circuit of V1-a. Phase-shift oscillators operate best with just enough plate load resistance to maintain oscillation. In this application a higher plate load may be needed for sufficient output amplitude. The OSCILLATOR and AMPLITUDE controls should be adjusted carefully for optimum performance.

When the unit is used on 110-115-volt d.c. lines, V2 and V3 may be 25CD6-G's, 25BQ6-GT's, 50CD6-G's or equivalents. When used as a variable-frequency supply, V2 and V3 may be any convenient transmitting, audio or

When using the circuit as an inverter for operating small 60-cycle tape or phono motors from d.c. lines, connect the motor and an a.c. voltmeter across the output inductor and apply plate voltage. Shunt various values of capacitance — use paper capacitors — across the motor until the voltage peaks, indicating resonance. Adjust the output voltage to the desired value with the AMPLITUDE and OSCILLATOR controls.

Adjust the frequency by counting the revolutions of a phono motor over a period of several minutes or by measuring the amount of tape pulled past the head in a given period of time.

When using the circuit as a variable frequency supply operating from 60-cycle lines, you can check frequency and waveform with a scope. Output voltage can be adjusted with the controls and by varying the plate voltage on the output tubes. When high-power tubes are used for V2 and V3, screen voltages should be obtained from a separate supply or through a dropping resistor.

BOOSTED HIGH VOLTAGE

After converting a TV set for a larger tube or replacing major components in the high-voltage or deflection circuits service technicians sometimes need more high voltage for greater brightness and sharper focus. This problem was posed by a reader of the

"Query Corner" in *The Radio Constructor*, a British radio magazine. The diagram shows the circuit suggested for boosting the output of a flyback type power supply about 40%. The added components are shown in dashed lines in the figure.

Save TV Alignment Time
with the **EAZY** to use **Align-O-Pak**
TV alignment Bias Battery Eliminator



★ **Quickly determines AGC troubles**

Think of the time wasted connecting batteries in series... The **Align-O-Pak** provides all the voltages recommended by these leading TV manufacturers:

- ADMIRAL 1½-4½v
- MOTOROLA 3v • PHILCO 7½v
- RCA Tv • ZENITH 5v Variable.

★ Forget messy Bias Batteries

★ Fix only TWO AGC troubles and your Align-O-Pak is paid for

★ Just Plug it in - - -

★ Provides from 0 to 10 Volts BIAS Instantly

★ Completely isolated from Power Line and Case

Only 785
DEALER NET

INSTRUCTIONS

FOR ALIGNMENT: Plug Align-O-Pak in and turn unit on. Connect black lead to the Receiver AGC buss and red lead to B minus (usually chassis). Set Align-O-Pak knob to voltage recommended by TV manufacturer.

FOR AGC TROUBLE SHOOTING: With Align-O-Pak connected as described above, turn control knob slowly from 0 to 10. If normal picture appears, AGC is defective.

"MORE THAN 10,000 IN USE TODAY"

Carried by Your Jobber!

Senco SERVICE
INSTRUMENTS COMPANY
ADDISON, ILLINOIS

RADIO-ELECTRONIC CIRCUITS (Continued)

The high positive pulses at the plate of the horizontal output stage are rectified and added to the voltage available from the normal high-voltage circuit. Between pulses the junction of R1 and C1 is at the same potential as filter capacitor C3. When a pulse ap-

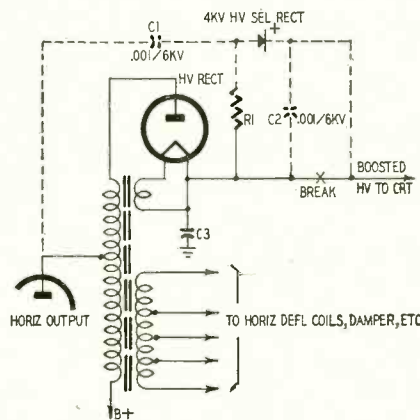

pears at the plate of the output tube, it is rectified by a high-voltage selenium rectifier and charges C2 an additional 1,500 to 3,000 volts. This voltage is applied to the picture tube.

Experimenters may use a Sarkes-Tarzian 026-175H-T or equivalent high-voltage rectifier and a standard high-voltage type resistor for R1.

NEW PULSE TRANSFORMER

Blocking oscillators are frequently used as pulse generators in timing, triggering, switching, gating, calibrating and other applications. Very often the design problem is one of obtaining a sufficiently fast rise time. A new type of pulse or blocking transformer developed at the National Bureau of Standards has exceptionally fast rise time—from 0 to 90 volts in less than .02 μ sec in a conventional circuit.

The speed with which the oscillator output voltage pulse rises and the pulse repetition rate are determined largely by transformer design. When using conventional pulse transformers with laminated cores, the shortest pulses obtainable have a duration (width) of about 0.1 μ sec. With the new transformer it is possible to obtain pulses less than .06 μ sec wide with a rise time of less than .02 μ sec.

Construction of the new transformer

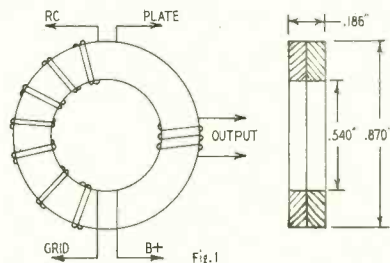

is shown in Fig. 1. The core is made by cementing together two standard commercially available ferrite toroids. The plate, grid and output windings consist of 13, 12 and 6 turns, respectively,

NOW HEAR THIS

for improved high fidelity

GOODMANS LOUDSPEAKERS

in the New

'Friction-Loaded' AXIOM Enclosures

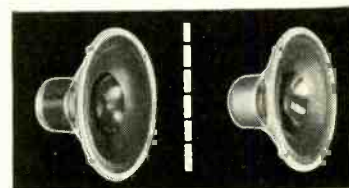

Axiom 22 Mk II Axiom 150 Mk II

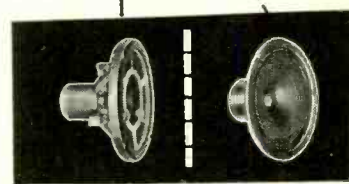
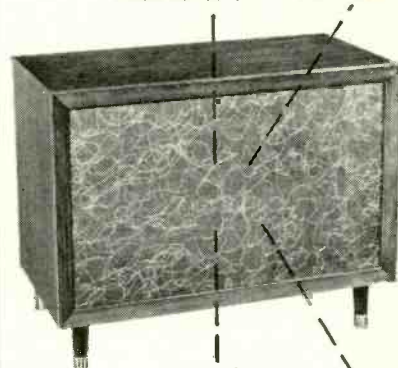

Axiom 80 Axiette

Complete do-it-yourself construction details — available on request

Mail this Coupon... Today

ROCKBAR CORPORATION Dept. NL-9
215 East 37th St., New York 16, N. Y.

Please send me:

- Complete information about GOODMANS High Fidelity Loudspeakers.
- Complete details about the new 'friction-loaded' AXIOM Enclosures.

NAME.....

ADDRESS.....

CITY..... ZONE..... STATE.....

Question Box

SQUARE WAVES FROM SINES

Please print a diagram of a miniature-tube square-wave clipper for the wide-range oscillator described in the July, 1954, issue. I plan to use the square-wave signals and a scope for checking audio equipment.—R. B., Lafayette Hill, Pa.

The drawing shows how a direct-coupled clipper can be added to the

oscillator between V2 and V3. This circuit is used in the EICO model 377 audio generator.

The components that have been added to the circuit are shown within the dashed lines. Change the input filter capacitor from 60 to 100 μ f and use this point for the B plus line to the clipper tube.

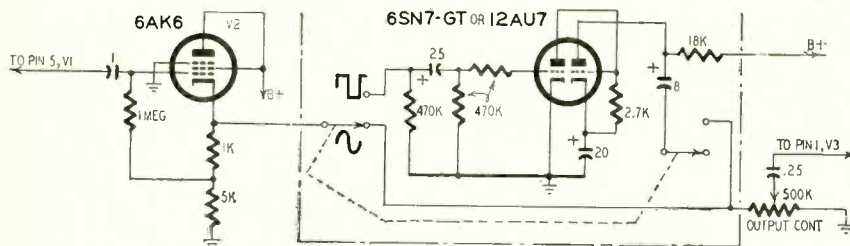

75-WATT TRANSMITTER

I am a newly licensed Novice amateur radio operator and would like to construct a simple 50-75-watt CW transmitter for 80 and 40 meters. Several old-timers have recommended a one-tube 6L6 transmitter popular around 1940 but none can supply the circuit. They recall that the rig used pilot lamps instead of meters to measure plate and crystal currents. Can you print the circuit?—R. P., Brentwood, N. Y.

The transmitter was probably one of the "QSL" series described by the late Fred Sutter, W8QBW, in QST magazine between early 1938 and April, 1941. The diagram shows the circuit of the QSL-Sixty as modified for use at my pre-war station. I substituted a shunt-fed pi network for the series-fed

parallel-tuned circuit to simplify matching various types of antennas. The power supply shown delivers about 600 volts at 150 to 200 ma.

Although the tube is run beyond manufacturers' ratings, its life will be close to normal if you use care in tuning and do not hold the key closed for long periods. (For a period of one year we operated this rig with 120-150 watts input without tube failure. Glass type tubes are required in this circuit because metal ones have a tendency to arc in the base when plate voltage exceeds about 400. Power input to the plate was 200 ma at 600 volts or 100 ma at 1,500 volts.)

Since you are a Novice we suggest that you arrange to switch a 250- or 300-ma meter in series with the pilot

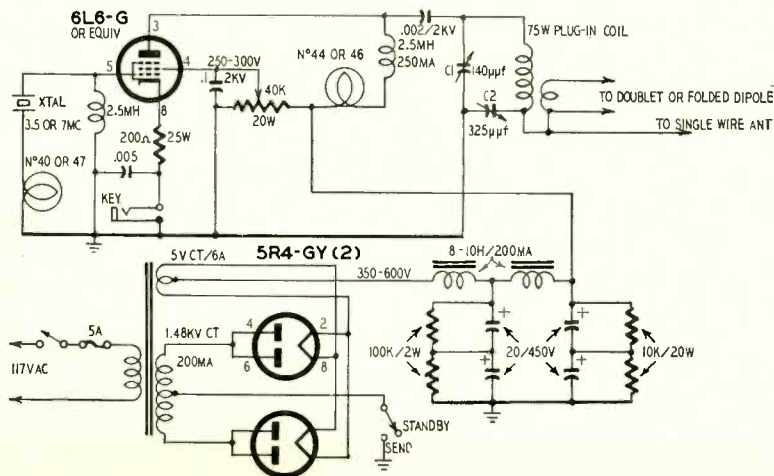

ARE YOU GOING TO BUILD A SPEAKER SYSTEM?

OR, ARE YOU GOING TO BUY IT COMPLETE?

Either way, YOU CAN'T GO WRONG WHEN YOU END UP WITH UNIVERSITY

It's all a matter of taste. Some people like to assemble things themselves, or (because of budget requirements) build toward the best. Others prefer to have the best—all at once. Either way, UNIVERSITY makes it easy.

IF YOU'RE GOING TO BUILD

P·S·E—the Progressive Speaker Expansion Plan by University, makes it possible to build a great variety of magnificent sounding systems in inexpensive stages regardless of budget or space limitations.

University speaker components, enclosures and networks are so uniquely designed that it's possible to start an excellent basic system, at low cost, and add to it later—while enjoying immediate listening satisfaction. Thus you are assured that your system can never become obsolete. Instructive folders called TECHNIGRAMS, are available FREE to help you plan your system.



IF YOU'RE GOING TO BUY A COMPLETE SYSTEM

The CLASSIC, at right, is one of many outstanding systems that you can purchase. University offers a complete range from the space saving TINY-MITE to the ultimate in speaker systems—the CLASSIC and the DEAN. Free literature on request.



P-S-S-S-T! Learn more with our free literature!

University

LOUDSPEAKERS, INC. Desk B4
80 South Kensico Avenue, White Plains, N. Y.
Please send me further details.

- I want to build a system.
 I want to buy a system complete.
 I want information on both.

NAME _____
ADDRESS _____
CITY _____ STATE _____

to 900 volts for choke input filters. If the current exceeds 70 ma, use two 6X4's in parallel. RFC1, RFC2 and RFC3 are 10-amp A chokes. The vibrator is a Mallory 859 or equivalent. The value of the buffer capacitor across the secondary should be determined experimentally.

The high-voltage supply uses a universal photoflash power transformer (T2) and a 4-volt vibrator (Thordarson T-22R43 and Radiart 5436 or equivalents, respectively). The high-voltage rectifier is a CK1013. If you require a negative potential for the C-R tube, reverse the connections to plate and cathode of the rectifier. The 10-megohm resistor should be connected between plate and starter electrode in either case.

T2 has a 117-volt, 60-cycle primary as well as a 4-volt vibrator winding so a battery-charging circuit has been provided. The rectifier should have a rating of at least 14 volts a.c. input and deliver 4 amperes or more. The 1-ohm 25-watt resistor should be adjusted for 4 volts between ground and the center tap on the vibrator winding when the unit is delivering power to the load. The power supply impedance should be high enough to limit peak steady-state and surge cathode currents to 50 and 150 ma, respectively. If you are not sure of the impedance insert a 10,000-ohm 1-watt resistor at X.

Shield the power supply well to avoid hash and other interference caused by the vibrators. This point is extremely important since these spurious signals will often upset normal sweep operation in the scope. Thus, shielding should include all vibrator wiring.

V.H.F. BOOSTER

I have a Gonset model 3009 (30-40-mc) tuner and would like to have a diagram of a 6BQ7 cascade booster for it.—R. O., New Britain, Conn.

The cascade preamplifier is shown. Coils L1 and L3 each consist of 10 turns of No. 20 enameled wire close-wound on CTC (Cambridge Thermionic Corp.) type LS-3 (or equivalent) forms. The antenna and output coils are hookup wire wound over the ground

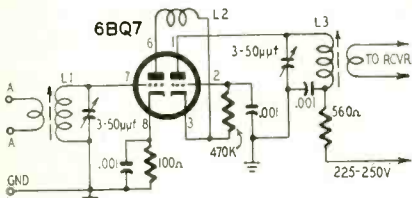

ends of L1 and L3, respectively. Adjust the number of turns and spacing for best results. About 4 or 5 turns should be right.

The neutralizing coil (L2) is approximately 15 turns of No. 22 enameled wire wound on a 1/4-inch form and spaced for lowest noise. This coil can be omitted with a slight increase in noise level. END

FREE! BA's NEW 1956 CATALOG

YESSIR-IT'S THE KING-SIZE CATALOG—
164 "KING-SIZED" (8 1/4 x 10 1/2) PAGES
OFFERS MORE ITEMS PER PAGE--IT'S EASIER TO USE...IT'S EASIER FOR YOU TO ORDER

COMPLETE GUIDE TO EVERYTHING IN RADIO, TV, ELECTRONICS

100'S OF BRAND NEW ITEMS LISTED HERE FOR THE VERY FIRST TIME

INCLUDES 21 BIG PAGES OF BARGAINS NOT FOUND IN ANY OTHER CATALOG

1956 ANNUAL CATALOG NUMBER 561

BA SINCE 1927

A Complete Buying Guide for Everything in RADIO TELEVISION ELECTRONICS

BURSTEIN-APPLEBEE CO.
 1012-14 MCGEE ST., KANSAS CITY 6, MISSOURI

RUSH COUPON FOR THIS BIG CATALOG NOW!

Send Free B-A Catalog No. 561.

NAME _____

ADDRESS _____

CITY _____ STATE _____

EASY TO LEARN CODE

It is easy to learn or increase speed with an Instructograph Code Teacher. Affords the quickest and most practical method yet developed. For beginners or advanced students. Available tapes from beginner's alphabet to typical messages on all subjects. Speed range 5 to 40 WPM. Always ready—no QRM.

ENDORSED BY THOUSANDS!

The Instructograph Code Teacher literally takes the place of an operator-instructor and enables anyone to learn and master code without further assistance. Thousands of successful operators have "acquired the code" with the Instructograph System. Write today for convenient rental and purchase plans.



INSTRUCTOGRAPH COMPANY

4701 Sheridan Rd., Dept. RC, Chicago 40, Ill.

ELECTRONICS IN 27 MONTHS

Prepare for un-limited opportunities of the Electronic Age! Earn your B.S. degree in 27 months at Indiana Technical College. Intensive, specialized course. Comprehensive training in math and electrical engineering, advanced radio theory and design, television, electronics. Modern laboratories. Low rate. Also B.S. DEGREE IN 27 MONTHS in Aeronautical, Chemical, Civil, Electrical and Mechanical Engineering, G.I. approved. Enter December, March, June, September. Earn part of your expenses in Fort Wayne while studying. Write for catalog.

INDIANA TECHNICAL COLLEGE

1711 E. Washington Blvd., Fort Wayne 2, Ind.

Please send me free information on B.S. ENGINEERING DEGREE IN 27 MONTHS as checked.

Electronics Chemical Aeronautical

Civil Mechanical Electrical

Name _____
 Address _____

AUDEL'S TV TELLS HOW TO ANSWER RADIO T.V. QUESTIONS SERVICE LIBRARY

HERE IS LATE INFORMATION IN A HANDY FORM FOR TELEVISION AND RADIO REPAIRMEN, SERVICEMEN AND STUDENTS



AUDEL'S T.V. RADIO SERVICE LIBRARY—Highly Endorsed—Over 1500 Pages—1048 Illustrations & Diagrams, 1001 Important Facts & Figures on Modern Television, Radio, Electronic Devices at your finger ends.

INCLUDES TRANSISTORS & Transistor Circuits, Record Changers, Rectifiers, P.A. Systems, Tape Recorders, Phonograph Pick-ups, F.M., Auto Radio; Radio Compass, Short Wave, Radar, etc.

ASK TO SEE IT! IT WILL PAY TO KNOW—The Basic Principles—Construction—Installation—Operation—Repairs—Trouble Shooting—Shows How to get Sharp, Clear T.V. Pictures. Install Aerials—How to Test. Explains Color Systems, Methods of Conversion, Terms, etc. Includes Ultra High Frequency—Valuable for Quick Ready Reference and Home Study.

\$6 COMPLETE 2 VOLUMES Get this Information for Yourself. **7 DAY TEST—PAY ONLY \$1 A Month**

MAIL ORDER
AUDEL, Publishers, 49 W. 23 St., N.Y. 10, N.Y.
Mail AUDEL'S T.V. RADIO SERVICE LIBRARY (2 Volumes) \$6 on 7 days free trial. If O. K. I will remit \$1 in 7 days and \$1 monthly until \$6 is paid. Otherwise I will return them.

Name _____
Address _____
Occupation _____
Employed by _____ **RE**

ATLAS Cobra-Jectors

- wide angle dispersion
- indestructible fiber-glass
- all-weather construction

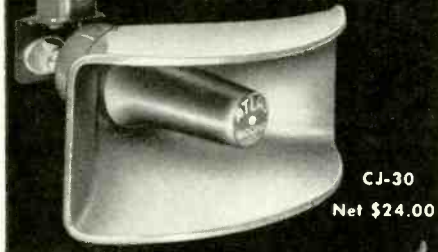

CJ-30
Net \$24.00

Weatherproof universal line transformer, \$5.10 Net.



CJ-14
Net \$16.80

Designed for wide angle coverage, paging, high efficiency intercom, sensitive talk-back. Tops in articulation. Convenient omni-directional mounting bracket. In appearance, they're "beauts".

| SPECIFICATIONS | CJ-30 | CJ-14 |
|-------------------|------------|-----------------|
| Input pwr (cont.) | 15 w | 5 w |
| Input imp. | 4 or 8 A | 4, 8 or 45 A |
| Response (cps) | 250-9,000 | 400-10,000 |
| Dispersion | 120° x 60° | 120° x 60° |
| Bell Size | 14" x 6" | 9 1/2" x 5 1/2" |
| Over-all length | 14" | 8 1/2" |

Amazing "power packages"—use the Cobra-Jectors for the "tough" jobs.



WRITE FOR COMPLETE CATALOG
ATLAS SOUND CORP.
1443—39 St., Bklyn. 18, N. Y.
In Canada: Atlas Radio Corp., Ltd., Toronto, Ont.

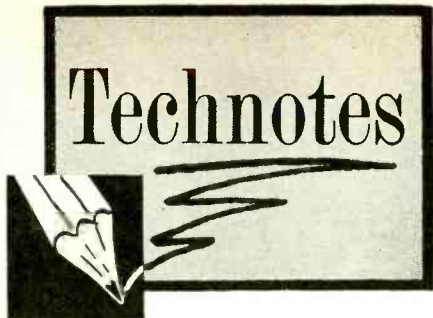

SYLVANIA MODEL 336

Over several months I had difficulty in maintaining proper width in this 27-inch set. There was a vertical overdrive line and the picture was distorted in the center. The damper and horizontal output tubes were each replaced twice without correcting the situation. Finally the picture became extremely narrow and dark and would bloom when the brightness control was turned up.

Components in the horizontal oscillator and output circuits were checked. One capacitor was found to be defective but replacing it did not improve the situation. It was then decided to replace the flyback transformer—obtainable only from Sylvania. The unit was installed and the set functioned normally.—*Jacob Dubinsky*

HORIZONTAL BLACK BAND

A 21-inch Motorola came in recently with a single black line about 1 inch wide horizontally across the screen. The set used selenium rectifiers for the low-voltage power supply. The black band caused no loss in height or width, and a peculiar odor was noticed. At first examination it appeared that the trouble was radiation from an incandescent lamp. Further checking showed the trouble to be the selenium rectifiers. Replacement removed the black band.—*Joseph C. Pomichter*

PHILCO 41-623

In the phonograph amplifier, which uses one half of a XXD, there is a two-section filter capacitor (C12, C12A). The 6-μf section is used in the plate circuit and the 10-μf section in the cathode circuit. Leakage between the two sections causes distortion and low volume. When this occurs, install two separate filter capacitors.—*George Anglado*

SILVERTONE 101-800

When this battery-operated set comes in noisy and intermittent or completely inoperative, check the blue-and-red leads to the oscillator assembly. To do this, remove the transparent cover from the tuning unit. Then carefully remove the fine wire leads from the wax and check for poor connections.

To repair a poor connection, cement two small strips of very fine sandpaper to the inside points of a pair of tweezers and carefully clean the ends of the coil leads. Then resolder the troublesome joint.—*Hurley D. Robinson*

HERSHEL SPECIALS

All New MYSTERY PACKAGE of ELECTRONIC PARTS
Worth \$40.00
Our Price **\$3.95** Ship Wt 20 lbs.
It's the surprise of your life! 20 pounds of brand new usable Govt surplus the ideal gift for ham, etc.
We now ship parcel post to save you more money!

KIT SPECIALS

KIT 1, HARDWARE Over 1,000 pcs. Assorted. For Radio & TV **99c**

KIT 2, CERAMICONS 100 Assorted. 75 mmfd. to 6,000 mmfd. **\$2.50**

KIT 4, Rotary Switches 25 Assorted. Terrific Buy **\$2.50**

KIT 5, RESISTORS 100 Assorted. 1 ohm to 15 meg. 1/2 to 5 watts **\$1.75**

HI GAIN DYNAMIC MIKE KIT Uses UTC Transformer and Western Electric Mike. Ideal for Hams, P.A. CAP, Recording, Mobile Equip. —50 DB, 80, 7500 CPS. Diagram Furnished **\$1.95**

PHOTO ELECTRIC CELL CE Vacuum Cell used in AMPRO Sound Projector. Also useful for opening garage doors and Alarm Systems. **95c**

BUTTERFLY CONDENSERS

YOUR CHOICE \$4.95

TYPE A 4 1/4" Dia. TYPE A—106 330 MC—Antenna Type

TYPE B 4 7/8" Dia. TYPE B—300 1000 MC—Uses 308A3 tube

TYPE C 2 1/2" Dia. TYPE C—300 1000 MC—Cite for Xial Det

TYPE D 2 1/2" Dia. TYPE D—135 485 MC

These units make the finest tuners for Ultra-high frequency transmitters, receivers, frequency meters, and oscillators.

RCA OUTPUT TRANSFORMER P.P. 6L6's 25 watt **\$1.95**

PRI 5000 Ohms output Sec. #1 500 Ohms Sec. #2 600 Ohms. Siltstone 15 to 15,000 cy. flat.

VARIABLE CONDENSERS YOUR CHOICE 95c

TYPE A 100 MMFD—Double Spaced 1 1/2" x 2 1/2" x 3/8" W x 1 1/2" H. Germanium Mfg.

TYPE B 200 MMFD—Shielded Can 1/4" Shaft

PHONOGRAPH CRYSTAL Ceramic Type **\$2.25**

Made by Selenite Mfg. 1 1/4" x 1 1/2" x 1/8" High. Weight .20 to .24 mg. Cycle 4.7 Mc. Res. 1000 Ohms. M.P. 100° C.

ARC-5 COMMAND TRANSMITTER YOUR CHOICE **\$6.95**

2.1 to 3 MC. 7 to 9.1 MC. Brand New in Cartons with tubes.

HOTTEST BUY IN THE COUNTRY

GUN CAMERA MOTOR Brand New **95c**

Used in Gun camera 24 VDC. Will run on 110 VAC.

TERMS: Cash with order or 25% DOWN—BALANCE C.O.D.
ALL PRICES NET F.O.B. DETROIT
MINIMUM ORDER \$2.00

HERSHEL RADIO CO. 5249 GRAND RIVER
Detroit 8, Michigan
Phone TYler 8-9400

NEW! WRIST RADIO

Amazingly powerful! Plays while you wear it. 400 mile reception using just its own antenna. Tunes entire broadcast band with sharp selectivity.

BUILD YOUR OWN—New book has complete instructions. 11-w-10-do-it book \$1.98 incl. Also a basic kit consisting of attractive pre-drilled case, "cutting" chassis, and all the necessary non-electronic parts and hardware \$2.98 incl. Combination of book and basic kit, **SPECIAL \$3.98** postpaid. Send postcard for FREE descriptive literature.

HUCKERT ELECTRONICS—Box 7400-C4, Washington 4, D.C.

INVENTORS

Send for **PATENT INFORMATION** Book and **INVENTORS RECORD** without obligation

GUSTAVE MILLER RE-115 WARNER BUILDING WASHINGTON 4, D. C.

REGISTERED PATENT ATTORNEY
ASSOCIATE EXAMINER U.S. PAT. OFF. 1922-1929
Patent Attorney & Adviser U.S. Navy Dept. 1930-1947
PATENT LAWYER

get to know the Gernsback Library

A complete, accurate, easy-to-read series of low-cost books on practical electronics.



TRANSISTORS

Transistors — Theory and Practice—No. 51. \$2.00

Rufus P. Turner explains transistors for the practical man. Applications in well known circuits. Includes a guide to commercial transistors.

SERVICING

TV Repair Techniques—No. 50. \$1.50

Save hours of servicing time. Learn how to solve tough servicing problems from the experience of top technicians.

Television Techniques—No. 46. \$1.50

Gives the causes, symptoms and cures of over 600 tough troubles which pop up frequently in scores of sets.

TEST INSTRUMENTS

Sweep and Marker Generators for Television and Radio—No. 55. \$2.50

Hard cover ed. \$4.00
Bob Middleton tells how and why these important servicing devices work.

Probes—No. 54. \$2.50
Hard cover ed. \$4.00

How to use probes to get the most out of test instruments. Construction details include transistorized model.

The Oscilloscope—No. 52. \$2.25
Hard cover ed. \$4.00

Shows you how to get the most out of your scope. Gives tips and new uses.

Radio & TV Test Instruments—No. 49. \$1.50

Construction details on essential test instruments.

HI-FI, R/C, MISCELLANEOUS

High-Fidelity—Design, Construction, Measurements—No. 48. \$1.50

High-Fidelity Techniques—No. 42 \$1.00

Radio-Control Handbook—No. 53 \$2.25

Model Control By Radio—No. 43 \$1.00

Basic Radio Course—No. 44 (hard cover) \$2.25

Radio Tube Fundamentals—No. 45 \$1.00

Radio & TV Hints—No. 47. \$1.00

Public-Address Guide—No. 41. .75c

Practical Disc Recording—No. 39. .75c

See your distributor—or mail this coupon

GERNSBACK PUBLICATIONS, INC. Dept. 115
25 West Broadway
New York 7, N.Y.

Enclosed is my remittance of \$.....

Please send me the following books postpaid.

39 41 42 43 44 45 46
 47 48 49 50 51 52 53
 54 55

Hard cover editions \$4.00 ea., by mail only.

52H 54H 55H

Name
(Please print clearly)

Street

City Zone State.....

JOIN THE NEL-KAYE RECORD CLUB and get —

ANY AND ALL L.P. RECORDS

OF YOUR CHOICE at a **38%** DISCOUNT

FREE— plus **ANY** 10" or 12" L.P. RECORD YOU CHOOSE!

with each new membership:

There is absolutely no catch to this offer—no ifs, ands or buts. The facts are as follows: For a yearly membership fee of only \$10 you may purchase as many L.P. records as you wish—any label—RCA, DECCA, COLUMBIA, CAPITOL, MERCURY, etc. and you receive 38% off the current list price.

| | | | |
|---|------------------------|------------|-------------|
| There are no restrictions as to the number of records you must purchase—order as many or as few as you wish. All records are guaranteed brand new and in perfect condition. | For example: | Lists for: | Club Price: |
| | ANY L.P..... | 3.98..... | 2.47 |
| | ANY L.P..... | 2.98..... | 1.86 |
| | ANY EXTENDED PLAY..... | | .99 |

Orders are filled promptly. \$10 completely covers your yearly membership and also entitles you to one 10" or 12" L.P. record of your choice FREE! plus a monthly L.P. catalogue without charge.

**Join Nel-Kaye today—
the only record club
of its kind in America!**

Make checks payable to **NEL-KAYE RECORDS, Inc., 1604 York Ave., N. Y. 28, N. Y.** Dept. RE-11

I am enclosing \$10 check or money order covering one year membership in the "Nel-Kaye Record Club of the Year". This does not obligate me in any way. I may order as many or as few records of my choice as I wish.

My free L.P. record choice is.....

NAME.....
ADDRESS.....
CITY.....ZONE.....STATE.....

Membership
Limited to
Mail Order
Buyers Only!

LEARN TV

the practical way..

17", 21"
and
27"

BUILD the New TRANSVISION TV KIT

\$15⁰⁰
ONLY gets you started*

*THIS MODEST INVESTMENT gets you started on a most fascinating project— assembling the new "E" type Transvision TV Kit in easy stages. For \$15 you get PACKAGE #1 (standard first package for all new "E" kits). This package gives you the BASIC CHASSIS and required first-stage TV COMPONENTS, with complete instructions. When ready, you order the next stage (pkg. #2), etc.

PROFIT 3 WAYS:

- 1 Learn TV
- 2 Save up to 50%
- 3 Prepare for COLOR TV

Shows 8 Great TV Kits:

EXCLUSIVE: Only Transvision TV Kits are adaptable to UHF. Ideal for FRINGE AREAS. No Previous Technical Knowledge required. Write now!

FREE CATALOG

TRANSVISION

THE OLDEST NAME IN TV KITS

NEW ROCHELLE, N. Y.

MAIL THIS COUPON TODAY

TRANSVISION, INC., NEW ROCHELLE, N. Y. Dept. RE-11

I'm enclosing \$..... deposit. Send standard kit PACKAGE #1, with all Instruction Material. Balance C.O.D.

Send FREE copy of your new TV Kit Catalog.

Name.....
Address.....
City.....State.....

Get your
F.C.C. LICENSE
Quickly!

More Jobs Than We Can Fill

Jobs in radio-TV electronics are going begging. A commercial (not amateur) F.C.C. license is your ticket to higher pay and more interesting employment. We train you quickly — then help you find the job you want!

Learn By Mail or In Residence

Correspondence training conducted from Washington, D. C. Day and evening resident classes held in Hollywood and Washington. Write for starting dates.

Grantham Training Is Best

We specialize in preparation for FCC license examinations. Beginners get 2nd class license in 8 weeks, 1st class license in 4 additional weeks.

FCC-type tests are used with every lesson and as final examinations. Constant practice with these FCC-type tests helps you prepare for the actual FCC examination.

If you should fail the FCC examination after finishing our course, we guarantee to give you additional training at NO ADDITIONAL COST—up to two years until you pass! Read details of this guarantee in our free booklet.

Write or Phone for Free Booklet

Write to:
Dept. 101-RX

GRANTHAM School of Electronics

737 - 11th St., N.W. OR 5910 Sunset Blvd.
Washington 6, D. C. Hollywood 28, Calif.



WELLER TOOLS ARE TOPS FOR CHRISTMAS



To give or receive, here are two practical gifts that will bring year-round pleasure to any serviceman, homemaker, hobbyist, experimenter or hi-fi fan.

COMPLETE SOLDERING SET

includes everything you need—Weller Soldering Gun, over 100 watts; famous Kester Solder; Wire Brush for cleaning connections; and Soldering Aid for twisting wire and opening old joints... all in a sturdy cardboard case.

\$7.95
list

WELLER POWER SANDER

and polisher with power and performance that exceeds any sander in its price class. More than twice the sanding area of comparable tools—25 square inches—finishes jobs faster.

Straight-line action sands with the grain, giving satin-smooth finishes with no bucking. Goes all the way into corners and underlow places. Practically impossible to stall.

\$14.95
list



Weller
ELECTRIC CORP.
EASTON, PA.

ORDER FROM YOUR ELECTRONIC PARTS DISTRIBUTOR

for faultless playback
of pre-recorded tape!

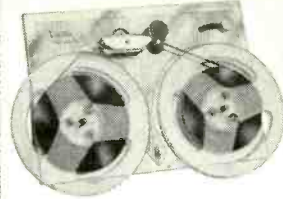

PROVIDING
FULL FIDELITY
PERFORMANCE—
40-14,000
CPS at 7.5"

\$59.95

USER NET

VIKING
Full Fidelity 75
TAPE DECK

- Meets broadcast requirements for minimum distortion, flutter, and wow.
- The Viking innovation of a belt-driven capstan eliminates vibration and flutter—*tape speed is constant!*
- The basic monaural unit pictured can be easily converted to full fidelity binaural playback or erase-record playback, ideal for tape duplicating.
- Check Viking's coordinated line of NARTB standard pre-amps, erase bias oscillators, record/playback amplifiers.



Sold thru dealers; write for information

VIKING OF MINNEAPOLIS

Dept. RE-11

3520 E. 43rd St., Minneapolis, Minn.



America's
Finest
Line...

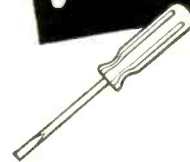

Screw Drivers

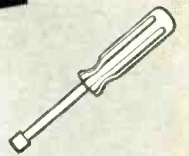

Nut Drivers

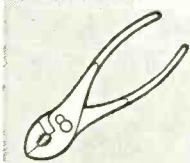

Pliers

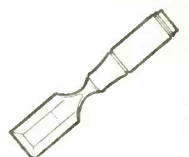

Wood Chisels

Professional Quality...
Unconditionally Guaranteed

No matter what VACO tool you buy, you always get the best in design, materials and workmanship. Get the finest... get VACO!

New
VACO
Catalog

Nothing else like it! 40 pages—4 colors. Heavily illustrated with photos, charts and tables. You'll want a copy, order on your letterhead today.

VACO PRODUCTS COMPANY 317 E. Ontario St.
Chicago 11, Ill.
In Canada: Vaco-Lynn Products, Ltd.

ATTENTION!

SCHOOLS, HOBBYISTS,
RADIO TECHNICIANS!

CATHODE RAY SCOPE TUBE

3AP1, made by famous tube maker - Jan type! Electrostatic focus and deflection. Medium 7 pin base. Individually cartoned. Packed for export.

Regular net \$15.75.

79¢ ea. Lots of 4
individ. packed
4 to a carton

SINGLE 99¢ EA.

Send for FREE catalog
RE-11 with over 400
tube types at savings!



**Rad
Tel
TUBE CO.**

115 COIT ST., IRVINGTON II, N. J.

RADIO-ELECTRONICS is paying good rates on acceptance for original and unusual articles on audio, television, FM and AM servicing, as well as articles on industrial electronic equipment and application. Send for a copy of our Authors' Guide. Address:

**THE EDITOR
RADIO-ELECTRONICS**

25 West Broadway, New York 7, N. Y.

1954 CHEVY AUTO RADIO

A rasping output in these sets can usually be traced to a loose output transformer mounting. The odd way in which these transformers are mounted permits the car motion to break the transformer loose, causing an intermittent ground. This trouble can be corrected by connecting a piece of flexible braid from transformer frame to the chassis and don't spare the solder!—*D. R. Cross*

STROMBERG-CARLSON TC-19

The horizontal oscillator in this receiver contains a .01- μ f capacitor (C253) connected from pin 2 of the 6AL5 horizontal phase detector to ground. This unit should be changed to .022 μ f to correct for frequency changes which cannot be corrected with the horizontal hold control.—*Milo Banister*

CROSLY SUPER-V 431-1

This set uses the new single-string heater series, with 480 volts on the damper cathode. Three successive 12AX4-A's arced over from cathode to the 90-volt heater. Crosley's Service Department recommended lowering the screen voltage of the 12CU6 or installing a trimmer in the grid circuit of the horizontal output tube to vary the drive. However, either method affects the width and brightness. One solution is to remove the 12AX4-A from the heater string and replace the 45-ohm dropping resistor with a 65-ohm unit. Then use a 6AX4 damper heated with a filament transformer with 5,000-volt insulation (Merit P3074 or equivalent).

—*James M. Hartley*

VERTICAL NOISE PULSES

An Admiral chassis 21B1 came into the shop with a complaint of vertical noise pulses in the picture and noise in the sound. I carefully checked the vertical circuits, but to no avail. There was, however, a large spike voltage on the grid of the 6S4 vertical output tube that was apparently causing the trouble. This narrowed the defect to the vertical oscillator circuit, but a check of the components revealed that everything was normal. I then replaced the vertical peaking resistor with a pot and put a scope on the grid of the 6S4. Varying the pot, I found that, when 460 ohms was in the circuit, the noise in the sound and the picture ceased. The pot was then replaced with a fixed resistor.—*Ray W. Keller*

RCA 6T71

On this and similar RCA chassis the filament leads to the 6W4 damper run along the rear of the chassis. Insulation breakdown between these leads and chassis is a common occurrence. However, in some cases the arcing cannot be heard and the only effect is complete loss of horizontal sync with the horizontal hold having virtually no effect. If leads are not badly burned, they can be taped and dressed away from chassis.—*W. Hitchcock* END



STOP using compromise antennas

NOW THERE'S A TRAPPER[®] FOR EVERY AREA!

SUPER TRAPPER
A dependable fringe and extreme-fringe antenna for reception of channels 2 through 13.
Cat. No. 1890—Single Bay Super Trapper
Cat. No. 1892—Stacking Line peaked for high-band
Cat. No. 1883—Stacking Line peaked for low-band

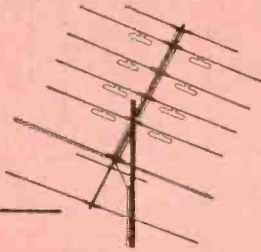

TRAPPER
No. 1 choice of the trade for medium to fringe area reception of channels 2 through 13.
Cat. No. 1830—Single Bay Trapper
Cat. No. 1882—Stacking Line peaked for high-band
Cat. No. 1883—Stacking Line peaked for low-band

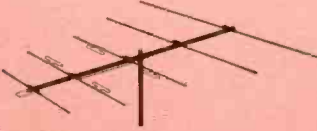

New! TRAPPER[®] ROYAL
A new Taco Trapper design providing greater gain on channels 2 through 6 and high-band channels 8 through 13. Another Taco area-tailored antenna, designed to provide better reception in every locality.
Cat. No. 2885—Single Bay Trapper Royal
Cat. No. 2887—Stacking Line peaked for high-band
Cat. No. 2888—Stacking Line peaked for low-band

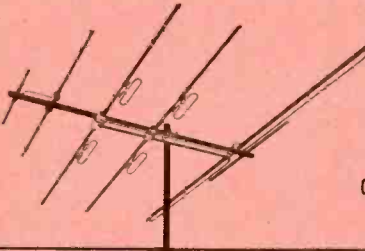

TRAPPER JR.
Streamlined, compact design for channels 2 through 13 in strong to medium signal strength areas. An excellent antenna for attic installations in metropolitan areas.
Cat. No. 1870—Single Bay Trapper Jr.

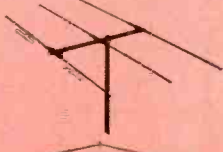

GET COMPLETE DETAILS ON THE TRAPPER BEST SUITED TO YOUR NEEDS FROM YOUR TACO DISTRIBUTOR



TACO TECHNICAL APPLIANCE CORPORATION
SHERBURNE, N. Y.

HERE'S EVERYTHING YOU NEED TO KNOW ABOUT OSCILLOSCOPES!

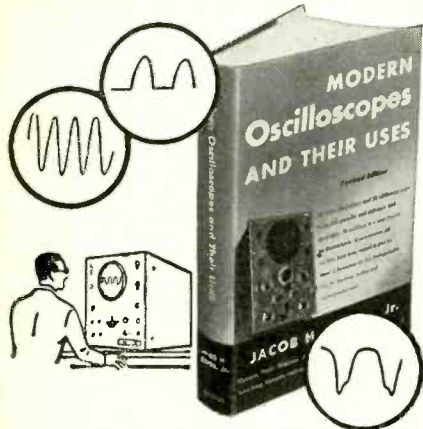

Service Any Radio-TV ever built EASIER-BETTER-FASTER

Oscilloscopes are gold mines for servicemen who learn to use them fast and accurately—and here, in a brand new, completely revised 2nd edition, is THE book that really shows you how.

In plain, easily understood language, MODERN OSCILLOSCOPES AND THEIR USES teaches you just when, where and exactly how to use your oscilloscope. You learn how to handle tough jobs easier and faster than you may have dreamed. Every detail is clearly explained—from making connections to adjusting circuit components and setting oscilloscope controls.

Equally important, you learn how to analyze oscilloscope patterns accurately and in far less time. Almost 400 illustrations including dozens of pattern photos make things doubly clear.

This big book is more widely used than any other of its type—because it gets right down to “brass tacks.” No involved mathematics. No complicated discussions. You learn exactly what the oscilloscope is and exactly how to use it on all types of AM, FM and television service (including color)—from locating troubles in a jiffy to handling tough realignment jobs.

Send coupon for 10-day free trial. You be the judge!

PRACTICE 10 DAYS FREE!

Dept. RE-115, RINEHART & CO., Inc.,
232 Madison Ave., New York 16, N. Y.

Send new 2nd edition of 370-page MODERN OSCILLOSCOPES AND THEIR USES for 10-day FREE EXAMINATION. If book is what I want, I will then send you \$6.50 promptly in full payment. If not, I will return book postpaid in good condition and owe you nothing.

Name.....

Address.....

City, Zone, State.....

OUTSIDE U.S.A.—Price \$7.00, cash only. Money back if you return book in 10 days.

Rinehart Books Are Sold by Leading Book Stores

Just Out! NEW, ENLARGED 2ND EDITION

This new book contains the latest data on oscilloscopes—the handiest, most versatile service instrument of all. More than 30 EXTRA pictures and 50 additional pages in this new edition include newest details on use of scopes in color TV, industrial electronics... even in atomic energy work!

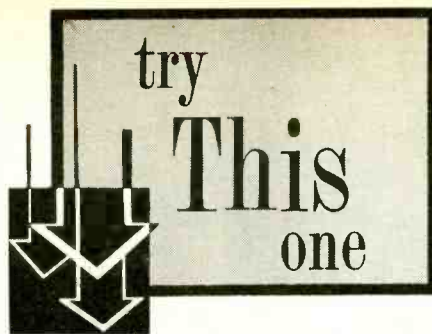

FROST-PROOF TV MAST

The next time you erect a TV mast or antenna poles in a concrete base, borrow a trick from the building trades and you won't have to worry about heaving due to frost. Cast the concrete in the form of a truncated cone or pyramid as shown at *a* and *b*, respectively, in the drawing. (A truncated cone or pyramid is one with the pointed end cut off square.) Now, frost action tends to

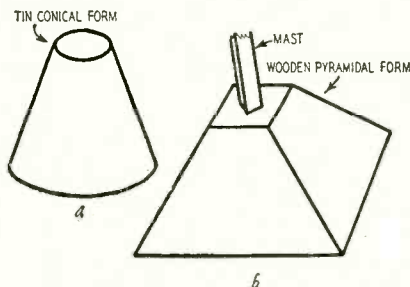

force the base straight down and not up or to one side as is often the case when the concrete base has straight sides.

The pyramidal form can be made of wood or any convenient material. If it is cast in the ground, the form should be plywood about 1/8 inch thick—thicker material leaves voids as it rots away. Tin or other sheet metal can be used for the conical form.—E. K. James

(The cone from a metal TV picture tube makes a good form for casting a concrete base for a tubular type mast 2-3 inches in diameter.—Editor)

RE: CODING CABLED LEADS

Mr. Chang's item "Coding Cabled Leads" in the March, 1955, issue is interesting but I believe my method to be simpler and more expandable. I use it to identify speaker and intercom leads in school and industrial sound installations.

Place an alligator clip on each end of as many resistors as there are pairs of leads to identify. Clip a resistor to each pair of leads and then measure the resistance at the far end. Tag the ends as they are measured and identification is complete.

The values of the resistors should be at least 50% apart for positive identification with an ohmmeter. If you use an electronic multimeter for measurements, you can easily identify more than 75 pairs.—Allen A. Gault

for the finest in sound



Acrosound

ULTRA-LINEAR

OUTPUT TRANSFORMERS

- * The quality of Acrosound transformers is accepted throughout the world as being unequalled.
- * The finest amplifier quality comes from the optimum integration of the best output transformers and the best circuits.
- * Acro-developed Ultra-Linear circuits are likewise accepted as the best, and the combination of these factors make the finest sounding and finest performing amplifiers obtainable.
- * Excellence of Acrosound transformers and circuits is illustrated by specifications of the TO-330 model designed for high-power Ultra-Linear amplifiers using the new 6550 tubes.

Frequency response
± 1 DB, 10 CPS to 100 KC

Power rating—
50 watts 20 CPS—30 KC
100 watts 30 CPS—20 KC

Impedance—3300 ohms plate to plate to 4, 8, 16 ohms. Primary taps located at 40% for best U.L. performance.

Price: \$39.75 at leading distributors.

- * Catalog available upon request.
- * Distinctive features protected by patent!

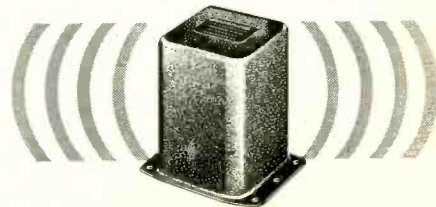

ACRO PRODUCTS CO.

369 Shurs Lane Philadelphia 28, Pa.

RADIO-ELECTRONICS

MAKE YOUR OWN HIGH FIDELITY RECORDS

33 $\frac{1}{3}$, 45 or 78 rpm

FROM YOUR FAVORITE HIGH FIDELITY TAPE RECORDINGS

WITH THE

REK-O-KUT

Challenger

AND PLAY THEM BACK ON ANY PHONO SYSTEM

REK-O-KUT Company Dept. DL-13
38-01 Queens Boulevard
Long Island City 1, N. Y.

Send me complete details about the Challenger professional type, portable Recorder and Playback Phonograph. Also include literature covering:

- Rondine 12-inch Turntables
- Portable Phonograph Units

Name _____
Address _____
City _____ Zone _____ State _____
My Dealer is _____

HERE'S HOW

NOVEMBER, 1955

TRY THIS ONE

(Continued)

PROTECTING SCHEMATICS

Service technicians, engineers and experimenters often maintain a vast number of schematics—many of them hand-made. To preserve them, spray each sheet with Acrylic or similar clear lacquer. This prevents such disfigurements as fingerprints, smears and aging.—*G. Samkofsky*

TUBE-TESTER MODIFICATION

Desiring a reliable tester for detecting intermittent heaters and filaments in tubes, I devised a simple circuit modification for the Heathkit TC-1 and similar free-point type tube testers. The neon-lamp type continuity tester frequently recommended is worthless in this application because it does not permit the tube to heat up so the intermittent can develop.

This modification (see diagram) uses a minimum of parts and is simple to install and use. The only parts required are the s.p.s.t. normally closed momen-

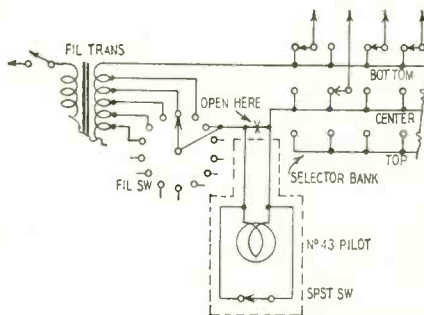

A simple modification tests intermittent tube heaters and filaments.

tary toggle switch and a type 43 pilot lamp and socket. These components are enclosed in dashed lines. The rest of the tube tester operates normally.

To check for intermittent heaters and filaments—particularly in metal tubes—let the tube warm up in the tester and then open the switch while watching the indicator lamp. It lights steadily when the tube is good and flashes on and off when it is intermittent.

I installed the indicator lamp in the spare-socket blank and the toggle switch on the right-hand end of the selector switch bank. A type 43 pilot lamp is recommended as an indicator because it carries the current drawn by most tubes with a low voltage drop.—*L. M. Dilley*

HANDY CHEATER CORD

I've serviced several TV sets that were mounted in a bookcase or installed in a wall. It's always a problem to find a convenient place to plug in a standard cheater cord.

I solved this problem by replacing the a.c. plug on a standard cheater cord with a male interlock plug. I then use this cord to connect between the back of the set being serviced and its chassis plug.—*Bill Kane*

For the first time...



Model 1012 Amplifier/Preamp

Everybody can own HI-FI with

NEWCOMB

COMPACT AMPLIFIERS and FM-AM TUNERS

EXPENSIVE BUILT-INS UNNECESSARY

Here is an entirely new concept in high fidelity enjoyment created by Newcomb, the originator of the "compact" design. Amplifier/preamp units and AM-FM tuners in beautiful new satin gold finish, so small they fit your convenient chairside table top. Makes expensive built-ins unnecessary. No technical knowledge necessary to connect. Performance to please the most ardent hi-fi fan. Combination amplifier/preamp units available in 10, 12, or 20 watt output, with all the exclusive recognized Newcomb features. Not only technically superb but audibly better.

Economical high-efficiency AM-FM tuner, or deluxe model with many advanced features available in matching design.

THE YEAR'S GREATEST HI-FI SENSATION

NEWCOMB
THE SOUND OF QUALITY SINCE 1937

SEE YOUR NEAREST DEALER OR WRITE FOR DETAILS NOW!



NEWCOMB, Dept. RE-11
6824 Lexington Ave., Hollywood 38, Calif.

- Enclosed is 25c. Please send me new booklet "Hi-Fi is for Everybody."
- Send name of nearest Newcomb dealer and complete details about the Newcomb Compact.

NAME _____
ADDRESS _____
CITY _____ STATE _____

WANT POWER & VERSATILITY?

FOLLOW THE LEADER...



©55



KIT \$29.95

Wired \$38.95

6V & 12V BATTERY ELIMINATOR & CHARGER #1050

- operates 6V and 12V auto radios for servicing and sales demonstration.
- charges 6V and 12V storage and Edison Batteries.
- operates mobile and marine receivers, transmitters, boat lights, electric trains, projection and other equipment.

SPECIFICATIONS

- 6-Volt range: 0-8V (up to 20 Amp.)
- 12-Volt range: 0-16V (up to 10 Amp.)
- variatic-type transformer for continuously variable voltage adjustment.
- reads volts and amperes at same time on 2 separate meters.
- Transformer primary and secondary fully protected.

In stock at local jobbers throughout the world. Write for free Catalog CB-11. Prices 5% higher on West Coast



84 Withers Street
Brooklyn 11, N. Y.



© 1955

Need a Tube Tester?

FOLLOW THE LEADER...

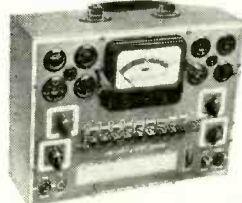

**TUBE TESTER #625
KIT \$34.95 Wired \$49.95**

- Tests latest 600-mil series string type tubes.

More Servicemen buy EICO TUBE TESTERS — in KIT and wired form — than any others sold through distributors. Why? Because EICO gives you the MOST value at LOW-EST cost.

- Test all conventional & TV tubes and pilot lights.
- 10 individual lever-type element switches.
- Illuminated anti-backlash rollchart kept up-to-date by EICO's Engineering Dept.
- 4 1/2" meter, 3-color "Good-Bad" scale.
- Line-adjust control. Blank socket for new tubes. Protective overload bulb.

In stock at your local jobber. Write for free Catalog CT-11 Prices 5% higher on West Coast.

ELECTRONIC INSTRUMENT CO., INC.
84 Withers Street • Brooklyn 11, N. Y.

TRY THIS ONE

(Continued)

RE: AUDIO SWITCHING

On page 133 of the March issue a reader described his method of automatically switching the outputs of a TV set, FM tuner and phono preamplifier to the input of his audio amplifier system. I believe that my system is considerably simpler and just as effective. I simply connect the secondaries of the output transformers in series as shown and feed them into the amplifier input.

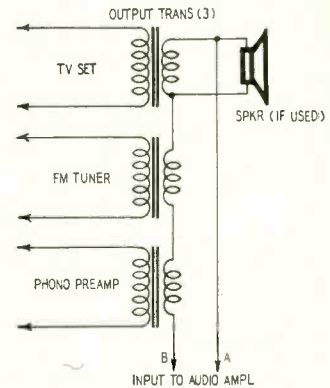

If the phono preamplifier or tuner does not have an output transformer, one can be added at a small cost. Most amplifiers have a high-impedance input (about 1/2 megohm) so there are practically no losses in the idle transformers. There are no switches, and the speaker of the TV set may also be used.

—Thomas L. Bartholomew

(Surprisingly enough, this circuit works quite well. Shorting out the two idle transformer secondaries did not cause a noticeable change in response or volume when the connecting leads were kept short. Too, we found that this trick can be used to connect several receivers to a common speaker. We removed 6-inch speakers from the TV set and a three-tube a.c.-d.c. record player and connected the output transformer secondaries in series with the secondary on a large AM console with a good 12-inch speaker. This speaker was then connected across A-B.—Editor)

SINGING GUY WIRES

The winds up here in the shadow of Buckingham Mountain (Pa.) often reach gale velocity, but we hadn't expected they'd annoy the customer for whom we'd installed an antenna.

He complained that a singing noise kept the family awake. Yet each time our service truck went out, the noise was nonexistent so we awaited a really big wind and hot-footed out right away.

The antenna's guy wires were really humming a tune as they were whipped about by the blow. We quieted the orchestra by wrapping each wire with a 6- to 12-inch strip of heavy felt in a spiral, halfway between the top and bottom, and securing the ends with tape. Acting like a finger on a vibrating violin string, the felt dampened the oscillations of the guy wires and ended the "singing."—Henry Josephs END

NEW! SUPER POWERFUL

All Channel VHF-UHF TV RECEPTION IN ALL DIRECTIONS

Only \$23.50

MODEL AX-524
ROCKET DIRECTRONIC MOTORLESS TV ANTENNA 360° ELECTRONICALLY SWITCHED BEAM

In the fringe or ultra-fringe, the NEW 1955 Motorless Directronic will out-perform any ordinary antennas. This sensational new 360° UHF-VHF TV Antenna offers "around the compass" reception WITHOUT Rotors. Provides superb ghost-free picture clarity. Model AX-524 "Serviceman's Array" contains Hi-Pac Molded Insulator of Extreme tensile strength. 24 hi-tensile aluminum elements, including 6 Multi-purpose Reflecto-directors. 1 set matched tie rods. Universal Mast Clamps. 6-position Beam Selector Switch. 75' Low-loss UHF-VHF Tubular TRI-X Cable.

Our Greatest BARGAIN

2 BAY 16 ELEMENT CONICAL ARRAY

\$4.99 EACH IN LOTS OF 3 \$5.30 Each

Hi-gain 16-element conical with sturdy 3/8" hi-tensile aluminum elements. For fringe use. Complete coverage of Ch. 2 thru 13. Packed in cartons of three 16-element arrays per carton, with tie rods at \$14.95 per carton. Single 16-element array..... \$ 5.30
1 carton of 6 arrays..... 13.50
no tie rods..... 13.50
4 bay stacking assembly..... 1.95
No. 415..... 1.95

Super UHF RECEPTION HI-GAIN YAGI

Provides guaranteed sensational UHF fringe reception. Amazing sensitivity provides up to 30 db gain, using 2, 4, or 6 bay stacked arrays. Ghosts, interference minimized or eliminated. Each serviceman's array provides 4 directors, 2 folded dipoles, 2 reflectors. And our low price insures a low cost installation. Select the model required in your area.

\$1.95 ea.

| | |
|-------|----------------|
| Model | Covering |
| F-7A | Channels 14-48 |
| F-7B | Channels 27-62 |
| F-7C | Channels 47-83 |

Matched stacking bars \$0.30 pr.

FAMOUS ROCKET ZOOM-UP TOWERS

Sturdy • Reliable • Easiest installation
Economize with Rocket Zoom-up Towers. Offers quickest, easiest way to make an installation up to 50'. Each section telescopes inside the other—to erect, simply slide out each section in its turn—insert bolt thru section below—tighten to keep mast from turning. Each tower complete with guy rings, bolts, and mounting base suitable for peak or flat roof. Handsome and sturdy. Rocket Zoom-ups offer you economy and long life. Order by size.

| | | | |
|-----|---------------|-----|---------------|
| 20' | \$ 8.75 | 30' | \$13.95 |
| 40' | \$ 17.95 | 50' | \$ 24.95 |

(Deduct 10% discount in lots of 3)

| | |
|---|--------|
| 100 ft. UHF Tubular Lo-Loss Lead..... | \$4.95 |
| PAM-9 Chimney Mount with Strapping..... | 1.49 |
| TWA Lightning Arrestor..... | .69 |
| BO Barkhausen Eliminator..... | .69 |

NEW LOW PRICE! RADIART TELEROTOR

Radiart's famous TR-2 at new money-saving price. Powerful, rugged, weather-proof—handles installations up to 150 lbs. Control box heat indicates orientation of antenna. Factory lubricated for life. Truly a good buy at our new price. Uses 8-cond. wire. 8-cond. wire..... \$0.08 ft.

\$26.97

MODEL TR-2

FALL CATALOG AVAILABLE

UHF CORNER REFLECTOR

ONLY \$2.99 EACH IN LOTS OF 6

SINGLE LOTS \$3.50 EACH

This hi-gain UHF Corner Reflector can only be offered you at this low, low price for a short time. 8 to 11 db gain across UHF band. Order Model F-6.

National Electronics OF CLEVELAND

THE HOUSE OF TV VALUES

6608 Euclid Ave., Dept. E-11, Cleveland 3, Ohio

People

Russell D. Gawne joined G-C Electronics Manufacturing Co., a new division of General Cement Manufacturing Co., Rockford, Ill. A 15-year veteran in the electronics industry, he was formerly sales manager of Crescent Industries Home Instrument Division and assistant to the vice president of Webster-Chicago. G-C Electronics is merchandising packaged replacement *Stackpole* carbon resistors.



Russell Gawne

tive and district sales manager for Channel Master Co.

Robert W. Felber joined American Phenolic Corp., Chicago, as head of the newly organized Community TV Division. He was formerly national service manager of Stewart-Warner. In his new position Felber will devote his full efforts to sales engineering of Amphenol cables, connectors, related components.



Robt. Felber

Albert J. Harcher was appointed plant manager of the CBS-Hytron TV picture-tube plant in Kalamazoo, Mich. He was heretofore plant manager of the Newburyport TV picture-tube plant.



A. J. Harcher



Gerald Rich
Electronic Defense at Mountain View.

Gerald C. Rich was appointed manager of the Sylvania Microwave Tube Laboratory at Mountain View, Calif. He was formerly manager of technical liaison at the Laboratory located



Aribert Bombe

Aribert Bombe joined the staff of Finney Co., Cleveland, as a special sales representative. He will make his headquarters in Glenview, Ill. Bombe had been special representa-



M. P. Fumaro

Michael P. Fumaro joined JFD Manufacturing Co., Brooklyn, N. Y., as publicity director. He has had wide experience in industrial and consumer public relations in other fields.

Philip A. Portnoy, executive assistant to Harry R. Ashley, president of Electronic Instrument Co., Inc., Brooklyn, N. Y., was appointed vice president of the corporation which manufactures Eico kits and instruments.



P. A. Portnoy

Obituary

Fielding Simmons, Jr., plant manager of the Sprague Electric Co.'s operation at Nashua, N. H., died recently after a short illness.

Get This Valuable Book Just for Examining COYNE'S New 6-Volume Set

FREE



"Applied Practical Radio-Television"

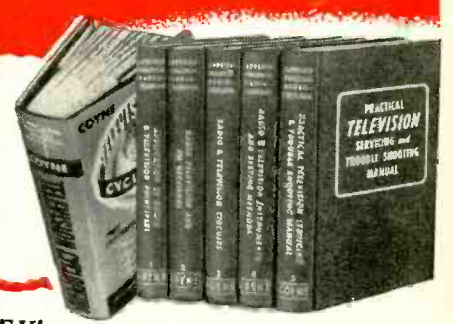

Yes, you get this big, brand new book, "150 Radio-Television Picture Patterns and Diagrams Explained", absolutely FREE! Just off the press! Gives complete 11x22" Schematic Diagrams on leading models Radio and Television Sets. Easy-to-read, large 8 1/2 x 11" pages, with full instructions on how to read and use the diagrams. A "must" in every Radio and Television service-man's repair kit. You get this valuable book as a FREE Gift for asking to see Coyne's great new 6-book set, "Applied Practical Radio-Television"!

ON 7 DAY
FREE TRIAL!

At Last! Money-Making "Know-How" on Transistors, Color TV and Servicing

Coyne's great new 6-volume set gives you all the answers to servicing problems—quickly! For basic "know-how" that is easy to understand, you'll find everything you want in volumes 1 to 5 which contain over 5000 practical facts and data. They cover every step from principles to installing, servicing, trouble-shooting and aligning all types of radio and TV sets. So up-to-date it includes COLOR TV and UHF, adapters, converters. Also covers latest data on TRANSISTORS.

Extra! 900-Page Television Cyclopeda Included

And then, for speedy on-the-job use, you get volume 6—the famous Coyne TELEVISION CYCLOPEDIA. It answers today's television problems on servicing, alignment, installation and others. In easy-to-find ABC order, cross indexed. Use this 6 volume TV-RADIO LIBRARY free for 7 days; get the valuable Servicing Book ABSOLUTELY FREE!

SEND NO MONEY! Just mail coupon for 6-volume set on 7 days free trial. We'll include book of 150 TV-Radio Patterns & Diagrams. If you keep the set, pay \$2 in 7 days and \$2 per month until \$22.50 plus postage is paid. (Cash price \$20.95). Or you can return the library at our expense in 7 days and owe nothing. **YOU BE THE JUDGE.** Either way, the book of TV-Radio Patterns is yours FREE to keep! Offer is limited. Act NOW!

FREE BOOK—FREE TRIAL COUPON!

Educational Book Publishing Division
COYNE ELECTRICAL SCHOOL, Dept. 85-T1
 500 S. Paulina St., Chicago 12, Ill.

YES! Send 6-volume "Applied Practical Radio-Television" for 7 days FREE TRIAL per your offer. Include TV-Radio Patterns & Diagram Book FREE.

Name Age.....
 Address
 City Zone State.....
 Where Employed.....
 Check here if you want library sent COD. You pay postman \$20.95 plus COD postage on delivery. 7-day money-back guarantee.

Educational Book Publishing Division
COYNE ELECTRICAL SCHOOL
 500 S. Paulina St., Dept. 85-T1, Chicago 12, Ill.



and NOW a **NEW**

ERIE CERAMICON[®] TV SERVICE Kit

HERE'S WHAT YOU GET

- ① 63 High Stability ERIE Disc or Tubular Ceramicon
- ② 18 Popular Values
- ③ Handy, Convenient 18 Section Plastic Storage Case
- ④ Exceptional Value

HERE'S WHAT YOU SAVE

REGULAR PRICE
 63 Piece ERIE Ceramicon Assortment \$15.00
 18 Section Plastic Case 1.75
Total Value \$16.75
YOU PAY \$10.65
YOU SAVE \$ 6.10

ORDER NOW
From Your
ERIE
DISTRIBUTOR

ERIE ELECTRONICS DISTRIBUTOR DIVISION
ERIE RESISTOR CORPORATION
 Main Offices: ERIE, PA.
 Factories: ERIE, PA. • LONDON, ENGLAND • TRENTON, ONTARIO

SENSATIONAL CHANGER SALE

Repeated by Popular Request
 Our Lowest Prices Ever . . .

NOVEMBER ONLY
Order Now And Save

630 FA9 FOR 24" & 27"
CUSTOM INSTALLATION

- | | |
|---|---|
| (1) 630 FA9 Chassis | (1) 630 FA9 Chassis |
| (2) 24" Sylvania aluminized silver screen pict tube | (2) 27" Sylvania aluminized silver screen pict tube |
| (3) Heavy duty tube mounting brackets | (3) Heavy duty tube mounting brackets |
| (4) Knobs, ion trap, hardware, etc. | (4) Knobs, ion trap, hardware, etc. |

\$214.95

\$239.95

with 12" RCA Spkr. with 12" RCA Spkr.

630 FA9 FOR 21"
CUSTOM INSTALLATION
\$159.95

With 21" Sylvania Alumin. tube (silver screen), heavy duty tube mounting brackets, knobs, ion trap, hardware, etc. 12" RCA speaker

W. E. Elec Power Line Amplifier
 = D162308; 3 tube operation compl. with ruggedized 6L6GY, 6SJ7GY. **\$2.95**
 GSC7GT.

TRIPLE PLAY CARTRIDGE
 TYPE GE RPX050 **\$5.99**

RECORD CHANGER BASES & BOARDS
 Bases—\$3.49 Mounting Boards—\$1.87
 VM — Webster — Garrard — Collaro. Give model.

10 Watt Hi-Fi Amplifier
 Push-pull, pre-amp, bass, treble, **\$19.95**

FREE CATALOG
 Of latest hi-fi equipment
 Sent Upon Request

WEBSTER (NEWEST MODEL): Automatic shut off, Hi-fi ceramic cartridge with dual sapphire styli. Heavy duty 2 pole motor. Plays 7-10-12" records. Regularly \$37.50 **\$23⁹⁷**

VM TRIOMATIC: 3 speed intermix with sapphire dual styli. Reg. \$34.50 **\$22⁹⁷**

WEBSTER latest model 3 speed hi-fi changer with GE Reluctance RPX 050 cartridge. Heavy duty 4 pole motor, Automatic shutoff. Reg. \$40.00 **\$27⁸⁷**

GARRARD RC 80: 3 speed. One of finest British changers. Automatic shutoff. Weighted turntable. 4 pole motor. Complete with plug-in head. Reg. \$50.00 **\$37⁴⁹**

COLLARO RC 54: 3 speed. Fine British import, automatic shut off, weighted turntable. 4 pole motor. Intermix. Complete with plug-in head. **\$39⁹⁶**

With Ronette Dual Sapphire Style, Hi-Fi Cart—\$40.50

All merchandise is brand new, factory fresh & guaranteed. Mail & phone orders filled on receipt of certified check or MO of 20% of items as a deposit. Balance C.O.D., F.O.B. factory N. Y. Prices & specifications subject to change without notice.

AIREX RADIO CORP., 171 Washington St., N. Y. 7

CO 7-5218

Important Notice to SUBSCRIBERS

If you're moving, please don't forget to send us your address including the numbers shown beside your name, as well as your new address. If possible, send us your address label from the lower right-hand corner of the front cover.

If we receive this information before the 20th of the month, you will continue getting the magazine without interruption.

Your cooperation will be most helpful and greatly appreciated. Please send your new address to:

Subscription Department RADIO-ELECTRONICS 25 W. Broadway, New York 7, N. Y.

PEOPLE

(Continued)

Personnel Notes

. . . Gwilym A. Price, president of Westinghouse Electric Corp., was elected chairman and president. He continues as chief executive officer. Mark W. Cresap, Jr. was elected executive vice president and deputy chief executive officer. He was formerly vice president and assistant to the president.

. . . Jacob H. Ruiter was appointed manager of advertising and promotion for the Technical Products Division of Allen B. Du Mont Laboratories, Clifton, N. J. He had been public relations manager. Benjamin C. Bowker succeeds him in his former position. Bowker formerly headed his own public relations firm.

. . . G. Leonard Werner was named director of sales for Astatic Corp., Conneaut, Ohio. He was formerly general sales manager. John P. Yohe, who had been assistant purchasing agent, was named director of purchases for the company.

. . . Wilbert H. Steinkamp joined Weston Electrical Instrument Corp., a subsidiary of Daystrom, Inc., Newark, N. J., as vice president of sales. He was previously vice president and general sales manager of Beckman Instruments.

. . . Robert Zollars joined Shure Bros., Chicago, as staff assistant to V. Machin, vice president in charge of sales. He was formerly a manufacturers' representative.

. . . Fritz A. Gross, authority on radar and electronic devices, was appointed manager of Raytheon Manufacturing Co.'s Equipment Engineering Division, Waltham, Mass. He had been chief engineer of the division. Nathaniel B. Nichols, former manager of Raytheon's Research Division, was named manager of commercial equipment engineering activities.

. . . Louis Martin joined Westinghouse Electronic Tube Division, Elmira, N. Y., as general sales manager. Previously he was general sales manager of Standard Coil Products Co. and had been associated with RCA for approximately 15 years.

. . . Robert C. Sprague, Jr., Sprague Electric, was reappointed chairman of the RETMA Executive Committee of the Industrial Relations Department. J. H. Craft, Jr., Stromberg-Carlson, was appointed chairman of the Service Committee. Ray C. Ellis, Raytheon, was named chairman of the International Department. The following RETMA committee chairmen were reappointed:—Glen McDaniel, general counsel, Legal Committee; Douglas H. Carpenter, JFD, Antenna Committee; Edward C. Tudor, I.D.E.A. Inc., Credit Committee; John B. Swan, Jr., Philco, Traffic Committee; and H. J. Hoffman, Machlett Laboratories, Membership and Scope Committee. **END**

INTRODUCING YOUR NEW PROFIT MAKER

SAVE SERVICE TIME SELL MORE TUBES

MODEL GCT-5

SECO

GRID CIRCUIT TUBE TESTER

\$29⁹⁵ Slightly higher West

Now quickly and accurately detect "positive grid" conditions in amplifier tubes used in circuits employing a high value of grid return resistance. **EXCLUSIVE!**



"HARD TO FIND" TV TUBE FAULTS LOCATED FAST!

- Poor picture contrast
- Grainy picture
- Twisting, bending or pulling of the picture
- AGC, RF, IF and Sync. Group tube faults
- Vertical jitter or bounce
- Sync. Buzz in the sound
- Any or all symptoms caused by sync. pulse compression.

Stop guessing and substitution checking, test and sell tubes with conviction on the first call, avoid embarrassing and costly callbacks.

Filament Selector Switch accommodates all the latest tubes for TV and INDUSTRIAL uses.



Another Seco Exclusive!
FLY BACK INTERVAL & INDUCTANCE ANALYZER

Checks horizontal circuits without disconnecting!

For specialized applications to meet your specific need, contact:

SECO MFG. CO.
5015 Penn. Ave. So.
Minneapolis, Minn.

Business

Merchandising and Promotion
Technical Appliance Corp., Sherburne, N. Y., designed a colorful wall banner as a point-of-sale promotion



piece for its *Taco* antennas. It is available to service technicians through *Taco* distributors.

G-C Electronics Manufacturing Co., a division of General Cement Manufacturing Co., Rockford, Ill., is merchandising its new G-C 60 line of Stackpole carbon resistors in color-coded, hinged-



cover plastic boxes. The company designed a self-service display rack holding 77 RETMA resistor values.

Pentron Corp., Chicago, is offering a free prerecorded tape *Moods in Music* to purchasers of its tape recorders.

ORRadio Industries, Opelika, Ala., is under way on the largest fall and winter advertising campaign in its history on its *Irish* brand magnetic tape.

JFD Manufacturing Co., Brooklyn, N. Y., is packaging its Venus indoor antennas in a newly designed carton which doubles as a display stand. The antennas are individually packaged in

BUY DIRECT FROM MANUFACTURER
BUY THE FINEST TV RECEPTION AT BIG SAVINGS

ALL ANTENNAS SOLD ON MONEY-BACK GUARANTEE

METEOR MODEL 2-M 2 BAY
AMERICA'S LOWEST PRICE FRINGE AREA ANTENNA

Engineered for both VHF and UHF — black and white or color. Specially designed broad-band 2 Bay Array for deep fringe reception. Has the new electronic dipole separators for highest gain on both high and low bands. Gives an unbelievably high 11.5 db gain. Exceptional front-to-back and front-to-side rejection of unwanted signals. All aluminum. KWIK-RIG installation—pre-assembled. \$34.50 LIST with Stacking Kit. \$17.25 NET.

METEOR SINGLE BAY — MODEL M-1
\$16.25 LIST \$8.15 NET.

COMET MODEL C-1 SINGLE BAY

This highly desirable Yagi type meets the reception VHF requirements for primary, medium fringe and fringe areas — Channels 2 — 13. Also for UHF in primary areas. Engineered for strong front gain and has low side and rear pick-up with wave-trap principle for in-phase tuning. KWIK installation—pre-assembled. Aluminum. \$19.75 LIST \$9.95 NET.

STAR-KING MODEL S SERIES

For all areas where broad reception is required. An outstanding value in a Conical Type Antenna. Gives VHF Super-fine reception for Channels 2 — 13. KWIK-RIG installation — completely pre-assembled. All aluminum.

| MODEL | LIST | NET |
|-----------------------------|---------|---------|
| S-1 SINGLE BAY | \$9.99 | \$4.50 |
| S-2 TWO BAY | \$18.00 | \$9.00 |
| S-4 FOUR BAY | \$36.00 | \$18.00 |
| 2 Bay Stacking Kit—No. SK-2 | | \$1.50 |
| 4 Bay Stacking Kit—No. SK-4 | | \$1.95 |

PLANET "SUPER-DE LUXE"

For the finest VHF All-Channel performance. Channels 2 — 13. Highly recommended for extreme fringe area use — for distances up to 150 miles and more. Eliminates co-channel interference and has highest front-to-back ratio. Also designed for color. KWIK-RIG pre-assembled. Aluminum.

| MODEL | LIST | NET |
|-----------------------|---------|---------|
| P-1 Single Bay | \$34.95 | \$15.95 |
| P-2 Bay Stacked Array | \$69.90 | \$31.90 |

All prices F.O.B. Burbank, California. **DO NOT REMIT MORE THAN PURCHASE PRICE.** You pay shipping charges on receipt of goods. 25% deposit required on all C.O.D. orders. **DEALER INQUIRIES SOLICITED.**

FORD ELECTRONICS
4000 West Burbank Blvd. Dept. 114
Burbank, California.

PLEASE SHIP ANTENNA NO. _____

Check or Money Order enclosed.

NAME _____

ADDRESS _____

CITY _____ STATE _____

made better!



NEW DESIGN means NEW SALES

Now, the newest, finest Radio-Control Garage Door Opener styled in a modern spun-aluminum fixture that beautifies garage interiors.
Convenience and safety features galore — New automatic shut-off, positive locking of door, FCC authorized radio frequency . . . and many more plus qualities!
Write today for descriptive literature.

Perma-Power
NEW Garage Door Opener

mfd by **Perma-Power Company**
4727 N. Damen Ave., Chicago 25, Ill.
Manufacturers of electronic equipment since 1928
EXPORT: Scheel International, Chicago, Ill.

BUSINESS

(Continued)

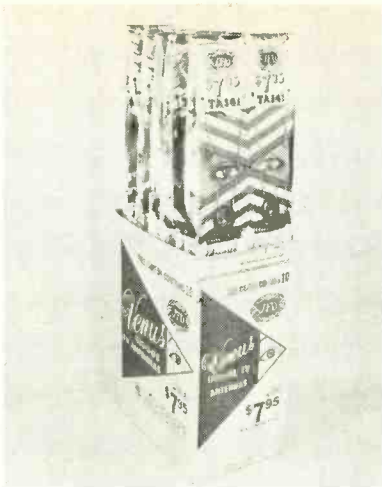

gold or silver foil carrying a similar pattern to that on the carton.

Finney Co., Cleveland, introduced its new *Geomatic* series of broadband u.h.f. TV antennas with an aggressive promotion campaign. In addition to



M. L. Finney, Jr., Finco general sales manager, receives zipper case from A. Fox of Allied Advertising. Watching are H. Freed, left, and W. Zagar, of Allied.

advertising and direct mail, the company offered to double distributors' initial orders of the antennas up to 12, at no extra cost. The company announced the promotion to its distributors by sending them, by certified mail, a personalized zipper case containing literature outlining the entire campaign.

The Institute of High Fidelity Manufacturers, Inc., New York City, adopted



an insignia designed by Avery Fisher of Fisher Radio, one of the members of the group.

Production and Sales

RETMA reported the production of



THE NEW
PRECISION
MODEL 88
HIGH SENSITIVITY VTVM
and ELECTRONIC OHMMETER
Complete with 3-way Universal Test Probe
PEAK TO PEAK VOLTAGE
RANGES TO 3200 VOLTS

A compact wide range VTVM-Ohmmeter for modern electronic circuit checking in the laboratory, on the production line and for general service-maintenance. Features include Peak-to-Peak voltage ranges which afford a new high in P-P reading accuracy of pulsed wave-forms in color or monochrome TV and similar applications.

7 DISTINCTLY SEPARATE FUNCTIONS
40 SELECTED, WIDE-SPREAD RANGES

- ▶ **6 TRUE-ZERO-CENTER DC VOLT RANGES:**
Constant 26½ Megs input resistance.
0 ±1.2 ±6 ±12 ±60 ±300 ±1200 volts.
- ▶ **5 ELECTRONIC OHMMETER RANGES:**
0-1000-10,000 ohms. 0-1-100-1000 Megs.
- ▶ **6 PLUS and 6 MINUS DC VOLT RANGES:**
(Left-Hand-Zero) constant 13½ Megohms input.
0-1.2-6-12-60-300-1200V.
- ▶ **6 HIGH IMPEDANCE RMS AC VOLT RANGES:**
0-1.2-6-12-60-300-1200 volts
Input Characteristics: Up to 60V Range — 3 Megs., 90 mmfd; 300 V Range — 1 Meg., 70 mmfd; 1200V Range — 4 Megs., 67 mmfd.
- ▶ **6 HIGH IMPEDANCE P-P AC VOLT RANGES:**
0-3.2-16-32-160-800-3200 volts
Input Characteristics: Up to 160V Range — 6 Megs., 90 mmfd; 300V Range — 1 Meg., 70 mmfd; 3200V Range — 4 Megs., 67 mmfd.
- ▶ **5 SPECIAL HIGH FREQUENCY PROBE RANGES:**
0-1.2-6-12-60-300 volts RMS.
(Requires optional PRECISION RF-10A HF Probe).
Probe input capacity:—approximately 5 mmfd.
- **ONE UNIVERSAL COAX. AC-DC* VTVM PROBE** serves all functions other than HF ranges.
- **PEAK-TO-PEAK "RE-SET" PUSH-BUTTON** for rapid "zero" return of special electronically damped test circuit.
- **EXTRA-LARGE 5¼" RUGGED PACE METER.**
200 µA sensitivity ±2% accuracy.
- **1% MULTIPLIERS and SHUNTS.**

MODEL 88: complete with detachable AC line cord, internal ohmmeter battery, coaxial VTVM Probe and operating manual.
Size: 5¾ x 7 x 3½".....\$69.75 net

ACCESSORIES FOR THE MODEL 88
RF-10A HF vacuum tube probe.....\$14.40 net
TV-8 60 Kilovolt safety probe..... 14.75 net
ST-1 Snap-on foldaway tilt-stand..... 1.00 net

PRECISION APPARATUS CO., INC.

70-31 84th Street, Glendale 27, L. I., N. Y.
Export: 458 Broadway, New York 13, U. S. A.
Canada: Atlas Radio Corp., Ltd., 560 King St. W., Toronto 28

4,173,088 TV and 7,777,378 radio sets for the first seven months of 1955, compared with 3,152,132 TV sets and 5,324,620 radios for the 1954 period.

RETMA reported manufacturers' sales of 5,429,817 TV picture tubes and 254,842,000 receiving tubes during the first seven months of 1955. This compares with 4,471,584 picture and 139,856,000 receiving tubes for the 1954 period.

New Plants and Expansions

Precision Radiation Instruments, Inc., Los Angeles, purchased **Radio Craftsmen Inc.**, Chicago manufacturer of high-fidelity components, which it will operate as a wholly owned subsidiary. John H. Cashman, president of Radio Craftsmen, will serve in an advisory capacity until the end of the year. Precision's executive committee will operate Radio Craftsmen. Robert Kaufmann, vice president—advertising and public relations of Precision, stated that the executive committee is analyzing and studying the company's future sales policy. It has not been decided whether distributors will be used, but according to Lee Goodman, vice president—sales, dealers are being informed that Craftsmen merchandise will not be sold direct to the public from the factory.

RCA Tube Division, Harrison, N. J., leased a new warehouse and office build-

ing in Los Angeles as a centralized distribution point for its tubes in California, Arizona and Nevada.

Elgin National Watch Co., Elgin, Ill., established warehouse and distribution facilities in Elgin for two of its West Coast subsidiaries, **American Microphone Co.**, Pasadena, and **Advance Relay Co.**, Burbank.

Raytheon Manufacturing Co., Waltham, Mass., established a laboratory at White Sands Proving Grounds, Las Cruces, N. M. The laboratory is being set up by the Missile and Radar Division of Raytheon's Equipment Operations.

Xcelite, Inc., Orchard Park, N. Y., acquired a new building which increases its production facilities for screw drivers, nut drivers, etc., by 25%.

Sylvania Electric Products, New York, has formed a new company with **Thorn Electrical Industries Ltd.**, London, for the manufacture of black-and-white TV picture tubes in England.

British Industries Corp. moved from New York City to larger quarters at 80 Shore Rd., Port Washington, N. Y.

Berlant-Concertone, Los Angeles, established Eastern warehouse facilities through the appointment of **Electronic Corp. of America**, New Brunswick, N. J., as factory parts exchange warehouse.



"Don't play it until I get back with a JENSEN NEEDLE."

NEW, ADVANCED *Precise* TEST EQUIPMENT
KIT FORM—ALL NEW COMPONENTS—NO SURPLUS

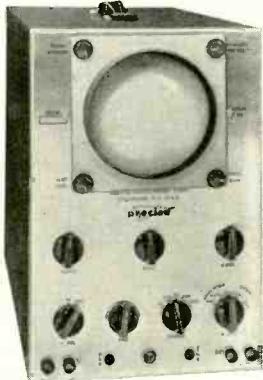

No. 315K 5" OSCILLOSCOPE

- Has frequency compensated vertical and horizontal attenuators along with identical vertical & horizontal amplifiers (within 6DB through 500KC).
- Uses SCP1 type tube with post accelerator. Both horizontal and vertical sections are cathode-follower input type and are AC coupled. Outputs are push-pull.
- Basic sensitivity is approximately 250 millivolts per inch.
- Sweep rate from approximately 10 cycles to 100KC. Hard vacuum type sweep circuit.

Kit Price \$49.95

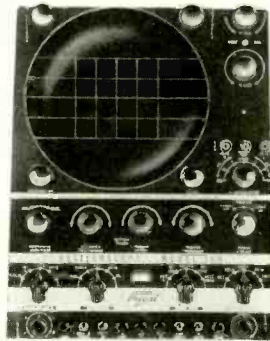

No. 308K 8 1/2" OSCILLOSCOPE

- Does everything more expensive scopes can do and does it better.
 - Full 8 1/2" tube designed specially for this model.
 - Voltage regulated.
 - Electronic magnifier allows any part of a signal to be magnified up to 10 times equivalent to 70" of horizontal deflection.
 - High Frequency—Low Frequency—Normal Frequency—Synchronization Circuit.
 - Separate intensifier anode.
- PLUS dozens of other features found only in more expensive scopes.

Kit Price \$129.95
Wired \$229.50



No. 111K TUBE TESTER

- CHECKS BOTH EMISSION & GM SEPARATELY
- Allows filament current to be measured directly on the meter.
- Checks AC-DC tubes & indicates "Voltage Drooping."
- Tests horizontal sweep tubes by pulse emission.
- Tests all tubes for emission and GM at the flick of the switch manipulation.
- Measures tube bias directly.
- Tests all types of tubes including latest types & cathode ray tubes.

Kit Price \$69.95
Wired \$139.95



VACUUM TUBE VOLTMETER

NEW PRECISE MODEL 9071 . . . VACUUM TUBE VOLTMETER WITH VR. PRECISE again the leader—featuring the FIRST VTVM with TRUE VOLTAGE REGULATION. NEW TYPE VR TUBE assures true, accurate and stable readings . . . no drift . . . no shift . . . large, rugged 7 1/2" meter; separate 5V AC scale; 25 MEG. input on DC; true zero center; deeply etched aluminum panel; sturdy steel case; step-by-step 3 color construction book. Wt.: 11 lbs. Size: 11" x 8" x 5".

9071K Kit Price \$35.95
Factory wired \$49.95

SEND FOR COMPLETE CATALOG OF PRECISE EQUIPMENT

Send complete shipping instructions plus 25% deposit. Balance C.O.D., or, deduct 2% for check or money order in advance.

ELECTRONIC WHOLESALERS,
1419 N. 3rd St., Harrisburg, Pa.

Please send _____

Name _____

Address _____

ELECTRONIC WHOLESALERS
1419 N. THIRD STREET HARRISBURG, PENNA.

Wire Record-Playback Head

Used in Wireway, St. George, Crescent, etc. Precision-built triple coil (including erase) \$6.95
Standard 4 pin base, SPECIAL!
WIRE RECORD TURNTABLE for wire take-up & disc play. 3 1/2" O.D. Moulded bakelite. 1.69
HEAVY DUTY RECORDING MOTOR (RM4 type) IDEAL for WIRE, TAPE or DISC RECORDING. 115V AC. 4 pole, silent operating. 5/16" shaft. 3 3/4" sq. x 2 3/4". Less mtg. plate assbly. 4.95



TV Focus Coils, EM-PM Type, 1100 ohm coil

1-5/16" I.D. ELECTROMAGNETIC 300 ohm coil. 1.95
I.D. PHILCO TV TURRET TUNER (PL. #76-3109, less coil, contact strips) for '48 & '49 models. 1.49
Above tuner with 3 socket wired RF strip. 1.98
MINIATURE INPUT TRANSFORMER (3/4" sq x 3/8") for CARBON MIKES, LO-IMP. PICK UPS, etc. ea. 75c. 3/1.98
PHOTO TURNTABLE FELL COVERS. Brown, center hole. 10" size 29c. 12" 39c
PHOTOELECTRIC CELL (Selenium). Wood case. Converts Light into Electricity to operate Relays, Instruments, etc. 2 1/2 x 1 1/2 x 3/4". 98
EXPERIMENTAL TUBES. Kit of 40 ass'd. reovz. types. 1.98

!! Repair Your Own Speakers !!

Clear, simple INSTRUCTIONS supplied with every cone or repair kit order.
Kit "A"—SPEAKER CONES. An assortment of popular sizes 4" to 12", incl. oval. Less voice coils. Kit of 12 assorted. 1.98
Kit "B"—DELUXE CONE KIT. Same as above, but containing a larger variety of 20 assorted cones. 2.98
Kit "C"—SPEAKER REPAIR KIT. A PROFESSIONAL ASSIGNMENT of RIBS, Spiders, Voice Coil Forms, Pett. Chamois Linr. Shim Kit, Cement & Instructions. 2.49

!! Special !! . . Both Kits "A" & "C" Only 3.95

F.W. BRIDGE RECTIFIER (W.E.) . . . Max. Input 24V., 300 ma. 3/4" O.D. x 2" L. ea. 69c 3/1.98
5" PRECISION DIAL & 3 1/2" shaft. Calib. 0-200 (360°). Metal housed. 7/8" shaft. 79

!! IT'S NO MYSTERY !!

Here's JUST what you get in every "Jumbo Radio-Electronics Parts Kit"

17 FULL LBS. of new & surplus RADIO, TV and ELECTRONIC COMPONENTS

AT A FRACTION OF ITS REAL VALUE!
Included are: SWITCHES, WIRE, CONTROLS, SOCKETS, PHOTOFACTS, DIAGRAMS, RESISTORS, CAPACITORS, COILS, PLUS DOZENS OF OTHER ITEMS WORTH MANY TIMES THE PRICE OF (shpg. wt. 20 lbs) \$3.95

Min. Order \$3.00—20% Dep. Req. with all orders.

LEOTONE RADIO CORP.
67 Day Street
New York 7, N. Y.

December RADIO ELECTRONICS on sale Nov. 25!

KARL F. ROSS
Registered Patent Agent
(U. S. and Canada)
Specializing in electronic patent matters
305 Broadway, New York 7, N.Y. WO 2-3449

BUILD COLOR TV
COLORDAPTOR. Simple 9 tube circuit and rotating color wheel converts any black and white TV, direct view or projection, to receive compatible color TV. Specifications, including theory of operation, complete simplified construction plans, schematic, and sample color filters. \$2.95
COLORDAPTOR. 3471 Ramona, Palo Alto, Calif.

technical Literature

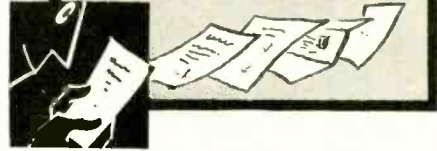

SOUND REPRODUCERS

Permoflux's literature sheet *JH-401* describes the HD-1 high-fidelity head-set. *JS-S-402* gives complete data on the new Largo Dual 8 speaker system and *JS-S-401* describes the Diminnette speaker system.

Permoflux distributors; Permoflux Corp., 2835 N. Kedzie Ave., Chicago.

Any or all of these catalogs, bulletins, or periodicals are available to you on request direct to the manufacturers, whose addresses are listed at the end of each item. Use your letter-head—do not use postcards. To facilitate identification, mention the issue and page of RADIO-ELECTRONICS on which the item appears. UNLESS OTHERWISE STATED, ALL ITEMS ARE GRATIS. ALL LITERATURE OFFERS ARE VOID AFTER SIX MONTHS.

RESISTORS

A 20-page, *Bulletin LC-1030A* covering encapsulated resistors, illustrates the CE 100 and CE 200 series for axial wire terminals, radial wire terminals and radial lug terminals, and PW 100 and PW 200 series for printed circuitry. Dimensional details, wattage ratings, maximum resistance and military equivalents are stated.

Cinema Engineering Co., Div. of Aerovox Corp., 1100 Chestnut, Burbank, Calif.

BASE DIAGRAMS

Tung-Sol's base diagram book contains blueprints of more than 350 base connections for over 1,300 electron tubes. Each page in the loose-leaf type book is devoted to a single base diagram. A numerical index makes it easy to locate any diagram.

Tung-Sol distributors.

TRANSISTOR CIRCUITS

A *General Electric* booklet contains suggested circuits for the 2N107. Among them are a simple audio amplifier, code practice oscillator, two-transistor radio receiver and loudspeaker audio amplifier.

General Electric distributors.

ELECTRONIC ORGANS

Organ Builders Manual by Robert L. Eby describes all phases of building your own electronic organ, including console design, tone generators, manuals, pedals, amplification and accessories. Also includes a parts price catalog on the Artison line for amateur organ builders.

Electronic Organ Arts, 4878 Eagle Rock Blvd., Los Angeles 41, Calif. \$1.

Color Servicing

IS NOW IN THE FAMOUS

Mandl's TV Servicing



The new section on color servicing and color circuits gives you the same clear how-to-do-it instruction that has made this book a favorite with servicemen everywhere. You'll be FULLY prepared to service any set, do the best job of installation or trouble shooting in minimum time, either for color or for black and white.

EASY to learn

Simple, clear explanations show you how each unit in the TV receiver functions, with lists of the flaws that may occur in it, what points in the circuitry cause them, how they affect other components, how they show up on the TV screen. Every step is fully illustrated with large clear schematics, photographs of test patterns, scope patterns and other helpful illustrations.

How to locate trouble quickly

A complete master trouble index gives the possible causes of distortions or faults in picture or sound, with references to the pages on which servicing instructions are given. You can quickly and easily diagnose the source of trouble and know just what to do about it.

Methods used by experts

You'll learn the practical time-saving methods used by the most experienced servicemen and technicians—ways of locating those hard-to-find troubles, simple signal tracing procedures, how to improve reception in fringe areas, how best to use test equipment. You'll learn the necessary why's and wherefore's of TV reception, but won't be confused by unnecessary theory or involved math—just what you need in order to do a skilled servicing job is given here.

Recent improvements

In addition to the instruction on color—how it works, how to service color sets—you'll have the latest data on such improvements as cascade tuners, automatically focused tubes, new types of high frequency I.F. systems, transistors, UHF-VHF receivers. You'll learn TV for today and TOMORROW from this book.

Look it over without obligation. See for yourself how easy and practical this book is—how quickly you'll become expert with it, how useful it is on any job. Get a copy on

10-day FREE TRIAL

THE MACMILLAN COMPANY,
Dept. RE 9
60 Fifth Avenue • New York 11

Please send me a copy of the new Mandl's TV Servicing. I will either pay the full price of \$5.75 plus a small delivery charge or return the book in 10 days. (SAVE: send check or money order and we pay delivery charge.)

Signed _____

Address _____

This offer good only within continental limits of U.S.A.

LEARN TV

'At the most practical school in the west'

Work on late model sets—using modern equipment and techniques: under qualified technician instructors. Short resident and correspondence courses—no unnecessary math or theory—also UHF and Color TV.

APPROVED FOR VETERANS . . . day and nite classes.
Write for free literature. Dept. 1 A

V.S.I. TELEVISION SCHOOL

4570 Firestone Blvd.
South Gate, California

PHOTOGRAPHS

RADIO-ELECTRONICS can use good photographs of service benches, service shops, high-fidelity audio layouts, and any other interesting and original radio-electronic devices. We will pay \$6.00 each for good professional photos or equivalent, suitable for reproduction. Full information on subject photographed will increase their acceptability.

The Editor, RADIO-ELECTRONICS
21 West Broadway, New York 7, N. Y.

COYNE
trains you for
big pay jobs
in...

You Can Quickly
be doing interesting
profitable work
like this!

TELEVISION

-RADIO in shops of COYNE
... or in
spare time at HOME

A fascinating field! A great future! A good job or independence in a business of your own! TV is growing by leaps and bounds—1227 new communities, 1845 new stations given "go-ahead". Trained men are worth their weight in gold!

COYNE HAS TRAINED MORE SUCCESSFUL MEN

Thousands of successful men trained at COYNE—the largest, oldest, best-equipped school of its kind (established 1899). A Coyne-trained man is a top-trained man. Coyne methods require no advanced education or previous experience.

TRAINING TAILORED TO MEET YOUR NEEDS

Resident Shop Training—You can learn on real equipment in the Great Shops of Coyne. Learn quickly-easily at Coyne. Practical Technical method gives practical experience on massive outlay of full-size equipment plus necessary technical training. Finance Plan whereby you can enroll now and pay most of tuition later. Also Monthly Payment Plan especially designed for K-Vets. If you need part-time work to help out with living expenses while at COYNE, we'll help you get it. Coupon brings FREE BOOK and details.

OR

Coyne Tested Home Training—To those who cannot come to the Coyne shops here in Chicago, we offer modern, up-to-the-minute training designed to meet Coyne standards. Practical, down-to-earth, easy to follow, step-by-step instruction. So practical, you can quickly be earning money in

B. W. COOKE, President FOUNDED 1899

COYNE ELECTRICAL SCHOOL

A TECHNICAL TRADE INSTITUTE CHARTERED NOT FOR PROFIT

500 S. Paulina Street, Chicago 12, Dept. 85-TR4
ELECTRICITY • RADIO • TELEVISION • REFRIGERATION • ELECTRONICS

Television and Radio while learning—personal supervision by Coyne Staff—men who know TELEVISION AND RADIO, AND KNOW HOW TO TEACH IT—and the cost is low—you pay only for training—no costly extras. Send coupon below for Picture Folder and full details, including easy Payment Plan.

MAIL COUPON FOR FREE INFORMATION

Fill in and mail coupon, TODAY. Check the training you're interested in. If you want information on both, check both. Complete details will come by return mail. No cost—No obligation—No salesman will call.



B. W. COOKE, President
COYNE ELECTRICAL SCHOOL
500 S. Paulina Street, Chicago 12
Dept. 85-TR4

Send details of your offer on training checked below. This does not obligate me and no salesman will call. I am interested in:

- TELEVISION-RADIO HOME TRAINING
 TELEVISION-RADIO IN COYNE SHOPS

Name

Address

City State

RECTIFIERS

Bulletin GPR-1 describes germanium power rectifiers in style C (which has a d.c. output current range from 10 to 30 amps at 26-66 a.c. input voltage range) and style F (which has d.c. output current ranges from 150 to 1,500 amps at 26-66 a.c. input volts).

International Rectifier Corp., 1521 E. Grand Ave., El Segundo, Calif.

POWER RECTIFIERS

Bulletin MP-755 on silicon power rectifiers gives their maximum ratings, typical characteristics and a comparison of various types of rectifiers.

Automatic Manufacturing Corp., 65 Gouverneur St., Newark 4, N. J.

MUSIC ON TAPE

Berkshire's brochure on their pre-recorded tapes of classical music gives data on the Hi-Fi Supreme, Royal Deluxe and Extended Deluxe series.

Berkshire Recording Corp., 150 W. 90th St., New York 24, N.Y.

FERRAMIC MAGNETIC CORES

General Ceramics' brochure contains 11 graphs on the magnetic properties of Ferramic H cores and a table of magnetic properties of other Ferramic bodies.

General Ceramics Corp., Keasbey, N. J.

PLUG-IN-UNITS

New 40-page illustrated Catalog 827 presents circuit drawings and specifications on 36 different EECO plug-in units. A number of typical applications are also presented to illustrate the use of plug-in units.

EECO Production Co. (Subsidiary of Electronic Engineering Co. of California), 506 E. 1st St., Santa Ana, Calif.

CRYSTAL DIODES

The second edition of CBS Crystal Diode Manual E-217 includes information on germanium and silicon diodes, glass- and plastic-encased. The revised edition is divided into three parts: construction and advantages, electrical and mechanical data, selection and application.

CBS-Hytron, Danvers, Mass.

RESISTORS

Catalog G-1a contains eight pages of data on construction, specifications, installation, tolerances, voltage and temperature coefficients, ratings, insulation, terminations, of type MV high-voltage resistors. It is illustrated with charts and graphs.

Catalog B-6a contains data on 1/2-, 1- and 2-watt boron carbon Precistors. Information on types, construction, applications, performance, temperature coefficients, tolerances, insulation, terminations, etc., is given in four pages with charts and graphs.

International Resistance Co., 401 N. Broad St., Philadelphia 8, Pa.

SUBMINIATURE RELAYS

Subminiature relays are described in Filtors' booklet. Features, specifications, diagrams and illustrations are given.

Filtors, Inc., 30 Sagamore Hill Dr., Port Washington, N. Y. END

Easy
as pie!



ARKAY KITS

LABORATORY
TESTED

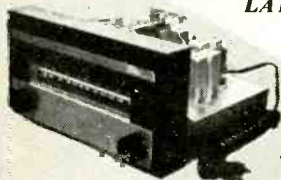

Arkay FM-AM Tuner Kit

7 tube circuit plus selenium rectifier includes separate mixer and Oscillator stages, 3 double tuned IF stages with Foster-Seeley discriminator and grounded grid amplifier for excellent response characteristics:

Sensitivity & Selectivity—FM 5 μ v for 30db quieting, 200 kc bandwidth 6db down. AM 25 μ v with 8 kc bandwidth 6db down.

Frequency response —
FM \pm 5db 20-20,000 cps
AM \pm 3db 20-5000 cps
Image rejection —30db minimum
Hum level — -65db.

AFC control and defeat. \$25.95
Available in FM only. Model FM6

Arkay FL-10 High Fidelity Amplifier Pre-Amp Kit;

Unity coupled pushpull 12 watt output; frequency response \pm 2db 20-20,000 cps with extremely low IM and Harmonic distortion; 5 position input selector with record equalizer; loudness, bass, and treble controls; tapped output; extremely low noise level; completely enclosed—no cabinet problem; for clean, flexible, brilliant audio.

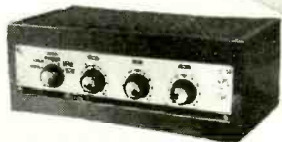

Write for technical information on this model. \$19.95

\$28.95

Arkay A-12 High Fidelity Amplifier Kit Featuring

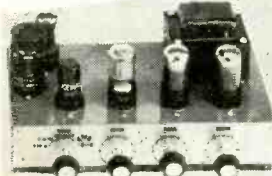

12 watt output, push pull 6V6's; frequency response \pm 1db 20-20,000 cps with low distortion; 5 inputs, master controlled at front panel; tapped output transformer; separate bass and treble control, each with maximum db boost and cut; built-in Pre-Amplifier; ideal for home installations.

\$22.95

OTHER PRODUCTS IN THE ARKAY LINE OF KITS

- Radios • Testing Equipment
- Experimenters Equipment
- Audio Amplifiers
- Phonographs
- Geiger Counters
- Television Kits

Visit your local distributor for these wonderful kits and write today for the special FREE Radio Kits Catalogue and list of dealers. Your copy will be sent by return mail with no obligation. Write to

Radio Kits Inc., Dept. R-11
120 Cedar Street New York

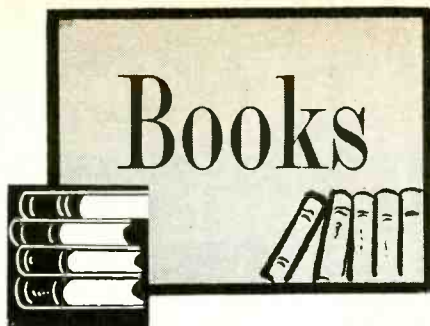

ELECTRO-TECHNOLOGY, by M. G. Say. Philosophical Library, Inc., New York, N. Y. 5½ x 8½ inches, 167 pages. \$6.

This book doesn't have many pages but contains a great deal of useful information. It is written like an encyclopedia, with each chapter divided into main topics. The material is concentrated but clearly discussed.

Part I starts with basic electricity. Thermal, chemical, magnetic and electric effects are discussed. Other topics include harmonic analysis, three-phase circuits, vector algebra, resonance, etc. To show how comprehensive the book is, we find here charts and tables on chemical elements, the frequency spectrum, properties of conductors and many pages devoted to electrical units and definitions.

Part II develops circuit calculations. Important circuit theorems are stated and complete examples are worked out in d.c., a.c. and multiphase circuits. Transient analysis is given adequate coverage. Math is on the engineering level.

The book ends with many math tables and formulas.

U.H.F. CIRCUITS AND COMPONENTS, by Milton S. Kiver. D. Van Nostrand Co., Inc., New York, N. Y. 6 x 9 inches, 408 pages. \$7.50.

Describing u.h.f. without complicated theories and math is not easy. Yet this author does an excellent job of it. Circuits and components are treated in simple language with the aid of many photos and diagrams. This is not a design or engineering handbook, but is written for technicians, telling what u.h.f. is, how to install and operate practical microwave devices.

Transmission lines, waveguides and cavities are described as logical extensions of low-frequency circuits. The chapter on waveguides is especially detailed and complete in itself. After outlining the need for special tubes at u.h.f., the magnetron, klystron, traveling-wave tube, resnatron, etc., are discussed. The chapters on antennas, measurements and receivers are also clearly written, with diagrams on nearly every page. Typical TV converters and tuners are covered in the last chapter.

ELEMENTS OF PHYSICS (Second Edition), by George Shortley and Dudley Williams. Prentice-Hall, Inc., New York, N. Y. 6 x 9 inches, 880 pages (plus 18-page index). \$10.60.

This book covers all topics in classical

Rauland
"GOLDEN SERIES"
HIGH FIDELITY
The Very Best for Less!



HF155 "Golden Gate"
FM-AM HI-FI TUNER

Here is quality FM (response \pm 0.5 db, 20 to 20,000 cps) and improved AM, both most perfectly realized for finest reception in a unit only 4" high—at a very reasonable price. Outstanding features: Sensitivity, FM—3 microvolts for 20 db of quieting; AM—5 microvolts for 1.5 volts output; separate RF stage on FM and AM; discriminator with dual limiters: cathode follower with 2 outputs; AFC; flywheel tuning, FM di-pole antenna, etc.

NEW! HI-FI SOUND FOR TV!

Now, make your TV sound "come alive". Just plug the new RAULAND TV55 Tuner into the unit above and enjoy TV sound through your hi-fi system. Exclusive with RAULAND. See it—hear it soon.



1520 "Golden Crest"
20-WATT HI-FI AMPLIFIER

Designed for those who appreciate the finest in Hi-Fi reproduction—the very best for less. Features: Full 20 watts output; response, \pm 0.5 db, 20 to 40,000 cps; 6 response curves (compensation for all record types); 5 inputs for complete hi-fi versatility; separate bass, treble controls; contour and volume controls; variable damping control; rumble filter, plus many other deluxe features. In compact cabinet, 4" high.

HANDSOME "SPACE-SAVER" DESIGN

RAULAND matching "Space-Saver" units are decorator-styled in smart charcoal black with marbled gold finish, control panels in soft brushed brass. No cabinets required—fit beautifully anywhere. (Extension shafts available for behind-panel mount.)



Hear these
RAULAND Hi-Fi
units at your
dealer's, or write
for full details

RAULAND-BORG CORPORATION
3515 W. Addison St., Dept. A, Chicago 18, Ill.

LABORATORY DESIGNED for
UHF and VHF! ... It's NEW!

MOSLEY

2-WAY TV ANTENNA SWITCH

- Extremely low Standing Wave Ratio — by actual test!
- Positive rotary action!
- Silver-to-silver contacts!
- Compact size!
- Solderless — easy to install!
- Low cost!

Cat. No. F-40
List Price
\$1.95

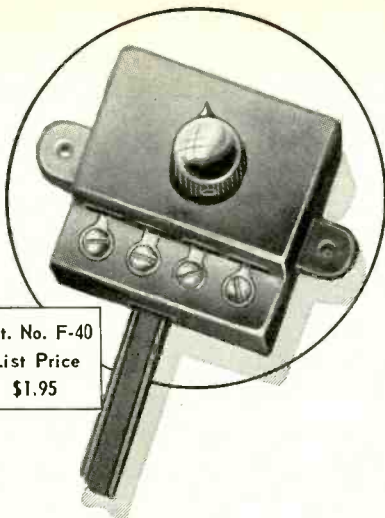

Mosley
Electronics, Inc.
8622 ST. CHARLES ROCK ROAD
ST. LOUIS 14, MISSOURI

Another PREMIUM QUALITY MOSLEY Accessory
for BETTER TV INSTALLATIONS!

Watch for the December RADIO-ELECTRONICS On the Stands November 24th

Hi-Fi record reproduction requires a **PRECISION** turntable...

THE NEW PRESTO

Pirouette
T-18

MADE BY THE WORLD'S LARGEST MAKER
OF PRECISION RECORDING EQUIPMENT

- Improves record performance tremendously...delivers professional broadcast quality!
- Simple operation—a sideways flick of the control lever selects 3 speeds—33⅓, 45, 78 rpm.
- Quiet insured! Precision deep-well turntable bearing.
- Quality plus! Extra heavy weight, cast aluminum 12-inch turntable covered with non-slip cork.
- Beautiful design—smart telephone black and brushed chrome finish.
- Easy to install...only rectangular cut-out needed. Easy to buy at only \$53.50.



Revolutionary 3-Speed Mechanism

The Pirouette embodies the exclusive PRESTO "flick shift" speed mechanism, with 3 idler wheels mounted on a single movable plate. Insures professional speed accuracy and trouble-free performance.



Presto Pirouette T-18H Turntable
The history-making T-18 with hysteresis motor... a magnificent hi-fi instrument. \$108.



Presto Pirouette T-68 Turntable
The 16" version of PRESTO's flick-shift T-18...for homes with fine hi-fi collections. \$79.50.



Presto Pirouette T-68H Turntable
A 16" flick-shift turntable with hysteresis motor... a new pinnacle in hi-fi. \$134.

Send this coupon for more information →

PRESTO RECORDING CORPORATION
Paramus, New Jersey

Export Division: 25 Warren Street, New York 7, N. Y.
Canadian Division: Instantaneous Recording Service, 42 Lombard Street, Toronto

PRESTO RECORDING CORP
Hi-Fi Sales Division, Dept. RE-10
Paramus, New Jersey
Rush catalog sheets on the new PRESTO
Pirouette T-18, T-18H, T-68, T-68H
turntables and name of nearest PRESTO
distributor.
Name _____
Address _____
City _____ Zone _____
State _____

BOOKS

(Continued)

and modern physics. Written especially for students of science and engineering, it is a clear description of fundamental principles. Many examples are worked out completely in the text, and practical problems (many with answers) are given at the end of each chapter.

The book has six parts. The first five are devoted to mechanics, heat, sound, light, electricity (and magnetism). The last is reserved for modern physics. Many diagrams and tables appear throughout. Mathematics is not stressed.

Various tables of physical and math constants are printed at the end of the book. An extensive list of conversion factors (mass, force, electricity, etc.) is among them.

A.R.R.L. ANTENNA BOOK (Seventh Edition), American Radio Relay League, W. Hartford, Conn. 6½ x 9½ inches, 344 pages. \$2 in U. S.; \$2.25 elsewhere.

Every ham will find this book useful, since there is no substitute for a good transmitting antenna. It is a comprehensive treatment, well illustrated and arranged. It shows how to design various antenna types, how to support them, how to paint the mast, how to drive a rotary beam—and much other practical information.

The discussion starts with fundamentals of propagation and radiation, with instructions for making directive arrays and multiband antennas. A lengthy chapter on transmission lines covers this subject so that it is no longer a mystery. It shows how to couple to antenna and rig, how to make measurements, how to reduce harmonics. All design may be done from the many charts and tables.

Separate chapters discuss antennas for specific bands. Even TV antennas are discussed under v.h.f. Support and construction of any type antenna is well described with drawings and photos of actual masts and towers. The last chapter is devoted to mobile antennas (loops, whips, etc.).

APPLIED ELECTRONICS (Second Edition), by Truman S. Gray. The Technology Press and John Wiley & Sons, Inc., 440 4th Ave., New York 16, N. Y. 6 x 9 inches, 881 pages. \$9.

This can be considered a basic course with emphasis on principles rather than applications. The wide range of electronics is covered in a logical manner, starting with facts about the electron and proceeding to tube and transistor circuits. No higher mathematics is used, but equations and charts appear freely.

The first chapter discusses the electron and its motion, electron optics and fields. Emission and conduction are next described.

Circuits are covered in separate chapters and grouped in the order: amplifiers, oscillators, modulators. These chapters are well illustrated and fully explained with the aid of equations. The last chapter is on crystal diodes and triodes. **END**

SENDING SPEED
CODE RECEIVING

Be a "key" man. Learn how to send and receive messages in code by telegraph and radio. Commerce needs thousands of men for jobs. Good pay, adventure, interesting work. Learn at home quickly through famous Candler System. Quality for Amateur or Commercial License. Write for FREE BOOK.
CANDLER SYSTEM CO.
Dept. 3M, Box 928, Denver 1, Colo., U.S.A.

RCA INSTITUTES, INC.
A service of Radio Corporation of America
350 West 4th St., New York 14, N. Y.

OFFERS COURSES IN ALL TECHNICAL PHASES OF RADIO, TELEVISION, ELECTRONICS
Approved for Veterans
Write Dept. RE-55 for Catalog

TV REPAIRMEN EARN TOP MONEY!

IN JUST 12 MONTHS, COMPLETE TV SERVICE TRAINING, INCLUDING COLOR TV. Streamlined course gives you all essentials for a good job as service technician. Graduates in great demand; jobs are plentiful in this growing field. Other electronic courses in radio operation and maintenance. Day or evening classes. Opportunity for employment in local industry. Approved for Korean veterans.

Write for Catalog 111 Today

INDIANAPOLIS ELECTRONIC SCHOOL
312 E. Washington, Indianapolis 4, Ind.

TELEVISION
PREPARE FOR A GOOD JOB!
BROADCAST ENGINEER
ELECTRONICS
RADIO SERVICING

Television Servicing

(Approved for Veterans)
SEND FOR FREE LITERATURE
BALTIMORE TECHNICAL INSTITUTE
1425 EUTAW PLACE, BALTIMORE 17, MD.

ELECTRONICS
Prepare for un-limited opportunities in electronics B.S. degree in 27 months. Intensive, specialized courses. Math, electrical engineering, TV, advanced radio theory & design, Mod. labs. Low tuition. Self-help. Also Aeronautical, chemical, Civil, Electrical, Mechanical Engineering, G.I. approved. Enter Dec., Mar., June, Sept. Catalog.
INDIANA TECHNICAL COLLEGE
1511 E. Washington Blvd., Fort Wayne 2, Ind.

GET INTO ELECTRONICS

You can enter this unovercrowded, interesting field. Defense expansion, new developments demand trained specialists. Study all phases radio & electronics theory and practice: TV; FM; broadcasting; servicing; aviation, marine, police radio. 18-month course. Graduates in demand by major companies. H.S. or equivalent required. Begin Jan., March, June, Sept. Campus life. Write for catalog.
VALPARAISO TECHNICAL INSTITUTE
Dept. C Valparaiso, Ind.

Get Your **F.C.C. LICENSE** Quickly!
Guaranteed preparation. In a MINIMUM OF TIME, for F.C.C. commercial operator examinations. Our highly specialized training is available by correspondence, or in resident classes in
WASHINGTON, D.C. and HOLLYWOOD, CALIF.
Write for our free booklet with complete details.
GRANTHAM School of Electronics
Dept. 101-X, 737 11th Street S.W., Washington 1, D.C.

RADAR

Our school is now introducing a correspondence course in Radar, Microwaves, and Loran. Get your FCC endorsement, high paying job in industry as a radar technician. Special introductory offer. Write
PROGRESSIVE ELECTRONICS INSTITUTE
P.O. Box 27764 Los Angeles 27, Calif.

RADIO SCHOOL DIRECTORY

MORE JOBS than graduates
Electronic Engineers
Excellent opportunity for professional growth and advancement in exciting and growing field.

Demand for our engineering graduates exceeds supply. *Effective placement service.* Study in this world-famed college established 1884. Quarters start Jan., March, June, Sept. Approved for Veterans.

Bach. Sc. degree in 27 months
Complete Radio Eng. course includes TV, UHF and FM. Also Mech., Civil, Elec., Chem., Aero. and Adm. Eng.; Bus. Adm.; Acct. Small classes. Well-equipped labs. Modest costs. Prep. courses. Write *Jean McCarthy, Director of Admissions, for Catalog, View Book and "Your Career" Book.*

TRI-STATE COLLEGE
24115 College Avenue, Angola, Indiana

LEARN TV SERVICING
Send for free 24-page illustrated booklet which tells you how to become a successful TV technician. America's leading TV servicing school offers you a specialized training program that omits non-essential math & design theory. You concentrate on radio & TV servicing only. You get professional training & experience right in our fully-equipped shops & laboratories. Write Dept. E-11-55
Approved for Veterans
WESTERN TELEVISION INSTITUTE
341 W. 18th St. Los Angeles 18, Calif.

To help you **MOVE AHEAD in INDUSTRIAL ELECTRONICS**

This Library makes plain methods used by today's electronics engineers

HERE'S a Library to help you prepare for a top job in the booming industrial-electronics field. . . help you save time and work in your present job. Experts give you basic theory, practices, and methods. They explain electronic circuits and devices, vacuum tubes, the analysis and use of electron-tube circuits, and provide a vast amount of other data on electronic equipment!

INDUSTRIAL ELECTRONICS ENGINEERING LIBRARY

4 volumes, 1998 pages, 1637 charts, diagrams, and illustrations
\$24.95—payable on EASY TERMS

In this Library are the sort of practical facts that can help you step out in front of the "average" electronics man—they give the kind of help that could very well mean a top-paying job in electronics work.

You get practical data on electronic instrumentation, a wealth of facts on vacuum tubes, useful information on electron-tube circuits, and the basic laws of electronic motion. The basic knowledge here can be applied in radar, television, pulse communication, and a wide variety of general electronic control. Use coupon below for free trial—no obligation.

EASY TERMS • 10-DAY FREE TRIAL

4 Big Volumes
Cage's THEORY AND APPLICATION OF INDUSTRIAL ELECTRONICS
Harman's FUNDAMENTALS OF ELECTRONIC MOTION
Spangenberg's VACUUM TUBES
Seely's ELECTRON-TUBE CIRCUITS

McGraw-Hill Book Co. Attn: H. W. Buhrow.
Industrial & Business Book Dept.
327 W. 41st St., New York 36, N. Y.

Send the *Industrial Electronics Engineering Library* for 10 days' examination on approval. In 10 days, I will send \$4.95 then \$4.00 monthly until low price of \$24.95 is paid. If not wanted, I will return books postpaid.

PRINT Name.....
Address.....
City..... Zone..... State.....
Employed by.....
For price and terms outside U. S., write McGraw-Hill Int'l., N. Y. C. RE-11

Become an **ELECTRICAL ENGINEER**

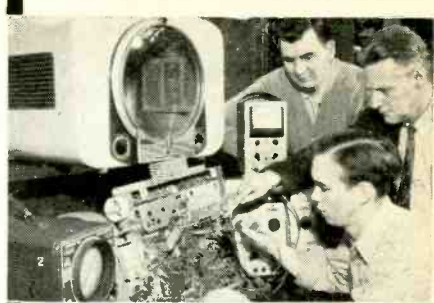

Major in Electronics or Power BS Degree in 36 months
Prepare now for a career as an electrical engineer or engineering technician — and take advantage of the many opportunities in these expanding fields.

You can save a year by optional year 'round study. Previous military, academic, or practical training may be evaluated for advanced credit.

WESTERN TELEVISION INSTITUTE
341 W. 18th St. Los Angeles 18, Calif.

Enter Radio and Television — courses 12 to 18 months

You can be a radio technician in 12 months. In an additional 6-months you can become a radio-television technician with Associate in Applied Science degree. Color television instruction is included in this program.

These technician courses may form the first third of the program leading to a degree in Electrical Engineering. Twenty-one subjects in electronics, electronic engineering and electronic design are included in these courses.

Courses also offered: radio-television service (12 mos.); electrical service (6 mos.); general preparatory (3 mos.).

Terms — January, April, July, September

Faculty of specialists. 50,000 former students—annual enrolment from 48 states, 23 foreign countries. Non-profit institution. 52nd year. Courses approved for veterans. Residence courses only.

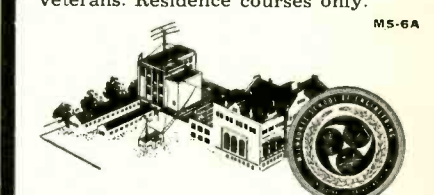

MILWAUKEE SCHOOL OF ENGINEERING

MILWAUKEE SCHOOL OF ENGINEERING
Dept. RE-1155, 1025 N. Milwaukee Street
Milwaukee 1, Wisconsin
Send FREE illustrated booklets
 Career in Electrical Engineering,
 Career in Radio-Television.

I am interested in..... (name of course)
Name..... Age.....
Address.....
City..... Zone..... State.....
City..... Zone..... State.....
If veteran, indicate date of discharge.....

Only the 5 TOP QUALITY brands of

STANDARD BRAND TUBES

AT SENSIBLE PRICES!

All tubes are dependable quality, factory-fresh TV stock. Each tube carries a dual guarantee. Standard factory RTMA guarantee and Barry's own guarantee of positive customer satisfaction. Be SAFE! Buy BARRY!

- Individually boxed, First quality only, Latest dating, Standard RTMA guarantee, No private brands, No rejects, No rebrands or rewashed bargains

FREE! Newest handy air-mail order form printed in carbon snap-out sets for your ordering convenience. Lists over 400 popular replacement types. Write for your free copy today!

- Lists ALL popular TV & radio types, Makes mail-ordering a real pleasure, All tube orders over \$25.00 (with remittance) postpaid. Overnight shipment.

SPECIAL-PURPOSE TUBES

Write for our complete listing on Transmitting, Industrial Special-Purpose Tubes, and Crystal Diodes. We STOCK over 2000 types at excellent prices.

INFRA-RED TUBES & PARTS SNOOPERSCOPE TUBE. Supersensitive. Converts invisible infra-red rays into a bright image. Sees in total darkness.

- Type CRI-143 either type, SPECIAL CRI-147 SPECIAL \$3.95

INFRA-RED FILTER, Snap-on type. For extremely sharp images. SPECIAL EACH \$1.05

7MWT HI-VOLTAGE CONVERTER. Miniature type. Hermetically sealed. Capable of delivering 6000 VDC (low current). Operates from a single standard size-D flashlight cell. Includes circuit diagram & complete application instructions describing use in portable power supplies for snooperscopes, photo-flash units, geiger counters, etc. NET EACH \$12.50

SELSYN INDICATOR ASSEMBLIES

110 volt, 60 cycle. Perfect trackers. Ideal for antenna rotation and direction indicator systems. May be used as light duty remote control antenna rotator. Completely enclosed in machining aluminum. Mounted on small chassis with 90° rotating dial face and pointer on front. Equipped with 2 bulb indicator light system complete with dimmer control and 6.3 volt step down transformer. Made by Bendix. Type XV. Cal-11900A - 78386. Used, but in guaranteed perfect condition. SPECIAL PER PAIR \$9.75 QUANTITY LIMITED (Net each \$5.00).

RACK PANELS for above. Standard size by 1 1/2" high. Metallic grey enameled finish. EACH \$ 7.95

DIRECTRON SELENIUM RECTIFIERS

Table with columns: Max. Amps, 18VAC, 14VDC, 36VAC, 28VDC, 54VAC, 42VDC, 72VAC, 56VDC, 130VAC, 100VDC. Rows for 1, 2, 3, 4, 6, 10, 12, 20, 24, 30, 36, 50, 100 amp types.

We build other Selenium Rectifiers, Transformers and Chokes to your specifications. Buy from the Direct Source for Quick Delivery.

NEW RECTIFIER TRANSFORMERS

1 Amp.....\$ 5.75, 2 Amps.....\$ 6.75, 5 Amps.....\$ 8.75, 12 Amps.....\$ 16.85, 24 Amps.....\$ 35.65, 50 Amps.....\$ 59.00, 100 Amps.....\$ 108.00

NEW RECTIFIER CHOKES

Continuous Ratings: 1 Amp .1 Hy. 1.5 ohm. \$ 4.95, 2 Amps .04 Hy. .9 ohm. 5.95, 4 Amps .07 Hy. .6 ohm. 7.95, 12 Amps .01 Hy. .1 ohm. 14.95, 24 Amps .004 Hy. .025 ohm. 29.95, 50 Amps .005 Hy. .01 ohm. 54.00

FILTER CAPACITORS

Table with columns: Capacity, W. Voltage, Each. Rows for 500 MFD (200 V, \$1.95), 1000 MFD (50 V, .85), 1000 MFD (50 V, .35), 2000 MFD (50 V, 2.25)

2 COLOR TUBE CARTONS

Keeps your tube stock neat. New safety partition prevents tube breakage. Distinctively lithographed in glossy red and black. The most distinctive tube carton available today. Minimum quantity: 100 of any one size. Write for case lot quantity prices.

Table with columns: SIZE, FOR TUBE TYPES, PER 100. Rows for Miniature, GT, Large GT, Large G

NEW! White glossy boxes without printing (completely blank) otherwise same as above. Same high quality, same prices. Specify "White".

TERMS: 25% deposit with order, balance C.O.D. All merchandise Guaranteed. F.O.B. N.Y.C.

BARRY ELECTRONICS CORP. Dept. RE 512 Broadway N.Y. 12, N.Y. Phone: WAlker 5-7000

ADVERTISING INDEX

Radio-Electronics does not assume responsibility for any errors appearing in the index below.

Table listing various companies and their page numbers, including Aero Products Co., Airex Corp., Alliance Manufacturing Co., Allied Radio Corp., Alma Radio Co., American Electrical Heater Co., etc.

Table listing various companies and their page numbers, including Rohn Manufacturing Co., Ronette Corp., Ross (Karl F.), Sams (Howard W.) & Co., Inc., Saco Manufacturing Co., Service Instruments Co., etc.

Table listing companies and their page numbers, including EBY Sales Co., Edie Electronics, Electro-Voice, Inc., Electronic Instrument Co. (EICO), etc.

Table listing companies and their page numbers, including Mallicrafters Co., Hawkins (P. E.) Co., Heath, Hershel Radio, Huckert Electronics, etc.

Table listing companies and their page numbers, including Lafayette Radio, Lektron Specialties, Leotone Radio Corp., LMB

Table listing companies and their page numbers, including Macmillan Co., Major Grand Tube Co., Mallory (P. R.) & Co., McGraw-Hill Book Co., etc.

Table listing companies and their page numbers, including National Co., National Electronics of Cleveland, National Radio Institute, etc.

Table listing Opportunity Adlets 132-133

Table listing companies and their page numbers, including Perma-Power Co., Permo, Inc., Phaoston Co., Pickering & Co., Inc., etc.

Table listing companies and their page numbers, including Quam-Nichols, Quietrole Co., RCA Institutes, Inc., Radiart Corp., etc.

Table listing companies and their page numbers, including Radio Corp. of America (Test Equipment), Radio Corp. of America (Tube Division), Radio City Products, Radio Receptor, Inc.

RADIO SCHOOL DIRECTORY PAGE 163

Table listing educational institutions and their page numbers, including Baltimore Technical Institute, Candler System Co., Grantham School, etc.

Table listing companies and their page numbers, including Radio-Television Training Association, Rad-Tel, Rauland-Borg Corp., etc.

When Writing to Advertisers

Always Mention

RADIO-ELECTRONICS

DON'T THROW OLD RADIOS AWAY!



Here's the data you need to fix them FAST—good as new!

Just look up the how-to-do-it data on that old radio you want to fix! Four times out of 5, this giant, 3 1/2-pound, 744-page Ghirardi RADIO TROUBLESHOOTER'S HANDBOOK gives exactly the information you need to fix it in a jiffy. Tells what is likely to be causing the trouble... shows how to fix it. No useless testing. No wasted time. Handbook covers common troubles and their remedies in practically every radio receiver model made by 202 manufacturers between 1925 and 1942. Using it, even beginners can easily fix old sets which might otherwise be thrown away because service information is lacking. With simple repairs, most of these old sets can be made to operate perfectly for years to come.

THE ONLY GUIDE OF ITS KIND! Gets service time in half!

Included are common trouble symptoms and their remedies for over 4,800 models of old home, auto radios and record changers, Airline, Apex, Arvin, Atwater Kent, Belmont, Bosch, Brunswick, Clarion, Crosley, Emerson, Fada, G.L. Kolster, Majestic, Motorola, Philco, Pilot, RCA Silvertone, Spartan, Stromberg and dozens more. Gives how-to-do-it data on SPECIFIC jobs—NOT general theory. Includes hundreds of pages of tube and component data, service short cuts, etc. No longer available from any other source still in print.

TRY IT 10 DAYS . . . at our risk!

Dept. RE-115, RINEHART & Co., Inc. 232 Madison Ave., New York 16, N.Y. Send Rinehart's RADIO TROUBLESHOOTER'S HANDBOOK for 10-day free examination. If I decide to keep book, I will then remit the full price of only \$6.50 plus a few cents postage. Otherwise, I will return book postpaid and owe you nothing.

NAME, ADDRESS, CITY, ZONE, STATE. Outside U.S.A.—Price \$7.00, cash only. Same return privilege. Rinehart Books are sold by leading book stores

...STOP UNWANTED SOUNDS

with the NEW **664** VARIABLE D*



CARDIOID

for P.A.



Now... Broadcast Performance Designed for Public Address

COMPLETELY NEW ALL-PURPOSE CARDIOID DYNAMIC MICROPHONE BRINGS NEW EFFICIENCY OVER WIDE FREQUENCY RANGE

All the advantages of the E-V Variable D* are now available in the new high-fidelity "664"...for public address, recording, communications and similar applications. Uniform cardioid polar pattern provides high front-to-back discrimination against unwanted sounds, without close-talking boominess. Easily solves sound pick-up and reproduction problems under a great variety of conditions. Gives distinct, natural reproduction of voice and music. Increases working distance from microphone. Gives greater protection against feedback. Especially useful where ambient noise and severe reverberation exist. Pop-proof filter minimizes wind and breath blasts. E-V Acoustalloy diaphragm guarantees smooth wide-range reproduction. Can be used on a floor or desk stand or carried in the hand. No finer microphone for performance and value! *Write for Technical Specification Sheet.*

*EV Pat. Pend.

Model 664. Variable D* Super-Cardioid Dynamic Microphone. Uniform response at all frequencies from 60 to 13,000 cps. Output level -55 db. 150 ohm and high impedance. Impedance changed by moving one connection in connector. Line balanced to ground and phased. Acoustalloy diaphragm, shielded from dust and magnetic particles. Alnico V and Armco magnetic iron in non-welded circuit. Swivel permits aiming directly at sound source for most effective pick-up. Pressure cast case. 3/8"-27 thread. Satin chrome finish. 18 ft. cable with MC4M connector. On-Off switch. Size: 1 1/4 in. diam. 7 1/8 in. long not including stud. Net wt.: 1 lb. 10 oz. List Price **\$79.50**

Model 419 Desk Stand available for use with the "664" (extra).



Electro-Voice®

ELECTRO-VOICE, INC. • BUCHANAN, MICH.

Export: 13 East 40th Street, New York 16, N. Y. U. S. A. Cables: Arlab

HOW YOU CAN BUILD NEW BUSINESS AND BIGGER PROFITS WITH RCA

Silverama

SUPER-ALUMINIZED PICTURE TUBES!

Take an active part in RCA's powerful sales promotion and advertising campaigns in your neighborhood now!

RCA's campaigns to introduce "SILVERAMA" are the most dynamic sales stimulators in picture tube history. Make your store "sales headquarters" for RCA "SILVERAMA" in your own neighborhood. Join successful hands with RCA and your RCA Tube Distributor. Use these *sell-powered* advertising and sales promotion materials to increase your business, prestige, and profits . . . now!



Window Display Kit, Streamers, and Hanger . . . dramatic, eye-catching traffic stoppers! These tell your neighbors *your store* is "Hq" for the great new "SILVERAMA" Picture Tube!

SALES PROMOTION

Merchandising Booklet . . . the top secrets of "putting on a good front" window display are revealed to you. Shows you how to "stop them . . . so you can sell them!"



Direct Mail Piece . . . handy self-mailer or envelope stuffer. Ties your name and shop in with RCA "SILVERAMA" national advertising campaigns!



ADVERTISING

National Magazines . . . "Advertised in Life" . . . and in TV Guide! Important, consistent big ads in these top magazines tell your customers about the wonders of RCA "SILVERAMA." Be ready for the demand. Contact your RCA distributor!



Local Newspapers . . . ad mats available to your distributor will feature names and addresses of service-dealers handling RCA "SILVERAMA". Be sure *your name* is on the list. Contact your RCA Tube Distributor!

Radio and TV . . . "Milton Berle" and "Martha Raye" coast-to-coast TV Shows, and network radio programs such as "Monitor", and "Fibber McGee and Molly" will bring the RCA "SILVERAMA" story right into your customers' homes . . . send them to your shop. Be ready. Contact your RCA Tube Distributor!

There's more, too! And your RCA TUBE DISTRIBUTOR has the complete story. Cash in on the new, dynamic RCA "SILVERAMA" campaign. SEE YOUR RCA TUBE DISTRIBUTOR NOW!



RADIO CORPORATION of AMERICA
TUBE DIVISION
HARRISON, N. J.