

\$1.25 ■ OCTOBER 1979

Radio-Electronics

ANNIVERSARY



ISSUE

THE MAGAZINE FOR NEW IDEAS IN ELECTRONICS

GERNSBACK PUBLICATIONS

HOUSE LOGIC CONTROL

Build This System For Your Home

RADIATOR MONITOR

Warns When Your Car's Radiator Water Is Low

SATELLITE TV

Frequencies, Reception Problems, What An Earth Station Looks Like

DIGITAL VCR CIRCUITS

More On How They Work

BAR-GRAPH CONTEST

The Winning Circuits

DRUM SYNTHESIZER

Accessories Make It Better

PLUS

Hobby Corner
Computer Corner
Service Clinic
R.E.A.L. Sound Lab Reports
Communications Corner
Equipment Reports

TODAY PLUS 50
Electronics in 2029

LOOKING BACK
R-E's First 50 Years

PROGRESS
Yesterday To Today

LIGHTS THAT FAILED
Great Inventions That Never Were

FOUNDER
The Great Hugo

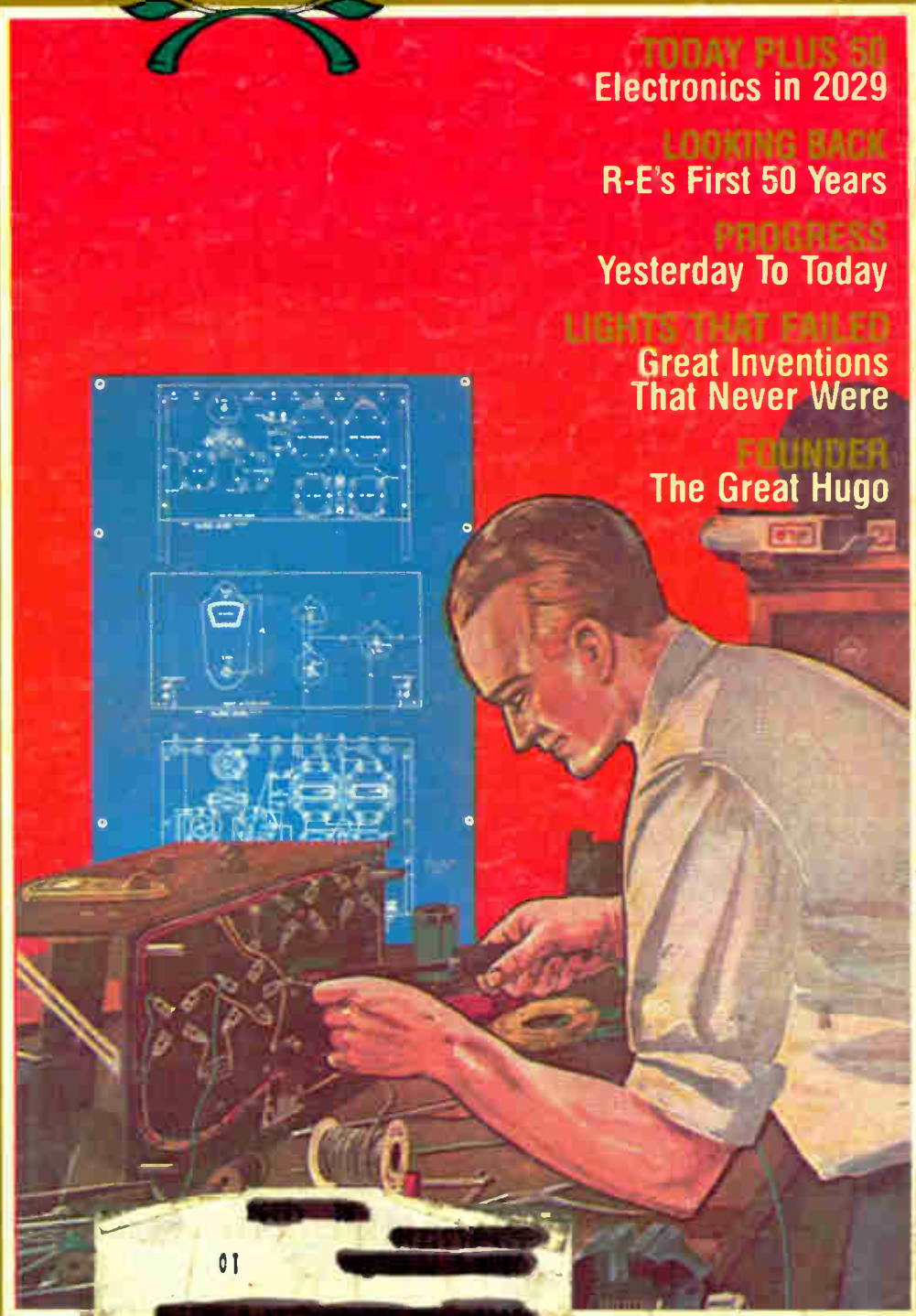

Tomorrow's tools. For today's problems.

You might say we make time machines. CSC's smarter tools for testing and design help you make the most of your time in every corner of electronics, by working *smarter* instead of harder, for far less than you'd expect.

We give your head a head start with a variety of solderless breadboarding systems that let you translate ideas directly into working circuits, as fast as you can think.

We offer the most logical way to test logic — The Logical Force™ — portable, circuit-powered digital instruments that dramatically cut the time (and cost) of diagnosing state-oriented logic. Available singly or in Logical Analysis Test Kits. The Logical Force

simplifies design, maintenance, field service, education... wherever you need logical answers at a logical price.

Also instrumental in making life easier are CSC's value-packed test instruments. Including palm-size frequency counters that go from audio to past 550 MHz. Our Ultravari-able Pulse Generator™ that lives up to its name with a range of 0.5Hz to 5 MHz and a duty cycle variable over ten-million-to-one. A function generator whose VCO is externally sweepable over 100:1.

There's a lot more, too. All in our new 38-page catalog, crammed full of smarter ideas in testing and design. Send for your free copy today.



Smarter tools for testing and design.

CONTINENTAL SPECIALTIES CORPORATION



Call toll-free for details
1-800-243-6077
8:30AM-5PM Eastern Time

70 Fulton Terr. New Haven CT 06509 (203) 624-3103 TWX 710 465-1227
OTHER OFFICES: San Francisco (415) 421-8872 TWX 910 372 7992
Europe: CSC UK LTD Phone Saffron-Walden 0799 21682 TLX 817477
Canada: Len Finkler Ltd. Ontario

Available at selected local distributors. © Copyright 1979 Continental Specialties Corporation

CIRCLE 37 ON FREE INFORMATION CARD

Here it is at last... **THE FIRST
FLOPPY DISK BASED COMPUTER
FOR UNDER \$1000**



The C1P MF
\$995

- Complete mini-floppy computer system
- 10K ROM and 12K RAM
- Instant program and data retrieval

The Challenger 1P Mini-disk system features Ohio Scientific's ultra-fast BASIC-in-ROM, full graphics display capability and a large library of instant loading personal applications software on mini-floppies including programs for entertainment, education, personal finance, small business and now *home control!*

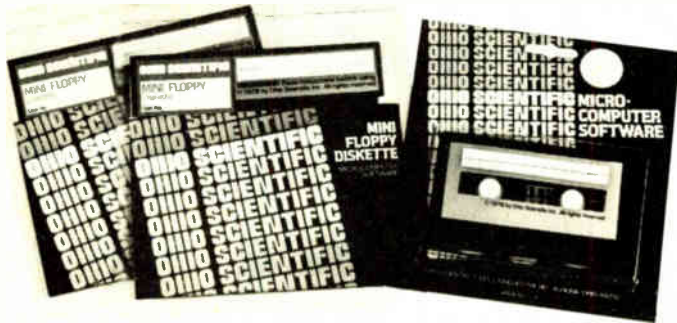

The C1P MF configuration is very powerful. However, to meet your growth needs it can be directly expanded to 32K static RAM and a second floppy by simply plugging these options in. It also supports a printer, modem, real time clock and AC remote interface as well as the OS-65D V3.0 development oriented operating system.

Or Start with the C1P
**CASSETTE BASED
Computer for just \$349.**

The cassette based Challenger 1P offers the same great features of the mini-disk system including a large software library except it has 4K RAM and conservative program retrieval time. Once familiar with personal computers, you'll be anxious to expand your system to the more powerful C1P MF.

You can move up to mini-disk performance at any time by adding more memory and the disk drive. Contact your local Ohio Scientific dealer or the factory today.

*Both systems require a video monitor, modified TV or RF converter and home television for operation. Ohio Scientific offers the AC-3 combination 12" black and white TV/monitor for use with either system at \$115.00 retail.

All prices, suggested retail.

OHIO SCIENTIFIC

1333 S. CHILLICOTHE RD., AURORA, OHIO 44202 (216) 562-3101

At 1 $\frac{7}{8}$, it outperforms other cassette decks. At 3 $\frac{3}{4}$, it's in the open-reel class. B-I-C introduces the T-4M. With full metal tape capability, and performance so unprecedented it puts cassette technology on a new plane. Thanks to B-I-C's exclusive Broadband Electronics, at 1 $\frac{7}{8}$ ips the T-4M ranks with the world's finest cassette decks. At 3 $\frac{3}{4}$, it challenges even expensive open reel machines. The numbers speak for themselves: guaranteed frequency response of 20 Hz to 23 kHz \pm 3dB at 3 $\frac{3}{4}$ on 70 μ Sec tape (20 Hz to 21 kHz at 1 $\frac{7}{8}$!). For complete literature write B-I-C/Avnet, Dept. T, Westbury, N.Y. 11590. **The new T-4M Two-Speed Cassette Deck.**



TM

Say "Bee-Eye-Cee". Think "Best-In-Components."

Series Z Changer-Turntables | Cassette Decks | SoundSpan™ Speaker Systems | The Beam Box®

CIRCLE 64 ON FREE INFORMATION CARD

Radio-Electronics®

THE MAGAZINE FOR NEW IDEAS IN ELECTRONICS

Electronics publishers since 1908 OCTOBER 1979 Vol. 50 No. 10



SPECIAL SECTION

- 39 **50TH ANNIVERSARY ISSUE**
32 pages lead you through a memorable look at the past 50 years and the next 50 years.

BUILD ONE

- 75 **Automate Your Home**
A programmable control system you can tailor to your own home. **Noel Nyman**
- 94 **Automotive Radiator Monitor**
Don't get stranded! This device tells you when your car's coolant level is low. **L. Steven Chaeira**
- 96 **Headroom Test Generator**
Find out how much undistorted power your hi-fi amplifier can deliver above its power rating. **Doug Farrar**
- 98 **Percussion Synthesizer Accessories**
3 accessories that greatly expand PerSyn's capabilities. **James J. Barbarello**

VIDEO

- 81 **Home Reception via Satellite**
What an earth station looks like and some of the reception problems. **Bob Cooper**
- 109 **Digital Logic in Videocassette Recorders**
A look at the digital circuitry and how it works. **Forest Belt**
- 136 **Service Clinic**
Test jigs—what they are and how they're used **Jack Darr**
- 138 **Service Questions**
R-E's Service Editor solves service problems

AUDIO

- 101 **All About Microphones**
The different types, specifications and how to select the best one. **Len Feldman**
- 104 **R.E.A.L. Sound Lab Tests Tandberg TR-2080 Receiver**
Top-of-the-line receiver rates excellent. **Len Feldman**
- 107 **R.E.A.L. Sound Lab Tests Audio Pulse Model Two**
This digital time delay can simulate a concert hall. **Len Feldman**

TECHNOLOGY

- 4 **Looking Ahead**
Tomorrow's news today. **David Lachenbruch**
- 90 **Bar-Graph Display Contest Winners**
The 8 best applications
- 114 **Hobby Corner**
A mystery circuit puzzle plus much, much more **Earl "Doc" Savage, K4SDS**
- 118 **Communications Corner**
A look at an inexpensive FM deviation meter. **Herb Friedman**
- 126 **State-Of-Solid-State**
A new A/D Interface for microprocessors. **Karl Savon**

EQUIPMENT

- 24 **Fluke 8010A/8012A Digital Multimeters**
- 26 **Bearcat Thin Scan Portable Scanner**
- 32 **Alco 2000A LCD Digital Multimeter**
- 34 **Pace EZ Phone Wireless Telephone**

DEPARTMENTS

- | | | | |
|-----|----------------------------|-----|------------------------------|
| 176 | Advertising Index | 145 | Stereo Products |
| 14 | Advertising Offices | 147 | New Products |
| 6 | What's News | 149 | New Lit |
| 14 | Editorial | 150 | Books |
| 16 | Letters | 151 | Next Month |
| 122 | Radio Products | 152 | Market Center |
| 134 | Computer Products | 177 | Free Information Card |

ON THE COVER

The photograph shows the front cover of the first issue of **Radio-Craft** (which eventually changed its name to **Radio-Electronics**). That first issue was printed in 1929 and to celebrate this occasion, we've put together a memorable look at those 50 years. The voyage starts on page 39.



Radio-Electronics, Published monthly by Gernsback Publications, Inc., 200 Park Avenue South, New York, NY 10003. Phone: 212-777-6400. Controlled Circulation Postage Paid at Concord, NH. One-year subscription rate: U.S.A. and U.S. possessions, \$9.98, Canada, \$12.98. Other countries, \$14.98. Single copies \$1.25. © 1979 by Gernsback Publications, Inc. All rights reserved. Printed in U.S.A. (ISSN 0033-7862)

Subscription Service: Mail all subscription orders, changes, correspondence and Postmaster Notices of undelivered copies (Form 3579) to Radio-Electronics Subscription Service, Box 2520, Boulder, CO 80322.

A stamped self-addressed envelope must accompany all submitted manuscripts and/or artwork or photographs if their return is desired should they be rejected. We disclaim any responsibility for the loss or damage of manuscripts and/or artwork or photographs while in our possession or otherwise.

As a service to readers, Radio-Electronics publishes available plans or information relating to newsworthy products, techniques and scientific and technological developments. Because of possible variances in the quality and condition of materials and workmanship used by readers, Radio-Electronics disclaims any responsibility for the safe and proper functioning of reader-built projects based upon or from plans or information published in this magazine.

looking ahead

Satellite explosion: Suddenly, satellite channels available for private use in the United States are being more than doubled. At the end of July, 72 transponders were available for hire. Now, as a result of two FCC actions, it appears certain that domestic satellite capacity will reach 180 transponders by the end of this year. The Commission's two actions: (1) It ended a three-year moratorium on the use of AT&T's Comstar satellite system for private-line use. (2) It approved the launch of a third Western Union Westar satellite. As the result of these two moves, it now appears certain that FCC will give RCA the go-ahead to launch its third Satcom bird in December.

Most of the new transponders available on the satellites probably will be used for television—cable-TV systems now receive pay-TV and "superstation" programming via satellite, along with an occasional special. Public Broadcast System (PBS) uses satellites to interconnect both its television and radio affiliates. The Holiday Inn chain has decided to erect its own earth stations to receive Home Box Office programming, and this is expected to touch off a new video rush among other major hotel-motel chains. AT&T currently interconnects the commercial stations via microwave, and it presumably will supplement this nationwide grid with satellites, at substantial cost savings. The new proliferation of birds is expected to spark many more TV uses, including portable earth stations to transmit sporting and news events.

When will the public have unquestioned legal access to satellites for direct TV viewing? At presstime, the question was still up in the air (perhaps about 22,300 miles up). The Commission is considering "decontrol" of earth stations—which would mean no license or special permission would be required to build or operate one—and there are some who feel that its current control of receiving facilities wouldn't withstand a court test, anyway. While the FCC currently says it won't license earth stations for regular consumer viewing, it's known that many manufacturers (and some large retail chains) are preparing to offer low-cost consumer earth stations when the day arrives. How low? We've heard such estimates as "eventually under \$1,000." Not yet, though.

TV's bill of health: After 10 years of study, investigations and hearings by itself and its predecessor organization, the federal Consumer Product Safety Commission has ruled that no government standards are necessary for television receiver safety. Two years ago, the CPSC dropped proposals for three standards—mechanical hazards, implosion and shock—on the grounds they weren't necessary, leaving pending only proposals for fire-safety regulations. In 1977, the television manufacturing industry adopted its own strict fire code. In dismissing the proceeding, the commission decided the fire hazard is now so low no government regulations are necessary.

"More than 95% of the requirements contained in the recommended federal standard" are in the industry's voluntary code, the CPSC said. A comparison of fire incidents involving 1975-1977 sets with more recent data showed that the risk had been reduced fourfold. The major advance is adoption of new plastic cabinet materials which not only make it difficult to start a fire, but actually extinguish any that could start.

1979 TV boom: Despite the constant threat of a recession, the public bought more 1979-model color TV sets

than any other models in history, passing the 10-million mark for the first time in any model year. The 10.3 million color sets sold represented a 4.8% increase over the number of 1978-model sets sold. Black-and-white sales enjoyed a resurgence, 6.2 million sets, exceeding the preceding year's number by 7.2%. Some 439,434 home videocassette recorders were sold during 1979.

Another VCR format: N.V. Philips, the Holland-based electronics giant, has introduced a completely new home videocassette recording system for the European market and says it will have a U.S. (NTSC color standard) version in about a year. The *Video 2000* system was designed for flexibility in adapting to new developments, such as metal tape, stereo sound and special control signals. The cassette, about the same size as a VHS type, contains half-inch tape and can record for up to eight hours on two quarter-inch helically scanned tracks. Like Philips' audio cassette, it is turned over after one track is recorded or played. Future recorder models obviously will have an auto-reverse feature to eliminate the turn-over operation.

Perhaps the most noteworthy development in the new system is the inclusion of a *Dynamic Track Following* circuit that uses auxiliary signals to assure that the head is properly positioned on the tape both for recording and playback for complete compatibility, and to provide clean, noiseless slow-, fast- and stop-motion. The cassette has special indexing tabs to adjust the recorder for either chrome or metal tape (the latter not yet available.). The tape has two auxiliary signal tracks (not used in the first machines).

Philips' first VCR designed for the new system has a micro-processor wireless remote-control system that not only governs the record and play functions, but tunes in broadcast channels, can locate any segment of the tape by dialing up a four-digit figure corresponding to a number on the digital tape counter, and is used to pre-select any five programs over a 16-day period for automatic recording. The system was co-developed with Grundig, which is producing its own VCR models. It's incompatible with all other home VCR systems in use, including Philips' previous system. Magnavox, Philips subsidiary in the United States, currently sells VHS video recorders built by Matsushita of Japan. It's not yet clear whether Magnavox will offer a version of the Philips' system in this country.

One possibility offered by the *Video 2000* system is a compact portable VCR using one-quarter-inch tape—in effect, a single track instead of two parallel tracks. A Philips spokesman conceded that "in the system it is possible" to do this. Although such a shaved-down cassette wouldn't be compatible in size with the home recorder, conceivably an adapter could be made available to let the big machine scan the mini-cassettes.

Videodiscs rising: Prices of *Magnavision* videodisc players and MCA *DiscoVision* discs have been increased, long before nationwide marketing has been reached. Magnavox boosted the price of players to \$775 from \$695 and MCA hiked the price of some movie discs from \$9.95 to \$15.95, others from \$15.95 to \$24.95. RCA, which plans to introduce its own videodisc system in about a year, commented through a spokesman: "We still think a \$400 player and a \$10-to-\$17 disc are reasonable goals."

DAVID LACHENBRUCH
CONTRIBUTING EDITOR

Endorsement Battle

NEW PRODUCT

A famous golf star endorses the Lanier. Our unit is endorsed by our president. You'll save \$100 as a result.



We not only took the unit apart, we examined our competition as well.

Judge for yourself. That new Olympus micro recorder shown above sells for \$150. Its closest competition is a \$250 recorder called the Lanier endorsed by a famous golf star.

FANCY ENDORSEMENT

The famous golf star is a pilot who personally flies his own Citation jet. The Olympus recorder is endorsed by JS&A's president who pilots a more cost-efficient single engine Beachcraft Bonanza. The golf star does not endorse the Lanier unit for free. After all, a good portion of his income is derived from endorsing products.

Our president, on the other hand, does not get paid for endorsing products—just for selling them. And his Bonanza is not as expensive to fly as the golf star's Citation. In fact, our president also drives a Volkswagon Rabbit.

SOLD DIFFERENTLY

The Lanier is sold through a national network of direct salesmen similar to the IBM sales force. Naturally, these salesmen must be paid expenses and commission.

JS&A efficiently sells the Olympus through this advertisement—a very direct and inexpensive way to market a product.

With less overhead, no direct national sales staff, and no expensive endorsements, Olympus can sell its recorder for less money to JS&A. And with our company's efficiency, we can sell you practically the same recorder as the Lanier for much less—a savings of \$100.

Is the Olympus better than the Lanier for less money? We weren't sure, so we took them both apart and what we found amazed us. Other than a slight size difference, the units were practically identical. For example:

CORELESS MOTOR

Both units have the new coreless motor. Conventional motors require a long and heavy solid core that is wirewound. In a coreless motor, the windings are on the outside or stationary part of the motor making it flatter, yet it has greater initial torque and more consistent speed than any other conventional motor.

THE FERRITE HEAD

Both units use ferrite for their recording heads—the same material used in precision studio recorders. This extremely hard, diamond-like material will last a lifetime and prevents oxide build-up.

A NEW KIND OF MIKE

Both units also use an electret condenser microphone with automatic level control. In an electret system, the impedance of the microphone remains constant, thus passing on the natural sound quality of all frequencies without distortion. The Lanier is a clear recording with an extremely low signal-to-noise ratio, so you'll hear less objectionable background hissing or humming.

MANY SIMILAR FEATURES

Both units use the microcassette tapes that play 30 minutes per side. The Olympus measures only 1" x 2 1/2" x 4 7/8" and weighs only 9 ounces. The Lanier is the same weight as the Olympus and measures only 7/8" x 2 1/2" x 4"—practically the same size.

HERE'S OUR PLAN

But prove it to yourself. Order an Olympus recorder from JS&A. After you receive it, call in your Lanier sales representative. Have him bring you a sample of his unit. (You might even check to see what kind of car the salesman drives.) Then make a side-by-side comparison. Compare both units feature for feature



Micro cassettes are the newest recording medium. Each cassette will record for 30 minutes per side.

and see how much better the Olympus sounds. Then carry them both in your pocket and on trips. Use them at meetings or while you drive in your car. Really give them both a workout.

Then decide. If you don't feel that the Olympus is as good a unit or better than the Lanier for \$100 less, simply return the Olympus within 30 days for a prompt refund and then purchase the Lanier unit, keeping

one of our tapes as a gift. If you decide to keep the Olympus, consider yourself a smart shopper. Anyone who would take the time to read this advertisement and take the action to order and test the Olympus unit, deserves to save \$100.

SERVICE AT ITS BEST

Both the Lanier and the Olympus units are solidly backed by efficient service organizations. Olympus has an outstanding service-by-mail facility so no matter where you live, just slip your unit in its handy mailer and send it in. Olympus is the same company that manufactures high quality precision cameras and optics, and JS&A is America's largest single source of space-age products—further assurances that your modest investment is well protected.

To order your Olympus unit for our comparison trial, send your check for \$150 plus \$3.50 for postage and handling to: JS&A Group, Inc., One JS&A Plaza, Northbrook, Illinois 60062. (Illinois residents add 5% sales tax.) Credit card buyers may call our toll-free number below. We will promptly ship your unit, one free tape, complete instructions, and one-year warranty. If you wish to order additional cassettes, you may order them for \$3 each or \$15 for a package of five (our minimum quantity).

CONSUMERS CAN BENEFIT

Endorsements are very helpful when you sell products. They attract attention and give consumers confidence that their purchase is also used by someone famous. But indirectly, consumers pay for endorsements. They also pay for a large sales force and less efficient marketing methods.

When you purchase an Olympus from JS&A, you pay for just what you get. A great product. Why not order an Olympus recorder at no obligation, today?

JS&A PRODUCTS
THAT
THINK

Dept. RA One JS&A Plaza
Northbrook, Ill. 60062 (312) 564-7000
Call TOLL-FREE 800 323-6400
In Illinois Call (312) 564-7000

© JS&A Group, Inc., 1979

Solar Cell 25 years old

The first practical device for converting sunlight directly into useful electric power was invented by three Bell Labs scientists just 25 years ago. It was described completely, with a cover picture, in August 1954 issue of **Radio-Electronics**.



BELL LABS SCIENTISTS Gerald L. Pearson, Daryl M. Chapin and Calvin S. Fuller, checking and comparing several cells under a controlled light source during the development of the solar cell. All three scientists are now retired.

Though it was known in the 1800's that light could produce electricity, it was not until semiconductors came under intense study that practical solar cells were developed. The Bell Labs cell was made of silicon, and produced its voltage across a PN junction. A large number of cells—thin sheets of silicon about 2 inches long and 1/2-inch wide—connected in an array about a yard square, produced 50 watts of electricity, with a conversion efficiency of 6 percent.

Present silicon cells operate at 18 percent efficiency and are put to a number of practical uses, best known of which is to furnish power to satellites.

Service managers can now receive certification

The National Association of Service Managers (NASM) reports having established a certification program, under which 150 service managers have already been certified, and are entitled to use the letters CSE (Certified Service Executive) after their names. NASM is a 1,000-member organization of executives oriented toward providing service to mechanical and electronic products and equipment used in home, industrial and commercial situations.

Certification is based on a point system, 75 points to be earned through experience and 70 by a written examination. Points gained from experience vary from 7.5 for each year as a national or regional service

manager to 0.5 for each NASM chapter meeting attended.

The certification fee is \$150, consisting of a non-refundable \$25 application fee and a \$25 test and plaque fee, which is refunded if the applicant does not qualify for certification. (It is not necessary to be a member of NASM to become a CSE.)

An interesting feature of the program is that CSE's must continue to progress. After three years, the CSE must be recertified, for which he must have acquired an additional 36 points. After three recertifications, the CSE becomes a "Life CSE" and needs no further recertification.

For information and applications, write to NASM Certification Board, NASM National Headquarters, 6022 West Touhy Avenue, Chicago, IL 60648.

BIGGEST RADIO TELESCOPE



The world's largest radio telescope of its type is this 38-mile-long array, made up of 25 parabolic antennas strung out along a configuration of railroad tracks on the plains of San Augustine, NM. Each antenna is 82 feet across, stands 94 feet high and weighs 213 tons. Their main use is to monitor the hiss of quasars. That accomplishment may help reveal how the universe was created, according to the National Radio Astronomy Observatory, which deployed the antennas.

Vocational students hold skill Olympics at Atlanta

A public display of skills in 36 occupational areas ranging from auto mechanics to dental assistance was the feature of the National Leadership Conference of the 280,000-member Vocational Industrial Clubs of America. Vocational students attending the conference compete for national awards in their fields.

The two-day conference sessions placed

special emphasis on developing professionalism among trade, health and technical students, in line with VICA's national program: to encourage motivation, positive attitudes and pride in the types of work that result in highly developed skills and personal self-respect.

Talking language translator is new aid for tourists

Travelers trying to communicate in a foreign language will now be able to get help from the hand-held Talking Language Translator exhibited by Texas Instruments, at the Consumer Electronics Show in Chicago last June.



T. I.'S TALKING LANGUAGE TRANSLATOR

Components of the new unit include a speech synthesizer chip, a controller and four random memory chips. An earphone is provided for "quiet" use.

Up to 25 phrases may be programmed into the instrument, and numbers of other phrases may be made up by combining words from the memory with preprogrammed partial phrases (Where is . . . ? How much is . . ." etc.). Thus thousands of spoken phrases can be made up.

English and Spanish language modules are expected to be available in September, with French and German to follow later and Japanese and Chinese to follow early in 1980. Each module contains about a thousand words, of which half will be spoken or displayed, the other half displayed only.

This new 8-track tape has a rewind feature

A weakness of the ordinary 8-track tape cartridge is that it cannot be reversed. This is a significant disadvantage in home recording or dictation, since one must fast-forward the complete tape from the beginning-to-end to correct an error or hear something just recorded.

The new REV8 tape cartridge, made by KRS Magnetics of Los Altos, CA, has a unique solution for the problem. A double-track reel—two reels mounted concentrically—is used. About two minutes of playing time can be rewound onto the second reel when desired. At present the rewind is manual, though some companies have indi-

continued on page 12

Take the step up from handheld DMM's



To Fluke's new 8010A and 8012A bench/portable DMM's. You'll find all the features of our popular 8020A handheld DMM plus many more capabilities (some not found in any other DMM) in these two instruments. At prices only a few dollars more than most handhelds.

A sensible package with sensible features. The 8010A and 8012A's bench/portable design is ideal for those who want the best of both worlds. They fit smartly on your bench and use ac power or get right up and go to the job with you. Optional rechargeable batteries are available. Both incorporate the same design goals that made our handheld 8020A DMM so rugged and reliable.

Extensive overload protection (to 6000V) and 0.1% basic dc accuracy make for two DMM's you can really rely on. 20 basic ranges of ac and dc volts and current, six ranges of resistance plus three ranges of conductance prove their measurement versatility.

Conductance = 1/Resistance. It's a unique way to measure high resistance and check leakage in capacitors, pcb's, cables and in-

ductors, and general use above 20 MΩ. A Fluke exclusive found in both the 8010A and 8012A. Ask for our Conductance Measurements Application Note.

To tell the truth. Fluke's hybrid true RMS converter gives you the honest ac answers you demand. You can measure non-sinusoidal waveforms out to 50 kHz without missing any significant distortion components.

Exclusive capabilities for surprising prices. For high current measurement applications, the 8010A boasts an extra 10A range for \$239*. The 8012A replaces the current range with another important feature — two low ohms ranges, making it the world's widest range ohmmeter. Its 1 milliohm resolution (on the 2Ω range) is ideal for locating shorts in circuit boards and motor windings. All for only \$299.*

Handheld or bench/portable: It's your choice. Whichever best fits your application, you can buy them both from Fluke. With confidence that

you'll be owning the finest quality DMM's available. Contact the Fluke stocking distributor, sales office or representative in your area or call:

800-426-0361

If you prefer, just complete and mail the coupon below.



*U.S. Prices only.

IN THE U.S. AND NON-EUROPEAN COUNTRIES:	IN EUROPE:
John Fluke Mfg. Co., Inc. P.O. Box 43210 MS #2B Mountlake Terrace, WA 98043 (206) 774 2481 Telex: 32-0013	Fluke (Holland) B.V. P.O. Box 5053, 5004 EB Tilburg, The Netherlands (013) 673-973 Telex: 52237

- Please send 8010A/8012A specifications.
- Please have a salesman call.
- Please send me your Conductance Measurements Application Note.

Name _____
 Title _____ Mail Stop _____
 Company _____
 Address _____
 City _____ State _____ Zip _____
 Telephone () _____ Ext. _____

RE 10 79

CIRCLE 67 ON FREE INFORMATION CARD

Microcomputers are here! Get in on the ground floor with NRI's new "at home" training in computer technology.

Only NRI Gives You "Hands-on" Experience as You Build Your Own
Designed-for-learning Microcomputer

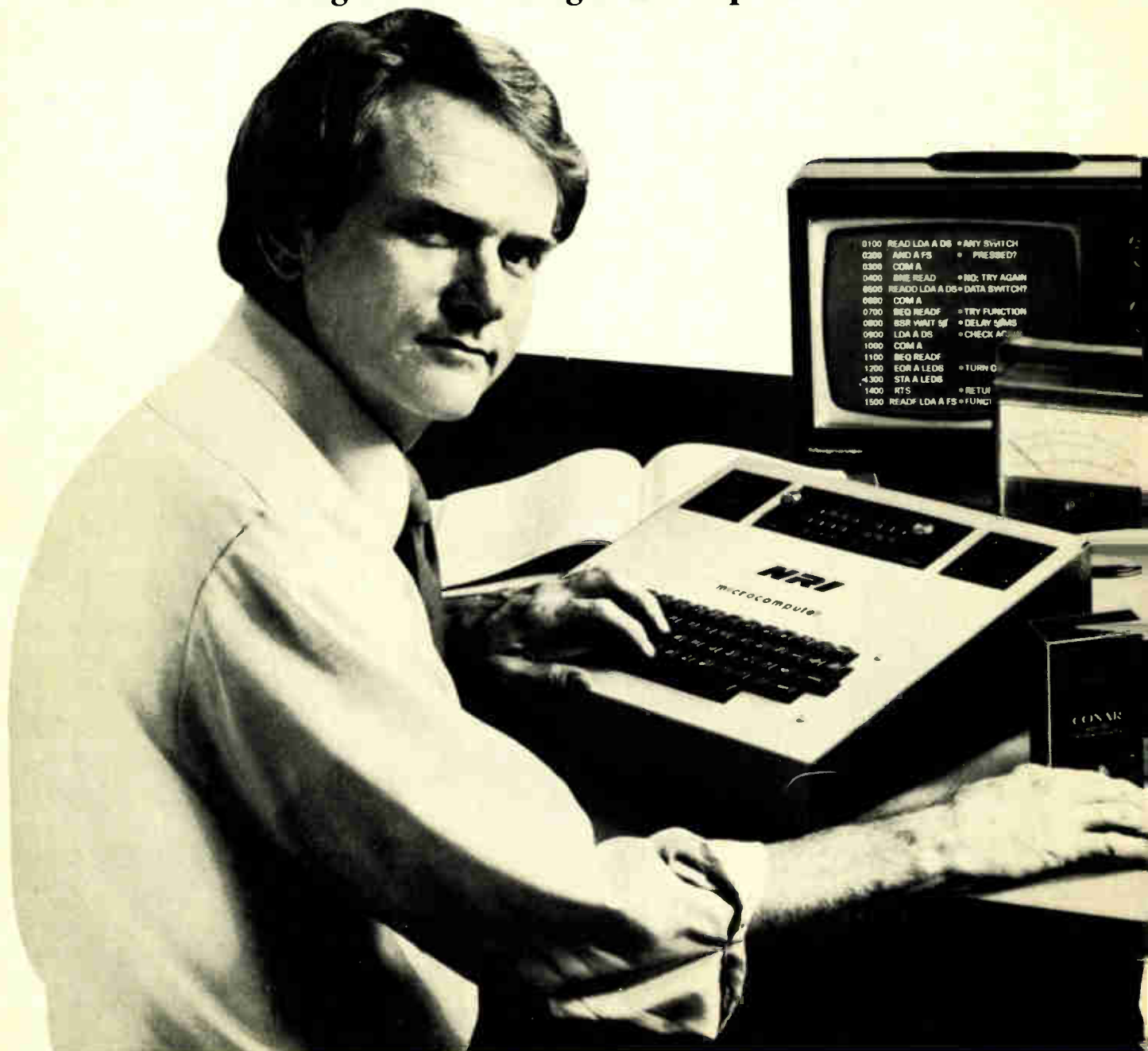

The microprocessor, that amazing little chip which shrinks electronic circuitry to microscopic size, has changed the world of the computer with dramatic speed. Now, big-performance computers are here in compact sizes...priced to make them practical for thousands of medium and small businesses, even homeowners and hobbyists.

Microcomputers are already being put to work on jobs like inventory control, payrolls, cost analysis, billing, and more. In homes, they're able to handle budgets and tax records, control environmental systems, index recipes, even play sophisticated games. And hobbyists across the country are expanding the state of the art while developing their own programs.

**Become a Part of This Incredible World ...
Learn at Home
in Your Spare Time**

NRI can give you the background you need to get into this booming new field. Microcomputers require a new discipline, a broader viewpoint...the ability to think in both hardware and software terms. And NRI's new course in computer technology is geared to bridge the gap.

You get a firm foundation of digital theory while you get practical,



"hands-on" experience working with the NRI Discovery Lab®, assembling test instruments you keep, and even building your own fully functional microcomputer.

Best of all, you do it at your own convenience. You learn at home with clearly written, "bite-size" lessons that carry you through the course in logical progression. There's no need to go to night school or quit your job...you progress at the pace that's most comfortable to you, backed by your personal NRI instructor and individual counseling whenever you want it.

Assemble an Advanced Microcomputer with Exclusive Designed-for-Learning Features

Only NRI trains you with a microcomputer that's specifically designed to teach you important principles as you build it. This state-of-the-art unit performs every function of comparable commercial units, has capabilities well beyond many. But each step of construction provides specific training, reinforces theory to make it come alive. And once you've finished, your microcomputer is ready to go to work for you. Or you can even sell it commercially.

You also assemble professional test instruments for use in your training. You get your own CMOS digital frequency counter and transistorized volt-ohm meter to keep and use in diagnosing problems and servicing computers. Together with up-to-the-minute lessons and NRI's 60-plus years of home study experience, you get the most in training and value.

Other Courses in Today's Electronics

Even the servicing of home entertainment equipment has taken quantum jumps forward. NRI keeps you right up with the latest, with training in stereo, video tape and disc players, and the latest TVs. You even build your own 25" diagonal color TV, the only one complete with built-in digital clock, varactor tuning, and computer control that lets you program an entire evening's entertainment. In our complete communications course, you learn to service two-way radio, microwave transmitters, radar, AM and FM transmitters, CB radio, paging equipment, and more. And you build your own 2-meter transceiver or 40-channel CB while you learn.



Free 100-Page Catalog No Salesman Will Call

Send the postage-paid card today for your personal copy of the NRI electronics course catalog. It shows all the equipment, training kits, and complete lesson plans for these and many other courses. There's no obligation of any kind and no salesman will ever bother you. Find out how you can learn new skills, keep up with technology, advance your future with training for new opportunities. Get in on the ground floor now! If card has been removed, write to:



NRI Schools
McGraw-Hill Continuing
Education Center
3939 Wisconsin Ave.
Washington, D.C. 20016

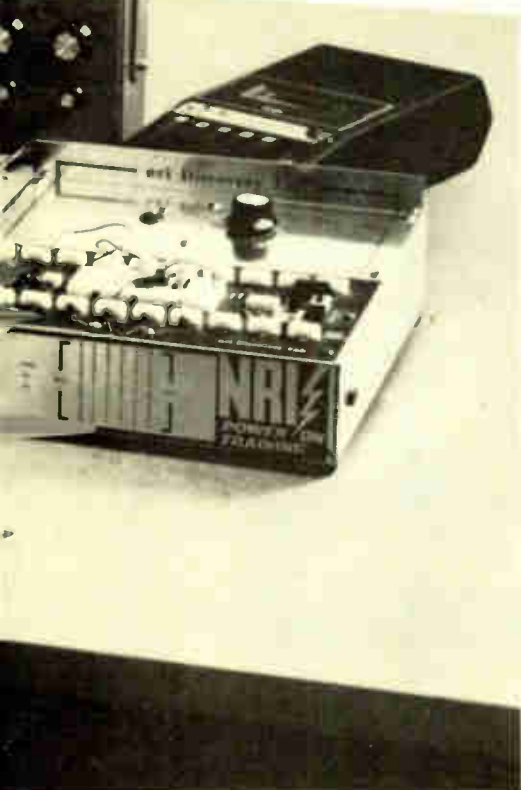

continued from page 6

cated they will make automatic rewind machines.

The rewind is made possible by special plastic springs on the rewind reel. Radiating out like spokes from the center, they compress as the tape is rewound onto them, adjusting themselves to the diameter of the other reel. Since the two reels then become approximately the same diameter, the takeup problem is solved.

The REV8 is supplied in 45 and 90-minute blanks, usable in any 8-track recorder.

A STORY OF GROWTH



THE LITTLE SATELLITE at lower right in the photograph is a model of the Hughes Aircraft Company's original *Syncom*. That bird could handle 50 telephone calls or one television channel. The comparative giant at left is a full-scale model of the Satellite Business Systems (SBS) communications satellite (or of the identical Canadian *Anik C*). The big satellite can handle 13,900 simultaneous telephone calls. Its solar panels produce 900 watts, as compared with the 29 watts of *Syncom*. Its concentric cylinders, which deploy in space, will make it two-and-a-half stories tall when fully extended.

The models shown were on display at the Paris Air Show this summer. In 1981, SBS will provide American business customers with voice, data, facsimile and teleconferencing services. *Anik C* will bring audio, visual and data telecommunications services to Canada.

News for home computers

United Press International's World News Report is being made available to home computer owners under an agreement between UPI and Telecomputing Corp of America (TCA) of McLean, VA.

UPI's full news report will be delivered at high speed into a TCA computer at Silver

Spring, MD. Home computer owners can connect with the computer by dialing a local telephone number in most cities of the United States. Once connected, the user can call out items of interest by punching simple codes on a key pad. TCA will also supply such services as electronic mail, business packages and a library of 2,000 programs to home computers.

"Encoded disc" technique reduces surface noise

A new noise reduction system for discs and tapes is now being marketed by dbx Inc., of Newton, MA. The company is a subsidiary of BSR.



THE dbx MODEL 21 DISC/TAPE DECODER

In recording, a compression-expansion device linearly compresses the signal 2:1 over a 100-dB range. In playback, it is expanded the same amount. According to a spokesman for dbx: "These 'noiseless discs' provide a 50 percent greater dynamic range than is available on most conventional records, in addition to being free from audible surface noise, which is typically 30 dB lower than on conventional records. Other benefits include eliminating turntable rumble and groove echo, as well as reducing the inner groove distortion."

The system is compatible with standard playing equipment, though a decoder must be connected between the encoded disc and the stereo playing system. A library of encoded discs is already available. Though the decoding instrument is called the Model 21 tape and disc decoder, no encoded tapes have so far been mentioned in the company's literature.

IHF opposes recommendation to narrow FM bandwidths

The Institute of High Fidelity characterized a recommendation made by the National Telecommunications and Information Administration to the FCC, that the FM bandwidths should be lowered from the present 200 kHz to 150 kHz or even 100 kHz, as "unnecessary, counterproductive and technically incomplete," in comments filed with the FCC by Robert Gur-Arie, Executive Vice President of the Institute.

Narrowing the bands, states the IHF, would negate the progress in FM during the past two decades, and would have an

adverse effect on owners of home and auto high-fidelity FM receivers capable of receiving present-day FM broadcast music with undistorted fidelity and full stereo separation. Furthermore, technical problems in making the changeover would cause unnecessary expense and confusion. It would make some receivers, which keep the set on frequency automatically, and which normally operate in 200-kHz increments, useless.

New low-cost memory chip carries own spare parts

A new high-speed, high-capacity dynamic memory chip developed by Bell Labs includes spare elements that can be connected to replace any parts of the chip found defective after manufacture.

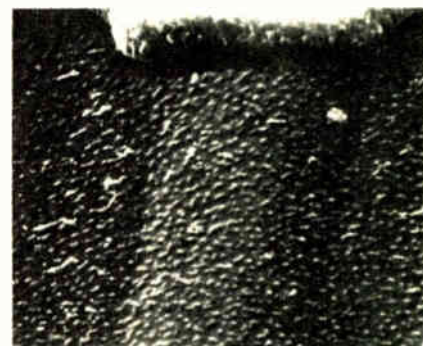

SUBSTITUTING GOOD MEMORY elements for bad ones requires focusing a laser beam to a spot on the chip. Two links, magnified 10,000 times, are shown. One link is intact, the other has been disconnected from the memory array by a blast of laser energy.

The new chip is a 64K random-access unit (exact size is 65,536 bits) and can be accessed in 170 nanoseconds. The replacement technique reduces the effective cost of production significantly.

About five per cent more elements than are actually needed are built into the chip. During wafer testing after manufacture, any marginal elements are disconnected and good spares substituted—a process that typically takes only ten seconds per chip.

R-E

SYLVANIA PUTS EMERSON AND ADMIRAL BACK IN BUSINESS.



In the 55 years Sylvania has been making receiving tubes a lot of companies have gone out of business. But thanks to Sylvania their products haven't gone out of service. Because Sylvania makes receiving tubes to replace those of every make of radio and television. Even those whose manufacturers haven't been seen in years.

When it comes to replacement parts the right place to come

is Sylvania. Your Sylvania distributor carries a complete line of receiving tubes, picture tubes, test equipment and ECG® semi-conductors designed to make any brand work like it's brand new.

Sylvania. The easy way to get even the hardest part.

SYLVANIA

GTE



1929

50 years ago the first issue of **Radio-Electronics** (then called **Radio-Craft**) appeared. The Editor-in-Chief was the late Hugo Gernsback.

The word *electronics* was just beginning to appear in print. The new growing electronic industry was primarily concerned with sound reproduction—radio broadcasting and reception, the phonograph, talking motion pictures and amateur radio.

American homes housed 11-million radio receivers. All were huge compared to today's sets. Even the smallest table models were nearly as large as modern 15-inch TV's. Console radios had elaborate wood cabinets and line-operated radios had been on the market only about two years. "Portable" radios were available too, but they were cumbersome and heavy. The automobile radio had not yet arrived.

Radio-phonographs using heavy magnetic pickups, the audio amplifier, and radio speaker had been on the market for several years, but were not too popular. Most people were still quite happy with the free entertainment available on the radio.

FM broadcasting was still about 11 years in the future and the term "high fidelity" would not be used (at least in the U.S.) for another 4 or 5 years. True high-fidelity reproduction in the home was some 20 years in the future.

A few thousand resourceful experimenters were receiving postage-stamp size TV pictures on their mechanical scanning-wheel TV receivers. The picture was created on a small argon-filled tube. A score of experimental TV stations were broadcasting programs to those hardy experimenters. Picture definition was only 60 lines. All-electronic cathode-ray TV was a laboratory curiosity.

Sound motion pictures—the Talkies—were just beginning to appear. Across the country motion picture theaters were rushing to replace silent projectors with sound projectors so they could show the new talking pictures.

Radio broadcasting was only 9 years old. The national radio networks were new: NBC was only three years old, CBS was two. ABC was a second network owned by NBC.

CB radio was about 30 years in the future but amateur radio was flourishing. It had already been around for over 20 years.

Tube manufacturers had just begun to explore the possibilities of multi-grid and multi-element tubes. The first screen-grid tube introduced two years earlier had already caused an upheaval in radio set design. Pentodes, pentagrid converters, beam-power tubes and all the rest were still on the drawing boards or merely gleams in designer's eyes . . .

Although the transistor and the dawn of the solid-state era were 19 years in the future, there were a few solid-state devices in general use: the galena crystal detector was used in simple radio receivers for children, and the copper-oxide rectifier was used in some industrial equipment. But it was bulky and inefficient compared to modern solid-state rectifiers.

The progressive service technician of 1929 was the proud owner of a voltmeter with a 1000 ohms-per-volt sensitivity and possibly an AM signal generator tuning from 100 to 1500 kHz.

As you have seen, electronics in 1929 was a pleasant luxury and did not play a very large role in everyday life. Today, it's different . . . very different. We depend on electronics systems to help us operate almost every important device we use. The most obvious applications are still entertainment—but what about that electronic fuel injection system in your car, the computer that issues your pay check and helps fill your mailbox with bills? And the IC's that have made all electronic devices smaller and many of our newest ones possible.

Today *it is a world of electronics*. And we will continue the tradition that began in 1929 of stimulating your imagination, challenging your brain and keeping you usefully (and happily) occupied each month.

M Harvey Gernsback

M. HARVEY GERNSBACK
EDITOR-IN-CHIEF

Radio-Electronics®

Hugo Gernsback (1884-1967) founder
M. Harvey Gernsback, editor-in-chief and publisher
Larry Steckler, KTX-3644, CET, editor
Arthur Kleiman, KTZ-3288, managing editor
Robert F. Scott, CET, W2PWG, KXK-8533, technical editor
Jack Darr, CET service editor
Leonard Feldman contributing high-fidelity editor
Karl Savon, semiconductor editor
Herb Freidman, communications editor
David Lachenbruch, contributing editor
Earl "Doc" Savage, K4SDS, hobby editor
Ruby Yee, production manager
Robert A. W. Lowndes, production associate
Marie J. Stoffi, production assistant
Gabriele Margules, circulation director
Arline R. Fishman, advertising coordinator

Cover design by Synergy

Radio Electronics is a member of the *Institute of High Fidelity* and is indexed in *Applied Science & Technology Index* and *Readers Guide to Periodical Literature*.

Gernsback Publications, Inc.
200 Park Ave. S., New York, NY 10003
(212) 777-6400
President: M. Harvey Gernsback
Vice President: Larry Steckler
Treasurer: Carol A. Gernsback

ADVERTISING SALES

Paul McGinnis
Director of Marketing

EAST

Stanley Levitan
Radio-Electronics
200 Park Ave. South
New York, NY 10003
(212) 777-6400

MIDWEST/Texas/Arkansas/Okla.

Ralph Bergen
The Ralph Bergen Co.
540 Frontage Road—Suite 361-A
Northfield, Illinois 60093
(312) 446-1444

PACIFIC COAST Mountain States

Jay Eisenberg
J.E. Publishers Representative Co.,
8732 Sunset Blvd.,
4th Floor,
Los Angeles, CA 90069
(213) 659-3810
Sales Mart Building
1485 Bayshore Blvd., Box 140
San Francisco, CA 94124
(415) 467-0125



REACH FOR THE STARS!



When you sit down at the keyboard of this new Wersi Saturn, you're ready to experience one of today's most advanced musical instruments.

Like all fine Wersi organs, Saturn integrates state-of-the-art computer technology with beautifully simple styling. The result: space-age wonders of almost endless potential—an instrument that looks great, sounds superb in any home.

Build It Yourself or Factory Assembled

Wersi manufactures a full line of advanced electronic organs, pianos and related keyboards in easy-to-build kit form or com-

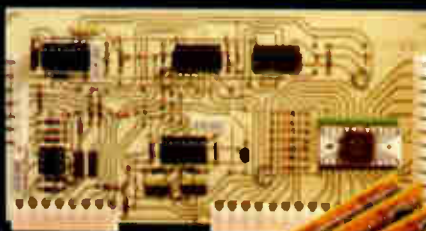

pletely assembled. For your Wersi Demo-Package (LP with organ registration plus 104-page color catalog and price list) send six dollars to your nearest Wersi Sound Center.

Wersi Electronics, Dept. 1, 1720 Hempstead Road, Lancaster, PA 17601. Or Wersi Organs and Kits, Dept. 1, 14104 E. Firestone Blvd., Santa Fe Springs, CA 90670.

 **WERSI**

Letters

FUTURE ELECTRONIC DEVICES

In answer to your September 1978 and April 1979 editorials, I offer two ideas and remind you that your September editorial stated: "Many experts have proven that airplanes won't fly and that the world is flat." Perhaps these two ideas will fall off the edge of the world, too.

I took part of item 2 in the September editorial to make the first of my machines. I also used some of items 1 and 3 to make my second machine. And, of course, other electronic devices are combined with each machine. I operated item 2 in reverse of your method, storing every bit in several devices as in item 1.

I then made a robot similar to the Six Megabuck Man, but with no human parts, of course. To make up for this lack, particularly the senses, I used your item 3 for sight. For hearing, I used a microphone. The rest of the components were more difficult. Although they were not entirely adequate, I used many pressure and temperature transducers for the sense of touch or feeling. Although pain may not be desirable, it was simulated by detecting upper and low-

er limits on pressure and temperature. Smell was simulated with an automated gas analyzer. The sense of taste was considered unessential as eating, for a robot, would be a refueling operation. However, to keep the robot happy, a chemical analyzer with limited capability was installed.

So I have made a humanoid robot that has all the faculties of the person whose brain was recorded in the robot's memory banks; and with its sensors, has the capability of placing more data into its memory. It comes close to enabling a person to live forever!

Actually, I am dead. The robot is sending you this letter.

HAROLD ARMSTRONG
East Falmouth, MA

DIGITAL TIMER INFORMATION

If parts or kits for the Digital Timer ("Build A Digital Timer for Your Dark-room," July and August 1978) are needed, they may be obtained from Raymond Kostanty, 54 Lincoln Avenue, Wood-Ridge, NJ 07075. Please also note there has been several price changes: please write directly

to me for the latest prices.
RAYMOND KOSTANTY

EINSTEIN'S THEORY

I would like to try to answer some of reader Ecklin's questions ("Letters" column, June, 1979) insofar as is possible in limited space, and to clear up some of the confusion he shares with most of us since Einstein proposed his famous theories.

It is probably best to start with the last question first, since the answer to this is at the heart of the problem.

Yes, Mr. Ecklin, the value of C is indeed a universal constant, and is the same for all observers regardless of their motion. If you would measure the velocity of a photon speeding past you, you would measure its velocity as C , no matter how fast you were moving. That was the conclusion of the famed Michelson-Morley experiment (and a number of others since then). This fact is probably one of the most difficult conceptual points to understand, but is the foundation of much of post-Einstein physics.
continued on page 22

Plug in the capacitor, push the appropriate range button, and read the value to 0.1% accuracy. With the Data Precision Model 938 digital capacitance meter it's that easy. The 8 easy pushbutton ranges cover 0.1 picofarads to 1999 microfarads, and the exclusive "Δcharge/Δvolt" measurement circuit (patent pending) holds its $\pm 0.1\%$ basic accuracy for a full year. A 0.5" high liquid crystal display is easy on the eyes and easy on the battery — up to 200 hours operation on a standard 9V battery. The Model 938's small size and light weight make it easy to carry where you need it.

But best of all, it's easy on the budget — only \$149.00 (USA) — complete with a 2-year warranty. Just what you expect from Data Precision.

Capacitance Made Easy — \$149.

Order by phone-toll free
(800) 223-0474

 DATA PRECISION

**ADVANCE
ELECTRONICS** 

54 West 45 Street, New York, N.Y. 10036 (212) 687-2224



Take a good look at VACO.



**THE SUPER CASE
70260**

The world famous Super Case. Complete with 48 of the most popular and professional problem-solving tools. From screwdrivers and nutdrivers to pliers, wrenches, crimping tools and more. A super variety and super value. *All* unconditionally warranted from Vaco, of course. The Super Case and all the other fine Vaco tools can be seen in our new 1979 catalog. It's free, just write. Say you want to take a good look at VACO.

Vaco Products Company, 1510 Skokie Blvd.,
Northbrook, IL 60062 U.S.A.

VACO[®]

CIRCLE 21 ON FREE INFORMATION CARD

“If you’re going to learn electronics, you might as well learn it right!”



*“Don’t settle for less.
Especially when it comes
to career training...because
everything else in your life
may depend on it. That’s
why you ought to pick CIE!”*

You've probably seen advertisements from other electronics schools. Maybe you think they're all the same. They're not!

CIE is the largest independent home study school in the world that specializes exclusively in electronics.

...

Meet the Electronics Specialists.

When you pick an electronics school, you're getting ready to invest some time and money. And your whole future depends on the education you get in return.

That's why it makes so much sense to go with number one... with the specialists... with CIE!

There's no such thing as bargain education.

If you talked with some of our graduates, chances are you'd find a lot of them shopped around for their training. Not for the lowest priced but for the best. They pretty much knew what was available when they picked CIE as number one.

We don't promise you the moon. We do promise you a proven way to build valuable career skills. The CIE faculty and staff are dedicated to that. When you graduate, your diploma shows employers you know what you're about. Today, it's pretty hard to put a price on that.

Because we're specialists, we have to stay ahead.

At CIE, we've got a position of leadership to maintain. Here are some of the ways we hang onto it...

Our step-by-step learning includes "hands-on" training.

At CIE, we believe theory is important. And our famous Auto-Programmed® Lessons teach you the principles in logical steps.

But professionals need more than theory. That's why some of our courses train you to use tools of the trade like a 5 MHz triggered-sweep, solid-state oscilloscope you build yourself—and use to practice troubleshooting. Or a beauty of a 19-inch diagonal Zenith solid-state color TV you use to perform actual service operations.

Our specialists offer you personal attention.

Sometimes, you may even have a question about a specific lesson. Fine. Write it down and mail it in. Our experts will answer you promptly in writing. You may even get the specialized knowledge of all the CIE specialists. And the answer you get becomes a part of your permanent reference file. You may find this even better than having a classroom teacher.

Pick the pace that's right for you.

CIE understands people need to learn at their own pace. There's no pressure to keep up... no slow learners hold you back. If you're a beginner, you start with the basics. If you already know some electronics, you move ahead to your own level.

Enjoy the promptness of CIE's "same day" grading cycle.

When we receive your lesson before noon Monday through Saturday, we grade it and mail it back—the same day. You find out quickly how well you're doing!

CIE can prepare you for your FCC License.

For some electronics jobs, you must have your FCC License. For others, employers often consider it a mark in your favor. Either way, it's government-certified proof of your specific knowledge and skills!

More than half of CIE's courses prepare you to pass the government-administered exam. In continuing surveys, nearly 4 out of 5 CIE graduates who take the exam get their Licenses!

For professionals only.

CIE training is not for the hobbyist. It's for people who are willing to roll up their sleeves and go to work... to build a career. The work can be hard, sure. But the benefits are worth it.

Send for more details and a FREE school catalog.

Mail the card today. If it's gone, cut out and mail the coupon. You'll get a FREE school catalog plus complete information on independent home study. For your convenience, we'll try to have a CIE representative contact you to answer any questions you may have.

Mail the card or the coupon or write CIE (mentioning name and date of this magazine) at: 1776 East 17th Street, Cleveland, Ohio 44114.



Patterns shown on TV and oscilloscope screens are simulated.

CIE Cleveland Institute of Electronics, Inc.

1776 East 17th Street, Cleveland, Ohio 44114

Accredited Member National Home Study Council

YES... I want the best of everything! Send me my FREE CIE school catalog — including details about troubleshooting courses — plus my FREE package of home study information. RE-73

Print Name _____

Address _____ Apt. _____

City _____

State _____ Zip _____

Age _____ Phone (area code) _____

Check box for G.I. Bill information: Veteran Active Duty

MAIL TODAY!

LETTERS

continued from page 16

and leads directly to such phenomena as time dilation and the Lorentz-Fitzgerald contraction.

Thus, when the measurement of the Doppler radar signal is made, you would find that the change in frequency is accompanied by a corresponding change in the wave length, of exactly the right magnitude for the product $\lambda\delta$ to remain constant.

Incidentally, another aspect of relativity theory demonstrates that "simultaneous" measurements of the kind envisioned cannot be made when relativistic effects are taken into consideration, because simultaneity does not exist. Einstein showed that events that are simultaneous to one observer cannot be simultaneous, even in principle, to other observers who are in motion compared to the first. The main conclusion of the theory of relativity is that, in a quite literal sense *everything* is relative, especially time.

If Mr. Ecklin (or any other reader) wishes to pursue the matter further, he can probably find at least one of several quite excellent books in his local public library discussing these and other points. While they bear quite formidable titles (Theory of Relativity or something similar) they are quite respectable attempts to discuss this difficult and complex subject in layman's terms.

DR. HOWARD MARK
Suffern, NY

RADAR-DETECTOR CONSTRUCTION HINTS

As a loyal reader/subscriber, I would like to suggest an idea for one of your construction projects. My suggestion would be to develop a project on a first-quality police-band radar detector.

In discussions with many of my electronic-buff friends, we have together developed certain characteristics that the project should contain, if possible. These characteristics are as follows:

1. Prime-quality construction and state theory.
2. Long-range capability.
3. Inclusion of all bands (X-Y band, etc).
4. Forward and reverse direction sensing. This is becoming extremely important as moving radar is being used to rear track more and more often.
5. Range and direction indication.
6. Universal mounting system.

JOE M. WILSON
Jacksonville, FL

AFRTS CORRECTED

I thoroughly enjoy reading your magazine; however I did notice one small discrepancy in your "Looking Ahead" column in the July 1979 issue.

Your mention of AFRTS being Armed Forces Radio and Television Service was incorrect, it is *American Forces* Radio and Television Service. I could not help noticing as they are one of our customers.

Again, thanks for a great magazine.

ROBERT J. GOSCIAK
Fidelipac
Mount Laurel, NJ

R-E



CREATE!

You don't waste a second on "mechanics" with A P All-Circuit Evaluators.

You figure out the circuit you want, then plug it in for testing. You decide to improve your layout, and you make your moves as quickly as you think them up. There's just no faster or easier way to build and test circuits and circuit ideas.

But just because breadboarding is now such a cinch, don't get the idea that you don't have electronic integrity. Our solderless plug-in tie

points are made of a special non-corroding alloy. Use them as often as you like.

How many tie points do you need? Our smallest ACE has 728, our largest has 3,648. And all of them accept all DIP sizes.

Everything is quality all the way. You can even see the difference in our harder, shinier plastic matrix.

See for yourself. Phone (toll-free) 800-321-9668 for the address of your nearby A P Products dealer. And ask for our complete A P catalog, The Faster and Easier Book.



AP PRODUCTS INCORPORATED

Box 1108 • 72 Corwin Drive
Painesville, Ohio 44077
Tel. 216/354-2101
TWX: 810-425-2250

Faster and Easier is what we're all about.

CIRCLE 74 ON FREE INFORMATION CARD

We confess.

To sell an advanced DMM for under \$70 we had to cut corners.



And we sure did! First, we cut off the dealer's mark-up. Then we shaved off the overhead costs of national sales offices and warehouses. Finally, as if that wasn't enough, we even cut out the high labor costs of factory assembly lines.

All in all, we cut over \$100-worth of corners! But not a single one that affected the quality and performance of our new DMM.

Don't let our low price fool you!

Because Sabtronics sells factory-direct – without all the hidden charges a dealer would track on – we can offer the superior 2010A DMM kit for a surprisingly low \$69.95. Surprising because you get the accuracy, features and performance you'd expect from the high priced units.

The 2010A offers you the long-term accuracy of a laser-trimmed resistor network, an ultra-stable band-gap reference element and single chip LSI circuitry – all in a compact, rugged, human-engineered housing. With 31 ranges and 6 functions, you can measure AC and DC volts from 100 μ V to 1000V; AC and DC current from 0.1 μ A to a surprisingly high 10 A; resistance from 0.1 Ω to 20 M Ω . Typical DCV and Ohms accuracy is 0.1% \pm 1 digit. And you see these precise readings on a bright, 3 1/2-digit

LED display with automatic decimal placement and large, 9mm numerals.

Of course, that's what you'd expect from a quality DMM. But we've even added more features for extra convenience, flexibility and reduction of human error.

- Unique X10 Multiplier Switch – gives you convenient push-button selection to the next higher decade range. Hi-Lo Power Ohms capability gives you three high-ohms ranges that supply enough voltage to turn on a silicon junction for diode and transistor testing. For in-circuit resistance measurement without turning on a semiconductor junction, you use the three low-ohms ranges.
- Wide Frequency Response – 40Hz to 40kHz bandwidth lets you measure audio through ultra-sonic AC signals.
- Touch and Hold Capability – with optional probe, retains readings for as long as you wish. You can make measurements in hard-

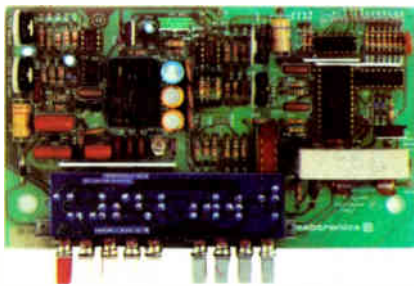

to-reach places without taking your eyes off the probe tip or stopping to record data.

- Plus More – Auto Polarity, Auto Zero, Overrange indication and fully overload protected on all ranges.

And, although designed for benchtop use, the sleek, compact 2010A is powered by 4 "C" cells (not included), bringing wide-range lab performance to the field when you need it.

You save either way.

Your 2010A DMM kit comes complete with easy-to-follow assembly instructions, all parts (including high-impact case), and test leads. You can complete assembly in a single evening. However, for a slight additional fee, Sabtronics will ship your 2010A factory-assembled and calibrated: at \$99.50 it's still an incomparable value!

Whether you're a professional or hobbyist, if quality and accuracy are important – and padded prices aren't – you should inspect the 2010A DMM for yourself. If you're not completely satisfied, return it in its original condition within 10 days for a prompt and courteous refund of purchase price. Call us with your MasterCharge or Visa order today, or simply fill out the convenient order form.

Making Performance Affordable

sabtronics INTERNATIONAL INC.

13426 Floyd Circle M/S 35 • Dallas, Texas 75243
Telephone 214/783-0994

Brief Specifications

DC Volts: 100 μ V to 1000V in 5 ranges

AC Volts: 100 μ V to 1000V in 5 ranges

DC Current: 0.1 μ A to 10 A in 6 ranges

AC Current: 0.1 μ A to 10 A in 6 ranges

Resistance: 0.1 Ω to 20 M Ω in 6 ranges

Diode Test Current: 0.1 μ A, 10 μ A, 1mA

ACV Frequency Response: 40Hz to 40kHz

Input Impedance: 10 M Ω on ACV and DCV

Overload Protection: 1200 VDC or RMS on all voltage ranges except 250 VDC or RMS on 200mV and 2V AC ranges. Fuse protected on ohms and mA ranges.

Power Requirement: 4.5 to 6.5 VDC (4 "C" cells)

optional NiCd batteries or AC adapter/charger

Display: 0.36" (9.2mm) Digits reading to \pm 1999

Size: 8"W x 6.5"D x 3"H (203 x 165 x 76 mm)

Weight: 1.5 lbs. (0.68kg.) excl. battery

To: Sabtronics International, Inc. 13426 Floyd Circle M/S 35, Dallas, TX 75243

Please send me . . .

_____ Model 2010A Digital Multimeter kit(s) @ \$69.95 plus \$4.00† shipping and handling each \$ _____
 _____ Model 2010A Digital Multimeter Assembled @ \$99.50 plus \$4.00† shipping and handling each \$ _____
 _____ # AC-115 AC adapter/charger(s) @ \$7.50 each \$ _____
 _____ # NB-120 NiCd Battery set(s) @ \$17.00/set \$ _____
 _____ # THP-20 Touch and Hold Probe(s) @ \$18.00 each \$ _____
 _____ For delivery in Texas, add 5% Sales Tax \$ _____

I enclose check money order for _____ TOTAL \$ _____

or, please charge to my Visa MasterCharge: Code # _____

Account No. _____ Expiration Date: _____

Name _____

Street _____ Apt. _____

City _____ State _____ Zip _____

†Continental U.S. only AK, HI & PR \$5.00 Canada: \$6.50. Foreign \$19.00 Airmail

equipment reports

Fluke 8010A/8012A DMM's

THE JOHN FLUKE MANUFACTURING COMPANY, Inc. (P.O. Box 43210, Mountlake Terrace, WA 98043) has developed a pair of digital multimeters, the *models 8010A and 8012A* (shown). The DMM's are almost identical, except that they differ in two ranges. They

have the same basic circuitry, features and ranges of the popular pocket *model 8020A* DMM. But these units are AC-powered bench models, with battery-power options available, along with several different optional line voltages and frequencies.

The range difference between the two instruments is as follows: The *8010A* has a high-

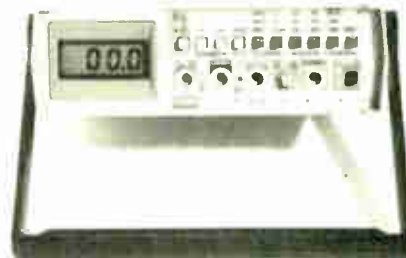

CIRCLE 101 ON FREE INFORMATION CARD

When you're into electronics, Calectro is into whatever you need – whether it's ideas, instructions, or a complete supply of parts

Calectro has projects designed for you: a "Project of the Month", conceived by the Calectro engineering department, along with detailed instructions and a list of all the Calectro parts you need to build it!



Calectro has parts and accessories: printed circuit materials, tools, meters, testing devices, equipment boxes, sockets, switches, IC's, transistors, rectifiers, lugs, fuses, bulbs, wire, connectors, terminals, jacks, transformers, and lots more – everything you need to complete your project. And you'll find more of the parts you want at your Calectro store than anywhere else.



Calectro has literature: the Calectro Handbook – a valuable guide and product reference for the experimenter, hobbyist, audiophile, technician, and student; plus handbooks on semiconductors, circuits, and more! Coming soon: a new Calectro Handbook, a compendium of popular project ideas.

Whatever you need in electronics, your Calectro distributor is your surest, finest source!



Calectro

Products of GC Electronics, Rockford, IL 61101

current range that measures up to 10 A; the *8012A* has two very low-resistance ranges of 2.0 ohms and 20 ohms full-scale. Resistances as low as 0.001 ohms can be measured! For absolute accuracy, these ranges have a variable zero control that is used to zero out the resistance of the test leads. Basic accuracy on the low range is 1%, ± 2 digits.

Both the *8010A* and *8012A* contain conductance ranges for reading very high resistance into thousands of megohms. The applied voltage is low, so it's possible to read high resistance of IC's and MOS devices. To find the actual resistance, a handy nomograph is provided in the manual; all you need is a straight-edge. An interpolation table (also included) lets you measure to three places for accuracy.

These DMM's give the same true RMS readings of AC voltages as does the *model 8020A*. The manual includes charts for converting the reading into the actual values shown with sinewaves, squarewaves, sawtooth waveforms, pulses, half- and full-wave rectified voltages, and more; a crest-factor chart is also provided.

Using the conductance ranges, transistors may be tested with a simple plug-in test fixture. All you need is a dual banana plug, a transistor socket, a switch and a 470K resistor. The type of transistor can be identified, and even very minute leakages can be read.

The meters are protected against accidental overloads up to 1000 volts DC or peak AC on all voltage ranges; and to 300 volts DC or peak AC on all resistance ranges. The current ranges are protected by a 2A fuse built into the milliampere input jack. If this fuse blows, just unscrew the jack and it pops out for easy replacement.

The readouts are 3.5-digit LCD's, large enough to be seen at quite a distance. Available accessory probes include a high-current probe that lets you read currents from 2A up to 600A; and a high-voltage probe that raises the voltage range to 40 kV DC or peak AC. A high-frequency probe reads from 0.25 volt to 30 volts RMS up to 100 MHz. A temperature probe turns the meters into accurate thermometers, reading from -50°C to $+150^{\circ}\text{C}$, or -58°F to $+302^{\circ}\text{F}$. Finally, a "touch-and-hold" probe freezes the readout for as long as you want (within reason; don't leave it on for several hours!). It does this by stopping the

continued on page 26

Many amps can deliver pure sound. The Sansui AU-919 delivers pure music.



Today's audio engineering has reached the point where you can select among a number of affordable high-power amplifiers that have virtually no "total harmonic distortion." That's good. But THD measurements only indicate an amplifier's response to a pure, continuously repeating, steady-state test signal (below, left). They don't tell you how the amp responds to the never-repeating, rapidly-changing transient waveforms of real music (below, right). And only an amplifier designed to reproduce the demanding dynamics of music signals can satisfy the critical audiophile. An amp like the Sansui AU-919.

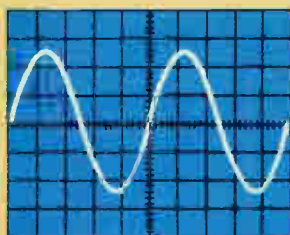

SINE WAVE

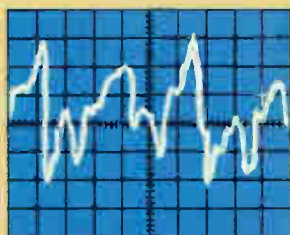

DYNAMIC MUSIC SIGNALS

Because low THD without low TIM is like sound without music, the Sansui AU-919 is designed to respond well to both simple sine-wave test signals and also to handle the jagged, pulsive edges required for realistic reproduction of music — without imparting that harsh, metallic quality known as "transient intermodulation distortion" (TIM).

The Sansui AU-919 sounds better than conventional amps because Sansui developed a unique (patent pending) circuit that is capable of achieving both low THD and low TIM simultaneously.

Our DD/DC (Diamond Differential/DC)* circuitry provides the extremely high drive current necessary to use proper amounts of negative feedback to reduce conventionally-measured THD (no more than 0.008%, 5Hz-20,000Hz into 8 ohms at 110 watts, min. RMS) without compromising our extraordinary 200V/ μ Sec slew rate, ensuring vanishingly low TIM, as well. The power amplifier frequency response extends from zero Hz to 500,000Hz.

Since ultimate tonal quality depends on more than the power amplifier alone, Sansui also uses its DD/DC* circuitry in the phono equalizer section — where current demands are also particularly high — to prevent TIM. ICL (input capacitorless) FET circuits are used throughout the AU-919, and a "jump switch" is provided that will let you run pure DC from the Aux. input to the output.

Visit your authorized Sansui dealer today, and he'll show you a lot more that the AU-919 has to offer. Like twin-detector protection circuitry and our Penta-Power Supply system. Two-deck monitoring/recording/dubbing facilities. And a high-performance ICL/FET pre-preamp for moving-coil cartridges.

Then listen to the AU-919 with the most demanding music you can find. You'll hear the way the music should sound. Like music. Not just like sound.

*The Diamond Differential/DC, Sansui's (patent pending) totally symmetrical double ended circuitry with eight transistors, is named for its Diamond-shaped schematic representation.

SANSUI ELECTRONICS CORP.

Lyndhurst, New Jersey 07071 • Gardena, Ca. 90247
Sansui Electric Co., Ltd., Tokyo, Japan
Sansui Audio Europe S.A., Antwerp, Belgium
In Canada: Electronic Distributors



CIRCLE 61 ON FREE INFORMATION CARD

EQUIPMENT REPORTS

continued from page 24

clock signals to the circuit.

I am very impressed with the instruction manual, which discusses every single test possible with these versatile instruments and explains them in great detail. (The English used is so plain that even I could understand it!) A detailed circuit description, plus calibration instructions and procedures, are all included in the manual. It even tells you exactly how to take the unit out of the case correctly.

Optional versions of the DMM's are available for either 50-Hz or 60-Hz line frequency. This is done because of the use of special noise-immunity filter crystals in the circuit that provide maximum line noise rejection at either frequency. Also available are 90-240 AC line voltages.

These high-quality instruments, designed for maximum ease of use and flexibility, should provide many years of accurate service without problems. All the controls are plainly marked, and color-coding on the panel makes it easy to find the different functions. The model 8010A sells for \$239, and the model 8012A, for \$299. **R-E**

Bearcat Thin Scan Portable Scanner

WHILE PORTABLE SCANNERS HAVE BEEN around for some time, few have been classed as true pocketable receivers. Bearcat's new *Thin Scan* is indeed pocketable. Measuring only



CIRCLE 102 ON FREE INFORMATION CARD

about an inch thick and 2 1/4 inches wide, the scanner will fit in most pockets with ease. Its 5 1/2-inch height poses no particular problems, either. Nor does its 7 ounce weight.

The *Thin Scan* comes equipped with two antennas. More than likely, the user will want to sport the "rubber ducky" flexible antenna. A thin, insulated wire antenna is also provided that may be used where unobtrusive reception is necessary. The wire antenna may be routed anywhere that is convenient, with some reduction in reception range to be expected because of body capacity.

The appearance of the little scanner is handsome and conservative. The black case is accented by a metallic-brown front bezel. A row of LED's signal the channel scanning sequence on the front panel.

Functionally, the *Thin Scan* (model *two-four*) is a four channel, two band (high and low VHF) crystal controlled receiver. It is powered by four AAA cells, with a nickel-cadmium charging provision at a side jack. An external power supply jack is also provided for long-term operation from an AC source. Current drain is nominally 20 mA squelched, 50 mA at full output.

Thumbwheel controls for volume and squelch are conveniently located on the side, making adjustment quite natural. For privacy, an external earphone may be plugged into an audio jack on the top of the receiver.

Channels are individually controlled by lockout switches. Manual pushbutton stepping from channel to channel is also allowed by a fingertip control.

The internal 2-inch speaker is driven with up to 100 milliwatts of audio, adequate for any personal monitoring. Audio remains quite intelligible (10% total harmonic distortion) even at high output levels.

Crystals may be mixed between high- and low-band in any proportion. An automatic socket switching arrangement accommodates the pleasure of the user. The *Thin Scan* is a double conversion superheterodyne, with IF's of 10.8 MHz and 455 kHz. The crystal formula for low band selection is: receive frequency + 10.8 MHz = crystal frequency. At high band, the formula becomes:

continued on page 32

Another reason to join RCA's QT Parts Program! You get four free information packages every year.



RCA's QT-150 Parts Program is better than ever!

Registered dealers receive four free information mailings per year through RCA's Direct Information Service program.

Quarterly mailings include:

- Complete Dealer Price Book — RCA Consumer Parts • Latest Price Supplement • RCA Drawing Number to Stock Number Cross Reference • Color TV Module Cross Reference • B&W TV Module Cross Reference • Dealer QT Inventory Control Form; and many other useful publications.

To join, contact your RCA Distributor and register as a QT Dealer. You will receive your package of 150 of the most-needed, fastest-moving parts to repair older TV sets.

You will also receive your first quarterly information package. Every information mailing will include the latest price publication, plus additional information about RCA Parts required in your servicing business.

Don't forget, your QT Parts inventory program has automated annual drop-ship updating for your convenience. A special QT Parts Rack is also available to save time and space.

Call your RCA Distributor or write to RCA Distributor and Special Products Division, Deptford, N.J. 08096.

RCA QT Parts

Replace three power supplies with the one that tracks

Almost anyone can build three power supplies in one box, but B&K-PRECISION has built one power supply capable of *outperforming* three separate supplies. An exclusive automatic tracking circuit is the reason.

The B&K-PRECISION 1650 multiple-output power supply was designed for use with both linear and digital circuitry. For digital requirements, the unit offers a 5 volt DC, 5 amp output; and two separate A & B 0-25 volt DC outputs at 0.5 amps for analog circuits. The exclusive automatic tracking circuit allows the B output to precisely track voltage changes of the A supply, while maintaining complete electrical output isolation. As a result, any combination of outputs

may be connected in series or parallel, or be totally isolated.

The heart of B&K-PRECISION's automatic tracking circuit is a tiny LED opto-isolator. A pulse-width modulated light beam is transmitted through this device, providing a control signal which directs proportional control of the B supply when the A supply

output is varied. For example, if the B control is set at 100%, the same voltage level will appear at both the A and B outputs. If the B control is instead set to a 50% position and the A output is set for 10 volts, the B output will deliver 5 volts.

Auto-tracking makes the 1650 the ideal power source for breadboard and prototype digital circuits. It can provide two simultaneously varying test voltages, or positive and negative voltages for operational amplifiers. The 1650 is a money-saving alternative to separate power supplies with features that can't be met by separate supplies. For immediate delivery, a ten-day free trial or in-plant demonstration, contact your local B&K-PRECISION distributor.

CIRCLE 68 ON FREE INFORMATION CARD

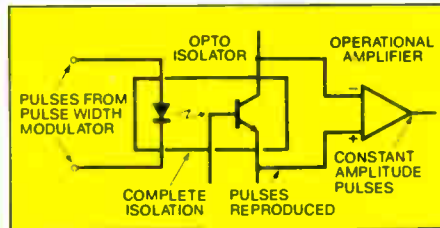

BK PRECISION DYNASCAN CORPORATION

6460 W. Cortland Street • Chicago, IL 60635 • 312/889-9087

In Canada: Atlas Electronics Ontario International Sales Empire Exporters Inc 270 Newtown Road Plainview L.I. N.Y. 11803

B&K-PRECISION
Model 1650 S275
Other power supplies
from \$110



Train with NTS for the MicroComputers, digital the first name



MicroComputers

The world of electronics is daily becoming more challenging. Technology is growing more specialized, and the importance of digital systems increases every day. Test instruments, home entertainment units and industrial control systems are all going digital. And now, NTS training programs include a wider choice of solid-state and digital equipment than ever before offered in any home study course: Advanced NTS/Heath digital color TV (25" diagonal with optional programming capability), NTS/Heath microcomputer, digital test equipment, digital stereo receiver (70 watts per channel), NTS compu-trainer, plus much more state-of-the-art equipment to make your training exciting and relevant.

The equipment you receive with NTS training programs is selected to provide you with a solid

background in electronic systems. Kits and lessons are designed to work together to demonstrate electronic principles and applications. The kit-building not only shows you how electronic hardware functions, but how various circuit designs accomplish different purposes. Your lessons guide you through any number of experiments associated with many projects. This is the Project-Method, and it works. Step-by-step, you learn how and why digital electronics has become a part of our world, and the even bigger role it is sure to play in the future.

Whether you are looking for training in Consumer, Commercial, or Industrial electronics, NTS offers fourteen courses, some basic, many advanced, in several areas of electronics. An all-new full-color NTS catalog shows you what each course covers,

electronics of the future.

systems and more...from
in home study.



**Test
Instruments**



**Basic
Electronics**



**Digital
Color TV**

Simulated TV Reception

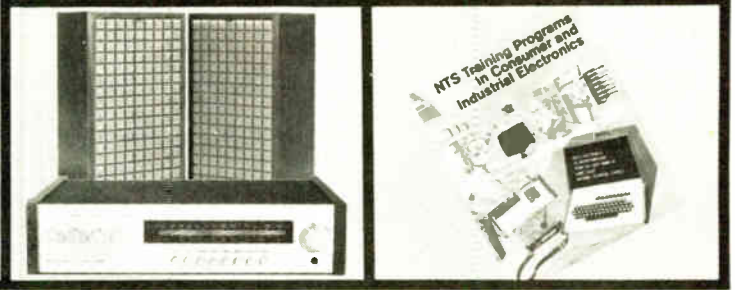

NTS Training Programs
in Consumer and
Industrial Electronics

and every piece of equipment included.

Send for it today, and see for yourself what's really happening in electronics training technology at NTS. Find out how much has changed, and what new directions the field is taking. You'll probably want to be a part of it.

It's free. Just mail the card or coupon. Today.

**NO OBLIGATION. NO SALESMAN WILL CALL.
APPROVED FOR VETERAN TRAINING.**

NATIONAL TECHNICAL SCHOOLS

TECHNICAL-TRADE TRAINING SINCE 1905
Resident and Home-Study Schools
4000 South Figueroa St., Los Angeles, Calif. 90037

NATIONAL TECHNICAL SCHOOLS Dept. 206-109
4000 South Figueroa Street, Los Angeles, California 90037

Please send FREE Color Catalog and Sample Lesson.

- Color TV Servicing
- B & W TV and Radio Servicing
- FCC License Course
- Electronic Communications
- Electronics Technology
- Audio Electronics Servicing
- Digital Electronics
- MicroComputers/MicroProcessors

Name _____

Address _____

Apartment Number _____ Age _____

City _____

State _____ Zip _____

Check if interested in G.I. Bill information.

Check if interested ONLY in classroom training in Los Angeles.

EQUIPMENT REPORTS

continued from page 26

receive frequency — 10.8 MHz

3

Crystals may be ordered as type number A-135 from Electra at \$5 per frequency.

Factory alignment is optimized for midband in the 33-47 and 152-164 MHz ranges. Midband sensitivity is advertised as typically 0.6 microvolt. In fact, our lab measurements confirmed this approximate sensitivity for 20-dB quieting. Sensitivity decreases to about one microvolt at the ends of the alignment ranges. Although not quite so sensitive as more elaborate and expensive scanners, it is perfectly adequate for the local use for which such a device is typically purchased.

Scanning rate is 8 channels-per-second. Squelch sensitivity is near 0.5 microvolt, adjustable to 2 microvolts by the squelch control. Spurious signals are rejected some 50 dB, with images down 35 dB. Modulation acceptance is designed for narrowband ± 5 kHz.

The internal circuitry is very straightforward, using recently developed IC's for communications applications. A Motorola MC3357 FM IF IC drives an LM386N audio amplifier. All RF and oscillator stages are discrete transistors. Adjacent channel selectivity is controlled by ceramic filters.

The circuitry is designed so that the oscillator will not drop out until battery voltage has been depleted to about 4½ volts. As with all battery operated equipment, it is a good idea to check the scanner briefly for operation after long periods of inactivity to make sure that the

batteries are still functional. This will help protect against possible battery leakage damage. Better yet, remove the four AAA cells until the unit is to be used again.

We found the *Thin Scan* to be attractive, reliable, and quality built. It is manufactured offshore for Electra by a prominent electronics firm. The model *two-four Thin Scan* has a suggested retail price of \$149.95. Available from Electra, 300 East County Line Road, Cumberland, IN 46229.

ALCO 2000A LCD DMM

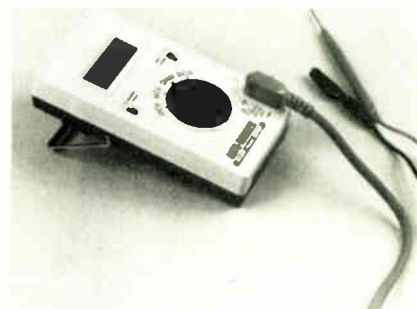

CIRCLE 103 ON FREE INFORMATION CARD

IN SPITE OF THE SLOWER DISPLAY TIME OF liquid crystal displays, there seems to be a definite trend toward these devices for readouts in test equipment, radio transmitting and receiving equipment, and consumer electronics appliances. Their success and general acceptance in wristwatches has undoubtedly stimulated the appeal.

One area in which the LCD's are making substantial headway is in digital multimeters. The old analog VOM's have been taking a beating as the precision and convenience of reading in the new DMM's are now available at ever-lowering prices.

A recent entry into the field of LCD multimeters is ALCO's model *2000A Auto-Ranger*. As the name implies, the *2000A* does not require manual selection of multipliers within a function. Naturally, the normal selection of volts, amps, and ohms must still be done manually.

The ALCO meter measures a little over 6 X 3 X 1-inch, and weighs only 12 ounces complete with its battery installed. The 0.4-inch high 3½-digit LCD display is quite contrasty and thus easy to read in ambient light.

The instrument housing is impact-resistance Cyclac plastic. The beige color is a nice modern departure from the classical basic black. A folding tilt bracket permits the instrument to be adjusted to a comfortable viewing angle when placed on a bench.

ALCO provides a set of one-piece molded test leads. Interchangeable alligator clips and test prods are also included.

The *2000A* is switched on by a recessed, side-mounted slide switch. The low profile position of the switch prevents accidental turning of the unit while it is being transported.

Because of the liquid medium for LCD displays, storage temperature is somewhat more restricted than with other types of displays. In the case of the *2000A*, this range is -20° to +60° C. Operating temperature is from 0° to +40° C.

The LCD multimeter is designed to operate for 30 hours continuously from a standard 9-volt transistor radio battery. Current consumption

continued on page 34

The DR22-C

Fully Synthesized General Coverage Receiver from McKAY DYMEK



FEATURES

- Shortwave, CB, ham radio, ships at sea, overseas phone calls, etc.
- Hi Fi, SWL, commercial, industrial and government uses.
- High level RF front end for excellent inter-modulation rejection and sensitivity.
- Crystal filters in first and second IF amplifiers, ceramic filter in third IF.
- Quartz crystal tuning accuracy at all frequencies, no crystals to buy.
- Built in power supply for 110-120 or 220-240 VAC switchable, 50-60 Hz.
- Low Phase Noise Synthesizer
- Solid state, phase locked, digital synthesis tuning.
- Extreme ease of tuning at all frequencies.
- No mechanical tuning dial error or backlash.
- Switch selectable 4 or 8 kHz RF bandwidth.
- Built in monitor speaker with external speaker connectors.
- Switchable impulse noise limiters for AM and SSB.

SPECIFICATIONS

- Frequency coverage: 50 kHz to 29.7 MHz, continuous. Digital synthesis in 5 kHz steps, fine tune for ± 5 kHz.
- Reception modes: AM, upper sideband, lower sideband, CW.
- Sensitivity for 10 dB S + N/N:

	100 kHz	200 kHz	400 kHz-20MHz	20MHz-29.7MHz
CW, SSB	5 μ V	1.5 μ V	0.5 μ V	0.75 μ V
AM	10 μ V	3.0 μ V	1.0 μ V	1.5 μ V
- Selectivity: -6dB @ ± 2 kHz or ± 4 kHz and -60dB @ ± 5 kHz or ± 14 kHz
- AM Harmonic distortion: 50% modulation = 0.6% T.H.D., 90% modulation = 1.5% T.H.D. (1kHz modulation)
- Frequency stability: Within ± 40 Hz in any 8 hour period at a constant ambient of 25C, after 30 minute warm up.
- Circuitry: 43 integrated circuits, 18 transistors, 16 FETs and 54 diodes.
- Dimensions & Wt.: (W x D x H) 17.5 x 14.5 x 5.1 inches. Shpg. Wt. 19 lbs. (8.7 Kg)



McKay Dymek Co.
111 South College Ave.
P.O. Box 5000
Claremont CA. 91711

Exclusive rent/own plan available in U.S.



Nationwide
800/854-7769



California
800/472-1783

In Canada

WSI Sales Company
Kitchener

Great Metropolitan
Sound Co. Ltd.
Toronto

TWX Telephone
910 581 4990 714/621-6711

CIRCLE 40 ON FREE INFORMATION CARD

LX303

ALL THE MOST WANTED FEATURES AT A MOST WANTED PRICE...

BIG 1/2" HIGH LCD DISPLAY
USE INDOORS OR OUT
200 HOUR 9V BATTERY LIFE
AUTO ZERO, POLARITY,
OVERRANGE INDICATION
100 mV DC F.S. SENSITIVITY
19 RANGES AND FUNCTIONS



Removable cover stores test lead set furnished as part of the unit



Available accessories include AC adapter, padded vinyl carrying case, 40KV DC probe, 10 Amp DC shunt



Temperature Probe available. TP-20C measures from -55° to +150° C. TP-20F from -67° to +302° F



\$74.95
ONLY
HICKOK

THE HICKOK ELECTRICAL INSTRUMENT CO.
 12714 Dupont Avenue • Cleveland, Ohio 44108
 (216) 541-8080 • TWX: 810-421-8285

Here is the handful of accuracy you've been waiting for. Handsomely encased. Compact. Efficient. Only 12 ounces. Hickok's exciting, new LX 303, 3 1/2 digit Mini-Multimeter with high quality components, one year guarantee and rugged Cycolac case offers features previously found only in expensive units... at a price under \$75.00! So why wait any longer? The amazing LX 303 is here, NOW! Another American made test equipment breakthrough from Hickok, The Value Innovator. Order today!

See your local Hickok distributor or order below

SPECIFICATIONS:

DC VOLTS (5 RANGES): 0.1mV to 1000V; Accuracy: ±0.5% rdg ±0.5% f.s.; Input imped: 10MΩ; Max. input 1kV except 50CV on 200mV range

AC VOLTS (40Hz to 5kHz): 0.1V to 600V; Accuracy: ±1.0% rdg ±0.5% f.s. (-2dB max. at 5kHz); Max. input: 600V

RESISTANCE (6 LOW POWER RANGES): 0.1Ω to 20MΩ; Accuracy: ±0.5% rdg ±0.5% f.s. (±1.5% rdg on 20MΩ range; input protected to 120VAC all ranges)

DC CURRENT (6 RANGES): 0.1nA to 100mA; Accuracy: ±1.0% rdg ±0.5% f.s.

DIMENSIONS AND WEIGHT: 5-7/8" x 3-3/8" x 1-3/4"; 12 oz - **POWER:** 9V batt (not incl.) or Hickok AC adapter. **READ RATE:** 3/sec. **OPERATING TEMPERATURE:** 0° -50°C

ADVANCE ELECTRONICS

TO ORDER CALL TOLL FREE
 800-223-0474

54 West 45th Street, New York, N.Y. 10036 212-687-2224



PLEASE SEND ME

- _____ Hickok LX303 Digital Multimeters @ 74.95 ea.
- _____ RC-3 AC Adapter, 115VAC (220VAC avail.) @ 7.50 ea.
- _____ CC-3 Deluxe Carrying Case @ 7.50 ea.
- _____ VP-10 X10 DCV Probe Adapter @ 14.95 ea.
- _____ TP-20 Temperature Probe (specify C or F) @ 39.95 ea.
- _____ VP-40 40 KV DC Probe @ 35.00 ea.

Payment encl. Bill my: Master Charge VISA

Account # _____ Exp. Date _____

Name _____

Address _____

City _____ State _____ Zip _____

Add \$3.00 Postage and Handling, N.Y. residents add sales tax.

CIRCLE 75 ON FREE INFORMATION CARD

EQUIPMENT REPORTS

continued from page 34

carried about. Anyone who has ever had the experience of working outside when the phone rings knows the futile feeling that goes with it.

Now, a number of companies are marketing cordless telephone equipment. We decided to try the *EZ Phone* from Pace (Pathcom).

Typical of the new breed of cordless phones, the *EZ Phone* consists of two units: The base unit and the cordless handset. The base unit is essentially the dialer/telephone line interface (repeater) while the handset is a full duplex transceiver.

The installation of the *EZ Phone* is totally compatible with existing telephone equipment,

and in no way interferes with normal telephone use or operation. It may be considered merely a very flexible extension on your existing telephone system.

An extensive owner's manual covers all aspects of installation and operation. Because of the complexity of the system, no electronic maintenance procedures are included, and no circuit diagram is furnished. The handset is a standard *Princess* size, with an integral *Touch Tone* pad.

The handset contains rechargeable AA nickel-cadmium batteries, and is automatically in a charge mode when replaced in the base unit cradle. A small, telescoping whip antenna helps extend the useable range of the handset away from the base unit. LED status lights signal the user that the handset is functioning, or that battery voltage is low. A switch-selecta-

ble volume control boosts earphone level for noisy environments. When an incoming call is being received, the remote handset emits a loud paging tone. A belt clip is provided for convenient carrying when the handset is not in use, but is standing by for a call.

The base unit is easily installed. It comes with both male and female modular connectors for compatibility with most modern telephone systems. Access to a 120 VAC receptacle is also required to power the base unit and recharge the batteries that are included in the handset.

The base unit is designed to be mounted either on a desk top, or screwed to a wall bracket at eye level. The higher mounting is preferred to enhance coupling between the whip antennas, thereby increasing overall coverage.

The remote handset may be paged from the base unit by pressing a CALL key. A SECURITY key prohibits illicit use of your telephone system by an unauthorized user sharing the same frequency. Since there is a limited number of frequencies allocated to this service, there is a possibility of co-channel interference in large metropolitan areas. As the use of these types of devices becomes more commonplace (and it is inevitable), such interference could become considerable.

A bank of LED indicators inform the user of the circuit status of the base unit. These indicators include: charging the handset, handset in use, AC power on, and security provision in operation.

The actual frequencies of operation for the duplex operation of the *EZ Phone* system are vastly separated in spectrum, making expensive filters unnecessary. The base unit transmits at 1670 kHz, and the handset transmits at 49.82 MHz. Both are allocated by the FCC as license-free low power frequencies.

In spite of the reputation of license-free walkie-talkies, those toys share little in common with a sophisticated piece of electronics like the *Pace EZ Phone*. Using only the telescoping whips provided with the two units, reliable two-way telephone conversations were readily conducted at distances of up to 300 feet between the base unit and the handset. Naturally, maximum range may be expected to vary with the type of structural environment. Audio quality of the *EZ Phone* is excellent—certainly as good as a wired telephone system. A condenser microphone in the handset certainly helps.

The transmitting characteristic of the *EZ Phone* provides an interesting possibility: Group monitoring of telephone calls—a type of conference arrangement. An inexpensive shortwave radio (or a detuned AM radio) may tune in the low frequency signal. The 49 MHz channel may be monitored by a conventional scanner or single-channel low-band FM receiver.

For an executive on call, constantly away from his desk the *EZ phone* would be convenient. Supervisory personnel who must be mobile around factory assembly areas, shipping yards, and other hand-to-locate positions, will appreciate the immediate access to the wireless telephone. And for home users, the price is not prohibitive to the average citizen who wants to be near a telephone, no matter where he is.

The *EZ Phone* wireless telephone extension retails for \$339.95 from Patchom, INC., 24049 South Frampton Avenue, Harbor City, CA 90710 and includes a 90-day limited warranty.

R-E

International's 6024B 40 Channel CB Frequency Meter

- Power Meter
- Signal Generator
- Secondary Frequency Standard

Complete with connecting cable, dummy load, rechargeable battery and charger.

\$448³⁷

Cat. No. 035311

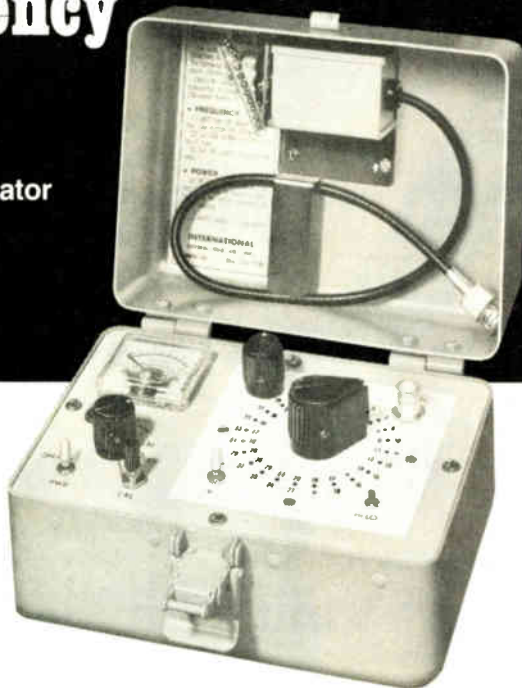

The 6024B provides three test instruments in one convenient case for professional servicing on all makes of Citizens Radio transceivers.

1. Secondary Frequency Standard, range 26.965 to 27.405 MHz, including the newly authorized frequencies 27.235 to 27.405 MHz. Plus a counter circuit, zero to 2500 Hz.
2. Signal Generator 26.965 to 27.405 MHz.
3. Dummy Load/Power Meter, up to 5 watts.



International Crystals are available from 70 KHz to 160 MHz.

Write for information.

ICM
M/S Dept. P.O. Box 32497
Oklahoma City, Okla. 73132



INTERNATIONAL CRYSTAL MFG. CO., INC.
10 North Lee / Oklahoma City, Okla. 73102

CIRCLE 39 ON FREE INFORMATION CARD

now 3-strong

Xcelite® family of attaché tool cases



TC-150/ST

And here's the newest addition... Model TC-150/ST... containing an intermediate assortment of tools for the technician, serviceman, or field engineer. It contains 53 items in all, including 24 famous Xcelite "Series 99" interchangeable-blade tools, a broad variety of other Xcelite Professional screwdrivers, nutdrivers, pliers, cutters, strippers, measuring tape, and specialized electronic tools, plus a Weller® pencil-type, changeable tip Soldering Iron and rosin core solder. Tools are mounted in a durable, attractive case with Whiskey-tan Marvelon exterior and sun-tan vinyl lining. Plenty of extra space for additional tools, prints and manuals! Solid brass hardware and padded handle are additional quality touches.

It joins the other members of the family...

Model TC-100/ST, the "big daddy" of Xcelite's cased tool sets, with the greatest variety—a total of 86 types and sizes of drivers, wrenches, pliers, cutters, strippers...and Model TC-200/ST, the 37-piece set that's unequaled in economy and value.

See the new TC-150/ST at your distributor now. And ask for Xcelite literature, which will give you a detailed listing of the contents of all three Xcelite Attaché Tool Cases.



TC-100/ST



TC-200/ST



The Cooper Group
Electronics Division

BOKER® • CRESCENT® • LUFKIN® • NICHOLSON® • WELLER® • WISS® • XCELITE®
P. O. BOX 728, APEX, NORTH CAROLINA 27502, 919.362-7511

CIRCLE 17 ON FREE INFORMATION CARD



Fact:

**We make over
1,700 products.**

**But we sell only one thing:
Quality.***

***Suitability, Performance, Reliability**



222 Hartrey Ave., Evanston, IL 60204 • In Canada: A.C. Simmonds & Sons Limited
Outside the U.S. or Canada, write to Shure Brothers Inc., Attn: Dept. J6 for information on your local Shure distributor.
Manufacturers of high fidelity components, microphones, sound systems and related circuitry.

**SPECIAL
SECTION**



It was a mere 50 years ago that Radio-Electronics magazine was first published under its original name of Radio Craft. In memory of that occasion, this special section has been assembled by our editors. It provides a rather special look at the field of electronics that we love and is assembled to depict our industry as seen through the pages of Radio-Electronics. It extends on with our views of 2029, only 50 short years in the future. It makes fascinating reading. We found it a joy to put together. We present it to you as an expression of our thanks to you and our wonderful industry that has worked its special magic to keep us 50 years young.

. . . The Editors



CIGARETTES
in the

MELOROL CONE 5¢
SUNDAE 10¢
Malted Milk with HORTON'S ICE CREAM 10¢
HORTON'S MELOROL ICE CREAM 10¢

ate
SHOOP

beginning



”

... there was **Radio-Craft**, the magazine that evolved into the issue of **Radio-Electronics** that you are reading now. In this special 50th Anniversary edition, we are going to do many special things; present some forgotten, yet important events; talk about the state of electronics in 2029, some 50 years in the future.

So get ready to relive the past, enjoy the present and anticipate the future . . . your future . . . the future of this wonderful world of electronics.

50th Anniversary Issue Contents

- 42 History Of Electronics Through The Pages Of Radio-Electronics
- 47 Electronics Magazines Published By Gernsback Publications Inc.
- 53 The World Of Electronics In 2029—Tomorrow Plus Fifty
- 57 Lights That Failed
- 62 Founder—The Great Hugo
- 70 Author! Author!

MANFRED VON ARDENNE.

It was a great experience for me when in 1926 I met the great American electronics pioneer, the inventor of the first grid-controlled high vacuum electron tube, Dr. Lee de Forest, and showed him the Loewe Triple tube which I had developed in Berlin at that time. The triple tube (Fig. 1), which was manufactured by the millions, contained three electron tube systems with their coupling elements in a single envelope and therefore represented the first integrated circuit. In 1927, at the age of 20, I went to New York, and then again met with Lee de Forest who was then continuing his work which he had begun in the early '20's on sound-film technology. After lectures to the Institute of Radio Engineers in New York, concerning the broad-band amplifier I had developed with especially low capacitance de-

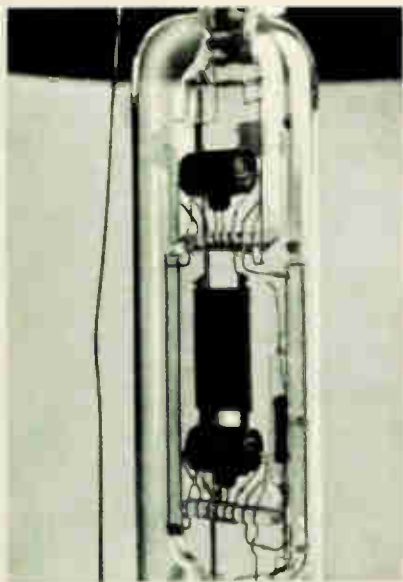

Fig. 1

Bob Hertzberg's article on New York's famous Radio Row, Cortlandt Street, appeared in the September, 1932 issue. Along with its photographs it almost projects the feel of that fantastic street to those who have not seen and cannot possibly imagine it. (One newcomer described it as an area "where unavailable parts are piled up on counters—for pennies!") The article mentioned "the Stromberg-Carlson Treasure Chest—once the finest radio in existence" on the sidewalk with a \$3.00 price tag on it, exactly 1 percent of its \$300 list price, 6 years earlier. (A trip to Cortlandt Street the week after the article appeared found no Treasure Chest—and the Grebes in a nearby store window had also disappeared!)

The first true midget radio—the International Kadette—appeared in 1933. In a bakelite cabinet measuring 5.6 x 6.5 x 4 inches, it weighed 6 pounds. Transformerless, it would work on AC or DC, and, with adapters, on 6 or 220 volts. It became the universal small receiver, and according to the magazine, "enjoyed a

sign in the form of a double tube (Fig. 2), I met H. Gernsback personally.

This acquaintanceship led to my sending regular reports on the results of our work in Berlin-Lichterfelde for publication



Fig. 2

in his magazine, the trailblazer in field of publicity in radio, television, and electronics. Specifically, the reports in his magazines were very helpful in making our new developments known, not only in the U.S.A., but in Europe as well, and putting them into practice. Gernsback was a technical editor with unique requirements. He was there from the first days of radio and was a good friend of many historical personalities of this technology: Lee de Forest, David Sarnoff, the long-time president of RCA, with Vladimir K. Zworykin, among others.

A few months after the English television pioneer, J. Baird, saw the television with electron beam tubes at my laborato-

greater sale than any other set on the market." Not a superhet, it had three tubes plus a tube rectifier.

The mighty "Westingmouse"

Gernsback's "Westingmouse" Superhetero-Ultradyne, a set so small that it could (almost) be carried in the pocket, appeared in the May 1933 issue which reached the readers early in April. The seven tubes shown in the photograph were pilot lights with faked bases of shiny black paper. Although it was plainly tagged as an engineer's nightmare, and the story ended with the words APRIL FIRST in capitals (even the tubes were APR-1's), readers were so eager to have such a set they refused to believe their senses. Orders flooded in, not only to *Radio-Craft* but to a large company whose name somewhat resembled that of the alleged manufacturer of the wonderful set.

The "Radio Month in Review" department started in the November, 1933 issue, and continued to this day under

ry in Lichtefelde, H. Gernsback visited me in Berlin-Lichterfelde on 26 June 1932 (Fig. 3). Before that, Gernsback had repeatedly reported in his magazines in

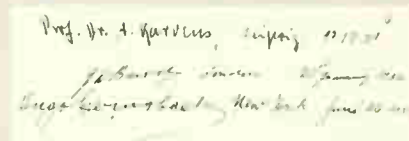
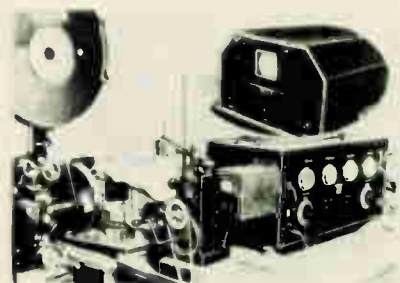

Fig. 3

great detail about my television system with electron beam tubes in the transmitter side (flying spot scanner) and on the receiving end which was first demonstrated at the end of 1930. Thanks to the development of electron beam tubes, with very bright light spot, light control electrodes and step-by-step improved spot focusing methods, we were able to demonstrate at the Berlin Broadcasting Exhibition in 1931 the technical deliberation which in 1932 led to the conversion of all laboratories and firms working on tele-

The New York Times.



The Flying Spot Scanner

Fig. 4

different titles. Because of the time-lag between the event and the magazine's reaching the reader, the "month" was often three months past. (At various intervals attempts were made to "modernize" the page by referring to each item as "last month.") The first installment had an item by Nikola Tesla (then in his 70's) who suggested destroying tornadoes by using robot planes to drop a bomb in the mouth of the funnel.

Events moved fast in 1934. Station WLW in Cincinnati was granted permission by the government to experimentally increase its power from 50-kW to 500-kW, blanketing large areas. Power had to be reduced temporarily until arrangements to avoid blanketing certain stations were made. All-wave radios became increasingly popular, in spite of Gernsback's prediction that the shortwave expert would never use switching—only plug-in coils could give maximum results. Bell Labs engineers gave a demonstration of "solid sound" (stereo) to IRE and AIEE engineers.



Fig. 5

vision to the purely electronic approach.

A later conversation with the American pioneer of electronic television, Dr. Zworykin, revealed that our demonstrations preceded his famous demonstration with the iconoscope. It also appeared in the newspapers and technical journals of the USA, especially in the Gernsback magazines, with many detailed reports (Figs. 4 and 5). The number of lines in the TV picture in these first experiments was only about 100 (Fig. 6). Our electron beam tube (Fig. 7) would not permit a higher number of lines. In the advanced state of electronic technology in 1979, line numbers of, for example, 1250 would be appropriate.

In a letter, which I sent to my friend, Dr. Zworykin, (Fig. 8) in 1977, shortly before his death, I wrote to him: "The market will soon be saturated with color TV sets. Why shouldn't RCA start introducing in the USA a new color TV system, with, for example, 1250 lines, in-line color TV



Fig. 6



Fig. 7

tubes and PAL system? Electronic technology seems to me to be ready for this new start. The progress in picture quality would fully justify the costs."

At an advanced age, Dr. Zworykin, as I did, turned to biomedical technology. Since about 1960, I have concentrated on transferring the selection principles of radio technology (feedback, series-connected similarly tuned selective elements) into biology. Our goal, to which we have come very close, is the creation of a highly-selective cancer therapy (cancer multistep therapy) which will destroy only the cancerous tissue, but not sound tissue in the human organism. We reported on the state of our Dresden work in which new types of high frequency process, with Raster movements of the applicator were extremely important, in New York at a



Fig. 8

symposium on fighting cancer with hyperthermia (March 15, 1979). The symposium was sponsored by the New York Academy of Sciences, and we presented the paper, "The Use of Hyperthermia within the Frame of the Cancer Multistep Therapy" by M. von Ardenne and W. Krüger.—*Manfred von Ardenne*

Manfred von Ardenne was one of the earliest advocates of cathode-ray television, practically "a voice crying in the wilderness" in the early '30's. Though Gernsback had serious doubts about the possibility of using the tube for TV, he printed all the articles the youthful von Ardenne sent him. (Other authorities, among them Lee de Forest, thought that the cathode-ray tube was too expensive, too unreliable, too complex, and too dangerous to be used in TV.)

Manfred von Ardenne is now head of the research institute named after him, and is chiefly engaged in electronic medical work, with the emphasis on cancer.

The year 1934 was also the year of prediction. The April cover that year showed a man picking up the morning paper from a slot in the front panel of his radio, and had an article describing facsimile equipment already manufactured by RCA and others that would make that possible. The June cover showed a foot patrolman wearing a radio unit resembling some of those actually used later on. The radio was a receiver, intended only to pick up broadcasts from police headquarters. Even Gernsback did not expect police to be equipped with hand-held two-way radios.

A 1934 cover also showed the Gernsback Phonosone, a bone-conduction hearing aid that was an improvement on the Gernsback Osophone of 1923 that permitted a deaf person to hear a radio broadcast through his forehead. Despite two cover articles with illustrations on this device, an inventor was issued a patent on a bone-conduction aid in the late '30's. Gernsback never protested: "I didn't intend to manufacture it," he said.

"Why bother somebody else?"

In September 1934 the first article in *Radio-Craft* to use the words high-fidelity appeared, when the story "A New High-Fidelity Dual-Channel Amplifier" was published.

A "four-dimension" audio system is also mentioned in 1935. It used four mikes and four speakers; a pair of headphones center-tapped to make stereo phones is also shown. The avalanche of new tubes reached a new peak the same year. New types had been increasing for a few years; "new tube" articles that described two or three types began to cover a half-dozen, then more, and finally the metal tube was released about the middle of the year. October was a special metal-tube issue, and it was stated that glass tubes were now on the way out.

"Armstrong Invention Ends Static," announced the "Radio Month" in the June 1935 issue. Thus, FM was announced, purely as a static eliminator, though there are hints of other uses: "The new system may affect television, since it

permits extremely wide modulation." Other 1935 events included a Connecticut law that would have banned auto radios. It was withdrawn before it was reported out of committee. Alfred Ghirardi, later known as the author of the "Radio Physics Course," contributed his first article to the magazine. Hugo Gernsback and de Forest agreed that the cathode-ray tube was not the solution to television—the young Du Mont insisted emphatically that it was.

Also in 1935, again ahead of the times, there were two hi-fi stories—"Putting High-Fidelity In Old Sets" and "How To Add High-Fidelity To Old Sets". In the May 1935 issue there were 5 articles dealing with hi-fi.

A news item in 1936 told of an Iowa farmer who put a radio in a box on his plow in order to be able to hear the baseball games. (Today, a radio is standard equipment on tractors.) The German television inventor/researcher Baron Manfred von Ardenne described a new cathode-ray television set that could be

viewed in a lighted room and had a definition of 400 lines. RCA was making million-dollar experiments in television with cathode-ray tubes. In February and March 1936 readers learned from a 2-part article by M. H. Gernsback how to build a high-fidelity TRF receiver.

A serial, "How to Build Your Radio-Craft Television Receiver" ran through the first several issues of 1937; it used a 5-inch CRT with a resolution of 441 lines. Marconi died in July. The so-called "machine-gun" microphone was described by M.H. Gernsback. It was highly directional and designed to pick up outdoor events at long distances. Hugo Gernsback's surrealist art piece "Radio" was shown in the September 1937 issue. (Gernsback had visited a surrealist art exhibition, then had gone back to the office, dug up some items from the junk room, had them welded together and entered them in the show).

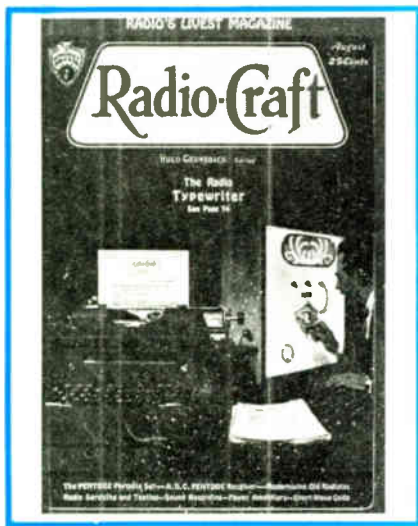

In 1938 the first foreboding of radio censorship appeared. Mae West played F've opposite the snake (not stated who played that part). The FCC decided that the program had been "far below minimum standards" and hinted that it would be remembered at license-renewal time. Two states introduced bills for state control of broadcast programs (techniques for preventing programs from crossing state borders were not described). The Institute of Public Opinion found that 41 percent of the public favored government censorship of broadcasting; 59 percent opposed it. The radio industry decided to police itself.

"Radio Waves Flow Through Tubes," in the May 1938 issue, described Southworth's work with coax cable and waveguides. It included the fantastic experiment with 8-inch-diameter coax with quartz insulation, in which Southworth first removed the center conductor, demonstrating waveguide transmission, then the outer one, transmitting the waves by the different refraction characteristics of quartz and air.

High-power broadcasting was well on the way. General Electric threatened 1200 kW. Station WLW started broadcasting with 500 kW again, after erecting a "suppressor" antenna to prevent drowning out Canadian stations on their own territory. The latest television station list had 19 stations. Five stations were on 441 lines, with 30 frames-per-second. Some still used scanning discs. Power varied from 15 watts to 30 kW.

Foresighted Professor Rogers of the Massachusetts Institute of Technology advised graduating students: "Your most secure and profitable career will be on the public payroll, supported by the rest of the population." Television claimed its first life with the death of No. 1 amateur Ross Hull, who was electrocuted while trying to pick up New York from Hartford, CT, on an experimental breadboard set.

A January 1939 article described the

JOHN R. PIERCE
My Hero and Yours—Hugo Gernsback

A number of years ago I was talking about Hugo Gernsback with several prominent members of the National Academy of Sciences—Lloyd Berkner and Detlev Bronk, former president of the Academy and then president of Rockefeller University, were among them. All had been introduced to radio by buying things from Gernsback's Electro Importing Company and through his early publications. As a result of that conversation, Bronk called Gernsback and had a pleasant conversation with him.

It is hard to overestimate Gernsback's effect on young people who later became members of the technical and scientific community. His publications certainly played a large part in my case. He published a brief note of mine on an improvised galvanometer when I was in high school. He asked me to write "How to Build and Fly Gliders," published in 1929, and published other glider articles of mine. He attracted me to science fiction and published my first story in *Science Wonder Stories* in 1930.

How well I remember Gernsback's various publications. He was always young, daring, interested in what was new and informative about it. A very few years before his death he invited me to visit him at his office and later took me to lunch. He was distinguished and charming, and I was delighted to meet again a man who had had such an influence on my life—and on the lives of others.

It is good to be reminded, by the fiftieth anniversary of *Radio-Craft/Radio-Electronics*, that what Gernsback began still endures.—John R. Pierce

John R. Pierce was director of electronic research at Bell Laboratories until his retirement some years ago. He is, as he points out, also a science fiction author—under a pseudonym—and a composer of electronic music. At present he is Professor of Engineering at the California Institute of Technology.

absolute altimeter, which measured height by reflecting radio waves from the earth back to the plane. That was actually a type of radar, and the wartime censorship refused the magazine permission to reprint it in 1944, even though the term "radar" was already known to the public.

Extremist right-wing agitator Father Coughlin was refused air time by station WMCA for a talk explaining that Nazism was an outgrowth of Communism, unless he first submitted a text. "Broadcasts inciting racial and religious hatred are an evil not to be tolerated," said the President of the National Association of Broadcasters.

The Milwaukee Journal filed an application to broadcast TV programs on a commercial basis. Franklin D. Roosevelt was the first U.S. president seen on TV when he opened the New York World's Fair in the spring of 1939. The experimental NBC-RCA TV station in New York City broadcast the event.

Nuclear age begins

In the June 1939 issue, "Radio Month" had noted in passing that a Dr. O. Hahn of Berlin had produced barium by bombarding the synthetic element ekauranium with neutrons. Neither the editor or readers seem to have considered the event important.

Dr. Edouard Branly celebrated his 95th birthday on October 3, 1939—with no radio. He said: "It bothers me to think I had anything to do with it."

Station W2QXR, New York City, started transmitting experimental FM broadcasts 42 hours a week in 1940. The FCC on Oct. 31, 1940 issued construction permits to 15 stations to build commercial FM stations. The band, 42-50 MHz was authorized to be used starting January 1, 1941. However, the first station to be licensed was W47NV which went on the air in Nashville, Ky. on May 29, 1941. The Indianapolis Power and Light Company found that replacing its two-way AM auto radios with FM radios doubled their range. Portable radios were at last becoming truly portable—the RCA Model BP-10 (measuring 9.5 x 3.5 x 3 inches) led the market with a "camera-type" set. A Galvin (Motorola) bicycle radio used permeability tuning. The April 1940 issue mentioned hearing-aid "microtubes" the size of pilot-light bulbs (exactly the same size as the "Westinghouse" APR-1's of the 1933 April Fools story.)

Commercial TV begins

The FCC authorized commercial TV broadcasts to start on July 1, 1941 using the 525-line standard and channels 2 to 13 (channel 1 was transferred from TV to

THE FIRST COVER of the first issue of every electronics magazine Gernsback Publications has ever produced is shown on the page at the right. How many do you remember?

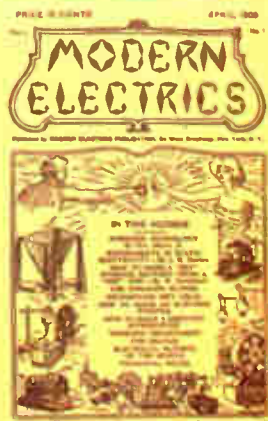

1908



1913



1919



1920

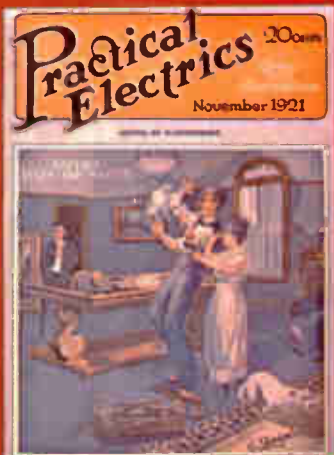

1921



1925

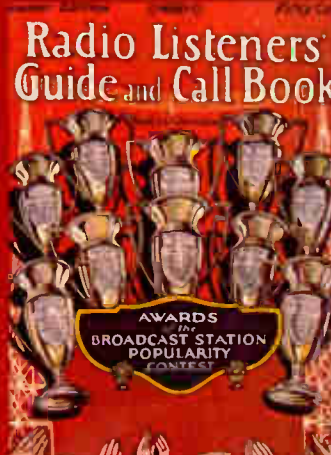

1927



1927

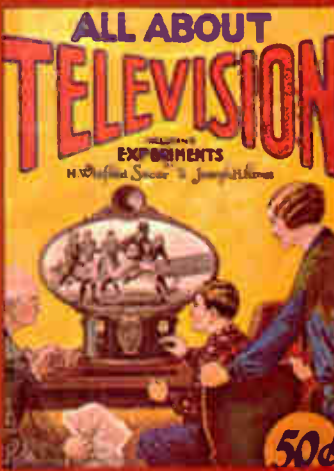

1927

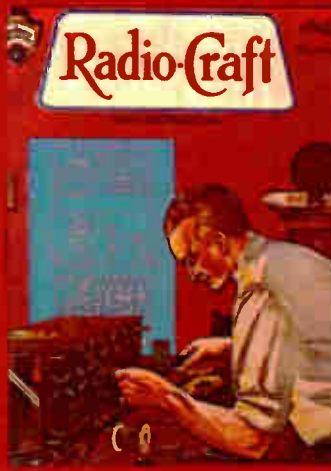

1929

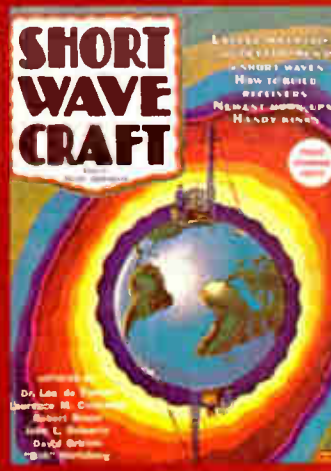

1930



1931

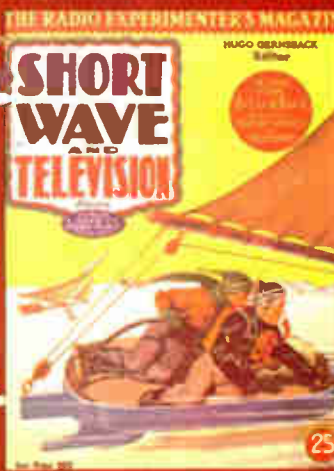

1937



1938



1948



1957

FM broadcasting). Station WNBT (now WNBC-TV) in New York City received the first license on June 17, 1941. The outbreak of World War II in Dec. 1941 put a freeze on all new TV activity and



receiver manufacturing till 1945.

"Preparedness" was a theme that began to pervade the magazine in 1940. Editorials were entitled "Radio for Defense" and "Radio War Inventions." The news items in the "Radio Month" feature indicated that the U.S. was already looking ahead to war. A new section, "Radio Defense," appeared early in 1941; scarce metals were being swept up, and a correspondent made suggestions on saving scarce aluminum. *Radio and Television* (formerly *Short Wave Craft*) merged with *Radio-Craft* at the end of 1941. The publisher explained that in the "present emergency" advertisers were cutting their space and that the National Defense Program required conservation of resources such as paper.

The magazine had survived through the depressed 1930's, though several others in the field had failed. But times became even more difficult as the 1940's began. "National Preparedness" was the countrywide issue. The government stockpiled raw materials, cutting down on materials available for civilian use and raising prices. Manufacturers cut back their advertising. Just to keep going was a constant struggle, and the consolidation of the two magazines was a sign of it. And the first two issues of *Radio-Craft* in 1942 were combined into one January-February number.

The "Roaring Forties"

The same thing happened with the August-September 1942 issue, though by that time there was already light at the end of the tunnel. The tide began to turn toward the end of the year. Practically complete employment and industrial output at 100 percent had a startling effect on circulation and advertising. And the war increased interest in electronics, es-

Hugo Gernsback . . . an appreciation ROBERT HERTZBERG

He was the pioneer publisher of radio magazines in the United States. He was the father of the entire science-fiction cult, a visionary who far outdid Jules Verne. Many of his "wild ideas," as incredulous readers called them, materialized years later: network broadcasting, television, radar, moon-bounce transmission, guided missiles, jet propulsion, nuclear fission, to name a few.

As a very young writer/editor, I worked for Hugo Gernsback in the 'twenties and 'thirties, and kept in close personal touch with him right up to his death in 1967. He was a private man, a bit on the formal side. I never heard anyone address him by his first name. He was always Mr. H to his staff.

Mr. H. came from Luxembourg, a tiny duchy squeezed into a corner formed by Germany, France and Belgium. He was well educated, and was fluent in German, French, English, and a native speech, called "Letzeburgish." He was a European gentleman of the old school, always meticulously dressed. He was a connoisseur of wines and women, and a practiced gourmet. One day he took me to lunch at a posh New York restaurant, where he was greeted with great deference by the head waiter. The latter returned in a flash with the head cook, resplendent in his white garments. He and Mr. H shook hands cordially, exchanged a few pleasantries in French, and then spent fully five minutes discussing the preparation of an omelet. An omelet? I'll never forget that dish. It was a work of art.



Hugo Gernsback was camera-shy. People who read his magazines for half a century had no idea of his appearance. This picture of him is a rarity, and I happen to have it because I took it myself in his office in 1931, when he was only 47 years old. It was one of those sneaky "candid" shots, and no one was more surprised than I was after I developed and printed it.—Robert Hertzberg

pecially radio. Circulation started going up, in an ever-rising curve that led the staff who survived to refer to the period as *Radio-Craft's* "Roaring Forties."

In 1941 the possibility of war was on everyone's lips. And, of course, with the Japanese attack on Pearl Harbor in early December, we were involved. *Radio-Craft* was also involved, facing an entirely new set of reader problems and presenting solutions to them.

By the time the January-February 1942 issue was printed, the country was actually at war, and *Radio-Craft* was faced with a new task—showing the service technician how he could keep radios playing without replacement parts. Ha-



rold Davis—technician from the Deep South—warned of the trouble in the March issue, but even he failed to see the full horror of the situation ahead. His article showed how the technician could get by with the five types of electrolytics permitted under the defense plans. Actually, the service technician's problem (within the year) was how to get along *without* them. The April 1942 editorial suggested that the young technician could gather up old sets and build new radios from their parts.

An article entitled "Stabilized Feedback," by Harold S. Black, its inventor in the June 1942 issue, describes negative feedback, which up to that time had been mentioned only in highly technical journals.

The July 1942 issue reported that the FM Broadcasters Association had discovered that FM listeners preferred serious music to all other programs, with less than one percent interested in news, lectures or drama.

A letter from Ben Miessner, inventor of electronic organs, says that Fritz Lowenstein, for whom he worked in 1911, used oscillating vacuum tubes in that year even before they were called vacuum tubes. (Lowenstein called them "ion controllers.") He had had a radiotelephone working between two of his laboratories

at 115 Nassau Street, New York City.

The effects of the war began to appear in the later issues of 1942. There was less material on servicing and more theory (some by authors who themselves appeared to be learning), and stories on wartime repairing and wartime limitations. (Lt. Cooke, inventor of a radio slide rule and author of a popular mathematics book for radiomen, reports that, because of "priorities," he can't get one of his own Cooke slide rules).

Nikola Tesla, the great electrical inventor-engineer who invented the induction motor and the multiphase AC power distribution system among other things, died on January 7, 1943, and the February issue was a special Tesla number. Hugo Gernsback (possibly Tesla's last friend) wrote of the great technologist's achievements from his own memory and from the patent files. A page of appreciative comments from prominent people in the field revealed that many of them still had a photographic memory of some of the pages in "The Inventions, Researches and Writings of Nikola Tesla" (published 1894).

The war cut off not only radio supplies, but news as well. "Post-War Planning" was the substitute feature and many an item on the news page described events in the postwar world instead of present news. Gernsback predicted that after the war we would have combination alarm clocks and radios that would wake you up with music. There would also be plastic radio tubes (the plastic actually waited for solid-state) and radios that would fit into a suit pocket and provide loudspeaker volume. Using industry as a source of material, the magazine printed articles on germicidal tubes, dust precipitators, and *Heatronic* molding machines.

The May 1942 cover had another notable feature. The magazine had been running items on careers for women in the military forces. *Radio-Craft* was approached by a publicity man for the U.S. Coast Guard, with a promise of a cover picture to run with an article on women



"radiomen" in the Coast Guard. The picture was to be original, he said, and not offered to any other magazine. But the May issue of every magazine in the radio field had a different and "original" picture of the same Coast Guard "radiogirl." The editors were not pleased, and the clever publicity man found it impossible to place any of his publicity releases in their magazines for some years.

"Post-War Planning" extravaganzas went so far that Zenith Radio was impelled to protest, in a July 1943 cartoon showing their proposed after-the-war model. It included the kitchen sink, plus all imaginable forms of electronic entertainment, facsimile newspaper, and even a soft-drink dispenser. It did have one true prediction of things to come—a radio oven.

SENATOR BARRY GOLDWATER

Yes, I remember *Radio-Electronics*, I remember Hugo Gernsback, and, in fact, I started with amateur radio in 1922 or 1923, and the names you have mentioned bring back very fond memories.

I remember the eagerness that each of these publications was met with, and I particularly remember the interest in anything that Hugo had to say about what was becoming a great service and is today one of the greatest any group can offer its fellow citizens.—*Barry Goldwater*

Barry Goldwater, K7UGA, K3UIG, is the radioman in the United States Senate. While never an author for the magazine, his name has appeared in it frequently in news reports of legislation benefiting radio amateurs or technicians.

Radio-Craft reorganized on a wartime basis with the November 1943 issue. The covers—all on military subjects—were handpainted in flaming reds and yellows by science fiction artist Alex Schomburg. The influx of money to pay authors began to show up in improved articles, and headline type and captions spruced up. (Those bright wartime covers continued until 1945, when the magazine went back to peaceful subjects.)

The January 1944 editorial, "Shrinking Radio," points out that while locomotives, planes, and ships were getting larger, radio was bucking the trend. Tubes that were 4 inches high in the '20's were now the size of a flashlight bulb. A "set no larger than a dime is not an impossibility and . . . will be produced." Even record players would shrink, and possibly "future records will be made on plastic tape."

In a lighter vein

In the April 1944 issue, Gernsback reinstated the April Fool hoaxes, which had been abandoned after the repercussions of the "Westinghouse" portable of 1933. The "Radium Radio Receiver (Ra



WHEN PHOTOFACTS were announced, service data became readily available.

Ra 4-1)" gave full loudspeaker output with only one tube—in fact it needed a throttle instead of a volume control. The set could be turned on at any time by a signal from the local station, to receive disaster warnings or important bulletins. In spite of plain clues in the story and the closing words, "APRIL FOOL?" Gernsback was deluged with orders and offers to invest. The April Fool stories were printed every year until the mid-1950's. Some of the ideas were pretty unbelievable—but one, at least, was patented within two years after it appeared as pure fiction.

The June 1944 issue escaped suppression by a narrow margin. Its cover showed planes dragging wire nets as a "radar-defensive reflector" to confuse enemy radar. The idea was so close to the tinfoil "chaff" actually being used secretly that the censorship held up the magazine for a considerable time. (The readers didn't notice—so many issues were late during that period.)

Radio-Craft introduced a new type of fiction, the "Sally the Service Maid" series in the early 40's. They were the only love stories ever illustrated with schematic diagrams.

In the March 1945 issue, McMurdo Silver, high-fidelity pioneer, suggested that 8000 cycles-per-second should be a good top limit for audio, and that an amplifier should reproduce well down to about 50 cycles.

That year saw other events: Amateurs went back on the air in midsummer; a new soldering instrument "that draws no current when not in use and heats up in half a minute" was described, with photos courtesy of the Weller Company. An interesting item to viewers of today's news programs appeared in the October, 1945 issue: The president of the National Broadcasters Association opposed the new practice of inserting a commercial in the middle of a news broadcast. "No more reason why a news broadcast should

RADIO-CRAFT—1937 RECEIVER

As before the RADIO-CRAFT 60, set of Home, Radio, and Television. The receiver is a superheterodyne, with an audio amplifier, a 500 cycle tone arm, and a 500 cycle tone arm. It is a superheterodyne, with an audio amplifier, a 500 cycle tone arm, and a 500 cycle tone arm.

The receiver for this issue, containing the patterns of a set of Home, Radio, and Television. It is a superheterodyne, with an audio amplifier, a 500 cycle tone arm, and a 500 cycle tone arm.



The receiver for this issue, containing the patterns of a set of Home, Radio, and Television. It is a superheterodyne, with an audio amplifier, a 500 cycle tone arm, and a 500 cycle tone arm.

The receiver for this issue, containing the patterns of a set of Home, Radio, and Television. It is a superheterodyne, with an audio amplifier, a 500 cycle tone arm, and a 500 cycle tone arm.

The receiver for this issue, containing the patterns of a set of Home, Radio, and Television. It is a superheterodyne, with an audio amplifier, a 500 cycle tone arm, and a 500 cycle tone arm.

The receiver for this issue, containing the patterns of a set of Home, Radio, and Television. It is a superheterodyne, with an audio amplifier, a 500 cycle tone arm, and a 500 cycle tone arm.

The receiver for this issue, containing the patterns of a set of Home, Radio, and Television. It is a superheterodyne, with an audio amplifier, a 500 cycle tone arm, and a 500 cycle tone arm.

The receiver for this issue, containing the patterns of a set of Home, Radio, and Television. It is a superheterodyne, with an audio amplifier, a 500 cycle tone arm, and a 500 cycle tone arm.

The receiver for this issue, containing the patterns of a set of Home, Radio, and Television. It is a superheterodyne, with an audio amplifier, a 500 cycle tone arm, and a 500 cycle tone arm.

The receiver for this issue, containing the patterns of a set of Home, Radio, and Television. It is a superheterodyne, with an audio amplifier, a 500 cycle tone arm, and a 500 cycle tone arm.

The receiver for this issue, containing the patterns of a set of Home, Radio, and Television. It is a superheterodyne, with an audio amplifier, a 500 cycle tone arm, and a 500 cycle tone arm.

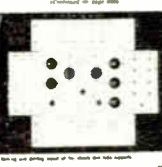

The receiver for this issue, containing the patterns of a set of Home, Radio, and Television. It is a superheterodyne, with an audio amplifier, a 500 cycle tone arm, and a 500 cycle tone arm.

The receiver for this issue, containing the patterns of a set of Home, Radio, and Television. It is a superheterodyne, with an audio amplifier, a 500 cycle tone arm, and a 500 cycle tone arm.

The receiver for this issue, containing the patterns of a set of Home, Radio, and Television. It is a superheterodyne, with an audio amplifier, a 500 cycle tone arm, and a 500 cycle tone arm.

The receiver for this issue, containing the patterns of a set of Home, Radio, and Television. It is a superheterodyne, with an audio amplifier, a 500 cycle tone arm, and a 500 cycle tone arm.

The receiver for this issue, containing the patterns of a set of Home, Radio, and Television. It is a superheterodyne, with an audio amplifier, a 500 cycle tone arm, and a 500 cycle tone arm.

The receiver for this issue, containing the patterns of a set of Home, Radio, and Television. It is a superheterodyne, with an audio amplifier, a 500 cycle tone arm, and a 500 cycle tone arm.

The receiver for this issue, containing the patterns of a set of Home, Radio, and Television. It is a superheterodyne, with an audio amplifier, a 500 cycle tone arm, and a 500 cycle tone arm.

The receiver for this issue, containing the patterns of a set of Home, Radio, and Television. It is a superheterodyne, with an audio amplifier, a 500 cycle tone arm, and a 500 cycle tone arm.

The receiver for this issue, containing the patterns of a set of Home, Radio, and Television. It is a superheterodyne, with an audio amplifier, a 500 cycle tone arm, and a 500 cycle tone arm.

The receiver for this issue, containing the patterns of a set of Home, Radio, and Television. It is a superheterodyne, with an audio amplifier, a 500 cycle tone arm, and a 500 cycle tone arm.

The receiver for this issue, containing the patterns of a set of Home, Radio, and Television. It is a superheterodyne, with an audio amplifier, a 500 cycle tone arm, and a 500 cycle tone arm.

The receiver for this issue, containing the patterns of a set of Home, Radio, and Television. It is a superheterodyne, with an audio amplifier, a 500 cycle tone arm, and a 500 cycle tone arm.

The receiver for this issue, containing the patterns of a set of Home, Radio, and Television. It is a superheterodyne, with an audio amplifier, a 500 cycle tone arm, and a 500 cycle tone arm.

The receiver for this issue, containing the patterns of a set of Home, Radio, and Television. It is a superheterodyne, with an audio amplifier, a 500 cycle tone arm, and a 500 cycle tone arm.

The receiver for this issue, containing the patterns of a set of Home, Radio, and Television. It is a superheterodyne, with an audio amplifier, a 500 cycle tone arm, and a 500 cycle tone arm.

The receiver for this issue, containing the patterns of a set of Home, Radio, and Television. It is a superheterodyne, with an audio amplifier, a 500 cycle tone arm, and a 500 cycle tone arm.

The receiver for this issue, containing the patterns of a set of Home, Radio, and Television. It is a superheterodyne, with an audio amplifier, a 500 cycle tone arm, and a 500 cycle tone arm.

The receiver for this issue, containing the patterns of a set of Home, Radio, and Television. It is a superheterodyne, with an audio amplifier, a 500 cycle tone arm, and a 500 cycle tone arm.

The receiver for this issue, containing the patterns of a set of Home, Radio, and Television. It is a superheterodyne, with an audio amplifier, a 500 cycle tone arm, and a 500 cycle tone arm.

The receiver for this issue, containing the patterns of a set of Home, Radio, and Television. It is a superheterodyne, with an audio amplifier, a 500 cycle tone arm, and a 500 cycle tone arm.

The receiver for this issue, containing the patterns of a set of Home, Radio, and Television. It is a superheterodyne, with an audio amplifier, a 500 cycle tone arm, and a 500 cycle tone arm.

The receiver for this issue, containing the patterns of a set of Home, Radio, and Television. It is a superheterodyne, with an audio amplifier, a 500 cycle tone arm, and a 500 cycle tone arm.

The receiver for this issue, containing the patterns of a set of Home, Radio, and Television. It is a superheterodyne, with an audio amplifier, a 500 cycle tone arm, and a 500 cycle tone arm.

The receiver for this issue, containing the patterns of a set of Home, Radio, and Television. It is a superheterodyne, with an audio amplifier, a 500 cycle tone arm, and a 500 cycle tone arm.

The receiver for this issue, containing the patterns of a set of Home, Radio, and Television. It is a superheterodyne, with an audio amplifier, a 500 cycle tone arm, and a 500 cycle tone arm.

The receiver for this issue, containing the patterns of a set of Home, Radio, and Television. It is a superheterodyne, with an audio amplifier, a 500 cycle tone arm, and a 500 cycle tone arm.

The receiver for this issue, containing the patterns of a set of Home, Radio, and Television. It is a superheterodyne, with an audio amplifier, a 500 cycle tone arm, and a 500 cycle tone arm.

The receiver for this issue, containing the patterns of a set of Home, Radio, and Television. It is a superheterodyne, with an audio amplifier, a 500 cycle tone arm, and a 500 cycle tone arm.

The receiver for this issue, containing the patterns of a set of Home, Radio, and Television. It is a superheterodyne, with an audio amplifier, a 500 cycle tone arm, and a 500 cycle tone arm.

The receiver for this issue, containing the patterns of a set of Home, Radio, and Television. It is a superheterodyne, with an audio amplifier, a 500 cycle tone arm, and a 500 cycle tone arm.

The receiver for this issue, containing the patterns of a set of Home, Radio, and Television. It is a superheterodyne, with an audio amplifier, a 500 cycle tone arm, and a 500 cycle tone arm.

The receiver for this issue, containing the patterns of a set of Home, Radio, and Television. It is a superheterodyne, with an audio amplifier, a 500 cycle tone arm, and a 500 cycle tone arm.

The receiver for this issue, containing the patterns of a set of Home, Radio, and Television. It is a superheterodyne, with an audio amplifier, a 500 cycle tone arm, and a 500 cycle tone arm.

The receiver for this issue, containing the patterns of a set of Home, Radio, and Television. It is a superheterodyne, with an audio amplifier, a 500 cycle tone arm, and a 500 cycle tone arm.

Radio-Electronics pulled a clear majority of 58 percent over all the others combined, and was adopted. (Runners-up were *Radio Science* and *Radiotronics*). *Radio-Craft* remained on the cover for a few months, becoming gradually smaller until it disappeared.

The October issue also described the

NORMAN CROWHURST

Before World War II, in my native England, I was Chief Engineer of an aggressive electronics company. Then Britain led the world in electronics. Before the term "systems design" was coined, we were doing it, being first with an automated power station, medical electronics equipment, multiple language translation systems, to name a few.

After the war, political interference allowed America to steal the lead, resulting in the "brain drain"—engineers like me coming to America. I realized that publication would provide a way round this bottleneck—making technology available for more than a select few. But I was an engineer, not a writer.

Trying many technical magazines in this country, I found *Radio-Electronics* the really helpful one. Many engineers even, merely used their fancy jargon without knowing what it meant, while others were bamboozled by them. I found that, once concepts were truly understood, they were easy to explain. That was my starting point.

Radio-Electronics contributed another side. Even easy explanations can be understood only if the reader understands the words used. *Radio-Electronics* editors were very ready to work with me, sending back pieces with "What's this mean?" written on them. (Jargon can be so much of a habit that, even though you explain it, you forget you are using it.)

A *Radio-Electronics* editor would sometimes say to me, "I think I know what this means, but would you explain it for me, to make sure I do?" After I had explained it in really simple terms, he'd say, "Now write it like that."

After a year or so of this, other publications, who had previously turned down my work, came to me to ask why I had "bypassed" them. Perhaps there is a lesson here. Since then, I have found that too many editors change what a writer says, to say what the editor thinks he should have said. Are they frustrated writers? It often seems that way. But *Radio-Electronics* people had the right idea: help a writer to say what he really wants to say, so the reader understands it.—*Norman H. Crowhurst*

Norman Crowhurst was Chief Engineer of Tannoy, a manufacturer of audio equipment and transformers, in England. Coming to this country in the early '50's, he covered the technical advances in audio, writing explanatory articles on stereo, FM, and similar subjects. He moved to the West Coast after a year with Fairchild in the East, and is now interested in the field of education as well as electronics.

first twin-track tape recorder on the market.

The December 1948 cover and a feature article described waveguides, now becoming important. Electronics in medicine was also receiving attention, and a six-part series ran through the latter part of 1948.

Also in the December 1948 issue, Hugo Gernsback pointed out that the younger generation were developing perceptual abilities unknown to most of their parents. While listening to the radio, for example, they could carry on exhausting work. He predicted they would do the same when television became common. Not all the older generation, he said, are monopercptual, and cited the organist who can play one set of notes with his hands, another set with his feet, can read notes, can read words, and sing—fivefold multipercptual.

A series of meetings of several New York State technicians' associations culminated in the formation of the Empire State Federation of Electronic Technicians (ESFETA). Similar organizations were springing up in California, Pennsylvania, and the central states.

The March 1949 cover showed the first nude ever to appear on any American technical magazine—a statuette: "The Spirit of Television" by Lily Rona, wife of Professor Felix Ehrenhaft of magnetic current fame. *Radio-Electronics'* first television issue, it was a big 146-page magazine, with a TV station list of 69. Though a little short on technical information, it was long on optimism, which the future abundantly justified. (Even Hugo's editorial, "Radio's Biggest Boom is Now in the Making," was a rank understatement within five years.) A chart of receiver characteristics showed 71 manufacturers represented. One of the characteristics listed was "number of channels." Some models had only five channels, and all the Philco sets were 8-channel sets.

Electrets were the subject of the April 1949 cover, the main article and *Radio-Electronics* exhibit at the IRE convention, where many engineers still refused to believe in their existence.

A new breed

In May 1949, Hugo Gernsback reported that the term "radio serviceman" would no longer appear in the magazine. "Service technician" was the correct description. The term took a long time to take hold but is now universal; today a "serviceman" is a member of the armed forces.

The television technician now found a new and totally unexpected difficulty. Many customers, a little afraid of possible expensive television service problems, eagerly accepted "service contracts" guaranteeing them trouble-free TV reception for a year or period of years. Technicians accepted these contracts—sold to them by dealers—eagerly. They represented a

large cash influx. But the customer, not having to pay for the calls, called the service technician on the slightest pretext. The service shop of course, went broke. Some fairly large and reputable firms were destroyed before the unlimited service contract was abandoned. Strangely, the one-man shop that usually gets the worst of everything was not much affected. It had not been easy for the one-man operation to get in on the big contract boom.

The Citizens radio band—460-470 MHz—opened in the fall of 1949. Equipment prices were so high and tuning so difficult that this band was never fully occupied, and CB radio didn't become popular until the lower frequency band was opened. (Incidentally, 460-470 MHz CB is still in use, and the band is not crowded!)

The nuclear age was beginning to open, and the September 1949 issue had four articles on uranium prospecting, as well as an explanation of the Geiger counter.

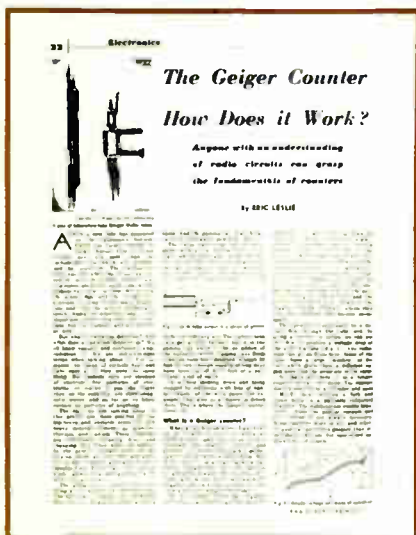

The rival qualities of the FM discriminator vs. the ratio detector were being hotly debated. In the United States, commercial rivalry overpowered scientific detachment, and *Radio-Electronics* decided to run tests in a neutral area. In England, *Radio-Electronics* correspondent Ralph Hallows, assisted by engineer H.K. Milward, ran a series of tests. The discriminator with one limiter came out slightly ahead—and with two limiters far ahead—of the ratio detector.

The January 1950 issue was proclaimed the Annual Television issue, and started a seven-part series: "Build a de Luxe Teviser." The author supplied large schematics and templates for a fee, and several hundred were ordered by readers. An illustrated TV station list, with 77 station-identification patterns (out of a total list of 99 stations) filled six pages of the issue.

The most famous story?

The January 1950 issue also contained

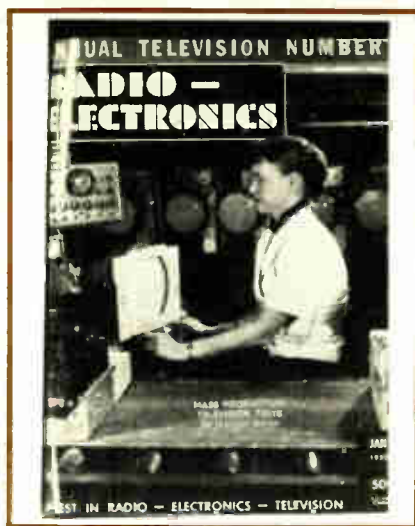

one of *Radio-Electronics'* all-time outstanding articles. TV viewers often saw strange things on their screens and called on service technicians to whom TV was also strange. The technician would tell his customer: "outside interference," and both would usually agree that "it must be an amateur." The author of the story, William L. Kiser, was an FCC employee. A new resident in a Long Island, NY, village, he was known vaguely as a "radio man" to the neighbors. One night half a dozen husky men, one carrying an axe—presumably to chop down his radio mast—and another a rope (prospective purpose not disclosed) invaded his home and demanded to see the man who was blocking their reception.

The group left somewhat discomfited, but not before giving Kiser a revealing view of what the radio amateur was up against. Kiser then wrote a story directed at the service technician, that placed the responsibility where it belonged. It showed various kinds of interference patterns and how to clear them up, often by placing a filter on a badly designed set. *Radio-Electronics* received so many inquiries that it was necessary to have hundreds of reprints of the article made. An amateur radio magazine, QST, which normally would not run a story already printed by another magazine, asked for and received permission to run the whole story in its pages.

CBS started experimental color broadcasting early in 1950. The viewer needed to be able to adjust his set to the 410-line scanning frequency of the system, and a "color wheel" was necessary to view the correct color at the correct instant. The picture could not be seen in black & white on a standard set. Some sets could be adjusted to 410 lines, others showed a mosaic of six images. Color wheels became available—some viewers made their own. The most ingenious wheel was mounted on an egg beater, and was powered and synchronized by hand. An article in the May 1950 issue mentioned a new development that might make the

color wheel obsolete—the shadow-mask tube. "Should be available in a couple of years," said the article.

Radio-Electronics printed one of its most remarkable covers on the July 1950 issue. The photographer received a special award for "taking a picture of sound in a dark room." What was really photographed was a demonstration by Dr. Winston Kock and F.K. Harvey of the Bell Telephone Labs, of an acoustic lens, useful for Focusing UHF radio waves (or sound waves of the same length.) A microphone and neon lamp on the end of a rod that swung up and down was mounted on a carriage that moved slowly away from the lens. The mike was connected to the input of an amplifier, and the neon tube was connected to its output. Thus, a photograph could be taken of the standing-wave pattern of the sound as the mike-neon lamp backed slowly away from the lens. (The photographer and scientists went out for coffee during the 10-minute exposure.)

The space age

Often considered "far out," *Radio-Electronics* ventured into space with the December 1950 issue. The "Father of Space Navigation," Dr. Herman Oberth, found himself in the United States practically without funds. He communicated with Hugo Gernsback, whom he had known in the past. The result was two articles entitled "Electric Space Ships."

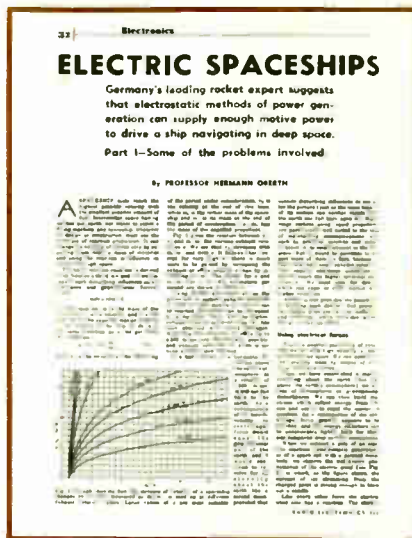

At the time, they were almost science fiction. The articles nevertheless attracted considerable attention, and *Radio-Electronics* was afterward able to boast that it was the first American technical magazine to print an article on space navigation.

The December 1950 issue also had an article on multiplex FM broadcasting. The purpose was to facilitate a second program—possibly for "storecasting" or facsimile broadcasts—no one was thinking of stereo at the time.

continued on page 64

ELECTRONICS TOMORROW... 2029

MARTIN BRADLEY WEINSTEIN

AS I SIT HERE AT MY TYPEWRITER, IT IS A FEW DAYS BEFORE August 1, 1979. My friends at Radio-Electronics have asked me to bring into focus what our todays will be like 50 years from now, especially in terms of how electronics (or its future forms) will be playing their part. And I'm wondering how possibly to predict anything without too much raw speculation, how to forecast without the flavorings of a lifelong gadget nut.

Well, I can't! So here—as our friends in broadcasting would say—is a big, fat disclaimer.

Don't count on anything. I have tried to apply more than technological trends to my predictions. For new technology and future inventions to have any impact on our lives, we're going to have to want, buy, and accept them. That means that they will have to offer us such benefits as convenience, savings, or versatility that outweigh their costs.

Alas, this is not the place for lessons in marketing, sociology, or economics. There is much business at hand and we'd best plug in our crystal balls now.

The computer evolution

There will be dozens of computers in the homes of the future . . . and there will be none . . . both by today's definitions.

Just as relays, timers, and rheostats gave way to transistor and IC controls in kitchen appliances, for example, semicustomized microprocessors are sure to become the most economical way for an appliance manufacturer to let his customers "talk" to his products, and vice versa.

Soon, manufacturers will respond to the pressures of the marketplace and develop ways of letting their appliances "talk" to each other. For example, a microwave oven can start the coffee even before you wake up using an input from a clock and an output to the coffeemaker. It will then start the toaster and your eggs when it "hears" the bathroom light turn off.

This will mean that manufacturers will have to incorporate a *kitchen bus* (similar to a microcomputer S-100 bus) as an input/output data port on appliances. To all the world, it will simply seem to be an extra plug on the back of the box; at least until it is incorporated into standard house wiring practices, at which point it will be known as the expanded *household bus*.

As soon as there's a bus, manufacturers are sure to exploit it with a controller—a new kitchen appliance that will coordinate all the others. That controller will probably have some smarts of its own, too. It will keep tabs on whatever food (and possibly utensils) you have on hand, scan the newspapers (which won't be newspapers, quite, but I'm getting ahead of myself) for the best prices, suggest a shopping list, and, subject to your approval, place your order with the "store."

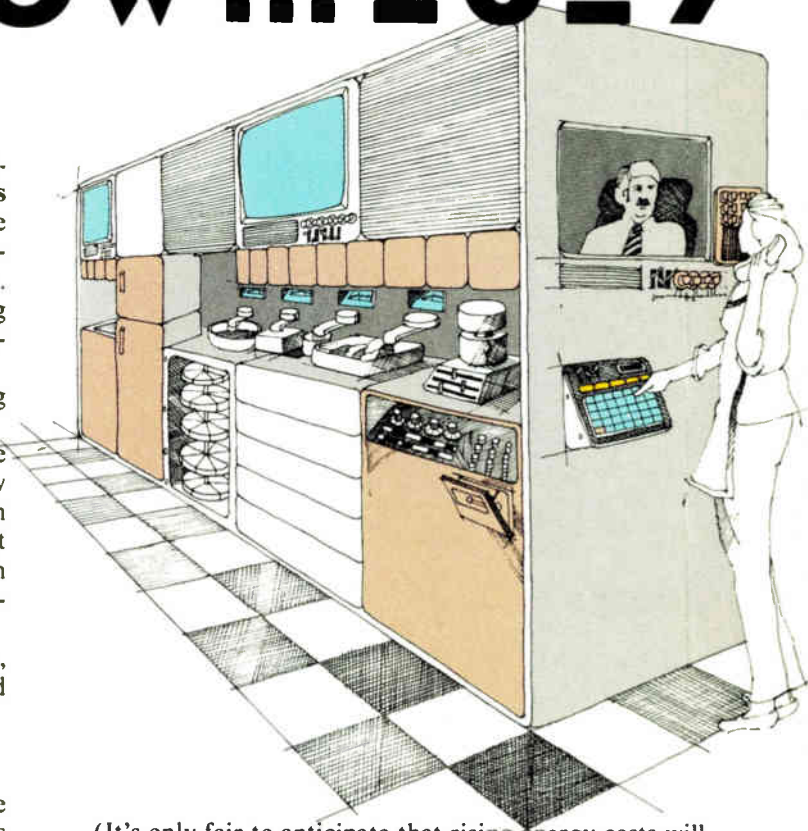

(It's only fair to anticipate that rising energy costs will dictate the return of the delivery route and the near-disappearance of actual stores; in energy terms, it's cheaper to deliver goods on efficiently planned routes than to have shoppers drive to stores. Eventually, multiservice route delivery would replace both individually run store delivery services plus mail and package delivery services.)

The kitchen controller could also suggest meals and menus, count calories, balance diets, and teach you how to cook things you'd never cooked before.

The chances are also better than excellent that your kitchen controller will be able to both listen and talk in plain language (although in 50 years, the language used will not likely be at an adult level).

How will you pay for your food? This one's dangerous, but I think if we follow the trends of bank services we will see checking, saving, and credit functions merging. Properly, the complicated legislation controlling the banks in administering your money means that very complicated schemes must be devised and implemented by banks in order to make their services seem simple to you. In the end, it should mean that you will have a single account that will be good for whatever money you need (whether you have it or not) in line with good credit practices. How you access that money is a challenge for electronics that may never be fully met, but I foresee some combination of voiceprint, fingerprint, facial recognition, magnetic card, holographic card, secret code number, signature, and possibly central nervous system signal recognition.

"Memory Bank, Savings & Loan"

Today, home computer enthusiasts are discovering that bulk memory is the most expensive part of their hobby. While bulk memory prices may well come down, it is even more likely that software requirements for bulk memory will explode.

Think about that and you'll realize that the bigger the bulk memory, the smaller the probability that you will need access to any given part of it any one time. That means that the overhead costs of maintaining increasing amounts of memory will increase, even while the utilisation of each bit of memory is reducing.

Here enters the entrepreneur.

Let's take an example. Say you are the head of a family with several young school-age children. You've decided it would be wise to provide your family with some form of encyclopedia.

Encyclopedias in bound volumes are very expensive, and because most of the information they offer is never read, they are very inefficient learning tools. And since the information they provide is fixed, updating is out of the question. All of that makes the encyclopedia a natural for computer storage and access, given an inexpensive access to enough bulk memory to store it.

It's not hard to imagine a farsighted businessman investing his money into an enormous computer with enough bulk memory to store an encyclopedia, and then devising ways to make that data available to given customers on either a subscription or pay-as-you-go basis.

Fifty years from now, there may be hundreds or thousands of similar services available. Your home terminal (possibly available through the telephone company and tied to phone lines) will help you use them. You can shop for a used car, look up an old **Radio-Electronics** construction article, learn about the country of Zanzibar, see what's new in fashion, plus more.

Oh yes, stores will tie in to that service, too. Now you can select new furniture, or shop for presents (probably in full color) from your living room. And you can tap the library to have them transmit a chapter of *Jude The Obscure* to your printer or local "not-so-bulk" storage facilities for a little bedtime reading.

In addition, you'll be able to rent your own memory deposit blocks into which you can enter personal or financial data for your own access later.

Morning magblox gazette

The cost of newsprint is rising, the cost of labor is rising, and the cost of publishing and distributing a daily newspaper is nearly prohibitive, even today. Fifty years from now, we'll probably let a terminal do it.

That terminal will tie into a fairly high-speed data-transmission network for a minute or so each afternoon, night or early morning, automatically recording the daily paper on magblox. In some homes, the terminal will then automatically produce a paper hard-copy output; in others, a magblox replay on the terminal will be enough.

The service just may be free. Since the bulk of a newspaper's income comes from advertisers and not subscribers, and since magblox is a very inexpensive distribution method as compared with regular delivery, newspapers may use free subscriptions as an advertiser incentive.

Magazines are likely to arrive on a single holograph. Holography seems to offer both the data compression and fidelity required for delivering a magazine full of information on a single magazine-sized holographic "transpar-

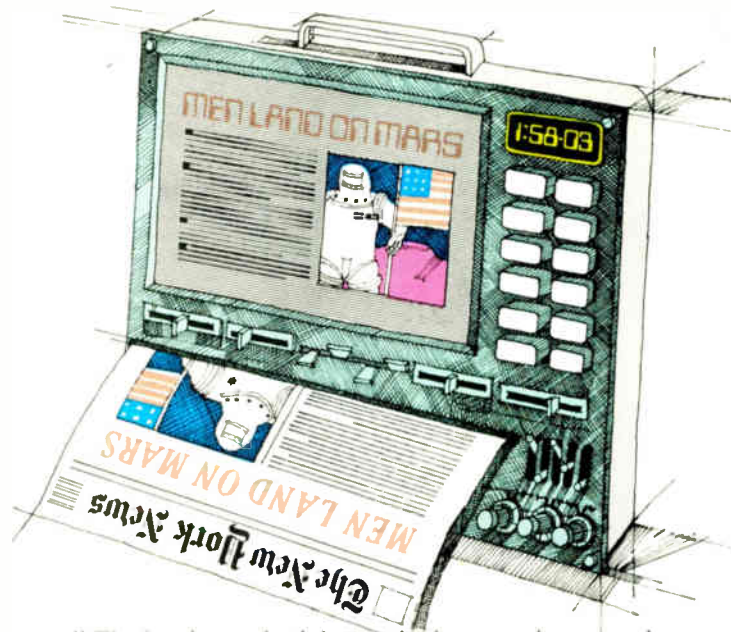

ency." The burden on both increasingly expensive natural resources and delivery systems will be reduced, and back-issue storage will require virtually no space. Also, holo-zine "reader" hardware should be available in the \$100 to \$200 range.

What's on the screens?

Nobody expected the FCC actually to take TV stations off the air, but it worked out fine. After all, the developing nations had really been putting a squeeze on for more spectrum space. And what with all the new personal radio and telephone services demanding so much spectrum themselves—well, something had to give.

Cable TV was everywhere, too, and it was better than ever. There were hundreds of channels to choose from, for one thing, and even though most of them had only special interest material most people would never watch, there were still plenty of other good programs to choose from all the time. That was the strength, they said, of the new optical cable; still, some folks still suspect that skyrocketing aluminum and copper prices had a lot to do with the switch.

And now that the Interstate Master Cable had been completed, those tall towers with the ugly Yagis were finally disappearing. Most of them were converting to the microwave and infrared horns to pick up the additional satellite channels directly. Funny how most people preferred the old single-channel Weathercon so much, with its false-color video view of the clouds and temperature strata. As if folks could tell the weather better than the 30-day forecast from the bureau.

But they'd sit at their screens at home, poking their buttons or waving their wands or calling out the words that changed channels and perspectives. Normal people got funny where the screens were concerned. They'd buy screens built into mirrors and bathtubs and planters and walls and furniture and bracelets and every which thing.

Funny how TV sets with the preset perfect color never sold. Folks wanted to make their own adjustments. And there wasn't one out of a hundred who ever had the color adjusted correctly. Well, that's nostalgia for you.

All you ever heard at parties was the old argument about which was better . . . the do-everything screens or the special-purpose screens. Proponents of the former argued that since generally people only do one thing at a

time, who wanted to watch both news and an old "magblox" (magblox denotes some offspring of mechanically spooled magnetic-tape-storage media) movie and terminal up a catalog at the same time? The special-purpose side liked the idea of a big screen for prerecorded magblox programs, a handy workscreen in a little home office cubbyhole for the terminal, and the portable screen for watching the telly cable.

Thank goodness, at least, the screens were so thin and light. Can you imagine trying to watch one of the coarse pictures those old bulky tubes used to show? And the sound then was even monophonic! No wonder our grandparents never liked programs or commercials.

More household changes

As long as we've gone this far, let's take a look at a few other possible changes to familiar household things.

In the laundry room, for example, it's fair to anticipate motionless washing machines. Some combinations of infrareds and microwaves with ultrasonics will heat and agitate the water—perhaps a lesser grade than drinking water—to wash the clothes, then repel the water out of them. The driers will be using smaller motors to force-feed a small but intense stream of air while stirring rather than tumbling clothes.

In the bedroom, mattresses will be filled with a combination of air sacs and gel sacs that are selectively and indirectly heated with a planar infrared source. A nonelectronic wick-action humidifier will be part of the headboard.

Two new appliances will grace the kitchen: The first, a phased microwave oven, using high-power solid-state arrays and a microprocessor-controlled driver to cook separate dishes individually to different cooking times and temperatures. The other is a supercold snap-freezer, using techniques now being developed for commercial frozen-food preparation.

The house will be lighted throughout with soft, highly efficient tertiary emission lamps. (Don't look that one up yet! I'm counting on some technology transfer between materials and physical optoelectronics developments that are still just laboratory curiosities.)

By the way, your garbage disposal unit will probably feed the neighborhood catalytic waste-to-power conversion station. Those stations will store and reconvert power from many sources—much like state-of-the-art uninterruptible power supplies but on a larger scale.

The holobox

I'm going to go against the grain of other predictors of things to come and say—with some conviction—that there will not be a 3-D TV in 50 years. Instead there may be a home 3-D theater that uses lasers and film-recorded holography. Three-dimensional plays and movies will be available in stores and by subscription, but I believe the nature of holography and the data density it requires will prevent its transmission, even over ultra-wideband optical cable.

Three-dimensional home recording will be available, but most likely as a plaything for the wealthy.

The rest of us will have to settle for our "vidimatic" home VTR "movie" cameras. Snapshots will also be taken electronically, with high-resolution, scanned-array cameras that store pictures in memory. You will be able to transfer memory into other memory media, and eventually into hard copy if preferred. Do you suppose it'll be called a "RAMera"?

Is your terminal linked?

Trying to tell you about the terminal is like trying to explain a telephone to Thomas Jefferson: it's simple, it does a lot, there's a labyrinthic structure behind it, and where do you begin?

The terminal has a screen, like a TV screen, probably in color. It also has a box hooked to it that takes what appears on the screen and puts it onto a piece of paper—maybe in color, but probably not usually in color if we're just looking 50 years ahead.

What your terminal can do depends on how many of the options you've bought and had installed in it. So understand that not every terminal will be able to do everything I suggest.

The terminal has two modes of operation, Local and Link. We'd better start with some of what it does in the local mode.

For one thing, the terminal is a word processor, similar to a typewriter, but having a display that you can see

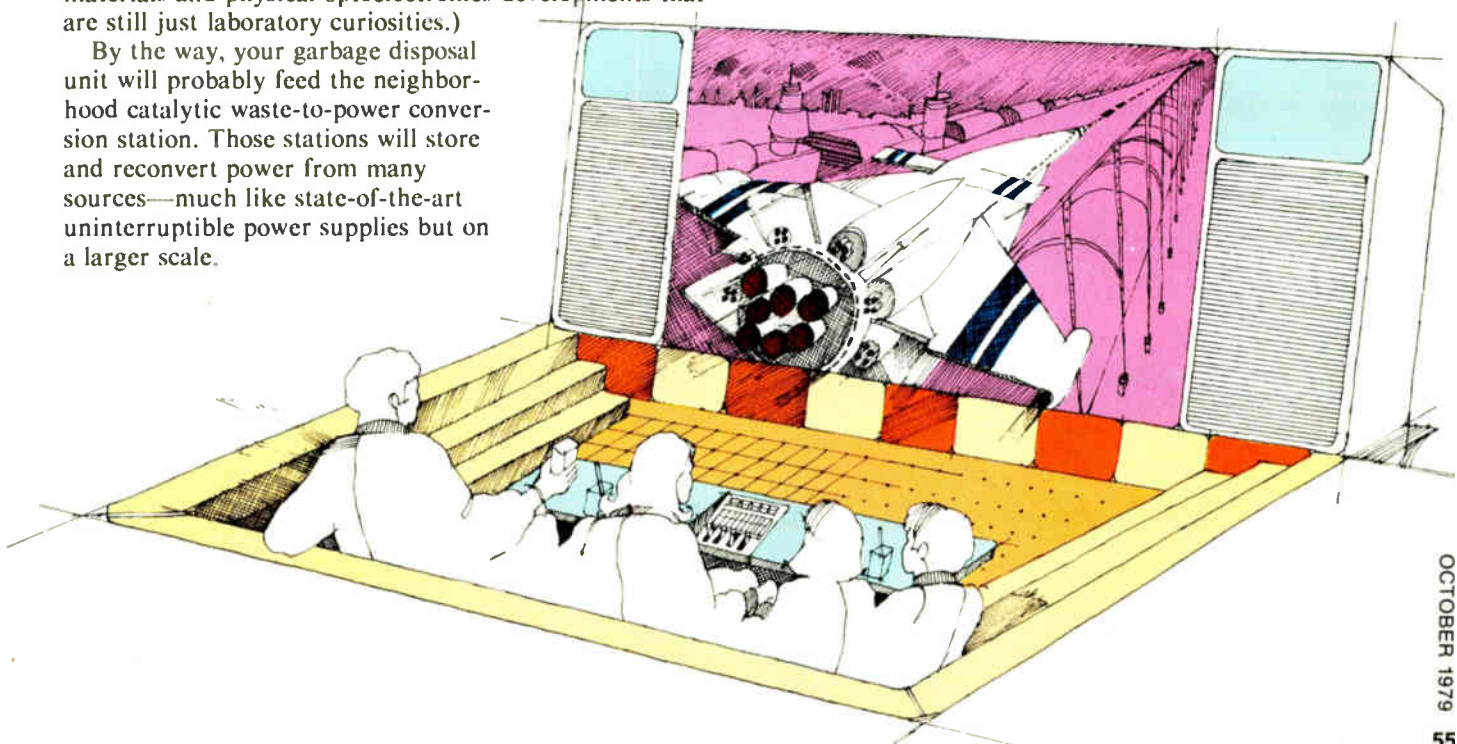

before the words hit paper. Here's how it works: Say you want to prepare a written report. First, you either type or dictate your report into the terminal. The terminal displays your report on the screen. You either correct or approve what you see, then the terminal prints it (this looks more like facsimile reproduction than printing, and more like dot-matrix printing than pen-plotting). If you prefer, the terminal could record it on a small magblox that you can put in your library, take with you, or transmit later.

The terminal screen can show you several kinds of displays: alphanumeric, graphics, and still photography. It switches automatically according to codes included in the transmission and operations protocol. In the local mode, it accepts inputs from a keyboard, speech, magblox, camera, camera stand, OCR (Optical Character Recognition) scanner, or a special auxiliary input. (That auxiliary input might be used, for example, to hook up your "MediScan"—a pulse/temperature/heartbeat/blood pressure/EKG/blood-oxygen/white-cell analyzer—when you are linked up with a doctor's office or the "MediCenter" computer).

The terminal screen can store information temporarily on magblox, print it, or display it. And every function it performs in the local mode it can perform when linked to remote terminals.

The family car

Yes, there will still be petrochemically fueled, wheeled vehicles 50 years from now. Many will be able to afford them, although not as haphazardly as today.

Electric vehicles will be fully developed and available as urban utility vehicles, and will be highly popular.

Mass transportation systems will offer more frequent service and more systematic routing. That will mean quicker overall trips, despite an abundance of available stops and transfer points.

What's the family car going to be like? It will be smaller because of the tremendous costs of labor and materials for larger cars, the incredibly high cost of fuel, and the resultant demands on fuel economy. And it will be a safer vehicle, thanks to electronics.

Collision avoidance will be a legislated mandatory feature. And many types of hardware will be available for the job: Microwave radar, infrared scanning lasers, ultrasonic SODAR, matrix-image analysis, implanted inductive pulse-code transponders, etc.

Maps will be stored on magblox and viewed on the car's screen. Many vehicles will have limited service terminals, others will have "radionav" and display both the map and its position, à la James Bond.

And when the police chase speeders, a Doppler laser device will be the "picture taker".

Speed, braking, steering and perhaps even routing will be out of your hands; electronics will most likely become the car's chauffeur.

The wristworks

In 1979, wristwatches were produced that display the time, the date, and short messages; they worked as stopwatches, sounded alarms, incorporated calculators, displayed a pulse, worked on solar power, and (no doubt), more.

What might you speculate we'll find in a future wrist-box?

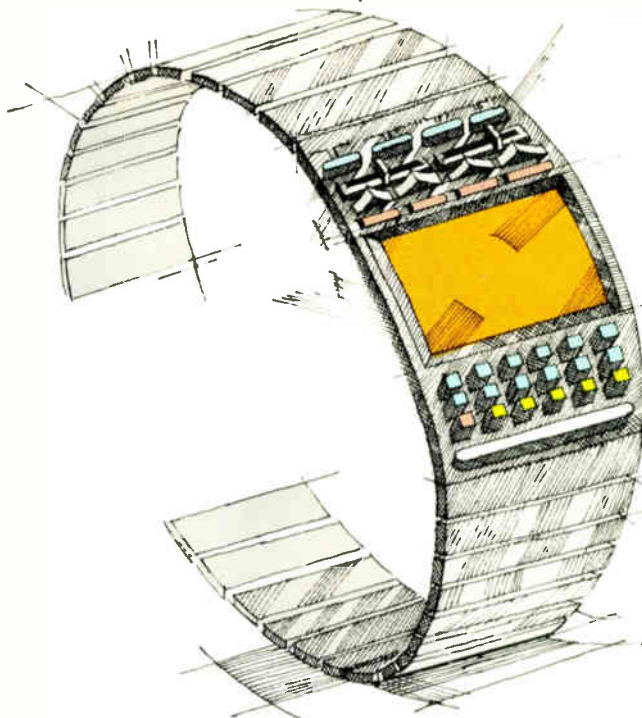

It seems the likely place for a "pocket" pager, for one thing. It's less bulky, won't rip pockets and won't be left behind.

It would also be simple to envision a personal modulated pulse code—in optical, infrared or microwave—as an electronic key to permit you access to your home, car, office, and so on.

Nor is it hard to include a readout of the ambient temperature. And it could keep an eye on your temperature, too, as well as your pulse and heartbeat, to warn you when your metabolism goes out of bounds.

And there will probably still be room enough left to engrave your initials.

The world won't change

In spite of all these predicted changes, life won't be too different. Any of us, suddenly thrust 50 years into the future, would quickly adapt.

However, just imagine over 50 years how competing manufacturers could escalate the features and benefits of their products in their struggles for a healthier share of the marketplace.

Imagine over 50 years how our mushrooming population will make demands on itself that require legislative control.

Imagine over 50 years how the changes in supply and cost of natural resources may change the way we order options and rank alternatives.

And remember that 50 years from now, it'll still be you and I, our kids and their kids trying to make a living and keep things comfortable.

On the other side of the crystal ball, the changes that occurred during the past 50 years seem a natural progression of perfectly reasonable developments. And so it is looking forward.

And 50 years from now, somebody will be asked to look into his future to predict high-fidelity speakers the size of a walnut, personal-fusion power vehicles, and blue LED's!

It's just a straw man we build. In a decade or so, he'll appear laughably naive. But for right now, he'll do just fine.



LIGHTS

THAT

FAILED

AT VARIOUS TIMES *RADIO-CRAFT/RADIO-ELECTRONICS* HAS ANNOUNCED remarkable new discoveries, that might change the whole direction of electronic progress. In one or two cases the expectations were more than fulfilled. No one could have expected our whole solid-state age to develop from the simple transistor reported in the September, 1948 issue. And the multiple uses of the laser were not even suggested when Bell Laboratories revealed the discovery of coherent light. (Certainly no one ever dreamed it might even be used as a surgical tool or a precision drill.)

But the majority of those new discoveries simply dropped into oblivion. We were determined to find out why, and contacted a number of discoverers or developers. As might have been expected, we found that most of them had simply been made obsolete by newer and better devices or developments that did the work more efficiently.

The most important exception to the "drop into oblivion" rule was the electret, which was so little known when the magazine published the first electret article that many scientists would not believe it existed. (The electret is the electric counterpart of a permanent magnet—a piece of material with a permanent positive charge on one side and a permanent negative one on the other. Originally they were wax discs from two to eight inches across and about a quarter of an inch thick. Later, electrets or electret-like devices have been made of thin plastic film, and those are the type now in common use.) We heard of it from the "mad Austrian" scientist Ehrenhaft, and persuaded an author to make a few. Even after several articles and after exhibiting the electret at an IRE convention, it was largely ignored until the military began picking up a few mysterious microphones in captured Japanese equipment.

Today electret microphones are standard equipment. There were rumors of other uses, and we contacted James West of Bell Laboratories, one of the persons responsible for much of the development of modern electrets. From materials supplied by him, it appears that electrets are now widely used in such unrelated devices as gas filters and radiation dosimeters. The Bell Speakerphones are now using electret microphones, as are many operator's headsets, and electret transmitters (microphones) will replace other types in ordinary telephones as new models come out. Millions of electret microphones are in use all over the world. Electrets have also been used in headphones and phonograph cartridges, and are coming into use in photographic processes.

The Stenode Radiostat

About the time *Radio-Craft* came into being, a revolutionary new receiver, the Stenode Radiostat, was expected by some to make it possible to have

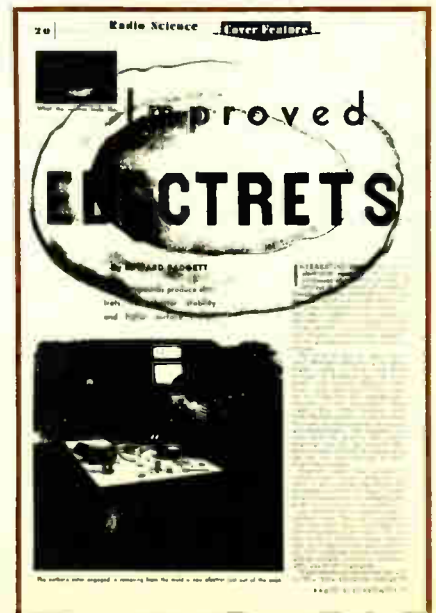
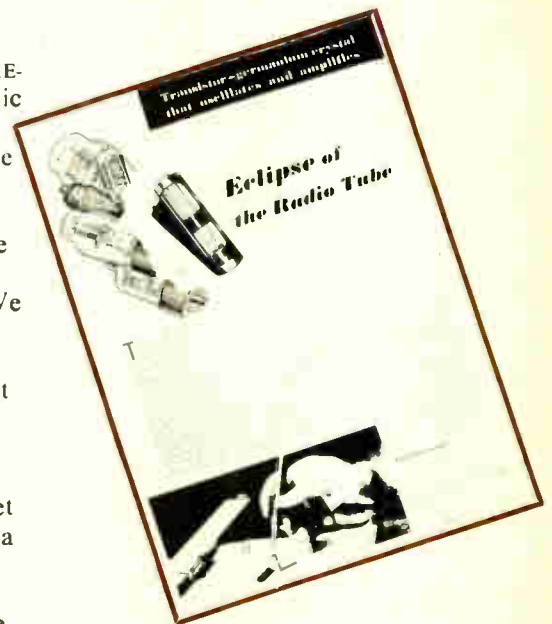

many more broadcast stations on the band, while cutting down interference tremendously. It was supposed to be able to operate on a bandwidth of about 60 Hz (as compared to the 10,000 Hz allowed at the time for each radio broadcast transmission), while maintaining the quality of an ordinary receiver.

Circuitwise, the Radiostat looked like an ordinary superhet with a crystal filter in one of the intermediate frequency stages. That made the IF bandwidth extremely narrow, and low notes were "disproportionally amplified" while the higher notes were cut down fantastically. To compensate for the sideband cutting, the highs were boosted tremendously in the audio stages.

The exact way the circuit worked was a matter of (sometimes heated) discussion, which actually gave a better idea of how little was known about modulation at the time than of the operation of the Radiostat. (Some explanations even denied the existence of sidebands, which of course couldn't be cut off by the sharp IF if they didn't exist.)

In the long run, it was generally admitted that what was happening was that the high frequencies were simply cut down in the IF, then boosted up again in the A.F. audio stages to restore something like normal reproduction. As Clyde Fitch, who wrote extensively on the subject at the time, said years later: "It was a delusion—not that the circuit wouldn't work, but that nothing would be gained if it did!"

The Eveready Air Cell

The April 1931 issue carried a story on a remarkable new battery that—together with a new series of tubes—was to be a boon to the millions of rural listeners who had been bypassed when manufacturers turned their main attention to "electric" receivers operating on alternating current. The new '30 series of tubes (including a screen-grid type) operated with filament currents of 60 mA (the '31 output tube used 130 mA). Those were used in receivers equal in sensitivity and quality to the line-operated sets then available.

The Air Cell was designed to power such sets. Its capacity was 600 ampere hours at a current drain of about half an ampere. That battery would power a 6-tube set using tubes of the '30 series, something that would have been expensive and impractical with dry cells.

The Eveready Air Cell was especially interesting because it used no chemical depolarizer. Instead of the manganese dioxide of the dry cell, it had a positive pole or anode of a special type of carbon, which projected through the top of the case. It absorbed oxygen from the air, which combined with the hydrogen bubbles that collected on it and tended to insulate the positive electrode, to form water. Incidentally, while always called an Air Cell, it was a two-cell battery, as the two projecting carbon anodes proclaimed.

After an initial surge, the battery sank into oblivion: it was no longer mentioned in the technical press nor advertised. The reason was unique—its application was fast dwindling to the vanishing point. Development in rural electrification paralleled that of rural radio receivers, and the radio families without electricity, originally about seven million, were rapidly reduced in number.

Thus the battery was not made obsolete by new developments. It continues quietly in use in more limited applications, according to Roswell Bennett of Union Carbide, who answered our inquiries on the subject. Among its present-day uses are railway signalling applications in remote areas where alternating current is not available, for buoy lighting, and for off-shore drilling rigs. It was used for much emergency lighting in World War II, and we may expect to see it soon in miniature form as a power supply for hearing aids and digital watches.

Discovery of the Age?

In March 1944, *Radio-Craft* published an article: "Magnetic Current—Discovery of the Age?" It described the work of refugee scientist Felix Ehrenhaft, Director of the Physics Institute, University of Vienna. Ehrenhaft believed that he had discovered particles with a one-pole magnetic charge (either N or S, but not both). Beaming light on the gap between the poles of a powerful electromagnet, on the lower polepiece of which powdered metal had been scattered, he found that when the magnet was activated, he

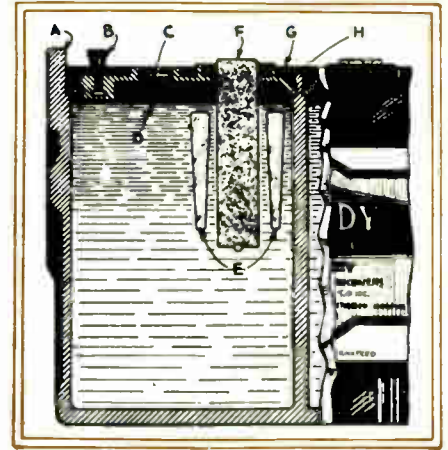

Fig. B
Cross-section of an "air-cell": A, case; B, terminal; C, filling vent; D, level of electrolyte; E, zinc electrode; F, carbon electrode; G, seal; H, partition.



could see some of the particles spring from the lower to the upper pole. Ehrenhaft believed that this indicated that they had a monopolar magnetic charge. (Others were not so sure.)

The work attracted a great deal of attention. (*Radio-Craft* devoted two articles and an editorial to it.) There is a gap in electromagnetic theory that would be filled neatly by monopole magnets and magnetic current, and students were extremely interested. Ehrenhaft made a number of other experiments that also supported his hypothesis. Unfortunately one of the most dramatic ones—indicating that water could be decomposed magnetically—went wrong. It was absolutely unrepeatable. The professor was tremendously embarrassed, and to some extent withdrew from public discussion, carrying on his experimental work in the semi-seclusion of Manhattan College.

He returned to his post in Vienna after the war, and some of his later work was published in French and other scientific journals. He died not so long after, and interest in magnetic monopoles seemed to have died with him, until about 1970. Then one H. R. Kolm reported finding a track produced by a particle that was strongly accelerated in a magnetic field, something that might indicate a monopole magnet. He never published a formal paper on the subject, and presumably did not feel that he had enough evidence that a magnetic monopole existed.

In 1975, scientists of the University of California and of the University of Houston (TX) reported the existence of a particle, far heavier than any yet discovered, that fitted the characteristics of a magnetic monopole as laid down theoretically by Dirac in 1931. For one thing Dirac had suggested that the particle—if it existed—should have a basic charge of 68.5 or a multiple of that number. The suspected particle had a charge of 137.

Three years later no further discoveries have been reported. An inquiry to Dr. Alfred Goldhaber, who commented with interest on the 1975 discovery, reveals that though he has been doing theoretical work on the subject since 1975, "neither I nor anyone else has any evidence of the existence of magnetic monopoles." The final conclusions of the 1975 experimenters, he said, were that the track was not compatible with the magnetic monopole.

So the subject is still open. Theoretically, there is a place in the universe for magnetic monopoles, but apparently so far nobody has ever "seen" one.

Magnetrons in TV sets?

The August 1951 cover and a feature article showed and described a new development—magnetron oscillators for UHF TV sets. It was not easy to get regular receiving tubes to oscillate reliably at the frequencies needed in UHF television. To a magnetron, such frequencies were low. The main problem seemed to be how to make a magnetron small enough to put in a receiver. General Electric solved that problem—the magnetron oscillators were the size of a standard miniature receiving tube.

But the little tubes were too good as oscillators—they radiated into all parts of the receiver; it was extremely difficult to shield them to the point where they didn't create interference in various circuits in the set. That, combined with the rapid improvement of more conventional tubes, made them impractical, and the miniature magnetron never did reach the general market.

The brilliant failure

One device did not fit the general definition: something with a great deal of intrinsic merit, but edged out by newer and better devices. Nothing has ever been found better than the Ionophone, a loudspeaker with no moving mechanical parts. Completely inertialess, it produced sound of a quality that could not be equalled by other speakers. The speaker was completely described in the issue of November 1951, and treated less fully in other issues. The active unit was a heated wire, specially treated to give off large quantities of ions. When heated by a radio-frequency field, the wire maintained a cloud of ions between it and a shield surrounding it. The field that heated the wire was modulated by the output of the audio-frequency amplifier, thus expanding and contracting the ion cloud in the space between the wire and the shield (which formed the small end of the speaker horn). That produced sound. The problem was that the ion-producing wire destroyed itself in an impractically short time. The idea was so good,

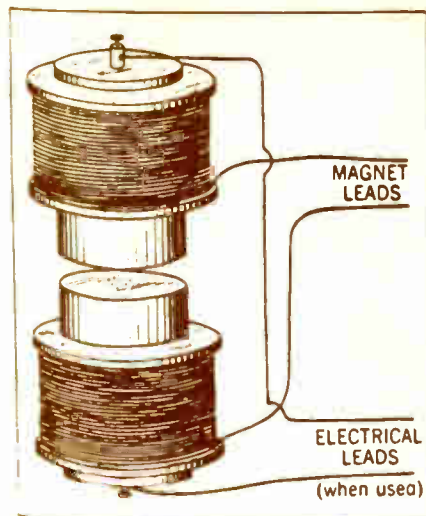

Fig. 2—The Ehrenhaft condenser. Magnetic or electric fields may exist between its faces.

RADIO-CRAFT for MARCH.

12 Television **Cover Feature**

Miniature Magnetron

for V.H.F. TV Receivers

Left picture a G.E. 9610 magnetron; right picture a similar magnetron; right, to explain how...

A MINUTELY constructed, it is a miniature magnetron tube. It is the size of a standard miniature receiving tube. It is the size of a standard miniature receiving tube. It is the size of a standard miniature receiving tube.

By FRED SHUNAMAN

The magnetron has long been used in radar sets. It is the size of a standard miniature receiving tube. It is the size of a standard miniature receiving tube. It is the size of a standard miniature receiving tube.

45 **New Design**

IONOPHONE

By E. AISEBEG* and M. BONHOMME**

Long the dream of engineers, the inertialess loudspeaker is now reality. It produces sound from electric current with ionized air molecules

The inventor, E. Aisebeg, is shown holding a small, cylindrical device. The device is the ionophone, a loudspeaker with no moving mechanical parts.

JULY 1951 will surely be a month in the memory of few readers of this article. On that day they were informed that a new type of loudspeaker had been developed. It was a loudspeaker with no moving mechanical parts. It was a loudspeaker with no moving mechanical parts. It was a loudspeaker with no moving mechanical parts.

however, that it was hard to abandon it: one English company, Plessey, actually manufactured and sold units. But it finally disappeared—in the words of one consumer magazine: “A brilliant failure.”

The January 1957 cover (and an accompanying article) showed and described a picture tube that Philco had been developing secretly under the code name “Apple.” Instead of the phosphor dot pattern of all kinescopes of the time, the Apple had a pattern of stripes of red, blue and green. In addition to the beam carrying the color information, the Apple used another “pilot” beam that located the vertical stripes, so that the correct color information would fall on the right ones. There was more than a possibility that this tube would replace the conventional shadow-mask type—it was supposed to be cheaper to make and much simpler to adjust.

Attempts to learn the fate of the Apple have been made difficult by changes in the Philco organization, possibly also because Philco apparently ceded its interests in the tube to one of the engineers who developed it. But it would appear that, in view of the number of tubes now successfully using vertical stripes without the necessity of a pilot beam, the pilot beam technique of the Apple was found unnecessary. (However, a recent news item tells of a developmental kinescope that emits X-rays from the boundaries between the stripes. Could that be an attempt at guidance similar in intention to that of the Apple?)

Two “different” amplifiers

The cover of the November 1957 issue showed what was expected to be a revolutionary new solid-state device, the Spacistor. One of the disadvantages of transistors was their low input and output impedances and their high input capacitances. The input and output impedances of Spacistors were higher than those of vacuum tubes, and their input capacitances were low, also in the order of those of tubes. The transistor is a low-voltage device—the Spacistor operated at about 100 volts. The device seemed so potentially valuable it was surprising that nothing more was heard of it. An inquiry to Raytheon brought—after some searching for a person who remembered it—this information from Herman Statz of Raytheon’s Research Department:

“Spacistors were made in the laboratory with FET-like characteristics in the middle ’50’s. The Spacistor employed a source and a gate contact in a high field space charge region of a junction. Because of the small dimensions of typical space charge regions (at most a few micrometers), the fabrication of these devices required photolithography with dimensions of the order of $1\ \mu\text{m}$. This technology was really not in hand for production in 1957. When regular FET devices came along with high input impedance characteristics, work on the Spacistor stopped.

However, in recent times, technical people have contacted the company as to whether a Spacistor-like device could yield high frequency operation beyond the capabilities of present GaAs microwave FET devices. The answer to this question is probably yes, because of the high fields that exist everywhere in the Spacistor. The concept may therefore be reexamined, since present-day technology would allow its fabrication in some form.”

In the same article that described the Spacistor, another amplifier, the Solion, that didn’t depend on electrons, was described. It was a flat cylindrical liquid cell about two inches across. It produced an electric current, the intensity of which depended on the agitation of the iodine electrolyte. Thus, with one side of the cell acting as a diaphragm, it became a sort of microphone, responding to low and subsonic frequencies from about 400 Hz down to less than one per second. A modification of the device was usable as a flow meter.

The Solion was developed by the Navy, and was expected to be useful in aerial navigation, among other things. An inquiry to the Navy brought back the information that, while the device worked well, it was outmoded by the development of modern transistors. At least one commercial company has investigated it for special applications, and it is still too early to state that it—or a modification of it—will never be used.

Earth’s charge leaking off?

An unnerving phenomenon was revealed in November 1957. Professor Koenigsfeld of the University of Liege reported that the atmospheric potential had dropped significantly. Normally at least 100 volts at one meter

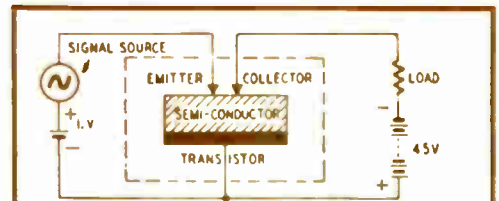

Fig. 4—This is basic transistor amplifier.

The “separated detector”

The Solion principle may be used in a variety of modified designs for special jobs. An example of a slightly different type of Solion is that in Fig. 5. It is adapted to the measurement of unidirectional flows and pressures. The hookup resembles that of Fig. 3, except that one of the outside electrodes is at the same voltage as the cathode, which in this cell is a piece of closely woven platinum gauze. (Its response is linear rather than logarithmic.) The ions tend to drift toward the left (positive)

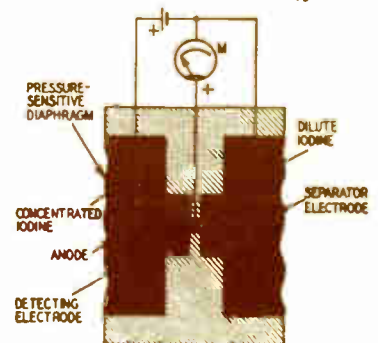

Fig. 5—Separated detector measures unidirectional liquid motion; acts as rectifier on back-and-forth flows.

electrode (anode) where they become iodine molecules. In time, practically all the iodine ions find themselves, under the attraction of the anode, on the left side of the cathode (separator electrode). Now, if there is a movement of liquid toward the right, due to pressure on the left diaphragm, new ions are brought into contact with the cathode, and increased current flow is indicated on the meter. If flow is from right to left, there is no action—there are practically no iodine ions in the liquid in the cell’s right section.

HUGO GERNSBACK, WHOSE FAME RESTS ON HIS WRITING, publishing, and predicting not only future events, but the whole course of an industry, thought of himself originally as an inventor and engineer. Graduating from one of the best technical institutes in Europe, the Technicum at Bingen, he came to the United States as a young man of 19, with a patent on a layer-built battery he intended to exploit.

The young Hugo sought work with a battery company while trying to sell his invention. (It never did sell. While the idea was good—and was used many years afterward in heavy-duty “B” batteries—it cost nearly twice as much to make as the batteries it was designed to replace.) With the importance of cost now in mind, he designed a new, lighter, and cheaper steel battery case for his new employer. But here a typical Gernsback characteristic—one that was very valuable to him in his future career—came into play. His was not the plodding, painstaking approach of an engineer—he wanted to cut through to the final results without fussing too much with details along the way. Shipped to customers before being carefully tested for corrosion, the new batteries started to leak, customers began to return them, and his employer nearly went bankrupt before he could fire the brilliant young engineer.

Hugo and a friend were carrying on radio experiments, for which they had to import most of the necessary components from Europe. The two decided to start a small business and sell radio parts to fellow hobbyists. Thus the Electro Importing Co., the world’s first company to specialize in radio materials, was born. From importing, it was only a step to manufacturing many of the components.

In 1906, the company sold the first radio ever offered to the public, advertising it in *Scientific American*. The *Telimco* Wireless Outfit (the name came from ELECTRO IMPORTING CO) was a spark transmitter and receiver with a range of about a mile, completely powered by three dry cells (two for the transmitter and one for the receiver). These and other company products were described in a small mail-order catalogue. (Early editions of that catalogue are worth their weight in gold.) Because little was known of radio, lengthy explanations accompanied the description of any new item, and the explanations formed a considerable part of the catalogue. Hugo decided to start a magazine and put the technical information in it. So, in 1908, his first magazine, *Modern Electrics*, was born. In spite of the name, it was primarily a wireless magazine.

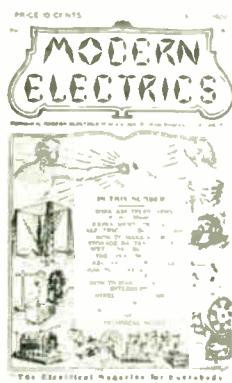

1908

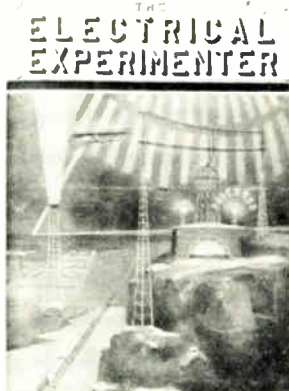

1913

Later (in the early 'teens) he started the *Electrical Experimenter*, then *Radio News*, in 1918, and finally *Radio-Craft*, in 1929. (*Modern Electrics* was combined

Hugo Gernsback— Founder



1929



1979

with a number of other magazines which finally became *Popular Science*; *Radio News*, after a few name and ownership changes is still published as *Popular Electronics*.)

Gernsback began his career as a prophet soon after starting his magazine. One of his first predictions was of the inevitability and necessity of television, and one of the articles in an early issue of *Modern Electrics* was entitled “Television and the Telephot.” He was widely credited with inventing the word “television” but disclaimed the honor, saying that it had been used in France. (However, he was probably the first person to introduce the word to English.) In his book *Ralph 124C 41+* (serialized in *Modern Electrics* in 1911) he describes a televised opera in color, projected life-size on a wall made up of a mosaic of Telephot. The other predictions in that book read like a description of scientific progress through the first half of the 20th Century, and range from radar (his most famous prediction) through tape recording to night baseball.

The *Electrical Experimenter*, Gernsback’s chief magazine of the 'teens, was not so well adapted to scientific prediction, but *Radio News* (which reached its peak in the '20's) carried full-length articles—by Gernsback and other authors—describing the wonders (and often the absurdities) of the future. Two of the most important predictions in that magazine were the one-dial radio receiver (written when the better broadcast receivers had anywhere up to eleven controls) and the article, “Can We Radio the Planets?” in 1927. (When the results of the first Venus contact were announced by the Massachusetts Institute of Technology, the speaker began his report: “This was first proposed by Gernsback in 1927.”)

Gernsback continued to press television, among other things as a useful instrument in war. An illustration for one of his articles shows a wall display of six large television screens, each looking at the same combat scene, from six different aerial viewpoints.



In *Radio-Craft*, Gernsback used his editorials to forecast the future. In November 1930 he assured his readers: "Television is coming to the home." The editorial listed 27 experimental stations broadcasting TV (almost all of them by the Jenkins scanning method). In 1933 he says again: "The radio of 1953 . . . will have a television face-plate." (Most people at the time thought of TV as merely an adjunct to the radio, with the TV sound of course going through the radio's audio amplifier—some receivers of the '30's had an input jack marked "TV.") Another prediction about the set of 1950 was not as fortunate: "The present broadcast band will probably be abandoned and stations will move to the higher frequencies."

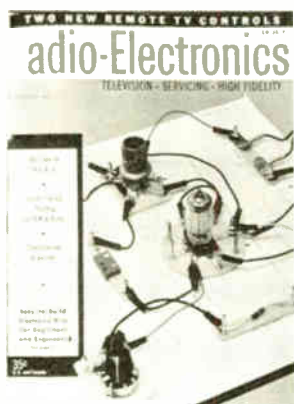

1957



1920

In 1935 he predicted CB: "A two-way radio in tomorrow's car," and pointed out its value in accident cases. "A special frequency will be needed," he says, and it must be above 50 MHz.

Gernsback did not let his career as a publisher get in his way as a radio inventor and experimenter. He patented some 80 inventions in his career, none of which, he said, made him any money. (It is credibly reported, though, that Crosley paid him royalties for the "book condenser" used in one of the early Crosley sets. The patent was on compression-type variable capacitors, and ran out before the trimmer capacitor became common.) He described a bone-conduction hearing aid in at least three issues of his magazines, but when one was patented several years after his last article, he made no protest. "I never intended to manufacture it," he said. "Why should I bother someone else?"

Some of his circuits, notably the Interflex and the Peridyne, were published in *Radio News*. The Peridyne was the first circuit to use non-magnetic metal in the field of a coil, to trim it by reducing its inductance.

His last invention, which he did not patent, was a device for detecting the charge on an electret. The electret was

placed on a sheet of metal, which was connected to one terminal of a small neon tube. The tube's other terminal was attached by a wire to a disc of sheet copper about the size of the electret. Moving the disc toward the electret produced a high voltage that caused the tube to flash.

But Gernsback's predictions remained the most important facet of his career. In later years they appeared in two forms: editorials in which he proposed, demanded, or showed how to achieve improvements in present equipment or practice, and in April Fool hoaxes, which described things a little too far out to be the subject of serious prediction. Those were realized, in fact, possibly as often as his more serious proposals. Automatic equipment testing, electronic sleep, and sound cancellation have all been patented, one within two years after it appeared as a hoax.

One of his most serious proposals, a computerized National Facts Center, on the other hand, may never be realized, because many fear invasion of privacy. And his most often reiterated prediction (or demand): television as a major means of education, is making slow progress, in spite of the obvious need for some better means of education than the traditional ones. Yet that was what Gernsback pushed most insistently, in numerous editorials, and even mailings to public officials, members of legislative bodies, and prominent individuals, from the President down. His multiple television receiver, which would permit a viewer to enjoy one program while keeping an eye on several others on small screens around the edge of the main one, is being manufactured in Belgium, but does not appear to be readily available.

So Hugo Gernsback may go down in history as a publisher—a science fiction and electronics publisher—rather than as a prophet. (Although, whenever a new development comes into being, there may always be someone to remember "Hugo Gernsback described this in 19—.") Founder of the first serious magazines for the radio hobbyist and professional technician, an editor who was more interested in explaining new things in language his readers could understand, than in promoting the latest models of his advertisers or in maintaining a "scholarly" publication, his magazines have been the stepping stones by which countless intelligent youngsters have made their way to careers in radio and other branches of electronics.

In science fiction he is the acknowledged master—so much so that the Oscar-type awards the science fiction associations give the year's leading science fiction author are called Hugos. Known in that field as the Father of Modern Science Fiction, he could equally well be called by electronics enthusiasts: the Father of Radio-Television publication.

R-E

Hugo Gernsback was a true genius. Not only did he have the ability to cut through a mass of details to come to a conclusion, but showed up equally well when forced to handle difficulties of detail when they appeared. His ingenuity was fantastic. I picked up a little puzzle at a press conference by Pyramid Electronics—three or four small pieces that formed a pyramid when properly fitted together. It took me just three minutes to solve it. Then I took it to a person I considered about the smartest man on the staff. He worked with it for two minutes, then showed his intelligence by refusing to fool with it any longer. When I next took some editorial material to Hugo, I showed him the widget. Gernsback's time—40 seconds. *Fred Shunaman*

The January 1951 (Annual Television) cover shows CBS color television in action. The FCC had made a tentative decision favoring the system, but announced that other systems were being studied. That January issue also told of an FCC crackdown on an illegal TV repeater at Emporium, PA, a town ringed by high hills. The culprit was a large television and tube manufacturer. The term "TV" for television was used in the magazine for the first time in that news item.

Blind inventor and engineer Bob Gunderson was featured on the March 1951 cover, with one of the pieces of test equipment he designed for the blind.

Remarkable records were made in TV dx. Reception of more than 1000 miles was common. London's sound channel was received regularly in South Africa, and the picture seen occasionally. Station KPRC in Texas was heard all over the United States and abroad; the most fantastic report was from Manchester, England, *two years after the station had ceased transmitting!*

Radio astrology?

One midsummer 1951 article created some controversy. John Nelson, RCA Communications' propagation predictor, advised on the best routes for long-distance radio hops for a given contact. (Depending on weather, magnetic conditions, etc., the best transmission to distant stations might be around the world in one direction one week—the opposite direction the next week.) Working with various factors, he discovered that the angular position of the planets with respect to Earth had a strong effect on long-distance propagation, and used that factor in his predictions. Asked by reporters if this was not using astrology, he indignantly denied any connection. But later on—possibly after reading up on the astrologers' claims—he was heard to remark: "One thing you have to say for those old astrologers—they sure had the angles figured out right!"

A country is only as good as its schools," wrote Hugo Gernsback in the September 1951 issue, in one of his many editorials on education. Television, he felt, was the answer to upgrading teaching.

Radio-Electronics' only article on a CBS-type commercial color receiver was printed in the November 1951 issue. By the time the article appeared, the Korean situation had brought on a national emergency, and all color broadcasting was shut down. When the freeze lifted, the present NTSC color TV system had been approved, and CBS receivers were obsolete.

Fips, the master inventor, had been slowing down. His "Hypnotron" (electronic sleep inducer) was almost immedi-

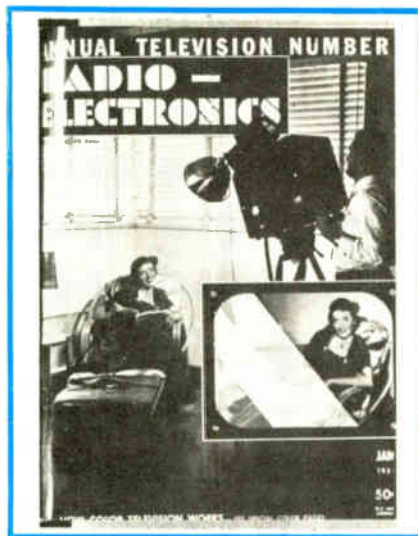

ately announced by the Russians as a serious discovery. The "Electronic Brain Servicing," which appeared in the editorial for April 1950, was put on the market by Lavoie Labs a few years after that article appeared; and the masterful "Noise Neutralizer," in which he picked up office noise, reversed its phase, amplified it and retransmitted it into the office to produce quiet, was patented by Harry Olson of RCA within two years! (It would not be long before Hugo Gernsback submitted his official resignation as a prophet, saying "Two years ago I would not have dared predict that a hearing aid, complete with microphone, amplifier, and loud-speaking telephone, could within the next five years be made small enough to fit in the human ear. Yet today there are several on the market!")

In another editorial, Hugo stated that the public had never taken kindly to the term "transistor," and suggested the word "Crystron" instead. (He could not have predicted what the youth of the 1970's would call a small portable radio!)

An improved audio amplifier, called the Williamson, described in a construction article by M. Harvey Gernsback in 1949, made news in 1952. For a few years, no audiophile would dream of using another circuit.

Flyback squeal was another technical discovery of 1952. A letter from a service technician complaining about the 15,750-Hz whistle was printed—with some reservations: the man might have been a crackpot. The response left no doubt that the squeal existed and bothered many people. A complete article was compiled from letters received from those who suffered from this problem.

At this point, transistors were working up to 250 MHz. A new type of audio amplifier—an NPN and PNP transistor in-series for push-pull output—was announced. Television distribution systems were inaugurated with a two-set coupler.

Radio-Electronics began to serialize an internationally famous book on televi-

sion, under the title: "Television, It's a Cinch!" The FCC adopted the NTSC television standards that gave us compatible television. RCA was already transmitting a few broadcasts using the new standards. Both RCA and Sylvania announced mass-production methods for printed circuits. Radios were really becoming smaller; Emerson had one measuring 6 x 3.5 x 1.25 inches.

Volume 24 of *Radio-Electronics* contained 15 issues. *Radio-Craft* had started in July 1929, and the volumes ran from July to June. War emergency shortages and consequent financial problems forced the elimination of a few issues, so that new volumes started with the October issue. To round off the year, the volume running in 1953 was extended to December, and the January 1954 issue was Volume 25, No. 1.

"The Most Useful (TV) Circuits of 1953" (was this an apology for dropping the data sheets?) appeared in that January issue. Five of the circuits were on two-page schematics. Four more appeared in the July 1954 issue.

The hi-fi boom

While high-fidelity sound started to become a new household word in the late 1940's, Joseph Marshall's "Golden Ear" department began, with Joe writing under the name of Monitor. He also contributed an occasional article under his own name. Associate Editor Dick Dorf, an organist, now the owner of Schober Organs, started a series on high-fidelity music.

Progress in 1955 was marked by the development of a hearing aid incorporated in a set of eyeglasses. Industrial electronics was making progress, a manufacturer of plastics was sentenced to a 30-day jail term for interfering on a military channel. The world's largest transmitter was installed at Jim Creek, WA. It provided power of more than a million watts with a frequency from 14 to 35 kHz. Its purpose was to communicate with submarines under water, among other things.

During the summer of 1955 we first heard of transistor radios being installed in Chrysler cars, with resultant great savings of current. Tropo-scatter, a new form of radio propagation, was the subject of the August cover and feature article. In the September issue, the article entitled "Making Printed Circuits is Easy" showed the hobbyist that he, too, could become a printed-circuit manufacturer.

The September cover represented a scene dating back to an April 1 story that outdid Ulysses Fips. April 1, 1955, two *Radio-Electronics* staff members made the classic journey to visit Dr. Fish at the Aquarium with the idea of getting a story on "fish talk" and an accompanying cover. The expedition was a success, and Dr. (Marie Poland) Fish, probably the world

authority on fish noises, supplied plenty of material for an informative story.

Color television took a sharp upturn in 1956, with a rapid increase in programming that made owning a color set worthwhile. Up to October 1955, there were no daytime color programs and few in the evenings. About 50,000 color sets had been manufactured by the end of the year. Prices were high—around \$700 for the types that were readily available. Sets were becoming simpler—only 26 tubes now as against 37 in 1954.

Sylvania pioneered in industrial computer use. A large data center was constructed in Camillus, NY, to handle all data for the company's 10 divisions throughout the country, and even to write the paychecks for all its employees. The equipment was still very large—room-high rows of plug-in units to hold the computer's 58,000 tubes.

The 110-degree B-W picture tube—only 14 inches long instead of 21 inches long, was mentioned in the December 1956 issue, as was an improved light amplifier devised by RCA.

The "re-wash" tube racket made news in early 1957. *Radio-Electronics* had made a quiet study of the "surplus-tube" situation, buying and testing its advertisers' products, and adopted a policy of refusing to place ads for anyone who would not guarantee that all tubes were unused.

Information on a new amplifier—a maser operated at extremely low temperatures—appeared in the April 1957 issue. The signal-to-noise ratio was said to be 100 times greater than could be obtained by any other receiver.

Fifty years of consumer radio were celebrated in the June issue with a news item and a photograph of Hugo Gernsback presenting the Ford Museum one of the first radio sets sold to the public (in 1906-1907). A spark transmitter and receiver with a range of about a mile, the set received code signals with a coherer, and used an ordinary doorbell as its output device. The total price was \$7.50.

A new associate editor, Larry Steckler, joined the magazine in the summer of 1957.

Stereo phonograph records were demonstrated at the Audio Engineering Society convention in the fall of 1957. London demonstrated the vertical-lateral technique, and Westrex presented the 45-45-degree technique.

Articles on transistors and transistor equipment outnumber stories on tubes and their related apparatus in the latter part of 1957. Tubes are still running neck-and-neck with solid-state devices in the construction articles.

FM comes into its own

FM started to come out of the cellar in 1958. Starting optimistically, FM broadcasting had increased its stations from about 150 in 1946 to 750 in 1949; then,

because of the forced shift to the 88-108 MHz band, and the popularity of TV, it started a skid that bottomed out only in 1956, with about 525 stations still on the air. The receiving-set slump was more dramatic: 1.6 million sets were manufactured in 1948 and only about 200,000 in 1954. Production started climbing in 1955, and about a half-million sets were manufactured in 1957. An avalanche of applications for new station permits poured in to the FCC; and FM started to climb to its present favorable situation.

The first stereo disc was marketed late in 1957. (It was terrible!)

In 1958, St. Clare of Assisi became the patron saint of television, by proclamation of the Vatican. The designation was based upon St. Clare's vision, in Christmas 1252, of Midnight Mass being celebrated in the basilica of St. Francis, two miles away.

It was also in 1958 that Dr. Land of Polaroid pulled the props from under conventional color theory. Using only red and white light, he produced sensations of color that could not be explained by the three-primary approach.

Stereo came to the forefront in the March 1959 issue, with 15 articles on the subject. Several new stereo pickups had

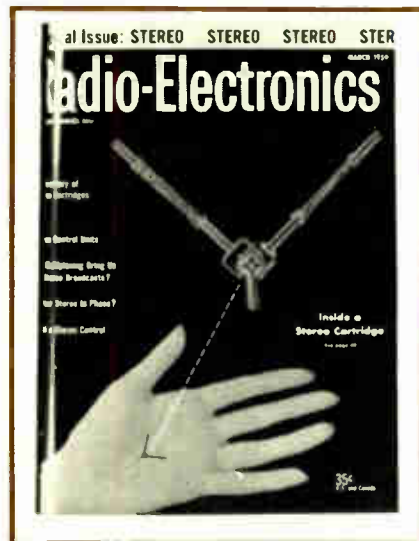

already been described in the February issue, and even the annual April 1 hoax was about stereo . . . with a promise of four-dimensional stereo next year!

The October 1959 issue contained the first mention of electronic behavior modification. Dr. Delgado of Yale University reported that very weak electrical charges applied to selected parts of an ape's brain could elicit reactions of pain, rage, or pleasure.

Marked advances in electronic physics were described in the 1959 issues. The tunnel diode (invented by Esaki in 1958) was first described; so was the avalanche diode, as well as the nuvistor tube, then believed to be a revolutionary device. The fuel cell was first publicized, and magnetohydrodynamics was invented or discov-

ered toward the end of the year. In the latter, a stream of gas is heated to create a conductor and then is passed between the poles of a magnet, producing electricity as any other conductor would.

Three-million-mile transmission

A new duplex record was set at the opening of the 1960 IRE convention in the New York Coliseum. A signal from New York was transmitted to the Jodrell Bank radiotelescope in England, which retransmitted it to the satellite Pioneer V (then 1.7 million miles away). Pioneer V then sent it back to New York, where it was amplified to produce the signal that opened the convention. Unfortunately, there was a snafu at the Coliseum itself. A worker accidentally kicked a plug out of a 120-volt socket, darkening the TV screens that were to show an oscillogram of the signal. The sound, which was carried on another circuit, was OK.

The June 1960 issue reported the opening of the world's most accurate time and frequency station, WWVL, at Boulder, CO, with a frequency of 20 kHz and a 20-kW power capability. The signals were 20 times as accurate as those of station WWV on a 20-MHz frequency.

The optical maser, or laser, was demonstrated by Bell Labs in October, 1959. Practical applications for this "coherent light" were then unknown. It was called "a wonderful solution for a problem not yet discovered."

In February 1960, Manfred von Ardenne, German pioneer in cathode-ray television and video amplifiers, proposed a new safety measure for automobile traffic. Citing the example of an aviator who fell half a mile into a haystack and suffered no more than a broken leg, he suggested a car in which occupants would ride facing backward in heavily padded seats mounted on sliders (similar to those used on some field guns) that would back into "braking material" in a crash or sudden stop. Three TV screens "ahead" of the driver would give him a 270-degree field of vision. The rear-view mirror would be a simple opening to the road behind.

Two more electronic advances—the Giaever two-way tunneling device and electric anesthesia—were revealed early in 1961, as well as a less-inspiring innovation; the use of hand-held portables in burglaries.

The September 1961 cover was possibly the most striking the magazine had ever printed. Showing only one side of the face of a young girl wearing a single earphone that contains a complete superheterodyne receiver, it attracted widespread attention and kept cropping up in ads until a much later date.

Lesser news items of 1961: Philco's Lansdale, PA plant and the CBS plants at Danvers and Newbury, CT stopped manufacturing vacuum tubes. And the man who started them in business, Dr. de

Forest, died on June 30. German electronic engineer Marlene Schmidt became Miss Universe. The first use of pulse-code modulation on subscriber telephone circuits was reported in the Newark-Passaic area of New Jersey. OSCAR—Orbiting Satellite Carrying Amateur Radio—the ham satellite, was launched in December.

In the February 1962 issue, Hugo Gernsback echoed the words of FCC Commissioner Minnow: ("Television is a Wasteland.") Television programs, he said, have "shrunk to an incredible low," turning off viewers and their sets. His remedy—canned TV Recordings, either in tape or disc format, already in experimental form, must be commercialized. Then, the viewer can buy his own programs and run them when he wants, seeing "worthwhile, adult television fare." (In 1962 "adult" and "pornographic" were not synonyms.)

The United States is brain-draining from Asia as well as Europe, the March 1962 issue stated. Dr. Esaki, inventor of the tunnel diode, was working in this country for IBM.

Dr. Fips (emulating the "tough guy" who "shaves with a blow-torch") invented for readers of the April issue a new cathode-ray shaver that burns the user's whiskers off.

Women are getting into electronics, stated the *Wall Street Journal*. Raytheon, the newspaper reported, has tripled its female staff. (Quantitatively, the breakthrough was not impressive—an increase from 3 to 10.) The Gracco-Schenectady vocabulary now exceeded 500 terms, from Accutron to Zyklotron. (Some terms like Shucktron—a device for removing oyster shells—were not electronic.)

Telstar, the first active communications satellite, was launched on July 10, 1962, and the September issue had a Telstar article. Voiceprinting was discovered.

Bell Labs developed an electret microphone (in telephone language—(transmitter) and earphone (receiver) early in

1963. Light-emitting diodes were on sale for \$130 each from General Electric, according to the February 1963 issue, and Tappan started marketing a microwave oven range for home kitchens. Radar ranges had already been sold to restaurants, hotels, and similar institutions for some years.

A record for remote radio repair was set in 1963: Telstar, which had been out of order for six weeks, was repaired from the earth—a distance of 300 miles (average). The first weather satellite, TIROS, was launched. MOSFET (Metal-Oxide-Semiconductor-Field-Effect Transistor) technology was announced in the April issue.

The August 1963 editorial was written by Arthur Clarke, the scientist and science fiction author who was the first to predict satellite radio (in 1945). Expansion of satellite communications may lead to the day when anyone on earth may call anyone else by dialing a number; when businesses may abandon central offices (files will be replaced by "memory banks beneath the Arizona desert, the Mongolian steppes, the Labrador muskeg.") Earth's languages may drop to one or two, with present languages becoming local dialects.



Technicians were beginning to show great interest in color TV troubleshooting. There were eight articles on the subject and one on color-TV test equipment in the December 1963 issue.

In the January 1964 issue, Hugo Gernsback predicted a voice-operated typewriter, citing the pre-electronic work of Flowers, of RCA's Harry Olson, and of Count Dreyfus-Graf, who had progressed to the point where he could dictate readable Christmas cards.

"Biggest Telescope in the Earth" is the title of a February 1964 article. Scooped out of a natural hollow in the hills south of Arecibo, Puerto Rico, this spherical radio telescope, still in operation today, covered more than 18 acres, had a diameter of a thousand feet, and was 10,000

times as sensitive as the radio telescope in Millstone Hill, MA, that detected the first reflected signals from Venus. Radio astronomy scored another victory when Channel 37, important to radio astronomers, was withdrawn from television use and set aside for radio astronomy.

Joe Marshall, one of *Radio-Electronics'* most important audio authors, died on February 23, 1964. Aircraft designer Igor Seversky demonstrated an ion-powered craft that could lift itself off the ground—he claimed it could rise to 60 miles above sea level. Bell started commercial *Picturephone* service between New York, Chicago, and Washington, DC. The cost: \$16 for three minutes. The first pictures of the moon, taken by the Ranger satellite from a thousand feet up, were shown. Pan-American Airways adopted inertial guidance for its entire fleet.

John Reinartz, the world's greatest ham operator, died on October 6.

New approach to editorials

Most of the 1965 editorials were written by guest writers. Struggling against his failing powers, Hugo Gernsback wanted only to write enough editorials to supply material for his last Christmas booklet, *Forecast—1966*. This he accomplished; and he wrote only one more editorial, "Fuel Cells", after finishing the booklet. The February 1965 editorial was written by John Pierce of Bell Labs, who suggested that the future might see a telephone in everyone's pocket.

Bob Middleton, in September, 1965, points out that fame often descends on the famous rather than the deserving. As examples, he cited the Wheatstone bridge, invented by Christie; the d'Arsonval galvanometer, invented by Pouillet, and Coulomb's Law, discovered by Cavendish.

The guest editor in January 1966 was David Lachenbruch, once associate editor of the magazine. In one more year or two, he said, probably all TV programs will be in color; all programs, but not all sets. As long as black-and-white sets are considerably cheaper, they will continue to be produced and sold in heavy volume.

The February editorial (written by managing editor Fred Shunaman) demonstrated a strange contradiction in U.S. law: This is the only civilized country in the world that cannot prevent a manufacturer from making and selling dangerous equipment, though the *buyer* can be put in jail for using it. And much harm can result before the user goes to jail! Interference expert Rexford Daniels tells of an electroencephalograph that sent people to mental institutions on the strength of signals picked up from a freight elevator in a hospital. A taxi dispatcher's message to a driver blew up a missile on the launching platform.

With the March issue, Fred Shunaman, who had edited the magazine for 23



warranty practices were the most grievous problem. (For example, one manufacturer who charged a walk-in customer \$19.95 for a repair allowed a service shop only \$7.50 for the same job.) RCA was the shining exception—warranty payments were identical to RCA's published rates for the same work.

"Which Way Does Current Flow?" was the subject of a discussion in the June 1971 issue, decades after everyone (well, almost everyone) thought it had been laid to rest. Audio author Mannie Horowitz held that today there is some justification for the "current flow" (positive to negative) approach, since the hole current in transistor circuits can be better expressed as current flow from positive to negative.

By December 1971, 37 percent of the TV sets, 63 percent of the phonographs, 92 percent of the radios, and 96 percent of the tape recorders purchased in the U.S. were foreign imports.

In 1972, projection TV began to be mentioned in connection with such names as Sony and Advent. Telegames were also mentioned for the first time; electronic captions on the TV screen for deaf viewers were proposed. RCA came up with its new 3-in-line, slotted-mask tube, which gets rid of most convergence problems. The transistor celebrated its 25th birthday. Calculators that sold for \$200 just two years ago could be bought for half that price. Next year, according to the November 1972 issue, the little calculators would be available for less than \$50.

Japanese taking first place?

"Looking Ahead" in the January 1973 issue stated that the Japanese were now technically ahead of us. One reason, said contributing editor Lachenbruch, may be that consumer electronics is the lifeblood of the Japanese electronics industry—in the United States, military and industrial electronics come first.

Bob Gerson took over Gernsback's old job for predicting the TV of the future. Ten years hence, he predicted the picture will be on the wall—with projection. The screen may be of liquid crystal, adjustable for use as a window at one end of the "opacity control" range—as a mirror at the other. The only other controls will be a station selector and a volume control. All other controls will be automatic. Satellites will transmit programs from all countries; CATV will provide a wide range of services—the TV set may become a home message center, and even receive and record calls when you are away from home.

Four-channel audio reached the point where an issue (March 1973) devoted six articles to the subject. School students, the May issue warned, were being exposed to dangerous radiation from lasers in the school science labs.

The August 1973 issue tells about the phase-locked loop for stereo detection.

That appears to have been the first mention of the PLL, which became so much more prominent in the next few years.

Harry Secor died at the age of 85. He had worked as an editor in the Gernsback organization—with two brief interruptions—for 54 years, retiring at age 80.

In the September 1973 issue, *Radio-Electronics* entered the space (and mark) age with the famous TV typewriter, which prompted such a flood of inquiries that the magazine had to publish a special reprint, with additional details and information. Thousands of these were mailed

market checkout-counter computer system was put into action in Cleveland. Bell researchers raised the temperature of niobium to 23.2 degrees Kelvin without losing its superconductivity.

Two important figures in the early electronics field died in 1975: William D. Coolidge, of ductile tungsten and high-voltage X-ray fame, died on February 3, at age 101; and E.F.W. Alexanderson, developer of the high-frequency alternator that was the most important high-power transmitter in the early years, died on May 14 at age 97.

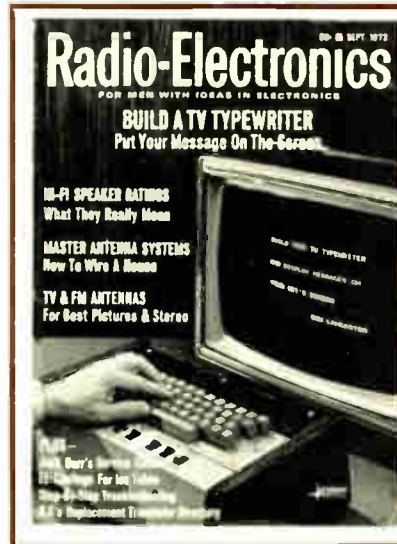

to readers, at \$2 each. This was followed, in 1974 by the first computer article to be published anywhere. Again the demand was staggering at a \$5 price.

A gift of 8 million dollars by audio manufacturer Avery Fisher to improve the acoustics of New York's Philharmonic Hall made news in the January 1974 issue. (The building became Avery Fisher Hall over Fisher's objections.)

Latest CB designs now showed a Channel 9 monitor to operate while the user is working on another channel; SSB receiver and transmitter; and automatic level control. The first electronic super-



If you haven't thrown out that old radio in the attic, don't, the October 1975 issue warned. An early-breadboard Atwater-Kent may sell for \$200; some others may fetch nearly the same price. A new FM tuner (the *Sequerra*) was described by Len Feldman as worth every cent of its purchase price of \$2500.

Citizens band rules were relaxed somewhat in 1975. The FCC began to recognize that CB is a hobby, and legalized the already universal practice of contact between different stations. It had previously tried to confine communication to a base and its auxiliaries. The first report of

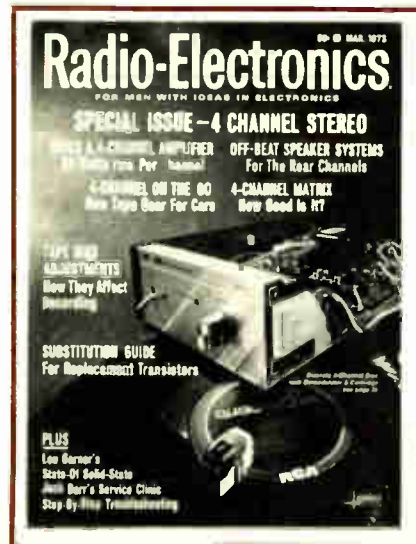

cooperation between police and truckers via CB appeared in late 1975. Still bitterly at odds over speed limits and radar traps, both groups began to realize that they had a strong common interest in traffic safety. Police chiefs started to suggest that all police cars be equipped with CB radios.

The monopole magnet—a magnet with only an N or an S pole—in hibernation since the days of Ehrenhaft (1944-1945) surfaced again in the work scientists were conducting at the University of Houston, TX, and the University of California. The magnet would fit into electromagnetic theory so neatly that scientists were willing to believe that it existed with much less proof than might be required for some less-convenient discovery. The new particles the scientists hoped they had discovered fit in very well with the characteristics predicted by Dirac in 1931 for such a monopole, should it exist.

The impossibility of total recall in relation to defective equipment was demonstrated in the January 1976 issue, when Panasonic attempted to bring back some 240,000 TV sets from its customers' hands. The sets were to be inspected and modified to avert possible X-ray dangers. Of the 240,000 units, Panasonic was able to locate and modify only about 80,000; most of those were still in dealers' hands.

Increased efficiency does not always lead to profit. "TV is in a slump—the industry cannot supply the fantastic demand for CB equipment. So why not use idle TV factories to turn out CB?" The E.F. Johnson Company, for one, ordered 100,000 units to be produced at the Magnavox TV plant in Morristown, TN. The cumulative result was a general dumping of CB equipment in late 1977, as even the ever-increasing demand could not keep up with the vast oversupply.

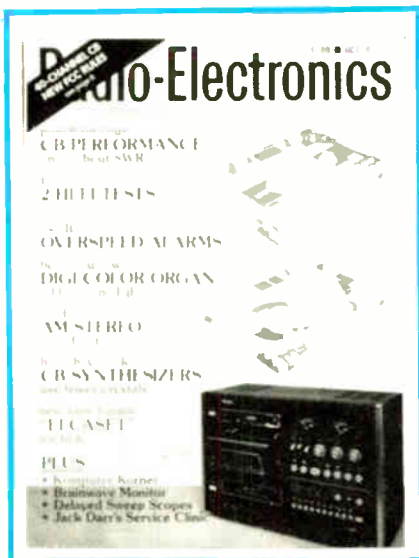

Dangerous interference from TV games was reported from several areas. One game arcade blocked out the city's police communications system. There

were 364 million TV sets in the world—more than 100 million of those in color. The U.S. had 58 million color sets and 63 million black-and-white sets. Brazil adopted a color system that would be compatible with both NTSC and its close relative, PAL. There were 196,000 service technicians in the country and 66,000 service shops. The National Bureau of Standards was looking for a definition of the word "portable" (some warranties specified that portable sets must be carried to the shop for servicing). The traditional definition, "anything with a handle" wouldn't do. RCA put out a TV receiver—in the XL-100 line—with no controls on the set; the unit was operated completely by remote control.



The Hugo Gernsback scholarship award (given to correspondence school students) presented to two women, Sally Knight and Mazine Anderson, indicated that the home-study schools were at last beginning to wake up to the vast potential market that this half of the country's population had to offer.

RCA's great Harrison (N.J.) receiving tube plant closed on July 30, 1976. Only 80 million tubes were manufactured in the U.S. in 1975—10 years ago the output was half a billion.

CB takes its great leap

The October 1976 issue revealed that CB channels had expanded to 40, effective January 1. The FCC stated that 23-channel CB sets would in no way be made obsolete by the expanded band. The long-proposed temporary licenses were authorized. A CB buyer could obtain his license at the store where he bought his set and could use his initials as call letters while waiting for his license to come through. The FCC reported that 85 percent of the 100,000 annual interference complaints they received were due to CB. More than 90 percent of all state police agencies are now cooperating with the CB-ers, and 36 states have installed CB radios in about half of all police vehicles.

Projection color TV finally arrived. Over four dozen models, made by 26 manufacturers, were on the market by the end of 1976. Only a half-dozen were definitely 3-tube projection-type sets. Cable TV viewers in Hastings, England, were receiving TV programs via optical cables, possibly the first use of optical cable in entertainment electronics. The British were also using optical cables in experimental telephone lines. Bell Telephone was now using bubble memories in subscriber message equipment. ("That number has been . . ." etc.)

The January 1978 issue told of a Belgian manufacturer who produced a set long predicted by Hugo Gernsback: At the press of a button, a small image of any desired channel appears in the upper left-hand corner of the screen. Thus, the viewer can see what's happening on the other channels without interrupting the program he is watching.

A Main Frame Round-Up replaced the Television Characteristics Charts that appeared regularly in *Radio-Electronics* not so many years ago. It ran through two 1978 issues and described 46 main frames. (Meanwhile, "Looking Ahead" listed the seven remaining U.S. TV manufacturers.)

The oscilloscope—taken for granted but receiving little space in the magazines—received due attention in a special 12-page section in the May 1978 issue. Triggered, delayed-sweep, dual-trace scopes were described and other scope features discussed in this section.

A portable tape player that speeds speech up to 2 and 1/2 times for playback—or that slows it down to 60 percent of the recording time if desired—was developed by the Variable Speech Control Company of San Francisco. This may help the problem of tape correspondence by bringing the time required to listen to a letter nearer to that in which it can be read. And the slowed-down transcriptions can be useful in following difficult technical descriptions or learning a language.

Television may be on the threshold of another period of transformation and advancement as the 1980's begin. Experts are beginning to say that our present standards are outmoded. Don Fink, who was a member of the NTSC committee that set up the present standards, so informed an IEEE luncheon, stating that a 1,000-line system, with a wide-screen aspect ratio, would give TV viewers the equivalent of a 35-mm moving picture.

VCR's, Videodisc, and who knows what else are in their early days now. On the drawing boards are many other unique electronic devices. There is no question that electronics will become steadily more important to our everyday life and there is no question that *Radio-Electronics* will continue to keep its readers up to date. For a look at 2029, you'll want to read about the future of electronics, elsewhere in this issue.

R-E

Author . . . Author !

In the long run, a magazine's value depends on the quality of its contents. And the contents, in turn, depend on the authors. Many of *Radio-Craft's* authors were developed by the magazine itself. Because of its specialized readership, that was a necessity. Neither the writer for the popular journals, nor for the engineering magazines, spoke the language of the technician-hobbyists who make up the bulk of *Radio-Craft/Radio-Electronics* readership.

So the magazine's authors have been to some extent a special breed. They have ranged from at least one semi-illiterate writer (whose only qualification was that he knew what he was talking about and could express it only in simple language) to heads of college physics departments.

The near-illiterate writer described the replacement of a part in series of short sentences, each beginning "I . . ." (i.e., I unsoldered the three wires to the part. I removed the nut holding it to the panel . . . etc.). We printed the item in more conventional form, and should have saved the original as an example in the use of simple English. But nobody thought it was possible to forget it—and so we did!

When a person submitted even a short technical hint that showed compatibility with the *Radio-Craft* style and seemed able to put his thoughts in writing, he was encouraged. He would then sometimes come back with a longer article, which was often returned to him with suggestions that he rewrite it. Even outright rejections were regularly returned with detailed suggestions. (One author and, later, teacher of technical writing, Allan Lytel, told his class: "*Radio-Craft* is the only magazine whose rejections are sometimes longer than the article.")

It was through a rejection that Jack Darr came to the magazine. His first contribution was returned with the comment; "It is worth about \$35 to us, but if we accept it at that price you will probably never send another one." Correspondence continued to the point of planning a coherent series on television servicing, and his contributions increased until

he became the Service Editor.

One of the steps in developing authors is to encourage reader-correspondents to think for themselves. That sometimes fails. (One correspondent wrote: "This is a new low in reader service!") On one occasion it paid off beautifully. Otto Wooley, who had occasionally supplied short hints and "kinks," asked a question that went something like: "The circuit calls for a 70-mA choke. I have a 75-mA choke, can I use it?" Especially jolted because the reader had been a semi-author, we reprimanded him mildly and called his attention to a few of the electronic facts of life.

We got no reply from Wooley, and were about to consider him another case where we'd been too "helpful," when a manuscript arrived—his first full-length story. He went right through the circuit of a small receiver, showing what parts values were critical and in what locations large variations could be tolerated. ("The RF screen bypass could be any value from .02 to 2.0 μ F without making any noticeable difference.")

The story was just what we needed, and we printed it under the title "Circuitry and Common Sense." Apparently, other editors also needed such a story because it was reprinted in almost every country in the world! We saw it first in the magazines with which we exchanged publications. Then, magazines we had never known existed mailed us copies with the article, including the only radio magazine in Turkish that we had ever seen.

Once he learned that he could write, Wooley contributed several other articles until his early death (related to injuries received in World War II).

Another unexpectedly developed author was a young German, Otto von Gericke, who sent in a hint that was interesting but not as interesting as his name. When we printed his suggestion, we used the ancient spelling of his name—Otto von Guericke. He came right back and admitted he was a descendent of the man who—because of his early work in producing a vacuum—he called the father of electronics. Later, he contributed a number of useful articles.

There are other ways of obtaining good material. The television issue of 1965 carried an article entitled "World Television," written by E. Aisberg (the world's foremost radio-television author, whose book *Television—It's a Cinch*, has been translated into 22 languages). Aisberg suggested that some Europeans translate the initials of the American system, NTSC, as "Never Twice the Same Color." RCA indignantly demanded equal time and was mildly surprised that **Radio-Electronics** seemed so willing to open its pages for a rebuttal (by one of their top scientists, who otherwise would never have "had the time" to prepare an article for the magazine).

Unexpected talent sometimes lurks under our very noses. The Question Box editor, Schendel, wrote a "Letter to the Editor" that concerned service technician licensing. We needed a story on licensing, so sent him all the notes we had been gathering on the subject and asked him to write an article. He responded with a reasonably good story. Then, some months later he sent in two excellent articles on iron-cored components—magnetic circuits, a subject on which few are competent to write but on which he was an expert. We immediately sent a talent-scouting questionnaire to all our authors!

Once in a while, one author breeds another. An article from a young woman started out: "Whenever I need a little extra money, my husband asks, 'Why don't you write an article, like I do?'" So she wrote a story on the special problems of radiomen's wives, whose husbands work hard in the radio shop all day and experiment with new circuits or talk to Timbuctoo all night, and sent it to the magazine her husband wrote for. The story was not particularly complimentary to the craft, and even went so far as to suggest that radiomen's families tend to be smaller than the national average. Next time our author appeared in the office, we complimented him on his wife's work, but his replies were in monosyllables. We wondered just what was the cumulative effect of his well-meant suggestion on his family life!

R-E

HITACHI OSCILLOSCOPES

Single and dual trace, 15 and 30 MHz. All four high sensitivity Hitachi oscilloscopes are built to demanding Hitachi quality standards and are backed by a 2-year warranty. They're able to measure signals as low as 1mV/division (with X5 vertical magnifier). It's a specification you won't find on any other 15 or 30 MHz scopes. Plus: Z-axis modulation, trace rotation, front panel X-Y operation for the dual trace models, and X10 sweep magnification. And, both 30 MHz oscilloscopes offer internal signal delay lines. For ease of operation, functionally-related controls are grouped into three blocks on the color coded front panel. Now here's the clincher: For what you'd expect to pay more, you actually pay less. Suggested list price of our top line V-302 dual trace 30 MHz is only \$945.00. The other models comparably less. Check our scopes before you decide.

Hitachi...The measure of quality.

- V-302 30 MHz Dual Trace \$945.00
- V-301 30 MHz Single Trace \$745.00
- V-152 15 MHz Dual Trace \$695.00
- V-151 15 MHz Single Trace \$545.00



HITACHI
Hitachi Denshi America, Ltd.

For more information, contact
Hitachi Denshi America, Ltd.,
175 Crossways Park West, Woodbury, N.Y. 11797
(516) 921-7200.

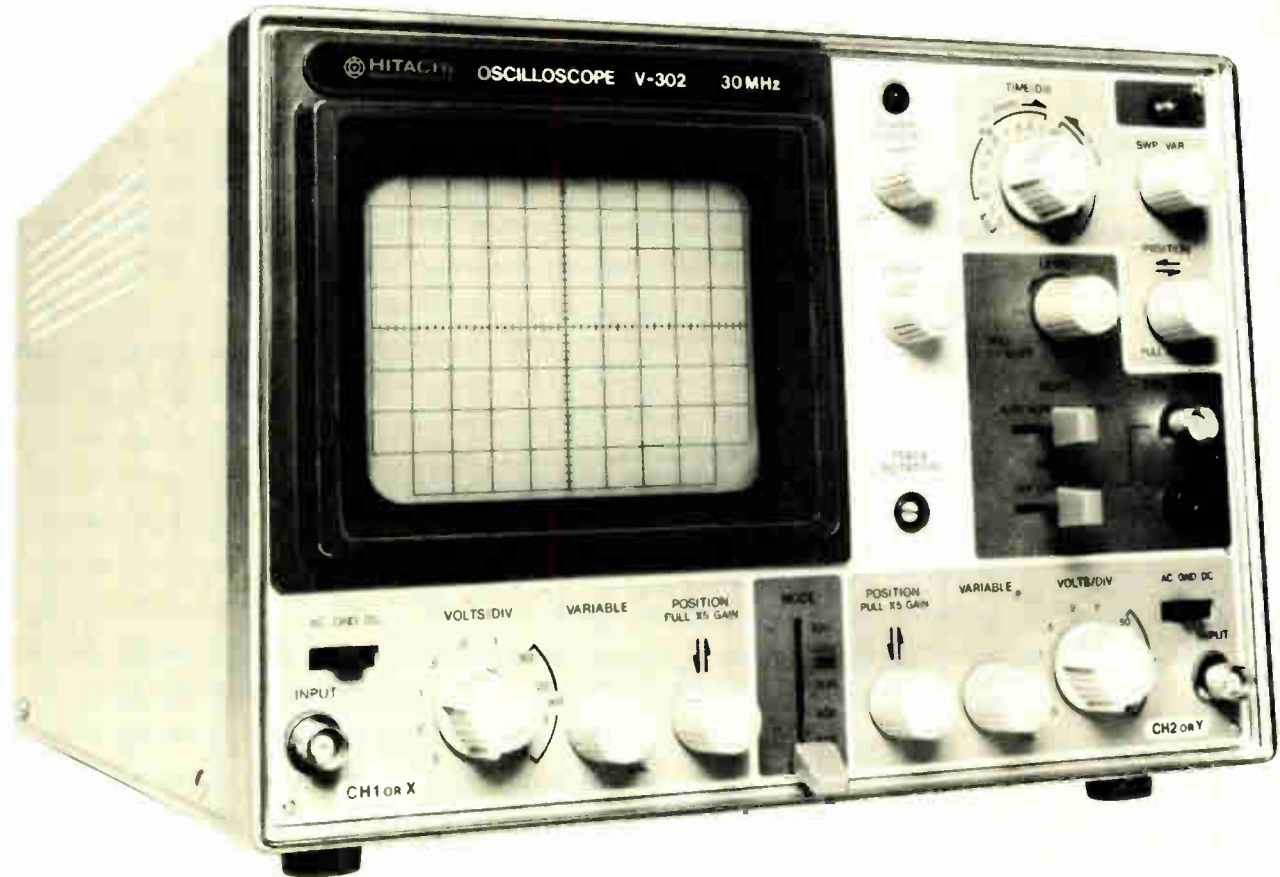

More sensitive to your input.

CIRCLE 82 ON FREE INFORMATION CARD

Celebrate **RADIO-ELECTRONICS'**
50th Anniversary with our \$ale

VIZ formerly **RCI**

TRIPLETT



PHILIPS

HICKOK



New Portable Digital Capacitance Meter

MODEL 820



BK PRECISION

- Measures capacitance from 0 1pF to 1 Farad
- Resolves to 0 1pF
- 10 ranges for accuracy and resolution
- 4 digit easy-to-read LED display
- 0 5% accuracy
- Special lead insertion jacks or banana jacks
- Fuse protected
- Uses either rechargeable or disposable batteries
- Overrange indication

Call For Our Price

3-1/2 Digit DMM with .5% Accuracy

BK PRECISION

MODEL 2810

- 3½ digit easy to read LED display
- 0 5% DC accuracy typical
- 100µV, 01 resolution
- 10 ohm range and control to zero lead resistance
- Selectable High-Low-power ohms on four ranges
- Auto zeroing



Call For Our Price

80MHz Counter with Period Function

MODEL 1820

- 5Hz to 80MHz reading guaranteed—100MHz typical
- Period measurements from 5Hz to 1MHz
- Period average, auto and manual positions
- One PPM resolution
- Totalizes to 999999 plus overflow
- Elapsed time measurements from 01 to 9999 99 seconds plus overflow
- One-megohm input resistance
- Bright 43' high LED readouts



BK PRECISION

Call For Our Price

New Low Distortion Function Generator

BK PRECISION



Call For Our Price

MODEL 3010

- Generates sine, square and triangle waveforms
- Variable amplitude and fixed TTL square-wave outputs
- 0 1 Hz to 1MHz in six ranges
- Push button range and function selection
- Typical sine wave distortion under 0 5% from 0 1Hz to 100kHz
- Variable DC offset for engineering applications
- VCO external input for sweep-frequency tests



DIGITAL MULTIMETERS

NEW 8022A

- Extensive overload and transient protection
- Rugged construction
- Hi/Lo power ohms for in-circuit resistance and diode testing
- 10 MΩ input impedance doesn't load circuit
- 200 hour battery life — low battery indicator
- Large LCD readout — 2000 counts
- 1 year calibration cycle
- One-hand operation

NOW \$129.

BASIC SPECIFICATIONS

	DC Volts	AC Volts	DC Current	AC Current	Ω
Range	0.2 1000V	0.2 750V	0.002 2A	0.002 2A	20 20
Resolution	100 µV	100 µV	1 µA	1 µA	0
Accuracy	(0.25 + 1)	(1. + 2%)	(0.75 + 1)	(1.5 + 2%)	10.2



DIGITAL MULTIMETERS

8020A NOW 0.1% Basic dc accuracy

- 26 Ranges—5 Functions plus New Conductance Function for up to 10,000 MΩ Leakage Measurements
- Extensive Overload and Transient Protection
- Rugged Construction—2 Year Warranty
- Hi/Lo Power Ohms for In-circuit Resistance and Diode Testing
- 10 MΩ AC/DC Input Impedance Doesn't Load Circuit
- 200 Hour, 9V-Battery Life—Low Battery Indicator
- Large LCD Readout—2000 Counts
- 0 1% Basic dc accuracy
- One Hand Operation
- Complete with Battery and Test Leads

The new Fluke 8020A continues the standard of excellence set by the highly successful 8000A multi-meter family. Many features set the 8020A apart as a truly exceptional instrument. Twenty-four ranges and 5 functions include measuring capability up to 1000V dc, 750V ac, 2A ac/dc and 20 MΩ Hi/Lo ohms are included for in-circuit resistance and diode test capability. In addition, a new Conductance function allows resistance and leakage measurements up to 10,000 MΩ, a must for circuit board work and component checking.

The 8020A has been designed with the user in mind and features exclusive one hand operation. For harsh service environments, the 8020A has a ruggedized case and extensive overload/transient protection backed up by a 1-year warranty. Long term stability (1-year calibration cycle) is excellent with only three cal adjustments. Up to 200 hours of continuous operation can be expected from a single 9V alkaline battery.

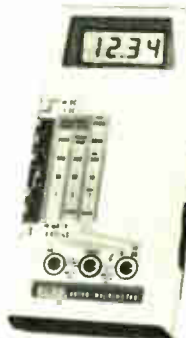

\$169.

FREE CASE WITH 8020A

LCR-740
Transistorized LCR Bridge

LEADER
Instruments Corp

Regular price \$350
\$299.95

- Highly accurate 3 unit digital readout
- Measures inductance (L) Capacitance (C) and Resistance (R), within ± 0 5% accuracy
- Operates on one 9V battery

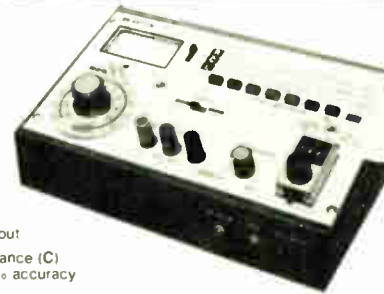

New Sweep/Function Generator

BK PRECISION



Call For Our Price

MODEL 3020

- Four instruments in one package—sweep generator, function generator, pulse generator, tone-burst generator
- Covers 0 02Hz-2MHz
- 1000 1 tuning range
- Low-distortion high-accuracy outputs
- Three-step attenuator plus vernier control
- Internal linear and log sweeps
- Tone-burst output is front-panel externally programmable

Simpson

BK PRECISION

LEADER

DORIC



Non-Linear Systems



DATA PRECISION

FINAL CLOSE-OUT

DUAL-TRACE 5" 30MHz TRIGGERED SCOPE...

BK PRECISION MODEL 1474



Call For Our Price

- Rise time 11.7 nS or less
- Built-in signal delay line permits view of leading edge of high frequency pulse rise time
- Triggers on signals up to 50MHz
- 5mV cm vertical sensitivity
- Mode automatically shifts between CHOP and ALTERNATE as you change sweep time
- Checks most digital logic circuitry, including ECL
- High accuracy ten position vertical input attenuator
- Flat response with smooth rolloff past 30 MHz
- PDA CRT with P31 phosphor
- Built-in high- and low-pass filters
- Maintains calibration accuracy from over 105-130 VAC and 205-260 VAC
- 20 calibrated sweeps — 0.2 uS cm — 0.5 S cm
- Differential input capability
- Algebraic addition and subtraction
- Built-in RF detector for modulation envelope display
- Illuminated graticule

PORTABLE OSCILLOSCOPES

BATTERY OPERATED

NLS Non-Linear Systems

MS15

MS215

MS230



Single Trace 15MHz

Dual Trace 15 MHz

Dual Trace 30MHz

Reg. price \$318
\$269⁹⁵

Reg. price \$435
\$359⁹⁵

Regular price \$559
\$459

Automatic Transistor Checker

LEADER Instruments Corp

MODEL LTC-906

Regular price \$189
\$159.⁹⁵



Lights Up. Sounds Off. Measures. Identifies. Displays.

- A multipurpose, portable, transistor checker automatically better for laboratory, shop and school
- Checks transistors, FETs, diodes good or bad & in or out of circuit
- Automatically tests a broad range of parameters with simple, program on-off switches—no confusing buttons or lead changes
- Automatically identifies Germanium or Silicon, plus emitter base and collector
- LED display plus audible tone indicates defective or good performance
- Absolute meter readout of DC parameters

Lab-Quality Semiconductor Tester...

MODEL 530



BK PRECISION

- Measure F_T of bipolar transistors up to 1500 MHz
- Nondestructive testing of transistor and diode breakdown voltages
- Measures transistor beta or FET gm
- Measures all transistor breakdown and leakage parameters
- Fast testing of transistors, FET's, and SCR's—in or out-of-circuit
- Base diagrams are not required
- No biasing information required
- Identifies all leads of transistors and SCR's
- Automatic identification of PNP NPN types and N- or P-channel FET's

Call For Our Price

MASTER CHARGE

THE TEST EQUIPMENT SPECIALISTS

VISA

TOLL FREE HOT LINE
800-223-0474

ADVANCE ELECTRONICS

54 WEST 45th STREET, NEW YORK, N.Y. 10036 212-687-2224

OCTOBER 1979

73

WHEN THE GOING GETS TOUGH, BECKMAN'S NEW DIGITAL MULTIMETERS KEEP GOING.



Featuring new continuity function.

If you've ever been troubled by a faulty multimeter—or had to use one that wasn't quite up to the tougher jobs—your troubles are over. Now there's the Beckman line of digital multimeters. A new generation of 3½-digit models that combine superior reliability with highly versatile features.

Features like a unique continuity test function. With Beckman's new Insta-Ohms™ quick continuity indicator, you no longer need an analog VOM for fast, convenient continuity checks.

There's also 10-amp current ranges, in-circuit resistance measurement capability in all six-ohm ranges, a dedicated diode test function, and up to two years normal operation from a common 9V battery.

The Model TECH 310 with all these features,

7 functions, 29 ranges, and 0.25% Vdc accuracy is only \$130.

The Model TECH 300 with 0.5% Vdc accuracy, but without the continuity function or the 10-amp current ranges, is just \$100.

Whichever model you choose, you get a multimeter that won't let you down. There's exceptional overload and 6kV transient protection, plus ruggedness to take a 6-foot fall and to come up working.

So get the Beckman digital multimeter that performs and keeps on performing. No matter how tough the going gets. For information on the complete line and accessories, write or call your local distributor or the Advanced Electro-Products Division, Beckman Instruments, Inc., 2500 Harbor Boulevard, Fullerton, CA 92634, (714) 871-4848, ext. 3651.

BECKMAN

CIRCLE 22 ON FREE INFORMATION CARD

AUTOMATE YOUR HOME

Tailor this programmable control system to do the job

NOEL NYMAN

YOUR HOUSE CONTROLLED BY COMPUTER! What was science fiction a few years ago is a practical reality today . . . or is it? There are several problems you'll encounter if you computerize your home. This article deals with a system that tries to overcome some of them.

Connecting a computer to house electrical systems requires special interfacing circuitry. The computer needs inputs to tell it what's happening in the outside world. Also, its outputs must be connected to the devices you wish to control. The input and output circuits should isolate the computer from the house line voltage, and should also allow the computer and the people living in the house to control the same devices without disturbing each other.

There are ready-made interfaces and kits that do this. Most of them use modulated radio waves carried over the house wiring. Such circuits are expensive and complex. The assumption is that most people don't want to "run wires all over the house." While this may be true of many homeowners, electronics activists enjoy spending time on their projects. Running wires does take time, but it also drastically reduces the cost of interfacing. The noise problems that sometimes plague even sophisticated RF systems are eliminated, and the interface we describe here allows both computer and human control of the same device without disturbing either living patterns or computer programs.

Another set of problems concerns the computer itself. Hobbyist machines are usually short on memory. We all need more memory than we have, and even a simple program for a few appliances takes an important part of that limited space.

The computer must run all day every day without shutdown to maintain control. To time electrical systems, a real-time clock is needed. This is an expensive option in machines designed for it and difficult to add to others. And the biggest problem is very basic to many of us . . . we don't own a computer yet!

The system described here is a dedicated control. Rather than tie up a computer, the control circuits are designed around discrete logic. The system is "programmed" using wire and a patch panel rather than software. This drops the cost dramatically, especially if surplus parts are used. The interface uses simple circuits with few parts. Even if all new components are used, each device-controlling circuit can be built for under \$10. If you don't own a computer, you might want to build an entire system similar to the one described here. If you do own a computer, the interface circuits may help you expand your machine to control your house.

A basic part of the control logic is the real-time clock. Clock IC's are readily available; but to control electrical devices you need separate outputs for hours, minutes and, if used, seconds. These outputs aren't readily available from conventional clock IC's. I built up a clock using counters and decoders. For reasons that will be explained later on, I used a 24-hour format and I needed only hour and minute outputs.

Figure 1 is the block diagram of the house-control system. A divide-by-60 counter is clocked by 1-second pulses to count 60 seconds. A divide-by-10 counter clocks a divide-by-6 counter to get the divide-by-60. Any other arrangement can be used that achieves the same result; for example, a single-IC programmable counter.

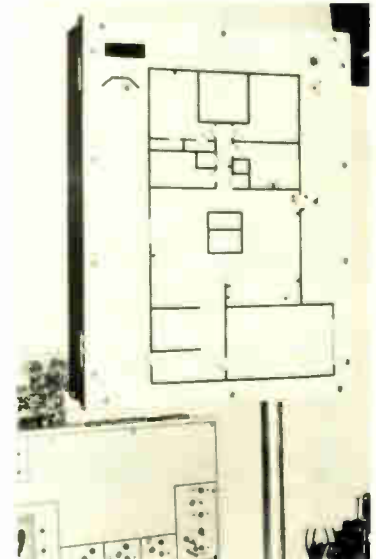

FRONT PANEL of logic system has house layout. LED's show status at different points.

I got the 1-second pulse from the flashing colon on a digital clock display, and used a resistor voltage-divider network to drop the pulse to the proper voltage level. Another approach would be to use a low-voltage transformer and Schmitt triggers to provide 60-Hz pulses and a divide-by-60 counter to get 1-second pulses. Both methods provide power-line accuracy that is adequate. A DPST switch changes the real-time clock input to a free-running astable with adjustable frequency that provides setting pulses.

The seconds counter clocks another divide-by-60 that counts minutes. Since I wanted control that is accurate to individual minutes, I used decoders for the outputs of both sections of this counter. The first section provides a logic 1 or logic high for each minute as it's counted (the 7442 decoder outputs go low or to a

it usually is for these applications), three-input NAND gates will suffice. The fewer the inputs, the fewer total IC's you'll need. The latch can be formed either from part of a flip-flop or from two cross-coupled NOR gates.

Most household devices are controlled by humans, however, and some provision must be made for people to override the logic circuits. When you start to computerize your home, you may find that selling the idea to your family is the hardest part of the project. Your spouse may have enjoyed the stereo amplifier and thought the electronic dice game was cute, but may be very reluctant to have you tinker with the house lights and electrical appliances. Therefore, anything you can do to make these controlled devices behave normally when operated by people will help.

To allow human control, several gates are added to the basic circuit, see Fig. 3. The input NAND gates now set and clear the latch via one-shots. The latch has been changed from an R-S flip-flop to a clocked flip-flop, and a switch and a one-shot clock the latch. The output goes to an interface as before. The NAND gates set and clear the latch; but any time the clock one-shot is fired by the switch, the latch changes state. This means that people can turn the controlled device on or off regardless of what part of the program the logic is in. Clocking the latch does not change the logic cycling, and the device still turns on and off as programmed.

If you use a computer instead of IC logic for your system, you can replace the NAND gate outputs with computer outputs. The one-shots for the set and clear signals are used because people can't clock the latch while the set or clear inputs are low. Not using the one-shots

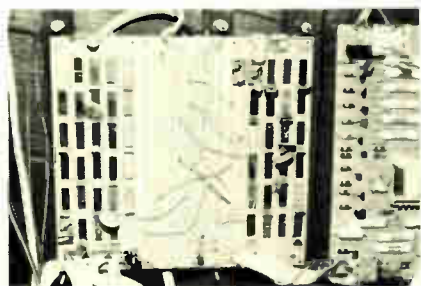

LOGIC CLOCK and logic circuits are at left. The interface board is at far right.

means there would be two 1-minute periods each day when the device couldn't be human-controlled. The one-shot on the clock input has a long period (50ms) and prevents extra triggering impulses resulting from switch-contact bounce. The other one-shots have shorter periods—about 1 ms. Only a brief switch pulse is needed on the one-shot that clocks the latch.

Most house lights and switched outlets use wall SPST toggle switches. Lights that are turned on or off from two locations use SPDT switches (also called three-way switches) that look the same

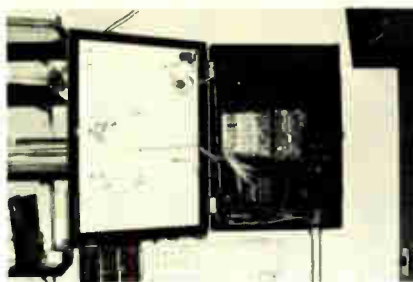

DISPLAY PANEL is hinged to permit access to logic, patch and interface boards.

except for the ON and OFF labels. These SPDT's are break-before-make or non-shorting switches. As they are thrown, both circuits are open briefly. You can replace the existing wall SPST switch with an SPDT switch and clock the latch without running additional wires to the wall box. The cable that goes to the existing switch is located and cut at a convenient point. The SPDT switch is installed with one wire going to the common connection (a black screw), and the other going to both of the other connections. **Turn the AC power off before working on the house circuits. Follow local electrical codes in terminating the unused end of the cable.**

The wire spliced to the switch side of the cut cable carries logic-level voltage and can be small-gauge wire. The input of the one-shot is pulled high by a resistor and grounded through the SPDT switch. When the switch is thrown the ground circuit opens briefly, the one-shot input is triggered when it is pulled high by the resistor, and the latch clocks. When a person operates the switch, the wall system seems normal; throwing the switch changes the on/off state of the device, yet the logic still has control. If two or more on/off cycles are needed, more four-input NAND gates are used with their outputs OR'd to the one-shots.

Other applications

There are other useful inputs besides time and wall switches. You may want to trigger circuits when doors are opened or closed. Commercial magnetic-reed switches are available for this purpose, but it is easy to make your own by removing the switch section from commercial magnetic-reed relays. If you can remove the moldings from around doors and windows, you can mount the switches behind them and run the wires where they won't

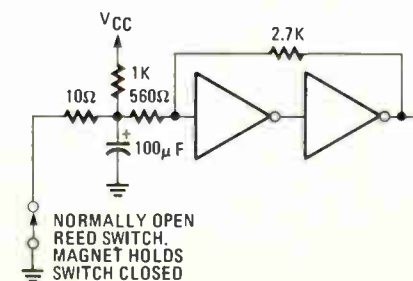

FIG. 4—MAGNETIC SWITCHES trigger the control logic when doors are opened or closed.

be seen. The magnets controlling the switches can be mortised into the door or window so that the switches are completely invisible. Figure 4 shows a typical input circuit for a magnetic switch. The capacitor and resistors condition the input, and the resistor feedback across the inverters provides a snap action or Schmitt trigger. The inverters outputs can provide OPEN zero and OPEN 1 signals to the patch panel.

A light sensor can be used to sense that a lamp is on without having to install extra wires to the lamp itself, (a typical circuit is shown in Fig. 5) A photoDarlington transistor (for example, an FPT 120 625) is mounted near the floor and aimed toward the lamp being sensed.

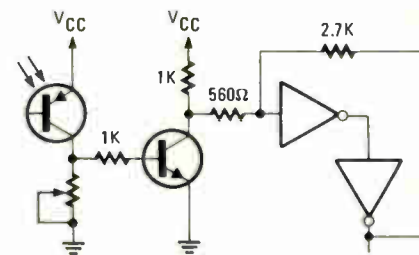

FIG. 5—LIGHT SENSOR may be a phototransistor or a sensitive photo Darlington.

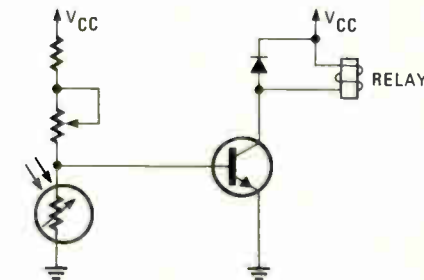

FIG. 6—PHOTORESISTIVE CELL has enough sensitivity for use in dusk/dawn sensor.

A dawn/dusk signal is also useful. However, the Fig. 5 circuit may be too sensitive for this input. Figure 6 shows a simple photoresistive cell that is mounted outside the house facing west. The resistors in series with the cell are selected to bias-off the transistor during the day. As the sky darkens, the photocell resistance goes up until the transistor conducts sufficiently to energize the relay. The variable resistor is adjusted to trigger the relay at the desired darkness level.

Circuit applications

Now, for some actual circuits that I use. In my household we must take our garbage cans out on Thursday mornings. It was easy for us to forget to do this, and became a good logic-circuit application. Figure 7 shows the circuit I used. A three-input NAND gate (IC1) receives input signals from DOOR OPEN 1, a clocked-latch Q output and the real-time-clock THURS output. On any day but Thursday, the THURS output is low and nothing happens. At midnight on Wednesday, THURS goes high. At 4 am, 4H and zeroH are both high, output IC3

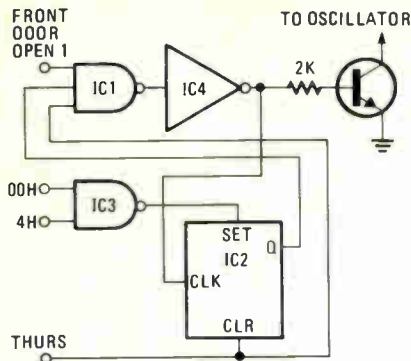

FIG. 7—GARBAGE DAY circuit sounds alarm as you start out on day garbage is collected.

goes low and sets IC2. With the latch set, IC2's Q output goes high. Two inputs to IC1 are now high.

When the door is first opened in the morning, the third IC1 input goes high; its output goes low, is inverted by IC4 to bias-on a transistor that powers an oscillator outside the front door. The sound of the oscillator reminds us to take out the garbage. The clocked input to the latch is used to prevent the oscillator from being activated all day Thursday whenever the door is opened. The clock triggers on a negative-going pulse edge so the high-

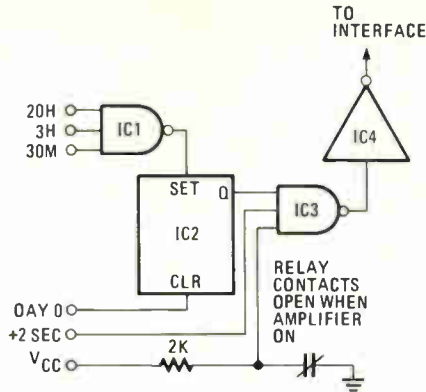

FIG. 8—STEREO ON reminder flashes bedside lamp if stereo is advertently left on.

going inverter output that turns on the oscillator doesn't affect the latch. When the front door is closed, the inverter output goes low, turning the oscillator off and clocking the latch. The Q latch output goes low and pulls one of IC1's inputs low, preventing further circuit action. At midnight the THURS signal goes low, holding the latch in a cleared state and the IC1's THURS input low for the next six days.

Here's another circuit I devised: I have remote speakers in my workshop, and I

used to leave my stereo system on inadvertently. Figure 8 shows a circuit that flashes a night light in the master bedroom if the stereo is still on after 11:30 pm. IC1 sets a latch at 11:30 pm (23.30) and a low-going signal at dawn clears the latch. The Q output of IC2 drives one input of IC3 high. Another input of IC3 goes high when the stereo is on. This is accomplished by using a 120 VAC relay located at the amplifier. The relay is plugged into the switched outlet on the amplifier, but any appliance can provide an "on" signal by using a relay operated by the appliance's on/off switch. The wires running from the relay to the logic circuit can be small-gauge wires since they carry only low voltage.

With the "stereo-on" input high and the latch input high, IC3's output goes low and high alternately with the +2SEC alternations. The NAND gate output is inverted and interfaced to the night light.

The most complex circuit, shown in Fig. 9, in my system controls the porch light and a lamp near the front door that is operated via a wall-switched floor outlet. Although the circuit may seem very involved at first, you can use its compo-

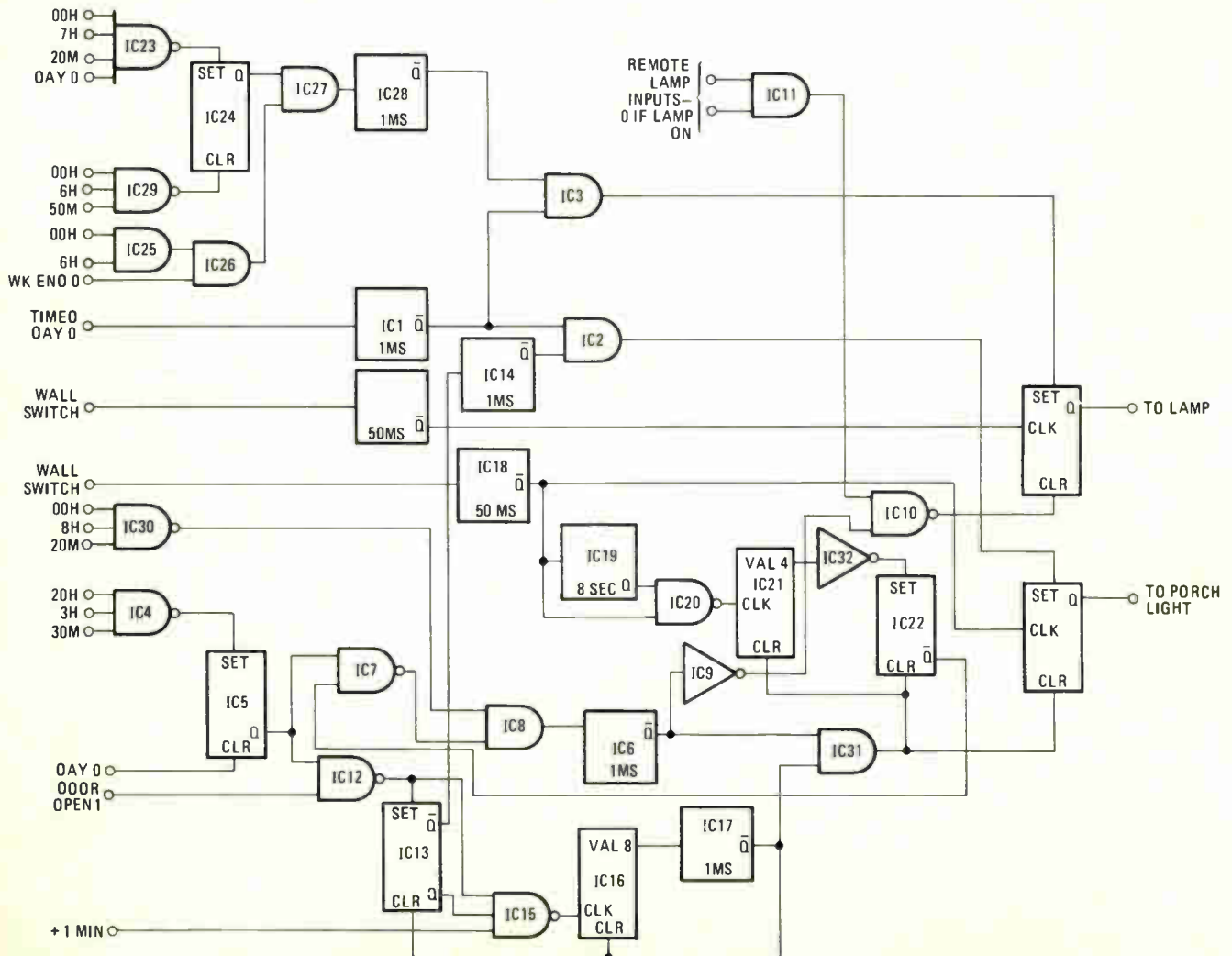

FIG. 9—COMPLEX CONTROL turns porch lamp, and one other lamp, on at 11:30 pm and off at dawn. Circuit is not fooled by shadows or bright light flashes.

nents or develop ideas from it to achieve almost any kind of sophisticated control for a house electrical system. This circuit grew one stage at a time and its construction may be more involved than necessary for your particular application. I suggest you examine it carefully to see how you could save IC's in your own system.

Figure 9 shows the complete porch light and lamp circuit. Using the SPDT/one-shot technique described earlier, the wall switches still allow human control of the light and lamp. The first logic control turned the light and lamp on at dusk and off at 23:30. To avoid false triggering, the dusk sensor described earlier is connected through inverters (providing DAY 1 and DAY ZERO signals) to a counter; see the circuit shown in Fig. 10. The counter is clocked by the +1 MIN signal and after 8 minutes, sets a latch that provides a TIMED DAY zero signal that goes high 8 minutes after dusk. Dawn or the DAY zero signal clears the latch so that dark periods of less than 8 minutes or cloud shadows don't turn on the lights.

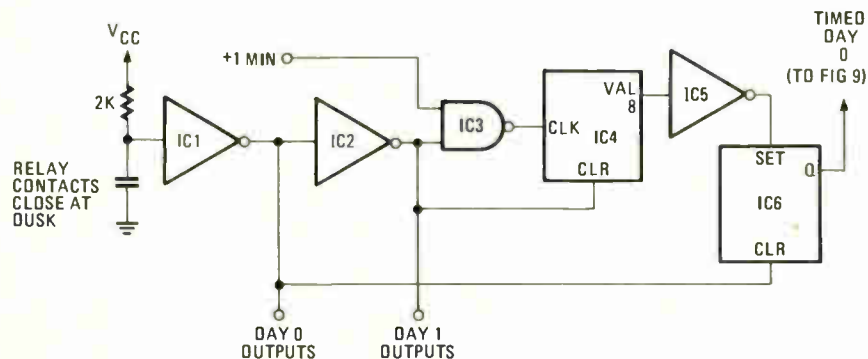

FIG. 10—THE LOGIC DELAY circuit prevents the porch light from coming on until 8 minutes after dusk. Shadows or dark periods shorter than 8 minutes don't turn on the lights.

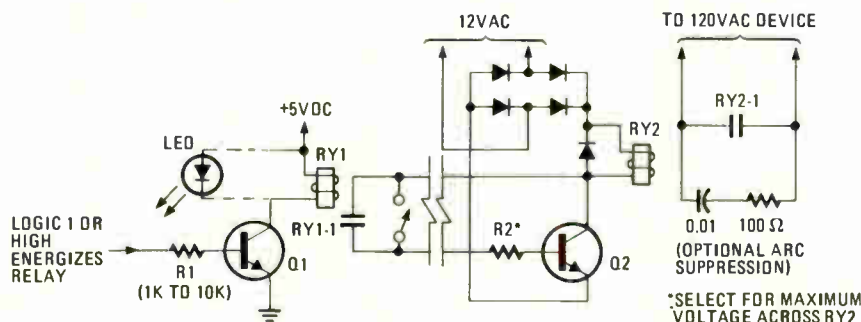

FIG. 11—HOW INTERFACE RELAYS provide total isolation between the logic voltages and the higher voltages used to power the control devices or stages.

The TIMED DAY 0 signal sets the porch-light latch and the lamp latch through one-shot IC1 and AND gates IC2 and IC3 (Fig. 9). In the descriptions that follow, we'll assume that any other gate inputs are as they must be to allow the gates to function as described. AT 23:30, IC4 sets latch IC5, and its Q output fires one-shot IC6 through IC7 and IC8 to clear the porch-light latch through IC31 and the lamp latch through IC9 and IC10.

In our home whenever we have visitors in the front room at 23:30, since it would be rude to have the indoor lamp turn off,

I added another circuit to prevent this. One of two other lamps are usually on in addition to the front door's logic-controlled light. One of these lamps is wall-switch controlled, and I placed a relay in parallel with it to provide an "on" signal to the control logic. The other lamp is of a more conventional design. Instead of adding a relay and wires to the lamp, I used the remote light sensor with a photoDarlington input. If either of these lamps is on, one IC11 input is low. This makes one IC10 input low and prevents the 23:30 one-shot pulse from passing through IC10 to clear the lamp latch. The lamp stays on at 23:30 even though the porch light goes off.

When the guests leave, it's convenient to have the porch light come on, stay on until they reach their cars, and then turn off.

To accomplish this, the IC5 Q output sends one input of IC12 high. The other input goes high with FRONT DOOR OPEN 1. The IC12 output sets latch IC13 and fires one-shot IC14 so that the porch-light

stayed out late. Ideally, this circuit should be enabled easily without additional switches. I decided to use the porch-light switch. When the porch-light wall-switch one-shot IC18 clocks the porch-light latch, it also fires one-shot IC19, which has a period of about 8 seconds. When IC19's output Q is high, it allows the IC18 pulses to pass through IC20 to a counter. IC21. If the switch is thrown four or more times during the 8-second period, IC21 sets latch IC22. The latch Q output controls the path of the 23:30 pulse. With one input of IC7 low, its output stays high at 23:30, and the porch light and lamp stay on. When the front door is opened and then closed, the 8-minute counter described earlier cycles and clears the porch-light latch again. However, this pulse also clears counter IC21 and latch IC22, and places latch-output Q high. Latch IC5 output Q is still high, so IC7 goes low and fires one-shot IC6, which also clears the lamp latch. Eight minutes after someone returns home and closes the door, the porch light and lamp both go off.

Memory circuit

The final circuit (see Fig. 9) is a memory circuit that is used to retain information from the previous day. During the dark winter mornings, when I go to work, I like to keep the front room lamp on when I leave. On weekends or mornings when it's light outside, the lamp doesn't have to come on at all. In the memory circuit, IC23 sets latch IC24 if it is not yet dawn at 7:20 am (DAY ZERO is still high). Nothing else occurs that day, but at 6 am the following day, IC25 output goes high. If the day is a weekday (WEEKEND ZERO isn't low), IC26 goes high and, through IC27, fires one-shot IC28, which sets the lamp latch. At 6:50 am every morning, latch IC24 is cleared by IC29 so the lamp only goes on at 6 am if it had been dark at 7:20 the previous day. Then, IC30 fires one-shot IC6 to turn the lamp off at 8:20 am; and IC30 acts as a master backup circuit to the entire turnoff system. If the porch light was enabled to stay on past 23:30 but the front door wasn't opened all night, IC30 will turn off the porch light too.

Relays

The circuits I chose to interface to the 120 VAC house wiring use relays. Optoisolators would work as well for the logic-voltage sections of the interface. Magnetic-reed relays that operate on low voltage draw little current and are available from surplus outlets or by mail order. Relays offer total isolation between the logic voltages and the higher voltages used in the following stages. Using reed relays involves only a few components (see Fig. 11). A small-signal NPN transistor, Q1, provides a ground path for the relay coil. When the logic-level input signal goes high, it biases Q1 on through

a current-limiting transistor and energizes relay RY1. Don't forget to include the diode across the relay coil to limit back EMF surges. The LED shown in Fig. 11 is optional for a display of which logic systems are ON.

Reed relay contacts have a current rating that is much too low to operate 120-VAC systems directly. Having the 120 VAC control in a central location means running grounded NM house cable from many locations; this adds to the project cost. To avoid this I used a second relay at or near the controlled device. Using a transformer with a high-current secondary, I ran a 12 VAC line wherever necessary throughout the house. Near the controlled device I installed the second relay, RY2, which is energized by Q2 when the logic-controlled relay RY1 contacts close.

You may need a small filter capacitor across the bridge output. It may be less expensive to use four separate diodes than a commercial bridge assembly. A supply of 50 PIV at 1 A or more is fine for these diodes. Although it is possible to use any 12 VDC relay whose contacts will handle 120 VAC with enough current rating, I found that 24 VAC relays work very nicely on 12 VDC. These relays run cooler and are easier to obtain on the surplus market. The ones I used draw 0.25 A at 12 VDC. I used surplus power transistors rated at about 20 watts to insure that they would run cool. This part of the interface may not be easy to reach once installed, and overrating component values will minimize failures.

Relay RY2 will probably have several poles of contacts; use all of them in parallel to reduce on contact arcing. You may want to use a 0.01- μ F, ceramic disc and 100-ohm, 1/2-watt resistor in series across the relay contacts to reduce both arcing and electrical noise. Then, decide whether the device will be on or off most of the time. If the device will usually be off, wire it to the normally open contacts; energizing the power relay will turn the device on. If the device is on most of the time, wire the contacts normally closed. The logic signal will energize the relay to turn the device off. You can use this circuit to control the hot water heater.

The 12 VAC supply should run through relatively heavy wire—16-gauge or 14-gauge lamp cord is recommended. Although local electrical codes may cover such low-voltage wiring, the wires can usually be run in any convenient manner without using electrical boxes, etc. The connections to the power relay, however, are 120 VAC and *must* conform with electrical codes. In general, this means that the relay must be mounted in an approved electrical box that may need to be properly grounded. There may be restrictions on how the wire can be run from the relay to the controlled device; check your local codes. You may want to place your circuitry inside an external

cabinet near the controlled device. The cabinet would have its power cord plugged into a wall receptacle, plus a convenience outlet to control the device. This would avoid most code restrictions.

If you've never done any house wiring or if you plan to remove drywall or plaster to run new wires, check out do-it-yourself books. These booklets are available in many hardware, drug and grocery stores, and are geared to the novice. You'll find the circuit descriptions are oversimplified, but the books do contain step-by-step ideas on how to run new wires. Running wires under or over the rooms is obvious if you have an attic or a basement. But it may not have occurred to you to run wires behind baseboards and through walls using easily patched small holes. I found these do-it-yourself booklets invaluable, and so far I've installed my system using over ten 120 VAC interfaces without having to make any noticeable changes in the living areas.

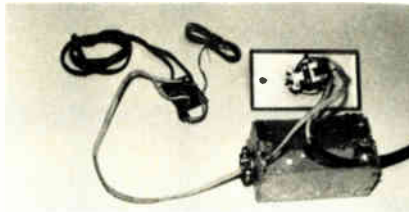

CONTROL RELAY used as interface to line-operated devices is in approved enclosure.

The logic used

The logic circuits I used are TTL, but CMOS circuits should work equally well. I used TTL circuitry because I had the IC's on hand. A system as complex as this has a high IC count, and TTL circuits will require a power supply of several amps at a tightly regulated 5 volts. Fan-out to the patch panel has to be considered with TTL circuits too, so CMOS IC's might be a better choice for a large system.

Helpful hints

If you do choose TTL IC's, here are some tips that might be helpful. I used 74123's for the one-shots instead of the more popular 555. You'll find some one-shots triggered by high-going pulses and others by low-going pulses. You'll also find that both the Q and \bar{Q} outputs of one-shots are used. This is easy with the 74123 and requires no more socket space per one-shot than the 555.

I also had some 8280 counters, which, unlike the more common 7490's, are loadable counters. An 8280 works fine in these circuits but, my counter had the alarming habit of resetting to 9999 instead of zero, and occasionally it would reset at a count of 5 instead of 10. I found that tying the LOAD ENABLE and all LOAD inputs to V_{cc} corrected the first problem, and a 0.01- μ F ceramic disc at the socket from the clock input to ground cured the second problem.

When you design your control system, keep track of the unused gates on the IC's. If you need an inverter for example, you can use an unused NAND or NOR gate from another IC. Use ceramic discs across the supply lines at every other socket—*minimum*. Supply lines should be of heavy gauge wire. Use a surplus wire-wrap board or perforated board and wire-wrap sockets if at all possible, even if you have to invest in wire-wrap equipment. The tools are relatively low-cost, and it is easier to change your designs as you go along. If you must use a printed circuit board, breadboard everything first and construct the system one circuit at a time. It is helpful to use 0.01- μ F discs on all the input signals coming into the logic board. These capacitors to either ground or to V_{cc} help shunt noise pulses.

Document ALL your work. Use color-coded wire if possible, and label wires if necessary. Identify every wire and component on paper. Years from now you may have to troubleshoot your system and writing everything down will save many hours of tracing circuits and wire runs.

A wall-mounted LED display isn't necessary, although it looks impressive. It *is* helpful to have LED's indicating the outputs during the troubleshooting setup for isolating problems. You can use switches to simulate the various inputs such as DUSK and DOOR OPEN in check-outs or troubleshooting. Switches wired across the logic relay contacts of RY1, as shown in Fig. 11, can be used to operate controlled devices manually if the boards are powered down for any reason.

Other circuit ideas

Here are some circuit ideas to add to your basic system:

1. Add a crystal-controlled clock and battery power to maintain timing in case of power failure.
2. Use door and window monitors to warn you as you leave the house that some entries are open or unlocked.
3. Add smoke and fire detectors; Use commercial detectors, but have each detector sound a unique series of pulses, and trigger the other alarms with the same sound so you know immediately where the fire is located.

You can also use the logic control to protect your house against burglary when it is occupied by turning the house lights on and off automatically. These circuits should be set to operating in somewhat random fashion over several days. They should start operating before dusk as during normal operation when the house is occupied. Regardless of what time the sequences start, they should end near the time your lights normally go out. And, as before, system should allow for human control. The possibilities for using logic circuits to control your house are limitless. What further uses can you think of?

Home Reception *via* SATELLITE

Part 3—This month we'll see where home satellites stand legally and then take a good look at the technical requirements and how they are met.

BOB COOPER

IN THE AUGUST AND SEPTEMBER, 1979 issues of **Radio-Electronics**, we learned that, through a network of largely non-affiliated geo-stationary communication satellites, multiple channel television is now available to virtually any point on the globe. Satellite television, using geo-stationary satellites, rises above terrestrial television in many ways. It is virtually immune to interference, does not suffer from lower atmosphere weather changes, and is of a technical quality that can only be approached (but not exceeded) by the ground-based microwave networks that link the cities of a nation together in a communications grid.

Now we are going to learn how this marvel functions, and how persons with some mechanical skills and ambition can put it to work for themselves.

The legal side

There are as many myths around relating to the legalities of building your own satellite terminal and intercepting satellite television broadcasts as there are myths concerning equipment. The bottom line is that *you can do it*, although there are FCC rules, regulations, and policies that restrict the nature of what you can do legally.

The FCC is responsible for governing two different types of transmissions: public and private. Public transmissions include the radio broadcasting you listen to and the television broadcasting you watch. Any transmissions intended for the public at large are public broadcasts. In the United States no license is required for reception of such signals. Private broadcasts are another matter.

A private transmission would include public safety transmissions (intended only for personnel operating as a part of the licensed system), mobile telephone transmissions, and the many forms of common carrier transmissions. In other words, if the transmission is *not* intended for the public at large but for one or more specific addressees, it is private. The FCC

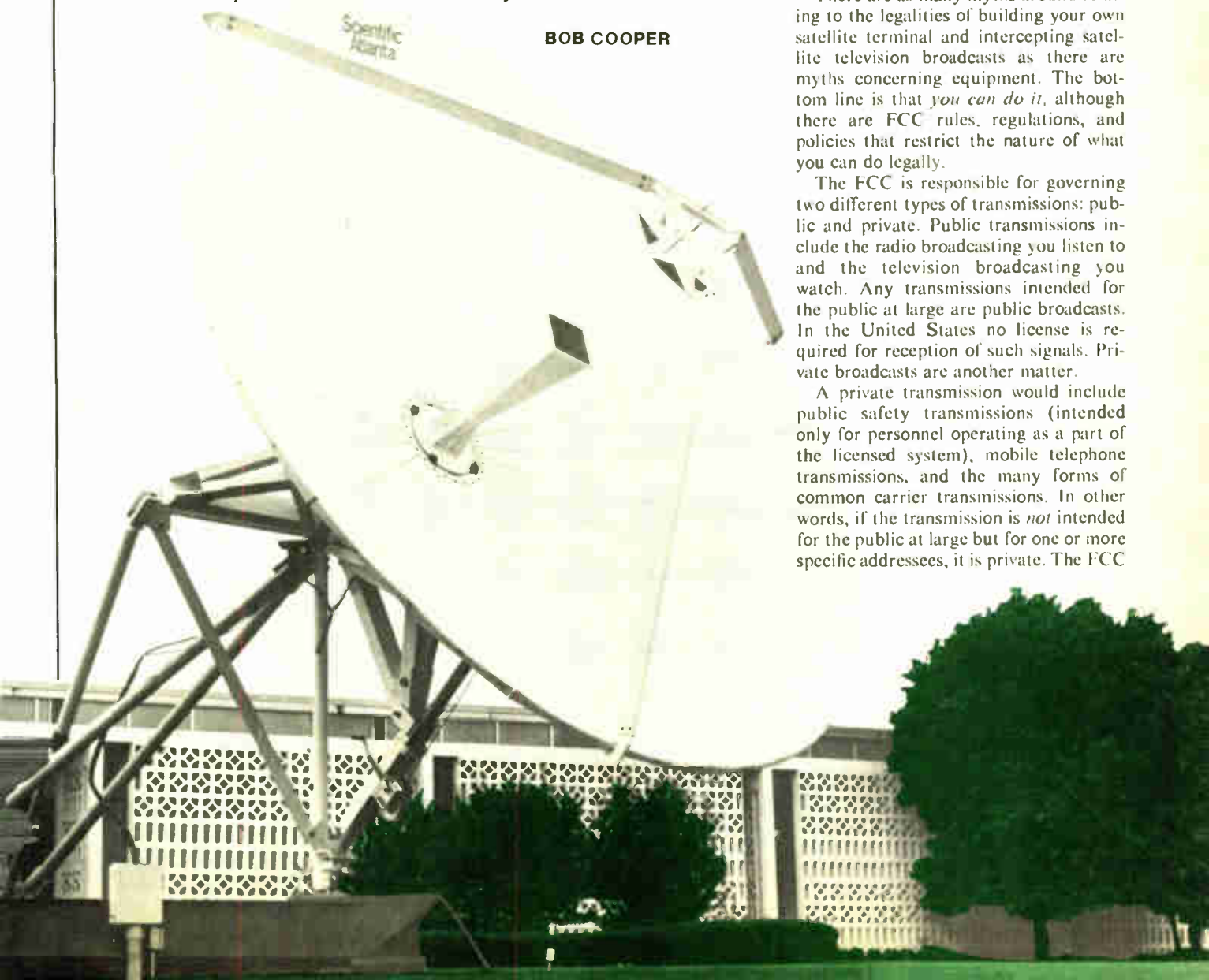

has rules and regulations, created from the broad authority given to the agency by the 1934 Communications Act, to help non-public transmitters keep their transmissions private. The strongest tool in that arsenal of bureaucratic mumbo-jumbo is something called Section 605, a portion of the regulations that deals with secrecy of communications. Section 605 tells us that private transmissions are intended for specific recipients and that if you are not a specific recipient you are not to "tune in." Section 605, also says that if you should happen to tune in (as in by accident) you are not to (1) divulge to anyone else what you have heard (seen), or (2) pass on to anyone else the fact that you have tuned in a private broadcast, and, (3) "profit" from the interception of the private transmission.

As a category, all common carrier transmissions are classified as private; and all satellites operate as common carriers. On the surface that sounds as if anyone who sets out to tune in satellite TV transmissions without the official permission of the transmission agent is acting in violation of Section 605.

Between the language of the 1934 law and the application of 1979 regulations there is a wide gap of practicality. As a practical matter much of what is transmitted via satellite is no more private than your local television station's programs. Signals such as WTCG, WGN and KTVU were broadcast signals before they became satellite signals. In fact they are taken out of the air (*i.e.* public domain) and sent via satellite. The FCC and others recognize that there is a wide gap between a set of rules based upon a 45-year-old law and the onrush of technology. At the present time the FCC is attempting to sort all of this out by proposing a new system that will eliminate the mandatory licenses that, up to this point, have been required of all satellite receive terminals. The Commission suggests a simple registration process with special dispensation for individual terminals constructed or installed by non-commercial entities. In the interim, a number of private terminals have been installed following something called the experimental/developmental licensing route¹ (I'm licensed as WF92) while many thousands more have simply been installed.

The basic terminal

Remember that we are dealing in satellite television reception with two technical parameters that do not coincide with

¹ The FCC will authorize experimental/developmental class licensing for TVRO terminals established for the purpose of equipment development testing. The author, and others with an interest in developing the technology base of the service, have followed that procedure to obtain one-year, renewable licensing in this service. An "Experimental Terminal Licensing Guide" is available for \$5.00 from TPI, Suite 106, 4209 NW 23rd, Oklahoma City, Ok. 73107. Enclose payment with order.

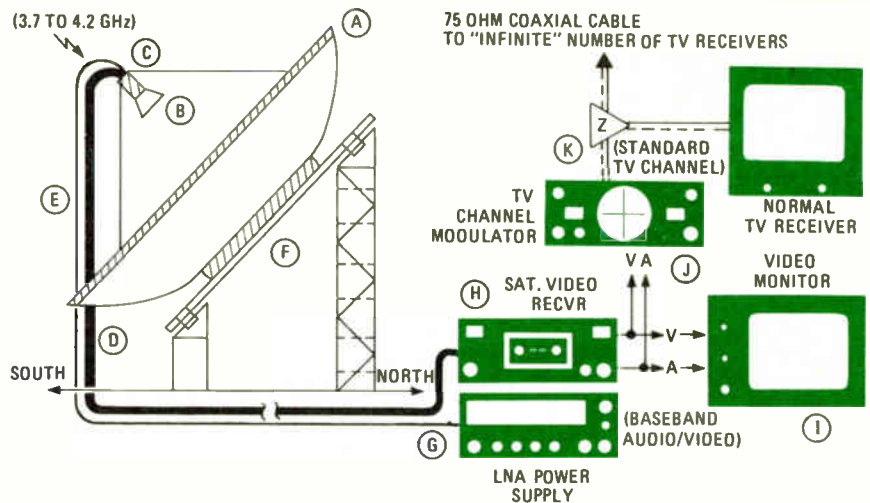

FIG. 1—THE BASIC SATELLITE television receive terminal system. The 3.7 to 4.2 GHz satellite signals are received and focused by the parabolic reflector (A) to the feed or focal point antenna (B). The signals are amplified in a low-noise amplifier (C) and carried to the receiver in low-loss coaxial cable (D). The most common antenna mount is a "Polar Mount" (F) which allows side to side (azimuth) antenna movements from satellite to satellite. The 3.7 to 4.2 GHz satellite signals are processed and demodulated in a satellite video receiver (H). DC power for the low noise amplifier is fed from a separate power supply (G) through a dedicated weather protected line (E) to the LNA. Video/audio (baseband) from the satellite video receiver can be fed to a local video (audio) monitor (I), or to a RF (TV channel) modulator (J) which produces a standard NTSC (color) modulated signal at the modulator's design RF channel.

our established VHF-UHF television system. We have a different frequency range for the transmissions, and we have a different modulation format. Both of those changes are evident as we review Fig. 1 which establishes what the basic terminal looks like.

Our 4 GHz frequency band requires a different approach to antennas. We need a fair amount of signal gain since our satellite is operating at a relatively low power level (5 watts or +7 dBm). It turns out that with current technology the most cost effective way to acquire such gain is to use a parabolic reflector. The gain of a parabolic is dependent upon several factors:

1. The foremost factor is the antenna aperture or capture area. That is the surface area of the antenna that intercepts signals; each time the surface area doubles, the gain of the antenna increases by a textbook 3 dB. Remember that the area is the square of the surface region so it turns out that a physical size increase of 50% results in approximately double the surface area.
2. The second most important factor is the design of the feed or focal point antenna. The parabolic achieves its gain by capturing energy from the intended transmitter over its large surface area and focusing that energy to a central point. The actual pick-up antenna mounts at that (pre-determined) focal point. The feed antenna will by necessity have a reception pattern of its own which means it "sees" the parabolic reflector surface with varying degrees of efficiency. To realize as much gain as possible from the full reflector surface the

feed antenna must be carefully designed.

3. The feed must be sufficiently broadband to cover the whole of the satellite downlink frequency band (3.7 to 4.2 GHz). That simply says that the antenna must work equally well throughout the whole of the spectrum.
4. The surface accuracy of the parabolic surface must be carefully controlled. In commercial antennas, the design criteria calls for surface accuracies of ± 0.050 inches. That may be a little tight for a totally home constructed antenna although some builders have developed techniques² that assure accuracies in the ± 0.080 region. When the surface tolerance varies too much, the gain of the antenna suffers. A 0.050 variation over the full surface can create gain-losses in the 0.5 dB region (off of maximum theoretical gain) while variations of 0.1 inches will result in gain losses of over 1.0 dB. If all of that sounds like not very much loss, think again.

The science of satellite reception is a very exacting one at its present stage of development. One of the mental hurdles you must adjust to is thinking in terms of 0.1 dB or 0.5 dB differences as being *substantial* differences.

The feed antenna signal is coupled

² A complete textbook on building your own 16 foot aperture TVRO antenna using readily available hardware store supplies is available from PARAFRAME R & D, P.O. Box 423, Monee, Illinois 60449 (312-534-7435). That antenna has been developed primarily for duplication by private terminal enthusiasts and the manual includes step-by-step construction details including full parts sourcing. Price of the manual is \$55 postpaid; enclose payment with order.

directly into a low noise amplifier (or LNA, as it is known in the trade). That is simply a signal booster, not unlike the antenna mounting signal boosters used for fringe area terrestrial TV. However that is where all similarities cease. The LNA is rated by its gain and by the noise factor (*i.e.* noise figure). Gain is important, but that is secondary to the noise figure of the unit. To achieve the kind of noise figures required to produce high quality television pictures we have to push the science of transistor technology to its very uppermost limits. The latest thing in low noise transistors for the 4 GHz frequency range are GaAs-FET's: Gallium Arsenide Field Effect Transistors. The latest of these devices are capable of creating noise figures in the 1.2 dB region. However there is a price for such low noise at 4 GHz: money. The transistors available for this application are in short supply (although it is improving rapidly) and that keeps the price up. A per-transistor-price of \$200-\$300 is not uncommon and a pair in that range are typically required in commercial LNA units.

There is another way to go here; to lower the costs, the system designer can trade antenna size for LNA noise figure. By using less expensive front end transistors and a slightly larger antenna, the home builder can shave large dollar numbers from the terminal cost as we shall see.

In a commercial installation, the LNA is connected to the receiver through a length of low loss coaxial cable. If you are into cable, you should suspect that at 4 GHz regular coaxial cable is a disaster; RG8, 11, or other cables (including even the CATV type aluminum sheathed cable) have very high losses at that frequency. Therefore you graduate to more expensive cables with larger diameters and lower loss. The most commonly employed cable for this application is the *Heliac* or spiral-air insulated line. Losses in 100 feet are in the 4-6 dB range at 4 GHz and that can usually be tolerated.

The receiver can be called a demodulator since it actually takes the 4 GHz input signal and through a series of steps translates the RF signal down to baseband video and audio. Receivers in the commercial area are available in either single channel or tuneable formats.

The LNA must be powered and the most common power source is a DC supply in the 12-18 volt region. Normally a power line carrying that operating voltage is run from the inside location to the antenna where the LNA mounts. The current requirements are minimal (150-250 mA being typical) although voltage transients are a problem since the GaAs-FET's tend to be easily destroyed by spikes. Therefore many LNA supplies are Nicad cells constantly under trickle charge with the LNA connected to the battery bank that acts as a

"sump" for primary line voltage transients.

Because we cannot convert the FM/FM format to a standard TV receiver IF and then to video/audio, the output of the satellite video receiver is baseband audio and video. To view this signal requires a separate box or series of boxes. For the highest quality local viewing most systems have one or more studio-type color video monitors. Such monitors are expensive, but with extremely high signal to noise video coming out of the satellite receiver (50-55 dB signal to noise is the range we are dealing with) the end result (the picture) is enhanced by this approach. That's fine for on-site viewing, but not practical for multiple viewing locations. Therefore most often the baseband video/audio signals are looped to a TV RF modulator operating on some specified TV channel. Modulators come in all shapes, sizes, and price ranges, running the gamut from single transistor oscillators to complex mini-broadcast stations with separate audio and video modulation controls, aural to visual carrier ratio controls, peak white limiting, and a host of other professional features. Once we've fed the satellite baseband signals to a TV RF modulator the signal may be carried on through standard 75 ohm coaxial cable (as found in MATV, CATV and home cabling projects) to an infinite number of standard TV receivers.

The parabolic antenna

The antenna does two important things for the system:

1. It provides the necessary signal gain to produce a 4 GHz signal level of sufficient intensity to create an interference-free picture, and,
2. It provides a way to discriminate (separate) between the desired signal and others operating in the same frequency range that are not desired at that moment.

If you could stand off to the side of the earth, as depicted in Fig. 2, and look at a cross section of the earth plus the geostationary satellite belt, you would notice that for locations north of the equator the satellite antenna has to look "downhill" to see the satellite hovering above the equator. For a satellite terminal directly on the equator, the satellite is overhead. For locations north of the equator, the satellite is progressively lower and lower to

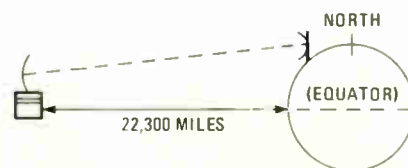

FIG. 2—THE GEOMETRY of the earth-space-earth system. The geostationary satellite is positioned directly above the equator approximately 22,300 miles. The satellite is maintained in a "station-keeping" box approximately 70 miles on a side by earth controllers.

our southern horizon as we progress north. That "tilting" of the satellite receiver antenna is measured in terms of inclination. An antenna pointing exactly at the horizon would have a 0 degree inclination while an antenna pointing straight up would have a 90 degree inclination. For most of North America, the inclination is between 50 degrees down to eventually 0 degrees at the 80th north parallel. By placing a protractor (angle finder) parallel to the flat back surface of the dish and measuring the inclination (or elevation angle as it is also known) you can adjust the angle to match the desired angle. A computer chart that spells out the elevation angle, azimuth angle (left and right), and distance to all visible geostationary satellites from your location is available.³

Rather than standing off to the side of the earth, if you moved to a point directly above the north pole and looked down at the earth and the circular orbit belt surrounding the earth you'd get a view similar to Fig. 3, which shows only the six television carrying satellites presently in service for North American domestic relay. By international agreement the orbit belt from 70 degrees west to 140 degrees west is set aside for North American domestic relay satellites. Also by international agreement all such satellites are required to maintain a 4 degree spacing between themselves, as a minimum. For example, SATCOM II is located at 119 degrees west while WESTAR II is located 4.5 degrees further west at 123.5.

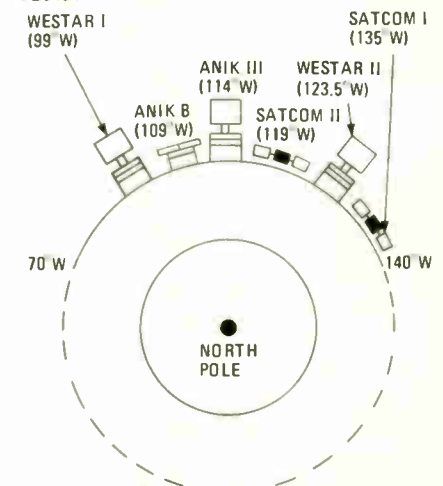

FIG. 3—THE SATELLITE geostationary belt as seen from a position directly above the north pole of the earth. U.S. and Canadian "orbit belt" extends from approximately 70 degrees west to 140 degrees west longitude. From your location a satellite due-south of you will appear highest "in the sky" while satellites east or west of that point will gradually be closer and closer to the "horizon" as their longitude differs more from your own.

³ A highly useful computer derived chart that locates every geostationary satellite location that is within "line of sight" of your location is available. Enclose your geographic coordinates (longitude and latitude with degrees and minutes) plus \$4 per location and order from TPI, Suite 106, 4209 NW 23rd, Oklahoma City, Ok. 73107.

Now, years ago the FCC was a party to an international set of technical standards that specified that domestic satellite earth terminals had to use receive antennas "no less than 9 meters in size . . ." a whopping nearly 30 foot aperture. Naturally, for as long as that rule was on the books earth terminals cost a bundle, \$100,000 being typical.

In early 1976, I conducted tests to determine just what type of service might be practical with smaller antennas and determined that antennas down to at least 4.5 meters (15 feet aperture) provided adequate service and that such antennas were not bothered from interference created when two adjacent-in-orbit position satellites were operating at the same time on the same transponder channel. Those tests were refined and submitted to the FCC in the form of a Petition for Rule Change and in late 1976 the FCC changed its rules and allowed antennas smaller than 9 meters (down to 4.5 meters) to be licensed for satellite receive terminal purposes.

There is, however, a substantial difference between a commercial terminal and a private (non-commercial) terminal. It happens that the FCC, in granting licenses for commercial terminals insists that these terminals maintain an "excess signal margin" of nearly 3 dB. What is an excess signal margin? The FCC says that when you design a receive terminal you will marry together the gain of the antenna, the known or predicted signal contour of the satellite being licensed for, the noise figure (and gain) of the LNA, and the receiver parameters to compute what your ultimate signal-to-noise figure at baseband video will be. As an applicant for the service you submit those calculations to the FCC as part of your license application. The rules state that if your calculations show the "threshold of noise" to be at the 48 dB signal-to-noise point (that is where it typically falls) then your terminal must have approximately 3 dB *more signal* than is required to attain the 48 dB ratio as a safety margin. It turns out that the 3 dB "excess signal margin" can be very expensive.

We've alluded to "signal contours" from the satellite several times so far. What happens is this: The output power is 5 watts per transponder channel. That output power is coupled into a directional antenna on the satellite and the directional antenna has lobe characteristics, like any other terrestrial directional antenna. Dead in the center of the pattern, where maximum gain occurs, is called "boresight." Off boresight the gain of the transmit antenna falls off and therefore the signal level on the ground becomes lower. Refer to Fig. 4 which shows a typical antenna EIRP (Effective Isotropic Radiated Power) contour pattern from an operating satellite. The strongest signal levels are found within the 36 dB portion of the coverage, while lower sig-

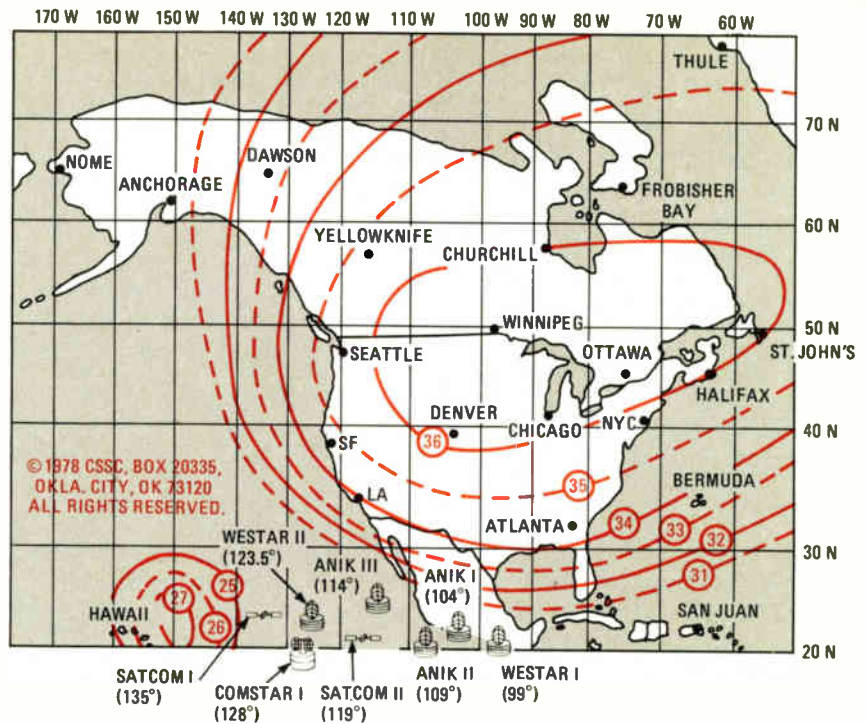

FIG. 4—SIGNAL LEVEL CONTOUR MAPS are called EIRP Contours. The output power of the satellite transponder (typically 5 watts) is converted to decibels above one watt (i.e. +7dBw) and is added to the gain of the transmitting antenna. If the antenna gain is 29 dB at boresight (center of the pattern) the radiated power becomes 7 + 29 or 36 dBw EIRP.

nal levels prevail in the 35,34, etc. contour circles or ellipses. Sets of those maps are available for the primary domestic satellites in operation.⁴

The trade-offs

It turns out that there are several combinations to get the same signal to noise ratios. We speak of measuring signal to noise as a baseband measurement function. There are other ways to measure the system but that turns out to be the best system for repeatable apple and apple measurements, since we are dealing here with the final result of the whole system: the quality of the picture (and audio) as measured at the receive terminal.

Here are ways to increase the baseband signal to noise ratio at a location with a given signal contour (EIRP):

1. Make the antenna gain larger
2. Lower the noise figure of the LNA
3. Reduce the bandwidth of the receiver (by progressively sharpening up the IF bandwidth, ahead of the discriminator/demodulator)

Now if in a given (36 dBw EIRP) contour area calculations show that to license the terminal commercially you must employ a 4.5 meter (15 foot aperture) antenna plus a 150 degree Kelvin⁵ LNA with a 30 MHz IF bandwidth, what would it take to produce not the FCC mandated 51 dB (48 plus 3) signal

to noise ratio but rather a more modest (for private use) 48.5 dB signal to noise?

The antenna could be reduced to 3.0 meters (10 feet), or, the LNA could be replaced with a 300 degree Kelvin unit. Or, you could narrow the receiver IF to 15 MHz rather than 30 MHz, go to a ten foot aperture antenna and get by with a 180 degree Kelvin LNA.

The antenna gain and the LNA noise figure can be played back and forth directly without many side effects. Make the antenna larger, use a lesser quality LNA. Make the antenna smaller, use a better quality LNA. There are limits, of course (an 8 foot dish is about as small as you can go even in high EIRP areas and still expect a high quality signal.) The receiver IF trade-off is one of those areas that begs for additional well documented exploration. The transmitted bandwidth is nearly 36 MHz. However, most commercial receivers are employing 30 MHz IF bandwidths because they gain a bit in signal to noise that way without degrading the baseband video quality. Tests conducted by myself, and others, indicate that the 3 dB bandwidth points of the IF can be narrowed to 15 MHz on highly critical transmitted material, such as color bars, and the human eye cannot tell

⁵ The science of noise figure measurement in the satellite equipment area is very sophisticated. LNA noise figures are measured by using the Kelvin (K) temperature scale with 0 degrees K being a no-noise source and higher K numbers indicating amplifiers with progressively higher noise figures. Certain benchmarks are: 1.0 dB noise figure is 75 degrees K, 1.5 dB noise figure is 120 degrees K, 2.0 dB noise figure is 170 degrees K, 2.5 dB noise figure is 225 degrees K, 3.0 dB noise figure is 290 degrees K and 4.0 dB noise figure is 435 degrees K.

⁴ A set of 11 satellite EIRP maps is available covering SATCOM I (4 maps), SATCOM II (4 maps), WESTAR I and II and ANIK III (1 map each) for \$10 postpaid from TPI, Suite 106, 4209 NW 23rd, Oklahoma City, Ok. 73107. Enclose payment with order.

that the picture quality has been degraded. Yes, on a waveform monitor you can begin to see some telltale signs of waveform distortion but to the eye that distortion is not yet apparent.

You can afford to engage in trade-offs because we are dealing with an extremely stable signal environment. In spite of the FCC's mandated 3 dB excess signal margin for commercial terminals (they say that is to protect the viewers connected to commercial terminals in case there are a series of simultaneous system degradations), numerous chart recorder tests indicate that worst case signal variations over a full year's term should amount to less than ± 0.7 dB of the nominal value. This suggests that once you attain performance that is above the noise threshold, you are "home free." This would be a good time to explain why you don't have the luxury of watching "slightly snowy pictures" with this service.

Noise in the picture disappears when the carrier level reaches a point where the receiver is into limiting. A 48 dB video (baseband) signal to noise actually indicates a carrier to noise (at 4 GHz) of perhaps 11 dB. In other words, if the carrier is 11 dB higher than the noise at 4 GHz you will have a 48 dB signal to noise ratio at baseband after demodulation. That incredible performance is made possible by something called the "FM Improvement Factor." In this service, with the bandwidths employed, it amounts to a healthy 37 dB (plus change). You can compute video signal to noise ratio by taking the FM improvement factor (call it 37 dB) and adding to that the carrier to noise ratio.

By now, you must be impatient to know (based upon your having spotted your own location in Fig. 4) just what type of equipment you might require at your own location to get 48 dB signal to noise ratio service. Some rough guidelines, subject to refinement, is shown in Table 1.

TABLE 1		
EIRP Contour	Antenna Size	LNA Required
36 to 37	20 foot	600°K
	15 foot	300°K
	12 foot	200°K
	10 foot	120°K
	8 foot	100°K
34 to 36	20 foot	300°K
	15 foot	200°K
	12 foot	120°K
	10 foot	90°K
32 to 34	20 foot	200°K
	15 foot	120°K
	12 foot	90°K
30 to 32	20 foot	120°K
	15 foot	90°K

These are meant to be guideline numbers and are subject to some refinement since the system designer works with factors such as receiver IF bandwidth (30

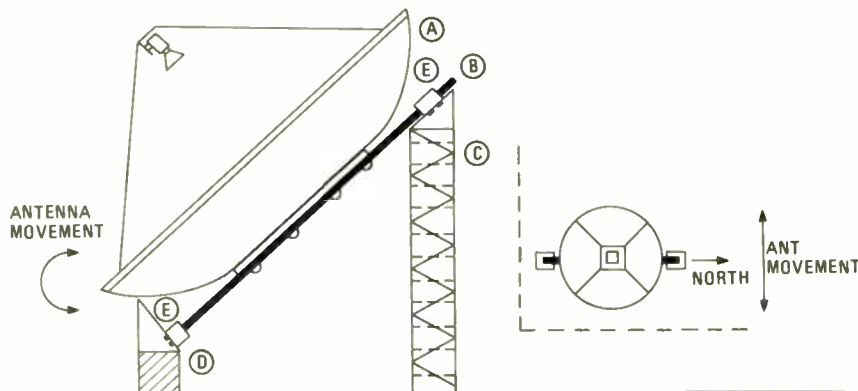

FIG. 5—POLAR MOUNT MECHANISM requires system that suspends the reflector surface (A) on an axle (B) suspended between two supports (C) (D). The axle "floats" in some type of thrust bearing collar (E) on both ends of the axle at each support. The taller of the two supports is the "north" end while the shorter is the "south" end. Supports (D) and (C) are spotted on the ground so that they fall precisely (within 0.1 degree true after magnetic correction) on a north-south line. The height of the shorter support is determined by the amount of azimuth play you wish built into the system. To be able to turn the surface from horizon to horizon requires a height at (E) at least equal to 50% of the diameter of the dish. The height of the taller support (C) is in turn determined by the height of the shorter support, and, your latitude. The farther north you are located, the taller the north-end support so that at the line-of-sight limit (80 degrees north latitude) the reflector surface sits virtually at right angles to the ground and points at your horizon.



ARTIST'S CONCEPT of the Satcom III satellite that will be launched in December 1979.

MHz is assumed in the above), antenna elevation angle (low angles start to become noisy) and so on.

If you miss the suggested goal by a small amount you can live with the result, which will be slightly noise marred pictures. Noise is more evident on a static picture (*i.e.* color bars, identification slide) than it is on a moving scene. In practice, if you are 1-4 dB below threshold you can sit and enjoy the picture and proudly show it off. It won't have that network-control-room look, but you'll be pleased with the results.

The polar mount

Recall that our satellites are "stacked" horizontally along an imaginary line called the satellite belt. Within the control parameters, they are stationary inside of a 70-mile by 70-mile by 70-mile cube or box, which from our distant earth point means that they move so slightly that we won't notice the movement.

The geo-stationary belt reaches its maximum elevation for our own location

at a point due south. By using the charts available³ we can determine how much elevation to adjust the antenna to for each of the locations where the satellites rest. This means that if you wish to move from one satellite to another, you would have to adjust the antenna elevation (angle of inclination) and *also* adjust the antenna's boresight (azimuth). These are two separate adjustments that interrelate. You might have the right boresight heading (azimuth) but if you have the incorrect elevation you won't see the satellite, and vice versa. There are many commercial antennas that use this type of mount adjustment system (called an Az-El as in azimuth over elevation) and for those installations where satellite changing occurs infrequently it is an acceptable system.

There is a better system, however, for frequent satellite change; see Fig. 5. The Polar Mount consists of a long axle on which the reflector surface is mounted, with the axle suspended in thrust bearings or collars at each end. The thrust bearings or collars are in turn mounted on inclined surfaces, as shown with the south support stub quite short while the north support is fairly tall. The angle of the axle is your elevation angle for your particular location and, as you can see by dropping the short stub and/or raising the height of the north support, that angle can be finetuned for your particular latitude.

Now it happens, as a wonder of celestial mechanics, that if the two supports for the Polar Mount are fixed on the ground on a true north-by-south line and the inclination angle is adjusted for a true southerly heading so that, from that point onward, the Polar Mount will track across the geo-stationary orbit belt without additional adjustments to the elevation. That makes a very nice system for frequent satellite changes since the adjustments are now limited to one direction (left or right).

R-E



An introductory Electronics



ENGINEERING FUNDAMENTALS FOR PROFESSIONAL ENGINEERS' EXAMINATIONS, Second Edition. By L. M. Polentz. 416 pp., 326 illus. Here—in this single volume—you'll find all the latest, most essential material you need to prepare for and pass your state's engineering registration exam. Hundreds of examples and practice problems are all drawn from actual PE exams, and were selected because they are representative of the problems that will appear on your exam. 503/80X Pub. Pr., \$23.50 Club Pr., \$16.95

STANDARD HANDBOOK FOR ELECTRICAL ENGINEERS, 11/e. By D. G. Fink and H. W. Beaty. 448 pp., 1,414 illus. A giant in every sense of the word, today's most widely used source of electrical engineering information and data serves you as no other single work available anywhere when you need detailed, accurate, timely, and reliable facts and how-to on the generation, transmission, distribution, control, conversion, and application of electric power. 209/74X Pub. Pr., \$49.50 Club Pr., \$38.00

APPLICATIONS OF DIGITAL SIGNAL PROCESSING. Edited by A. V. Oppenheim. 499 pp., illus. Digital processing of speech, images, sonar signals, signals in the field of geophysics, and many more are gone into in full detail. The book explains the important similarities and differences in the ways in which basic techniques and technology are applied, and it takes you into such different assumptions and constraints as data rate and real-time requirements. 787/263 Pub. Pr., \$25.00 Club Pr., \$18.95

MICROPROCESSORS AND MICROCOMPUTERS AND SWITCHING MODE POWER SUPPLIES. By Texas Instruments, Ltd. 216 pp., illus. The book has information on power supplies, deflection systems, new consumer systems, microprocessors, and third-generation microcomputers. It is quickly being snapped up by engineers seeking updating in their design skills in the fast-moving area of semiconductor devices and relying on the TI people for the facts, figures, and circuit designs that help them pinpoint solutions instantly. 637/563 Pub. Pr., \$21.50 Club Pr., \$16.95

ELECTRONIC DISPLAYS. By E. G. Bylander, Texas Instruments Incorporated. 172 pp., illus. The book describes current electronic displays by family types, discussing all aspects of their operation, application, and circuit requirements. You cover photometry and contrast enhancement, together with the fundamentals of such critical components as mounts and drives, interface requirements, and other necessary engineering information. 095/108 Pub. Pr., \$19.50 Club Pr., \$15.95

DIGITAL FILTERS. By A. Antoniou. 524 pp., illus. This all-inclusive, up-to-date treatment guarantees your thorough understanding of today's digital filters and the theories, techniques, and procedures you'll be using in their analysis, design, and implementation. The book gives you many design examples, together with the numerous possible approaches and engineering tradeoffs relating to their hardware implementation. 021/171 Pub. Pr., \$23.95 Club Pr., \$18.50

BUCHSBAUM'S COMPLETE HANDBOOK OF PRACTICAL ELECTRONIC REFERENCE DATA. By W. H. Buchsbaum. 2nd Ed., 645 pp., 371 illus., 70 tables. It gives you all the technical electronic information you need—from the factual foundations of electronics to the latest technical advances in optoelectronics, large scale integrated circuits, digital logic, microprocessors, and computers. Hundreds of formulas, graphs, charts, and tables. 786/550 Pub. Pr., \$19.95 Club Pr., \$16.95

BE SURE TO CONSIDER THESE IMPORTANT TITLES AS WELL:

INTRODUCTION TO MICROPROCESSOR SYSTEM DESIGN
By H. Garland
228/71X Pub. Pr., \$17.95 Club Pr., \$13.95

MICROPROCESSORS AND SMALL DIGITAL COMPUTER SYSTEMS FOR ENGINEERS AND SCIENTISTS
By G. A. Korn
353/670 Pub. Pr., \$29.50 Club Pr., \$18.95

MASTER OF AMP APPLICATIONS HANDBOOK
By H. W. Fox
784/477 Pub. Pr., \$16.95 Club Pr., \$13.50

CRYSTAL OSCILLATOR DESIGN AND TEMPERATURE COMPENSATION. By M. E. Frerking.
784/973 Pub. Pr., \$16.95 Club Pr., \$13.50

GUIDEBOOK OF ELECTRONIC CIRCUITS. By J. Markus
404/453 Pub. Pr., \$41.50 Club Pr., \$30.50

GROUNDING AND SHIELDING TECHNIQUES IN INSTRUMENTATION, 2/e
By R. Morrison
786/666 Pub. Pr., \$16.50 Club Pr., \$12.25

NOISE REDUCTION TECHNIQUES IN ELECTRONIC SYSTEMS
By H. Ott
769/63X Pub. Pr., \$21.25 Club Pr., \$15.50

DISCRETE/TRANSISTOR CIRCUIT SOURCE-MASTER
By K. W. Sessions
786/720 Pub. Pr., \$24.95 Club Pr., \$19.50

IC SCHEMATIC SOURCEMASTER
By K. W. Sessions
784/922 Pub. Pr., \$27.95 Club Pr., \$21.00

LOGIC DESIGNERS' MANUAL
By J. D. Lenk
784/671 Pub. Pr., \$18.95 Club Pr., \$15.75



PRINTED CIRCUITS HANDBOOK, 2/e. By C. F. Coombs, Jr. 256 pp., 327 illus. Blueprints every important phase of printed circuitry. Provides the information you need to establish a production facility and control the processes. A virtual encyclopedia in the field, five major sections cover engineering, fabrication, assembly, soldering, and testing. 126/089 Pub. Pr., \$32.50 Club Pr., \$24.50

DIGITAL INTEGRATED CIRCUITS AND OPERATIONAL AMPLIFIER AND OPTOELECTRONIC CIRCUIT DESIGN. Edited by B. Norris. 206 pp., 400 illus. Having this vast amount of case-tested data, proven shortcuts, worked-out circuit designs, and circuit diagrams handy saves you valuable time for your other, more vital, areas of creative design—and cuts down costs in all areas! 637/539 Pub. Pr., \$21.50 Club Pr., \$15.95

RADIO HANDBOOK. By W. I. Orr. 21st Ed., 1,135 pp., 1,364 illus. Now completely updated, expanded, and more deserving than ever this profusely illustrated reference gives you everything you need to know to understand, design, use, and experiment with every circuit and piece of equipment (All recent technological breakthroughs are covered). 772/630 Pub. Pr., \$21.50 Club Pr., \$16.60

TRANSFORMER AND INDUCTOR DESIGN HANDBOOK. By W. T. McLyman. 428 pp., illus. User-oriented throughout, it covers everything from transformer design and inductor design with dc, power inductor design, designing for regulation, inductor design without dc, constant voltage transformer, current and three-phase transformer, to application of magnetic components in power electronics. 786/755 Pub. Pr., \$35.00 Club Pr., \$26.50

offer to new members of the and Control Engineers' Book Club

OPTOELECTRONICS Theory and Practice. By Texas Instruments Incorporated. Edited by A. Chappell. 442 pp., 475 illus. Right here is where you'll find all the knowledge and know-how you need to take any of today's optoelectric components and develop your own circuits and uses. You get both the background and the technical specifics (with all the proven circuits you want!)
637/555 Pub Pr., \$26.50 Club Pr., \$20.95

HANDBOOK OF OPERATIONAL AMPLIFIER CIRCUIT DESIGN. By D. F. Stout. Edited by M. Kaufman. 434 pp., 223 illus. Compact, concise, highly concentrated, and containing a storehouse of information, this one-stop volume will help you solve any op amp circuit problem!
617/97X Pub. Pr., \$29.65 Club Pr., \$17.50

MICROELECTRONICS Digital and Analog Circuits and Systems By J. Millman. 881 pp., 700 illus. This giant book takes you step by step from a qualitative knowledge of a semi-conductor, to an understanding of the operation of devices, and finally, to an appreciation of how these are combined to form micro-electronic chips.
423/27X Pub. Pr., \$24.50 Club Pr., \$19.50

MINICOMPUTER SYSTEMS Organization, Programming, and Applications (PDP-11) Second Edition. By Richard H. Eckhouse Jr. and L. Robert Morris. Clearer than you ever hoped a book could be on the organization, programming and applications of current small computer systems, it gives you—in enjoyable, readable discussions and explanations—the fundamental ideas of computer architecture and structure, both hardware and software, and the uses of these concepts in producing programs for data acquisition and manipulation. It examines the interaction of algorithms, programs, and data structure to produce the desired results.
787/026 Pub. Pr., \$21.95 Club Pr., \$17.75

ELECTRONICS DESIGNERS' HANDBOOK. Edited by L. J. Giacoletto. 2nd Ed. 2,344 pp., 1,686 illus. Now doubled in size and with 90% of its material new, this famous classic (first edition by Landee, Davis, Albrecht) has been thoroughly revised and updated to give you not only the *how* and the *why* of all your design work but also the *how much* of every design step you take!
231/494 Pub. Pr., \$56.50 Club Pr., \$41.50

ELECTRONICS DICTIONARY. Edited by John Markus. 4th Ed. 768 pp., 1,173 illus., 17,090 terms. With the new edition of this world-renowned dictionary you'll be able to quickly find the meaning and correct usage of any electronics term, no matter how obscure!
404 313 Pub. Pr., \$24.50 Club Pr., \$19.50

ELECTRONICS ENGINEER'S HANDBOOK. Editor-in-Chief, D. G. Fink. 2,104 pp., 2,026 illus. Huge in every sense, this instant-reference volume gives you every latest essential in the field, 2,100 formulas and equations, a 2,500-item bibliography, and every illustration you need to clarify all of modern electronics!
209/804 Pub. Pr., \$52.50 Club Pr., \$37.50

OSCILLOSCOPES. Applications and Uses in Electronics By R. Van Erk. 270 pp., 248 photos and diagrams. The amount of technical information it contains is stupendous, beginning with the oscilloscope's basic operations (plus additional features and their functions) and continuing with the special oscilloscopes and variants, oscilloscope probes, and measurement pitfalls.
670/501 Pub. Pr., \$19.50 Club Pr., \$14.50

MICROCOMPUTER-BASED DESIGN By J. B. Peatman. Expanded 4th printing, 604 pp., over 400 photos and other illustrations. Do all your best day-to-day designs, as well as your supercreative and special designs, around the new microcomputers and the specific "how-to" help you get here!
491/380 Pub. Pr., \$26.95 Club Pr., \$18.95

any one
of these great
professional books
for only **\$1.89**
values up
to \$56.50

Special \$1.89 bonus
book comes to you
with your first
club selection

Books are selected from a wide range of publishers

ELECTRONICS AND CONTROL ENGINEERS' BOOK CLUB saves you both time and money!

Here is a professional book club designed to meet your on-the-job engineering needs by providing practical books in your field on a regular basis at below publisher prices. If you're missing out on important technical literature—if today's high cost of reading curbs the growth of your library—here's the solution to your problem.

The *Electronics and Control Engineers' Book Club* was organized for you, to provide an economical reading program that cannot fail to be of value. Administered by the McGraw-Hill Book Company, all books are chosen by qualified editors and consultants. Their understanding of the standards and values of the literature in your field guarantees the appropriateness of the selections.

How the club operates: Thirteen times a year you receive free of charge *The Electronics and Control Engineers' Book Club Bulletin*. This announces and describes the Club's featured book for that period as well as alternate selections available at special members' prices. If you want to examine the Club's featured selection, you do nothing. If you prefer one of the alternate selections—or if you want no book at all—you notify the Club by returning the card enclosed with each Bulletin.

As a Club member, you agree only to the purchase of four books (including your first selection) over a two-year period. Considering the many books published annually, there will surely be at least four you would want to own anyway. By joining the Club, you save both money and the trouble of searching for the best books.

MAIL COUPON TODAY

ELECTRONICS AND CONTROL ENGINEERS' BOOK CLUB
P.O. Box 562, Hightstown, New Jersey 08520

Please enroll me as a member and send me the two books indicated. I am to receive the **PREMIUM BOOK** at the introductory price of **\$1.89 plus my first selection at the discounted price to members, plus tax, postage and handling.** If not satisfied, I may return the books within 10 days and request that my membership be canceled. If I keep the books, I agree to take a minimum of three additional books during the next two years. I will receive the Club Bulletin 14 times a year. If I want to examine a featured selection, I need take no action. It will be shipped automatically. If I want an alternate selection—or no book at all—I notify the Club by returning the card enclosed. A postage and handling charge is added to each shipment. I will have a minimum 10 days in which to return the card, and you will credit my account fully, including postage, if this is not the case. Membership in the club is continuous but cancellable by me at any time after the four book purchase requirement has been fulfilled. *This order subject to acceptance by McGraw-Hill.*

WRITE BELOW:

Write Code # of \$1.89 premium book selection here Write Code # of first selection here

NAME

ADDRESS

CITY

STATE ZIP

Orders from outside the U.S. must be prepaid with international money orders in U.S. dollars. **E33394**

LED Bar-Graph 8 Best Applications

Looking for a simple but useful electronic gadget you can build for your home or car? Here are some good one-evening projects you'll like.

IN THE MARCH 1979 ISSUE WE PRESENTED an application note covering the GL-112R3 bar-type LED array and the IR-2406 driver that works with it. In the editorial you were invited to send in innovative applications for these novel devices. As a measure of encouragement, we offered \$50.00 each for the three best applications and \$10.00 each for the others that we selected for publication.

We were surprised to find that two monitors for automotive electrical systems were among the top entries. Rather than have our judges select the one to use, we decided to publish both and let you decide which one you'd use in your car, van or RV.

Electronic thermostat

This circuit (Fig. 1) shows an energy-saving thermostat designed to control home heating and air conditioning systems. Minor modification would allow it to control any heating or cooling function. Thermistor RT1 is the temperature-sensing element that develops a voltage proportional to the temperature in a ratio of 11 mV-per-degree-Celsius. This voltage is amplified and scaled to the range required for the IR-2406, whose reference voltages are +1 VDC and +6.2 VDC. The IR-2406 then drives the GL-112R3 and two AND gates whose outputs are amplified to a level suitable for driving a relay. Jumpers J1 and J2 select the temperature at which the voltages are fed to the gates.

The onboard power supply provides +17 VDC unregulated and +1 VDC and +6.2 VDC regulated voltages for the references for IC3. The +17 VDC source is applied as V_{CC} for IC1, IC2, IC3 and the LED array DIS1. The power supply requires 24 VAC from the existing thermostat transformer.

In Fig. 1, RT1 and R5 form a voltage divider whose output is proportional to

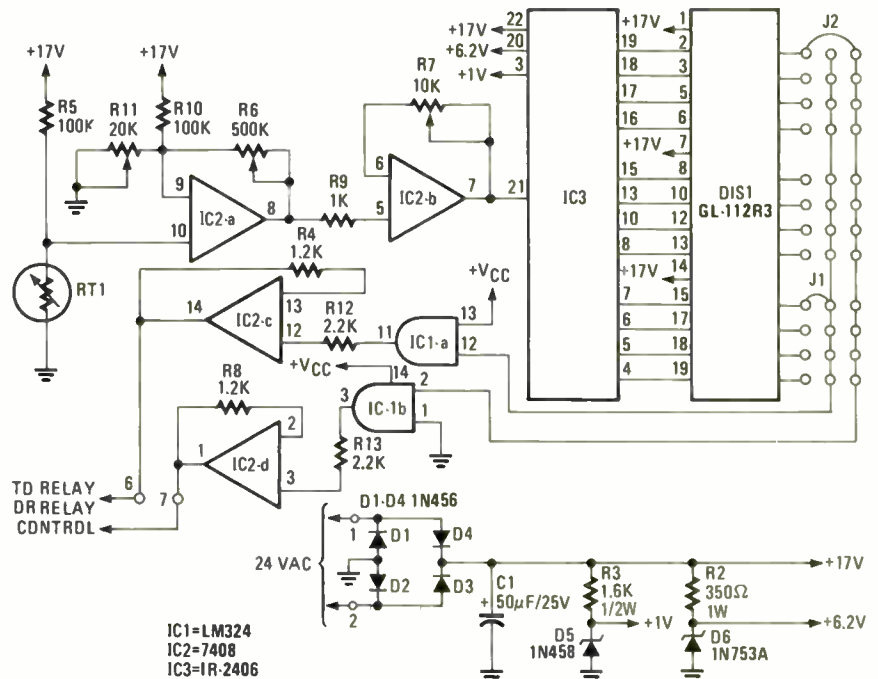

FIG. 1—ELECTRONIC THERMOSTAT has bar-graph temperature display. Two gates, fed from segments of the display, develop signals to control heating or cooling devices.

the ambient temperature in a ratio of approximately 11.3 mV-per-degree-Celsius. Amplifier IC2-a is connected as a differential amplifier that scales the input and amplifies with a gain of about 42. This voltage is then applied to IC3 that drives the display. The pins of DIS1 are connected to gates IC1-a and IC1-b by jumpers that select the operating temperature. IC1-b has one input connected to ground and the other to the input voltage so that as the temperature drops below the preset level its output goes positive. This is amplified by IC2-d to the required level to activate a control device for the heating system with the output level adjusted by R8. Gate IC1-a has one input connected to V_{CC} and the other to the high-limit bus that makes its output posi-

tive when the temperature exceeds the preset level. IC2-c amplifies this voltage to the level required for the air conditioner control device with the level set by R4.

Figure 2 is the parts layout and printed circuit board component side with runs shown. Figure 3 shows the lower side of the board with the shaded area being etched away leaving the major portion for a ground plane. Figures 2 and 3 are scaled 1 line equals .1 inch and the circuit requires a 2.6×3.4-inch board. The labelled terminals on the circuit board and their functions are:

1. 24 VAC
2. 24 VAC
3. Sensor RT1
4. Ground
5. Ground

Display ons

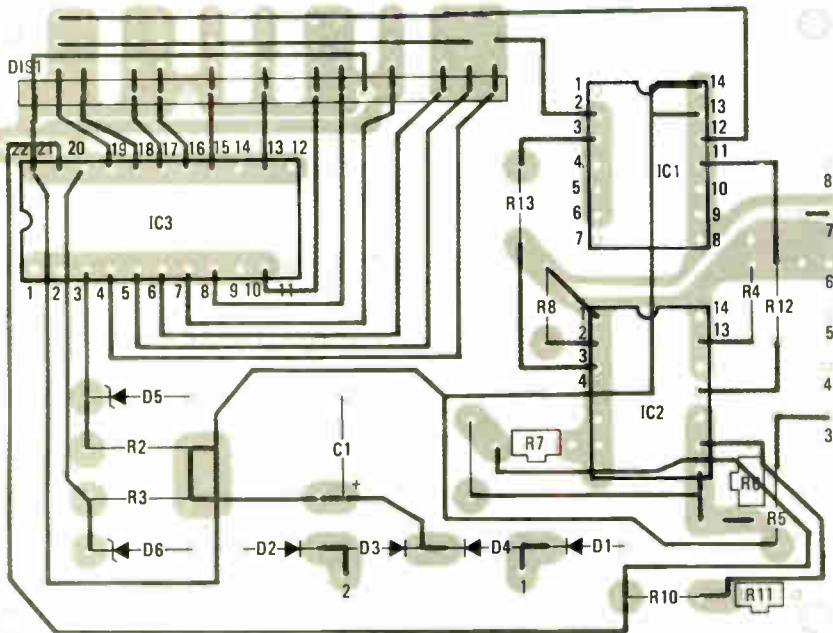

FIG. 2—PARTS LAYOUT as viewed from component side of the board. Note that the shaded areas have been etched away. Component connections can be soldered or wire-wrapped

- 6. Air conditioner control
- 7. Heater control
- 8. Ground

Initial Adjustment:

1. Adjust R11 to give 1.42 VDC at IC1 pin 9.
2. Set R6 so that the output voltage at IC1 pin 8 is (voltage on pin 9—voltage on pin 10) × 5.
3. Set R7 so that IC1 pin 7 reads a voltage of $8.475 \times$ pin 5 voltage.

This will cause the GL-112R3 indicator to illuminate the first segment at 16 degrees Celsius and add one segment for each 1 degree Celsius increase until at 27 degrees Celsius all will be illuminated. Minor adjustments may be required (R11 adjusts linearity while R6 and R7 adjust gain and set indicator range.) Other settings of R11, R6, and R7 will make the reading and control in degrees Fahrenheit.—*Jerry V. Barrington*

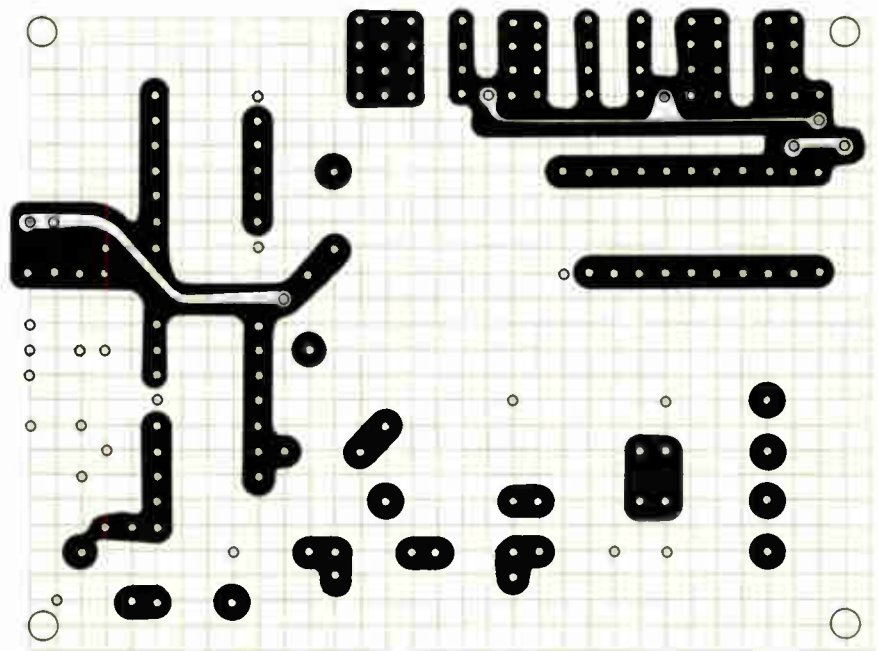

FIG. 3—FOIL PATTERN for the thermostat board can be drawn free-hand with each vertical and horizontal line representing one-tenth inch.

Two expanded-scale voltmeters

In response to your challenge in the March '79 issue, here are two designs using the GL-112R3 LED Array and IR-2406 LED Driver. Both designs are for expanded-scale voltmeters. The first is a line-voltage monitor which displays voltage in the range of 108 to 130 volts. The second design is an automotive charging system monitor/tester displaying voltage in the 10- to 16-volt range.

Line voltage monitor

The line-voltage monitor circuit (Fig. 4) lights the first LED in the array when line voltage exceeds 108 volts and lights successive segments for each 2-volt increase above 108 volts. All twelve segments are lighted when line voltage reaches or exceeds 130 volts.

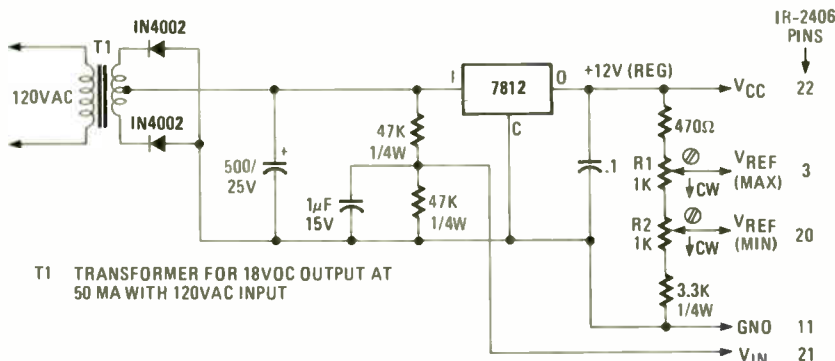

FIG. 4—LINE VOLTAGE MONITOR has bottom end set at 108 volts while the top end is adjusted so all twelve segments are lighted when input exceeds 130 volts.

Calibration requires an AC voltmeter and a method for adjusting the input voltage such as a variable transformer. Initially set R1 and R2 fully counterclockwise [highest $V_{REF}(\text{Min})$ and $V_{REF}(\text{Max})$]. With the input voltage at 108 volts, turn R2 clockwise until segment 1 just lights. Set line voltage to 130 volts and turn R1 clockwise until segment 12 just lights.

Automotive charging system monitor/tester

The charging system monitor/tester (Fig. 5) lights successive segments of the LED array for each 0.5-volt increase in input voltage. The first segment turns on at an input of 10 volts and all twelve are

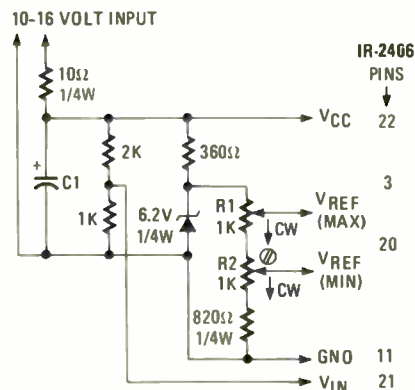

FIG. 5—VOLTAGE TESTER for car's electrical system. Checks voltage in 0.5-volt steps.

on for inputs of 15.5 volts or more.

Calibration requires a DC voltmeter and power supply. First turn R1 and R2 fully counterclockwise. Set the input voltage at 10 volts and advance R2 until segment 1 just lights. Adjust input voltage to 15.5 volts and advance R1 until segment 12 just lights.—*J. R. Kinnard*

Car Battery voltage monitor

Auto manufacturers have long since given up ammeters and voltmeters for idiot lights. This is unfortunate since the idiot lamp is inaccurate and may not even be functional. The circuit in Fig. 6 will read out your battery voltage in 0.5-volt steps from 10.5 to 16.0 volts. This will show at a glance the condition of the battery, the charging system, and electrical load.

The advantage of this circuit is its simplicity and small size. Being small as a pack of cigarettes, the monitor can be mounted virtually anywhere on the dashboard.

A precision reference voltage is provided by the 78L08 and R3, and R4. This provides the min/max range for IC1. V_{in} is provided through the R1-R2 network with C2 to smooth out the transient response.

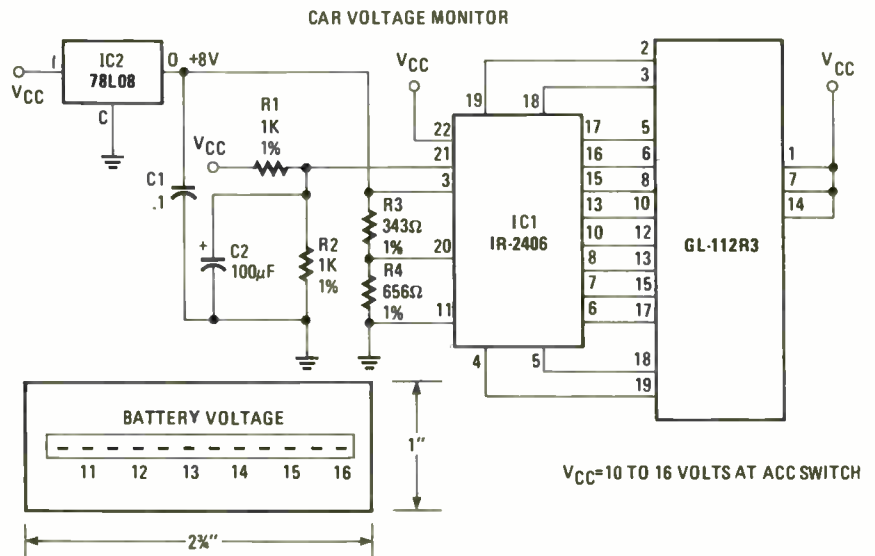

FIG. 6—CAR BATTERY voltage monitor replaces idiot light and indicates electrical system output voltage in 0.5-volt steps from 10.5 to 16.0 volts.

This circuit can be wired in any fashion to suit the case used. Hook-up requires only a ground lead and a voltage line to the accessory switch of the car so that power is removed when the ignition is turned off.—*John Damkier*

Position indicator for remote selector switch

Thanks for bringing these devices to our attention. We will use four sets of them in a remote indicating system to be installed at the Indianapolis Center for Advanced Research. A low-speed wind tunnel is used in studying wind effects on oil tanks like those used at refineries. There are six positions of four different variables. The information on these positions must be transmitted to the person logging the test conditions, some of which is fed to a computer. The test operator is in the computer room. Figure 7 shows the circuit that was devised.

The operator at the wind tunnel sets the switch to indicate one of the six test positions. The selected position is indicated on the LED readout.

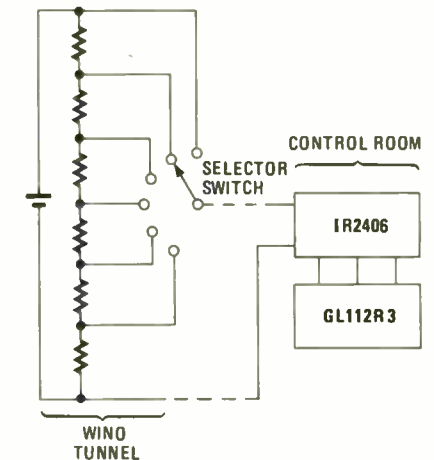

FIG. 7—INDICATOR CIRCUIT shows the position of a selector switch or control potentiometer at a remote location.

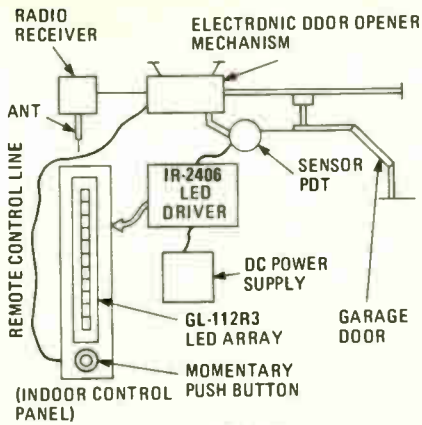
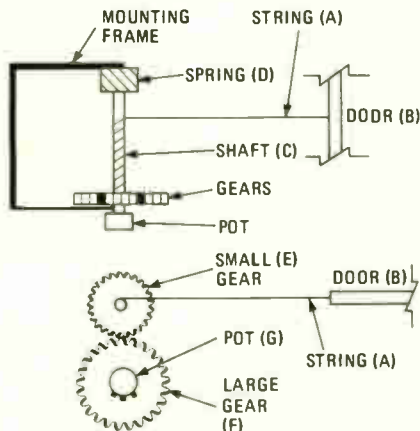

FIG. 8—BASIC ARRANGEMENT of the garage-door position indicator.



NOTE: STRING (A) IS ATTACHED TO DOOR (B) AND WOUND AROUND SHAFT (C). AS DOOR OPENS, SPRING (D) ROTATES SMALL GEAR (E), WINDING UP STRING ON SHAFT AND ROTATING LARGE GEAR (F) AT A MUCH SLOWER RATE. LARGE GEAR TURNS POT (G) THAT VARIES RESISTANCE IN PROPORTION TO AMOUNT THAT DOOR IS OPEN OR CLOSED.

FIG. 9—HOW THE SENSOR POT is controlled by the position of the garage door.

Solar heating temperature indicator

In a study of solar heating, we have a water storage tank fitted with thermocouples measuring temperature at four different levels. We could amplify the resultant voltages and feed four of these displays. A quick glance will then show the temperatures at four levels within the tank.—*R. O. Whitaker*

Garage door position indicator

Well, let's fact it. . . . Lotsa' folks are buying automatic garage door openers.

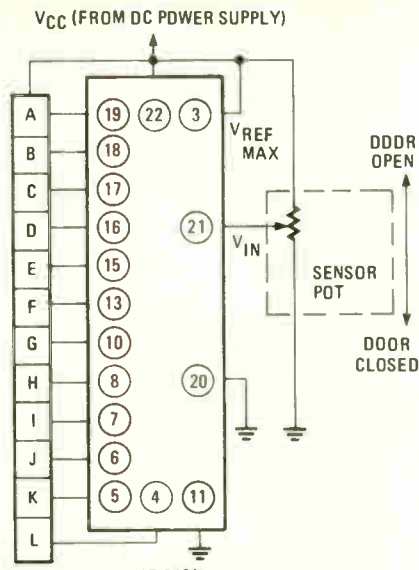

FIG. 10—HOW THE SENSOR POT connects to the IR-2406 LED driver.

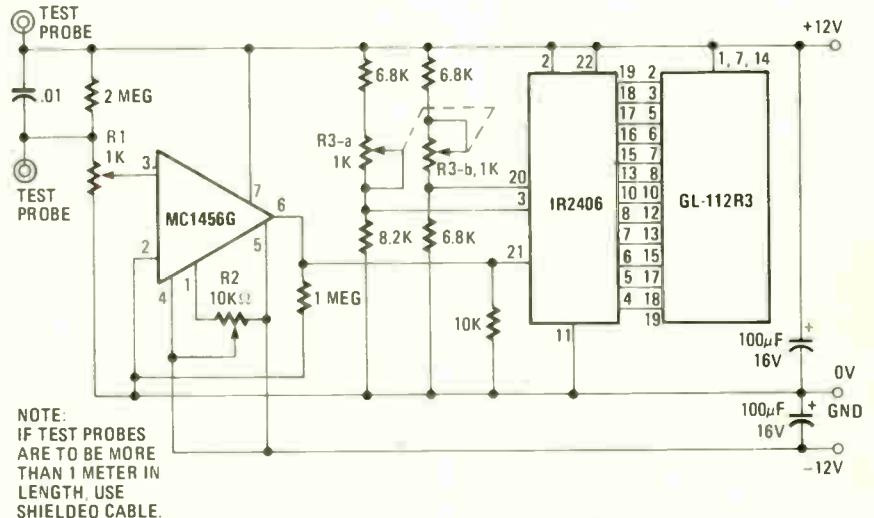

FIG. 11—"LIE DETECTOR" is extremely sensitive to skin-conductivity changes. These changes occur in response to mental stress.

Those little transmitters are great for opening and closing the door from your car but, how about in the house where you can't even see the garage?

With my application, you can raise or lower the door from inside your home and know exactly what position the door is in at any time. The system consists of a sensor pot mechanically coupled to the garage door and the LED driver and display located with a remote pushbutton in the house. See Figs. 8, 9 and 10 for system hook-up, sensor pot assembly and

electrical connections, respectively. As the door raises, the wiper of the sensor pot rotates, raising the input voltage to the LED driver IC. This causes the segments of the LED display to come on one-at-a-time until the door is at the top of its travel. All of the segments are then lit. The display will remain lighted until the door is lowered at which time the segments will extinguish in reverse order. When the door is completely down, the display is once again dark.—*John E. Shepler*

Lie detector

Conventional hobby-type "lie detectors" usually use indicators such as a meter or a change in audio frequencies. When using these devices, it is sometimes very hard to detect a change. However, this "lie detector" has two major improvements. One is the very easy detection of a rate of change through the use of a bar-graph LED display. The other is its

extreme sensitivity which can be set to register changes as small as 125 µV. This is achieved through the use of the sensitivity bandwidth control, R3. (See Fig. 11.)

In typical use, you would tape the probes to two individual fingers of one hand after wiping the contact area with alcohol. Set pot R1 to about midway, and adjust the gain (R2) so that the LED display lights up about halfway. Control R3 can then be used to give reliable results.—*Rob Cameron* R-E

SOLID STATE NEWS

Second-generation VMOS device

Siliconix's second-generation VMOS power FET, the VN84GA, is rated at 12.5 amp and 80 volts which is a six-times current increase over previous transistors. With only microwatt input power, the VN84GA produces up to 80 watts output at low frequencies and a 50-watt output at 30 MHz. The devices do not show any of

the secondary breakdown and thermal runaway characteristics of bipolar transistors. These FET's interface directly with CMOS, TTL, DTL and MOS families for use in switching regulators, motor controllers, audio amplifiers and micro-processor interfaces.

Using VMOS devices in linear amplifiers up to 30 MHz produces lower distortion because of the linear-transfer characteristics and good high-frequency behav-

ior of the VN84GA, and the low distortion means that only small amounts of feedback are required. The devices can also be used in Class-D audio amplifiers because of their fast switching and zero storage time.

The VN84GA is mounted in a TO-3 package and is priced at \$19.76 in quantities from 1 to 99. Siliconix Incorporated, 2201 Laurelwood Road, Santa Clara, CA 95054. R-E

Automotive Radiator Monitor

You could be in big trouble if your car loses its coolant through boilover or a leaky radiator or heater hose. Don't take a chance on being stranded. This easy-to-build monitor warns you the instant the coolant level drops.

L. STEVEN CHEAIRS

IN A WARM ENVIRONMENT, AN AUTOMOBILE is definitely put to the test. During any of the warm months, about ten per year, one can take a drive down any of our highways and observe every few miles a car with its hood up and steam boiling out of the radiator. There is no sure solution to this problem; but, an important precaution is the radiator monitor described in this article.

About the Monitor

About the easiest method to detect a low fluid level, if the fluid is conductive, is to use an ohmmeter. If the fluid level is above the level of the probe tip then a relatively low resistance is detected; but, if the level falls below the probe tip's level then an infinite resistance is measured. If a threshold reference resistance is chosen between these two extremes, a binary detection system can be used. If the measured resistance is below that of the threshold then the fluid level is OK; but if the resistance of the sensor is above this threshold then the radiator needs more coolant.

The circuit described in this article is built around a National Semiconductor LM1830 integrated circuit fluid detector. The LM1830 contains its own internal regulated power supply, a detector, a power amplifier, an oscillator, and a reference resistance. In normal operation, an AC signal is generated by the oscillator. This signal is passed through the conductive liquid by two probes. A detector circuit determines, by comparing the resistance of the fluid between the two probes to that of the reference resistor, if the fluid is present at the probe level. The output of the detector is coupled to the open-collector output amplifier; that drives a LED. When the LED is lit, the fluid level is low.

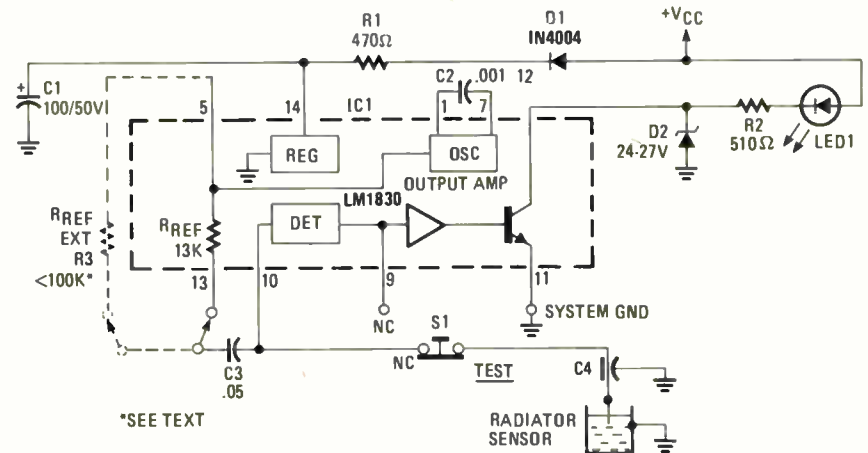

FIG. 1—RADIATOR MONITOR checks the level of coolant in the car's radiator and flashes a signal on the dashboard when coolant is low.

Refer to the schematic diagram shown in Fig. 1. Whenever electronic circuits are used in an automotive environment, transient protection must be considered. There are two types of transients that occur. The first is when a dead battery is being charged at a high-current rate and a cable is removed. This causes a positive transient on the power line, in the order of 60 to 120 volts; the transient is due to alternator inductance. The second transient is negative; about -75 volts on the ignition line. This type is due to field decay. That is, when the ignition is turned "off" the energy stored in the field winding will produce this negative pulse.

During this negative transient, diode D1 will be reverse biased and will prevent the flow of reverse current in IC1. If the transients occur only for a short time, then capacitor C1 will power IC1 and provide continuous operation. In the case of a positive transient, resistor R1 in conjunction with an internal resistor and Zener diode limit the voltage across IC1.

Also, external Zener diode D2 and resistor R2 protect the output transistor of the IC power amplifier.

Only external capacitor C2 is required to complete the oscillator; if C2 is 0.001 μF, as shown in Fig. 1, then the output

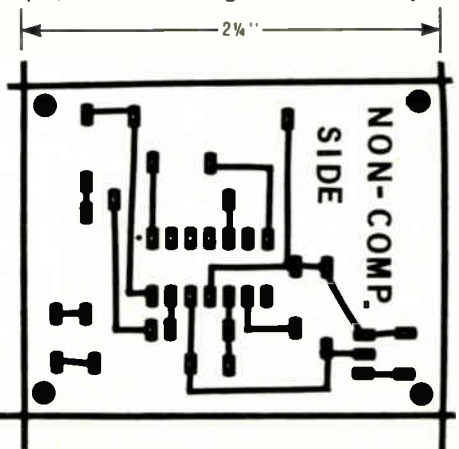

Fig. 2—FOIL PATTERN for the PC board used in constructing the radiator monitor.

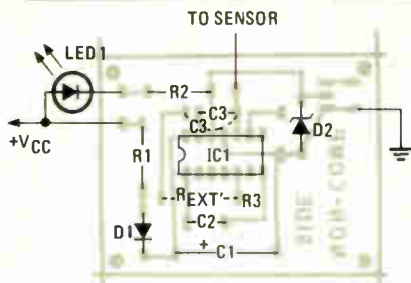

FIG. 3—PARTS PLACEMENT GUIDE for the radiator monitor. The placement of C3 depends on whether reference resistor R3 is internal or is external.

frequency will be approximately 6 Hz (the frequency of the oscillator is inversely proportional to this external capacitor. The oscillator output is available at pin 5 at pin 13 through the internal reference resistor. In most applications where the resistance of the fluid between the probe tips is less than 10K the output AC signal is applied to the sensor probe and detector input via an internal 13K resistor and external capacitor C3. If the resistance of the fluid is above 10K, then an external reference resistor (the resistance must be larger than the fluid's resistance, but less than 100K) is substituted for internal standard. An AC signal is used in this circuit to prevent the plating problems encountered by using a DC signal. Also, blocking capacitor C3 is used to prevent any net DC current being applied to the probe.

Construction

Begin construction by making up a PC board from the pattern in Fig. 2 and then install the components following the parts layout in Fig. 3 and the parts list. If the sensor resistance is less than 10K (this will depend on fluid composition and the

PARTS LIST

- Resistors 1/4 watt, 10%**
 R1—470 ohms
 R2—510 ohms
 R3—See text; as required but less than 100,000 ohms
 C1—100 μ F, 50 volts, electrolytic
 C2—.001 μ F, disc
 C3—.05 μ F, disc
 C4—See text, low-value feed-through
 D1—1N4004 or equivalent diode
 D2—Zener diode, 24 to 27 volts
 LED1—Red general-purpose LED
 IC1—LM1830 fluid detector (National Semiconductor)
 S1—normally closed pushbutton switch

The following may be obtained from Questar Engineering Co., 50 South McDonald Drive, Mesa, AZ 85202: a kit of all parts (including case but excluding R3, C5, Q1 and the 2K value of R2) \$19.95; PC board \$5.50; LM1830 IC \$2.50. Add \$1.75 for shipping in U.S., \$3.00 on foreign orders. All COD orders will incur COD charges.

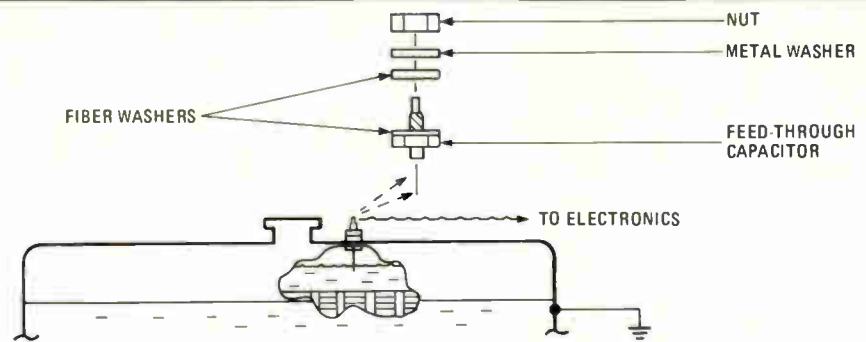

FIG. 4—HOW SENSOR is constructed and installed. Fiber washers insulate against shorts and provide a coolant pressure seal.

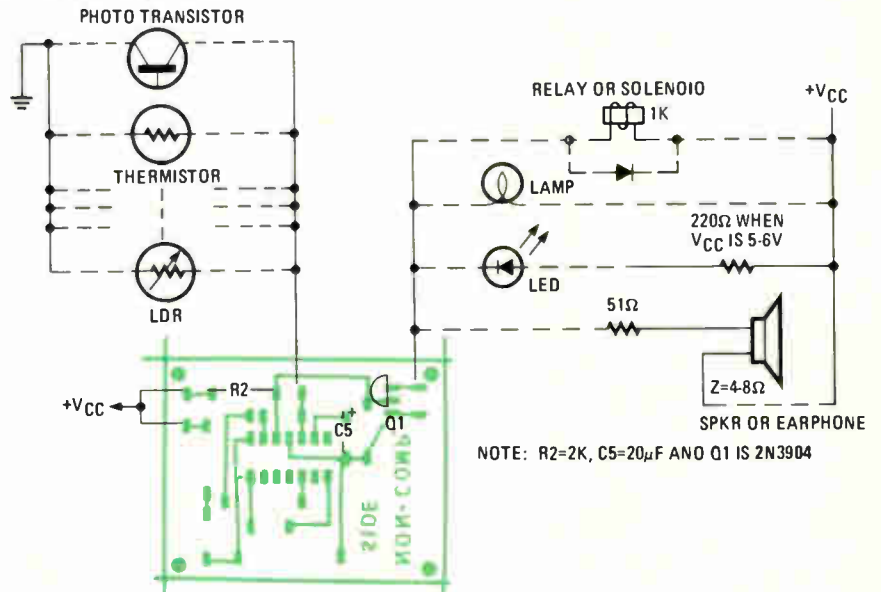

FIG. 5—PARTS PLACEMENT and input and output configuration for a variety of applications.

probe geometry), assemble the circuit as shown. Only nine components are required at this time, one IC, three diodes, two resistors, and three capacitors. If the fluid resistance is greater than 10K one additional resistor is required (the external reference resistor). Install the resistors, capacitors, and diodes onto the PC board last.

Figure 4 shows how I designed the sensor. A feed-through type capacitor, (value is unimportant—100 pF was used), was installed near the radiator cap. The area chosen was both smooth and level. A set of vernier calipers was employed to determine the diameter of the capacitor's stud; a hole slightly larger was then drilled in the radiator, in the area previously discussed. Two fiber washers were then fabricated from heavy asbestos gasket stock, using the drill and a pair of scissors. One fiber washer is placed upon the capacitor; then, via the radiator fill spout, the capacitor assembly is fed through the mounting hole, stud end up. The other fiber washer and a metal washer (the inside of the metal washer should be drilled out or reamed to provide a snug fit) are then placed upon the stud. Next,

place the nut supplied with the capacitor on the stud and tighten. Now, solder a length of light-gauge Teflon-coated wire to the top terminal of the capacitor. The other inside terminal is cut, via the radiator filler neck, to the level desired; consult your automobile owner's manual. After placing a piece of heat-shrinkable tubing over the solder joint, route the wire to the auto's dashboard area. A 2 x 1 1/2 x 2 1/4-inch aluminum utility box was used to fabricate a case. A small general-purpose red LED and an SPST normally-closed pushbutton switch was mounted on one end; the LED, of course, is used to inform the driver as to the level of coolant. The SPST pushbutton switch is used to test the monitor; it is in series with the sensor—thus, when pressed, the contacts are opened, and the line impedance should be infinite. This will of course light the LED.

Seven holes were also drilled in the case; four were used to mount the PC board, on insulating spacers; two were used to mount the assembly on the underside of the auto's dashboard; and one was used to bring out the power and sensor wires via a rubber grommet, the case

continued on page 141

Headroom TEST GENERATOR

Want to know how much undistorted power your hi-fi amplifier can deliver above its continuous power rating? If so, build this inexpensive test accessory that will tell the story.

DOUG FARRAR

UP UNTIL NOW, CONTINUOUS POWER HAS been used as the standard measuring stick for all amplifier power ratings. Those in the know have long been aware that most amplifiers can supply undistorted bursts of power beyond the continuous power rating. The question was how to standardize and measure it. A test for measuring what's now called Dynamic Headroom was recently adopted by the Institute of High Fidelity (IHF) that does just that. A 1-kHz sinewave input is adjusted to drive the amplifier to its rated continuous power output for 1980 cycles, and is followed by a 20-cycle burst with the same frequency but higher amplitude. The burst amplitude is adjusted until the output clips. The ratio of the two output voltages is then used to determine the dynamic headroom (DH) as follows:

$$DH = \log \frac{V_2}{V_1}$$

where V_2 is the burst output voltage, and V_1 is the continuous voltage. Well-designed amplifiers will have close to 0-dB dynamic headroom, while less expensive units may have as much as 3-dB (2:1). For a more elaborate presentation, see the December 1978 article in *Radio-Electronics* entitled "Understanding Dynamic Headroom."

The circuit described here, in conjunction with any audio sinewave generator (like the construction project described in the October and November 1978 issues of *Radio-Electronics*), generates the desired waveform. Since total supply current is less than 10 mA, it is powered by a 9-volt transistor radio battery. Low-cost IC's are used throughout, keeping the cost of the total unit easily under \$20.

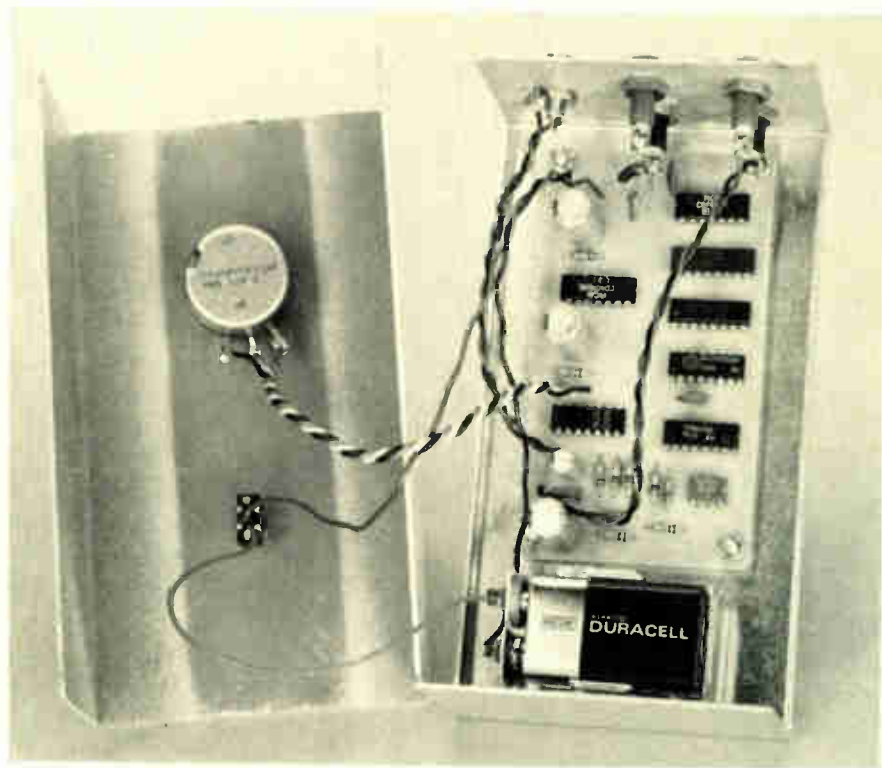

INSIDE THE DYNAMIC HEADROOM GENERATOR. Most parts are on the simple PC board. Parts on the front panel are the switch and burst control.

How it works

The complete schematic is shown in Fig. 1. The 1-kHz sinewave is capacitively coupled to op-amps IC1-a, IC1-b and IC1-c. The first op-amp is a voltage follower (with a gain of 1), the second is a variable-gain amplifier (with a gain of 1 to 11) controlled by potentiometer R12, while the last has a fixed gain of about 11. These three op-amps are biased through R7 by R1, R2 and C1. Operational-amplifier IC1-c drives comparator IC2,

which has about 100 mV of hysteresis due to R8 and R10. Thus, the sinewave is converted to a squarewave at the comparator output, which is used as the clock input to the CMOS counter chain.

Integrated circuits IC3 through IC6 are decade counters, but the first is set up to divide by 2, giving a total count of 2000. The count state is decoded such that the output of NOR gate IC7-c is at a logic high level for 20 of 2000 clock inputs. This signal is used as the oscillo-

BUILD THE Percl Synth Acc

James J. Barbarello

LAST MONTH WE COVERED THE CONSTRUCTION of the PerSyn percussion synthesizer and "striking blocks" used to trigger the three percussion-tone generators. Now we are going to show you how to build and use three accessory devices that will greatly improve the versatility of the PerSyn. The accessory pulse generator can be used to trigger the PerSyn and produce a variety of sound effects. You can use the balanced modulator for special effects such as gongs and chimes, as well as the sound of bells and all the various types of drums. A special interface module will permit triggering the PerSyn from the amplitude envelope of an electrified instrument such as a guitar.

The pulse generator

The circuit shown in Fig. 10 produces a positive-going pulse that, when connected to a trigger input, will automatically trigger that generator in the PerSyn. The pulse rate is adjustable from about 1 to 500 hertz. The circuit is simply an oscillator designed around a 555 timer IC. To use, connect J1 (PWR) to TAP on the PerSyn and J2 (TRIG) to the appropriate trigger (TRIG) jack on the synthesizer. Some interesting effects that can be created include "Flying Saucer" (rotate the generator frequency control slowly clockwise) and "Talkbox" (set pulse generator frequency for a continuous output sound, rotate the generator frequency control between minimum and maximum). The PC board pattern is in Fig. 11; parts placement is in Fig. 12.

Balanced modulator

The circuit shown in Fig. 13 is essentially a voltage-controlled amplifier (VCA) whose control signal is provided by an internal oscillator. A generator output signal is connected to the modula-

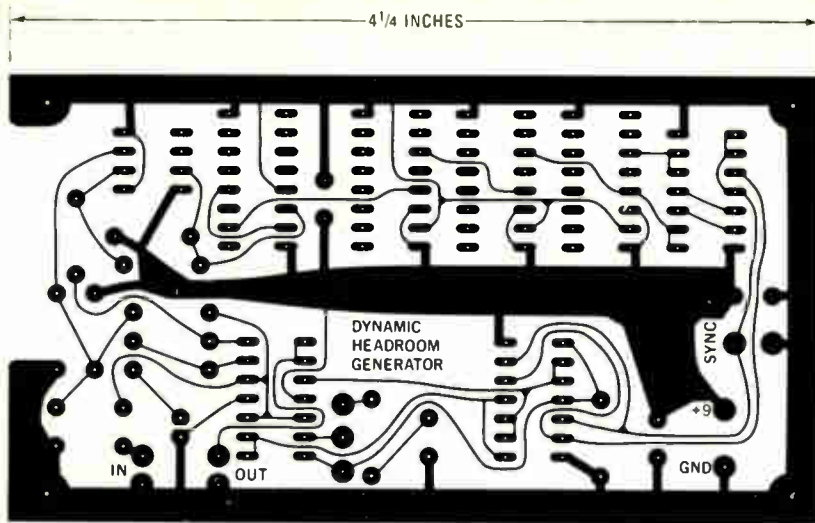

FIG. 2—PRINTED-CIRCUIT FOIL pattern is shown here full-size. A full-size photonegative is available from a source named in the parts list.

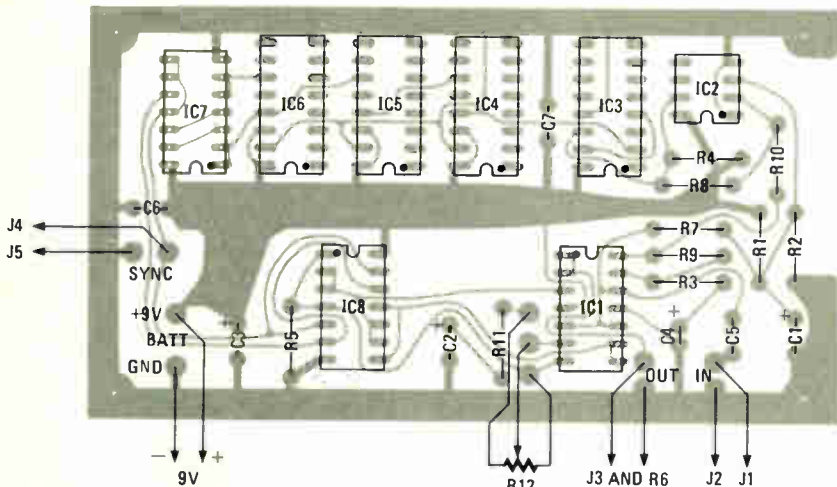
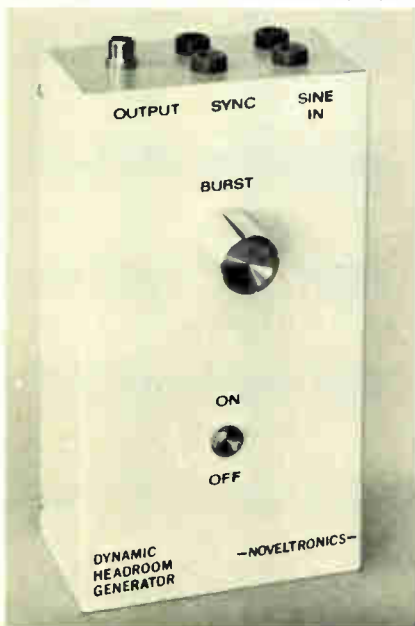

FIG. 3—PARTS PLACEMENT on the PC board. The circuit is relatively simple so IC sockets and wire-wrap can be used in the assembly if you desire.



FRONT VIEW of the headroom generator. Instrument measures 6 x 3 x 2 inches.

diagram shown in Fig. 3 or perforated board for the construction. If you choose the latter, use short wire lengths around IC 1 and IC 2 to minimize chances of

oscillation. Place bypass capacitors C6 and C7 near the CMOS IC's to minimize switching transients in the +9-volt supply. For best results, keep the linear and digital circuits physically separated to minimize noise pickup.

How to use it

An input signal with a 10-mV P-P minimum level is required to trigger the dynamic headroom generator. Connect the sinewave source to the input of the unit and its output to your amplifier's input(s). The sync output connects to your scope's EXT SYNC input. Connect a suitable load to the amplifier's output(s) and adjust the sinewave frequency to 1 kHz. Because the signal repeats only once every two seconds, you have to watch the scope trace quite carefully. Adjust the sinewave generator's amplitude until the amplifier's rated continuous output is reached. Now, increase the burst amplitude with the BURST control until you see clipping at the amplifier output. Measure the two amplitudes, apply the DH formula and you'll get the dynamic headroom specification in decibels. Here's hoping your amplifier is as good as you think it is.

R-E

PerSyn Percussion Accessories



If you built the PerSyn percussion generator described last month you'll want to try the three accessories described here to stimulate gongs, chimes, bells and all the various types of drums.



THE PULSE GENERATOR is designed to trigger the PerSyn generator at 1 to 500 Hz.

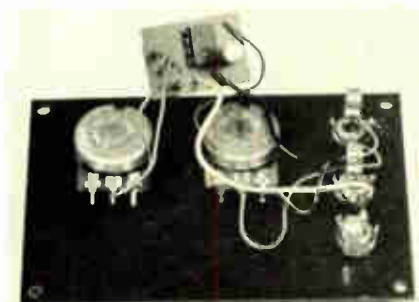

INSIDE THE PULSE GENERATOR. Components are on the tiny PC board.

tor's input. The modulator's output is, in turn, connected to a mixer input on PerSyn. Power is obtained by connecting power input jack J3 to J16 (TAP) on PerSyn. (Construction details are in Figs. 14 and 15.)

Before using, adjust R2 so that no output is heard when no input is provided, the modulator's LEVEL is at maximum and the modulator's FREQ is near maximum. By adjusting the GEN FREQ and ENVELOPE controls, and the modulator's FREQ and LEVEL controls, such effects as a chime, gong or other metallic sounds can be generated.

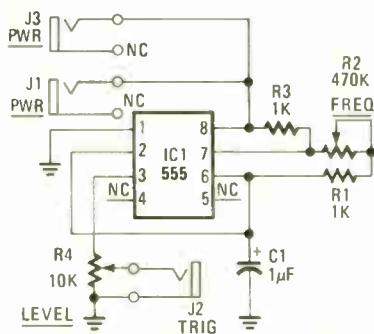

FIG. 10—SCHEMATIC DIAGRAM of the pulse generator. Timer IC is the main component.

PARTS LIST FOR PULSE GENERATOR (Fig. 10)

- R1, R3—1000 ohms, 1/4 watt, 5%
- R2—470,000 ohms, miniature potentiometer, log taper
- R4—10,000 ohms, miniature potentiometer, linear taper
- C1—1 µF, 10 volts or higher
- IC1—555 timer
- J1—J3—phone Jack

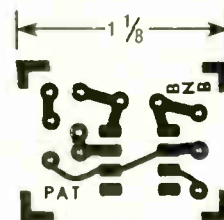

FIG. 11—FULL-SIZE foil pattern of PC board in the pulse generator.

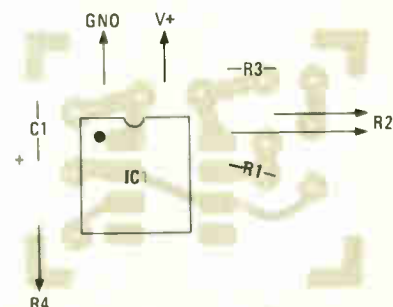

FIG. 12—COMPONENT PLACEMENT and connections to parts and points not on the board.

The modulator can also be used to create controlled distortion, that can add "crispness" to a bongo or such. Simply set the VOLUME control on PerSyn until distortion is heard and then back off the control just enough to remove the distortion.

Trigger interface

The circuit in Fig. 16 produces a positive going pulse each time the level of the

PARTS LIST FOR BALANCED MODULATOR (Fig. 13)

Resistors 1/4 watt, 5% unless otherwise noted

- R1, R5, R6—4700 ohms
- R2—100,000 ohms, miniature PC mount trimmer potentiometer
- R3—47,000 ohms
- R4—100 ohms
- R7, R10—22,000 ohms
- R8—100,000 ohms
- R9—10,000 ohms
- R11, R13—10,000 ohms, potentiometer
- R12—470 ohms
- C1, C2—1.0 μ F tantalum
- IC1—CA3080 transconductance op-amp (RCA)
- IC2—5558, LM1458 or MC1458 op-amp
- J3, J4—phono jacks

Note: Complete kits (including all required components, predrilled and marked enclosures) are available from BNB Kits, R.D. #1, Box 241H, Tennent Road., Englishtown, NJ 07726: Pulse Generator (PPG-1) at \$14.75; Balanced Modulator (PMA-1) \$19.95 and Trigger Interface (PTI-1) \$14.95. The PC boards alone (PPG-PC, PMA-PC and PTI-PC) are \$5.50 each.

The above prices include U.S. postage and handling. Canadian orders please add \$1.50. New Jersey residents add 5% sales tax. No C.O.D. orders. Please allow 4 to 6 weeks for delivery.

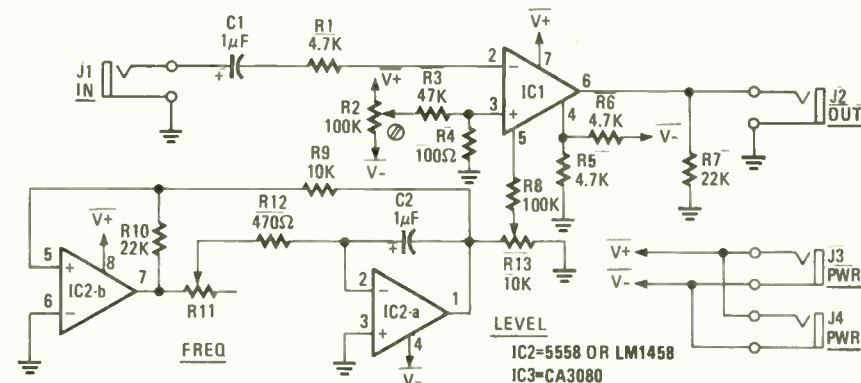

FIG. 13—THE BALANCED MODULATOR schematic diagram. Circuit is basically a voltage-controlled oscillator controlled by an internal source. Output feeds a mixer input on the PerSyn.

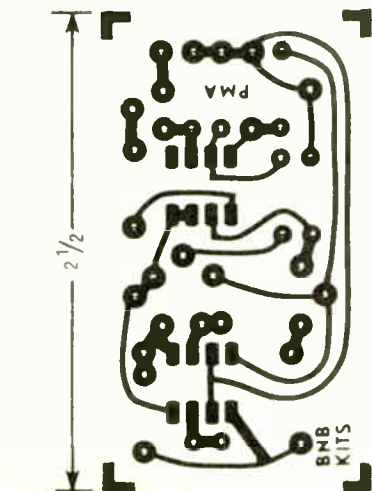

FIG. 14—BALANCED MODULATOR foil pattern is reproduced here at full-size. There is ample room for the few components used.

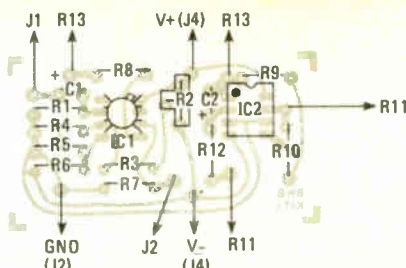

FIG. 15—THE TWO IC'S and other components are positioned on the PC board as shown.

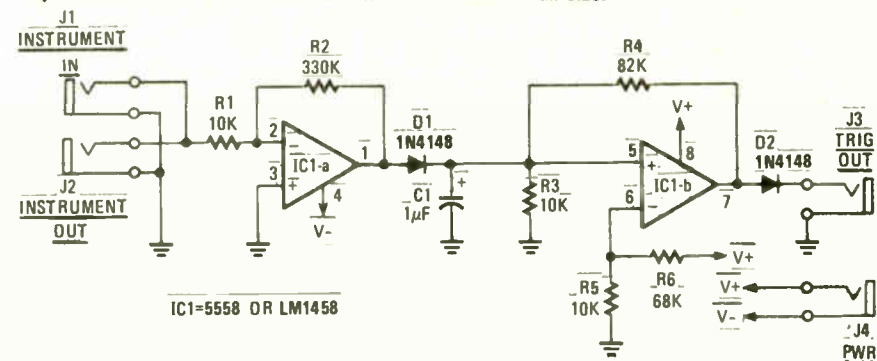

FIG. 16—THE TRIGGER INTERFACE produces a positive-going pulse when the amplitude of the input signal exceeds a preset level.

input signal goes above a preset level. In operation, your instrument is connected to J1 and J2 is connected to an amplifier. Jack J3 (TRIG OUT) is connected to an appropriate TRIG jack on PerSyn. The trigger interface is assembled on the PC

PARTS LIST FOR TRIGGER INTERFACE (Fig. 16)

Resistors 1/4 watt, 5% unless otherwise noted.

- R1, R3, R5—10,000 ohms
- R2—330,000 ohms
- R4—82,000 ohms
- IC1—5558, LM1458, CA1458 or equal
- D1, D2—1N4148
- C1—1 μ F, 10 volts or higher
- J1—J4—phone jacks, 1/4 inch

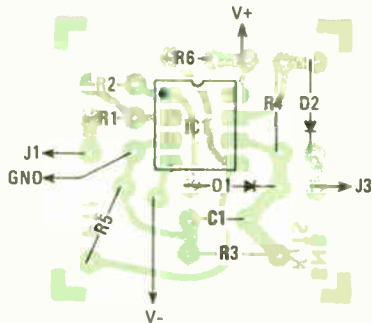

FIG. 18—HOW PARTS ARE GROUPED around the IC on the interface PC board.

board in Fig. 17. Assembly details are in Fig. 18.

As with the other options, power is obtained by connection to the TAP jack on PerSyn. Set your instrument's volume control to minimum. Slowly increase the instrument volume while striking a note

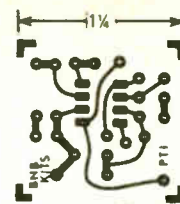

FIG. 17—THE INTERFACE FOIL PATTERN is shown full-size.

as hard as you will when you wish to trigger PerSyn, until an output is heard from PerSyn. You have just set the threshold level. Now any time your instrument is played at that same volume, PerSyn will be triggered. If you set your instrument's volume too high, you may hear a number of outputs from PerSyn each time you strike a note. To eliminate this multiple triggering effect, simply lower the volume slightly on your instrument until proper operation is obtained.

PerSyn has been designed to be nearly "goof-proof" in operation, so do not hesitate to experiment with all controls, interconnections and any special circuits you may think of. The more you experiment, the more you will realize the possibilities for new and different sounds.

In a follow-up article in an early issue, we will describe two additional accessories: the Snare/Cymbal and the Sequencer. The former allows synthesis of Snare Drum, Cymbal and special effects. This makes it possible to synthesize all conventional percussion sounds. The Sequencer produces three distinct programmable 8-bit serial trigger pulse patterns and can be used to automatically trigger the PerSyn and the Snare/Cymbal accessory. The PerSyn system can now double as a fully programmable complex rhythm unit. R-E

All About Microphones

A microphone is the prime source of all live material recorded electronically. There are several types. Learn how mikes operate and how to select one that's best for your job.

LEN FELDMAN
CONTRIBUTING HI-FI EDITOR

ALMOST EVERYONE INVOLVED IN AUDIO electronics is well versed in the technology of amplifiers, preamplifiers, loudspeakers, turntables and even tape decks. However, a key element in the storage or transmission of audio information that most audiophiles ignore almost entirely is—the microphone. After all, a microphone is at the start of any audio program, and with more and more hi-fi buffs doing “live” recording, a fundamental understanding of the workings of this basic component is essential if you hope to select and use a microphone properly.

Audio-Technica (33 Shiwasee Ave., Fairlawn, OH 44313) manufactures phono cartridges and now also offers a complete line of microphones. And, in an effort to take some of the mystery out of this little-understood component, the company has published a brief guide to microphones. I found the booklet so concise and readable that with Audio-Technica's permission, I'd like to convey some of the information it contains. While you may not become a microphone expert by reading this article, you will probably be better able to select the right mike for your own recording applications.

Although there are many ways to convert sound into electrical energy (the sole job of a microphone) we'll concentrate on the two most popular microphone methods: the dynamic and condenser mikes. These are the mike types most often found in home hi-fi recording systems.

Dynamic microphones

Dynamic microphones are completely analogous to conventional loudspeakers. Both have a magnetic system with the coil in its gap. In a speaker, electric current

flows through the coil, and the interaction of the magnetic field created with the magnetic field of the permanent magnet forces both the coil and cone to move, thus producing sound output. In the case of a dynamic microphone element (see Fig. 1) the diaphragm is moved by the changing sound pressure. This moves the coil, which causes current to flow as the magnetic flux lines are cut. Instead of putting energy into the coil, you get energy out of it.

Dynamic microphones are noted for their ruggedness and reliability. They need no batteries or external power sup-

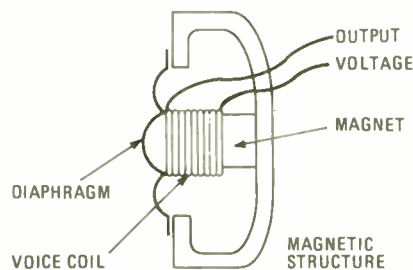

FIG. 1—DYNAMIC MICROPHONE consists of diaphragm, voice coil and magnet. Sound pressure moves diaphragm and voice coil which induces current flow when the voice coil slides over magnet.

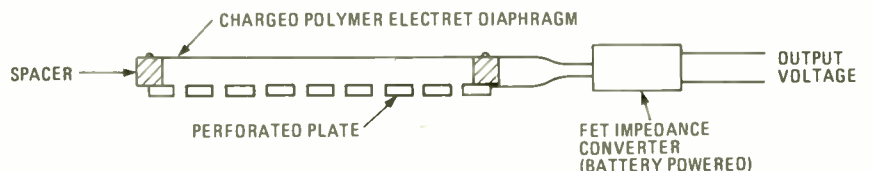

FIG. 2—CONDENSER MICROPHONE changes capacitance between electret diaphragm and perforated plate in response to sound pressure. Output voltage is provided by an impedance converter circuit.

ply. They can deliver smooth, extended frequency response, or can be modified for special applications. Output levels are high enough to work directly into most mike inputs on tape recorders that have excellent signal-to-noise ratios.

Condenser microphones

Condenser (condenser is a leftover term from the old days that means capacitor) microphones use a lightweight membrane and a perforated plate that act as opposite plates of a capacitor (see Fig. 2). Sound pressure applied against the thin membrane causes it to move; this changes the capacitance of the circuit, which creates a varying electrical output. In many respects, a condenser microphone is similar to an electrostatic tweeter. Two basic types of condenser microphones are available. One uses an external power supply to provide the polarizing voltage needed for the capacitive circuit, and is often used in professional studios.

A more recently developed form of condenser type of microphone is the so-called electret condenser microphone. In these, the polarizing voltage is impressed on the diaphragm during the manufacturing process, and will remain there indefinitely. Accordingly, no external high-

voltage power supply is needed, although an FET impedance matching circuit is usually required, and is often powered by a small low-voltage battery housed in the microphone itself.

Electret microphones are suitable for high-fidelity and semiprofessional recording applications, and are sometimes also found in professional recording studios. State-of-the-art electret condenser microphones are capable of a very uniform frequency response and can respond with excellent clarity to fast, transient sound impulses. The low mass of the diaphragm permits extended high-frequency performance, and also insures excellent low-frequency response.

Ribbon microphones

Another type of microphone often found in professional recording studios is the ribbon microphone. This mike is actually a variation of the dynamic microphone; it is equipped with a thin metallic ribbon that serves as both the voice coil and the diaphragm. The free metallic ribbon is suspended between the poles of a permanent magnet, as shown in Fig. 3. While the ribbon microphone (sometimes called a velocity microphone) is capable of excellent performance and is highly directional, the ribbon element must be protected against high acoustic pressures or wind blasts since, in many designs, it is quite fragile. For this reason very few ribbon microphones are found in nonstudio applications such as sound reinforcement or home recording (although there are a few exceptions to this rule).

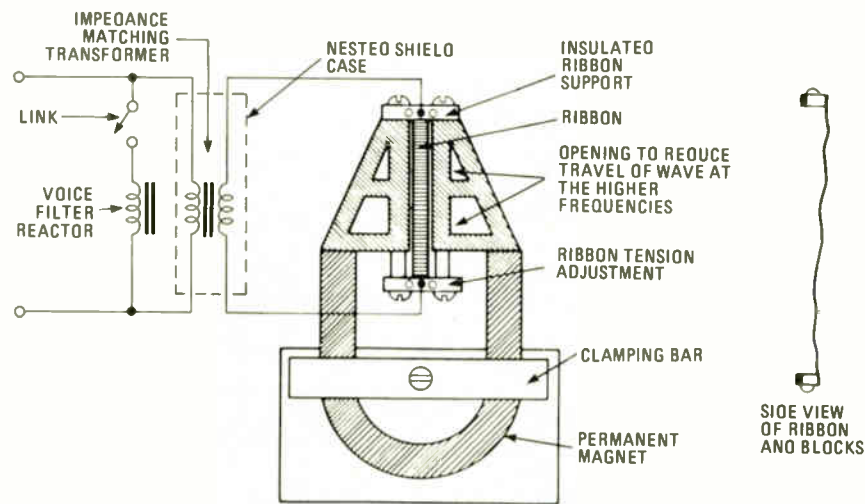

FIG. 3—RIBBON MICROPHONE is a variation of a dynamic mike. Metallic ribbon suspended between the poles of a permanent magnet acts as a combination voice coil and diaphragm.

Ribbon microphones are often designed to respond to sound from both front and back. Such mikes are said to have a bidirectional pickup pattern and are sometimes used when such a pattern is required. In the bygone days of radio drama, the bidirectional ribbon microphone was a favorite among actors, since they could position themselves on either side of the microphone without crowding

each other. All of which brings us to the next major consideration: directionality.

Pickup pattern

In addition to microphones being divided or classified as to their generating elements, they can also be classified according to their directional-pickup qualities. Several major directional categories exist: omnidirectional, unidirectional and, as we have just noted in the case of ribbon microphones, bidirectional. In home or semiprofessional applications, only the first two directional patterns are generally encountered.

Omnidirectional mikes

Omnidirectional-pattern microphones pick up sound from almost every direction equally. They work about as well when they are pointed away from the sound source as when pointed towards it if the distances to the source are equal. Response is not totally identical from all directions, however, since even the best omnidirectional microphones tend to become directional at higher audio frequencies. Thus, sound arriving from behind the microphone may be a bit duller than sound coming from the front. Figure 4 shows the directional characteristics of an omnidirectional microphone.

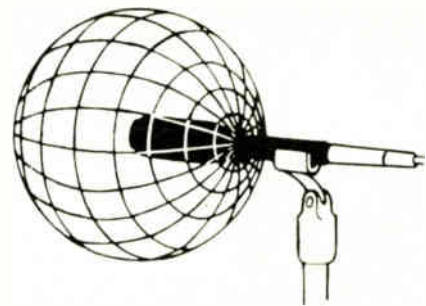

FIG. 4—OMNIDIRECTIONAL MICROPHONE picks up sound equally from every direction.

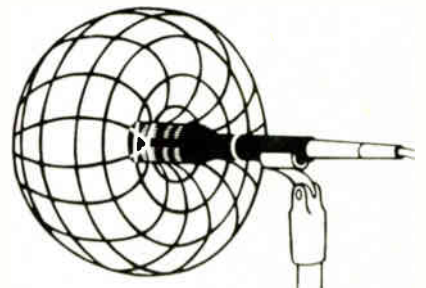

FIG. 5—CARDIOID MICROPHONES respond best to sounds coming directly from the front.

Unidirectional mikes

Unidirectional or cardioid microphones respond best to sound coming from the front, but tend to reject sound that arrives from the sides or rear, as shown in Fig. 5. This effect varies with

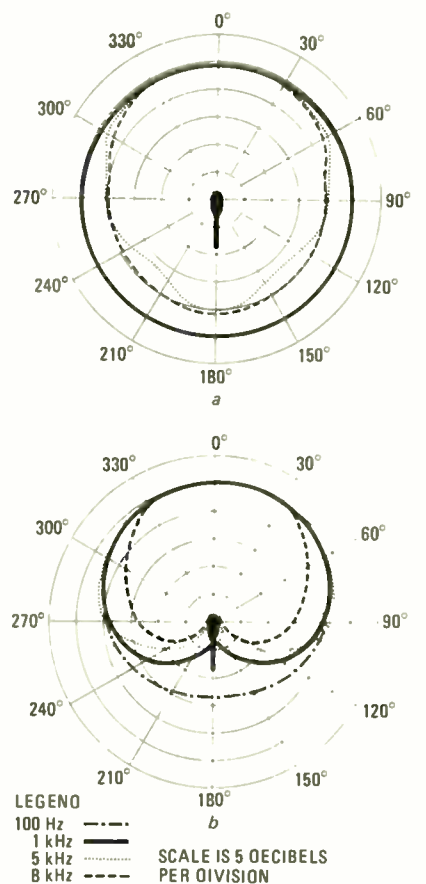

FIG. 6—POLAR RESPONSE PLOTS showing directional characteristics of a microphone. Typical omnidirectional pattern is shown in *a*, while typical cardioid pattern is shown in *b*.

frequency; only the very best-quality microphones are able to provide uniform rejection over a wide frequency range.

A unidirectional microphone's characteristics are usually the result of external openings and internal passages inside the microphone that allow sounds to reach both sides of the diaphragm. Depending upon which direction it comes from, the sound reaching opposite sides either can-

cel or aids the diaphragm motion. Polar plots or polar patterns are used to show the relative sensitivity of a microphone, in dB, as it is rotated in front of a fixed sound source. These polar plots are gen-

erally made for more than one frequency. Figure 6-a and Fig. 6-b contain examples of the polar response of a typical omnidirectional mike and a unidirectional mike. Because most unidirectional microphones reveal a heartshaped pattern (as in Fig. 6-b) the name 'cardioid' is usually applied to this class of microphone.

In the cardioid pattern of Fig. 6-b, the polar response is down 5 dB at 90 degrees off-axis at 1 kHz, 100 Hz and 5 kHz. This means that if two people were speaking, one on axis and one 90 degrees off axis but both at the same distance from the microphone, the person on the side would sound twice as far away as the person that is on-axis. Conversely, for the individual on the side to sound as loud as the person on-axis, he or she would have to move closer to the mike and be half the distance away as the person speaking directly in front of the mike.

In practice, polar patterns are generally plotted in an anechoic chamber (that is, a totally absorbent room). In actual home and studio recording, reflections from sounds that were originally positioned behind the microphone tend to bounce off room surfaces so that some of the sounds reach the front of the microphone after all. So although cardioid microphones can help reduce unwanted sounds from the rear, they cannot eliminate such sounds entirely.

From a distance of 2 feet or so in an absolutely "dead" room, a good omnidirectional mike and a good cardioid mike sound very much alike. Put the same pair of microphones in a live, reverberant room, however, and you will hear an immediate difference. The omnidirectional mike will pick up all the reverbera-

tion and echoes. The cardioid mike will pick up just some of the reverberation, but not nearly as much as the omnidirectional mike. In a noisy environment, if you point a cardioid microphone away from the noise, this will produce a better ratio of wanted to unwanted sound than with an omnidirectional microphone.

Proximity effect

Within about 2 inches of a cardioid microphone, bass response seems to increase, and the closer you get the greater the bass boost. This phenomenon is known as the proximity effect, and it does not occur with omnidirectional microphones.

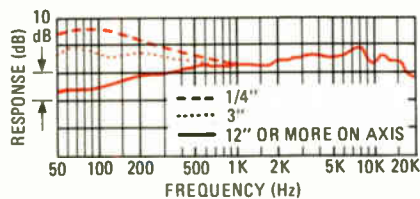

FIG. 7—PROXIMITY EFFECT on a typical cardioid microphone response. Bass response increases as the distance between microphone and sound source decreases.

Proximity effect can be a problem or it can sometimes be used to advantage. If a performer sings at a constant volume level but moves closer to and farther away from the microphone, this will create variations in tonal balance. On the other hand, some singers like to work very close to the microphone to 'beef up' an otherwise light voice. The proximity effect can also be used to cut feedback in sound reinforcement. If the speaker or singer works very close to the microphone and

doesn't require the extra bass provided by the proximity effect, the recordist or control engineer can turn down the bass response of the amplifier or equalizer. This makes the microphone less apt to feed back at low frequencies, since it is now less sensitive to bass tones arriving from greater distances. Figure 7 shows the influence of the proximity effect on a typical cardioid microphone response.

Which pattern is the best?

Whether you choose a cardioid microphone or an omnidirectional microphone depends on acoustic conditions and the kind of recorded sound you want. Cardioid microphones can suppress unwanted noise and reduce the effects of reverberation, but in good acoustic surroundings omnidirectional microphones (when properly positioned) preserve the "sound" of the location and are often preferred for their flat response and lack of proximity effects. Serious recordists often own both types of microphones to meet the requirements of any recording situation.

Balanced output microphones

Most of the higher-quality microphones offer balanced outputs; these are uniformly phased at the time of manufacture. Balanced lines (in which the cable shield is connected to ground and the signal appears across the two inner wires) are much less susceptible to noise and hum pickup because signal currents are flowing in opposite directions in each wire at any given moment, and noise that is common to both is effectively cancelled out. Such noise cancellation will not take place when only one inner-conductor signal wire plus a shield are used. While it is possible to wire a low-impedance microphone directly to a low-impedance unbalanced input, this will negate the noise-cancelling benefit. In the case of long cable runs, it is preferable to use a balanced-to-unbalanced matching transformer that can then be positioned at the end of the cable run (close to the recorder microphone input).

Sensitivity

Sensitivity ratings for microphones (i.e., how much electrical signal is produced for a given applied sound pressure) are not always exactly comparable since different manufacturers use different rating systems. (The same problem exists in quoting speaker sensitivity.) Typically, the microphone output in a sound field of specified intensity is quoted in dB compared with some reference standard. The majority of microphone manufacturers use a reference level well above the output level of most microphones; therefore, the resulting sensitivity value, in dB, is negative. A microphone with a sensitivity rating of -55 dB provides a greater output than one rated at -60 dB. One

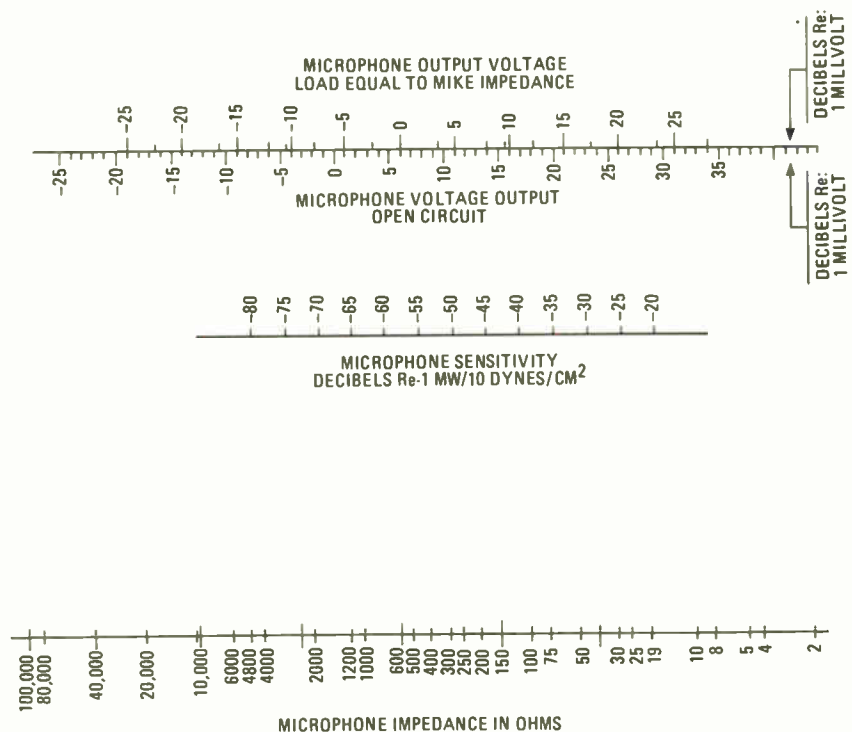

FIG. 8—NOMOGRAPH is used to find the output voltage from a microphone knowing the microphone's sensitivity and impedance.

continued on page 144

TANDBERG TR-2080 AM/FM Receiver

LEN FELDMAN

CONTRIBUTING HI-FI EDITOR

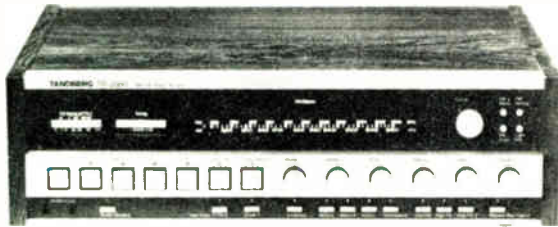

1
CIRCLE 106 ON FREE INFORMATION CARD

TANDBERG OF AMERICA, INC., HAS GAINED an enviable reputation in the U.S. for its excellent open-reel and cassette decks. In recent years a line of high-performance receivers has been added to the list of products sold in this country.

Their newly introduced top-of-the-line stereo receiver, the model TR-2080, is similar in appearance to their earlier receiver designs and replaces the model TR-2075-II.



Figure 1 shows a front-panel view. The light-colored lower portion of the panel incorporates the major, most often used controls and switches. Seven square-shaped light-touch pushbutton switches take care of POWER turn-on and program source selection (including two phono inputs, AM, FM, and a pair of tape monitor switches). Rotary knobs handle VOLUME, BALANCE, BASS, MIDRANGE AND TREBLE tone-control adjustment and speaker selection.

Up to three sets of speakers can be connected to the receiver, and various combinations of one or two systems can be activated by the speaker switch.

Along the bottom edge of the panel below these major controls and switches are two stereo headphone jacks plus 12 small rectangular pushbuttons. The pushbutton at the lower left converts the signal-strength tuning meter into a power-output meter. The pushbuttons located below the tape-monitor switches select tape copying or dubbing (from TAPE COPY 1 to TAPE COPY 2 or vice versa). The pushbutton below the master volume control introduces loudness compensation. The remaining pushbutton switches select the operating mode (STEREO, MONO L, MONO R), bypass the tone-control circuitry when desired, introduce low-cut and high-cut filtering (two high-cut filter pushbuttons can be used singly or in tandem to provide three different rolloff curves), and let you apply the tone controls ahead of the tape copy 2 output circuits to pre-equalize program sources prior to recording. Each of the 12 pushbutton switches described above has a tiny LED indicator above it that lights up when the button is depressed.

The upper left-hand portion of the front panel contains two illuminated meters. The center-of-channel tuning meter is calibrated in

RADIO-ELECTRONICS AUDIO LAB

R.F.A.L. SOUND

RATES

TANDBERG TR-2080 RECEIVER

SUPERB

Copyright © Garnsbach Publications Inc., 1979

kilohertz of deviation from perfect center-tuning. The signal-strength meter is calibrated in microvolts across 75 ohms, and in watts of output into 8 ohms for its alternate function previously mentioned. To the right of these meters are well-illuminated FM and AM frequency scales, above the scales is the usual FM stereo indicator light. To the right of the frequency numerals are a large tuning knob coupled to an effective flywheel for friction-free operation, and four small pushbuttons that select mono FM, FM muting, 25- μ s de-emphasis (for use when receiving Dolby FM programs that must be decoded using a separate connected Dolby decoder-adaptor), plus front-panel dimmed illumination.

The rear panel contains three sets of speaker-connection terminals on the lower left, each clearly identified with polarity and channel notations. Pre-amplifier-output and main amplifier-input jacks at the upper left are interconnected by wire jumpers that can be removed to provide separate access to the pre-amplifier and main-amplifier sections. The phono 1 and phono 2 input jacks are each augmented by a European-type DIN socket (for use with some turntables equipped with such multiconductor output cables); and, in addition, the phono 1 inputs have an associated input-level control to vary phono 1 input sensitivity over a 2.2 mV–10 mV range (for rated output).

Both tape monitor circuits are also equipped with input-sensitivity controls that permit adjusting the sensitivity from 150 mV to 600 mV (for rated output).

Antenna terminals for 300-ohm and 75-ohm FM plus external AM antenna transmission lines as well as a ground terminal are located at the upper right of the rear panel, and just below these is a pivotable AM ferrite bar antenna. One switched and two unswitched AC convenience receptacles at the lower right of the panel complete the layout. The rear panel is shown in Fig. 2.

MANUFACTURER'S PUBLISHED SPECIFICATIONS:

FM TUNER SECTION:

IHF Usable Sensitivity: mono, 1.7 μ V (9.8 dBf). **50-dB Quieting:** mono, 3.0 μ V (14.8 dBf); stereo, 32 μ V (35 dBf). **S/N Ratio:** mono, 78 dB; stereo, 75 dB. **Muting Threshold:** 6 μ V (20.8 dBf) **Stereo Threshold:** 15 μ V (28.8 dBf). **Frequency Response:** 30 Hz to 15 kHz, +1, -2 dB. **THD at 50-dB Quieting:** mono or stereo, 0.3%. **THD:** mono, 0.2% at 1 kHz, 0.4% from 30 Hz to 15 kHz; stereo, 0.3% at 1 kHz; 0.5%, 30 Hz to 15 kHz. **IM Distortion:** 0.2%. **Capture Ratio:** 0.9 dB. **Selectivity:** 80 dB. **Spurious, IF and Image Rejection:** 100 dB. **AM Suppression:** 70 dB. **Stereo Separation:** 60 Hz to 10 kHz, 40 dB. **Subcarrier Product Rejection:** 60 dB.

AM TUNER SECTION:

IHF Usable Sensitivity (External Antenna): 20 μ V. **Selectivity:** 45 dB. **IF Rejection:** 80 dB. **Image Rejection:** 60 dB. **THD (30% Modulation):** 0.8%.

AUDIO SECTION:

Power Output: 80 watts-per-channel into 8 ohms, 20 Hz to 20 kHz, both channels driven. **Rated THD:** 0.05%. **IHF IM Distortion:** 0.05%. **Dynamic IM:** 0.02%. **Damping Factor:** 20 Hz to 20 kHz into 8 ohms, 60. **Overall Frequency Response:** high level, 6 Hz to 150 kHz, -1.5 dB; phono, RIAA \pm 0.3 dB. **Bass, Midrange and Treble Control Range:** \pm 15 dB at 50 Hz; \pm 7 dB at 1 kHz; \pm 15 dB at 10kHz. **Low-Cut Filter:** -3 dB at 30 Hz. **High-Cut Filter:** -3 dB at 9 kHz, 8 kHz or 7 kHz. **Signal-to-Noise Ratios ("A"-Weighted):** phono 1 and 2, 77 dB and 79 dB, referenced to maximum input sensitivity; high-level tape, 98 dB referenced to 150-mV input. **Input Sensitivities:** phono 1, 2.2 mV to 10 mV adjustable; phono 2, 3.0 mV. **Tape:** 150 mV to 600 mV adjustable. **Phono Overload:** phono 1, 120 mV; phono 2, 150 mV.

GENERAL SPECIFICATIONS:

Power Requirements: 120-220-240 volts, 50 to 60 Hz, 305 watts at full power into 8 ohms, 40 watts at no signal. **Dimensions:** 20 1/4" W \times 6 H \times 13 1/4" D (less knobs). **Weight:** 27.2 lbs. **Suggested Retail Price:** \$1200.

An internal view of the receiver is shown in Fig. 3. Although the owner's manual does not include a schematic, we were able to note the massive power transformer that contains separate windings for powering each channel, plus the twin pairs of filter capacitors for the high-voltage power supplies. Circuit modules are well designed and ideally positioned for easy access and minimum hum-and-noise pickup.

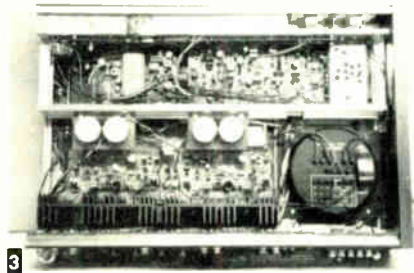

The receiver's safety circuits are worth describing in some detail. A dynamic peak time-delay circuit prevents premature or accidental sound interruption by the safety circuits as a result of speaker systems that exhibit momentary low-impedance excursions. An electronic power-limiting circuit is activated when net resistive loads connected to the receiver are lower than 3 ohms, but will not cause system shutdown with 4-ohm or reactive loads. The unit can safely operate under no-load conditions and remains protected even if there is a direct short-circuit at the speaker terminals.

A thermal protection circuit guards against any overheating that is due to inadequate ventilation. When and if thermal shutdown takes place, normal operation is automatically restored when proper thermal operating conditions have been restored. Diode protection against transient feedback from inductive loads is also provided. A voltage sensing circuit activates a relay to protect loudspeakers from any subsonic oscillations or DC offset voltages. This delay also forms part of a 6-second delay-time constant to prevent turn-on and turn-off transient signals from reaching the speakers. In addition, the primary winding of the power supply is fused internally.

FM measurements

Table 1 summarizes our lab measurements of the FM tuner. If you compare the results we obtained with the published specifications, you might well wonder why Tandberg publishes such conservative values when, in fact, almost every specification was exceeded by a wide margin. Signal-to-noise ratios in both mono and stereo modes were about the best we have ever measured (81 dB for mono; 76 dB for stereo); and, in fact, we suspect that our readings were "limited" by the residual modulation noise in our FM Signal Generator. The AM suppression figure of 71 dB (as compared with the 70 dB claimed) is also the highest we have ever measured and, this value, coupled with the low capture ratio, accounts in part for the tuner's audibly superior rejection of multipath distortion (though of course, a properly oriented antenna with good directional characteristics can help even more).

Distortion figures at all three test frequencies, in both mono and stereo modes, are well below the published limits, and the value of 0.15% at 6 kHz in stereo is about as low as we have measured for any receiver or tuner.

TABLE 1 RADIO-ELECTRONICS PRODUCT TEST REPORT		
Manufacturer: Tandberg of America, Inc.		Model: TR-2080
FM PERFORMANCE MEASUREMENTS		
	R-E Measurement	R-E Evaluation
SENSITIVITY, NOISE AND FREEDOM FROM INTERFERENCE		
IHF sensitivity, mono (μ V) (dBf)	1.7 (9.8)	Excellent
Sensitivity, stereo (μ V) (dBf)	3.2 (15.3)	Excellent
50-dB quieting signal, mono (μ V) (dBf)	2.5 (13.2)	Excellent
50-dB quieting signal, stereo (μ V) (dBf)	32.0 (35)	Very good
Maximum S/N ratio, mono (dB)	81	Superb
Maximum S/N ratio, stereo (dB)	76	Superb
Capture ratio (dB)	0.9	Superb
AM suppression (dB)	71	Superb
Image rejection (dB)	100	Excellent
IF rejection (dB)	100+	Excellent
Spurious rejection (dB)	100+	Superb
Alternate channel selectivity (dB)	80	Excellent
FIDELITY AND DISTORTION MEASUREMENTS		
Frequency response, 50 Hz to 15 kHz (\pm dB)	1.0	Very good
Harmonic distortion, 1 kHz, mono (%)	0.068	Superb
Harmonic distortion, 1 kHz, stereo (1%)	0.11	Excellent
Harmonic distortion, 100 Hz, mono (%)	0.08	Excellent
Harmonic distortion, 100 Hz, stereo (%)	0.10	Excellent
Harmonic distortion, 6 kHz, mono (%)	0.09	Excellent
Harmonic distortion, 6 kHz, stereo (%)	0.15	Superb
Distortion at 50-dB quieting, mono (%)	0.3	Superb
Distortion at 50-dB quieting, stereo (%)	0.3	Excellent
STEREO PERFORMANCE MEASUREMENTS		
Stereo threshold (μ V) (dBf)	2.5 (13.2)	Excellent
Separation, 1 kHz (dB)	53	Superb
Separation, 100 Hz (dB)	35	Fair
Separation, 10 kHz (dB)	40	Excellent
MISCELLANEOUS MEASUREMENTS		
Muting threshold (μ V) (dBf)	4.5 (18.3)	Good
Dial calibration accuracy (\pm kHz at MHz)	+200, -0.0	Good
EVALUATION OF CONTROLS, DESIGN, CONSTRUCTION		
Control layout		Excellent
Ease of tuning		Excellent
Accuracy of meters or other tuning aids		Superb
Usefulness of other controls		Excellent
Construction and internal layout		Excellent
Ease of servicing		Very good
Evaluation of extra features, if any		Very good
OVERALL FM PERFORMANCE RATING		Superb

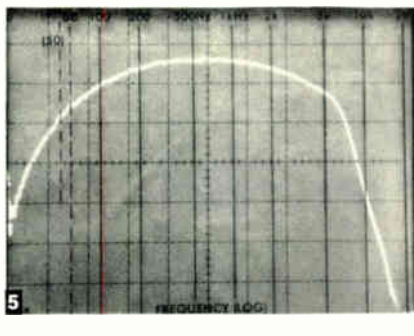
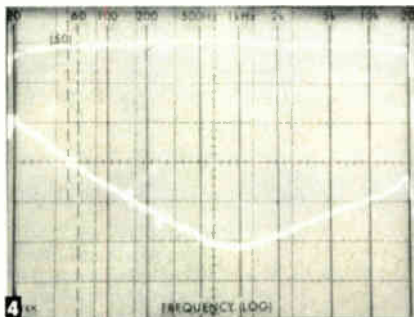

Stereo FM frequency response is shown in the upper trace of Fig. 4, while the lower trace represents the tuner's stereo FM separation

capability. At 100 Hz, separation fell a bit short of published claims, but at 1 kHz it measured a high 53 dB and remained a high 40 dB at 10 kHz as claimed.

Although sensitivity and other published AM specifications were all met or exceeded, AM frequency response was not much better than that typically found in most competitive stereo AM/FM tuners and receivers, although final rolloff at a steep rate does not begin until 5 kHz (see Fig. 5).

Amplifier measurements

Measurement results of the power amplifier and preamplifier are summarized in Table 2. As might be expected, the amplifier delivered its rated power over its rated bandwidth with some reserve, and at mid-frequencies, both harmonic and intermodulation distortion were considerably lower than claimed by the manufacturer. The damping factor measured a high 79 at the new IHF test frequency of 50 Hz.

Based upon comments received from several manufacturers, we are reporting the new IHF dynamic headroom specification as a value (in dB) but are not assigning a quality rating or evaluation to it. The dynamic headroom of an amplifier (i.e., its capability of producing higher power than the rated values for short-term musical signals) is largely a function of power-supply design. Some manufacturers prefer to use stiff power supplies (which inevitably result in low dynamic headroom values), while

tude at each moment, Delta Modulation uses a waveform detector to digitally encode the moment-to-moment changes in the audio-signal voltage. This system requires less memory and lowers the cost of the circuitry.

In real acoustic space every original sound generates dozens of reflections at many different time intervals. Audio Pulse uses an elaborate set of mixing, filtering, phase-shifting and recycling circuits that tailor the delayed sounds and recycle them repeatedly through the basic time-delay system to obtain a natural sense of space.

Lab measurements

The results of our laboratory measurements for the Audio Pulse *Model Two* are shown in Table 1. Note that the amplifier could not sustain a 25 watts-per-channel output on a continuous signal basis since the circuit breakers would cut out. This should not, however, be regarded as a deficiency. The manufacturer's published specs state that the 25-watt value applies only if the protective circuit breakers are defeated during the tests made for continuous power. From a practical point of view, under music-signal conditions, the amplifier would handle its full rated 25 watts-per-channel and then some.

The narrow power bandwidth is also "built-in." As we suggested earlier, in a live listening situation, reflected sound energy does not have the full audio bandwidth (20 Hz to 20 kHz) that is characteristic of "direct" sounds. Highs are usually absorbed by the surfaces against which the sounds bounce.

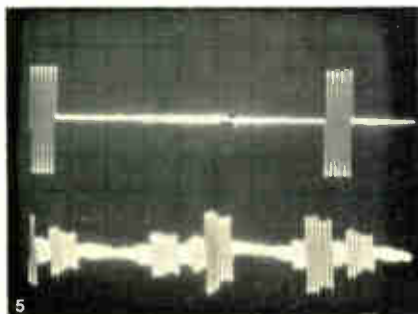
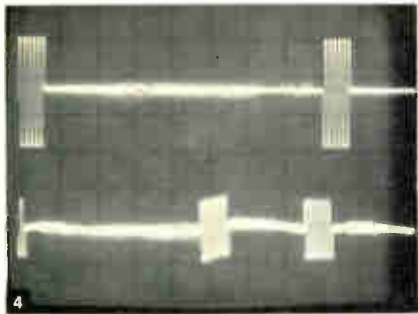

Figure 4 shows the effect of one possible setting of the controls. When a tone burst is applied as an input signal (shown in the upper trace), the result is a complex of delayed tone bursts of varying amplitudes at the rear-amplifier outputs (lower trace). In this example, the ambience control was set to the minimum position. When the ambience control is moved to the maximum position, the results (for the same tone-burst input signal) become more complex (see the lower trace in Fig. 5) as recirculated components are added and the decay

TABLE 1		
RADIO-ELECTRONICS PRODUCT TEST REPORT		
Manufacturer: Audio Pulse	Model Two	
AMPLIFIER PERFORMANCE MEASUREMENTS*		
	R-E Measurement	R-E Evaluation
POWER OUTPUT CAPABILITY		
RMS power/channel, 8-ohms, 1 kHz (watts)	28.5	Very good
RMS power/channel, 8-ohms, 40 Hz (watts)	20.0	Fair
RMS power/channel, 8-ohms, 8 kHz (watts)	20.0	Fair
DISTORTION MEASUREMENTS		
Harmonic distortion at rated output, 1 kHz (%)	0.08	Excellent
IM distortion at rated output (%)	0.09	Excellent
Harmonic distortion at 1 watt (%)	0.05	Very good
IM distortion at 1 watt (%)	0.10	Good
HIGH LEVEL INPUT MEASUREMENTS		
Frequency response (Hz-kHz, \pm dB)	65 - 11, 3.0	See test
Hum/noise referred to 0.5 volt in, 1 watt out (dB) (new IHF, "A"-weighted)	68/70(86 direct)	Good
TONAL COMPENSATION MEASUREMENTS		
Action of bass and treble controls	See Fig. 8	Good
COMPONENT MATCHING MEASUREMENTS		
Input for 0-dB indication (mV)	50 to 3300	
DELAY SPECIFICATIONS		
Short initial delay (ms)	19.33 & 51	Excellent
Long initial delay (ms)	39.66 & 103	Excellent
Reverberation decay time (ms)	100 to 600	Excellent
EVALUATION OF CONTROLS, DESIGN AND CONSTRUCTION		
Arrangement of controls (panel layout)		Good
Action of controls and switches		Very good
Design and construction		Excellent
Ease of servicing		Excellent
OVERALL AMPLIFIER PERFORMANCE RATING		
		Good
OVERALL TIME-DELAY SYSTEM RATING		
		Good

* All measurements were taken through the digital delay circuitry. Amplifier performance alone is much better in terms of distortion.

TABLE 2	
RADIO-ELECTRONICS PRODUCT TEST REPORT	
Manufacturer: Audio Pulse	Model Two
OVERALL PRODUCT ANALYSIS	
Retail price	\$599
Price category	Low
Price/performance ratio	Very good
Styling and appearance	Good
Sound quality	Good
Mechanical performance	Very good

Comments: Audio Pulse has managed to cram a great deal of sophisticated circuitry into its combination amplifier/time-delay unit and offers everything you need to create the illusion of a large listening space (except for the extra speakers) at a very attractive price. When we tested the Audio Pulse *Model One* nearly two years ago, it then sold for around \$600, and a user had to add his or her own second stereo power amplifier in addition to extra speakers. Unfortunately, getting what you pay for holds true in the case of the *Model 2*. It works well, to be sure, but is not nearly as effective or as accurate in its creation of concert-hall ambience as the *Model One* (or even some of the other recently introduced ambience or time-delay units such as those produced by ADS, Advent and Sound Concepts).

Of course, the ability to vary "apparent space" from a small nightclub to a cavernous auditorium or cathedral is retained, but we found that when you try to use the *Model Two* for really expanded listening space simulation, the sound tends to seem artificial even with careful adjustment of its operating controls. On the other hand, used at more moderate settings of initial delay and reverberation, we could effectively create moderately large listening spaces, which, with our eyes closed, seemed to us very much like the real thing.

The problem lies not so much with the 8-kHz cutoff frequency of the added channels (a valid choice for reflected sounds, as any student of reverberation-frequency content can verify), but rather in the unit's sharp rolloff even at the low end of the audio spectrum. The rolling, lingering bass effect of a large concert hall just cannot be duplicated faithfully with this unit, even if you use wide-range secondary speakers.

In summary, the *Model Two* Time-Delay System is a low-cost ambience time-delay unit that is fairly effective at what it sets out to accomplish, but, if you can afford it, we still prefer the *Model One* unit.

characteristics of the reverberant rear-channel sounds appear.

Figure 6 is a spectrum analysis of a 1-kHz

signal (tall spike), as observed with the selector switch set to the direct position (no time

continued on page 142

Digital Logic in VCR Servicing

Gates, truth tables, transistor and diode logic—these seem easier to understand once you see how useful they are in video cassette recorders.

FOREST BELT

THE TERMS *DIGITAL LOGIC* AND *binary numbers* conjure up images of complicated new arithmetic systems. Unfortunately, your first introduction to digital logic often comes through Boolean algebra and oddly unfamiliar numbering.

It doesn't have to be that complicated. Sure, base-2 math is nice to know. I recommend that you study it whenever you have the time and the inclination. It does expand your knowledge of design theory. However, you don't need binary arithmetic to troubleshoot circuits and stages that incorporate digital logic.

Not so long ago you could troubleshoot home electronic equipment without knowing anything about logic circuits. You bothered about them only if you contemplated servicing computers. But then digital systems infiltrated the world of industrial and medical electronics. Today you find digital controls in TV sets—and, more recently, in video cassette recorders.

Now is the time to tackle digital logic head-on. You may have avoided it so far, but you can get by no longer. Ignore this technology, and you will very soon be obsolete as a technician.

Video cassette recorders offer a natural medium for coming to grips with digital logic. VCR sections and stages use digital gates and circuits extensively. And, more often than not, VCR digital stages are direct and generally easy to understand. You cannot become familiar with VCR operation without seeing digital logic per-

form many functions. Fortunately, the very act of learning one reinforces the other. You will probably be astonished at how simple and practical digital logic is. In fact, you already know more about it than you may have realized.

Transistor logic

For now, put aside whatever you've read about binary numbers and Boolean algebra; you don't need them.

Let's start with the transistor stage shown in Fig. 1-a. It's a common-emitter NPN transistor hookup. You've seen it many times. It accepts input signal at the base. Output taken from the collector is an amplified reproduction of what's coupled to the base. You normally see this stage as a simple analog amplifier. If you recall amplifier operation, you know that the output signal is inverted.

The NPN transistor stage in Fig. 1-b has much the same character. Except, of course, it's a common-collector hookup—often called an emitter-follower. Output taken from the emitter is a copy of what's fed to the base. But in this hookup, as you remember, the signal is *not* inverted from input to output.

In *analog* operation, a signal varies continuously up and down in voltage. You pass through many different voltage points or levels as you trace along the continuum of an analog-signal waveform. For example, look at a sinewave on an oscilloscope. Analog signals come in all sorts of shapes and amplitudes.

Digital operation, on the other hand, recognizes only two signal states: *high* and *low*. A *high* signal is really not a signal at all, as you think of an analog signal, but is a DC voltage condition. A *low* signal, in digital parlance, is the absence or near-absence of a DC voltage.

For those who prefer numbers, the high-DC state can be represented by a 1; and the low condition, by a 0. But for all practical purposes, you need only think of the two "signals" as *high* and *low*. In fact, start calling them *logic high* and *logic low*.

Now apply this pair of conditions to what we will call a *digital* or *logic* mode of

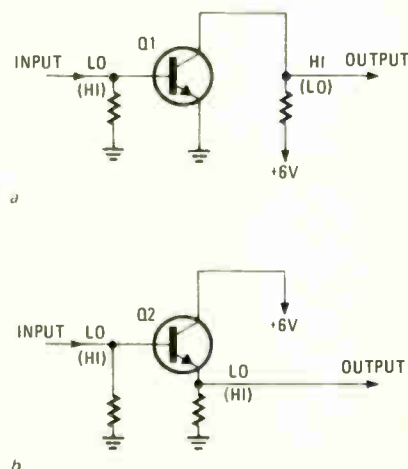

FIG. 1—UNDERSTANDING DIGITAL LOGIC begins with actions you already know about in plain transistor amplifiers.

operation for the two amplifiers shown in Fig. 1.

Imagine the transistor amplifier of Fig. 1-a first in its quiescent condition with input zero. Since there's no DC bias at the base, the transistor draws no collector current. Essentially, the transistor is cut off. With no current through the load or supply resistor in the collector circuit, full supply voltage appears at the collector and at the output point.

Let's now restate this condition in logic terms: No input means there's no DC voltage at the base. This is the *logic-low* condition, and you merely say the input is "low." Output, on the other hand, rests at full DC voltage. This corresponds to *logic high*, and you say that the output has "gone high."

Conclusion One (stated in digital-logic terms): In a common-emitter stage, when the input is *logic low*, the output is *logic high*.

Next, imagine the same transistor amplifier with a logic-high DC voltage, that is positive in polarity (called positive logic), applied to the input. The NPN transistor, that is now heavily forward-biased, turns on. In fact, at any input value above 0.7 volt, the transistor saturates. Heavy collector current through the supply resistor drops the voltage to nearly zero at the collector. Therefore, the output takes on a logic-low condition.

Conclusion Two: In a common-

emitter stage, when the input is at *logic high*, the output goes to *logic low*.

It is interesting to note that at this point the common-emitter digital stage *inverts* the logic state from input to output. An input low causes an output high; an input high causes an output low. The labels on the input and output leads, as shown in Fig. 1-a, help you remember this. Plain Lo/Hi labels marked LO/HI refer to the natural or ready condition of the stage, sometimes called the off condition. The LO/HI labels contained in parentheses refer to the active or on condition.

Now take a look at Fig. 1-b, the emitter-follower stage. Again think first of the off condition, with no input (or, rather, with logic-low input). Unbiased, the transistor draws no collector current. With no transistor current, no voltage develops across the emitter-load resistor. No DC voltage appears at the output terminal. Output therefore is *logic low*, the same as the input.

Conclusion Three: In a common-collector stage, a logic-low input causes a logic-low output. There is no logic inversion.

Now, imagine a logic-high input applied to the transistor base. It's positive logic, of course, and biases the transistor on—into saturation. Heavy collector current flows. Current drawn through the emitter-load resistor produces a voltage drop, with the positive end at the emitter. The on condition thus produces a logic-high output.

Conclusion Four: In a common-collector stage, logic-high input creates logic-high output. There is no logic inversion.

In the final analysis, these four conclusions typify all digital logic. You are concerned only with logic input/output states, either low or high. Exact DC values for logic low and logic high depend, actually, on the kind of logic devices selected. *Logic low* stays around zero and near-zero. . . seldom more than 0.2 volt or so. *Logic high* ordinarily runs from around 4 volts to as high as 16 volts.

To troubleshoot logic systems, you only have to figure out two things: which output state a logic circuit should produce, and whether it does or does not. Should a logic "stage" invert the logic presented to its input or pass it through right-side up? Knowing that, you can verify correct operation with a DC voltmeter.

Here's the fundamental procedure. Feed in logic low first, then logic high. Your voltmeter verifies each input. Then, at the output terminal, your voltmeter shows whether the expected logic condition has been produced for each input. In a noninverting stage, a logic-low input causes a logic-low voltmeter reading at the output; logic high makes the meter read logic-high output. An inverting stage does just the opposite. With low input, your voltmeter measures high output; then with high input, you measure low output voltage.

GATE LOGIC

Sections and stages that use logic in real equipment are generally more complex. Nevertheless, they are nothing more than combinations of elements that manipulate the two basic operating conditions. Logic-low and/or logic-high inputs create one condition or the other at the output of each circuit, stage or section.

Many logic stages are still put together with discrete components, as shown in Fig. 1. But transistors, diodes and resistances are nowadays generally placed on a monolithic substrate and become integrated circuits. Medium- and large-scale integration (MSI and LSI) allow extensive combinations that perform complex operations. Yet even the most elaborate LSI chips consist of "building-block" logic circuits. These circuits are called *gates*.

Gates can appear complicated, but when you consider what they do, they turn out to be simpler than you might expect. So that's the way you should approach them here.

You will find "truth tables" are included with each gate circuit. A truth table is a way of depicting in "easy-to-see" form how a gate reacts to various logic-input combinations. Because, after all, this is the purpose of each kind of gate: to respond one way or another to various input conditions.

NOT Gate—This is the simplest gate of all. Study the symbols shown in the NOT Gate chart. Pay no attention to the truth table at this time.

A triangle by itself (bottom left of chart) represents an amplifier. For digital logic, an amplifier merely passes along the logic condition that is fed to it. The logic-high level (DC voltage value) may be different at the output than at the input. But in a plain amplifier, both values nonetheless represent one condition: logic high. Through a simple amplifier, symbolized by the triangle, logic low (near-zero DC volts) creates logic-low output, and logic high creates logic-high output. Actually, this bare triangle symbol is seldom seen in digital logic systems. . . only when level

CHART 1—NOT GATE



INPUT	OUTPUT
0	1
1	0

NOTE:

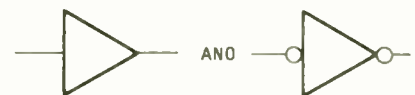

REPRESENT A NON-INVERTING AMPLIFIER (OFTEN A BUFFER).

or value changes occur and not logic changes, since there is no logic change from input to output.

You very often do see one or the other of the two shown at the top of this chart—i.e., the triangle with a small circle

at its output tip or input edge. This symbol represents a *NOT* gate.

The little circle has a special meaning: It is a "negating" symbol used with logic gates. Wherever you see it, the little circle negates (reverses) whatever logic condition would otherwise pass that point.

How does the little circle work as part of a *NOT* gate symbol? The triangle (an amplifier) by itself would pass along its input logic intact. But the circle negates the normal output of the amplifier. Hence, a logic-low input causes logic-high output from a *NOT* gate. And logic-high input becomes inverted, as it passes through a *NOT* gate, to logic-low output.

Basically, then, a *NOT* gate, the triangle-and-circle symbol, represents a digital-logic inverter. In other words, whatever condition appears at its input changes to the other condition at its output. If you compare the *NOT* gate with the simple stages in Fig. 1, you'll find it matches the operation of Fig. 1-a.

Now, examine the *NOT* gate truth table. Truth tables use 1 and 0 to represent the high and low states, respectively. (You can even say "high" for 1 and "low" for 0 if this helps you recognize what's happening with the actual gate.)

The first line of the *NOT* gate truth table says that, with a *NOT* gate, a logic-low input brings a logic-high output. The second line tells you that logic-high input brings logic-low output. And that's how a *NOT* gate operates.

AND Gate—This simple gate introduces, in digital logic, what you can consider as "dependencies." The output condition from this gate depends on input combinations.

The *AND* gate takes its name from the fact that it must receive logic high to inputs *A* and *B* before the output becomes logic high. If input *A* alone has logic high applied, the output remains at logic low. Similarly, a logic-high input at *B* alone will not turn on this gate: the output remains logic low. However, once input *A* and input *B* have logic high applied, the output also goes to logic high.

What's the purpose? Figure 2 illustrates one *AND*-gate application in a video cassette recorder. It's an end-of-tape shutoff. Pressing the Rewind button on the VCR deck applies logic high to *AND* gate input *A*. Input *B* comes from an end-of-tape sensor. As long as the tape is rewinding, input *B* sees only logic low. So, the *AND*-gate output remains at logic low.

When all the tape has unwound from the take-up reel, the end sensor sends a logic-high signal to gate input *B*. Inputs *A* and *B* are now both high, so the gate output goes high. This sends a logic high to a Stop Solenoid section, that returns all keyboard buttons to the STOP position.

That action releases the REWIND button, returning input *A* to logic low. Hence, even if the tape-end sensor continues to send a logic high to input *B*, the

AND-gate output goes low. Thus, the Stop Solenoid section cannot prevent depressing the other operating buttons.

As for the *AND*-gate truth table, it is read as follows:

Line 1: If inputs *A* and *B* are both at logic low, output also is logic low.

Line 2: If only input *B* goes to logic high, output remains at logic low.

Line 3: If only input *A* goes to logic high, output continues logic low.

Line 4: If inputs *A* and *B* both receive logic high, output goes to logic high.

As you can see, a truth table explains concisely how the gate functions. If you have trouble figuring out how a gate operates from knowing its symbol and meaning, you should memorize the truth tables for each of the gates explained in this section. Familiarity with these gates simplifies your understanding of VCR operation. And you cannot troubleshoot without knowing how the gates work.

OR Gate—Another dependency-type logic gate uses more than one input. Gate turn-on depends on one input or the other receiving a logic-high signal. In other words, logic high at either input results in a logic-high output.

Extending the reasoning for this type of gate, you would decide that if either input can gate a logic-high output, then both can. This proves true in an ordinary *OR* gate. This configuration is termed an *inclusive-OR* gate. Turn-on (output high) comes from either gate going high, and includes both gates if they happen to be high at the same time.

But another version of the *OR* gate is termed an *exclusive-OR* gate (*X-OR*). Either input excludes the other input. It works like this: If input *A* goes high, the gate output goes high. Or, if input *B* goes high, it gates a high output. But the instant one input goes high, it automatically excludes the other input. The moment the second input goes high, the gate turns off and the output returns to logic low.

Truth tables for *OR* and *X-OR* gates reveal this peculiar characteristic. As you study them, note also the difference in

symbols for the two varieties of *OR* gate.

The inclusive-*OR* truth table tells you that two low inputs produce a low output. Logic high at input *B* or input *A* or both brings a logic-high output.

The exclusive-*OR* truth table shows that a both-low condition produces the same result as for the plain *OR* gate; and so does a high condition at input *A* or *B*. But logic high to both inputs of an *X-OR* gate leaves the gate output low (or returns it low if one input has placed the output high).

NAND Gate—This gate is often called a *Not-AND* or a *Negated-AND* gate. Either term gives you a strong clue to how it works.

Note the symbol in the *NAND*-gate

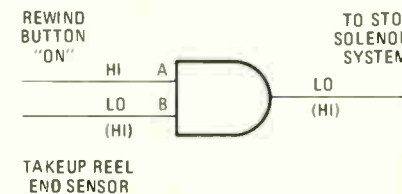
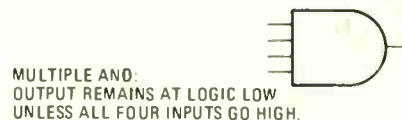
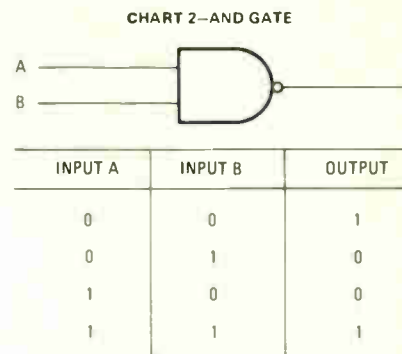

FIG. 2—SIMPLE AND GATE as used in one video cassette recorder proves how uncomplicated digital logic is, taken one gate at a time.

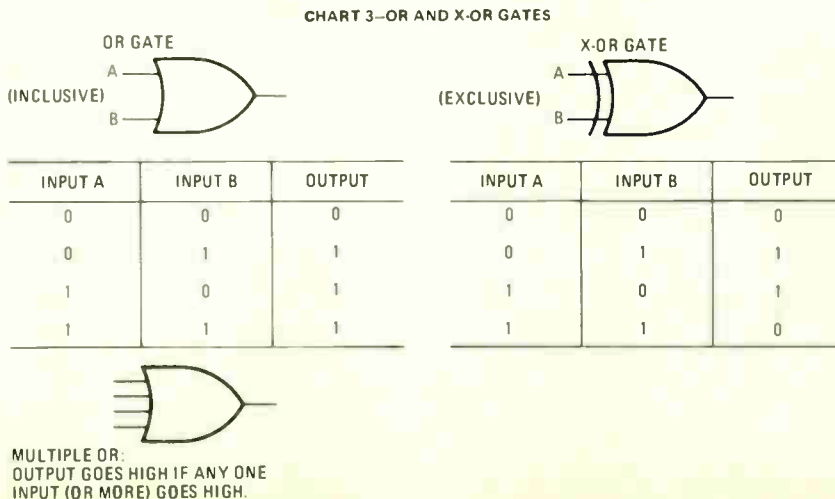
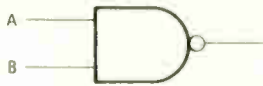

CHART 4 - NAND GATE



INPUT A	INPUT B	OUTPUT
0	0	1
0	1	1
1	0	1
1	1	0

chart. It resembles the symbol for an AND gate, except for a small circle at the output. This small circle makes this a NAND gate. The circle negates (or inverts) whatever output would be normal from the AND gate. (Remember the NOT gate. . . an amplifier with a circle that negates or inverts the output?)

So, whenever the normal AND output would be low, NAND output is high. Conditions that would make an AND gate output high bring the NAND gate output low. In other words, gate operation is *Not AND*, or is AND negated or inverted.

By now, truth tables should be helping you to quickly recognize how a gate operates. Study the NAND-gate truth table.

A low at both inputs of an AND gate would produce low output. Through a NAND gate, this becomes inverted, so that the output is high when both inputs are low.

Input B alone going high would not turn on an AND gate, so output would be

CHART 5 - NOR AND X NOR GATES

NOR GATE



INPUT A	INPUT B	OUTPUT
0	0	1
0	1	0
1	0	0
1	1	0

low. The *Not* circle of the NAND gate inverts this result, so the NAND-gate output stays high when only one input goes high.

With input A high, if the other input is low, the same condition results—a continued high output from the NAND gate.

Applying logic high to both inputs in the AND portion of this gate would create a logic-high output. But the *Not* circle negates the high state, so, with logic high at both inputs of this NAND gate, the output goes low.

You could wire a NOT gate following an AND gate and get the same result. But designers easily construct the two gates as one: and the result is a NAND gate.

NOR Gate—In like manner, designers have put together *Not-OR* or *Negated-OR* gates. Operation of this type of gate begins as with an OR gate, except that the output is then inverted. Notice the *Not* circle at the output of the OR symbol in the NOR-Gate chart. (By now, you could probably write a NOR gate truth table

X NOR GATE



INPUT A	INPUT B	OUTPUT
0	0	1
0	1	0
1	0	0
1	1	1

yourself. Cover up the one shown and try. It makes good practice and tests whether you really understand gate principles.) Notice that this *Not* circle symbol indicates an inclusive-NOR gate. Line 4 in the truth table changes for an exclusive-NOR gate or X NOR gate.

Line 1: Both inputs low would bring an OR-output low, so the NOR output is high.

Lines 2 and 3: Either input high would bring the OR output high, so the NOR output goes low.

Line 4: In an inclusive-OR configuration, both inputs high would cause a high output, so the inclusive-NOR output is low. In an exclusive-OR gate, both inputs high would make the output low again, so an exclusive NOR gate delivers high output.

You've been introduced to basic digital logic and are now ready for more advanced logic operations and the VCR troubleshooting procedures coming next month.

R-E

THE DEVIL'S DUNGEON, by Dr. C. William Engel. Engel Enterprises, P.O. Box 16612, Tampa, FL 33687. 15 pp. 8 1/2 X 11 in. Softcover, \$3.50.

The legend is that quantities of gold are hidden in a maze of caves beneath the earth. There's a volcano, demons, monsters and poison gas thrown in. It's a computer simulation written in BASIC. You get a program listing, a sample run, instructions for modifying the program variables. You need a computer to play, of course, and it's really just a variation on "Caves" or "Hunt The Wampus." Worth trying if you don't already have a program for "Caves" or "Hunt The Wampus."

HOW TO BUY, INSTALL, AND MAINTAIN YOUR OWN TELEPHONE EQUIPMENT, by Joseph La Corrubba and Louis Zimmer. Almar Press, 4105 Marietta Dr., Binghampton, NY 13902. 52 pp. 5 1/2 X 8 1/2 in. Softcover, \$3.

This book is designed to help you cut the cost of your telephone and related equipment by installing your own system (now permitted by recent FCC rulings). The easy-to-read instructions for purchasing, installing and maintaining the equipment are accompanied by diagrams and illustrations of basic parts. Dial, pushbutton and party-line phone systems are described, as well as such extras as answering devices, loudspeakers, special handsets, etc. The FCC and phone company requirements are listed in the back.

IEEE STANDARD DICTIONARY OF ELECTRICAL & ELECTRONICS TERMS, Second Edition, Revised and Expanded. Wiley-Interscience, Div. of John Wiley & Sons, Inc., 605 Third Ave., New York, NY 10016. 882 pp. 7 X 10 1/4 in. Hardcover, \$24.95.

This latest edition of 20,000 technical definitions is a must for all engineers, technicians, teachers and students, technical editors, writers and publishers. Each definition is an approved standard of the Institute of Electrical and Electronics Engineers, with the stress laid on American usage, although some internationally recommended terms are also included. Definitions are in alphabetical order and contain data on preferred usage, variations in meaning among specialties, cross-indexing and code numbers defining the source of each term.

TV TUNER SCHEMATIC/SERVICING MANUAL, VOLUME 2, 1974-1977, by Bob Goodman. TAB Books, Blue Ridge Summit, PA 17214. 200 pp. 7 X 10 in. Softcover \$6.95; hardcover \$9.95.

This manual provides TV technicians with much-needed up-to-date servicing and troubleshooting data on practically every UHF, VHF, mechanical or varactor tuner made between 1974-1977. The manual includes response curves, test equipment setups, diagrams, charts, exploded views of modules along with step-by-step troubleshooting techniques. The book also

tells you how to use test equipment, run certification checks, solder connections; it even includes instructions on how to construct a test tuner.

MY COMPUTER LIKES ME, by Bob Albrecht. Dymax, Menlo Park, CA 94025. 62 pp. 8 1/2 X 11 in. Softcover, \$2.

This book talks about people, computers and the programming language, BASIC. A teletypewriter must be used together with the book, which assumes prior knowledge of the machine.

THE CHEAP VIDEO COOKBOOK, by Don Lancaster. Howard W. Sams & Co., Inc., 4300 W. 62nd St., Indianapolis, IN 46268. 256 pp. 5 1/2 X 8 1/2 in. Softcover \$5.95.

This book contains complete do-it-yourself information on designing and constructing inexpensive alphanumeric and graphic microprocessor-based video displays. Details on IC's that provide cursor, loading and editing capabilities are given. Chapter 1 covers design basics. Chapter 2 shows you how to design low-cost systems and includes software for alphanumeric programs in most formats. Chapter 3 covers hardware; Chapter 4 contains construction and debug details on the TVT 675/8; and Chapter 5 discusses transparency—ways to compute and display simultaneously. An appendix contains IC pinouts, ASCII code table and a number conversion chart.

NOW THERE ARE 7 SIMPSON DMM'S ...choose the one that's best for you!

THE LATEST! Model 463, CORDLESS with LCD readout, 200-hour battery operation, 26 ranges, 0.2% DC V accuracy . . . all in a compact package.

\$170



All Simpson Digital Multimeters Have

reliable overload-protected LSI circuitry, easy-to-read 3-1/2-digit displays, automatic polarity. 200-hour burn-in backed by a 1-year guarantee. A full line of optional accessories.

For \$161

Popular Compact Model 461 with 26 pushbutton ranges, 0.25% DC V accuracy.

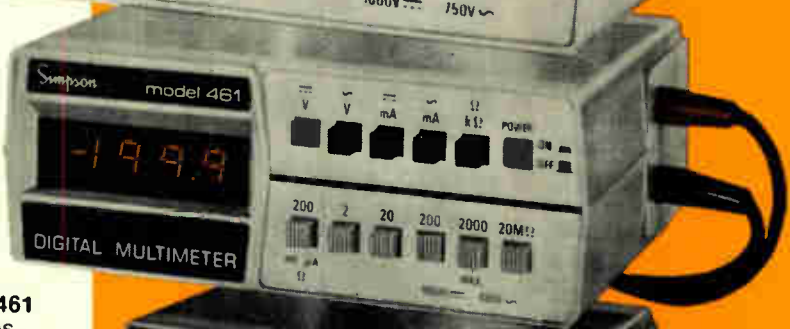

For \$199

Autoranging Compact Model 462 with batteries, charger/adapter. 0.25% DC V accuracy.

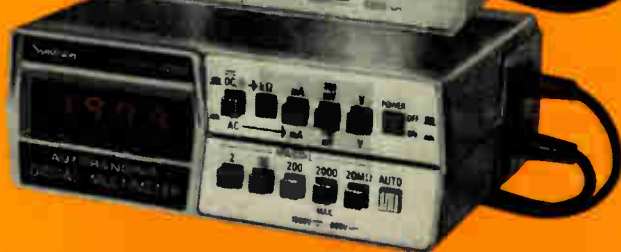

For \$310

360-2 Digital VOM with 0.25% DC V accuracy, 28 ranges, low-power ohms, AC/battery operation.



For \$323* **Deluxe 460-3A** with 0.1% DC V accuracy, 32 ranges, low-power ohms, analog trend display.



For \$345* **Autoranging Model 465A** with 0.1% DC V accuracy and low-power ohms ranges.



For \$245* **Popular Bench Model 464A** with 0.1% DC V accuracy and 28 ranges.

*Price for AC line version. AC/battery charging version available for \$42 additional cost.

CHOOSE THE ONE THAT'S BEST FOR YOU.
SEE THEM AT YOUR LOCAL SIMPSON DISTRIBUTOR.



SIMPSON ELECTRIC COMPANY

853 Dundee Avenue, Elgin, Illinois 60120
(312) 697-2260 • Cable SIMELCO • Telex 72-2416

CIRCLE 23 ON FREE INFORMATION CARD



OCTOBER 1979

Multiple tidbits plus a mystery circuit you should try to solve.

EARL "DOC" SAVAGE, K4SDS, HOBBY EDITOR

RECENTLY, I ATTENDED A MICROCOMPUTER workshop at Virginia Polytechnic Institute in Blacksburg, VA. The four-day session was under the excellent direction of David Larsen and Peter Rony, ably assisted by Jonathan and Chris Titus and others from the University staff.

The workshop was on interfacing and instrument automation. It was quite a treat—both the lectures and labs were well done. Even a microcomputer novice such as I learned a great deal.

I have felt strongly that microcomputers—even the so-called hobby type—could do many things besides play games. Now I have a reasonable handle on what many of those things are *and* how to make the computers do them. By the time you read this, I plan to have a microcomputer in my electronics lab to help develop and test the circuits you see here in "Hobby Corner." Then, I'll let it help write and edit the column! When not otherwise engaged, it can operate my ham station; and that's just for starters!

When you are trying to get a handle on a field that is new to you, reading and experimenting on your own will help. However, especially when it is a rapidly developing field, getting the word directly from the horse's mouth is very advantageous. If you can arrange to attend one of the many workshops put on by Dave, Peter, *et al*, by all means do so. (I was surprised to find fellow participants from all over the East Coast—from Canada to Alabama, Minnesota to Iowa. These same fellows, by the way, also conduct workshops in other parts of the country.) If you can't attend a workshop, the next best thing is to study the *Bugbook* series (published by E & L Instruments, 61 First St., Derby, CT).

This series specializes in the 8080 and its various relatives, and provides a most thorough documentation on that family. Much of the material covered is directly applicable to systems based upon any microprocessor, and the remainder can be so modified.

As for me, I'm getting my feet wet. In case you, too, are at the thinking or beginning stages, I'll pass along some helpful information from time to time. The "Hobby Corner" will continue to run the gamut in the broad field of electronics—microcomputers will become simply just another hobby.

Back to the pot!

We have discussed before the characteristics of a parallel resistor/potentiometer combination. Reader Daniel Koellen (WB9TCU) of Madison, WI, writes of yet another aspect of its two-terminal use:

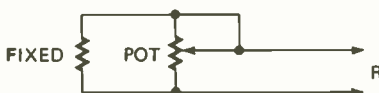

FIG. 1

If the pot is wired as shown in Fig. 1, the result is a smooth progression from zero to the value of the parallel combination. In this case the value does *not* rise to a peak and then decrease. In fact, the only change is the apparent *taper* of the original pot.

Many thanks to Mr. Koeller for this suggestion. Now, I hope we can put the pot to rest!

Mystery lights puzzle

Mr. Tom Faron of Catawba, VA, has developed a very interesting little circuit. It is quite simple but also very deceiving. I'll tell you about it and give you a chance to figure it out before the entire circuit appears in "Hobby Corner."

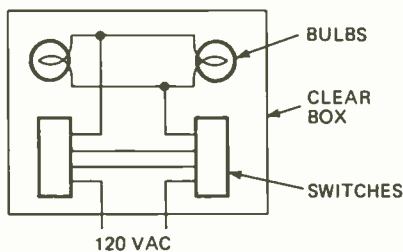

FIG. 2

This project involves a clear plastic box so that you can see everything that's inside. At one end of the box are two DPST switches; the other end contains two clear 7½-watt night-light-type bulbs. Connections are made by soldering directly to the bulb bases so that nothing can be hidden in sockets. The whole outfit looks like the sketch in Fig. 2.

Note that only *two* wires run from the switches to the bulbs. Yet, by placing the switches in various positions, you can have both lights off, both lights on, only

the left light on, or only the right light on.

Now, if you could run another wire up from the switches to the bulbs, this would be a simple problem, but there are only two wires. Try to see if you can find the answer to the puzzle. For safety and convenience, you may want to use a lower voltage (filament transformer and dial lamps).

Next time, I'll show you how Mr. Faron's box works. In the meantime here's a hint: I didn't say that there is nothing else in the box—I've described only what you can see.

Circuit board catalog

The Trumbull Company (833 Balra Drive, El Cerrito, CA 94530) has a new catalog of circuit board and related items, with several unusual listings.

One item is a "rub-on" silver-plating powder for use on PC boards, switches and relay contacts—in fact, it can be used on any copper, brass or silver base. It really is a no-mess, no-fuss plating process. Other notable items include a diazo-based film for artwork and some handy circuit board spacer/supports that eliminate the need for bolts, spacers, washers and nuts.

Roy Trumbull also passes along a helpful idea for cleaning blank PC boards prior to coating them with etch resist. He uses the standard 3M—*Scotchbrite*, but he puts it into a vibrator-type sander for speed and uniformity of result.

Tone control circuit

Mr. Dowdy of Blanco, TX, has asked for a simple tone control circuit to add to an audio amplifier. I recall one that was used often in the old tube-type radios, record players, and just about everything. Some of you may remember it, too.

As shown in Fig. 3, this ultrasimple tone control requires only two components. It won't provide top-flight, hi-fi performance, but it is surprising just how effective it is. The control works by passing varying amounts of high-frequency signals and, thus, preventing them from reaching the speaker.

Components values are not critical. You may want to try different values for the capacitor to alter the effect of the control.

This tone control can be used in any tube-type audio circuit, but can't be used in transistor-based amplifiers? I tried it on several such amplifiers around the

continued on page 116

PLUG IT IN AND TAKE COMMAND



X-10 Remote Control For Lights and Appliances

NO WIRES NO HASSLES

System X-10 requires no special wiring or complicated installation. Simply plug a Command Console into your wall outlet in any desired location in your home. Plug each Lamp or appliance into the appropriate module and then plug that module into any wall outlet. Any number of Command Consoles may be used in a single system.

TOTAL CONVENIENCE

With System X-10 you can operate almost every light and electrical appliance in your home without leaving the comfort of your easy chair. Imagine turning on a TV set or stereo, even dimming a light, in the next room without moving from your chair.

Think of the money you can save on electric bills with System X-10. Turn off heaters or appliances from any location in your home without a lot of running around.

DELUXE ULTRASONIC COMMAND SYSTEM

The Console controls all modules from its built-in keyboard, plus it completely controls all modules from its wireless hand held ultrasonic control unit. Simply aim the hand held unit at the Console, press any appropriate Command button to turn on and off, dim and brighten lights, or turn on and off appliances. Hand held unit operates at distances of up to thirty feet, line of sight of console (does not operate through walls). A worthwhile addition to any existing X-10 system or an excellent way to begin.

STANDARD COMMAND CONSOLE

Fully controls all modules as above system, but will not respond to hand held remote unit commands - may be intermixed with the deluxe Command System or used separately to form independent control systems.

MICROPROCESSOR BASED DESIGN

The BSR X-10 System uses the latest digital techniques for trouble-free operation. Digital pulse codes are sent through the house power lines to assure reliable control throughout the system. Amazingly compact; The Command Consoles measure only 4 3/4" X 3 1/2" X 3 1/2".

LAMP MODULE

Each module will control any incandescent lamp rated up to 300 watts from control signals received from the Command units. Functions include on and off, brighten and dim. UL listed.



APPLIANCE MODULE

Each module receives signals from the Command units to turn appliances on and off; such as TV, stereo, fan, etc. Maximum appliance ratings: Resistive load - 15 amps. Motor load - 1/3 HP, Incandescent lamp - 500 watts. UL listed.



WALL SWITCH MODULE

Receives signals from the Command units to control incandescent lamps normally operated by a wall switch up to 500 watts. Installs just like any normal wall switch. Functions include on and off by remote or local control and brighten and dim by remote control. UL listed.



GETTING STARTED

Deluxe-Ultrasonic starter kit includes: 1-Deluxe Ultrasonic Command Console, 1-Hand Held Remote Unit, 2-Lamp Modules, 1-Appliance Module. Only \$112.95

Standard starter kit includes: 1-Standard Command Console, 2-Lamp Modules, 1-Appliance Module. Only \$87.95
Extra Lamp, Appliance or Wall Switch Modules only \$16.00 each.

Extra Deluxe Ultrasonic Command Console with Hand Held Remote Unit, \$64.95.

Extra Standard Command Console \$39.95.

Please include \$3.00 shipping and handling on all orders.

ADVANCE ELECTRONICS		To order — use this coupon or call
		TOLL FREE HOT LINE
		800-223-0474
54 West 45 Street New York N Y 10026		IN NEW YORK STATE 212-637-2224
Please send me		
BSR 5 piece Deluxe Ultrasonic starter kit		\$112.95 set
BSR 4 piece Standard starter kit		\$87.95 set
Lamp Mod	Appliance Mod	Wall Switch Mod
		\$16.00 each
Deluxe Ultrasonic Console with Handheld Remote Unit		\$64.95 each
Standard Command Console		\$39.95 each
Payment Enclosed <input type="checkbox"/>	Bill my MASTER CHARGE <input type="checkbox"/>	VISA <input type="checkbox"/>
Acct #		Exp Date
Name		
Address		
City	State	Zip
Add \$3.00 Shipping and Handling N Y S Res. add sales tax		

In An Instant. YOU CAN SAFELY PLUG AWAY WITHOUT OVERLOADING OR COMING UP SHORT

You can do it thanks to SGL WABER® multiple outlet strips. There are over 250 versatile models with unsurpassed quality workmanship. Each exceeds National Electrical Code standards and is safety tested. Ideal for organizing your work area and having extra outlets *exactly* where you want them. Over 2,000 electronic distributors carry the SGL Waber line. Send for our free 24-page catalog, today!

SGL WABER Electric
A division of SGL Industries, Inc
Dept. H—300 Harvard Avenue
Westville, New Jersey 08093
(609) 456-5400



CIRCLE 24 ON FREE INFORMATION CARD

COMMUNICATIONS CORNER continued from page 118

inner trace is the overall peaked response with both the primary and auxiliary filters switched in and set for maximum selectivity. Similar results would be obtained in the notch mode, both filters providing a steeper notch than could be obtained with only the primary filter.

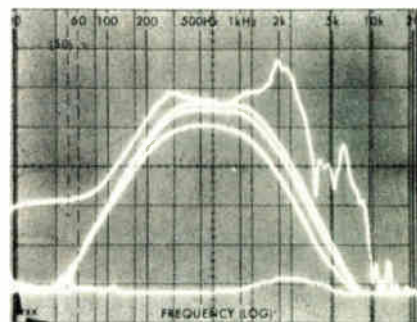

FIG. 4

Figure 4 shows the low-pass filter action. The *clean*, almost symmetrical, inner traces show the effect of adjusting the selectivity control; as you can see, there is no great variation in the passband caused by the selectivity control. If the selectivity control is advanced too far, however, it can cause the *breakup* (instability) shown the jagged outer trace of Fig. 4. Instability as the result of attempting to use excessive selectivity is true of all operating modes.

While there is little use for the low-pass mode for CW reception, it does come in handy for SSB reception because it permits the auxiliary notch filter to literally punch a hole in the low-pass passband, thereby suppressing heterodyne interference (as from a CW station).

I haven't touched on the high-pass filter mode because I can't find a use for it that improves on results obtained from the other modes. This is common for MFJ equipment, for their gear often appears to include everything a circuit can provide even if there isn't any practical use for a particular feature.

The *MFJ Signal Enhancer II* has two phone jack outputs for a speaker and headphones. The headphone output is somewhat unusual in that it is designed for stereo phones, with the unprocessed input signal being fed to one earpiece and the processed output signal fed to the other earpiece. This is another example of an unneeded feature. This so-called "simulated stereo" simply places all the interference in one ear, which makes it very confusing to monitor. Your best bet is to wire monophonic headphones between the *tip* and *sleeve* of a stereo plug, leaving the *ring* (input signal) free. Or you can plug the phones into the speaker jack. When the signal enhancer is turned OFF the input is connected to the speaker for normal monitoring.

R-E

HOLD IT! Anywhere you want it.

PanaVise tilts, turns, rotates. One quick turn of the control knob and you securely position your work exactly where you want it. Holds firmly but gently the most delicate electronic parts and P. C. boards.

Whether you're into building home electronics, trouble shooting, or professional servicing... you'll wonder how you got along without this modestly priced 'extra hand.'

Model 396 Wide Opening PanaVise shown. An ingenious variety of other interchangeable bases, holders and accessories also available. See your electronics distributor, or write for FREE brochure.

PANA VISE® Dept. CE2
2850 29th St., Long Beach, CA 90806



CIRCLE 4 ON FREE INFORMATION CARD

**One Call.
Your Mallory distributor's
got them all.**

Take the search and wait out of your electronic parts finding.

Go straight to your Mallory distributor, by phone or in person.

Get to know the convenience and economy of simplified single-source buying. To

deliver exactly what you want in parts, quality, and quantity. Immediately from stock on hand, or in most cases within 24 hours from the factory.

Your Mallory distributor goes all out for his Number 1 VIP . . . you. Get in touch with him soon. Mallory Distributor Products Company, a division of P. R. Mallory & Co. Inc., Box 1284, Indianapolis, Indiana 46206. (317) 856-3731.

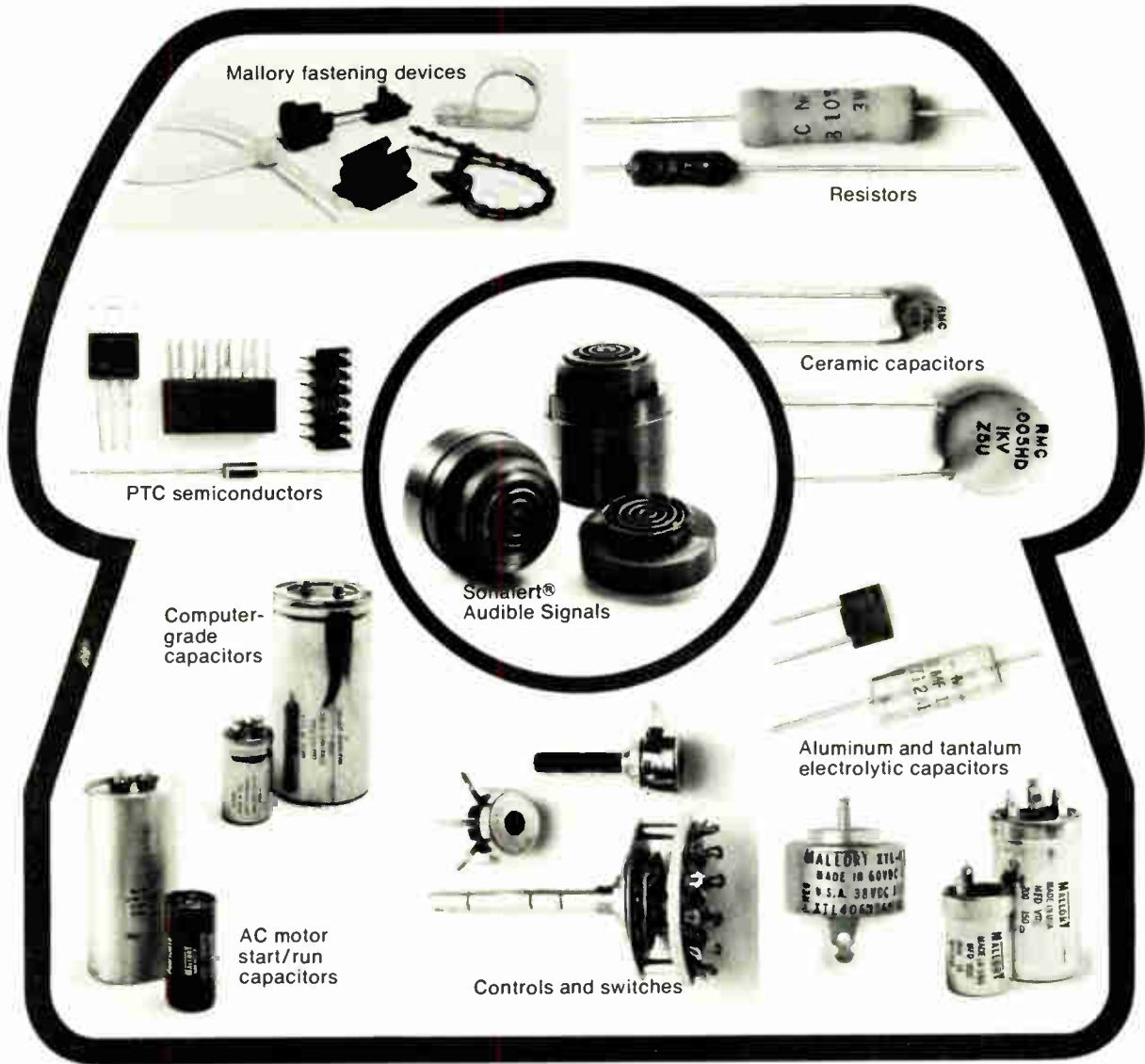

MALLORY

Capacitors • Controls • Fastening Devices • Resistors • Security Products • Semiconductors • Solderless Terminals • Switches

CIRCLE 58 ON FREE INFORMATION CARD

radio products

More information on radio products is available from manufacturers of items identified by a Free Information number. Free Information Card is inside the back cover.

FM MOBILE TRANSCEIVER, model TR-7600, features memory and 4-MHz coverage (800 channels on the 2-meter), plus simplex or repeater modes. The unit also includes orange LED display and warning indicator light; dual concentric knobs; offset switch; selector switch; switch-selectable power output from 10 watts to 1 watt; and mike.



CIRCLE 111 ON FREE INFORMATION CARD

Optional *model RM-76* microprocessor control unit allows the *model TR-7600* to perform the following functions: keyboard-select any 2-meter frequency; store frequencies in six memories; automatic and manual scan (in 5-kHz steps); lower and upper scan limit selectability; busy/open-channel scan; reset, stop and cancel scan capabilities; and select repeater mode. Digital

display indicates frequency and functions. Retail prices: *model TR-7600*, \$375; *model RM-76*, \$125.—**Trio-Kenwood Communications, Inc.**, 1111 W. Walnut, Compton, CA 90220.

CB TRANSIVER, Bold Warrior, is a compact AM unit that features LED channel readout, squelch, noise limiter, transmit/modulation indicator



CIRCLE 112 ON FREE INFORMATION CARD

lights, PA jack, speaker jack, mike and mounting hardware. Suggested retail price: \$79.95.—**Colt Communications, Inc.**, 5424 W. Touhy Ave., Skokie, IL 60077.

HAM MOBILE TRANSCEIVER, model FT-225RD, uses PLL circuitry and covers entire 4-MHz range of the 144-MHz band for SSB, CW, AM and FM operation. Optional memory unit is available for storing and recalling any frequency. Other fea-



CIRCLE 113 ON FREE INFORMATION CARD

tures include bright LED readout to 0.1-kHz resolution, squelch, VOX, PTT, tone burst, noise blanker, squelch, clarifier and FM zero-center tuning meter. Power output is from 1 watt to 25 watts, variable. Unit measures 280 W X 125 H X 315 D mm, and weighs 9.0 kg. Suggested retail price: \$895.—**Yaesu Electronics Corp.**, Box 498, Paramount, CA 90723.

UNIVERSAL-MOUNT CB ANTENNA, model 12620, is a 48-inch, top-loaded antenna that can be installed anywhere on a vehicle. The glass-fiber whip comes with 17 feet of RC-58/U coax cable and PL-259 connectors; and two L-shaped brackets are included for security and vertical alignment. Mount accommodates 1/4-inch metal thickness.—**Antenna Incorporated**, 26301 Richmond Rd., Cleveland, OH 44146.

CIRCLE 114 ON FREE INFORMATION CARD
continued on page 124

THE BIG PLUS + Graphic Equalizer

ASSEMBLED
\$189⁹⁵

KIT
\$99⁹⁵



LOADED with Quality Features!

- Stereo . . . Eleven Bands Per Channel • Extremely Low Noise & Distortion • LED Peak Indicators • Center Detent ("flat") sliders • Built-in "record" Switching • Line and Microphone Level Inputs/Outputs • Regulated Power Supply • Fully Guaranteed • Horizontal or Vertical Cabinets • Kit or Fully Assembled • Plus Much, Much More!

Absolutely equals or exceeds overall performance and features of any graphic equalizer made today!

AARON-GAVIN INSTRUMENTS, INC.

17231 Corla Avenue Tustin, California 92680

Yes! I've enclosed \$ _____, RUSH me: cabinet send brochure
 _____ assembled equalizers at \$189.95, p.p.d. Horizontal (flat) Vertical (up-right)
 _____ unassembled equalizer kits at \$99.95, p.p.d.
 California residents include 6% sales tax
 Visa & Master Charge orders accepted

Name _____ Card No. _____
 Address _____ Exp. Date _____ Bank _____
 City _____ State _____ Zip _____ No. _____

Dealer inquiries invited
CIRCLE 16 ON FREE INFORMATION CARD

calcumeter™

The unique handheld multimeter controlled by a microprocessor. Simple keyboard programming transforms V-Ω-A measurements directly into useful engineering readouts: % deviation, automatic averaging, decibel voltage values, pressure and temperature (mx + b conversion).

Another programmable mode sets up HI-LO limits, permitting automatic component sorting or the troubleshooting of logic circuits (via an audible alarm!). You can even determine parallel or shunt resistances automatically (xy/x + y and xy/x - y keys).

- Full performance 3½-digit multimeter.
- 5-way memory storage.
- Autoranging or fixed.
- Single or continuous measurement modes.
- Scientific RPN calculator.
- Long life battery!

Available from local distributor for only

\$389

U.S.A.

Send for color brochure.

esi Electro Scientific Industries, Inc.

13900 N.W. Science Park Drive
Portland, Oregon 97229

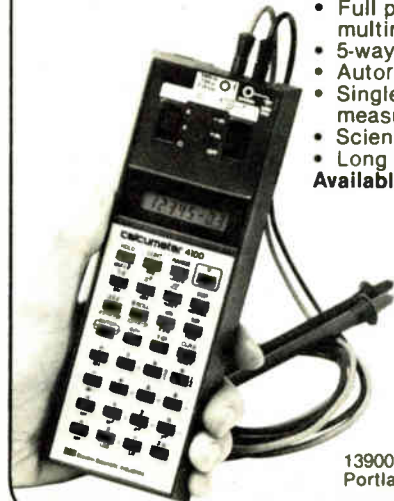

CIRCLE 87 ON FREE INFORMATION CARD



TRUST US TO TAME YOUR ARC ENEMY.

High voltage used to be the enemy of field technicians.

In order to measure it accurately, they'd either have to tote bulky test equipment to the installation site, or tote the unit to the test bench.

Then, in 1967, ITT Pomona Electronics introduced the first high voltage test probe with a built-in meter.

This compact, lightweight instrument made high voltage trouble-shooting practical and convenient anywhere. And it became an instant success everywhere.

Now we make six different ITT Pomona Electronics high voltage test probes. There are models for color and black and white television, microwave ovens, neon signs, electronic air cleaner systems, etc.

Best of all, they're priced so low that every serviceman can have one along.

See our new catalog for details on the full high voltage test probe line. Plus more than 640 other products you know and trust.

ITT Pomona Electronics, 1500 East Ninth Street, Pomona, CA 91766 • Phone: (714) 623-3463 • TWX: 910-581-3822

AVAILABLE THROUGH YOUR FAVORITE ELECTRONIC PARTS DISTRIBUTOR

FREE 1979 YEARBOOK CATALOG

Contains 100 pages of adapters, cable assemblies, jacks, plugs, boxes, sockets, connectors, jumpers, clips, probes, patch cords, wire, and much more. Yours free upon request. See our pages in EEM.



Pomona Electronics **ITT**

Learn Electronics along with MATHEMATICS

The Grantham Electronics-With-Mathematics SERIES — in six volumes, written in *home-study-course* style — now available by mail order...

(To order, check off the volumes wanted.)

- Introductory Electricity With Mathematics. Size, 7 x 10½. 288 pages. \$12.95
- Fundamental Properties of AC Circuits. Size, 7 x 10½. 267 pages \$12.95
- Mathematics for Basic Circuit Analysis. Size, 7 x 10½. 352 pages \$14.75
- Basic Electronic Devices and Circuits. Size, 7 x 10½. 431 pages \$16.75
- Basic Radio and Television Systems. Size, 7 x 10½. 409 pages \$16.75
- Antennas, Transmission Lines, & Microwaves. Size, 7 x 10½. 315 pages. \$14.75

The books listed above are written in easy-to-understand home-study-course style. The author's extensive teaching experience enables him to anticipate questions the reader might ask, and thus to answer them. Many circuit diagrams with explanations, sample problems with step-by-step solutions, practice problems with answers given — easy-to-understand language, *in-depth* explanations. Order any of these books you want from GSE Home Study Books, at address below.

Prepare for Your F.C.C. LICENSE

- Grantham's FCC License Study Guide. Size, 7 x 10½. 377 pages \$14.75

This not a Q & A book, not a correspondence course, but simply an authoritative down-to-earth presentation of what you should know to pass FCC license exams for 3rd, 2nd, and 1st class radiotelephone licenses. Four information sections. 1465 FCC-type multiple-choice questions, with more than 65,000 words "explaining" the correct answers. Self-study presentation. Order from GSE — address at bottom of page.

OTHER GSE BOOKS

- Improve Your Technical Communication (How to write technical reports, manuals, proposals, articles, etc.). Size, 7 x 10½. 216 pages \$4.95
- Geometry for Science and Technology. Size, 7 x 10½. 141 pages \$5.95
- Modern Electronic Calculations. Size, 7 x 10½. 207 pages \$6.95
- Answers in the Mail (The author, a correspondence instructor in electronics, physics, and math, gives examples of questions written in by students, along with his detailed replies.) Size, 6 x 9. 217 pages \$4.95

TO ORDER any of the books listed above, check off the ones you want, compute the total price, *add only 85¢ (regardless of the number of books you are ordering) for postage and handling*, and mail this ad with your name and address and payment (no C.O.D.s) to:

GSE Home Study Books
(2500 S. LaCienega Blvd.)
P. O. Box 35499, Los Angeles, CA 90035
CIRCLE 30 ON FREE INFORMATION CARD

CB TRANSCEIVER, Dyna-Com 40, is a hand-held unit that combines full 5-watt input, LED readout and PLL circuitry. Transceiver also contains "range boost" circuit squelch, automatic gain



CIRCLE 115 ON FREE INFORMATION CARD

control, noise limiter, S/R/F meter, battery power indicator and mike input jack. Suggested retail price: \$149.99.—Lafayette Radio Electronics Corp., 111 Jericho Turnpike, Syosset, NY 11791.

CB BASE TRANSCEIVER, Excalibur SSB model 1200, features rack mounting, variable RF gain, noise blanker, squelch, clarifier control, tone control, and RF, SWR and signal strength meters.



CIRCLE 116 ON FREE INFORMATION CARD

Other features include TX, RX, USB, LSB, AM mode lights, antenna inputs and jacks. Suggested retail price: \$529.95.—Colt Communications, Inc., 5424 W. Touhy Ave., Skokie, IL 60077.

CB BASE STATION MICROPHONE, model 48-034, contains a built-in preamplifier. External controls include press-to-talk bar switch and sliding gain switch. The mike provides a frequency response of 300 Hz-7 kHz, with an output level of -36 dB at 1 kHz with a 30-dB amplifier gain. The unit features a lock-swivel head, comes housed in heavy steel with baked-enamel finish, and includes a 6-foot, 5-conductor wire cable with



CIRCLE 117 ON FREE INFORMATION CARD
wiring diagram. The model 48-034 measures 4¼ X 3¼ X 7½ inches, and weighs 19 oz. Suggested retail price: \$115.—Robins Industries Corp., 75 Austin Blvd., Commack, NY 11725. R-E

THE MEAN LITTLE KIT

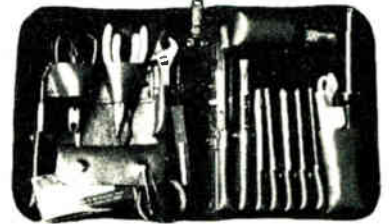

New compact 24 piece kit of electronic tools for engineers, scientists, technicians, students, executives. Includes 7 sizes screwdrivers, adjustable wrench, 2 pair pliers, wire stripper, knife, alignment tool, stainless rule, hex-key set, scissors, 2 flexible files, burnisher, miniature soldering iron, solder aid, coil of solder and desoldering braid. Highest quality padded zipper case, 6 x 9 x 1 3/4" inside. Satisfaction guaranteed. Send check, company purchase order or charge BankAmericard/Visa or Mastercharge. We pay the shipping charges.
JTK-6 TOOL KIT \$72 00

FREE CATALOG



Page after page of hard-to-find precision tools. Also contains complete line of tool kits and tool cases. Send for your free copy today!

JENSEN TOOLS & ALLOYS
1230 SOUTH PRIEST DRIVE - TEMPE, AZ 85281

CIRCLE 25 ON FREE INFORMATION CARD

FREE SWTP

CATALOG

Audio—Computers
Instruments
Kits & Assembled



Southwest Technical Products Corporation
219 W. RHAPSOODY
SAN ANTONIO, TEXAS 78216

CIRCLE 71 ON FREE INFORMATION CARD

state of solid state

A new analog-to-digital interface module for microprocessors

KARL SAVON, SEMICONDUCTOR EDITOR

BURR-BROWN RESEARCH CORPORATION manufactures several products that simplify interfacing analog input and output peripherals to a digital microprocessor. One of these products, the MP7400, is a multicomponent printed-circuit module that connects to as many as 64 analog inputs and, optionally, to two analog outputs. The input-level ranges are adjustable and can be selected as either single-ended or double-ended. The system has been specifically designed to be electrically and mechanically compatible with Motorola's 6800 micromodules and EXORciser.

Figure 1 shows that the MP7400 system is synchronized to the microprocessor $\phi 2$ and VMA/VUA inputs by the control and timing logic. The $\overline{\text{HALT}}$ line to the processor transfers the return handshake for proper system coordination. Inputs and outputs are addressed at memory locations assigned by the address decoder block. The PC board is factory-programmed for addresses 95F0 and 95F1 for inputs, and for 95F2 and 95F3 for outputs. Inserting jumpers and drilling out plated-through holes reassigns the peripheral functions to any other preferred location in the memory space.

The 8-bit bidirectional data bus D0-D7 is wired in parallel with the computer system bus, and is used to transfer an input channel number to the MP7400, send back converter status data and digitized voltages to the processor, and transmit data from the processor to the optional D/A output converters. Read/write control logic senses the direction of transfers from the processor's R/W output line, and either sets up a transfer to or from the input circuitry, or strobes one of the two output converters. The optional DC/DC converter shown in Fig. 1 lets the device operate from the single +5-volt processor supply by generating the ± 15 volts the module requires.

An input operation requires selecting the channel to be sampled, followed by either a read, or a status check and read. Let's assume that the application is not a particularly busy one, and there is plenty of time to wait for the input A/D converter to finish operating before the processor takes on other program tasks. To select one of the 64 input channels, a store-accumulator instruction is exe-

cut. For example, to enable Channel 31, one of the two processor accumulators is loaded with the binary equivalent of 31, and the contents of the accumulator are then stored at address 95F0. In a mnemonic program listing, this looks like $\text{LDAA } \#31$ or $\text{LDAA } \#\$1F$ followed by $\text{STAA } \$95F0$. This is the standard format the 6800 assembler converts into machine code. The number sign in front of the 31 means it is an immediate instruction with the data contained in the second word of the instruction. Since no dollar sign is included in the first instruction, the assembler knows that 31 is in base 10 and that it must perform a conversion to hexadecimal.

Hexadecimal conversion eliminates the clumsiness of writing binary sequences. Eventually, when the code is loaded into the processor, it will be converted into binary, the only form the computer understands. In the case of $\text{LDAA } \#\$1F$, the dollar sign shows that the data is already in hexadecimal and no further conversion is required by the assembler

($1F_{16} = 1 \times 16 + 15 = 31$). When these instructions are executed, the 95F0 address is put on the address lines, and the MP7400's address decoder activates the module. The channel number is transferred from the accumulator, the input multiplexer selects the 31st channel, and the A/D converter begins its conversion. During the 44- μs to 94- μs period required for the conversion, the MP7400 sends a $\overline{\text{HALT}}$ signal to the microprocessor, stopping program execution.

Since the MP7400 cannot immediately send out the halt pulse because of the inherent circuit delays, the $\overline{\text{HALT}}$ line does not swing low until later in the conversion cycle. The processor does not actually stop until the end of the next instruction, so it is necessary to follow the store instruction with a dummy instruction that does not affect system operation. A NOP (No Operation) is the logical choice. When the conversion is complete, the $\overline{\text{HALT}}$ line swings high and the processor continues with the instruction following the NOP. This next instruction is usually a read of the converted output—for example, $\text{LDAA } \$95F1$.

continued on page 128

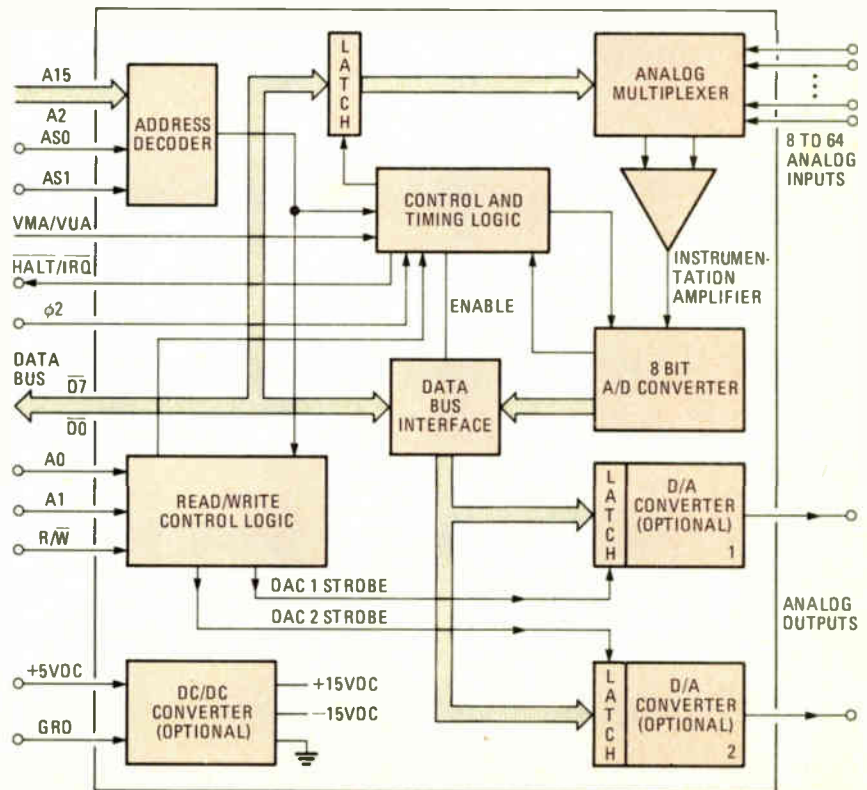

FIG. 1

Congratulations To Radio Electronics

*We've enjoyed serving folks interested
in electronics for a long time, too!*

1926



FIRST AIRCRAFT KITS An airplane was the Heath Company's first kit. Carrying the name, "the Heath Parasol," it sold for \$199 (less engine) in kit form.

1947



FIRST ELECTRONIC INSTRUMENT KITS The electronics era blossomed after World War II, and Heath was offering a kit-form oscilloscope for the low price of \$39.95 F.O.B. Benton Harbor.

1949



FIRST CONSUMER ELECTRONICS KITS Encouraged by the scope's success, Heath expanded its line and by '49 offered an FM tuner kit, a hi-fi amp, and a 3-tube "all-wave radio."

1952



FIRST AMATEUR RADIO KITS Amateur Radio gear entered the Heath line when a grid dip meter was offered in 1952, soon followed by the AT-1 CW transmitter kit.

1957



FIRST PERSONAL COMPUTER KITS In March of 1957, a new Heathkit flyer announced the introduction of two analog computer kits. The computer age had arrived for the kit builder.

1979



STILL THE WORLD LEADER IN QUALITY ELECTRONIC KITS When Radio Electronics began, who could have imagined the electronics in today's Heathkit Catalog? Write for your free copy now.

FREE

Send for it!

Heathkit

Heath Company,



Dept. 020-580
Benton Harbor, Michigan 49022

computer products

More information on computer products is available from manufacturers of items identified by a Free Information number. Free Information Card is inside the back cover.

SYSTEM SUPPORT BOARD, model ZPU-2, is a Z80A S-100 board that provides functional system support via two options: System support option consists of memory-mapping and multi-



CIRCLE 121 ON FREE INFORMATION CARD

task registers (model ZPU-2-compatible Xitan-K memory series supports up to 1 megabyte of memory for larger tasks). Four DMA channels are provided that allow data-transfer rates of 2 megabytes-per-second. Interrupt control and pro-

grammable timers for 1 μ s-1-second clocked pulses is provided. Floating-point option contains LS1 arithmetic processing unit which, when added to basic board, increases system's speed up to 10 times.

The model ZPU-2 operates at a switch-selectable 2- or 4 MHz. Wait state is provided separately on memory, DMA and I/O operations. Model ZPU-2 basic board price: \$395; system support package, \$674; and floating-point option, \$894.—Xitan, Inc., P.O. Box 157, Hansom, MA 02341.

COMPUTER SOFTWARE, PASCAL/Q, allows 8080 and Z-80 systems to execute PASCAL instruction sets (PASCAL developed by University of Southern California at San Diego), and is designed for MITS/Altair, iCOM and Intel floppy-disc systems, and for MITS/Altair cartridge disc systems. System features include QSAM (enhanced ISAM access method) structured files and automatic disc-file storage allocation.

A monthly software update service is available, with subscribers receiving a diskette with updates plus a newsletter. Prices: PASCAL/Q,

\$300; subscription service, \$19/month.—Queue Computer Corp., 1044 University Ave., Berkeley, CA 94710.

CIRCLE 122 ON FREE INFORMATION CARD

CONTROL BOARD, Paneldriver, is an S-100 bus-compatible board built around the Intel 8279 microprocessor and can handle up to 64 switches and provide 16 seven-segment displays. The board latches data from the bus for internal storage, and data is continuously multiplexed out to a series of displays. The Paneldriver also features

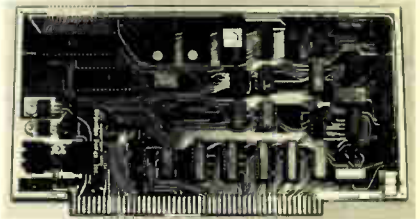

CIRCLE 123 ON FREE INFORMATION CARD

two-key or "N"-key rollover for automatic de-bounce, plus an on-board FIFO buffer. Space is provided on-board for 6K PROM. The board is available as a kit (without PROM's) and retails for \$194.95; in Canada, pay \$5 shipping charges; overseas, \$20.—Objective Design, Inc., P.O. Box 20325, Tallahassee, FL 32304.

NEW!

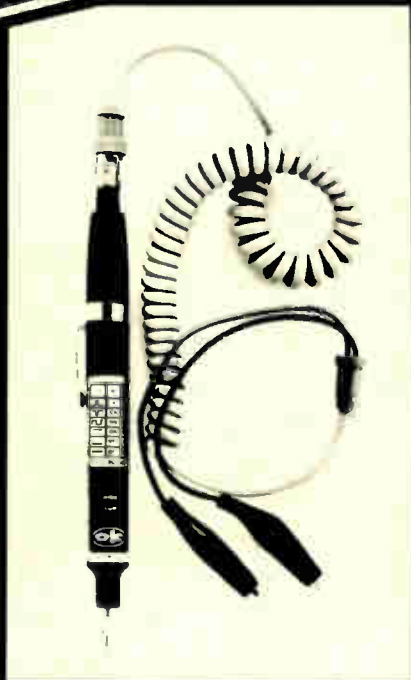

PRB-1 DIGITAL LOGIC PROBE

Compatible with DTL, TTL, CMOS, MOS and Microprocessors using a 4 to 15V power supply. Thresholds automatically programmed. Automatic resetting memory. No adjustment required. Visual indication of logic levels; using LED's to show high, low, bad level or open circuit logic and pulses. Highly sophisticated, shirt pocket portable (protective tip cap and removable coil cord)

- DC to > 50 MHZ
- 10 Nsec. pulse response
- 120 K Ω impedance
- Automatic pulse stretching to 50 Msec.
- Automatic resetting memory
- Open circuit detection
- Automatic threshold resetting
- Compatible with all logic families 4-15 VDC
- Range extended to 15-25 VDC with optional PA-1 adapter
- Supply O.V.P. to ± 70 VDC
- No switches/no calibration

\$36⁹⁵*

* ADD \$2.00 FDR SHIPPING (N. Y. CITY AND STATE RESIDENTS ADD TAX)

OK MACHINE & TOOL CORPORATION

3455 Conner St., Bronx, N.Y. 10475 (212) 994-6600 / Telex 125091

CIRCLE 31 ON FREE INFORMATION CARD

COMPUTER SYSTEM, *Micro 68*, is built around the 6800 microprocessor and provides on-board EPROM capability. System has 16-pushbutton hex keyboard, 6-digit LED display, built-in power supply, 128 words of RAM (expandable to 768

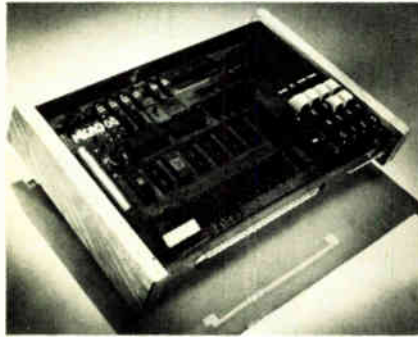

CIRCLE 124 ON FREE INFORMATION CARD words) and 2K of user-programmable EPROM. Monitor PROM contains all routines to load, inspect and edit programs; insert breakpoints for debugging; and execute programs. Suggested retail price: \$595.—**Electronic Product Associates, Inc.**, 1157 Vega St., San Diego, CA 92110.

LINE PRINTER, *model WH-14*, is a 5- X 7-dot matrix printer designed to interface with Heath *model H8* and *model H11A* computer systems via RS-232C serial interface or 20-mA current loop. Handshaking is provided by reverse data channel or busy control signal. The unit prints 96-character ASCII upper- and lower-case characters at a speed of 135-characters-per-second, 6-lines-per-inch spacing (8-lines-per-inch, software-selectable) and 80-, 96- or 132 characters-per-line, with a selectable baud rate up to 9600. The *model WH-14* uses 0.5-inch-wide ribbon on 2-inch spools, features adjustable-width sprocket to accommodate fan-folded paper, and comes with



CIRCLE 125 ON FREE INFORMATION CARD 25-pin EIA connector. Price: \$895.—**Heath Co.**, Dept. 570-140, Benton Harbor, MI 49022.

MICROCOMPUTER SYSTEM, *model JF68*, kit or assembled, is built around the 6800 microprocessor, is SS50-bus compatible and includes a 16-slot motherboard and power supply. The CPU board contains JFBUG(c), a 2K-byte resident ROM that allows implementation of any existing



CIRCLE 126 ON FREE INFORMATION CARD MIKBUG software without modification. Serial I/O card (included with system) allows RS-232 or current-loop interfacing; plus an audio cassette interface, using Kansas City Standard Recording technique. JFBUG monitor incorporates LOAD and SAVE commands. Prices: *model JF68* kit, \$549.95; assembled, \$749.95.—**JF Products**, 1441-5 Pomona Rd., Corona, CA 91720. **R-E**

NEW PRECISION COAX CABLE STRIPPER



Won't nick conductor or your pocketbook!

This little tool can make the big difference in CB reception! Prepares cable for connector perfectly without nicks or scratches and in seconds!

Models available for virtually every communication coaxial cable:

MODEL	CABLE	CONNECTOR
UT-5800	trims RG-58/U	for PL-259
UT-5900	trims RG-59/U	for "F"
UT-5901	trims RG-59/U	for PL-259 or TV wall plate
UT-6000	trims RG-6/U	for "F"
UT-8000	trims RG-8/U	for PL-259

Extra precision blades available, #CB-60. Packaged 2 blades per pack.

Available from your local authorized Cablematic distributor.



RIPLEY COMPANY, INC.
UTILITY TOOL DIVISION
CROMWELL, CT 06416 (203) 635-2200

CIRCLE 60 ON FREE INFORMATION CARD

They look expensive.
They sound expensive.
But they're not because you
build them yourself.

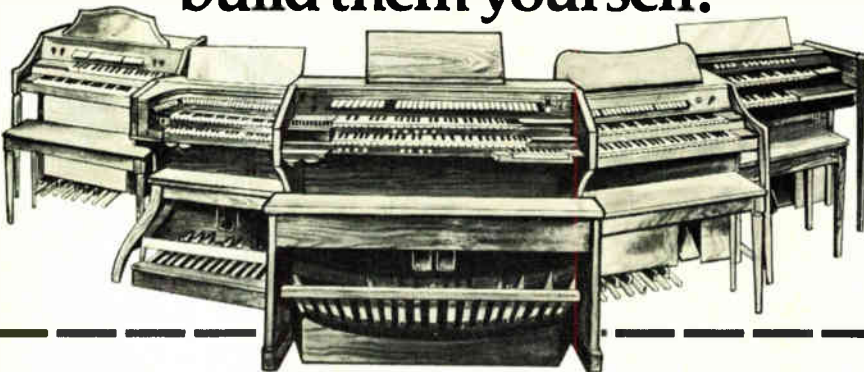

The Magnificent Schober Electronic Organs.

Imagine the pride and joy of owning one of the world's great organs. And for up to 50% less than an instrument of comparable sound and quality. Schober organ kits come in 5 different styles and sizes to fit your musical taste and budget.

Mail this coupon today for free information.

The Schober Organ Corp., Dept. RE-86
43 West 61st Street, New York, N.Y. 10023

Send me free catalog. Enclosed is \$1 for your 12" demo record.

Name _____

Address _____

City _____ State _____ Zip _____

CIRCLE 90 ON FREE INFORMATION CARD

Test jigs can be a big help in troubleshooting a chassis.

JACK DARR, SERVICE EDITOR

LET'S DISCUSS A VERY USEFUL PIECE OF test equipment; the Test Jig. A test jig is a cabinet with a picture tube, deflection and convergence yokes, convergence board and a set of extension cables so that it can be hooked to a TV chassis that is out on the bench. With the chassis out on the bench and a test jig, you can power up the chassis and take readings. Also, by replacing all at once the picture tube/yoke/convergence board, the test jig can be used as a very quick check to see if all of these parts in the set are good or bad.

Back in those Good Old Days, when a whole lot of color TV sets used RCA chassis, if you had a trade-in RCA with a good picture tube and yoke, anything from about a CTC-9 on, you could use it as a test-jig for any of the "round-tube" RCA chassis. If you had a "rectangular-tube" set, this would work not only with the later chassis but also with almost any of the round-tube types. This is a one-way swap, though. The round-tube jig won't work with the rectangular-tube chassis. These are handy for any sets, up to the time when solid-state came in.

With the all solid-state came problems. Yoke impedances were far lower, and the tube-type jig was out. However, in the hybrid sets with tubes in the horizontal and vertical output stages, the jigs do nicely.

Quite a few set manufacturers also have test jigs; RCA, Sylvania, etc., and some independents; Tele-Matic, etc. In

1971, RCA came out with a pair of test jigs. One, the 10J102, fits all round-tube RCA's made since 1957. The 10J103 is built for rectangular pix tube chassis, and will also work with round-tube types. They called this the ICTJ (*Industry Compatible Test Jig*). It came with a large handbook listing adapters for 28 different makes and the various chassis in these lines.

Sylvania has a test-jig called *Chek-A-Color*. This one can handle solid-state or tube sets by using an impedance-selector switch for the yoke. Most commercial jigs have built-in high-voltage meters. If yours doesn't have one, they can be bought separately and hooked up to your jig.

A slightly less expensive alternative, though not so versatile, is a set of extension cables with plugs and sockets matching the set. With these you can pull the chassis and use the set's own tube/yoke, etc. Tele-Matic, Pomona, and many others have these cables for specific set models and types.

A late but very useful type of test jig is Sylvania's *Module Extension Cable* sets. At present these are made for Zenith and RCA, and they can make things a lot simpler by letting you get a suspected module out where you can get at both sides for tests.

Pitfalls

There are a couple of minor pitfalls.

The major one is close impedance matching of the deflection yoke in the jig to the set. In tube sets, the tolerances were fairly loose. In solid-state, they're much tighter. If the yoke is not matched to the chassis, this can upset the boost voltage, flyback timing, and other things. (Hint: If you put the set on a jig and all of a sudden you have *new* problems, look out! Something is very apt to be mismatched.) However, the jig can give you quick answers in cases like boost problems. If the boost voltage is off and you suspect the horizontal winding of the yoke of being shorted, try a test jig. If the boost comes back, you can be fairly sure the original yoke is shorted.

The other major pitfall is the increased high voltage used in some later models. Some of the older jigs can't handle the new sets using up to 30 kV. Sams *photo-facts* has a caution on many data folders warning that the high voltage may be too high for some jigs. This should be checked before putting the chassis on the jig.

Another possible pitfall showed up in one of the very first test jigs. I used to get quite a few letters about it and still get the occasional one. Due to the 3 to 4-foot multiconductor cable used between the picture tube and chassis, there is quite a bit of shunt capacitance that develops and appears in the video circuits. So, you'll usually notice a perceptible horizontal smear or fuzziness on the jig. This is **NORMAL**. In fact, we called it "jig-smear". Ignore it till the chassis is back in its own cabinet.

Another hazard on all jigs is the exposed connection between the jig's high-voltage lead and the set. This can bite, arc over to the chassis and so on if not properly laid out. I invented (?) an enclosure for mine (see Fig. 1). This is just a polyethylene food-dish with a snap-on lid. I punched a hole in the bottom of the dish and ran the high-voltage lead from the jig inside it. Then I cut a slot in the lid. Now all I do is run the high-voltage lead from the chassis inside and connect the two leads. The cover protects the connection. Working with solid-state sets, where arcs are not at all welcome, this kind of protection is very useful.

One more point: Due again to added capacitance in the cables, you should never try convergence adjustments on the test jig. If you do, you'll have to do it over again when the chassis is back in its own cabinet. Ignore anything but very severe

continued on page 138

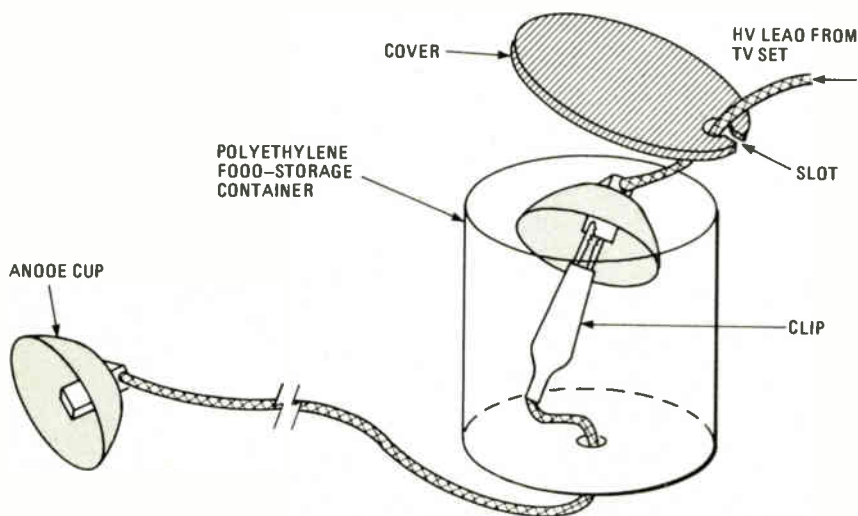

FIG. 1

When Quality Counts . . .

LEADER

We Stock A Full Range of Leader Equipment including Frequency Counters, Digital Multimeters, Audio Analyzers, Bridges, Testers and more...

ALL LEADER INSTRUMENTS ARE BACKED BY A TWO YEAR WARRANTY

Model LBO-515A
25 MHz Dual Trace/Dual Time Base Scope with Variable Delay



NEW

List Price \$1595
Call For Our Price

A Compact, High Performance Instrument for Lab or Field Use.

- Delayed Sweep permits accurate viewing of complex waveforms and precise time interval measurements
- Built-in delay line permits viewing leading edge of triggering waveform.
- Internal graticule, PDA CRT.
- Variable trigger hold off stable triggering on complex waveforms.
- Comprehensive triggering controls.
- Compact, rugged construction meets field service requirements.

Model LBO-520
30 MHz Dual Trace Scope with Delay Line



List Price \$1100
Call For Our Price

High Sensitivity. Wide Bandwidth. Single Shot Trigger. P-D-A CRT.

- 5mV sensitivity facilitates accurate signal viewing from low level sources.
- Built-in delay line makes it easy to view the leading edge of a pulse.
- Single shot trigger (CH-1, CH-2) captures transient phenomena—no guesswork, no "double-takes".
- 5" P-D-A CRT assures brighter, sharper trace at all sweep speeds.
- 20nS/cm sweep capability plus 11.7nSec rise time

20 MHz Oscilloscopes

Model LBO-507A
Single Trace
5" CRT



List Price \$580
Call For Our Price

Model LBO-508A
Dual Trace
5" CRT



List Price \$835
Call For Our Price

Sound, Reliable Performance...Stable, Easy-to-Read Displays.

- Conveniently placed, logically grouped, front panel controls facilitate quick, easy operation.
- Add & subtract modes (with CH-2 invert), permits differential measurements (Model LBO-508A only).
- 17.5 nanosec rise time for easy viewing of high speed pulses and wave forms.
- Automatic trigger from either channel, including TV sync. extends convenience and versatility.

10 MHz at 1 mV, 5" Oscilloscopes

Model LBO-513
Single Trace

NEW

Model LBO-514
Dual Trace



List Price \$495
Call For Our Price



List Price \$645
Call For Our Price

Low Cost, High Performance...for Production, Education and Service.

- 5mV Sensitivity; 1mV with X5 Vertical Magnifier.
- 0.2S/cm to 0.5 μ S/cm sweep speeds in 18 ranges plus X5 Horizontal Magnifier.
- Z-Axis Modulation.
- Bright 8x10cm Display Area
- Comprehensive Triggering Controls.

Model LBO-308
20 MHz, Dual Trace Portable Oscilloscope

NEW

List Price \$950
Call For Our Price



A Versatile, Rugged Instrument For Lab or Field Service

- 2mV/Div Sensitivity; 12 ranges in 1-2-5 sequence with continuously variable control.
- 17.5 nS Rise Time; 0.2 Sec/Div to 0.5 μ S/Div Sweep Speed; x 5 magnifier.
- Comprehensive trigger controls include CH 1&2, \pm slope, Norm/Auto, Int./Ext.
- 115 Volts AC or 12 Volts DC operation—rechargeable battery pack optional.

MASTER CHARGE

THE TEST EQUIPMENT SPECIALISTS

VISA

**TOLL FREE HOT LINE
800-223-0474**

54 WEST 45th STREET, NEW YORK, N.Y. 10036 212-687-2224

**ADVANCE
ELECTRONICS**

OCTOBER 1979

137

This is easy- anyone can solder- WITH KESTER SOLDER

**KESTER
SOLDER**

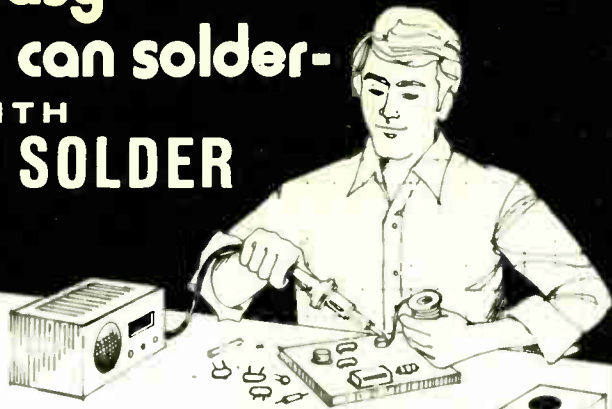

Handymen! Hobbyists! DO-IT-YOURSELFERS!

Let Kester Solder aid you in your home repairs or hobbies. For that household item that needs repairing — a radio, TV, model train, jewelry, appliances, minor electrical repairs, plumbing, etc. — Save money — repair it yourself. Soldering with Kester is a simple, inexpensive way to permanently join two metals.

When you Solder go "First Class" — use Kester Solder.

For valuable soldering information send self-addressed stamped envelope to Kester for a FREE Copy of "Soldering Simplified".



KESTER SOLDER

Litton 4201 WRIGHTWOOD AVENUE/CHICAGO, ILLINOIS 60639

CIRCLE 88 ON FREE INFORMATION CARD

YOU DESERVE IT!

GET IT EVERY MONTH!

Come on, treat yourself—and save money, too. Subscribe to Radio-Electronics today, and make sure you get all of the most interesting, most exciting and authoritative electronics reporting in any magazine, month after month. Don't miss a single one of the upcoming issues jam-packed with new-equipment test reports, projects to build, servicing ideas, and news of solid state, computers, hi-fi, hobbies and everything electronic. Save money, too—as much as \$11 off the newsstand price when you subscribe to Radio-Electronics. Come on, you deserve it—check off the money-saving offer you prefer on the handy coupon, and start enjoying Radio-Electronics every month.

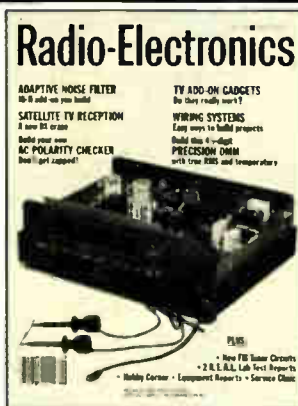

Get The Authority—Every Month

40K9

Name (Please print) _____

Address _____

City _____

State _____

Zip Code _____

Indicate the offer you prefer:

1 Year—12 issues ONLY \$9.98
(You save \$5.00 off newsstand price.)

2 Years—24 issues ONLY \$19.00
(Save More! \$11.00 off newsstand price.)

Payment enclosed (send one extra issue)

Bill me

Check here if you are extending or renewing your subscription.

Extra Shipping: Canada \$3.00 per year, all other countries \$5.00 per year.

Mail to: **Radio-Electronics**

SUBSCRIPTION DEPT., P.O. BOX 2520 BOULDER, COLO. 80322

RADIO-ELECTRONICS

SERVICE CLINIC

continued from page 136

misconvergence seen with the chassis on a jig.

The test jig can get you some valuable data quickly. Had a letter just last week that said "This set works fine on a test jig. When I put it back in the cabinet, both vertical output transistors blew out!" The cause of this is obvious. The set had the popular complementary-symmetry vertical output stage, just like audio amplifiers. These circuits won't be damaged by an open output circuit, but they will not put up with a short in the output. So this was an easy diagnosis. There's a short somewhere in the vertical yoke windings or the pincushion corrector circuitry.

Don't overlook the pincushion circuits in cases like this. In a great many sets, the pincushion circuit will be found hooked in series between the two halves of the vertical deflection yoke. Since the circuit has both vertical and horizontal frequencies in there (usually at boost voltage), any shorts around here can cause some real problems. (One chassis had me stumped for quite a while until I accidentally found an arc-over on the pin-transformer—a circuit with boost voltage! The assembly was very close to chassis and the short remained open until the voltage hit it, so it didn't show with ohmmeter.)

To sum up; used properly, a test jig can be a useful piece of test equipment and one that can save a lot of time. Anything that helps troubleshoot a chassis faster is worth having around. **R-E**

service questions

RASTER BRIGHTNESS PROBLEM

A question in the January 1979 issue dealt with a brightness-shading problem in a Sony model KV-1910. I suggested that the reader check the three neon bulbs used in the horizontal blanking circuit. Michael J. Batis of Athens, TX, now has another suggestion, which sounds quite possible:

He says that if one of the flyback-derived low-voltage supply filter capacitors opens up, this would place a 15,750-Hz ripple on that line. This ripple is at a horizontal rate and in sync with the horizontal sweep! If the cathode voltages of the CRT or the video had this ripple on it, the same symptoms would be seen.

I'll buy that! For one thing, because of the shape of the drive pulse, this ripple could well be a sawtooth waveform. This would cause the brightness effect from one side of the screen to the other. Using a scope on the DC output of these supply

continued on page 140

Now — fix today's color TV sets fast!

COLOR TV SERVICING

By Walter H. Buchsbaum

Third Edition

Save \$12.66! Publisher's price \$14.95.

YOURS FOR JUST \$2.29.

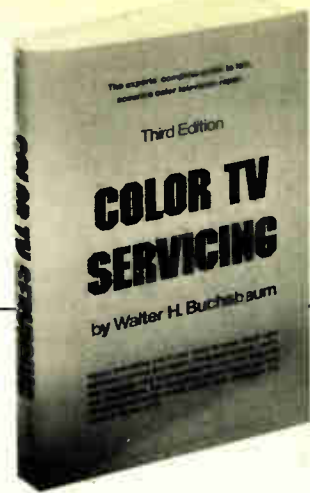

Buchsbaum! TV servicing! What a combination!

It's the brand-new, up-to-the-minute edition of Walter H. Buchsbaum's authoritative **COLOR TV SERVICING** — bringing you a mint of information on the latest color TV technology — the newest integrated circuits — the latest solid-state circuits — and the newest color TV picture tubes — **all illustrated with over 140 diagrams and photographs** that make troubleshooting procedures easier for you to use.

This book is presently selling for \$14.95. But, now, you can have it for just \$2.29! It's our way of introducing you to the **Electronics Book Service**, the no-obligation, risk-free book club which is presently keeping over 50,000 technicians, troubleshooters and hobbyists informed of the best, the most useful new books in the field of electronics.

COLOR TV SERVICING is typical of the practical selections we offer our members. It gives you solid, expert help on all kinds of color TV repair problems. It shows you how to save time — money — and work.

This is why we've chosen it to introduce you to the **Electronics Book Service**. Join now, as a trial member, and you receive your copy of **COLOR TV SERVICING**, 3rd Edition, for just \$2.29. This is your only purchase commitment of membership.

The **Electronics Book Service** has NO additional purchase requirements. Once you have paid \$2.29 for your copy of **COLOR TV SERVICING**, you are under no obligation to buy any other club selection. This is why the **Electronics Book Service** is unique.

Since the first edition of **COLOR TV SERVICING** was published, over 50,000 copies have been sold. Over 50,000 smart TV repairmen and hobbyists have been using it as their Bible. Over 50,000 TV servicemen have boosted their incomes with its help.

Since 1968, when the second edition was published, a lot has happened in electronics. Integrated circuits. Transistor configuration. New color picture tubes. Greatly improved control circuitry. And the servicing techniques you used in 1968 just aren't sufficient today.

This is why Walter Buchsbaum — who is in constant touch with the latest developments in electronics — has written a new edition of **COLOR TV SERVICING**. To show you how to **troubleshoot and service today's color TV receivers**.

The new Third Edition of **COLOR TV SERVICING** gives you over **140 illustrations** (many in full color) and over **270 pages** of sure-fire, money-saving troubleshooting tips.

- Crystal-clear, step-by-step procedures and diagrams show you exactly what to do when troubleshooting.
- Scores of color plates show you every possible color defect you could ever run into.
- Tested and proven money-making pointers and time-saving short-cuts help you install and service any color set — NEW or OLD — quickly and easily.

This easy-to-use bench manual wastes no words on abstract theory. It gets right down to the **USEFUL TROUBLESHOOTING INFORMATION YOU NEED**. It shows you how to spot defects quickly. Then how to repair them in a flash.

In everyday language — with the help of diagrams, tables, charts and circuitry — it wraps up the **whole subject** of present-day color TV servicing.

Everything you need to know to make big money servicing color TV sets.

COLOR TV SERVICING points out the important differences between color and monochrome TV. It shows you the functions and detailed circuitry of all types of chroma bandpass amplifiers, demodulators and matrixing circuits. It shows you how each works — how it delivers signals — and how to test and repair each one.

You see how color synchronizing works — how the color burst signal is converted — how each type of circuit works and how it is adjusted — **EVERY SIGNIFICANT FACT** you need to service present-day color TV efficiently.

Adjustments. You see where and why color sets are most apt to give trouble — and what to check and adjust in color signals, in tuning, and in synchronization. And you have **COMPLETE** instructions for aligning all sections of the color set.

Repair and troubleshooting. You see how to identify and repair literally every defect that can possibly crop up in a color TV set — monochrome defects, "no color" defects, "wrong color" defects, intermittent defects and those "impossible to find" defects.

What's more, you see what to do about color synchronizing errors, interference and misalignment of the receiver. You see what to do when the set has been tampered with — wrongly adjusted — or overlooked by the manufacturer's test department.

Installation. You see how to check for color fidelity — select the right antenna — locate the set properly in the home — check antenna installations — make quick tests for good reception conditions — and tell if the trouble lies in the set or the antenna system. You even see how to win your customer's complete satisfaction by giving him tips on how to take good care of his set.

The color picture section of **COLOR TV SERVICING** alone — ten full pages — is worth the price of the book. It shows you every possible receiver defect **AND** the corrections that will produce a perfect true-color image.

COLOR TV SERVICING, 3rd Edition, is the **expert's complete guide to fast, accurate television repair**. It brings you **everything** you need to know to become an efficient, well-paid expert on color TV servicing today! And, for this reason, it's a perfect way to introduce you to the **Electronics Book Service**.

Whatever your interest in electronics, membership in the **Electronics Book Service** can help to advance your career, add to your income, or enhance the enjoyment of your hobby.

The **Electronics Book Service** does the job for you which you have no time to do for yourself. We carefully screen the hundreds of books on the subject, selecting only those which are the most useful and valuable, or which bring you the latest information on technical innovations and improvements of prime importance.

Even if you never buy another book you'll still be informed every four weeks of books that can be yours at generous savings — books written by some of the most knowledgeable men in the field, and on all phases of electronics.

Your membership is an ideal way to keep in touch with the onrushing advances in electronics and its applications. In an industry where novelty today is old hat tomorrow, there is no better way to keep on top of the changing technology.

As a member, you can exercise a discriminating choice in building a professional library of superb quality and permanent value — one which will meet your every interest and requirement, always available for you to consult for enlightened, expert help. And you can acquire this library as quickly or as slowly as you choose.

Begin your membership today.

Mail this coupon now.

All you need do to begin your trial membership in the **Electronics Book Service** is fill out and mail the coupon below. As soon as we receive it, we will mail your copy of **COLOR TV SERVICING**, Third Edition, at once.

Remember, the **Electronics Book Service** has no **additional purchase requirements** as some book clubs do. Once you've paid \$2.29 — plus postage and handling — for **COLOR TV SERVICING**, you don't need to purchase any further selections!

Why delay? Mail the coupon below to get your copy of this \$14.95 bench manual for only \$2.29 — and to receive all the benefits of membership in the **Electronics Book Service**. Fill out and mail your coupon right away. **Now.**

Here is the practical and efficient way in which the **Electronics Book Service** operates.

1. When you enroll as a member, you receive — for only \$2.29 (plus postage and handling, with tax where applicable) — your copy of **COLOR TV SERVICING**. This is the only purchase you are committed to make.

2. Thereafter you are under **no obligation** to accept any minimum number of selections within any time limit. **You can take as many or as few as you wish.** And, you may resign at any time with no obligation once you have paid for your copy of **COLOR TV SERVICING**.

3. On selections you do accept, your membership entitles you to a discount from the publisher's list price. This discount is available to members only and provides you with substantial savings.

4. Every four weeks we'll send you a free bulletin describing the current selection. If you want the selection, no action is required; it will be shipped to you automatically. If you don't want it, just return the card enclosed with the bulletin.

5. You have at least 10 days to decide whether you want the selection or not. Return the card so we receive it no later than the date specified. If you don't have 10 days to answer and receive an unwanted selection, return it **at our expense**.

6. Each bulletin also describes a number of alternate or additional selections, also available to you at the special discount price for members.

ELECTRONICS BOOK SERVICE

Membership Enrollment Center
P.O. Box 42, West Nyack, N.Y. 10994

Please enroll me in the **Electronics Book Service** on a risk-free trial basis. As my first selection under this trial membership, send me **COLOR TV SERVICING**, Third Edition, for only \$2.29 plus postage and handling, with tax where applicable. I am to receive announcements free of charge and will be entitled to full privileges as a member — without obligation to buy any additional club selections.

Name

Address

City State Zip

59-6 15239-7 6699-M1 (7)

Offer limited to new members (U.S. and Canada) only.

CIRCLE 3 ON FREE INFORMATION CARD

MOVING?

Don't miss a single copy of **Radio-Electronics**. Give us:

Six weeks' notice

Your old address and zip code

Your new address and zip code

ATTACH
LABEL
HERE

name (please print)

address

city state zip code

Mail to: Radio-Electronics
SUBSCRIPTION DEPT., P.O. BOX 2520,
BOULDER, COLO. 80322

SERVICE QUESTIONS

continued from page 138

voltages would pinpoint this instantly. Thanks to Mr. Batis for his idea.

VDR PROBLEM

I wrote you about the high-voltage problem in a Zenith model 14A10C29 TV set. You suggested I check the VDR's in the high-voltage regulator circuit. While staring at this chassis one evening, I noticed that the part number printed on VDR R178 was 63-8161. The parts list I had showed this number as 63-7658! After obtaining the exact replacement VDR, the problem was solved! My advice is, always look at the number on the part and then check the parts list.—K. Y., Marysville, MI.

Right!

BLOWN FUSE TEST

A General Electric model 19YC-2 came into the shop with no video, raster or sound. The 1.25-amp fuse, F910, had blown. Connecting an ammeter and a variac in the circuit showed there was a dead short. Everything else checked out OK—transistors, etc.

I then called GE's Technical Department (Tukwila, WA), which sent me some material on this set, plus an interesting test. The test reads: "Check the hori-

zontal output transistor Q702 for a short. If it's good, connect a 100-watt lamp across fuse F910, with the brightness set to minimum." When I did this, no raster at all appeared. The GE troubleshooting sheet diagnosed this symptom as "yoke shorted." I put in a new yoke plus a new fuse, and I was in business! This sounds like a good idea so I thought I'd pass it along.—M.C. Wright, Wright TV, Seattle, WA.

This is a very good idea. Thanks very much for the hints.

ARCING PROBLEM

This old black-and-white Zenith model 14Y33 arcs from the bottom of the picture tube to a metal brace that supports the tube. Separating the brace doesn't help. Can you tell me what's going on?—J.N., Houston, TX.

If the arcing comes from the dag coating of the tube to the (grounded) metal brace, the coating is *not* properly grounded! My pet remedy for this used to be to take a long, thin coil spring and stretch it from one side of chassis to the other to make as much contact as possible with the dag coating on the bell.

What probably happened when you took the chassis out of the set and replaced it, was that the little brass leaf spring on the front of the chassis got bent and it doesn't make contact with the dag coating. R-E

Now, an automotive computer plus cruise control at your fingertips!

This is CompuCruise! The first true computer for your car, truck or RV. It's the most effective and functional cruise control ever designed, PLUS complete trip computing, an efficient fuel management system, and a split-second-accuracy quartz time system.

CompuCruise is a cruise control with a memory. A unique seek-and-hold capability makes highway driving easier and more enjoyable. Fully electronic, making it more accurate and reliable.

CompuCruise is a true computer, constantly reacting via automatic sensors to changing conditions, updating vital data for you every second. Just look at what CompuCruise gives you:

- Time, E. T. Lap timing, Alarm
- Time, Distance, Fuel to arrival
- Time, Distance, Fuel to empty
- Time, Distance fuel on trip
- Current or average MPH, MPG, GPH
- Fuel used, Distance since fillup
- Inside, outside or coolant temp.
- Battery voltage
- English or Metric display

CompuCruise works on foreign or American cars (except Diesel and fuel-injected vehicles). It's priced for the budget-minded, and easily installable by you or your automotive outlet.

Only \$199.95 with Cruise Control, \$159.50 without. Fully warranted for 90 days from date of purchase. Delivered

complete with easy-to-follow installation guide. And backed by a 100% satisfaction guarantee. If not fully satisfied when you receive your unit, return it before installation and your money will be fully refunded without question.

For the name of your nearest dealer, call or write us right now: ZEMCO, 12907 Alcosta Blvd., San Ramon, CA 94583. Phone (415) 838-8060.

Do it today—for a better cruise control and more automotive information than you've ever had before.

 **COMPUCRUISE**



provides the ground. Note that this circuit depends upon the auto's electrical system employing a negative ground; the radiator tank is used as the negative sensor probe, and the case of the electronics package was used as ground terminal.

In normal operation, the LED will only be lit if the coolant level is low or the TEST pushbutton is being pressed. Also, during normal operation of your vehicle, the LED may occasionally blink on and off; this is normal and will vary with water level, the number of bumps encountered, and the speed at which the coolant is flowing (this will depend upon the engine RPM and temperature).

Other possible applications.

The circuit board shown in Fig. 2 can be put to uses other than those previously described. It could be used in an aquarium to detect a low-water condition; a relay then could switch on a water pump, or open a water valve to fill the aquarium. It could be used as part of a sump-pump system in your basement to remove the water from a broken pipe or the spring rains. Or it could be used in a washing machine or dish washer to sense the full water condition (or empty state). Other fluid-sensing areas are steam boilers, water reservoirs, irrigation systems, etc.

Observe the parts placement guide in Fig. 5—another two components are shown: transistor Q1 to provide enough current drive capability for a relay (or low-current solenoid) and capacitor C5 to provide steady on and off states. Without C5 the output will oscillate with a 50% duty cycle; the output device should be a LED, earphone, or speaker. If capacitor C5 is used, the output device could be a relay, solenoid, or LED.

On the other hand, the input sensor could be a set of probes in a tank of conductive liquid (as previously seen), a photo-transistor, a light-dependent resistor, a thermistor, a strain gauge, a humidity sensor, a carbon microphone, etc. . . . The only requirement is that the device have a resistance level above and below the chosen reference resistance over the range of the phenomena being observed. As you can see, this circuit could be the heart of any system from a fire or burglar alarm to a light switch. Its usefulness is limited only by your imagination. R-E

PREVENT CHILD ABUSE. WRITE:



National Committee for
Prevention of Child Abuse,
Box 2866, Chicago, Ill. 60690.

A Public Service of This Magazine
& The Advertising Council



At last a moving coil cartridge you can recommend to your best friend!

New AT30E
Stereo Phono Cartridge
with Vector-Aligned™
Dual Moving MicroCoils™
and user-replaceable Stylus



The subtle, yet unique characteristics of moving coil cartridges have had their admirers for years. A top-quality moving coil cartridge exhibits remarkable sonic clarity and transparency. This performance can be attributed to the very low mass, and low inductance of the tiny coils used to sense the stylus motion.

But until now, moving coil cartridge popularity has been limited by three major problems which seemed almost inherent to moving coil designs.

1) It seemed impossible to make a user-replaceable stylus assembly without compromising performance; 2) most moving coil cartridges exhibited relatively low tracking ability due to rather stiff cantilever mounting systems; and 3) output of the cartridge was below the level needed for commonly available amplifier inputs.

Introducing the new Audio-Technica AT30E and the end to all three problems! Our design approach is simple and direct. Rather than locate the coils in the cartridge body, they are integral with the stylus assembly. If the stylus becomes worn or damaged, the entire moving system, coils and all, is simply unplugged and replaced, just like a moving magnet cartridge. Large, gold-plated connectors insure loss-free connections so vital at the low voltages generated by a good moving coil cartridge. The result is easy field replacement with no penalty in terms of performance. Careful research indicated that good tracking and moving coil design were indeed compatible. By controlling effective mass and utilizing a radial damping system similar to our famed Dual Magnet™ cartridges, we have achieved excellent tracking ability

throughout the audio range. Compliance is individually controlled during manufacture of each assembly to optimize performance. This extra step, impossible with most other designs, coupled with our unique radial damping ring, insures excellent tracking of the high-energy modulation found in many of the top-quality recordings now available.

Each coil is located in the ideal geometric relationship to reproduce "its" side of the record groove. This Vector-Aligned™ design assures excellent stereo separation, minimum moving mass, and the highest possible efficiency. It's a design concept which is exclusive to Audio-Technica, and is a major contributor to the outstanding performance of the AT30E.

We can't take credit for solving the low output problem. The AT30E output is similar to many other fine moving coil cartridges. But an increasing number of amplifiers and receivers are featuring built-in "pre-amplifiers" or "head amplifiers" to accommodate moving coil cartridges directly. Thus the new systems buyer can make a cartridge choice based on sonic characteristics rather than on input compatibility. In addition, Audio-Technica offers the Model AT630 Transformer for matching to conventional amplifier inputs.

The new Audio-Technica AT30E Dual Moving Micro-Coil Stereo Phono Cartridge. With the introduction of this remarkable new design, every important barrier to full enjoyment of the moving coil listening experience has been removed. Progress in sound reproduction from Audio-Technica... a leader in advanced technology.

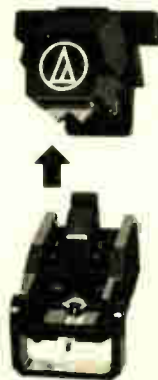

audio-technica
INNOVATION □ PRECISION □ INTEGRITY

AUDIO-TECHNICA U.S., INC., Dept 109E, 33 Shiawassee Avenue, Fairlawn, Ohio 44313
CIRCLE 27 ON FREE INFORMATION CARD

The world of electronics gee-wizardry

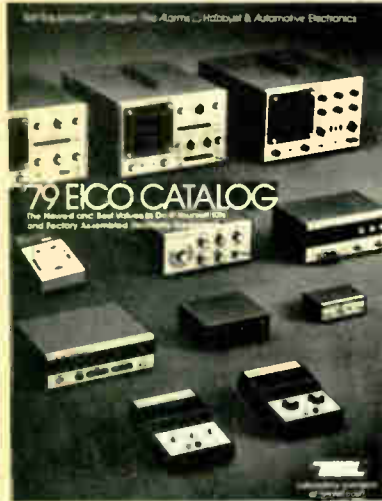

-YOURS FREE.

32-pages of test instruments — from the latest digital multimeters to the famous EICO scopes. Security systems. Automotive and hobbyist products. Kits and assembled. EICO quality. EICO value. For FREE catalog, check reader service card or send 50¢ for first class mail.

EICO® 108 New South Road
Hicksville, N.Y. 11801

CIRCLE 49 ON FREE INFORMATION CARD

the DRUM T.M. by PAR

PERCUSSION SYNTHESIZER

- * Modular design provides flexibility to realize as large or small a system as you need.
- * Continuously variable controls rather than switches allow true synthesizer versatility.
- * Numerous rear panel interfacing and control options permit multi-voice patches.
- * Variety of sensor mounting options, permanent or temporary, on your own drum set or our practice pads.
- * Available as quick and easy to assemble kit — \$269.75, or factory wired and tested — \$399.95.

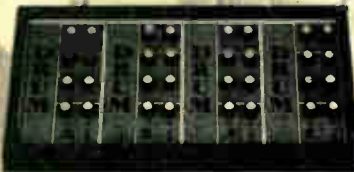

- () I'm Sold, Send the 5700P The Drum package kit \$269.75 enclosed
- () Send the 5700P-A The Drum assembled \$399.95 enclosed
- () Send Assembly & Using Manual for The Drum, \$5.00 enclosed (refundable upon purchase)

() SEND FREE CATALOG

Name: _____

Address: _____

City: _____ State: _____ Zip: _____

PARA 1117 BROADWAY, Dept. 10-4, NEW YORK, N.Y. 10019

CIRCLE 38 ON FREE INFORMATION CARD

REAL SOUND continued from page 108

delay). The second and third harmonic components to the right of the fundamental signal are very small (around 75 dB below the reference output signal, which corresponds to around 0.02%) and random noise is minimal. When the same signal is passed through the delay circuits (long delay mode), noise increases

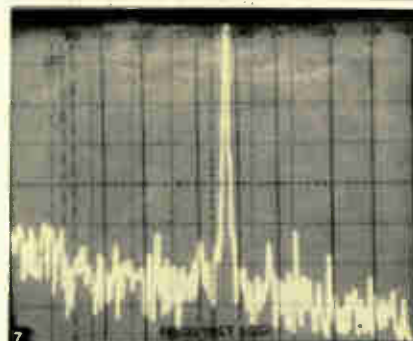
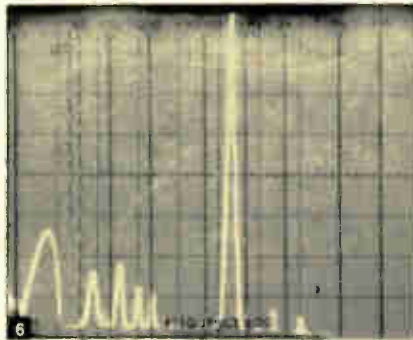

markedly along with the significant harmonic distortion components shown in Fig. 7. These results correspond to the single-meter readings of the S/N ratio shown in Table 1 (68 dB to 70 dB for the delayed mode, but a much higher 86 dB for the amplifier used in the direct mode).

Figure 8 indicates the range of bass and treble controls on the Model 2. As with all the other scope photos of our spectrum analyzer's display, the vertical sensitivity is 10 dB per vertical-division. Note that even with the controls set to their nominally "flat" positions, amplifier response rolls off sharply above 8 kHz. This amplifier is therefore intended solely for use in reproducing ambience or time-delay audio channels, and, even though it does have a direct position, we do not recommend its use as a regular stereo amplifier. The direct setting is intended more to enable you to compare four-speaker sound when all four speakers are fed the same basic signals, using time-delayed audio reproduction from the rear channels and direct sound from the front channels.

Summary and use tests

Our overall product evaluation and summary comments are shown in Table 2. We preferred setting the tone controls to the mid- or flat-response setting, but we cannot fault Audio Pulse for including bass and treble controls since in some listening rooms their use might be called for. Happily, not too much boost is provided (far less than in the usual integrated amplifier), so there is little danger of overdriving the low-powered amplifier

through exaggerated use of these controls. In general, we found that very little power was required for the rear speakers to achieve the desired ambience effects. We probably never used more than a couple of watts peak for the rear speakers. If you can distinctly hear the rear speakers playing, you probably either have them turned up too high, or you have selected speakers whose mid-frequency coloration differs greatly from that of the main speakers. As Audio Pulse points out, this is an important

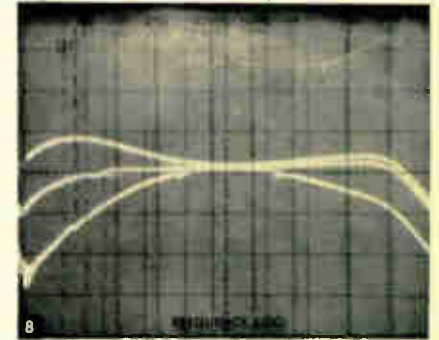

consideration when you choose the secondary speakers. They should sound very much like the primary speakers (especially in the mid-range) but do not require the power-handling capability or the bandwidth of the front speakers.

The placement of the speakers is also important. We preferred placing the secondary speakers just slightly behind our listening position and facing into the room. Elevating the speakers above ear level also seemed to aid in the overall illusion of increased space, although this may vary greatly from room to room, depending upon its size and length/width ratio. In any event, some experimentation is required before you select a final resting place for those secondary speakers.

If you purchase the Audio Pulse Model Two, you will probably tend to overuse it at first (just as we did). Some program material requires relatively little time delay and reverberation and if, with such program material, you exaggerate the effect, the sounds become twangy and almost suggest those "spring-reverb" units of yesteryear. Remember, what you are trying to achieve is concert hall realism. Making the music sound like it's being played at the bottom of the Grand Canyon may be interesting and novel (and is almost possible with this unit), but if realism is what you're after, you'll want to spend some time with the controls and learn just what effects you can create.

R-E

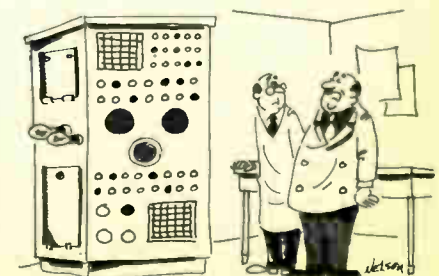

The audio response is a terrific idea—but I think it should have a deeper, more John Barrymore voice—

**Blonder-Tongue's
new boosters are
making a lot of 'noise.'**

Disappear.

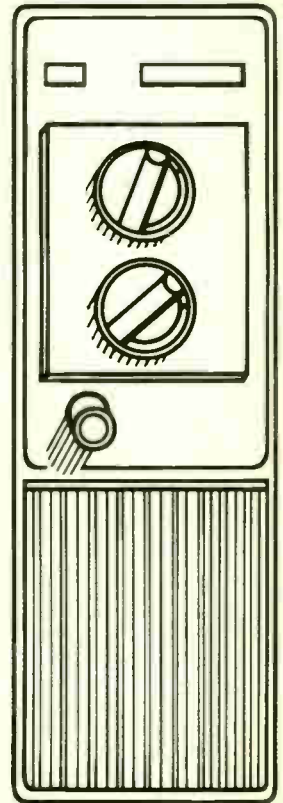

With the lowest noise figure on the market for a crisp, clean, clear T.V. reception.

Rather than a bigger, more expensive antenna, a booster may be just what your customers need to get a better picture. Your distributor can tell you. And when he does, ask him about the new line of Galaxy boosters from Blonder-Tongue.

He'll tell you they outperform any other booster made. With a lower noise figure which means less snow . . . a better picture.

So ask him all about the extraordinary new line of boosters Blonder-Tongue has just come out with. They're getting a great reception. Because that's precisely what they give.

Ask your electronics distributor for more information.

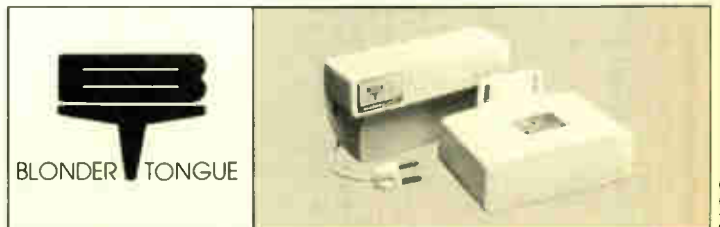

CIRCLE 42 ON FREE INFORMATION CARD

stereo products

More information on stereo products is available from manufacturers of items identified by a Free Information number. Free Information Card is inside the back cover.

CASSETTE TAPES, Series LN-46-LN-120 and Series UD-46-UD-120 (shown), come packed in polystyrene shells and feature tensilized poly-



CIRCLE 131 ON FREE INFORMATION CARD

ter magnetic tape in 46-, 60-, 90- and 120-minute lengths (1 1/4 ips). Both the LN (Low Noise) and UD (Ultra Dynamic) series contain a 4-function leader

tape that includes head-cleaning tape, indicator tabs, tape-travel indicators, and 5-second cue bar. Both cassettes use slip sheets, machined guide rollers, screening shield, pressure pads and bonded windows. Price range: LN Series, \$2.30-\$5.20; UD Series, \$3.50-\$7.50.—Maxell Corp. of America, 60 Oxford Dr., Moonachie, NJ 07074.

SUB-WOOFER SYSTEM, Chartwell model SW-135, is designed for use with model LS3/5A and model PM-100 speaker systems to provide a 40 Hz-120 Hz ± 2 dB frequency response. System handles both left and right channels simultaneously. Features include the model CEA 305P/P 12-inch driver with a polypropylene cone, double-spider construction and voice coil. The model SW-135 specifications include: 80-watt RMS capacity for use with amplifiers providing up to 150-watt-per-channel output; acoustic output, 85 dB at 1 meter, at 1 watt (mono, 82 dB). Comes in teak, walnut or rosewood veneers; optional casters are available. Suggested retail prices: wal-



CIRCLE 132 ON FREE INFORMATION CARD

nut/teak, \$400; rosewood, \$510.—Osawa & Co. (U.S.A.), Inc. 521 Fifth Ave., New York, NY 10017.

DIRECT-DRIVE TURNTABLE, model SR-5090, is a two-speed unit with a single knob for complete automatic control, repeat control feature and endless-play option. The electronically controlled drive system uses a high-torque, 20-pole, 30-slot brushless DC servomotor. Specifications include wow-and-flutter, 0.038%; rumble, 67 dB; and S/N ratio, 57 dB. Other features include aluminum-alloy platter with 4 rows of strobe patterns (two each for both speeds), built-in strobe light, fine-speed controls, S-shaped pickup arm, direct

3-WAY mini SPEAKERS

with the MAXI stereo sound



Reg. \$139
OUR PRICE

\$69.50
per pair

- 8-ohms, 50W
- For car stereo use
- 2 miniature speakers
- Deluxe black brushed aluminum finish

FORDHAM

855 Conklin Street
Farmingdale, New York 11735
(516) 752-0050

Call TOLL FREE
(800) 645-9518

Master Charge, Bank Americard, Visa,
C.O.D.'s accepted.

In N.Y. State call (516) 752-0050



AUTO best buys STEREO

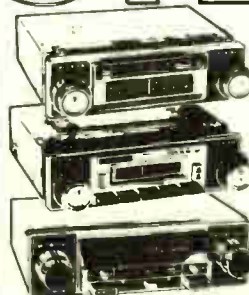

In-Dash 8-Track Stereo Player
with AM/FM MPX Radio

Model C777
\$52.50

In-Dash Cassette Stereo Player
with AM/FM MPX Radio

- Fast forward
- Push button eject

Model CAS 888
\$57.50

In-Dash Auto Reverse
Cassette Stereo Player
with AM/FM MPX Radio

- Fast forward rewind
- Push button eject

Model CAS 999
\$79.95

Stereo Power Booster **\$24.95**

Model POW-40

- 40 Watts Stereo • 20 Watts/Channel • Bass Boost



6" x 9" 3-Way
Speaker

\$14.95
ea.

Model BP 2000-69TR

- 20 oz ceramic magnet
- Freq Response: 60-18000 Hz
- Peak Watts: 25W
- Impedance: 8 ohms



6" x 9" Coaxial
Speaker

\$12.95
ea.

Model BP 2000-69CX

- 20 oz ceramic magnet
- Freq Response: 70-15000 Hz
- Peak Watts: 25W
- Impedance: 8 ohms

FORDHAM

Call TOLL FREE (800) 645-9518

In N.Y. State call (516) 752-0050

Master Charge • Bank Americard
• C.O.D. • Check • Money Order
Add \$3.00 for shipping and insurance
C.O.D.'s Extra New York State
residents add approx. sales tax

855 R Conklin St. Farmingdale, N.Y. 11735

CIRCLE 92 ON FREE INFORMATION CARD

to 20 megohms. Other features include autozeroing, autopolarity, and automatic low battery and overrange indicators. Overload protection is provided for up to 600 volts on all ranges; a 9-volt

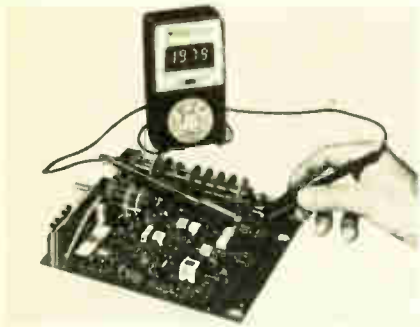

CIRCLE 154 ON FREE INFORMATION CARD

battery provides up to 200 hours continuous operation. The unit measures 3 W × 5 1/2 L × 1 1/2 inches D; weighs 10 oz., complete with battery; and comes in a high-impact thermoplastic case. The model 3400 comes with test probes, alligator clips, battery and instruction manual. Suggested retail price: \$140.—Triplet Corp., 286 Harmon Rd., Bluffton, OH 45817.

DUAL-TRACE OSCILLOSCOPE, model Telequipment D67A, is a 25-MHz unit that offers both dual trace and delayed sweep with mixed sweep capabilities. The mixed sweep feature permits a signal to be displayed at one sweep rate on part of the screen and at another sweep rate on the rest of the screen. The scope offers a vertical sensitivity of 10 mV to 50-volts-per-division, a rectangular CRT with internal graticule, a reset mode, single-trace mode, internal and external

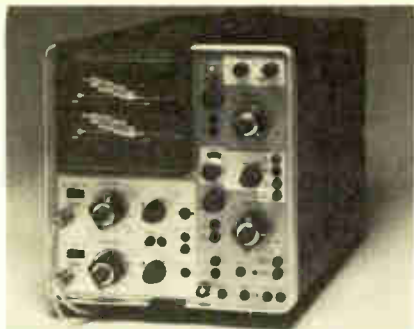

CIRCLE 155 ON FREE INFORMATION CARD triggers, positive/negative trigger slope, and high-frequency rejection. A TV trigger switch is also provided. Suggested list price: \$1325.—Tektronix, Inc., Box 500, Beaverton, OR 97077.

CAPACITANCE SUBSTITUTION UNIT, model 237, is a hand-held unit with slide switches. It provides a 5-decade capacitance range, from



CIRCLE 156 ON FREE INFORMATION CARD

100pF to 11.1μF, uses nonpolarized 5% capacitors, has a special discharge feature and five-way binding posts. The unit is housed in a sturdy metal case, measuring 4 × 6 × 1 1/2-inches, and weighs 1 lb. Special introductory price, \$95.—Phipps & Bird, Inc., Box 27324, Richmond, VA 23261.

VIDEO CONVERGENCE MODULES, models TSP1, TSP11, are designed to plug into model 1410 and model 1411 signal generators for servicing TV sets. The unit routes all signals through

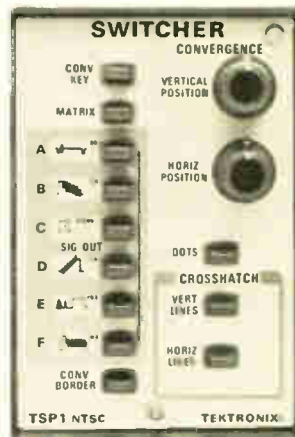

CIRCLE 157 ON FREE INFORMATION CARD

a single switch-selectable output. Other features include matrixing from 2 to 6 signals in 8 formats; a convergence border mode; a VITS circuit; plus blanking, sync and burst insertion for nonvideo signals. Prices: the models TSP1 and TSP11, \$850.—Tektronix, Inc., Delivery Station 19-313, Box 500, Beaverton, OR 97077. R-E

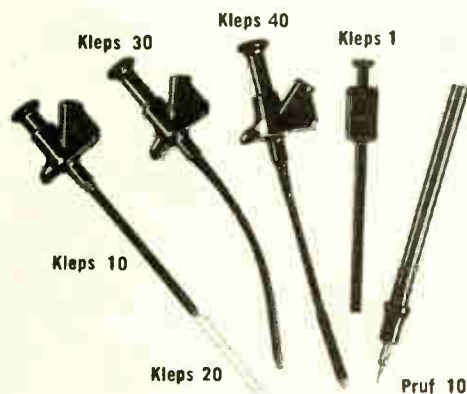

Clever Kleps

Test probes designed by your needs—Push to seize, push to release (all Kleps spring loaded).

Kleps 10. Boathook clamp-grips wires, lugs, terminals. Accepts banana plug or bare wire lead. 4 3/4" long. \$1.59
Kleps 20. Same, but 7" long. \$1.69
Kleps 30. Completely flexible. Forked-tongue gripper. Accepts banana plug or bare lead. 6" long. \$1.99
Kleps 40. Completely flexible. 3-segment automatic collet firmly grips wire ends, PC-board terminals, connector pins. Accepts banana plug or plain wire. 6 1/4" long. \$2.89
Kleps 1. Economy Kleps for light line work (not lab quality). Meshing claws. 4 1/2" long. \$1.09
Prof 10. Versatile test prod. Solder connection. Molded phenolic. Doubles as scribing tool. "Bunch" pin fits banana jack. Phone tip. 5 1/2" long. \$.99

All in red or black - specify. (Add 50¢ postage and handling). Write for complete catalog of - test probes, plugs, sockets, connectors, earphones, headsets, miniature components.

Available through your local distributor, or write to:



RYE INDUSTRIES INC.

127 Spencer Place, Mamaroneck, N.Y. 10543
 In Canada: Rye Industries (Canada) Ltd.

CIRCLE 46 ON FREE INFORMATION CARD



TUNE in with DAVIS FREQUENCY COUNTERS

NOW . . . for the FIRST TIME
 RECEIVE FREQUENCY ADAPTER
 ONLY **49⁹⁵**

7208 10 Hz to 600 MHz MINI COUNTER

- All Metal Cabinet
- 8 Digit 4 LED Readout
- 115V or 12V Operation
- 1 & 1 Sec. Gate Times
- Automatic DP
- Stable Crystal Timebase ± 1 ppm C

7208 Kit	99⁹⁵	7208A Assembled	\$199.95
Options:	Prop. Crystal Oven (OCXO) ± 1 ppm 10 to 50 C		\$39.95
	Ni-Cad Battery Built-in with charger		\$39.95
	Handle		\$5.00
	V.I.F. UPN Presamp		\$10.00
	200V		\$10.00
	Bicourse Frequency Adapter		\$49.95

*OCXO - achieve superior frequency stability through the use of proportional control oven which maintains the crystal at a stable temperature.

CALL FACTORY DIRECT

1-716-874-5848

TERMS Add \$3.00 shipping to U.S. & Canada. Other countries add 10% to total price. N.Y. State residents add 7% sales tax. C.O.D. Fee \$1.00. P.O. accepted from rated companies.



DAVIS ELECTRONICS
 636 Sheridan Drive
 Tonawanda, New York 14150
 (716) 874-5848



CIRCLE 48 ON FREE INFORMATION CARD

new lit

TEST INSTRUMENTS, *Catalog BK-9*, is a pocket-sized version of catalog *BK-79*, and contains 52 illustrated pages describing specifications, features and applications for oscilloscopes, multimeters, and frequency counters, as well as CB, radio and TV maintenance and repair instruments. The following new products are included: a battery/AC operated portable dual-trace oscilloscope, a 3½-digit lab DMM, a multiple-output power supply and a portable color TV pattern generator.—**B&K-Precision**, Dynascan Corp., 6460 W. Cortland St., Chicago, IL 60635.

CIRCLE 141 ON FREE INFORMATION CARD

TOOL CATALOGS list manufacturer's new product line: *Catalog No. SD-222* is a 12-page, full-color catalog describing the "E" Pak line of insulated and noninsulated terminals; nylon ties; wire connectors; and male/female quick connectors. The catalog also describes wire strippers, electrical tools and merchandising displays. *Catalog No. SD-233* is a 4-page supplement to *SD-222* and contains such units as the *TORX* 5-in-1 magnetic screwdriver, a terminal service kit, pliers and tool sets.—**Vaco Products Co.**, 1510 Skokie Blvd., Northbrook, IL 60062.

CIRCLE 142 ON FREE INFORMATION CARD

INSTRUMENT CASE BROCHURE, 4-page, 4-color brochure describing full line of injection-molded, impact-resistant portable instrument cases. The three standard case sizes come in 8 standard colors, shown in a chart (custom-matched colors are also available), and complete specs for all cases are included.—**NOBEX Components**, 1027 California Dr., Burlingame, CA 94010.

CIRCLE 143 ON FREE INFORMATION CARD

REPLACEMENT GUIDE, 14 pages, lists hundreds of semiconductor replacements, including FET's, Darlington transistors, IC's, Zener diodes, plus Sanyo replacement semiconductors. Also featured are TV, stereo and CB replacement parts, such as an 8-track play/record head, a replacement AC cord, bridge rectifiers, a microswitch, plus many more. The back of the guide contains a cross-reference guide for ECG parts, a replacement price list and information on MCM's speaker recording service.—**MCM Audio, Inc.**, 639 Watervliet Ave., Dayton, OH 45420.

CIRCLE 144 ON FREE INFORMATION CARD

OSCILLOSCOPE BROCHURE, *Form No. 449-7*, is a 4-page, 4-color brochure describing low-cost, general-purpose oscilloscopes suitable for radio-TV troubleshooting, medical/biophysical applications and electronics and amateur radio hobbyists. The instruments are fully described and complete specs are given. The brochure also describes optional scope accessories.—**Gould Inc.**, Instruments Div., 3631 Perkins Ave., Cleveland, OH 44115.

CIRCLE 145 ON FREE INFORMATION CARD

COMPONENTS CATALOG, *Catalog 800*, provides 272 pages of data on more than 24,000 components, including solder terminals, coil forms, variable and fixed coils, connectors, pins, panel and chassis hardware, plus over 100 new products. Complete specs, schematics and applications data are included.—**Cambridge Thermionic Corp.**, 445 Concord Ave., Cambridge, MA 02138.

CIRCLE 146 ON FREE INFORMATION CARD

SEMICONDUCTOR REPLACEMENT GUIDE, *SPG-202X*, 339 pages listing 957 solid-state replacement devices for over 135,000 domestic and foreign semiconductors. Guide contains data on full line of replacement transistors, rectifiers, thyristors, IC's and high-voltage triplers. Also featured is a dual numbering system that pairs SK stock numbers and those used in all other numbering systems; an index; and a comprehensive data section. The guide sells for \$1.50 and is available from RCA distributors and the manufacturer.—**RCA Distributors and Special Products Div.**, P.O. Box 597, Woodbury, NJ 08096.

ELECTRONICS CATALOG, *Catalog No. FF, 64* pages chock-full of discounted electronic components, gadgets and factory surplus items geared to hobbyists, educators and dealers alike—from TV and hi-fi equipment components to calculator keyboards, plus switches, resistors, capacitors, alarm systems, etc. Also included is a 32-page wholesale supplement listing hundreds of items suitable for dealers and volume users.—**ETCO Electronics Corp.**, North Country Shopping Center, Plattsburgh, NY 12901.

CIRCLE 147 ON FREE INFORMATION CARD

TRS-80 BULLETIN is a monthly publication designed for *TRS-80 Computing* subscribers and features product and club news stories, how-to articles and programs developed around the TRS-80. Publication is available to nonsubscribers also, either in single or bulk quantities.—**Computer Information Exchange, Inc.**, Box 158, San Luis Rey, CA 92068.

CIRCLE 148 ON FREE INFORMATION CARD

COMPUTER CATALOG AND BUYERS GUIDE comes as a 2-part set. The catalog contains 310 pages covering state-of-the-art reports on Challenger 1P, C2-4P, C2-8P and C3 computers plus available software; it also covers a wide range of personal and small business computer applications, including future expansion. Price list supplement contains 16 pages. Both are available for \$1 per set.—**Ohio Scientific, Publications Dept.**, 1333 S. Chillicothe Rd., Aurora, OH 44202.

ROBOTICS NEWSLETTER is a monthly periodical aimed at professional and hobby robot enthusiasts, and features articles on such topics as microprocessors, batteries, motors, sensory devices, manipulators, robot history, etc. Yearly subscription price is \$8 (U.S.).—**International Institute for Robotics**, Box 615, Pelahatchie, MS 39145.

COMMUNICATIONS BROCHURE contains four pages of SWR and power meters, an RF speech processor, coaxial switches and a line of high-pass, low-pass, audio and AC power-line filters. Complete specs and photos are shown for each product.—**Bell Industries, J. W. Miller Div.**, 19070 Reyes Ave., Box 5825, Compton, CA 90224.

CIRCLE 149 ON FREE INFORMATION CARD

BRIDGE SELECTION CHART, *Pic-A-Bridge*, lists complete specifications on bridge rectifiers with from 1.5- to 30-amp operation range. Includes all specifications such as average current, operating temperature, peak-current rating, along with voltage ratings, recovery times, etc. Flip side of chart shows case dimensions.—**Electronic Devices, Inc.**, 21 Gray Oaks Ave., Yonkers, NY 10710. **R-E**

CIRCLE 150 ON FREE INFORMATION CARD

A scanning monitor receiver without a monitor antenna is like a kite without a tail:

way down!

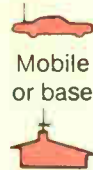

Mobile or base

Want the high performance you paid for? Choose a professional A/S monitor antenna. 12 models, one for your exact need. Let us send our catalog.

the antenna specialists co.



Strives of Quality
a member of The Allen Group Inc.
12435 Euclid Ave. Cleveland, Ohio 44106

CIRCLE 91 ON FREE INFORMATION CARD

A Classroom In Your Mailbox!

STUDY
Two-Way Radio

THROUGH THE
REVISED

MTI

Home Study Course

Send coupon below for free course outline
No obligation - No salesman will call

Professional Training in a Unique Career Field

Providing Training to the Industry Since 1960

study FM two-way radio at home!

I am interested in learning more about professional FM two-way radio. Please send me full details on the MTI training program.

Name _____
Address _____
City/State/Zip _____

MTI

A3K

Mobile Training Institute

Box 735, Camp Hill, PA 17011-U.S.A.

CIRCLE 55 ON FREE INFORMATION CARD

OCTOBER 1979

149

Nobody does it better than VIZ

The Everything Scope

Dual Trace

WO-555 \$799

AVAILABLE NOW!

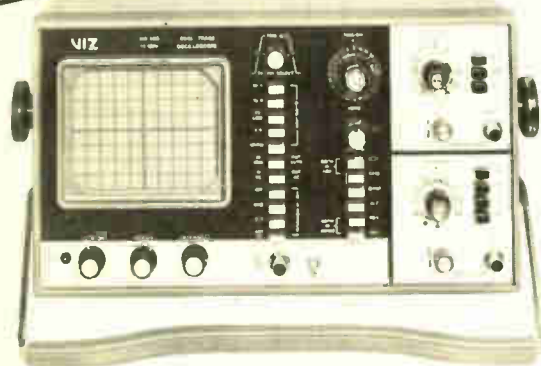

The 15MHz scope with more accuracy, convenience, versatility and a broader voltage capability (DC thru 600V) than several others costing more money. View channels A or B, A and B, A + B or A - B with calibrated X-Y capability through 15MHz. Built-in delay line allows for viewing the full input waveform so information such as "undershoot and overshoot" can be seen and analyzed. *Unique simplified trig* hold and adjustment control with LED indicators show trig polarity at a glance. Two direct/X10 LoCap probes are supplied.

The Everything Scope

Single Trace

WO-527A \$575



The ideal scope for most industrial, laboratory, educational and servicing applications. Frequency response DC to 15MHz. Rise time 23 nsec. Sensitivity 10mV/cm P-P. Ultrastable trig action with simplified level adjustment and LED polarity indicators. One direct/X10 LoCap probe supplied.

See your local VIZ distributor or write VIZ

VIZ Test Instruments Group
335 E. Price St., Philadelphia, PA 19144

The VoltOhmyst company

books

TINY ASSEMBLER 6800, VERSION 3.1, DESIGN AND IMPLEMENTATION OF A MICROPROCESSOR SELF-ASSEMBLER, by Jack Emmerichs. BYTE Publications, Inc., 70 Main St., Peterborough, NH 03458. 74 pp. 8 1/2 x 11 in. Softcover \$9.00.

This book contains reprints of articles first published in the April, May and September 1977 issues of *BYTE* magazine. The first two sections deal with Tiny Assembler version 3.0 (which is listed as Appendix A). The third section is a reprint of "Expanding the Tiny Assembler," and the fourth section contains the "Tiny Assembler's User's Guide," updated to reflect version 3.1. The complete version 3.1 listing and bar code information are shown in Appendixes B and C.

TELEVISION MAGIC, by Eurfron Gwynne Jones, 1st American Ed., (printed in Great Britain). The Viking Press, 625 Madison Ave., New York, NY 10022. 64 pp. 8 1/2 x 11 1/2 in. Hardcover \$5.95.

This Viking Junior Book (first printed in England and edited for the U.S.) takes young readers aged 9-13 behind the scenes of a modern TV studio. It provides a straightforward explanation of how pictures and sounds are transformed to broadcast signals; what elements go into creating a sports program, a play or a cartoon show; teaches youngsters something about the techniques of creating TV illusions. The book contains many illustrations and the text is easy to follow.

UNDERSTANDING SOLID-STATE ELECTRONICS, developed by Texas Instruments Learning Center. Texas Instruments, Inc., Box 3640, M.S. 84, Dallas, TX 75285. 270 pp. 5 1/2 x 8 1/2 in. Softcover \$3.95.

This book is the third (and updated) edition of a self-instructional textbook that does not require a technical background in electronics. It is aimed at serious hobbyists and experimenters who wish to understand how semiconductors work. The simple, clearly written text is accompanied by many diagrams, photos, glossaries and self-quizzes. Basic theory and the use of diodes and transistors are stressed; Chapter 12 deals with MOS and LSI circuits, and Chapter 13 discusses linear IC's and their applications.

THE BASIC HANDBOOK, by David A. Lien. COMPUSOFT PUBLISHING, Div. of CompuSoft, Inc., P.O. Box 1669, San Diego, CA 92119. 360 pp. 7 x 9 in. Softcover \$14.95.

This definitive reference book contains just about all you need to know about BASIC statements, functions, operators and commands, explained in easy to understand language. It contains over 50 variations of the BASIC language used in PET, Apple, Heath, Altair and many more mainframes, micro- and minicomputers.

TAKE MY COMPUTER . . . PLEASE! by Steven Ciarcia. SCLEBI Publications, P.O. Box 133 PP STN, Milford, CT 06460. 128 pp. 4 1/2 x 7 in. Softcover \$5.95 + 75¢ postage.

If you're into computers (and even if you're not) you'll enjoy this funny book. It tells about the author's misadventures (based on true experiences) with his uncooperative computer. Many humorous illustrations are included.

AN INTRODUCTION TO MICROCOMPUTERS: VOLUME 2—SOME REAL MICROPROCESSORS, by Adam Osborne with Jerry Kane. Osborne & Associates, Inc., Dept. X2, 630 Bancroft Way, Berkeley, CA 94710. 1400 pp. 7 x 9 in. Softcover \$25; with binder, \$30.

AN INTRODUCTION TO MICROCOMPUTERS: VOLUME 3—SOME REAL SUPPORT DEVICES, by Jerry Kane with Adam Osborne. Osborne & Associates, Inc., Dept. X2, 630 Bancroft Way, Berkeley, CA 94710. 700 pp. 7 x 9 in. Softcover \$15; with binder, \$20.

Volume 2 is an expanded version of an earlier edition and covers all major microprocessors currently in use. It analyzes and compares 20 CPU's, and includes a section on newer units such as Intel's 8086 and TI's 9940, as well as support devices.

Volume 3 offers a thorough reference guide on the support devices that can be used with a variety of processors. Among the categories discussed are memory devices, parallel and serial I/O, and system buses. Both volumes contain many diagrams, tables and indexes.

TRS-80 MICROCOMPUTER TECHNICAL REFERENCE HANDBOOK, No. 26-2103. Radio Shack, 1400 One Tandy Center, Fort Worth, TX 76102. 108 pp. 8 1/2 x 11 in. Softcover \$9.95.

This handbook is designed for those with a technical background in digital logic circuits. Written in straightforward language, it contains technical data and diagrams for both Level-I and Level-II TRS-80 systems. Topics include theory of operation, adjustments and troubleshooting and external devices (including memory-mapped devices). A parts list and basic schematic diagrams are included.

R-E

next month

NOVEMBER 1979

■ **TRS-80 Breadboard Interface**

Great way to experiment with your computer. This device contains all the buffers, power supplies plus a breadboard and is designed to plug into the TRS-80. With slight modification, it can be used with almost any computer.

■ **Desoldering Tools and Techniques**

How to remove and replace components, especially DIP's, without destroying the PC board.

■ **Telephone Dialler Roundup**

Some include clocks, others include calculators, but almost all include pushbutton dialling and memory. Here's a look at what's available including a comparison chart of the features.

■ **Music On Hold**

This device adds a hold feature to your telephone and lets the caller listen to music while on hold.

PLUS:

Two R.E.A.L. Sound Lab Test Reports

Equipments Reports

Communications Corner

Service Clinic

Equip yourself with the best.

PTS 8001 Component Analyzer

Solid state component tester works in or out of the circuit. Simple hook-up to any standard oscilloscope. High, medium and low range switch for matching the impedance of the component being tested.



PTS DG-1 Digital Power Supply

External variable power supply for substituting voltages in televisions, stereos, radios, computers, microprocessors, appliances, CB equipment, telephone equipment, electronic cash registers, security systems and other electronic devices.



PTS DG-4 Voltage Control Center/ Digital Power Supply

Independently produces four variable DC supply voltages. Excellent for substituting critical control voltages for TV electronic/varactor tuners. All units come in vinyl cabinet in optional walnut, black or blue and carry a one year limited warranty.



These products available from any PTS stocking distributor as well as PTS tuner/module servicers. Check the yellow pages for the servicer nearest you.



PTS ELECTRONICS, INC.
The Only Name You Need To Know

market center

CLASSIFIED COMMERCIAL RATE (for firms or individuals offering commercial products or services) \$1.50 per word (no charge for zip code) . . . minimum 15 words.

NONCOMMERCIAL RATE (for individuals who want to buy or sell personal items) 85¢ per word . . . no minimum.

ONLY FIRST WORD AND NAME set in bold caps. Additional bold face (not available as all caps) at 10¢ per word. Payment must accompany all ads except those placed by accredited advertising agencies. 5% discount for 6 issues, 10% for 12 issues within one year, if paid in advance. All copy subject to publisher's approval. Advertisements using P.O. Box address will not be accepted until advertiser supplies publisher with permanent address and phone number. Copy to be in our hands on the 26th of the third month preceding the date of the issue (i.e., August issue closes May 26). When normal closing date falls on Saturday, Sunday, or a holiday, issue closes on preceding working day.

PLANS & KITS

CONSTRUCTION plans for profitable business ideas. Catalog \$1.00. **GARLING**, 438 N. Garfield Street, Lombard, IL 60148

BUILD your own speaker system. Write for free catalogue. **McGEE RADIO**, 1901 McGee St., Kansas City, MO 64108

ELECTRONICS completed kits. No wiring. FM mic. VU meter. Touch control switch. Programmable music block. Wheel fortune game. Etc. Save up to 50%. Write for free catalog today. Postcard will do. **SUPERTRONICS INC.**, 39 Bowery, Box 88, New York, NY 10002

SHOCKING! Build versatile high voltage supply. Adjustable 6 to 12 kV. Great for ion generators, bug zappers, security and experimental device devices. Plans \$5.00. **LUNATRIX**, Box 891, Yucalpa, CA 92399

ATTENTION high school electronic teachers and students. Kits designed for students. Free flyer. **AUSTIN ELECTRONICS**, 1242 El Vago St., La Canada, CA 91011

GRAPHIC EQUALIZER

TWELVE bands/channel \$100 kit still available. See May 1978 cover story. Complete instructions, reprint review \$2.50. Free information. **SYMMETRIC SOUND SYSTEMS**, 1608 South Douglas, Loveland, CO 80537

EDUCATION & INSTRUCTION

TELEPHONE bugged? Don't be Watergated! Countermeasures brochure \$1.00. **NEGEYE LABORATORIES**, Box 547-RE, Pennsboro, WV 26415

UNIVERSITY degrees by mail Bachelors, Masters, Ph.D's . . . Free revealing details. **COUNSELING**, Box 317-RE10, Tustin, CA 92680

UNDERSTAND digital electronics. Programmed learning courses. Design of Digital Systems, 6 volumes, only \$19.95. Digital Computer Logic, 4 volumes, \$14.95. Both \$29.95. Free details. **GFN INDUSTRIES**, Bldg. 7-20, 203 Loudon Road, Concord, NH 03301

COLLEGE students! Improve your grades. Send \$1.00 for 356-page, collegiate research papers catalog. 10,250 available. **RESEARCH ASSISTANCE**, Box 25097RE, Los Angeles, CA 90025. (213) 477-8226.

INTERESTED in Radio Announcer-DJ work? Get started. "How to get your lifetime third class FCC license. No Government test or fees. \$2.50 plus 50¢ postage. **R.C.I. RADIO**, Box 3347, Batesville, AR 72501

EXPERIMENTERS

EXPERIMENTER'S DIRECTORY—Best buys, parts, test equip., microcomputers, phones, tech. info., more. Descriptive source listing. \$1.95 + 30¢ postage. **K.M.H.**, 5102 Inverness, Baytown, TX 77521

To run your own classified ad, put one word on each of the lines below and send this form along with your check for \$1.50 per word (minimum 15 words) to:

Radio-Electronics, 200 Park Avenue South, N.Y., N.Y. 10003

ORDER FORM

PLEASE INDICATE in which category of classified advertising you wish your ad to appear. For special headings, there is a surcharge of \$10.

() Plans/Kits () Business Opportunities () For Sale
() Education/Instruction () Wanted ()

Special Category: \$10

(PLEASE PRINT EACH WORD SEPARATELY, IN BLOCK LETTERS.)

1	2	3	4	5
6	7	8	9	10
11	12	13	14	15
16	17	18	19	20
21	22	23	24	25
26	27	28	29	30
31	32	33	34	35

TREMENDOUS BUYS In New And Gov't Surplus Equipment

Dial Telephone "SUPER BUY"

• Save us the labor costs of cleaning and polishing and save \$\$\$\$ on standard dial telephones. Work on any commercial system. Complete. (no parts missing) in good working order. Your choice of desk or wall models. These are take-outs from commercial service (not toys). Instructions furnished.

Wall Model #215 WB1 \$7.95
Desk Model #215 DB1 \$7.95
PREPARED BY S.A. DOES NOT INCLUDE SHIPMENT, INSURANCE, P.S.
PRICE EACH



FREE CATALOG Shows BIG SAVINGS On
• ELECTRONICS • ELECTRICAL • ALARM SYSTEMS • TELEPHONES • PUMPS
• BINOCULARS • GEAR MOTORS • WINDMILLS • SURVEYING INSTRUMENTS
• GENERATORS • COMPRESSORS • HYDRAULICS • POWER TOOLS • WELDERS
• POWER PLANTS • CHEMICAL SPRAYING • TARP-AUTOS • MANY OTHERS

Surplus Center Box 82209-RE Lincoln, Ne. 68501

FOR SALE

RADIO & TV tubes 36¢ each. One year guaranteed. Plus many unusual electronic bargains. Free catalog. **CORNELL**, 4217-E University, San Diego, Calif. 92105

TEST equipment catalog listing used Tektronix, HP and GR equipment at bargain prices. Price \$1.00 refundable with first order. **PTI**, Box 8699, White Bear Lake, MN 55110

NAME brand test equipment. Guaranteed discounts up to 50%. Free catalog. **SALEN ELECTRONICS**, Box 82-M, Skokie, IL 60077

PRINTED-circuit boards, reasonable. Also, artwork, prototypes, designs, fabrication and testing. **MICROCON INC.**, Box 43, Glenview, IL 60025

SENSITIVE converter 1.6-2.4 GHz \$99.95 postpaid. Details for stamp. **GW ELECTRONICS**, POB 688, Greenwood, IN 46142

AUDIO noise reduction kit—318 silencer for tapes, records, FM. Free brochure. **LOGICAL SYSTEMS**, 3314 "H" St., Vancouver, Washington 98663.

TUBE caddys: Just like the old favorite. . . Only better! Free catalog: (800) 233-8851. **JOHN ANTHONY TELEVISION**, Box 13, Matamoras, PA 18336

SATELLITE TV

GET 50 CHANNELS!

It's all true! No matter where you live receive movies, sports, pay television, sports from around the world! 24-hour programming! Crystal clear reception! For complete information, sources and design information, send \$7.95.

SPACECAST RESEARCH
Dept. B, P.O. Box 442, Altamonte Springs, FL 32701



SCANNER/monitor accessories—kits and factory assembled. Free catalog. **CAPRI ELECTRONICS**, Route 1R, Canon, GA 30520

FREE catalog, IC's, LED's, semi's, parts. **CORONET ELECTRONICS**, 649A Notre Dame W., Montreal, Que., Canada H3C 1H8. U.S. inquiries.

RESISTOR LEDS—5 FOR \$1.00—Prime H.P. Subminiature LEDS. Red lens, red color. Minimum order \$5.-include 10% for shipping. Send check to, **AVANTI'S NEON NITES**, 3424 Knox Place, N.Y., N.Y. 10467

Govt. SURPLUS ELECTRONIC EQUIPMENT CATALOG

New ITEMS . . . New BARGAINS!

FREE UPON REQUEST!

Send today for FREE copy of NEW CATALOG WS-79. Address Dept. RE

FAIR RADIO SALES
1016 E. EUREKA • Box 1105 • LIMA, OHIO • 45802

- Minimum Ad Order \$5.00
- Please Include \$1.00 for Postage (USA).
- Visa, MC and COD orders Accepted.
- Most Phone Orders Shipped Within 24 Hours.
- Send for Our Free Giant Catalog of Unique Items.

P.O. BOX 27038, DENVER, COLO. 80227 PHONE ORDERS: 303-781-5750

STROBE ITEMS

120 VAC Xenon Strobe Kit



Complete variable rate strobe light kit. Contains all parts, PC board, line cord and instructions.

C23071 **\$7.50**

6VDC Xenon Flasher Kit



Battery operated device emits intense bursts of light at approximately 1 per second rate. Complete with all parts & PC board. (Less battery).

C23808 **\$8.00**

Photoflash Caps



250MF ... 330V ...	C22927	\$1.00
570MF ... 360V ...	C23371	\$1.25
720MF ... 360V ...	C22930	\$1.50
520MF ... 500V ...	C23809	\$5.00

LASCR



Extremely sensitive units used in automatic strobes slaves, fire alarms, etc. Perfect for making slave triggers. Brand new. Rated 400V at .5 amps.

C22795 **2/\$1.25**

6KV Trig. Coil



Small ferrite core trigger coil. Required to fire all Xenon strobe tubes.

C23474 **89¢**

Shutter Cords



14" straight cord: **\$1.00**
 4' coiled cord: **\$1.25**

C23359

Reflector



Highly polished, for strobe tubes. Horseshoe type C23375
 Straight tube type: C23451

Your choice: **\$2.49**

Horseshoe Tube



Super power rated horseshoe type strobe tube. Rated 100WS.

C23865 **\$3.95**

Strobe Tube Special



Brand new factory prime strobe tubes. Assortment of 5 xenon tubes, plus a page of schematics.

C23280 **\$3.00**

SPECIALS

Wheel of Fortune



Popular game device uses LEO's, transistors & IC to give the effect of a bright red ball spinning around numbers. Unit emits sound as ball spins & finally stops on a number. Incl. all parts faceplate & PC board.

C23806 **\$8.99**

LED Flasher Kit



Simple to build kit uses the popular 555 timer IC to alternately flash a red and green LED. Comes complete with all parts, including the PC board. (9V battery is not included).

C23287 **\$2.49**

Calculators (REJECT)



Complete 4 function portable calculators w/ % key & constant function. Fix them and save.

C23877 **\$2.98**

Walkie Talkie



Reject units. These are complete crystal controlled units with built-in antennas. Most are very easy to fix.

C23876 **\$2.95**

Zipper Close Bags



High quality 2-mil thick for packaging parts, etc. Price listed is for a package of 100.

2 x 3 ...	C23330 ...	\$ 2.25
3 x 4 ...	C23331 ...	\$ 2.50
3 x 5 ...	C23332 ...	\$ 2.75
4 x 6 ...	C23334 ...	\$ 3.00
5 x 8 ...	C23335 ...	\$ 3.25

Black Box



Attractive 3.7" x 3.2" x 2.4" bakelite box containing reed switch, relay, vibrating reed, etc. Government surplus. Great experimenter items.

C22706 **\$2.50**

Digital Counting Module



Made for an electronic diet aid. Push button unit flashes for period of time then advances to next number. Operates on 9V battery (not incl.).

C2287 **\$2.00**

TV Game Special



Reject Video Olympiad TV game units. Play three exciting color TV games, with on-screen digital scoring and realistic sound effects. You repair and save.

C23872 **\$8.95**

POPULAR REQUESTED ITEMS

LED Panel Mounting Kit



C22707 **12 sets for \$1.00**

Pot Hex Nuts



Fits standard 3/8" bushings.

C22791 **30 for \$1.00**

Jumbo Red LED



Diffused white lens.

C23778 **10 for \$1.00**

LCD Watch Display



Motorola, with specs.

C23097 **\$1.25**

Mini Reed Switch



Actuated by magnet. Size is 1-1/8" x 1/8".

C23640 **5 for \$1.00**

RO170 Rectifier



Popular 1000V @ 2.5 amp.

C23784 **5 for \$1.00**
100 for \$15.00

GE Sub-C Nicad



Fast charge type. Brand new, with tabs.

C23876 **\$2.00**

Color Crystal



Metal case color TV crystal. 3.579545 Mhz.

C23877 **\$1.00**

SLA-1 Readout



Prime 7-segment LED readout. Common anode.

C23598 **4 for \$2.00**

6V DC-AC Adaptor



Rated 6V at 100Ma. For calculators, etc.

C23604 **\$3.00**

Tube Specials



7AK7 6SN7
 12AU7 12AH7
 12AT7

Your choice: **2 for \$1.00**

Alco Knob



Stylish brushed aluminum. With set screw for 1/4" shafts.

C23671 **2 for \$1.00**

AA Nicads & Charger



2 fast charge AA nicads and matching charger.

C23480 **\$6.95**

Photo Album



Compact size 6" x 3-7/8". Holds 24 pictures. Available in blue, yellow or pink.

\$1.50

AA Nicad Bonanza



Removed from equipment. Some are good, some bad. You ZAP them and clean them up. As Is.

C23813 **5 for \$1.00**

10 HOUR TAPE RECORDER

Top quality AC-DC cassette recorder, modified to provide 5 continuous hrs. of recording and playback of true fidelity, distortion-free sound on each side of cassette for a total of 10. Many spec. built-in features. TDK D-C180 cassette supplied. **\$155.00***

VOX VOICE ACTIVATED CONTROL SWITCH

Solid state. Self contained. Excellent adj. sensitivity. Voices or other sounds activate recorder. Uses recorder mike or remote mike. 2 1/4" x 1 3/4" x 3/4" **\$24.95***

PHONE RECORDING ADAPTER

Solid state. FCC Approved. Records incoming and outgoing calls when connected to phone line and tape recorder. Automatically activated when phone is used. 2 1/4" x 1 3/4" x 3/4" **\$24.50***

Amazing Electronic MICRO MINI MIKE WIRELESS MICROPHONE

Among world's smallest, solid state. Self contained. Picks up sounds and transmits without wires up to 300 ft. through FM radio. FCC Approved. 2 1/4" x 3/4" x 1/2" **\$18.95***

Phone Call Adapter \$24.50, Mike \$18.95, VOX \$24.95, (* plus \$1.00 ea. pstg. and hdg.), 10 hr. Rec. \$155.00, (* plus \$4.00 pstg. and hdg.) Cal. res. add tax. Mail Order, VISA, M/C, cod's o.k., qty. dis. avail. Money back guarantee. Free data.

AMC SALES, Dept. 18, 9335 Lubec St., Box 928, Downey, CA 90241.

CIRCLE 93 ON FREE INFORMATION CARD

Dialco Seven Segment LED Readout Assembly



ORIGINAL PRICE was \$42 Delta No. 5723R
\$9 L.O.W. Price...
2 FOR \$18.

739-0703 — Consists of seven .625" LED 7-segment readouts with decimal points...all mounted in a handsome plastic bezel—complete with red filter. Readouts are common anode. All ready for mounting. A ready-to-go assembly for your freq. counter or any instrument using 7 digits. Assembly may be taken apart to get the 7 readouts...which represents a bargain for quality readouts of this size. Original price was over \$42.

Pre Programmed PARTS

Would You Believe 250,300 (or 114 lb.) of Assorted Parts For

PRE-PROGRAMMED components mounted on reels for use in automatic inserting eqpt. These strips consist of a variety of components such as resistors, capacitors, diodes, sensors, etc. Fortunately we have acquired several 100-lb. roll mounted on reels with full leads. Upon examination of these strips we noted there were tantalum capacitors, mostly 5% resistors and many zeners

\$3

Delta No. 6600R-1/4	1/4 lb.	\$ 3.00
Delta No. 6600R-1/2	1/2 lb.	\$ 5.50
Delta No. 6600R-1	1 lb.	\$10.00

A sample 14 lb. had the following: 216 1/4-watt 5% resistors, 18 1/4-watt 5% resistors, 28 small signal diodes and 30 tantalum capacitors. Not every 14-lb. assortment is the same, but the one we chose is average. We guarantee a minimum of 250 components with most lots running over 300 for a 14-lb. assortment

Delta Burglar ALARM



Featured in April, 1979 Radio Electronics DETECTION DETECTOR. This device detects any motion or movement for a minimum distance of 8-ft. The secret is in the ultra complex custom LSI chip, which combines the latest in linear & digital circuitry. The device is completely self-contained, in a case 6" x 3" x 2", and operates from four "AA" NiCad batteries. Nothing else is needed for the device to perform its basic function, motion detection. When motion or movement is detected, a "whoop" alarm is sounded. The MOTION DETECTOR is designed to provide either an audible or silent alarm. The silent alarm is controlled by a timer, which delays the alarm up to 30 seconds. The silent alarm activates a relay, whose contacts are brought out to plug, and will activate ANY device, such as siren, horn, tape recorder, telephone dialer, etc.

Delta No.	Description	Sale
5611R	Complete motion detector kit (less batteries)	\$24.50
1072R	Motion Detector Chip only, with data	8.95
5611R	P.C. boards, set of 2	6.50
5288R	"AA" NiCad Batteries, set of 4	4.50
5636R	Battery charger for above	5.95
5635R	Completely assembled kit, w/batteries & charger	69.50

Speaker Cabinet Kit!

We have a limited number of speaker assemblies from a famous prestige manufacturer of audio equipment. The photo shows an assembled kit. The speaker case is 10" x 17 x 9". Assembly holds a "twice an 8" woofer (not included), and has a 2" port. Provision is made for a paddle adjustment (not shown). This assembly was used in the maker's 800 speakers. Case material is simulated walnut. Kit is available in the following ways:

- Delta No. 5715R Above, (2 for \$26) less spkrs. **\$13.95**
- 5716R Above, less spkrs, with grille cloth assembly, paddle assembly, terminal mtg. plate & terminals **\$15.95 (2 for \$30)**
- 5673R Tweeter **\$3.95 (2 for \$7)**
- 5718R 8" Woofer for above, 10" air-suspended speaker **\$16.95 (2 for \$33)**

Computer Board GRAB-A-BAG

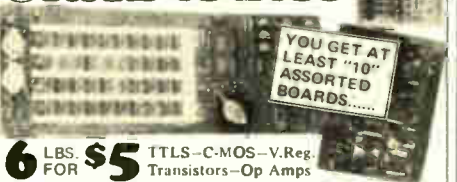

6 LBS. \$5 FOR TTLs—C-MOS—V.Reg. Transistors—Op Amps

Here's your chance to build your stock pile or replenish it! Well...DELTA's Computer Board Grab-A-Bag is one of the most inexpensive ways of doing it. We have a very wide & varied selection of computer boards. The parts on these boards can be easily removed with a Bernz-O-Matic torch & a pair of tweezers. Complete instructions on parts removable are included. The following is a list of SOME of the parts found on these boards.

TTL & C MOS IC'S, Voltage Regulators, Transistors, Power Transistors, Op Amps, Optical Couplers, Relays, Reed Relays, small Transformers, heat sinks, diodes, resistors, capacitors, SCR's, etc. Delta No. 9801R

MAIL-ORDER ADDRESS:

FREE 120-PG. 'SURPLUS' CATALOG

DELTA ELECTRONICS

176 SECOND AVE. WALTHAM, MASS. 02154

Minimum Order \$8.00

TEL. (617) 388-4705

Tested 'AA' NICADS SPECIAL-BY-MAIL OFFER

Brand new — slight imperfections on case!

Delta No.	Type	Hours	Dimen.	SALE
5686R	13A	170	619dia.x.680	78
5686R+	13A	200	619dia.x.756	88
5676R	AA	500	645dia.x.1.83	98
5689R	AA	550	687dia.x.1.98	98
5680R	Sub C	1.2	865dia.x.1.645	1.58
5677R	C	2.0	1.06 dia.x.1.87	2.08
5687R	C	2.0	1.02dia.x.1.85	1.98
5679R	1/2D	2.3	1.30dia.x.1.75	1.98
5678R	D	4.0	1.30dia.x.2.28	2.78

BUTTON CELLS		Sale	
5685R	1.2 .05	.89dia.x.205	.58
5683R	1.2 .15	.98dia.x.275	.68
5684R	1.2 .22	1.36 dia.x.207	.78
5682R	1.2 .22	1.36 dia.x.208	.88
5681R	1.2 .22	1.61 dia.x.320	.98

100% Guaranteed—Rechargeable

*Have tabs to permit soldering. **buttons on both ends.

MECHANICALLY INCLINED INDIVIDUALS

Assemble electronic devices in your home. Investment, knowledge, or experience not necessary. Get started in spare time. Above average profits. \$300-\$600/wk. possible. Sales handled by others. Write for free details.

ELECTRONIC DEVELOPMENT LAB
Box 1560R, Pinellas Park, FL 33565

BIG SCREEN OSCILLOSCOPE

Converted from ANY Size TV Set... Hams, Technicians, Hobbyists, Broadcasters Minor, inexpensive changes convert TV set to super sensitive testing device. No electronic experience needed. Follow clear cut plans. Fully illustrated. Use in workshop, lab, school, etc. Any size screen. Any size TV set.

Complete Set of Plans \$4
(INCL. 50¢ FOR POST & HANDLING)

MILICO IND., DEPT OP 03 BOX 91, KOSSÉ, TX 76653

SELLING Rider's manuals, Sams' Photofacts, Supreme Publications, Factory manuals, textbooks. BEITMAN, Box 46, Highland Park, IL 60035

INTRUSION detectors—microwave, ultrasonic, infrared, magnetic sensors, etc. From distributor liquidation. Low prices. Write for list—OAKNOR, 15 Pheasant Lane, St. Paul, MN 55110

STICK anywhere data (bumper) stickers. \$2 each. Specify: 7400 series, octal ASCII code, 8080A octal instruction set. Write SAJE, P.O. Box 5765 Bethesda, MD 20014

NEW HAMS, SHORTWAVE, SCANNER LISTENERS. Unique chart "Worldwide Listeners Guide to the Radio Spectrum". 0 to 30 GHz. Find the QEI's frequency! 35"x25" Full color. Guaranteed satisfaction or money refunded. \$4.50. RADIO PUBLICATION, P.O. BOX 28R, Lake Geneva, WI 53147

RECEIVERS. National NC 300 automatic noise limiter \$500/Hallicrafters tuner, multi-band four, AM&CW \$100/Crystal control scanner SX105 \$50/One band CRX-1 30-50 meg. \$150. MS. BARBARA REINSH, 28 Riverview Ave., Deep River, CT 06417 (203) 526-2774

SATELLITE Television—movies, sports, etc. Build or buy your own Earth Station. Send \$3.00 for information. SATELLITE TELEVISION, Box 140, Oxford, NY 13830

BUSINESS OPPORTUNITIES

MECHANICALLY inclined individuals desiring ownership of Small Electronics Manufacturing Business—without investment. Write: BUSINESS-ES, 92-R, Brighton 11th, Brooklyn, NY 11235

LEARN to repair PLL or crystal synthesis CB for profit, 30 PLL's covered. Send \$12.95 for instruction book. A.P. SYSTEMS, PO Box 488, Milford, PA 18337, Dept. RE

START A Consumer Electronics business. Details 2.00 (refundable). ICBF, PO Box 46, Nashville, IL 62263

SECURITY systems—Want to make some extra money or break into a whole new career—Write now. BOTRONX INTERNATIONAL, P.O. Box 44886, Parkland, WA 98444

JOINT venture—No investment. Giant screen TV'S, VCR'S, Videomovies, etc. Write NPC, Box 321, Maple Shade, NJ 08052

BREATHE REFRESHING "VITAMINS OF THE AIR" with an amazing **NEGATIVE ION GENERATOR** ROOM-PORTABLE-CAR UNITS, TESTERS AND ACCESSORIES (Dealers Wanted) **\$129.00** Or Send \$1.00 for fascinating details to **GOLDEN ENTERPRISES, INC.** P.O. Box 1282-RE Glendale, Arizona 85311

AMAZING ELECTRONIC PROJECTS and PRODUCTS: Lasers Super Powered, Burning, Cutting, Rifle, Pistol, Pocket. See in Dark—Shotgun Directional Mike—Unscramblers—Giant Tesla—Stunwand—TV Disrupter—Energy Producing, Surveillance, Detection, Electrifying, Ultrasonic, CB, Auto and Mech. Devices. Hundreds More—All New Plus INFO UNLTD PARTS SERVICE Catalog \$1. Information Unlimited, Dept. R8 Box 716 Amherst, N.H. 03031.

When in our area, northeastern Mass. or southern N.H. visit our retail at 7 Oakland St., Amesbury, Mass.

CIRCLE 12 ON FREE INFORMATION CARD

FM/AM Tuner Chassis



499
RA-744
Reg. ~~898~~

- 2 Gang Tuning Capacitor
- Replacement
- 3-Pos. Selector Switch •Hobby
- Wire in to Any Amplifier
- Auxiliary Input
- Requires 8.2 VDC Voltage
- With Schematic
- 6x2 1/2x2 1/4" •1 lb.

Volume Controls



39c
Reg. ~~129~~
VC-274

- 12 Piece Kit •Bargain Hunters Special
- Less Than 11c Each •12 Popular Values
- Various Diameters & Lengths •Wt. 1 lb.

Cassettes

60 Minute



Pkg. of 3
\$1
Reg. ~~720~~

- 180 Minutes of Recording Time
- Less Than 1c Per Minute
- Music or Voice •Wt. 1/2 lb.

Thomas Air Compressor



1599
XM-771
Reg. ~~2998~~

- use for Paint Sprayer, Air Brush, Tires, Air Bag Pump
- 117 VAC @ 1.2 Amps.
- Diaphragm Type
- Capacitor Start Motor
- Requires AC Cord
- .5 CFM at Max
- Die-Cast
- 4 1/4" dia. x 8 1/4" long
- Inlet/Outlet—Std. 1/4"
- Washable Filter •15 lb.

AC to 3, 4.5, 6, 9 VDC Adapter



399
BA-159 Reg. ~~749~~

- For Recorders, Radios, Calculators
- Converts Battery Devices to House Current
- Styles Vary •2x1 1/2x1 1/2" •Wt. 1 lb

8-Track Tapes

40 Minutes



69c
TA-907 Reg. ~~99c~~

- Quality Reproduction
- Length For Recording Some LP's, etc.
- Erased—Not Used •Shpg. wt. 1/2 lb.

Mono FM/AM Receiver Chassis

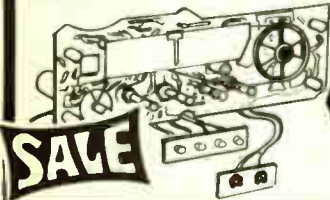

449
RA-573
Reg. ~~899~~

- Phono Inputs
- AM-FM Antennas
- Extension Speaker Outputs
- Tape Outputs
- Size: 9 x 4 x 3"
- 11-12 VAC Operation
- Schematic
- Limited Quantities
- Shpg. wt. 2 lbs.

Pillow Speaker



129
SS-995 Reg. ~~129~~

- Compact Size •6 Ft. of Cable
- For Late Night Listening
- 3.5mm Plug •Shpg. wt. 1/4 lb.

12 VDC Fan



199
MO-452
Reg. ~~249~~

- Cool Mobile Electronic Gear
- 120V Heating Element •Fan 1 1/2x2 1/4"
- 12 VDC Fan and Motor •Wt. 1/2 lb.

11c SALE BUY 1 AT REGULAR PRICE GET 2nd ONE OF SAME NUMBER FOR ONLY 1c

Back-of-Set VHF Antenna
469 each **2/470**
AA-875
Works completely hidden from view. 4-section dipoles can turn to any position. With lead-in wire, terminals and mounting bracket. Wt. 2 lbs.

Cassette Head Cleaner
2/301
\$3 each
TA-545
•Extends Tape Life
•Shpg. wt. 1/4 lb.

5-Digit Counter
2/301
\$3 each
XM-543
•3/16 x 1/4" Diameter Shaft
•Size: 1 1/2 x 1 1/4 x 1 1/4"
•Shpg. wt. 1/2 lb.

5 1/2" Round Speaker Grilles
2/80c
PAIR
79c Pair
CA-888
•Pkg. of 2
•Shpg. wt. 1/4 lb.

5-Piece Solenoid Kit
2/250
249 each
•Styles May Vary
•Shpg. wt. 5 lbs.

12 VDC Battery Charger
2/996
995 each
AU-652
•For Trickle Charging Overnight or Idle Periods
•Shpg. wt. 2 lbs.

Gutter Mount
2/\$2
199 each
AA-218
•Use With Most All Antennas
•Size: 2 1/2 x 1 1/4 x 2"
•Shpg. wt. 1 lb.

FM Dipole Antenna
2/130
129 each
AA-211
•Attaches to Stereo or Radio
•Shpg. wt. 1/2 lb.

Electret Condenser Mike Element
2/501
\$5 ea.
MK-126
•Miniature Size Only 3/8" Thick
•Shpg. wt. 1 lb.

9 VDC Horn
2/199
1.99 ea.
XM-808
•Adjustable 1 1/4" Diameter
•3/4" Deep •Wt. 1/4 lb.

12 VDC Relay
2/150
1.49 ea. SW-854
•Single Pole, Single Throw N.O. Contacts •Shpg. wt. 1/4 lb.

Photo Cell
2/101
\$1 ea.
TR-567
•1300-4 Meg Ohms
•Shpg. wt. 1/4 lb.

Olson electronics
260 S. FORGE ST. DEPT. LU
AKRON, OHIO 44327
FREE!
Master Charge
VISA

NAME _____
ADDRESS _____
CITY _____ STATE _____ ZIP _____

Qty.	Stk. #	Description	Price Ea.	Total

24 Hour PHONE Service Call (216)535-1800
 Please send me a free subscriber.
 to Olson Value Packed Catalog. (Within the Continental USA Only)

Postage _____
Tax _____
TOTAL _____

DIGITAL AUTO SECURITY SYSTEM

4 DIGITS
PERSONAL CODE!!

- proximity triggered
- voltage triggered
- mechanically triggered



3-WAY PROTECTION!

This alarm protects you and itself! Entering protected area will set it off, sounding your car horn or siren you add. Any change in voltage will also trigger the alarm into action. If cables within passenger compartment are cut, the unit protects itself by sounding the alarm.

SPECIAL \$19.95

ALL UNITS FACTORY ASSEMBLED AND TESTED—NOT A KIT!

THE MOST ADVANCED TIMEPIECE OF ITS KIND IN THE WORLD!

LCD Quartz Alarm Chronograph with calendar and dual time zone!! Watch is the same as Seiko but you pay a lot more for the name!

Features



- * 24 hour alarm
- * Chronograph counts up to 12 hrs., 59 mins, 59.9 sec.
- * Precision of chrono up to 1/10 sec indicated by 10 moving arrows!!
- * Lap time (with chrono running uninterrupted)
- * Time displays by LCD for hour, min, sec, day, date of the week and AM/PM
- * Calendar gives out date-day
- * Dual time zone for any two cities of the world at your own choice.
- * With light switch to allow you to see the time in the dark!

\$55.50

ONE YEAR FULL WARRANTY!



NEW MARK III 4 Steps 4 Colors LED VU

Stereo level indicator kit with arc-shape display panel!! This Mark III LED level indicator is a new design PC board with an arc-shape 4 colors LED display (change color from red, yellow, green and the peak output indicated by rose red). The power range is very large, from -30dB to +5dB. The Mark III indicator is applicable to 1 watt - 200 watts amplifier operating voltage is 3V - 9V DC at max 400 MA. The circuit uses 10 LEDs per channel. It is very easy to connect to the amplifier. Just hook up with the speaker output!

IN KIT FORM \$18.50

ELECTRONIC DUAL SPEAKER PROTECTOR

Cut off when circuit is shorted or over-load to protect your amplifier as well as your speakers. A must for OCL circuits.



**KIT FORM
\$8.75 EA.**

FM WIRELESS MIC KIT

It is not a pack of cigarettes. It is a new FM wireless mic kit! New design PC board fits into a plastic cigarette box (case included). Uses a condenser microphone to allow you to have a better response in sound pick-up. Transmits up to 350 ft.! With an LED indicator to signal the unit is on.



KIT FORM \$7.95

100 W CLASS A POWER AMP KIT

Dynamic Bias Class "A" circuit design makes this unit unique in its class. Crystal clear, 100 watts power output will satisfy the most picky fans. A perfect combination with the TA-1020 low T.I.M. stereo pre-amp.

Specifications:

- * Output power : 100W RMS into 8-ohm
125W RMS into 4-ohm
- * Frequency response: 10Hz - 100 KHz
- * T.H.D.: less than 0.008%
- * S/N ratio: better than 80dB
- * Input sensitivity: 1V max.
- * Power supply: $\pm 40V$ @ 5amp



**TA-1000 KIT
\$51.95**
Power transformer
\$15.00 each

LOW TIM DC STEREO PRE-AMP KIT TA-1020

Incorporates brand-new D.C. design that gives a frequency response from 0Hz - 100KHz $\pm 0.5dB$ Added features like tone defeat and loudness control let you tailor your own frequency response. Independent I.C. regulated power supplies to eliminate power fluctuation! Specifications: *T.H.D. less than .005% *T.I.M. less than .005% *Frequency response: DC to 100KHz $\pm 0.5dB$ *RIAA deviation: $\pm 0.2dB$ *S/N ratio: better than 70dB *Sensitivity: Phono 2MV 47K/Aux. 100mV 100K *Output level: 1.3V *Max output: 15V *Tone control: bass $\pm 10dB$ @ 50Hz/treble $\pm 10dB$ @ 15Hz *Power supply: ± 24 D.C. @ 0.5A
Kit comes with regulated power supply, all you need is a 48V C.T. transformer @ 0.5A

ONLY \$44.50

X'FORMER



PROFESSIONAL FM WIRELESS MICROPHONE

TECT model WEM-16 is a factory assembled FM wireless microphone powered by an AA size battery. Transmits in the range of 88-108MHz with 3 transistor circuits and an omni-directional electric condenser. Element built-in plastic tube type case; mike is 6 1/4" long. With a standard FM radio, can be heard anywhere on a one-acre lot; sound quality was judged very good. **\$16.50**

Sanwa

- COMPACT -
- LIGHTWEIGHT -
- ULTRA-SLIM -
- BATTERY CHECKER
- LED TESTER -

**T-55D (w/o temp probe)
\$44.50**
**T-55THD (temp probe)
\$66.50**



SPECIFICATIONS

DC Voltage:	150mV, 500mV, 1.5V, 5V, 15V, 50V, 250V, 1KV (AII 20k Ohm IV)	Accuracy: DC Voltage: $\pm 2.5\%$ f.s.d., DC Current: $\pm 2.5\%$ f.s.d., Best Check: $\pm 2.5\%$ f.s.d.
DC Current:	250V 10uA (ung HV probe)	AC Voltage/Power: $\pm 5\%$ f.s.d., AC Voltage/Power above 15V range: $\pm 3.5\%$ f.s.d., AC Current: $\pm 5\%$ f.s.d., Resistance/Temperature: $\pm 3\%$ of arc
AC Voltage:	250uA, 2.5mA, 25mA, 250uA (500mV drop)	Dimensions: 148 x 97 x 26 mm thick
AC Current:	10V, 150V, 500V (5k Ohm IV)	Weight: 240g
Resistance:	8mA, 6A (2V end 55mV drop)	Instrument supplied with BATTark: 1.5V (UM 3 or R612) Fuse & Spare: 500mA, 250V
Load Current:	10k Ohm, 100k Ohm, 1M Ohm, 5M Ohm (max cabin)	Temperature Probe (T-55THD only)
Load Voltage:	10V, 15V, 50V, 100V, 500V, 1KV (10k Ohm load)	
Decibels:	0.9 to +50dB	
Batt Check:	0.9 to +50dB	
LED Check:	(Available)	
Temperature:	50 to +100C and 0 to +200C (Probe not supplied with T-55D)	

HICKOK LX303 DIGITAL LCD MULTIMETER

- 3 1/2 digits display
- 200 hours 9V battery life
- Auto zero; polarity; overrange indication
- 100mV DC F.S. sensitivity
- 19 ranges and functions
- D.C. volt: 0.1 MV to 1000 V
- A.C. volt: 0.1 V to 600 V
- Resistance: 0.1Ω to $20 M\Omega$ (Available)
- D.C. current: $0.01\Omega A$ to 100 MA

CALL FOR OUR DISCOUNTED PRICE



60W + 60W



COMPLETED UNIT—NOT A KIT!

OCL pre amp. & power stereo amp. with bass, middle, treble 3-way tone control. Fully assembled and tested, ready to work. Total harmonic distortion less than 0.5% at full power. Output maximum is 60 watts per channel at 8Ω . Power supply is 24 - 36V AC or DC. Complete unit

Assembled \$49.50 ea.
Power transformer \$ 8.50 ea.

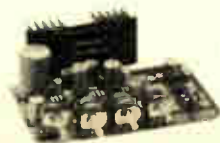

30W + 30W STEREO HYBRID AMPLIFIER KIT

It works in 12V D.C. as well! Kit includes 1 PC SANYO STK-043 stereo power amp. IC LM 1458 as pre amp, all other electronic parts, PC Board, all control pots and special heat sink for hybrid. Power transformer not included. It produces ultra hi-fi output up to 60 watts (30 watts per channel) yet gives out less than 0.1% total harmonic distortion between 100Hz and 10KHz. **\$32.50 PER KIT**

POWER TRANSFORMER \$6.50 EACH

MARK IV 18 STEPS LED POWER LEVEL INDICATOR KIT

This new stereo level indicator kit consists of 36 4-color LED (18 per channel) to indicate the sound level output of your amplifier from -36dB ~ +3dB. Comes with a well-designed silk screen printed plastic panel and has a selector switch to allow floating or gradual output indicating. Power supply is 6 ~ 12V D.C. with THG on board input sensitivity controls. This unit can work with any amplifier from 1W to 200W!

Kit includes 70 pcs. driver transistors, 36 pcs. matched 4-color LED, all other electronic components, PC board and front panel.



MARK IV KIT \$31.50

JUMBO 1" LED ALARM CLOCK MODULE

- Assembled - not a kit!
- Features: * 1" 4 digits red LED display
 - * 12 hours real time format
 - * 24 hours alarm audio output (just add speaker)
 - * Power failure indicator
 - * Count down timer 59 mins
 - * 12-16V AC 50/60 Hz input
 - * 10 min snooze control
- Red Display \$8.50 each
Green Display \$10.50 each
Transformer \$ 1.75



A RARE FIND!

LAMBDA HIGH POWER REGULATOR 3205 MODULE

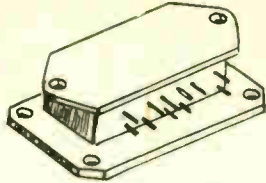

\$12.95
W/SPECS
LIMITED QTY.

- 5V @ 10A with 8-30VDC input.
- Current limiting, thermal shutdown and short protection.
- .2% Load regulation.
- Only 2 external components needed.

All you need to add is a transformer, rectifier, heatsink and filter cap to have a super regulated supply for 5 volts at 10 amps!

SPECIAL BONUS! Order the 3205 Module and get **FREE** a LAMBDA L-20-5 overvoltage protector that triggers at 6.6 volts up to 20 amps.

LAS15U - 1.5A Four Terminal Adjustable Regulator. 3-30V W/current limiting, short protection and thermal shutdown. TO-3 style. All units are prime. Spec sheets included. \$2.50

AY3-8910 PROGRAMMABLE SOUND GENERATOR

The AY3-8910 is a 40 pin LSI chip with three oscillators, three amplitude controls, programmable noise generator, three mixers, an envelope generator, and three D/A converters that are controlled by 8 BIT WORDS. No external pots or caps required. This chip hooked to an 8 bit microprocessor chip or Buss (8080, Z80, 6800 etc.) can be software controlled to produce almost any sound. It will play three note chords, make bangs, whistles, sirens, gunshots, explosions, bleets, whines, or grunts. In addition, it has provisions to control its own memory chips with two IO ports. The chip requires +5V @ 75ma and a standard TTL clock oscillator. A truly incredible circuit.

\$14.95 W/basic Spec Sheet (4 pages) 60 page manual with S-100 interface instructions and several programming examples, \$3.00 extra

SE-01 SOUND EFFECTS KIT

• 76477 CHIP IS INCLUDED. EXTRA CHIPS \$2.95 EACH

• \$16.95
LESS SPEAKER & BATTERY



The SE-01 is a complete kit that contains all the parts to build a programmable sound effects generator. Designed around the new Texas Instruments SN76477 Sound Chip, the board provides banks of MINI DIP switches and pots to program the various combinations of the SLFOscillator, VCO, Noise, One Shot, and Envelope Controls. A Quad Op Amp IC is used to implement an Adjustable Pulse Generator, Level Comparator and Multiplex Oscillator for even more versatility. The 3 1/4" x 5" PC Board features a prototype area to allow for user added circuitry. Easily programmed to duplicate Explosions, Phasor Guns, Steam Trains, or almost an infinite number of other sounds. The unit has a multiple of applications. The low price includes all parts, assembly manual, programming charts, and detailed 76477 chip specifications. It runs on a 9V battery (not included). On board 100MW amp will drive a small speaker directly, or the unit can be connected to your stereo with incredible results! (Speaker not included)

assembly manual, programming charts, and detailed 76477 chip specifications. It runs on a 9V battery (not included). On board 100MW amp will drive a small speaker directly, or the unit can be connected to your stereo with incredible results! (Speaker not included)

4 DIGIT 1/2 INCH CHARACTER LED DISPLAY
Bowmar readout stick with colons. COMMON CATHODE ONLY. 100% Prime. All segments and colons brought out to edge pads. With pinout. LIMIT 5 PER CUSTOMER

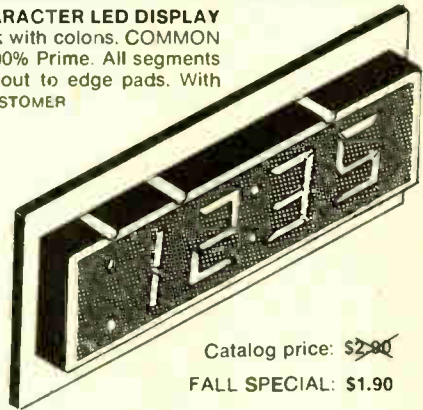

Catalog price: ~~\$2.90~~
FALL SPECIAL: \$1.90

IL-1 OPTO ISOLATORS
STANDARD PINOUT USE
50¢ WHILE THEY LAST

ULTRASONIC SENDER RECEIVER KIT

TOTAL SECURITY! Completely invisible ultrasonic (23KHZ) sound beam works like a photoelectric beam but is unaffected by light, heat or noise. Separate Transmitter and Receiver can be used from 6 inches to 25 feet! A solid object breaking the beam causes an output to go low that will sink up to 150 MA to Drive a Relay, TRIAC etc. Complete electronics are provided. Works on 12VDC (unregulated) and draws less than 100 MA. Use it for burglar alarms, object counters, automatic door openers, automatic door bells, electronic rat trap(s) and more.

3.95
COMPLETE KIT LESS CASES 21.50
Optional entry delay and Alarm Timeout Circuit will source or sink up to 200 MA DC

MC1351P FM-IF AMP AND DISCRIMINATOR

USED IN FM & TV SOUND CIRCUITS. REQUIRES MINIMUM EXTERNAL COMPONENTS. 14 PIN DIP. DIRECT REPLACEMENT FOR HEPC 6060, ECG 748 and MANY OTHERS. HOUSE # WITH SPECS 50¢

NEW! 4 DIGIT AUTO/VAN CLOCK

- LARGE CHARACTERS LED
- QUARTZ XTAL TIMEBASE
- ALARM & SNOOZE OPTIONS
- NOISE FILTERING
- EASY TO ASSEMBLE
- 4 1/2" x 3" x 1 1/2"
- DRILLED & PLATED PC BOARDS

Hand made solid hardware case for the Clock. Includes ruby front filter and back panel! 6.95

COMPLETE KIT 12 VDC **\$16.95**

739 FAIRCHILD

DUAL LOW NOISE AUDIO PRE-AMPLIFIER
80¢ 2/1.69

9500@75V Computer Grade Filter Cap 2" x 5 1/2" 2.95

WIREWRAP Wire 50 gauge KYNAR Insulat. 500 FT **4.50**

WARRBLE ALARM Kit

A fun EASY kit to assemble that emits an ear piercing 10 watt dual tone scream. Resembles European siren sound. Great for alarms or toys. Operates from 5-12VDC at up to 1 amp fusing 12VDC & 8 ohm speaker. Over five thousand have been sold. All parts including PC board, less speaker. **2.50** ORDER WB-02

7 WATT AUDIO AMP KIT

SMALL SINGLE HYBRID IC AND COMPONENTS FIT ON A 2" x 3" PC BOARD. INCLUDED! RUNS ON 12 VDC. GREAT FOR ANY PROJECT THAT NEEDS AN INEXPENSIVE AMP. LESS THAN 3" THICK @ 5 WATTS COMPATIBLE WITH SE 01 SOUND KIT **\$5.95**

MC1469R POSITIVE VOLTAGE REGULATOR

AMP COMPLETE SPECS AND APPLICATIONS SHOW HOW TO BUILD FIXED OR VARIABLE POWER SUPPLIES FROM 3 TO 30VDC. DRIVE EXTERNAL SERIES PASS FOR CURRENT TO 20 AMPS! 1.25 EA. 10/10.00 HOUSE #

PARTS

301 DP AMP & LEAD CAN	3/100
723 VOLT REG. 1D LEAD CAN	50
*13741 FET INPUT 741 MINI DIP	3/1 1/0
30 000 @ 15V COMPUTER GRADE	2 1/0
2N4400 PNP GEN. PURPOSE	8/1 00
2N4402 PNP COMPLIMENT	8/1 00
2N6028 P.U.T. W/SPECS	50
LM380 2W AUDIO IC W/SPECS	1 09
LM377 DUAL LM380 W/SPECS	2 50
*7815 VOLT REG. 1A 15V	69
*725 LDW NOISE DP AMP	99
IL 1 OPTO ISOLATOR MINI DIP	60
*MEM 631 DUAL GATE MOSFET DIODE PROTECTED. SIMILAR TO 40673	50
MV1624 VARICAP DIODE 1D PFD	49
1N4003 1A 200V DIODE	15/1 00
TIP30 TAB PNP POWER	3/1 00
*MC1351P FM IF DISC IC	50

*INDICATES ITEM IS "HOUSE NUMBERED"

LED'S

JUMBO GREEN	4/ 89
JUMBO RED	5/ 89
MEDIUM RED (1/2")	15
MEDIUM GRN OR YELLOW	16

-NO COD'S -ADD 5% FOR SHIPPING -ORDERS UNDER \$10. ADD .75 for HANDLING
-SEND CHECK OR MONEY -TEX RESIDENTS ADD 5% TAX (214) 278-3553
ORDER OR CHARGE CARD NO. -FOREIGN ORDERS ADD 10%,
PHONE ORDERS ACCEPTED ON VISA & MC COPYRIGHT

Radio Shack — Your No. 1 Parts Place™

Low Prices and New Items Every Day!

Low-Power Schottky ICs

Low As **49¢**

- 100% Prime
 - Guaranteed Specs
- Improved 5-volt logic devices use Schottky diode technology for minimum propagation delay and high speed at minimum power.



Type	Cat. No.	ONLY
74LS00	276-1900	.49
74LS02	276-1902	.59
74LS04	276-1904	.59
74LS08	276-1908	.49
74LS10	276-1910	.59
74LS13	276-1911	.99
74LS20	276-1912	.59
74LS27	276-1913	.69
74LS30	276-1914	.59
74LS32	276-1915	.69
74LS47	276-1916	1.29
74LS51	276-1917	.59
74LS73	276-1918	.69
74LS74	276-1919	.69
74LS75	276-1920	.99
74LS76	276-1921	.79
74LS85	276-1922	1.29
74LS90	276-1923	.99
74LS92	276-1924	.99
74LS93	276-1925	.99
74LS123	276-1926	1.19
74LS132	276-1927	.99
74LS151	276-1929	.99
74LS157	276-1930	1.19
74LS161	276-1931	1.49
74LS164	276-1932	1.49
74LS175	276-1934	1.19
74LS192	276-1935	1.49
74LS193	276-1936	1.49
74LS194	276-1937	1.49
74LS196	276-1938	1.59
74LS367	276-1835	1.19
74LS368	276-1836	1.19
74LS373	276-1943	2.39
74LS374	276-1944	2.39

4000-Series CMOS ICs

Type	Cat. No.	EACH
4001	276-2401	.69
4011	276-2411	.69
4012	276-2412	.79
4013	276-2413	.99
4017	276-2417	1.69
4020	276-2420	1.69
4021	276-2421	1.69
4023	276-2423	.69
4027	276-2427	.99
4028	276-2428	1.29
4046	276-2446	1.89
4511	276-2447	1.69
4049	276-2449	.79
4050	276-2450	.79
4051	276-2451	1.49
4066	276-2466	1.39
4070	276-2470	.79
4518	276-2490	1.49
4543	276-2491	1.99

All Prime from Major Semiconductor Manufacturers. Specs and Pin Out Diagram Included with Each Device.



NEW! **NEW!**

Low As **2⁹⁵** Need Info? — Find it at Radio Shack!

- Ⓐ Motorola RF Data Manual. Power and small-signal RF transistors, hybrid amplifier modules, more. 62-1380 4.95
- Ⓑ Motorola Low-Power Schottky TTL. Data and diagrams plus selection guide for choosing best device. 62-1381 3.95
- Ⓒ Linear Applications, Vol. 2. Latest data, diagrams, applications briefs and articles. Indexed. 62-1374 2.95
- Ⓓ CMOS Integrated Circuits. Covers 74C, CD4000-series with complete data, diagrams. Cross referenced. 62-1375 3.95
- Ⓔ Memory Data Book. Complete info on MOS and bipolar memory components, support circuits. 62-1376 3.95

Archer® Semiconductor Reference Handbook

NEW! **1⁹⁹**

Available Only at Radio Shack!

A complete guide to Radio Shack's line of high-quality solid-state devices. Cross reference and substitution guide for over 100,000 types. Pin outs, detailed data for ICs, diodes, LEDs, SCRs, displays and more! 224 pages. 276-4003 Only 1.99



SN-76477 "Sound and Music Synthesizer" IC

2⁹⁹



Combines Linear and I²L Technology on a Single Chip of Silicon!

Creates almost any type of sound — from music to explosions and "gunshots"! High level op amp output. Includes 2 VCOs, low frequency osc., noise generator, filter, 2 mixers, timing logic. 28-pin DIP. With data. For 9VDC. 276-1765 2.99

3 Hall-Effect Sensors

NEW!



1⁹⁸ Pkg. of 3

Open-Collector Output
Detects magnetic fields electronically. 750 gauss "on" threshold. Constant amplitude independent of frequency. Similar to type ULN 3006. Ideal for tachs, position sensing, pulse counting. 5 to 16V supply. TO-92 case. With data. 276-1646 Pkg. of 3/1.98

BIFET Op Amps



Low As **1⁸⁹**

NEW!

Feature very high input impedance, low noise. Fast 13V μ S slew rate is ideal for low TIM distortion audio amplifiers. Internally compensated. Up to \pm 18V supply.
Ⓐ LF 353N. Dual BIFET Op amp. 8-pin DIP. 276-1715 1.89
Ⓑ TL 084C. Quad BIFET Op amp. 14-pin DIP. 276-1714 2.99

NEW! 10 Assorted Mini Reed Switches

1⁹⁸ Pkg. of 10



Hermetically sealed. Gold-plated contacts close when magnetic field is present. Includes mini and micro types. 275-1610 Pkg. of 10/1.98

V to F, F to V Converter

NEW!
3⁴⁹



High Linearity and Accuracy
9400CJ. Accepts analog voltage and generates linear proportional output frequency or provides a voltage output depending on input frequency. Operates either mode up to 100 kHz. With data. 14-pin DIP. 276-1790 3.49

Dual Audio Delay IC

NEW!
10⁹⁵

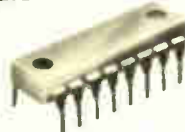

Variable Electronic Time Delay
SAD1024A. "Bucket Brigade" device has 2 independent 512-stage shift registers to produce echo, reverb, chorus and phase shift effects. 18-pin DIP. With circuits, data. 276-1761 10.95

10-Position BCD Switch

NEW!
2⁹⁹



Contacts Gold-Plated
Full 0-9 binary coded outputs for logic circuits. Eliminates extra encoding circuitry. Positive detents. Fits standard 8-pin DIP socket or mounts on PC board. 275-1310 2.99

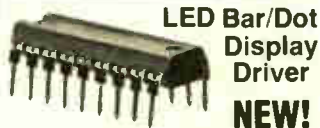

LED Bar/Dot Display Driver
NEW!

Ideal for Voltage, Current and Audio Power Displays **3⁴⁹**
LM3914N. Features 10 adjustable analog steps, bar or dot display mode. Current-regulated LED outputs. 8 to 25VDC supply. 18-pin DIP. 276-1707 3.49

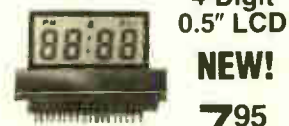

4-Digit 0.5" LCD
NEW!
7⁹⁵

Includes Socket
Easy to read liquid crystal display with snooze, alarm and PM indicators. Direct drive design. Requires 5 VDC at 10 μ A. With pin-out data. 276-1230 7.95

Three 12VDC Motors

NEW!

1⁹⁸ Pkg. of 3



High torque, permanent magnet type motors operate up to 10,000 RPM at no load. Shaft diameter: .32" Overall length: 1/2" Ideal for hobby projects. 273-213 Pkg. of 3/1.98

**WHY WAIT FOR MAIL ORDER DELIVERY?
IN STOCK NOW AT OUR STORE NEAR YOU!**

Radio Shack®

Prices may vary at individual stores and dealers

A DIVISION OF TANDY CORPORATION • FORT WORTH, TEXAS 76102
OVER 7000 LOCATIONS IN 40 COUNTRIES

CIRCLE 44 ON FREE INFORMATION CARD

LEADER OSCILLOSCOPES

Instruments Corp.



Model LBO-507
20 MHz, TRIGGERED

- Single trace, automatic trigger for highly stable, bright display
- 17 5nSec rise time
- 10mV/cm to 20V/cm Vertical Sensitivity, 11 steps.



Model LBO-508
20 MHz, DUAL TRACE

- Add, subtract modes on CH-1 & CH-2 facilitate easy checkout for simultaneous pulses, signal levels, distortion & noise cancelling.



Model LBO-515
25 MHz, DELAYED SWEEP, DUAL TRACE

- Built in variable delay circuitry — 1μSec to 5 Sec
- 5mV/Div Vertical Sensitivity

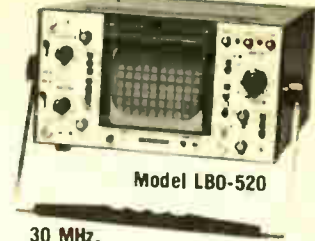

Model LBO-520
30 MHz, FIXED DELAY, DUAL TRACE

- Dual trace, 30 MHz bandwidth
- 5mV/cm Vertical Sensitivity

COLOR BAR GENERATORS, BRIDGES, TESTERS.



Model LCG-396
NTSC Color Bar Pattern Generator

- Provides full field or IQW insertion, plus on/off control of chroma and luminance
- Better checking and adjusting of purity and white balance via red, blue, green, white trasers
- One and single crossbars for convergence raster and all other alignment requirements
- 7551 Video 1 (Vid) fixed and RF output for TV and VTR equipment
- Equalizing pulse phase locked to color subcarrier
- Adjustable scanning control permits progressive or interlaced scanning to eliminate flicker
- Provides all signals required to time test & evaluate all MATV, CATV, VTR/VCR color and black systems



Model LCG-397
Completely Portable, Battery Operated TV Color Analyzer

- RF & composite video outputs
- 0-100% variable color burst for easy chroma service
- 18 convergence patterns — 10 bar gated, 3 bar gated and rainbow patterns
- 3 dot patterns, 2 crosshatch patterns
- 3 vertical lines and 3 horizontal lines plus gray scale
- Oscilloscope trigger outputs
- Battery operated 4 standard C cells 1.5V each



Model LCR-740
Transistorized LCR Bridge

- Highly accurate 3 digit readout
- Measures inductance (L), capacitance (C) and Resistance (R) within 0.5% accuracy
- Readouts variable with built-in 10% overrange
- Loss Factor scale (D)
- Operates on 1.5V battery or through built-in AC adapter



Model LTC-906
The Automatic Transistor Checker

- Automatically checks means steps P-E-T, emitter, good/bad, in or out of circuit
- Automatically identifies Germanium or Silicon
- Automatically identifies elements
- Automatically tests broad range of parameters with simple program on oscilloscope
- LED display plus audible tone indicates defective or good performance
- Absolute meter readout of H_{FE} , Base and Leakage current
- Totally portable, battery operated — 9V battery

Before you buy, check our prices...

Call TOLL FREE (800) 645-9518
In N.Y. State call (516) 752-0050

FORDHAM
YOUR ONE STOP DISCOUNT CENTER

Master Charge, Bank Americard, Visa, C.O.D.'s accepted.

FREE Send for new 1978 catalog of over 3000 items 164 pages of test equipment CB tools tubes components and electronic supplies

RADIO SUPPLY CO. INC.
855R Conklin St.
Farmingdale, N.Y. 11735

ADD \$3.00 TO COVER SHIPPING, HANDLING & INSURANCE N.Y. R/S add approx sales tax.

HICKOK 3 1/2 Digit Mini-Multimeter
Model LX 303
\$69.50

GOULD 15 MHz Dual Trace
Triggers in excess of 25 MHz
Model DS2551
\$795 including probes

SENCORE TV-VTR-MATV and Video Analyzer
Model VA48
\$875.00 Reg. \$975.00

CONTINENTAL SPECIALTIES 100 MHz 8-Digit Counter
• 20 Hz to 100 MHz Range • 6 LED Digits • Fully Automated
• Includes 100 IPC (printed) signal cable option
Model MAX-100
NOW AVAILABLE **PS500 500MHZ Prescaler \$52.95**

BSR Changer Accessories
Model BSR 129
\$29.95

Sinclair PDM35 digital MultiMeter
Model PDM35
\$52.95

Ungar Heat Gun
Reg. \$65.00
\$46.50

Logic Monitor
Model LM1
\$52.95 complete

BK PRECISION Digital Capacitance Meter
Model 820
\$249.95 Model 1500 **\$400**

Code-A-Phone Telephone Answering Devices
Wireless Command 1400 \$199.95

BK PRECISION 3 1/2-Digit Portable DMM
• Overhead Protected • Battery or AC operation • 3" high LED display • Auto Zeroing • Model 2800
comes complete with test leads, operating manual and spare fuse

Weller Xcelite
Model XCELITE
\$147.95

Service Master Attache Style Tool Kit
Model 995M
\$42.95

Wahl NEW ISO-TIP "Quick Charge"
1 1/2 AMP
\$27.95

Microflame Deluxe Gas Torch Kit
Model 4400
Reg. \$39.95
\$29.95

NLS 15 MHz Mini Oscilloscope
Model MS 15
Reg. \$318.00
\$269.95

Tool Cases
Model TC 100/ST
Reg. \$283.00
\$269.95

Roll Kit
Model 99PR
\$15.95

platt Attach Tool Case with 2 Removable Pallets
Model 600T
Reg. \$89.00
\$65.00

HICKOK Function Generator
Model 1270
\$169.15

Logic Probe
Model LP 1
\$40.00

20 MHz. Dual Trace
• Add, subtract modes on CH-1 & CH 2
• Front panel X-Y operation
• 17.5 nSec rise time
Reg. \$789.95
\$654.50 with accessories

700 Series LAMP
Model MG 10A
\$49.50

Touch K100 Scanner
Model 250
\$299.95

Dual-Trace 5" 30MHz Triggered Scope
Model 1474 P
INCLUDES TWO PR36 PROBES
\$147.95

SENCORE POCKET CRICKET TRANSISTOR/FEET TESTER
Reg. \$125.00
\$99.95

RC Circuit Box/RCA-VIZ
• 36 resistors (15 ohms to 10 megohms)
• 18 capacitors (100 pf to 0.22 μf)
Model WC 412A
Reg. \$40
\$36

30MHz Portable Frequency Counter
Reg. \$120.00
\$59.95

Bearcat Scanner
Model 250
\$299.95

Controlled Output Soldering Station
Model WTCP N
Reg. \$75.00
\$45.00

Function Generator
Model 7001
Reg. \$149.95
\$127.50

Chess Challenger
• Ten levels of play
Model LCX
\$179.95

Regency 10 channel computer controlled
Reg. \$269
\$199.95

Substitution Box
Model 2910
\$169.15

FREE 1979 Catalog

Function Generator
Model 7001
Reg. \$149.95
\$127.50

Chess Challenger
• Ten levels of play
Model LCX
\$179.95

Regency 10 channel computer controlled
Reg. \$269
\$199.95

Substitution Box
Model 2910
\$169.15

FREE 1979 Catalog

Function Generator
Model 7001
Reg. \$149.95
\$127.50

Chess Challenger
• Ten levels of play
Model LCX
\$179.95

Regency 10 channel computer controlled
Reg. \$269
\$199.95

Substitution Box
Model 2910
\$169.15

FREE 1979 Catalog

Function Generator
Model 7001
Reg. \$149.95
\$127.50

Chess Challenger
• Ten levels of play
Model LCX
\$179.95

Regency 10 channel computer controlled
Reg. \$269
\$199.95

Substitution Box
Model 2910
\$169.15

FREE 1979 Catalog

"We Will Beat Any Advertised Price"

FORDHAM
855R Conklin St. Farmingdale, N.Y. 11735



50 ps RISETIME GENERATOR

Model TD-50PA and Model P5A (250 ps risetime) are intended for precision measurement and testing of high-speed circuit and systems and for TDR applications. They are also ideal sources to drive amplifiers, because they exhibit low transient aberrations and excellent pulse flatness. The TD-50PA has a separate pretrigger (85 ns) and normal trigger output. Both units come with their own power supply so they can be used with any oscilloscope system. The TD-50PA is priced at \$449, the P5A at \$149.

COLBY INSTRUMENTS, Inc.
P.O. Box 84379
VA Branch(C),
Los Angeles, CA 90073
(213) 476-6139

CIRCLE 76 ON FREE INFORMATION CARD

GILFER

North America's Shortwave Mail Order Place

*Drake, Grundig, Panasonic, Sony, Yaesu receivers—special mods for better performance *Digital Readouts *Antennas *Tuners *Calibrators *Clocks *Logs *QSL albums *All SWL Accessories & Books

NEW "Confidential Frequency List"

104 page book identifies 5000 special HF stations (SSB, CW, FAX) from 4 to 26 MHz. \$6.95 ppd.

FREE SWL CATALOG GILFER SHORTWAVE

Dept. R-10, Box 239, Park Ridge NJ 07656



SpeakerGuts.



The absolute latest in advanced speaker technology. Wave Aperture™ Drivers, the Patented Nastrovic Woofer System™, raw speaker components selected for their excellence. Horns, crossovers, subwoofers, woofers, midranges, horn and dome tweeters. Over 30 in all. Build your own speaker system and we'll provide top quality speakers and design information. Send for FREE 48 page color catalog from the largest, most experienced speaker kit manufacturer in the world. **DON'T DELAY. Write today!**

Speakerlab
Dept. 10-RE, 735 N. Northlake Way
Seattle, Washington 98103

CFR ASSOCIATES' USED PRINTER BARGAINS

● *Diablo* ● *Centronics* ● *"Selectrics"*
Supplies Limited!!
Call Us NOW to Reserve Your Printer!
"The Best of the Bunch"
● **Modified "SELECTRIC" I/O Printers:**
2 Models avail. 'A' is almost fully useable as a stand-alone typewriter printer, while 'B' has servo-driven carrier & printer (X&Y) for BIDIRECTIONAL capability. Both models use solenoid to activate mechanisms, and all circuitry is brought out at a connector on a 10' cable. Used, removed from equip. AS-IS, good condition.
Model 'A' \$389.00
Model 'B' \$359.00
Complete Data Package (Specify Which). Only \$14.00
*Needs +26VDC to activate solenoids (Shift, tab, etc.)

● **Centronics Dot-Matrix Printers:**
The workhorses of the industry. Over 100 characters/second! Model 101 tested & func't: \$695.00; AS-IS: \$420.00; Model 102A tested and func't: \$980.00; AS-IS: \$490.00. (Interfaces with TRS 80 cable too!)
*As is machines are whole but do not include print heads

● **Diablo 1355-WP "Daisy Printers":**
Serial or parallel inputs. Used on all Zeros word processors—takes metal "daisy" wheel. Includes all Diablo PC cards, mainframe, printer, power supply, case, conn., and data.
Call for prices and availability.



● **Modular DC to DC Converters** (2 Inch Square)
- 15 Volts In ± 15 Volts Out at 100 mA \$18.00
- 5 Volts In - 12 Volts, - 5 Volts Out \$18.00
- 12 Volts In - 5 Volts Out @ 1.5 Amps \$18.00

● **Center-Zero Analog Panel Meter**
5 1/2" wide by 4 1/4" high. F.S.: 50-0-50 u Amps, MIRRORED SCALE. BRAND NEW, log. linear scale. \$14.95

● **Flexible 3-Wire Line Cords**
120 Volt standard power cords, six feet in length, brand new, removed from unused equipment, 3-prongs. Only 99¢ ea., 4163.00

● **Hybrid Active Filter Special!!!**
AF-100 state variable filter with MP, BP, LP & NOTCH outputs. Operates from ± 15 VDC, DC to 10KHz (AF100-ICJ). Only \$4.95 ea.
PLUS OUR LINE OF LOW COST ANALOG BARGAINS
So write for our LATEST CATALOG and get on our Mail List!

CFR Associates, Inc.
Newton, N.H. 03858

(603) 382-5179
Add \$2.00 for shipping
● MC, VISA, & C.O.D. accepted ● Phone orders are welcome
SATISFACTION GUARANTEED

CIRCLE 43 ON FREE INFORMATION CARD

MOTOROLA PIEZO SUPER TWEETER



100 WATTS
\$7.95

KSN 1005A
NO CROSSOVER NEEDED!
NO VOICE COIL — No moving or rubbing parts to burn or wear out!
EXCELLENT TRANSIENT RESPONSE

AUDIOFOX CB RECEIVER



\$9.95

The CBC-100 Converter uses your regular car radio and antenna to receive 23 citizens band channels. Micro in size, this unit utilizes 10 crystals, 10 transistors, 7 diodes, dual conversion superheterodyne with crystal filter and built-in noise limiter circuit. No FCC license required.

WINEGARD FM AUTO RADIO BOOSTER



BF-8809
EASY TO INSTALL

IMPROVES YOUR FM RECEPTION!
\$19.95
AMPLIFIES FM RADIO SIGNAL AN AVERAGE OF 8 TIMES
EXTENDS YOUR RADIO'S RANGE AND ALLOWS GREATER SELECTION OF STATIONS

ITC EXCLUSIVE! NEVER BEFORE SOLID STATE DIGITAL AMPLIFIER



\$12.95
HUNDREDS OF DOLLARS IN PRECISION PARTS

IDEAL FOR EXPERIMENTORS — CONTAINS 69 TRANSISTORS, 175 RESISTORS, 45 DIODES, 14 50K POTS, 41 SILVER MICA CAPS, 11 WIREWOUND RESISTORS, 4 MYLAR CAPACITORS, 1 BRIDGE RECTIFIER, 6 COILS, 1 RELAY, 1 24 VOLT POWER SUPPLY, AND ASSORTED SWITCHES, CONNECTORS, HEAT SINKS, AND OTHER COMPONENTS.

CONTAINS BUILT-IN 24 V POWER SUPPLY

VACUUM VISE



NEW
\$3.95

UNIQUE VACUUM BASE IDEAL FOR PRECISION HANDLING OF SMALL COMPONENTS AND ASSEMBLIES
1 1/2" WIDE JAWS WITH SCREW LUGS FOR PERMANENT INSTALLATION

24 VOLT 4PDT RELAY
PLASTIC DUST COVER
3 AMP CONTACTS \$1.69

2 WATT STEREO AMP



\$3.95

COMPLETE WITH VOLUME, BALANCE, AND TONE CONTROL
PRE-WIRED SPEAKER TERMINAL BOARD AND HEADSET JACK INCLUDED

**DPDT ILLUMINATED
ROCKER SWITCH**
3 AMP 250 VAC 99¢

24 VCT TRANSFORMER
75 AMP 117 VOLT INPUT \$2.99

NEW SHIPMENT JUST ARRIVED
Write us for low, low prices on high quality miniature aluminum electrolytic capacitors — axial or radial leads

**SOLID STATE
UHF TUNER
CHANNELS**
14-83 \$4.95

ROTRON BISCUIT FAN

THE ONLY AIR MOVING DEVICE THAT FITS INSIDE A 1 1/2" RACK PANEL MOUNTED INSTRUMENT
HIGH PERFORMANCE AND LOW NOISE LEVEL



\$14.95

BT2A1

IC INSERTER — EXTRACTOR

INS1416 \$3.75
UNIQUE QUICK RELEASE FEATURE

INSERT IC'S EASILY WITH THIS PRECISION TOOL. ALSO PICKS UP IC'S AND STRAIGHTENS PINS.

ITC®

ELECTRONIC SUPERMARKET

2772 W. Olympic Blvd.
Los Angeles, CA 90006
(213) 388-0621

Minimum Order \$5.00
Please add \$2.00 postage and handling.
California residents add 6% Sales Tax
VISA/Master Charge: state number and expiration date.
OEM and institutional inquiries invited.



FREQUENCY COUNTER KIT

Outstanding Performance
 Incredible Price **\$89.95**
CT-50

The CT-50 is a versatile and precision frequency counter which will measure frequencies to 60 mHz and up to 600 mHz with the CT-600 option. Large Scale Integration, CMOS circuitry and solid state display technology have enabled this counter to match performance found in units selling for over three times as much. Low power consumption (typically 300-400 ma) makes the CT-50 ideal for portable battery operation. Features of the CT-50 include large 8 digit LED display, RF shielded all metal case, easy pushbutton operation, automatic decimal point, fully socketed IC chips and input protection to 50 volts to insure against accidental burnout or overload. And, the best feature of all is the easy assembly. Clear, step by step instructions guide you to a finished unit you can rely on. **Order your today!**

CT-50, 60 mHz counter kit **\$89.95**
 CT-50WT, 60 mHz counter, wired and tested **159.95**
 CT-600, 600 mHz scaler option, add **29.95**

CB-1, Color TV calibrator-stabilizer **\$14.95**
 DP-1, DC probe, general purpose probe **12.95**
 HP-1, High impedance probe, non-load **15.95**

- SPECIFICATIONS:**
 Frequency range 6 Hz to 65 mHz, 600 mHz with CT-600
 Resolution 10 Hz @ 0.1 sec gate, 1 Hz @ 1 sec gate
 Readout 8 digit, 0.4" high LED, direct readout in mHz
 Accuracy adjustable to 0.5 ppm
 Stability 2.0 ppm over 10 to 40 C, temperature compensated
 Input IBCN, 1 megohm 20 pF direct, 50 ohm with CT-600
 Overload 50VAC maximum, all modes
 Sensitivity less than 25 mv to 65 mHz, 50-150 mv to 600 mHz
 Power 110 VAC 5 Watts or 12 VDC @ 400 ma
 Size 6" x 4" x 2", high quality aluminum case, 2 lbs
 ICS 13 units, all socketed

CAR CLOCK

The UN-KIT, only 5 solder connections

Here's a super looking rugged and accurate auto clock which is a snap to build and install. Clock movement is completely assembled—you only solder 3 wires and 2 switches takes about 15 minutes! Display is bright green with automatic brightness control photocell—assures you of a highly readable display day or night. Comes in a satin finish anodized aluminum case which can be attached 5 different ways using 2 sided tape. Choice of silver black or gold case (specify)

DC-3 kit 12 hour format **\$22.95**
 DC-3 wired and tested **\$29.95**
 110V AC adapter **\$5.95**

Under dash car clock

12 24 hour clock in a beautiful plastic case features 6 jumbo RED LEDs high accuracy (1 min mo) easy 3 wire hookup display blank with ignition and super instructions. Optional dimmer automatically adjusts display to ambient light level

DC-11 clock with mig bracket **\$27.95**
 DM-1 dimmer adapter **2.50**

PRESCALER

Extend the range of your counter to 600 mHz. Works with any counter. Includes 2 transistor pre-amp to give super sens, typically 20 mv at 150 mHz. Specify ± 10 or ± 100 ratio

PS-1B, 600 mHz prescaler **\$59.95**
 PS-1BK, 600 mHz prescaler kit **49.95**

OP-AMP SPECIAL

741 mini dip **12/\$2.00**
 B1-FET, mini dip, 741 type **10/\$2.00**

VIDEO TERMINAL

A completely self-contained, stand alone video terminal card. Requires only an ASCII keyboard and TV set to become a complete terminal unit. Two units available, common features are: single 5V supply, XTAL controlled sync and baud rates (to 9600), complete computer and keyboard control of cursor. Parity error control and display. Accepts and generates serial ASCII plus parallel keyboard input. The 3216 is 32 char. by 16 lines, 2 pages with memory dump feature. The 6416 is 64 char. by 16 lines, with scrolling, upper and lower case (optional) and has RS-232 and 20ma loop interfaces on board. Kits include sockets and complete documentation.

RE 3216, terminal card **\$149.95**
 RE 6416, terminal card **189.95**
 Lower Case option, 6416 only **13.95**
 Power Supply Kit **14.95**
 Video/RF Modulator, VD-1 **6.95**
 Assembled, tested units, add **60.00**

CALENDAR ALARM CLOCK

The clock that's got it all! 6-5" LEDs, 12 24 hour snooze, 24 hour alarm, 4 year calendar, battery backup, and lots more. The super 7001 chip is used. Size 5x4x2 inches

Complete kit, less case (not available) **\$34.95**
 DC-9

30 Watt 2 mtr PWR AMP

Simple Class C power amp features 8 times power gain. 1 W in for 8 out, 2 in for 15 out, 4 W in for 30 out. Max. output of 35 W, incredible value, complete with all parts, less case and T-R relay

PA-1, 30 W pwr amp kit **\$22.95**
 TR-1, RF sensed T-R relay kit **6.95**

FM MINI MIKE KIT

A super high performance FM wireless mike kit! Transmits a stable signal up to 300 yards with exceptional audio quality by means of its built in electret mike. Kit includes case mike on-off switch antenna battery and super instructions. This is the finest unit available.

FM-3 kit **\$12.95**
 FM-3 wired and tested **16.95**

CLOCK KITS

our Best Seller
 your Best Deal

Try your hand at building the finest looking clock on the market. Its satin finish anodized aluminum case looks great anywhere, while six 4" LED digits provide a highly readable display. This is a complete kit, no extras needed, and it only takes 1-2 hours to assemble. Your choice of case colors: silver, gold, bronze, black, blue (specify)

DC-11 clock with mig bracket **\$22.95**
 DC-10 clock with 10 min ID timer, 12 24 hour **27.95**
 Alarm clock 12 hour only, DC-8 **24.95**
 12V DC car clock, DC-7 **27.95**
 For wired and tested clocks add \$10.00 to kit price

Ramsey's famous MINI-KITS

FM WIRELESS MIKE KIT

Transmits up to 300' to any FM broadcast radio uses any type of mike. Runs on 3 to 9V. Type FM-2 has added sensitive mike preamp stage.

FM-1 kit **\$2.95**
 FM-2 kit **\$4.95**

VIDEO MODULATOR KIT

Converts any TV to video monitor. Super stable, tunable over ch 4-6. Runs on 5-15V. accepts std video signal. Best unit on the market!

Complete kit, VD-1 **\$6.95**

SUPER SLEUTH

A super sensitive amplifier which will pick up a pir drop at 15 feet! Great for monitoring baby's room or as general purpose amplifier. Full 2 W rms output, runs on 6 to 15 volts uses 8-45 ohm speaker.

Complete kit, BN-9 **\$5.95**

COLOR ORGAN/MUSIC LIGHTS

See music come alive! 3 different lights flicker with music. One light for lows, one for the mid-range and one for the highs. Each channel individually adjustable and drives up to 300W. Great for parties, band music, nite clubs and more.

Complete kit, ML-1 **\$7.95**

TOPE DECODER

A complete tone decoder on a single PC board. Features 400-5000 Hz adjustable range via 20 turn pot. voltage regulation 567 IC Useful for touch-tone decoding, tone burst detection, FSK, etc. Can also be used as a stable tone encoder. Runs on 5 to 12 volts.

Complete kit, TD-1 **\$5.95**

POWER SUPPLY KIT

Complete triple regulated power supply provides variable -6 to 18 volts at 200 ma and +5V at 1 Amp. Excellent load regulation, good filtering and small size. Less transformers, requires 6.3V @ 1 A and 24 VCT.

Complete kit, PS-3LT **\$6.95**

LED BLINKY KIT

A great attention getter which alternately flashes 2 jumbo LEDs. Use for name badges, buttons, warning panel lights, anything! Runs on 3 to 15 volts.

Complete kit, BL-1 **\$2.95**

WHISPER LIGHT KIT

An interesting kit, small mike picks up sounds and converts them to light. The louder the sound the brighter the light. Completely self-contained, includes mike, runs on 110VAC, controls up to 300 watts.

Complete kit, WL-1 **\$6.95**

SIREN KIT

Products upward and downward wail characteristic of a police siren. 5W peak audio output, runs on 3-15 volts, uses 3-45 ohm speaker.

Complete kit, SM-3 **\$2.95**

Hard to find PARTS

LINEAR ICs		REGULATORS	
301	\$ 35	78MG	\$1.25
324	50	723	50
380	25	309K	85
380-8	75	7805	85
555	45	78L05	25
556	85	7905	1.25
566	15	7812	85
567	25	7912	1.25
1458	50	7815	85
3900	20	74500	35
CMOS ICs		7447	65
4011	20	7475	50
4013	35	7476	50
4046	1.85	7490	50
4049	40	74196TI	1.35
4518	1.25	SPECIAL ICs	
5369	1.75	11C90	13.50
		10116	1.25
TRANSISTORS		4511	2.00
2N3904 type	10 1.00	5314	2.95
2N3906 type	10 1.00	5375AB	2.95
NPN 30W Pwr	3 1.00	7001	6.50
PNP 30W Pwr	3 1.00	4059-N	9.00
2N3055	60	7208	17.95
UJT 2N2646 type	3 2.00	LEDs	
FT MPF02 type	3 2.00	Jumbo red	8 1.00
UMF 2N5179 type	3 2.00	Jumbo green	6 1.00
MRP-238 RF	11.95	Jumbo yellow	6 1.00
SOCKETS		Mini red	8 1.00
8 pin	10 2.00	Micro red	8 1.00
14 pin	10 2.00	BiPolar	8 1.00
15 pin	10 2.00	FERRITE BEADS	
24 pin	4 2.00	With info, specs	15 1.00
28 pin	4 2.00	6 hole balun	5 1.00
40 pin	3 2.00		

ramsey electronics

PHONE ORDERS CALL
 (716) 271-6487

BOX 4072, ROCHESTER, N.Y. 14610

TERMS: Satisfaction guaranteed or money refunded COD, add \$1.50. Minimum order, \$6.00. Orders under \$10.00, add \$75. Add 5% for postage, insurance, handling. Overseas, add 15%. NY residents, add 7% tax.

CIRCLE 57 ON FREE INFORMATION CARD

High Technology/Low Prices

Econoram* boards are generally available in 3 forms: unkit (sockets and bypass caps are pre-soldered in place for simple, 1 evening assembly), assembled and tested, or qualified under our high-reliability Certified System Component (CSC) program (200 hour burn-in, immediate replacement in event of failure within 1 year of invoice date). 1 year limited warranty on all products. Chart below gives pricing.

Name	Storage	Bus	Configuration	Notes	Unkit	Asm	CSC
● Econoram IIA	8K X 8	S-100	2-4K blocks	1	\$149	\$179	\$239
● Econoram IV	16K X 8	S-100	1-16K	1	\$269	\$329	\$429
● Econoram VIIA-16	16K X 8	S-100	2-4K, 1-8K	1	\$279	\$339	\$439
● Econoram VIIA-32	24K X 8	S-100	2-4K, 2-8K	1	\$398	\$485	\$605
● Econoram IX-16	16K X 8	Dig Grp	2-4K, 1-8K	1	\$319	\$379	n/a
● Econoram IX-32	32K X 8	Dig Grp	2-4K, 1-8K, 1-16K	1	\$559	\$639	n/a
● Econoram X	32K X 8	S-100	2-8K, 1-16K	1	\$529	\$649	\$789
● Econoram XI	32K X 8	SBC/BLC	2-8K, 1-16K	1	n/a	n/a	\$1050
● Econoram XII-16	16K X 8	S-100	see notes	1, 2	\$329	\$419	\$519
● Econoram XII-24	24K X 8	S-100	see notes	1, 2	\$429	\$539	\$649
● Econoram XIII	32K X 8	S-100	see notes	1, 3	\$559	\$699	\$849
● Econoram XIV	16K X 8	S-100	see notes	1, 4, 5	\$289	\$349	\$449
● Econoram XV-16	16K X 8	H8	1-16K	1, 6	\$329	\$395	n/a
● Econoram XV-32	32K X 8	H8	2-16K	1, 6	\$599	\$729	n/a

Notes:

- Works at 5 MHz with 8085, 4 MHz with Z-80.
- Bank select board — 2 independent banks addressable on 8K boundaries.
- Bank select board — 2 independent banks addressable on 16K boundaries.
- Bank select board — 1 bank addressable on 16K boundaries.
- 24 address lines for extended addressing.
- Bank select option included for implementing memory systems greater than 64K.

*Econoram is a trade mark of Bill Godbout Electronics.

CARBON FILM 1/4W-5% Resistors

CODE	RESISTANCE	TOLERANCE	PRICE
2.7	11	47	270
3.0	12	51	300
3.3	13	56	330
3.6	15	62	360
3.9	16	68	390
4.3	18	75	430
4.7	20	82	470
5.1	22	91	510
5.6	24	100	560
6.2	27	110	630
6.8	30	120	680
7.5	33	130	750
8.2	36	150	820
9.1	39	160	910
10	43	180	1000

HIGH QUALITY - LOW O.E.M. PRICE

5 for .25 10 for .40 100-\$1.60 - 1000 at \$14. one value one value 100 per value

CMOS BOARD \$2.95

CONTAINS:
4553 3 digit decade counter
4511 4bit latch 7 seg. decoder
driver for LED display
4060 oscillator w/1st stage binary counter.
4011 CMOS inverter
2 switches, resistors, capacitors.
HP 2 digit LED display

RCA to 220 8A, 600V TRIAC ea. 99¢ ten- \$9.50 \$89/c

BISTABLE RELAY OPTO ISOLATOR Ge or Si SIGNAL DIODES

FC8280 6pin DIP
WILL DRIVE A TTL GATE WITH TEN MA LED CURRENT
\$2.95 ea. 69¢ ea ten \$6 40 for \$2

P.U.T. PROGRAMMABLE UNIJUNCTION Prime 2M6026

50¢ ea. ten \$4 100-\$30
Material no. 19837

VOICE ACTUATED SWITCH 95¢ ea

1A, 100V
Varo VM18
ten \$4 100-\$30 removed from boards

VIBRANIC dual delay \$12.95

DIODE ARRAY ID IN914's
25¢ each 10 - \$2.25

ZERO CROSSING SWITCH 60¢ ea \$5- ten

12 TURN 1/2" 5K or 200K only mg. DALE \$1.50 TEN FOR \$4

1/2 WATT RESISTORS POTTER BRUMFIELD TYPE R1P RELAY

4PDT 3AMP
24VDC 500 ohms or 120VAC 10.5MA
please specify coil required. \$1.75

Numeric Display 1/4" Single Digit GaAsP LED

65¢ each - 10 for \$5.95

VARO SEMICONDUCTOR

30 ea. 10 for \$7.50 100-\$65

SMOKE ALARM

\$179 2 \$3

new! new!



ECONORAM II CLOSEOUT \$129 unkit (3/\$375), \$155 assm

Limited quantity. Our new Econoram IIA is out, but this is still a great memory for 2 MHz systems. Low power, configured as 2 independent 4K blocks, reliable and cost-effective operation. 1 evening assembly, 1 year limited warranty.

16K MEMORY EXPANSION CHIP SET \$87.20

20% off our regular \$109 price while they last. For Radio Shack-80, Apple, Exidy Sorcerer memory expansion. Low power, 250 ns parts. DIP shunts and instructions included. 1 year limited warranty.

INTERFACER S-100 I/O BOARD \$189 unkit, \$249 assm

Dual serial port with 2 full duplex parallel ports for RS-232 handshake; crystal controlled timebase; operates with 2 to 5 MHz systems; many software programmable functions; much more.

2708 S-100 EPROM BOARD \$85 unkit

4 independently addressable 4K blocks. Includes all support chips and manual, but does not include EPROMs.

TERMS: Cal. res. add tax. Allow 5% for shipping, excess refund. VISA/Mastercharge call our 24 hour order desk at (415) 562-0636. COD OK with street address for UPS. Prices good through cover month of magazine.



GODBOUT ELECTRONICS
Bldg. 725, Oakland Airport, CA 94614
FREE FLYER: We'll be glad to tell you much more than the space of this ad permits. Just send your name and address, we'll take care of the rest. Include 41c in stamps for 1st class delivery if desired.

CIRCLE 54 ON FREE INFORMATION CARD

RHYTHM GENERATOR ROM

\$1.89

FND-359

69¢ 7/\$4.30

CRYSTALS

1.000MHz .001% \$5.95
3.570MHz .002% \$1.28
4.000MHz .002% \$2.95
5.000MHz .001% \$4.50
10.000MHz .001% \$4.50

LM340K-5

\$1

LM3900

55¢

WOW! DIGITAL TIMER-COUNTER

POWER WITH 9V BATTERY
IC'S ALONE WORTH \$9!
4011, 4060, 4511, 4553
COMPACT: 1" x 2" PCB

\$1.95 2/3

Build a 7 Digit Portable Counter

FREQUENCY COUNTER CHIP SET

ICM 7207A \$15.50
ICM 7208 \$21.50

"FIRE SALE" ASSEMBLED & TESTED

PHOTOELECTRIC TYPE
NO BATTERY TO BUY!

\$179 2 \$3

5.24288MHz Quartz Crystal

450
6-36pf Trimmer 49¢

SMOKE ALARM

\$179 2 \$3

DIAMONDBACK ELECTRONICS COMPANY

PO BOX 12095 SARASOTA, FL 33578

*** FREE CATALOG ***
ALL MERCHANDISE 100% GUARANTEED
MINIMUM ORDER \$5
FLA. RESIDENTS ADD 6% SALES TAX
PLEASE INCLUDE SUFFICIENT POSTAGE
PHONE ORDERS 813/963-2829

RADIO-ELECTRONICS

PO BOX 41778 Sacramento California 95841
SEND FOR FREE FLYER TODAY
\$5 minimum order, add \$1 handling charge to orders less than \$10. We pay post or UPS on domestic orders over \$10. BAC, MC and VISA accepted, \$15 minimum and shipping is added. Open orders accepted from government entities and large retail firms.
SAME DAY SHIPMENT - telephone (916) 334-2161
4811 Myrtle Avenue, Sacramento, CA 95841

BABYLON ORDER NOW! ELECTRONICS

CIRCLE 77 ON FREE INFORMATION CARD

CIRCLE 69 ON FREE INFORMATION CARD

15-240 WATT!

SUPER IC

(hybrid)

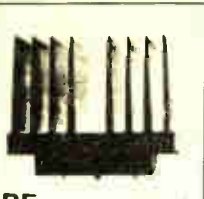

only five connection, no external part in most of them, built in heatsink. **+** MORE.

HY5

Preamplifier

The HY5 is a mono hybrid amplifier ideally suited for all applications. All common input functions (mag. Cartridge, Tuner, etc) are catered for internally. The desired function is achieved either by a multi-way switch or direct connection to the appropriate pins. The internal volume and tone circuit merely require connecting to external potentiometers (not included). The HY5 is compatible with all I.L.P. power amplifiers and power supplies. To ease construction and mounting a P.C. connector is supplied with each pre-amplifier.

FEATURES: Complete pre-amplifier in single pack—Multi-function equalization—Low noise—Low distortion—High overdrive—Two simply combined for stereo.

APPLICATIONS: Hi-Fi—Mixer—Disc—Guitar and Organ—Public address.

SPECIFICATIONS:
 INPUTS: Magnetic Pick-up 3mV, Ceramic Pick-up 20mV, Tuner: 100mV, Microphone 10mV, Auxiliary 3-100mV, Input Impedance 47k Ω at 1kHz.
OUTPUTS: Type 100mV; Mono output 500mW @ 8 Ω S.
ACTIVE TONE CONTROLS: Treble \pm 10dB at 10kHz, Bass \pm at 100Hz.
 DISTORTION: 0.1% at 1kHz, Signal/Noise Ratio 80dB.
 OVERLOAD: 300dB on Magnetic Pick-up SUPPLY VOLTAGE \pm 10-50V

\$18.95

HY200

120 Watts into 8 Ω

The HY200 now improved to give an output of 120 Watts has been designed to stand the most rugged conditions such as disco or group while still retaining true Hi-Fi performance.

FEATURES: Thermal shut-down—Very low distortion—Load line protection—Integral Protection—No external components.

APPLICATIONS: Hi-Fi—Disc—Monitor—Power slave—Industrial—Public Address.

SPECIFICATIONS:
 INPUT SENSITIVITY: 500mV
OUTPUT POWER: 100W RMS into 8 Ω LOAD IMPEDANCE 4-16 Ω DISTORTION 0.5% @ 100W at 1kHz.
SIGNAL/NOISE RATIO: 80dB FREQUENCY RESPONSE 10Hz-45kHz—3dB SUPPLY VOLTAGE \pm 25V
 SIZE 114 50 85mm

\$79.95

HY400

240 Watts into 4 Ω

The HY400 is a I.L.P. "Big Daddy" of the range producing 240W into 4 Ω . It has been designed for high power disco address applications. If the amplifier is to be used at continuous high power levels a cooling fan is recommended. The amplifier includes all the qualities of the rest of the range (to read the market) as a true high power Hi-Fi/Party power module.

FEATURES: Thermal shut-down—Very low distortion—Load line protection—No external components.

APPLICATIONS: Public address—Disc—Power slave—Industrial.

SPECIFICATIONS:
OUTPUT POWER: 240W RMS into 4 Ω LOAD IMPEDANCE 4-16 Ω DISTORTION 0.1% @ 240W at 1kHz.
SIGNAL NOISE RATIO: 80dB FREQUENCY RESPONSE 10Hz-45kHz—3dB SUPPLY VOLTAGE \pm 25V
 INPUT SENSITIVITY: 500mV SIZE 114 100 85mm

\$99.95

- | | |
|---------------------------|---------------|
| HY30 - 15W/8ohm: \$17.49 | 1Yr warranty |
| HY50 - 25W/8ohm: \$24.90 | free shipping |
| HY120 - 60W/8ohm: \$49.00 | call resident |
| | add 6% tax |
| | visa & mc/v |

K V ELECTRONICS TEL: (213) 466 9005
 6734 W. SUNSET BLVD, HOLLYWOOD, CA. 90028, USA.

CIRCLE 85 ON FREE INFORMATION CARD



Electricity from the sun.

- 5 Volt panel 1/4 amp \$50
- 2.5 Volt panel 1/2 amp \$40
- GIANT 3 1/2 inch cell, delivers 1 amp \$8.50
- Above cell with special motor & prop, runs in sun \$10.25

LOGIC power supplies, unused, solid state construction.

- 5 Volt 4 amp \$35
- 5 Volt 15 amp \$45
- 5 Volt 25 amp \$45
- 5 volt 35 amp \$50



Govt surplus walky talky, used cond.
 47-55.4 mc extra.
 Ant. \$5 each extra.
 With data.

\$25 ea 2 for \$45
 AN/PRC-6



SEE IN THE DARKNESS

IR viewer, portable, new with choice of one lens...close up, telephoto or gen. purpose.
 Requires 6 volt DC btry.
 \$250

Shipping extra on all merchandise

Meshna Inc., PO Box 62, E. Lynn, Mass. 01904

CIRCLE 45 ON FREE INFORMATION CARD

FAIRCHILD RED LED LAMPS

#FLV5057 Medium Size Clear Case RED EMITTING These are not retested off-spec units as sold by some of our competition. These are factory prime first quality new units.



10 FOR \$1.19
 50 FOR \$4.95

"WE BOUGHT 250,000 PCS."

LAB-BENCH VARIABLE POWER SUPPLY KIT

5 to 20 VDC at 1 AMP. Short circuit protected by current limit. Uses IC regulator and 10 AMP Power Darlington. Very good regulation and low ripple. Kit includes PC Board, all parts, large heatsink and shielded transformer. 50 MV. TYP. Regulation.

\$15.99 KIT

NATIONAL SEMICONDUCTOR JUMBO CLOCK MODULE

MILITARY TIME FORMAT!

MA1008D BRAND NEW!

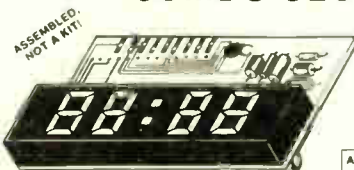

ZULU

50% OFF SALE!

PERFECT FOR USE WITH A TIMEBASE.

\$4.95
 \$7.95

REG. \$9.95

ADD \$1.95 FOR AC XFMR

- FEATURES**
- FOUR JUMBO 1/2 INCH LED DISPLAYS
 - 24 HR REAL TIME FORMAT
 - 24 HR ALARM SIGNAL OUTPUT
 - 50 OR 60 HZ OPERATION
 - LED BRIGHTNESS CONTROL
 - POWER FAILURE INDICATOR
 - SLEEP & SNOOZE TIMERS
 - DIRECT LED DRIVE (LOW RF)
 - COMES WITH FULL DATA

COMPARE AT UP TO TWICE OUR PRICE!

MANUFACTURER'S CLOSEOUT!

16K DYNAMIC RAM CHIP

WORKS IN TRS-80 OR APPLE II

16K X 1 Bits 16 Pin Package Same as Mostek 4116-4 250 NS access 410 NS cycle time. Our best price yet for this state of the art RAM. 32K and 64K RAM boards using this chip are readily available. These are new, fully guaranteed devices by a major mfg.

VERY LIMITED STOCK!

"MAGAZINE SPECIAL" — 8 For \$79.50

NATIONAL SEMICONDUCTOR

NEW!

CAR CLOCK MODULE - #MA6008

\$6.99

each

Originally used by HYGAIN to indicate time and channel on an expensive C.B. Mini size, self contained module. Not a Kit. Four digits plus flashing indicator for seconds. Includes MM5369 and 3.58 MHZ crystal for super accurate time base. With hookup data.

INCLUDES CRYSTAL TIMEBASE!
 WORKS ON 12 VDC!

MFGR'S CLOSEOUT LIMITED QTY.

CLOCK MODULE OPTIONS

MA1008 A and D MA1013

Switches and pot for all options.

- Includes:**
- 5 push buttons
 - 1 toggle
 - 1 10K pot \$2.50
 - Alarm Parts (including high impedance transducer) Much more efficient than a speaker \$1.50
 - Transducer only (unbelievably loud!) \$1.10

TOSHIBA POWER AUDIO AMP

5.8 Watt RMS Typical Output. 50 to 30,000 HZ \pm 3 DB. For CB's, tape decks, PA's, etc. Works off of a single supply voltage from 10.5 to 18 VDC. 10 Pin plastic DIP with special built in heat sink tab. Perfect for use on 12VDC. With Data. \$3.99 each

SONY 23 WATT AUDIO AMP MODULE

#STK-054. 23 WATTS SUPER CLEAN AUDIO. 20 HZ TO 100 KHZ \pm 2 DB. HYBRID, SILICON, SELF-CONTAINED MODULE. ONLY 1 1/2 x 2 1/2 IN. WITH DATA. COMPARE AT UP TO TWICE OUR PRICE! \$8.99 each \$8.99 EACH

LED BAR GRAPH AND ANALOG METER DRIVER

New from National Semi. #LM3914. Drives 10 LED directly for making bar graphs, audio power meters, analog meters, LED oscilloscopes, etc. Units can be stacked for more LED's. A super versatile and truly remarkable IC. Just out. SPECIAL PRICE: \$3.99 INCLUDES 12 Page Spec. Sheet

TERMS: Add 50% postage, we pay balance, Orders under \$15 add 75% handling. No C.O.D. We accept Visa, MasterCard, and American Express cards. Tex. Res. add 5% Tax. Foreign orders (except Canada) add 20% P & H. 90 Day Money Back Guarantee on all items.

Digital Research: Parts

(OF TEXAS)

P. O. BOX 401247 GARLAND, TEXAS 75040 • (214) 271-2461

 <p>HOUSE MARKED DARLINGTON TRANSISTOR 16 AMPS 60 VOLTS 150 WATTS Specify NPN \$1.50 or PNP \$1.50 each</p>	<p>ROTRON 3 BLADE COOLING FANS</p>  <ul style="list-style-type: none"> used but fully tested 115 vac 14 watts 4 5/8 inch x 4 5/8 inch 1 1/2 inch <p>\$8.00 each</p>
<p>12 MFD 6 VOLTS</p> <p>TANTALUM CAPACITORS</p> <p>15 for \$1.00</p>	<p>INDOOR-OUTDOOR PAGING HORNS</p>  <ul style="list-style-type: none"> 8" SIZE/30 WATTS \$24.95 6" SIZE/15 WATTS \$17.95 5" SIZE/5 WATTS \$6.50
<p>LINEAR SLIDE POTS</p> <ul style="list-style-type: none"> approx. 1 1/2 inch long 1 3/8 inch slide 10K or 20K <p>50c each SPECIFY VALUE</p>	<p>SPECIAL SALE</p>  <p>1000 MFD 16VDC 4 for \$1.00</p>
 <p>P.C. MOUNT D.P.D.T. RELAY</p> <ul style="list-style-type: none"> 1 1/8 inch x 7/8 inch x 5/8 inch 1100 ohms coil res 3 amp contacts 28 VDC <p>\$1.50 each</p>	<p>P.N.P. GER. TRANSISTOR</p>  <p>2N1038 TO - 39 \$1.00 each 40 volts 8 amps 20 watts</p>
<p>HOUSE MARKED DARLINGTON POWER TRANSISTOR</p> <p>SPECIFY 5 AMPS 85 WATTS NPN 80 VOLTS SIMILAR TO TIP 121NPN PNP TIP 121NPN T0220 75c each</p>	<p>HEAVY DUTY 12 VOLT RELAY</p>  <ul style="list-style-type: none"> Clear Plastic Enclosed 3 POT 12 Amp Contacts <p>\$3.00 each</p>
<p>MAGNETICALLY ACTUATED SWITCH</p> <ul style="list-style-type: none"> N/O W/Magnet Engaged Installs in 3/4" Hole Magnet Included <p>75c each</p>	<p>MALLORY COMPUTER GRADE</p>  <ul style="list-style-type: none"> 150,000 MFD 15VDC 3 Dia 5 High 18V Surge \$3.50 each
<p>ALCO MINIATURE SWITCH</p>  <ul style="list-style-type: none"> 5 P O T 6 amps @ 125 volts <p>\$1.15 each</p>	<p>ALL ELECTRONICS CORP.</p> <p>SEND FOR OUR FREE FLIER</p> <p>905 S. Vermont Ave. Los Angeles, CA 90006 (213) 380-8000</p> <p>Store & Warehouse Hours 9 AM - 5 PM Monday thru Friday</p> <ul style="list-style-type: none"> Quantities Limited Min Order 55.00 Add \$1.50 Shipping USA Calif Res Add 6% Same Day Shipping with Cert Check or M/O

CIRCLE 5 ON FREE INFORMATION CARD

SEND FOR YOUR FREE TEK-EL CATALOG

Complete Listings of IC Transistors, Capacitors, Resistors and readouts along with milligram closeouts and surplus material.

• Hobbyist • Wholesaler • Scientist • Dealer inquiries invited.

4 DIGIT LED KIT

Brand new MA-1002 clock module, with .5" digits, alarm output, snooze control, and much more. Kit comes complete with a filament transformer, switches and case. You supply the speaker for an audible alarm. Complete kit with detailed instructions and schematics.

Cat. No. 200-R Wt. 3 lbs. \$15.00

MERCURY BATTERIES

The famous DURACELL by Mallory. Type RM-12 delivers 1.4 volts, and in most cases can replace a double A (AA). These batteries are factory fresh and have a shelf life of three years or better.

Cat. No. 201-R Wt. 4 oz. 2 for \$1.20

TV GAME BASIC KIT

Basic kit includes: one game chip capable of Hockey, Tennis, and Handball. All in full color with sound (MM57100N), a direct drive clock circuit for the game chip (MM53104), and an RF modulator for the game (LM1889N). Chip set comes with full documentation for building your own TV game.

Cat. No. 202-R Wt. 5 oz. \$13.00 per set

COD'S MAY BE PHONED!
TERMS: Add Postage
RATED: Net 30
PHONE: (617) 935-7328 9:00 A.M. to 5:00 P.M.
MINIMUM ORDER: \$10
Mastercharge and Visa accepted.
When ordering, always use catalog number, type no., the name of the magazine you are ordering from and the month.



TEK-EL Corp.
P.O. Box 2361R
01888

We have moved to larger quarters.

CIRCLE 47 ON FREE INFORMATION CARD



save on gas!

Enjoy the benefits of 20% better gas mileage, quicker starting, elimination of tune-ups, reduced pollution, and 50,000 miles on plugs and points.

Update your car with a TIGER solid state electronic ignition system. Easily installed in 30 minutes . . . even on new cars.

Tiger 500 CD
Assembled \$49.95
Simplikit \$29.95

Postpaid USA.
Master Charge & BankAmericard accepted.

Tri-Star Corporation

Phone (303) 243-5200
P.O. Box 1727
Grand Junction, Colorado 81501
CIRCLE 6 ON FREE INFORMATION CARD

RADIO-ELECTRONICS

LEADER Test Instruments

OSCILLOSCOPES



The 30 MHz Dual Trace Oscilloscope with Delay

- 5mV sensitivity.
- Built-in delay line.
- Single shot trigger (CH-1, CH-2).
- 5" P-D-A CRT assures brighter, sharper trace.
- 20 nS/cm sweep capability plus 11.7 nSec rise time.

MODEL LBO-520

LIST PRICE: \$1050 OUR PRICE: **\$895**



25 MHz Dual Trace, Oscilloscope Delayed Sweep

- Sweep delay, continuously variable from 1 uSec to 5 Sec.
- 5 mV/Div. Vertical Sensitivity with ±3% acc.
- Rectangular CRT with internal graticule.
- 14 nSec rise time.
- CH-1 or 2 trigger; HF filter; and TV sync.

MODEL LBO-515A

LIST PRICE: \$1465 OUR PRICE: **\$1280**



The 20 MHz Dual Trace Oscilloscope

- Add & subtract modes (with CH-2 invert).
- Front panel X-Y operation.
- 17.5 nanosec rise time.
- Automatic trigger from either channel, including TV sync.
- 10 mV sensitivity.

MODEL LBO-508

LIST PRICE \$769 OUR PRICE: **\$650**



The 20 MHz Single Trace Triggered Oscilloscope

- Outstanding trigger sensitivity over entire operational range.
- 10 mV sensitivity and 17.4 nSec rise time.
- X5 magnification (±5%) delivers 100 nS/cm maximum speed for easy, precise readings.

MODEL LBO-507

LIST PRICE: \$549 OUR PRICE: **\$475**

CIRCLE 41 ON FREE INFORMATION CARD

FLUKE

NEW DIGITAL MULTIMETERS



8022A

10,000 MΩ resistance meas with conductance function
Extensive overload and transient protection
Rugged construction — MIL-T-28800
Hi/Lo power ohms for in-circuit resistance and diode testing
10 MΩ input impedance doesn't load circuit
200 hour battery life — low battery indicator
Large LCD readout — 2000 counts
1 year calibration cycle — only 3 adjustments
One-hand operation

OUR PRICE: **\$129**



8010A

Large 3 1/2-Digit LCD's - view in any light
Conductance function - resistance to 10,000 MΩ
AC measurements to 50 kHz and higher
True RMS for ac accuracy
Touch-Hold probe for tricky places (Option)
Diode test and low power ohms
One year accuracy reduces calibration costs
COMMON floatable to 500V
Recessed jacks reduce shock hazard
Current mode fuse protection to 600V
Voltage mode transient protection to 6 kV
Autozero and autopolarity
AC or dc current to 10 amps with 8010A
Resistance resolution to 0.001Ω with 8012A
Built-in batteries and charger (Option -01)
Rugged enough for field or bench

OUR PRICE **\$239**



8012A

OUR PRICE **\$299**

SEND FOR OUR CATALOG
Call TOLL FREE:

N.J. CALL:
(800)526-2514 • (201)227-7720

AMPOWER INST., INC.
26 JUST ROAD, FAIRFIELD, N. J. 07006

THE MEASUREMENT SPECIALISTS
"WE SERVICE WHAT WE SELL"

Mastercharge
BankAmericard
and
COD Accepted
add \$3.00 to
cover shipping
handling insurance
N.J. res. add
5% tax.

FREE TEST LEADS WITH EVERY ORDER

CALL TODAY

HOME of SURPLUS BARGAINS
ELECTRONIC SUPERMARKET
 P.O. BOX 619 — (DEPT R10) LYNNFIELD, MASS. 01940
 Phone orders (617) 532-2323 — Use your Charge Card - Visa-MC-AE
 TERMS: Add Postage; No. C.O.D.'s — \$10.00 Minimum Order

3M - SCOTCH FLEX FLAT CABLE
 25 Connector - 26 AWG Solid Round Conductor Flat Cable 3M No. 3349/25 available in lengths of 10', 25', 50' @ less than 1/2 price more computer surplus.
 Sh. Wt. 2 Lb. 10" 9CS0377 \$5.00
 Qty. Ltd. 25' 9CS0378 \$12.50
 50' 9CS0379 \$20.00



"AUTOMATIC RADIO" - SAVE \$51.07!
 AM/FM CAR RADIOS

These pushbutton radios with front/rear speaker control & power antenna switch/burglar alarm control are completely built up in Japan, but to get a low custom rate the radio was assembled in Japan less dial & face plate & Pointer. We supply stuff to put together a complete radio - all in foam packed boxes from Japan. Made to sell for \$79.95 each - yours for ONLY \$28.88 each!
 Sh. Wt. 12 lbs. 9DS0376 \$28.88 ea.
 3 for \$78.88 9DS0376 \$78.88/3



COMPACT 2 WAY SPEAKER SYSTEMS KIT - Contains Walnut Vinyl Clad Cab. - 8" Full range spkr w/40 watts (RMS) cap., free air res. p. 30 Hz., freq. resp. 40 Hz to 13K Hz., 4" phenolic ring tweeter, free air res., 1700 Hz., freq. resp. 1.5K Hz. to 20K Hz., 2.6" (W'R'), 2.4" Tweeters, 2-Grills you cut to size, 2-P Button Term. Asses Damp'g, wrs & Velcro Fastners, Hrdwre, Clk'g Mat'l, etc., with instructions.
 Reg. Price: \$110.00/pr. SAVE: \$70.00
 Size: 16Hx10Wx6D SD COMPACT!
 Sh. Wt. 38 Lbs. 9310286 \$39.88/pr.
 3 pr. for \$113.88 9310286 \$113.88/3 pr.

STDP WATCH CONVERSION KIT
 We have obtained a small quantity of Counting Modules that can be easily converted to a stop watch by adding a few parts from your junk box. Turns off a 9V battery unit - contains: LED display, 4553 I.C. - 3 digit BCD, Counter, 4011, 4511, 4060 ICS, etc. & small parts with battery connector. This super item won't last long so order now. In present form unit counts on a display.
 Sh. Wt. 4 oz. 9MS0375 \$4.88

- CB Chassis Remote \$9.88
- CB Chassis - w/dash \$12.88
- A/N Micro/SW Keyboard \$17.50
- Piezo Buzzer Mid \$2.88
- Comp. Cassette Recorder \$48.88
- Wakefield Heat Sink, No. 690 \$1.25/3
- Wakefield Heat Sink, No. 680 \$1.25/2
- 12 V Car Alarm Board \$2.88
- CB/Tape Player Power Sup., 13.8Vx13.88/2
- Book Shelf Speakers \$13.88/2
- 2/28V Lited Rocker Switch DPDT \$1/2
- TEK Scope Carts 500 TY \$48.88 ea.
- Solar Cell/Motor/Prop. \$6.88
- Stereo Clock Radio 1" Disp. \$39.88
- V. Wind Motor/Generator \$3.88
- Motorola 3/4" Super Horn Tweeter \$14.88/pr.
- Touch Switch Alarm 8MI0475 \$6.88

COMPACT 3 WAY SPEAKER SYSTEMS KIT - Walnut Vinyl clad Speaker system kit contains all components to build 2 complete compact 3 Way systems. Contains 8" Pass. Rad. w/ rear firing, 6" W. Range 4" phenolic ring tweeter, freq. resp. 35 Hz. to 20K Hz. power cap. 30 watts RMS. U must add sm components to cabs. & cut hole in rear of cab. for 8" P'R' woofer, w/black foam grills & inst. Size: 16Hx10Wx6D
 Sh. Wt. 43 Lbs. 9310287 \$59.88/pr.
 3 pr. for \$169.88 9310287 \$169.88/3pr

CIRCLE 89 ON FREE INFORMATION CARD

For faster service
 USE ZIP CODE
 on all mail

HIGHLY PROFITABLE ONE-MAN ELECTRONIC FACTORY
 Investment unnecessary. knowledge not required, sales handled by professionals. Ideal home business Write today for facts! Postcard will do. Barta-RE-V, Box 248, Walnut Creek, CA 94597.

PASS FCC EXAMS
 The Original FCC Tests Answers exam manual that prepares you at home for FCC First and Second class Radiotelephone licenses. Newly revised multiple choice exams cover all areas tested on the actual FCC exam. Plus "Self-Study" Ability Test. Proven! \$9.95 postpaid. Moneyback Guarantee.
COMMAND PRODUCTIONS P.O. Box 26348 E San Francisco, CA 94126
 Radio Engineering Division

PICTURE TUBE MACHINE
 We buy and sell NEW and USED CRT rebuilding machinery. COMPLETE TRAINING. Buy with CONFIDENCE from the ORIGINAL MFRG.
 For complete details send name, address, zip to
LAKESIDE INDUSTRIES
 4071 N. Elston Avenue
 Chicago, Ill. 60618
 Phone: 312-583-6565

FREE KIT Catalog
 AUTORANGE DIGITAL CAP-METER contains KIT. Still the best for only \$74.95
Phone 415-447-3433 TEST & EXPERIMENTERS' EQUIP.
 Write or Phone for FREE CATALOG. Average 1 minute Saturday call is 21¢.
DAGE SCIENTIFIC INSTRUMENTS
 BOX 1054R LIVERMORE CA 94550

<p>7400 TTL</p> <p>7400 .16 7404 .18 7408 .19 7410 .16 7412 .25 7413 .40 7416 .25 7420 .16 7425 .28 7426 .28 7427 .25 7430 .16 7437 .24 7438 .24 7440 .16 7445 .75 7451 .16 7454 .16 7474 .35 7475 .49 7483 .58 7485 .78 7486 .35 7489 1.80 7490 .43 7492 .42 7493 .42 7495 .65 74107 .35 74123 .49 74141 .78 74151 .58 74155 .75 74160 .86 74165 .86 74175 .75 74180 .75 74181 1.85 74195 .65</p>	<p>P1103A 1024 X1 Dynamic RAM 42c</p> <p>741PC MINI-DIP OP AMP .29c</p> <p>LM300H VOLTAGE REGULATOR \$1.00</p> <p>82S115 512 X8 PROM 60ns OTYS LIMITED \$4.75</p> <p>LM305H VOLTAGE REGULATOR T0-99 75c</p> <p>74S201 256 X1 Static RAM 50ns \$1.95</p> <p>2716 16K EPROM \$38.50</p> <p>MC1458P Dual Op-Amp 24c</p>	<p>S-10016K BOARD ASSEMBLED & TESTED \$279.00</p> <p>7114A APPLE II™ PROM MODULE PERMITS THE ADDITION OR REPLACEMENT OF APPLE FIRMWARE WITHOUT PHYSICAL REMOVAL OF THE APPLE ROMS. +NEW+ \$79.95 LESS PROMS</p> <p>7811A ARITHMETIC PROCESSOR + BASED ON AMD'S AM9511 + ADD * SUBTRACT * MULTIPLY * DIVIDE TRIG * ROOTS * LOGS \$400.00</p> <p>Calculator CREDIT CARD SIZE w/MEMORY AUTOMATIC SHUT-OFF \$19.95</p>	<p>NIXIE TUBE BURROUGHS \$1.25</p> <p>8038C VCO Waveform Gen w/sine \$2.75</p> <p>2708 1024 X8 EPROM 250ns \$8.50</p> <p>555 TIMER 28c</p> <p>3HT1 3 AMP 100 VOLT FULL WAVE BRIDGE .50c</p> <p>1702A 256 X8 EPROM \$3.95</p> <p>ULN2001 High-Current Drivers. Darlingtons 75c</p> <p>SOROC TERMINAL 10 120 \$749.00</p>	<p>LINEAR</p> <p>LM300H .78 LM301N .35 M305H .60 LM306H/N 1.50 LM307H/N .35 LM308N .95 LM309K 1.25 LM310N 1.10 LM311N .85 LM320T5 1.25 LM320T12 1.25 LM320T15 1.25 LM322N 1.75 LM323K 5.75 LM340T5 1.25 LM340T12 1.25 LM340T15 1.25 LM556 .89 LM566 1.65 LM711N/H .39 LM723N .55 LM725H 1.75 LM733N .95 LM741N/H .35 LM747N .78 LM749N .85 LM3900 .46 781105 6.95 SQ-501 1.95</p> <p>TRANSISTORS</p> <p>2N2272A 5/1.00 2N2907A 5/1.00 2N3055 .85 2N3904 6/1.00 2N3906 6/1.00 2N4401 6/1.00 2N4403 6/1.00 HFE2955 1.20 HFE3055 1.00</p> <p>DIODES</p> <p>1N914 20/1.00 1N4003 15/1.00 1N4005 12/1.00 1N4007 10/1.00 1N4148 20/1.00</p>
------------------------------------------------------------------------------------------------------------------------------------------------------------------------------------------------------------------------------------------------------------------------------------------------------------------------------------------------------------------------------------------------------------------------------------------------------------------------------------------------------------------------------------------------------------	--------------------------------------------------------------------------------------------------------------------------------------------------------------------------------------------------------------------------------------------------------------------------------------------------------------------------------------------------------------------------------------------------------------	----------------------------------------------------------------------------------------------------------------------------------------------------------------------------------------------------------------------------------------------------------------------------------------------------------------------------------------------------------------------------------------------------------------------------------------------------------------------------------------------------------------------------------------------------	-----------------------------------------------------------------------------------------------------------------------------------------------------------------------------------------------------------------------------------------------------------------------------------------------------------------------------------------------------------------------------------------------------------------	----------------------------------------------------------------------------------------------------------------------------------------------------------------------------------------------------------------------------------------------------------------------------------------------------------------------------------------------------------------------------------------------------------------------------------------------------------------------------------------------------------------------------------------------------------------------------------------------------------------------------------------------------------------------------------------------------------------------------------------------------------------------------------------------------------------------------

<p>6301-1J 256 X 4 PROM \$165</p>	<p>20,000 VOLT RECTIFIER 25 ma \$1.65</p>	<p>CONCORD COMPUTER COMPONENTS 1971 South State College-Anaheim, Calif. 92806 Visa - Master Charge Check or M.O. (714) 937-0641 No COD</p>	<p>78H05 5 AMP 5VOLT REGULATOR IN TQJ-3 PKG \$4.95</p>	<p>8AMP SCR 2N4442 200 V .50</p>
----------------------------------------------	------------------------------------------------------	-------------------------------------------------------------------------------------------------------------------------------------------------------------------	-------------------------------------------------------------------	---------------------------------------------

CIRCLE 78 ON FREE INFORMATION CARD

Active Electronic Sales Corp.

EPROM'S

1702A-6	\$6.95	\$4.45
256 x 8 1.5 uS		
2708		\$9.95
1K x 8 450 NS		

MOS Static RAM's

Part No.	Price	
2101 1K 22 PIN	\$2.45	\$2.39
2102LFPC 1K 350NS (Low Power)	\$1.49	\$1.14
2102-1PC 1K 450NS	\$3.99	0.94
2114 4K (1K x 4) 300NS	\$6.75	\$5.99
2114 4K (1K x 4) 450NS	\$6.50	\$4.99

MOS Dynamic RAM's

Part No.	Price
4K 4027	\$2.95
16K 416-3 16K (16K x 1) 200NS 16PIN	\$11.95
16K 416-5 16K (16K x 1) 300NS 16PIN	\$9.95

UART's

Part No.	Price
AY5-1013A	\$4.50 \$4.25
AY3-1015	\$5.50 \$5.25

1K CMOS RAM

Part No.	Price
5101	\$4.95 \$4.50
450NS (Low Power)	

L.E.D. LAMPS

LED209	T-1 3mm Red	.09
LED211	T-1 3mm Green	.13
LED212	T-1 3mm Yellow	.13
LED220	T-1-3/4 5mm Red	.11
LED222	T-1-3/4 5mm Green	.15
LED224	T-1-3/4 5mm Yellow	.14

DISPLAYS

MAN74A	300' Common Cathode	\$0.99
FND357	375' Common Cathode	\$1.25 \$1.09
FND500	500' Common Cathode	\$1.20 \$1.09
FND507	500' Common Anode	\$1.20 \$1.09
FND567	500' Common Anode	\$1.20 \$1.29
DL747	630' Common Anode	\$2.25 \$2.30
DL704	300' Common Cathode	\$1.25 \$1.29
DL707	300' Common Anode	\$1.25 \$1.29

ISOLATORS

IL1	Opto Coupler 1500V	49
4N26	Opto Isolator 2500V	59
MCT6	Dual Opto Isolator 1500V	\$1.25 \$1.29

MICROCOMPUTER BOARDS

NEC MICROCOMPUTER TK-80A

The TK 80A is a complete microcomputer on a board based on the industry standard 8080A. The board has both 1K RAM and 1K Electrically Erasable PROM expandable to 4K x 8 and 1K x 8 respectively. In Board it also features 300 to 1200 baud cassette interface, the Kansas City type and three 8 Bit Programmable I/O Ports, 24 on-key Keyboard with 20 matrix, dot grid dot calculator keypad and 8 in. q. bright 3 digit LED display are also included.

TK-80A \$299.00

MICROPROCESSOR CHIPS

CPU's

Part No.	Price
8080A	5.50
8085	12.95
6800	7.85 6.95

INTERFACE SUPPORT CIRCUITS

Part No.	Price	Part No.	Price
8212	2.95	8255	5.50
8214	3.95	8257	10.95
8216	2.75	8259	14.95
8224	2.95		
8226	1.98	6810	3.95
8228	4.75 3.98	6820	3.95
8238	4.75 3.98	6821	3.95
8251	5.50	6850	4.95 4.50
8253	14.95	6852	4.95 4.50

BOURNS POTENTIOMETERS

TRIMPOT® Potentiometers

MODEL	POWER	STANDARD RESISTANCES	DIMENSIONS (H x W x L)	PRICE
3006P	0.75 Watt	10 ohm - 2 Meg	25" - 19" - 75"	\$0.80
3299W	0.5 Watt	10 ohm - 1 Meg	39" - 37" - 25"	\$1.42
3386P	0.5 Watt	10 ohm - 2 Meg	375" - 375" - 19"	\$0.60

P = Printed Circuit Pins (flat mounting)
W = Printed Circuit Pins (edge mounting)

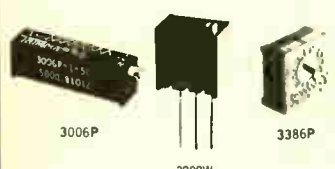

Special of the Month

Zilog

Z80-CTC	\$7.95 \$7.95
Z80A-CTC	\$8.95 \$8.95
Z80-DMA	\$24.95 \$24.95
Z80-SIO/0	\$35.00 \$35.00
Z80A-SIO/0	\$45.00 \$45.00
Z80-CPU	\$9.95 \$9.95
Z80A-CPU	\$11.95 \$11.95
Z80-SIO/1	\$35.00 \$35.00
Z80A-SIO/1	\$45.00 \$45.00
Z80-PIO	\$7.95 \$7.95
Z80A-PIO	\$8.95 \$8.95
Z80-SIO/2	\$35.00 \$35.00
Z80A-SIO/2	\$45.00 \$45.00

1979 IC MASTER 2500 pages

Complete integrated circuit data selector. Master guide to the latest I.C.'s including microprocessors and consumer circuits.

"Special Offer" \$29.95

Free Quarterly Updates



Texas Instruments Low Profile Sockets

Finest Quality Socket available in the world. Nobody can match Texas Instruments quality — a unique combination of I.C. technology and multi-metal expertise.

Over one million pieces in stock

Contacts	Price	Contacts	Price
8 PIN	.08	22 PIN	.22
14 PIN	.12	24 PIN	.24
16 PIN	.14	28 PIN	.28
18 PIN	.18	40 PIN	.40
20 PIN	.20		



VOLTAGE REGULATORS

High Current (TO-3)

78H05SC	\$4.92	5V/5A
78H12SC	\$5.07	12V/5A
78H15SC	\$5.07	15V/5A
78P05SC	\$7.56	5V/10A
78HGKC	\$5.75	5V-24V/5A Positive Adjustable
79HGKC	\$8.32	-24V to 2.11V/5A Negative Adjustable
SH1605	\$12.22	3V-30V/5A Adj. Step Down Switching
SH1705	\$7.56	5V/5A Fixed Positive

7800UC Series (TO-220 Plastic) Positive 1 AMP 5, 6, 8, 12, 15, 18, 24, Volts \$0.99

Data Available on Request

Active Electronic Sales Corp.

P.O. BOX 1035 FRAMINGHAM, MASSACHUSETTS 01701

Over the counter sales, 12 Mercer Rd. Natick, Mass 01760
Behind Zayres on Rte 9
Telephone Orders & Enquiries (617) 879-0077

IN CANADA
5651 FERRIER ST. MONTREAL, QUEBEC H4P 2K5
Tel (514) 735-6425

4800 DUFFERIN ST. DOWNSVIEW ONTARIO M3H 5S9
Tel (416) 661-1115

MINIMUM ORDER \$10.00 • ADD \$2.00 TO COVER POSTAGE & HANDLING

Foreign customers please remit payment on an international bank draft or international postal money order in American dollars

BAXTER CENTRE 1050 BAXTER ROAD OTTAWA ONTARIO K2C 3P2
Tel (613) 820-9471

3070 KINGSWAY VANCOUVER B C V5R 5J7
Tel (604) 438-3321



LOW, LOW DISCOUNT PRICES

POPULAR COMPONENTS INC.

OFFERS YOU:

- HARD TO GET COMPONENTS
- MONEY SAVING DISCOUNT PRICES
- TOP SELECTION OF FIRST QUALITY POPULAR COMPONENTS
- ALL COMPONENTS GUARANTEED TO BE FACTORY PERFECT (MONEY BACK GUARANTEE)

UARTS	
AY-5-1013A	54.20
TR1602B	3.90
AY-3-1015D	5.20
AY-3-1014A	6.75
TELECOMMUNICATIONS	
AY-5-9100 Push Button Telephone Dialer Circuit	13.95
AY-5-9200 Repetory Dialler	13.95
AY-5-9500 C-MOS Generator	4.25
GENERATOR/ENCODERS	
RO-3-2513 Character Generator (upper or lower case)	6.50
AY-5-2376 Keyboard Encoder	12.10
AY-5-3600 Keyboard Encoder	12.95
8080/8085 SUPPORT CHIPS	
UPD8080AFC 8-Bit N-Channel Microprocessor	5.35
UPD8085AC Single Chip 8-Bit N-Channel Microprocessor	12.75
UPD8155C 2048 Bit Static MOS RAM with I/D Ports & Timer	18.95
UPB8212C 8-Bit I/D Port	1.95
UPB8214C Priority Interrupt Controller	3.90
UPB8216C 4-Bit Parallel Bidirectional Bus Driver	1.95
UPB8224C Clock Generator & Driver for 8080A Processor	2.55
UPB8226C 4-Bit Parallel Bidirectional Bus Driver	2.85
UPB8228C 8080A System Controller & Bus Driver	3.95
UPB8238C 8080A System Controller & Bus Driver	3.95
UPD8251C Prog. Communication Interface	5.40
UPD8253C Prog. Interval Timer	13.50
UPD8255C Prog. Peripheral Interface	4.90
UPD8257C Prog. DMA Controller	16.95
UPD8259C Prog. Interrupt Controller	14.90
MICROPROCESSOR CHIPS	
UPD780C(Z80) 8-Bit N-Channel Microprocessor completely Z80 compatible	13.50
UPD780C(1280A) 8-Bit N-Channel Microprocessor completely Z80 compatible (4MHz)	15.95
CONTROLLER CHIPS	
UPD765 Single Density Floppy Disk Controller	59.95
FO1771B Single Density Floppy Disk Controller	59.95
FO1791B Dual Density Floppy Disk Controller (IBM compatible)	59.95
CRT-5027 CRT Controller	39.95
UPD372D Floppy Disk Controller	39.95
RAMS	
UPD2102ALC-4 1024 Bit Fully Decoded Static MOS RAM (low power)	2.60
UPD2101ALC-4 1024 Bit (256x4) Static MOS RAM with separate I/O (low power)	2.75
UPD2111ALC-4 1024 Bit (256x4) Static MOS RAM with common I/O & output disable (low power)	3.50
2114UCB 4K Static RAM 450ns	6.45
UPD5101C-E 1024 Bit (256x4) Static CMOS RAM	3.90
UPA411AC 4K Dynamic RAM	4.95
UPA416C 16K (16384x1) Bit Dynamic MOS RAM	12.75
BAUD RATE GENERATORS	
COM5016 Dual Baud Rate Generator	15.50
COM5036 Dual Baud Rate Generator	15.50
BR1941L Dual Baud Rate Generator	9.80
SOUND GENERATOR	
SN76477 Complex Sound Generator	3.65
ASTRO	
COM1671 Asynchronous/Synchronous Receiver-Transmitter	24.50
LINEAR	
SG3524N/J Switching Regulator Converter	5.40

TO ORDER: Specify part number, name, price & quantity. Check or money order must accompany order. Add \$1.75 for postage & handling. New York State residents add 7% sales tax. Foreign Customers: Payment must be in U.S. dollars by international postal money order or cashier's check. Add 20% for shipping & handling.

FREE WITH EACH ORDER. WE WELCOME INQUIRIES FROM MANUFACTURERS, DISTRIBUTORS, & INSTITUTIONS. NO C.O.D., MINIMUM ORDER \$10.00.

(PRICES GOOD THRU OCTOBER 15, 1979)

Order Today from:

POPULAR COMPONENTS INC.
DEPT. RE 1079
P.O. BOX 866
MELVILLE, N.Y. 11747

ADVERTISING INDEX

RADIO-ELECTRONICS does not assume any responsibility for errors that may appear in the index below.

Free Information Number Page

93	AMC Sales	154
74	A P Products	22
16	Aaron-Gavin Instruments	122
50	Active Electronics	175
—	Advance Electronics	16,72-73,115,137
7	Advanced Computer Products	173
5	All Electronics	172
73	Amelect, Inc.	146
33	American Antenna	Cov. 4
41	Ampower	172
91	Antenna Specialists	149
86	Arrow Fastner Co., Inc.	146
27	Audio-Technica	141
68	B & K Dynascan Co.	27
64	B. I. C.	2
77	Babylon Electronics	164
—	Karel Barta	174
22	Beckman	74
42	Blonder Tongue	143
—	Bullet Electronics	159
—	Burdex Security Co.	176
43	C F R Associates	162
—	Chaney Electronics	153
—	C I E - Cleveland Institute of Electronics	18-21
76	Colby Instruments	162
—	Command Productions	174
78	Concord-Computer Components	174
37	Continental Specialties	Cov. 2
17	The Cooper Group-Electronics Div.	37
62,63	Creative Computing	131
—	Dage Scientific	174
48	Davis Electronics	148
12	Delta Electronics	154
69	Diamondback Electronics	164
34	Digi-Key	169
—	Digital Research Corporation	168
49	E I C O	142
87	E S I-Electro Scientific Industries	122
3	Electronics Book Service	139
—	Electronic Development Lab	154
89	Electronic Supermarket	174
—	Electronics & Control Engineer's Book Club-McGraw Hill Book Div.	86-89
52	Enterprise Development	128
—	Fair Radio Sales	152
67	Fluke	7
92	Fordham Radio Supply Co.	145,161
—	Forest Belt's Training Workshop	133
13,14	Formula International	156-157
—	Fuji-Svea	170
70	GC Electronics	24
51	GFN Industries	129
—	GTE Sylvania-Consumer Renewal	13
—	Giffer Shortwave	162
54	Godbout Electronics	164
—	Golden Enterprises	154
30	Grantham College of Engineering	124

100	Heath	127 & Cov. 3
75	Hickok Electrical Instruments	33
82	Hitachi-Denshi	71
53	Hobby World	158
39	International Crystal Mfg. Co.	36
83	International Technology	34
79	ITC-International Television Corp.	162
—	Information Unlimited	154
—	J S & A	5
8,9	Jameco Electronics	166-167
25	Jensen Tools & Alloys	124
10	Jim-Pak	119
85	KV Electronics	168
88	Kester Solder	138
84	Kontron	116
—	Lakeside Industries	174
40	McKay Dymek	32
58	Mallory	121
45	Meshna	168
56	Micro Mart	158
—	Millco Industries	154
55	MTI-Mobile Training Institute	149
—	National Radio Institute (NRI)-Div. of McGraw Hill	8-11
—	National Technical Schools	28-31
65,66	Netronics	132,144
32,31	O.K. Machine & Tool	35,134
35	Ohio Scientific	1
—	Ohio	155
19	Optoelectronics	117
38	PAIA	142
26	PTS Electronics	151
4	Panavise	120
18	Poly Paks	171
80	Pomona Electronics	123
2	Popular Components	176
36	Quest	165
—	RCA	26
44	Radio Shack	160
57	Ramsey Electronics	163
60	Ripley Co., Inc.	135
46	Rye Industries	148
24	SGL Waber Electric	120
—	Sabtronic	23
61	Sansui	25
90	Schober Organ	135
—	Sheldahl	147
—	Shure	38
23	Simpson Electric	113
11	Solid State Sales	158
71	Southwest Technical Products	124
—	Spacecoast Research	152
—	Speakerlab	162
59	Sprague Products Co.	128
—	Surplus Center	152
15	Tab Books	125
20	Techni-Tool	147
47	Tek-El Corp.	172
6	Tri-Star	172
21	Vaco	17
81	Vector	116
—	V.I.Z. Mfg.	150
28	Wersi Electronics	15
29	Zemco	140

Burglar-Fire Protection

Protect Your Life, Home, Business, Auto, etc.

• Our catalog shows how. Install your own alarm systems and devices and save \$\$\$\$. We offer FREE write-in engineering service.

FREE CATALOG Lowest Prices on Reliable, High Quality Alarm Systems and Devices

Burdex Security Co. Box 82802-RE Lincoln, Ne. 68501

no loose ends

All-In-One: computer, floppy, I/O, 16K RAM. \$1595*

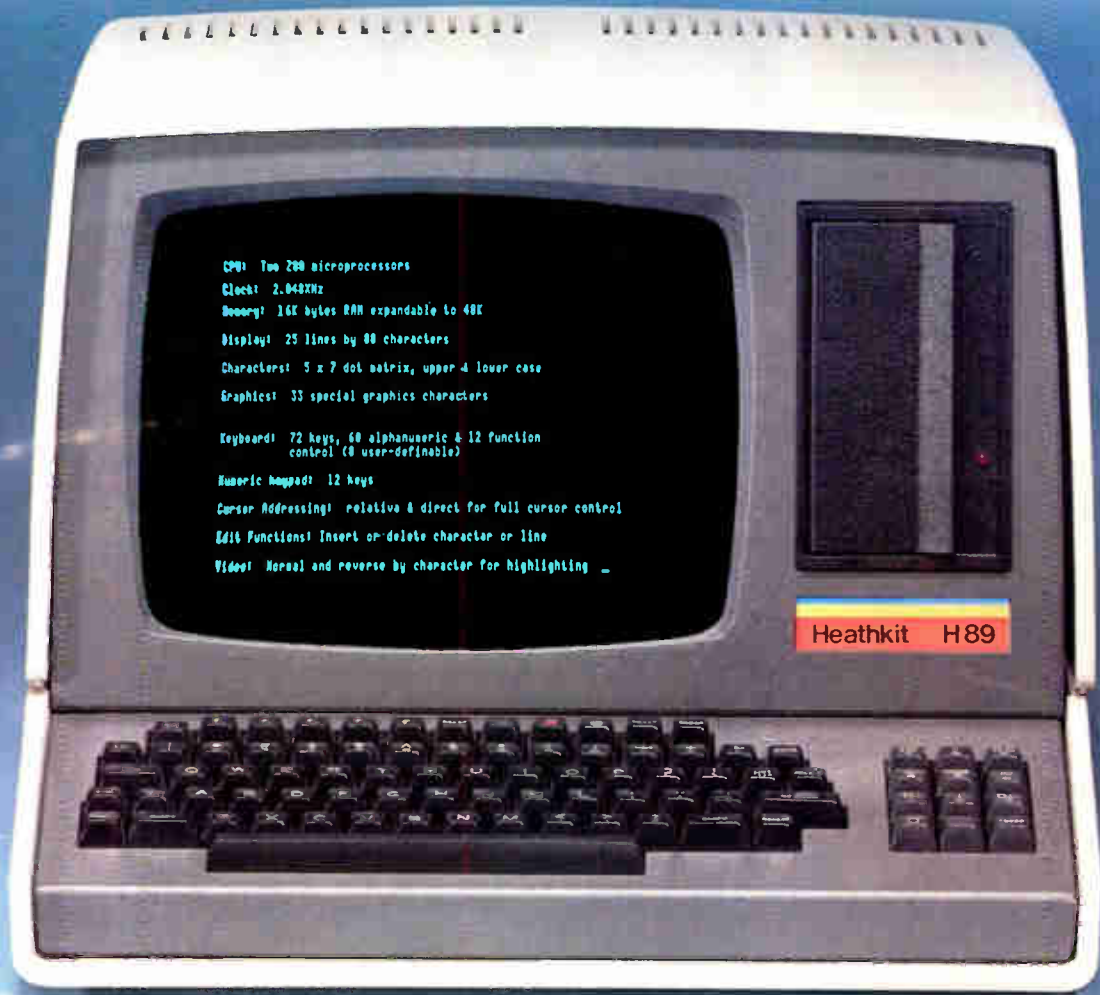

New Heathkit® H89 All-In-One Computer

Heath takes the risk out of selecting a balanced computer system. Now, video terminal, floppy, keyboard and 8-bit computer are brought together in one self-contained, compact unit. Nothing hangs out.

Two Z80's

The personal computer has never been simpler. Or smarter. Two Z80 microprocessors mean terminal never shares power with computer, as do most desk-top units. So this terminal is capable of a multitude of high-speed functions, all controllable by keyboard or software.

*\$1195 without floppy. Mail order kit price, F.O.B. Benton Harbor, MI. Also available at Heathkit Electronic Centers at slightly higher prices. Prices subject to change without notice.

102K bytes storage

Built-in floppy disk system gives you fast access to programs and data. Each 5¼-inch diskette has more than 102K bytes of storage area, enough to hold entire files. The All-In-One comes with 16K RAM, expandable to 48K.

Hundreds of uses at home or work

The All-In-One Computer runs programs written in MICROSOFT™ BASIC and ASSEMBLER Languages. And it accepts all current software written for the popular Heathkit H8 computer. You can choose from scores of practical programs for home and business.

Learn by building

What better way to learn about computers than to build one yourself? The All-In-One is available in easy-to-build kit form, as well as completely assembled. Like all Heath electronic kits, it comes to you with its own easy-to-follow assembly manual and a nationwide network of service centers to assure smooth sailing.

FREE CATALOG



For complete details on the Heathkit H89 All-In-One Computer and nearly 400 other electronic kits for your home, work or pleasure, send today for the latest Heathkit Catalog of values.

Heathkit®

HEATH COMPANY, DEPT. 020-580, BENTON HARBOR, MI 49022

CP-165

THE K40 SPEECH PROCESSOR

The K40 Speech Processor.
So unique it's patented.
So good its guaranteed to out-perform any microphone on any radio.



CLIPS ANYWHERE WITHOUT A CLIP!

Molded four-pole internal magnet clamps instantly to any steel surface. Steering column, metal dash, roof top, or the side of your CB radio. No groping for your mounting clip.

PROCESSES SPEECH WITH A COMPUTER CIRCUIT!

It's its own computer—it automatically monitors your speech and adjusts it in micro-second increments pumping so much db gain into your speech that you get 400% more power than a standard mike.

TWO MICS WITH ONE SWITCH!

Switch up for a high-pitched transmission for cutting congested city traffic. Switch down for a mellow base in open, uncluttered rural areas.

NOISE CANCELLING

Pull the Processor directly to your mouth and speak directly into the mic. The Processor adjusts to your voice—and blanks out all the cab noise while you're speaking. Automatically.

FRESH CHARGE WITH NO BATTERIES!

Patented electronic storage system recharges while you listen to the radio. It provides a fresh electrical charge every time you squeeze the trigger. You never replace batteries.

SOUND SENSITIVE 2 INCHES OR 2 FEET!

A microphone so sensitive it will select your voice and process your speech no matter how close or far you are from the microphone.

Double Guarantee

GUARANTEE I:

The K40 Speech Processor is guaranteed to outperform any microphone it replaces or return it for a complete and full refund within 7 days from the K40 Dealer that installed and tuned it.

GUARANTEE II:

Unconditionally guaranteed for 12 months. Guaranteed against cracking, chipping, or rusting. Guaranteed against mechanical failure. Guaranteed against electrical failure. No exclusions. No gimmicks. For a full 12 months.

\$42.50*

American Antenna Corp., Elgin, IL 60120

*suggested retail.

CIRCLE 33 ON FREE INFORMATION CARD

SOLD AND SERVICED EXCLUSIVELY BY 3,500 REGISTERED K40 DEALERS THROUGHOUT THE U.S. AND CANADA