

Radio- Electronics

**HOW IT WORKS:
LASER VIDEODISC**

\$1.25 MAR. 1981

**New trends in SW jamming
Self-diagnostic car electronics
How to build your own robot**

**How to identify unmarked IC's
Anti-negative feedback for hi-fi
Build your own digital do-nothing**

BUILD THIS HI-FI NOISE REDUCER



303092 DRK 6450H091 14 9 DEC86
LLOYD DAPKHELL
6450 HYRLEWOOD DR
CUPERTINO CA 95014
03

THE NEW

performer.

... UNBEATABLE PRICE / PERFORMANCE RATIO

The Model 7000 Universal Counter / Timer



ONLY \$300

MADE IN USA

Built for your budget, the Model 7000 is a micro-processor controlled reciprocal universal counter. It is capable of measuring both input signal frequency and period over the full 5Hz to 80 MHz range in one second with six digit resolution. The autoranging unit has both frequency and multiple period averaging measurement capability. Its microprocessor executes the optimum measurement and displays the desired format, frequency or period.

1. High resolution, μ P controlled reciprocal counting design provides both input signal frequency and period measurements.
2. 80 MHz frequency measurement plus event counting to 1 bil-

lion and elapsed time measurement from 100 μ S to 100 hours.

3. Single function knob for easier operation and built in self testing confidence test circuit.

Its ease of operation, versatility and accuracy make the Model 7000 an ideal instrument for the hobbyist, technician or engineer. The Model 7000 can also be ordered with a temperature-compensated oscillator for applications where higher accuracy is needed.

See your Triplet distributor, Mod Center or representative for a free no-obligation demonstration. Triplet Corp., Bluffton, Ohio 45817. (419) 358-5015, TWX (810) 490-2400.



Triplet performance... a tough act to follow

TTT. TRIPLET

Bone Fone Clone

If you thought the Bone Fone was great, wait until you hear what's new. Here's the latest on the Bone Fone spin-offs.



It started with the Bone Fone. And this very unusual stereo system has created a whole new series of products.

The Bone Fone is an AM/FM stereo radio that drapes around your neck like a scarf. Two speakers, placed near your ears, not only provide excellent stereo separation, but vibrate slightly through your bones to give you the same sensation as standing in front of your home stereo system.

UNEXPECTED APPLICATIONS

Shortly after it was introduced, the Bone Fone became a very popular product for a variety of reasons. A lady in Helena, Montana who bought the unit for her son told us, "It's made a significant contribution to my sanity. No more rock n' roll blasting through the house, the sound goes where my son goes."

A jogger in Rowlett, Texas wrote us "Amazing separation, fantastic stereo response, helps my jogging tremendously. I wasn't really expecting this type of quality through a magazine ad at this price."

But one of the most unexpected letters came from a man in Belle Center, Ohio. "You don't have to be young and jog to enjoy Bone Fone. You see, I'm 73 years old. I just sit and listen."

LETTERS EVERYWHERE

Letters have come from mailmen, roller skaters, skiers, cyclists, motorcycle enthusiasts, hikers and even people who listen to the Bone Fone stereo while walking their dog. The Bone Fone appeals to practically every American.

The Bone Fone was designed by an engineer who wanted to listen to good stereo music without carrying heavy box radios or bulky headphones. Headphones block out all other sounds—even warnings which could be dangerous outdoors, and box radios are heavy and disturb those around you. So he invented the Bone Fone—"the stereo sound you wear around."

Weighing only 17 ounces and powered by

4AA cell batteries the Bone Fone stereo provides a sound that would be impossible to describe in an advertisement. The cliché, "you've got to hear it to believe it," certainly applies here. And for \$69.95 it's the lowest priced stereo entertainment product available.

But what about the sport enthusiast who can care less about stereo music? Or the person who wants just the news? Or simply the person that just listens to AM radio and doesn't want to spend \$69.95?



The Bone Fone drapes around your neck like a scarf and has a sound that you find incredible when you first hear it.

Enter NUTS! NUTS is the AM version of the Bone Fone for sports nuts, news nuts, jogging nuts or anybody who wants a low cost Bone Fone without FM or stereo. NUTS sells for \$39.95 complete with two speakers and a strap that firmly attaches the unit to you for any physical activity.

Sitting at a football game, walking your dog, jogging—NUTS gives you a convenient way to listen to music, news and sports without paying a premium for stereo.

But the Bone Fone spinoffs don't end there. There's the Neck Fone—a device you place over your shoulders and plugs into your home stereo system. This lets you enjoy your home stereo without disturbing those around you and without the bulk of headphones. The Neck

Fone sells for \$34.95.

So there you have it. Three exciting products—Bone Fone, NUTS, and the Neck Fone—three unusual solutions designed to solve any gift-giving problem.

LOWEST-PRICED STEREO

Compare the Bone Fone price with any box radio, stereo system or even the new \$200 Sony Walkman. The Bone Fone is the lowest-priced quality personal stereo system you can buy. It is also safer than headphones as it leaves you free to hear the sounds around you and keeps you in touch with the environment.

To order any of the above products, simply send your check or money order for the amount listed above plus \$2.50 for postage and handling (Ill. residents add 6% sales tax) to the address below, or credit card buyers may call our toll-free number below. Each unit is backed by a 90-day limited warranty and a service-by-mail facility as close as your mailbox. Service should rarely be required as the units use solid-state components and are designed to take rugged treatment. JS&A is America's largest single source of space-age products—further assurance that your modest investment is well protected.

The Bone Fone started a small revolution. Be part of that revolution with the space-age way to listen to music, news and sports. Order a Bone Fone product at no obligation, today.



Dept. RA One JS&A Plaza
Northbrook, Ill. 60062 (312) 564-7000
Call TOLL-FREE 800 323-6400
In Illinois Call (312) 564-7000

©JS&A Group, Inc., 1980

Beckman brings a new dimension to hand held Digital Multimeters

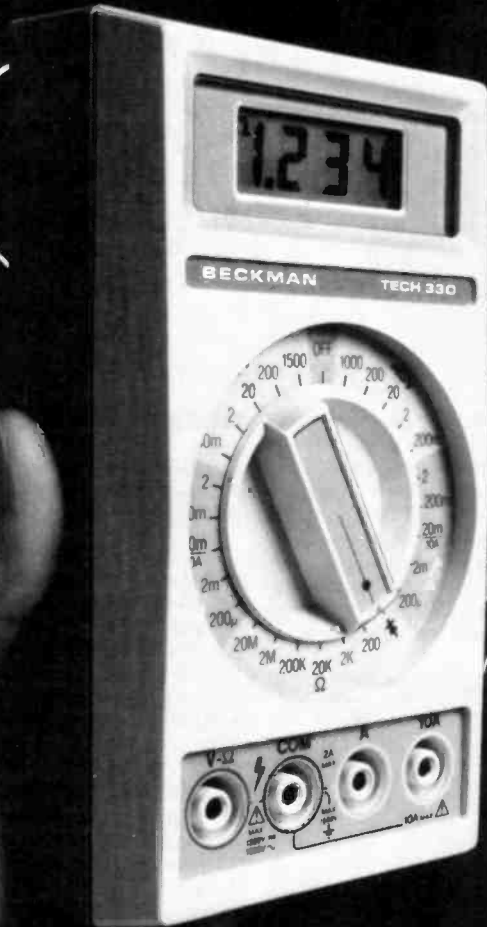

True RMS capability at an affordable price





Now you can measure the exact power content of *any signal* — regardless of waveform. Beckman delivers the new TECH™ 330 multimeter with true RMS capability and many more fine performance features for just \$210.

Unlike most multimeters calibrated to read only the true power content of sine waves, the TECH 330 extends its true RMS capability to give you accurate readings of both sine and non-sine waveforms.

True RMS makes a significant difference in accuracy when measuring switching power supplies, flyback power circuits, SCR or TRIAC controlled power supplies or any other circuit generating a non-sine signal.

The TECH 330 also accurately measures the entire audio band up to 20 kHz. But that's not all you can expect from Beckman's top-of-the-line multimeter.

Measurement Comparison Chart

Waveforms (Peak = 1 Volt)	Average Responding Meter	Beckman TECH 330	Correct Reading
Sine Wave 0 	0.707V	0.707V	0.707V
Full Wave Rectified Sine Wave 0 	0.298V	0.707V	0.707V
Half Wave Rectified Sine Wave 0 	0.382V	0.500V	0.500V
Square Wave 0 	1.110V	1.000V	1.000V
Triangular Sawtooth Wave 0 	0.545V	0.577V	0.577V

You also get 0.1% basic dc accuracy, instant continuity checks, 10 amp current ranges, a separate diode test function, 22 megohm dc input impedance, and an easy-to-use rotary switch.

With so much capability in hand, you'll be able to depend on the TECH 330 for a long time. That's why Beckman designed it tough enough to go the distance.

Enclosed in a rugged water-resistant case, the TECH 330 can take a 6-foot fall onto concrete and still perform up to spec. And to further ensure reliable, trouble-free operation, the TECH 330 gives you 1500 Vdc overload protection, RF shielding, 2000-hour battery life, gold switch contacts, and fewer electronic components to worry about.

Add another dimension to your world of electronics. Visit your Beckman distributor today for more information on the TECH 330 and Beckman's complete line of digital multimeters, starting at \$120.

For your nearest distributor, or a free brochure:

CALL TOLL FREE

24 HOURS A DAY, 7 DAYS A WEEK

1-(800)-821-7700 (ext. 517)

in Missouri 1-(800)-892-7655 (ext. 517)

BECKMAN

CIRCLE 47 ON FREE INFORMATION CARD

Radio- Electronics

THE MAGAZINE FOR NEW
IDEAS IN ELECTRONICS

MARCH 1981

Vol. 52 No. 3

Electronics publishers since 1908

SPECIAL FEATURE

- 49 **ELECTRONICS IN YOUR NEXT CAR**
Microprocessors now make it possible for your car to tell you what's wrong with it. **Martin Bradley Weinstein**

BUILD THIS

- 41 **AUDIO SIGNAL RESTORATION UNIT**
Hear your records and tapes as you've never heard them before. **Joseph M. Gorin**
- 60 **DO-NOTHING BOX**
Does "nothing" like you've never seen it done yet. **Noel Nyman**
- 63 **UNICORN-1 ROBOT**
The first step on the road to radio control. **James A. Gupton, Jr.**

TECHNOLOGY

- 4 **LOOKING AHEAD**
Tomorrow's news today. **David Lachenbruch**
- 16 **SATELLITE TV NEWS**
The latest happenings in an exciting new industry. **Gary H. Arlen**
- 55 **IDENTIFYING UNMARKED IC'S**
Every IC has a "signature" that sets it apart from other types. An ohmmeter and a piece of paper will let you classify the contents of your junk box. **Kenneth H. Recorr**
- 70 **HOBBY CORNER**
More on Light Mystery No. 2, some reader ideas and some reader questions. **Earl "Doc" Savage, K4SDS**

VIDEO

- 67 **VIDEODISC SIGNAL PROCESSING**
How laser videodisc signals are encoded and decoded. **Len Feldman**
- 84 **SERVICE CLINIC**
About sweep-circuit timing problems. **Jack Darr**
- 86 **SERVICE QUESTIONS**
R-E's Service Editor solves technicians' problems.

RADIO

- 45 **SHORT WAVE JAMMING DEVELOPMENTS**
International broadcasts are still frequently plagued by jamming. Here's what's happening now. **Stanley Leinwoll**
- 76 **COMMUNICATIONS CORNER**
How to suppress harmonic radiations effectively. **Herb Friedman**

AUDIO

- 52 **ALTERNATE MEANS OF DISTORTION REDUCTION**
A new system for minimizing distortion without having to resort to negative feedback. **Len Feldman**

EQUIPMENT REPORTS

- 24 **Keithley Model 169 DMM**
- 26 **A P Products Hobby-Blox**
- 32 **Hickock Model 216 Transistor Tester**
- 36 **Gold Line Model 1139 Power Supply**
- 37 **Sony ICF-6700W Receiver**

DEPARTMENTS

- | | |
|----------------------------------|-------------------|
| 14 Advertising and Sales Offices | 22 Letters |
| 110 Advertising Index | 89 Market Center |
| 90 Computer Market Center | 74 New Products |
| 14 Correction | 80 Radio Products |
| 111 Free Information Card | 6 What's News |

ON THE COVER

The ASRU (Audio Signal Restoration Unit) is a combination noise-reduction and signal-expander device that offers features not even found on some commercial units. Build one yourself and hear things from your records and tapes that you never heard before. The first part of this project begins on page 41.



FIND OUT HOW laser videodisc players handle the complex signals inscribed on those shiny platters. The story starts on page 67.



UNMARKED IC's can be a bargain. Learn how to find out what's inside those plain black packages on page 55.

Radio-Electronics, (ISSN 0033-7862) Published monthly by Gernsback Publications, Inc., 200 Park Avenue South, New York, NY 10003. Controlled Circulation Postage Paid at Concord, NH. One-year subscription rate U.S.A. and U.S. possessions, \$13.00. Canada, \$16.00. Other countries, \$18.00. Single copies \$1.25. © 1981 by Gernsback Publications, Inc. All rights reserved. Printed in U.S.A.

Subscription Service: Mail all subscription orders, changes, correspondence and Postmaster Notices of undelivered copies (Form 3579) to Radio-Electronics Subscription Service, Box 2520, Boulder, CO 80322.

A stamped self-addressed envelope must accompany all submitted manuscripts and/or artwork or photographs if their return is desired should they be rejected. We disclaim any responsibility for the loss or damage of manuscripts and/or artwork or photographs while in our possession or otherwise.

As a service to readers, Radio-Electronics publishes available plans or information relating to newsworthy products, techniques and scientific and technological developments. Because of possible variances in the quality and condition of materials and workmanship used by readers, Radio-Electronics disclaims any responsibility for the safe and proper functioning of reader-built projects based upon or from plans or information published in this magazine.

looking ahead

TYPEWRITER WILL TRAVEL



Combining high-density magnetic recording, miniaturization and consumer-electronics design principles, Sony has introduced what could be the forerunner of a major and basic new kind of product—a noiseless, completely portable electronic typewriter. Sony's *Typecorder* actually is far more than a typewriter. In a slim $8\frac{1}{2} \times 11 \times 1\frac{1}{2}$ inches, weighing only three pounds, it combines a word-processing terminal, a dictating machine and a stenotype system. A built-in microcassette can store up to 120 pages of typed material and make sound recordings. There is a 40-character (half-line) LCD readout on the machine.

A portable printer makes the *Typecorder* a complete out-of-office typing system, or with various peripherals, it can be integrated into word-processing systems. An interface lets it operate any IBM Selectric typewriter, either directly or via phone line. Another accessory will punch out a Telex tape from its cassette, or it can be interfaced as a remote terminal to any word-processing system via a modem. The *Typecorder* will be available around midyear at \$1400. The portable printer accessory will be about \$600. *Typecorder's* debut marks Sony's entry into the office-equipment word-processing business. A new Sony line of word-processors is geared to a new $3\frac{1}{2}$ -inch floppy-disk drive, with a recording density 1.47 times that of a 5.25-inch floppy disk. Sony's Series-35 word-processing equipment also employs microcassettes and is compatible with the *Typecorder*.

HI-VI?

Is video the next wave in hi-fi? Apparently many audio manufacturers think so. Advent was the first audio manufacturer to go into video, through its VideoBeam projection system. Pioneer is now making and selling the LaserDisc optical videodisc system and will add a video projector. Who's next? Well, Fisher will have a deluxe console containing audio equipment, an optical disc player and Beta VCR, scheduled for next fall. And Sansui plans to bring out a VHD videodisc player later this year, followed by a VCR. Superscope is expected to go into video under the Marantz brand, possibly bringing out both a projection TV set and a videodisc player. Advent will add an optical videodisc player, and both Kenwood and Aiwa are studying possible entry into the video market in the U.S.

RCA'S DISC LAUNCH

This is the month that RCA's CED *SelectaVision* videodisc player makes its debut—scheduled to go on sale the week of March 22 in 5,000 stores coast-to-coast, backed by a record advertising campaign on television, in newspapers and magazines. RCA already has trained technicians in 1,000 company-owned and independent service shops. The number of players on hand for the start of sale will be at least 20,000 and possibly as high as 30,000. The player will carry a suggested list price of \$499.95, and the initial disc catalog will contain 100 titles, selling at \$14.98 to \$27.98, but most of the discs will sell for under \$20 with the highest-priced selections containing more than one two-hour disc. Movies will be the mainstay of RCA's first offerings, although there will also be classic TV shows, sports, and music, as well as children's and educational selections. RCA says it will offer 25 new titles in May; 25 in September, and 10 monthly thereafter. RCA's disc-ad campaign will stress programming, simplicity of operation, and low cost.

PROJECTION'S CLEAN SWEEP

Projection TV, too, is sweeping the American television industry, seven years after Advent popularized the first home color-projection system. Major holdout RCA has introduced a single-piece three-tube unit, to be followed soon by Zenith, Magnavox, Sylvania and Curtis Mathes, with giant-screen sets now fielded by virtually all American TV brands and most Japanese ones. Sears Roebuck added its own projector late last year. Three-tube projection sets are also being offered by GE, Sony, Quasar, Panasonic, Toshiba, MGA and Kloss Video, with Hitachi, Sanyo and Toshiba expected to come along soon. Sales of specially built TV projectors (as opposed to modifications of small-screen sets) totaled about 28,000 in 1979, rising to nearly 50,000 in 1980 and are expected to reach 75,000 this year.

SPEED VIEWING



With all of the new video information sources available to us, will we soon be required to watch and listen at a faster pace to take it all in? VSC Corporation thinks we will, and it is forecasting that the next generation of home VCR's will incorporate its new variable speech-control IC which permits speeded-up audio without a change in pitch. Although most VCR brands now offer special-effects models that permit high-speed viewing, all except JVC disable the audio. One JVC model contains the VSC IC and allows watching and listening to programs at less time than it took to record them. Just think of all the extra viewing you can do if you can watch *60 Minutes* in 30.

DAVE LACHENBRUCH
CONTRIBUTING EDITOR

Magnavision® is Gourmet Video.

Video for people who know and love video.

If you seek the ultimate in your electronic gear, Magnavox has a bright idea for you called Magnavision. It is Gourmet Video for the video gourmet. **A picture that's clearer than tape and less costly, too.**

Magnavision is an advanced LaserVision™ videodisc player. Its optical laser scanner, a videodisc and your TV set team up to give you a picture that's amazingly sharp and clear.

Even better, the Magnavision picture remains this good even after thousands of viewings. That's because there is no direct contact between our laser and the disc. Unlike your phonograph, Magnavision doesn't use a needle.



Simulated TV picture.

The hearing's as good as the seeing.

Magnavision is designed to be played through your home stereo system so you hear what you see in full high-fidelity stereophonic sound. And since there is no disc

wear, the Magnavision sound stays crystal clear, playing after playing. **Studio-like controllability puts you in command of the action.**

Now the real fun begins. You not only watch and hear Magnavision. You play with it, too. Reverse, Slow Motion, Still, Fast Forward, Search, Numerical Index, Stereo Sound. Only LaserVision systems like Magnavision let you watch and play so many different ways. **Watch what you want whenever you want.**

With Magnavision, you have a complete library of MCA DiscoVision® programming to choose from. Blockbuster movies like *The Electric Horseman*. Classic films like *The Bride of Frankenstein*. Cooking lessons by Julia Child. Documentaries from Jacques Cousteau. How-to-do-it tennis, golf, swimming and crafts. Music, concerts, cartoons, the arts and NFL football.

Discover Gourmet Video today. Call toll-free 800-447-4700 for the Magnavision dealer nearest you. In Illinois, call 800-322-4400.

© 1983 ALFRED J. HITCHCOCK PRODUCTIONS, INC.

© 1981 MAGNAVOX CONSUMER ELECTRONICS CO.

MAGNAVOX
MAGNAVOX
MAGNAVOX
MAGNAVOX

The brightest ideas in the world
are here to play.

CIRCLE 48 ON FREE INFORMATION CARD



Encyclopedia on one disc?

Drs. Alan E. Bell and Robert A. Bartolini of RCA Labs, Princeton, NJ, have received U.S. patent for a recording method that makes it possible to put 100 billion bits of information on the two sides of a single disc. That is 10 to 100 times the capacity of any magnetic-storage disc used today.

The information is recorded with an intense beam from a novel semiconductor laser, which burns a series of microscopic holes in a thin tellurium layer deposited in the coating structure of the plastic disc. The information is read out by a less intense beam from the same laser. It shines through the microscopic holes and is reflected by a layer of aluminum located below the tellurium.

The high-density system has many po-

tential applications. A multi-volume encyclopedia could be stored on the two sides of a single disc. It may also be possible to replace conventional X-ray film, which requires expensive silver. Other possible applications are in word processing, still and motion pictures, and in storing bulky business and government records.

Video viewers are passive

The average video viewer of prospective video viewer shows little interest in programs that call for viewer participation, such as do-it-yourself programs. Those interested only 15.9 percent of the potential audience, while new movies would attract 66.5 percent, or two-thirds, according to a recent survey by Venture Development of Wellesley, MA.

Movie classics are next highly regarded, with a 50.2 percent rating, and PBS series and specials follow with 31.6 percent.

Between 20 and 30 percent of the prospective audience would be interested in pop, rock, and jazz concerts, educational courses, plays and dramatic specials, sports events, and old television series. Comedy specials, classical music concerts, and news and documentaries all rank between 14 and 20 percent, while musical-variety specials would interest only 14 percent. At the bottom of the list are children's programs, sports lessons, and foreign-language movies, all with ratings lower than 10 percent.

Power savings for UHF TV

A committee of nineteen Public Television engineers have reported that the efficiency of UHF stations using klystron transmitting tubes can be increased to make a power saving of nearly 50 percent with no decrease in output, or with a considerable increase in output if input power is maintained. The statement was backed up with a 67-page report describing experiments at several television stations and with a transmitter manufacturer.

One of the techniques is to cut the beam permeance, reducing beam current while raising the voltage to maintain the same output power. Another is to pulse the modulation anode—the element in a klystron that corresponds most closely to the grid in a triode tube—during the TV sync periods. That increases efficiency notably. In effect, the power of the tube is increased during the sync pulses.

Greater efficiency was also achieved by using a system of tuning, or "alignment" developed by the BBC, and now used by most European stations. A significant amount of power was also saved by cutting the ratio of audio to video power from the conventional 20 to 10 percent and installing a special audio coupler that would increase efficiency.

Because UHF stations require several times as much power as VHF stations, savings on power can mean a significantly greater net income to many UHF TV stations, most of which use klystrons.

Allocated territories for Tronics 2000

Tronics 2000—a new nationwide franchising organization designed to give the independent service shop owner the prestige that small business proprietors in other fields have achieved through national franchise organizations—has sold its first three territories, during its first three weeks of operation.

Robert P. Neal, of Able Electronics, Waukegan, IL, has purchased a master franchise
continued on page 12



THE HIGH DENSITY DISC is held by Dr. Bell. Dr. Bartolini is at left.

Facts from Fluke on low-cost DMM's

Direct readings in decibels: Keeping track of your gains and losses.

If you'd rather forget about the last time you got wrapped up in an audio jungle, you'll want to respond to this ad.

Meet our new 4½-digit Model 8050A Multimeter — the first low-cost DMM with self-calculating dB features that let you keep your mind on your mission instead of on conversions and formulas.

While most analog meters read dBm referenced only to 600 ohms, the Fluke 8050A delivers direct readouts in decibels over a 108 dB range referenced to any one of 16 impedances (8 to 1200 ohms) with 0.01 dB resolution.

Push one button, and the microprocessor in the 8050A scrolls

through its reference impedances. Simply stop at the one that matches your system and get back to work. No more math; just action. And with the 8050A's relative reference feature you can measure gains or losses in dB throughout your system faster than you thought possible.

When you're dealing with voltage, current or resistance, an offset function provides a means of comparing stored inputs with all subsequent inputs, automatically displaying the difference. A real timesaver.

And there's more. True RMS measurements to 50 kHz; 0.03% basic dc accuracy; conductance (measures leakage and high resistance); extensive overload protection and safety features; a full line of accessories; and a low price of \$349 U.S.

For all the facts on how to maximize your gains with the 8050A, call toll free 800-426-0361; use the coupon below; or contact your Fluke stocking distributor, sales office or representative.

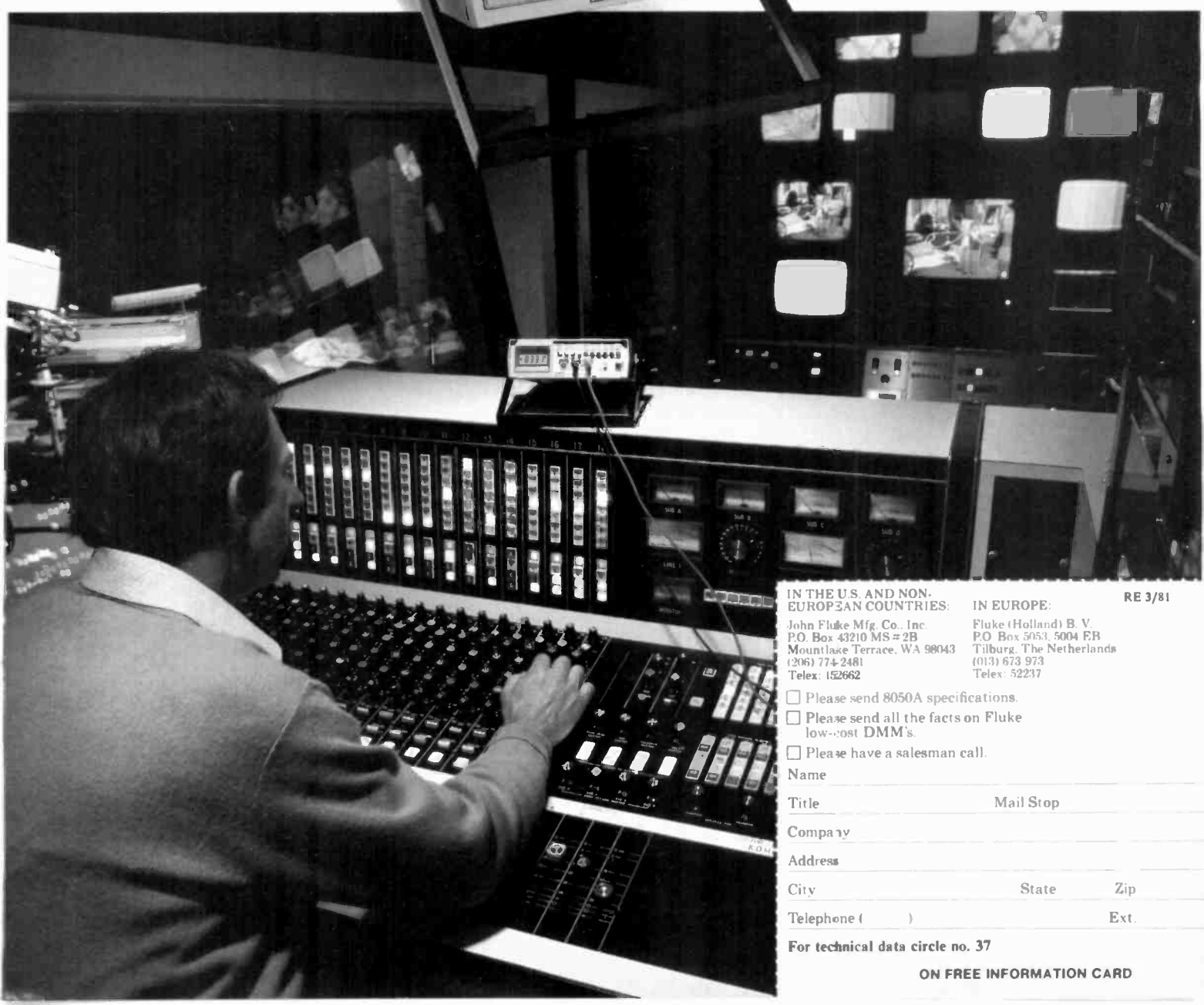

IN THE U.S. AND NON-EUROPEAN COUNTRIES: IN EUROPE: RE 3/81

John Fluke Mfg. Co. Inc.
P.O. Box 43210 MS # 2B
Mountlake Terrace, WA 98043
(206) 774-2481
Telex: 152662

Fluke (Holland) B.V.
P.O. Box 5053, 5004 EB
Tilburg, The Netherlands
(013) 673 973
Telex: 52237

- Please send 8050A specifications.
- Please send all the facts on Fluke low-cost DMM's.
- Please have a salesman call.

Name _____

Title _____ Mail Stop _____

Company _____

Address _____

City _____ State _____ Zip _____

Telephone () _____ Ext. _____

For technical data circle no. 37

ON FREE INFORMATION CARD

**NRI training in TV
and Audio Servicing
keeps up with the
state of the art.
Now you can learn to
service video cassette
and disc systems.**





You build color TV, hi-fi, professional instruments.

Now, in addition to learning color TV and audio systems servicing, you get state-of-the-art lessons in maintaining and repairing video cassette recorders, and the amazing new video disc players, both mechanical and laser-beam types.

Learn at Home in Your Spare Time

And you learn right at home, at your own convenience, without quitting your job or going to night school. NRI "bite-size" lessons make learning easier...NRI "hands-on" training gives you practical bench experience as you progress. You not only get theory, you actually build and test electronic circuits, a complete audio system, even a color TV.

Build Color TV with Computer Programming

As part of your training in NRI's Master Course in TV/Audio/Video Systems Servicing, you actually assemble and keep NRI's exclusive designed-for-learning 25"

(diagonal) color TV. It's the only one that comes complete with built-in computer tuning that lets you program an entire evening's entertainment. As you build it, you introduce and correct electronic faults, study circuit operation, get practical bench experience that gives you extra confidence.

You also construct a solid-state stereo tuner and amplifier complete with speakers. You even assemble professional-grade test instruments so you know what makes them tick, too. Then you use them in your course, keep them for actual TV and audio servicing work.

NRI Includes the Instruments You Need

You start by building a transistorized volt-ohm meter which you use for basic training in electronic theory. Then you assemble a digital CMOS frequency counter for use with lessons in analog and digital circuitry, FM principles. You also get an integrated circuit TV pattern generator, and an advanced design solid-state 5" triggered-sweep oscilloscope. Use them for learning, then use them for earning.

NRI Training Works... Choice of the Pros

More than 60 years and a million students later, NRI is still first choice in home study schools. A national survey of successful TV repairmen shows that more than half have had home study training, and among them, it's NRI 3 to 1 over any other school.

(Summary of survey on request.)

That's because you can't beat the training and you can't beat the value! For hundreds of dollars less than competing schools, NRI gives you *both* color TV and audio...

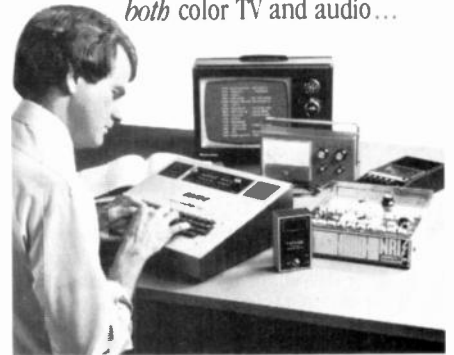

Other NRI training includes Computer Technology, Complete Communications Electronics.

and now includes training in video cassette and disc systems. Send for our free catalog and see for yourself why NRI works for you.

Free Catalog... No Salesman Will Call

Send today for our free 100-page catalog which shows all the kits and equipment, complete lesson plans, and convenient time payment plans for courses to fit your needs and budget. Or explore the opportunities in other NRI home study courses like Microcomputers & Microprocessors, CB and Mobile Radio, Aircraft and Marine Radio or Complete Communications. Send the postage-paid card today and get a head start on the state of the art. If card has been removed, write to:



NRI Schools
McGraw-Hill Continuing
Education Center
3939 Wisconsin Ave
Washington, D.C. 20016

Learn at home at your convenience.

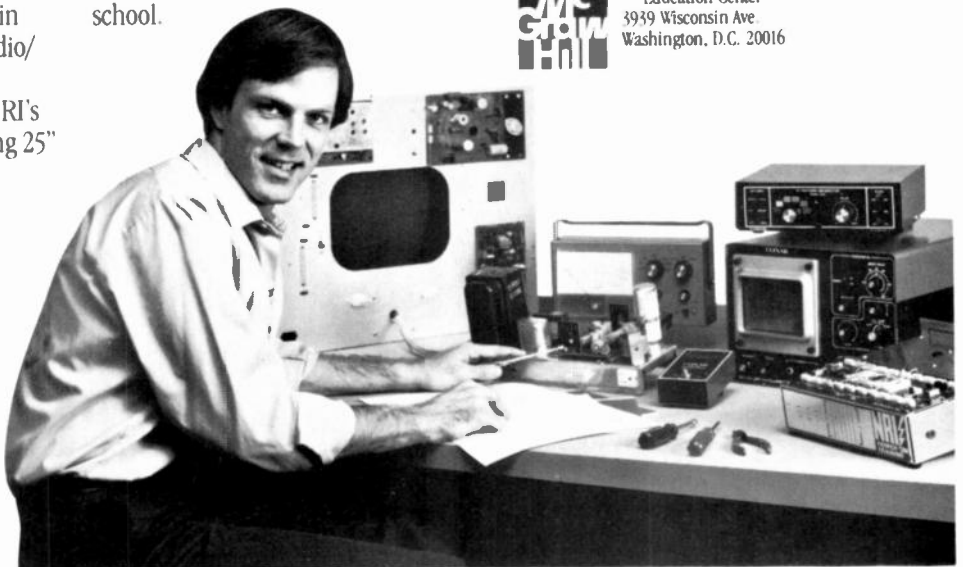

what's news

continued from page 6

chise for three counties with a total population of 615,000. Jim Cardnell, Homosassa Springs, FL, has also purchased a three-county block, with a population of about 685,000, and William B. Terrel, Cincinnati businessman, has become the master franchiser of Hamilton County, with a population of around 877,000.

Each of the Tronics 2000 territorial franchisers will offer franchises to a limited number of qualified service centers in their territories, with programs in advertising, volume buying, technical support, and business management.

"The consumer-electronics service industry is one of the largest left unfranchised in the United States," says David Hagelin, President of Tronics 2000 and former publisher of *Electronics Technician/Dealer*. "And today independent operations, rightly or wrongly, often mean consumer mistrust."

The concept that Tronics 2000 has in mind, says Hagelin, is close to what Century 21 has done in the real estate field. "Franchisees will receive assistance in all phases of business management, including training, advertising, promotion, and individual consultation. Advertising will be local and regional, with a national identity symbolized by a bold blue logo that will identify the Tronics 2000 operation to the consumer wherever he goes in the United States."

3-dimensional television

The world's first public transmission of 3D television is claimed by 3D Television Systems of North Hollywood, CA. Subscri-

bers to the SelectTV television-cable system saw 3D films for the first time on December 19, 1980.

3D is well known in movies—though it has never become popular—and has been transmitted experimentally on TV. The process developed by 3D Television transfers three-dimensional films electronically to a master 3D videotape. Viewers of SelectTV on Channel 22 were able to see the 3D pictures by wearing stereo glasses similar to those used for 3D movies. Complimentary glasses were made available to SelectTV subscribers before the transmissions.

The system is described as "being able to portray objects coming out of the screen to within several inches of the viewers' eyes and then going deep back into the television screen."

Test lab for nuclear fusion

The Lawrence Livermore National Laboratory, operated by the University of California, is constructing a Mirror Fusion Test Facility (MFTF) to explore the possibility of producing power by nuclear fusion. To that end, a contract has been let to RCA to produce 48 Neutral Beam projectors for the project.

Producing a plasma in the MFTF requires evacuating a 40-foot diameter by 60-foot long cylindrical fusion chamber to an almost perfect vacuum. Thereafter, 20 start-up Neutral Beam injectors mounted around the wall of the chamber insert bursts of deuterium atoms to form the target plasma, which is confined in the center of the machine by powerful magnets. Once the plasma is formed, 24 high-powered Neutral

Beam injectors raise the plasma temperature to the more than the 100-million degrees Celsius required for fusion.

Deuterium is the heavy isotope of hydrogen, in which a neutron as well as proton are contained in the nucleus. Deuterium is available in nearly unlimited quantities through extraction from sea water.

The 48 Neutral Beam injectors to be built by RCA include two spares of each type. Each consists of an arc chamber to ionize the deuterium working gas as well as an accelerator assembly to inject and focus the ion stream, which is later neutralized to form atoms, into the vacuum chamber. Twenty-two of the beam injectors are start-up beam sources, rated at 20-kilovolts accelerator voltage and 100-amperes current with pulse durations of 0.01 second. The remaining 26 devices are sustaining beam sources; they are rated at 80 kilovolts and 80 amperes, with pulse durations of 0.5 second.

Nuclear fusion is expected to provide power generation with improved safety, efficiency, and lower cost compared with present fission (splitting the atom) methods. For those reasons, many engineers believe fusion may be the basis for the nuclear power plants of the next century.

CB installers are warned

The Electronic Industries Association (EIA) has issued a warning about the danger of electrocution while installing CB or TV antennas. (Through long and bitter experience, many amateurs have learned to keep away from power lines and icy roofs. However, recent casualty figures show that many CB and TV users still have to learn that lesson.)

The EIA recommends that anyone putting up an antenna obtain the free U.S. Government *Antenna Alert* sheet, by writing to Antenna Alert Sheet, Consumer Product Safety Commission, Washington, DC 20207. The Association also reiterates some important points of that document:

Make sure the antenna is twice its length away from any power or light lines. Remember that even insulated lines are dangerous. Insulation may be worn, or be cut through when struck by an antenna.

If the antenna is more than 30 feet high, or is to be erected in an area where light or power lines are closer than twice the antenna height, better use professional help.

The EIA warning and the government "Alert" confine themselves to electrical dangers. Probably more accidents—with TV antennas at least—consist of falling off roofs. The mast erected from the ground and fastened to the side of the building is many times safer for the non-professional installer.

R-E



VIEWERS BEING TERRIFIED by the latest development in television

Sabtronics.

An entire range of low-cost, top-quality instruments.

Sabtronics revolutionized the market with the first low-cost, high-performance Digital Multimeter. Now we have an entire range of outstanding instruments in a reasonable range of prices. In fact, nobody can beat us in our price/performance ratio. And we can sell at a low price for some very good reasons. Our engineers design high performance products to be built at a low cost. And we refuse to stick on high mark ups. Plus we make sure your price stays low by selling directly to you. Because we sell so many instruments, we don't have to charge a high price. Naturally, we also offer all the helpful accessories you might want. And all our products are under warranty for good quality and high performance. In addition, you get from us the same quality aftersale service as any high priced instrument manufacturer. With Sabtronics instruments available, there's no need for you to spend a lot of money to do highly accurate testing and measuring.

2010A 3½ Digit LED DMM
 2015A 3½ Digit LCD DMM
 8610A 600 MHz 8-Digit Frequency Counter
 8110A 100 MHz 8-Digit Frequency Counter
 5020A 0.2 to 200 KHz Function Generator
 8000B 1 GHz 9-Digit Frequency Counter
 8610B 600 MHz 9-Digit Frequency Counter
 2035A 3½ Digit LCD Handheld DMM
 2037A 3½ Digit LCD Handheld DMM

*price in kit form. Also available factory assembled, tested, and calibrated. Call us for prices.

**price fully assembled, tested, and calibrated.

Call us for more information:
 (813) 623-2631

Making Performance Affordable

sabtronics 
 INTERNATIONAL INC.

5709 N. 50th Street Tampa, FL 33610

MARCH 1981
 13

A. 2010A — \$84.00*, B. 2015A — \$99.00*, C. 8610A — \$99.00*, D. 5020A — \$85.00*,
 E. 8000B — \$199.00**, F. 2035A — \$79.00*, G. 2037A — \$99.00*

IN CANADA CONTACT: Kumar & Co., Mississauga, Ont. Canada

Hugo Gernsback (1884-1967) founder
M. Harvey Gernsback, editor-in-chief
Larry Steckler, CET, publisher
Arthur Kleiman, managing editor
Josef Bernard, K2HUF, technical editor
Carl Laron, WB2SLR, assistant editor
Jack Darr, CET service editor
Leonard Feldman
contributing high-fidelity editor
Karl Savon, semiconductor editor
Herb Freidman, communications editor
Gary H. Arlen, contributing editor
David Lachenbruch, contributing editor
Earl "Doc" Savage, K4SDS, hobby editor
Ruby Yee, production manager
Robert A. W. Lowndes, production
associate
Joan Burwick, production assistant
Gabriele Margules, circulation director
Arline R. Fishman,
advertising coordinator

Cover photo by Robert Lewis

Radio-Electronics is indexed in *Applied
Science & Technology Index* and *Readers
Guide to Periodical Literature*.

Gernsback Publications, Inc.
200 Park Ave. S., New York, NY 10003
President: M. Harvey Gernsback
Vice President: Larry Steckler
Secretary/Treasurer: Carol A. Gernsback

ADVERTISING SALES 212-777-6400

Larry Steckler
Publisher

EAST

Stanley Levitan
Radio-Electronics
200 Park Ave. South
New York, NY 10003
212-777-6400

MIDWEST/Texas/Arkansas/Oklahoma

Ralph Bergen
The Ralph Bergen Co.
540 Frontage Road—Suite 361-A
Northfield, Illinois 60093
312-446-1444

WESTCOAST

Marvin Green
Radio-Electronics
413 So. La Brea Ave.
Los Angeles, Ca 90036
213-938-0166-7

SOUTHEAST

Paul McGinnis
Paul McGinnis Company
60 East 42nd Street
New York, N.Y. 10017
212-490-1021

Error... Error... Error... Error...

THE MISSING LINK

A serious omission was made in Part 2 of the "Pay TV Decoder" article that appeared in the February 1981 issue of **Radio-Electronics** (page 51). Someone apparently got so excited over the photo of Bo Derek that the first page of Part 1 was printed (again) instead of the first page of Part 2. What got left out was most of the conclusion of the "theory of operation" part of the article. The missing text appears below, and we apologize for any inconvenience this slip may have caused.

IN THE FIRST PART OF THIS ARTICLE WE discussed how pay-TV signals are scrambled and began talking about a device to decode them. Refer to Part 1 and Fig. 3 as we finish the discussion and describe the construction and connection of a decoder board.

Returning to IC1 for a moment, the phase-locked oscillator produces a square-wave output signal at pin 11 that is used to trigger a 74123 dual one-shot (IC2-a and -b). That one-shot produces the gating signal required to restore the sync and blanking pulses. The first section, IC2-a, has a period of approximately 30 microseconds. The trailing edge of its output pulse is used to trigger IC2-b, which has a period of approximately 12 microseconds—the width of the horizontal-blanking pulse. Because of the design of IC1, the 15.75-kHz output signal at pin 11 occurs somewhere in the middle of a scan line. An adjustable delay that allows the gating signal to begin at the proper time is provided by IC2-a. The actual gating signal is generated by IC2-b, and its width is set to match the width of the horizontal-blanking interval. The combination of R6-C9 is used to position the gating signal and the combination of R7-C10 is used to control its width. The gating signal appears at pin 13 of IC2-b, and its amplitude is controlled by R8. That signal is used to increase the IF gain of the TV receiver during the horizontal sync- and blanking-pulse intervals and thus correct the video waveform.

We have now discussed all of the circuitry required to reconstruct the

original video and audio signals. Now it is necessary to re-combine them into a useable TV signal. We have obtained a stable picture, but still have no sound. However, the intended use of our adapter is to provide a VHF signal for viewing on another, unmodified, TV set. Therefore, the video signal is taken from the video detector and applied to IC4, which is a complete video-modulator IC. The tank-circuit L1-C21 is used to set the video-carrier frequency. Resistor R21 controls the voltage at pins 2, 3, 4, and 13 of IC4 which, in turn, controls the percentage of modulation of the video input at pin 12. The sound is generated by FM-ing a 4.5-MHz oscillator using a transistor

Photo of Bo Derek copyright 1979
by Orion Picture Company

NOTE:

The legality of the use of privately-owned devices to decode subscription TV broadcasts is currently the subject of much debate and pending litigation. The subscription companies have taken the position that decoding of broadcasts without payment is "theft of service" and the FCC has issued a notice to the effect that subscription-TV decoders are subject to FCC approval.

This article merely explains how such decoding devices are built and used, and you should obtain independent advice as to the propriety of its use depending upon your individual circumstances.



CM-600 Circuit Mount

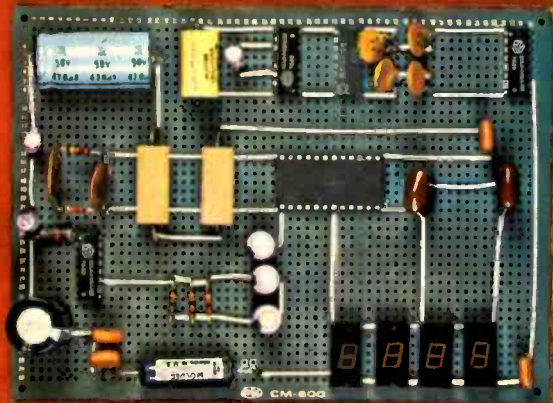
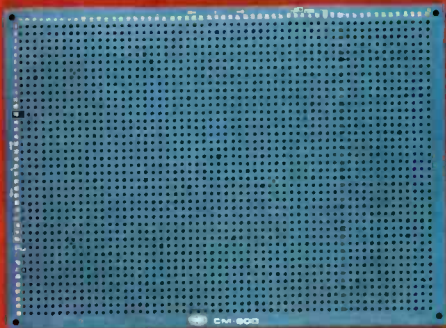

CM-600 \$6.95*
RW-50 \$2.98*

NEW CM-600 SOLDERLESS PROTOTYPE BOARD

CM-600 is a unique system for solderless construction of circuit prototypes, useful to both engineers and hobbyists. The CM-600 is a neoprene board $4\frac{1}{2}$ " (114mm) x 6" (152mm) with 2280 holes on .100" (2.54mm) centers. Standard components including DIP's are mounted by simply inserting leads into the holes in the long life neoprene material. Interconnections are easily made using 20 or 22 AWG (0.8 or 0.65mm) wire jumpers. Positive contact is assured by the elasticity of the hole, which compresses the leads together. To remove components or leads, simply pull out. This facilitates easy circuit changes making it ideal for breadboarding experimental circuits. CM-600 also features numbered rows and columns for easy reference.

Accessory Kit RW-50 contains 50 pcs of AWG 20 (0.8mm) insulated jumper wires of assorted lengths from $\frac{1}{2}$ " (13mm) to 4" (100mm). Both ends are stripped and bent 90° for easy insertion. In stock directly from

OK Machine & Tool Corporation
3455 Conner St., Bronx, N.Y. 10475 U.S.A.
Tel. (212) 994-6600 Telex 125091

* Minimum billings \$25.00, add shipping charge \$2.00
New York State residents add applicable tax

DIRECT-BROADCAST SATELLITE PLAN REVEALED



Satellite Television Corp., the direct-to-home broadcasting subsidiary of Comsat, has revealed details of its plans to create a high-power pay-TV service that could be in operation by 1986. The three-channel service would offer major motion pictures, popular concerts, children's programs, sports, experimental theater and other shows, beamed directly into homes via a 2.5-foot dish to be placed atop roofs nationwide. The satellites that will carry the signals will operate in the 17-GHz band on the uplink and be received in the 12-GHz range, with signals beamed via a high power carrier (1700 watts). The birds will be of the new PAM-D class, a refinement of the current breed now used by other Comsat subsidiaries.

Satellite TV Corp., which is applying to the FCC for permission to build the new pay-TV satellite system, envisions that subscribers will pay about \$100 for the reception antennas and then about \$25 per month for the decoder. It will also be possible to buy the receiving equipment, then pay about \$18 per month for the programming alone. STC engineers promise that the encoding/scrambling format for the video signal will be so complicated that the programs will be immune from piracy by unauthorized receivers.

STC wants to launch four separate satellites during 1986, each of which would cover a different time zone in the U.S. (with the Western satellite including spot beams for Alaska and Hawaii). The birds would be spaced about 20° apart in orbital arcs at 115°, 135°, 155° and 175° west longitude. Two other satellites would be used as in-orbit spares in case one of the primary birds encounters technical troubles.

The entire project will cost at least \$400 million, STC estimates. In addition to the 2.5-foot dishes atop home roofs, the company expects that apartments and other housing complexes—especially areas without cable TV—will be users of the new pay-TV service.

The FCC, which is currently examining a number of Direct Broadcast Satellite policy options, is expected to begin consideration of the STC plan within the year. In any case, STC admits that it will take at least three years to build and launch the system.

ABUNDANCE OF NEW EQUIPMENT

Lower-priced—and more versatile—satellite reception equipment continues to flood the market, as was evident at several recent industry meetings. Manufacturers serving both the hobbyist market and the low-cost professional user are offering a variety of new antennas and terminal devices. For example, such established companies as Microdyne Corp. (PO Box 7213, Ocala, FL 32672; phone 904-687-4633) are offering new 12-foot antennas, with EIRP contours between 36 and 33 dBW. Hughes has unveiled a new expandable dish, offering a basic 3.7 meter TVRO antenna that can be upgraded to 5-meter diameter. Hughes says the 3.7 meter version provides 52% more gain than a standard 3-meter dish, and that it can be expanded to the 5-meter configuration without upgrading the foundation or mount structure. (Hughes Microwave Communications Products, PO Box 2999, Torrance, CA 90509; phone 213-517-6100.)

Downlink Inc., a new company, unveiled a modular satellite-TV system during the Consumer Electronics Show, with a promise that it intends to "become the Apple computer of satellite TV"—a reference to the successful easy-to-use home-computer system. The Downlink package includes a control console with receiver mounted at the antenna, 12-foot spherical antenna, 120° low-noise amplifier, feedhorn and rotor with back assemblies, plus 100 feet of cables. (Downlink Inc., PO Box 33, Putnam, CT 06260; phone 203-928-7955.)

Chaparral Communications has introduced a new Feed Horn, designed to optimize the capabilities of parabolic antennas—providing an improvement of at least half a dB of system operation over a conventional rectangular horn. The \$135 feed horn consists of a standard WR220 waveguide flange and a front plate which is held in place with a set screw. The Chaparral feed is not intended for use with spherical antennas because of their high focal length-to-diameter ratios (Chaparral, PO Box 832, Los Altos, CA 94022; phone 415-941-1555.)

AROUND THE SATELLITE CIRCUIT

Cable News Network, the all-news channel (Satcom 1, Transponder 14) is carrying an electronic cable-TV guide on a sideband. The slow-scan video listings offer a program directory to what is being carried on cable-TV systems, including a rundown of that day's programs on other satellite-fed cable channels. The slow-scan sideband signals are intended to be used by cable systems on an otherwise blank channel.

Intelsat V, the \$34 million international satellite, completed its launch sequence and is now slated to go into operation in May as the primary Intelsat bird over the Atlantic Ocean. The big bird (4,300 pounds, two video transponders) is the first of nine new Intelsat satellites being built by Ford Aerospace.

GARY ARLEN
CONTRIBUTING EDITOR

Hand-held computer power is here!

An autoranging DMM breakthrough from B&K-PRECISION.

B&K-PRECISION's new microcomputer controlled Model 2845 is a major advance in digital multimeter technology. At a price comparable to ordinary manually operated units the 2845 brings microcomputer intelligence to a handheld portable DMM. When applied to a circuit, its computer selects the range providing maximum resolution without the slow "hunting" action characteristic of many bench-type autoranging DMM's.

The 2845 is certainly the most user oriented hand-held DMM available. No other DMM can match its speed and simplicity of operation. With tilt stand, large display and optional AC power adapter, it becomes a remarkable inexpensive bench DMM.

- Microcomputer autoranging speeds operation and stabilizes readings
- Auto-skip program for best resolution in least time
- Easiest, fastest-to-use DMM available
- 0.1% basic DC accuracy
- 3½ digit, 0.5" LCD display
- Continuity test "beeper"
- Range-lock, holds selected range
- Measures AC/DC voltage; AC/DC current; resistance
- Meets tough U.L. 1244 safety standards

For immediate delivery, contact your local distributor or phone toll-free 800-621-4627 (except in Illinois) for detailed technical information.

B&K PRECISION
DYNASCAN
CORPORATION

6460 West Cortland Street
Chicago, Illinois 60635 • 312/889-9087

Int'l. Sls., 6460 W. Cortland St., Chicago, IL 60635
Canadian Sales: Atlas Electronics, Ontario

CIRCLE 3 ON FREE INFORMATION CARD

Model 2845 \$175



“If you’re going to learn electronics, you might as well learn it right!”

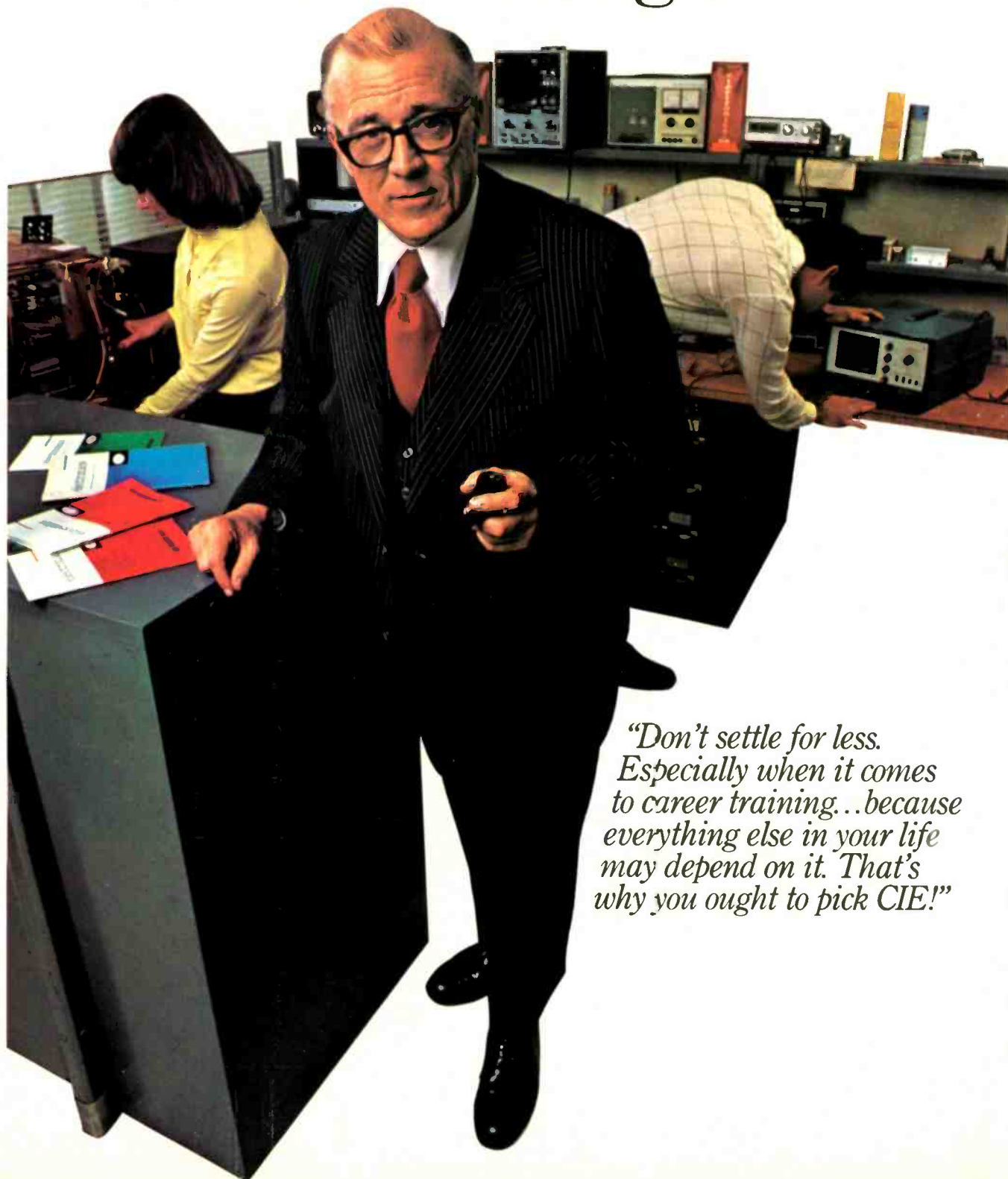

“Don’t settle for less. Especially when it comes to career training...because everything else in your life may depend on it. That’s why you ought to pick CIE!”

You've probably seen advertisements from other electronics schools. Maybe you think they're all the same. They're not!

CIE is the largest independent home study school in the world that specializes exclusively in electronics.

...

Meet the Electronics Specialists.

When you pick an electronics school, you're getting ready to invest some time and money. And your whole future depends on the education you get in return.

That's why it makes so much sense to go with number one... with the specialists... with CIE!

There's no such thing as bargain education.

If you talked with some of our graduates, chances are you'd find a lot of them shopped around for their training. Not for the lowest priced but for the best. They pretty much knew what was available when they picked CIE as number one.

We don't promise you the moon. We do promise you a proven way to build valuable career skills. The CIE faculty and staff are dedicated to that. When you graduate, your diploma shows employers you know what you're about. Today, it's pretty hard to put a price on that.

Because we're specialists, we have to stay ahead.

At CIE, we've got a position of leadership to maintain. Here are some of the ways we hang onto it...

Our step-by-step learning includes "hands-on" training.

At CIE, we believe theory is important. And our famous Auto-Programmed Lessons teach you the principles in logical steps.

But professionals need more than theory. That's why some of our courses train you to use tools of the trade like a 5 MHz triggered-sweep, solid-state oscilloscope you build yourself—and use to practice troubleshooting. Or a Digital Learning Laboratory to apply the digital theory essential to keep pace with electronics in the eighties.

Our specialists offer you personal attention.

Sometimes, you may even have a question about a specific lesson. Fine. Write it down and mail it in. Our experts will answer you promptly in writing. You may even get the specialized knowledge of all the CIE specialists. And the answer you get becomes a part of your permanent reference file. You may find this even better than having a classroom teacher.

Pick the pace that's right for you.

CIE understands people need to learn at their own pace. There's no pressure to keep up... no slow learners hold you back. If you're a beginner, you start with the basics. If you already know some electronics, you move ahead to your own level.

Enjoy the promptness of CIE's "same day" grading cycle.

When we receive your lesson before noon Monday through Saturday, we grade it and mail it back—the same day. You find out quickly how well you're doing!

CIE can prepare you for your FCC License.

For some electronics jobs, you must have your FCC License. For others, employers often consider it a mark in your favor. Either way, it's government-certified proof of your specific knowledge and skills!

More than half of CIE's courses prepare you to pass the government-administered exam. In continuing surveys, nearly 4 out of 5 CIE graduates who take the exam get their Licenses!

Associate Degree

Now, CIE offers an Associate in Applied Science Degree in Electronics Engineering Technology. In fact, all or most of every CIE Career Course is directly creditable towards the Associate Degree.

Send for more details and a FREE school catalog.

Mail the card today. If it's gone, cut out and mail the coupon. You'll get a FREE school catalog plus complete information on independent home study. For your convenience, we'll try to have a CIE representative contact you to answer any questions you may have.

Mail the card or the coupon or write CIE (mentioning name and date of this magazine) at: 1776 East 17th Street, Cleveland, Ohio 44114.



CIE **Cleveland Institute of Electronics, Inc.**
 1776 East 17th Street, Cleveland, Ohio 44114
 Accredited Member National Home Study Council

YES... I want the best of everything! Send me my FREE CIE school catalog — including details about the Associate Degree program — plus my FREE package of home study information. RE-08

Print Name _____
 Address _____ Apt. _____
 City _____
 State _____ Zip _____
 Age _____ Phone (area code) _____

Check box for G.I. Bill information: Veteran Active Duty

MAIL TODAY!

control. If you are interested in learning more about this, I refer you to a three-part article I wrote for the January, February, and March 1980 issues of Byte magazine. The title is: "A Computer Controlled Security System."
STEVE CIARCIA

UNICORN-1

I am following with interest your series on building your own robot. However your readers may be interested to know that the manipulator arm wiring can be simplified by using two additional diodes. The circuit shown in the figure below (compare with Fig. 18 on page 58 of the September 1980 issue) performs the same functions, but

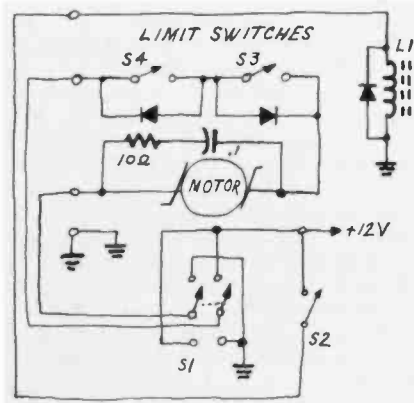

reduces the amount of wiring required on the arm and saves four positions on the terminal barrier strip. The diodes should be

rated at 50 volts and be able to handle the motor current.

Also, the network shown across the motor can profitably be used across all motors and solenoids to protect the switches from damage caused by arcing when the power is suddenly turned off. Without those, the life of the switches may be considerably shortened. If the current through a motor or solenoid is always in the same direction, a clamping diode, as shown on the "hand" solenoid can also be used.

It's easy to remember which way to connect a clamping diode: simply orient it so it *doesn't* short out whatever it is connected across!

GUY JUTRAS
Ottawa, Ontario, Canada

VIDEO SIGNALS

Any government attempt to "stop unauthorized reception" of video signals is logically equivalent to prohibiting you from hearing the governor burp.

Incidentally, Officer Brown (Letters, October 1980), "laws" prohibiting radar detection are equally illegitimate in the U.S.A.

"Piracy?" Commissioner, if you don't wish to water your neighbor's lawn, then direct your hose elsewhere.

JACK D. DENNON
Warrenton, OR

ON EINSTEINIAN IMPOSSIBILITIES

I am astonished that you would print such a letter as "Einsteinian Impossibilities," by A. H. Klotz even in your "April Fool" issue.

In fairness to your other readers, you should have pointed out the obvious flaw in Mr. Klotz's argument:

The constant velocity of light is *not* predicted by Einstein's theory, as Mr. Klotz apparently believes. But the scientifically-proved fact that the velocity of light is constant, regardless of its source, is one of the physical world's anomalies that prompted Einstein to formulate his theory in the first place.

To argue with Einstein's theory, one must ask the question: "How can I account for the fact that the velocity of light from all sources (some of which are moving) is constant?"

If Mr. Klotz has new evidence about the speed of light, I am sure we would all like to hear about his experiments.

JERRY MILLER,
Littleton, CO

WIDE-RANGE AUDIO GENERATOR

In reference to the "Wide-Range Audio Generator" article in your May 1980 issue: It has 2 Zener diodes. Those are *not* 0.1-volt Zeners as stated but rather both numbers are for 5.1-volt Zener diodes (1N5231 and 1N751).

I ordered all required parts, but had trouble finding a 0.1-volt Zener diode. Fortunately the numbers given were in an ad in the back of the issue, so I checked both of them, and both turned out to be 5.1-volt Zeners.

It sure looks like a good project and I'm looking forward to completing it.

CRAIG LEWIS,
Kailua, HI

R-E

More cross-references, more line items, more support data. There's more in it for you than ever before with Zenith Universal Semiconductors covering Zenith exact replacements... plus the most popular types in the industry.

And now—TEXACO GIFT CERTIFICATES!

With every qualifying purchase from your participating Zenith distributor by March 31, 1981, you get Texaco Gift Certificates to apply against the purchase of gasoline, oil, tires, batteries and many more items at

any Texaco Service Station. Call your Zenith distributor's Parts Manager and learn how you can get Texaco Gift Certificates with your purchase of Zenith Universal Semiconductors.

Call now, too, for your copy of Zenith's latest, greatest Universal Semiconductor cross-reference guide. **There's more in it for you than ever before!**



ZENITH

The quality goes in before the name goes on®

Zenith Radio Corporation / Service, Parts & Accessories Division
11000 Seymour Avenue / Franklin Park, Illinois 60131

CIRCLE 31 ON FREE INFORMATION CARD

equipment reports

Keithley Model 169 DMM



CIRCLE 101 ON FREE INFORMATION CARD

THE CHOICE OF A NEW DIGITAL MULTIMETER IS influenced by many factors. Since most units within a certain price range will have almost identical accuracies, other features such as ease of operation, special ranges, and cabinet sizes may be more important. In the past it was common to select a portable unit to take advantage of its use in the field as well as on the bench. In most cases however it has been discovered that a hand-held unit is not the most convenient one for bench use.

Keithley Instruments, Inc. (28775 Aurora Road, Cleveland, OH 44139) has introduced its *model 169*, a digital multimeter designed for bench use. Since the *model 169* uses six C-size batteries for power, it can also be taken into the field if the need arises.

The *model 169* features a large (0.6-inch) 3½-digit LCD display. The easy-to-understand front panel has color-coded pushbuttons. Units are displayed on the LCD to confirm the range and use selected. Since the front panel is larger than that of a hand-held unit, the push-buttons are easier to operate and the cabinet (again due to the larger size) remains stable. One hand can be used to change ranges. A large bail-type carrying handle attached to the sides of the cabinet also serves as an adjustable stand to allow the user to position the meter at an angle. The cabinet has four feet attached to the underside. Those feet have provisions for test-lead storage. Test leads can be connected to the front panel with standard banana jacks. That means you will still be able to use your favorite special-function leads. The *model 169* is supplied with standard test leads, including probes.

Input protection is provided for all functions

on the *model 169*. Those who forget to change the ranges and functions will be happy to know that the *model 169* will withstand 1400 volts (peak) on the voltage ranges and 300 volts on the resistance ranges. A two-ampere fuse protects the current ranges and the fuse is accessible without removing the cabinet.

These specifications will provide the reader with a brief idea of the *model 169's* versatility. Both AC and DC voltage is measured on five ranges from 200 mV up to 1,000 volts full-scale. Accuracy on the DC ranges is 0.25% of reading + 1 digit. Accuracy on AC is 0.75% of reading + 5 digits at frequencies under 1 kHz. Input impedance is 10 megohms shunted by less than 100 pF. Current can be measured on five scales from 200 µA to 2,000 mA full-scale on both AC and DC, although the DC readings are more accurate than AC. Resistance is measured on six ranges from 200 ohms to 20 megohms full-scale. Voltage resolution will vary from 100 µV to 1V, depending upon the range, in either the AC or DC functions. Likewise current resolution is from .0001 to 1 mA and the resistance ranges offer resolutions of from 0.1 to 10K ohms.

continued on page 26

BK PRECISION

Microcomputer-Controlled Autoranging DMM Model 2845



- Computer stabilized accuracy to 0.1%
- Auto-perfection
Selects range for maximum resolution
- Audible continuity indicator
Built-in audible tone generator
- G-MOV overload protection
Provides AC and DC voltage range protection to 1000 VDC or AC peak
- Shielded in RF fields
Accuracy maintained in RF fields

- Long life, high reliability
Four hermetically sealed reed relays perform range switching with virtually no contact wear
- Microcomputer intelligence
Designed around 4-bit microcomputer. Analyzes stored data and range that provides greatest display resolution. Program memory capacity 1024 x 8 bits of ROM supported by 48 x 4 bits of data memory RAM

... in stock and available for IMMEDIATE delivery.

Dual Trace 5"
30 MHz Triggered Scope
Model 1479A



Sweep/Function
Generator
Model 3020

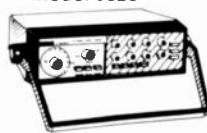

Semiconductor
Transistor Tester
Model 520B



Portable Digital
Capacitance Meter
Model 820



Order with Confidence and get the Fordham Advantage!

Call for
our prices **TOLL FREE**
(800) 645-9518
in N.Y. State call (516) 752-0050

FORDHAM
855 Conklin St. Farmingdale, N.Y. 11735



- Master Charge
- BankAmericard
- VISA
- COD
- Money Order
- Check
- COD's extra

CIRCLE 55 ON FREE INFORMATION CARD

Here's the easy way to write your own programs.

Heathkit Self-Study Courses give you a complete command of computer language, so you can write the programs that do your specific tasks. Choose from four programming languages.

Easy, step-by-step learning

You learn at your own pace, performing exercises on your computer and following a clearly written and illustrated text. Tests at the end of each unit assure your understanding before proceeding to the next unit. In most courses your reading is reinforced by cassette tapes, so you see *and hear*, for more thorough learning.

Hands-on programming exercises

You learn by *doing*, not just reading. Special exercises guide you through the steps of designing and writing your own programs for your computer. Upon completion of the courses you'll be able to tailor existing programs to your specific needs, or write your own original programs from scratch.

Recommended for college credit

Many Heathkit Courses are now recommended for college credit by the American Council on Education. If you can't go back to college, now you can bring college home to you.

Free Heathkit Catalog

Details and prices on the complete line of Heathkit Self-Study Courses on computer and electronics subjects are in the new, free Heathkit Catalog. Send for yours today or pick one up at your nearby Heathkit Electronic Center.

FOUR HEATHKIT PROGRAMMING COURSES

BASIC™: easiest-to-learn, hobbyist's language
PASCAL™: sophisticated, easy-to-use language
COBOL™: the businessman's language
ASSEMBLY: very efficient, very precise language
Coming soon: FORTRAN™ and Microsoft™ BASIC™



Send for free catalog
Write to Heath Co.,
Dept. 020-754,
Benton Harbor, MI 49022.

In Canada, write Heath Co.,
1480 Dundas Highway East,
Mississauga, Ontario, L4X 2R7.



Visit your
Heathkit Store
Heathkit products
are displayed,

and serviced at 62 Heathkit
Electronic Centers in the U.S.
and Canada. See your telephone
white pages for locations.

In the U.S., Heathkit Electronic
Centers are units of Veritechnology
Electronics Corporation.

Heathkit®

EQUIPMENT REPORTS
continued from page 24

Overrange is indicated when the three least significant digits are blanked on the display. There is automatic polarity reversal, and a display indicator will signify the polarity of the test voltage or test current. The display will also indicate when there is less than five percent of battery life remaining. The estimated battery life is 1,000 hours when carbon-zinc batteries are used, and 2,000 hours with alkaline batteries.

The instruction manual also serves as a repair manual for those who like to maintain and calibrate their own equipment. It contains exploded views of the unit, complete parts lists, and an extra large two-page schematic diagram. In addition, there is an excellent discus-

sion of the instrument's theory of operation and how the instrument is used.

All circuitry is contained on a 4½ × 7½ inch printed-circuit board and, due to the relatively large size, troubleshooting is greatly simplified. The front panel is attached to the board with connectors that makes removal easy. The LCD display is fastened to the panel by two studs and it is connected to the main board by ribbon cable. The model 169 measures 3½ × 9¼ × 10¼ inches and has a net weight of three pounds.

The unit has been tested and it performed well. All ranges equalled or exceeded the published specifications. If you are in the market for a large DMM that can also be used in the field, it may be worth your time to check out this versatile unit. The model 169 from Keithley sells for \$169. **R-E**

A P Products Hobby-Blox Solderless Breadboarding System



CIRCLE 102 ON FREE INFORMATION CARD

IT SEEMS THAT EVERY TIME WE TURN AROUND, someone has taken another step toward making prototyping less complicated, more instantaneous, and, admittedly, a little more fun. A P Products' *Hobby Blox*, are a very versatile series of breadboarding products that, working together, perform as a complete system for circuit building.

The generous use of color and the low prices of the several elements of the *Hobby-Blox* system can easily lead to the impression that it is a system intended strictly for beginners. That is not the case. *Hobby-Blox* perform on a par with any professional breadboard, in most applications. Its many unique elements permit the easy incorporation of circuit elements that would be difficult to accommodate with many breadboarding products.

Part of the secret of the flexibility of *Hobby-Blox* lies in its unique carrier tray. In addition to its primary purpose of providing structural rigidity for the breadboard strips, the tray also has a number of molded-in features that contribute to the modularity and expandability of the system. The side rails, for example, feature a tongue on one edge and a mating groove on the opposite. There are also slots spaced along one edge to accommodate the blank panel, control panel, or speaker panel elements of the system.

The trays can be readily stacked side-to-side or, with tray extender clips, end-to-end. Also available is a right-angle, vertical tray pack that includes a smaller tray and adapter strip. Either large or small trays, however, may be vertically mounted using the adapter strip.

The standard tray is 6.3 × 3.12 inches and the shorter tray is 3.7 × 3.12 inches. The inside width, between the side rails, is 2.75 inches. That is the same as each of the solderless strip elements of the system except one—a between-the-trays, 6.3-inch long, bus strip with two continuous rows of 60 connected, solderless tie points each.

There are five different types of solderless breadboarding elements designed to fit in the *Hobby-Blox* tray. Yellow terminal strips provide a row of 26 three-tie-point terminals. Red distribution strips each provide two rows of 26 connected tie points. Gray 3 × 16-inch terminal strips repeat arrays of 16 three-tie-point terminals (arranged as twin columns of eight each on either side of a 0.3-inch DIP-standard center spacing) three times across its width—perfect for placing three 7-segment DIP displays in a row. Gold LED strips accept six discrete LED's, provide a solderless tie-point connection to each solderless LED socket lead,

continued on page 32

ADVANCE IS PROUD TO INTRODUCE the KEITHLEY Line of High Quality Digital Multimeters Featuring The New 130 Hand-Held DMM

Take a look at Keithley's new Model 130 measurement problem-solver.

Easy to use

- Two rotary switches instead of eight pushbuttons
- Large, easy to read 1.8cm (.6") LCD digits—larger and sharper than competitors'

Rugged

- High-impact ABS plastic case
- Shock-mounted LCD
- Tough polycarbonate plastic window and front panel

Performance Plus

- Convenient size and weight—only 10 oz. (7.0"x 3.1"x 1.5")
- 200 hour battery life
- Low battery annunciator
- Easy to maintain—all components on one board
- One-year guarantee on specifications
- Only one calibration adjustment, only once
- 25 Ranges and five functions: DC volts, AC volts, DC amps, ohms
- 100µV, 1µA, 0.1Ω sensitivity
- 1000V DC, 750V AC, 10A and 20MΩ upper range limits



\$115
Case \$10.00
Shipping \$3.00

SPECIFICATIONS

	RANGE	ACCURACY
DC VOLTAGE	200mv, 2V, 20V, 200V, 1000V	.5%
AC VOLTAGE	200mV, 2V, 20V, 200V, 750V	1%
DC CURRENT	2mA, 20mA, 200mA, 2000mA, 10A	2%
AC CURRENT	2mA, 20mA, 200mA, 2000mA, 10A	3%
RESISTANCE	200Ω, 2kΩ, 20kΩ, 200kΩ, 20MΩ	.5%

THE TEST EQUIPMENT SPECIALISTS
TOLL FREE HOT LINE
800-223-0474

54 WEST 45th STREET NEW YORK N.Y. 10036 212-687-2224

ADVANCE ELECTRONICS

The first personal computer for under \$200.

The Sinclair ZX80.
A complete computer—
only \$199.95 plus \$5.00 shipping.

Now, for just \$199.95, you can get a complete, powerful, full-function computer, matching or surpassing other personal computers costing several times more.

It's the Sinclair ZX80. The computer that "Personal Computer World" gave 5 stars for 'excellent value.'

The ZX80 cuts away computer jargon and mystique. It takes you straight into BASIC, the most common, easy-to-use computer language.

You simply take it out of the box, connect it to your TV, and turn it on. And if you want, you can use an ordinary cassette recorder to store programs. With the manual in your hand, you'll be running programs in an hour. Within a week, you'll be writing complex programs with confidence.

All for under \$200.

Sophisticated design makes the ZX80 easy to learn, easy to use.

We've packed the conventional computer onto fewer, more powerful LSI chips—including the Z80A microprocessor, the faster version of the famous Z80. This makes the ZX80 the world's first truly portable computer (6½" x 8½" x 1½" and a mere 12 oz.). The ZX80 also features a touch sensitive, wipe-clean keyboard and a 32-character by 24-line display.

Yet, with all this power, the ZX80 is easy to use, even for beginners.



Your course in computing.

The ZX80 comes complete with its own 128-page guide to computing. The manual is perfect for both novice and expert. For every chapter of theory, there's a chapter of practice. So you learn by doing—not just by reading. It makes learning easy, exciting and enjoyable.

You'll also receive a catalog packed with items that can make your ZX80 even more useful. Including 27 program cassettes, from games and home budgeting for just \$6.95, to Sinclair's unique Computer Learning Lab. And books, hardware options and other accessories.

ZX80's advanced design features.

Sinclair's 4K integer BASIC has performance features you'd expect only on much larger and more expensive computers.

- Unique 'one touch' entry. Key words (RUN, PRINT, LIST, etc.) have their own single-key entry to reduce typing and save memory space.



- Automatic error detection. A cursor identifies errors immediately to prevent entering programs with faults.
 - Powerful text editing facilities.
 - Also programmable in machine code.
 - Excellent string handling capability—up to 26 string variables of any length.
 - Graphics, with 22 standard symbols.
 - Built-in random number generator for games and simulations.
- Sinclair's BASIC places no arbitrary restrictions on you—with many other flexible features, such as variable names of any length.
- And the computer that can do so much for you now will do even more in the future. Options will include expansion of 1K user memory to 16K, a plug-in 8K floating-point BASIC chip, applications software, and other peripherals.

Order your ZX80 now!

The ZX80 is available only by mail from Sinclair, a leading manufacturer of consumer electronics worldwide.

To order by mail, use the coupon below. But for fastest delivery, order by phone and charge to your Master Charge or VISA. The ZX80 is backed by a 30-day money-back guarantee, a 90-day limited warranty with a national service-by-mail facility, and extended service contracts are available for a minimal charge.

Price includes TV and cassette connectors, AC adaptor, and 128-page manual.

All you need to use your ZX80 is a standard TV (color or black and white). The ZX80 comes complete with connectors that easily hook up to the antenna terminals of your TV. Also included is a connector for a portable cassette recorder, if you choose to store programs. (You use an ordinary blank cassette.)



The ZX80 is a family learning aid. Children 10 and above will quickly understand the principles of computing—and have fun learning.

Master Charge or VISA orders call: (203) 265-9171. We'll refund the cost of your call.
Information: General and technical—(617) 367-1988, 367-1909, 367-1898, 367-2555. Phones open Monday-Friday from 8 AM to 8 PM EST.

sinclair

Sinclair Research Ltd., 475 Main St.,
P.O. Box 3027, Wallingford, CT 06492.

To: Sinclair Research Ltd., 475 Main St., P.O. Box 3027, Wallingford, CT 06492.

Please send me _____ ZX80 personal computer(s) at \$199.95* each (US dollars), plus \$5 shipping. (Your ZX80 may be tax deductible.)

I enclose a check/money order payable to Sinclair Research Ltd. for \$_____.

Name _____

Address _____

City _____ State _____ Zip _____

Occupation: _____ Age: _____

Intended use of ZX80: _____

Have you ever used a computer? Yes No.
Do you own another personal computer? Yes No.

*For Conn. deliveries, add sales tax.

RE 3-1

**THESE ARE NOT
HOME-MADE TRAINING DEVICES.
THESE ARE PRODUCTION MODEL
MICRO-SYSTEMS.
NO OTHER HOME STUDY SCHOOL
OFFERS THEM EXCEPT NTS.**



1.



2.

3.





2-Meter FM Transceiver

IN FACT, NTS ELECTRONICS PROGRAMS INCLUDE THE WIDEST ARRAY OF SOLID-STATE AND DIGITAL EQUIPMENT EVER OFFERED BY ANY HOME STUDY SCHOOL.

Now, for the first time, you can learn all about microcomputers by working with your own production model at home. We'll explain the principles of troubleshooting and testing this remarkable instrument and, best of all, we'll show you how to program it to do what you want.

It's the perfect opportunity for you to learn BASIC high level language programming *and* assembly language programming.

Then, to learn how to localize microcomputer problems and solve them, you'll experiment and test with a digital multimeter and other testing gear.

But most important, you get to assemble and work with today's most sophisticated microcomputers, not home-made training devices. We believe this makes learning a lot more relevant and exciting.

In fact, production-model equipment is featured in all NTS electronics programs.

Our Color TV servicing program boasts the NTS/HEATH digital color TV (25" diagonal) you actually build and keep.

In Communications Electronics you'll build and keep an NTS/HEATH 2-meter FM transceiver, along with digital multimeter and service trainer.

Whichever NTS electronics program you choose, you can count on working with much the same kind of equipment you'll encounter in the field.

Find out more in our full color catalog on the program of your choice.

NTS also offers course in Auto Mechanics, Air Conditioning and Home Appliances. Check card for more information.

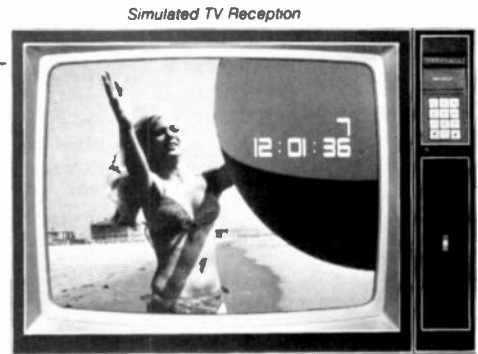

Simulated TV Reception



Digital Multimeter

1. The NTS/HEATH H-89 Microcomputer features floppy disk storage, "smart" video terminal, two Z80 microprocessors, 16K RAM memory, expandable to 48K. Available in NTS's Master Course in Microcomputers.
2. The NTS/Rockwell AIM 65 Microcomputer A single board unit featuring an on-board 20 column alphanumeric printer with 20 character display. A 6502-based unit 4K RAM, expandable. Available in NTS's Microprocessor Technology Course.
3. The NTS/KIM-1 Microcomputer A single board unit featuring a 6 digit LED display with an on-board 24 key hexadecimal calculator-type keyboard. A 6502 based microcomputer with 1K of RAM memory, expandable. Available in NTS's Master Course in Electronic and Industrial Technology.

NO OBLIGATION. NO SALESMAN WILL CALL.
APPROVED FOR VETERAN TRAINING.



TECHNICAL-TRADE TRAINING SINCE 1905
Resident and Home-Study Schools
4000 SO. FIGUEROA ST., LOS ANGELES, CA. 90037



NATIONAL TECHNICAL SCHOOLS

4000 South Figueroa Street, Dept. 208-031
Los Angeles, California 90037

Please rush FREE color catalog on course checked below

- | | |
|---|---|
| <input type="checkbox"/> MicroComputers/MicroProcessors | <input type="checkbox"/> Auto Mechanics |
| <input type="checkbox"/> Communications Electronics | <input type="checkbox"/> Air Conditioning |
| <input type="checkbox"/> Digital Electronics | <input type="checkbox"/> Home Appliances |
| <input type="checkbox"/> Industrial Technology | <input type="checkbox"/> Color TV Servicing |

Name _____ Age _____

Address _____

Apt. _____ City _____

State _____ Zip _____

- Check if interested in G.I. information.
 Check if interested ONLY in classroom training in Los Angeles.

EQUIPMENT REPORTS
continued from page 26

and include a bus of 23 connected tie points for easy connection to power buses through limiting resistors. Blue discrete component strips provide 14 terminals with five connected, solderless tie points each. These strips use 0.2-inch center spacing (versus DIP-standard 0.1-inch spacing used in the other elements) with adjacent rows staggered 0.1 inches.

Unique and welcome features on those *Hobby-Blox* elements include raised molded lines to show the electrical connections between sol-

derless tie points, and a molded letter-and-number indexing system for each hole.

The yellow terminal strips may be spaced for standard (0.3-inch center) or LSI-wide (0.6-inch center) DIP spacing by using a 0.3 × 2.75-inch spacing strip. Those include the same molded slots as the side rail, and can double as support strips.

The *Hobby-Blox* system includes a battery-holder pack that houses a standard 9-volt battery (not included), plus twin three-tie-point terminals for power connections and a binding-post strip with one black and two red binding posts. Each binding post is brought out to a solderless tie point.

A P Products has made available two starter packs, one for IC's at \$5.97 and one for discrete components at \$6.57. Each starter pack includes a tray, breadboarding elements, and a book of 10 well-documented, easy-to-build projects. Prices for individual elements range from \$1.29 to \$3.59.

All-told, *Hobby-Blox* represents a very interesting and well planned approach to solderless breadboarding. Its features should appeal to beginner and professional alike. A P Products, 9450 Pineneedle Drive, Mentor, Ohio 44060. **R-E**

ADVANCE IS PROUD TO INTRODUCE
The  **HITACHI** Line
of High Quality Oscilloscopes
All Hitachi Instruments
Are Backed by
A Two-Year Warranty

Hitachi Oscilloscope V-302 B
DC-30MHz dual-trace

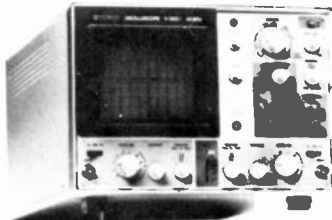

1. TV sync-separator circuit
2. High-sensitivity 1mV/div (5MHz)
3. Signal delay line
4. X-Y operation
5. Sweep-time magnifier (10 times)
6. Trace rotation
7. Z-axis input (Intensity modulation)

ADVANCE ELECTRONICS

THE TEST EQUIPMENT
SPECIALISTS

TOLL FREE HOT LINE
800-223-0474

54 WEST 45th STREET.

NEW YORK, N.Y. 10036 212-687-2224

Hitachi Oscilloscope V-152 B
DC-15MHz dual-trace



1. TV sync-separator circuit
 2. High-sensitivity 1mV/div (5MHz)
 3. X-Y operation
 4. Sweep-time magnifier (10 times)
 5. Trace rotation
 6. Z-axis input (Intensity modulation)
- (Also available in single-trace)

 **HITACHI**

V-302 B & V-152 B

- TV sync-separator circuit facilitates rapid video signal measurement.
- Extra-high sensitivity; vertical sensitivity of 1mV/div. now available.
- Built-in signal delay line for leading edge observation of quick-rising waveforms (V-301 and V-302).
- X-Y operation very convenient for measuring phase difference of two waveforms.
- Sweep-time magnifier effective for precise measurement; sweep time magnifying 10 times with one-touch operation.
- Trace rotation system for easily adjusting bright-line inclination caused by terrestrial magnetism.
- Z-axis input provided-possible to use as CRT display.
- 0.2µs~0.2s-wide sweep range setting.
- One-touch shifting waveform slopes.
- Five modes of vertical deflection operation (Type V-152 and V-302).
- Panel layout with color-coding of respective functions.

Put a proven Hitachi dual-trace oscilloscope on your bench for as little as \$695. Our V-152 15MHz model includes unprecedented sensitivity (1 mV/div)...10X sweep magnification...front panel XY operation...trace rotation...Z-axis input...and more. Need greater bandwidth? Our V-302 model is the only 30MHz dual-trace scope with signal delay line priced under \$1000, with all the above features, to make your testing operations fast, easy, and accurate. Reliability is exceptional too. (As you'd expect from a manufacturer with over 20 years of experience "outscoping" the competition.) So exceptional, in fact, that Hitachi quality is backed by a 2-year warranty...the longest in the industry. Whether you use it for teaching or repairs, for video, audio, or computer testing, you can't find more scope for your dollar than at Hitachi. Call for more details.

Normal Price

- V-152 B 15, MHz Dual Trace \$735*
- V-302 B 30, MHz Dual Trace \$995*

* Probes included.

Call For
Special Introductory
Price Offer

Hitachi...The measure of quality.

Hickok Model 216 Transistor Tester



CIRCLE 103 ON FREE INFORMATION CARD

ANYONE WHO HAS SPENT ANY AMOUNT OF TIME with an illegibly-marked group of three-legged semiconductors knows how frustrating and time-consuming a task it is to sort through them. Hickok (10514 Dupont Avenue, Cleveland, OH 44108) has automated the task with an amazing new handheld tester, the *model 216*, that performs in- or out-of-circuit pass/fail tests. It also identifies NPN, PNP, or FET type; diode and SCR polarity; and the base or gate lead—all in a few seconds.

A device can be plugged into the front-panel transistor socket (graphics clearly identify which of the pins to use to test diodes), or a set of three colored leads may be plugged into the front-panel jacks and alligator-clipped to the device. The comprehensive instruction manual offered by Hickok specifies that for in-circuit testing, the maximum load between any two leads is 500 ohms, 0.2 µF, or any impedance equivalent to 500 ohms at 1000 Hz.

All indications are made through six front-panel LED's. There is a red LED marked FAIL and two green LED's marked PASS, one with the letter P and a diode symbol with the cathode at the left and the other with the letter N and a diode symbol with the cathode at the right. Each of the three terminals to which the device under test is connected has a red LED associated with it. That is true both for the socket on the front panel and the three banana jacks that the color-coded (red-black-yellow) test leads plug into.

A single switch controls operation of the *model 216*, selecting the transistor test mode, the diode test mode, or off. After a few seconds (approximately four) of blinking through the test sequence, the LED's hold on a fixed pattern that identifies whether the device is PNP (P LED lights) or NPN (N LED lights). The LED associated with the lead connected to the

continued on page 36

Light-torque rotary switches make the LM-3.5A DMM as easy to operate as it is to carry.

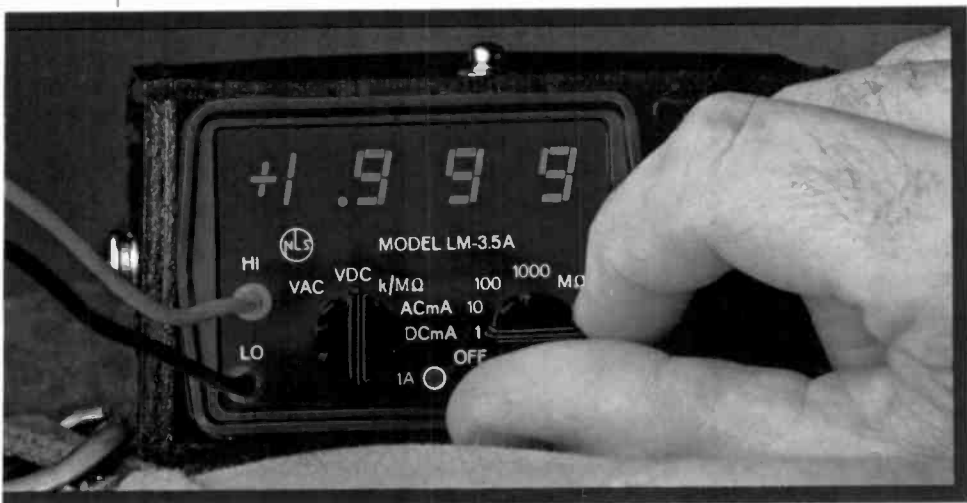

On a benchtop or a belt, over a shoulder or in a tool kit, the LM 3.5A DMM, and its LCD counterpart, the LM-350, are ready to go when you are.

Convenience. That's the key to Non-Linear Systems' best-selling LM-3.5A. A high-performance, competitively-priced, all-purpose mini DMM. Convenience from light-torque rotary switches. So operation's a cinch. Convenience from bold, bright LEDs. For instant, accurate, numeric answers. Unlike some competitive meters, the LM-3.5A features both vertical and horizontal readings. And an optional leather carrying case with belt loops and shoulder strap assures hands-free operation.

At 9.2 oz., the LM-3.5A is portability at its best. There's more. The LM-3.5A is a 3½-digit DMM. Features 2,000 counts per range — 100% over-ranging. Result? Increased accuracy and resolution between readings of 999-2,000. It also reduces the amount of range shifting when measuring near 1,000.

Troubleshooters swear by it. Repairmen find the LM-3.5A works wonders on tvs, business machines, even cameras. Checks all quiescent AC and DC voltage values. Spots current drains. Measures the resistance of suspect components. Quickly and precisely.

Other DMMs to match your needs. The LM-3.5A is just one in a full series of 3 to 4-digit DMMs. If you need LCD convenience for measurements outdoors, we market the LM-350, among others. You don't pay for true RMS capabilities you don't need. But if you do need true RMS readings, Non-Linear Systems can oblige.

FM-7. The bantam frequency meter.

Portability teams with performance in the FM-7. The smallest, 7-digit, 60-MHz, battery or AC line-operated instrument available.



Operator convenience is the key to our line of frequency and temperature meters, too. Pictured left to right, SC-5 prescaler, FM-7 frequency meter, LED format LT-3 digital temp meter, and its LCD cousin, the LT-31. Top, the MLB-1 digital logic probe.

Hobbyists, radio and tv studios, phone companies and the military all depend on the versatile FM-7. Whether the job calls for calibrating fixed, variable frequency or voltage-controlled oscillators, checking flowmeters, high-speed photocell counters, or setting the IF or heterodyne frequency in communications equipment, the FM-7 is a standout performer.

SC-5 Prescaler. Top range booster. This 512-MHz, battery or AC line-operated prescaler was developed to extend the frequency range of the FM-7 from 60 to 512 MHz. Adapts to most other frequency meters, too.

LM-3.5A at a glance.

DC Volts	1 to 1,000, 4 ranges
AC Volts	1 to 750, 4 ranges
Kilohms	1 to 10000, 5 ranges
AC/DC Current	1 mA to 1A, 4 ranges
Polarity Selection	Automatic
Readout	0.3" Red LED
Size	1.9" H x 2.7" W x 4.0" D
Weight	9.2 oz (batteries installed)
Power	3 type AA rechargeable Nicad batteries and charger
Price	\$165.85

LT-3 Digital Temp Meter. Featuring 0.1° resolution and high accuracy, the 3½-digit, 2,000 count full scale LT-3 is indispensable for home or industry. Checks everything from thermostats to appliances. Even monitors critical operations like photoprocessing and electroplating.

The LT-3 can be supplied with any of eight thermistor and RTD temp sensors to read ranges of 0-100°C, 32-199.9°F, or 0-199°C or F.

Work outdoors? Then the LT-31 (LCD format) is the ticket.

Get the word on us. We offer a full lineup of convenient, competitively-priced products. From DMMs, frequency and temp meters to miniscopes and DPMs.

For further technical information or the names of your nearest distributors, contact Non-Linear Systems Inc., 533 Stevens Ave., Solana Beach, CA 92705. Telephone (714) 755-1134. TWX 910-322-1132.



Non-Linear Systems, Inc.

Specialists in the science of staying ahead.

© 1981 Non-Linear Systems, Inc



HITACHI

KEITHLEY

VIZ formerly RCA

TRIPLETT



PHILIPS

HICKOK

FLUKE

New Portable Digital Capacitance Meter

BK PRECISION



Call For Our Price

MODEL 820

- Measures capacitance from 0.1 pF to 1 Farad
- Resolves to 0.1 pF
- 10 ranges for accuracy and resolution
- 4 digit easy-to-read LED display
- 0.5% accuracy
- Special lead insertion jacks or banana jacks
- Fuse protected
- Uses either rechargeable or disposable batteries
- Overrange Indication

FLUKE DIGITAL MULTIMETERS

Model 8022A:
The Troubleshooter

\$139

- Six functions
- 3 1/2-digit resolution
- 0.25% basic dc accuracy
- LCD display
- Overload protection

Model 802C A:
The Analyst

\$179

Model 8024A:
The Investigator

\$219



NEW

- Seven functions
- dc voltage
- ac voltage
- dc current
- ac current
- resistance
- diode test
- conductance (1/R)
- 3 1/2-digit resolution
- 0.1% basic dc accuracy
- LCD display
- Overload protection
- Free case
- Two year parts and labor warranty

- Nine functions
- dc voltage
- ac voltage
- dc current
- ac current
- resistance
- diode test
- conductance (1/R)
- logic level and continuity detect
- temperature (K-type thermocouple)
- Peak hold on voltage and current functions
- Selectable audible indicator for continuity or level detection
- 3 1/2-digit resolution
- 0.1% basic dc accuracy
- LCD display
- Overload protection

DATA PRECISION Model 938

0.1%, 3 1/2-Digit, LCD DIGITAL CAPACITANCE METER



Special \$149 reg. \$179

- WIDE RANGING — from 199.9 pF full scale (0.1 pF resolution) up to 1999 µF full scale. In eight ranges, virtually every capacitance you'll ever need to measure.
- FAST AND EASY TO USE — Direct reading, pushbutton ranges. Just plug in and read.
- EXCEPTIONALLY ACCURATE — provides ±0.1% basic accuracy.
- TOUGH AND COMPACT — Built to take rough usage without loss of calibration accuracy. Fits and goes anywhere, takes very little bench space, always handy for quick capacitance checkout, matching, calibration, and tracking.
- PORTABLE — Palm-sized, light-weight, operates up to approximately 200 hours on a single 9V alkaline battery.
- EASY READING — big, clear, high-contrast 3 1/2-digit LCD display, a full 0.5" high, readable anywhere.
- VALUE PACKED — Outstanding measurement capability and dependability. Outperforms DC time-constant meters, and even bridges costing 2 to 5 times as much.
- RELIABLE — warranted for 2 full years.

HITACHI

- V-151B 15 MHz Single Trace
- V-152B 15 MHz Dual Trace
- V-301B 30 MHz Single Trace
- V-302B 30 MHz Dual Trace
- V-550B 50 MHz Dual Trace, Dual Time Base

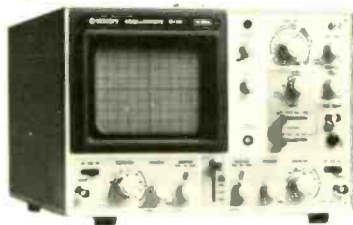

Call For Special Intro Price Offer

New Low Distortion Function Generator

BK PRECISION



Call For Our Price

MODEL 3010

- Generates sine, square and triangle waveforms
- Variable amplitude and fixed TTL square-wave outputs
- 0.1 Hz to 1MHz in six ranges
- Push button range and function selection
- Typical sine wave distortion under 0.5% from 0.1Hz to 100kHz
- Variable DC offset for engineering applications
- VCO external input for sweep-frequency tests

New Sweep/Function Generator

BK PRECISION



Call For Our Price

MODEL 3020

- Four instruments in one package—sweep generator, function generator, pulse generator, tone-burst generator
- Covers 0.02Hz-2MHz
- 1000:1 tuning range
- Low-distortion high-accuracy outputs
- Three-step attenuator plus vernier control
- Internal linear and log sweeps
- Tone-burst output is front-panel or externally programmable

Simpson

BK PRECISION

LEADER

DORIC



Non-Linear Systems

WESTON



DATA PRECISION

PORTABLE OSCILLOSCOPES
BATTERY OPERATED

MS-15



Single Trace 15MHz



Non-Linear Systems

Call For Our Prices

MS-215



Dual Trace 15 MHz

MS-230



Dual Trace 30MHz

THESE 1981 B&K OSCILLOSCOPES ARE IN STOCK AND AVAILABLE FOR IMMEDIATE DELIVERY



BK PRECISION

- 1479A Dual-Trace 30 MHz
- 1477 Dual-Trace 15 MHz
- 1432 Dual-Trace 15 MHz Portable
- 1476 Dual-Trace 10 MHz
- 1466 Single-Trace 10 MHz
- 1405 Single-Trace 5 MHz
- 1420 Dual-Trace 15 MHz Portable

CALL FOR OUR EARLY BIRD SPECIAL LOW PRICE

KEITHLEY

Model 169
BENCH/PORTABLE DMM
 • 3½ Digit liquid crystal display
 • 0.25% basic accuracy
 • 26 Ranges
\$169.00



WESTON

The Roadrunner
Model 6100

- 5 Range audible signaling function
- 0.5" LCD display
- 6 Functions
- 29 Ranges

\$139.00



BEEP!
BEEP!

80MHz Counter with Period Function



- MODEL 1820
- 5Hz to 80MHz reading guaranteed—100MHz typical
 - Period measurements from 5Hz to 1MHz
 - Period average, auto and manual positions
 - One PPM resolution
 - Totalizes to 999999 plus overflow
 - Elapsed time measurements from 0.1 to 9999.99 seconds plus overflow
 - One-megohm input resistance
 - Bright .43" high LED readouts

BK PRECISION

Call For Our Price



THE TEST EQUIPMENT SPECIALISTS
TOLL FREE HOT LINE
800-223-0474



54 WEST 45th STREET, NEW YORK, N.Y. 10036 212-687-2224

ADVANCE ELECTRONICS

EQUIPMENT REPORTS

continued from page 32

base of the transistor also lights. If the device is bad, the FAIL LED flashes alternately with the others. If the device is an FET, the N indicates N-channel, the P indicates P-channel, and the lead LED signifies the gate. The *model 216* will not give a correct indication on some low g_m FET's because of their low on-resistance, though it will indicate the validity of any P-N junction in the diode test mode. Also, the *model 216* cannot test where there is no junction, as in the gate lead of an IGFET.

In the diode test mode, only the two lead connections marked with a circled D are used, and a good device is indicated by the lighting of the appropriate PASS LED's, indicating the

polarity of the diode or junction. The instruction manual explains how to use that mode to test SCRs, triacs, bridges, and other devices. The *model 216* will not test PUT's or temperature-compensated Zeners.

The circuitry of the Hickok *model 216* is a fascinating hybrid of analog and digital approaches to semiconductor testing. A 4022 octal counter/driver scans the tester through a sequence of tests, controlling a total of 12 analog switches. A bipolar oscillator's output is applied to two leads of the device under test, and its third lead is connected to the input of an op-amp configured as an inverting lowpass (DC-smoothing) filter. All three permutations of lead connections are tried, in sequence.

It can be shown that for the two-diode model of a semiconductor, a device with an open or shorted junction will always provide a zero out-

put from the op-amp for at least one of the three configurations of leads, but a good device never will.

The output of the first scan goes from the op-amp filter to an op-amp integrator, and the result of the three lead configurations (two always result in one polarity of voltage out of the filter, the third in the opposite polarity) is stored while the same three configurations are repeated.

Thanks to some very clever use of logic gates, a comparison between the integrator-stored majority-vote voltage polarity and the second-scan output of the op-amp filter triggers three events: first, a four-second delay is introduced, inhibiting the next count of the 4022 and permitting adequate display time for the results of the tester's analysis; second, another op-amp circuit lights either the P or N LED depending upon the polarity of its input (intriguingly, that same op-amp resets the 4022 to light the FAIL LED in the case of a zero-voltage out of the filter); third, as that sequence of events has uniquely identified the base lead, the approximate LED is lit.

The *model 216* does not (nor is it intended to) provide any information on the gain or any other device characteristic. Those seeking quantitative tests must look elsewhere. But as a qualitative tester, it is one of the simplest, most foolproof, thorough and informative instruments we've encountered.

Power for the *model 216* comes from a pair of 9-volt batteries and a rechargeable battery option is available. All inputs are protected with back-to-back Zener diodes in case of residual voltages during in-circuit (power-down) tests. Hickok offers a one-year limited warranty. The 18-page instruction manual includes a complete parts list, a schematic, and a printed circuit diagram.

Manufacturer's suggested U. S. retail price for the *model 216* is \$135. It's available through electronic distributors. R-E

No Bone Crusher Grip Needed...



... your CHANNELLOCK tongue-'n-groover provides the extra muscle. Long, drop forged steel handles. Patented undercut, can't slip adjustments. Parallel grip jaws. Right angle teeth. A power combo that multiplies your grip, generates tremendous leverage with less effort. Be sure you get the genuine CHANNELLOCK. Look for THA™ trade name on the pliers you buy.

CHAN NEL LOCK

CHANNELLOCK, INC. • Meadville, Pennsylvania 16335
Meet The Rest Of The Family. Send For Our Free Catalog.

Gold Line Model 1139 Base Station Power Supply



CIRCLE 104 ON FREE INFORMATION CARD

ALTHOUGH THERE ARE NUMEROUS DC POWER supplies on the market, it is difficult to find one with a higher current capacity. Gold Line, (PO Box 115, West Redding, CT 00896), an established name in mobile-radio accessories, has introduced its *model 1139* 3-amp base-station power supply. It is capable of short-term current drains of up to five amps. Overheating prevents long-term use at those current levels and the supply is protected from overloads by a thermal switch.

The 13.5-volt supply is well-regulated, and maintains the voltage output up to 6 amps, at which point the crowbar overload-protection drops the voltage considerably.

An internal trimpot adjusts the output voltage from 13.5-15 volts. Voltage regulation is provided by a type-723 IC, and the pass transistor is a 2N3055. A full-wave bridge consisting of four 1N5400 silicon diodes provides the DC rectification.

The husky transformer is capable of running at the full current limit without becoming hot. The current is limited by the power transistor which does become hot, even though adequately heat-sinked. A thermostatic switch mounted on the heat sink senses excessive heat dissipation and shuts down the power supply for several minutes when overloaded.

All circuit components (except the transformer and output transistor) are mounted on a phenolic circuit board. An internal fuse provides additional circuit protection. That fuse is soldered in place, but a replacement is rarely necessary.

Our test unit worked well, after shipping damage was repaired. The filter capacitor leads had broken loose during shipment and the power transformer was bent slightly on its frame (upright type "A" mount). Fortunately, component spacing proved to be adequate, and no secondary damage occurred from loose or bent components.

The model 1139 power supply cabinet is finished in a black-wrinkle enamel. Ventilation holes provide adequate cooling if the unit is operated within its specified limits. Rubber foot pads prevent the unit from scratching the surface of a desk or operating table. A front-panel incandescent pilot lamp lights when the unit is on. It is connected across the DC output of the power supply, providing a bleed load when the unit is off. A pair of (red and black) press-release terminals on the rear apron of the supply securely grips power leads.

The supply weighs about 4½ pounds, and measures 4½ × 3 × 6 inches. Our unit came without any literature or instructions.

Because of the 3-amp nominal current rating of the 13.5-volt supply, it proves to be particularly well suited for home operation of most mobile electronic equipment. The model 1139 3-amp base station power supply from Gold Line sells for \$27.98. **R-E**

Sony ICF-6700W
General Coverage Receiver



CIRCLE 105 ON FREE INFORMATION CARD

FOR QUITE SOME TIME, MANUFACTURERS HAVE made either very good or very bad shortwave receivers. There seemed to be nothing in the middle. But now the market is changing. Manufacturers seem to be recognizing the fact that there are a number of serious hobbyists who enjoy casual monitoring of the shortwave spectrum and expect dependable equipment with which to do it.

Sony has continued the trend with a series of

BYTE...for the Serious Microcomputer User.



Do you use a personal computer for business or pleasure? If so, join the over one-quarter million professionals, beginners, engineers, and business people who get the latest microcomputer information in BYTE.

With a circulation of 170,000 and a total readership of 320,000, BYTE is the world's largest computer magazine. Each month's issue brings you the latest about graphics, mass storage, personal data bases, word processing, speech synthesis, new integrated circuits, new software for engineering, business and fun, plus do-it-yourself projects of all kinds.

And if you are in the market for hardware or software, our new expanded product review section gives you the unbiased facts.

So, if you are serious about microcomputing, get serious about **BYTE**.

BYTE[®]
the small systems journal

Fill in and mail the coupon today. Read your first copy of **BYTE**. If it is everything you expected, honor our invoice. If it isn't, just write "Cancel" on the invoice and mail it back. You won't be billed and the first issue is yours at no charge.

Mail coupon or
call us toll-free
800-258-5485

BYTE Subscription Dept. P.O. Box 590 Martinsville, NJ 08836
Please enter my subscription for:

One year \$19 (12 issues) Two years \$34 Three years \$49

Check enclosed entitles me to 13 issues for price of 12 (North America only)
 Bill Visa Bill Master Charge Bill me (North America only)

Card Number _____ Expiration _____

Signature _____ Name (please print) _____

Address _____

City _____ State/Province/Country _____ Code _____

Foreign Rates (To expedite service, please remit in U.S. Funds)
 Canada or Mexico One year \$21 (12 issues) Two years \$38 Three years \$55
 Europe, one year (air delivered) \$45
 All other countries, one year (surface delivered) \$35. Air delivery available on request. **7831**

Please allow 6-8 weeks for processing

CIRCLE 12 ON FREE INFORMATION CARD ©BYTE Publications, Inc. 1981

EQUIPMENT REPORTS

continued from page 37

quality, hobby-class radio receivers. One of the better ones is the *model ICF-6700W*.

The military-styled cabinet measures 18 X 7 1/4 X 9 inches. Selectable upper or lower sideband, AM, and CW modes are available from .53-29.7 MHz (the receiver skips 10.4-11.3 MHz) with FM coverage from 87.5-108 MHz.

A narrow/wide IF selectivity switch really helps separate closely-spaced stations. Additional audio bandpass shaping is possible with the separate bass and treble controls. The RF gain control may be adjusted to reduce strong signal overload on SSB.

The FM fidelity is very good, with the AM

sound quality superior to that found on most small home-entertainment radios. A multiplex output jack allows coupling of the FM IF signal to a stereo adaptor. A timer jack provides for external on/off control of the receiver by a suitable timing clock (unfortunately, neither the stereo adaptor or timing clock are available from Sony.) Separate recorder and headphone output jacks are also included. Audio output is 900 milliwatts (at 10% harmonic distortion).

A switchable AFC control allows FM locking within approximately ± 100 kHz of the center frequency. An illuminated signal-strength meter doubles as a battery tester. The digital, five-character, LED frequency display works on all frequency ranges, and may be switched off to conserve battery power during portable operation of the receiver. It is quite accurate and our sample was within 1 kHz at

room temperature on all modes. The display is a little dim in bright ambient light, but that is probably intentional for lower current drain during battery operation.

The gating time of the display is a little slow, so it takes a fraction of a second for the display to catch up during tuning. That has a tendency to slow down the dial-searching process, because the receiver doesn't have a calibrated shortwave dial and the user is entirely dependent upon the digital readout.

Frequency stability of the receiver is excellent. Single sideband reception is quite acceptable, although dial setting is touchy. There is no fine tuning, so the initial setting process is rather delicate.

Minor pulling of the oscillator frequency occurs as a result of the normal AGC action when receiving strong CW and SSB signals. That effect is eliminated by reducing the RF gain. There is some hand-capacitance effect apparent on the front panel, but it is minor. The mechanical stability of the receiver is fair and tapping or pressing the cabinet will result in some frequency instability. No dial backlash was detectable.

The main tuning dial is a flywheel. It has a good rugged feel to it, and seems securely mounted. A linear-preselector dial is used for peaking the RF input to the receiver. It is poorly calibrated, so the user must depend upon an increase in background signal to know whether or not he has optimized receiver sensitivity. That may be a problem; if the preselector dial is peaked on the wrong frequency, image interference will be enhanced, and desired frequencies will be attenuated. Proper preselector setting may take a little getting used to. The receiver does not have a noise limiter and that may pose problems.

Antenna provisions include a built-in ferrite bar for AM broadcast (or push terminals for an external wire antenna), and a collapsible whip for FM and shortwave (or push terminals for an external shortwave antenna). There is no external FM antenna input.

One desirable feature is the automatic frequency-offset readout during upper and lower sideband monitoring. When the station is properly tuned in, the suppressed carrier frequency will be displayed. The offset is ± 2 kHz, ideal for SSB reception.

The battery compartment is accessible from the top of the cabinet (six D-type batteries are used). With the lid flipped up, a world time-zone chart and table of international broadcasting frequency allocations is displayed.

Carrying handles are mounted on the sides of the receiver, and slots are provided to accommodate shoulder straps. Adjustable plastic feet allow the receiver to be tilted for comfortable viewing and operation.

The *model ICF-6700W* may be operated from its own internal batteries, from an external 12-volt source (using a Sony battery cord to drop the voltage to 9 volts), or from AC lines (110, 120, 220, or 240 volts AC, switch-selectable). Power consumption (AC) is 7 watts.

The accompanying service manual is rather brief. It does provide basic user tips, but has very little theory; no schematic or block diagram of the receiver is included. No warranty policy was supplied with the unit that we evaluated, but there was a list of regional service centers.

The *model ICF-6700W* lists for \$439.95 and it is available from Sony dealers. From Sony Division, Sony Industries, 9 W. 57th Street, New York, NY 10019. **R-E**



Design of Digital Systems - six volumes

Designing Digital Systems

Two programmed learning courses: hardware and software; theory and application.

ADVANCED COURSE DESIGN OF DIGITAL SYSTEMS

Six large-format volumes — each 11" x 8 1/2"

CONTENTS

The contents of Design of Digital Systems include:

Book 1 Octal, hexadecimal and binary number systems, representation of negative numbers, complementary systems, binary multiplication and division.
Book 2 OR and AND functions, logic gates, NOT, exclusive-OR, NAND, NOR and exclusive-NOR functions, multiple input gates, truth tables, DeMorgan's Laws, canonical forms, logic conventions, Karnaugh mapping, three-state and wired logic.

Book 3 Half adders and full adders, subtractors, serial and parallel adders, processors and arithmetic logic units (ALUs), multiplication and division systems.

Book 4 Flip-flops, shift registers asynchronous counters, ring, Johnson and exclusive-OR feedback counter, random access memories (RAMs), read-only memories (ROMs).

Book 5 Structure of calculators, keyboard encoding, decoding display data, register systems, control unit, program ROM, address decoding, instruction sets, instruction decoding, control program structure.

Book 6 Central processing unit (CPU), memory organization, character representation, program storage, address modes, input/output systems, program interrupts, interrupt priorities programming, assemblers, executive programs, operating systems, and time-sharing.

OUR CUSTOMERS

Design of Digital Systems has been bought by more than half the 50 largest corporations in America, and by Motorola, Intel, DEC National Semiconductor, Fairchild General Instrument, Hewlett-Packard, Heath Co., M.I.T., NASA, Smithsonian Institute, Bell Telephone Labs. And many, many more, as well as corporations and individuals in over 50 countries.

- Order free by phone
- Mastercharge/VISA
- No shipping charges
- Money-back guarantee
- Tax deductible
- Save \$5

BASIC COURSE



Digital Computer Logic & Electronics

CONTENTS

Digital Computer Logic and Electronics is designed for the beginner. No mathematical knowledge other than simple arithmetic is assumed, though you should have an aptitude for logical thought. It consists of 4 volumes — each 11 1/2" x 8 1/2" — and serves as an introduction to the subject of digital electronics.

Contents include: Binary, octal and decimal number systems, conversion between number systems, AND, OR, NOR and NAND gates and inverters, Boolean algebra and truth tables, DeMorgan's Laws, design of logical circuits using NOR gates, R-S and J-K flip-flops, binary counters, shift registers and half-adders.

NO RISK GUARANTEE

There's absolutely no risk to you. If you're not completely satisfied with your courses, simply return them to CLI within 30 days. We'll send you a full refund, plus return postage.

TAX DEDUCTIBLE

In most cases, the full cost of CLI courses can be a tax deductible expense.

PHONE ORDERS - FREE

To order by phone, call (617) 664-2364 with your credit card information. It won't cost you a dime, because we'll deduct the cost of your call from the price of the courses you order.

TO ORDER BY MAIL

You may use the order form below if you wish, but you don't need to. Just send your check or money order (payable to Cambridge Learning, Inc. to the address below. If you don't use the order form, make sure your address is on your check or the envelope, and write "DGS" (Design of Digital Systems), "DCE" (Digital Computer Logic & Electronics), or "both" (both courses) on your check.

Mass. Residents add 5% sales tax. We pay all shipping costs. We also accept company purchase orders.

AIR MAIL

The prices shown include surface mail postage anywhere in the world. Air mail postage costs an extra \$10 for both courses (10 volumes).

DISCOUNTS

Call or write for details of educational and quantity discounts, and for dealer costs.

SAVE \$5

If you order both courses, you save \$5. Order at no obligation today.

To: Cambridge Learning Inc., 1 Judith Drive, North Reading, MA 01864	
Please send me	
sets of Design of Digital Systems	\$19.95 \$ ____
sets of Digital Computer Logic & Electronics	\$14.95
sets of both courses	\$29.90
Enclosed is check/money order (payable to Cambridge Learning Inc.) for total \$ ____	
NAME _____	
ADDRESS _____	
CITY/STATE/ZIP _____	

CAMBRIDGE LEARNING Inc.

1 Judith Drive
North Reading,
MA 01864

Call (617) 664-3657 to
order by phone — free

7 days, 24 hours

CIRCLE 57 ON FREE INFORMATION CARD

Two New Portable Instruments From Simpson

Compare the Specs! Compare the Price!

MODEL 454 3" DUAL TRACE TRIGGERED SWEEP SCOPE

- DC to 15 MHz bandwidth, 5 mV/div. sensitivity, 100 nsec/div. (X5) to .5 sec/div. sweep range
- Differential amplifiers provide stable, clean waveforms
- Voltage calibrated vertical and horizontal input attenuators
- 100 KHz chopping rate for low-speed waveforms
- Alternate mode automatically selected on high sweeps
- 24 nsec rise time, 0.5 V P-P calibrator
- Displays CH A, B, A and B, A + B, A - B, X and Y
- External, CH A or CH B triggering, TV sync
- Compact 4-5/8 x 9-7/8 x 13-1/4", weighs 13 lbs.
- Two low-cap. X1/X10 probes included

MODEL 420 FUNCTION GENERATOR

- Provides sine wave, triangle wave, square wave and DC voltage output
- Fixed TTL output drives up to 10 TTL loads
- Wide frequency coverage of 0.1 Hz to 1 MHz in 7 ranges
- Voltage-controlled generator input for sweep signals
- Continuously variable DC offset control with convenient Off position
- Model 420D provides full day's operation on batteries*, and it can also be re-charged overnight. The instrument can be operated from AC line voltage without the batteries installed. *Batteries not supplied.
- Compact 2.7 x 8.4 x 9" unit matches our DMM styling
- Adjustable tilt-view handle



SEE THEM AT YOUR LOCAL SIMPSON DISTRIBUTOR

MODEL 420 A
for AC line
operation—\$182

MODEL 420 D
for AC line and
battery operation—\$217

SIMPSON ELECTRIC COMPANY
853 Dundee Avenue, Elgin, Illinois 60120
(312) 697-2260 • Cable SIMELCO • Telex 72-2416
IN CANADA: Bach-Simpson, Ltd., London, Ontario
IN ENGLAND: Bach-Simpson (U.K.) Ltd., Wadebridge, Cornwall
IN INDIA: Ruttonsha-Simpson Private, Ltd., Vikhroli, Bombay



ELECTRICAL EQUIPMENT
AND PRODUCTS GROUP

Economy. Accuracy. Portability. Versatility. Whatever's important to you, count on us.



When it comes to frequency counters, we've cut the industry giants down to size. Whatever and wherever you're counting, we offer you far more performance for far less money.

In handheld, start with our portable MAX-50 and MAX-550 counter. At just \$77* and \$165*, they deliver precision six-digit frequency readings to 50 and 550 MHz respectively. They feature easy, instant operation, ideal for audio, VHF and UHF applications and are available with a complete line of accessories and input cables.

For a larger (0.43") display, greater accuracy or TTL compatibility, our portable eight-digit MAX-100 is the natural choice. With a range of 5Hz to 100MHz, it's perfect for audio, video, microprocessor and RF applications, in lab, production line or field. Especially when you consider its ± 4 ppm accuracy, versatility and complete line of accessories at a low \$149* price.

For more demanding challenges in process control, audio applications and low frequency counting, our remarkable Model 5001 Universal Counter-Timer, priced at only \$360*, offers a range of DC through 10MHz. Measuring frequency (selectable gate

times .01, .1, 1.0, 10 sec), frequency ratio, period, multiple period average, time interval, time interval average and event count—on a bright, 0.43" eight-digit LED display. All, with full input signal conditioning on two input channels, and variable display sampling rate.

For the ultimate in high-precision, our Model 6001 is your best value. It covers a range of 5Hz to 650MHz with a unique NBS-traceable 10MHz TCXO with 0.5ppm accuracy. And boasts selectable gate times, switchable low-pass filter, external timebase input, buffered timebase output and a bright 0.43" eight-digit LED display. Priced at just \$425*, its performance is unequalled by counters at twice the price!

When you consider that all our counters are guaranteed to meet or surpass published specifications, isn't it time you had a Global Specialties' counter on your bench?

70 Fulton Terr., New Haven, CT 06509 (203) 624-3103, TWX 710-465-1227
OTHER OFFICES: San Francisco (415) 421-8872, TWX 910-372-7992
Europe: Phone Saffron-Walden 0799-21682, TLX 817477
Canada: Len Finkler Ltd., Downsview, Ontario

**GLOBAL
SPECIALTIES
CORPORATION**

Call toll-free for details
1-800-243-6077
During business hours

*Suggested U.S. resale. Prices, specifications subject to change without notice. © Copyright 1981 Global Specialties Corporation.

CIRCLE 58 ON FREE INFORMATION CARD

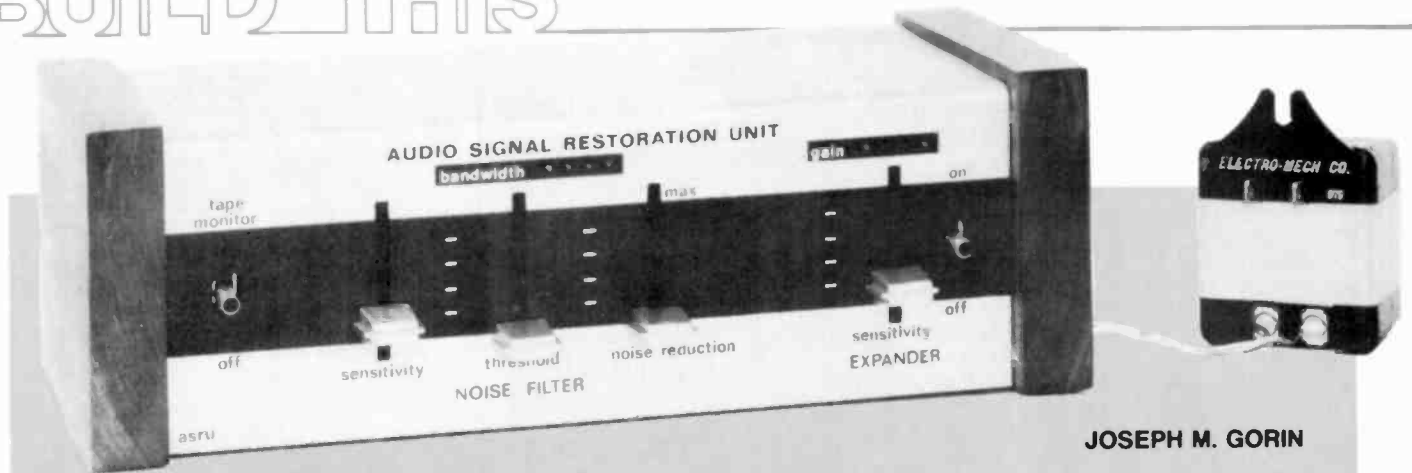

JOSEPH M. GORIN

HI-FI NOISE FILTER/Range Expander

Bring out the best in any recording with this combination noise filter/dynamic range expander.

THE ARTICLE, "NOISE REDUCTION TECHNIQUES," that appeared in the January and February 1981 issues of *Radio-Electronics*, presented block diagrams of commercially available dynamic range expanders and noise filters. That two-part article showed how, by improving the dynamic range of even the best recorded musical signals, expanders and noise filters restore much of the emotional impact that is lost during the recording process. This two-part article will describe the operation and construction of a combination dynamic range expander/noise filter called the ASRU (Audio Signal Restoration Unit).

This month, we will describe the basic operation of the ASRU and provide an in-depth description of how the expander portion of the circuitry works. Next month, we will discuss how the noise-filter circuitry of the ASRU works and provide the construction, installation, and operation details.

The expander—how it works

Like the expanders discussed in the January 1981 issue of *Radio-Electronics*, the expander section of the ASRU makes the low-level signals softer and the loud signals louder, thus providing improved realism and reduced noise. The expansion curve of the circuit is shown in Fig. 1. Note that the total change in gain is about 8.5 dB; the slope is very shallow. It requires over 40 dB of range to change from minimum to maximum gain, for an average expansion rate of about 1.2:1 (the ratio of output-level change to input-level change in dB). The curve shown provides expansion without unnatural side-effects.

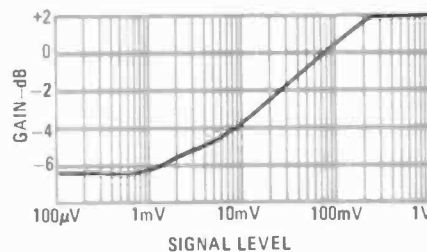

FIG. 1—EXPANSION CURVE of the ASRU shows a shallow slope.

A block diagram of the expander portion of the ASRU is shown in Fig. 2.

The first stage sums the right- and left-channel signals coming from the noise filter so that both channels can be controlled together, preventing the stereo image from changing due to variations in signal level in one channel or the other.

The control-voltage filter takes the output of the summing network and attenuates the high- and low-end frequencies to produce an audio signal that approximates the response of the

human ear (see Fig. 3). That response is shown by the well-known Fletcher-Munson curves (Fig. 4) that depict the sensitivity of the ear for equal perceived loudness at different frequencies. Note that, at most levels, the ear is significantly more sensitive to midrange frequencies than to high- or low-end ones. In fact, due to the resonance of the ear canal, the ear is most sensitive to sounds in the 4-kHz range.

That midrange sensitivity accounts very strongly for our perception of the loudness of a sound and the control-voltage filter is designed to take advantage of that fact.

The attenuation of both ends of the audio spectrum tends to reduce the effects of noises such as turntable rumble and FM multiplex "hiss."

Furthermore, the steep roll-off at low frequencies prevents low-frequency signals from causing rapid and unnatural-sounding gain changes. That is beneficial because sudden changes in gain during the period of a signal can result in harmonic distortion—something we

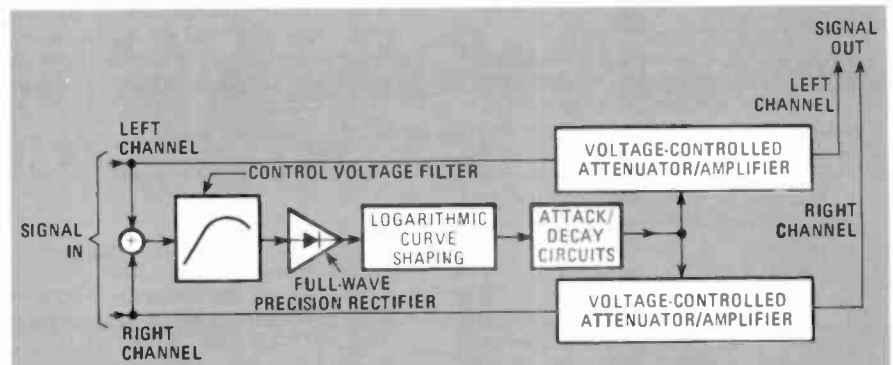

FIG. 2—BLOCK DIAGRAM of the expander portion of the ASRU. The first stage sums both channels to maintain stereo imaging.

R-E TESTS IT

LEN FELDMAN
CONTRIBUTING HI-FI EDITOR

We tested a prototype of the Audio Signal Restoration Unit in our laboratory, using static signals as well as musical program material. As the author suggests, setting up the unit is a bit tricky. To some degree (unless the expander section is turned off altogether), there is some audible interaction between the various front-panel controls on the unit. We found that the best setting for the sensitivity control is such that medium or average loudness-level portions of the program source cause sequential extinguishing of the indicator LED's. The threshold control should be set so that in the absence of any signal, the lowest-level LED flashes only occasionally.

With the expander switch to the on position, optimum setting of the expander-sensitivity control occurs when the right-hand LED flashes only intermittently. Of course, it is possible to use each section (noise reduction, dynamic filter and expander) as required, to suit program material, but we found that with the controls set as described above, we were able to improve reproduction of most program sources without having to make extensive readjustments every time we altered program material or content.

With the expander out of the circuit, and with the unit set for widest bandwidth (no dynamic filtering or noise reduction), overall frequency response of the unit measured flat within ± 0.75 dB from 20 Hz to 20 kHz. The unit has essentially unity gain, but that may be varied by means of the input sensitivity control. With 0.5 volt input, we measured a signal-to-noise ratio of 90 dB, IHF "A"-weighted. With both the expander and the noise filter on, total harmonic distortion for a 1-kHz input signal at the 0.5-volt level measured 0.17%. With the expander turned fully off (the threshold control at its minimum position) but the noise filter on, distortion decreased to less than 0.1% for the same test signal.

A series of composite spectrum analyzer sweep photos for the expander/filter/noise-reduction unit is shown in Fig. 1. In both the upper and lower series of sweeps, the expander is on and degree of expansion is varied, as are the noise reduction and filtering action. Note that greater expansion occurs at the higher signal-level (upper traces) and that regardless of the level at which the tests were made, no expansion is evident at the low-bass frequencies.

Figure 2 shows the expander action alone (without any noise reduction or band-filtering action). With the expander turned off, response is flat from 20 Hz to 20 kHz; but with the

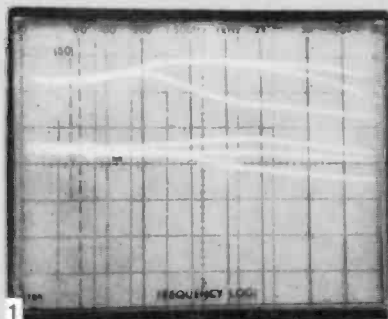

1 COMPOSITE spectrum-analyzer sweep photos for the ASRU.

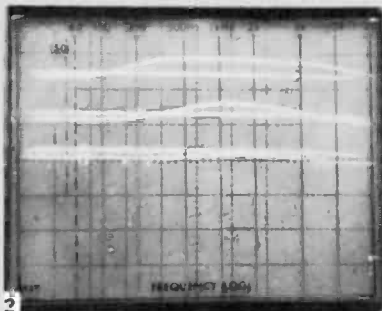

2 SPECTRUM-ANALYZER sweep photos for the expander alone.

expander turned on, the degree of expansion for louder passages, less for moderate passages and, in the lower traces, even a bit of downward expansion for quietest passages.

The Audio Signal Restoration Unit operates with very few side effects once it is properly adjusted. By not allowing expansion to take place at the bass frequencies, the designer has overcome some of the pumping and breathing effects common to other linear expanders. The 1.2:1 ratio of expansion is quite moderate, compared with some other commercially available expanders, but nevertheless is sufficient to add a measure of realism to most program material that has been compressed during recording.

As for the variable-bandwidth filters: if used to excess, they can create some undesirable audible effects; but it is possible to benefit from them without suffering such effects if adjustment of threshold and bandwidth is carefully done while listening to program material. We did not find the indicator LED's to be as helpful in setting up the unit as the author had suggested; but we did find that, with a little practice, we were able to use the "ASRU" with just about any component system that is equipped with an ordinary tape-out/tape-play monitor loop. The tape-monitor loop on the amplifier that is used to connect this unit is duplicated on the unit itself, so owners of cassette or open-reel tape decks need not worry about losing it.

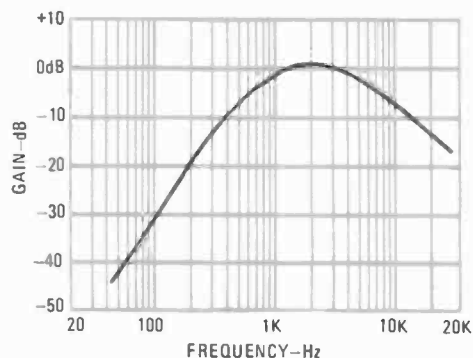

FIG. 3—FREQUENCY RESPONSE of control-voltage filter matches that of ear.

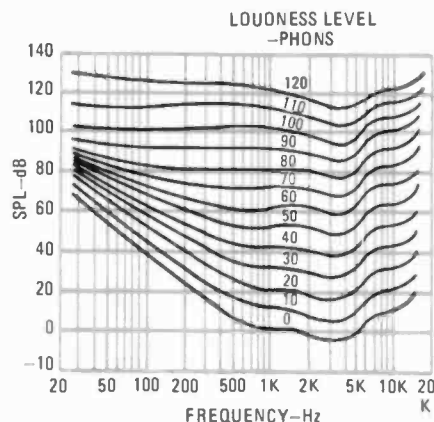

FIG. 4—FLETCHER-MUNSON curves show that the ear is most sensitive to midrange frequencies.

can do without.

The audio from the filter is passed through a precision full-wave rectifier that generates a current used to produce the control signal.

The logarithmic curve-shaping and attack/delay circuits convert that current into a control voltage that is approximately proportional to the logarithm of the current and that section of the expander provides attack and decay times that adjust themselves to the rate of change in signal strength.

Finally, the control voltage is supplied to the voltage-controlled attenuator/amplifier where it is used to modify the qualities of the original audio signal.

The ASRU's expander does not expand signals in the low-bass region as much as it does in others. There are two reasons for that.

First, consider Fig. 5-a, showing a warp or rumble (very-low-frequency) waveform along with a toneburst. As can be seen in Fig. 5-b, at the moment the toneburst is added, the level of the warp signal will increase because the expander will increase the gain and a "thump" will be evident, even though the warp noise alone was inaudible. Figure 5-c shows what happens when the ASRU is used—the "thump" doesn't occur because the action at very low frequencies is minimal.

Second, although the ear is relatively insensitive to very low frequencies—refer to the Fletcher-Munson curves in

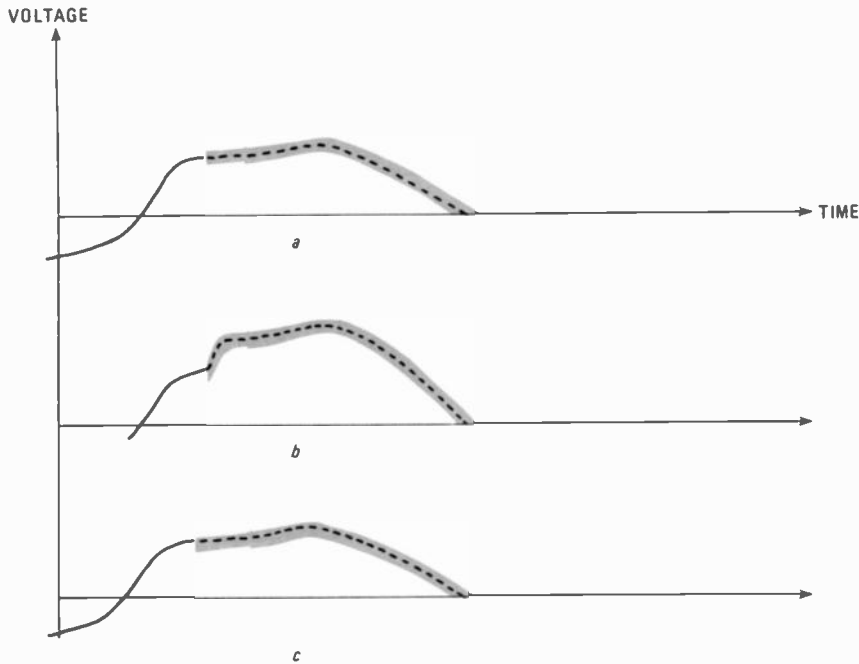

FIG. 5—WARP OR RUMBLE (thin line) with tone burst (thick line). The ASRU (c) eliminates thumps by not expanding such a signal.

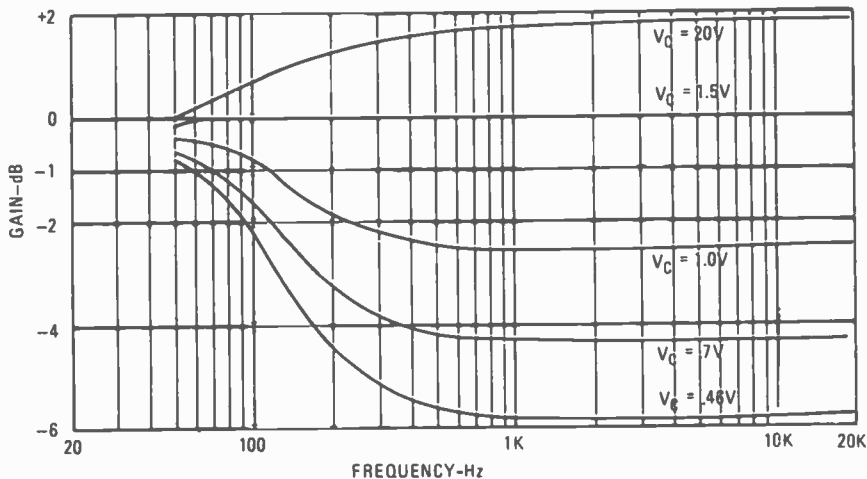

FIG. 6—THE ASRU's gain vs. frequency response curves at varying control-voltages. Note that the low-bass region is not expanded.

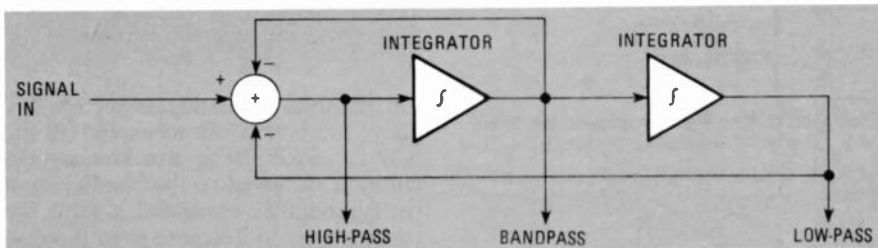

FIG. 7—THE TRIPLE-OUTPUT voltage-controlled filter has two integrators for each channel.

Fig. 4—once their level is above the threshold of hearing, a 2-dB increase appears as great as a 5-dB increase in the midrange area.

For both of those reasons, as well as to keep distortion to a minimum, the ASRU's expander does not expand the low-bass as much as it does the midrange. Figure 6 shows the ASRU's gain

vs. frequency response at varying control-voltage levels. Note how well that matches the changes in gain sensitivity shown in Fig. 4.

The ASRU's shallow expansion-slope, midrange-emphasized control-signal and minimized low-bass expansion explain why it is so clean-sounding, while allowing 8.5 dB of

effective expansion.

The noise filter—how it works

The heart of the noise-reduction system is a triple-output, voltage-controlled filter, the block diagram of which is shown in Fig. 7. It is a state-variable filter, which means that certain of its characteristics can be modified while others are maintained.

The integrators process the signal for use by later stages of the noise-reduction system (see Fig. 8). For sinewaves, the output is reduced by a factor of two (6 dB) for every octave increase in input frequency. By varying the gain or time-constant of those integrators, or the amount of feedback around them, the corner frequency (the frequency at which the amount of attenuation reaches 3 dB) can be changed without changing the shape of the filter.

Refer to Fig. 8 as we discuss the ASRU noise-reduction system.

If no signal is present, the control voltage sets the corner frequency of the triple-output filter to 1.2 kHz. Figure 9 shows the frequency response of each output of the triple-output filter with the corner frequency set at 1.2 kHz. The overall output of the noise filter is taken from the low-pass output via a buffer. Thus, with no input signal present, any noise will be greatly attenuated.

If a 5-kHz tone is suddenly applied to the input, it will appear unattenuated at the high-pass output and will be greatly attenuated at the low-pass and bandpass outputs. The AC-DC converter connected to the high-pass output will provide a strong signal that will rapidly pass through the attack/delay element and cause the control voltage to increase. As the control voltage increases, the corner frequency of the filter will also increase until it exceeds 5 kHz.

Soon there will be a stronger signal in the bandpass section than in the high-pass section. That is converted to DC and will be fed back and reduce the control voltage. In the case of a steady tone, that action will serve as a feedback loop that forces the bandwidth of the filter to "catch" the input frequency, allowing it to go through the low-pass filter to the output, while the noise above that frequency is filtered out.

Music, of course, is more than just simple tones. The ASRU noise filter will track the highest significant frequency of a complex signal. During a transient—a short, but intense, increase in high-frequency energy—the corner frequency will overshoot slightly. That is desirable, since transients mask noise very well.

If the signal is extremely strong,

PARTS LIST

All resistors 1/4 watt, 5% unless otherwise specified

R1, R9, R10, R101, R109, R110, R221, R521—100,000 ohms
 R2-R5, R102-R105, R211, R213, R214, R305, R306, R309, R310, R405, R406, R409, R410, R519, R533, R535—10,000 ohms
 R6, R106, R230, R507, R508, R520, R530—20,000 ohms
 R7, R12, R107, R112—200 ohms
 R8, R14, R15, R108, R114, R115, R205, R501, R502, R529—2200 ohms
 R11, R111, R218—36,000 ohms
 R13, R113, R201, R208, R209, R212, R215, R220, R222, R229, R513, R522, R528—4700 ohms
 R16, R116, R202, R203, R210, R503—10,000 ohms, 30%, slide potentiometer, linear taper
 R17, R117, R506, R537—3900 ohms
 R204—2700 ohms
 R206, R207—1.5 megohms
 R216—68,000 ohms
 R217, R509—3300 ohms
 R219—820 ohms
 R224, R307, R308, R312, R407, R408, R412, R514, R531, R532, R534—1000 ohms
 R226, R516—270 ohms
 R228—150 ohms
 R231, R302, R303, R402, R403—270,000 ohms
 R232, R304, R404—1200 ohms
 R223, R510—6800 ohms

R225, R233, R313, R413, R504—560 ohms
 R227, R527—120 ohms
 R301, R401, R526, R536—1500 ohms
 R311, R411, R525—12,000 ohms
 R505—470,000 ohms
 R511—910,000 ohms
 R512, R515, R517—22,000 ohms
 R518, R523—47,000 ohms
 R524—47 ohms
 R601—1.5 ohms

Capacitors

C1, C3, C5, C101, C103, C105, C201, C202, C204, C506—0.01 μF , 5% Mylar
 C2, C6, C7, C102, C106, C107, C503, C504—3.3 μF , 35 volts, electrolytic
 C4, C104, C205, C212-C214—0.022 μF , 10%, Mylar
 C203—0.001 μF , 10%, Mylar
 C206, C208—0.0033 μF , 10%, Mylar
 C207, C209—680 pF ceramic disc
 C210, C211, C301, C401—10 μF , 25 volts, electrolytic
 C215, C505—1 μF , 35 volts, electrolytic
 C216, C302, C307, C402, C407, C502—0.1 μF , 5%, Mylar
 C303, C304, C403, C404, C501—100 pF, ceramic disc
 C305, C306, C405, C406—22 μF , 16 volts, electrolytic
 C601, C602—1000 μF , 25 volts, electrolytic
 C603-C607—0.1 μF , ceramic disc

Semiconductors

D201-D204, D206-D210, D501-D513, D515-D517—1N4148
 D205—3.3-volt Zener
 D514—4.7-volt Zener
 D601-D604—1N4001
 LED201-LED204, LED501, LED502—mini-LED (TL209 or equivalent)
 Q201-Q203, Q501, Q502—2N3904
 Q204-Q206—2N4250
 IC1, IC2, IC4, IC7, IC9, IC10, IC11—RC4136 quad op-amp
 IC3, IC6—4049 CMOS hex inverter
 IC5, IC8—739 dual audio preamplifier
 IC12, IC13—78L12A 12-volt positive voltage regulator
 L201, L202—6.8 mH coil
 T1—13.5 VAC, 350 mA, wall-plug transformer (Dormeyer PS14204 or equivalent)
 J1-J4, J101-J104—RCA-type phono jacks
 S1, S2—DPDT toggle or slide switch

Miscellaneous: 12-conductor ribbon cable, IC sockets, chassis and end panels, solder, wire, hardware, etc.

The following are available from Symmetric Sound Systems, 912 Knobcone Place, Loveland, CO 80537: Complete kit (ASRU) \$110.00; PC boards (ASRU-PC), \$18.00. Write for information on assembled units. No other parts or different combinations are available. End panels are unfinished. All prices include UPS shipping within U.S. Colorado residents add 3% tax.

EXPANDER-ONLY KIT

For those requiring only the expander portion of the ASRU, a kit, somewhat different from the one described here, is available from Symmetric Sound Systems. That kit, the EX-1, is priced at \$60.00. A bare PC board, the SSS7, is also available for \$11.00. See parts list for ordering information. A schematic, parts list, and a diagram for laying out your own EX-1 PC board can be obtained from the above company if a self-addressed, legal-size, stamped envelope (28 cents) is sent along with the request.

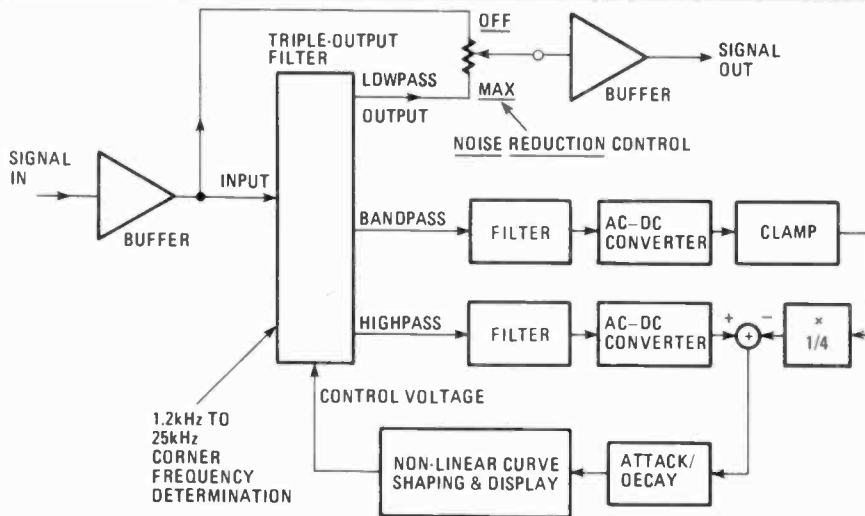

FIG. 8—BLOCK DIAGRAM of the ASRU's noise reduction system. If no signal is present, the corner frequency of the filter is set to 1.2 kHz.

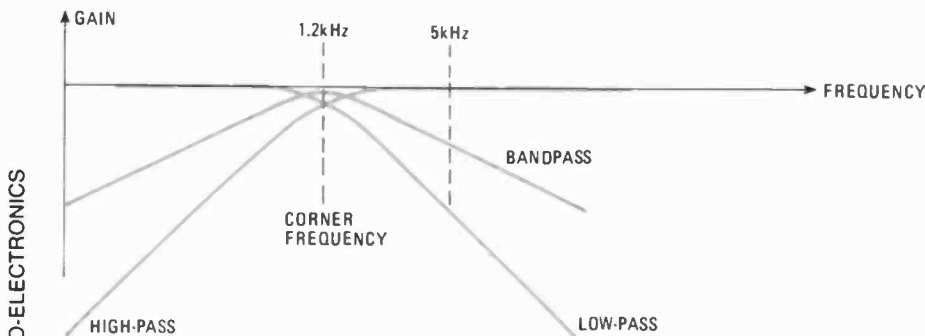

FIG. 9—THE TRIPLE-OUTPUT filter has low-pass, high-pass, and bandpass outputs. The scale here is log-log.

the clamp in the bandpass section will allow the bandwidth to extend all the way to 25 kHz. The attack/decay circuitry is designed so the bandwidth of the filter can be expanded rapidly, but takes longer to decrease than it did to increase. Because of the large amount of feedback used to control the bandwidth, that nonlinear response does not affect the steady-state (constant-level) response, but becomes very important in the case of transients.

As pointed out in the "Noise Reduction Techniques" article in the February 1981 *Radio-Electronics*, one of the advantages of a filter/expander combination is that each section can be adjusted to keep side-effects to a

continued on page 110

NEW DEVELOPMENTS IN



With us since radio's early days, jamming stands as the biggest obstacle in the way of fair use of the shortwave broadcast-bands. Here's a look at the current situation.

STANLEY LEINWOLL

WHAT WILL PROBABLY TURN OUT TO BE the most important shortwave broadcasting conference ever held has been scheduled by the Administrative Council of the International Telecommunication Union.

Acting on the recommendation of WARC-79, (World Administrative Radio Conference—1979), the Council has set January 1983 for a shortwave broadcasting WARC that is to establish technical standards and procedures related to planning the use of the shortwave broadcast spectrum. A second session of the BC-WARC is scheduled for October 1984. At that session an attempt will be made to plan the efficient and equitable use of the bands allocated to shortwave broadcasting.

The Conference has its work cut out for it, with a number of major obstacles to overcome before any serious effort at planning can succeed. One of the problems overhanging the Conference like a dark and ominous cloud is jamming. Indeed, many of the world's most competent shortwave broadcasting experts feel that rational planning of high-frequency broadcasting is impossible as long as jamming continues.

To understand fully why jamming

and technically feasible high-frequency broadcast planning are judged by many observers to be incompatible, it is necessary to provide some information about jamming, and to describe attempts by jammed broadcasters to overcome it.

Jamming is the deliberate transmission of raucous, irritating noise and other interference on a frequency in order to hamper or utterly destroy the programs of another broadcaster operating on the same frequency.

Jamming doesn't only interfere with the target broadcast; it also degrades the transmissions of broadcasters operating on adjacent frequencies because of its broadband characteristics. Consequently, for each frequency jammed, three are adversely affected, as a rule: the one being jammed, plus the frequency on either side of that one.

During the height of the Cold War, virtually every major Western broadcaster transmitting to the Communist world was jammed. In recent years, however, there has been a decrease in jamming; but it is still a serious blight on the shortwave spectrum. At the present time the USSR and some of its satellite countries are responsible for

most of the jamming being observed. Soviet jamming is currently being directed principally toward the broadcasts of Radio Free Europe, Radio Liberty, The Voice of Israel, and the People's Republic of China. In addition, the People's Republic of China jams some Soviet programs beamed to China.

To accomplish their task, the USSR and its satellites have developed a highly complicated and very sophisticated jamming network, consisting of several thousand jammers at hundreds of different locations throughout eastern Europe. It is estimated that it takes about five thousand technicians and administrators to operate the jamming system at a cost far exceeding that of the broadcasts being jammed. Furthermore, the original cost of setting up such a jamming system probably exceeded a quarter of a billion dollars.

There are two types of jammers: local, and sky-wave. Local jammers operate primarily in and around large population centers, usually those with a population of a quarter of a million or more persons. They are generally located so that they overlook the region to be jammed. Local jamming, which is often incorrectly referred to as

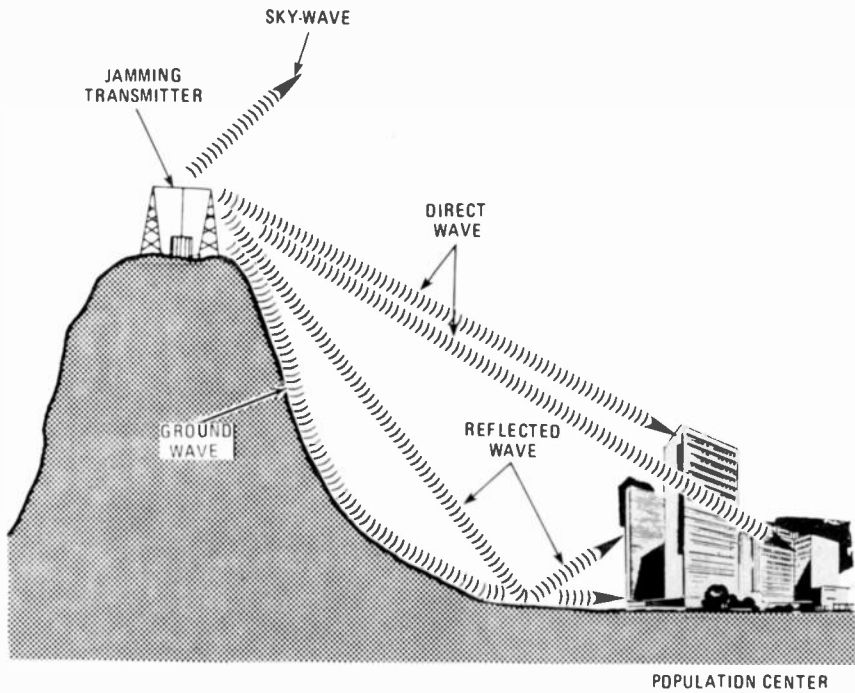

FIG. 1—LOCAL JAMMING consists primarily of a direct wave and a reflected wave. The ground wave is fairly unimportant in this type of jamming.

ground-wave jamming, consists principally of a direct wave and a reflected wave, as shown in Fig. 1. It is evident, from Fig. 1, that ground-wave jamming plays a relatively minor role in the effectiveness of that type of jammer.

The effective range of local jammers depends on the height of the jamming antenna. Although the average range is about 20 to 30 kilometers from the antenna tower, it is obvious that the higher the antenna, the greater the distance the jamming signal will travel. Most local jamming antennas are placed on tall buildings, church steeples, or on hills or mountains overlooking the target.

Depending on the size of the area they must cover, and the number of people in it, local jamming stations have between fifteen and fifty jamming transmitters. Those are of relatively low power, which ranges from 5 kW to 20 kW each.

Sky-wave jammers are used to propagate the jamming signals great distances via the ionosphere. They can cover considerably larger areas than the local jammers, and their principal mission is to blanket areas lying in the rural and suburban parts of a target area that lie beyond the range of the local jammers. That is shown in Fig. 2.

Sky-wave jamming transmitters are of much higher power than local jammers, being of the order of 50 kW to 100 kW each. The antenna systems used are more sophisticated (rhombics and log-periodic antennas, compared with low-gain broadband dipoles employed with local jamming transmitters.)

Jamming transmitters are modulated in two ways: *white noise* is produced electronically and covers most of the

tried to overcome its effects in a number of ways. Some of those techniques have failed while others have been highly successful. In order to assess fully the impact of jamming on planning efforts at WARC-83/84, the major anti-jamming techniques will be discussed.

Those anti-jamming techniques include using high-power transmitters of up to 1000 kW, and high-gain, highly directional curtain antennas, by means of which effective radiated powers of more than 100 megawatts can be achieved. That *brute force* technique produces very high signal-levels, on the order of five to ten millivolts-per-meter, delivered to the target areas. Signals of that order of magnitude put considerable strain on the jammers and increase areas in which desired signal strengths are above the jammer noise. That enables listeners to receive the programs.

One of the best methods of countering the effects of jamming is generally known as *saturation-* or *barrage-* broadcasting, in which as many transmitters as possible—each on a different frequency—are massed simultaneously to carry a particular program. Satur-

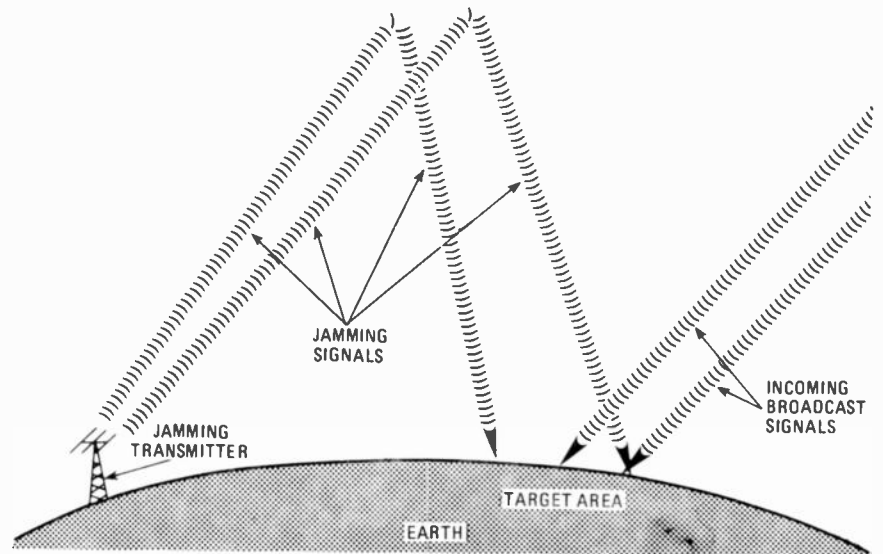

FIG. 2—SKY-WAVE JAMMING uses the ionosphere to propagate jamming signals over great distances.

audio spectrum. It is referred to as noise jamming and is very effective.

In *Mayak* jamming, distorted program material is transmitted in lieu of white noise. The word *mayak* means "beacon," which is the name of one of the Soviet domestic home-service programs. It is not unusual to find three or four simultaneous *Mayak* transmissions, each slightly out of phase with the others, each distorted, operating on one frequency. They, too, are highly effective.

Over the years, broadcasters whose transmissions were being jammed have

tion-programming has been quite successful in putting pressure on the jamming system to the point where some of the frequencies being used to transmit a program are either thinly covered by the jammers, or not covered at all.

It is obvious that even in population centers with their own local jamming networks, if more than fifteen transmitters are used to carry a program and the jammer complex has fewer than fifteen jammers, some frequencies will be clear of local jamming.

In the past, when broadcasts of BBC, VOA, Deutsche Welle, etc.

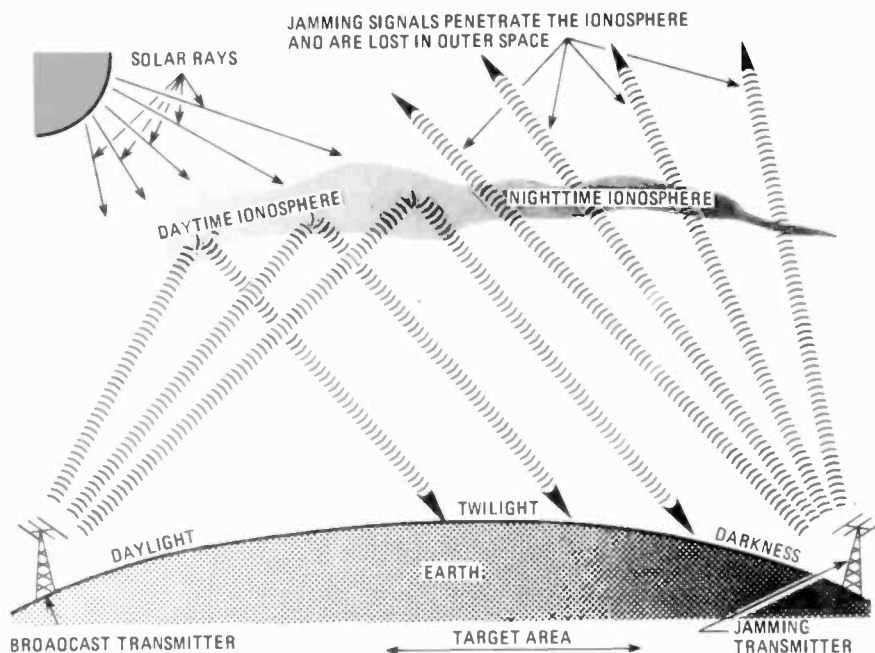

FIG. 3—DURING THE TWILIGHT PERIOD only local jamming is effective because key-wave jamming signals are not reflected by the ionosphere.

were jammed, efforts were made to coordinate programming among them so that the maximum number of frequencies were being used to carry jammed transmissions. That method, when used, was highly successful.

Perhaps the most effective method of all for overcoming jamming is the

use of a basic shortwave radio propagation technique usually referred to as *twilight immunity*. During the daylight hours the ionosphere is able to propagate higher frequencies than at night. That is so because radiation from the sun produces ions and free electrons in the ionosphere. The range

of frequencies the ionosphere can reflect is proportional to the number of those particles. At night, radiation from the sun is cut off and free electrons and ions begin to re-combine, resulting in a less dense ionosphere, which is capable of supporting only the lower frequencies.

It follows, therefore, that a transmitter to the west of a target area will enjoy a period of several hours in the late afternoon (twilight) when the path between the transmitter and the target is in daylight, but the target area itself is in darkness. That is shown in Fig. 3. During that twilight period as many high-frequency transmissions as possible are scheduled. Examination of Fig. 3 shows that jammers operating via the sky-wave mode are relatively ineffective because attempts to use the higher frequencies are generally fruitless, since those frequencies are not reflected by the ionosphere. During twilight immunity-periods only local jammers are effective. Since there are literally thousands of cities and towns that do not have local jammers, a high degree of effectiveness can be achieved by using the saturation technique.

It is clear at this point that attempts by WARC-83/84 to develop technical standards or to plan the rational use of the spectrum will be severely hampered by continued jamming.

Preliminary planning for the broadcasting WARC has included discus-

A HISTORY OF JAMMING

The Germans are generally credited by radio historians as being the first to use jamming techniques. As early as 1915, they transmitted random characters to disrupt a radioteletype circuit between France and Russia, which were allies during World War I.

In the 1920's, before radio broadcasting was regulated, some broadcasters deliberately transmitted on frequencies being used by competing broadcasters in an effort to drown out their programs. Although some of the interference caused during those early days was accidental, there is no doubt that much of it was intentional.

The first case of political jamming occurred in the mid-1930's before the German-Austrian *anschluss*. The government of Chancellor Dolfuss of Austria jammed some Nazi-German broadcasts to Austria that were critical of that country. The Nazis themselves were quick to recognize the effectiveness of jamming to keep out unfavorable comment, and the Spanish, French, Russians, Japanese, and Italians soon followed suit.

Jamming increased in intensity and effectiveness during World War II, being used as a military weapon, both to keep out unwanted broadcasts and to disrupt military circuits. The Germans jammed

broadcasts of the BBC extensively, and the escape to the open seas of the German warships *Scharnhorst*, *Gneisenau*, and *Prinz Eugen*, under the nose of British artillery, was possible because the Germans effectively jammed British radar installations overlooking the English Channel.

With the advent of the Cold War after the conclusion of World War II in 1945, jamming flourished to an extent that had not been dreamed of before. The Russians jammed programs in the Russian language that were beamed to the USSR from Franco Spain, and the Spanish, in turn, jammed Spanish-language broadcasts emanating from the Soviet Union.

In early 1948, however, a jamming effort was begun by the Russians that dwarfed anything that had been attempted before. In February of that year a dozen or so Russian transmitters were used to jam the Russian-language programs of the Voice of America. The Russian-language broadcasts of the BBC were jammed shortly thereafter, and by 1950, over 450 such jamming transmitters were in operation.

Although we have no way of knowing for certain, it appears that the decision to launch a massive jamming campaign was twopronged: first, it was a method of

keeping control of the information monopoly within the USSR, where total censorship of news from external sources was the policy. Second, jamming could be used militarily, as had been demonstrated in World War II, and by operating large numbers of jammers the military jamming-machine was kept well oiled.

By the end of 1951, most of the other countries in the Communist orbit had commenced jamming operations of their own against Western broadcasts; and in the beginning of 1952, over 1,000 jamming transmitters were in continual operation.

By 1956, between 2,500 and 3,000 jamming transmitters were in operation against most major Western broadcasters, with particular attention to Radio Free Europe and Radio Liberty, which had begun broadcasting in 1951 and 1953 respectively.

On November 24, 1956 the first break in the electronic curtain occurred when jamming directed against RFE Polish-language broadcasts abruptly ended after a series of riots in the Polish city of Poznan, and the coming to power of a new Polish leader, Ladislaw Gomulka.

The Polish press had been complaining vociferously about jam-

ming, and there is considerable evidence to indicate that the people of Poland resented it. That is supported by the fact that during the first hours of the Poznan riots the local jamming station in that city was destroyed.

The hiatus in jamming against RFE Polish-language programs lasted 14 years. In 1970, following food riots in the north of Poland, jamming against RFE Polish programs was hastily resumed. Apparently caught off-guard, Polish authorities ordered that transmitters being used by Radio Warsaw in its external shortwave broadcasting service be redeployed and operated as jamming transmitters. Until jamming transmitters became available, Radio Warsaw international service was sharply curtailed.

Additional major breaks in the jamming pattern began in June 1963, when jamming directed against BBC and VOA broadcasting in the languages of the USSR, including Russian, were discontinued shortly after the conclusion of an atomic test-ban treaty. That marked the first time in 15 years that those programs were un-jammed, and were another indica-

tion that a thaw in the Cold War had occurred. In July 1963, Romania stopped jamming all Western broadcasts; in February 1964, Hungary followed suit.

Two months later, Czechoslovakia stopped most jamming of BBC and Voice of America programs, but continued jamming RFE.

However, jamming can be turned on and off at the discretion of the Communist bloc; therefore, the situation proved to be temporary. On August 21, 1973, 200,000 Warsaw Pact troops invaded Czechoslovakia and within hours massive jamming of VOA, BBC and Deutsche Welle was resumed. It continued until 1973, when it was again discontinued.

The jamming transmitters no longer being used against BBC and VOA broadcasts were not taken out of service. Relations between the USSR and the People's Republic of China had worsened in 1973, and many of the jamming transmitters were rescheduled against Peking transmissions in Russia to the Soviet Union.

In addition, the Soviets had launched a major jamming effort against the Voice of Israel, whose broadcasts to the Soviet Union

called for a more liberal emigration policy toward Soviet Jews—a position not greeted with enthusiasm by the Soviet Politburo.

At the present time, all Radio Liberty programs beamed to the Soviet Union are jammed. In addition, Radio Free Europe programs in Bulgarian, Czechoslovak, and Polish are jammed. Radio Free Europe programs in Hungarian and Romanian are not. Deutsche Welle programs in Bulgarian are jammed and Voice of Israel broadcasts to the USSR in Russian, Hebrew, and Yiddish are jammed, as are People's Republic of China transmissions to the USSR in the Russian language.

On August 20, 1980, the Russians resumed jamming of the Voice of America, BBC, and Deutsche Welle. The resumption of jamming, after seven years, was generally thought to be due to growing labor unrest in Poland, and the Russians' fear that it could spread to the Soviet Union. BBC and Deutsche Welle programs in Russian were affected. Voice of America broadcasts in Russian, Ukrainian, Uzbek, Armenian, Latvian, Lithuanian, and Estonian were hit by noise jammers and *Mayak* jammers.

sions of power limitations, limiting the number of frequencies per transmission, protection ratios, and the gradual introduction of single sideband to the broadcasting service.

Evidently, rational planning in the face of jamming is a paradox. In addition, jamming against broadcasters such as the BBC and Voice of America can resume at any time, since the USSR has demonstrated in the past that it can turn jamming on and off like a faucet.

The United States is eager for the BC-WARC to succeed because this country firmly believes in the rational, equitable use of the high-frequency

broadcast spectrum. It is a certainty, therefore, that U.S. planning for WARC-83/84 will emphasize the technical standards and planning necessary to a successful conference. However, it would be naive to assume that the ugly specter of jamming does not loom over the Conference, or that it will not be a major impediment to its successful conclusion.

At WARC-79 the United States expressed its grave concern about jamming by entering a formal reservation when it signed the Final Acts of the Conference. This reservation states:

"The administration of the United States of America, calling attention

to the fact that some of its broadcasting in the high-frequency bands allocated to the broadcasting service is subject to willful harmful interference by administrations that are signatory to these Final Acts, and that such interference is incompatible with the rational and equitable use of these bands, declares that for as long as this interference exists, it reserves the right with respect to such interference to take necessary and appropriate actions to protect its broadcasting interests. In so doing, however, it intends to respect the rights, to the extent practicable, of administrations operating in accordance with these Final Acts." R-E

What's News

New software systems to spur office automation

Lack of integration is possibly the greatest weakness in the present rapid automation of office systems. Too often many of the benefits of partial automation are not realized. For example, a word processor may be obtained, but remain isolated from existing automated facilities, such as machine dictation, telephone, and facsimile.

By the mid-1980's, reports Frost & Sullivan, Inc., international business research reporters, that piecemeal approach to business automation will be replaced by general systems offering a broad and integrated range of facilities: text editing, report formatting, teleconferencing, mail calendar, on-line data access, statistical

analysis, dictation, telephone services, document and information retrieval, dictionary, and other services.

Hardware components for such systems, says F & S, are already available. Software is the primary bottleneck. Three fundamental challenges must be faced by software for future automated office systems: adaptability to changing user needs, suitability to extensive customization, and conformability to existing office practices (rather than vice versa).

New fusion-reactor concept

Hope for an earlier solution of the problem of nuclear fusion is being held out by scientists of the University of Wisconsin. Their new conceptual nuclear reactor design—which is yet to be tried out experi-

mentally—is called WITAMIR (Wisconsin Tandem Mirror). They believe that WITAMIR has many advantages over TOKAMAK, the Russian design up to now considered the most promising.

The new concept calls for a magnetic confinement vessel as long as a football field and roughly ten yards in diameter. Magnets would be positioned along the length of the chamber, and several extra coils placed at each end to reduce plasma leakage.

It is those extra coils, which create electrostatic and magnetic potentials that hold the plasma in the long central tube, that give the new concept an advantage over earlier ideas. "It is the first tandem mirror design that could produce electricity cheaper than a Takomak, and be easier to build and maintain," according to Gerald Kuchinski, leader of the University of Wisconsin's fusion-research program.

ELECTRONICS IN YOUR NEXT CAR

MARTIN BRADLEY WEINSTEIN

THIS IS THE FINAL INSTALLMENT IN OUR series on electronics and automobiles. This month we'll take a look at how electronics are helping carmakers design-in self-diagnostics that aid the service and repair operations every car eventually requires.

An interesting concept in auto service is being developed at the General Motors Service Development Center at Warren, MI. When you buy a new car, the selling dealer installs a small, inexpensive radio transmitter that sends out a signal with your personal code.

When you reach the dealership and drive up to the service garage, a receiver reads the code. The garage door is opened and the code is passed to a computer where your service records are stored.

By the time your car is in the door, the service technician knows who you are and has a complete service record of the car, including a flag on any recalls. The computer terminal even prints out your repair order, saving another aggravating delay.

That personalized code, by the way, would be your vehicle's VIN (Vehicle Identification Number). New Federal requirements are increasing it from 13 digits to 17. There may be an added benefit in transmitting that code: it would make police recovery of stolen vehicles much easier. Unfortunately, it would also make computerized ticketing for such offenses as speeding a technological breeze.

Check engine

A new telltale signal (idiot light) is showing up on car dashboards. It reads CHECK ENGINE, or something very close to it (Fig. 1). James G. Vorhes, General Motors Vice President in charge of Consumer Relations and Service, explains why it's there:

"The Computer Command Control system (see Fig. 2—editor) has been on most of the GM gasoline-engine automobiles in California since the start of the 1980 model year and will be on nearly all cars sold in this country in the 1981 model year. It's the largest new use of computer controls in the history of the industry and we will be prepared for it.

"One of the most exciting features of the system is its ability to automatically diagnose the cause of any malfunction. We have designed-in an extremely high degree of reliability. Like all systems, it can malfunction. But, unlike other systems, it will help diagnose itself.

Electronic self-diagnostics are taking the guesswork out of auto repair, and that should make you, and your mechanic, a lot happier.

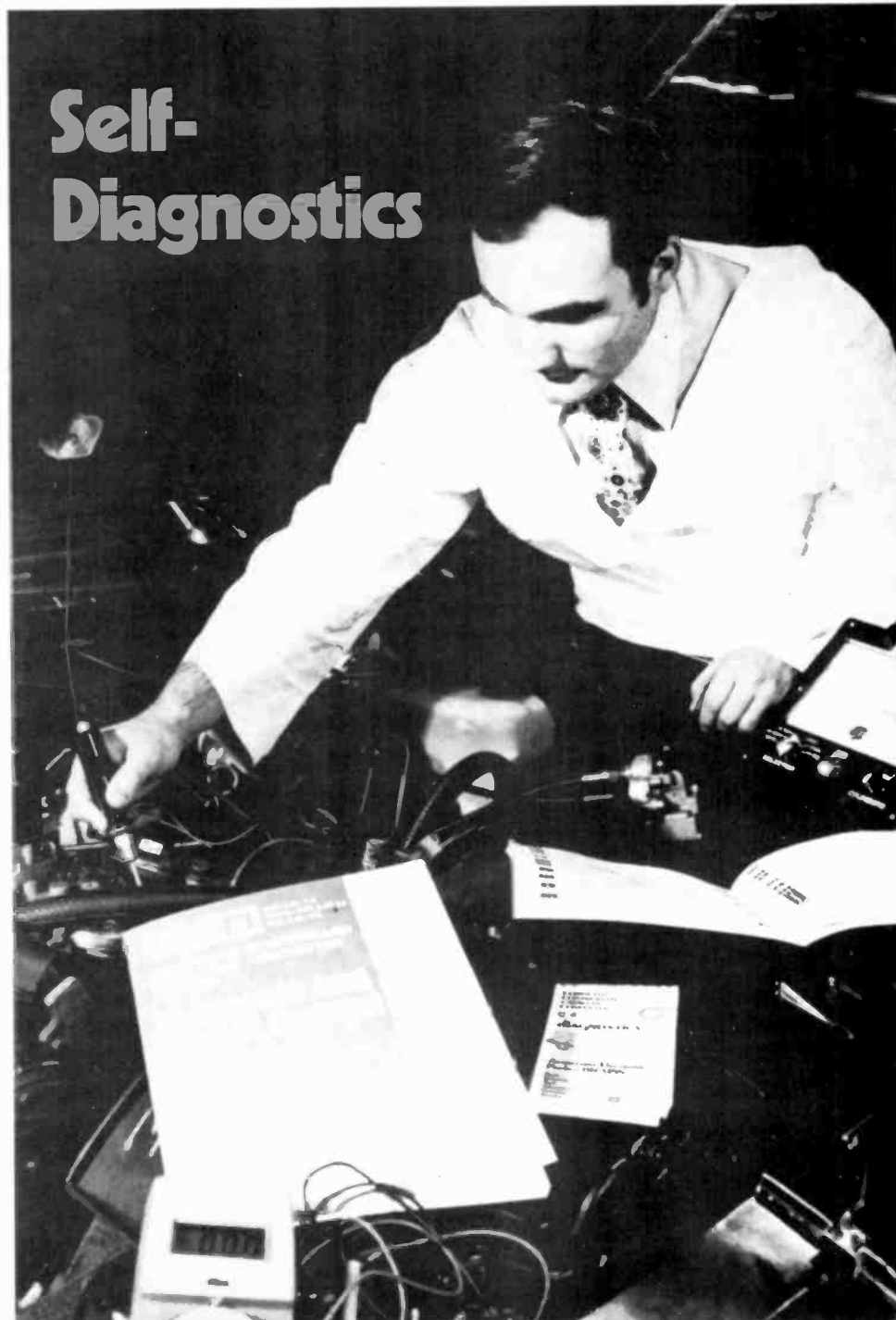

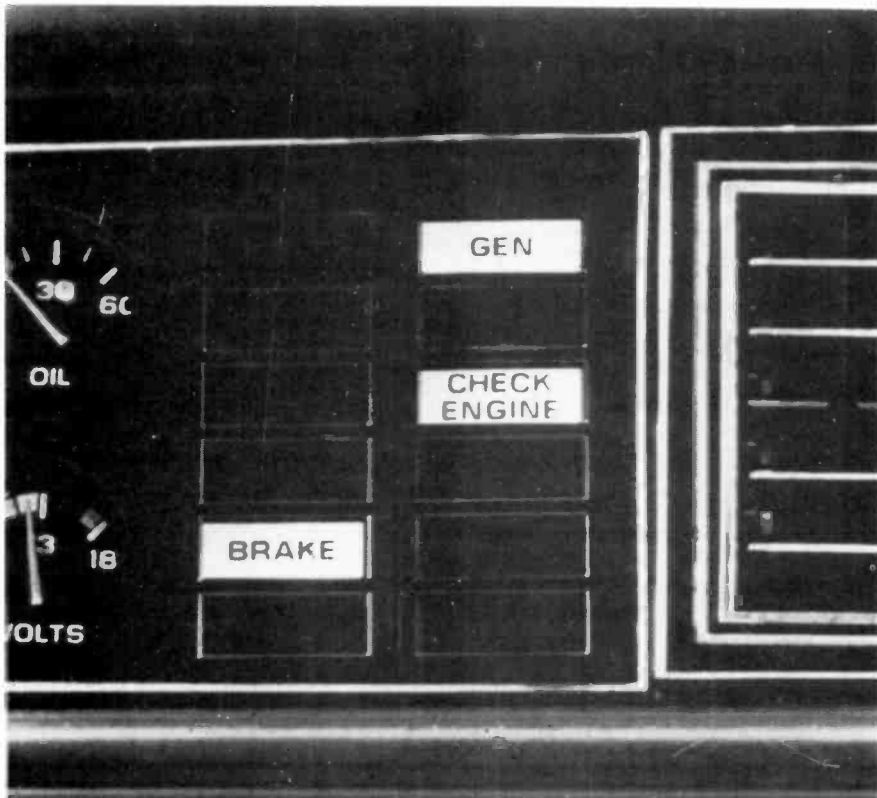

FIG. 1—A NEW TELLTALE SIGNAL informs motorists of a malfunction. It's part of GM's new Computer Command Control system.

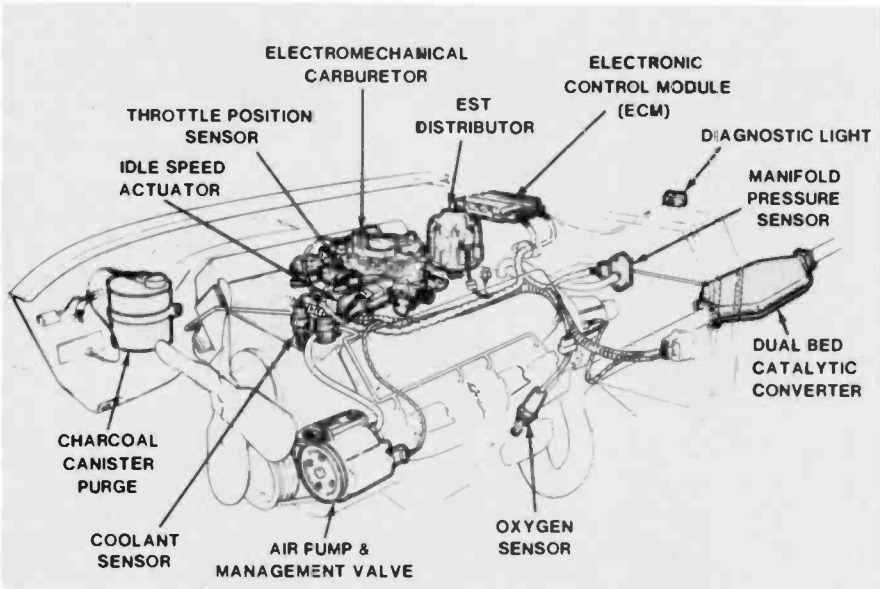

FIG. 2—KEY FEATURES of GM's Computer Command Control system. It is offered on nearly all of their 1981 cars.

"Mechanics will not have to become electronic engineers to work on the system. In fact, there will be no need for expensive computer testers. All a mechanic will need is an ordinary dwell meter, a test light, some jumper wires, a vacuum source, a tachometer, and a digital voltmeter. Most shops already have this equipment. Any qualified technician who can work on current engines will be able to fix one equipped with the system."

The CHECK ENGINE light is there to aid both the motorist and the mechanic.

When it lights, indicating a malfunction, the motorist will still be able to drive the car in for service. Once there, the *Computer Command Control* system tells the technician which system may have the problem by flashing a code. Then the technician goes through a simple factory-provided diagnostic routine to determine whether the component, a wire, or a connection is at the root of the problem.

Self-test at Ford

"Self-test in its various forms is

going to reduce diagnostics to the very simple goal of determining which part is bad. We, the industry, are headed that way."

That's the forecast of Walter Doelt, the fellow at Ford in charge of this area. **Radio-Electronics** was privileged to enjoy an exclusive interview with Mr. Doelt dealing with a wide range of subjects relating to the role of electronics in designing a car for serviceability. Ford's commitment to microprocessors is very strong.

"They provide the best economic approach to providing the widest degree of freedom in control strategy, and to very flexible control systems. The key is mandated performance requirements versus drivability."

Mandated performance requirements include emission and fuel economy goals, both in terms of government regulations and corporate marketing and design objectives.

Mr. Doelt continued:

"When implemented with a microprocessor, you can freeze the basic design early in the design cycle, then work the calibration in software later."

Ford has been working to reduce the component count in their various on-board systems (engine control, dashboard, etc). Systems that used seven or eight IC's in 1978 were down to four in 1979, two in 1980, and should be down to one in the near future. Since the majority of failure modes are in the interconnections of IC's, single-IC microprocessors are very popular.

The 6800 series (6809, etc.) is used for Ford's advanced *Electronic Message Center* dashboard. The 8048/8049 series is used for engine control where continuous timing is not required. The company also uses a number of custom circuits in integrated control systems (ignition, carburetion, fuel metering, and carburetor feedback) in their top-of-the-line models. Motorola, Intel, Toshiba, and Texas Instruments are among Ford's suppliers.

For example, 1980 models sold in California included a new feedback carburetor design using an Intel 8048; earlier designs used a number of discrete analog IC's and devices. By incorporating the 8048, Ford was able to include a limited self-test feature.

Lead times

One important point about new developments is that it takes time to incorporate them. For example, 1981 model year cars were introduced in October of 1980. The pilot runs of those cars began in July 1980. The control units to go into those pilot production vehicles had to be built by late March 1980. So the microprocessors had to start as silicon slices way back in December of 1979, with design requirements frozen even earlier. But each

year brings more advancements.

STAR performance

One of the most intriguing aspects of the Ford self-test system is the way the under-hood microprocessor "talks" to the service technician: it uses a digital code of 1/2-second pulses, 1/2-second apart, with two seconds between digits.

That pulse timing was decided on to let any service technician read the code with just a VOM. But there's a nice alternative called STAR (Self-Test Automatic Readout) shown in Fig. 3. That handheld, calculator-sized gadget translates the pulses and displays the result on a two-digit LED readout. The self-test sequence can be initiated from a front-panel pushbutton. A readout of "11," for example, translates to "test complete, everything normal."

The STAR costs about \$70. They're being built for Ford by the Hickok Electrical Instrument Company. Hickok also sells an inexpensive DMM to Ford for their service technicians.

One feature of the Ford self-test system is that it's designed so all systems test the same way, no matter which model is being examined. There are also a number of universally-applicable manual test operations.

For example, a testing unit will read the voltages at various sensors through a selector switch. The switch setting, selected sensor and anticipated voltages are the same from vehicle to vehicle. Another example is that any vehicle's self-test sequence will, at a given point, call for an EGR (Exhaust Gas Recirculator) flow of 30%, then check the position sensor on the throttle body. At other points, hydrocarbon and carbon monoxide exhaust tests will be performed, both at idle and, with the engine unloaded, at some higher RPM.

Testing on demand in that way is well within the capabilities of both engine and electronic technology. Just beyond is the goal of full-time testing, where a car monitors its own performance periodically during normal driving.

Noise and interference

The biggest problem EMI used to cause in a car was noisy radio reception. But today, with multiple micro-computer systems and miles of harness wire on board, anti-EMI measures are a high priority in design.

Communication links between modules are designed for very low impedance. Modules are housed in metal enclosures, with both the top and bottom grounded. Measurements from analog sensors are performed ratiometrically to make them less sensitive to power-supply variations. Sensor wires are very carefully routed, especially around ignition areas. Diode and capacitor buffering is used on all I/O lines. Roll-off filters block higher and



FIG. 3—SELF-TEST AUTOMATIC READOUT, or STAR, translates a diagnostic pulse string into an easily read fault code.

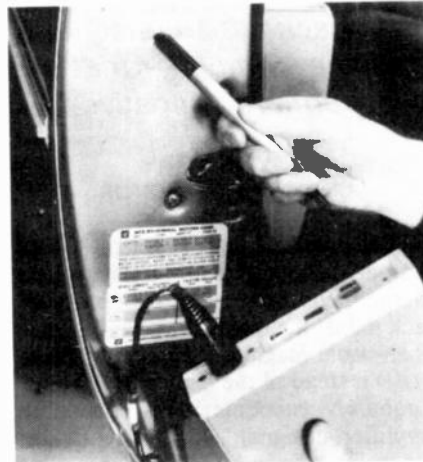

FIG. 4—THE VIN (Vehicle Identification Number) can be written as a bar code that may be read by a portable data terminal.

lower frequency signals. And the buzzer has become obsolete.

Buzzers created tremendous noise problems, generating harmonic-filled spikes with hundreds of volts in them. Now they're being replaced with electronic tone and chime generators that, surprisingly, cost about the same.

Ford and others are taking a serious look at fiber optics as a possible answer to many noise problems but, in Walter Doelt's opinion, they won't be incorporated until there is some significant improvement in the cost of material, the cost of terminations, and the performance of optoelectronic links.

Another area being explored is the digitization of position sensors. That permits both noise reduction and the reduction of wiring through time-division multiplexing.

In the near future, non-volatile RAM will be used more and more, especially since it permits alterable test criteria as improvements are developed. Also, the lower cost of memory is going to permit designers an enormous increase in program lineage, with 10K chunks of ROM replacing each 1K available today.

One important question is what happens in the fail-fail mode? What if the

computer crashes so badly that it can't even yell for help? The answer is that all systems are designed so that in any event of computer failure, the car keeps going. Those "baseline conditions" may keep the engine running, but there's no way the driver can fail to notice that there is a problem. The car bucks, surges, gurgles, and wheezes like a sick hippo. And yes, that "reduced drivability" is also designed-in.

GM developing the TOUCH

The theory is that explaining a problem is the biggest part of solving it, or, as expressed in a recent GM press release, "... once a symptom is accurately described, there is one set of most probable causes." Either way, the idea has led to a system being developed by GM called TOUCH (Touch-Operated Universal Communications Helper).

TOUCH is a computer system that asks a customer questions about his problem, and uses each answer to formulate either a new question or a "hunch" as to what the problem might be. And it can even be used when the repair facility is closed.

The customer could, for example, drop his car off at night. TOUCH might look very much like a 24-hour banking terminal. If the car is making a noise, TOUCH might ask where it's coming from and display a picture or diagram of the car to help the customer describe the location. It could ask what the noise sounds like, prompting the customer with either descriptive words, recorded sounds, or a sound-effects generator. Then it might ask if the noise happens all the time, or just when climbing a hill, coasting to a stop, turning a corner, or whatever.

Then, if the customer has described a squealing sound that comes from the front of the car during turns for example, TOUCH would print out a repair order telling the technician to check the power-steering pump belt for slack. You put your keys in an envelope and TOUCH takes them, gives you a receipt, and tell you when your car should be ready.

More future goodies

That 17-digit VIN we mentioned earlier appears in more places this year, and it will appear on still more in the future. GM is translating it into a bar code so it can be read by wands and portable data terminals (Fig. 4). In addition to helping identify cars being recalled for various reasons, the service history of an individual car, and even the identification of its owner, the VIN is important in recovering stolen cars. As it appears on more and more major components—such as engine blocks, frames, and glass—it makes it easier for law enforcement operations to locate

continued on page 88

ANTI-NEGATIVE FEEDBACK FOR HI-FI AMPLIFIERS

High levels of negative feedback can actually add to dynamic distortion. Here's a look at a totally new amplifier that uses power MOSFET's and eliminates conventional negative-feedback circuits.

LEN FELDMAN
CONTRIBUTING EDITOR

WHEN NEGATIVE FEEDBACK WAS FIRST used in an audio amplifier, back in the early days of vacuum tubes, it seemed as though it would be the panacea for all audio-distortion problems. Add 20-dB of negative feedback to any old amplifier having a harmonic distortion level of 10% and presto, the distortion drops to 1.0%. Add another 20 dB to that, for a total of 40 dB, and distortion is reduced by another whole order of magnitude, to 0.1%. Of course, with each addition you lose 20 dB of gain or so, but that's easily made up by adding extra stages of amplification that are not all that expensive.

The age of solid-state electronics made the application of high levels of feedback even more attractive to design engineers. After all, the transistor is not the most linear of amplifying devices (and is therefore better suited to switching applications than it is to linear audio-amplification service), and feedback could be used to cover a multitude of sins. Unfortunately, as engineers found out much later, it could also introduce new sonic aberrations to audio amplifiers—defects that were not apparent from static single-tone bench measurements but were definitely audible when the amplifiers were called upon to amplify real-world music signals. By now, all of us have read about transient intermodulation distortion, and other forms of dynamic distortion, that are aggravated through the use of inordinately high amounts of negative feedback.

It is not surprising, therefore, that many manufacturers of audio equipment, both here and abroad, have been addressing the problems associated with negative feedback and finding

ways to eliminate those problems. Some companies, such as Lux Audio and Onkyo have come up with double feedback loops, the first of which is of lower-than-usual magnitude (typically, 30 to 40 dB instead of the higher 60 to 80 dB commonly encountered in solid-state amplifier designs), while the second, generally referred to as a servo-DC feedback loop, addresses the problem of feedback in the infrasonic region. That helps to stabilize DC-amplifier designs, reduce DC drift, and act as a sub-

sonic filter all at once.

Still other companies, such as Sony Corporation, have taken a different approach. At the recently held Tokyo Audio Fair, they introduced a new high-quality monaural power amplifier, called the *model TA-N-900*, pictured in Fig. 1. That amplifier uses an entirely new circuit that eliminates the conventional negative feedback circuit used in other amplifiers. One of the developments that makes it possible is the new 2SK173 power MOSFET recently developed by Sony. Figure 2 shows a highly magnified view of the chip used in the construction of that power MOSFET while in Fig. 3 we see a cross-sectional diagram.

Similar to a standard FET, a power MOSFET has a high input impedance and low storage time. It is characterized as having a wide area of safe operation and high reliability. The double diffusion type power MOSFET developed by Sony also has a very high gain and a high maximum rated voltage of 210 volts. As can be seen in Fig. 3, the drain of the MOSFET is at the same potential as the case so that there is no increase in capacitance between the drain and heat sink (when used as a source follower) and no degradation in frequency response.

A simplified partial schematic diagram of the amplifier circuitry is shown in Fig. 4. The first predriver stage consists of a differential-input double-cascode bootstrap circuit, using junction FET's and bipolar transistors. It has been designed so that high-frequency distortion caused by non-linearity of the FET's is reduced to minimum limits and also to achieve thermal stability through the use of a cascode-connected

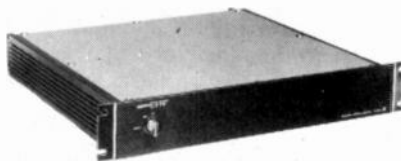

FIG. 1—MONAURAL power amplifier, the *model TA-N-900* from Sony does not use negative feedback.

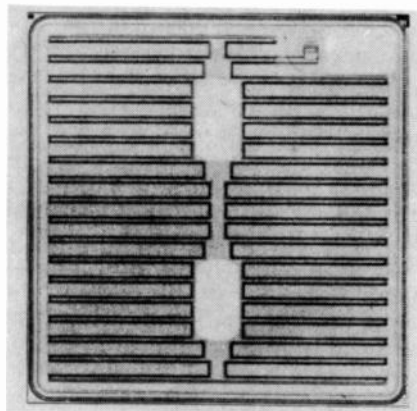

FIG. 2—HIGHLY-MAGNIFIED view of the new MOSFET chip.

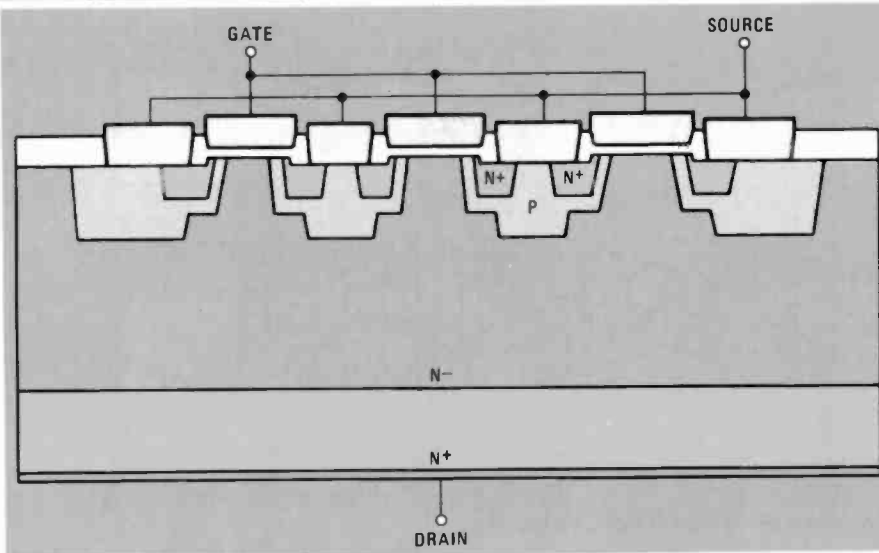

FIG. 3—CROSS-SECTIONAL diagram of the 2SK173 power MOSFET recently developed by Sony.

current-mirror load and finally to improve power-supply ripple-rejection characteristics.

The second stage consists of a cascode bootstrap inversion-amplifier using a bipolar transistor. It provides good linearity and, like the first stage, features high power-supply ripple-rejection characteristics. The final stage of the prepower stages is a complementary

emitter follower single-ended push-pull output circuit. All stages up to that point have light loads and are isolated from the speaker load and the power stage, so that there can be virtually no problems caused by reactive output loads. As a result, negative feedback can be used around those stages without affecting power-stage performance.

The power-output stage itself is a

source follower single-ended push-pull output circuit using four of the new power MOSFET's connected in parallel. The driver stage has a distortion-reduction circuit that compensates for the nonlinear characteristics of the output devices. The power MOSFET's operate in the Class A mode.

As can be seen in Fig. 4, there is no negative-feedback loop from that power stage to the pre-power/driver stages. Despite the lack of an overall loop-feedback circuit, the amplifier is able to achieve remarkably low distortion figures: less than 0.05% THD at 200 watts output into 8-ohm loads and less than 0.05% IM distortion for the same output. The 200 watts rating applies to all load impedances from 8 ohms down to 2 ohms. In the direct-coupled mode, frequency response remains flat from DC to 100 kHz, -3 dB. Damping factor, normally one of the first parameters to suffer in the absence of high amounts of loop feedback, remains a high 50 (referred to 8 ohms) and slew rate is an impressive 150 volts-per-microsecond.

Pulse-locked power supply

Since a power amplifier is called upon to transfer high levels of currents into a

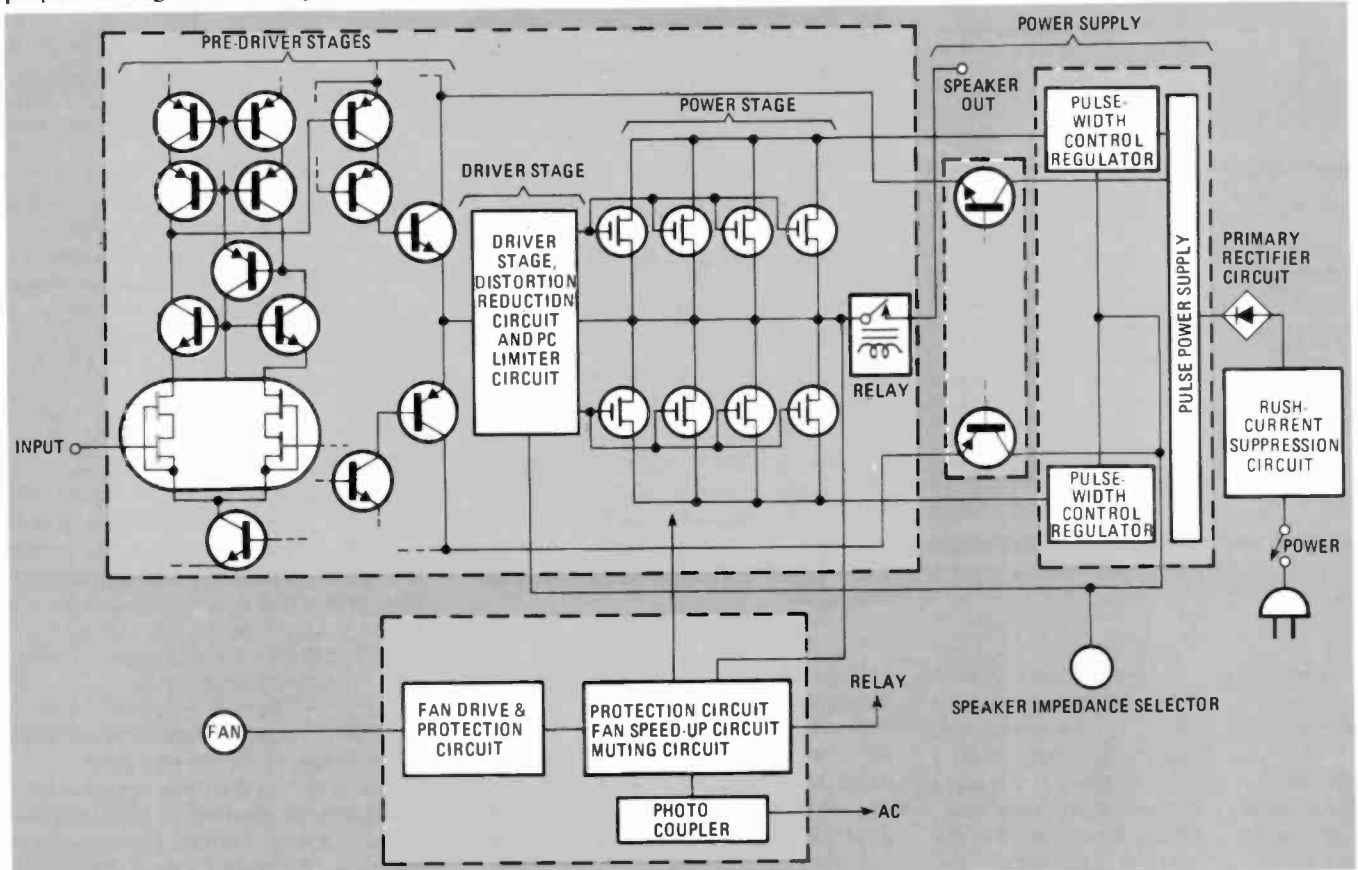

FIG. 4—THERE is no negative-feedback loop in the model TA-N900, as can be seen in this simplified schematic of the amplifier circuitry.

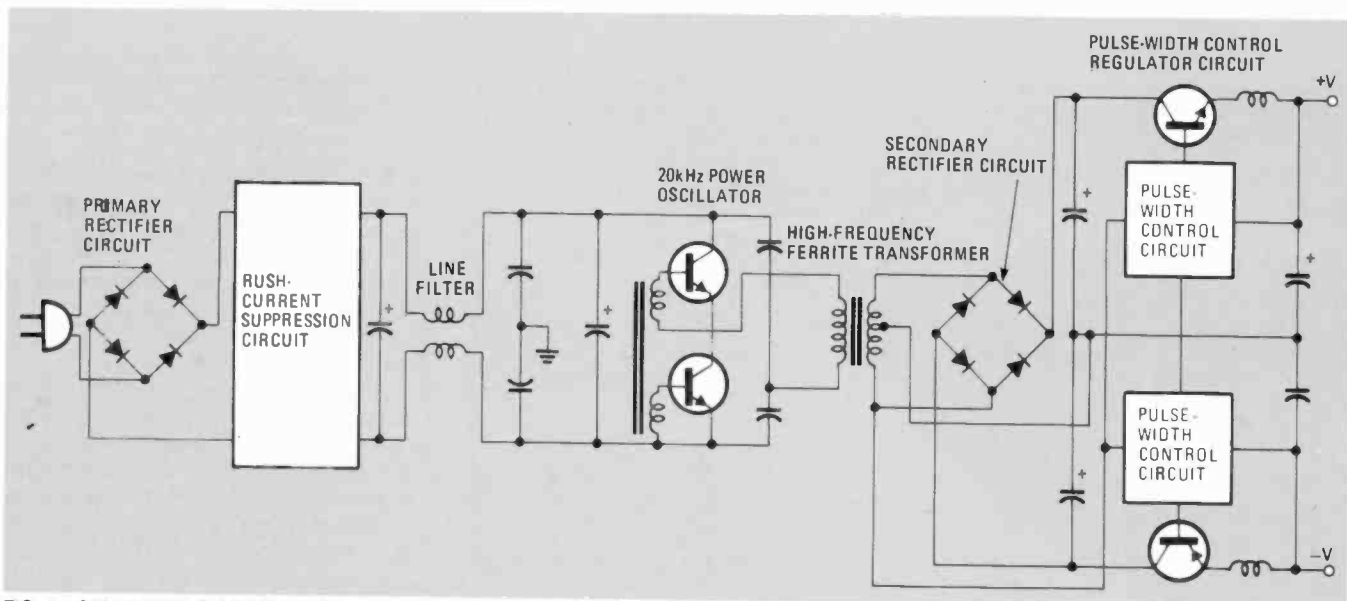

FIG. 5—SCHEMATIC DIAGRAM of the power supply. A diode bridge is used to rectify the incoming line voltage.

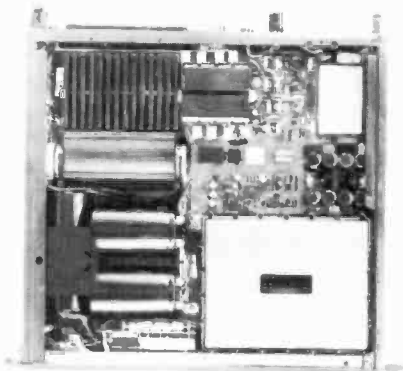

FIG. 6—INTERNAL VIEW OF THE model TAN900 amplifier.

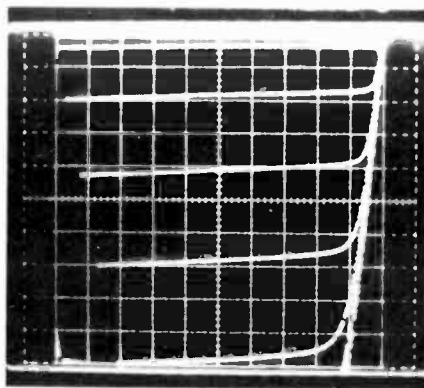

FIG. 8—TRANSFER CURVE for the 2SJ54 (P-channel) power MOSFET.

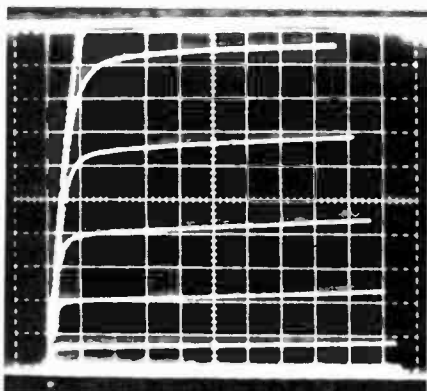

FIG. 7—TRANSFER CURVE for the 2SK173 power MOSFET.

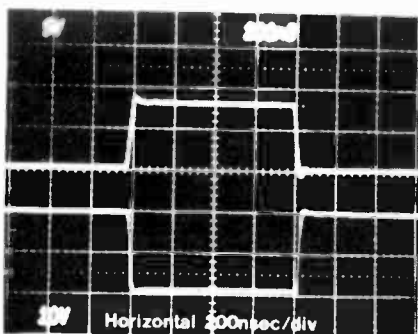

FIG. 9—INPUT and output waveforms for a 625-kHz signal.

speaker load, the power supply of such an amplifier plays an important role in the overall design. In the model TAN900, Sony chose to use a pulse-locked power supply that offers extremely good regulation, low output impedance, low hum and noise levels, as well as other advantages. A diagram of the power-supply circuit is shown in Fig. 5. The circuit rectifies incoming line

voltage directly, by means of bridge-connected diodes. The section identified as the 20-kHz power oscillator generates a 20-kHz squarewave signal using four high-power switching transistors in an oscillator circuit that supplies the needed power to the converter transformer.

Because that transformer handles a high frequency signal of 20 kHz, it can

use a ferrite core that has low high-frequency losses. Compared with transformers that can handle conventional power supplies (operating at 50 or 60 Hz), this transformer can be constructed with fewer windings that, in turn, results in an extremely low internal impedance. The secondary rectifying circuit shown in Fig. 5 rectifies the 20-kHz output, using high-speed diodes, to convert the voltage into positive and negative DC. Finally, the pulse-width control circuits shown in Fig. 5 sense the positive and negative DC potentials that are applied to the final stage of the power amplifier and control the pulse width of the 20-kHz signal to maintain the output voltage at a constant level for both positive and negative supplies. The filter capacitors are 22,000 μ F units that are incorporated at the output of the power-supply circuitry to insure that the amplifier can handle high-level transient signals without difficulty.

An independent series-type constant-voltage supply is provided for low-level stages (including the driver stage), completely separate from the pulse-locked power supply so that there can be no interference from the power-output stage to the low signal-level stages.

Referring once more to Fig. 4, there is a protection circuit that senses and monitors the DC voltage of the power amplifier, the temperature of the power MOSFET's, and the load impedance. That protection circuit will cut off the output should either the connected load (speaker) or the power amplifier approach operational limits.

The amplifier is equipped with a speaker-impedance switch that allows the speaker to be driven in the most efficient and stable manner possible, regardless of whether it has an impedance of 8.4, or 2 ohms. The impedance switch simply controls the voltages produced by the pulse-locked power supply

continued on page 87

HOW TO

Identify

Unmarked IC's

Every IC has an unique signature. Here's a look at how to read it.

KENNETH H. RIDDLE

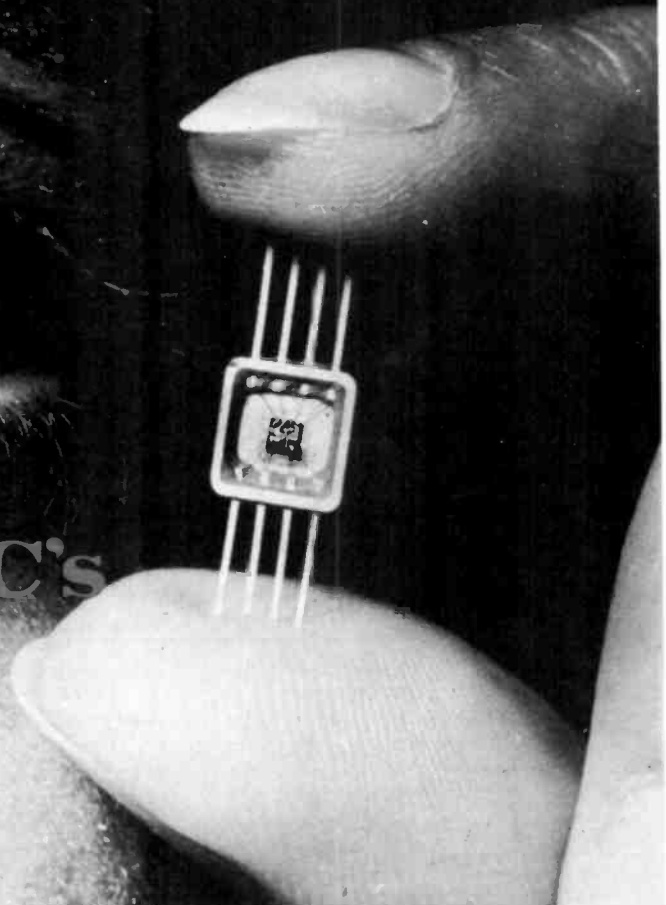

TEMPTED TO BUY THAT GRAB BAG LOADED with unidentified IC's? Go ahead—those IC's have a signature that will tell you what pins are probably outputs. From there on it's easy—a few voltage measurements, some current measurements, and you should know what you've got. You should even be able to determine if the device is defective. So grab your trusty ohmmeter and get ready to record your first IC signature.

An IC signature is an array of resistance readings derived from the IC and displayed in an organized way. The $\times 100$ range of an ohmmeter is used. (Be sure you know which ohmmeter lead is positive; some ohmmeters change polarity when switching from volts to ohms.)

The signature is obtained by recording the resistances between all terminal pairs of the IC. Use the form shown in Fig. 1. Connect the ohmmeter's positive lead to pin 1, and move the negative lead sequentially through the remaining pins. Record the measured resistances across the top row of the signature chart. A resistance measurement of over several

hundred thousand ohms does not convey very much useful information, so there is no need to record it—put a dash through the box instead.

Move the positive lead to pin 2 and fill in the second row of the chart by moving the negative lead to pin 1, 3, 4, ..., etc. Continue in the same manner until every row of the signature chart is completed. If this is done properly, you should have as many rows in your chart as there are pins on the IC.

The steps that follow show how to use the completed signature to identify your IC.

Step 1: Examine the chart and circle each terminal-to-terminal resistor—you can tell which ones those are because each purely resistive connection between two terminals reads approximately the same in both directions.

For example: In Fig. 2 there are 12 circled boxes, 6 above the diagonal and 6 below. The circled number in Row 5, Column 3 has its mirror image on the opposite side of the diagonal in Row 3, Column 5. The resistance is 7K ohms in both directions and it is therefore a ter-

minial-to-terminal resistance. That is noted to the right of the chart (Fig. 2), along with the other resistance values and identified as step one. The remaining terminal pairs show grossly different resistance measurements in opposite directions, indicating the presence of one or possibly several semiconductor junctions in the path.

It is highly unlikely that a TTL IC, or for that matter any linear IC, would contain 6 identically valued terminal-to-terminal resistances. (Maybe the IC is RTL or DTL?)

Step 2: Disregard all circled boxes and scan the signature to locate the row with the lowest resistance readings—Row 4 in this case. That uniquely identifies pin 4 as the substrate connection of the IC or, in other words, the most negative terminal of the IC.

Scan across Row 4 for the lowest uncircled reading—in this case it is the 750-ohms reading in Column 11. That tells us that pin 11 is the V_{CC} terminal of the IC. Record those numbers in the place provided at the right of the chart—Step 2, Fig. 2.

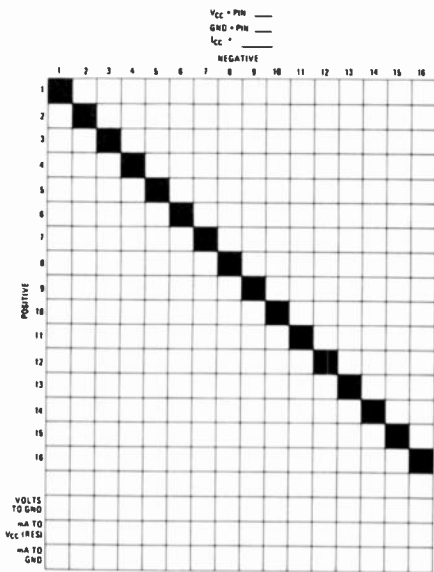

FIG. 1—THIS FORM is used to record all resistances between terminal pairs of the unknown IC.

The other uncircled low-resistance readings in the ground row usually identify transistor collectors; i.e., output terminals. That is an important clue to be used later.

Step 3: Before proceeding to the identification of other terminals we measure I_{CC} . Apply a low voltage, say 3.6 volts (RTL supply voltage), to the IC through a 100 mA milliammeter. The positive voltage goes to the V_{CC} terminal (in this case pin 11) and the return connects to the IC substrate (in this case pin 4).

To protect the IC and the equipment, place a 120-ohm resistor in series with the current meter. A dead short in the IC will only draw 30 milliamps. Remove the resistor and re-connect the current meter only when it is clearly safe to do so. Most standard TTL gates draw between 2 to 4 mA. Thus, a quad NAND or NOR would draw 12 to 15 mA. In the case at hand, there was no current flow at all.

DTL or TTL would have shown some current—so again the evidence suggests RTL.

A third clue: If there is a normal current flow, raise the voltage to 5 volts, measure, and record I_{CC} in the space provided at the right of the signature chart.

Step 4: Remove the milliammeter and apply the selected voltage directly between the V_{CC} and ground pins. Measure volts-to-ground, mA-to- V_{CC} (through a 330-ohm resistor) and mA-to-ground for each pin of the IC. Record the measured values in the rows at the bottom of the signature chart.

The "volts-to-ground" row generally identifies all inputs and outputs. Voltages from about 2.2 volts up to the applied voltage indicate outputs in the high state (for a logic chip). Thus, pins 3, 5, 8, and 14 are likely candidates for output terminals. (You will recall in step 2 that

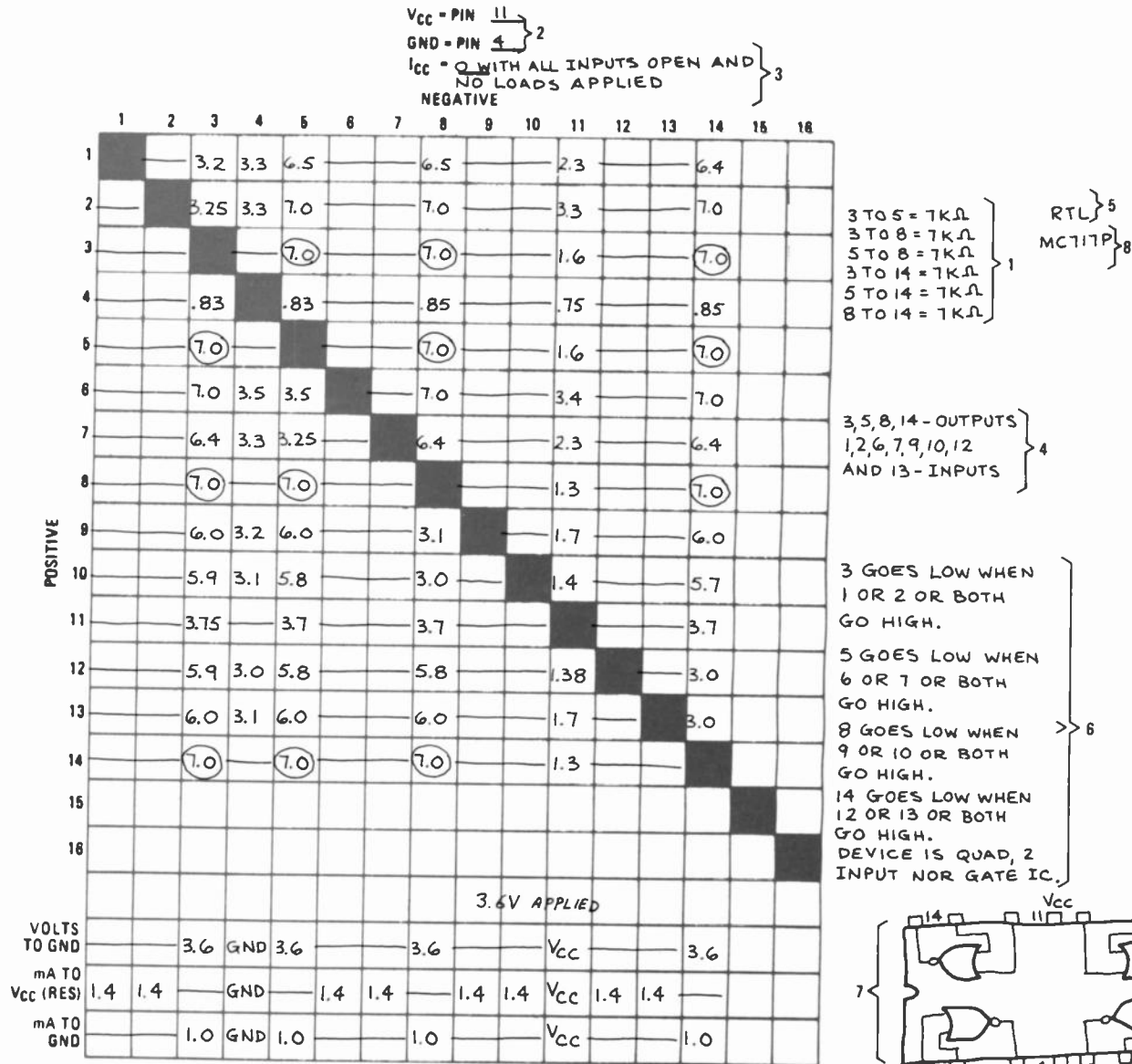

FIG. 2—COMPLETED SIGNATURE CHART for the unknown IC. It turned out to be a quad, 2-input NOR gate.

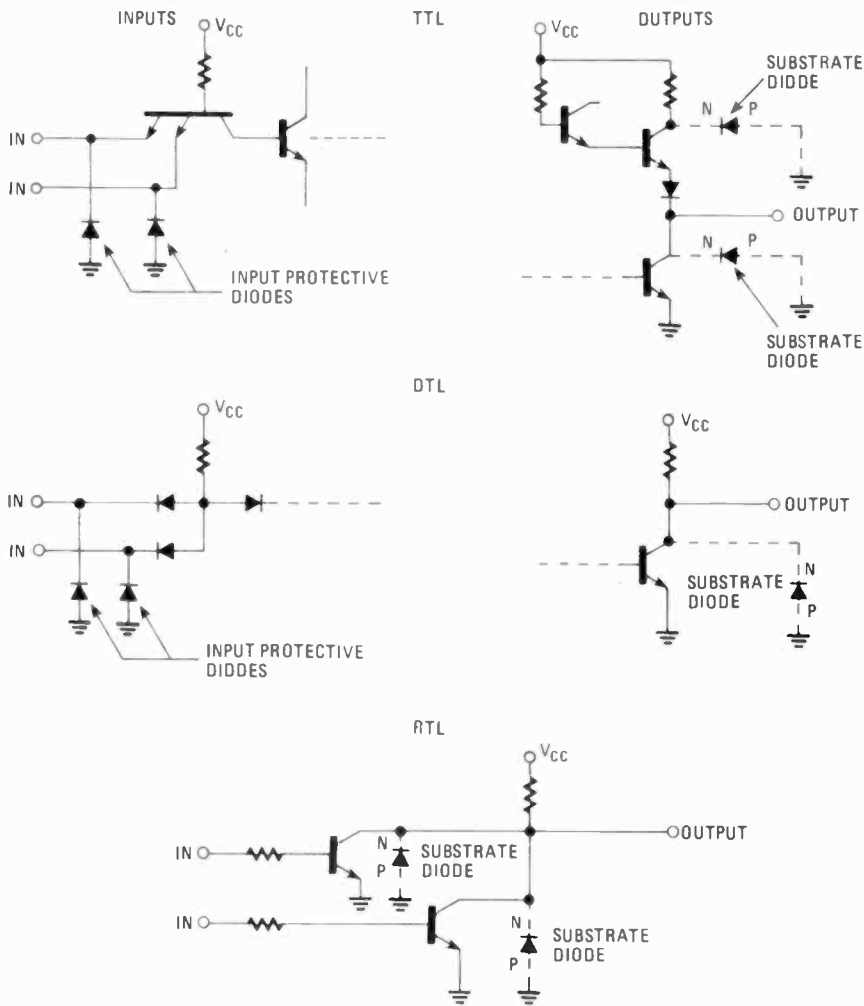

FIG. 4—LOGIC input and output circuits. Use these circuits along with your resistance measurements to determine the logic family of the unknown IC.

WHAT MAKES THE IC SIGNATURE POSSIBLE

Practically all IC outputs, linear or digital, are formed from transistor collectors. All NPN collectors are imbedded in a P-type substrate that is designated ground ($-V$ for linear IC's). As shown in the accompanying diagram, the collector and substrate form a P-N junction that, like any other diode, conducts well in one direction and poorly in the other.

Connecting an ohmmeter from substrate to collector in the forward direction (positive lead to substrate) will cause the ohmmeter to indicate between 500 and 900 ohms. Other diodes in the same IC will read between 950 and 1300 ohms. Actual resistance values will vary with the type of ohmmeter and the degree of doping in the IC, but the IC outputs will always give the lowest readings.

Thus it is possible to locate every output terminal on an IC. The row containing all those low-resistance readings will be the ground ($-V$) row.

In every IC there are usually several transistors whose collectors are connected to V_{CC} either directly or through

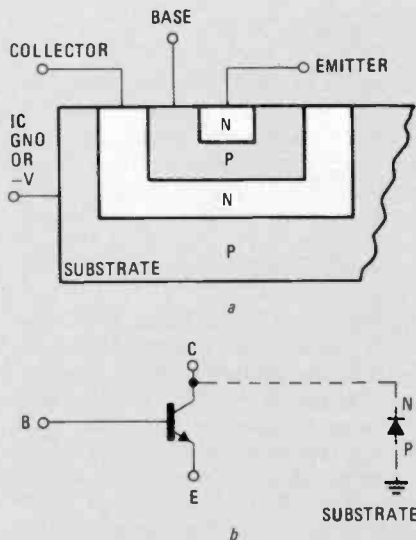

some resistance. When reading forward resistance from substrate to V_{CC} ($+V$ in linear IC's), that multiplicity of paths will give a lower reading than any other terminal on the IC.

Thus it is possible to identify the V_{CC} terminal.

A LOGIC-FAMILY TREE

Mention is made in this article of the RTL (Resistor-Transistor Logic), DTL (Diode-Transistor Logic) and TTL (Transistor-Transistor Logic) families. Of the three, TTL is the only one that is still in common use, but a look at its predecessors is worthwhile. (Refer to Fig. 4.)

As advances in technology have made it possible to construct more complicated devices on a silicon chip, we have been able to take advantage of their sophistication to create faster and more elaborate logic families.

All three of those logic-families IC's work by causing their output transistors to go into saturation (a condition where no amplification takes place—only conduction) but differ in the way input signals are processed to bring about that state.

RTL was the first IC logic-family to find widespread use. Each input line going to the output transistor contains a resistor. Its purpose is to reduce the amount of current consumed by the device and to isolate the logic-gate inputs. The input voltage passed through the resistors drives the output stage into saturation, making the collector voltage of the output transistor drop and causing the output to go "low."

The resistors, though, slow down the switching speed of RTL devices because they increase the time needed to charge and discharge the input capacitance of the output transistor.

Typically, RTL has a switching speed on the order of 50 nanoseconds and operates from a 3.6-volt supply.

The next step in IC evolution was DTL. That family substitutes diodes for the resistors used in RTL. The diodes provide better isolation at the inputs and, because of their low forward resistance, make it possible for DTL circuits to switch more rapidly than their RTL equivalents.

DTL has a typical switching speed of 25 nanoseconds and requires a four-volt supply.

Finally, TTL uses multi-emitter transistors in the input stage. The base-collector junction of those transistors is never fully off, meaning that a state of saturation can be reached considerably more quickly than with either RTL or DTL.

Switching speeds for simple TTL IC's are frequently under 10 nanoseconds. TTL uses a five-volt supply.

While it is still possible to find RTL and DTL IC's on the surplus market, the TTL family is now the dominant one. Its two most common forms are standard TTL and "LS" (Low-power Schottky) TTL, the latter being even faster and having a lower power consumption, at a small sacrifice in drive capability.

$$+V_{CC} = \text{PIN } 7$$

$$-V_{CC} = \text{PIN } 4$$

$$I_{CC} = \text{---}$$

NEGATIVE

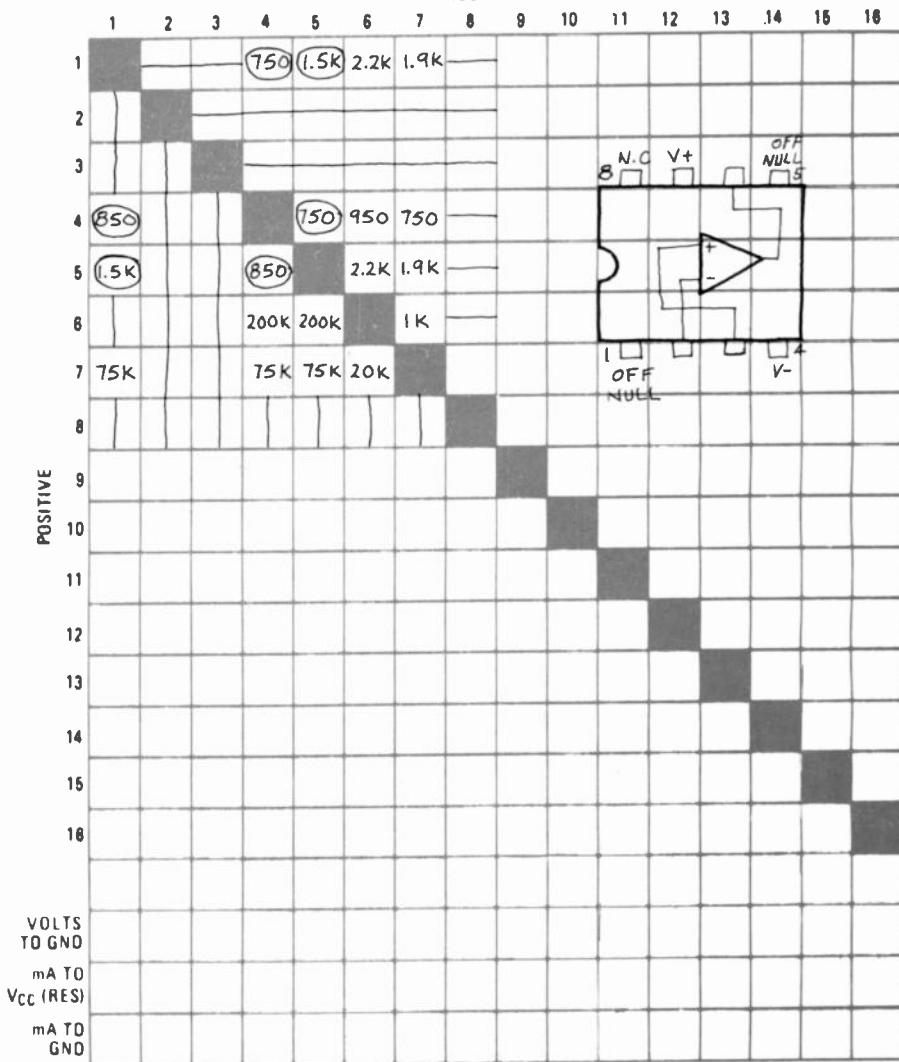

FIG. 5—LINEAR DEVICES can also be identified using the signature chart. This is the signature of a 741 IC.

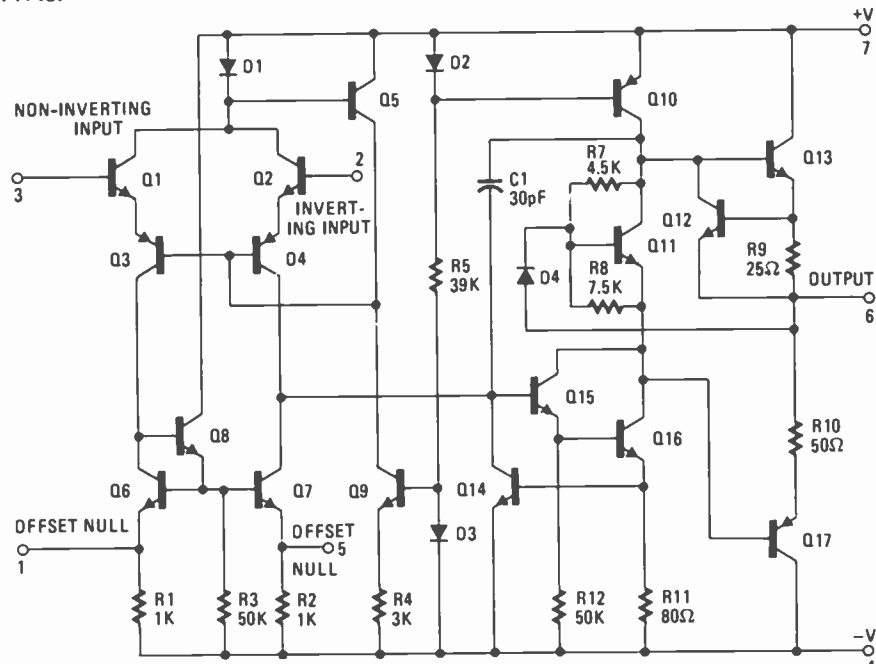

FIG. 6—PIN-OUT for the 741 IC is shown in this schematic diagram. There are 1K resistors between each offset-null terminal and -V.

Motorola IC book containing RTL data sheets. The electronics department at the local college was good enough to let me look through their copy. If you need that kind of assistance, let me urge that you make the local college your first stop. I wish I had—it would have saved a lot of time.

The Motorola book had 256 pages of RTL data—whew! Fortunately the plastic-case style of my IC eliminated two of the three RTL sections. The index of the remaining section listed only two IC's that were quad 2-input NOR gates. The collector pull-up resistors of the first IC type were nominally 640 ohms. The collector resistors in the second IC type were nominally 3.6K. *Bingo!* (We guessed 3.5K in step 4—not bad!).

The device is without a doubt an MC 717P/817P and all the information on that data sheet applies to this IC. I am unable to differentiate further between the 717P and its higher-performance counterpart the 817P. Since the safer move is to assume that the more restricted temperature range applies, I declared the device to be a Motorola RTL IC, type MC717P.

Those techniques work on linear devices as well as digitals.

For example: A signature of an 8-pin DIP 741 op-amp is shown in Fig. 5. Note that the low-resistance row still identifies the substrate, -V, for an op-amp, and also that the lowest reading in that row identifies +V. The only other uncircled reading in row 4 is 950 ohms in column 6, identifying pin 6 as the output terminal.

Figure 6 shows the 741 schematic with the 8-pin DIP pin-out. Note the nominal 1K resistors from each offset-null terminal to -V. The circled resistances in Fig. 5 illustrate some interesting facts about IC resistors: They do not always read the same in both directions—750 ohms one way, 850 ohms the other (pins 1 and 4, and 5 and 4), and they may deviate quite a bit from nominal (1K). Nevertheless the offset-null-terminals are clearly identified.

The op-amp inputs are almost impossible to identify from a signature, but the information already obtained is enough to identify the IC in the data books.

I highly recommend that all those interested in identifying IC's read Olson and Zevnik's excellent article in the January 1980 issue of *Radio-Electronics*, "How to Identify Unmarked IC's." The article is filled with useful suggestions for getting advance information from the PC board.

The smart tinkerer uses all the clues he can get. But when there aren't any advance clues—when there is no PC board—when there are no markings to go by—then the only alternative is the IC signature.

R-E

BUILD THIS

This up-to-date version of an old favorite makes an amusing conversation piece, and a great project!

NOEL NYMAN

THE STATE-OF-THE-ART OF DOING NOTHING

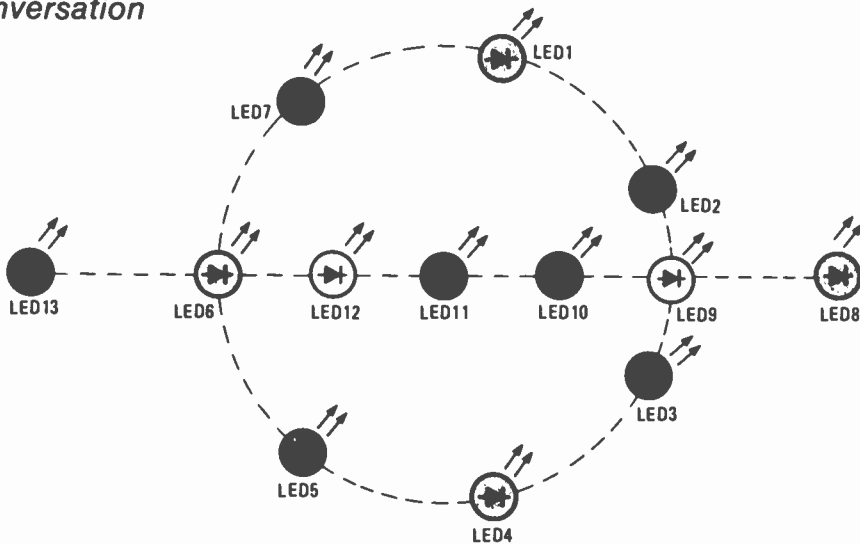

A POPULAR CONSTRUCTION PROJECT some years ago was the "do-nothing" box: one or more neon lamps that flash one-at-a-time either randomly or in sequence. The basic circuit is a relaxation oscillator based on the neon-lamp characteristic of firing at about 65-volts. Figure 1 shows a one-lamp flasher. The capacitor charges at a rate determined by the R-C constant. When the neon trigger voltage is reached the lamp flashes, discharging the capacitor and the cycle repeats. Figure 2 shows circuits with more lamps.

To get the lamps to fire in sequence requires careful *mismatching* of the lamps. Because neon lamps characteristics change as they age, the sequential firing may deteriorate after a while. For more information on neon flashers, see the October 10, 1958 engineering issue of *Electronics* magazine.

The popularity of that circuit was probably due to the bright display that "moves" with no moving parts (remember that was twenty years ago). The parts were cheap and easy to obtain and the power supply was simple. Because of the low current required you could even run it from batteries (expensive ones).

Integrated circuits and LED's have upgraded the "do-nothing" box considerably. A simple sequential circuit

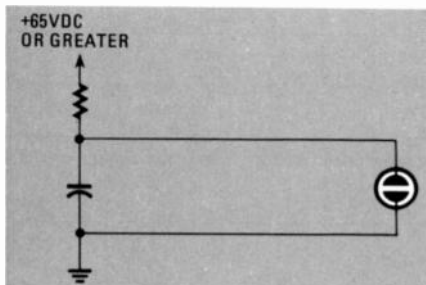

FIG. 1—ONE-LAMP flasher fires when the neon trigger-voltage is reached.

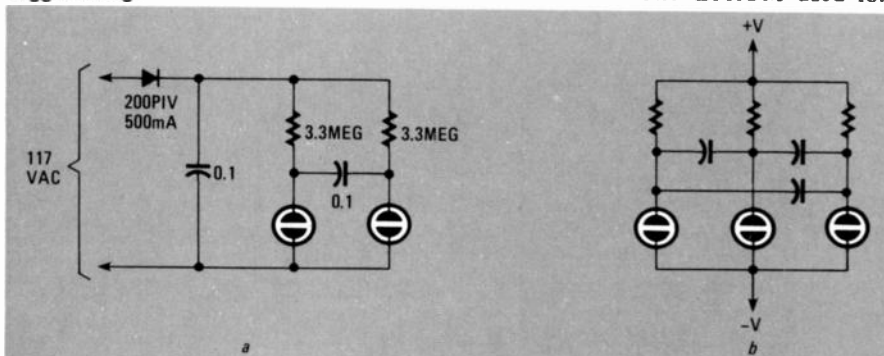

FIG. 2—MULTILAMP flasher circuit. The neon lamps must be carefully mismatched if they are to fire in sequence.

of ten LED's requires only two IC's as shown in Fig. 3. That circuit can use inexpensive batteries, fires sequentially, and the clock frequency is easily changed.

Although that is a clever modern way of doing nothing, the Erasable Programmable Read-Only Memory (EPROM) has made it obsolete also. In case you're unfamiliar with them, EPROM's are field-programmable IC memories that retain their stored information even with circuit power turned off. The programmed information appears on output lines when the appropriate logic levels are placed on address lines. The EPROM used for

this project can store up to 2,048 eight-bit words (16,384 bits) if it's a 2716, or up to 1024 eight-bit words (8,192 bits) if it's a 2758—which is really half of a 2716.

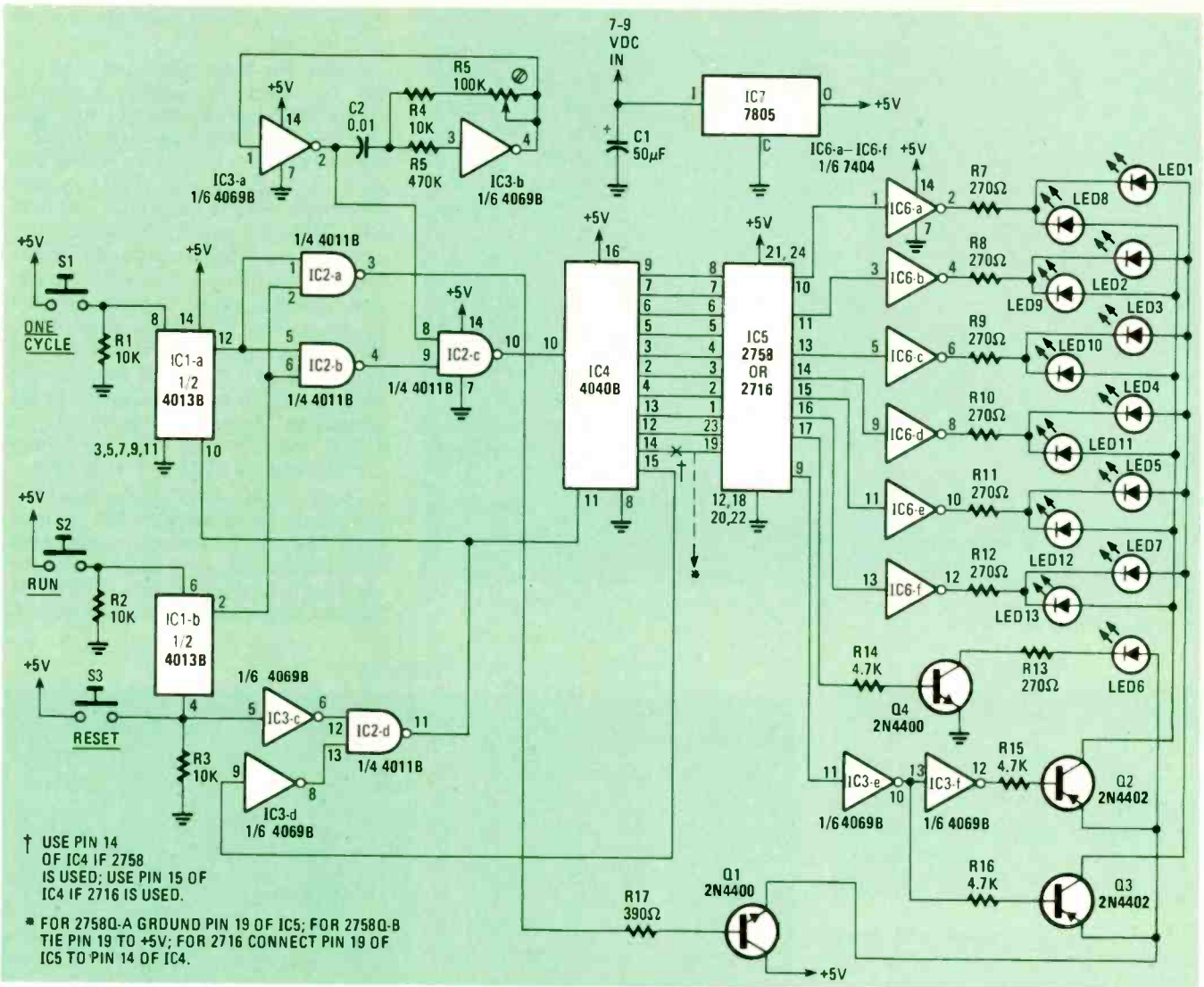

FIG. 4—SCHEMATIC DIAGRAM for the state-of-the-art "do-nothing" box. The line and circle displays share LED6.

available (see parts list).

Figure 4 shows the schematic and Fig. 5 the 2716/2758 pinout. Inverters IC3-a and IC3-b form a clock oscillator. A NAND gate, IC2-c, gates the clock pulses to counter IC4. As IC4 counts, its binary outputs address each memory location of EPROM IC5 in sequence. The seven highest data-outputs of IC5 control LED's. Six pairs of LED's are controlled by inverters (TTL for high current output) and LED6 is controlled with a transistor (using a seventh inverter would waste five inverters of another IC). The 270-ohm resistors limit LED current to about 20 mA. The D0 IC5 output controls Q2 and Q3 through inverters. A logic-1 from D0 will cause Q3 to conduct and the LED's in the circle will light. A logic 0 will light the line LED's using Q2.

Although an on-off switch isn't necessary, I decided to use latches to get three operating modes: RUN, ONE-CYCLE, and RESET. Pushing the ONE-CYCLE switch sets latch IC1-a, allows clock pulses through IC2-c, and switches Q1 on through IC2-a.

TABLE 3

0	0000	8	1000
1	0001	9	1001
2	0010	A	1010
3	0011	B	1011
4	0100	C	1100
5	0101	D	1101
6	0110	E	1110
7	0111	F	1111

TABLE 4

81	02
41	06
21	0E
11	1E
09	3E
05	7E
03	FE
04	

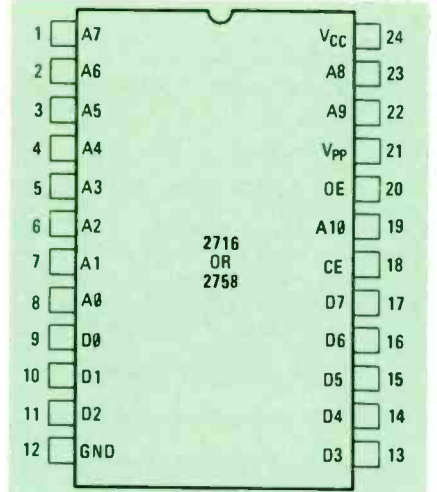

FIG. 5—PINOUT for the EPROM. Either a 2716 or a 2758 may be used.

Transistor Q1 controls all display current and shuts off the display when the RESET pushbutton is depressed. When counter IC4 reaches a count of 512, all addresses of IC5 will have been displayed and pin 14 of IC4 will go high. That resets latch IC1-a and

IC4 through IC3-d and IC2-d. If the RUN switch is depressed, IC1-b will latch and the display will operate as before. The logic-1 appears at pin 14 of IC4 and resets IC4 to 0, but since it does not reset latch IC1-b, the cycling repeats.

continued on page 87

UNICORN-1

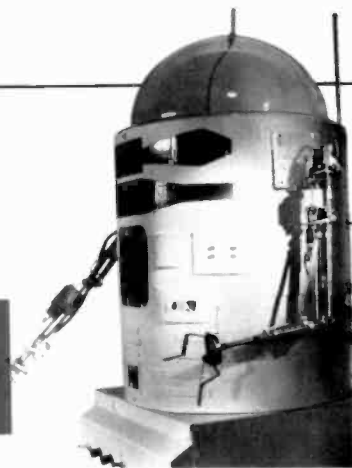

ROBOT

A LOT OF THOUGHT WAS GIVEN TO HOW Unicorn-1 could be controlled remotely. A number of schemes were considered—ultrasonics (not reliable enough and not enough range); infra-red (the same, but more so), and, of course, radio. A system was even devised using model-airplane R/C equipment, but that proved to be expensive and not easily expandable to computer-control.

The system finally chosen was inspired by one used by amateur radio operators for VHF and UHF repeater control and its principles are probably familiar to most **Radio-Electronics** readers from at least one other source—the telephone company.

Before getting into the actual construction of the robot's R/C system, it might be a good idea to fill you in on this scheme, so you have an idea of the direction we're headed in.

The heart of the system is the DTMF (Dual Tone Multi-Frequency) system—also known as *Touch-Tone*. A 16-key pad (shown in Fig. 65)—or a matrix of

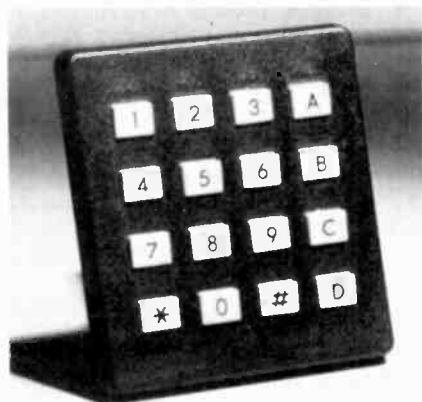

FIG. 65—A 16-KEY *Touch-Tone* pad similar to this one was used in the prototype to modulate an FM transmitter.

switches providing the equivalent function—is used to instruct a DTMF generator IC, in this case a ICM7206JPE, to produce a pair of tones unique to the key pressed.

That tone-pair modulates an inexpensive, low-power FM transmitter operat-

ing in the FM-broadcast band. The signal is received by a standard FM broadcast-band receiver located in the robot and the tone-pairs are decoded to generate a one-out-of-sixteen control signal. That control signal is fed to a relay-driver board to energize the coils of the appropriate relays (as described in Part 7 of this series) and operate the robot's motors and solenoids.

This method will lend itself particularly well to computer control. The 16-key pad is arranged as a 4-row by 4-column switch matrix where each row generates its own tone, as does each column. The result, if the rows and columns are considered together (lined up in one row) is the equivalent of a computer *byte*—the standard 8-bit word.

A computer can output, through a parallel port, an eight-bit binary number that can represent those same switch closures. That byte can be used in place of the keypad to cause the tones to be generated, thus allowing a computer program to direct the robot's actions.

Alternatively, if the robot carries an on-board computer, the output of its parallel port can easily be translated into control signals for the relays.

Several installments will be required to describe the control system in detail. This one will talk about FM transmitters and the relay-driver board. The next will talk about the *Touch-Tone* encoding and decoding circuits, and their interfacing to the others.

Finally, we'll talk about computer interfacing and a little about programming as it pertains to robot control.

FM transmitter

This transmitter can actually be used for two purposes, although not simultaneously. In essence, it is what's commonly called an FM wireless mike. Usually it is used to transmit voices or music on an unused frequency of the FM broadcast band for personal entertainment purposes.

In that mode, using the robot's built-in amplifier and speaker (see Part 5), the robot can talk to persons in its vicinity—with a little help from the operator. In

Part 8—Last month we began to look at a remote-control system for the Unicorn-1 robot. In this part we will continue with that system by describing our control scheme, a simple FM transmitter, and a relay-driver board.

JAMES A. GUPTON, JR.

fact, if the robot carries a second wireless mike, operating on a different frequency, a two-way conversation can be carried out.

However, that is secondary to our main purpose—actually controlling the robot. (Come to think of it, though, the control tones could also be fed to the robot's amp and speaker, making him sound a little like good old *R2-D2*.)

A schematic for a wireless mike is shown in Fig. 66. No foil pattern is given, since the circuit can be easily constructed on perforated construction board. Suitable FM transmitters are also available from a number of companies who advertise in **Radio-Electronics**.

Transmitter construction

If you build your own transmitter, it can be constructed on a piece of perforated

PARTS LIST—FM TRANSMITTER

All resistors 1/2 watt, 5%

R1, R2—1 megohm
R3, R6, R9—8200 ohms
R4—330 ohms
R5—470,000 ohms
R8, R11—15,000 ohms
R12—3900 ohms
R13—220 ohms
R14 (optional)—390,000 ohms

Capacitors

C1, C3, C4, C6—5 μ F, tantalum
C2—0.1 μ F, ceramic disc
C5—10 μ F, tantalum
C7, C11—0.01 μ F, ceramic disc
C9—5-15 pF, variable (E.F. Johnson 274-0035-005 or equivalent)
C10—7 pF (approx.), ceramic disc
L1—see text
L2—see text

Miscellaneous: construction board, high-impedance microphone, solder, wire, etc.

ic, and most of the ones available as kits, are intended to be modulated by a high-impedance microphone. (If you intend to use a crystal mike, be sure to include resistor R14.)

If you are going to use the transmitter only with the *Touch-Tone* pad for control purposes, the first two stages—Q1 and Q2—can be omitted, and the output of the tone-generator IC applied to the base of Q3, since its output level is much higher than that of a microphone, and not as much amplification is needed. In fact, you probably will have to add several hundred kilohms of resistance to attenuate the tones so they do not overdrive the transmitter and cause distortion.

Best results with the homebrew transmitter were obtained when tantalum capacitors were used where values of five and ten μ F were needed. The tuning capacitor, C9, should have a value such that, when it is paralleled with C10, the

num efficiency, the length of the antenna is not critical—about ten inches seems to work well.

Locate the antenna right at the transmitter, which can be mounted inside the command console if you like. It is not necessary to feed the antenna with coaxial cable—it can be connected directly to the output of the transmitter. What is important, though, is that the antenna be insulated from the case containing the transmitter, if that case is metallic, to prevent it from shorting out to ground.

The frequency of the transmitter can be affected by the antenna. It should be as rigid as possible and, more important, because of capacitance effects, it should be as far away from possible contact with your body as possible. Keep that in mind when you are tuning the transmitter, especially if the transmitter and antenna are mounted on the case containing the keypad and tone encoder.

The best section of the FM band for your use is probably the bottom—around 88 MHz. Tune your receiver to a clear spot in that area and turn up the volume so you can hear some background hiss. Then, using an insulated—or plastic—screwdriver, *slowly* adjust C9, or its equivalent, if you assembled a kit, until the hiss is blanked out. That will indicate that you are receiving your transmitter's carrier. Be patient—the tuning process is critical. It may also be necessary for you to stretch or compress L1 slightly to get into the right portion of the band. Before you fire up the transmitter, you should be aware of the FCC regulations governing the use of such devices. Those regulations may be summarized as follows:

- The use of such devices for personal surveillance is illegal!
- The range of such devices is limited to 100 feet. Do not attempt to extend that range through the use of higher power or more efficient antenna systems—use only what you need! Improve your receiver, if necessary.
- Do not attempt to use the transmitter below 88 MHz or above 108 MHz. The former may interfere with commercial two-way radio services; the latter with aircraft communications. Do not use the transmitter anywhere near commercial airplanes!

To be safe, make sure the signal begins to fade out about 90 feet from the transmitter. If it is too strong at that range, shorten the antenna or reduce the input power. That will not only keep you out of trouble, but will ensure that you can clearly observe—and control—the robot's actions before it does something to embarrass you.*

In the next part of this series we'll go into detail on connecting the tone genera-

*Due to the difficulty in obtaining positronic brains, Isaac Asimov's Three Laws of Robotics do not apply here, and we have to use our own judgment, rather than rely on the robot's.

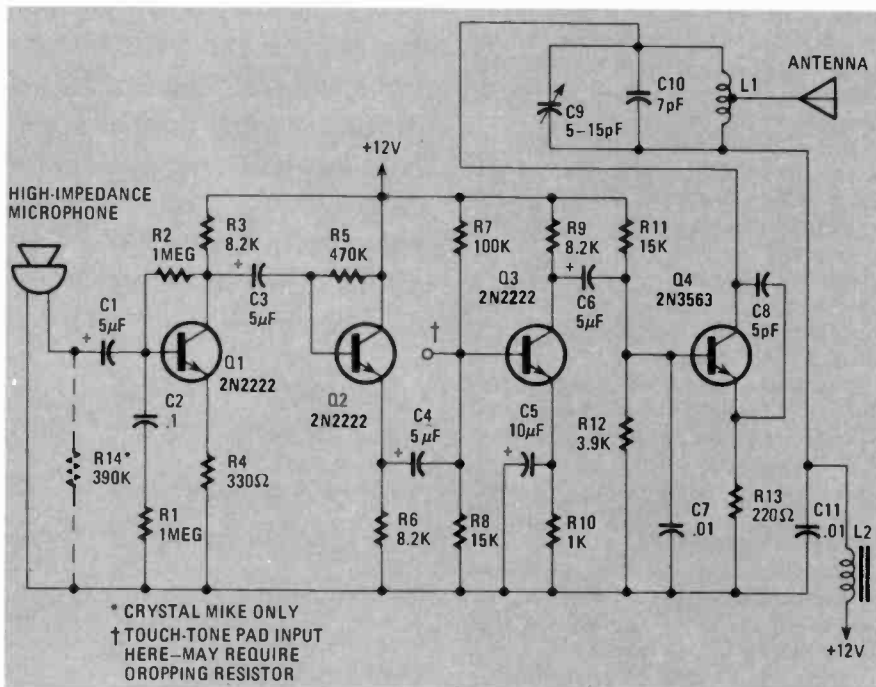

FIG. 66—SCHEMATIC DIAGRAM for the FM transmitter. Value of dropping resistor R14 may range from several hundred kilohms to two megohms or more.

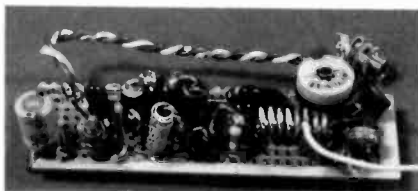

FIG. 67—PROTOTYPE TRANSMITTER built on a small piece of board. Any construction technique may be used.

rated construction board or on a prototyping board. A prototype transmitter, built on a piece of board about 1 × 4 inches, is shown in Fig. 67. Wire-wrap or point-to-point wiring techniques can be used. Keep the leads as short as possible—lead length begins to get critical at these frequencies (80-108 MHz).

The transmitter shown in the schemat-

total capacitance does not exceed 22 pF. A good place to look for something to use as C9 is in a junked portable FM radio.

Coil L1 is made using eight turns of No. 16 copper wire. Its outside diameter is 1/4-inch and the total length of the coil is 0.6 inches. Coil L2 consists of 12 turns of No. 30 wire (wire-wrap wire will do nicely) closely wound around a quarter-watt resistor of the highest value you have on hand (it should be at least 100K). The ends of that coil can be soldered to the resistor leads, which, of course, then become the leads of the coil.

The antenna lead is soldered to the third turn of L1, counting from the 12-volt end of the coil. The antenna itself can be either a fancy telescoping type, or simply a piece of stiff wire. Since we are deliberately *not* trying to obtain maxi-

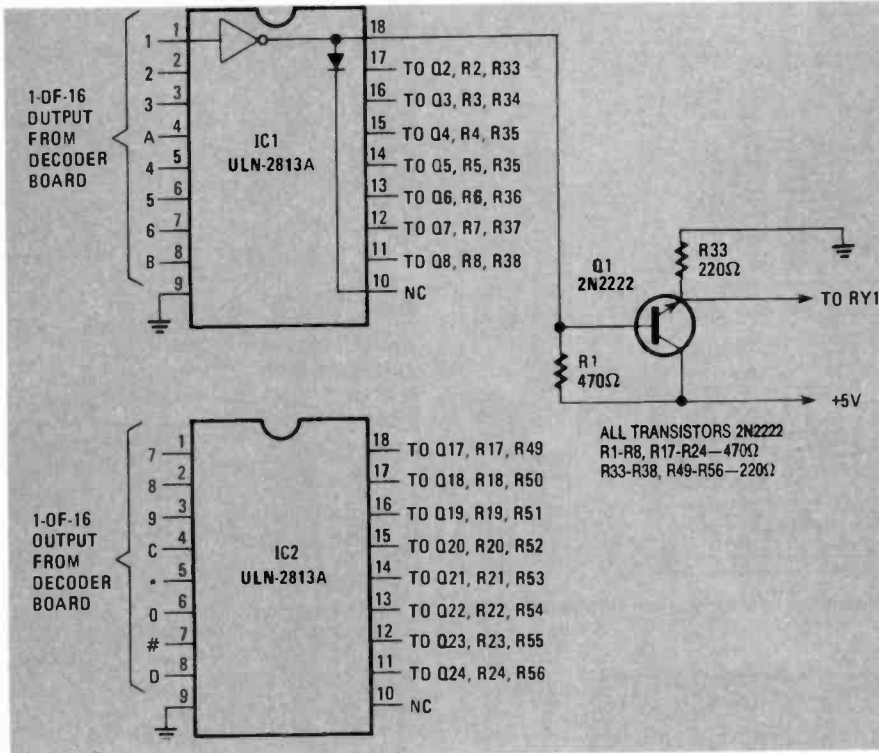
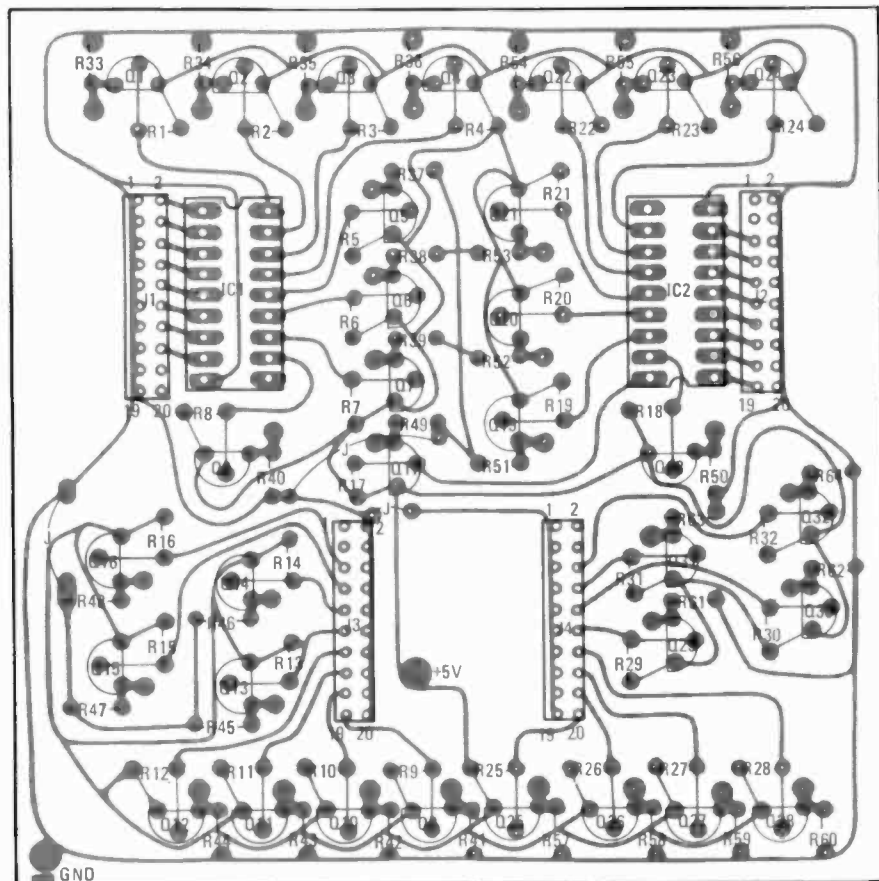

FIG. 68—SIMPLIFIED SCHEMATIC of the relay-driver board. Only one section is shown as all others are the same.



TRANSISTORS SHOWN
HERE ARE 2N2222



NOTES: R1-R32-470Ω
R33-R64-220Ω
PAY CAREFUL ATTENTION TO
TRANSISTOR LEAD ORIENTATION
Q1-Q32-SEE TEXT FOR DEVICE
SELECTION

FIG. 70—PARTS PLACEMENT diagram for the relay-driver board. If 2N2222 transistors are not handy, almost any other type may be used.

tor to the transmitter, and the tone decoder to the receiver (and to the robot).

Relay-driver board

A portion of the relay-driver board circuit is shown in Fig. 68. There is really very little more to it than that—the same circuit, for all intents and purposes, is repeated 32 times.

A foil pattern for the relay-driver board is shown in Fig. 69, and the parts-placement diagram in Fig. 70. Don't be put off by its complexity, though. Initially, we'll use only half of that board—each relay will have its own output from the ULN-2813A driver IC and its own transistor. The balance of the board is reserved for future use—primarily when it becomes necessary for the robot, when it gets its on-board computer, to respond to stimuli from its environment. It can also serve to provide other control functions if a more sophisticated control system is used, and suggestions for that will appear in a future part of this series.

Jacks J1 and J2 will be used to connect the relay-driver board to the decoder board.

Here's how the circuit works: The ULN-2813A is an inverting octal driver. What that means is that it has eight identical sections; and when a logic-high signal (about five volts) from the decoder board is applied to the input of one of the sections, the output of that section goes to a logic-low state (zero volts, or ground) and will act as a ground for any voltage that is applied to it.

When an output of the IC goes "low," it causes its associated transistor to be saturated. That allows five volts to pass from the collector and out the emitter to the coil of the relay assigned to that transistor, causing the relay contacts to close. That's all there is to it.

Although IC pin and function assignments are arbitrary, Table 1 shows a suggested arrangement for use with a 16-key Touch-Tone keypad.

Because we are limited to 16 on/off control signals, several of the robot's original functions temporarily have had to be eliminated or combined. For example, we can no longer beep the horn, and both end-effectors now operate simultaneously.

Regaining those lost functions will be easy under computer control and later we'll present a couple of ideas for some simple logic circuits that will allow the 16 radio-control channels to provide more than 16 functions.

Construction of the board is straightforward. The 2N2222 transistors were used because they were handy. As Fig. 71 shows, almost any transistor can be used—you can see four different types there. If you have PNP—say, 2N2907—instead of NPN transistors, the only change that has to be made is to insert the transistors in the board backwards—the emitter goes where the collector would

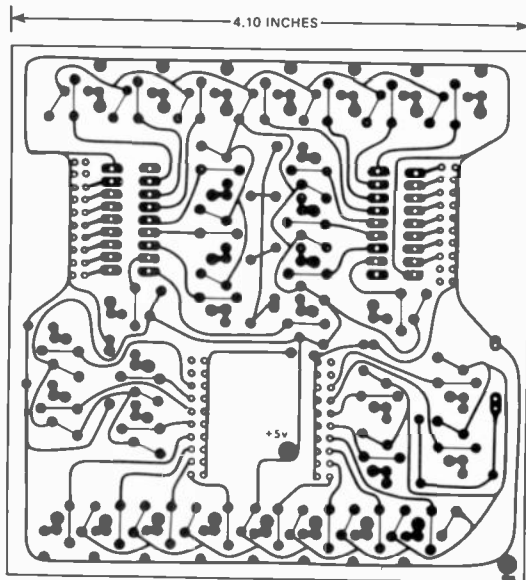

FIG. 69—FOIL PATTERN for the relay-driver board. Only half the board will be used at this time, with the rest reserved for expansion.

TABLE 1

IC No., Pin No.	Key No.	Function
IC1, 1	1	Both wheels, forward
" , 2	2	Both wheels, reverse
" , 3	3	Left wheel, forward
" , 4	A	Left wheel, reverse
" , 5	4	Right wheel, forward
" , 6	5	Left & right arm solenoids
" , 7	6	Body rotate, right
" , 8	B	Body rotate, left
IC2, 1	7	Left shoulder, up
" , 2	8	Left shoulder, down
" , 3	9	Right shoulder, up
" , 4	C	Right shoulder, down
" , 5	*	Left arm, up
" , 6	0	Left arm, down
" , 7	#	Right arm, up
" , 8	D	Right arm, down

TABLE 2

Transistor	Relay No.	Finger No.
Q1	RY3, RY5	R, 6
Q2	RY4, RY6	M, 3
Q3	RY3	R
Q4	RY4	M
Q5	RY5	6
Q6	RY19, RY20	18, 4
Q7	RY1	20
Q8	RY2	17
Q17	RY9	P
Q18	RY10	L
Q19	RY11	7
Q20	RY12	2
Q21	RY15	N
Q22	RY16	8
Q23	RY17	5
Q24	RY18	1

be, and vice-versa. The resistor placement can stay as shown.

Installation

After the relay-driver board has been

PARTS LIST—RELAY-DRIVER BOARD

All resistors 1/4 watt, 5%

R1-R32—470 ohms

R33-R64—220 ohms

Semiconductors

IC1, IC2—ULN-2813A inverting octal driver (Sprague)

Q1-Q32—2N2222 or equivalent NPN-type; 2N2907 or equivalent PNP-type (see text for details)

J1, J2—20-pin, double row, header connector (AP Products AP923862-R or equivalent)

Miscellaneous: PC board, 22/44-finger prototyping board (Radio Shack 276-154 or equivalent), two 22/44-pin sockets (Radio Shack 276-1551 or equivalent), 18-pin IC sockets, mating connectors for J1 and J2, 20-conductor ribbon cable, hardware, wire, etc.

A PC board for the relay driver board is available from PPG Electronics Co., Inc, 14663 Lanark St., Van Nuys, CA 91402. (213) 988-3525. Price is \$9.95 plus \$1.00 for shipping and handling. CA residents add 6% tax. MC and Visa accepted.

completed, it is piggy-backed onto a 22/44-finger board like the one that was used for the relay board, using 1/4-inch spacers. Make positively sure that the two boards are electrically isolated from each other.

The emitter (output) of each 2N2222 transistor is connected to a finger on the piggy-back board. You can use wire-wrap wire for that. The most straightforward way is to use the same finger number (or letter) as that which is connected to pin 16 of the appropriate relay on the relay board (See Table 2).

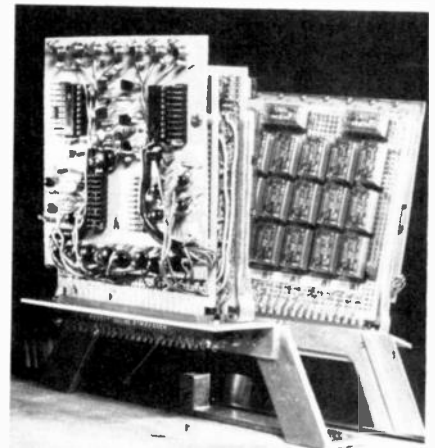

FIG. 71—THE RELAY-DRIVER BOARD is mounted parallel to the relay board, seen reflected in the mirror.

A 22/44-pin edge connector is mounted parallel to the one for the relay board (refer to Fig. 71) and, assuming that you have followed the wiring scheme described above, connections are made between like-numbered pins on the driver-board socket and the relay-board sock-

continued on page 82

NEW TECHNOLOGY

Here's how the picture and sound are transferred from the disc to your TV set in the new laser videodisc system.

MUCH HAS BEEN WRITTEN ABOUT THE makeup of the three videodisc systems currently vying for acceptance in the marketplace. There are laser optical discs favored by Magnavox, Pioneer, and others, capacitance-pickup grooveless discs, proposed by JVC, Matsushita, and General Electric, and capacitance-pickup groove-type discs developed by RCA. In the case of the optical and capacitance videodisc systems so far proposed, we have seen many diagrams of how tiny "pits" or dark and light spots in the disc tracks will be carrying the encoded information. But little has appeared in the literature as to just what that information is, how it is encoded, and what the circuitry needed to decode it will be like, once you get past the question of pickup format.

The Magnavox Consumer Electronics Company has prepared an excellent booklet about their model VH-3000 Videodisc Player in order to familiarize technicians and others with their laser disc system as well as with playback circuitry. While the booklet deals with all aspects of the optical-laser videodisc player's operation, our concern here will be only with the signal-processing circuits that handle the signals picked up by arrays of photo-sensitive diodes that catch the laser-beam reflections from the surface of the spinning disc.

To understand the circuit descriptions that follow, we must know just what sort of signals are contained in the

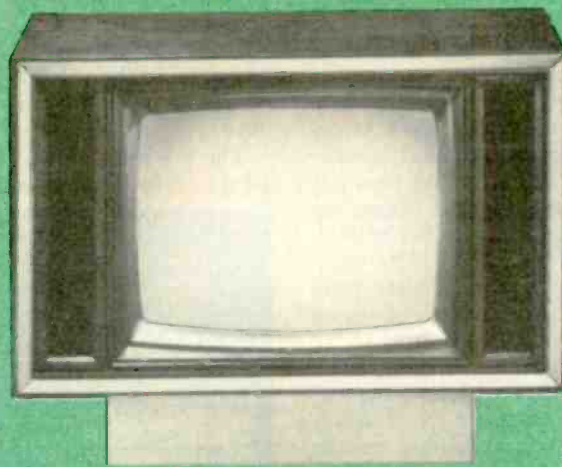

LASER VIDEODISC

How the Video Signal is Processed

LEN FELDMAN



laser-disc tracks themselves. The intelligence that is encoded on the videodisc is the combination of three different FM signals:

1. An 8.1-MHz FM signal modulated with composite video, including chroma.
2. A 2.3-MHz FM signal modulated with Channel-I sound.
3. A 2.8-MHz FM signal modulated with Channel-II sound.

Figure 1 shows those three signals in the frequency spectrum. Each sound carrier (the videodisc contains two independent sound channels and thus has the capability, among other things, for stereo sound) has a maximum FM deviation of ± 100 kHz. The 8.1-MHz video carrier has a deviation of 1.7 MHz (from sync tip to peak white) with its bandpass extending from below 4 MHz to above 12 MHz to include all sidebands. Each of the sound signals modulates the 8.1-MHz video FM to create the resultant signal that becomes encoded on the videodisc, as shown in Fig. 2.

Signal processing

A simplified block diagram of the signal-processing circuitry needed to produce the video and audio signals from the laser disc is shown in Fig. 3. The total composite FM signal from the photosensitive diodes and preamplifier module is applied to a high frequency amplifier/splitter. Frequency tuned networks separate the sound-FM signals from the video FM. The sound FM is applied to two frequency-sensitive

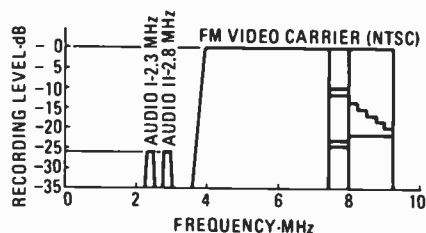

FIG. 1—AUDIO AND VIDEO signals as recorded on videodisc. One video sideband—note sync pulses and video ramp waveform—is shown at 8.1 MHz.

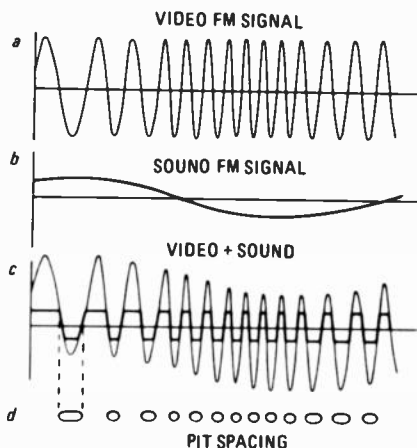

FIG. 2—RESULTANT SIGNAL created when both of the sound signals modulate the 8.1 MHz video-FM.

stages: a 2.8-MHz sound demodulator and a 2.3-MHz sound demodulator. Those stages serve as ordinary FM detectors and retrieve the audio signals from their respective FM carriers. The two resulting audio signals are applied to an electronic-switch network that applies either one or both of them to the RF modulator of the player. Front-panel switches on the videodisc player determine which audio signals are heard and used.

The 8.1-MHz video-FM signal is applied to Video Demodulator I that extracts

the composite video signal from the carrier. That composite signal is amplified by a video amplifier and applied to the RF modulator. Since each frame of the 54,000 frames contained on a single side of the disc is numbered, and the player is capable of displaying that number on the TV screen, the picture-number information is stripped from the composite video signal by the clipper/decoder circuit. Here, the picture-number information is decoded and converted to a picture-number video signal. That signal is also amplified by the video amplifier and

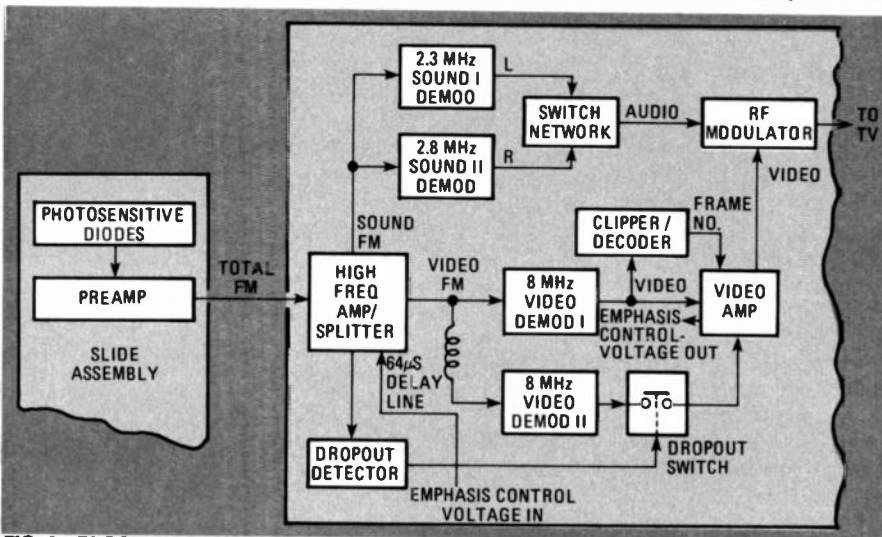

FIG. 3—BLOCK DIAGRAM of the circuitry used to derive audio and video from the videodisc.

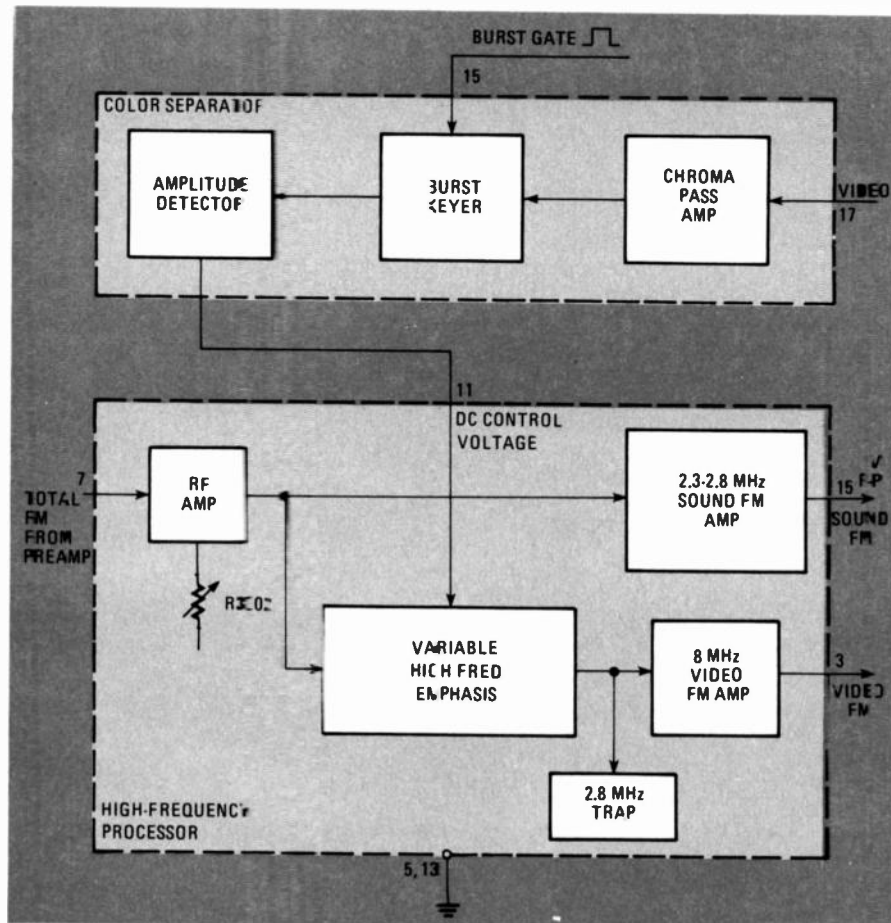

FIG. 4—DETAILED block diagram of the splitter and high-frequency signal processor. The color separator removes the color burst from the video.

applied separately to the RF modulator. The RF modulator places the audio and video onto the required RF frequencies for TV Channel 3, or Channel 4, selectable by the user. The output from the RF modulator is connected to antenna

terminals on the viewer's TV set through an antenna-switch box.

The video circuitry creates a varying DC voltage that is proportional to the burst amplitude. That voltage is called the emphasis-control voltage and is ap-

plied from the videodisc. A dropout, in that case, is defined as an area on the videodisc that has incorrect encoding or no encoding at all. Such a loss of encoding could be caused by physical damage to the disc after it has been used, or by manufacturing imperfections. The dropout-correction circuitry built into the Magnavox player can compensate for the loss of up to one complete horizontal line on the TV screen.

The 8.1-MHz video-FM signal is applied to a dropout-detector circuit. If a bad spot on the videodisc is encountered, the 8.1-MHz signal will be absent and the dropout detector will sense that absence.

The 8.1-MHz signal is also applied through a 64-microsecond delay line, to Video Demodulator II. Since 64 microseconds corresponds to the sweep time of a single horizontal line, when a dropout is encountered, the dropout detector activates an electronic switch that then applies the delayed, *previous* horizontal line in place of the one that has dropped out. The result on the video screen of the viewer's TV set is two horizontal scan lines with the same video information. In other words, the dropout has been filled in by repeating the previous line of video information.

A more detailed look

A more detailed block diagram of the high-frequency signal processor and splitter is shown in Fig. 4. The entire composite FM signal is applied to an RF amplifier whose gain control, R3002, is used to set the correct output level. The output of the RF amplifier is applied to the sound FM amplifier. The input of the sound FM amplifier is tuned to pass only the 2.3-MHz and 2.8-MHz sound carriers, both of which are then present at the output of the amplifier.

The color-separator circuit shown in Fig. 4 removes the color burst from the video signal by gating the burst keyer with the horizontal burst-gate pulse. The amplitude detector creates a DC voltage proportional to the burst amplitude. As that DC voltage decreases, the high-frequency response of the video amplifier increases. The net effect is to boost the high frequencies towards the inner section of the videodisc. The video FM amplifier boosts the 8.1-MHz video-FM signal. The 2.8-MHz trap removes any remaining Channel-II audio carrier at that point. Any remaining Channel-I (2.3-MHz) sound carrier is trapped out later in the signal path.

Sound signal processing

The sound-FM signals are processed by two circuit modules, whose block diagrams are shown in Fig. 5. The sound-FM signal is applied to the 2.3-MHz FM demodulator on the Sound

continued on page 83

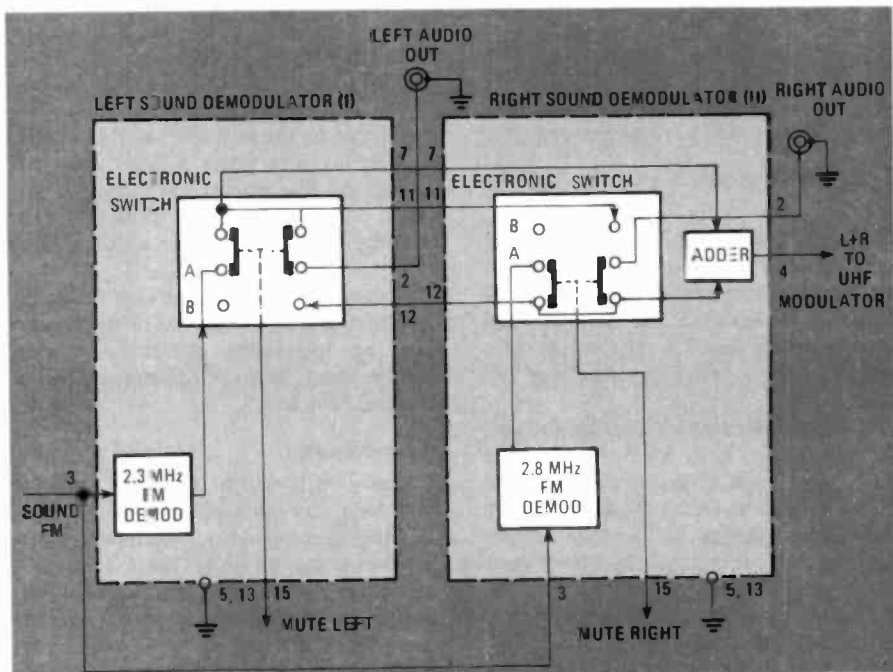

FIG. 5—SOUND SIGNAL processing modules. The sound-FM signals are processed by these two circuits.

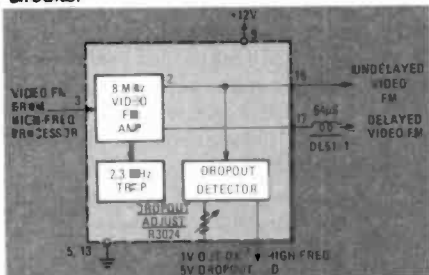

FIG. 6—DROPOUT DETECTOR activates signal restoration circuitry when it detects missing information.

plied to a high-frequency amplifier to emphasize high frequencies when operating near the inner diameter of the videodisc (where such high frequencies would tend to be more attenuated). The control is necessary because the "pits" on the surface of the disc are more closely spaced at the inner diameter of the disc.

The player is also designed to compensate for minor dropouts of informa-

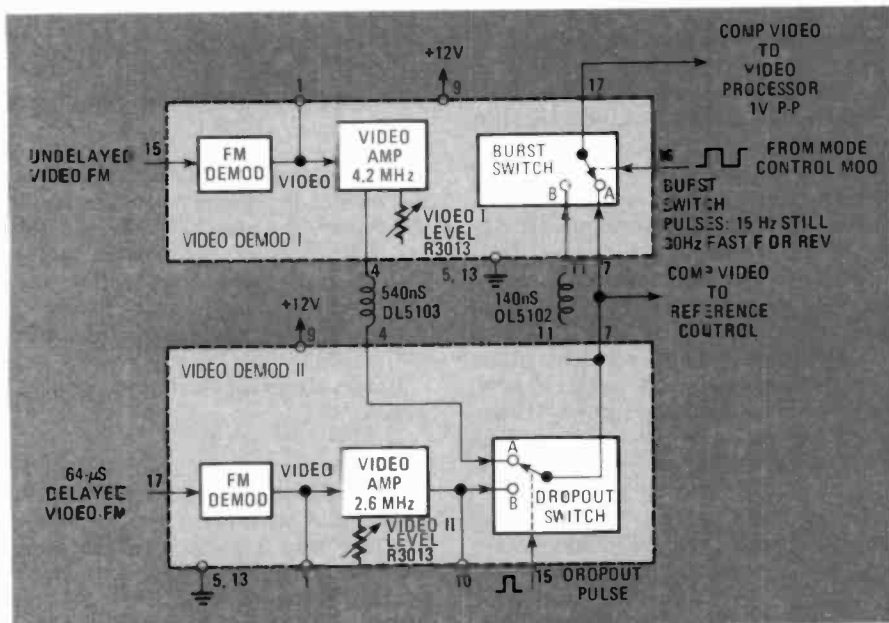

FIG. 7—VIDEO-FM and delayed video-FM are supplied to the demodulator circuit as shown in this block diagram.

When analyzing simple circuits, be careful not to overlook the obvious.

EARL "DOC" SAVAGE, K4SDS, HOBBY EDITOR

WELL, THE ELECTRONS HAVE SETTLED from Light Mystery No. 2 (see Hobby Corner, August 1980 issue). And those electrons were flying all over the place from California to Connecticut and everywhere in between.

Let's take another look at Don Francois' puzzle. He constructed the two circuits shown in Fig. 1 and found that the bulb brightness in one was greater than in the other.

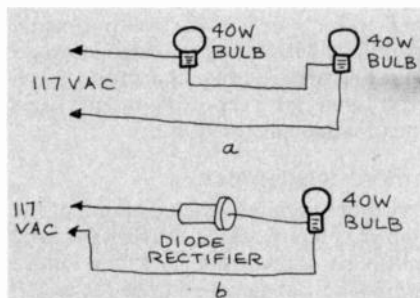

FIG. 1

Things got tough when he measured the same voltage across each bulb. And, to make matters worse, Don measured the same current in each circuit.

That puzzle can be attacked by breaking it down into three questions:

1. How can the voltages and currents be the same in the circuits shown in Figs. 1-a and 1-b?
2. Are the bulbs brighter in either circuit?
3. Why is the brightness different?

The answer to No. 1, of course, is that the voltages and currents *cannot* be equal if the brightnesses are different. All the responses that addressed that question were correct though in some cases the reasoning was fuzzy.

The voltage waveforms in the two circuits are shown in Fig. 2. The fallacy of

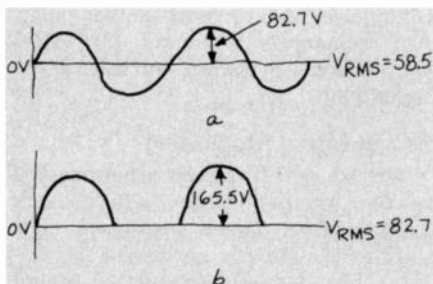

FIG. 2

the "equal" measurements lies in the fact that common AC meters are designed to measure sinewaves (Fig. 2-a). If the waveform is not sinusoidal, the meter gives an inaccurate reading. A DC meter also gives a false reading on pulsating DC (Fig. 2-b).

We must assume that Don used a typical multimeter. If so, his readings in the diode circuit would be wrong whether he measured AC or DC. Actually, as Fig. 2 shows, the voltages and currents are *not* the same and therefore, the power (and brightness) differs.

Getting on to the question of which is brighter—That is where I got a surprise. Two readers "proved" that the bulbs in both circuits are equally bright in spite of Don's report to the contrary. And, almost half of the responses were wrong!

One sure way to find the answer is to hook up the circuits and observe the difference in brightness. Quite obviously many of you did not do that.

In fact, it appears that none of you who wrote tried the circuits. Come on, guys and gals; trying it out (experimenting) is the only way you can be sure that your reasoning is correct. Logic and computation are fine if you have all the facts and don't overlook something. Even some of the right answers were based on incomplete facts.

Sometimes things are not as simple as they first appear. Everyone remembered that the diode "cuts out" half of the AC sinewave. But did you remember that the two bulbs in series effectively divide that 117 volts AC between them? Did you remember to take into account that the circuit resistances of both circuits are *not* the same? What else did you overlook? The way to tackle any electronics problem is to use a combination of reasoning and experimentation.

Those of you who answered the question correctly used a great variety of logical and/or mathematical proofs. Three sharp readers threw in some calculus (that almost threw me—it *has* been a long time). Let me hasten to say that calculus is not necessary to prove the answer. However you did it, congratulations to you—unless, of course, it was an accident.

I have given a lot of thought to making this report on Light Mystery No. 2. Hav-

ing stirred up the dust with what has been said so far, I'm going to stop short of giving you the answer. You may think that's "dirty pool" but, actually, the answers and the facts *are* above. Have fun!

A very special thanks to Don Francois for sharing that mystery with us. If you have an interesting electronic puzzle, send it along. Perhaps you too can make the electrons fly.

Speedometer

Henry Milowski of Welland, Ontario sent me a very interesting letter. It seems that the speedometer on his exercise bicycle broke and he saved some bucks by making a replacement. The basis of his design can be used to measure the rate of any rotating object.

Henry used an old DC motor as a generator that is turned by the bike tire (Fig. 3). His motor came from a discarded tape deck. The output voltage is proportional to the speed and that output is measured by the meter (a miles-per-hour scale was added). The LED protects the meter if the tire turns backwards and it also adds to the appearance.

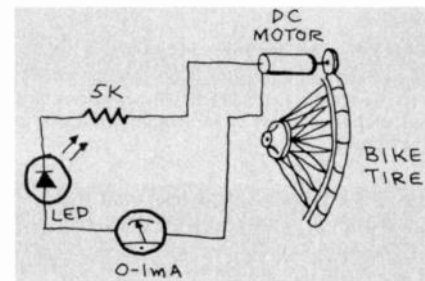

FIG. 3

You may need to change the value of the resistor depending upon the meter and motor you use. Not only will the motor be different, but the size of the shaft "wheel" pressing on the tire will determine the output range. I suggest that you start with a 10K or 20K pot in the circuit.

Thanks Henry for sharing your project with us.

Fundy

Noting Henry's Canadian address, reminds me of my summer trip around the Bay of Fundy. I guess I saw about as much as one can see there in a couple of weeks. I was duly amazed. Those 20- and 30-foot tides are all but unbelievable—

continued on page 72

ELECTRONICS BOOK CLUB

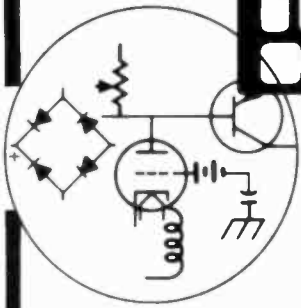

Take 6 great books for **\$2⁹⁵**
(values to \$101.70)

Start saving now for discounts up to 75% on hundreds of interesting, info-packed volumes . . . PLUS special Members' Bonus Benefits!



1169 List \$15.95 1062 List \$12.95

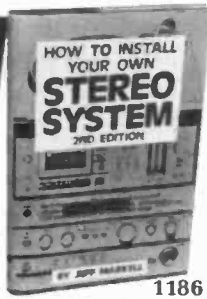
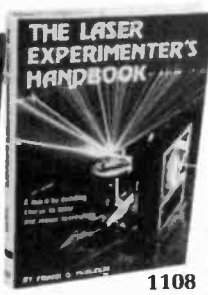

1261 List \$12.95

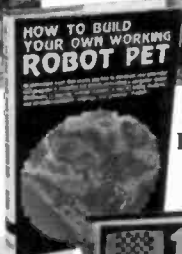
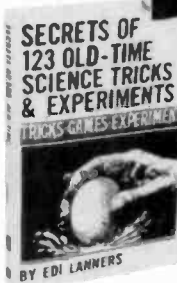

1141 List \$11.95

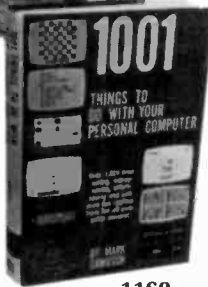

1160 List \$12.95

- 1108 List \$9.95 1186 List \$12.35
- More fine books to pick from . . .**
- 303 Dynamic Electronic Circuits. List \$9.95. No. 1060
 - Modern Digital Communications. List \$10.95. No. 955
 - How To Make Your Own Alcohol Fuels. List \$9.95. No. 2074
 - 99 Test Equipment Projects You Can Build. List \$12.95. No. 805
 - How To Design & Build Your Own Custom TV Games. List \$14.95. No. 1101
 - How To Make Home Electricity From Wind, Water, and Sunshine. List \$10.95. No. 1128
 - The Complete Handbook of Robotics. List \$12.95. No. 1071
 - The Master IC Cookbook. List \$6.95. No. 1199

1076 List \$2.95



1236 List \$14.95



1205 List \$15.95

1155 List \$22.35



1203 List \$14.95



1275 List \$14.95



1201 List \$15.95

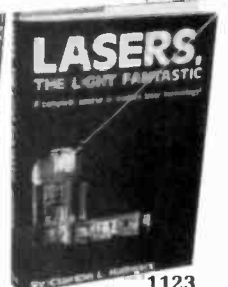

1123 List \$9.95

7 very good reasons to try Electronics Book Club . . .

- **Reduced Member Prices.** Save up to 75% on books sure to increase your know-how
- **Satisfaction Guaranteed.** All books returnable within 10 days without obligation
- **Club News Bulletins.** All about current selections—mains, alternates, extras—plus bonus offers. Comes 14 times a year with dozens of up-to-the-minute titles you can pick from
- **"Automatic Order"**. Do nothing, and the Main selection will be shipped to you automatically! But . . . if you want an Alternate selection—or no books at all—we'll follow the instructions you give on the reply form provided with every News Bulletin
- **Continuing Benefits.** Get a Dividend Certificate with every book purchased after fulfilling Membership obligation, and qualify for discounts on many other volumes
- **Bonus Specials.** Take advantage of sales, events, and added-value promotions
- **Exceptional Quality.** All books are first-rate publisher's editions, filled with useful, up-to-the-minute info

ELECTRONICS BOOK CLUB Blue Ridge Summit, PA 17214

Please accept my Membership in Electronics Book Club and send the 6 volumes circled below. I understand the cost of the books selected is \$2.95 (plus shipping/handling). If not satisfied, I may return the books within ten days without obligation and have my Membership cancelled. I agree to purchase 4 or more books at reduced Club prices during the next 12 months, and may resign any time thereafter.

805	955	1060	1062	1071	1076	1101	1108
1123	1128	1141	1155	1160	1169	1186	1199
1201	1203	1205	1236	1241	1261	1275	2074

Name _____ Phone _____

Address _____

City _____

State _____ Zip _____

(Valid for new members only. Foreign and Canada add 15%.)

RE-381

NEW 16K-RAM PERSONAL COMPUTER

\$249

(And 20% OFF ALL TAPE PROGRAMS)

SPECIAL FACTORY PRICE!!

For \$249, you get new Interact Model "R" Computer, 16K-RAM, 2K-ROM, 8080A Microprocessor, color, sound, full 53 keyboard, high speed cassette deck, AC adapter, R.F. Modulator, Black Console Case, 90 day parts and labor warranty, owners guide, FCC approval, UL LISTED.

SPECIAL FACTORY PACKAGE SALE \$344.

(Lists for over \$740.00)

Everything you get for \$249, plus: Level II Users Manual, Level II basic program tape, Level II command cards, Level II basic examples book. Two 8 axis action controllers. 3 program tapes. Diagnostic instruction program tape, Diagnostic manual, Service manual, Cassette head alignment tape, Schematics and parts list, Money saver service and warranty card. (everything you need to learn to operate, program and service your computer).

(15 DAY FREE TRIAL) - Return within 15 days complete and undamaged for refund of purchase price. Don't miss this sale - order now for Christmas!! Send certified check, money order, or personal check to PROTECTO Enterprises, Box 502, Franklin Park, IL 60131 (312/382-5244) Add \$15 for shipping and insurance via United Parcel. Illinois residents add 6% sales tax. **WE SHIP C.O.D. AND HONOR VISA - MASTER CHARGE ORDERS.**

CIRCLE 44 ON FREE INFORMATION CARD

HOBBY CORNER

continued from page 70

even when you are standing there looking at them. And while you're watching that awesome amount of water flow up and back every few hours, you cannot help but think how much electrical power it could generate.

You stand, watch, and dream just as countless others have done before you. Some day that potential will be harnessed. That will be something to see! (Any new ideas?)

Another clock

If there is a piece of digital equipment that has universal appeal and application, it is the clock.

Larry Neel of Cincinnati, OH has raised a question that brings forth some interesting thoughts. Larry wants a clock that normally displays local time but could give Coordinated Universal Time (GMT for you old-timers) at the push of a switch. I certainly agree that it would be better than using two clocks for hams, SWL's, and others.

I haven't had a chance to work on this problem yet but it doesn't appear to be very difficult. Why not a switchable circuit between the clock IC and the display? That circuit would add five, six, or whatever hours needed to the time before it is displayed. Or perhaps it would be easier to switch between two continuously running clock IC's.

Have any of you built a clock like that? If so, send me the info and I'll pass it along.

Reader question

E. M. Shanley of Novato, CA is looking for a control circuit to operate a piece of apparatus by radio control. The radio part is not causing him a problem—it's what comes after the receiver.

What E.M. needs is a circuit to close and latch a relay on the first pulse, and then open (unlatch) the same relay on the second pulse.

Can anyone offer any help?

Flash anyone?

Frank Eatherton of Alameda, CA is a photographer and is looking for a reliable circuit for a wireless "slave" flash control. Frank says that he is not only tired of tripping over wires, but that it can be costly when he does so and topples over a flash or camera!

What is needed is a small unit to actuate additional flash units when the main one fires. Such a unit could operate by radio or light-control.

If you have developed a flash-control circuit, or any type of wireless control that could be adapted for flash use, send along a schematic with description of the device. Perhaps we can save Frank and other readers from damaging any more camera equipment.

R-E

U.S. & foreign patents

SAY GOODBYE to old manual wire wrapping tools!



**NEW P184
SLIT-N-WRAP**
tool with Tefzel
wire makes
connections as
reliable as
other wrap tools.

Now you can wrap
thick insulated wire
4 TIMES FASTER
with
NO pre-cutting
NO pre-stripping
DAISY CHAIN
RUNS.

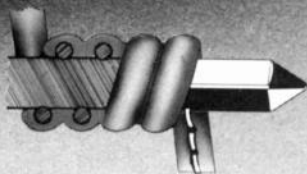

Insulation is slit
open before
wrapping on post,
not between
posts. No unwanted
cut-thru.

P184, with
100' of 28
gage Tefzel
wire, \$30.00.

P184-4T with batteries and recharger, \$105.00 (includes P184).
P184-4T1 110V AC, \$105.00 (includes P184). Tefzel wire, 28 gage, various
colors, \$5.39/100 ft. If not available locally, factory order—add \$3 handling charge.
Prices subject to change without notice.

Vector

ELECTRONIC COMPANY, INC., 12460 Gladstone Av., Sylmar, CA 91342

phone (213) 365-9661, twx 910-496-1539
571177

CIRCLE 39 ON FREE INFORMATION CARD

UNIVOLT'S DT-810 DIGITAL MULTIMETER

The unique space age digital multimeter with transistor gain (hFE) measurement capability should be the only multimeter you own.

Ora Electronics has offered in the past many fine Digital Multimeters (D.M.M.'S). We still sell the famous D.M.M.'S such as Beckman, Fluke, Hickok, and others. We have always followed the advance in technology used in D.M.M.'S, and we always wanted to supply our many good customers with the most Ideal Multimeter, at a price they can afford. In the past we had to sell good, but expensive Multimeters, expensive but "fair" Multimeters, and plain "cheap" Multimeters.

WE FOUND IT!

Several months ago, a famous Test Equipment Manufacturer, walked in to our headquarters with a Prototype of a Digital Multimeter. We were very impressed it had almost everything we wanted plus a bonus, the only question remaining was "how expensive is it?" When we heard the answer, a big smile appeared on our faces. After several improvements we are proud to offer it. After you read the features (and price) I am sure you are going to order one or more, of these fine D.M.M.'S that we call the "UniVolt".

LCD DISPLAY.

The unit has a 3.5 Digit liquid crystal display. The sharp digits are 14mm high and have a viewing angle of 140°.

HIGH ACCURACY.

The basic D.C. accuracy of the UniVolt is 0.5% of reading +1 digit, which makes it one of the more accurate instruments in its class. The input impedance is very high, 10 mega- Ohms (10,000,000) Ohms, which helps in measurements of low voltage and high frequency signals.

MEASUREMENT RANGES.

The UniVolt has D.C. voltage range of 100uv to 1000V in five steps, A.C. voltage range of 100mV to 1000V, current measurement range of 100mA to 10A (DC) and resistance range of 1 to 2,000,000 Ohms.

CONTINUITY & DIODE TEST.

A fast and accurate continuity test mode utilizes a built-in buzzer to indicate continuity. The same mode is used to check diodes and their approximate forward voltage.

EASE OF OPERATION.

The UniVolt is small, it measures 6½" x 3¾" x 1¼". It's light weight, only 9.87 oz. including battery! It utilizes push buttons, for easy one-hand operation and the front panel has a unique color coding for reduced errors.



OVERLOAD PROTECTION

The unit has an extensive overload protection on all ranges. On D.C. current ranges it uses a .5A GMA type fuse. A spare fuse is supplied with the unit at no extra cost.

MAINTENANCE FREE

The heart of the UniVolt Multimeter is a 40 pin L.S.I. chip; the Intersil ICL710G. This space ages chip has proven to be one of the most sophisticated and reliable micro-electronic circuit in use, it is supported by minimum amount of external parts, which are over specified to insure failure safe instrument. Of course, Ora Electronics stands by this instrument and guarantees it for one year (See specific warranty information).

ORA ELECTRONICS

A division of Alliance Research Corp.

**OUR SERVICE
MAKES THE DIFFERENCE**

18215 PARTHENIA ST. NORTHRIDGE, CA 91325
(213) 701-5848 Telex 181011

© 1980 ORA ELECTRONICS

CIRCLE 9 ON FREE INFORMATION CARD

OTHER FEATURES

It uses one 9 volt carbon battery (included), which last approximately 200 hours of continuous use. Its sampling time is 0.4 seconds, operating temperatures of 30°F to 104°F, and operating humidity of less than 80% R.H.

BONUS!!

We left the best to the end. The UniVolt DT-810 has something unique. It has a transistor gain (hFE) measurement mode! This unique feature enables you to measure hFE values of 0-1000 of either P.N.P. or N.P.N. transistors.

SPECIAL PRICE

We had originally decided to sell the unit for \$119.95, but in order to promote the new advancement in D.M.M. design, represented by the UniVolt, for a limited time only you can buy this incredible unit for only \$99.95 including: standard red & black test leads, a fresh 9v carbon battery, a spare 0.5A GMA type fuse and an instruction manual.

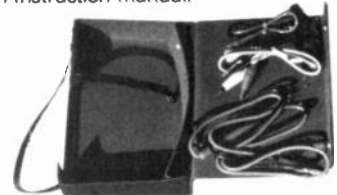

FREE CASE

We have worked long on the UniVolt project and we hate to see scratches or bad looking units. So we decided to go all the way, when you buy the UniVolt DT-810 Multimeter (and for a limited time only!) we will give you absolutely free a hard vinyl leatherette, carrying case, with felt padding and a compartment for your test leads. The regular selling price for this case mode CC-01 is \$8.00.

ACCESSORIES AVAILABLE.

The only two accessories available are: UP-11, hFE probe with special plug and 3 color codes alligator clip, and the UP-12 I.C. clip adaptor, which will help you hook your multimeter to any I.C. pins. (You can buy both probes for only \$6.00, but only when you purchase the UniVolt DT-810 now.)

ORDER NOW!

It's very easy to order your UniVolt DT-810 multimeter. Send \$99.95 (California residents add 6% sales tax) plus \$2.50 delivery charge to the address below, if you want the optional accessories, please add \$6.00 (California residents add 6% sales tax). A cashier check or money order will help speed your order. Credit card holders (master card or visa) can call our toll free number (800) 423-5336, in California it's (800) 382-3663. C.O.D. orders will be accepted, but you must pay by cash or money order and a C.O.D. charge of \$1.40 will be added. If you decided to buy another brand of Multimeter, please call us too, we carry many other types of multimeters and test equipment at low prices.

FREE

The newest in home computers, fine stereo components, color TV, HAM radio, precision test equipment, innovative electronics for the home—all in easy-to-build, money-saving kits.

Send today for your **FREE Heathkit® Catalog**



If coupon is missing, write Heath Co., Dept. 020-752 Benton Harbor, MI 49022

Send to: Heath Co., Dept. 020-752 Benton Harbor, MI 49022

Send my free Heathkit Catalog now. I am not currently receiving your catalog.

Name _____

Address _____

City _____ State _____

CL-724A Zip _____

CIRCLE 25 ON FREE INFORMATION CARD

new products

More information on new products is available. Use the Free Information Card inside the back cover.

ELECTRONIC DESIGN LAB, model CA-16, features a variable-function generator: frequency 1 Hz to 100 kHz variable rate, 2-volts output level, sinewave distortion less than 1%, squarewave TTL and CMOS logic levels, and triangle and sinewave for linear operation. Power supplies include 6 regulated voltages, current-limited and short-circuit proof. Noise: 20 mV under load; There is a +5-volt supply—1-amp maximum load and a +12, +15, -5, -12, -15, 750 mA maximum load.

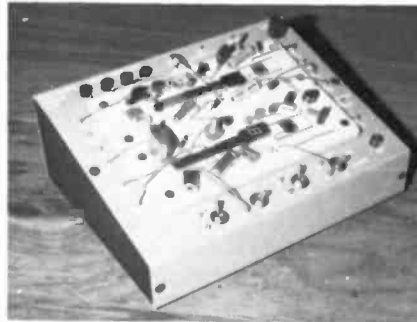

CIRCLE 151 ON FREE INFORMATION CARD

Also featured are four LED logic-level indicators for TTL and CMOS logic, four (Hi and Lo) debounce toggle switches for TTL and CMOS logic, and two CMOS-to-TTL logic-level converters. Everything is at the user's fingertips and the components can be used over and over again. The *model CA-16* has been designed for engineers and technicians for testing new prototypes, modifications, circuit changes, and ideas, and is recommended as a teaching aid for students just starting in electronics. Price is \$99.95.—Cascade Labs, 4156 South Alder Ave., Freeland, WA 98249.

PROGRAMMABLE ELECTRONIC THERMOSTAT, the Comfort Zone, is the only electronic thermostat on today's market that offers triple setback, or the selection of three temperature periods in a 24-hour sequence. In addition, each day in a seven-day sequence can be programmed separately. A full week's program can be entered at one time and will repeat indefinitely until changed.



CIRCLE 152 ON FREE INFORMATION CARD

Comfort Zone has been designed for easy operation: When programming, the user rotates easy-to-use thumbwheel until the desired time

and temperature settings appear on display. Pushing a key enters the time and temperature settings into the unit's memory, and an audio tone tells the user that the information has been properly entered. The previous day's program can be repeated at the touch of a key. When not being programmed, the time, temperature, and the day of the week are on continuous display.

Comfort Zone is fully automatic, but can be used manually for special periods of heating or cooling. The user may also arrange for 10-, 20-, or 30-minute bursts of heat or cold without disrupting the pre-selected program. The device is solid-state, and no additional wiring, transformers, or relays are necessary for installation. A battery protects the microcomputer's memory in the event of power failure. *Comfort Zone's* suggested list price is less than \$200.00—PCI, Incorporated, 1145 Sonora Court, Sunnyvale CA, 94086

FUSE BLOCK, the Snaptrack fuse block series 6BF, features neon indicator lamps that light when a 3AG fuse blows. (The 3AG fuse is very

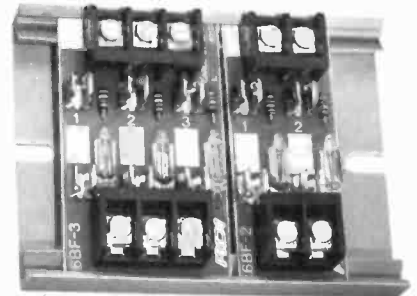

CIRCLE 153 ON FREE INFORMATION CARD

small and difficult to find when blown.) The 6BF-series fuse blocks are available in models carrying two or three fuses. Connections are made via screw terminals. The fuse clips, terminal blocks, and lamps are wave-soldered to epoxy-glass printed-circuit boards that snap-in mount in *Snaptrack* mounting channel; the modules mount easily there, along with relay sockets, edge connectors, power supplies, and other RDI control modules. *Snaptrack* requires only two fasteners per foot of track instead of two fasteners per fuse block. Rating is 10 amperes, 300 volts, with 120-volt neon lamp; the block handles 3AG fuse (1.25 X .25 in.) Price: three fuse modules, \$4.35 each in 100 lots.—RDI, 525 Randy Road, Carol Stream, IL, 60187.

WIDEBAND UHF/VHF AMPLIFIERS, are a line of low-cost, high-performance, prepacked hybrid IC wideband amplifiers for CATV, MATV, and similar applications that has been introduced by Amperex Electronic Corporation. They operate from a 12-volt supply voltage and cover a 40- to 860-MHz frequency range. The line is produced as thin-film circuits on ceramic substrates and consists of 1-, 2-, and 3-stage types, with gain ranging from 12 dB for the single-stage amplifier to 28 dB for the 3-stage type.

The line includes five devices: *ATF445/OM 345* has 12 dB gain and 99 dBμV output; *ATF442/OM350* has 18 dB gain and 100 dBμV output; *ATF443/OM360* has 23 dB gain, 105 dBμV out-

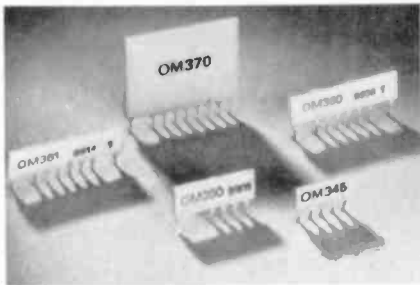

CIRCLE 154 ON FREE INFORMATION CARD

put; ATF444/OM361 has 28 dB gain, 105 dB μ V output, and ATF446/OM370 has 28 dB gain, 113 dB μ V output. Higher gain is achieved by cascading two amplifiers. The hybrid UHF/VHF wide-band amplifiers are priced as low as \$3.05 each (1000 qty) for the AFT445.—**Ampex Electronic Corporation**, Providence Turnpike/P.O. Box 98, Slatersville, RI 02876.

VID-KADDY offers an attractive means of storing the cords and cables at the back of your VCR unit. It is a small, simple storage case that holds the remote pause control device and cable. All that will then be visible will be the compact black

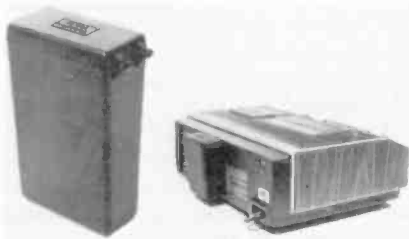

CIRCLE 155 ON FREE INFORMATION CARD

box, but the remote control can still be used easily at any time. *Vid-Kaddy* can be attached with foam tape to the back of the VCR unit in a matter of seconds. Price is \$6.95.—**Video Specialties**, P.O. Box 244, Fraser, MI 48026.

HOBBYIST'S ELECTRONIC COURSE, designed for individuals with little or no previous education in electronics, is arranged in seven easy-to-understand units. The course includes the relationships among voltage, current, resistance and power, magnetism, DC and AC, transformers, inductance, reactance, and the proper use of a voltmeter, ammeter, and ohmmeter. In addition, the fundamentals of rectifiers, filters, power supplies, and oscillators are covered, as well as many types of digital circuits and an explanation of how a digital computer works.



CIRCLE 50 ON FREE INFORMATION CARD

Finally, the course provides an overview of the major electronics hobbies—experimentation and construction, shortwave listening, amateur radio, R/C, personal computing, and high-fidelity audio. Twenty-six optional experiments will provide thorough hands-on experience with electronic devices. They will, however, require that the student purchase the Heathkit/Zenith model ET-3100 Experimenter/Trainer Kit. The Hobbyist's Course is priced at \$54.95; the Trainer Kit is \$74.95.—**Heathkit/Zenith Educational Systems**, Dept. 350-470, Benton Harbor, MI 49022. **R-E**

Let onComputing™ be your guide to personal computing.

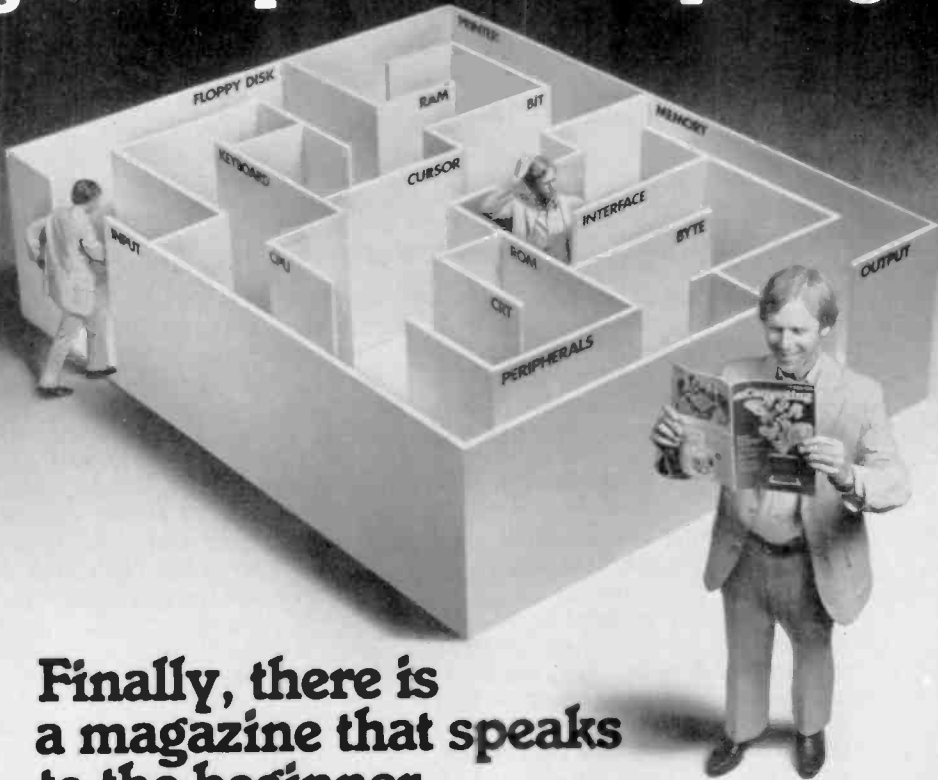

Finally, there is a magazine that speaks to the beginner.

onComputing is the new McGraw-Hill quarterly that tells what's ahead — without talking over your head — in the 1980's with personal computers.

onComputing puts you on target with all the applications that go beyond your imagination.

- Personal computers in the home.
- Classrooms.
- They bring computer music.
- Electronic mail.
- Robots.
- They manage your personalized investment.
- The list goes on and on in **onComputing**.

If you're a beginner with personal computers, get the most understood magazine on computers, **onComputing**. And even if you're an experienced computer user, **onComputing** has the information you need in today's fast-growing personal computer market.

Get onto onComputing. Call 800-258-5485.

onComputing Subscription Dept. P.O. Box 307, Martinsville, NJ 08836

DOMESTIC subscription rate:

U.S. 1 yr. (4 issues) @ \$8.50 Canada & Mexico, 1 yr. (4 issues) @ \$10.00

FOREIGN (to expedite service, please remit in U.S. funds drawn on a U.S. bank)

Europe (and all other countries, except above), 1 Yr. @ \$12.00 — surface delivery.

Bill Visa Bill Master Charge Bill me (North America only)

Card Number

Expiration

Signature

Name (please print)

Street/Apartment Number

City

State/Province/Country Code

7831

Please allow 6-8 weeks for processing.

MARCH 1981

CIRCLE 11 ON FREE INFORMATION CARD

75

Harmonics? Here's a simple and inexpensive way to get rid of them.

HERB FRIEDMAN, COMMUNICATIONS EDITOR

THERE ARE VIRTUALLY NO NEW FRONTIERS left as far as the radio spectrum is concerned. It's no longer a matter of when devices would be introduced that could efficiently generate and amplify transmissions on the next higher slice of the spectrum but rather, it's where do we put everyone who wants to use the radio spectrum.

Until recently, no one really cared where spurious signals from transmitters were going. Early spark-gap telegraph operators actually depended on their signals taking up hundreds of kilohertz with sideband-splash, clicks, pops, and crackles. How else was anyone to know they were on the air? When the interference got too bad (because more than two stations were trying to operate within a half-megahertz of each other) the old Department of Commerce simply forced the CW operators to change from an AC high-voltage supply to DC. That created a thunderous crash of silence in which many stations could operate at the same time.

As equipment improved, so did the rules tightening control of interference. But the harmonics of broadcasting stations still fell in the VHF marine band, and FM stations couldn't have cared less about their harmonics because simply no one was operating at 170 MHz or higher. Radio amateurs had even less of a problem because, until TV came along, their harmonics generally fell within their own bands.

But today there's someone operating on virtually every frequency, and the general rule is that if your station is causing interference to the reception of any other station because of transmitter characteristics such as harmonics or spurious signals, you either fix the problem or you

shut down. It is never the other station's problem. (Even amateur and CB transmitters now have strict limitations on harmonic and spurious output.)

Because of the need to squash all harmonics and spurious signals, many deep-notch filters that were formerly considered oddball, have now become commonplace in VHF and UHF transmitters. A good example of what to expect is the harmonic filter in Heathkit's model VF-7401 two meter scanning transceiver.

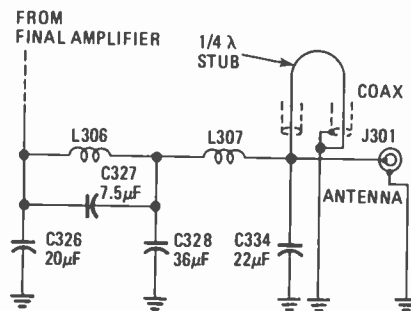

FIG. 1

Figure 1 shows a schematic of this filter. Components L306, C326, C327, C328, L307, C334 form a conventional low-pass filter used for harmonic suppression. The problem is that the L-C filter doesn't provide adequate second harmonic suppression. To cascade standard L-C filters might cause more harm than good because RF tends to seek a free path around the coils and capacitors, and really loss-free L-C filters are fairly expensive.

One way to get an inexpensive, effective filter is to short all, or actually most, of the RF to ground through a tuned line. That is precisely what's done in the VF-7401 by a $1/4$ -wavelength transmission-line stub, shown in Fig. 1 just ahead of

antenna connector J301.

The stub is an electrical $1/4$ -wavelength of shielded cable (coax) coiled within the transceiver. The center conductor is connected to the transmitter output at the junction of L307 and C334. The other end of the stub is shorted, with both the center conductor and shield connected to ground.

If you recall, a $1/4$ -wavelength stub is an impedance inverter. If one end is shorted, the other end appears as a high impedance. So, at the operating frequency, the stub actually does not exist in the circuit because it appears as a high impedance in parallel with the 50-ohm transmitter load (the antenna).

At the second harmonic frequency, however, the stub is an electrical $1/2$ -wavelength. Half-wavelength stubs are impedance repeaters, often called matching transformers. At the operating frequency, what appears at one end also appears at the other. Thus if one end is a short-circuit, the other end appears as a short-circuit and the stub in Fig. 1 is actually a low-impedance path to ground for the second harmonic.

Just because we can coil up a stub made of coax cable within a small cabinet doesn't mean we must always use flexible cable. For higher-power transmitters, rigid transmission line can be used. A practical example of what to expect is the filter used by FM stations whose harmonics interfere with UHF communications. Imagine if you will, an FM station with an assigned frequency of 91.3 MHz. Its fifth harmonic falls at 456.5 MHz, a frequency in the UHF spectrum used by police and fire departments, as well as land transportation systems such as taxi services. Now the fifth harmonic might not sound like much, but if the FM station is running from 10 to 20 kW on its assigned frequency, and its antenna is about one mile from, and on a direct line with, the antenna of a taxi service, it can create all sorts of reception problems for taxis on the fringes of their service area. In an actual instance, the received fifth harmonic was 1.8 μ V at the antenna terminals of a UHF receiver. It "broke" the squelch continually and just about destroyed radio communications for the taxis.

It might appear to be a contest between mismatched opponents, but remember the rule: If your gear creates interference it's your problem. The taxi service does

continued on page 78

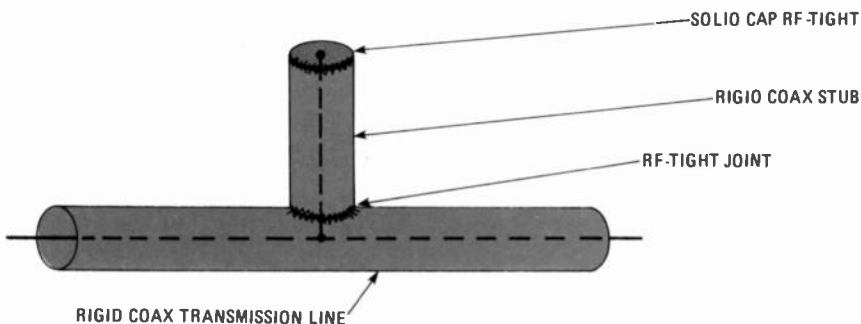

FIG. 2

Start learning and computing for only \$129.95 with a Netronics 8085-based computer kit. Then expand it in low-cost steps to a business/development system with 64k or more RAM, 8" floppy disk drives, hard disks and multi-terminal I/O.

THE NEW EXPLORER/85 SYSTEM

Special! Full 8" floppy, 64k system for less than the price of a mini! Only \$1499.95!

(Also available wired & tested. \$1799.95)

Imagine — for only \$129.95 you can own the starting level of Explorer/85, a computer that's expandable into full business/development capabilities — a computer that can be your beginner system, an OEM controller, or an IBM-formatted 8" disk small business system. From the first day you own Explorer/85, you begin computing on a significant level, and applying principles discussed in leading computer magazines. Explorer/85 features the advanced Intel 8085 cpu, which is 100% compatible with the older 8080A. It offers on-board S-100 bus expansion, Microsoft BASIC in ROM, plus instant conversion to mass storage disk memory with standard IBM-formatted 8" disks. All for only \$129.95, plus the cost of power supply, keyboard/terminal and RF modulator if you don't have them (see our remarkable prices below for these and other accessories). With a Hex Keypad/display front panel, Level "A" can be programmed with no need for a terminal, ideal for a controller, OEM, or a real low-cost start.

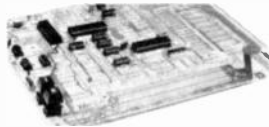

Level "A" is a complete operating system, perfect for beginners, hobbyists, industrial controller use. \$129.95



Full 8" disk system for less than the price of a mini (shown with Netronics Explorer/85 computer and new terminal). System features floppy drive from Control Data Corp., world's largest maker of memory storage systems (not a hobby brand!)

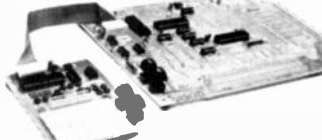

Level "A" With Hex Keypad/Display.

LEVEL "A" SPECIFICATIONS

Explorer/85's Level "A" system features the advanced Intel 8085 cpu, an 8355 ROM with 2k deluxe monitor/operating system, and an advanced 8155 RAM I/O... all on a single motherboard with room for RAM/ROM/PROM/EPROM and S-100 expansion, plus generous prototyping space.

PC Board: Glass epoxy, plated through holes with solder mask. I/O: Provisions for 25-pin (DB25) connector for terminal serial I/O, which can also support a paper tape reader... cassette tape recorder input and output... cassette tape control output... LED output indicator on SOD (serial output) line... printer interface (less drivers)... total of four 8-bit plus one 8-bit I/O ports. Crystal Frequency: 6.144 MHz. Control Switches: Reset and user (RST 7.5) interrupt... additional provisions for RST 5.5, 6.5 and TRAP interrupts on-board. Counter/Timer: Programmable, 14-bit binary. System RAM: 256 bytes located at F800, ideal for smaller systems and for use as an isolated stack area in expanded systems... RAM expandable to 64K via S-100 bus or 4k on motherboard.

System Monitor (Terminal Version): 2k bytes of deluxe system monitor ROM located at F800, leaving 8000 free for user RAM/ROM. Features include tape load with labeling... examine/change contents of memory... insert data... warm start... examine and change all registers... single step with register display at each break point, a debugging/training feature... go to execution address... move blocks of memory from one location to another... fill blocks of memory with a constant... display blocks of memory... automatic baud rate selection to 9600 baud... variable display line length control (1-255 characters/line)... channelized I/O monitor routine with 8-bit parallel output for high-speed printer... serial console in and console out channel so that monitor can communicate with I/O ports.

System Monitor (Hex Keypad/Display Version): Tape load with labeling... tape dump with labeling examine/change contents of memory... insert data warm start... examine and change all registers

single step with register display at each break point... go to execution address. Level "A" in this version makes a perfect controller for industrial applications, and is programmed using the Netronics Hex Keypad/Display. It is low cost, perfect for beginners.

HEX KEYPAD/DISPLAY SPECIFICATIONS

Calculator type keypad with 24 system-defined and 16 user-defined keys. Six digit calculator-type display, that displays full address plus data as well as register and status information.

LEVEL "B" SPECIFICATIONS

Level "B" provides the S-100 signals plus buffers/drivers to support up to six S-100 bus boards, and includes address decoding for onboard 4k RAM expansion selectable in 4k blocks... address decoding for onboard 8k EPROM expansion selectable in 8k blocks... address and data bus drivers for onboard expansion wait state generator (jumper selectable), to allow the use of slower memories... two separate 5 volt regulators

LEVEL "C" SPECIFICATIONS

Level "C" expands Explorer/85's motherboard with a card cage, allowing you to plug up to six S-100 cards directly into the motherboard. Both cage and card are neatly contained inside Explorer's deluxe steel cabinet. Level "C" includes a sheet metal superstructure, a 5-card, gold plated S-100 extension PC board that plugs into the motherboard. Just add required number of S-100 connectors.

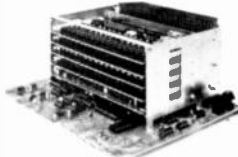

Explorer/85 With Level "C" Card Cage.

LEVEL "D" SPECIFICATIONS

Level "D" provides 4k of RAM, power supply regulation, filtering decoupling components and sockets to expand your Explorer/85 memory to 4k (plus the origi-

nal 256 bytes located in the 8155A). The static RAM can be located anywhere from 8000 to EFFF in 4k blocks.

LEVEL "E" SPECIFICATIONS

Level "E" adds sockets for 8k of EPROM to use the popular Intel 2716 or the TI 2516. It includes all sockets, power supply regulator, heat sink, filtering and decoupling components. Sockets may also be used for 2k x 8 RAM ICs (allowing for up to 12k of onboard RAM).

DISK DRIVE SPECIFICATIONS

- 8" CONTROL DATA CORP professional drive.
- LSI controller
- Write protect
- Single or double density
- Data capacity: 401,016 bytes (SD), 802,032 bytes (DD), unformatted.
- Access time: 25ms (one track)

DISK CONTROLLER/I/O BOARD SPECIFICATIONS

- Control up to four 8" drives.
- 1771A LSI (SD) floppy disk controller
- Onboard data separator (IBM compatible)
- 2 Serial I/O ports
- Autoboot to disk system when system reset
- 2716 PROM socket included for use in custom applications.
- Onboard crystal controlled
- Onboard I/O baud rate generators to 9600 baud
- Double-sided PC board (glass epoxy)

DISK DRIVE CABINET/POWER SUPPLY

- Deluxe steel cabinet with individual power supply for maximum reliability and stability.

ORDER A COORDINATED EXPLORER/85 APPLICATIONS PAK!

Beginner's Pak (Save \$26.00!) — Buy Level "A" (Terminal Version) with Monitor Source Listing and AP-1 5-amp Power Supply; (regular price \$199.95), now at SPECIAL PRICE: \$169.95 plus post. & insur. **Experimenter's Pak II (Save \$53.40!)** — Buy Level "A" (Hex Keypad/Display Version) with Hex Keypad/Display, Intel 8085 User Manual, Level "A" Hex Monitor Source Listing, and AP-1 5-amp Power Supply; (regular price \$279.35), all at SPECIAL PRICE: \$219.95 plus post. & insur.

Special Microsoft BASIC Pak (Save \$103.00!) — Includes Level "A" (Terminal Version), Level "B", Level "D" (4k RAM), Level "E", 8k Microsoft in ROM, Intel 8085 User Manual, Level "A" Monitor Source Listing, and AP-1 5-amp Power Supply; (regular price \$439.70), now yours at SPECIAL PRICE: \$329.95 plus post. & insur.

ADD A TERMINAL WITH CABINET, GET A FREE RF MODULATOR, Save over \$114 at this SPECIAL PRICE: \$499.95 plus post. & insur.

Special 8" Disk Edition Explorer/85 (Save over \$104!) — Includes disk-version Level "A", Level "B", two S-100 connectors and brackets, disk controller, 64k RAM, AP-1 5-amp power supply, Explorer/85 deluxe steel cabinet, cabinet fan, 8" SD/DD disk drive from famous CONTROL DATA CORP. (not a hobby brand!), drive cabinet with power supply, and drive cable set-up for two drives. This package includes everything but terminal and printers (see coupon for them). Regular price \$1630.30, all yours in kit at SPECIAL PRICE: \$1499.95 plus post. & insur. Wired and tested, only \$1799.95.

Special! Complete Business Software Pak (Save \$625.00!) — Includes CPM 2.0, Microsoft BASIC, General Ledger, Accounts Receivable, Accounts Payable, Payroll Package; (regular price \$1325), yours now at SPECIAL PRICE: \$699.95.

Please send the items checked below:

- Explorer/85 Level "A" kit (Terminal Version) \$129.95 plus \$3 post & insur
- Explorer/85 Level "A" kit (Hex Keypad/Display Version) \$129.95 plus \$3 post & insur
- 8k Microsoft BASIC on cassette tape. \$64.95 postpaid.
- 8k Microsoft BASIC in ROM kit (requires Levels "B", "D" and "E"). \$99.95 plus \$2 post & insur
- Level "B" (S-100) kit \$49.95 plus \$2 post & insur
- Level "C" (S-100 6-card expander) kit \$39.95 plus \$2 post & insur
- Level "D" (4k RAM) kit \$99.95 plus \$2 post & insur
- Level "E" (EPROM/ROM) kit \$3.95 plus \$6 p/h
- Deluxe Steel Cabinet for Explorer/85 \$49.95 plus \$3 post & insur
- Fan Far Cabinet \$15.00 plus \$1.50 post & insur
- ASCII Keyboard/Computer Terminal kit: features a full 128 character set, uel case, full cursor control, 75 ohm video output, convertible to baudout output, selectable baud rate RS232-C or 20 ma I/O, 32 or 64 character by 16 line formats and can be used with either a CRT monitor or a TV set (if you have an RF modulator). \$149.95 plus \$3.00 post & insur
- Deluxe Steel Cabinet for ASCII keyboard/terminal \$19.95 plus \$2.50 post & insur
- New! Terminal/Monitor: (See photo) Same features as above except 12" monitor with keyboard and terminal is in deluxe single cabinet kit \$399.95 plus \$7 post & insur
- Hazeltine terminals: Our prices too low to quote — CALL US
- Lear-Sloger terminals/printers: Our prices too low to quote CALL US
- Hex Keypad/Display kit \$99.95 plus \$2 post & insur

- AP-1 Power Supply kit ±8V @ 5 amps in deluxe steel cabinet \$39.95 plus \$2 post & insur
- Gold Plated S-100 Bus Connectors \$4.85 each, postpaid
- RF Modulator kit (allows you to use your TV set as a monitor) \$9.95 postpaid.
- 16k RAM kit (S-100) board expands to 64k \$199.95 plus \$2 post & insur
- 32k RAM kit \$299.95 plus \$2 post & insur
- 48k RAM kit \$399.95 plus \$2 post & insur
- 64k RAM kit \$499.95 plus \$2 post & insur
- 16k RAM Expansion kit (to expand any of the above in 16k blocks up to 64k). \$99.95 plus \$2 post & insur each
- Intel 8085 cpu Users' Manual. \$7.50 postpaid
- 12" Video Monitor (10MHz bandwidth) \$139.95 plus \$5 post & insur
- Beginner's Pak (see above) \$199.95 plus \$4 post. & insur
- Experimenter's Pak (see above) \$219.95 plus \$6 post & insur
- Special Microsoft BASIC Pak Without Terminal (see above) \$329.95 plus \$7 post & insur
- Same as above, plus ASCII Keyboard Terminal With Cabinet, Get Free RF Modulator (see above) \$499.95 plus \$10 post & insur
- Special 8" Disk Edition Explorer/85 (see above) \$1499.95 plus \$26 post & insur
- Wired & Tested \$1799.95 plus \$26 post & insur
- Extra 8" CDC Floppy Drives \$499.95 plus \$12 post & insur
- Cabinet & Power Supply For Drive \$99.95 plus \$3 post & insur
- Drive Cable Set-up For Two Drives \$25 plus \$1.50 post & insur

- Disk Controller Board With I/O Ports \$199.95 plus \$2 post & insur
 - Special: Complete Business Software Pak (see above) \$999.95 postpaid
- SOLD SEPARATELY
- CPM 1.4 \$100 postpaid
 - CPM 2.0 \$130 postpaid
 - Microsoft BASIC \$325 postpaid
 - Intel 8085 cpu User Manual \$7.50 postpaid.
 - Level "A" Monitor Source Listing \$25 postpaid

Continental U.S.A. Credit Card Buyers Outside Connecticut

CALL TOLL FREE: 800-243-7428

Te Order From Connecticut Or For Technical Assistance, call (203) 354-9375

Total Enclosed (Conn res. add sales tax) \$ _____
 Paid By:
 Personal Check Cashier's Check/Money Order
 VISA Master Charge (Bank No. _____)
 Acct. No. _____ Exp. Date _____
 Signature _____
 Print Name _____
 Address _____
 City _____
 State _____ Zip _____

NETRONICS Research & Development Ltd.
 333 Litchfield Road, New Milford, CT 06776

CIRCLE 59 ON FREE INFORMATION CARD

INTERNATIONAL FM-2400CH

FREQUENCY METER FOR TESTING MOBILE TRANSMITTERS AND RECEIVERS

Portable • Solid State • Rechargeable Batteries

The FM-2400CH provides an accurate frequency standard for testing and adjustment of mobile transmitters and receivers at predetermined frequencies.

The FM-2400CH with its extended range covers 25 to 1000 MHz.

The frequencies can be those of the radio frequency channels of operation and/or the intermediate frequen-

cies of the receiver between 5 MHz and 40 MHz.

Frequency stability: $\pm .0005\%$ from $+50^\circ$ to $+104^\circ\text{F}$.

Frequency stability with built-in thermometer and temperature corrected charts: $\pm .00025\%$ from $+25^\circ$ to $+125^\circ$ (.000125% special 450 MHz crystals available).

- Tests Predetermined Frequencies 25 to 1000 MHz
- Extended Range Covers 950 MHz Band
- Pin Diode Attenuator for Full Range Coverage as Signal Generator
- Measures FM Deviation.

FM-2400CH (meter only) \$690.49

RF crystals (with temperature correction) \$28.89 ea.

RF crystals (less temperature correction) \$21.92 ea.

IF crystals catalog price

Write for catalog



INTERNATIONAL CRYSTAL MFG. CO., INC.
10 North Lee Oklahoma City, Okla. 73102

CIRCLE 51 ON FREE INFORMATION CARD

DON'T FORGET

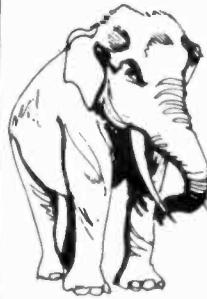

USE
YOUR
READER
SERVICE
CARD

COMMUNICATIONS CORNER

continued from page 76

not shut down or change frequency (the FCC did not permit a change). But the FM station must eliminate the interference or shut down. The fact that the FCC might have made a mistake in assigning a UHF channel located close to the FM station, and directly on the fifth harmonic, has nothing whatsoever to do with it. The fifth harmonic goes or else!

This problem can be handled by a stub serving as a harmonic filter. Figure 2 shows how it's done. The transmission line is a 50.5 ohm 3-inch rigid line that resembles a large pipe. The center conductor is copper tubing, approximately $\frac{5}{8}$ -inch in diameter. A filter, of the same material and construction as the transmission line, is soldered to the line and its shield and the center conductor are short-circuited at the end by a solid air-tight cap so that there are no breaks for the RF to escape. What we end up with is a grounded, fully shielded, stub. The effective attenuation is about 60 to 80 dB.

As the spectrum reaches saturation on a continuing basis, the need for, and use of, deep-notch filters will become more commonplace. Keep this in mind the next time you're working on a transmitter of any sort. The little piece of extra transmission line just might be the filter that allows the rig to stay on the air. R-E

HICKOK
the value innovator



DMM + Vari-Pitch + Logi-Trax = MX-333 World's Fastest Troubleshooter



Model 333
Model 331

- 0.1% Basic Accuracy
- LCD Display In Unique Wide Vue Case
- Uses Single 9V Battery
- Compact Size. Rugged Construction

- Overload Protection
- Exclusive VARI-PITCH Audible Output (MX333)
- Fast LOGI-TRAK Logic Function (MX333)
- 20 Ω Range (MX333)

... plus these popular sellers in stock and available for immediate delivery.

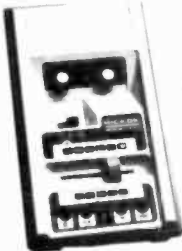

Compact Video Generator

- Video output for VTR, CCTV and monitor applications
- Adjustable RF channel 2-4
- 11 rock stable patterns • 10 step gray scale staircase • 3 bar and 10 bar gated rainbows
- Adjustable chroma levels (0-150%) • Crystal controlled chroma and timing oscillators for stability from 20' to 125'
- Rugged high impact thermoplastic case and protective cover

Model 240



Pocket Semiconductor Analyzer

- Automatic, "hands-off" operation — frees both hands for troubleshooting
- Instant GOOD-BAD analysis — including LEAKAGE — of NPN's, PNP's, FET's, diodes & SCR's, in or out-of-circuit.
- Rugged, all solid state — no moving parts
- Compact polypropylene case
- Will not damage transistors, diodes, or circuits under test
- Powered by 2 std. 9 V batteries (not inc.)

Model 216



LCD Digital Multimeter

- Automatic polarity, zero and overrange indication
- Easy-to-read $1\frac{1}{2}$ " high LCD display
- 7 year battery life in typical use
- 12 oz. including 9V battery
- Withstands 4 ft. drop without loss of accuracy
- Automatic decimal point, built in low battery indicator, diode and transistor testing capability (LX304 only)

LX 304 LX 303

Order with Confidence and get the **Fordham Advantage!**

Call for our prices **TOLL FREE**
(800) 645-9518
in N.Y. State call (516) 752-0050

FORDHAM

855 Conklin St. Farmingdale, N.Y. 11735



- Master Charge
- BankAmericard
- VISA • COD
- Money Order
- Check
- COD's extra

THE AFFORDABLE HOME COMPUTER



When PMC-80 was first introduced to the United States, the response was overwhelming! The Computer World was **ASTONISHED** at the **QUALITY**, as well as the **PRICE**. In fact, the PMC-80 has almost all the features of America's best selling computer, the TRS-80, but with a price tag of \$200.00 less! (SIMUTEK'S price is \$250.00 less!)

Microsoft's Level II Basic and 16K Memory.

Another reason for all the commotion is that the PMC-80 uses the same, easy to learn, LEVEL II BASIC language that the TRS-80 uses! What does this mean? It means that the PMC-80 can run all the 1000's of programs that have been written for the TRS-80 Level II, 16K computer! Some of the programs available include: Flight simulation, World Champion Chess program, Scores of educational and business programs, Word processing programs and hundreds of other games and simulations.

The PMC-80 is expandable!

Your PMC-80 is ready to grow with your needs. Using a special cable, available from Simutek for \$35.00, it may be connected to Radio Shack's Expansion interface, to give you up to 48,000 characters of memory, up to 4 disk drives, addition of a telephone communication system, Voice Synthesizer, various printers, a real time clock, as well as plotters and other neat interfaces! As your skills with the PMC-80 improve, you're sure to want some of the ADD-ON's described above (And these are just a few!) **Save Money! Use your own television!**

The PMC-80 has a built in RF MODULATOR so you can use your black and white or color TV for a VIDEO MONITOR! A simple hook-up to your television's antenna connector, makes channel 3 your computer's video channel. **Special Introductory Offer: 25 Free Programs**

SIMUTEK, a leading innovator in Home Computer Software, is making a **SPECTACULAR INTRODUCTORY OFFER**

IS NOW ON SALE.

destroyers, etc!, STAR WARS: Fly your space fighter into the Death Star to destroy it! But watch out, Darth Vader doesn't like you!, SPACE TARGET: A fantastic animated arcade game of skill and daring!, SAUCERS: Can you win the coveted Medal of Honor?

Here's what you get:

The PMC-80 microcomputer with 16,000 characters of "In Computer Memory", Microsoft's Level II Basic (built into the computer), a cassette player for storing or retrieving programs or data (cassette player is built into the computer!), an RF Modulator for connecting the PMC-80 to your television set, 25 FREE programs so you start using your computer immediately, complete instruction manual, learning manual and owners manual so you can begin writing your own programs right away!

Best of all, you have the chance to use the PMC-80 in your own home before making your final commitment! Keep it for two weeks, if, for any reason you decide not to become a PMC-80 owner simply send it back, (in new condition please), and we will promptly refund the full amount, including your delivery charge!

Comparison Chart

Features	PMC-80	TRS-80
Microsoft's Fantastic Level II Basic	Yes	Yes
Full 128 x 48 Graphics	Yes	Yes
16,000 characters memory	Yes	Yes
Tape recorder for storing or retrieving programs	Yes	Yes
Use your own TV (Save \$5)	Yes	No
Expandable to 48,000 characters of in computer memory	Yes	Yes
Use TRS-80 expansion interface	Yes	Yes
Expandable to 4 floppy disk drives (over 100,000 characters of storage on each one!)	Yes	Yes
Telephone Communications available connect to large computers / electronic mail etc	Yes	Yes
1000's of ready made programs available for "educational" and "scientific" applications?	Yes	Yes
Printers available	Yes	Yes
High Speed Z80 CPU	Yes	Yes
Interface available for controlling lights and appliances in home	Yes	Yes
Retail Price	\$645.00	\$849.00

to people that ORDER the PMC-80 NOW. With each purchase, we will give 25 FREE HOME COMPUTER PROGRAMS! Some of these include: Home Amortization tables program, Loan payment programs, Depreciation rate program, Interest table program, Annuity and Investment calculation programs as well as these great animated games: GRAPHIC-TREK 2000: Command the Enterprise!, INVASION WORG. Stop the invading marauders from space before they take over earth! You command Earth's forces of androids, space fighters, laser guns etc., against the enemy's robots, saucers, proton

CIRCLE 45 ON FREE INFORMATION CARD

Order Now Save \$50.00

Credit card holders may use our TOLL FREE NUMBER. Or send check for \$595.00 plus \$6.00 delivery. (Arizona residents add \$35.50 state tax) Please mention this magazine. (No tax on out of state orders).

**Call Toll Free
800-528-1149**

In Arizona call 602-886-5880 Collect

SIMUTEK COMPUTER PRODUCTS™

9881 E. Skyview Drive
Tucson, AZ 85710

TRS 80 is a registered trademark of Radio Shack a Tandy Corp

fact: a Shure stylus is a sound investment

A new stylus (needle) can actually save you money. Even a precision crafted diamond stylus eventually wears out, and a worn or broken stylus tip can damage your records in a single play! Protect your records by checking your stylus at least once a year. Your Shure dealer can inspect it, and if necessary, replace your stylus with a Genuine Shure replacement stylus that will bring your cartridge right back to its original specifications.



FREE! Shure Music-Lovers Stylus Guide

Cartridges don't wear out stylis do! This and many other helpful facts are discussed in a new pamphlet recently prepared by Shure. It includes everything you need to know to keep your Shure cartridge in perfect operating order. It even contains details on how you can improve the performance of some Shure cartridges beyond their original specifications. To get your copy, stop in at your Shure dealer, or write to Shure at the address listed below and ask for AL633



Shure Brothers Inc., 222 Hartrey Ave.
Evanston, IL 60204

In Canada: A. C. Simmonds & Sons Limited
Outside the U.S. or Canada, write to
Shure Brothers Inc., Attn: Dept. J6
for information on your local Shure distributor.
Manufacturers of high fidelity components,
microphones, sound systems and related
circuitry.

CIRCLE 52 ON FREE INFORMATION CARD

radio products

More information on radio products is available. Use the Free Information Card inside the back cover.

NEW 6.14 dBi GAIN omni-directional CB antenna, the *Sigma IV*, gives CB'ers the ability to transmit and receive farther than ever thought possible with an omni-directional antenna. Excellent bandwidth provides for a 1.1:1 SWR at resonance with 1.5:1 or better over all 40 channels. Unlike conventional bottom-radiating antennas, the *Sigma IV* radiates the majority of the signal from high

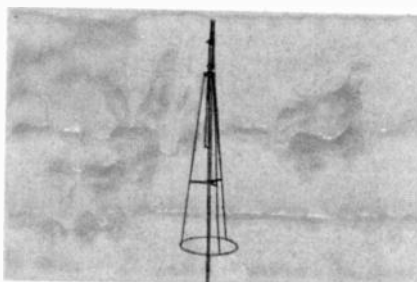

CIRCLE 121 ON FREE INFORMATION CARD

up on the antenna, giving an extra boost in performance. The antenna may even be mounted at ground-level—there's no need for tower or mast mounting to achieve excellence. The *Sigma IV* has an RF safety factor of 2,000 watts. Cost is \$89.95.—Avanti Research and Development, Inc., 340 Stewart Avenue, Addison, IL 60101.

TRANSCIVER, OMNI-C Series, model 546, covers bands from 160 through 10 meters and has all nine high-frequency bands, with crystals included for seven of the nine bands. It features a three-mode, two-range offset-tuning capability with a choice of offset tuning for the receiver, transmitter, or combined transceiver. Switching is provid-



CIRCLE 122 ON FREE INFORMATION CARD

ed for selecting the standard 8-pole 2.4 kHz SSB filter, the optional 1.8 kHz 8-pole SSB filter, the optional 250-Hz or 500-Hz 8-pole CW filters, cascading them for 16 poles of filtering, or placing them in the signal path along with 450 and 150 Hz active audio filters. The *OMNI-C* also has "hang" AGC and a standard noise blanker. Price is \$1189.—TEN-TEC, Inc., Highway 411 E., Sevierville, TN 37862.

TRANSMITTER KIT, model 1750 Meter Transmitter, for the 160 to 190 kHz experimenter's band. Operation at one-watt input power and with a 50-foot maximum antenna length is allowed by the FCC with no license required. The transmitter has two parts: The main assembly contains the frequency generator, power supply, and control panel, and is located at the operating



CIRCLE 123 ON FREE INFORMATION CARD

position. The antenna-tuning assembly mounts at the base of the antenna. The transmitter is for CW operation but can easily be converted to AM. Wiring of the kit takes about an hour using simple tools. Complete assembly and operating instructions are included. Suggested retail price is \$145.—Palomar Engineers, Box 455, Escondido, CA 92025.

MAGNET MOUNT, model K-350, comprises a heavy-duty, professional-grade magnet base with pre-assembled RG-58U cable and fittings to accommodate virtually all standard base-loaded or low-profile whips. The assembly will accommodate either 1/4-24 threadbase-loaded whips or, with an adapter (furnished), 1 1/2-18 thread. Cable



CIRCLE 124 ON FREE INFORMATION CARD

length is 12 feet, ample for rooftop vehicle installations, and is furnished with a pre-assembled PL-259 standard RF connector. The suggested retail price is \$28.75.—The Antenna Specialists Co., Professional Division, 1234 Euclid Ave., Cleveland, OH 44106.

AUTOMATIC ANTENNA TUNER, Auto Track model AT2500 is for use with amateur, commercial, and government communications systems. It can handle power in excess of 2500 PEP over a frequency range continuous from 3 to 30 MHz,



CIRCLE 125 ON FREE INFORMATION CARD

and the average automatic tune-up time is 15 seconds. Front-panel switch positions permit use
continued on page 82

ALBIA Electronics

NEW... LOW COST CAPACITANCE METER MODULE!!

NOT A KIT

Completely assembled and tested... for only

\$49⁹⁵
Includes Warranty

INSTANT ORDER INFORMATION BELOW!

Connect this high-quality Albia Capacitance Meter Module Model DM-8 to your digital multimeter and turn it into a Digital Capacitance Meter — the low cost way!

- Push to read range (button) from 1 pf to 20,000 μ F.
- Zero calibration control
- In one easy to use, self-contained package
- Battery powered (with "push to read" battery saver)

IN STOCK! IMMEDIATE DELIVERY!



LOW COST HIGH FREQUENCY COUNTER

NOT A KIT

The Albia Model DM-7, 8 Digit High Frequency Counter is easy to use, switch selectable time base input by a single BNC, nothing to build — nothing more to buy!

- 5 Hz to 550 MHz
- 8 big easy-to-read .43" high intensity LED display
- Crystal (± 3 ppm @ 25°C) controlled 0.1 or 1.0 sec. gate times
- Convenient benchtop size (7"x10"x3") durable attractive case

NEVER BEFORE AT THIS LOW PRICE

\$119⁹⁵
Includes Warranty



COMPLETELY ASSEMBLED • PRE-CALIBRATED • PRE-TESTED

NOT A KIT

NEW ALBIA DESIGN-MATE CIRCUIT DESIGNER

Albia Quality Hardware — your ideas — not a kit — pre-wired pre-tested — don't let this price fool you, this is a high quality, high IC capacity, portable self-contained circuit designer — includes:

- Control switches and buffered LED logic indicators.
- Plug in your IC's into solderless breadboards, tie in power and ground, connect your logic switches and LED indicators — FAST, EASY TO USE!
- All interconnections between LED's, switches, and circuits via 22-26 solid wire.
- Self-powered, in one compact, good looking and durable carrying case.
- Ideal for home experiments, the laboratory and students.
- Battery (4 1 1/2 Volt C cells*) or AC powered provides economical bench use or convenient portable use. Available in two models.



Albia Model DM-5A containing 4 LEDs and 4 logic switches

\$49⁹⁵
Includes Warranty

Albia Model DM-5 contains 8 LEDs and 8 logic switches
*Batteries not included.

\$64⁹⁵
Includes Warranty

INSTANT ORDER INFORMATION BELOW!

ALBIA'S ECONOMY DIGITAL DM-9 MULTI-LOGIC COMPATIBLE 5-15VDC PROBE

The features are many on this quality Albia test instrument; will detect low repeat rate pulses (up to 1.5 MHz); detects low, high or pulsed logic levels with a minimum detectable pulse width of 300 nsec. Easy-to-interpret 3 LED readout. Built-in over-voltage and reverse polarity protection.

\$26⁹⁵
Includes Warranty

IMMEDIATE DELIVERY... NOT A KIT

ALBIA EXTERNAL REGULATED, SHORT PROOF ADAPTER

Model DM-5B, supplies up to 300 Milliamps at 5V, saves batteries...

\$19⁹⁵
Includes Warranty

REGULATED TRIPLE POWER SUPPLY BARGAIN PRICED ALBIA MODEL DM-6

A fully assembled and tested power supply that provides a solid, fully wired triple power supply including fixed 5V @ 1 Amp, 5V to 15V @ 0.5 Amp, and -5V to -15V @ 0.5 Amp — all supplies regulated, short proof. Each supply has short indicator LED. Complete and ready for use in a durable (8"x6"x3 1/2") metal case.

\$79⁹⁵
Includes Warranty



FREE!!
BIG
1981 SALE
CATALOG

42 pages of exciting bargains! Send today!!



ALBIA SATISFACTION WARRANTY:

If for any reason, whatsoever, you are not completely satisfied with your purchase, return it within 30 days of purchase date for a full refund — it's as simple as that!

FOR FAST AND DEPENDABLE DELIVERY SERVICE

CALL TOLL FREE: 1-800-243-6953

WE ACCEPT MASTER CHARGE, VISA AND AMEX CREDIT CARDS
Connecticut Residents add 7 1/2% Sales Tax • Prices shown in U.S. currency only. Foreign orders add 15%.

ALBIA ELECTRONICS INC

24 Albia St. • New Haven, CT 06512

ORDERS	ADD
UP TO \$10.00	\$1.75
\$10.01 - \$25.00	2.25
\$25.01 - \$50.00	2.75
\$50.01 - \$100.00	3.25
ORDERS OVER \$100.00 WITHIN UNITED STATES	N/C



FREE ALBIA "TEMPLATE" WITH EVERY ORDER RECEIVED by March 25, 1981



JAN CRYSTALS
HOLD THE FREQUENCY

- CB
- CB standard
- 2 meter
- Scanners
- Amateur Bands
- General Communication
- Industry
- Marine VHF
- Micro processor crystals

Send 10¢ for our latest catalog. Write or phone for more details.



JAN CRYSTALS
 P.O. Box 06017
 Ft. Myers, Florida 33906
 all phones (813) 936-2397

CIRCLE 27 ON FREE INFORMATION CARD

RADIO PRODUCTS
continued from page 80

of three coaxial antenna outputs, one long-wire antenna, and one coaxial tuner bypass. The impedance is 10-300 ohms. A direct-reading SWR meter on the front panel is calibrated from 1.1 to infinity.

The front-panel power meter displays RMS power with continuous (CW) carrier and automatically displays the peak power when in the SSB mode in ranges of 0-250 W and 0-2500 W.

The price of the model AT2500 is \$698.00. —Bell Industries, J. W. Miller Division, 19070 Reyes Ave., P.O. Box 5825, Compton, CA 90224.

VARIABLE FILTER, the *Varifilter* can be set to maximize one signal (peaking) or to minimize an interfering signal (notching); it works with CW (Morse), single-sideband, and AM signals, without ringing, oscillation, or instability. The bandwidth is variable from under 30 Hz to over 1 kHz.

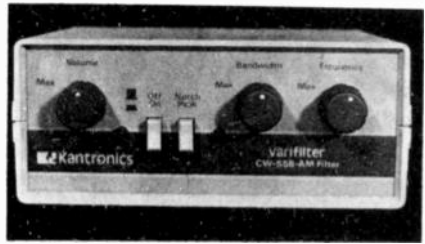

CIRCLE 126 ON FREE INFORMATION CARD

The *Varifilter* has its own internal power supply, which is switchable from 115 to 230 VAC, and can also run from 12 to 18 VDC. Each unit has a tuning eye that lets the operator see when he has filtered the signal he wants to.

The *Varifilter* is priced at \$139.95. —Kantronics, 1202 E. 23rd Street, Lawrence, KS 66044.

UNICORN-
continued from page 66

et. Table 2 will also help you with that. Because it is possible to insert the boards into the sockets backwards, we recommend that you use a marker pen or nail polish to indicate the finger-1 edge of the board and the pin-1 end of the socket. If the boards are removed and then replaced, lining up the marks will prevent embarrassing accidents.

Things to come

Because the radio/computer-control section of the robot involves so many parts, it is impossible to present everything in one section and make the transition from a cable-controlled robot to a radio-controlled one in a single jump.

The circuit described here, though, can be checked out by disconnecting the switches in the command console from the 12-volt supply, and providing them with five volts, instead. The motor and solenoid wiring inside the robot, which has served us well, can now be connected to the relays via the pins on the relay-board socket. Refer to Tables 1 and 3 in Part 7. The five-volts from the command-console switches can now be supplied, via the existing umbilical cable.

Next month we'll present the radio-control tone-encoding and decoding circuits, and Unicorn-1 will be able to cut its apron strings. R-E

ORDER FORM

Electronics Paperback Book Club
 Quality Paperbacks at Affordable Prices

\$15 for a 15% discount

I've checked off the book I want **FREE** and have included my \$15 membership fee. I understand that this fee makes me a member of your book club for one year and that during that time I can order as many books as I want and deduct 15% from the list price.

\$25 for a 20% discount

I've checked off the free book and have enclosed my \$25 membership fee. I understand that this fee makes me a member of your book club for one year and that during that time I can order as many books as I want and deduct 20% from the list price. I further understand that I can use my \$25 membership fee as a credit toward future purchases.

CASH NOW I've checked off the books that I want to buy.

To order from this ad: Check off the books you want. Total the prices. Add in 25¢ per book for shipping. NY State residents add Sales Tax. Total it up, enclose your check and mail.

- 1st Book of Hi-Fi Loudspeaker Enclosures \$2.75
- Radio Circuits Using IC's \$3.50
- Single IC Projects \$3.95
- IC 555 Projects (Expanded Edition) \$4.50
- Handbook Of IC Equivalents and Substitutes \$1.95
- First Book Of Diode Characteristics, Equivalents & Substitutes \$2.95
- A Practical Introduction to Digital IC's \$2.95
- Beginners Guide To Building Electronic Projects \$3.50
- Essential Theory For the Electronics Hobbyist \$3.50
- 1st Book Of Transistor Equivalents and Substitutes \$1.95
- 2nd Book Of Transistor Equivalents and Substitutes \$2.95
- How To Build Your Own Metal & Treasure Locators \$2.95

- Electronic Test Equipment Construction \$4.50
- 52 Projects Using The 741 \$2.95
- 28 Tested Transistor Projects \$3.50
- Electronic Calculator Users Handbook \$2.95
- Handbook Of IC Audio Preamp and Power Amp Construction \$3.25
- 50 Circuits Using Germanium Silicon and Zener Diodes \$2.25
- 50 Projects using Relays SCR's and Triacs \$2.95
- 50 FET (Field Effect Transistor) Projects \$3.50
- Digital IC Equivalents and Pin Connections \$6.95
- Linear IC Equivalents and Pin Connections \$6.95
- 50 Simple LED Circuits \$2.25
- How To Make Walkie-Talkies \$3.50
- Popular Electronic Projects \$3.50
- Electronic Music and Creative Tape Recording \$3.50
- Projects In Opto Electronics \$3.50

ORDERING INFORMATION

How many books have you ordered

Total Price

Shipping and Handling
 (60¢ 1 or 2 books. 25¢ each addl.)

Subtotal

Sales Tax (NY State Residents only)

Total Enclosed

MAIL TO:

ELECTRONIC TECHNOLOGY TODAY INC.
 17 Slate Lane, Central Islip, NY 11722
 No Canadian Orders

Signature

Name

Address

City State Zip

service clinic

The time constant is the key to recognizing faults in oscillator circuits.

JACK DARR, SERVICE EDITOR

AN OLD PROBLEM HAS COME UP AGAIN—incorrect time-constants in critical TV sweep-circuits. All circuits are critical, of course, but the two sweep oscillators are even more so. If the basic problem is recognized when you begin the diagnosis, it's a lot easier all around.

The symptom is that the oscillator is running, but at the wrong frequency. Vertical oscillators cause the display of two pictures, or an overlapped picture which can look almost like the first. If you see two complete pictures, but only half-height, the vertical oscillator is running at half-frequency—30 Hz. If you see two overlapped pictures, the oscillator's running at double frequency, or 120 Hz. In all cases, that is due to an incorrect time-constant in the frequency-controlling circuitry. In the multivibrator types so popular a while ago, that was an R-C time constant and resistor drift or capacitor leakage threw it off. In some of the new sets, however, oscillator transformers are coming back.

In the case that triggered this column, a *Quasar TS-938*, a two-winding transformer is used. The primary winding goes to the collector, and secondary to the base of the transistor. There is a resonating capacitor and some resistors across the secondary. That is shown in Fig. 1. The

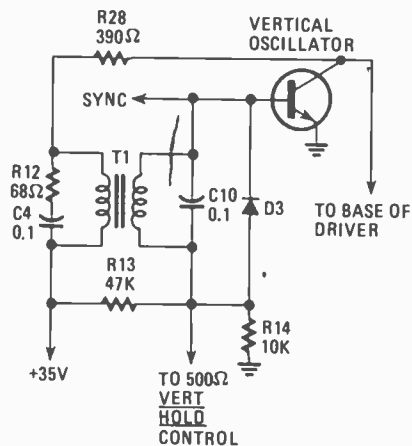

FIG. 1

time-constant involves all of the components: the secondary winding, the capacitor, and the resistors. All of those should be checked.

The symptom here was two complete

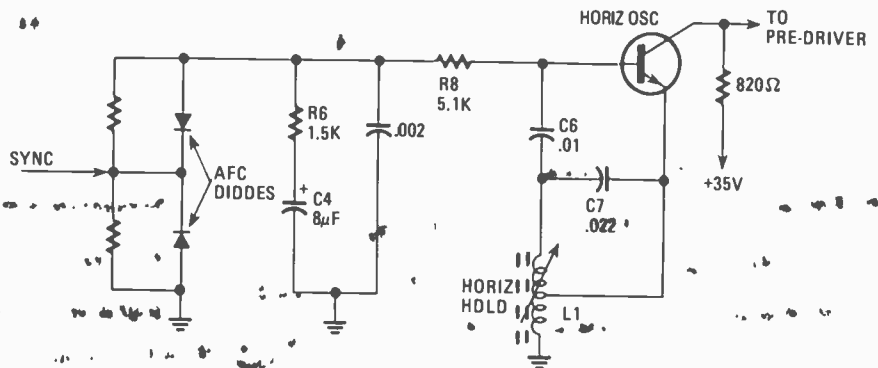

FIG. 2

pictures. The oscillator frequency was checked on a scope and it was 30 Hz, thus the oscillator was running slow. That is a valuable clue. A low frequency tells us that one of the values is far too large so a component must have increased in value. We have three possibilities: inductance, capacitance, and resistance. It is quite impossible for an inductor to go up in value. The same is true for a paper capacitor. So, we can eliminate those. That leaves us with resistance. And indeed it's quite possible for a resistor to increase in value. There are three resistors used: R13 (47K ohms); R14 (10K ohms); and the 500-ohm hold control. Checking those out showed that R13 had gone up to more than 100K ohms. After replacing it, the problem cleared up! You can see the reasoning that eliminated most of the components, and left us with the only ones that could produce the indicated fault. Incidentally, the DC voltages around the stage were very close to normal so, in this case they weren't of much help. But the picture on the screen plus confirmation with the scope gave us the needed information very quickly.

In similar cases with older sets, a slightly leaky capacitor in the feedback loop (output-stage plate back through an R-C network to the input grid) can upset the time constant and cause off-frequency operation. In a great percentage of those cases, the culprit was the last capacitor in the loop going to the input grid. Here, it affected the oscillator time-constant. By the same reasoning, a leaky coupling capacitor from the sync-separator to that grid can also upset things.

And the same thing can happen in the horizontal-oscillator stages too. In the cathode-coupled (emitter-coupled) circuit, where a tapped coil is used in the grid-cathode (base-emitter) circuit, there will be resonating capacitors across the coil. There is also a coupling capacitor from the top of the coil to the input. All of those capacitors are critical. Even very small leakage in any of them can cause trouble.

The horizontal AFC circuit can cause off-frequency operation, in some cases. That can be mistaken for a time-constant problem in the oscillator. Luckily, there is a very simple test for it: Just kill the AFC, and see if you can make the oscillator run on-frequency with the hold control. If so, the oscillator is OK and you have to deal with the AFC.

You do have some time-constant circuits in the horizontal AFC, by the way. Note the filtering circuitry between the AFC diodes and the oscillator base in Fig. 2. You can get a real headache if some of those parts have gone off-value.

There is an electrolytic capacitor and that can go down in value. One function of the filter network is to remove all sync signals from the AFC-control voltage. Failure will allow the sync to get into the oscillator control, and the result will be a "mysterious" horizontal jitter. Here again, don't rely on DC-voltage readings exclusively. The scope will show you whether there is any unwanted signal on the oscillator base, and that is a key clue.

R-E

Service questions are on page 86

Radio- Electronics

Copyright © Gernsback Publications Inc., 1980

**SPECIAL REPRINT
BUILD A BACKYARD SATELLITE TV RECEIVER**

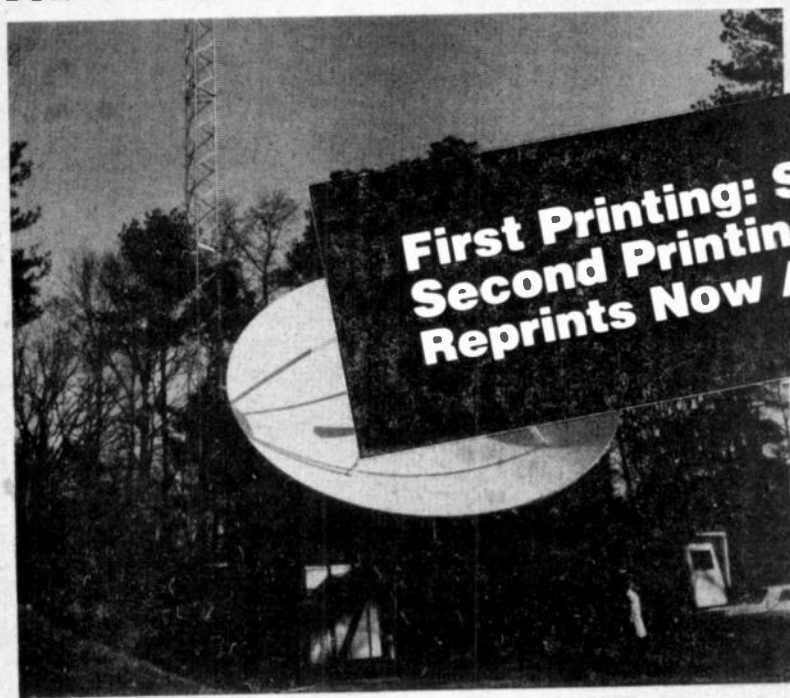

**First Printing: Sold Out!
Second Printing - Just Off Press!
Reprints Now Available!**

Don't miss out again!

Send away today for your 36-page booklet containing a complete reprint of all seven articles in the series on Backyard Satellite TV Receivers by Robert B. Cooper Jr.

This all-inclusive report gives you all the data you need to build your own Backyard Satellite TV Receiver.

- TELLS ALL ABOUT domestic satellite communications, with full details on how you can pull those elusive TV signals from space.
- LEGAL REQUIREMENTS, technical specifications, and how you, the

home constructor, can meet them. Find out what mechanical and electronics skills you need.

■ RECEIVER CHARACTERISTICS, technical details and specifications, along with examples of actual receivers built at comparatively low cost.

■ ANTENNA DESIGN... and exactly how you can build a spherical antenna, while keeping total earth-station cost for the complete system under \$1,000.

■ THE FRONT END is critical when you build your own system. We help you explore several different ap-

proaches to making one that will work for you.

■ RECEIVER-SYSTEM hardware, and how it goes together to bring you direct-from-satellite TV reception in your own home.

To order your copy:

Complete coupon and enclose it with your check or money order for \$6.00. We will ship your reprint, postpaid in U.S. and Canada, within 6 weeks of receipt of your order. All others add \$3.00 for postage. New York State residents must add 48¢ sales tax.

**Radio-
Electronics,**

Satellite TV Reprints
45 East 17th Street
New York, N.Y. 10003

I want _____ reprints @ \$6.00 each, postpaid.
I have enclosed \$ _____. N.Y. State residents must
add 48¢ sales tax.

Please print

(Name)

(Street address)

(City)

(State)

(Zip)

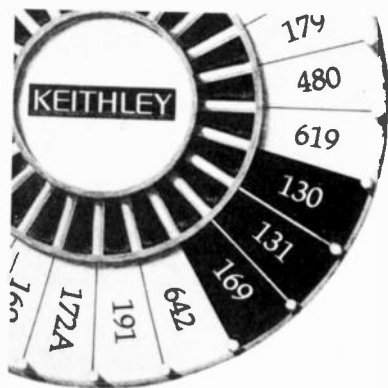

We've got your number.

Model 130
0.5% accuracy
10A range

\$115

Model 131
0.25% accuracy

\$134



Model 169
Portable/Bench.

\$169

Now available from your local electronics distributor.

For a complete list contact Keithley today or reader service number below.

Prices U.S.A. only.
Prices subject to change without notice.

KEITHLEY

Keithley Instruments, Inc.
28775 Aurora Road
Cleveland, Ohio 44139
(216) 248-0400 Telex: 98-5469

CIRCLE 33 ON FREE INFORMATION CARD

service questions

NO HIGH VOLTAGE

This GE 15XB has no high voltage. All of the DC voltage supplies are OK. There is no collector voltage on Q253 (horizontal output); I've checked all of the things I can find, no result. Any ideas?—C.C. Rio Grande, PR.

With no collector voltage on the horizontal output transistor, you'll never get high voltage! The fuse doesn't blow, so something is open. Go to the +131-volt source and start checking from there back to the collector of Q253. You'll find it somewhere in there.

(Feedback—R269 was open. That is 10-ohm 2-watt resistor from the +131-volt source to the flyback winding. I thought I was checking R269 but it was R266!)

INTERMITTENT VERTICAL

Complaint was no vertical sweep in this RCA EC338W. There was just a horizontal line. Fiddling with the vertical size and vertical linearity controls brought the sweep back and the raster filled the screen. Deciding that something in there is heat-sensitive, I went to work. I found nothing conclusive; sometimes it worked, sometimes it wouldn't. But I did use up

three cans of freeze spray! Finally got down to looking for odd things. There was some discoloration on the PC board near the height control. For lack of a better idea, I sprayed that area and the vertical sweep came back! Scraping the PC board clean and replacing the PC conductors from the height control to the pins with wires fixed everything.

Thanks to David A. Day of Apalachicola, FL for that one.

BREAKER TRIPS

I've got one in this RCA CTC-59XD that I can't pin down. The circuit breaker trips in three minutes. Seems to be in the high-voltage section. If I pull the MAG001 horizontal-oscillator module, the breaker stays in. Replaced MAG001 and trace SCR; no help. Where do I go from here?—V.S. Dalton, PA.

If the breaker doesn't trip for three minutes, it looks as if something is heating up and breaking down. If the breaker holds with no drive to the high-voltage section, I'll take that idea as OK. While the breaker is still holding, try spraying coolant on things around the high-voltage section. That might give you some help. We've had problems in some of those sets with driver transformer T403 breaking down.

(Feedback—Thanks! It was T403. I sprayed it with coolant and that worked. Replaced it and things are fine.) R-E

In An Instant.

YOU CAN SAFELY PLUG AWAY WITHOUT OVERLOADING OR COMING UP SHORT



You can do it thanks to SGL WABER® multiple outlet strips. There are over 100 versatile models with unsurpassed quality workmanship. Each exceeds National Electrical Code standards and is safety tested. Ideal for organizing your work area and having extra outlets exactly where you want them. Over 2,000 electronic distributors carry the SGL Waber line. Send for our free 24-page catalog, today!

SGL WABER Electric

A division of SGL Industries, Inc.
Dept. H—300 Harvard Avenue
Westville, New Jersey 08093
(609) 456-5400

IDEAL FOR
RACK MOUNTS

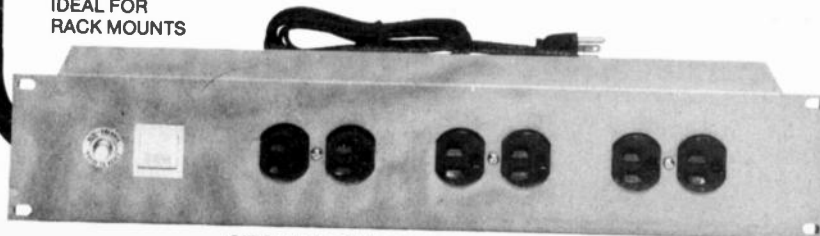

CIRCLE 14 ON FREE INFORMATION CARD

STATE-OF-THE-ART/DO-NOTHING
continued from page 62

Although CMOS gates are used for four IC's, the EPROM current requirements are high and the "do-nothing" box needs a regulated 5-volts at about 150 mA. I used a "battery eliminator" DC supply of the type used for calculators and cassette recorders. Those are often available inexpensively as discontinued items at surplus or discount outlets. Their regulation is poor and a 6-volt eliminator at 200 mA delivers closer to 8 volts and works well here. Batteries are an impractical power source for 150 mA.

Construction is straightforward. Point-to-point or wire-wrap will work best. A printed circuit board would be very complex because of the IC pinouts. You could substitute TTL IC's for the CMOS ones with some component changes and an increase in power-supply current. Use a small heat sink on the voltage regulator. I mounted the LED's on the circuit board and replaced the box cover with red plastic. You can mount the LED's separately or use transistor drivers and incandescent lamps instead. Whatever type of display you use, you will have a truly (for now) state-of-the-art "do-nothing" box. **R-E**

REDUCING DISTORTION
continued from page 54

so that the amplifier produces its rated power output for each of the selected impedances.

Layout and construction

Figure 6 shows the internal layout of the newly developed amplifier. The previously described power-supply section of the amplifier accounts for approximately half of the total cubic space inside the unit. Also visible in the photo is a highly efficient cooling system that uses a heat pipe with a related blower fan. A linear torque motor similar to the type used for turntables and tape decks, is used to drive the fan for silent operation.

Since the power stage of this amplifier does not have a negative-feedback loop, the quality of the materials used in all components—and the quality of their performance—has a close relationship to tonal quality, according to the designers of the new amplifier. The power block and the heat-dissipation fins, for example, are of extremely rugged construction. Boron nitride has been used as the material for the transistor insulators. That material has a thermal conductivity rate of the same

order as metal, thereby resulting in outstanding heat conductivity and dissipation for the power devices.

Because the amplifier is monophonic, there is, of course, no risk of crosstalk between channels. Nevertheless, any interference between the first stages and the output stages will still impair tone quality. Therefore, the layout has been planned so that the signal travels the shortest possible distance from input to output.

More technically oriented readers may be interested in additional details concerning the two new power MOSFET's that play such an important part of this new amplifier design.

In Figs. 7 and 8 we have reproduced transfer curves of the 2SK173 (N-channel) and its complementary 2SJ54 (P-channel) MOSFET's while in Fig. 9 we show the input waveform and output signal obtained for a squarewave having a repetition rate of 1600 nanoseconds (equivalent to a frequency of 625,000 Hz)! **R-E**



YOU CAN BUY AT THESE PRICES TOO!

AND THESE ARE NOT "FALL-OUTS", "REJECTS", "FUNCTIONAL-ONLYS", "COSEMETIC-DEFECTS", "DOUBLE-MARKS", ETC., BUT, ALL ARE PRIME IC, WITH FULL MANUFACTURER'S MARKING, AND 100% TESTED PER SPECIFICATIONS. THERE IS ALSO, NO TIME LIMITS, MINIMUM ORDER AMOUNT, OR OTHER CONDITIONS. AS A MEMBER OF ELECTRONIC BUYERS CLUB, YOU CAN BUY YOUR ICs OR OTHER COMPONENTS SUCH AS CAPACITORS, RESISTORS, DIODES, SOCKETS, EDGE-CONNECTORS, BREADBOARDING COMPONENTS AND EVEN MICRO-COMPUTERS AT PRICES THAT ARE WELL BELOW ANYTHING YOU HAVE EVER SEEN BEFORE. IF YOU BUY ONLY \$50 WORTH OF COMPO-

NENTS A YEAR, YOUR SAVINGS WILL COVER THE ANNUAL MEMBERSHIP FEE OF \$25.00, AND FROM THERE ON IT WILL BE NET PROFITS. SO DON'T DELAY, AND JOIN IN. IN ORDER TO GIVE YOU SUCH LOW PRICES, WE HAVE A VERY LIMITED ADVERTISING BUDGET, AND YOU WILL NOT SEE THIS "AD" EVERY MONTH. FOR INFORMATION ON HOW TO JOIN AND TO FIND OUT HOW THE CLUB OPERATES, CIRCLE "READER SERVICE INQUIRY NUMBER" OF THIS AD OR SEND A POST CARD WITH YOUR NAME AND ADDRESS TO: E-B-C, P. O. Box 617, Columbia, MO, 65205.

PLEASE NOTE: ONLY MEMBERS OF ELECTRONIC BUYERS CLUB ARE ELIGIBLE TO ORDER AT PRICES LISTED BELOW.

74xx	7451	\$0.15	74153	\$0.38	74283	\$1.20	74LS54	\$0.15	74LS168	\$0.57	74LS670	\$1.14	74S151	\$0.66	74C48	\$0.96	74C03	\$0.34	4016	\$0.28	4053	\$0.54	4528	\$0.71	
	7452	0.15	74154	0.53	74290	0.54	74LS55	0.15	74LS169	0.57			74S152	0.66	74C73	0.46	74C04	0.34	4017	0.54	4060	0.59	4539	0.74	
	7453	0.15	74155	0.38	74293	0.54	74LS56	0.21	74LS170	0.84			74S157	0.66	74C74	0.46	74C05	5.10	4018	0.54	4066	0.27	4555	0.48	
	7454	0.15	74156	0.38	74298	0.50	74LS57	0.21	74LS173	0.60			74S158	0.66	74C76	0.44	74C06	0.34	4019	0.27	4068	0.21	4556	0.59	
7400	\$0.15	7459	0.15	74157	0.38	74305	0.36	74LS58	0.23	74LS174	0.47			74S174	1.04	74C83	0.89	74C07	0.34	4020	0.63	4069	0.17	4582	0.59
7401	0.15	7460	0.15	74158	0.38	74306	0.36	74LS59	0.23	74LS175	0.47	74S00	\$0.23	74S175	0.95	74C85	0.89	74C08	0.76	4021	0.56	4070	0.23	4584	0.43
7402	0.15	7470	0.21	74158	0.38	74366	0.36	74LS76	0.23	74LS176	0.47	74S00	\$0.23	74S189	1.83	74C86	0.23	74C09	1.38	4022	0.56	4071	0.17	4702	3.87
7403	0.15	7472	0.21	74160	0.48	74367	0.36	74LS78	0.24	74LS181	1.36	74S01	0.23	74S194	1.17	74C89	2.42	74C10	3.27	4023	0.17	4072	0.17	4703	4.50
7404	0.17	7473	0.21	74161	0.48	74368	0.36	74LS83	0.47	74LS190	0.58	74S02	0.23	74S194	1.17	74C90	0.71	74C11	0.78	4024	0.47	4073	0.17	4704	3.98
7405	0.17	7474	0.21	74162	0.48			74LS85	0.54	74LS191	0.56	74S03	0.23	74S206	2.48	74C90	0.71	74C12	0.78	4025	0.17	4075	0.17	4705	5.04
7406	0.21	7475	0.30	74163	0.48			74LS86	0.24	74LS192	0.56	74S04	0.24	74S240	1.29	74C93	0.71	74C13	0.89	4026	0.99	4076	0.53	4706	5.32
7407	0.21	7476	0.21	74164	0.51			74LS89	0.33	74LS193	0.56	74S05	0.24	74S253	0.63	74C95	0.82	74C14	0.82	4027	0.36	4077	0.38	4720	3.78
7408	0.17	7480	0.22	74165	0.51	74LSxx		74LS92	0.33	74LS194	0.74	74S08	0.24	74S257	0.78	74C107	0.44	74C16	1.07	4028	0.50	4078	0.24	4723	0.78
7409	0.17	7482	0.34	74166	0.54	74LS00	\$0.15	74LS93	0.33	74LS195	0.74	74S09	0.24	74S280	0.78	74C151	1.37	74C15	2.04	4029	0.58	4081	0.17	4724	2.18
7410	0.15	7483	0.46	74167	1.06	74LS01	0.15	74LS95	0.54	74LS196	0.56	74S10	0.23	74S287	1.92	74C152	1.37	74C15	2.04	4030	0.23	4082	0.42	4725	2.15
7411	0.17	7485	0.50	74170	0.84	74LS02	0.15	74LS96	0.54	74LS197	0.56	74S11	0.23	74S289	3.11	74C160	0.71	74C16	1.07	4031	1.12	4086	0.42	48014	0.46
7412	0.17	7486	0.20	74173	0.58	74LS03	0.15	74LS99	0.22	74LS221	0.58	74S15	0.23	74S289	3.11	74C161	0.71	74C16	1.07	4034	1.30	4089	1.07	48085	0.89
7413	0.24	7489	0.95	74174	0.46	74LS04	0.17	74LS102	0.24	74LS240	1.23	74S20	0.23	74S387	2.98	74C161	0.71	4xxx		4035	0.71	4093	0.36	48098	0.38
7414	0.41	7490	0.30	74175	0.45	74LS05	0.17	74LS103	0.24	74LS241	1.23	74S21	0.24	93S00	1.08	74C162	0.71	4000	\$0.20	4040	0.63	4099	0.80	48106	0.46
7416	0.20	7491	0.47	74176	0.47	74LS06	0.16	74LS104	0.24	74LS244	1.23	74S22	0.23	93S05	1.25	74C163	0.71	4001	0.17	4041	0.54	4502	0.23	48160	0.71
7417	0.20	7492	0.30	74177	0.47	74LS09	0.16	74LS122	0.41	74LS251	0.54	74S23	0.24	93S10	1.88	74C164	0.71	4002	0.17	4042	0.54	4503	0.36	48161	0.71
7418	0.15	7493	0.30	74178	1.04	74LS10	0.15	74LS123	0.47	74LS253	0.54	74S24	0.28	93S12	0.74	74C165	0.77	4003	0.17	4043	0.54	4504	0.42	48162	0.71
7421	0.17	7494	0.38	74179	1.04	74LS11	0.17	74LS125	0.33	74LS257	0.41	74S40	0.24	93S16	1.85	74C173	0.65	4004	0.20	4044	0.54	4508	1.64	48163	0.71
7423	0.18	7495	0.38	74180	0.48	74LS12	0.17	74LS126	0.33	74LS258	0.41	74S50	0.24	93S17	1.85	74C174	0.65	4005	0.20	4045	0.54	4509	1.64	48164	0.71
7425	0.18	7496	0.38	74181	1.02	74LS13	0.30	74LS127	0.47	74LS259	0.41	74S51	0.24	93S24	0.82	74C175	0.65	4006	0.65	4046	0.54	4510	0.59	48174	0.65
7426	0.18	7497	1.58	74182	0.53	74LS14	0.60	74LS128	0.45	74LS260	0.21	74S60	0.24	93S24	3.24	74C192	0.72	4007	0.27	4046	0.63	4511	0.65	48175	0.65
7427	0.18	74107	0.20	74184	1.06	74LS15	0.15	74LS129	0.45	74LS262	0.27	74S64	0.24	93S46	0.84	74C193	0.72	4010	0.27	4047	0.64	4512	0.68	48192	0.72
7430	0.15	74109	0.22	74185	1.06	74LS20	0.15	74LS130	0.45	74LS279	0.29	74S65	0.24	93S62	1.44	74C195	0.71	4011	0.17	4048	0.38	4516	0.59	48193	0.72
7432	0.18	74120	0.60	74188	2.10	74LS21	0.15	74LS131	0.45	74LS283	0.47	74S74	0.36	93S62	1.44	74C195	0.71	4012	0.17	4049	0.28	4518	0.59	48194	0.71
7437	0.18	74122	0.37	74190	0.50	74LS22	0.15	74LS132	0.41	74LS285	0.47	74S74	0.36	93S62	1.44	74C200	4.08	4012	0.17	4050	0.28	4519	0.30	48195	0.71
7439	0.18	74123	0.38	74192	0.50	74LS27	0.16	74LS133	0.41	74LS286	0.47	74S74	0.36	93S62	1.44	74C21	0.96	4013	0.30	4050	0.28	4519	0.30	48195	0.71
7440	0.15	74125	0.30	74193	0.50	74LS30	0.13	74LS134	0.41	74LS288	0.47	74S74	0.36	93S62	1.44	74C21	0.96	4013	0.30	4050	0.28	4519	0.30	48195	0.71
7441	0.60	74126	0.30	74194	0.48	74LS32	0.17	74LS135	0.41	74LS289	0.47	74S74	0.36	93S62	1.44	74C21	0.96	4013	0.30	4050	0.28	4519	0.30	48195	0.71
7442	0.35	74132	0.39	74195	0.44	74LS37	0.18	74LS136	0.26	74LS290	0.58	74S74	0.36	93S62	1.44	74C21	0.96	4013	0.30	4050	0.28	4519	0.30	48195	0.71
7443	0.50	74141	0.53	74196	0.47	74LS38	0.18	74LS137	0.41	74LS291	0.58	74S74	0.36	93S62	1.44	74C21	0.96	4013	0.30	4050	0.28	4519	0.30	48195	0.71
7444	0.50	74145	0.45	74197	0.47	74LS40	0.15	74LS138	0.45	74LS292	0.58	74S74	0.36	93S62	1.44	74C21	0.96	4013	0.30	4050	0.28	4519	0.30	48195	0.71
7445	0.50	74147	0.89	74198	0.63	74LS42	0.42	74LS139	0.45	74LS293	0.58	74S74	0.36	93S62	1.44	74C21	0.96	4013	0.30	4050	0.28	4519	0.30	48195	0.71
7446	0.46	74148	0.62	74199	0.63	74LS47	0.60	74LS140	0.41	74LS294	0.58	74S74	0.36	93S62	1.44	74C21	0.96	4013	0.30	4050	0.28	4519	0.30	48195	0.71
7447	0.46	74150	0.54	74201	0.50	74LS48	0.51	74LS141	0.41	74LS295	0.58	74S74	0.36	93S62	1.44	74C21	0.96	4013	0.30	4050					

AMERICA'S BEST SELLING SCANNER JUST GOT EVEN BETTER.

Look what you get with the Bearcat 210XL. Exciting, new space-age styling. No-crystal, pushbutton tuning. New, 18 channel, 6-band coverage of over 6000 frequencies. And features like 2 scan speeds, Automatic Squelch, Search, and Lockout, Direct Channel Access, Selective Scan Delay. And much more. There's never been a Scanner like the Bearcat 210XL.



TAKE IT FROM A
SMART OPERATOR:

Don Adams

**BEARCAT 210XL
SCANNER
\$209.**

THE LOWEST PRICED, FULL-FEATURE, BEARCAT NO-CRYSTAL SCANNER EVER.

Bring home all the real excitement of scanning and save! Bearcat 160 features a smooth, keyless keyboard for all controls including volume and squelch. Has 5-band 16 channel coverage. Priority Selective Scan Delay. Automatic Lockout and Search. And much more. Bearcat is number one in scanning.

TAKE IT FROM A
SMART
OPERATOR:

Don Adams

**BEARCAT
160 SCANNER
\$189.00**

Add \$6.00 per scanner for U.P.S. ground shipping in the continental U.S. or \$12.00 for U.P.S. air shipping. Send your cashier's check or money order to our address below or order by phone if you have a Visa or Master Charge card. Order today!

**COMMUNICATIONS
ELECTRONICS™**

854 Phoenix □ Box 1002 □ Ann Arbor, Michigan 48106 U.S.A.
Call TOLL-FREE (800) 521-4414 or outside U.S.A. (313) 994-4444

CIRCLE 49 ON FREE INFORMATION CARD

CAR ELECTRONICS

continued from page 51

and shut down "chop shop" operations. It can even be used to keep the parts department from ordering the wrong part for your particular engine.

Service facilities are also increasingly dependent on thoroughly detailed engineering data from the manufacturers. Diagnostic and repair manuals are becoming much more graphic and their language more readable. But the more information that's available on each car, and the more cars, the harder it gets to store all that paper. Microfiche and other space-saving methods are being used, and a number of computer software packages are being developed.

Tools are also getting smarter. GM is developing an *Automotive Service Analyzer*, an advanced version of a cooling-system tester first developed in 1976. In its eventual form, it will be capable of diagnosing problems with air conditioning, cooling, electrical, and automatic transmission systems, and then will give repair instructions in English on an alphanumeric display.

The magic, of course, is performed by a built-in microprocessor. The tester is attached to the vehicle and the mechanic dials up the tests he wants to perform. The *Automotive Service Analyzer* walks him through a test procedure and gives him a diagnosis of the problem.

When development of the *Automotive Service Analyzer* is complete, GM will continue its policy of making technological advances like this available to qualified manufacturers of service tools and equipment, free of charge. That's how GM's SOS (Service Order Scheduling) system—developed by GM Service Research and Delco Electronics Division—became available through several commercial computer-system companies. SOS controls the work flow in a large service organization by scheduling and routing the flow of repair orders. That helps reduce shop inefficiency saving everybody time and money.

Let's hear from you

We've reported on electronics on the dashboard, under the hood, in the bells and whistles, and how it's helping cars spend less time in service. Now it's your turn.

If you think there's room for improvement, tell us your ideas. If you've developed a gadget that puts electronics to work in your car, describe it to us. If you think somebody's handing us a line, tell us about it.

And if you'd like to see more of this kind of coverage, tell us that, too. That's the way electronics moves from today to tomorrow.

CREATE ANY RHYTHM new improved memory



Our popular Programmable Drum Set's simple programming system allows even first time users to structure bass, tom, snare, wood-block and cymbal sounds into any rhythm in any time signature. Versatile memory organization provides simultaneous storage of two separate rhythm patterns each with its own bridge rhythm. Bridges are activated from either the control panel touch plate or optional foot-switch and are automatically synchronized to the main rhythm. Improved memory circuitry lets the "save" mode hold rhythm patterns for over one year while battery life for normal operation has been extended to several hundred hours.

In easy to assemble kit or fully assembled.

- () Send #3750 Drum Set Kit, \$89.95 plus \$3 shipping enclosed.
- () Send #3750 Drum Set Assembled, \$154.95 plus \$3 shipping enclosed.
- () Send Free Catalog.

Name: _____

Address: _____

City: _____ State: _____ Zip: _____

VISA: _____ M.C. _____ Card No. _____

PEMA ELECTRONICS, DEPT. 30, 1020 W. WALSHUR, OLLA CITY, OK 73116

CIRCLE 2 ON FREE INFORMATION CARD

Put Professional Knowledge and a COLLEGE DEGREE

in your Electronics Career through

HOME STUDY



Earn Your DEGREE

No commuting to class. Study at your own pace, while continuing your present job. Learn from easy-to-understand lessons, with help from your home-study instructors whenever you need it.

In the Grantham electronics program, you first earn your A.S.E.T. degree, and then your B.S.E.T. These degrees are *accredited* by the Accrediting Commission of the National Home Study Council.

Our *free* bulletin gives full details of the home-study program, the degrees awarded, and the requirements for each degree. Write for *Bulletin R-81*.

Grantham College of Engineering
2500 So. LaCienega Blvd.
Los Angeles, California 90034

market center

PLANS & KITS

ROBOTIC catalog—motors, gears, hardware, electronics, \$3.00; newsletter, \$8.00 per year; 12V robot motor with gear \$9.50, 2 for \$17.00. **MOUDY ELECTRONICS, R.D. 2, Box 427, Hollidaysburg, PA 16648**

SAVE 90%. Build your own minicomputer. Free details. **DIGATEK, 2723 W. Butler Dr., Suite E, Phoenix, AZ 85021**

CRYSTAL radio builders . . . \$1.00 brings you two sets plans, details, price list. **BOBRYAN, P.O. BOX 3039, Dept. R., Anaheim, CA 92803**

WIZ-KIT dealerships available. Fast selling sirens, blinkys, etc. Working display boards available. **WIZARD ELECTRONICS, 24 East Central, Toledo, OH 43608**

DECODER kit, TV UHF channels. Sine wave encoder system. Model 7 + 11, complete kit \$139.00, plus shipping. Also parts, etc. Catalog \$1.00. **SIMPLE SIMON ELECTRONIC KITS, 11850 S. Hawthorne Blvd., Hawthorne, CA 90250. Tel. (213) 675-2335**

CATALOG of electronic designs. Accessories for CB, ham radio, stereo and PA systems, telephone, and more. Catalog sent free upon request. **PETER-SCHMITT ENTERPRISES, Dept. RE, POB 07071, Milwaukee, WI 53207**

MICROCOMPUTER service. Maintenance and repair for all microcomputers and peripherals. Fast. Reasonable. **PRAIRIE MICRO CLINIC, Box 325, Herington, KS 67449 (913) 258-2179**

SUBSCRIPTION T.V. DECODER KIT. \$39.00
INCLUDES ALL PARTS, MANUAL AND ETCHED PC BOARD.
JOE P.O. BOX 61 CUMBERLAND, R.I. 02864

PAY-TV top of set sinewave and pulse decoders. Plan 5.00. **DECODERCO, Box 8930, Warwick, RI 02888**

PLANS: Subscription television decoder, \$10.00. Negative ion generator, \$3.00. Telephone memory dialer, \$3.00. Detailed instructions, circuit board patterns included. Kits available. **COLLINS ELECTRONICS, Box 6424, San Bernardino, CA 92412**

SUBSCRIPTION television education manual! Two scrambling/decoding methods, theory, circuits. Decoder dealers listed. \$14.95. Kits available. Satisfaction guaranteed. **ABEX, P.O. Box 26601-R, San Francisco, CA 94128**

FREE KIT Catalog
FUNCTION GENERATOR KIT \$59.95
Auto-Ranging Cap-meter kit \$79.95
contains TEST & EXPERIMENTER'S EQUIP.
Phone 415-447-3433
Write or Phone for FREE CATALOG.
Average 1 minute Saturday call is 21¢.
**DAGE SCIENTIFIC INSTRUMENTS
BOX 1054R LIVERMORE CA 94550**

DECODE Morse and RTTY signals off the air with new Morse-a-Word or RTTY reader. Morse keyboard also available. Kits or factory wired. Send for details. **MICROCRAFT, Box 513R, Thiensville, WI 53092 (414) 241-8144.**

PCB as low as 15¢ sq-in. Free drilling. **INTERNATIONAL ENTERPRISE, 6452 Hazel Circle, Simi Valley, CA 93065**

AMPLIFIERS, 35 to 150 watts RMS; DC amplifier designs and detailed plans and circuit board layouts, for under \$200.00. Send \$12.50 for complete plans and kits costs to **AUDIO ENGINEERING COMPANY, P.O. Box 210, Aida, NE 68810**

CLASSIFIED COMMERCIAL RATE (for firms or individuals offering commercial products or services). \$1.65 per word prepaid (no charge for zip code) . . . **MINIMUM 15 WORDS.** 5% discount for 6 issues, 10% for 12 issues within one year, if prepaid.

NON-COMMERCIAL RATE (for individuals who want to buy or sell a personal item) \$1.00 per word prepaid . . . no minimum.

ONLY FIRST WORD AND NAME set in bold caps. Additional bold face (not available as all caps) at 10¢ per word. All copy subject to publisher's approval. **ADVERTISEMENTS USING P.O. BOX ADDRESS WILL NOT BE ACCEPTED UNTIL ADVERTISER SUPPLIES PUBLISHER WITH PERMANENT ADDRESS AND PHONE NUMBER.** Copy to be in our hands on the 26th of the third month preceding the date of the issue (i.e., August issue closes May 26). When normal closing date falls on Saturday, Sunday, or a holiday, issue closes on preceding working day.

2716 EPROM \$11 programmer, hardware software plans. Send \$9. **CARTIER, 6844 Nashville Road, Lanham, MD 20801**

KILL obnoxious loud TV commercials automatically. Complete plans, \$5.00. **BRIDGES, 1248 N. Denver, Tulsa, OK 74106**

UNUSUAL electrical, electronic testers. Analog, digital and indicators. Hobbyist, professional. Free catalog. **BLUFFTON PRODUCTS, INC., 115 Poplar Road, Bluffton, OH 45817**

CABLE TV descramblers and converters, microwave antennas and downconverters. Plans and parts. Build or buy. For information send \$2.00 C & D COMPANY, PO BOX 21, Jenison, MI 49428

PROJECTION TV. . . . Convert your TV to project 7 foot picture. Results equal to \$2,500 projector. Total cost less than \$20.00. Plans & lens \$16.00. Illustrated information free. **MACRO-COMGG Washington Crossing, PA 18977**

PRINTED circuit boards from sketch or artwork. Kit projects. Free details. **DANOCINTHS INC., Box 261, Westland, MI 48185**

FREE catalog IC's semis, parts. **CORONET ELECTRONICS, 649A Notre Dame W., Montreal, Que, Canada H3C 1H8 US inquiries**

TELEVISION alignment—in minutes—while observing revolutionary pattern on screen. Check RF, IF, video, instantly! So simple and inexpensive it's incredible. Complete plans—\$6.00. Free details. **EZ-LIGN, Box 2702R, Clearwater, FL 33517**

Burglar-Fire Protection

Protect Your Life, Home, Business, Auto, etc.

• Our catalog shows how. Install your own alarm systems and devices and save \$\$\$\$.

We offer FREE write-in engineering service.

FREE CATALOG Lowest Prices on Reliable, High Quality Alarm Systems and Devices

Burdex Security Co. Box 82802-RE Lincoln, Ne. 68501

ATV Research ...specialists in CCTV and computer monitors!

Video monitors - color & B/W • TV Cameras, kits, parts & plans • Video-to-RF modulators • Free catalog. Phone or write. (402) 967-3771

13-RE Broadway Dakota City, NE. 68731

To run your own classified ad, put one word on each of the lines below and send this form along with your check for \$1.65 per word (minimum 15 words) to:

Radio-Electronics, 200 Park Avenue South, N.Y., N.Y. 10003

ORDER FORM

PLEASE INDICATE in which category of classified advertising you wish your ad to appear. For special headings, there is a surcharge of \$10.

() Plans/Kits () Business Opportunities () For Sale
() Education/Instruction () Wanted ()

Special Category: \$10

(PLEASE PRINT EACH WORD SEPARATELY, IN BLOCK LETTERS.)

1	2	3	4	5
6	7	8	9	10
11	12	13	14	15
16	17	18	19	20
21	22	23	24	25
26	27	28	29	30
31	32	33	34	35

PLEASE INCLUDE FOR OUR FILES YOUR PERMANENT ADDRESS AND PHONE NUMBER.

WANTED

IDEAS, inventions, new products wanted! Write for **Kit. INVENTION MARKETING, INC.-RE**, 701 Smithfield, Pittsburgh, PA 15222

MIRROR in the lid, spinning disc, and other pre-1946 television sets wanted. Call collect: (203) 521-5280

CRYSTAL RADIO
Complete
\$25.00 ppd.
BOB RYAN
PO Box 3039
Anaheim, CA
92803



DELTA CAPACITIVE DISCHARGE IGNITIONS. New, fully assembled, factory guaranteed. MK10B, \$41.50. MK10C, \$43.88. Tristar T-500, \$39.00. T-Max \$42.00. PPD domestic, Canada. **SIEVERTS ELECTRONICS**, P.O. Box 171, W. Campton, NH 03228

TELEPHONE on/off button—press to turn off bell—caller hears ring, you hear silence. Intimate moments, naps etc. Shuts off one phone. All normal phones. Instructions. Satisfaction or money back. Send \$5.95. **THE ARMCHAIR EMPORIUM Ltd.** 825 Surrey Ln. Dept RE1, Algonquin, IL 60102

SAVE up to 50% on name brand test equipment. Free catalog and price list. **SALEN ELECTRONICS**, Box 82-F, Skokie, IL 60077

MICROWAVE TV antenna. MDS designed yagi. 18 dB gain \$39.95. Details, plans and tech. data for same \$3.00. **BETA DESIGN GROUP**, POB 164, Airway Heights, WA 99001

SURPLUS catalog 8,000 items: electronics, stereos, speakers, alarms, tools, games, solar auto-home, 8 issues \$2.00. **BNF (R)**, 119 Foster St., Peabody, MA 01960

EDUCATION & INSTRUCTION

ELECTRONICS books from world publishers. Lowest prices, ask catalog. **BUSINESS PROMOTION**, Lajpatral Market, Delhi, India

UNIVERSITY degrees by mail! Bachelors, Masters, PhD's . . . Free revealing details. **COUNSELING**, Box 317-RE 1, Tustin, CA 92680

ASSURE career advancement opportunity through new **DIGITAL TECHNOLOGY** training program. Write **INNOVATIVE HOME STUDY**, Box 1046 R, Indian Rocks Beach, FL 33553

FOR SALE

ELIMINATE FADING from your **SW, CB, or AM RECEIVER**. New method. Any make or model. No drop-out of weak signals, no jolting volume surges. Complete plans, \$5.00. **INTERTECH**, Box 25568R, Cleveland, OH 44125

SCANNER/monitor accessories—kits and factory assembled. Free catalog. **CAPRI ELECTRONICS**, Route 1R, Canon, GA 30520

RECEIVE SUBSCRIPTION OR CABLE TV on the 2000 MHz to 2500 MHz frequency, with our fully guaranteed, complete, detailed MDS antenna plans. Send \$9.95 to **DYNACOMP ELECTRONICS**, Dept. GF-2, P.O. Box 4181, Scottsdale, AZ 85258

SCRAMBLED television, encoding/decoding. New Publication. Theory/circuits. \$9.95. **WORKSHOP**, Box 393 REG, Bethpage, NY 11714

GOVERNMENT surplus receivers, transmitters, sniperscopes, parts, fantastic 72 page catalog 25¢. **MESHNA**, Nahant, Mass. 01908

CABLE TV converters \$39.95. Incredible 96-page catalog free. **ETCO**, Box 762, Plattsburgh, NY 12901

MICROWAVE yagi antenna for MDS complete with hardware, type N connector \$49.95. **SIGNAL ELECTRONICS**, 4027 18th Avenue, Brooklyn, NY 11218

LASER handbook with burning, cutting, Ruby Reds, Co's, complete plans, books, and parts. Send \$4.00 to **FAMCO**, dept re, box 1902, Rochester, NH 03867

AUTOSOUND! Fuzzbusters! Electronic components! Send 30¢ in stamps for catalog. **POWER ELECTRONIC**, 15206 Blackstone, Dalton, IL 60419

RECONDITIONED test equipment. \$1.00 for catalog—**JAMES WALTER TEST EQUIPMENT**, 2697 Nickel, San Pablo, CA 94806

CHEMICALS, apparatus, project books, wide selection. Catalog \$1.00 send to: **PIONEER Ltd.** Ind, 14a Hughey St., Nashua, NH 03060

SATELLITE TV—the most complete single report—For novices or pros \$7. **SCOTT PALMER**, 9062 Andromeda Drive, Burke, VA 22015

TELEPHONE bugged? Uncle listening? Don't be Watergated! Latest countermeasures \$1.00. **NEGEYE ENGINEERING**, Pennsboro, WV 26415

"**THE Intelligence Library**" technical secrets. Books on **Electronic Surveillance, Lock-Picking, Demolitions, Covert Sciences**, etc. One dollar. (refundable); **MENTOR PUBLICATIONS**, Dept. Z, 135-53 Northern Boulevard, Flushing, NY 11354

RESISTORS 1/4W, 1/2W 5% carbon films 3¢ ea. No minimums. 1% metal films. Send for details. Bulk pricing available. **JR INDUSTRIES**, 5834-C Swancreek, Toledo, OH 43614

TEST equipment lowest prices B&K Leader, Hitachi, Viz, Beckman, OK Tool, Blonder Tongue, RCA parts transistors others, write call collect L.I. **Electronics**, 981 Sunrise Highway, Bayshore, NY 11706. 516-666-7360

PRINTED circuit board—double sided epoxy, approximately 2.5 sq.ft., min. size 6"x12", \$5.00 plus \$2.00 postage and handling; send certified cheque or money order: **CYCLOPS ELECTRONICS LTD.**, P.O. Box 4089, Vancouver, B.C. Canada V6B-3Z6

GRAPHIC EQUALIZER

TWELVE bands/channel \$100.00 kit still available; see May 1978 R/E cover story or write: **SYMMETRIC SOUND SYSTEMS**, 912 Knobcone PL, Dept. R, Loveland, CO 80537

BUSINESS OPPORTUNITIES

MECHANICALLY inclined individuals desiring ownership of Small Electronics Manufacturing Business—without investment. Write: **BUSINESS-ES**, 92-R, Brighton 11th, Brooklyn, NY 11235

NEW tax loopholes discovered. Everyone eligible. Free sample newsletter. Write: **ULC**, Box 179-CU, Clarkston, GA 30021

PROJECTION TV . . . Make \$200.00+ per evening assembling projectors . . . Easy . . . Results equal to \$2,500 projectors . . . Your total cost less than \$15.00 . . . **Plans, lens & dealer's** information \$14.00 . . . Illustrated information free . . . **MACROCOMGGX**, Washington Crossing, PA 18977

ROBOTS

UNICORN-1 Robot parts. Also robot kits, plans, books, hard to find gears, motors, metal stock, plastics. Everything you need for hobby robotics. Send \$3.00 for year's subscription to catalog and Hobby Robotics Newsletter. **ROBOT MART**, 19 West 34 St., New York, NY 10001

CB RADIO

GET more CB channels and rangel Frequency expanders, boosters, speech processors, interference filters, VOX, how-to books, plans. Catalog \$1. **CB CITY**, Box 31500RE2, Phoenix, AZ 85046

COMPUTER PARTS

I.C.'S: 2114L-2's, \$3.75; 4116-2's, \$4.00; 2708's, \$6.50; 2716's, \$10.00; 74LS240's, \$1.50; 74LS374's, \$1.50; CCS 16K/5MHz RAM board, A&T, \$250.00; TGE Box 64068, Va Beach, VA 23464

COMPUTER MARKET CENTER

COMPUTER MARKET CENTER ADVERTISING RATES 1" by 1 column (1 5/8") \$82.50. 2" by 1 column (1 5/8") \$110.00. All ads must be prepaid. Send order and remittances to Computer Market Center, **Radio-Electronics Magazine**, 200 Park Avenue South, New York, New York, 10003. Address telephone inquiries to 212-777-6400. Frequency rates are available.

TEXAS

PDP 8 Option Modules

M847\$482
M869\$500
M930-D\$61
M935\$49
M18-E\$482
MM8-AA\$995
MM8-AB\$1,625
MM8-E\$285
MM8-EJ\$1,170
Mod-1\$800
MOV-8\$800
MR8-AA\$420
MS8-AA\$412
PDP8-A 400 BP\$2,380
PDP8A 400 BP\$3,200

Federated Consultants

214-428-5300
1218 S. Ervay
DALLAS, TX 75215

CALIFORNIA

FREE! INFO-PAK for small computer users mailed twice a year. We sell and broker all kinds of **SMALL COMPUTER SOFTWARE** from S-100 to TRS-80. **SOFTWARE REVIEW**, 704 Solano Ave., Albany, CA 94706 (415) 527-7730.

BUY THIS SPACE

\$55.00 puts your ad in this space in front of 197,223 active Radio-Electronics readers. To place your ad write Computer Market Center, Radio-Electronics, 200 Park Avenue South, New York, New York 10003 or call 212-777-6400.

CANADA

DYNAMIC INFORMATION TECHNOLOGIES LTD.
P.O. BOX 6553 STN.A.
SAINT JOHN, N.B., CANADA
E2L 4R9 (506) 642-4260
TERMINALS, PRINTERS, MICROCOMPUTERS SOFTWARE.

RETAILERS

An ad for your computer store in this space in Radio-Electronics **COMPUTER MARKET CENTER** puts you in touch with our computer audience. They use microcomputer equipment for both business and hobby interests. For further details call 212-777-6400.

SUPPORT
MARCH OF DIMES



Take stock in America.
Buy U.S. Savings Bonds.



CAN YOU AFFORD NOT TO COMPARE?

COMPUTER SUPPORT CENTER



NEW LOW PRICES

Z80-CPU	2.5 MHz	8.45	Z80-SIO/0	2.5 MHz	22.45
Z80-CPU	4.0 MHz	9.45	Z80-SIO/1	4.0 MHz	28.56
Z80-PIO	2.5 MHz	5.98	Z80-SIO/2	2.5 MHz	22.45
Z80-PIO	4.0 MHz	7.65	Z80-SIO/2	4.0 MHz	28.56
Z80-CTC	2.5 MHz	5.98	Z80-SIO/9	2.5 MHz	16.85
Z80-CTC	4.0 MHz	7.65	Z80-SIO/9	4.0 MHz	21.54
Z80-DMA	2.5 MHz	18.65	Z80-DART	2.5 MHz	14.45
Z80-DMA	4.0 MHz	22.95	Z80-DART	4.0 MHz	17.50

MOS MEMORIES

Part No.	Price
IK (256 x 4) 350NS 22 PIN	3.95
IK (1K x 1) 250NS 16 PIN	1.09
P2111-45 IK (256 x 4) 450NS 18 PIN	3.45
P2112-35 IK (256 x 4) 350NS 18 PIN	2.50
2114L Low Power 4K (1024 x 4) 300NS	2.98
2147 4K (4K x 1) 55NS	9.95
2147 4K (4K x 1) 70NS	8.95

UART's

AY5-1013A 40 Khz Single 5V Supply	Special 3.95
-----------------------------------	--------------

IK CMOS RAM

5101 1K (256 x 4) 450NS 22 PIN Low Power	3.95
--	------

4K CMOS RAM

P6504 4K (4K x 1) 550NS 18 PIN 110MW	7.95
P6514 4K (1K x 4) 450NS 18 PIN 110MW	6.95

SHIFT REGISTERS

3341APC FIFO 1 MHz	4.98
3347PC 80 bit	3.95

MICROPROCESSOR CHIP SETS

Part No.	Price	Part No.	Price
8080A CPU	4.95	6800 CPU	5.45
8085 CPU	8.98	6802 CPU	10.95
8212	2.25	6810	2.99
8214	3.65	6821	2.99
8216	1.98	6850	2.99
8224	3.45	6852	2.99
8226	2.25		
8251	4.38	6502 CPU	7.85
8253	5.95	8504 CPU	8.45
8255	9.65	6505 CPU	8.45
8257	5.65	6520	5.72
8259	10.95	6522	9.45
		6532	12.50
		6531	12.40

EPROM'S

C2708 1K x 8 450 ns	\$ 9.95
C2732 (T.I. Pin Out) 32K (4096 x 8) 450 ns	\$21.00
C2732 (Intel version) 32K (4096 x 8) 450 ns	\$21.00
C2716/TMS2516 (Intel version) 16K 450NS Single 5V Supply	\$7.45
TMS2564 64K (8K x 8) 450 ns	\$195.00
16K MOS DYNAMIC RAM'S (16 PIN) 4116-20 (200NS)	\$3.65
4116-30 (300NS)	2.95
4K MOS DYNAMIC RAM'S TMS4060-30	Special 2.50
4K (4K x 1) 300NS 22 PIN TMS4060-20	3.50
4K (4K x 1) 200NS 22 PIN	
16K CMOS STATIC RAM 6116 16K (2K x 8) 150NS 16 PIN	\$52.00
64K MOS DYNAMIC RAM 4164 64K (64K x 1) 200NS 16 PIN	\$59.95

PROM'S

745288 3.45 256 bit 16 PIN	
745188 3.45 256 bit 16 PIN	
93427/MB7052 3.85 1K 16 PIN	
93417/MB7051 3.65 1K 16 PIN	
93446/MB7053 4.95 2K 16 PIN	
93436/MB7058 4.95 2K 16 PIN	
93453/MB7122 8.85 4K 18 PIN	
825185/7128 27.95 8K 18 PIN	
715478/7132 19.84 8K 24 PIN	
825191/7138 78.00 16K 24 PIN	

TTL

STANDARD, SCHOTTKY & LOW POWER SCHOTTKY

7400N	.22	74221N	.68	74LS51N	.22
7401N	.22	74246N	1.36	74LS54N	.21
7402N	.27	74247N	1.24	74LS55N	.24
7403N	.27	74251N	7.75	74LS73N	.32
7404N	.27	74259N	2.26	74LS74N	.49
7405N	.27	74273N	2.25	74LS75N	.36
7406N	.37	74276N	1.29	74LS76N	.54
7407N	.37	74278N	2.38	74LS78N	.29
7408N	.27	74279N	1.19	74LS83N	.77
7409N	.27	74283N	2.19	74LS85N	.48
7410N	.27	74293N	.72	74LS86N	.44
7412N	.38	74298N	.84	74LS90N	.39
7413N	.45	74351N	2.25	74LS91N	.89
7414N	.45	74365AN	.89	74LS92N	.49
7415N	.37	74366N	.89	74LS93N	.42
7417N	.37	74367AN	.69	74LS95N	.48
7420N	.32	74368AN	.69	74LS96N	.59
7422N	.37	74390N	.99	74LS107N	.38
7423N	.37	74393N	1.38	74LS109N	.38
7425N	.32			74LS112N	.38
7426N	.44	74500N	.44	74LS122N	.46
7427N	.32	74502N	.48	74LS123N	.69
7428N	.42	74503N	.48	74LS125N	.98
7430N	.22	74504N	.79	74LS126N	.54
7432N	.78	74505N	.79	74LS132N	.52
7433N	.44	74508N	.48	74LS133N	2.85
7437N	.37	74509N	.98	74LS136N	.44
7438N	.37	74510N	.69	74LS138N	.59
7440N	.22	74511N	.89	74LS139N	.74
7442N	.44	74520N	.68	74LS145N	1.19
7445N	.89	74530N	.48	74LS147N	2.49
7446N	.84	74532N	.98	74LS148N	1.39
7447AN	.69	74537N	1.87	74LS151N	.44
74507AN	.22	74538N	1.68	74LS153N	.36
7451N	.32	74540N	.44	74LS155N	.74
7453N	.32	74551N	.78	74LS156N	1.45
7454N	.32	74574N	.69	74LS157N	.58
7472N	.36	74585N	2.39	74LS158N	.52
7473N	.38	74586N	1.44	74LS160N	.72
7474N	.38	74587N	1.59	74LS161N	.72
7475N	.42	745112N	1.59	74LS162N	.65
7476N	.38	745124N	2.77	74LS163N	.72
7483AN	.52	745132N	1.24	74LS164N	.59
7484AN	1.36	745133N	.98	74LS165N	1.09
7485N	.66	745134N	.69	74LS166N	2.15
7486N	.44	745135N	1.48	74LS170N	1.95
7490AN	.35	745138N	1.15	74LS173N	.64
7491AN	.38	745139N	1.45	74LS174N	.39
7492AN	.38	745140N	1.45	74LS175N	.44
7493AN	.38	745151N	1.19	74LS181N	2.19
7494AN	.58	745153N	1.19	74LS190N	.89
7495AN	.54	745157N	1.19	74LS191N	.89
7497N	2.36	745158N	1.45	74LS195N	.54
74100N	1.38	745161N	2.85	74LS196N	.58
74101AN	.64	745162N	1.70	74LS193N	1.24
74102AN	.42	745163N	3.75	74LS194N	2.40
74105N	.42	745168N	4.65	74LS196N	.88
74110N	.45	745169N	5.44	74LS197N	.89
74111N	.58	745174N	1.09	74LS221N	.85
74116N	1.38	745175N	1.09	74LS240N	.99
74121N	1.25	745181N	4.47	74LS241N	.99
74122N	.54	745182N	2.95	74LS242N	.99
74123N	.52	745189N	14.95	74LS243N	1.09
74125N	.52	745194N	2.95	74LS244N	3.95
74125N	.52	745195N	1.89	74LS245N	1.95
74126AN	.52	745201N	14.95	74LS245N	1.25
74128N	.85	745202N	3.89	74LS246N	1.95
74129N	.45	745240N	3.98	74LS249N	.99
74136N	.52	745241N	3.75	74LS251N	1.45
74141N	.85	745251N	1.90	74LS253N	.79
74142N	2.98	745253N	7.45	74LS257N	.55
74143N	3.44	745257N	1.09	74LS268N	.59
74144N	3.44	745268N	1.49	74LS270N	2.95
74145N	1.22	745269N	1.83	74LS269N	.99
74147N	1.24	745274N	19.95	74LS266N	.44
74148N	.92	745275N	19.95	74LS273N	1.19
74150N	1.44	745290N	2.90	74LS275N	4.95
74151N	.42	745291N	3.89	74LS279N	.58
74153N	.38	745299N	6.98	74LS280N	1.98
74154AN	1.68	745373N	3.45	74LS283N	.89
74155AN	.54	745374N	3.45	74LS290N	.78
74157N	.54	745381N	7.95	74LS293N	.38
74159N	1.68	745412N	8.95	74LS298N	.99
74160N	.65	745471N	9.95	74LS299N	2.65
74161AN	.72	745472N	16.85	74LS320N	2.95
74162N	.65	745474N	17.85	74LS321N	3.95
74163AN	.65	745476N	8.95	74LS322N	4.95
74164AN	.69	745478N	16.95	74LS323AN	4.95
74165N	.63			74LS324N	2.50
74166N	.72	74LS00N	.17	74LS348N	2.95
74170N	2.18	74LS01N	.17	74LS352N	1.35
74172N	6.45	74LS02N	.24	74LS353N	1.95
74173N	.85	74LS03N	.24	74LS362N	1.95
74174AN	.67	74LS04N	.24	74LS365N	.84
74175N	.63	74LS05N	.24	74LS366N	.84
74176N	.79	74LS08N	.19	74LS367N	.98
74177N	.79	74LS09N	.24	74LS368N	.98
74178N	1.15	74LS10N	.19	74LS373N	1.39
74179N	1.15	74LS11N	.24	74LS374N	1.39
74180N	.75	74LS12N	.24	74LS375N	1.95
74182N	.52	74LS13N	.25	74LS377N	1.44
74184N	2.95	74LS14N	.42	74LS379N	1.35
74185N	.95	74LS20N	.19	74LS379N	1.19
74190N	.69	74LS21N	.19	74LS390N	1.44
74191N	.76	74LS26N	.48	74LS393N	1.29
74192N	.69	74LS27N	.34	74LS395N	1.35
74193N	.88	74LS30N	.19	74LS40N	.37
74194AN	.86	74LS32N	.39	74LS490N	1.95
74195AN	.48	74LS37N	.32	74LS630N	85.00
74196AN	.79	74LS38N	.32	74LS631N	85.00
74197N	.79	74LS42N	.45	74LS669N	1.25
74198N	1.56	74LS47N	.69	74LS670N	2.88
74199N	1.56	74LS48N	.99		

LINEAR I.C.'s

LM301AN-8	.34	LM324N	.52	LM741CN-8	.32
LM304CH	.89	LM339N	.52	LM747CN-8	.39
LM307N-8	.29	LM348N-14	.99	LM748CN-8	.39
LM308N-8	.89	LM358N-8	.79	LM1458N-8	.42
LM308CH	.95	LM555N-8	.29	LM1488N-14	.89
LM309K	1.56	LM556N-14	.49	LM1499N-14	.89
LM310HC	1.49	LM723CH	.89	LM3048N-14	.99
LM311N-8	.59	LM723CN-14	.48	LM3302N-14	.55
LM317T	1.19	LM723CN-8	1.75	LM3403N-14	.89
LM318N-8	1.45	LM733CN-14	1.59	LM3900N	.48
LM318CH	1.75	LM739CN-14	1.29	LM1369N-14	.89
LM318CH	1.75	LM741CH	.85	ULN2003AN	.89

DUAL-IN-LINE - LOW PROFILE - I.C. SOCKETS

CONTACTS	PRICE	CONTACTS	PRICE
8 PIN	.07	22 PIN	.21
14 PIN	.11	24 PIN	.23
16 PIN	.13	28 PIN	.27
18 PIN	.17	40 PIN	.39
20 PIN	.19		

• LOWEST PRICES ANYWHERE FOR THE HIGHEST QUALITY. AN UNBEATABLE COMBINATION.

CMOS

CD4001BE	.19	CD4026BE	1.69	CD4068BE	.24	CD4516BE	.89
CD4002BE	.19	CD4027BE	.44	CD4069BE	.19	CD4519BE	.54
CD4006BE	.75	CD4028BE	.58	CD4070BE	.24	CD4520BE	.69
CD4007BE	.32	CD4029BE	.75	CD4071BE	.24	CD4522BE	.84
CD4008BE	.69	CD4030BE	.44	CD4072BE	.24	CD4526BE	1.25
CD4009BE	.45	CD4033BE	1.75	CD4073BE	.29	CD4527BE	1.59
CD4010BE	.45	CD4034BE	2.56	CD4075BE	.29	CD4528BE	.84
CD4011BE	.19	CD4035BE	.84	CD4076BE	.87	CD4531BE	

ADVANCED COMPUTER PRODUCTS

FIRST TO OFFER PRIME PRODUCTS TO THE HOBBYIST AT FAIR PRICES!

1. Proven Quality Factory tested products only.
 2. Guaranteed Satisfaction
 3. Over \$1,000,000 Inventory
- ## 1981 CATALOG AVAILABLE SOON.
- Send \$2.00 for your copy of the most complete catalog of computer products. A must for the serious computer user.

STATIC RAM BOARDS

S-100 32K (uses 2114)
ASSEMBLED Kit *Less than 1/2¢ per bit!*
 450ns 459.00 450ns 429.00
 250ns 489.00 250ns 459.00
 Bare Board w/all parts less mem. 99.95

MODEL 2065 64K DYNAMIC RAM MODULE \$600.00
 • Designed to IEEE Promote S-100 bus standards
 • Supports 1M5A-type trim potentiometers
 • Operates with either an 8080 or 7800 based S-100 system providing excellent performance features with both
 • Bank-select system allows system memory expansion and is compatible with Commodore products
 • Bank select ports address 8 and/or 16K increments

California Computer Systems

APPLE/EXIDY/EXPANDO TRS 80 16K-UPGRADE KIT

\$49.95 TRS-80/APPLE \$49.95
MEMORY EXPANSION KITS.
 4116's, 16K (200/250 ns)
 8 pcs for \$49.95
 w/instructions & jumpers
 Call For Volume Pricing

- ★ Special: TRS80 Schematic..... \$ 4.95
- ★ Expansion Interface Schematic... \$ 4.95
- ★ Expansion Interface Connector... 7.95

EXPANDORAM II MEMORY KITS

★ Bank Selectable ★ Uses 4116 200 ns.
 ★ Write Protect ★ Power 8VDC, ±16VDC
 ★ Phantom NEW LOW ★ Up to 4 MHz

Expando 64 Kit (4116) Assem. & Tested Add \$50.
 16K \$269.00 48K \$435.00
 32K \$349.00 64K \$505.00

MICROPROCESSORS

28001 16 bit to 8MB	\$189.00
28002 16 bit to 64K	149.00
28003	107.75
28004	145.50
8 (13850)	16.95
2650	18.95
CD1802	13.95
8080A	8.50
8080A-4MHz	13.95
SALE 8085	14.95
8008-1	14.95
2901A	9.90
14185	14.95
2903 A 401 Supertrace	29.95
AM9517 DMA Controller	49.95
AM9519 RAM Controller	49.95
CP1802	39.95
6502	11.50
6502C	16.95
IM5100	29.95
8000C	11.75
8000C 2MHz	19.95
8008	17.95
8035	19.95
87145	19.95
8748	69.95
8086	37.95
8086	69.95

STATIC RAMS

21102 450ns	1.24	25-99	100
21102 250ns	1.30	125	99
2111	1.39	155	115
2111	3.75	365	355
2112	2.95	285	265
2101-1	2.90	175	152
2114L-250ns (4045)	6.50	525	475
2114L-450ns (4045)	8.50	525	475
4044 450ns	5.95	595	475
EMM44200A	9.75	875	795
EMM44200	7.25	725	625
AM9140/41	10.95	1025	925
AM9130/31	12.95	1135	1025
1101	1.95	175	152
P2125/3425 (45ns)	8.95	835	775
5618 1K 1 CMOS	7.95	795	725
2147 Low Power 4K Static	19.95	1845	1685
93415	9.95	895	850
TMS4046	11.95	1035	950

FLOPPY DISK I/O

1771 01 B 8 MiniFloppy 24.95
 uP0372 Nec Floppy 49.95
 1781 Dual Floppy 29.95
 1791 01 B 5 Floppy 39.95
 uP765 Floppy 49.95

A/D CONVERTERS

8700 8 bit Binary 13.50
 8701 10 bit Binary 22.00
 8703 8 bit TS 12.50
 9400 Volt to Freq Conv. 7.25
 1750 3 1/2 Digit BCD 13.95
 1406L 6 bit 3.95
 1406L 8 bit 5.95
 DAC01 D to A 5.95
 DAC 100 5.95
 DAC 100 15.95

TV CHIPS/SOUND

AY38500 1 6 Games B/W 4.95
 AY38515 Color Converter 2.95
 AY38603 1 Road Race 8.95
 AY38606 1 Wipeout 9.95
 AY38607 1 Shooting Gallery 9.50
 AY38610 Sound Generator 12.95
 SN76777 TI Sound Generator 3.95
 MM5202 21 TV Synch Gen 3.95
 MM5209 9F Modulator 3.95
 LM1869 RF Modulator 3.95
 MM5710 NBC Color TV 8.95
 MM5714 Color TV 37.95
 RF Modulator w/Audio 6.95
 M8R Modulator 29.95

WAVEFORM GEN.

8038 Function Gen. 3.95
 M4040 80 Pin Gen 29.95
 LM556 VCO 1.95
 XR2206 Function Gen 1.95

SHIFT REGISTERS

MM5004 Dual 2's 50
 MM5005B Dual 2's 50
 MM5009 Dual 128 2.95
 2510A Dual 100 1.95
 3301 300 4.95
 3341 Dual 80 4.95
 3351 40 x 8 FIFO 17.95
 3351 300 4.95
 9403 16 x 4 FIFO 24.95
 9408 10 Bit Sequencer 3.95
 3347 5.95

CTS DIPSWITCHES

CTS206-2 1.75 CTS206-7 1.75
 CTS206-8 1.75 CTS206-9 1.75
 CTS206-5 1.75 CTS206-6 1.75
 CTS206-1 1.75 CTS206-10 1.95

CONNECTORS (GOLD)

DB25P (RS232) 3.25
 DB25M (RS232) 3.25
 Hood 1.20
 Ser w/Hood Ser. \$75.00
 2244 40 Pin 29.95
 4386 W/M S/T, K/M 6.50
 50/100 S-100 Connector w/h 4.95
 50/100 S-100 Connector w/h 3.95

PACKED PC

2 80 CPU (Intel) \$34.95
 8080A CPU 34.95
 BK Static RAM (Logos) 24.95
 16K Static RAM (Logos) 24.95
 32K Static RAM (2114) 24.95
 8K EPROM (2708) 24.95
 1702 EPROM Board 30.00
 2708-2716 EPROM (W/MC) 30.00
 Realtime Clock 34.95
 ACP Proto Bd (3M Conn) 27.95
 Vector 8800 Proto 22.20
 Vector 8800 Proto 22.20
 ACP Extender (3M Conn) 18.95
 Video Interface (SSA) 31.95
 8 Slot Mother Board (W/MC) 2.95
 13 Slot Mother Board (W/MC) 2.95
 8 Slot Mother Board (W/MC) 2.95
 8 Slot Mother Board (W/MC) 2.95
 Pro-Tech Bare Boards CALL
 W/MC Floppy PCB 34.95

COMPUTER SPECIALS

Apple II Plus w/16K 1195.90
 PET 2001 16K 995.95
 Easy-Saver w/16K 1099.95
 Cromemco Sys III 6990.620
 Pascal Microsystem 1995.1585
 IP81 1620 Databox 3295.2695
 Anadex Model 43 1349.1150
 Centronics Micro S-1 995.975
 Sorac II 200 995.795
 Teletype Model 43 1349.1150
 HiFlo Floppy 1085.999
 HiFlo Digitizer 795.735
 Intelchem II 995.735
 Atari 800 999.740
 Atari 400 999.740
 TI 994A 1150.25
 Leades 12 Monitor 149.138
 Centronics 737 995.699
 Centronics 1100 379.349
 Trencrom T-200 595.525
 Sanyo 8' Monitor 200.169
 Sanyo 15' Monitor 795.249
 M01 22 MHz Monitor 296.219

DISCOUNTS!

18 Pin w/2L 5 35
 18 Pin w/2L 5 35
 20 Pin w/2L 15 25
 18 Pin w/1 15
 22 Pin w/1 15
 Call for volume pricing

SOCKET SPECIALS

TERMS: Use check, M/C, VISA, MC, or COD. COD requires 25% deposit. Charge Orders please include expiration date. Foreign pay items subject to your state and/or TWX. MINIMUM \$1000. Please include machine issue and phone no. SHIPPING 18.95 add \$2.00 for first 2 lbs. For surface add 30¢ for additional lbs. For air 70¢ for additional lbs. Not responsible for 15 days extra. Items subject to your state and/or TWX. Minimum \$1000. Please include machine issue and phone no. Items subject to previous notice. Order. We reserve the right to substitute manufacturer.

THE VISTA V-80 Disk Drive System

• 32M byte storage capacity
 • 120 day warranty
 • 40 track each at 80 CHARGE

TR80 ADD-ON \$299.00

THE VISTA V-200 FOR EXIDY

Price Starting as low as \$1199.00

Model	Capacity	Speed	Price
V200 E-20	2 1/2"	25 kbs	1199.00
V200 E-22	8 1/2"	25 kbs	1549.00
V200 E-30	8 1/2"	37.5kbs	1574.00
V200 E-32	11 1/4"	37.5kbs	1999.00

ATTENTION VIDEO HOBBYISTS!!!

- BOX BUILDERS
- USE AS REMOTE TUNER/TIMER
- FULL SCHEMATICS AVAILABLE
- FOR ONLY \$5.90! - FREE W/PURCHASE

NEW, UNUSUAL COMPONENTS

1 Unifun™ Tuner... \$59.95
 2 RF Modulator with Audio & Video... \$39.95
 3 Digital Color Multi-AM/FM Fluorescent... \$19.95
 4 300 Ohm to 75 Ohm Matching... \$74.95
 5 Complete Set of All The Above... \$74.95

RAM BOARDS SPECIAL

16K Static Dynamic RAM Boards
 Assem. & Tested \$119.95 Unfilled \$95.00

LOW COST FLOPPY DISK SUBSYSTEM

Seimens FDD 120-8 (2) VISTA Floppy Control
 (S-100) Case, Power Supply & Cable CP/M Disk Operating System Assembled & Tested
 Walnut Wood Sides \$1499.00
 • FREE 50¢ FLOPPY DISK 5 1/4" 256K
 • SAVE \$300.00 (\$1799.00 VALUE)

WATANABE MILOPT

Max speed 50 min/sec... \$1195.00

IMS STATIC RAM BOARDS

8K Static	\$209.00	450 ns.
16K Static	\$429.00	\$189.00
32K Static	\$749.00	\$399.00
	\$729.00	\$629.00

CENTRONICS PRINTER

Model 737
 • Centronics complete printer
 • The 737 has everything Check and compare the features
 • New low price \$835.00

SALE! SD SYSTEMS BOARDS TAKE 10% OFF!

SBC 100 Single Board Computer (2MHz)	\$265.00	\$238.50
SBC 200 Single Board Computer (4MHz)	299.00	269.10
Z80 Starter System	319.00	287.10
VDB 8024 Video Display Board	338.00	304.20
Vista-Floppy II	325.00	292.50
Expando PROM	118.00	106.20
SD100 Computer System w/disk	6995.00	6295.50
SD200 Computer System w/disk	7985.00	7186.50

6800 MICROMODULE™ PRICE LIST

MODEL NO.	DESCRIPTION	PRICE
9600A	Single Board Microcomputer	\$495.00
9609	Advanced Single Board Comp (6809)	\$95.00
9601	16 Slot Mother Board	175.00
9602	Card Cage	75.00
9603	8 Slot Mother Board	100.00
9604	Power Supply	275.00
9605	DC Input Power Supply	325.00
9610	Utility Proto Board	39.00
9611	4MB Random Memory Module	495.00
9612	Buffer/Utility Proto Board	49.00
9616	32K EPROM/RAM Module	250.00
9617	EPROM Programming Head	250.00
9620	16 Channel Parallel I/O Module	295.00
9622	Serial/Parallel I/O Module	325.00
9627	16K Static RAM Module 470ns	395.00
9629	32K Static RAM 450ns	595.00
9629A	32K Static RAM 200ns	895.00
9630	Card Extender	60.00
9640	Multiple Programmable Timer	395.00
9645	8 Channel Duplex Serial I/O Mod	395.00
9655	Intelligent Tape Controller	550.00
96103	32/32 I/O Module	275.00
96702	Contact Closure Module	350.00

UNPOPULATED BOARDS (Also Available)

PERSICI MODEL 298B DISKETTE DRIVE

3.2 Mbytes capacity (unformatted), max. seek time 100MS.
 ACP Price... \$2,199.00

UV "Eprom" Eraser

Model UVs-11E \$69.95
 Holds 4 Eprom's at a time
 Backed by 45 years experience
 Model S-52T... \$265.00
 Professional Industrial Model

EMAKO-20.. Reg. \$777.00 \$599.00

UNRELEASABLE!
 125 Caps, 60pin-Vertical
 Format Unit - 36 Characters
 Users Upper/Lower Case - 4.5" to 9.5" Character
 80 col/40 col double width - Full 96 char. ASCII

EMAKO-22... \$799.00

Price a 132 col/66 char. Available with parallel or serial output at same price

VISTA V-300 PRINTER

25 CPS, Full Character
 Daisy Wheel, 136 Column
 Model No. FP1500 \$1995.00

BASE II PRINTER

80 Column Impact Printer
 • 60 Lines Per Minute
 • 115/230 VAC, 50 or 60 Hz.
 • 12, 30, 96, 120 or 132 Lines
 • Self-Test Switch

REG. \$699.00
 WITH ALL OPTIONS ACP PRICE \$599.00
 Option "M" Terminal Screen Buffer (1920 Char.) 50.00
 Option "S" High Speed Paper Advance & Graphics 50.00
 Option "T" Teletor Feed 50.00

Z-80/Z-80A/8080 CPU BOARD

• On board 2708 • 2708 included (450ns)
 • Power on jump • Completely socketed
 • Z-80 Assembled and Tested \$185.00
 • Z-80 Kit \$129.95
 • Z-80 Bare PC Board \$34.95
 • For 4MHz Speed Add \$15.00

8080A Kit \$99.95

8080A Assembled \$149.95

S-100 MOTHERBOARD SPECIAL

8 slot expandable w/9 conn.
 reg \$69.95. NOW \$52.95

SIEMEN'S FLOPPY

SALE \$129.00
 \$149.00
 \$149.00
 \$149.00

ACOUSTIC MODEM

NOVATION CAT™ 0-300 Baud
 Bell 103 Answer, Originate

'D' CAT MODEM NOW AVAILABLE \$199.00

MONITORS

Samy 12" Data Display	499.00
DM510C1	329.00
Monitor 12" High Resolution	375.00
22 MHz OEM Mon	449.00
MS3000-340	219.00
Monitor 8" Same 15"	279.00
Monitor 8" 1520-1531 OEM	139.95

DATA BOOKS • COMPUTER BOOKS

1980-C Master \$59.95
 INTEL Data Book 7.50
 INTEL MCS 95 Manual 7.50
 SALE • OSBORNE BOOKS • SALE
 Intro to Micro Vol. I 12.50
 Intro to Micro Vol. II 12.50
 8080A Programming 27.50
 6800 Programming 12.50
 Z80 Programming 12.50
 Vol. II Some Real Microprocessors w/Binder 27.50
 Vol. III Some Real Support Devices w/Binder 18.50
 Intro to Microc Vol. III 18.50

SALE • SYBEX COMPUTER BOOKS • SALE

5120 Games 512.95
 Intro to Personal & Business Computing 12.95
 Microprocessors From Chips to Systems 12.95
 Microprocessor Interfacing Techniques 12.95
 Programming the Z80 12.95
 Programming the Z8000 12.95
 Programming the 8502 12.95
 6502 Applications Book 12.95
 CPM Handbook 12.95

ADVANCED SUPPORT

AM9511 Arith. Processor 175.00
 9512 Arith. Int. 175.00
 9513 Univ. Timing 79.95
 AM9517 DMA Controller 18.95
 AM9519 RAM Controller 18.95

Z-80 SUPPORT CHIPS

Z80-PH 2.5 MHz 8.75
 Z80-PIO 2.5 MHz 8.75
 Z80-CTC 2.5 MHz 8.75
 Z80-DM 2.5 MHz 29.95
 Z80-DMA 4.0 MHz 35.95
 Z80-SIO0 2.5 MHz 35.95
 Z80-SIO1 2.5 MHz 35.95
 Z80-SIO2 2.5 MHz 35.95
 Z80-SIO2 4.0 MHz 35.95

8080/8085 SUPPORT

8155/8156 I/O 24.95
 8755 I/O with Eprom 64.95
 8756 I/O with Eprom 64.95
 8205/745 138 Decoder 3.95
 8218 8 bit I/O 2.75
 8219 8 bit I/O 2.75
 8224 CDS ROM 2.75
 8224A (4MHz) 9.75
 8228 Bus Driver 2.95
 8228B Driver 2.95
 8228 Sys. Control 5.50
 8238 Sys. Control 5.50
 8251 Freq. I/O 6.95
 8253 Int. Timer 12.95
 8257 Prog. DMA 18.95
 8259 Prog. Int. 17.95
 8278 Prog. Keyboard 49.95
 8278 CTR Controller 49.95
 8278 Prog. Keyboard 49.95

6800 SUPPORT CHIPS

6810 128 x 8 Ram 4.15
 6820 PIA 5.95
 6821 PIA 5.95
 6821A Priority Int. 6.95
 6834-1 512 x 8 EPROM 16.95
 6845/04/04515 CRT Cont. 49.95
 6847 Card. Prot. 49.95
 6850 ACIA 5.95
 6852 Serial Adapter 5.95

7400

Table with 4 columns of part numbers and prices for the 7400 series.

74LS00

Table with 4 columns of part numbers and prices for the 74LS00 series.

CMOS

Table with 4 columns of part numbers and prices for CMOS components.

LINEAR

Table with 4 columns of part numbers and prices for linear components.

16K UPGRADE ONLY \$49.95 SPECIFY COMPUTER

TEXAS INSTRUMENTS 99/4 PERSONAL COMPUTER. Superior Color, Music, Sound & Graphics... \$499.00 Console only.

BECKMAN Digital Multimeters. Choice of Modes - The TECH 310 has all above features... \$129.95

NEW! MUSIC MACHINE 9 WITH 9 VOICES! \$129.95

FLOPPY DISK DRIVES. MPI B5-1.5% 40 tracks... \$279.00

CONTINENTAL SPECIALTIES. Model LM-3 40 channel Logic Monitor... \$585.00

Proto Clips. 14-Pin Chip PC-14 \$ 4.25

SEMICONDUCTORS SPEAK! DIGITAL TALKER™ Speech Synthesis System

DIGITAL TALKER™ Speech Synthesis System. The DIGITAL TALKER is a speech synthesis system...

ADVANCED COMPUTER PRODUCTS

Apple II. 16K or Apple II. Plus \$990 DISK SYSTEM SPECIAL. Apple II Plus w/48K Supermod Video Modulator...

NEW APPLE PRODUCTS. 'APPLE FAX' - Cures thermal problems from overcooked machines... \$49.95

NEW APPLE SOFTWARE. 1. CTE#81338E - Apple II version of Star Raiders... \$34.95

ATARI 800 & 400 Personal Computer System. ATARI 800 \$825.00 ATARI 400 \$449.00

SINGLE BOARD COMPUTER SELECTION GUIDE. BOARD PROCESSOR ACPI PRICE ENCLOSURE...

ACP'S COMPUTER PRODUCTS & GADGETS. You won't believe your earbones... THE BONE FONE

QUARTZ LCD WATCH WITH SNOOZE ALARM. The looks and functions of the expensive models at an affordable price. \$21.95

RETAIL STORES OPEN MON-SAT. STORE #1 1310 "B" E. Edinger Santa Ana, CA 92705. STORE #2 674 El Camino Real Tustin, CA 92680. P.O. Box 17329 Irvine, Calif. 92713. Direct Order Lines: (714) 558-8813 (800) 854-8230 or (800) 854-8241. FOR INTERNATIONAL ORDERS: 1310 E. Edinger (714) 953-0804 Santa Ana, CA 92705 TWX: 910-595-1565

4Kx16 MEMORY BOARD with 64 IC chips (2102) in sockets. Super deal at \$50 the complete board.

\$29 AUTO SECURITY SYSTEM alarm system \$7.00

- SANYO UHF VARACTOR TUNER 25.00
- SOUND GENERATOR IC \$1.00 ea 6/5.00
- SHUGART FLEX DISC DRIVE 5 1/4 inch 150.00
- SHUGART FLEX DISC DRIVE 8 inch 200.00
- PORTABLE ULTRASONIC ALARM 15.00
- MOTOROLA VIDEO MONITOR 12 inch 85.00
- MOTOROLA VIDEO MONITOR 9 inch 40.00

The above two monitors accept composite video signal
BALL VIDEO MONITOR 12 inch w/power supply \$0.00
 The above monitor requires comp video circuitry

DATA STATION CONSOLE w/keyboard 9 inch monitor, power supply. Logic boards broken. \$80
 Send for details on this one.

- TOUCH PAD** solid state w/LSI chip. Bell system compatible. For computers & phones \$24.00
- 12 VOLT GEL-CELLS** 2.5 AH \$14.00 5 AH \$17.00
- 12 INCH CRT** bonded face plate. New with specs. Made for computers. \$35.00

WALKY TALKIES Govt surplus used condition. 47-55.4 mc range. With schematics. Govt AN/PRC-6 \$25 each 2 for \$45. Ant. \$5 each

ASCII KEYBOARD parallel \$50
RED LED's 10 for \$1.00

MIN ORDER \$10.00

Shipping extra on all merchandise

Meshna Inc., PO Box 62, E. Lynn, Mass. 01904



CIRCLE 15 ON FREE INFORMATION CARD

More CFR Spectaculars!!!

ASCII Parallel Input
***SELECTRIC Typewriter/Printer**
 100% TRS-80 COMPATIBLE



Only
\$659.00

- Compatible w/Printer Cable or Expansion Interface
 - Refurbished Selectric Printer
 - Parallel Input, 15" Frame, 132 Cols.
 - Upper & Lower Case Typewriter/Printer
 - Complete & Ready For Use
 - BCD Type Element Included
 - Data Included
 - Fully Formed Characters, Approx 15 CPS
- Add \$20.00 for Handling & Packaging. Pay Shipping, When Delivered.

This Month's Specials

- SHUGART 901** 8" Floppy Disk Drive
 Used, whole untested. Data & Schematics included. 2/499.00
 Plus Shipping
- SHUGART SA400** 5 1/4" Mini Floppy
 Used, whole, untested. Data & Schematics included. 2/299.00
 Plus Shipping
- CDC9400** (MPI BR-803) 8" Floppy Drive
 Hard or Soft Sector'd Used, whole, untested. Data & Schematics included. 2/399.00
 Plus Shipping
- 12" VIDEO MONITOR** Motorola #XM-351
 80x24 or 16x64 Display. Requires only Composite Video Input and 110/230 VAC, 50-60 Hz. Tested, functional & guaranteed. Data and schematics included. \$95.00 ea.
 Plus Shipping
- 9" VIDEO MONITOR** Motorola #XM-227
 Same characteristics as above 12" video. Tested, functional and guaranteed. Data & Schematics included. \$79.00 ea.
 Plus Shipping

Call For Our Bargain-Packed PERIPHERAL FLYER!!!
 Prices Are Subject To Change On All Items

CFR Associates, Inc.

MAIL ORDERS: Box 144, Newton, N.H. 03958
 PHONE ORDERS: 617/372-8536 (Sorry, No Collect Calls) Mastercharge & VISA Welcome
 WAREHOUSE: 18 Granite St. Haverhill, Mass. 01830

CIRCLE 41 ON FREE INFORMATION CARD

apple II plus

With 48K of memory!
\$1042.00

With the purchase of the APPLE II select from the below SPECIAL PRICING!

- Base printer \$599.00
- Disk II w/corr 585.00
- Disk II 475.00
- Ser Printer Cd. 179.00
- SupRMMod. 23.00
- 3way IO Select. 33.00
- Video 100 12" 119.00
- Firmware Card. 149.00
- UHFtoRCA Cable. 5.00



apple II/apple II plus

With 60K of memory!
\$1259.00

- Switch from "APPLESOFT" to "INTEC BASIC" and back again.
- With Disc Operating System DOS 3.3 run PASCAL program without need for a PASCAL card.

COLOR



\$397.00 MONITOR 13"

APPLE INTERFACE CARDS

- CENTRONICS PRINTER COMMUNICATIONS \$129.00
- DATA II CONTROLLER \$149.00
- INTEC BASIC PAK \$95.00
- APPLESOFT PAK \$95.00
- PASCAL LANGUAGE PACKAGE \$69.00
- PARALLEL PRINTER \$75.00
- PROTOTYPING/HOBBY \$19.00
- IRISK PACKAGE \$49.00

- \$100
- 16K STATIC MEMORY \$8.99
 - 32K STATIC MEMORY \$8.99
 - 64K DYNAMIC MEMORY \$23.00
 - NOTICEBOARD 12 \$101.00
 - 1.8M CPU \$8.99
 - MASTERBOARD \$182.00
 - DISK CONTROLLER \$8.99

74LS00	26	74LS155	115
74LS02	26	74LS158	75
74LS03	26	74LS160	95
74LS04	26	74LS161	85
74LS08	28	74LS162	95
74LS09	26	74LS163	160
74LS10	26	74LS164	65
74LS20	26	74LS165	65
74LS21	28	74LS170	75
74LS22	26	74LS174	75
74LS26	49	74LS175	75
74LS27	26	74LS190	75
74LS30	29	74LS193	95
74LS32	32	74LS195	95
74LS38	32	74LS196	85
74LS42	65	74LS221	140
74LS48	78	74LS240	165
74LS51	25	74LS241	165
74LS54	35	74LS243	145
74LS74	38	74LS244	145
74LS75	60	74LS245	225
74LS83	44	74LS253	95
74LS85	95	74LS257	95
74LS86	95	74LS258	95
74LS90	69	74LS259	285
74LS93	69	74LS279	44
74LS107	45	74LS283	100
74LS112	38	74LS293	185
74LS113	48	74LS298	120
74LS122	48	74LS366	95
74LS123	95	74LS367	55
74LS126	69	74LS368	55
74LS138	69	74LS373	139
74LS151	44	74LS374	139
74LS153	44	74LS386	65

APPLE EXPANSION KIT

16K Memory Add-On
 MEMORY ADD-ON KIT INCLUDES INSTRUCTIONS
\$39.00

video 100



apple clock/calendar

\$124.95
 Seconds, minutes, hours, day-of-week month, date, & year
 On board batteries with one year life. Uses MSM5832 crystal controlled. California Computer Systems

MISCELLANEOUS

8038C	2.85
NE555V	.27
7905	
7908	
7915	
7918	
7805	.85
7806	
7808	
7812	
MC1330AIP	1.60
MC1350P	1.15
MC1359P	1.50
LM380N	1.75
NE565N	1.25
MC1458P	.50
IS410 SCR	.95
IT410 TRIAC	.95
2114 200ns	3.50
2114L 200ns	3.75
2114L 200ns	4.25
4116 300ns	4.95
4116 200ns	5.45



BUY FIVE OR MORE FOR \$16.95 each

CONCORD COMPUTER COMPONENTS

1971 SOUTH STATE COLLEGE ANAHEIM, CALIF. 92806
 VISA MASTERCHARGE CHECK OR M.O. NO C.O.D. CAL RES. ADD 5%
(714)937-0637 MINIMUM ORDER \$10.00 ADD \$1.50 FOR FR.T. ORDERS UNDER \$50. 5% IF OVER \$50

MSM5832 MICROPROCESSOR

\$745
REAL-TIME CLOCK
 The MSM5832 is a monolithic metal-gate CMOS integrated circuit that functions as a real-time clock/calendar for use in any microprocessor application. The on-chip 32 768 Hz crystal controlled oscillator time base is courted down to provide addressable B-B1, D data of SECONDS, MINUTES, HOURS, DAY OF WEEK, DATE, MONTH and YEAR. Data at pins is controlled by 4 bit address, chip select, read, write and hold signals. Other functions include 128 24-bit format selection, real-time identification and manual 30 second correct flip.

TRS 80

16K Memory Add-On
\$4395
 KIT CONTAINS DIP SWITCHES AND DETAILED INSTRUCTIONS

SOROC TECHNOLOGY, INC.



No "Glitches", Surges Or Interference
 THE SOROC TURNS AN ORDINARY OUTLET INTO A CONTROLLED FILTERED POWER SOURCE FOR UP TO EIGHT DEVICES
\$6750

CIRCLE 36 ON FREE INFORMATION CARD

INTERNATIONAL ELECTRONICS UNLIMITED

CERAMIC CAPACITORS

1pf	22pf	56pf	120pf	270pf	.0047uf	.030uf	
5pf	27pf	68pf	150pf	390pf	.001uf	.01uf	
7pf	33pf	82pf	180pf	470pf	.0015uf	.015uf	
10pf	47pf	100pf	220pf	600pf	.003uf	.022uf	
1pf	.1uf						
Total EA.	PK-10	PK-100	EA.	PK-10	PK-100		
1-1000	\$.20	\$.95	6.50	.25	1.25	9.00	
1000-	.20	.85	6.00	.25	1.10	8.00	

CERAMIC CAPACITOR KIT

CK-c2 5ea. of the above values \$11.50
CK-c3 10ea. of the above values 20.50

POLYESTER FILM CAPACITORS - 100V ± 10%

.001uf	EA.	PK-10	PK-100	EA.	PK-10	PK-100
.0015uf	.15	.95	7.50	.047uf	.20	1.15
.0022uf	.15	.95	7.50	.068uf	.25	1.30
.0033uf	.15	.95	7.50	.1uf	.30	1.75
.0047uf	.15	.95	7.50	.15uf	.35	2.25
.0068uf	.15	.95	7.50	.22uf	.40	2.55
.01uf	.15	.95	7.50	.33uf	.45	2.75
.015uf	.15	.95	7.50	.47uf	.50	3.50
.022uf	.15	.95	7.50			

TOTAL QTY. 1000 pcs. -10%, 5000 pcs. -15%

POLYESTER CAPACITOR KIT

5 ea of the above values \$14.95

TANTALUM CAPACITORS solid dipped ± 20%

.1uf/35V	.30	.25	4.7uf/16V	.38	.30	22uf/16V	.50	.40
.22uf/35V	.30	.25	4.7uf/25V	.45	.35	22uf/35V	.60	.55
.33uf/35V	.30	.25	6.8uf/6V	.35	.28	33uf/6V	.55	.45
1uf/20V	.30	.25	6.8uf/16V	.45	.39	33uf/10V	.60	.50
1.5uf/20V	.30	.25	10uf/20V	.42	.35	47uf/6V	.60	.50
2.2uf/20V	.35	.25	15uf/6V	.42	.35	47uf/15V	.65	.55
2.2uf/35V	.38	.28	15uf/20V	.50	.40	56uf/6V	.85	.75
3.3uf/35V	.40	.30						

TANTALUM CAPACITOR ASS'T.
5ea. of above - \$37.50

ELECTROLYTIC CAPACITORS - axial

1u/16V	.13	.11	09	22u/16V	.15	13	.11
1u/30V	.14	.12	10	22u/30V	.16	14	.12
1u/160V	.17	.15	12	33u/25V	.18	16	.14
2.2u/25V	.14	.12	10	47u/25V	.18	16	.14
2.2u/50V	.14	.12	10	50u/25V	.18	16	.14
2.2u/63V	.14	.12	10	100u/10V	.18	16	.14
4.7u/10V	.14	.12	10	150u/25V	.22	20	.17
5u/25V	.12	.10	08	220u/16V	.23	21	.18
10u/16V	.13	.11	10	220u/25V	.25	22	.20
10u/25V	.14	.12	10	470u/35V	.33	29	.26
10u/50V	.15	.13	11	1000u/35V	.89	85	.80
10u/150V	.18	.16	14	1000u/50V	1.00	95	.90

SOCKETS - LOW PROFILE, SOLDER TAIL



ea	100
8 pin	.20
14 pin	.25
16 pin	.22
18 pin	.32
24 pin	.48
28 pin	.65
40 pin	.75

TRANSISTORS

2N3904 NPN 10-92 5.25ea 10/S1.65 25/\$3.25 100/\$12.00
2N3906 PNP 10-92 5.25ea 10/S1.65 25/\$3.25 100/\$12.00
2N2222A NPN 10-18 5.45ea 10/\$3.50 25/\$8.00 100/\$24.50

DIODES

1N4148 (1N914) 400ma .5/\$1.00 100/\$5.00 1000/\$40.00
1N4001 50PIV 12/\$1.00 100/\$7.00 1000/\$60.00
1N4007 1000PIV 10/\$1.25 100/\$11.00 1000/\$100.00

VOLTAGE REGULATORS

LM320T-5 Negative 5 V reg (7905) 1.19
LM320T-12 Negative 12 V reg (7912) 1.19
LM320T-15 Negative 15 V reg (7915) 1.19
LM340T-5 Positive 5 V reg (7805) 1.19
LM340T-8 Positive 8 V reg (7808) 1.19
LM340T-12 Positive 12 V reg (7812) 1.19
LM340T-15 Positive 15 V reg (7815) 1.19

DISCRETE LED'S

JUMBO LED
20'dia, diffused
Red, Clear or White 10/\$1.00 25/\$2.00 100/\$9.00
Green or Yellow 7/\$1.00 25/\$2.85 100/\$9.75

SUBMINIATURE LED
.125'dia, diffused
Red or Clear 10/\$1.00 25/\$2.00 100/\$9.00
Green or Yellow 7/\$1.00 25/\$2.85 100/\$9.75

TTL

10% OFF ON \$25.00
15% OFF ON \$50.00

7400	5.18	7464	.30	74155	.50
7401	.18	7465	.30	74156	.64
7402	.18	7470	.49	74157	.60
7403	.18	7472	.32	74158	.75
7404	.20	7474	.18	74160	.70
7405	.25	7475	.49	74161	.79
7406	.20	7576	.49	74162	.85
7407	.20	7480	.35	74163	.85
7408	.27	7482	.25	74164	.85
7409	.27	7483	.58	74166	.85
7410	.16	7485	.50	74170	1.50
7415	.29	7486	.42	74173	1.25
7416	.26	7490	.75	74176	.85
7417	.26	7490	.59	74175	.85
7420	.20	7491	.64	74176	.70
7425	.39	7492	.59	74177	.70
7426	.35	7493	.35	74180	.35
7427	.25	7494	.59	74181	1.85
7430	.25	7495	.35	74182	.35
7432	.20	7496	.75	74196	.80
7437	.29	7405	.48	74190	1.15
7438	.13	74107	.35	74191	1.15
7440	.13	74121	.35	74192	.50
7441	.59	74122	.39	74193	.79
7442	.35	74123	.39	74194	.85
7443	.55	74125	.50	74195	.69
7444	.60	74126	.75	74196	.80
7445	.50	74132	.75	74197	.75
7446	.59	74141	.35	74198	1.40
7448	.59	74145	.50	74199	1.25
7450	.18	74148	1.25	745200	3.75
7451	.22	74150	1.35	74279	.65
7453	.18	74151	.50		
7454	.18	74153	.35		
7460	.18	74154	1.45		

CMOS

10% OFF ON \$25.00
15% OFF ON \$50.00

4000 Series	CMOS
4000	5.25
4001	.39
4002	.25
4006	.95
4007	.39
4008	.95
4009	.46
4010	.45
4011	.45
4012	.25
4013	.59
4014	.95
4015	.95
4016	.64
4017	1.08
4018	.95

LINEAR CIRCUITS

10% OFF ON \$25.00
15% OFF ON \$50.00

LM300H	5.30	LM565N	.55
LM301CN	.28	LM566H	1.39
LM302H	.28	LM566CN	1.45
LM304H	.30	LM567CN	1.19
LM307CN	.32	LM733H	.59
LM307H	.40	LM730CN	.39
LM308CN	.45	LM709H	.79
LM309H	1.05	LM710CN	.45
LM309K	1.15	LM711CN	.35
LM310CN	.75	LM723H	.59
LM310H	.75	LM723CN	.49
LM311CN	.39	LM733H	.45
LM318CN	1.45	LM739H	.45
LM319H	1.20	LM741CN	.29
LM320K-5	.95	LM741	.29
LM320K-5.2	.95	LM741CH	.45
LM320K-15	.95	LM747H	.79
LM322N	.45	LM747CN	.69
LM324N	1.19	LM748CN	.25
LM339N	.25	LM1310N	2.50
LM340K-6	.95	LM1414N	.35
LM340K-8	.95	LM1456CN	1.29
LM340K-12	.95	LM1458CN	.65
LM340K-15	.95	LM1496N	.89
LM370N	1.25	LM1800N	2.40
LM372N	.70	ULN2208	.79
LM376CN	1.25	ULN2209	.79
LM380N	1.19	CA3046N	1.29
LM380N	.45	CA3081N	1.25
LM381N	1.75	CA3082N	1.25
LM382N	.49	LM3900N	.45
LM385K	.99	LM7524H	.45
LM386CN	.99	LM7525H	.45
LM387CN	.99	LM7535	.99
NE546A	1.79	80388	3.79
NE550A	1.75	75450N	.35
LM555CN	.45	75451CN	.35
LM556N	.79	75452CN	.35
LM560N	2.95	75453CN	.35
		75454CN	.35
		75491N	.75
		75492N	.85

IMMEDIATE DELIVERY OF QUALITY RESISTORS



METAL FILM RESISTORS

METAL FILM 1% total quantity ea pk-10 pk-50 pk-100 pk-250
RMS (R.Ohm CR860F) 1/4watt 1-999 \$.25 1.00 2.00 7.50 17.50
Low temp coef - 50ppm/°C 1000-.20 .90 1.80 7.00 16.25
Low temp coef - 50ppm/°C 5000-.20 .85 1.70 6.50 15.00
color banded .138"dia x .355"long (body) 10000-.20 80 1.55 6.00 13.75

METAL FILM RESISTORS

10 or more resistors - not individually packaged - mixed - specify any assortment of values \$15ea

VALUES STOCKED (ohms)

Standard 1 metal film values from 10 ohm to 1M 1/4 watt

10.0	12.1	14.7	17.8	22.6	27.4	33.2	40.2	48.7	59.0	71.5	88.7
10.2	12.4	15.0	18.2	23.2	28.0	34.0	41.2	49.9	60.4	73.2	90.9
10.5	12.7	15.4	18.7	23.7	28.7	34.8	42.2	51.1	61.9	75.0	93.1
10.7	13.0	15.8	19.1	24.3	29.4	35.7	43.2	52.3	63.4	76.8	95.3
11.0	13.3	16.2	19.6	24.9	30.1	36.5	44.2	53.6	64.9	80.6	97.6
11.3	13.7	16.5	20.0	25.5	30.9	37.4	45.3	54.9	66.5	82.5	100.0
11.5	14.0	16.9	20.5	26.1	31.6	38.3	46.4	56.2	68.1	84.5	
11.8	14.3	17.4	22.1	26.7	32.4	39.2	47.5	57.6	69.8	86.6	

METAL FILM RESISTORS

METAL FILM 1% total quantity ea pk-10 pk-50 pk-100 pk-500
RMS (R.Ohm CR814F) 1/8watt 1-999 \$.25 1.00 4.00 7.50 35.00
Low temp coef - 50ppm/°C 1000-.20 .90 3.60 7.00 30.00
Low temp coef - 50ppm/°C 5000-.20 .85 3.40 6.50 30.00
color banded .094"dia x .225"long (body) 10000-.20 80 3.10 6.00 27.50

METAL FILM RESISTORS

10 or more resistors - not individually packaged - mixed - specify any assortment of values \$15ea

VALUES STOCKED (ohms) 1/8 watt

10.0	27.4	75.0	348	1.74K	5.11K	11.0K	20.5K	31.6K	54.9K	140K	324K
10.2	28.7	78.7	402	1.87K	5.36K	11.3K	21.0K	32.4K	57.6K	147K	332K
11.0	30.1	84.5	475	1.96K	5.49K	11.5K	21.5K	33.2K	60.4K	150K	348K
11.5	31.6	90.9	487	2.05K	5.76K	12.1K	22.1K	34.8K	64.9K	158K	374K
12.1	33.2	100	499	2.21K	6.04K	12.4K	22.6K	36.5K	68.1K	165K	402K
13.0	35.7	107	604	2.43K	6.49K	12.7K	23.2K	37.4K	69.8K	174K	432K
14.0	37.4	121	649	2.49K	6.81K	13.0K	23.7K	39.2K	75.0K	182K	453K
14.7	40.2	127	715	2.74K	7.15K	13.3K	24.3K	40.2K	76.8K	191K	464K
15.0	43.2	137	760	2.87K	7.50K	13.6K	24.9K	41.2K	82.5K	200K	475K
16.2	45.3	150	909	1.01K	8.25K	14.7K	25.5K	43.2K	90.9K</		

100W CLASS A POWER AMP KIT

Dynamic Bias Class "A" circuit design makes this unit unique in its class. Crystal clear, 100 watts power output will satisfy the most picky fans. A perfect combination with the TA-1020 low T.I.M. stereo pre-amp.

Specifications:

- Output power: 100W RMS into 8-ohm 125W RMS into 4-ohm
- Frequency response: 10Hz - 100 KHz
- T.H.D.: less than 0.008%
- S/N ratio: better than 80dB
- Input sensitivity: 1V max
- Power supply: $\pm 40V @ 5amp$



TA-1000 KIT
\$51.95
Power transformer
\$18.00 each

REGULATED VARIABLE D.C. POWER SUPPLY KIT

Uses UA723 I.C. and 2N3055 power transistor as regulator. Output voltages can be adjusted from 0-30V at an internal resistance of less than 0.005 ohm; ripple and noise less than 1 mV, with built on board LED and audible overload indicator. Kit comes with P.C. board; all electronic components, transformer, connectors; 2 panel meters for voltage and amp; a professional look metal cabinet and instructions.

Model TR-88A 0-15V D.C. 3 amp
Model TR-88B 0-30V D.C. 2 amp



\$59.50
per kit

WHISTLE ACTIVATED SWITCH BOARD

All boards are pre-assembled and tested. Your whistle to its FET condenser microphone from a distance, as far as 30 feet away (sensitivity can be easily adjusted) will turn the switch on, then latched you whistle to it again then it turns off. Ideal for remote control toys, electrical appliance such as lights, coffee pots, TV, Hi-Fi, radio or other projects. Unit works on 9V D.C.



Model 968
\$4.50 each

SUB MINI SIZE FET CONDENSER MICROPHONE

Specification:

Sensitivity: -65dB $\pm 3db$
FEO. Response: 50 Hz - 8 KHz
Output Impedance: 1K ohm max.
Polar Pattern: Omni-directional
Power Supply: 1.5V - 10V D.C.
Sound Pressure Level: Max. 120dB
EM4RP \$2.50 ea. or 2 for \$4.50



NEW MARK III 9 Steps 4 Colors LED VU

Stereo level indicator kit with arc-shape display panel!!! This Mark III LED level indicator is a new design PC board with an arc-shape 4 colors LED display (change color from red, yellow, green and the peak output indicated by rose). The power range is very large, from -30dB to +5dB. The Mark III indicator is applicable to 1 watt - 200 watts amplifier operating voltage is 3V - 9V DC at max 400 MA. The circuit uses 10 LEDs per channel. It is very easy to connect to the amplifier. Just hook up with the speaker output!

IN KIT FORM \$18.50

2 WATT AUDIO AMP

Pre assembled units. All you need is to hook up the speaker and the volume control. Supply voltage from 9-15V D.C. measures only 2" x 3 1/2", making it good for portable or discrete applications. Comes with hook up data.



BUY 2 FOR
\$4.99

MARK IV 15 STEPS LED POWER LEVEL INDICATOR KIT

This new stereo level indicator kit consists of 36 4-color LED (15 per channel) to indicate the sound level output of your amplifier from -36dB ~ +3dB. Comes with a well-designed silk screen printed plastic panel and has a selector switch to allow floating or gradual output indicating. Power supply is 6-12V D.C. with THG on board input sensitivity controls. This unit can work with any amplifier from 1W to 200W!

Kit includes 70 pcs. driver transistors, 38 pcs. matched 4-color LED, all other electronic components, PC board and front panel.



MARK IV KIT \$31.50



MARK V 15 STEPS LED POWER OUTPUT INDICATOR KIT

All functions same as Mark IV but this is with heavy duty aluminum front plate and case. Can be easily slot into the front panel of your auto, truck or boat. Operates on 12V D.C.



\$41.50 EACH KIT

BATTERY POWERED FLUORESCENT LANTERN

MODEL 888 R

FEATURES

- Circuitry: designed for operation by high efficient, high power silicon transistor which enable illumination maintain in a standard level even the battery supply drops to a certain low voltage.
- 9" 6W cool/daylight miniature fluorescent tube.
- 8 x 1.5V UM-1 (size D) dry cell battery.
- Easy sliding door for changing batteries.
- Stainless reflector with wide angle increasing illumination of the lantern.



\$10.50 EA

30W + 30W STEREO HYBRID AMPLIFIER KIT

It works in 12V DC as well! Kit includes 1 PC SANYO STK-043 stereo power amp. IC LM 1458 as pre amp. all other electronic parts. PC Board, all control



\$32.50 PER KIT

SW AUDIO AMP KIT

2 LM 380 with Volume Control
Power Supply 6 18V DC

ONLY \$6.00 EACH

PROFESSIONAL PANEL METERS



Type MU-52E

All meters white face with black scales. Plastic cover.

A. 0-50UA	8.50 ea.
B. 0-30VDC	8.50 ea.
C. 0-50VDC	8.50 ea.
D. 0-3ADC	9.00 ea.
E. 0-100VDC	9.00 ea.

SPECIAL 0.5" LED ALARM CLOCK MODULE

ASSEMBLE! NOT A KIT!

Features: • 4 digits 0.5" LED Displays • 12 hours real time format • 24 hours alarm audio output • 59 min. countdown timer • 10 min. snooze control.



ONLY \$7.00 EACH
SPECIAL TRANSFORMER FOR CLOCK
\$2.50

DIGITAL AUTO SECURITY SYSTEM

4 DIGITS
PERSONAL CODE!!!
SPECIAL \$19.95



- proximity triggered
- voltage triggered
- mechanically triggered

This alarm protects you and itself! Entering protected area will set it off, sounding your car horn or siren you add. Any change in voltage will also trigger the alarm into action. If cables within passenger compartment are cut, the unit protects itself by sounding the alarm.

3-WAY PROTECTION!

All units factory assembled and tested - Not a kit!

SANYO HYBRID AUDIO POWER AMPLIFIER I.C.



Typical ratings

Operating case temp. 85°C.
T.H.D. = 0.5% f = 20~20KHZ
Input resistance Po = 0.1W 30K Ω
Power band width 20HZ~20KHZ
Freq. response 10HZ~100KHZ

Output resistance = 8Ω
With built in protection circuit.

All units come with data sheet

PART	OUTPUT (W)	SUPPLY VOLTAGE	PRICE
STK040	10W+10W Stereo	$\pm 16V$ D.C.	\$14.50
STK041	15W+15W Stereo	$\pm 20V$ D.C.	\$18.50
STK043	20W+20W Stereo	$\pm 22V$ D.C.	\$22.50
STK054	23 WATTS	$\pm 23V$ D.C.	\$13.50
STK056	30 WATTS	$\pm 22V$ D.C.	\$18.50
STK050	50 WATTS	$\pm 35V$ D.C.	\$26.50
STK070	70 WATTS	$\pm 42V$ D.C.	\$32.50
STK1050	100 WATTS	$\pm 50V$ D.C.	\$40.50

PROFESSIONAL FM WIRELESS MICROPHONE

TECT model WEM-16 is a factory assembled FM wireless microphone powered by an AA size battery. Transmits in the range of 88-108MHz with 3 transistor circuits and an omni-directional electric condenser. Element built-in plastic tube type case; mike is 6 1/4" long. With a standard FM radio, can be heard anywhere on a one-acre lot; sound quality was judged very good.

\$16.50



FOR DECODER BUILDERS

Pre-Drilled PC Board	\$17.50
Tolriod Coils (Set of 4)	\$ 3.00
Multi Turn Trim-Pots 10K ohm	\$ 2.50
Trimmer Capacitor 6-35pF	\$ 0.60
MC1358	\$ 2.50
MC1350	\$ 2.00
MC1330	\$ 3.50
RC1458	\$ 1.00
LM380	\$ 1.80
LM340T-15	\$ 1.20
NE565	\$ 2.00

We also have transformer, capacitors set, resistors set antenna transformer. Please call for price.

LCD CLOCK MODULE!

• 0.5" LCD 4 digits display • X'tal controlled circuits • D.C. powered (1.5V battery) • 12 hr. or 24 hr. display • 24 hr. alarm set • 60 min. countdown timer • On board dual back-up lights • Dual time zone display • Stop watch function.

NIC1200 (12 hr) \$24.50 EA.
NIC2400 (24 hr) \$26.50 EA.

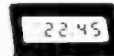

SANYO UHF VARACTOR TUNER

For UHF CH 14~83

Tuning voltage + 1V ~ + 28V/D.C. Input impedance 75 OHM. I.F. band width 7~16 MHZ. Noise figure 11.5 dB MAX. Size 2 3/8" x 1 1/4" x 3/4". Supply voltage 15V D.C. Sound I.F. = 58.0 MHZ. Video I.F. = 62.5 MHZ



All units are brand new from Sanyo.
MODEL 115-B-405A
\$35.00 EACH

FLUORESCENT LIGHT DRIVER KIT



With Case Only
\$6.50 Per Kit

12V DC POWERED
Lights up 8 ~ 15 Watt Fluorescent Light Tubes. Ideal for camper, outdoor, auto or boat. Kit includes high voltage coil, power transistor, heat sink, all other electronic parts and PC Board, light tube not included!

SUPER FM WIRELESS MIC KIT — MARK III



FMC-105
\$11.50 PER KIT

This new designed circuit uses high FET transistors with 2 stages pre amp. Transmits FM Range (88-120 MHz) up to 2 blocks away and with the ultra sensitive condenser microphone that comes with the kit, allows you to pick up any sound within 15 ft. away! Kit includes all electronic parts, OSC coils, and P.C. Board. Power supply 9V D.C.

PRESS-A-LIGHT SELF GENERATED FLASHLIGHT

EXCLUSIVE!! \$3.95 ea
Model F-179



Never worry about battery, because it has none! Easy to carry in pocket and handy to use. Ideal for emergency light. It generates its own electricity by squeezing grip lever. Put one in your car, boat, camper or home. You may need it some time!

ELECTRONIC DUAL SPEAKER PROTECTOR



Cut off when circuit is shorted or over load to protect your amplifier as well as your speakers. A must for OCL circuits.

KIT FORM
\$8.75 EA.

"FISHER" 30 WATT STEREO AMP



Super Buy
Only \$18.50

MAIN AMP (15W x 2)
Kit Includes 2 pcs. Fisher PA 301 Hybrid IC all electronic parts with PC Board. Power supply \pm 16V DC (not included). Power band with (KF 1% \pm 3dB). Voltage gain 33dB. 20Hz - 20KHz.

SPACE WAR SOUND GENERATOR BOARD



Brand new preassembled module for a toy factory. The board gives out 6 different selectable space sound with LED light effect. Sounds include UFO take-off, space gun blast, wave, and space chime. 7 LED on the board will work with the sound. Requires 9V battery to operate. Speaker not included. SPECIAL \$3.99 EACH SPEAKER \$1.25 EACH

ELECTRONIC PIEZO BEEP BUZZER



Unique surplus 7/8" Dia. piezo ceramic disc on circuit board gives a distinct high freq. buzz. Unit contains an I.C., 2 caps 6 resistors and is already pre-assembled. Requires 9V battery to operate. SPECIAL 2 FOR \$2.99

2 BIT COUNTER, WARBLE PULSE ALARM BOARD



This new assembly easily converts to a counter, stop watch, warble and pulse alarm generator by adding a few components. We supply the data and typical applications. Requires 9V battery to operate. SPECIAL 2 FOR \$1.99

PUSH-BUTTON SWITCH



N/Open Contact
Color: Red, White, Blue, Green, Black
3/\$1.00
N/Close also Available
50c each
LARGE QTY. AVAILABLE

HEAVY DUTY CLIP LEADS



10 pairs — 5 colors Alligator clips on a 22" long lead. Ideal for any testing.
\$2.20/pack

BATTERIES

PK/\$10.00
2 PKS/\$19.00



NICKEL CADMIUM BATTERY PACK 'D' SIZE

ILLUSTRATED LESS COVER

Output: 3.6 Volts @ 3.0 Amp/Hour. Consists of three each, 1.2 Volt "D" size Nickel Cadmium Cells stacked and plastic film encapsulated. Tabs are provided at each end for electrical connections. The individual cells can be cut apart if desired. Rated recharge rate is 30 mA, 14-18 hours. Size: 1 1/4" dia. x 7" long New Shpg. Wt each pack, 1 lb.

"C" SIZE BATTERY PACK



10 C size ni-cd battery in dng pack, gives out 12.5V D.C. 1.8 amp per hour. All fresh code, pull-out from movie cameras. Can be disconnected to use as single c cells. Hard to find \$15.00 per pack of 10 batteries

NI-CD BATTERY SALE



12V Pack 450 MA/HR Size 3" x 1" x 2" \$8.00 PER PACK
4 AA Pack 450 MA/HR \$3.50 PER PACK

All above batteries are used but late date code and we guarantee to take back all bad ones for exchange.

GELCELL 6V 9AMP/HR SEALED LEAD ACID RECHARGEABLE BATTERY



Sealed construction permits this battery to be operated in any position. Recharge rate 2.15 amp max. for 14-15 hours. All brand new. Limited quantities. Size of battery 4 1/8" x 2 3/4" x 5 1/2".

\$16.50 each

ELECTRONIC PIN BALL MACHINE

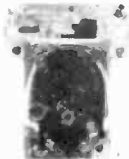

That sounds and plays like the real thing. All units are brand new but without the case. Functions of the game include double flipper control, kicker control, 1-4 players, 3 speed ball control, tilt switch, automatic score, extra bonus cave and many more. All solid state with LED panel, no moving parts. Requires 9V battery to operate. Speaker not included.

A perfect gift for yourself or friends.

SPECIAL \$8.99 EACH
SPEAKER \$1.25 EACH

ULTRASONIC SWITCH KIT

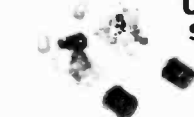

Kit Includes the Ultra Sonic Transducers, 2 PC Boards for transmitter and receiver. All electronic parts and instructions. Easy to build and a lot of uses such as remote control for TV, garage door, alarm system or counter. Unit operates by 9-12 DC. \$15.50

COMPLETE TIME MODULE

0.3" digits LCD Clock Module with month and date, hour, minute and seconds. As well as stop watch function!! Battery and back up light is with the module. Size of the module is 1" dia. Ideal for use in auto panel, computer, instrument and many others! \$8.95 EACH

SOUND ACTIVATED SWITCH



All parts completed on a PC Board SCR will turn on relay, buzzer or trigger other circuit for 2 - 10 sec. (adjustable). Ideal for use as door alarm, sound controlled toys and many other projects. Supply voltage 4.5V 9V D.C. 2 for \$3.00

\$1.75 ea.

REGULATED DUAL VOLTAGE SUPPLY KIT

\pm 4 30V DC 800 MA adjustable, fully regulated by Fairchild 78MG and 79MG voltage regulator I.C. Kit includes all electronic parts, filter capacitors, I.C., heat sinks and P.C. board.



\$12.50 PER KIT

AA SIZE NI-CD SPECIAL SALE

RECHARGEABLE BATTERIES LIMITED QUANTITY AVAILABLE

4 FOR \$6.00

SUB MINIATURE TOGGLE SWITCH 6 AMP 125V A.C.

SPDT \$1.20
SPDT MOMENTARY \$1.40
DPDT \$1.80
DPDT MOMENTARY \$1.80
DPDT (CENTER OFF) \$2.20
3PDT \$2.20
3PDT (CENTER OFF) \$2.50
4PDT \$2.80
4PDT (CENTER OFF) \$3.80

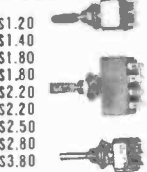

POWER SUPPLY KIT

0-30V D.C. REGULATED
Uses UA723 and ZN3055 Power TR output can be adjusted from 0-30V, 2 AMP. Complete with PC board and all electronic parts. Transformer for Power Supply, 0-30 Power Supply 2 AMP 24V x 2 \$8.50 \$10.50 each

FLASHER LED

Unique design combines a jumbo red LED with an IC flasher chip in one package. Operates directly from 5V-7V DC. No dropping resistor needed. Pulse rate 3Hz @ 5V 20mA.

2 for \$2.20

BIPOLAR LED RED/GREEN

2 colors in one LED, green and red, changes color when reverse voltage supply. Amazing! 2 FOR \$2.20

ELECTRONIC SWITCH KIT

CONDENSER TYPE
Touch On Touch Off
uses 7473 I.C. and 12V relay
\$5.50 each



1 WATT AUDIO AMP

All parts are pre-assembled on a mini PC Board. Supply Voltage 6 9V D.C. SPECIAL PRICE \$1.95 ea.



LOW TIM DC STEREO PRE-AMP KIT TA-10 20

Incorporates brand-new D.C. design that gives a frequency response from 0Hz — 100KHz \pm 0.5dB! Added features like tone defeat and loudness control let you tailor your own frequency supplies to eliminate power fluctuation!

Specifications: • T.H.D. less than .005% • T.I.M. less than .005% • Frequency response: DC to 100KHz \pm 0.5dB • RIAA deviation: \pm 0.2dB • S/N ratio: better than 70dB • Sensitivity: Phono 2MV 47K/Aux. 100MV 100K • Output level: 1.3V • Max. output: 15V • Tone control: bass \pm 10dB @ 50Hz/treble \pm 10dB @ 15Hz • Power supply: \pm 24 D.C. @ 0.5A
Kit comes with regulated power supply, all you need is a 48V C.T. transformer @ 0.5A

ONLY \$44.50
X'former \$4.50 ea.



SOLID STATE ELECTRONIC BUZZER

Mini size 1" x 3/4" x 3/4"
Supply voltage 1.5V - 12V
Ideal for Alarm or Tone Indicator



\$1.50 each



FORMULA INTERNATIONAL INC.

3/81

SHIPPING AND HANDLING CHARGES
Under \$50.00 purchase 1 Over \$50.00 purchase 2
Outside California 3
Outside Calif. (includes Mexico & Canada) 4
Outside U.S. 5
Minimum Order \$10.00/Kit. Residents Add 8% Sales Tax.
Phone Orders Accepted on Visa or MC ONLY. NO C.O.D./Store Hours 10-7 Mon. thru Sat.
17602 CRENSHAW BLVD., HAWTHORNE, CA 90250
PHONE: (213) 973-1921 • (213) 679-5162

Send \$1.00 For Detailed Catalogue

16K MEMORY EXPANSION SPECIAL: 8 RAMS \$35!

Low power, high speed (4 MHz) dynamic RAMs expand memory in TRS-80*, II, III, and Color model as well as machines made by Apple, Exidy, Heath H89, newer PETs, etc. Add \$3 for 2 dip shunts plus TRS-80* conversion instructions.

*TRS-80 is a trademark of the Tandy Corporation

MA1003 CLOCK MODULE \$14.95

Operates from 12V DC and includes internal timebase accurate to 0.01%. Ideal for mobile applications in car, van, or boat. Blue-green fluorescent readouts look great at night and don't wash out during the day. Easy to make into complete clock; add two time-setting switches, hook up power, and you're ready to go. With applications note that shows how to get the most out of your MA1003. Add \$5 for matching case with mounting hardware and optical filter.

- 5101L1 1K RAM 4X256 450 ns 10/\$17.50
- General purpose silicon signal diodes 50/\$2
- GT5306 NPN darlington, min gain 17000, 25V 200 mA, T092 package 100/\$8.95
- NPN transistor similar 2N3904 100/\$7.95
- PNP transistor similar 2N3906 100/\$8.95
- 4N28 opto-coupler 6 pin minidip, MCT-2/IL-1 pinout 5/\$2
- SN76477 complex sound generator 1/\$2.50

SEND FOR OUR FREE CATALOGUE

TERMS: Call res add tax. Allow at least 5% shipping, access refunded. Orders under \$15 add \$2 handling. VISA and Mastercard orders (for 16K Memory Expansion only) call (415) 562-0636, 24 hrs. include street address for UPS. Prices subject to change without notice.

GODBOUT

ELECTRONICS
OAKLAND AIRPORT, CA 94614

CIRCLE 38 ON FREE INFORMATION CARD

4PDT RELAY FLASHER LED

POTTER BRUMFIELD
Litronix FRL-4403

diffused red led with built in flashing unit T 1 w package pulse rate 3Hz ~ 30 ms

2 for \$1.70

COMPUTER GRADE CAPACITORS

ALL ARE BRAND NEW

- 1,700 MFD. \$2.00
- 150 VDC 2 1/2 in. dia. x 4 1/4 in.
- 6,400 MFD. \$2.50
- 60 VDC 1 3/8 in. dia. x 4 1/4 in.
- 11,500 MFD 18 VDC \$1.50
- 1 3/8 in. dia. x 3 1/4 in.
- 22,000 MFD. 15 VDC. \$2.50
- 2 in. dia. x 2 1/2 in.
- 22,000 MFD. 50 VDC \$3.50
- 3 in. dia. x 4 1/2 in.

CLAMPS TO FIT CAPACITORS 50c ea.

SUBMINI DPDT DIP RELAY

AROMAT #HB2-DC6V

- 6 VDC coil. Fits dip socket
- Norm. op power 500 mW
- Contacts rated 1 amp @120V

\$1.50 each 10 for \$13.50

7-17vdc S.S. BUZZER

STAR #CMB-12

- Fits dip socket
- CMOS compatible
- Max current 14mA
- Sound output

\$1.25 each 70dB @ 20 cm

TRANSFORMERS

120 volt primaries

- 3 VOLTS @ 200 mA \$1.25
- 6 VOLTS @ 150 mA \$1.25
- 12.6 VOLTS C.T. @ 150 mA \$1.50
- 16.5 VOLTS @ 3 AMPS \$8.50
- 24 VOLTS C.T. @ 200 mA \$1.65

1 1/2 RPM MOTOR

NEW SYNCHRON TIMING MOTOR

110 VAC 60 CY \$2.00 ea

10 per \$17.50

ELECTROLYTIC AXIAL CAPACITORS

- 600 MFD. 100 VDC \$1.00 ea.
- 2.1x1.18" long x 1" diameter

SALE PRICED

- 8,000 MFD 15VDC
- 3.78" long x 1.18" diameter

\$1.00 ea 10/\$9.00

ALL ELECTRONICS CORP.

905 S. Vermont Ave. SEND FOR OUR FREE CATALOG
Los Angeles, CA 90006
(213) 380-8000

TERMS

- Quantities Limited
- Min Order \$10.00
- Add \$2.00
- Shipping USA
- Calif. Res. Add 6%
- Prompt Shipping

CIRCLE 46 ON FREE INFORMATION CARD

ELECTRONIC KITS FROM HAL-TRONIX

2304 MHz DOWN CONVERTERS. TUNES IN ON CHANNELS 2 TO 7 ON YOUR OWN HOME T.V. HAS FREQUENCY RANGE FROM 2000 MHZ TO 2500 MHZ. EASY TO CONSTRUCT AND COMES COMPLETE WITH ALL PARTS INCLUDING A DIE-CAST ALUM CASE AND COAX FITTINGS, REQUIRE A VARIABLE POWER SUPPLY AND ANTENNA (Antenna can be a dish type or coffee can type depending on the signal strength in your area.)

2304 MOD 2 (Basic / Pre-amp) \$79.95

2304 MOD 3 (Hi-Gain Pre-amp) \$89.95

POWER SUPPLY FOR EITHER MODEL ABOVE IS AVAILABLE COMES COMPLETE WITH ALL PARTS, CASE, TRANSFORMER, ANTENNA SWITCH AND CONNECTORS \$29.95

15 KHZ DECODER KIT (CAN BE USED TO RECEIVE THOSE SECRET T.V. SIGNALS ON YOUR OWN T.V., COMPLETE WITH ALL NECESSARY PARTS AND P.C. BOARD WITH INSTRUCTIONS \$49.95

16 LINE TOUCH TONE DECODER KIT WITH P.C. BOARD AND PARTS \$69.95

12 LINE TOUCH TONE DECODER KIT WITH P.C. BOARD AND PARTS \$39.95

16 LINE ENCODER KIT, COMPLETE WITH CASE, PAD AND COMPONENTS \$39.95

12 LINE ENCODER KIT, COMPLETE WITH CASE, PAD AND COMPONENTS \$29.95

MANY, MANY OTHER KITS AVAILABLE

Send 15c stamp or \$ A.S.E. for information and free another HAL-TRONIX products. To order by phone, 1-313-285-1782.



HAL-TRONIX
P.O. Box 1101
Southgate, MI 48195

SHIPPING INFORMATION:

ORDERS OVER \$20.00 WILL BE SHIPPED POSTPAID EXCEPT ON ITEMS WHERE ADDITIONAL CHARGES ARE REQUIRED. ON ORDERS LESS THAN \$20.00 PLEASE INCLUDE ADDITIONAL \$1.50 FOR HANDLING AND MAILING CHARGES.

CIRCLE 63 ON FREE INFORMATION CARD

BULLET ELECTRONICS

P.O. BOX 401244R
GARLAND, TX. 75040
214 - 278-3553

Sound Effects Kit \$18.50

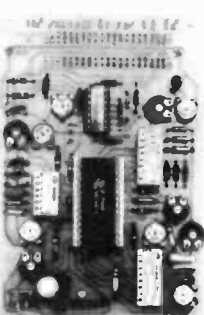

The SE-01 is a complete kit that contains all the parts to build a programmable sound effects generator. Designed around the new Texas Instruments SN76477 Sound Chip, the board provides banks of MINI DIP switches and pots to program the various combinations of the SLF Oscillator, VCO, Noise, One Shot, and Envelope Controls. A Quad Op Amp IC is used to implement an Adjustable Pulse Generator, Level Comparator and Multiplex Oscillator for even more versatility. The 3 1/2" x 5" PC Board features a prototype area to allow for user added circuitry. Easily programmed to duplicate Explosions, Phaser Guns, Steam Trains, or almost an infinite number of other sounds. The unit has a multiple of applications. The low price includes all parts, assembly manual, programming charts, and detailed 76477 chip specifications. It runs on a 9V battery (not included). On board 100mW amp will drive a small speaker directly, or the unit can be connected to your frequency NPN TO-92 (Speaker not included). 76477 is included. Available separately for \$3.15 each.

assembly manual, programming charts, and detailed 76477 chip specifications. It runs on a 9V battery (not included). On board 100mW amp will drive a small speaker directly, or the unit can be connected to your frequency NPN TO-92 (Speaker not included). 76477 is included. Available separately for \$3.15 each.

New! Special Purchase 2N3055 115W NPN POWER TRANSISTOR TO-3

Most popular transistor for power supplies, audio amps, switching, etc.
Limit 20 per customer 50c Each

PARTS

1N5350	13V 5W Zener	.25
1N5360	25V 5W Zener	.20
4M762	6.2V 400mW Zener	.08
1N3890	100V 12A High Speed Diode	1.38
40430	400V 6A Triac TO-66	.75
CD4046	PLL CMOS	.99
LM339/3302	Quad Comparator	.99
MPS A20	NPN Gen Pur TO-92	8/1.00
2SC1849	High Frequency NPN TO-92	8/1.00
CD4511	BCD to 7 Seg Decoder/Latch	.85
CD4026	Decade Counter w/7 Seg Out	1.80
CD4016	Quad Analog Switch	.50

SATISFACTION GUARANTEED ON ALL PARTS AND KITS. EXAMINE FOR 10 DAYS IF NOT PLEASED RETURN IN ORIGINAL FORM FOR REFUND. INSURE FOR AMOUNT IF PRODUCT VALUE IS OVER \$10.

BANKRUPT Game Manufacturer Dumps Computer Backgammon Game

The Engineers designed this one too good, making it too costly to be competitive. Result... Chapter XI. We bought all the parts and can offer the unit as a kit for over 60% off retail!

DISPLAY UNIT WILL VERIFY THE NUMBER OF PIECES ON ANY POINT

You get:
Double sided glass PC Board
Powerful 8035 Micro Processor Chip
Two 2716 style mask ROM RAM Chips, LED readouts, Keyboard, Instructions, AC Plug transformer

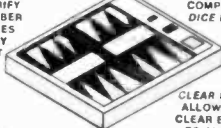

\$39.95

Includes Case
Does not include player pieces

7 Watt Audio Amp Kit \$5.95

SMALL, SINGLE HYBRID IC AND COMPONENTS FIT ON A 2" x 3" PC BOARD (INCLUDED). RUNS ON 12VDC. GREAT FOR ANY PROJECT THAT NEEDS AN INEXPENSIVE AMP LESS THAN 3% THD @ 5 WATTS. COMPATIBLE WITH SE-01 SOUND KIT.

Overvoltage Protection Kit \$6.95

Protect your expensive equipment from overvoltage conditions. Every computer should have one! Works with any fused DC power source from 10 to 20 volts up to 25 amps.

Super Value Power Transformer

Well made, open frame transformer with mounting ears. Build a +5 and +12 supply with inexpensive parts. Free schematics of several designs. Primary 117VAC. SEC #1 15VAC @ .5A SEC #2 15 VAC @ .5A SEC #3 8VAC @ 2.5A. ORDER: BET-0005

SPECIAL BONUS: Order 2 Get free 723 voltage regulator IC! \$2.95 Each

- NO C.O.D.'s
- SEND CHECK M.O. OR CHARGE CARD NO.
- PHONE ORDERS ACCEPTED ON VISA AND MASTERCARD ONLY.
- ADD 5% FOR SHIPPING
- TX. RES. ADD 5% SALES TAX
- FOREIGN ORDERS ADD 10% (EXCEPT CANADA) (20% AIRMAIL)
- U.S. FUNDS ONLY.

(214) 278-3553

The Greatest Breakthrough In Electronic Music Ever!

New! The Super Music Maker REVISION 2 \$24.95 (Basic Kit)

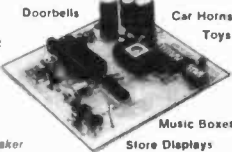

Does not include speaker switches or 2708 ROM.

Now you can play hundreds of songs using the Bullet Super Music Maker. The unit features a single factory programmed microprocessor IC that comes with 20 pre-programmed short tunes. By adding the additional PROMS (2708's) the system can be expanded to play up to 1000 notes per PROM. Just think... a compact electronic instrument that will play dozens, hundreds or even thousands of selections of music. The kit comes with all electronic components (less the PROM), and a drilled, plated and screened PC Board which measures 4" x 4 1/4". The 7 watt amplifier section is on the same PC board and drives an 8 ohm speaker (not included), from a whisper to ear splitting volume. Since the unit works on 12 VDC or 12 VAC, vehicle or portable operation is possible. What do you get for \$24.95? Everything but a speaker, transformer, case, switches, and PROM. Additional 2708 albums containing popular tunes are available for \$15.00 each or you can program your own PROMS using information provided with the kit instructions. Lists of available PROM albums are available on request. (Note: Unit plays electronic music one note at a time, it is not possible to play chords or a melody with harmony simultaneously.)

- Envelope control gives decay to notes.
- "Next tune" feature allows sequential playing of all songs.
- On board inverter allows single voltage (+12) operation.

OPTIONAL ACCESSORIES

DIP Switches	One 8 pos., One 5 pos. (Can be directly soldered to PC Bd. to access tunes)	2.00/Set
Rotary Switches	Two 5 position (For remote wiring to PC Bd. to access tunes)	2.50/Set
Attractive Black Plastic Case		6.50
Wallplug Transformer	(For operation on 117VAC house voltage)	3.00

ANCRONA HAS MOTOROLA ICs

BF9R0	\$ 1.88	MC1355P	2.10	MC3303P	5.80
BF9R1	2.42	MC1357P	1.55	MC3325P	2.10
CA3054	1.54	MC1358P	1.50	MC3340P	2.10
CA3059	3.34	MC1364P	2.01	MC3360P	1.00
CA3079	2.23	MC1372P	6.48	MC3370P	3.72
MB0101	73	MC1373P	5.19	MC3403P	1.68
MBD102	28	MC1391P	1.44	MC3405P	2.42
MB0201	1.03	MC1403AU	11.07	MC3408L	3.55
MBD501	1.57	MC1403JDS	4.23	MC3418L	31.42
MC664P	3.20	MC1405L	15.28	MC3423P1	1.66
MC680P	2.05	MC1408L	2.94	MC3438L	4.33
MC830L	2.27	MC1408L8	4.64	MC3476P1	3.18
MC832L	2.27	MC1413P	1.33	MC4016P	8.52
MC835L	2.46	MC1437L	3.99	MC4024P	5.75
MC836P	1.80	MC1439L	4.62	MC4026P	2.48
MC839L	5.88	MC1445L	3.97	MC4044P	5.75
MC839P	3.56	MC1445L	2.94	MC4558NCP1	3.18
MC840P	1.50	MC1455P1	7.77	MC10109L	1.24
MC846P	1.36	MC1455UDS	1.22	MC10116L	1.24
MC848L	3.17	MC1458CP1	68	MC10116P	.82
MC857L	2.46	MC1489G	4.24	MC10123L	2.39
MC857P	1.50	MC1489L	1.51	MC10124L	3.01
MC852L	2.27	MC1489AL	1.48	MC10125L	2.50
MC958L	4.43	MC1489L	1.48	MC10137L	5.38
MC1013P	5.0	MC1489P	1.39	MC10189L	3.27
MC1302P	3.72	MC1494L	6.04	MC10195L	2.52
MC1309P	2.86	MC1495L	5.28	MC101216L	1.88
MC1310P	2.86	MC1496G	1.80	MC14412VP	15.53
MC1320ALP	1.60	MC1808P	1.36	MC14435VP	11.53
MC1349P	1.72	MC1809P	1.36	MC14457P	6.60
MC1350P	1.15	MC3062L	5.25	MC14458P	13.73
MC1352P	2.01	MC3302P	88	MC14490VP	3.06

THE NEW NLS TECHNOLOGY TOUCH/TEST 20



TOUCH/TEST 20 comes complete with test leads, temperature probe, component test adaptor, batteries and charger unit. Order yours TODAY!

ORDER NO.	PRICE
NLS-T720	\$390
NLS-T720B	425
NLS-41-140	45

Capacitance Meter



- Easy to use - plug in capacitor, push range button and read the value to 0.1%
- 0.5 in. liquid crystal display
- Exclusive "Acharge/dvoit" measurement circuit (patent pending) holds $\pm 0.1\%$ basic accuracy for a full year.
- Up to 200 hrs operation on standard 9V Batt.
- 8 easy push-button ranges cover 0.1pf to 1999 microfarads.
- Best of all it's easy on the budget - only

MODEL 93B \$179

VOLTAGE REGULATORS

LM300H	\$.70	LM723CH	50	To220 Case	
LM300N	1.95	LM723CN	50	78M05CT	\$.85
LM304H	95	78L05ACP	55	78M06CT	1.45
LM305H	75	78L05CP	50	78M08CT	1.45
LM309H	1.45	78L08ACP	60	78M12CT	1.45
LM309K	1.25	78L08CP	55	78M15CT	1.45
LM317H	1.70	78L12ACP	80	78M18CT	1.45
LM317-TO220	1.60	78L12CP	55	78M20CT	1.45
LM317K	2.45	78L15ACP	60	78M24CT	1.45
LM320-5K	2.20	78L15CP	55		
LM320-6K	2.20	78L18ACP	60		
LM320-8K	2.20	78L18CP	55		
LM320-12K	2.20	78L24ACP	80		
LM320-15K	2.20	78L24CP	55		
LM320-12K	1.35	79L12CP	1.00		
LM320-24K	2.20	79L03CP	1.00		
LM323K	4.70	79L05ACP	1.50		
LM340-5K	1.35	79L05CP	1.00		
LM340-6K	1.35	79L12ACP	1.50		
LM340-8K	1.35	79L24CP	1.00		
LM340-12K	1.35	79L15ACP	1.50		
LM340-15K	1.35	79L15CP	1.00		
LM340-18K	1.35	79L18ACP	1.50		
LM340-24K	1.35	79L18CP	1.00		
LM350K	5.40	79L24CP	1.50		
LM353-5	7.50	79L24CP	1.00		
LM353-8	7.50	MC1463G	4.90		
LM353-12	7.50	MC1466L	9.90		
LM353-15	7.50	MC1468G	5.90		
LM353-18	7.50	MC1469G	4.90		
LM353-U	10.00				

VOLTAGE REGULATORS

To220 (Plastic)	To220 (Plastic)		
7805CP	\$.90	7905CP	\$.95
7812CP	90	7912CP	95
7815CP	90	7915CP	95
7818CP	90	7918CP	95
7824CP	90	7924CP	95

SYM-1 NEW LOW PRICE

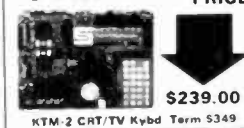

\$239.00

KTM-2 CRT/TV Kybd Term 5349

★ 8% ★ DISCOUNT COUPON

Bring this COUPON into one of our stores or mail to our Mail Order address shown below and receive a 8% DISCOUNT on purchases from this Ad of \$50.00 or more.

Offer EXPIRES on March 31, 1981

NAME _____
 ADDRESS _____
 CITY _____ STATE _____
 ZIP _____ PHONE NO _____

Coupons accepted only with full name and address filled in.

Intersil LED or LCD 3 1/2 DIGIT PANEL METER KITS



BUILD A WORKING OPM IN 1/2 HOUR WITH THESE COMPLETE EVALUATION KITS. Test these new parts for yourself with Intersil's low cost prototyping kits, complete with A/O converter and LCD display (7106) or LED display (7107). Kits provide all materials, incl. PC board, for a functioning panel meter. ICL7106V (LCD) \$34.46 ICL7107EV (LED) \$78.70

Power Supplies from ADTECH POWER

Model	Vdc	Amps	Model	Vdc	Amps
APS 8-3	5	3.0	APS 5-6	5	6.0
APS 12-1.8	12	1.8	APS 12-4	12	4.0
APS 15-1.5	15	1.5	APS 15-3	15	3.0
APS 24-1	24	1.0	APS 24-2	24	2.2
1-9	10 up	25 up	1-9	10 up	25 up
\$42.50	\$40.65	\$38.85	\$66.90	\$64.00	\$61.10

MARK IV LED POWER LEVEL INDICATOR

70 pcs KIT \$31.50
 • Display Range -36dB to +5dB
 • Floating or Gradual Output Indicating
 • Kit includes transistors, leds, capacitors, resistors, PC Board, and silk screened metal front panel

TEMPERATURE METER

• Wide-Ranging -65°C to +150°C -65°F to 302°F
 • Accurate $\pm 0.4^\circ\text{C}/\pm 0.7^\circ\text{F}$ over most of range
 • Fast 8 seconds to 98% of final change in reading
 • Versatile switch-selectable resolution (0.1° or 1°) and degrees C or F
 MODEL 940 \$189

PORTABLE thandar OSCILLOSCOPE



- DC-10MHz
- 2" Diagonal CRT
- SMALL SIZE (10 x 8 x 1 1/2)
- ULTRA LOW POWER CONSUMPTION
- LIGHT WEIGHT (2 lbs)
- AUTOMATIC CIRCUIT POWER DOWN FOR UNUSED SECTIONS

74LS...Series	74LS145N	1.20	74LS266N	.48	
74LS00N	\$.21	74LS151N	44	74LS273N	1.35
74LS02N	.23	74LS152N	75	74LS299N	2.60
74LS04N	.26	74LS153N	42	74LS365N	.95
74LS08N	.27	74LS160N	95	74LS366N	.79
74LS10N	.24	74LS161N	80	74LS367N	.70
74LS11N	.31	74LS162N	85	74LS379N	1.40
74LS20N	.24	74LS163N	85	74LS374N	1.40
74LS22N	.34	74LS164N	62	74LS377N	1.40
74LS26N	.39	74LS170N	2.65	74LS381N	2.90
74LS27N	.29	74LS174N	.49	74LS490N	1.80
74LS32N	.34	74LS175N	.49		
74LS37N	.36	74LS181N	2.30		
74LS40N	.34	74LS190N	1.20		
74LS42N	.45	74LS191N	.89		
74LS73N	.38	74LS193N	.89		
74LS74N	.54	74LS194N	.85		
74LS78N	.45	74LS195N	.65		
74LS90N	.44	74LS221N	.85		
74LS93N	.42	74LS240N	.95		
74LS109N	.52	74LS241N	.90		
74LS112N	.42	74LS243N	.99		
74LS123N	.79	74LS244N	.95		
74LS125N	.89	74LS245N	2.20		
74LS126N	.54	74LS251N	.90		
74LS128N	.59	74LS253N	.85		
74LS136N	.48	74LS257N	.80		
74LS138N	.66	74LS258N	.65		
74LS139N	.66	74LS260N	.65		

Z-80 SERIES

2.5 MHz	4.0 MHz		
Z80-CPU	\$ 8.95	Z80-A-CPU	\$ 9.95
Z80-CTC	6.50	Z80-A-CTC	7.55
Z80-PIO	6.50	Z80-A-PIO	7.95
Z80-DART	15.45	Z80-A-DART	18.85
Z80-DART-9	13.50	Z80-A-DART-9	16.50
Z80-S100	24.40	Z80-A-S100	30.50
Z80-S109	18.20	Z80-A-S109	23.40
Z80-DMA	20.10	Z80-A-DMA	24.90

OPTOELECTRONIC COUPLERS

Type No Description	10 up	10 up	50 up	100 up
TIL111 Transistor Coupler	\$1.32	\$1.26	\$1.20	\$1.14
TIL112 Transistor Coupler	1.32	1.26	1.20	1.14
TIL113 Darlington Coupler	1.76	1.68	1.60	1.52
TIL114 Transistor Coupler	1.32	1.26	1.20	1.14
TIL115 Transistor Coupler	1.32	1.26	1.20	1.14
TIL116 Transistor Coupler	1.32	1.26	1.20	1.14
TIL117 Transistor Coupler	1.32	1.26	1.20	1.14
TIL118 Transistor Coupler	1.32	1.26	1.20	1.14
TIL119 Darlington Coupler	1.47	1.40	1.33	1.26

680C SERIES

MC6800P	\$ 5.90	MC6886P	2.72
MC6801L1	65.44	MC6887P	2.72
MC6802P	11.50	MC6888P	2.72
MC6805U2P2	30.92	MC6889P	3.14
MC6808P	13.90		
MC6809P	35.50		
MC6821P	3.86		
MC6828P	9.90		
MC6840P	12.22		
MC6843P	45.39		
MC6844P	45.39		
MC6845P	22.00		
MC6846P1	39.90		
MC6846P3	66.50		
MC6847P	16.06		
MC6850P	3.40		
MC6852P	3.50		
MC6854P	32.26		
MC6859L	277.90		
MC6860P	10.80		
MC6862P	11.80		
MC6875L	6.90		
MC6880AP	3.14		
MC6881P	8.91		
MC6882AL	6.13		
MC6885P	2.72		

2708 \$ 4.60
 2716 (5V) 7.50
 2732 24.95

4116 (300 nsec) \$4.10
 4116 (300 nsec) 3.90
 2114 (250 nsec) 3.90
 2114L (200 nsec) 4.60
 2114L (300 nsec) 3.90
 MK4027N-3 (200 nsec) 3.40
 TMS2532 23.50

CMOS EPROM
 MC68870B8 \$ 32.26
 MC68876AC 309.89
 MC68876AC 309.89

RS232 CONNECTORS
 DB25P male 2.95
 DB25S female 3.60
 HOODS 1.75
 SET 7.50

SILICON GENERAL
 Linear IC and Voltage Regulator Databook
 214 pages \$4.50

ANCRONA MAIL ORDER

STORES DO NOT ACCEPT MAIL ORDERS
 P.O. BOX 2208R CULVER CITY, CA 90230

PHONE ORDERERS (213) 641-4084

Minimum Order \$10.00. Add \$2.00 to cover postage and handling. Master Charge and VISA accepted. Please include your charge card number, alternate number and expiration date. Some items are subject to price list. Not responsible for typos. Store pricing may vary from Mail Order pricing. We reserve the right to substitute manufacturer.

VISIT A STORE NEAR YOU TODAY - We stock a large selection of Technical Books, Discrete Components, Integrated Circuits, Test Equipment and Electronic Supplies.

ATLANTA 3330 Piedmont Rd. N.E. Atlanta, GA 30305 (404) 261-7100	CULVER CITY 11080 Jefferson Blvd. Culver City, CA 90230 (213) 390-3595	HOUSTON 2649 Richmond Houston, TX 77098 (713) 529-3489	PORTLAND 1125 N.E. 82nd Ave. Portland, OR 97220 (503) 254-5541	SANTA ANA 1300 E. Edinger Ave. Santa Ana, CA 92705 (714) 547-8424	SUNNYVALE 1054 E. El Camino Real Sunnyvale, CA 94087 (408) 243-4121	TUCSON 4518 E. Broadway Tucson, AZ 85711 (602) 881-2348
---	--	--	--	---	---	---

Radio Shack is Your Parts Place™

No Minimum Order! No Waiting! Low Prices!
All Prime Devices!

Bam! Beep! Boom! Zonk! And More with This IC



SN76488
28-Pin DIP

NEW
6⁹⁹

This sound-generator IC, a handful of parts and a little imagination can create an infinite variety of sounds! Can be controlled by a microprocessor for sophisticated multiplexing of sounds. Built-in audio amplifier drives a speaker. With data.
276-1766 **6.99**

Music-Maker Chip



S50240P
16-Pin DIP

Save 44%
Reg. **6.99**
3⁸⁸

Top-octave synthesizer IC produces 13 notes from C₈ to C₈# — use it in a keyboard instrument or musical doorbell! Requires single 12V supply and external clock. (A 4011, 100-pf cap and 10k pot will do the trick.) With full data.
276-1780 **Sale 3.88**

Computer Connectors & Cables Now in Stock

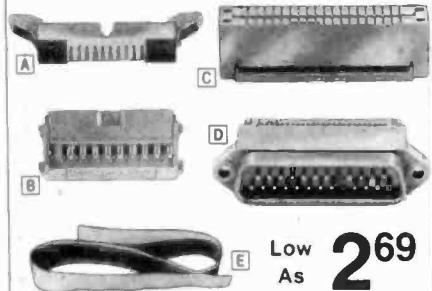

- A** 20-Pin Header with Ejectors. Polarized. For .100x.100" grid. 276-1556 **2.69**
- B** 20-Pin Cable Connector. Reusable insulation-displacement type mounts at ends or along length of cable. 276-1557 **3.49**
- C** 40-Pin Card Edge Connector. Reusable type. 276-1558 **5.95**
- D** DBM 25 Connector. Reusable type for your RS-232 bus. 276-1559 **4.99**
- E** 20-Conductor Ribbon Cable. 5 ft. 278-770 **3.95**
- 40-Conductor Ribbon Cable. 5 ft. 278-771 **6.95**



Right-Angle Switch
Save 50%
Reg. **1.99**
99¢

DPDT-type for PC boards. 6A @ 125VAC. 275-665 **Sale 99¢**



Pack of 10 Silicon Diodes
Stock Up Now!
99¢

Type 1N914 switching diodes. 100% prime. PIV: 75, minimum. 276-1122 **Pkg. of 10/99¢**

Three DC Motors

NEW

1⁴⁹
Pkg. of 3

For 1½ to 6VDC. Typical no-load RPM: 3550. Long leads for easy hookup. 273-208 **3/1.49**

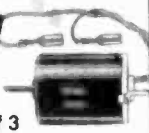

16K Dynamic RAM

Save 29%

Reg. 13.95
9⁹⁵
Each

MM5290-055/4116. Lots of memory in a 16-pin DIP! Requires ±5, +12VDC. Prime. Buy now and save! 276-2505 **Sale 9.95**



Spring-Lever Terminal Strip

Ideal for Speakers, Power Supplies

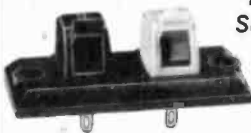

Deluxe terminals with lever release. Color-coded. 2½x1½". 274-621 **1.19**

10 Assorted Mini Reed Switches

Pkg. of 10

1⁹⁸

Hermetically sealed in glass. Contacts close when magnetic field is present. Gold-plated contacts rated 500 mA, 125VAC. 275-1610 **1.98**



Bar-Graph Display

NEW

3⁷⁹

Companion to our LM3914 and LM3915 display driver ICs. Ten LEDs in a 20-pin DIP. With data! 276-081 **3.79**

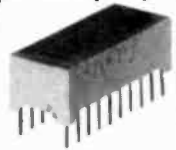

Pack of 100 Coils, Inductors & Chokes

Only 1⁹⁸

RF, IF and PC-mounts. Nice to have on hand. 273-1570 **Pkg. of 100/1.98**

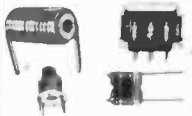

Bright 12-Volt Snap-in Lamps

NEW 1⁶⁹
Pkg. of 2

One red, one green. Long life. Heat-resistant housings. Leads. 272-331 **Pkg. of 2/1.69**



Pack of 10 PC Electrolytics

Save 30%

Reg. 3.95
2⁷⁷
Pkg. of 10

Radial leads. Two each of most-used values: 4.7, 10, 22, 47 and 100 µF. Rated 35WVDC. 272-1035 **Pkg. of 10/2.77**



Bright Red Flasher LED

1²⁹

CMOS Timer IC and LED in One Package!
5 Hz flash rate really gets attention. Ideal for displays, even electronic jewelry. 276-036 **1.29**



Adjustable Rhythm Generator Chip

Save 33%

Reg. 6.59
4⁴⁴

Build an electronic percussion device! Six combinable patterns. 16-pin DIP with data. 276-1785 **Sale 4.44**



Twelve Assorted Switches

1⁹⁸
Pkg. of 12

May include slide, rocker, push-button and momentary types rated up to 3A, 125VAC. 275-1601 **1.98**



Heavy-Duty SCRs

TO-220 Cases

Low As **99¢**

Ideal as motor speed controls, lamp dimmers. Rated 6 Amps. 200V. 276-1067 **99¢**
400V. 276-1020 **1.19**



Color-Coded Test Cable Sets

Low As

3⁶⁹

Insulated Clips At Each End
Set of ten 14"-long jumpers. 278-1156 **3.69**
Set of eight 24"-long jumpers. 278-1157 **3.89**



The Most-Popular Parts In-Stock!
Start Your Next Project at The Shack!

Prices may vary at individual stores and dealers

Radio Shack®

A DIVISION OF TANDY CORPORATION • FORT WORTH, TEXAS 76102
OVER 7000 LOCATIONS IN 40 COUNTRIES

CIRCLE 18 ON FREE INFORMATION CARD

MARCH 1981

105

ETCO

CABLE TV CONVERTERS AND OTHER GOOD STUFF!

SMASHING ALL SALES RECORDS - OUR NEW 30 CHANNEL CABLE TV CONVERTER!



Converts mid & super band cable channels for viewing on your TV set!
No. 292AE047

39⁹⁵ \$34.95 ea. / 5

HOT NEW IMPORT! REMOTE CONTROL 30 CHANNEL CABLE TV CONVERTER!

89⁹⁵ \$79.95 ea. / 5
\$74.95 ea. / 10

Includes remote TV on/off switch and fine tuning control!
No. 292VA276



ETCO MKII WIRELESS - THE ULTIMATE CABLE TV CONVERTER!



Set TV to channel 3, and the hand held remote control does the rest!
No. 292ZA008

189⁰⁰

VIORCOR 2000 CONVERTER ELIMINATES PROBLEMS WHEN TAPING FROM CABLE TV

89⁹⁵

Resolves your VCR's capability for programming. Restores remote channel control. Enables videotaping of one cable program while watching another.
No. 292VA950



UNUSUAL FACTORY SURPLUS MIO-BANO - SUPER-BANO CABLE TV TUNER



Converts cable channels to a common IF frequency. Experimenters' built cable converters, recorders etc. With schematic. No. 292VA342

19⁹⁵ \$17.50 ea. / 10

FACTORY SURPLUS UHF TUNERS

4⁹⁵ \$3.95 ea. / 10

Brand new production surplus. All solid state. Ideal for experimental work building cable TV converters, etc. No. 292SL008



MINIATURE FM WIRELESS MICROPHONE



Hides in the palm of your hand. Reception on any standard FM radio or receiver.
No. 292VA482

29⁹⁵ \$27.50 ea. / 5
\$24.95 ea. / 10

QUARTER MILE WIRELESS MICROPHONE & RECEIVER SYSTEM

69⁹⁵ \$49.95 ea. / 5

FCC approved crystal controlled wireless mike & receiver. All battery operated. Electret wide range response. VU meter.
No. 292VA083



ETCO GENERAL PURPOSE TUBE TESTER



IN KIT FORM. Checks for leakage, shorts, emission, 7, 9 pin, octal, loctal, compactors, neutrals. In portable case. No. 292KT108

49⁹⁵

Wired: No. 292TE053 - \$79.95
Pkg. tube adapter: 292TE344 - \$19.95

POUMPING! NORELCO ENDLESS LOOP CASSETTES!

4⁹⁵ \$6.49 ea. / 10

Impossible to find at any price!
3 minutes: No. 292VA006
6 minutes: No. 292VA008



IN STOCK - THE MURA CORDLESS TELEPHONE SYSTEM



Answer & originate calls with the simple touch-phones. 200 to 2000 ft. charging. Last number recall. Pkg. of handset, base unit, rotary, touch system. No. 292VA724

144⁸⁸ \$129.95 ea. / 5

SALE OF QUARTZ BATTERY OPERATED CLOCK MOVEMENTS!

9⁹⁵ \$8.95 ea. / 5

Accuracy of 1 min. / yr. vs. up to 4 min. operation on 1 alkaline 'C' cell imported from West Germany. No. 292VA081



20 AMP REGULATED 12VDC POWER SUPPLY!



13.8 vdc no load, 12.5 vdc full load. Easily handles ham station marine etc. 555 linear up to 400W P.E.P. Brand new. Factory sealed cartons. No. 292VA304

59⁸⁸ \$48.95 ea. / 5

292VA386 - as above, 10 amps - \$48.95, 30 amp ea. / 5

FREE OUR LATEST 98 PAGE FASCINATING CATALOG - jam-packed with unique items, electronic bargains and unusual offers. Write or circle the information card number below.



RUSH YOUR ORDER TODAY TO: ETCO ELECTRONICS NORTH COUNTRY SHOPPING CENTER PLATTSBURGH, N.Y. 12901

Check with order, please Visa & Mastercard OK. (Sorry, no C.O.D.). Add 15% for UPS & Handling (Invoices refunded). N.Y. State residents add 7% sales tax. Dealer & Export orders invited. Our telephone order desk never closes. Call 1-818-561-8700

SATELLITE TELEVISION

SATELLITE television...Howard/Coleman boards to build your own receiver. For more information write: ROBERT COLEMAN, Rt. 3, Box 58-ARE, Travelers Rest, SC 29690

SATELLITE spherical TV antenna easy to build from local parts for \$200.00. Detailed plans \$20.00. GEMINI T.V., 183 Lampport Blvd., S.I., NY 10305

Satellite TV

FOR THE HOME

Sick of Network TV?

Our receiver lets you get over 75 channels of television directly from earth-orbiting cable TV satellites! HBO, Showtime, super stations, sports and movies worldwide.

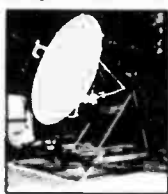

We don't just sell information! We Manufacture Hardware!

From offshore oil rigs, data links to hotels and backyard installations, we wrote the book. Constantly updated, our 94 Page technical information book and catalog gives you all the facts. Inexpensive dishes, feeds, telemetry software, kits and more. Recommended reading by NASA, The Office of Consumer Affairs and quality companies like Rockwell/Collins. Send \$7.95 today!



CALL 24-hr. C.O.D. Hotline (305) 339-7600

SPACECOAST RESEARCH CORPORATION
P.O. Box 442-E, Altamonte Spgs, FL 32701

Enjoy Satellite TV Now



Better than Cable TV—Over 200 TV and radio services. Why waste money? Learn the whole story and build a video system the family can enjoy. No commercials, FREE movies, sports and Vegas shows—worldwide, crystal clear reception connects to any TV set. Big (8 x 11 in.) book loaded with details, photos, plans, kits—TELLS EVERYTHING! Satisfaction Guaranteed.

Send \$7.95 TODAY! Add \$2.00 for 1st class (air mail) or call our 24 hour C.O.D. rush order line (305) 862-5068.

GLOBAL ELECTRONICS, P.O. Box 219-E, Maitland, Florida 32751

SATELLITE VISION

We manufacture the highest spec 3-meter dish & video dish in the world 41db gain! We also sell direct. Immediate delivery or you pick up. Complete details including satellite TV information, BUY DIRECT \$1.25 for postage & handling.

TIGER TENNAS P.O. Box 561 Casselberry, Florida 32707



CB EQUIPMENT

LIMITED quantity of Motorola 40-channel remote CB radios w/o mikes. These are a closeout of new D84Y18B806A radios made for 78-79 Lincoln/Mercury/Ford automobiles. Shipping is prepaid and orders received will be shipped within 24 hours. Send cashier's check or money order for \$70 to GUY GRIDER CB, 220 SE 89th, Oklahoma City, OK 73149

Solar Power

Solar Powered AM Radio
Place it in the sunshine and listen to your favorite station! Features good quality volume and tone from built-in speaker. Complete and ready to operate. Makes a unique gift! \$24.95



Solar Panels

Converts sunlight directly into electricity to power small fans, pumps, radios, recharge batteries, etc.
12V 125MA \$49.00 / 12V 500MA \$150.00

Special 9V 30MA Small Panel
For powering transistor radios, calculators \$12.00



Silicon Solar Cell Experimenters Assortment

Each cell converts sunlight into electricity. Assortment contains one whole 2 inch cell, 5 odd shaped pieces and a small motor. \$7.95



Sound Effects Generator Basic Kit

Now it's possible to build your own sound effects generator without spending a fortune. We supply you with the T176477 sound chip plus an etched and drilled glass epoxy PC board with schematic and layout instructions. This board makes it simple to build a generator capable of phaser sounds, locomotive, sirens, airplanes, clocks, etc. Does not require dip switches or other expensive unusual components. You supply a few standard resistors, capacitors, switches, pots, speaker, 2N2222 transistor and 9V battery.
C23883 Basic Kit containing T176477, PC board and instructions
Only \$5.95
2N2222 Transistor for above C23884 .39 each

120 VAC Xenon Strobe Kit

Complete variable rate strobe light kit. Contains all parts. PC board, line cord and instructions.
C23071 \$7.50



Wheel of Fortune

Popular game device uses LEDs, transistors, and IC to give the effect of a bright red ball spinning around numbers. Unit emits sound as ball spins and finally stops on a number. Incl. all parts, faceplate & PC board.
C23806 \$8.99



CHANEY electronics inc.

Phone Orders 303-781-5750

Minimum Ad Order \$6.00
Please include \$1.50 for postage
VISA MC accepted
Phone orders are welcome

P.O. BOX 27038 DENVER, COLORADO 80227

Send for our free catalog of unique items

CIRCLE 20 ON FREE INFORMATION CARD

LONG PLAY 10 HOUR TAPE RECORDER

Top quality AC-DC cassette recorder, modified to provide 5 continuous hours of recording and playback of true fidelity, distortion-free sound on each side of cassette for a total of 10 hours. Unit has many special built-in features. TDK D-C180 cassette supplied.



ONLY \$125.00*

PHONE RECORDING ADAPTER

Record incoming and outgoing calls automatically with this all solid state unit connected to your telephone jack and tape recorder. Starts recording when phone is lifted. Stops when you hang up, making a permanent record. Easily installed. No monthly charges.
FCC APPROVED \$24.50*

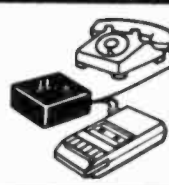

VOX VOICE ACTIVATED CONTROL SWITCH

Solid state. Self contained. Excellent adjustable sensitivity. Voices or other sounds activate and control recorder. Uses recorder mike or remote mike.
2 1/4 x 1 3/4 x 3/4" \$24.95*



Phone call Adapter \$24.50, VOX \$24.95* (* plus \$1.00 ea. shipping & handling), 10 hr. Recorder \$125.00* (* plus \$4.00 shipping & handling). California residents add tax. Mail Order, VISA, M/C, cod's okay, quantity discounts available. Money back guar. Free data.

AMC SALES, Dept. 19 9335 Lubec St., Box 928 Downey, CA 90241, Phone (213) 869-8519

CIRCLE 23 ON FREE INFORMATION CARD

ramsey

the first name in Counters!



9 DIGITS 600 MHz \$129⁹⁵ WIRED

PRICES

CT-90 wired, 1 year warranty	\$129.95
CT-90 Kit, 90 day parts warranty	109.95
AC-1 AC adapter	3.95
BP-1 Nicad pack + AC Adapter/Charger	12.95
OV-1, Micro-power Oven time base	49.95
External time base (opt)	14.95

The CT-90 is the most versatile, feature packed counter available for less than \$300.00! Advanced design features include: three selectable gate times, nine digits, gate indicator and a unique display hold function which holds the displayed count after the input signal is removed. Also, a 10mHz TCXO time base is used which enables easy zero beat calibration checks against WWV. Optionally, an internal nicad battery pack, external time base input and Micro-power high stability crystal oven time base are available. The CT-90, performance you can count on!

SPECIFICATIONS:

Range:	20 Hz to 600 MHz
Sensitivity:	Less than 10 MV to 150 MHz Less than 50 MV to 500 MHz
Resolution:	0.1 Hz (10 MHz range) 1.0 Hz (60 MHz range) 10.0 Hz (600 MHz range)
Display:	9 digits 0.4" LED
Time base:	Standard-10,000 mHz, 1.0 ppm 20-40°C Optional Micro-power oven-0.1 ppm 20-40°C
Power:	8-15 VAC @ 250 ma

7 DIGITS 525 MHz \$99⁹⁵ WIRED



SPECIFICATIONS:

Range:	20 Hz to 525 MHz
Sensitivity:	Less than 50 MV to 150 MHz Less than 150 MV to 500 MHz
Resolution:	1.0 Hz (5 MHz range) 10.0 Hz (50 MHz range) 100.0 Hz (500 MHz range)
Display:	7 digits 0.4" LED
Time base:	1.0 ppm TCXO 20-40°C
Power:	12 VAC @ 250 ma

The CT-70 breaks the price barrier on lab quality frequency counters. Deluxe features such as: three frequency ranges - each with pre-amplification, dual selectable gate times, and gate activity indication make measurements a snap. The wide frequency range enables you to accurately measure signals from audio thru UHF with 1.0 ppm accuracy - that's .0001%! The CT-70 is the answer to all your measurement needs. In the field, lab or ham shack.

PRICES:

CT-70 wired, 1 year warranty	\$99.95
CT-70 Kit, 90 day parts warranty	84.95
AC-1 AC adapter	3.95
BP-1 Nicad pack + AC adapter/charger	12.95



7 DIGITS 500 MHz \$79⁹⁵ WIRED

PRICES:

MINI-100 wired, 1 year warranty	\$79.95
MINI-100 Kit, 90 day part warranty	59.95
AC-Z Ac adapter for MINI-100	3.95
BP-Z Nicad pack and AC adapter/charger	12.95

Here's a handy, general purpose counter that provides most counter functions at an unbelievable price. The MINI-100 doesn't have the full frequency range or input impedance qualities found in higher price units, but for basic RF signal measurements, it can't be beat! Accurate measurements can be made from 1 MHz all the way up to 500 MHz with excellent sensitivity throughout the range, and the two gate times let you select the resolution desired. Add the nicad pack option and the MINI-100 makes an ideal addition to your tool box for "in-the-field" frequency checks and repairs.

SPECIFICATIONS:

Range:	1 MHz to 500 MHz
Sensitivity:	Less than 25 MV
Resolution:	100 Hz (slow gate) 1.0 KHz (fast gate)
Display:	7 digits, 0.4" LED
Time base:	2.0 ppm 20-40°C
Power:	5 VDC @ 200 ma

8 DIGITS 600 MHz \$159⁹⁵ WIRED



NEW READ RECEIVER FREQUENCY

SPECIFICATIONS:

Range:	20 Hz to 600 MHz
Sensitivity:	Less than 25 mv to 150 MHz Less than 150 mv to 600 MHz
Resolution:	1.0 Hz (60 MHz range) 10.0 Hz (600 MHz range)
Display:	8 digits 0.4" LED
Time base:	2.0 ppm 20-40°C
Power:	110 VAC or 12 VDC

The CT-50 is a versatile lab bench counter that will measure up to 600 MHz with 8 digit precision. And, one of its best features is the Receive Frequency Adapter, which turns the CT-50 into a digital readout for any receiver. The adapter is easily programmed for any receiver and a simple connection to the receiver's VFO is all that is required for use. Adding the receiver adapter in no way limits the operation of the CT-50, the adapter can be conveniently switched on or off. The CT-50, a counter that can work double-duty!

PRICES:

CT-50 wired, 1 year warranty	\$159.95
CT-50 Kit, 90 day parts warranty	119.95
RA-1, receiver adapter kit	14.95
RA-1 wired and pre-programmed (send copy of receiver schematic)	29.95



DIGITAL MULTIMETER \$99⁹⁵ WIRED

PRICES:

DM-700 wired, 1 year warranty	\$99.95
DM-700 Kit, 90 day parts warranty	79.95
AC-1, AC adaptor	3.95
BP-3, Nicad pack + AC adapter/charger	19.95
MP-1, Probe kit	2.95

The DM-700 offers professional quality performance at a hobbyist price. Features include: 26 different ranges and 5 functions, all arranged in a convenient, easy to use format. Measurements are displayed on a large 3 1/2 digit, 1/2 inch LED readout with automatic decimal placement, automatic polarity, overrange indication and overload protection up to 1250 volts on all ranges, making it virtually goof-proof! The DM-700 looks great, a handsome, jet black, rugged ABS case with convenient retractable tilt bail makes it an ideal addition to any shop.

SPECIFICATIONS:

DC/AC volts:	100uV to 1 KV, 5 ranges
DC/AC current:	0.1 uA to 2.0 Amps, 5 ranges
Resistance:	0.1 ohms to 20 Megohms, 6 ranges
Input impedance:	10 Megohms, DC/AC volts
Accuracy:	10.1% basic DC volts
Power:	4 °C cells

AUDIO SCALER

For high resolution audio measurements, multiplies UP in frequency.

- Great for PL tones
- Multiplies by 10 or 100
- 0.01 Hz resolution!

\$29.95 Kit \$39.95 Wired

ACCESSORIES

Telescopic whip antenna - BNC plug	\$ 7.95
High impedance probe, light loading	15.95
Low pass probe, for audio measurements	15.95
Direct probe, general purpose usage	12.95
Tilt bail, for CT 70, 90, MINI-100	3.95
Color burst calibration unit, calibrates counter against color TV signal	14.95

COUNTER PREAMP

For measuring extremely weak signals from 10 to 1,000 MHz. Small size, powered by plug transformer-included.

- Flat 25 db gain
 - BNC Connectors
 - Great for sniffing RF with pick-up loop
- \$34.95 Kit \$44.95 Wired

ramsey electronics, inc.

2575 BAIRD RD. • PENFIELD, NY 14526

PHONE ORDERS
CALL 716-586-3950

TERMS

Satisfaction guaranteed - examine for 10 days, if not pleased, return in original form for refund. Add 5% for shipping - insurance to a maximum of \$10. Overseas add 15%. COD, add \$2. Orders under \$10, add \$1.50. NY residents, add 7% tax.

CIRCLE 17 ON FREE INFORMATION CARD

MARCH 1981

R3013. Output at pin 4 is applied through a 540-nanosecond delay line, DL5103, to pin 4 of the Video Demodulator II module. Here the composite video signal is applied to point A of the electronic dropout switch.

The 64-microsecond delayed video-FM signal is applied via pin 17 to the FM demodulator stage of the Video Demodulator II module. Its composite video output is available at Pin 1 and is applied to a video amplifier. The frequency response of that amplifier rolls off at 2.6 MHz because the 64-microsecond delay line (DL5101 in Fig. 6) cannot pass signals above that frequency. As a result, dropout corrections occur in black-and-white only. The effect, however, is not noticeable on the TV screen because of the small areas of the picture involved. Gain control R3013 controls the gain of the video amplifier. The video input is applied to point B of the dropout switch and can be monitored at the test point on Pin 10 of the Video Demodulator II module.

The electronic-dropout switch therefore receives a 540-nanosecond delayed-video signal at point A and a line-delayed composite video signal at point B (64-microsecond delay). The voltage at pin

15 determines which of those signals will be applied to the electronic burst switch. When a dropout occurs, the voltage at pin 15 goes high and creates a dropout pulse for the duration of the dropout. The dropout switch, normally in position A, receives the undelayed video signal (540 nanoseconds). However, when a dropout pulse is present, the dropout switch moves to position B and receives the delayed (64-microsecond) video signal. The selected signal leaves the module at pins 7 and 11.

The undelayed video signal is actually delayed by 540 nanoseconds—the time required for the dropout circuitry to respond to the actual dropout. The actual time difference between the two types of video signals is 64 microseconds less 540 nanoseconds, or approximately 63.5 microseconds, the true scan time of one horizontal raster line.

The electronic burst switch in the Video Demodulator I module is used to maintain the 180-degree phase difference in the 3.58-MHz chroma (color) signal from frame to frame during special modes of operation, such as still-picture, reverse, fast forward, etc. The chroma signal is normally 180 degrees out of phase from track to track on the videodisc. That relationship is also true from frame to frame on normal TV broadcasts and its purpose is to cancel 3.58-MHz interference. However, when the

same track is being played over and over again, the chroma signal would not be out of phase from frame to frame. To introduce that phase difference, the signal is therefore delayed by 140 nanoseconds during alternate revolutions when still-picture viewing is called for. That delay is equivalent to one half of a 3.58-MHz period. The electronic burst switch switches the delay line DL5102 in or out depending upon the viewing mode being used (still picture, reverse play, fast forward, etc.).

The resultant composite video signal is then fed to a Video Processor module and to a Reference Control module, as shown in Fig. 8. A video-muting input at pin 16 blanks the video signal during return of the laser beam to the inside of the disc and during initial turn-on. The video signal is also processed by the DC clamp circuit that clamps the video signal to the correct DC level.

Composite video is clipped in the Reference Control module by the amplifier/clipper stage. The resulting clipped video contains the digital code that represents the picture or frame number. That code is applied to the decoder block on the Mode Control module. A video generator actually creates the separate video signal for displaying the picture number. A video signal that provides a gray background behind the numbers on the screen is also generated by those circuits. Those video signals are then applied to the 2nd video amplifier at pins 7 and 11 of the Video Processor module and the resultant video is then applied to the Rf Modulator as well as to the rear-panel monitor jack, via an emitter follower.

As elaborate as that video and audio processing circuitry may seem, it is really only one half the story of what takes place inside the new optical-laser video disc players. Fully as much electronic circuitry (not to mention the precision mechanical system) is associated with the servo-control circuitry that performs such functions as turntable motor control, tangential-tracking mirror control, radial-tracking mirror control, slide-drive control, objective-lens control (focus) and turn-on sequence logic. All of which makes the new videodisc players an almost miraculous achievement when one considers that they don't cost much more than many audiophiles spend for a super-performing audio turntable. **R-E**

YOU DESERVE IT! GET IT EVERY MONTH!

Radio Electronics

PROTECT YOUR CAR AGAINST AUTO THEFT

BY BOB KAPLAN

Build a backyard satellite TV receiver
14 silly things you can do with a PRAM IC
Build a thunderstorm alarm

Now for 1980 TV sets
Now super cheap A to-Z amplifiers
Circuits that talk back



NIFTY WIRE-WRAP TRICKS

Come on, treat yourself—and save money, too. Subscribe to Radio-Electronics today, and make sure you get all of the most interesting, most exciting and authoritative electronics reporting in any magazine, month after month. Don't miss a single one of the upcoming issues jam-packed with new-equipment test reports, projects to build, servicing ideas, and news of solid state, computers, hi-fi, hobbies and everything electronic. Save money, too—as much as \$5. off the newsstand price when you subscribe to Radio-Electronics. Come on, you deserve it—check off the money-saving offer you prefer on the handy coupon, and start enjoying Radio-Electronics every month.

Get The Authority—Every Month

Name (Please print) _____ 40C0

Address _____

City _____ State _____ Zip _____

Indicate the offer you prefer:

- | | |
|--|---|
| <p><input type="checkbox"/> 1 Year—12 issues ONLY \$13.00
(You save \$2.00 off newsstand price.)</p> <p><input type="checkbox"/> 2 Years—24 issues ONLY \$25.00
(Save More! \$5.00 off newsstand price.)</p> | <p><input type="checkbox"/> EXTRA SAVINGS if you enclose payment.
Payment enclosed (send two extra issues per year)</p> <p><input type="checkbox"/> Bill me</p> <p><input type="checkbox"/> Check here if you are extending or renewing your subscription.</p> |
|--|---|

Extra Shipping: Canada \$3.00 per year, all other countries \$5.00 per year.

Mail to: **Radio-Electronics**
SUBSCRIPTION DEPT., P.O. BOX 2520 BOULDER, COLO. 80322



United Way

Thanks to you, it works. For all of us.

A Microcomputer for everyone at a Micro Price

The **MicroAce** - a new generation of miniature computers
A COMPLETE COMPUTER for \$149.00 for 1K Kit

Post and Packing FREE

(Add 6% Tax for Shipments inside California)

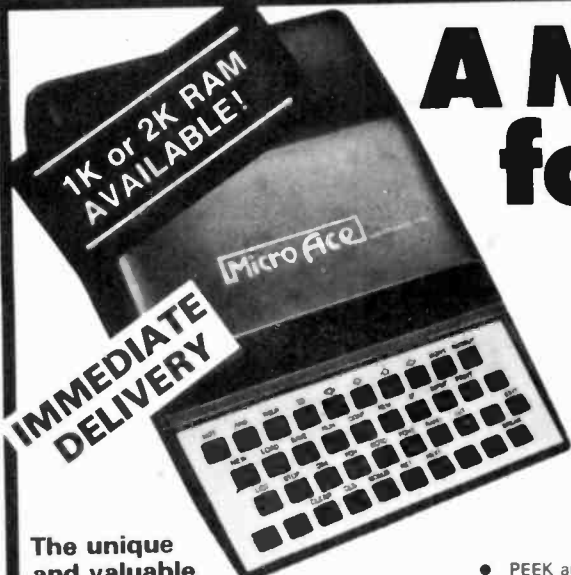

The unique and valuable components of the MicroAce

The MicroAce is not just another personal computer. Quite apart from its exceptionally low price, the MicroAce has two uniquely advanced components: the powerful BASIC interpreter, and the simple teach yourself BASIC manual.

The unique versatile BASIC interpreter offers remarkable programming advantages:

- Unique 'one-touch' key word entry: the MicroAce eliminates a great deal of tiresome typing. Key words (RUN, PRINT, LIST, etc.) have their own single-key entry.
- Unique syntax check. Only lines with correct syntax are accepted into programs. A cursor identifies errors immediately. This prevents entry of long and complicated programs with faults only discovered when you try to run them.
- Excellent string-handling capability - takes up to 26 string variables of any length. All strings can undergo all relational tests (e.g. comparison). The MicroAce also has string input - to request a line of text when necessary. Strings do not need to be dimensioned.
- Up to 26 single dimension arrays.
- FOR/NEXT loops nested up to 26.
- Variable names of any length.
- BASIC language also handles full Boolean arithmetic, conditional expressions, etc.
- Exceptionally powerful edit facilities, allows modification of existing program lines.
- Randomise function, useful for games and secret codes, as well as more serious applications
- Timer under program control.

- PEEK and POKE enable entry of machine code instructions, USR causes jump to a user's machine language sub-routine.
- High-resolution graphics with 22 standard graphic symbols.
- All characters printable in reverse under program control.
- Lines of unlimited length.

'Excellent value' indeed!

For just \$149.00 (including handling charge) you get everything you need to build a personal computer at home... PCB, with IC sockets for all ICs; case; leads for direct connection to a cassette recorder and television (black and white or color); everything!

Yet the MicroAce really is a complete, powerful, full-facility computer, matching or surpassing other personal computers at several times the price.

The MicroAce is programmed in BASIC, and you can use it to do quite literally anything, from playing chess to managing a business.

The MicroAce is pleasantly straightforward to assemble, using a fine-tipped soldering iron. It immediately proves what a good job you've done: connect it to your TV ... link it to the mains adaptor ... and you're ready to go.

Fewer chips, compact design, volume production-more power per Dollar!

The MicroAce owes its remarkable low price to its remarkable design: the whole system is packed on to fewer, newer, more powerful and advanced LSI chips. A single SUPER ROM, for instance, contains the BASIC interpreter, the character set, operating system, and monitor. And the MicroAce 1K byte

RAM (expandable to 2K on board) is roughly equivalent to 4K bytes in a conventional computer - typically storing 100 lines of BASIC. (Key words occupy only a single byte.)

The display shows 32 characters by 24 lines.

And Benchmark tests show that the MicroAce is faster than all other personal computers.

No other personal computer offers this unique combination of high capability and low price.

The MicroAce teach-yourself BASIC manual.

If the features of the MicroAce interpreter mean little to you - don't worry. They're all explained in the specially-written book free with every kit! The book makes learning easy, exciting and enjoyable, and represents a complete course in BASIC programming - from first principles to complex programs. (Available separately - purchase price refunded if you buy a MicroAce later.) A hardware manual is also included with every kit.

The MicroAce Kit:
\$149.00 with 1K COMPLETE
\$169.00 with 2K

Demand for the MicroAce is very high: use the coupon to order today for the earliest possible delivery. All orders will be despatched in strict rotation. If you are unsuccessful in constructing your kit, we will repair it for a fee of \$20.00, post and packing FREE. Of course, you may return your MicroAce as received within 14 days for a full refund. We want you to be satisfied beyond all doubt - and we have no doubt that you will be.

280 A microprocessor chip, widely recognised as the best ever made.

Sockets for TV, cassette recorder, power supply.

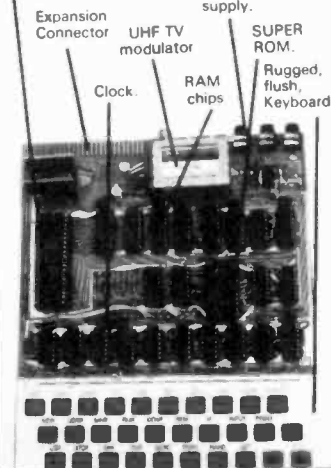

Your MicroAce kit contains...

- Printed circuit board, with IC sockets for all ICs.
- Complete components set, including all ICs - all manufactured by selected world-leading suppliers.
- New rugged keyboard, touch-sensitive, wipe-clean.
- Ready-moulded case.
- Leads and plugs for connection to domestic TV and cassette recorder. (Programs can be SAVED and LOADED on to a portable cassette recorder.)
- Mains adaptor of 600 mA at 9VDC nominal unregulated.
- FREE course in BASIC programming and user manual.

JOIN THE REVOLUTION - DON'T GET LEFT BEHIND - ORDER YOUR MICRO ACE NOW!!

Send Check, Money Order or quote your Credit Card No. to:
MicroAce 1348 East Edinger, Santa Ana, California, Zip Code 92705.
 or phone (714) 547 2526 quoting your Credit Card Number.

Quantity	Description	Unit Price	TOTAL
	MicroAce Kit 1K	\$149.00	
	MicroAce Kit 2K	\$169.00	
	Manual	\$10.00	
	1K Upgrade Kit	\$29.00	
		TOTAL	

Shipments inside California add 6% TAX

- Amex.
- Diners
- Check
- Money Order
- Master Charge
- Visa

Card No. _____

Exp. Date _____

Name _____

Address _____

City _____ State _____ Zip _____

ILP AUDIO MODULES

A new concept in audio design

Compact high performance modules

Ideal for * Home music systems

- Subwoofers and bi-amplification
- Musical instrument amplification
- Professional sound reinforcement

MODULAR SYSTEMS

APPROACH ALLOWS YOU TO BUY ONLY WHAT YOU NEED!

- Stereo or Mono, you decide wattage
- Basic power or with preamplification
- Start simple, expand when you need to * Design your own custom cases

FULL FIVE YEAR WARRANTY

Power Amplifiers

- Built-in heatsinks
- Protected circuitry
- No external parts required

* 5 simple connections

HY50 30 watts RMS \$28.95

High performance amp with rugged aluminum heat-sinks. Measure only 4" x 2" x 1" thick! Mounts with 2 screws. Gives 30 watts RMS at 0.02% distortion. Response 10 - 45 KHz. 4 to 16 ohms. ±25 V/2A.

HY30. 15 watts RMS. Size/specs as HY50. 20 V/2A. 25.95

HY200 120 watts RMS \$79.95

High performance amplifier with large heatsink area for cool operation. Fully protected circuitry. Distortion only 0.01% at 120 watts RMS (1 KHz). Response 10 Hz - 45 KHz. S/N ratio 100 db. Only five connections. Amazingly compact - only 4 1/2" x 4" x 2" D. Mounts with 2 screws. Requires ±45 V/3A.

HY120. 60 W RMS. Specs/size as HY200. 35 V/2A. 59.95

HY400 240 Watts (4 ohm). Double the power, double heatsink area! Same specs as HY120/200. May be used into 8 ohms at reduced output. 4" x 4 1/2" x 4". ±45 V/4A \$99.95

HY400 bridging circuit for 480 watts available 1981.

PreAmplifiers

HY66 Stereo \$48.95
HY6 Mono \$25.95

Inputs for RIAA phono, tape with monitor, tuner, auxiliary and microphone; full tone control circuitry. Incredible performance: Response DC to 100 KHz, distortion 0.05%, S/N 90 db. Output to 4.5 V RMS. Supplied with edge connectors. Compact. Reliable. Internal voltage regulation - use from 15 to 50 V safely! May be used in multiples for PA, instrument mixers etc. Order optional pcb's to extend edge connectors: B6 (for HY6) \$3.75 and B66 (for HY66) \$4.75

Power Supplies

Circuit boards with all components plus TOROIDAL transformers (except PSU30 and 36). Toroidals are half the size and weight of conventional transformers; and are quieter and more efficient. Note: HY6 and HY66 can also be powered from any supply.

PSU50 for 1 or 2 HY50	\$33.60
PSU60 for 1 HY120	\$51.00
PSU70 for 1 or 2 HY120	\$64.00
PSU90 for 1 HY200	\$65.50
PSU180 for 1 HY400 or 2 HY200	\$89.50
PSU36 for 1 or 2 HY30	\$33.60
PSU30 for 12 HY6 or 6 HY66	\$22.95

Telephone Order (716) 849-0735

DEALER AND OEM ENQUIRIES INVITED

Gladstone Electronics

901 Fuhrmann Blvd., Buffalo N.Y. 14203

Name _____
Address _____
City _____ Zip _____
Please send _____
Amt. enclosed _____
Check () M/O () Visa () M/C ()
Number _____ Exp. _____

In Canada: Gladstone Electronics, Toronto, Ontario

CIRCLE 24 ON FREE INFORMATION CARD

ADVERTISING INDEX

RADIO-ELECTRONICS does not assume any responsibility for errors that may appear in the index below.

Free Information Number Page

23	AMC Sales	106
—	AMF, Electro—Components Division	104
—	ATV Research	89
32	Active Electronics	91
34	Advanced Computer Products	92-93
—	Advance Electronics	26,32,34-35
54	Albia Electronics Inc.	81
46	All Electronics	102
22	American Antenna	Back Cover
40	Ancrona	103
3	B & K	17
—	Karel Barta	104
47	Beckman	2
—	Bullet Electronics	102
—	Burdex Security Co.	89
12	Byte	37
41	CFR, Associates Inc.	94
—	CIE, Cleveland Institute of Electronics	18-21
57	Cambridge Learning Inc.	38
28	Channellock Inc.	36
20	Chaney Electronics	106
—	Command Productions	104
49	Communications Electronics	88
36	Concord Computer Components	94
—	Crystal Radio	90
—	Dage	89
35	Digi-Key Corp.	99
62	Discwasher	Cover 3
4	Etco	104, 106
37	Fluke	7
56,55	Fordham	78,24
5	Formula International	96-97
24	Gladstone Electronics	110
58	Global Specialties Corp	40
—	Global T.V. Electronics	106
38	Godbout Electronic	102
—	Grantham College of Engineering	88
63	Hal-Tronix	102
26,25	Heath	25,74
—	Information Unlimited	104
13	International Components	87
51	International Crystal MFG, Co. Inc.	78
29	International Electronics Unlimited	95
—	JS & A	101
19	Jameco Electronics	100-101
27	Jan Crystals	82
—	Joe	89
33	Keithley Instruments Inc.	86
48	Magnavox	5
15	Meshna Inc.	94
6	Micro-Ace	109
—	Micro Management Systems, Inc.	110
—	NRI Schools	8-11
—	NTS, National Technical Schools	28-31
59	Netronics	77
30	Non-Linear Systems	33
8	O.K. Machine & Tool Corp.	15
11	On Computing	75
9	Ora Electronics	73
16	Paccom	83
2	Paia Electronics	88
43	Poly Paks	98

44	Protecto Enterprises	72
7	Quest Electronics	98
18	Radio Shack	105
17	Ramsey Electronics	107
14	SLG, Waber	86
—	Sabtronics	13
52	Shure Brothers Inc.	80
53	Simpson Electric Company	39
45	Simutek Computer Products	79
—	Sinclair Research Ltd.	27
42	Solid State Sales	104
—	Spacecoast	106
—	Surplus Center	104
10	Tab, Electronics Book Club	71
60,61	Triplett	Cover 2
—	USI	104
39	Vector	72
—	Wersi	83
31	Zenith Radio Corp.	22-23

DISCOUNT TRS-80[™] DEALER A301
COMPUTER SPECIALISTS



FREE
COMPUTER
CATALOG
UPON
REQUEST

\$ Discount
on TRS-80's

26-3001 4K Color..... \$360.00
26-1062 16K III..... 888.00
26-4002 64K 1 DRIVE... 3440.00
1-800-841-0860 TOLL FREE
MICRO MANAGEMENT SYSTEMS, INC.
Downtown Plaza Shopping Center
115 C. Second Av., S.W.
Cairo, Georgia 31728
(912) 377-7120 Ga. Phone No.

NOISE FILTER

continued from page 44

minimum. A further advantage provided by multiple notch-filter techniques, is that the worst possible adjustment is limited to between 8 dB and 10 dB of attenuation. If a sliding cut-off filter were used, that might not be the limit and the error induced could be intolerable.

With the ASRU, the maximum permissible error can be set by the user and the possibility of obtaining an unnatural response—where a low-frequency band might be attenuated more than a higher-frequency one—is avoided. The noise-reduction control and the spectral-tracking concept with feedback are two features that make the operation of the ASRU so effective, yet free of side effects.

Next month, we will provide the circuit details for both the noise reduction and dynamic range expander portions of the ASRU. The construction details will also be given.

R-E

DISCWASHER D4 SYSTEM

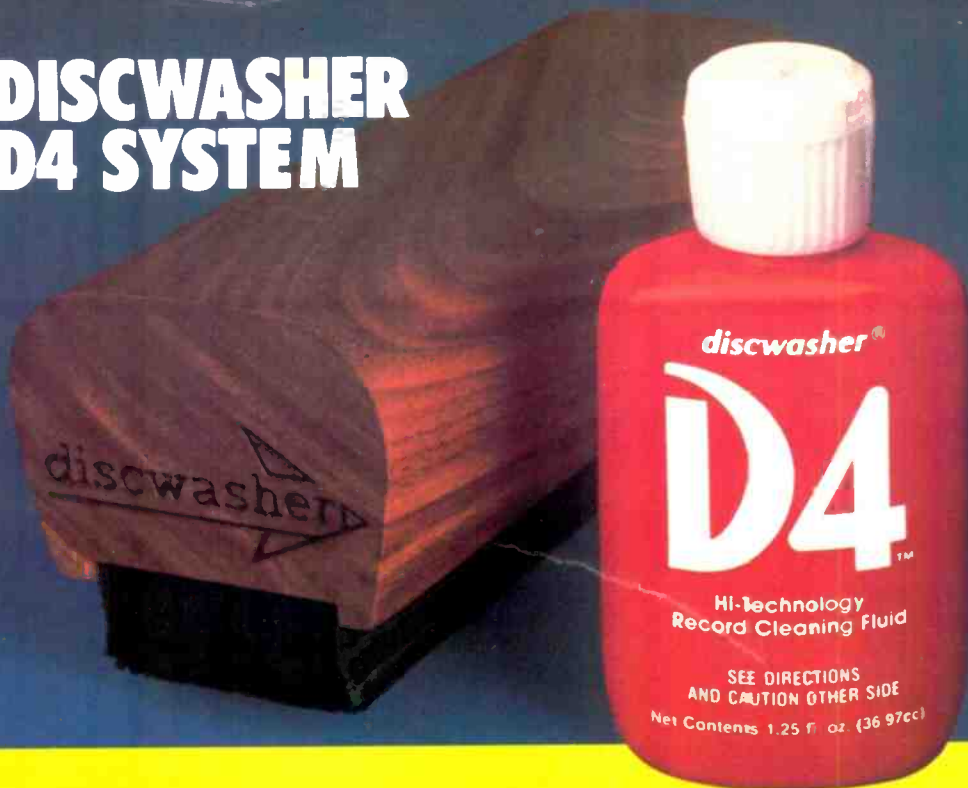

A NEW STANDARD OF RECORD CARE

NEW D4 FLUID

Inherently more active against record contamination. Inherently safe for record vinyl. Preferentially absorptive formula carries all contamination off the record.

NEW D4 FABRIC

Unique directional fibers preferentially remove fluid and contamination. D4 fabric results in clearly better cleaning, better drying and ultimately residue-free surfaces.

UNMATCHED VALUE

The Discwasher D4 System is enhanced by the durability and aesthetics of the hand-finished walnut handle. Included in the D4 System are the DC-1 Pad Cleaner and new instructions.

discwasher[®]

PRODUCTS TO CARE FOR YOUR MUSIC

Discwasher, Inc., 1407 N. Providence Rd., Columbia, MO 65201

CIRCLE 62 ON FREE INFORMATION CARD

In one year our **K40** antenna has become the largest selling CB antenna in the world!

1. It's more expensive ...

2. It's made better...

3. It's proven best!

...Here's what the leading CB publications said.

\$42.50

suggested retail

And when you pay more, you expect more!

MORE PERFORMANCE:

The K40 is guaranteed to transmit further or receive clearer than any antenna it replaces. We know it will. We've tested it with 771 CB'ers just like you for one year.

MORE FLEXIBILITY:

You can fit your K40 to any mounting surface. It will fit any vehicle you'll ever own! That includes choppers, dune buggies, gutters, mirror mounts, luggage racks, trunks, hatchbacks, through roofs, semis, pick ups and RV's.

MORE QUALITY:

It's not imported. It's not made in Taiwan, Korea or Japan. It's American made in an American town. It's made with better materials that cost more and by professional people we pay more. And we designed it right here in the U.S.A.

*Including optional mounts at extra cost.

...This Antenna is so DYNAMITE you receive a ...

DOUBLE GUARANTEE

GUARANTEE I: The K40 will transmit further and receive more clearly than the antenna it replaces or the customer will receive a prompt and full refund from the Registered K40 Dealer who installed and tuned it.

GUARANTEE II: Unconditionally guaranteed for 12 months. Guaranteed against cracking, chipping or rusting. Guaranteed against mechanical failure. Guaranteed against electrical failure. Guaranteed against accidental breakage. No exclusions. No gimmicks. For a full 12 months.



CB TIMES: "...it's not often that a product bursts onto the market scene, dominates and improves CB'ing for everyone. American Antenna and the K40 are doing it—repeated tests showed the K40 could out-perform the major competitive brands."

RADIO-ELECTRONICS: "The results of our tests showed that, in three different positions of the monitoring receiver, the model K40 equaled or out-performed the competitive antenna. Apparently, American Antenna's advertising is not merely Madison Avenue showmanship."

PERSONAL COMMUNICATIONS: "...an impressive 95% of the trials, the K40 out-performed the existing mobile antennas. We had to try one for ourselves.

"...in every case, the K40 either equaled or out-performed its competitor.

"No ifs, ands, or buts! The K40 Antenna from American Antenna would have to be just about the best antenna around.

CB MAGAZINE: "Introduced in October, 1977, the K40 quickly became the top seller and in mid 1978 became the number one selling antenna in the nation."

...Here's what CB'ers all across the country said.

ANTENNA SPECIALISTS: "...truck driver and CB'er for 10 years ... 50% further than my M410 'Big Momma'."

—J.H. Collett, 207 McFee, Bastrop, LA

AVANTI: "I'm an electronic technician with a Second Class FCC license ... I was able to transmit 70% further and tune the SWR 75% lower than my Avanti."

—H.R. Castro, VRB, Monserrante D-67, Salinas, Puerto Rico

PAL: "... 20% better in transmission and reception than my 5/8 wave Pal Firestick."

—John A. Blum, Box 446, Zelenople, PA

SHAKESPEARE: "... I've been a CB'er for three years and the K40 is the best I've ever had. Better in reception and transmission than my Shakespeare."

—H. Bachert, Jr., 15 King Rd., Park Ridge, NJ

HUSTLER: "Compared to my Hustler XBLT-4, the K40 can consistently transmit 40% further and the reception was better. The K40 is the perfect way to complete a CB system."

—Jerome R. Brown, 7800 S. Linder, Burbank, IL

GOOD STUFF FOR PROS ONLY!



(SPECIAL NOTE)

IF YOU'RE A BEGINNER:

Our K40 Dealers will be happy to sell you any of the older styles in expensive antennas that are great bargains for any beginning CB'er.

AMERICAN ANTENNA
ELGIN, IL 60120

©COPYRIGHT AMERICAN ANTENNA 1979

K40
POWER!

... Sold exclusively by 3500 American K40 Dealers throughout the U.S. & Canada.

CIRCLE 22 ON FREE INFORMATION CARD