

Radio- Electronics

**BUILD YOUR OWN
NEGATIVE ION GENERATOR**

\$1.25 JULY 1981

How to improve UHF TV reception
Build a disco light sequencer
New hi-fi error-correcting amplifier

IC comparator app-note
Build a \$60 computer MODEM

CORDLESS TELEPHONES

Answer your telephone
from anywhere in your home

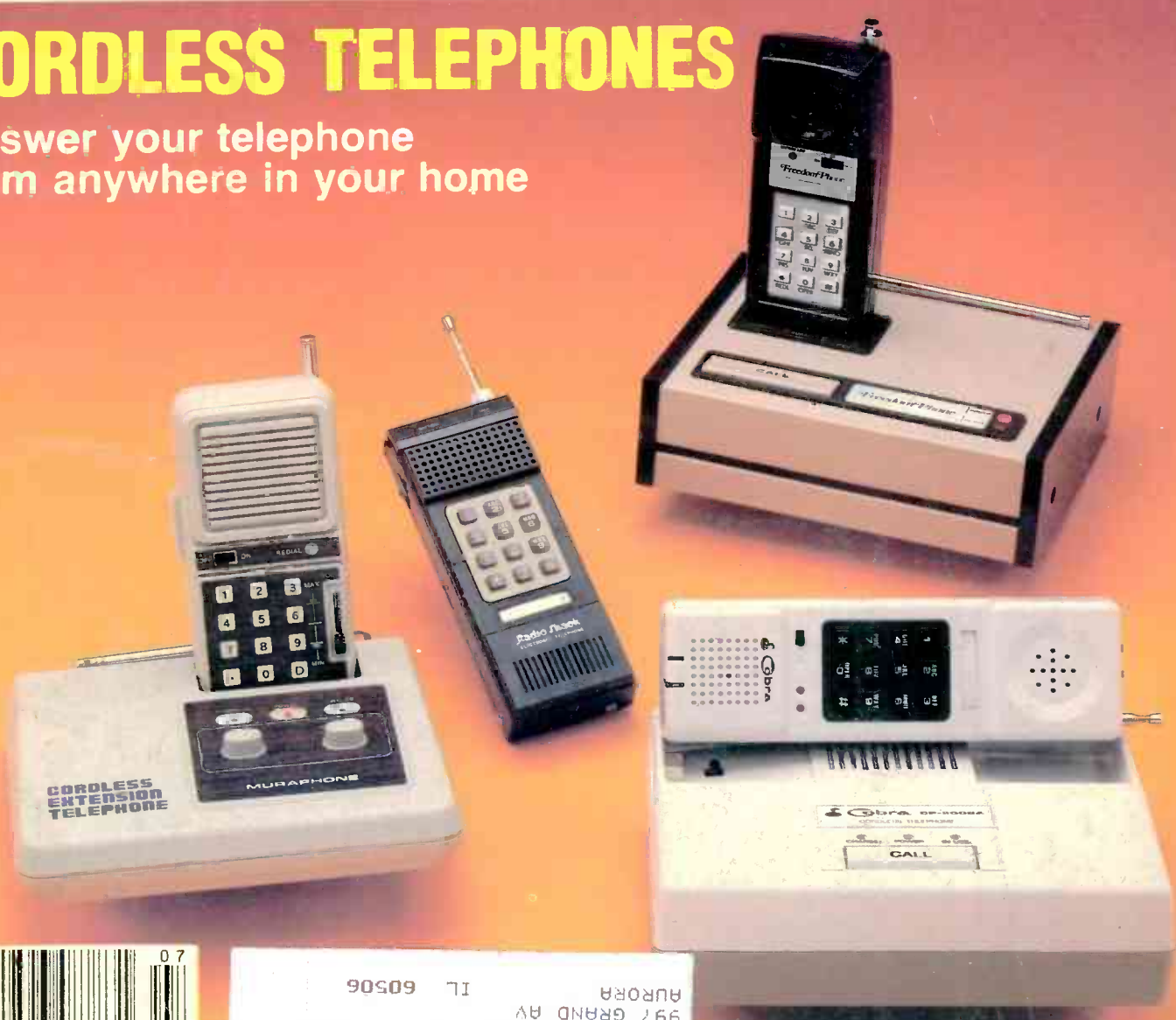

MR ROBERT DAHM
997 GRAND AV
AURORA IL 60506
390736 DHM 09976093 G4 A NOV81

Educator, Entertainer, Accountant.

Your Challenger Personal Computer.

Through the miracle of modern technology, a complete computer as powerful as the multimillion dollar room-sized computers of a few years ago can be put in a package the size of a typewriter and sells for as little as a color television set!

Through its years of microcomputer experience, Ohio Scientific has effectively channeled this tremendous computer power into a "friendly" computer with hundreds of personal uses, via a huge software library of programs for a broad range of personal, home, educational and business use.

This available software allows you to use and enjoy your computer without becoming an expert. The Challenger, however, is a powerful, general purpose computer which can be programmed in several languages by those who choose to.

Here are just a few of the popular uses of an Ohio Scientific Challenger Computer:

Education

The personal computer is the ultimate

educational aid because it can entertain while it educates. Software available ranges from enhancing your children's basic math, reading and spelling ability, through tutoring high school and college subjects, to teaching the fundamentals of computers and computer programming.

Entertainment

Many of the Challenger's games educate while they entertain, from cartoons for preschoolers to games which sharpen mathematical and logical abilities. But, entertainment doesn't stop here. The Challenger's graphics capabilities and fast operation allow it to display action games with much more detail than the best video games, providing spectacular action in games such as Invaders, Space Wars, Tiger Tank and more! All popular sports such as golf, baseball and bowling are available as simulated computer games as well as many conventional games such as chess where the computer plays the role of a formidable opponent.

Accounting

Your Challenger computer can keep track of your checkbook, savings account, loans, expenses, monitor your calorie intake and your biorythms.

If you are involved in a business, you can use it to do word processing; accounting, inventory control, order processing, customer lists, client records, mailing labels and planning.

And more:

This may seem like a lot of uses, but it's only the tip of the iceberg for a general purpose computer. For example, your Challenger can be expanded to control lights and appliances, manage your energy usage and monitor for fire and break-ins. Furthermore, it can communicate with you, with other computers and the new personal computer information services over the telephone.

In fact, the uses of general purpose, personalized computers are expanding daily as more and more people discover the tremendous capabilities

of these new technological wonders.

Ohio Scientific offers you four personalized computer systems starting at just \$479.



CIRCLE 9 ON FREE INFORMATION CARD

For a free catalog and the name of the dealer nearest you, call 1-800-321-6850 toll free.

OHIO SCIENTIFIC

a **MACOM** Company

1333 SOUTH CHILLICOTHE ROAD
AURORA, OH 44202 • (216) 831-5600

JULY » SPECIAL «

BK PRECISION

New Portable Digital
Capacitance Meter



MODEL 820
Call For Our Price



BEEP!
BEEP!

WESTON

The Roadrunner
Model 6100

- 5 Range audible signaling function
- 0.5" LCD display
- 6 Functions
- 29 Ranges

Reg. \$155.00

SPECIAL
\$139.00

includes free case

HITACHI

KEITHLEY



Non-Linear Systems

FLUKE

HICKOK

VIZ formerly
ROA

TRIPLETT



PHILIPS

WESTON

Simpson

BK PRECISION

LEADER

DORIC



DATA PRECISION

**ADVANCE
ELECTRONICS**

THE TEST EQUIPMENT
SPECIALISTS

TOLL FREE HOT LINE
800-223-0474



54 WEST 45th STREET, NEW YORK, N.Y. 10036
IN NEW YORK STATE 212-687-2224

PORTABLE OSCILLOSCOPES

BATTERY OPERATED



Non-Linear Systems

Call For Our Prices

MS-15



Single Trace 15MHz

MS-215



Dual Trace 15 MHz

MS-230

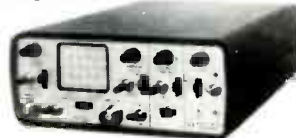

Dual Trace 30MHz

New Sweep/Function Generator

BK PRECISION



Call For Our Price

MODEL 3020

- Four instruments in one package—sweep generator, function generator, pulse generator, tone-burst generator.
- Covers 0.02Hz-2MHz
- 1000:1 tuning range
- Low-distortion high-accuracy outputs
- Three-step attenuator plus vernier control
- Internal linear and log sweeps
- Tone-burst output is front-panel or externally programmable

- V-151B 15 MHz Single Trace
- V-152B 15 MHz Dual Trace
- V-202 20 MHz Dual Trace
- V-301B 30 MHz Single Trace
- V-302B 30 MHz Dual Trace
- V-352 35 MHz Dual Trace
- V-550B 50 MHz Dual Trace,
Dual Time Base
- V-1050 100 MHz Dual Trace,
Dual Time Base

Call For
Special Intro
Price Offer



HITACHI



We carry a full line of multimeters, oscilloscopes, frequency counters, audio and RF generators, power supplies and accessories.

Just call our Toll-Free number and one of our experts will answer all your questions about test equipment.

SPECIAL FEATURE

- 31 **CORDLESS TELEPHONES**
A component-by-component look at how the circuits work.
Robert F. Scott

BUILD THIS

- 36 **NEGATIVE ION GENERATOR**
Negatively-charged oxygen is claimed to provide many benefits. Here's your chance to find out for yourself.
Ronald E. Pyle
- 45 **\$60 MODEM**
The second part of this article winds up the construction phase of the project and introduces the software. **Robert Ward**
- 56 **LUMITRON-4 LIGHT SEQUENCER**
Final construction and checkout and a fascinating light display. **David L. Holmes**

TECHNOLOGY

- 4 **LOOKING AHEAD**
Tomorrow's news today. **David Lachenbruch**
- 14 **SATELLITE TV NEWS**
The latest happenings in an exciting new industry.
Gary H. Arlen
- 60 **BURR-BROWN APPLICATION NOTE**
A simple comparator with variable hysteresis.
- 62 **HOBBY CORNER**
In and out of the mailbag. **Earl "Doc" Savage, K4SDS**
- 73 **NEW IDEAS**
A prize-winning application from a reader.

VIDEO

- 39 **BETTER UHF-TV RECEPTION**
There are a lot of worthwhile programs on UHF, and more to come with the new FCC ruling. Here's a survey of antenna systems and accessories to help you get the best reception.
Dennis C. Brown
- 75 **SERVICE CLINIC**
Overload-protection circuits. **Jack Darr**

RADIO

- 69 **COMMUNICATIONS CORNER**
How switching diodes operate. **Herb Friedman**

AUDIO

- 49 **FEEDFORWARD AMPLIFIER**
A new distortion-reduction technique that revives an old concept. **Len Feldman**

**EQUIPMENT
REPORTS**

- 19 **B&K Precision Model 2845 DMM**
- 20 **Nevom Model CM-100 Wireless Microphone**
- 21 **Hamtronics Out-of-Band Converters**
- 21 **Sony Model ICF-2001 Receiver**
- 22 **Osborne/McGraw-Hill: Some Common BASIC Programs**

DEPARTMENTS

- | | | | |
|-----|-------------------------------|-----|-----------------------|
| 12 | Advertising and Sales Offices | 105 | Free Information Card |
| 104 | Advertising Index | 16 | Letters |
| 74 | Books | 84 | Market Center |
| 84 | Computer Market Center | 67 | New Products |
| 77 | Computer Products | 71 | Stereo Products |
| 12 | Editorial | 4 | What's News |

ON THE COVER

Cordless telephones offer all the conveniences—and then some—of the wired kind. For a detailed description of what they have to offer and how they work, turn to page 31.



WE HAVE BEEN DELUGED by requests for plans for a negative ion generator. At long last we have one for you. The project starts on page 36.

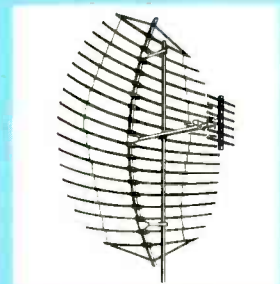

UHF-TV PROGRAMS OFFER a lot and would have a larger audience if the stations could be received better. The survey starting on page 39 can help you pull in their sometimes-elusive signals.

Due to space restrictions, the second part of the article on Solid-State Microwave Devices, scheduled to appear this month, will appear in the August issue.

Radio-Electronics, (ISSN 0033-7862) Published monthly by Gernsback Publications, Inc., 200 Park Avenue South, New York, NY 10003. Second-Class Postage Paid at New York, N.Y. and additional mailing offices. One-year subscription rate: U.S.A. and U.S. possessions, \$13.00, Canada, \$16.00. Other countries, \$21.50. Single copies \$1.25. © 1981 by Gernsback Publications, Inc. All rights reserved. Printed in U.S.A.

Subscription Service: Mail all subscription orders, changes, correspondence and Postmaster Notices of undelivered copies (Form 3579) to Radio-Electronics Subscription Service, Box 2520, Boulder, CO 80322.

A stamped self-addressed envelope must accompany all submitted manuscripts and/or artwork or photographs if their return is desired should they be rejected. We disclaim any responsibility for the loss or damage of manuscripts and/or artwork or photographs while in our possession or otherwise.

looking ahead

ALL-IN-ONE



A new generation of color-TV newsgathering and production equipment has arrived with the development of lightweight, high-quality, all-in-one camera/VCR combinations designed for the simplicity and flexibility of the film camera, but with all the advantages of the videotape medium. Two versions have been announced; both are scheduled for availability around this year's end, and both use completely new tape-recording formats based on 1/2-inch consumer cassettes.

RCA and Matsushita (Panasonic), working together, created a 22-pound single-piece combination that uses what is claimed to be a new type of tape packed in a standard VHS cassette. But instead of recording for two, four, or six hours, the new system uses a much faster tape speed, it also has an undisclosed recording format that is claimed to provide picture quality better than current 3/4-inch U-matic recorders and equivalent to 16mm film. The new camera component uses three half-inch pickup tubes. Camera/VCR combinations using the new format are being offered by both RCA and Panasonic. Meanwhile, Sony has developed a similar approach using a Beta cassette and its own non-standard format, also getting 20 minutes on a cassette. However, Sony's system uses a single-tube camera ("high-band SMF Trinicon"), cutting weight even further—it's down to 15 pounds. Both new approaches make possible field recording using just one person.

HOME MINI-VCRS

In the consumer field, the drive to shrink to VCR is in full swing. Less than a year ago, Technicolor introduced its 7-pound VCR using a 1/4-inch tape cassette. Now its size and weight are being challenged by home portable recorders accommodating standard 1/2-inch cassettes. Sony's new Beta portable weighs 9 1/4 pounds and, thanks to a new tape-wrap system, is just about the same in volume as the Technicolor, measuring 8 1/2 x 12 x 3 inches. Sanyo introduced a portable Beta weighing only 8 3/4 pounds but at 10 3/4 x 10 1/2 x 4 inches it's 50 percent larger than the Sony or the Technicolor.

Both Sony and Sanyo introduced new features with their new portables. Sony's companion camera has a "record-review" button that cues the recorder to re-show the last two seconds of the previous shot through the viewfinder for precise assemble-editing. Another feature on the recorder, "swing-search," makes possible instant forward-reverse jogging for precise location of any segment. Sanyo's new camera, designed as a companion to the portable VCR, contains such remote controls as forward and reverse search, and still-frame on the body of the camera itself as an aid to electronic photography.

INTERACTIVE TV

Now going into production at Pioneer Communications' plant in Japan, and scheduled for use soon in the United States, is a new, more versatile version of the QUBE two-way cable-TV system first introduced in Columbus, Ohio. The new consumer terminal has digital-random access and is capable of tuning up to 104 channels. It is designed to provide security on certain channels for special pay-per-view or other programming, and can offer the consumer ten or more choices of responses to material on the screen—as compared with the five options on the current QUBE system. Thus it can be used for teleshopping and other similar interactive uses. The combination of a central computer and the intelligent home terminal constantly shows the cable operator just who's watching what. It can be used for polling and allows the subscriber to transmit and receive many other types of material. It also can accommodate many different types of home-security systems.

BANDWIDTH SAVER

A 1965 patent recently changed hands and its new owners say it will make possible reduction in a TV channel's bandwidth to as little as 1 MHz, or high-resolution transmission in the current bandwidth, within a few years. Known as Variable Velocity Scanning, it uses a transmitted digital signal to speed up scanning when redundancy occurs in the picture, and to slow it down when there are changes from frame to frame. A converter at the set restores the conventional analog signal. The same system, theoretically, could make possible a video recorder which could tape up to 24 hours on a single cassette. According to the owner, Jones VVS Inc., the first use of the Variable Velocity Scanning system will be for foolproof encryption (scrambling) of pay-TV programs. A digital signal, which can be changed daily, weekly, or monthly, would be transmitted along with the picture containing the key to unscramble the transmission. Decoding could also be accomplished by a magnetic card sent in the mail. The code signal contains no clue as to how the picture has been rearranged. The encryption system is planned for introduction this year.

DAVID LACHENBRUCH
CONTRIBUTING EDITOR

Take a good look at VACO.



THE SUPER CASE
70260

The world famous Super Case. Complete with 48 of the most popular and professional problem-solving tools. From screwdrivers and nutdrivers to pliers, wrenches, crimping tools and more. A super variety and super value. *All* unconditionally warranted from Vaco, of course. The Super Case and all the other fine Vaco tools can be seen in our new 1981 catalog. It's free, just write. Say you want to take a good look at VACO.

Vaco Products Company, 1510 Skokle Blvd.,
Northbrook, IL 60062 U.S.A.

VACO[®]

CIRCLE 7 ON FREE INFORMATION CARD

Tesla Memorial Society Plans Scholarship

The Tesla Memorial Society is planning to offer a scholarship to a graduate student in the field of electrical engineering. The Society (non-profit, non-political) was founded on July 8, 1979 for the purpose of honoring the genius of Nikola Tesla, the Yugoslav-American inventor of alternating current, and the first man to succeed in transmitting electric power using RF.

Membership in the society is open to all, and may be obtained by making a \$10 contribution, which gives the donor full voting privileges at the annual meeting. (A \$25.00 contribution gives the donor the status of patron of the society.) All contributions are tax-deductible.

July 10, 1981 marks the 125th anniversary of Tesla's birth. The society will celebrate that event this year with the cooperation of the United Nations.

Contributions should be sent to the Tesla Memorial Society, 453 Martin Road, Lackawanna, New York 14218.

Insulin pump for diabetics

The electronics assembly for a tiny pump to deliver insulin inside the bodies of diabetics is being developed at RCA Missile

and Surface Radar, Moorestown, NJ, as "a spinoff from defense electronics," according to Ron Kolc, leader of the project. The electronic assembly is being developed for Sandia Laboratories, Albuquerque, NM, which has been working for some years to develop a programmed insulin pump for diabetics.

The Sandia system acts as an artificial pancreas, pumping small amounts of insulin into the patient's body as needed—less during sleep and exercise, and more after meals. The diabetic could override the system if desirable, and stop, start, and control the insulin flow.

Hybrid microelectronics are used in the assembly, which has 37 integrated circuits in flat, leadless ceramic carriers. The entire assembly measures only 1¼ X 2 inches. The system is powered by a pair of 3.7-volt lithium batteries, with a life of about one year.

Motorola and Signetics sign pact

Signetics Corp. (a wholly-owned subsidiary of U.S. Philips) and Motorola Inc., have signed a 5-year agreement under which Signetics/Philips will alternate-source Motorola's M68000 microprocessor family in a

technology exchange aimed at creating industry's strongest 16-bit product line. Both Motorola and Signetics/Philips will produce software that includes operating systems, language processors, application packages, and development system tools.

While the pact covers the development of circuits, hardware, software, and support tools, "manufacturing, marketing, and sales" will be conducted competitively, according to the agreement.

The program is designed to motivate the companies to exchange independently developed products and to maintain product-line architectural consistency through the coordinated efforts of the participants.

Satellite communications award

The International Telecommunications Satellite Organization (INTELSAT) and the Italian company Telespazio S.P.A. have joined to offer a new international award for contributions in the field of satellite communications. Telespazio is the organization designated by the Italian government to be the Italian member of the INTELSAT system.

The award is for "an original contribution of significant applicable value in the satellite communications field," and will be open to all university students or researchers of all INTELSAT member countries. It will be known as the Piero Fanti International Prize, in honor of Telespazio's first Director General, who died ten years ago. The \$10,000 prize will be presented jointly by INTELSAT and Telespazio every two years during the 1981-1990 decade.

Selection of winning papers will be based on intrinsic value and applicability to satellite communications, technical aspects, and the environment in which the studies have been performed. The papers may be written in English, French, or Spanish, and are not to exceed 20 pages including attachments. They should comprise a detailed description of the discovery, invention, development, or research on which the entry is based; a description of its application to satellite communications, including examples where appropriate, and a description of the environment under which the work was performed. INTELSAT will have full rights to publication of the winning paper. Other papers will be returned to their authors, and publication by INTELSAT or Telespazio will require agreement with the author.

Send papers before September 30, 1981, to: INTELSAT, 490 L'Enfant Plaza, S.W., Washington, DC 20024, attention J. L. Algrett. Final selection will be made before December 31, 1981. For further information, contact Mr. Gavin Trevitt, Public Information Officer, INTELSAT, at (202) 488-2683.

R-E

MICROWAVE BORN 50 YEARS AGO

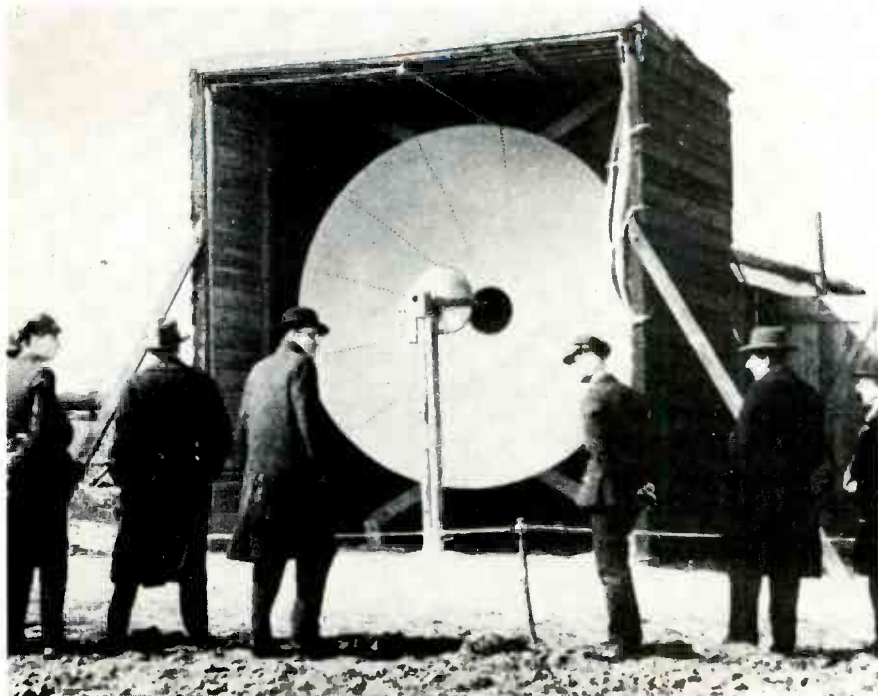

THE FIRST PUBLIC MICROWAVE DEMONSTRATION took place March 31, 1931, when scientists of two ITT companies in France and England beamed signals across the English Channel using directional reflectors and only half a watt of power. The frequency used was 1.7 GHz (18 centimeters). The parabolic reflector, which measured 3 meters (10 feet) in diameter, was set up on the cliffs at St. Margaret's Bay, Dover, to link with a similar antenna at Calais, France.

Facts from Fluke on low-cost DMM's

Direct readings in decibels: Keeping track of your gains and losses.

If you'd rather forget about the last time you got wrapped up in an audio jungle, you'll want to respond to this ad.

Meet our new 4½-digit Model 8050A Multimeter – the first low-cost DMM with self-calculating dB features that let you keep your mind on your mission instead of on conversions and formulas.

While most analog meters read dBm referenced only to 600 ohms, the Fluke 8050A delivers direct readouts in decibels over a 108 dB range referenced to any one of 16 impedances (8 to 1200 ohms) with 0.01 dB resolution.

Push one button, and the microprocessor in the 8050A scrolls

through its reference impedances. Simply stop at the one that matches your system and get back to work. No more math; just action. And with the 8050A's relative reference feature you can measure gains or losses in dB throughout your system faster than you thought possible.

When you're dealing with voltage, current or resistance, an offset function provides a means of comparing stored inputs with all subsequent inputs, automatically displaying the difference. A real timesaver.

And there's more. True RMS measurements to 50 kHz; 0.03% basic dc accuracy; conductance (measures leakage and high resistance); extensive overload protection and safety features; a full line of accessories; and a low price of \$369 U.S.

For all the facts on how to maximize your gains with the 8050A, call toll free 800-426-0361; use the coupon below; or contact your Fluke stocking distributor, sales office or representative.



IN THE U.S. AND NON-EUROPEAN COUNTRIES:
John Fluke Mfg. Co., Inc.
P.O. Box C9090, M/S 250C
Everett, WA 98206
(206) 356-5400
Telex: 152662

IN EUROPE:
Fluke (Holland) B.V.
P.O. Box 5053, 5004 EB
Tilburg, The Netherlands
(013) 673 973
Telex: 52237

- Please send 8050A specifications.
- Please send all the facts on Fluke low-cost DMM's.
- Please have a salesman call.

Name _____

Title _____ Mail Stop _____

Company _____

Address _____

City _____ State _____ Zip _____

Telephone () _____ Ext. _____

For technical data circle no. 46

RE 7/81

Now NRI takes you inside the new TRS-80 Model III microcomputer to train you at home as the new breed of computer specialist!

NRI teams up with Radio Shack advanced technology to teach you how to use, program, and service state-of-the-art microcomputers.



It's no longer enough to be just a programmer or a technician. With microcomputers moving into the fabric of our lives (over 250,000 of the TRS-80™ alone have been sold), interdisciplinary skills are demanded. And NRI can prepare you with the first course of its kind, covering the complete world of the microcomputer.

Learn At Home in Your Spare Time

With NRI training, the programmer gains practical knowledge of hardware, enabling him to design simpler, more effective programs. And, with advanced programming skills, the technician can test and debug systems quickly and easily.

Only NRI gives you both kinds of training with the convenience of home study. No classroom pressures, no night school, no gasoline wasted. You learn at your convenience, at your own pace. Yet you're always backed by the NRI staff and your instructor, answering questions, giving you guidance, and available for special help if you need it.

You Explore the New TRS-80 Model III Inside and Out

NRI training is hands-on training, with practical experiments and demonstrations as the very foundation of

your knowledge. You don't just program your computer, you go inside it... watch how circuits interact... interface with other systems... gain a real insight into its nature.

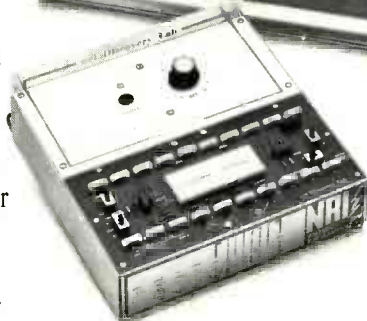

Training includes the new TRS-80 Model III microcomputer, 6-function LCD Beckman multi meter, and the NRI Discovery Lab with hundreds of tests and experiments.

You also work with a precision 26-scale, 6-function LCD Beckman multi-meter featuring full portability and a 3½ digit display. Using it along with the exclusive NRI Discovery Lab and your TRS-80, you perform over 60 separate experiments in all. You learn how to troubleshoot and gain greater understanding of the information your tests give you.

Advanced Technology Microcomputer Is Yours to Keep

As part of your training, NRI sends you the new, state-of-the-art TRS-80 Model III micro-computer. This functional unit is complete with 65-key keyboard and 12" display in one desk-top unit. It features

high-speed cassette loading, built-in interface for parallel printer, and provisions for optional disk drive. Its 4K RAM is internally expandable to 16K or 48K and its BASIC language is compatible with most Model I software.

Along with your multimeter and the NRI Discovery Lab, this latest concept in advanced microcomputers is yours to learn with, yours to keep and use for your own personal programs, business use, and other applications.

Send for Free Catalog... No Salesman Will Call

Get all the details on this exciting course in NRI's free, 100-page catalog. It shows all equipment, lesson outlines, and facts on other electronics courses such as Complete Communications with CB, TV and Audio Servicing, Digital Electronics, eleven different interest areas in all.

Send today, no salesman will ever bother you. Keep up with the latest technology as you learn on the world's most popular computer. If postcard has



been used, write to NRI Schools, 3939 Wisconsin Ave., Washington, D.C. 20016.

NRI Schools
 McGraw-Hill Continuing
 Education Center
 3939 Wisconsin Ave.
 Washington, D.C. 20016
We'll train you for the good jobs.



(TRS-80 is a trademark of the Radio Shack division of Tandy Corp.)

Digital Audio Is Coming Home

It's been almost two years since we reported on a demonstration by Philips of a "revolutionary" compact all-digital audio disc. (see our "What's News" column in the Sept. 1979 issue.) At that time, the digital audio disc was not expected to be introduced commercially until 1983. But that schedule has been moved up. Now it appears that formal introduction of the system will have taken place by the time you read this. The Philips system was scheduled for introduction at the Summer CES show in Chicago during the first week of June. And the actual hardware should be on retailers shelves soon thereafter.

The Philips CD (Compact Disc) system combines digital technology with laser optics. Each 4-inch diameter disc is recorded on only one side and contains one hour of high-quality stereo sound. The sound is placed on the disc using digital technology. Thus, this marks the first time that an all-digital format intended for home use will be introduced. Presently, because of its cost, digital technology is confined to studio use. Studios have to convert to digital signals to analog for distribution on conventional discs and tape. The only exception is the PCM accessories that are used with a videotape recorder. But even these require that the program material be fed to it in analog form. The Philips system eliminates the analog chain between the studios and the home and provides a digital-only chain with all its inherent benefits.

Philips Compact Disc provides a frequency response that is essentially flat from 20 to 20,000 Hz with a channel separation of better than 90 dB. The signal-to-noise ratio and dynamic range are an incredible 90 dB as compared to the 60 dB currently available on conventional discs. In addition, the Philips player replaces the conventional stylus with an aluminum-GaAs laser, thus eliminating disc wear, surface hiss, clicks, turntable rumble, room vibration and pickup-arm resonances. Considering the elimination of the stylus, another application for the player would be in automotive sound systems.

The Philips player will be introduced in the United States by Marantz. The software, always a sticky point when introducing a new format, will not be handled by Marantz. When questioned about the software, Marantz's only comment was that "Philips has already taken the software problem into consideration." Considering the tremendous power of the Philips organization, we'll venture a guess that the software won't be a problem. Interestingly, within the past few weeks, Matsushita has also embraced the Philips system.

Perhaps this revolutionary new consumer product will be introduced without the standardization problems that have plagued the industry of late. But don't let your hopes rise too high—there are two other systems: the AHD capacitive disc system from JVC, and a mechanical groove-type system from Telefunken.



ART KLEIMAN
Managing Editor

Hugo Gernsback (1884-1967) founder
M. Harvey Gernsback, editor-in-chief
Larry Steckler, CET, publisher
Arthur Kleiman, managing editor
Josef Bernard, K2HUF, technical editor
Carl Laron, WB2SLR, assistant editor
Jack Darr, CET, service editor
Leonard Feldman
contributing high-fidelity editor
Karl Savon, semiconductor editor
Herb Friedman, communications editor
Gary H. Arlen, contributing editor
David Lachenbruch, contributing editor
Earl "Doc" Savage, K4SDS, hobby editor
Ruby Yee, production manager
Robert A. W. Lowndes, production
associate
Joan Burwick, production assistant
Gabriele Margules, circulation director
Arline R. Fishman,
advertising coordinator

Cover photo by Robert Lewis

Radio-Electronics is indexed in *Applied Science & Technology Index* and *Readers Guide to Periodical Literature*.

Gernsback Publications, Inc.
200 Park Ave. S., New York, NY 10003
President: M. Harvey Gernsback
Vice President: Larry Steckler
Secretary/Treasurer: Carol A. Gernsback

ADVERTISING SALES 212-777-6400

Larry Steckler
Publisher

EAST

Stanley Levitan
Radio-Electronics
200 Park Ave. South
New York, NY 10003
212-777-6400

MIDWEST/Texas/Arkansas/Okla.

Ralph Bergen
The Ralph Bergen Co.
540 Frontage Road—Suite 361-A
Northfield, Illinois 60093
312-446-1444

PACIFIC COAST

Mountain States
Marvin Green
Radio-Electronics
413 So. La Brea Ave.
Los Angeles, Ca 90036
213-938-0166-7

SOUTHEAST

Paul McGinnis
Paul McGinnis Company
60 East 42nd Street
New York, N.Y. 10017
212-490-1021



EAST COAST

ΩMEGA Sales Co.
12 Meeting St.
Cumberland, RI 02864
1-401-722-1027

1-800-556-7586



WEST COAST

ΩMEGA Sales Co.
3533 Old Conejo Rd. #102
Newbury Park, CA 91320
1-805-499-3678
CA. TOLL FREE 1-800-322-1873

1-800-235-3581

SPECIAL OF THE MONTH



**ATARI 800 32K & EPSON MX-80 PRINTER
w/ INTERFACE & CABLE**

BOTH FOR \$1449

**with ATARI 810 DISK DRIVE
with LEEDEX/AMDEK COLOR-1 13" MONITOR
COMPLETE SYSTEM \$2,222**

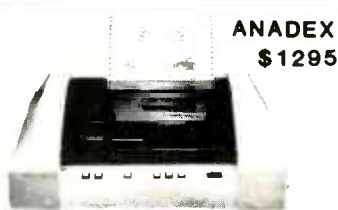

**ANADEX
\$1295**

**DIABLO 630
\$2145**

**Tractor option
\$245**

**NEC 12"
MONITOR
\$229**

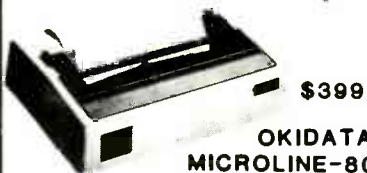

**OKIDATA
MICROLINE-80**

**ATARI 800 32K \$779
EPSON MX-80 \$CALL**

- WE ACCEPT C.O.D.'S
- NO SURCHARGE FOR CREDIT CARD ORDERS
- ALL EQUIPMENT FACTORY FRESH W/MFT.WRNTY.
- STOCK SHIPMENTS SAME DAY OR NEXT
- NO HIDDEN CHARGES!!!

INTERTEC SUPERBRAIN 64K RAM	\$2849
QD SUPERBRAIN	\$3195
NEC 5510 SPINWRITER	\$2595
NEC 5530 SPINWRITER	\$2595
OKIDATA MICROLINE-80	\$ 399
OKIDATA MICROLINE-82	\$ 529
OKIDATA MICROLINE-83	\$ 799
APPLE II PLUS 48K	\$CALL
APPLE DISK w/3.3 DOS Controller	\$CALL
APPLE DISK w/o Controller	\$CALL
BASE II PRINTER	\$ 599
HAZELTINE 1420	\$ 799
NORTHSTAR HORIZON II 32K QD	\$2975
ANADEX DP-9500	\$1295
TELEVIDEO 912C	\$ 669
TELEVIDEO 920C	\$ 729
TELEVIDEO 950	\$ 959
CBM 8032 COMPUTER	\$1475
CBM 8050 DISK DRIVE	\$1449
CBM 4032 COMPUTER	\$1090
CBM 4040 DISK DRIVE	\$1090
CBM 4022	\$ 679
CBM VIC-20	\$ 289
CBM C2N	\$ 85
RADIO SHACK II 64K	\$3245
RADIO SHACK III 16K	\$ 839
LEEDEX/AMDEK 100	\$ 139
LEEDEX/AMDEK 100G	\$ 169
LEEDEX/AMDEK COLOR-1 13" Color Monitor	\$ 349
MICROTEK 16K RAMBOARD for ATARI	\$ 99.95
MICROTEK 32K	\$ 165
ATARI 400 16K	\$ 349
ATARI 825 PRINTER	\$ 619
ATARI 850 INTERFACE	\$ 139
or both together	\$ 749
ATARI 810 DISK DRIVE	\$ 449
(Call for price list of ATARI software)	

PRICES ARE SUBJECT TO CHANGE WITHOUT NOTICE.

 **EAST COAST / WEST COAST** 
ΩMEGA SALES COMPANY

CIRCLE 34 ON FREE INFORMATION CARD

MUSIC TV CHANNELS

"MTV: The Music Channel" will go into service as a 24-hour all-music circuit August 1 on Satcom 1 Transponder 11. The Music Channel will be programmed by Warner-Amex Satellite Entertainment Co., the same people who operate The Movie Channel and Nickelodeon aboard that bird. The program package will include varying pop visual and audio features, using a backbone of "video records"—videotaped performances by popular recording artists. Many performers are creating innovative video shorts (including computer-generated graphics, animation, and other styles) as promotions for their latest records—and, of course, Warner Records, a cousin company of WASEC, is one of the largest record companies in the U.S.

"The Music Channel" will be advertiser-supported and offered free to cable-TV operators. Each hour on the channel will contain about eight minutes of commercials.

TWO ANIK BIRDS IN ORBIT

Anik A-2 and A-3 Canadian satellites are now orbiting next to each other in an effort to improve capacity of Telesat Canada's facilities. Each bird has 12 transponders and the co-location will provide greater flexibility of service until Anik D with 24 circuits is launched in August 1982 and Anik C (16 channels) goes into orbit next year. The move of Anik A-2 to a new slot at 114° west longitude took more than a month and involved a drift of 5300 kilometers. The two birds are now actually located a distance of about 90 meters, or about the length of a football field, apart from each other.

COMSTAR D-4 IN ORBIT

Comstar D-4 is expected to have gone into service May 1, according to the schedule which has been progressing ever since the newest domestic satellite was launched in mid-February. The 24-transponder bird, located at 127° west longitude, will be able to reach all 50 states and Puerto Rico with its beams. AT&T and GTE Satellite Corp. expect to use the newest Comstar satellite primarily for telephone, data, and other communications services they provide—although some of the circuits will be turned over to video as part of a plan to integrate them with the existing terrestrial network.

The new Comstar supplements the two original Comstar birds, which are still in service. Those older satellites will soon be co-located at 95° west longitude and operated as a single satellite in order to reduce their power load and conserve their batteries, thereby extending the life of the two birds.

\$900 AGILE RECEIVER

Automation Techniques Inc. has sold more than 1,000 of its *GLR 500* frequency-agile satellite receivers priced at \$899 each. The device includes an imageless mixer design that eliminates image-frequency noise or interference and also includes a separate remote tuning module so that it can be located near the LNA. A hot carrier FET clamp avoids black "key streaks" on weak signals or vertical blanking tilt of diode-transistor clamps. For more information, write: ATI, 1486 North 106th East Ave., Tulsa, Oklahoma 74116.

MODULAR SATELLITE PRODUCTS

Downlink Inc. is selling what it calls the first "modular satellite TV" system—aiming to become "the Apple Computer of satellite TV." The package includes a compact control console with receiver mounted at the antenna, a 12-foot spherical antenna, 120° LNA, feedhorn and rotor with bracket assemblies, and 100-foot cables with connectors. Downlink Inc. is a subsidiary of Black & White Enterprises Ltd, PO Box 33, Putnam, CT 06260.

AROUND THE SATELLITE CIRCUIT

"The Independent Producer's Handbook of Satellite Communications," a 128-page guide to program distribution via satellite, has been published by the National Endowment for the Arts. The handy \$3 reference volume includes substantial background material about satellite usage, although its primary emphasis is on how program producers and distributors can use satellites to expand their reach. The book is available from the Association of Independent Video and Filmmakers, 625 Broadway, New York, NY 10012, or the American Film Institute, Kennedy Center, Washington, DC 20566.

Western Union has asked the FCC for permission to launch a sixth Westar satellite, scheduled for orbit after 1982. The new bird would be a high-powered satellite with about 3.5 times the radiated power of current satellites and a footprint covering the entire continental U.S. as well as Hawaii and Alaska.

Rick's Video Service (Davis, California; 916-758-2623) has prepared a videocassette on how to install a private earth station, including site preparation and construction, according to Richard Walton.

GARY ARLEN
CONTRIBUTING EDITOR

**PHILIPS KNOWS
HOW TO SUCCEED
IN BUSINESS.
THEY JUST BOUGHT
SYLVANIA ECG.**

SYLVANIA RECEIVING TUBES SYLVANIA PICTURE TUBES
SYLVANIA ECG® SEMICONDUCTORS SYLVANIA SPECIAL PRODUCTS
SYLVANIA DATA DISPLAY TUBES

Philips ECG, Inc.

A NORTH AMERICAN PHILIPS COMPANY

letters

CABLE-TV MONOPOLIES

In his letter in the February **Radio-Electronics**, Richard Johnson makes some mistakes. The first is denying that cable-TV companies are monopolies. He points out that there are hundreds of cable-TV companies (forgetting that there are also hundreds of telephone companies) and seems to think that that is relevant.

It isn't. You can only buy telephone service, or cable-TV service, from one of the hundreds of companies that exist. That is what "monopoly" means: one seller. Each company has its own franchise area, and no one else in that area is allowed to sell to you. You have no choice; the fact that other companies exist, and that you might prefer what some of them have to offer, means nothing. Nor does the fact that many of the companies are not connected to each other have anything to do with it. Where you are, there's only one cable-TV source, and "monopoly" is exactly the right word to describe the situation.

Mr. Johnson also speaks of compatibility and quality-control problems. He seems to think that those things do not show up in the transmit-receive telephone network, but only in the receiver-only cable-TV systems. Wrong; they do. **JAMES E. HENDERSON**,
New York, NY

PROJECTION TV

Your brief item in the "Looking Ahead" section of the March 1981 **Radio-Electronics** on projection TV overlooks one major U.S. manufacturer: Heath.

Our Healthkit Model GR-4000 projection TV was introduced in 1979, and we are proud of its pioneering improvements in performance. We were the first manufacturer to use the brighter F 1.0 lenses—a major improvement in picture quality. That, combined with a wider IF bandwidth (required for quality projection), internal UHF/VHF splitter, and direct inputs and outputs for video and audio, have made the model GR-4000 a popular set.

As with so many other things, small, in-

novative companies like Heath have made advances in the past that larger companies are beginning to adopt only now. We certainly don't mind that, but we hope that you and your readers will remember where some of those good ideas came from originally.

MIKE ROCKWELL,
TV and Audio Product Manager,
Heath Company, Benton Harbor, MI

NOISE-REDUCTION

Perhaps Mr. Joseph M. Gorin, author of the article, "Noise-Reduction Techniques" in your February issue, was unaware of our Source Noise Suppressor; or perhaps he thought that we were no longer in business. At all events, he did not mention our device.

If I may, I'd like to bring you and him up to date on this system, which is far more effective than any other in the presence of severe surface noise, tape noise, and FM noise. It was designed (in 1975) to be effective with the very high degree of surface noise that is characteristic of

SPECIAL THIS MONTH

SPECIAL PRICE
GOOD UNTIL
7/31/81

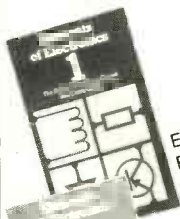

ELEMENTS OF ELECTRONICS.
Book I The simple electronic circuit & components. Regular price \$5.75

This month ONLY \$5.25

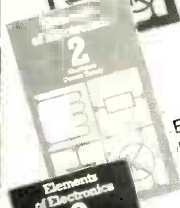

ELEMENTS OF ELECTRONICS.
Book II Alternating current theory. Regular price \$5.75

This month ONLY \$5.25



ELEMENTS OF ELECTRONICS.
Book III Semiconductor technology. Regular price \$5.75

This month only \$5.25

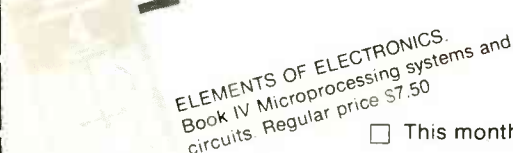

ELEMENTS OF ELECTRONICS.
Book IV Microprocessing systems and circuits. Regular price \$7.50

This month ONLY \$7.00

**SPECIAL OFFER—SAVE THE MOST
THE ENTIRE SET—ALL FOUR VOLUMES.**
Regular price \$24.75
This month only
\$19.95 Save \$4.75!!

This month ONLY \$19.95
Postpaid

Electronics Paperback Books

Quality Paperbacks at Affordable Prices

To order from this ad: Check off the books you want. Total the prices. Add in shipping. NY State residents add Sales Tax. Total it up, enclose your check and mail.

- Power Supply Circuits \$4.00
- Single IC Projects \$3.95
- IC 555 Projects (Expanded Edition) \$4.50
- Electronic Test Equipment Construction \$4.50
- 1st Book of Hi Fi Loudspeaker Enclosures \$3.25
- Handbook Of IC Audio Preamp and Power Amp Construction \$3.25
- 50 Circuits Using Germanium Silicon and Zener Diodes \$3.50
- Practical Computer Experiments \$4.75
- Power Supply Projects \$4.95
- Digital IC Equivalents and Pin Connections \$7.50
- Linear IC Equivalents and Pin Connections \$7.50
- Popular Electronic Circuits, Book 1 \$4.95
- Digital IC Projects \$4.95
- Popular Electronic Projects \$3.50
- Electronic Music and Creative Tape Recording \$3.50
- Projects In Opto Electronics \$3.50
- Electronic Games \$4.50

ELECTRONIC TECHNOLOGY TODAY INC. 7/81
17 Slate Lane, Central Islip, NY 11722

Price of Books
Sales Tax (NY State Residents only)

Shipping and Handling
(60c 1 or 2 books. 25c each add.)

TOTAL

Name

Address

City State Zip

LIMITED TIME OFFER

Order these RCA technical books to make VCR servicing easier and get **THREE FOR THE PRICE OF ONE**



RCA Technical Training on the very latest State-of-the-Art Video Cassette Recorders VHS

Model VET250/450/650 Technical Manual

Electronic systems and circuits employed in these microprocessor-controlled RCA VCR's are analyzed and described. Simplified block diagrams, circuit descriptions and recommended troubleshooting procedures are provided for each mode of operation. Includes a section on the VET650 remote control system and double speed, slow motion, freeze frame and frame advance special effects. Another section deals with basic digital logic operation and symbols. 280 pages (8½" X 11") in a durable vinyl covered three-ring binder. . . . **\$24.95**

Special Offer



If your order is received within the next 30 days we will ship two Workshop Training Manuals at no charge with your VET250/450/650 Technical Manual. VCR Workshop 4 — Servicing The VDP150 Video Cassette Recorder has condensed theory of operation explanations and step-by-step procedures for servicing this portable VCR. The RCA Models VCT201 and VCT400 are reviewed in the VCR Workshop 3 Manual. Each of these training books has a catalog price of \$4.50 but they will be sent to you free when you order the VET250/450/650 Technical Manual.

TO QUALIFY FOR THE TWO FREE WORKSHOP TRAINING MANUALS, MAIL WITHIN THE NEXT 30 DAYS

Yes!

I want to take advantage of this special offer. Send me the VET250/450/650 Technical Manual and two Workshop Training Manuals. Enclosed is my check for **\$24.95**.

8106RE

RCA

THIS IS YOUR SHIPPING LABEL — PLEASE PRINT

NAME _____

STREET ADDRESS _____

CITY _____ STATE _____ ZIP _____

Mail To: RCA Technical Publications I-450, 600 N. Sherman Dr. Indianapolis, IN 46201

shellac 78-rpm records, reproduced with flat (unequalized) treble; and it works very well, with a bare minimum of audible side effects. None of the products described in your article come near its performance in that respect. As you would expect, given its ability to cope with such massive noise, it is almost totally unobtrusive (much more so than the others) with modern source material.

Source Engineering products do not have wide distribution, but we're making the products; and among those who know of them, they're regarded much more highly than the dynamic-filter and notch-filter types.

We've been quiet lately because of other things, such as a line of psychological test instruments that we make. And

we've learned that our particular point of view, which is that of the dedicated music lover, isn't a good match for the typical dealer or what he sees as his typical customer. But we're a long way from being dead!

C. F. KERRY GAULDER,
Source Engineering,
Wilmington, MA

OOOOOOPS!

When the April issue of *Radio-Electronics* arrived, my brother and I happened to be trying to interface the AY-3-8910 programmable sound generator to our 8080A, and found your article helpful in getting it working. However, I noticed an error in Table 1 of the article. The "BC1" and "BC2" labels on the columns are reversed.

The chips won't be enabled correctly if those lines are confused.

JOHN FILION

RELATIVISTIC MASS REAFFIRMED

I was astonished to see the letter by Marty Nagel, M.S. (Physics) entitled "Einstein Not Contradicted" in your May 1981 "Letters" department. Mr. Nagel's attempted refutation of my letter on charged capacitor contradiction in the January issue is not only pseudoscientific and unbelievable; he even contradicts the letter's heading by rejecting the relativistic variation of mass!

There are, indeed, "special relativity considerations which must be applied to the electromagnetic fields of the capacitor", as he says—but they have *no connection* with my paradox.

Mr. Nagel's belief that there is no such thing as relativistic mass can only be considered a personal eccentricity. He claims it to be an "ubiquitous misconception" that mass increases relativistically. He says: "...mass does not vary with speed...it is the observed momentum that becomes infinite at the speed of light...No reputable physicist today would consider the mass of an object to increase with speed."

That should be news to physicists, physics students, and authors of books on relativity. Mr. Nagel further cited a reference that he had misinterpreted. A basic equation of special relativity for the variation of mass with speed is

$$m' = m / \sqrt{1 - v^2/c^2}$$

It can be found in any relativity book. The equation for the relativistic "observed momentum" is that equation above, multiplied by v . Yes, the "observed momentum" does become infinite at light speed—but why? Because (you guessed it, reader) the mass part of the equation becomes infinite. (Sorry about that, Mr. Nagel, but that's the way it is.)

ANTHONY HANS KLOTZ,
Babylon, NY

NON-STANDARD "STANDARDS"

I liked your editorial, "Non-Standard Standards" (*Radio-Electronics*, April), showing how the consumer has lost in the electronics battles of the recent past.

Regarding the new videodisc systems: I shall wait patiently until the winner is obvious, and continue to use my RCA VHS VCR system until then.

However, I'd like to say that I did purchase a 4-channel system (Panasonic) and really enjoyed it for many years. The 4-channel turntable gave me some trouble, and rather than continue to pour money into it, I purchased a direct-drive turntable (Panasonic). That is excellent, and just as useful as the other, because my amplifier has the unique feature of taking 2-channel sound and converting it to 4-channel sound whenever I desire. I was told by a salesman that my system is now quite rare. Thus, I feel that I was *not* a loser after the 4-channel craze died down.

I think that RCA will win out in the present-future videodisc battle.

I really enjoy your magazine; keep up the good work.
GABRIEL CURTIS, MD.
New York, NY

R-E

How To Stand Out In A Crowd Of Imitators:

BE THE ORIGINAL

...and the ORIGINAL in tongue and groove pliers is CHANNELLOCK. We invented this style of plier. We improved it with patented undercut, can't slip adjustments. Improved it again with the patented stress resisting flange. Developed ten styles and sizes from 4 1/2" to 16".

All of which is why tongue-n-groover's by any other name can't match CHANNELLOCK, the original. Besure THAT trademark is on the pliers you buy.

CHAN NEL LOCK

CHANNELLOCK, INC. • Meadville, Pennsylvania 16335
Meet The Rest Of The Family. Send For Our Free Catalog.

CIRCLE 13 ON FREE INFORMATION CARD

equipment reports

B+K Precision Model 2845 DMM



CIRCLE 101 ON FREE INFORMATION CARD

ONE OF THE NICEST HANDHELD DIGITAL MULTIMETERS on the market today is the *model 2845* recently introduced by B+K Precision division of the Dynascan Corporation (6460 W. Cortland St., Chicago, IL 60635). This compact meter incorporates several features usually found in higher-priced units as well as the usual functions and ranges found on DMM's in its price range.

A four-bit microprocessor makes it possible to offer autoranging on this low-priced and compact meter. Autoranging allows the *model 2845* to select automatically the range that will offer the greatest resolution, regardless of whether resistance, voltage, or current is being measured. There is also an Auto-Skip feature that allows the meter to switch immediately to the 200-volt range if the initial input is in excess of 25 volts. That feature lets the *model 2845* select the range more quickly by not having to switch through more than two voltage ranges. The range can also be locked by the operator when desired. That will reduce the delays usually inherent in DMM's. Overrange is indicated on the display by blanked digits and flashing decimal points.

A large (half-inch) 3½-digit LCD readout features high contrast for easy viewing under most lighting conditions. Resolutions of 1 millivolt, 1 microamp, and 1 ohm are possible with a basic accuracy of 0.1%. The accuracy will vary with the function and range and the user should consult the instruction book regarding the specific accuracy for each case.

Resistances between one ohm and 19.99 megohms are measured over five ranges. The meter will automatically select the resistance range offering the highest resolution. When turned on, the *model 2845* will automatically switch to the lowest range. The meter may be

locked into that range (or any other) if desired. A continuous tone lets you check low-resistance paths without looking away from your work. The tone (buzzer) will sound whenever the circuit resistance measures less than 179 ohms and when the *model 2845* is locked on the lowest resistance range. Since the tone will not

sound if the resistance is greater than 179 ohms, it is especially useful in finding intermittents such as a break in a microphone lead and/or connector. Flexing the wires at the suspected point will silence the buzzer at the first indication of the break. There will be no reason to look away from your work to know that the

GET TO KNOW COMPUTERS

Introduce yourself to the world of computers. Speak their language, feel their sensors and get to know them inside and out. FutureTec 180® is a complete Z-80 base computer developed by electronic educators and is all you need to get started in the fast-growing world of computers. This is a hands-on, user oriented computer now offered at the special introductory price of \$225.

FutureTec 180 can open doors for you into a world of scientific data that is as far reaching as space itself. How do computers think? What is a memory device? What is address decoding to peripheral devices? Answers to these questions and many more are covered in our easy step-by-step home instruction manual.

Our FutureTec 180 computer includes a spacious mahogany case with built-in power supply and reserve capabilities for external application. Powerful Concept® software monitor system and full on-board display section with tone indicator for audio-visual reinforcement makes learning easier. Automatic scrolling is included plus telephone-type keyboard for ease of operation. Execution of your program can be stopped any time, memory address or registers can be changed and your program can be continued with single key stroke. In fact 25 keyboard functions like data search, computing and tracing jump relatives and hardware testing facilities makes a truly user friendly operating system.

Experience a 180° turn in your career — send today for your FutureTec 180 computer.

SPECIFICATIONS

Z-80 CPU (Central Processing Unit)
Advanced Machine Language
Concept Software Monitor
Clock Frequency 2MHz
1K x 8 RAM
2716, 2K ROM
Regulated Power Supply 5V @ 1.2 amp
Dual Transistor Display Drivers
High Brightness LED's
40 Pin Edge Connectors for Expansion & Peripherals
Fully Expandable
12¼" Wide x 10¼" Long x 3½" High

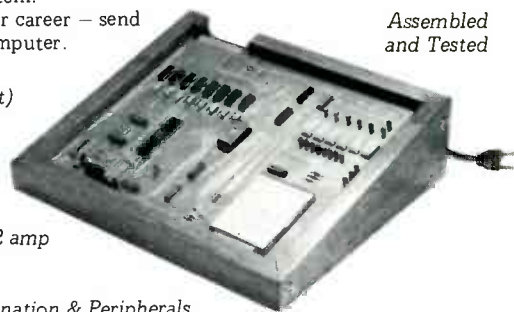
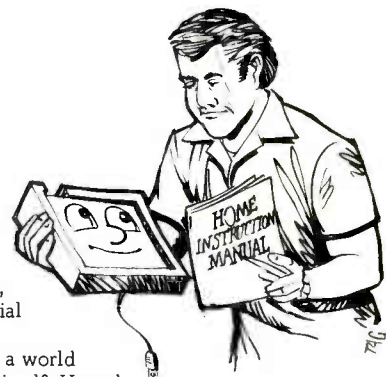

Assembled and Tested

National Users Association

FUTURETEC180

To order call 216-961-4041 or write P.O. Box 5784, Cleveland Ohio 44101
Price \$225 each Personal Check Cashiers Check/Money Order

VISA MasterCard (Bank No _____)
Acct No _____ Exp Date _____
Signature _____
Name (print) _____ Address _____
City _____ State _____ Zip _____

Allow 4 to 6 weeks for delivery.

break has been discovered.

Voltages between .001 volts DC and 1000 volts DC in four ranges and AC voltages from .001-volt up to 750 volts RMS, also in four ranges, can be measured. AC-range accuracy on the 2-20-volt range is from 1/2% at 50 Hz to 2% at 1 kHz, ± 3 LSD. Currents, both AC and DC, from .001 mA up to 1999 mA can be checked using the *model 2845*. Internal RF shielding contributes to the accuracy of the readings when the unit is operated in the presence of strong RF fields. All ranges are protected against overloads and mistakes in function- or scale selection. In most cases, the most serious damage that will be experienced will be a blown fuse.

A minus sign on the display indicates when the voltage measured is negative. Other display features include a resistance-range indicator

and a low-battery warning. The low-battery warning lets you know when only 20% of the battery-life remains.

For safety, the front panel jacks are designed to prevent accidental user contact. B+K Precision offers a full line of accessories for the *model 2845* including a battery eliminator for bench use. A carrying case is also available as an option.

A complete instruction manual is supplied with the *model 2845*. It includes operating instructions, complete specifications, a schematic diagram, and service- and user maintenance information. There is also a list of authorized service agencies.

All things considered, we are impressed with the *model 2845*. It does everything that's claimed and, aside from the "thinking time" delays that are inherent in all DMM's (and

especially ones with autoranging), we found it fun to use.

The *B+K Precision model 2845* has a list price of \$175.00. **R-E**

Nevcom Model CM-100 Wireless Microphone



CIRCLE 102 ON FREE INFORMATION CARD

"AN IDEA WHOSE TIME HAS COME" would appropriately describe the Nevcom *model CM-100 Magic Mike*. With a trend toward product portability and miniaturization, a cordless microphone is most appealing.

The *model CM-100* is actually an FM transmitter operating in the new 49-MHz (license-free) band. An FM receiver plugs into the existing microphone jack on a base-station radio to receive the signals from the microphone and cause them to be retransmitted.

The unit we tested had an operating range of at least 40 feet from a base-station radio, but that distance will probably decrease under adverse conditions, such as when the unit has to energize a radio from outside a vehicle.

Many applications for this device come to mind. For example, an emergency medical team or law-enforcement officer can use the little mike to key up a powerful mobile unit rather than rely on a bulkier low-power (and much more expensive) hand-held transceiver. Several wireless mikes could be carried by different people, any one of whom could operate the mobile (or base-station) equipment by remote control.

The units are lightweight, low-cost, and are powered by an inexpensive 9-volt battery (not included). The circuits are well designed and the component layout is professional.

Earlier units had some problems, all of which are now corrected. The operating range was very limited—a few feet at best. According to a Nevcom spokesman, that was done to assure compliance with FCC restrictions on radiation limits. Fortunately, the range of the newer units is considerably better without exceeding FCC restrictions.

Early units also suffered from an echoic audio quality; it sounded as if the user were talking from inside a barrel. That was because of a problem in the size of the mike element, but now the sound is crisp and clear.

The wireless mike and matching receiver are shipped in a tough cardboard container, and some mounting hardware is included. The receiver unit requires a 12-volt source—normally the car battery in a mobile installation. A microphone plug (not included) connects the transceiver and the *model CM-100* receiver. The unit comes with a booklet that shows microphone pin arrangements for the majority of CB radios, and a companion sheet provides some tips on installation and adjustment. After reading the instructions, we felt that it would be extremely difficult for an inexperienced user to install the wireless receiver. A technician's services should be sought by a non-tech-



Design of Digital Systems—six volumes

Designing Digital Systems

Two programmed learning courses:
hardware and software; theory
and application.

ADVANCED COURSE DESIGN OF DIGITAL SYSTEMS

Six large-format volumes — each 11 1/2" x 8 1/2"

CONTENTS

The contents of Design of Digital Systems include:

Book 1: Octal, hexadecimal and binary number systems; representation of negative numbers; complementary systems; binary multiplication and division.

Book 2: OR and AND functions; logic gates; NOT, exclusive-OR, NAND, NOR and exclusive-NOR functions; multiple input gates; truth tables; DeMorgan's Laws; canonical forms; logic conventions; Karnaugh mapping; three-state and wired logic.

Book 3: Half adders and full adders; subtractors; serial and parallel adders; processors and arithmetic logic units (ALUs); multiplication and division systems.

Book 4: Flip-flops; shift registers; asynchronous counters; ring, Johnson and exclusive-OR feedback counter; random access memories (RAMs); read-only memories (ROMs).

Book 5: Structure of calculators; keyboard encoding; decoding display data; register systems; control unit; program ROM; address decoding; instruction sets; instruction decoding; control program structure.

Book 6: Central processing unit (CPU); memory organization; character representation; program storage; address modes; input/output systems; program interrupts; interrupt priorities programming; assemblers; executive programs; operating systems, and time-sharing.

OUR CUSTOMERS

Design of Digital Systems has been bought by more than half the 50 largest corporations in America, and by Motorola, Intel, DEC, National Semiconductor, Fairchild, General Instrument, Hewlett-Packard, Heath Co., M.I.T., NASA, Smithsonian Institute, Bell Telephone Labs. And many, many more, as well as corporations and individuals in over 50 countries.

BASIC COURSE



Digital Computer Logic & Electronics

CONTENTS

Digital Computer Logic and Electronics is designed for the beginner. No mathematical knowledge other than simple arithmetic is assumed, though you should have an aptitude for logical thought. It consists of 4 volumes — each 11 1/2" x 8 1/2" — and serves as an introduction to the subject of digital electronics.

Contents include: Binary, octal and decimal number systems; conversion between number systems; AND, OR, NOR and NAND gates and inverters; Boolean algebra and truth tables; DeMorgan's Laws; design of logical circuits using NOR gates; R-S and J-K flip-flops; binary counters, shift registers and half-adders.

NO RISK GUARANTEE

There's absolutely no risk to you. If you're not completely satisfied with your courses, simply return them to CLI within 30 days. We'll send you a full refund, plus return postage.

TAX DEDUCTIBLE

In most cases, the full cost of CLI courses can be a tax deductible expense.

PHONE ORDERS - FREE

To order by phone, call (617) 664-3657 with your credit card information. It won't cost you a dime, because we'll deduct the cost of your call from the price of the courses you order.

TO ORDER BY MAIL

You may use the order form below if you wish, but you don't need to. Just send your check or money order (payable to Cambridge Learning, Inc.) to the address below. If you don't use the order form, make sure your address is on your check or the envelope, and write "DDS" (Design of Digital Systems), "DCL" (Digital Computer Logic & Electronics), or "both" (both courses) on your check.

Mass. Residents add 5% sales tax. We pay all shipping costs.

We also accept company purchase orders.

AIR MAIL

The prices shown include surface mail postage anywhere in the world. Air mail postage costs an extra \$10 for both courses (10 volumes).

DISCOUNTS

Call or write for details of educational and quantity discounts, and for dealer costs.

SAVE \$5

If you order both courses, you save \$5. Order at no obligation today.

To: Cambridge Learning Inc., 1 Judith Drive, North Reading, MA 01864	
Please send me	
<input type="checkbox"/> Sets of Design of Digital Systems	\$19.95 \$
<input type="checkbox"/> Sets of Digital Computer Logic & Electronics	\$14.95 \$
<input type="checkbox"/> Sets of both courses	\$29.90 \$
Enclosed is check/money order (payable to Cambridge Learning Inc.) for total \$	
NAME	
ADDRESS	
CITY/STATE/ZIP	

CAMBRIDGE LEARNING Inc.

1 Judith Drive
North Reading,
MA 01864

Call (617) 664-3657 to
order by phone—free.

7 days, 24 hours

- Order free by phone
- MasterCard/VISA
- No shipping charges
- Money-back guarantee
- Tax deductible
- Save \$5

CIRCLE 49 ON FREE INFORMATION CARD

nical user. We have been assured that the manual is being revised. In the meantime prospective buyers should be aware of the shortcomings in the instructions.

All in all, performance was better than expected. The freedom of movement (as well as the novelty) was quite a pleasure. Since the *model CM-100* receiver can be adjusted for microphone audio level, modulation can be controlled, providing some possible signal improvement. (Be sure not to *overmodulate*, however!)

The *model CM-100* wireless microphone sells for \$44.50 and is available from Nevcom, 3360 S. Decatur Avenue, Las Vegas, NV 89102. **R-E**

Hamtronics Out-Of-Band Converters



CIRCLE 103 ON FREE INFORMATION CARD

ONE OF THE MOST FREQUENT COMPLAINTS about scanners among their users is the scanner's restricted frequency ranges. A great deal of communication takes place outside the frequency limits of programmable scanners.

Hamtronics, well known for its amateur

accessories, has developed a series of six out-of-band converters designed to extend the frequency range of programmable scanners. The *model CVR72* covers 72-76 MHz. The other models in the series are the *model CVR135* (135-144 MHz), the *model CVR216* (216-225 MHz), the *model CVR240* (240-270 MHz), the *model CVR400* (400-420) MHz, and the *model CVR806* (806-894 MHz).

The units require 12-volts DC at 30 mA, and power may be taken from the rear DC receptacle found on most scanners used for mobile operation. (Modern scanners equipped for both fixed and mobile operation have a rear-apron quick-disconnect jack for 12-volt power. When the scanner is plugged into an AC receptacle, unregulated DC (12-20 volts) appears at that jack. Although the DC is well filtered, voltage will fluctuate with the accessory load. Normally, loads of 100 mA or so may be taken from this point without overheating the scanner's power-supply components. Under load, voltage may vary from 12-16 volts.)

While subtle variations exist among the various models, UHF circuit-features that are common to all the converters include shielded coils, double-sided epoxy PC boards, low-noise microwave RF transistors, and double-balanced mixers. The circuitry is enclosed in an all-metal cabinet for optimum shielding.

Conversion gain varies somewhat from model to model, but on the 135-144 MHz version, for example, center-frequency gain (138 MHz) is approximately 10 dB, dropping to 0 dB (unity gain) at the band edges.

The converters operate by translating the incoming signals to frequencies that fall within the bands commonly found on programmable scanners. These typically include high-band

(150-174 MHz) and UHF (420-512 MHz).

We discovered that while the converters functioned quite satisfactorily, metropolitan users should expect some IF feedthrough from users of the scanner conversion frequencies. For example, while listening to 400-420 MHz signals, some interference from 152-153 MHz mobile-telephone tones may be expected. A good tunable filter helps stubborn cases.

The Hamtronics converters are equipped with chassis-mount BNC low-loss connectors. A special version of the converters featuring Motorola connectors is also available. The modified converters may be ordered at no additional cost from Grove Enterprises, Brass-town, NC 28902.

The out-of-band converters have a suggested selling price of \$79.97 each. From Hamtronics, 65F Moul Rd., Hilton, NY 14468. **R-E**

Sony Model ICF-2001 Receiver



CIRCLE 104 ON FREE INFORMATION CARD

WHILE NEWS OF A PORTABLE MULTIBAND radio is generally nothing to get excited about, this new product from Sony (9 West 57th

MRO solid state problems?

1,400 RCA SK Series +3,500 JEDEC* Devices

4,900 MRO Solutions

To fill your solid state replacement needs — for MRO/industrial and consumer applications — see your RCA Distributor for copies of the 1981 RCA MRO Replacement Manual (1K6804) and the 1981 RCA SK Replacement Guide (SPG-202Z).

For a list of RCA Distributors, write to Sales Promotion Services, RCA Distributor and Special Products Division, 2000 Cements Bridge Road, Deptford, N.J. 08096.



For MRO/
industrial applications
Make replacements from your
RCA Distributor's shelf with 3,500 RCA
JEDEC and RCA commercial types.

For MRO/industrial and
consumer applications
1,400 SK replacements for more than
170,000 domestic and foreign types.



*Joint Electron Device Engineering Council

RCA SK Replacement Solid State

CIRCLE 48 ON FREE INFORMATION CARD

Street, New York, NY 10019) is an exception.

About the size of a cassette recorder, the *model ICF-2001* is a radical departure from other low-cost consumer radios. The new receiver features direct frequency selection (using a keypad) and an LCD readout. Continuous-coverage reception from 150 kHz-30 MHz (AM/CW/SSB) and 76-108 MHz (FM) is provided by a microprocessor-controlled superheterodyne circuit featuring double conversion below 30 MHz. The *model ICF-2001* uses up-conversion (66.35 MHz first IF) to eliminate primary images. An all-FET front end reduces intermodulation, cross-modulation, and spurious signal generation.

A frequency-calibrated BFO control lets you adjust CW/SSB signal-tone for best listening. Stable CW and SSB reception is

assured by a drift-free, quartz-crystal, phase-locked-loop frequency synthesizer.

Among the more innovative features is a six-channel memory, allowing the user to program his six favorite frequencies for instant recall. Automatic scanning with programmable limits is another of the receiver's features.

The absence of tuning knobs can be disconcerting to the veteran who is used to tuning across the dial of a general-coverage receiver, but after a few minutes of use, the keyboard will win over even the most stalwart sceptic! Rapid or slow tuning is a snap.

While the *model ICF-2001* does not have an S-meter, a five-step LED light-bar is used as a SIGNAL STRENGTH indicator. Antenna-circuit peaking is accomplished with a thumbwheel control.

A custom crystal filter provides medium selectivity in order to accommodate broadcast listening as well as monitoring of narrow-band communications. Although, Sony does not publish detailed specifications, bench tests are revealing.

Our lab tests

While RF selectivity varied somewhat throughout the shortwave spectrum, average sensitivity appeared to be approximately 1 microvolt.

The IF selectivity on our sample was -6 dB at 6 kHz and -60 dB at 17.5 kHz. That makes it a little broad for serious communications use, but, then, the *model ICF-2001* is not intended for that.

Slow or fast tuning and scan-rate control can be adjusted for 1-kHz or 10-kHz steps below 30 MHz, scanning either up or down in frequency. On the FM-band the scan rate can be in 100 kHz or 200 kHz steps.

While the receiver will operate on either AC or batteries, batteries are required for the microprocessor circuit. The RF, IF, and audio circuitry draw quite a bit of current, limiting continuous battery operation to a few hours before the batteries must be replaced.

The audio circuit provides rich, crisp sound even when driving the built-in 4-inch speaker. Audio output is 1.6 watts. Frequency response is adjusted by separate bass and treble controls.

The custom-LCD displays a variety of information to the user including frequency in kilohertz (megahertz on FM), numbers of preset channels in use, scanning-limit indicators, a TRY AGAIN message in response to improper commands, and a sleep-timer setting indicator. The display is backlit for visibility at night.

General comments

We were very impressed with the performance of the *model ICF-2001*. Even with the built-in telescoping whip antenna, worldwide reception of both broadcast and utilities communications was very good. Frequency drift was virtually non-existent, and frequency readout was accurate to within 1 kHz.

With an outside antenna, reception improved tremendously. Surprisingly, no problems with strong-signal overload were encountered below 30 MHz although some users have reported FM-band overload problems in metropolitan areas.

The Sony *model ICF-2001* has a suggested retail price of \$329.95. **R-E**

Hear there and everywhere.



Easy tuning, digital display, professional quality

R-1000

The R-1000 is an amazingly easy-to-operate, high-performance, communications receiver, covering 200 kHz to 30 MHz in 30 bands. This PLL synthesized receiver features a digital frequency display and analog dial, plus a quartz digital clock and timer.

R-1000 FEATURES:

- Covers 200 kHz to 30 MHz continuously.
- 30 bands, each 1 MHz wide.
- Five-digit frequency display with 1-kHz resolution and analog dial with precise gear dial mechanism.
- Built-in 12-hour quartz digital clock with timer to turn on radio for scheduled listening or control a recorder through remote terminal.
- Step attenuator to prevent overload.
- Terminal for external tape recorder.
- Tone control.
- Built-in 4-inch speaker.

- Three IF filters for optimum AM, SSB, CW, 12-kHz and 6-kHz (adaptable to 6-kHz and 2.7-kHz) for AM wide and narrow, and 2.7-kHz filter for high-quality SSB (USB and LSB) and CW reception.

- Dimmer switch to control intensity of S-meter and other panel lights and digital display.

- Effective noise blanker.

- Wire antenna terminals for 200 kHz to 2 MHz and 2 MHz to 30 MHz. Coax terminal for 2 MHz to 30 MHz.

- Voltage selector for 100, 120, 220, and 240 VAC. Also adaptable to operate on 13.8 VDC with optional DCK-1 kit.

OPTIONAL ACCESSORIES:

- SP-100 matching external speaker.
- HS-5 and HS-4 headphones.
- DCK-1 modification kit for 12-VDC operation.



KENWOOD

TRIO-KENWOOD COMMUNICATIONS INC.
1111 WEST WALNUT / COMPTON, CA 90220

Osborne/McGraw-Hill Some Common BASIC Programs



CIRCLE 105 ON FREE INFORMATION CARD

PERSONAL-COMPUTER OWNERS HAVE AN overwhelming selection of pre-recorded soft-



Get up-to-the-minute weather reports from your own Heathkit Digital Weather Computer.

Heathkit imagination applied to micro-processor electronics brings you a personal weather computer that monitors current weather, keeps track of changes and stores past data – and pushes it all at your fingertips.

Just push a button to get:

- Indoor and outdoor temperatures in Fahrenheit or Celsius
- Wind speed, both average and gusts, in mph, kph or knots
- Wind direction
- Barometric pressure and rate of change
- Wind chill factor
- Time and date

Memory stores highs and lows and the times they occurred. Data remains in memory for as long as you want, ready to be recalled at the push of a button.

Handsome solid walnut console adds

a touch of class to any home. Weather information is relayed to the console from a special transmitter that mounts on your TV antenna mast.



The transmitter features a unique infrared sensing device for greater sensitivity and accuracy. A special piezo resistive silicon bridge transducer senses the slightest changes in barometric pressure. For serious weather research, the Heathkit Digital Weather Computer can interface with chart recorder or digital computer.

Fun to build: Like all Heath electronic kits, the Digital Weather Computer comes with its own easy-to-follow assembly manual that guides you step-by-step through every phase of assembly. Anyone can do it. The Digital Weather Computer is also available completely assembled and tested.



Free Catalog

Complete details and price on the Digital Weather Computer are in the new Heathkit Catalog, along with descriptions of nearly 400 electronic kits for your home, work or pleasure. Send for your free catalog today or pick one up at your Heathkit Electronic Center.*

Heathkit®

* Visit your Heathkit Electronic Center where Heathkit Products are displayed, sold and serviced. See your telephone white pages for the location nearest you. Heathkit Electronic Centers are units of Veritechnology Electronics Corporation.

Write to Heath Company, Dept. 020-794, Benton Harbor, MI 49022
CIRCLE 10 ON FREE INFORMATION CARD

www.americanradiohistory.com

FOR ONLY \$129.95 Learn Computing From The Ground Up

Build a Computer kit that grows with you, and can expand to 64k RAM, Microsoft BASIC, Text Editor/Assembler, Word Processor, Floppy Disks and more.

EXPLORER/85

Here's the low cost way to learn the fundamentals of computing, the all-important basics you'll need more and more as you advance in computer skills. For just \$129.95 you get the advanced-design Explorer/85 motherboard, with all the features you need to learn how to write and use programs. And you can grow into a system that is a match for any personal computer on the market. Look at these features: 8085 Central Processing Unit, the microprocessor "heart" of the Explorer/85. (Join the millions who will buy and use the 8080/8085 this year alone). Four 8-bit, one 6-bit input/output ports from which you can input and output your programs as well as control exterior switches, relays, lights, etc. a cassette interface that lets you store and reload programs you've learned to write. . . . deluxe 2,000 byte operating system/monitor makes it easy to learn computing in several important ways. • It allows simpler, faster writing and entering of programs • It permits access by you to all parts of the system so you can check on the status of any point in the program. • It allows tracing each program step by step with provision for displaying all the contents of the CPU (registers, flags, etc.) • . . . and it does much more!

You get all this in the starting level (Level A) of the Explorer/85 for only \$129.95. Incredible! To use, just plug in your 8VDC power supply and terminal or keyboard/display — if you don't have them, see our special offers below.

- Level A computer kit (Terminal Version) . . . \$129.95 plus \$3 P&I.*
- Level A kit (Hex Keypad/Display Version) . . . \$129.95 plus \$3 P&I.*

LEVEL B — This "building block" converts the motherboard into a two-slot S100 bus (industry standard) computer. Now you can plug in any of the hundreds of S100 cards available.

- Level B kit . . . \$49.95 plus \$2 P&I.*
- S100 bus connectors (two required) . . . \$4.85 each, postpaid.

LEVEL C — Add still more computing power; this "building block" mounts directly on the motherboard and expands the S100 bus to six slots.

- Level C kit . . . \$39.95 plus \$2 P&I.*
- S100 bus connectors (five required) . . . \$4.85 each, postpaid.

LEVEL D — When you reach the point in learning that requires more memory, we offer two choices: either add 4k of a memory directly on the motherboard, or add 16k to 64k of memory by means of a single S100 card, our famous "JAWS".

- Level D kit. (CHECK ONE) . . . 4k on-board . . . \$49.95 plus \$2 P&I.* 16k S100 "JAWS" . . . \$149.95 plus \$2 P&I.* 32k S100 "JAWS" . . . \$199.95 plus \$2 P&I.* 48k S100 "JAWS" . . . \$249.95 plus \$2 P&I.* 64k S100 "JAWS" . . . \$299.95 plus \$2 P&I.*

LEVEL E — An important "building block" it activates the 8k ROM/EPROM space on the motherboard. Now just plug in one 8k Microsoft BASIC or your own custom programs.

- Level E kit . . . \$5.95 plus 50¢ P&I.*
- Microsoft BASIC** — It's the language that allows you to talk English to your computer! It is available three ways: 8k cassette version on Microsoft BASIC (requires Level B and 12k of RAM minimum, we suggest a 16k S100 "JAWS" — see above) . . . \$64.95 postpaid.
- 8k ROM version of Microsoft BASIC (requires Level B & Level E and 4k RAM, just plug into your Level E sockets. We suggest either the 4k Level D RAM expansion or a 16k S100 "JAWS") . . . \$99.95 plus \$2 P&I.*
- Disk version of Microsoft BASIC (requires Level B, 32k of RAM, floppy disk controller, 8" floppy disk drive) . . . \$325 postpaid.

TEXT EDITOR/ASSEMBLER — The editor/assembler is a software tool (a program) designed to simplify the task of writing programs. As our programs become longer and more complex, the assembler can save you many hours of programming time. This software includes an editor program that enters the programs you write, makes changes, and saves the programs on cassettes. The assembler performs the clerical task of translating symbols in code into the computer-readable object code. The editor/assembler program is available either in cassette or a ROM version.

- Editor/Assembler (Cassette version, requires Level B and 8k (min) of RAM — we suggest 16k "JAWS" — see above) . . . \$59.95 plus \$2 P&I.*
- Editor/Assembler (ROM version, supplied on an S100 card, requires Level B and 4k RAM (min) — we suggest either Level D or "JAWS") . . . \$99.95 plus \$2 P&I.*

8" FLOPPY DISK — A remarkable "building block." Add our 8" floppy disk when you need faster operation, more convenient program storage, perhaps a business application, and access to the literally thousands of programs and program languages available today. You simply plug them into your Explorer/85 disk system — it accepts all IBM-formatted CP/M programs.

- 8" Floppy Disk Drive . . . \$499.95 plus \$12 P&I.*
- Floppy Controller Card . . . \$199.95 plus \$2 P&I.*
- Disk Drive Cabinet & Power Supply . . . \$69.95 plus \$3 P&I.*
- Drive Cables (set up for two drives) . . . \$25.00 plus \$1.50 P&I.*

CP/M 2.2 Disk Operating System, includes Text Editor/Assembler, dynamic debugger, and other features that give your Explorer/85 access to thousands of existing CP/M-based programs . . . \$150.00 postpaid.

NEED A POWER SUPPLY? Consider our AP-1. It can supply all the power you need for a fully expanded Explorer/85 (note: disk drives have their own power supply). Plus the AP-1 fits neatly into the attractive Explorer steel cabinet (see below).

- AP-1 Power Supply kit (8V @ 5 amps) in deluxe steel cabinet . . . \$39.95 plus \$2 P&I.*

NEED A TERMINAL? We offer you choices: the least expensive one is our Hex Keypad/Display kit that displays the information on a calculator-type screen. The other choice is our ASCII Keyboard/Computer Terminal kit that can be used with either



1. Plug in Netronics's Hex Keypad/Display
2. Add Level B in convert to 8. Add your own custom circuits (prototyping area)
3. Add 4k RAM
4. Plug in Level F here: accepts Microsoft BASIC or Editor/Assembler in ROM
5. Add two S100 boards
6. Add your own custom circuits (prototyping area)
7. Connect terminal

a CRT monitor or a TV set (if you have an RF modulator)

- Hex Keypad/Display kit . . . \$69.95 plus \$2 P&I.*
- ASCII Keyboard/Computer Terminal kit featuring a full 128 character set, 10k1 case, full cursor control, 75 ohm video output, convertible to baud output, selectable baud rate, RS 232-C or 20 ma I/O, 32 or 64 character by 16 line formats . . . \$149.95 plus \$3 P&I.*

- Steel Cabinet for ASCII Keyboard/Terminal . . . \$19.95 plus \$2.50 P&I.*
- RF Modulator kit (allows you to use your TV set as a monitor) . . . \$8.95 postpaid.
- 12" Video Monitor (10MHz bandwidth) . . . \$139.95 plus \$5 P&I.*
- Deluxe Steel Cabinet for the Explorer/85 . . . \$49.95 plus \$3 P&I.*
- Fan for cabinet . . . \$15.00 plus \$1.50 P&I.*

ORDER A SPECIAL-PRICE EXPLORER/85 PAK — THERE'S ONE FOR EVERY NEED.

- Beginner Pak (Save \$26.00) — You get Level A (Terminal Version) with Monitor Source Listing (\$25 value) AP-1, 5-amp power supply, Intel 8085 Users Manual. . . (Reg. \$186.95) SPECIAL \$169.95 plus \$4 P&I.*
- Experimenter Pak (Save \$53.40) — You get Level A (Hex Keypad/Display Version) with Hex Keypad/Display, Intel 8085 User Manual, Level A Hex Monitor Source Listing, and AP-1, 5-amp power supply. . . (Reg. \$279.95) SPECIAL \$219.95 plus \$6 P&I.*
- Special Microsoft BASIC Pak (Save \$103.00) — You get Levels A (Terminal Version), B, D (4k RAM), E, 8k Microsoft in ROM, Intel 8085 User Manual, Level A Monitor Source Listing, and AP-1, 5-amp power supply. . . (Reg. \$439.70) SPECIAL \$329.95 plus \$7 P&I.*

ADD A ROM-VERSION TEXT EDITOR/ASSEMBLER (Requires Levels B and D or S100 Memory) . . . \$99.95 plus \$2 P&I.*

Starter 8" Disk System — Includes Level A, B floppy disk controller, one CDC 8" disk drive, two-drive cable, two S100 connectors, just add your own power supplies, cabinets and hardware . . . (Reg. \$1065.00) SPECIAL \$999.95 plus \$13 P&I.* 32k Starter System, \$1045.95 plus \$13 P&I.* 48k Starter System, \$1095.95 plus \$13 P&I.* 64k Starter System, \$1145.95 plus \$13 P&I.*

Add to any of above Explorer steel cabinet, AP-1, five amp power supply, Level C with two S100 connectors, disk drive cabinet and power supply, two sub-D connectors for connecting your printer and terminal. (Reg. \$225.95) SPECIAL \$199.95 plus \$13 P&I.*

Complete 64k System, Wired & Tested . . . \$1650.00 plus \$26 P&I.*

Special! Complete Business Software Pak (Save \$625.00) — Includes CP/M 2.2 Microsoft BASIC, General Ledger, Accounts Receivable, Accounts Payable, Payroll Package. . . (Reg. \$1325) SPECIAL \$699.95 postpaid.

*P&I stands for "postage & insurance." For Canadian orders, double this amount.

Continental Credit Card Buyers Outside Connecticut:
TO ORDER
Call Toll Free: 800-243-7428
To Order From Connecticut, or For Technical Assistance, call (203) 354-9375

★ (Clip and mail entire ad) ★

SEND ME THE ITEMS CHECKED ABOVE

Total Enclosed (Conn. Residents add sales tax): \$ _____ Paid by:

Personal Check Cashier's Check/Money Order

VISA MASTER CARD (Bank No. _____)

Acct. No. _____ Exp. Date _____

Signature _____

Print Name _____

Address _____

City _____

State _____ Zip _____

DON'T FORGET

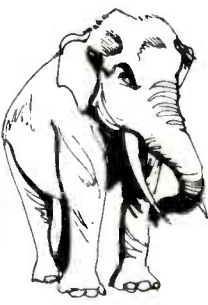

USE YOUR READER SERVICE CARD

For faster service

USE ZIP CODE

on all mail

ware from which to choose. Even so, *Some Common BASIC Programs* from Osborne/McGraw-Hill would be a useful addition to almost anyone's software library.

This cassette tape for the Commodore PET computer is based on the 76 programs contained in the book of the same name by Lon Poole and Mary Borchers.

To begin with, the idea of 76 programs on one tape is quite unusual. The programs are labelled with numbers corresponding to the pages where their description and listings are found in the source text. Originally tested on the Wang 2200 computer, the programs have been modified to run on the PET. The changes consist mostly of adjustments to scale the CRT display of some programs for the PET's 40-character line size. Apparently because of the general intent to make those programs machine independent, graphics are avoided except for the plotting routines that use universally available characters.

Computer hobbyists interested in any of the programs will find the absence of the pain of entering and debugging the programs well worth the tape's purchase price. The tape format also encourages you to try programs that may at first not seem to be your cup of tea.

The tape will give you a fast start toward justifying the expense of your machine. In particular, the math section is very helpful. The programs cover topics ranging from simple algebra and geometry through complex chi-square distributions and Nth-order regression. One program will solve a large set of simultaneous equations.

Other areas covered include finance, the home, and "general interest." Financial and math programs are by far in the majority.

The financial programs calculate mortgage amortization tables and the future values of an investment. Recipe-cost calculations, an alphabetizing routine, and a day-of-the-week program round out the collection.

The map check program, for example, takes the measurements found on a deed (angles, length of side, etc.) and calculates the land area. The day-of-the-week program may be useful to biorhythm enthusiasts who want to create something more complicated, using that program as the starting point.

Studying the programs will expand the knowledge of the beginning and intermediate level BASIC programmer. The purchasers should also seriously consider buying the book since it contains sample runs, suggestions, and remark statements that have been eliminated from the taped programs.

Some Common BASIC Programs—also available for the TRS-80—is recommended to intermediate-level computer hobbyists and to others who want a handy source of problem-solving routines. It sells for \$15 and is available at local computer stores, or directly from the publisher, Osborne/McGraw-Hill, 630 Bancroft Way, Berkeley, CA 94710. R-E

Support the
March of Dimes
BIRTH DEFECTS FOUNDATION

NETRONICS Research & Development Ltd.
333 Litchfield Road, New Milford, CT 06776

Sabtronics.

An entire range of low-cost, top-quality instruments.

Sabtronics revolutionized the market with the first low-cost, high-performance Digital Multimeter. Now we have an entire range of outstanding instruments in a reasonable range of prices. In fact, nobody can beat us in our price/performance ratio. And we can sell at a low price for some very good reasons. Our engineers design high performance products to be built at a low cost. And we refuse to stick on high mark ups. Plus we make sure your price stays low by selling directly to you. Because we sell so many instruments, we don't have to charge a high price. Naturally, we also offer all the helpful accessories you might want. And all our products are under warranty for good quality and high performance. In addition, you get from us the same quality aftersale service as any high priced instrument manufacturer. With Sabtronics instruments available, there's no need for you to spend a lot of money to do highly accurate testing and measuring.

2010A 3½ Digit LED DMM
 2015A 3½ Digit LCD DMM
 8610A 600 MHz 8-Digit Frequency Counter
 8110A 100 MHz 8-Digit Frequency Counter
 5020A 1Hz to 200k Hz Function Generator
 8000B 1 GHz 9-Digit Frequency Counter
 8610B 600 MHz 9-Digit Frequency Counter
 2035A 3½ Digit LCD Handheld DMM
 2037A 3½ Digit LCD Handheld DMM

* price in kit form. Also available factory assembled, tested, and calibrated. Call us for prices.

** price fully assembled, tested, and calibrated.

Call us for more information:
 (813) 623-2631 (9am to 5pm EST)

Making Performance Affordable

sabtronics 
 INTERNATIONAL INC.

5709 N. 50th Street Tampa, FL 33610

JULY 1981

25



A. 2010A — \$99.00*, B. 2015A — \$119.00*, C. 8610A — \$119.00*, D. 5020A — \$129.00**, E. 8000B — \$239.00**, F. 2035A — \$79.00*, G. 2037A — \$99.95*

Prices subject to change without notice.

**Learning
electronics
is no picnic.**



**At any level it
takes work and
a few sacrifices.
But with CIE,
it's worth it.**

Whoever said, "The best things in life are free," was writing a song, not living a life. Life is not just a bowl of cherries, and we all know it.

You fight for what you get. You get what you fight for. If you want a thorough, practical, working knowledge of electronics, come to CIE.

You can learn electronics at home by spending just 12 hard-working hours a week, two hours a day. Or, would you rather go bowling? Your success is up to you.

At CIE, you *earn* your diploma. It is not handed to you simply for putting in hours. But the hours you do put in will be on your schedule, not ours. You don't have to go to a classroom. The classroom comes to you.

Why electronics training?

Today the world depends on technology. And the "brain" of technology is electronics. Every year, companies the world over are finding new ways to apply the wonders of electronics to control and program manufacturing, processing...even to create new leisure-time products and services. And the more electronics applications there are, the greater the need will be for trained technicians to keep sophisticated equipment finely tuned and operating efficiently. That means career opportunities in the eighties and beyond.

Which CIE training fits you?

Beginner? Intermediate? Advanced? CIE home study courses are designed for ambitious people at all entry levels. People who may have:

1. No previous electronics knowledge, but do have an interest in it;
2. Some basic knowledge or experience in electronics;
3. In-depth working experience or prior training in electronics.

You can start where you fit and fit where you start, then go on from there to your Diploma, FCC License and career.

Many people can be taught electronics.

There is no mystery to learning electronics. At CIE you simply start with what you know and build on it to develop the knowledge and techniques that make you a specialist. Thousands of CIE graduates have learned to master the simple principles of electronics and operate or maintain even the most sophisticated electronics equipment.

CIE specializes exclusively in electronics.

Why CIE? CIE is the largest independent home study school that specializes exclusively in electronics. Nothing else. CIE has the electronics course that's right for you.

Learning electronics is a lot more than memorizing a laundry list of

facts about circuits and transistors. Electronics is interesting! It is based on recent developments in the industry. It's built on ideas. So, look for a program that starts with ideas and builds on them. Look to CIE.

Programmed learning.

That's exactly what happens with CIE's Auto-Programmed® Lessons. Each lesson uses famous "programmed learning" methods to teach you important principles. You explore them, master them completely, before you start to apply them. You thoroughly understand each step before you go on to the next. You learn at your own pace.

And, beyond theory, some courses come fully equipped with electronics gear (the things you see in technical magazines) to actually let you perform hundreds of checking, testing, and analyzing projects.

Experienced specialists work closely with you.

Even though you study at home, you are not alone! Each time you return a completed lesson, you can be sure it will be reviewed, graded and returned with appropriate instructional help. When you need additional individual help, you get it fast and in writing from the faculty technical specialist best qualified to

answer your question in terms you can understand.

CIE prepares you for your FCC License.

For some jobs in electronics, you must have a Federal Communications Commission (FCC) License. For others, some employers tend to consider your license a mark in your favor. Either way, your license is government-certified proof of your knowledge and skills. It sets you apart from the crowd.

More than half of CIE's courses prepare you to pass the government-administered exam. In continuing surveys, nearly 4 out of 5 graduates who take the exam get their licenses! You can be among the winners.

Associate Degree

Now, CIE offers an Associate in Applied Science Degree in Electronics Engineering Technology. In fact, all or most of every CIE Career Course is directly creditable towards the Associate Degree.

Today is the day. Send now.

Fill in and return the postage-free card attached. If some other ambitious person has removed it, cut out and mail the coupon. You'll get a FREE school catalog plus complete information on independent home study. For your convenience, we'll try to have a CIE representative contact you to answer any questions you may have.

Mail the card or the coupon or write CIE (mentioning name and date of this magazine) at: 1776 East 17th Street, Cleveland, Ohio 44114.

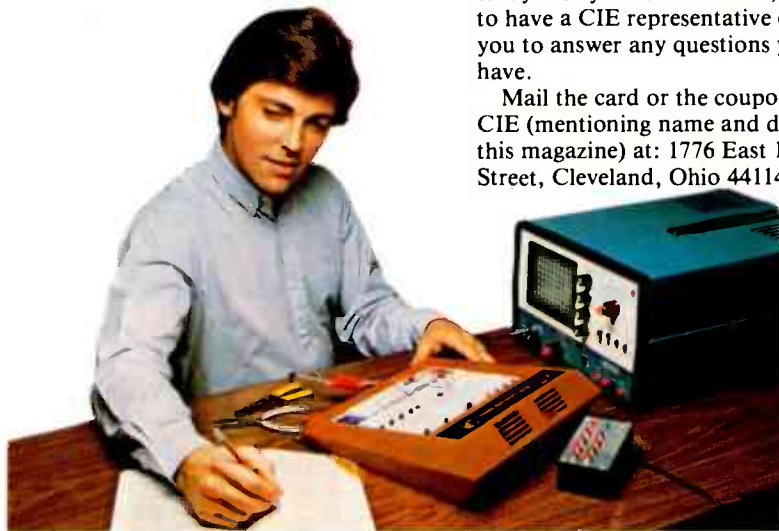

Pattern shown on oscilloscope screen is simulated.

CIE Cleveland Institute of Electronics, Inc.

1776 East 17th Street, Cleveland, Ohio 44114

Accredited Member National Home Study Council

YES... I want to learn from the specialists in electronics — CIE. Send me my FREE CIE school catalog... including details about the Associate Degree program... plus my FREE package of home study information.

Print Name _____

Address _____ Apt. _____

City _____

State _____ Zip _____

Age _____ Phone (area code) _____

Check box for G.I. Bill bulletin on Educational Benefits: Veteran Active Duty

MAIL TODAY!

RE-16

You can't beat The System.

The Experimentor System™ —a quicker transition from imagination through experimentation to realization.



Experimentor solderless breadboard.

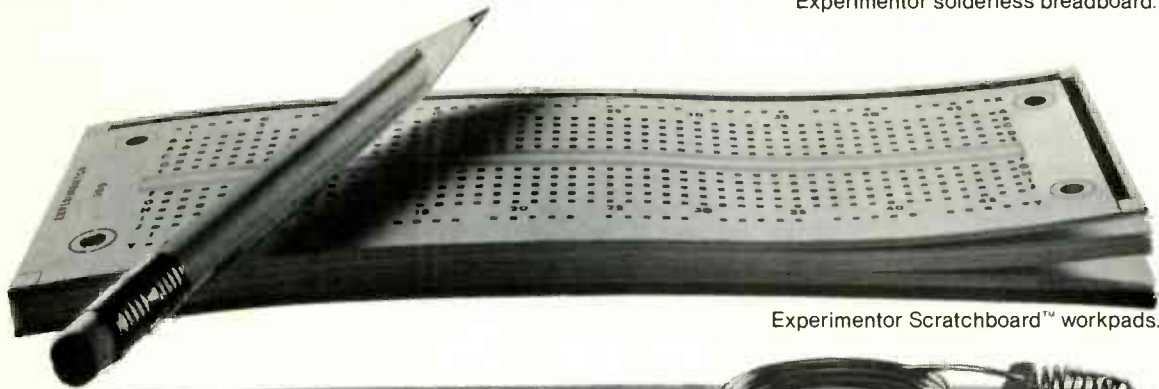

Experimentor Scratchboard™ workpads.



Experimentor Matchboard™ pre-drilled PCBs.

When you have a circuit idea that you want to make happen, we have a system to make it happen quicker'n'slicker'n ever before: The Experimentor System.

You already know how big a help our Experimentor solderless breadboards can be. Now we've taken our good idea one step farther. Twice.

We've added Experimentor Scratchboard workpads, with our breadboard hole-and-connection pattern printed in light blue ink. To let you sketch up a layout you already have working so you can reproduce it later.

With Experimentor Matchboard you can go from breadboard to finished nonstop! We've matched our breadboard pattern again, this time on a printed circuit board, finished and ready to build on. All for about \$2.70*.

There's even a letter-and-number index for each hole, so you can move from breadboard (where they're molded) to Scratchboard™ (where they're printed) to Matchboard™ (where they're silkscreened onto the component side) and always know where you are.

When you want to save time and energy, you can't beat The Experimentor System.

Smarter tools for testing and design.

70 Fulton Terr., New Haven, CT 06509 (203) 624-3103, TWX 710-465-1227
OTHER OFFICES: San Francisco (415) 648-0611, TWX 910-372-7992
Europe: Phone Saffron-Walden 0799-21682, TLX 817477
Canada: Len Finkler Ltd., Downsview, Ontario

**GLOBAL
SPECIALTIES
CORPORATION**

Call toll-free for details
1-800-243-6077
During business hours

*Suggested U.S. resale. Prices, specifications subject to change without notice. © Copyright 1981 Global Specialties Corporation.

CIRCLE 32 ON FREE INFORMATION CARD

NEW TECHNOLOGY

THE CORDLESS PORTABLE TELEPHONE IS one of the latest conveniences available for use in the home, business, or industry. It is portable and lets you take telephone calls while you are anywhere within 300 feet of the base telephone. Just think of the convenience and advantages of being able to answer the telephone while you are mowing the lawn or out shoveling snow.

Some of those little cordless telephone extensions are for incoming calls only. Other, more sophisticated, systems offer all the features of a full-service telephone. You can make calls as well as take them; you get push-button operation on any type of phone line—either *Touch-Tone* or rotary dialing. And in some of those units, the remote one has an automatic re-dial feature. You simply press a button and the internal memory recalls the last number entered and re-dials it automatically. Some, like the Rovafone *Rovette*, also have an intercom function.

The cordless telephone

The basic system consists of two parts; an AC-powered base unit that plugs into the telephone line and a hand-held portable unit that lets you answer your telephone from almost anywhere within a range of about 300

feet. The portable unit operates from rechargeable nickel-cadmium batteries that can be recharged by a charger built into the base unit.

The cordless telephone operates as a "low-power" device authorized under sections of Part 15 of the FCC Rules and Regulations. Modulation may be either AM or FM. Some systems have duplex operation (you talk and listen in a normal manner) while others use simplex operation—like CB and other two-way radio systems; push-to-talk, release-to-listen.

In addition to the voice transmissions, each cordless telephone unit transmits one or more control tones that perform such functions as bringing up dial tones, alerting the remote unit to an incoming call, and "hanging up the phone" when the call is completed.

The frequencies available for cord-

less telephones are four channels in the 1.6- to 1.8-MHz band (each 30 kHz apart) and five channels in the 49-MHz band. For example, the Radio Shack *model ET-300 DUOFONE* and the *Cobraphone model CP-155* (from the Dynascan Corporation) are pre-set at the factory to one of four channels. To provide duplex operation, each channel has one frequency in the 1.7-MHz band and one in the 49-MHz band. Base-station transmit-frequencies are 1.665, 1.695, 1.725, and 1.755 MHz while corresponding portable-to-base frequencies are 49.830, 49.845, 49.875, and 49.890 MHz. On the other hand, the *Freedom Phone* from Electra transmits and receives on the same frequency. One channel in the 49-MHz band is used.

In the *Muraphone* (Mura Corporation) series of cordless phones both base and remote units also transmit and

Cordless Telephones

If you've ever missed a telephone call because you were unable to reach your phone in time, you'll understand why cordless phones are so popular. Here's an in-depth look at how they work.

ROBERT F. SCOTT

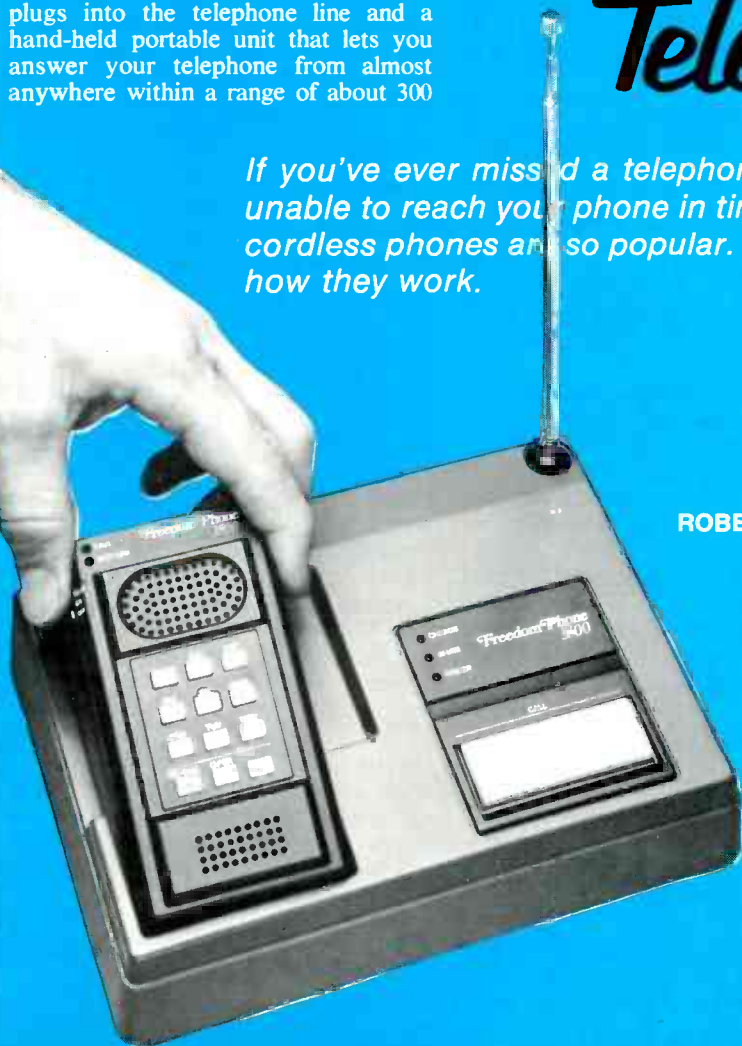

receive on the same radio frequency—49.860 MHz. The designers have developed a unique simplex system that gives the remote unit priority. The party using the portable telephone controls the functions of both stations.

Now, let's look at some of the unusual circuit applications in the Muraphones. The Muraphone Cordless Extension Telephone is available in two systems: the *MP-100/101* answer-only system and the *MP-300/301* full-feature dial-out system. The circuits covered here are those in the *MP-100/101*.

The *MP-101* base station connects to the telephone line and plugs into a standard 117-volt, 60-Hz AC outlet. The *MP-100* portable is a battery-powered hand-held unit small enough to fit into a pocket or clip onto a belt.

How the cordless phone operates

The *MP-100/101* system can be operated in three modes: 1) Answer-only telephone: The party with the portable unit can take calls but cannot make them. 2) The Intercom Mode permits the base and portable units to be used as a wireless intercom without interfering with normal telephone service. 3) in the Pager/Call Interceptor/Transfer mode, a person answering the regular telephone can transfer the call to the remote unit. The user in the house can "page" the remote, speak privately through the intercom to find out if the remote party will accept the call, and then transfer the call or hang up. (The outside caller is on "hold" and cannot hear the exchanges between the base and portable units.) The party in the house can stay on the line and make it a three-way conversation.

The base and portable units transmit on 49.860 MHz. To give the portable priority, a pulse oscillator in the base circuit is turned on when an incoming call is received or when the INTERCOM button is pressed. The oscillator supplies two 460-millisecond pulses each second, along with two 40-millisecond gaps. The base transmitter is on and its receiver is off when the 460-millisecond pulses are present. During the 40-millisecond gaps the base transmitter is off and its receiver is on.

An incoming call (or pushing the INTERCOM button) activates the base station. Its transmitter starts sending 460-millisecond bursts of 49-MHz RF, modulated by a 1000-Hz tone. That modulated signal is received by the portable unit and the user hears 1000-Hz "beeps." The person with the remote unit extends the collapsible antenna and presses the PUSH-TO-TALK button. A 49-MHz carrier, modulated by 7000-Hz, is transmitted by the remote and received by the base during the 40-millisecond periods that its receiver is active.

The 7000-Hz tone is fed to a 7000-Hz

decoder. As long as the decoder is receiving the 7000-Hz tone, it shorts the squarewaves from the pulse generator and locks the base unit in the receive mode. At the same time, the 7000-Hz tone actuates a relay. One set of relay contacts connects the 600-ohm winding of an audio transformer across the telephone line. That "picks up" the phone. The relay is latched by a second set of contacts.

As long as the PUSH-TO-TALK button is pressed, the user at the remote unit can talk to the calling party through the base unit. The remote's carrier is modulated simultaneously by speech and the 7000-Hz tone. The speech is detected, amplified, and fed to the telephone line through the audio transformer. The remote returns to the receive mode when the PUSH-TO-TALK button is released. The base no longer



THIS MODEL 3500 FREEDOM Phone from Electra is small enough to fit in a shirt pocket.

receives the 7000-Hz tone so the outside caller (or the person using the intercom function) can talk to the remote. The signal from the telephone line is fed through the audio transformer and an amplifier, and used to modulate the base's 49-MHz carrier. The short 40-millisecond gaps in the transmission are hardly noticeable.

At the end of the conversation, the person using the remote unit presses the LINE RELEASE button to "hang up" the phone. The remote unit's RF carrier is now modulated by a 4.5-kHz tone. That signal is received by the base during the 40-millisecond gap and applied to a 4.5-kHz tone decoder. The decoder output causes the relay to open and release the telephone line. The base is now standing by, ready for the next incoming call.

In the intercom mode of operation, the telephone is connected in series with the B+ supply across a winding of the line transformer. The carbon micro-

phone-element varies its resistance as the user speaks. That modulates the current flowing through the transformer winding. The speech voltage induced in the other transformer windings is used to modulate the base unit's RF carrier and is received at the remote unit. From here on, the operation is the same as with an incoming call.

Circuit analysis

Schematic diagrams of the *MP-100* remote and *MP-101* base are shown in Figs. 1 and 2, respectively. Refer to those diagrams as we discuss the circuits and their operations in greater detail. Let's start with the remote shown in Fig. 1.

The receiver section is a standard single-conversion superhet receiver with an RF amplifier, a crystal-controlled oscillator/mixer, and a two-stage IF circuit. When the PUSH-TO-TALK button is in the receive (R) position, any signal from the base unit is detected, amplified, and fed to the speaker through the lower secondary on T7, the audio output and modulation transformer.

When the PUSH-TO-TALK button is held down in the transmit (T) position, the 8-ohm loudspeaker is used as a microphone feeding the base circuit of amplifier Q5. After further amplification in the push-pull output stage, the speech signal appears in the upper secondary winding of the modulation transformer. At the same time, B+ voltage is applied directly to the transmit oscillator (Q12). The B+ for the RF final amplifier passes through the secondary of T7 so Q13's collector current is modulated by the audio signal. The modulated RF appears across tank coil L6 and is fed to the antenna through low-pass filter L1, L2, L3, C1, C2, and C3.

While the PUSH-TO-TALK button is in the transmit position, B+ is applied to the 7-kHz phase-shift oscillator (Q10) through diode D5. The 7-kHz tone is fed through a buffer to the primary of the driver transformer. After amplification, that 7-kHz signal modulates the RF output stage along with the speech. When the modulated signal reaches the base unit, the 7-kHz tone is decoded and used to latch the base in the receive mode.

When the conversation is over, the user releases the PUSH-TO-TALK button and presses the LINE RELEASE button on the portable phone. That applies operating voltage to the 4.5-kHz tone generator (Q9), buffer Q11, the transmit oscillator and final amplifier, and to the audio stages. The 4.5-kHz tone modulates the 49-MHz carrier and is used by the base to activate the line-release (hang-up) circuits.

Although the remote unit is in the receive mode, the receiver circuit is dis-

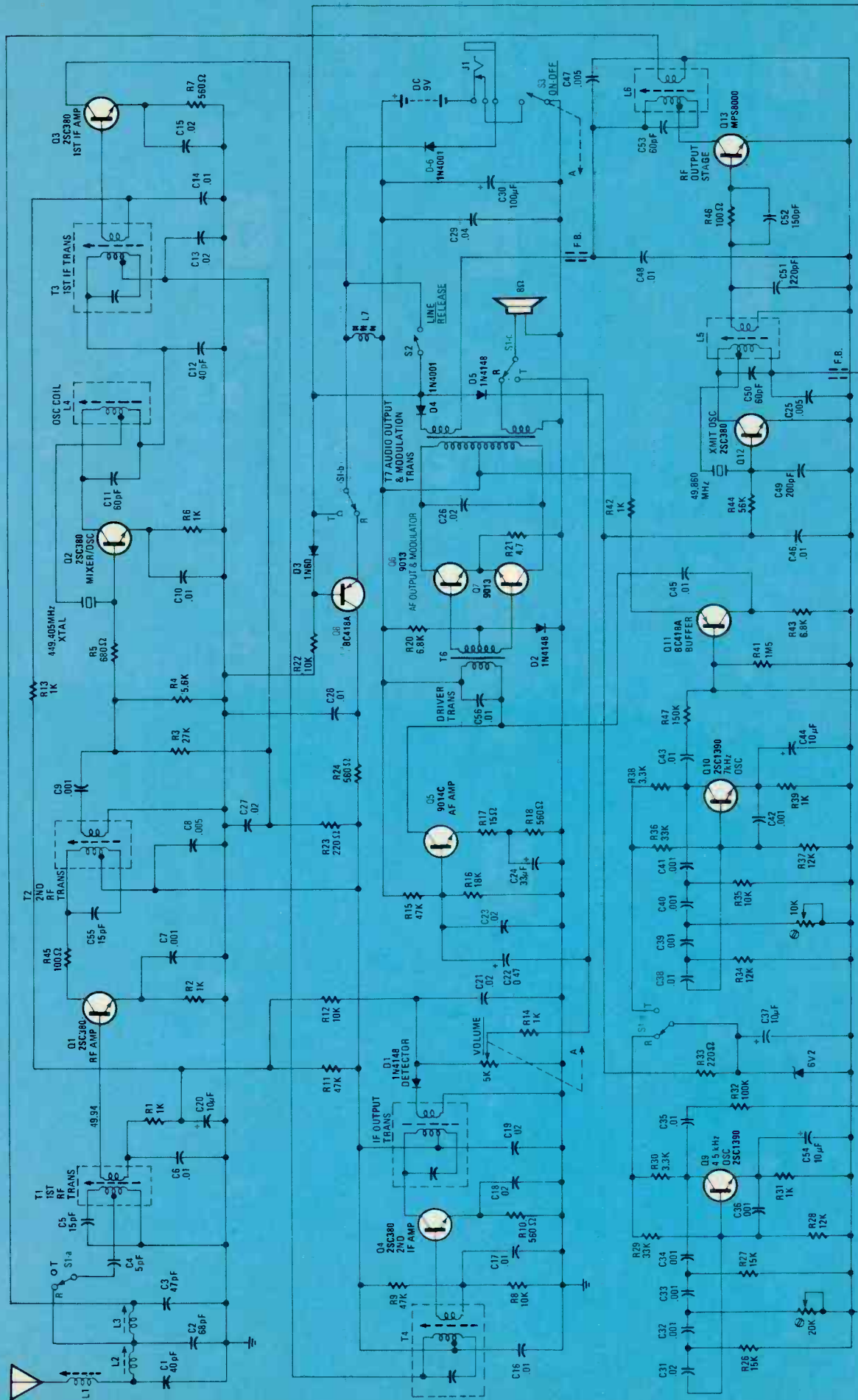

NOTE: S1 - PUSH-TO-TALK
 S2 - LINE RELEASE
 S3 - ON-OFF

FIG. 1—THE RECEIVER SECTION of the model MP-100 is a standard single-conversion superheterodyne receiver with an RF amplifier, a crystal-controlled oscillator/mixer, and a two-stage IF circuit.

abled by closing the LINE RELEASE switch. Normally, the entire receiver front-end (Q1 through Q4) is supplied with B+ through the emitter-collector section of Q8. (Note that Q8 is called "Line Release Switch" in Fig. 1.) Diode D3 is back-biased so Q8's base current cannot flow through to Q12 and Q13 in the transmitter RF circuits.

As the LINE RELEASE switch closes, Q8's base and emitter are tied together through D3, a germanium diode. The diode turns on. The voltage drop across D3's junction is less than the base-emitter junction voltage of Q8, a silicon transistor, so Q8 turns-off. That breaks the B+ path to the receiver RF and IF circuits.

The base circuits

Refer to Fig. 2 as you follow the details of circuits in the base unit. Power for the base is supplied from a 10-volt DC adaptor through Q18, a voltage regulator. No voltage is applied to most of the sections until the station is activated by an incoming phone call.

When the phone rings, a 20- to 60-Hz AC voltage appears on the telephone line. In the U.S. it ranges between 40 and 150 volts RMS riding on 52.5 volts DC. This voltage is tapped off the R and G terminals of the 4-prong modular plug and applied across neon lamp NE1 through R16 and a voltage-doubler circuit consisting of C13, D15, and D16. Light from the neon lamp is directed to photocell VR1, causing the photocell's resistance to drop. The initial resistance change produces a pulse through Q4, turning it on along with Q3 and Q2. Transistor Q2 saturates and supplies power throughout the base circuit as long as the ringing continues.

Pulse generator IC2 delivers two 460-millisecond positive pulses per second. Thus, there are two 40-millisecond gaps in the output each second. The 460-millisecond pulses turn on Q6, the electronic send-receive switch. The 40-millisecond gaps turn it off because the output of IC2 is at zero volts. Thus, when Q6 is on it supplies the base current necessary to turn on Q5, the 49-MHz transmitter oscillator. The oscillator drives the final RF amplifier (Q19). Any audio appearing at pin 5 of the LM386 modulator IC modulates Q19's collector current. The modulated RF signal is fed to the antenna through a low-pass filter network.

When the ring signal turns on Q2, B+ voltage for the 1-kHz oscillator (Q1) flows through the relay coil. The current drawn by Q1 is low and, since there is no path to ground, the relay remains unenergized. Full supply voltage—minus the small DC drop across the relay coil—is applied to the Q1 circuit. Its output modulates RF amplifier Q19 and the 1-kHz tone is heard in the portable unit to alert the user to the in-



BASE AND REMOTE units of the Cobra model CP-15S cordless telephone from Dynascan.

coming call.

When the send-receive switch (Q6) is turned on by the ring signal, it also biases on diodes D8 and D9, located between the emitters of the mixer and first IF amplifier in the receiver circuit. Heavy currents flow through emitter resistors R33 and R35 and develop voltages that bias Q10 and Q11 to cutoff. That is how the receiver is turned off while the base unit is transmitting the 1-kHz "ring" signal to the portable.

During the 40-millisecond gap, electronic switch Q6 is turned off, the RF transmit circuit is disabled, and the receiver is turned on.

When the user at the remote unit hears the 1-kHz beep, he answers by pressing the PUSH-TO-TALK switch. The remote then sends a 7-kHz tone to the base unit. That tone is received during one of the 40-millisecond periods that the receiver is turned on. The signal passes through the RF and IF circuits and the detector. The 7-kHz tone is recovered across R41 and R42 and processed by audio amplifiers Q13 and Q14.

The 7-kHz tone is fed from the emitter of Q14 to the inputs (pin 3) of the 7-kHz and 4.5-kHz tone decoders (IC4 and IC3) and to the base of buffer Q7. The outputs of IC3 and Q7 are not affected by the 7-kHz tone, but IC4's output pin (pin 8) is clamped to ground. Now, a DC path is completed through the relay, D4, and IC4 pin 8 to ground. That energizes the relay and closes its contacts. Contact RY2 connects the primary winding of the line transformer across the telephone line. That "captures" the line—in effect, picking up the receiver.

The ringing stops when the line is captured, so the power-on logic circuit (Q2, Q3, and Q4) is turned off and conversation can begin. Now that the bottom end of the relay coil is brought close to ground (via its connection through IC3), the voltage at this point is too low to keep Q1 oscillating. Therefore, the 1-kHz "ring" signal is cut off.

Finally, as relay contact RY1 closes, it supplies voltage through D5 to all the other circuitry in the base station, replacing Q2 as the current path. Contact RY1, in closing, also supplies a bias to Q8's base that turns the transistor on. Relay coil current now flows through Q8. So, as long as Q8 is conducting and



MURAPHONE MODEL MP-100 cordless extension telephone. This model is a receive-only unit.

CORDLESS TELEPHONES

For more information, circle the corresponding number on the Free Information card inside the back cover.

Dynascan Corporation
Cobra Communications
Product Group
6460 West Cortland St.
Chicago, IL 60635
CIRCLE NO. 96

Electra Company
300 East County Line Rd.
Cumberland, IN 46229
CIRCLE NO. 97

Fracom/Rovafone International
2130 W. Clybourn Street
Milwaukee, WI 53233
CIRCLE NO. 78

Mura Corporation
Westbury, NY 11590
CIRCLE NO. 98

Radio Shack
1400 North Tandy Center
Ft. Worth, TX 76102
CIRCLE NO. 99

contact RY1 remains closed, the relay remains energized and the line remains captured.

During the time that the 7-kHz tone is being received at the base unit—any time that the remote's PUSH-TO-TALK button is pressed—the ground potential at pin 8 of IC4 is connected through D7 to the base of Q6. Transistor Q6's base is thereby shorted to ground and Q6 is kept turned off. Thus, the base transmitter is off and the receiver is turned on for as long as the remote unit is transmitting.

Speech is transmitted from the portable unit along with the 7-kHz tone and is detected and fed to the same points as the tone. Speech signals do not affect the decoders. Buffer Q7 is an emitter-follower with a high-frequency roll-off (the 1- μ F capacitor and half the center-tapped winding of the line trans-

continued on page 72

NEGATIVE ION GENERATOR

A great amount of interest has been shown recently in negative-ion generators. Build one yourself and see how it benefits you.

RONALD E. PYLE

WITHIN THE LAST SEVERAL YEARS, negative-ion generators have found increasing popularity. Many benefits from exposure to negatively ionized oxygen have been claimed.* For example, some experimental evidence indicates that certain respiratory ailments can be alleviated: migraines, acute anxiety, and depression can be reduced or eliminated, and seriously burned patients can experience reduced pain and infection, and accelerated healing.

Physiologically, it has been found that in atmospheres containing an excess of *positive* ions, serotonin, a stress neuro-hormone that inhibits oxygen absorption in the body, is produced in the blood and carried throughout the circulatory system. An excess of serotonin can result in dizziness, inability to concentrate, fatigue, migraine, depression, and shortness of breath. Negative oxygen ions, on the other hand, cause the degradation of serotonin into a harmless by-product.

Because an oxygen molecule in air contains unpaired electrons it can readily accept an electron produced by natural or artificial means to become a relatively stable negative ion.

Negative oxygen ions can be produced efficiently and safely using the high-voltage corona-discharge method. High-voltage negative DC of approximately -6000 to -9000 volts is used to charge the tip of an emitting needle. That results in the production of a large quantity of electrons that are emitted at

high velocities from the tip due to the large accelerating potential. The relatively high-energy electrons that are released react with the oxygen molecules in the air to produce the desired negative oxygen ions.

How it works

Figure 1 shows a simple, low-cost circuit based on the high-voltage corona-discharge method. The NE555 is used in the astable mode. It produces a continuous squarewave at a frequency of approximately 40 Hz and duty cycle near 10% at pin 3. This square-wave output is then coupled through R3 to a Darlington transistor pair (Q1, Q2) that is used to switch the primary of a standard 12-volt three-terminal automobile-ignition coil.

The high-voltage, AC output from the ignition coil is then half-wave rectified by connecting it to the cathode of a 45,000-volt high-voltage diode assembly using standard high-voltage ignition wire. (Note the polarity of the diode carefully.) The resulting negative DC is then filtered by high-voltage capacitors C4, C5, and C6. A common sewing needle is used as the electron-emission source, and its blunt end is soldered to the anode end of the high-voltage diode assembly (often referred to as a stick diode).

In Fig. 2, a simple, unregulated, power supply for the negative-ion generator is shown. The output of power transformer T1 is half-wave rectified by D2, current limited by R5, and filtered by capacitor C7. The power supply produces (under load) approximately 10 volts for the circuit.

*Voisinet, Roger. Journal of Environmental Sciences, July/August 1978, pp. 28 - 29.

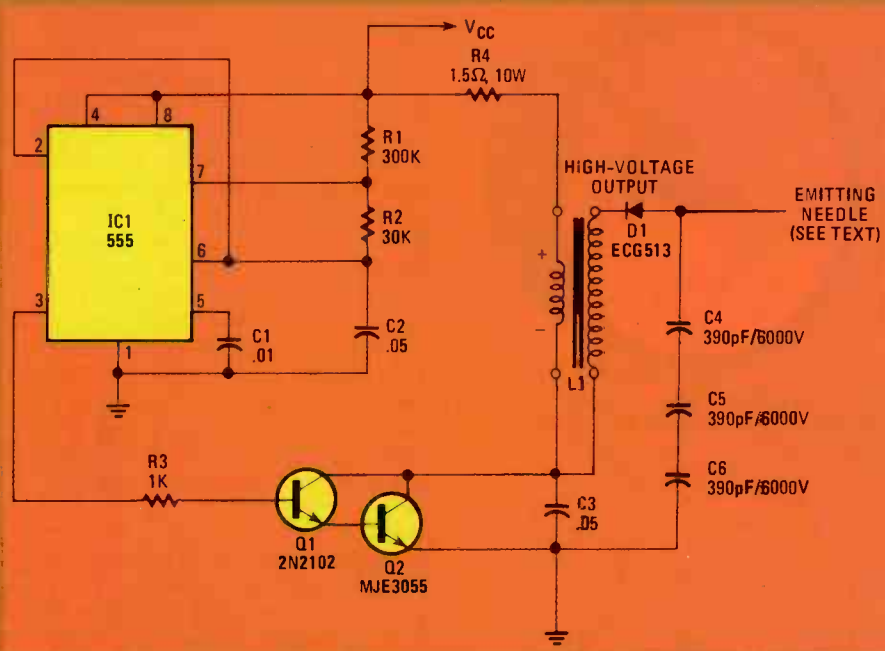

FIG. 1—SCHEMATIC DIAGRAM of the negative-ion generator. The NE555 is used in the astable mode.

PARTS LIST

Resistors ¼ watt, 5% unless otherwise indicated

- R1—300,000 ohms
- R2—30,000 ohms
- R3—1000 ohms
- R4—1.5 ohms, 10 watts
- R5—5 ohms, 10 watts

Capacitors

- C1—0.01 μ F, 50 volts, ceramic disc
- C2, C3—0.05 μ F, 100 volts, ceramic disc
- C4-C6—390 pF, 6000 volts, ceramic disc
- C7—1000 μ F, 35 volts, axial lead electrolytic

Semiconductors

- D1—ECG513 45,000-volt diode array
- D2—1N3880
- Q1—2N2102 NPN transistor
- Q2—MJE3055 NPN transistor
- IC1—NE555 timer
- L1—12-volt, three terminal, automotive ignition coil

Miscellaneous

- PC board, perforated board, or IC breadboard; four-inch diameter PVC pipe with end-caps; high-voltage automobile ignition wire; hookup wire; heat sink, mica washer, and heat-sink compound; terminal strip; aluminum bracket material; line cord; ½-amp fuse; hardware, etc.

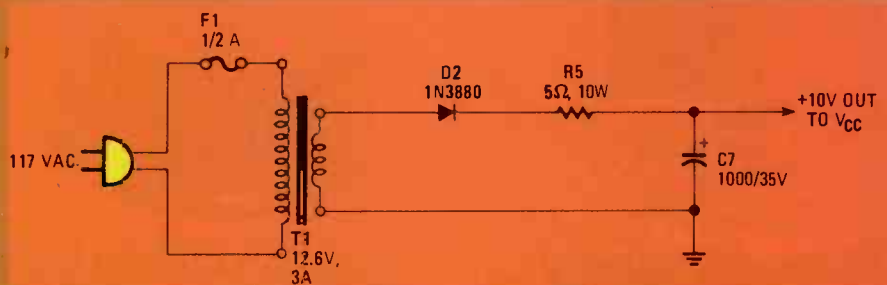

FIG. 2—THIS SIMPLE, UNREGULATED, POWER SUPPLY produces approximately 10 volts for the negative-ion generator.

Construction

The circuit in Fig. 1 can be built easily on a small (1¼ × 2¼ inches) piece of perforated board, printed-circuit board, or universal IC breadboard, as shown in Fig. 3. Transistor Q1 does not need to be heat-sunk as its load current (Q2's base current) requirements and therefore the transistor's power dissipation are not excessive. However, Q2 is mounted off the circuit board and heat-sunk for thermal overload protection as shown in Fig. 3. Because the MJE3055's (Q2) mounting tab is tied to the collector, care must be taken to

isolate the mounting tab from ground. That is done by using a mica washer and heat-sink compound between the transistor's case and the heat-sink, and mounting the transistor using a nylon bolt.

The +10-volt power supply shown in Fig. 2 was built to allow for a compact installation. A right-angle aluminum bracket made from a 2½ × 3-inch piece of 3/32-inch aluminum sheet was epoxied to the top of the power transformer, T1, as shown in Fig. 4. A seven-lug terminal strip was then epoxied to the bottom of the aluminum



FIG. 3—THE ICN-GENERATOR circuit is built on a small piece of circuit board. Transistor Q2 is mounted next to the board and should be heat-sunk as shown.



FIG. 4—A RIGHT-ANGLE BRACKET is epoxied to the top of transformer T1. The circuit board is mounted on the bracket using 1/4-inch plastic stand-offs. The connections to the ignition coil, and the lead from the coil's high-voltage terminal, will be concealed by the PVC pipe in the completed project.

bracket for component mounting as shown in Fig. 5. The power-supply components—rectifier D2, power resistor R5, and filter capacitor C7—are then soldered to the terminal strip. The small circuit board and Q2 (mounted



FIG. 5—ALL POWER-SUPPLY components, except T1, are mounted on a terminal strip that is epoxied to the bracket.



FIG. 6—INTERIOR VIEW of the top PVC cap. Rectifier D1 and capacitors C4, C5, and C6 are shown.



FIG. 7—A COMMON SEWING NEEDLE is used as the electron-emission source. The blunt end of the needle is soldered to the anode of the rectifier.

on its heat sink) are mounted on the other side of the bracket. Epoxy Q2's heat sink directly to the bracket, and mount the circuit board, using 1/4-inch plastic stand-offs and epoxy, as shown in Fig. 4.

Another piece of 3/32-inch aluminum sheet measuring approximately 2 1/2 x 2 1/2 inches, was epoxied at a right angle to the top of the power-supply bracket as shown in Fig. 4 to serve as a mounting base for the ignition-coil assembly. Once the epoxy has set, the ignition coil can be epoxied to the mounting base. All solder connections between the power supply, coil, and circuit

board can be completed now.

The completed assembly is housed in a piece of standard 4-inch diameter PVC 3/32-inch wall pipe, approximately 13 inches long, with two standard 4-inch PVC end-caps. The power supply, coil, and circuit-board assembly is bolted to the bottom end-cap after a suitable side hole is drilled for the 120-volt AC line cord.

The high-voltage rectifier, D1, and high-voltage filter capacitors C4, C5, and C6, are then mounted in place with epoxy through a 9/16-inch hole drilled in the top PVC end-cap as shown in Figs. 6 and 7. One end of the series-connected high-voltage capacitors is soldered directly to the anode of the rectifier; the other end is connected to ground on the power supply, coil, and circuit-board assembly. The automobile high-voltage ignition wire lead from the coil's high-voltage output is soldered to the cathode of the rectifier. A two-inch long common steel sewing needle is used as the emission source. The needle's blunt end is soldered to the anode of the rectifier. Make certain that the diode polarity is as shown in Fig. 1. In addition, after assembling the completed unit and PVC housing, make certain that the high-voltage connections are not located near any potential discharge-points on the assembly.

Summary

In the circuit shown, the high-voltage negative DC at the anode has been measured with a high-voltage probe at approximately -9000 volts, which is sufficient for generating negative oxygen ions. Although it is *not* lethal, the instrument is a high-voltage source and should be treated with respect and caution.

The "ion wind" generated by the rapidly moving ion flux from the emission source can be felt by carefully placing a finger near the emitting needle tip. For maximum effect, the negative-ion generator may be placed several feet from the user. R-E

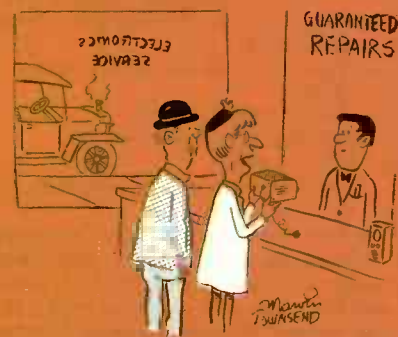

"Looks to me like the audio stage is dead, indicating a shorted output transistor—but Pa thinks it's a split resistor."



How to Improve UHF Reception

The results of this FCC study can help you improve your UHF-TV reception significantly.

DENNIS C. BROWN





DID YOU EVER WISH YOU COULD TEST DOZENS OF TV-RECEPTION ACCESSORIES (LIKE ANTENNAS, preamps, lead-ins, splitters, connectors and baluns) before deciding which to buy to improve your reception? The Federal Communications Commission has done it for you. In this report, we will reveal which UHF-TV antenna-system components were found to be the best when tested for the FCC by the electronics labs of The Georgia Institute of Technology.

The FCC has recently proposed adding a large number of low-power UHF stations intended to serve only small-coverage areas. Those proposed stations, in addition to the rapidly increasing number of regular UHF and UHF-translator stations, may cause you to think about upgrading your UHF-TV receiving system. In addition to luck and a little black magic, good UHF-TV reception requires good antenna-system components to get the signal to your receiver.

The FCC has long been concerned about the difficulties many households have in receiving UHF. In a recent report to the Commission, the FCC staff explained that the most efficient and effective way to improve UHF reception is to improve the antenna and transmission-line system. Under contract to the FCC, Georgia Tech tested a large number of UHF antennas and accessories. Its tests results were released by the FCC in a 200-page report. The report, however, carefully omitted the names of the manufacturers of the equipment tested.

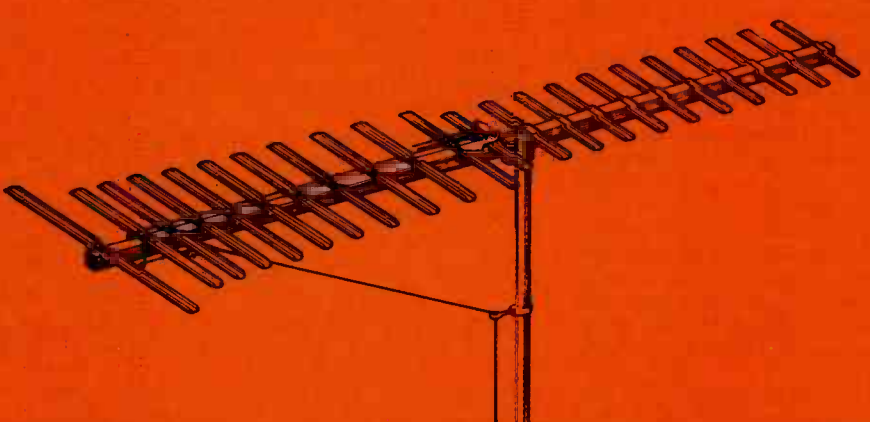
The author filed a Freedom-of-Information-Act Request with the FCC for the names of the manufacturers and the model numbers of the equipment tested. The FCC Office of Plans and Policy granted the request in full.



Three caveats are in order: First, although no doubt every effort was made to be thorough in the selection of components to test, some manufacturers' products may not have been tested. Omission of some product from the report should not be taken to indicate any conclusion about that product. Second, the Georgia Tech study does not take into account variations from unit to unit and from batch to batch in a maker's line for the more expensive products. Thus, the unit tested may have been a lemon, an exceptionally good piece, or an average sample. Third, because the public release was expected to be confidential in regard to the manufacturers' names, the report's conclusions should not be taken as either criticism or endorsement of a particular product or manufacturer by either Georgia Tech or the FCC.

Before we look at the test results themselves, let's look at Georgia Tech's general conclusions:

1. UHF-only antennas provide better UHF performance than UHF-VHF combination antennas, providing, on the average, a 2-dB gain advantage.
2. Considering both overall performance and cost, the outdoor 4-bay bowtie antenna, at an approximate cost of \$10, is considered the best antenna choice for UHF reception for most installations.
3. There are significant differences among preamps, with gains varying from -16 dB (an actual loss) to +35 dB, and with noise figures varying from 2.5 dB to 12 dB.
4. The benefit of a preamp is that it lowers the system noise figure, with a noise figure between 3 dB and 5 dB desirable.
5. A preamp mounted at the antenna will give better performance than one mounted indoors at the receiver. The improvement in performance is approximately equal to the loss suffered in the transmission line. A preamp gain of about 20 dB is desirable. A gain of 15 dB may be adequate, while more than 20 dB may be too much except in fringe areas.
6. New, dry, unshielded twin-lead exhibits the lowest insertion loss, while shielded twin-lead has the greatest loss.
7. Coaxial cables have the lowest VSWR (Voltage Standing Wave Ratio, a measurement of mismatch between connected components, with 1:1 indicating a perfect match) and shielded twin-lead shows the highest VSWR.
8. Unshielded twin-lead is susceptible to moisture and metal-proximity effects which cause significant degradation in performance. Shielded twin-lead and coax cables are immune to those conditions.
9. RG-6/U coax is the best choice for UHF-TV reception.
10. There is no clear correlation between the price of a splitter and its performance characteristics.
11. Insertion loss of splitters tested ranged from 0.1 dB to 5 dB, and insertion-loss differences among samples of the same model varied from 0.3 to 2.2 dB.
12. Splitter VSWR values ranged from 1.05:1 (very good) to 6.4:1 (not so good).
13. There does not appear to be much correlation between the price of a balun and its actual performance.
14. Insertion loss of the four models of baluns, from three manufacturers, ranged from 0.3 dB to 2.7 dB, with insertion loss difference among samples of the same model varying from 0.2 to 0.9 dB.

15. Balun VSWR values measured from 1.1:1 to 3.0:1, with VSWR differences among units of the same model ranging from 0.2 to 0.8.

The Georgia Tech study identified several efficient systems, ranging in cost from \$47 to \$260. The receiving system that the engineers considered to represent the optimum compromise between price and performance costs approximately \$70 and consists of a UHF-only 4-bay bowtie outdoor antenna, a UHF-only preamp with a noise figure of 2 dB to 5 dB and a gain of 20 dB, and RG-6/U transmission line.

Antennas

Georgia Tech engineers looked at 55 configurations of commercially available antennas and tested ten models, both as-manufactured and after pruning break-away elements for best performance on the higher UHF channels. The Public Broadcasting Service had tested 29 antenna models and released data on those tests in 1978. Rather than re-testing those models, Georgia Tech used the PBS figures in its analysis. The results of the tests are summarized in Tables 1-3.



THE OUTPUT IMPEDANCE of this Archer model 15-1134 from Radio Shack, a division of Tandy Corporation, is switch selectable (75 or 300 ohms).

As could be expected from an understanding of antenna theory, the Channel Master 6-foot parabolic dish antenna showed the highest gain and narrowest beamwidth, but an unexpectedly low front-to-back ratio, possibly because ribs, rather than screen wire are used for the reflector.

If you want a single antenna for both UHF and VHF reception, the Jerrold model VU-933S 33-element log-periodic VHF, yagi-with-corner reflector UHF, appears to be the best choice for UHF reception.

In general, among antennas you get pretty much what you pay for, with the higher-priced antennas generally giving better performance. Because not everyone will want to spend a lot of money or be able to accommodate some of the antennas (for example, I would dearly love to have the benefits of a six-foot dish but can't spare the space in my

apartment), a close look at the tables should provide guidance to the best antenna type for your needs.

Preamplifiers

Georgia Tech tested twelve marketed models from ten manufacturers, plus a Blonder-Tongue prototype that is not commercially available. They were tested at the center frequencies of seven UHF channels. Those preamps intended for VHF, as well as UHF, reception were also tested at channels 4 and 9. All preamps were tested for gain, noise figure, 1-dB compression point level, and VSWR. The test results are summarized in Table 4.

The one reason for having a preamp in the receiving system is that it can improve the system's overall noise figure. The preamp noise figure sets the floor for the system's noise figure. To help, the preamp noise figure has to be lower than the TV tuner's noise figure. Although methods for testing receiver noise performance are presently the subject of engineering controversy, the FCC advises that typical noise figures for VHF tuners are 7 dB and for UHF tuners are 12 dB. Video-recorder tuner noise figures are a little higher because there is a signal-splitter ahead of the tuner. The gain in dB of a preamp should equal the sum of the tuner-noise figure plus losses suffered in transmission line, baluns, and splitter used. To overcome the degradation in signal quality caused by the transmission line, splitter, and baluns, the preamp should be mounted at the antenna, rather than at the receiver.

No one preamp tested showed all the characteristics that one might desire, but Georgia Tech concluded that the Winegard model AC4490 was probably the best amplifier tested. Although there isn't a one-to-one correlation between price and performance among preamps tested, it does appear that you generally get something more for more money. For example, the most expensive preamp tested, the Q-Bit model Q-B0542, showed the most gain, but it has little headroom and undistinguished distortion figures, making it useful only in fringe areas or where high-loss accessories or a poor tuner are used. The second most expensive unit tested, the Jerrold model DSU-105, had high gain and was above average in all other measurements. Carefully consider the measurements and your particular situation when you decide which preamp to buy.

Transmission lines

Among the seventeen types of transmission lines from five manufacturers tested were twin-lead, shielded twin-lead, and coaxial cables. Two factors are important: insertion loss and VSWR. Although space considerations

TABLE 1

Summary of UHF Performance Characteristics of UHF-Only Outdoor Antennas

Maker/Model	Type	Price (\$)	Gain (in dB)			Avg. Beam Width (°)	Avg. F/B Ratio (dB)	Main/Side Ratio Avg. (in dB)	VSWR		Remarks
			Avg.	Max.	Min.				Max.	Min.	
1. Channel Master 4228A	8-bay Bowtie w/screen	32.18	13.0	15.0	9.5	21.1	17.9	10.1	3.4	1.3	
2. GC Electronics 32-8978	4-bay Bowtie w/screen	10.55	9.1	16.0	1.0	54.8	15.4	15.4	3.0	1.1	a.
3. Finco 4BT	4-bay Bowtie w/screen	10.80	10.6	16.0	5.0	49.1	13.1	13.1	3.5	1.1	a.
4. Winegard KU420	4-bay Bowtie w/screen	9.44	11.8	13.1	9.0	49.3	14.5	14.5	2.0	1.0	a.
5. Channel Master 4193	1-bay Bowtie w/corner	9.65	8.0	12.0	4.0	59.9	12.6	12.6	3.0	1.1	
6. Finco CRB	1-bay Bowtie w/corner	8.35	7.3	12.0	4.0	55.2	12.7	12.7	2.6	1.1	
7. RCA 2BG17	Yagi w/corner reflector	19.95	7.6	14.0	1.3	47.0	11.6	10.5	3.0	1.1	
8. Jerrold CYD-1470	Yagi w/corner reflector	15.75	7.2	10.0	2.0	39.5	9.8	9.8	4.6	1.1	
9. Radio Shack U-75	Yagi w/corner reflector	12.94	7.7	12.0	2.0	44.9	9.9	9.9	2.0	1.1	
10. Radio Shack U-100	Yagi w/corner reflector	19.95	7.8	13.5	-6.8	37.8	11.0	9.5	3.0	1.1	
11. Winegard CH-9075	Yagi w/corner reflector	23.90	7.3	13.5	-3.0	38.5	8.1	7.3	3.2	1.1	
12. Winegard CH-9075	Yagi w/corner reflector	23.90	5.8	9.6	-7.8	40.3	12.7	12.7	2.5	1.4	b.
13. Winegard CH-9075	Yagi w/corner reflector	23.90	5.9	9.0	-4.1	39.2	10.2	10.1	2.3	1.2	c.
14. Winegard CH-9095	Yagi w/corner reflector	37.59	8.0	11.5	0.5	36.9	9.4	9.4	3.0	1.1	
15. Winegard CH-9095	Yagi w/corner reflector	37.59	7.1	14.6	-7.7	37.1	12.0	11.4	2.9	1.4	d.
16. Winegard CH-9095	Yagi w/corner reflector	37.59	6.9	13.7	-11.7	36.2	14.1	14.1	2.3	1.5	e.
17. Kay Townes AAU14G	Yagi	18.45	-3.0	10.5	-15.7	49.4	3.8	3.8	10.0	2.0	
18. Antennacraft Y-44	Log-Periodic	18.25	7.9	12.0	1.0	39.0	13.0	9.5	6.5	1.0	
19. Blonder-Tongue 0511	Log-Periodic	21.66	5.1	7.4	2.4	55.9	14.2	14.2	3.5	<1.7	
20. Blonder-Tongue 0512	Log-Periodic	39.99	6.3	11.6	1.7	43.8	13.0	12.0	4.5	1.6	f.
21. Finco P-5	5' Parabolic w/Yagi Feed	54.80	10.1	13.9	-1.1	21.6	10.3	9.9	5.2	1.4	
22. Channel Master 4250	6' Parabolic w/2-bay Bowtie Feed	68.42	15.0	17.9	11.7	16.1	11.0	11.0	3.2	1.4	

- Remarks: a. Type concluded to be the best for most installations.
 b. Same as antenna #11 with internal balun.
 c. Same as antenna #12 pruned for better gain on higher channels.
 d. Same as antenna #14 with internal balun.
 e. Same as antenna #15 pruned for better gain on higher channels.
 f. Same as antenna #19 with director elements.

keep us from presenting complete tables of insertion loss and VSWR measurements for each sample tested, some important points should be considered.

Although twin-lead has the lowest insertion loss, in most practical installations it is not the best choice. Twin-lead is highly susceptible to performance degradation when it gets wet or when it is placed close to metal objects (such as an antenna mast). That weakness will often result in a significantly greater loss and a poorer impedance match (higher VSWR, which means greater loss and ghosts in the picture) than shown by coax under identical condi-

tions. Shielded twin-lead is virtually immune to performance degradation due to moisture or proximity to metal, but it has a higher insertion loss. Shielded twin-lead also has high VSWR, compared to coaxial cables.

Not tested by the engineers at Georgia Tech, but important in urban areas, is susceptibility to noise pickup. While coax is relatively immune to spark-noise pickup, twin-lead picks up noise from auto ignitions and electric motors fairly readily.

All things considered, the additional cost of good coax in a UHF system (especially considering the cost of the receiver) is truly trivial and coax should

be your choice for transmission line.

Splitters

The term "splitter" is used here to refer to a device that is used to separate VHF/UHF signals on one transmission line and feed only VHF signals to the receiver's VHF input and only UHF signals to its UHF input. Fourteen splitters were tested, all of which were packaged with UHF-VHF combination antennas. Because of the study's ultimate recommendation, we don't see much point in presenting complete figures on the splitter tests, but will offer some observations.

A splitter will cost you something in

TABLE 2

Summary of UHF Performance Characteristics of UHF/VHF Combination Outdoor Antennas

Maker/Model	Type	Price (\$)	Gain (in dB)			Avg. Beam Width (°)	Avg. F/B Ratio (dB)	Main/Side Ratio (in dB)	VSWR		Remarks
			Avg.	Max.	Min.				Max.	Min.	
1. Channel Master 4749	VHF LP*/UHF Yagi w/corner	25.95	0.7	6.0	-5.0	37.4	10.2	9.4	4.1	1.4	
2. Jerrold VU-933S	VHF LP/VHF Yagi w/corner	41.37	9.0	10.9	-16.2	44.3	15.3	14.4	3.0	1.2	a.
3. Jerrold VU-933S	VHF LP/UHF Yagi w/corner	41.37	8.8	10.1	6.3	48.8	15.1	13.7	2.9	<1.2	b.
4. Jerrold VU-933S	VHF LP/UHF Yagi w/corner	47.16	7.0	14.0	-14.5	39.1	14.4	13.4	3.2	1.0	c.
5. Jerrold VU-937S	VHF LP/UHF Yagi w/corner	107.70	10.7	13.0	-6.3	30.7	13.5	9.1	3.0	1.4	
6. Jerrold VU-937S	VHF LP/UHF Yagi w/corner	107.70	9.6	12.6	3.8	33.8	12.3	8.5	4.1	1.4	d.
7. Jerrold VU-937S	VHF LP/UHF Yagi w/corner	113.49	10.1	13.5	3.0	29.1	12.5	10.1	3.0	1.0	e.
8. Olson AA-965	VHF LP/UHF Yagi w/corner	39.95	9.5	15.0	1.5	61.3	7.2	6.2	5.0	<1.9	
9. Radio Shack VU-110	VHF LP "V" / UHF Yagi w/corner	34.97	6.1	10.5	0.0	31.3	7.1	5.8	5.0	<1.7	
10. Radio Shack VU-90	VHF LP "V" / UHF Yagi w/corner	27.97	6.2	10.0	-0.9	36.5	7.2	4.6	5.3	1.5	
11. Radio Shack VU-160	VHF LP "V" / UHF Yagi w/corner	54.97	7.2	12.0	2.5	34.9	8.5	5.0	2.4	1.6	
12. Sears 7931	VHF LP "V" / UHF Yagi w/corner	34.95	4.3	8.0	-1.0	62.7	12.0	11.5	5.3	2.0	
13. Winegard CH-7080	VHF LP/UHF Yagi	34.34	6.7	10.0	4.0	44.2	14.1	12.9	3.1	1.0	
14. Winegard CH-7080	VHF LP/UHF Yagi	34.34	5.7	11.5	-9.5	40.7	16.5	15.4	2.7	1.5	f.
15. Winegard CH-7080	VHF LP/UHF Yagi	34.34	6.0	9.2	-1.7	44.5	15.2	14.0	2.6	1.2	g.
16. Antennacraft KTK-27	VHF LP/UHF LP	20.48	4.7	10.0	-1.0	50.9	13.5	13.0	3.5	<1.4	
17. Lafayette 18F01836W	VHF LP "V" / UHF LP	21.95	1.6	4.5	-6.0	39.5	6.3	5.8	4.1	1.8	
18. Blonder-Tongue 0713	VHF LP "V" / UHF LP	65.98	5.6	8.2	2.0	40.4	17.7	15.0	2.8	1.7	
19. Blonder-Tongue 0714	VHF LP "V" / UHF LP	80.62	5.6	11.4	-5.0	40.4	14.6	11.8	4.3	1.9	h.

*LP: Log Periodic

- Remarks: a. Believed to be the best VHF/UHF combination antenna tested.
 b. Same as antenna #2 pruned for better gain on higher channels.
 c. Same as antenna #2 with director elements added for UHF.
 d. Same as antenna #5 pruned for better gain on higher channels.
 e. Same as antenna #5 with director elements added for UHF.
 f. Same as antenna #13 with internal balun.
 g. Same as antenna #13 with internal balun and pruned for better gain on higher channels.
 h. Same as antenna #18 with director elements added for UHF.

insertion loss (from 0.1 dB to 5 dB in Georgia Tech's tests). A splitter will also introduce some impedance mismatch, with VSWR's ranging from 1.6:1 to 6.4:1. That mismatch can cause up to a 3.25-dB loss and cause ghosts in the picture.

Georgia Tech found no clear correlation between the cost and performance of the splitters tested. The most expensive (Winegard model MSJ-5 at \$8.95) had the lowest VSWR, but the highest average insertion loss. A medium priced unit (Radio Shack model 6005 at \$3.99) had the lowest average loss. Several samples of some of those units were tested, with variations between samples

ranging from 0.3 dB and 1.5 dB.

Georgia Tech concluded that installing two transmission lines (one for VHF and one for UHF) to eliminate use of a splitter is a reasonable alternative. An additional 50 feet of RG-6/U cable will probably cost only a dollar or two more than a splitter, but will give better results. Two cables can usually be brought down from the antenna together, and installing them should not be much harder than installing a splitter.

Baluns

A balun (*BALANCED-to-UNbalanced*) transformer is used for impedance matching between 300-ohm

balanced line and 75-ohm unbalanced line. When using coax, you connect a balun between the antenna and the coax and, unless your receiver has a 75-ohm "F" connector on the back, you use another balun at the receiver to convert the 75-ohm impedance back to 300-ohms, balanced, for connection to the receiver screw terminals. In my experience, the balun used has a profound effect on the quality of UHF reception; an effect that is disproportionate to its slight cost and lack of complexity.

Georgia Tech tested several samples of four balun models. They found that there was little correlation between price and performance. Although the

TABLE 3

Summary of UHF Performance Characteristics of Indoor Antennas

Maker/Model	Type	Price (\$)	Gain (in dB)			Avg. Beam Width (°)	Avg. F/B Ratio (dB)	Main/Side Ratio Avg. (in dB)	VSWR		Remarks
			Avg.	Max.	Min.				Max.	Min.	
1. Radio Shack 15-233	UHF Loop	0.99	0.1	3.0	-3.0	85.5	1.2	1.2	5.0	1.0	b.
2. Radio Shack 15-623	UHF 2-bay Bowtie w/screen	6.95	4.0	7.7	-4.0	51.1	9.9	9.9	5.3	<1.4	a.
3. Radio Shack 15-1810	VHF Rabbit Ears/UHF Concentric Loops	11.95	-2.2	3.0	-6.0	57.6	0.4	0.4	>10.0	1.2	
4. Rembrant	VHF Rabbit Ears/UHF Concentric Loops	22.45	-6.2	1.5	-12.5	75.1	3.4	3.3	3.0	1.1	
5. Rembrant	VHF Rabbit Ears/UHF Quadrature Loops	11.20	-2.3	4.0	-9.0	78.4	3.4	3.0	3.9	1.2	

Remarks: a. Considered by the Georgia Tech engineers to be the best indoor antenna tested, said to be "significantly superior to other indoor antennas evaluated."
 b. Said by the study to "offer rather poor performance."

TABLE 4

Summary of UHF Performance Characteristics of Preamplifiers

Maker/Model	Type	Impedance (Ω) Input/Output	Price (\$)	Gain (in dB)			Noise Figure (Average)	1-dB Compression Point (Average)	VSWR		Remarks
				Avg.	Max.	Min.			Max.	Min.	
1. Q-Bit Q-B0542	UHF	75/75	182.00	33.9	35.0	31.7	4.6	-25.3	2.0	<1.1	a.
2. Jerrold DSU-105	UHF	75/75	125.10	27.3	30.8	24.0	9.4	-18.9	6.6	3.0	b.
3. Finco G-955-V	UHF	300/75	40.75	3.6	14.5	-15.9	10.2	-7.5	6.4	<1.9	c.
4. Blonder-Tongue 5018	UHF	300/300	42.44	13.7	16.0	10.6	4.8	-7.5	5.8	2.1	d.
5. RCA 10G203B	UHF	300/300	22.55	10.1	13.7	3.2	7.0	-9.3	5.8	<1.7	
6. JFD SP2382	VHF/UHF	300/300	35.74	10.7	17.6	1.0	10.9	-6.1	5.4	<1.2	e.
7. Jerrold 5283	VHF/UHF	300/300	93.23	14.7	19.3	9.5	6.5	-9.0	5.9	<1.7	f.
8. Radio Shack 15-1134	VHF/UHF	300/75	39.95	13.6	16.3	4.9	5.1	-17.4	4.5	<1.6	g.
9. Radio Shack 15-1134	VHF/UHF	300/300	39.95	14.2	18.1	7.5	5.2	-16.6	4.3	<1.6	g.
10. Channel Master 0064B	VHF/UHF	300/75	42.75	20.8	27.6	15.8	7.0	-12.0	5.0	1.4	
11. Winegard AC4990	UHF	300/75	52.76	16.4	20.0	11.1	4.6	-3.3	4.5	2.0	h.
12. Colormax CP35E	UHF	300/300	19.90	13.5	20.0	5.6	7.7	-7.0	6.3	1.5	
13. Blonder-Tongue Prototype	UHF	75/75	N/A	12.5	14.1	10.3	4.3	+2.9	3.2	1.2	

Remarks: a. The study concludes that the "usefulness of preamp #1 is limited to extreme fringe areas" or "situations where lossy components and/or an exceptionally poor tuner (high noise figure) are being used."
 b. The study takes note of preamp #2's high noise figure and VSWR, in view of its price.
 c. Preamp #3 is described by the study as, "may in fact be detrimental at frequencies above channel 54."
 d. When used with other good components, preamp #4 "would represent a substantial improvement in system performance for a reasonable purchase price."
 e. Preamp #6 is said by the study to be "of little benefit to system performance due to its extremely poor noise figure performance."
 f. When used for VHF reception, the Georgia Tech engineers said that preamp #7 "could significantly improve the system noise figure."
 g. Preamp #8 (same as preamp #9) "was considered to be one of the better preamplifiers (cost considered) that was tested on this program."
 h. Preamp #11 is designed only to plug into Winegard outdoor antennas to form "active antennas." In the opinion of the engineers, preamp #11 "was probably the best preamplifier tested."

UHF DX'ing

The author lives in a high-rise apartment building that has a master antenna system and prohibits additional outside antennas. The Spanish International Network (SIN) recently established a "satellator" (SATELLite transLATOR) station on Channel 56 in Washington, DC. It carries, directly from the Westar satellite, the SIN programming of KMEX, Los Angeles, and KWEX, San Antonio. In contrast to full-power UHF stations that usually operate with an effective radiated power of from one to three million watts (they may use up to five megawatts under FCC rules), Channel 56 radiates only 1000 watts. Such low power is used because the station is intended to cover only a small neighborhood where the District's Spanish-speaking people are concentrated. The problem of trying to receive a one-kilowatt signal at a distance of over three miles is complicated by the fact that my apartment windows face away from the transmitter and I have to pick the signal off an adjacent building by reflection.

I tried a four-bay bowtie antenna, but it was unsatisfactory because of reflections from a number of tall

buildings that lie in the antenna sidelobes. Not wanting to take up the whole room with a six-foot dish, I built a corner reflector, cut for Channel 56, from angle aluminum. Masonite, aluminum foil, brass rod, and a broomstick. I added a preamp and used a length of RG-59/U. When the Georgia Tech report came out, I immediately replaced the cable with RG-6/U. The RG-59/U must have come from an "off" batch. My eyes aren't calibrated in dB, but the improvement was greater than expected from predictions of the study.

The Georgia Tech study confirms my experience with baluns; there was a remarkable difference among baluns I tried, even among examples of the same model. One of the cheapest (I'd bought three of them at 99¢ each) was best for Channel 56.

Using the system described, during a period of good propagation, I have been able to log reception of 19 stations, including stations from Philadelphia, PA and Burlington, NJ. Total investment, including discarded components (RG-59/U and baluns) was under \$70, modest for the benefit. R-E

most expensive (Sony model EAC-13W at \$4.90) showed the lowest average insertion loss, the second most expensive (Channel Master model 7200 at \$4.45) had the highest insertion loss and worst VSWR. A \$2.89 unit (Channel Master model 0035B) had the best VSWR characteristics. My experience with respect to price and performance of baluns agrees with the Georgia Tech findings (see Sidebar). Insertion loss variation among samples of the same model ranged from 0.2 to 0.9 dB.

Connectors

Georgia Tech engineers observed that type of connectors used, and the nature of the connection itself, can have a significant effect on performance. In fact, their effect on picture quality sometimes seems to be magic. What appears to be a perfectly good connection may give a miserable picture, while a shaky connection that you wish you could trust to stay together gives a superb image on the screen.

Georgia Tech engineers noted that twin-lead plugs and sockets, spade lugs, and terminal strips all displayed such high VSWR levels that they could not be used in the test program. They speculate that similar effects may be observed in home installations. To avoid the problem of twin-lead connectors, the engineers finally resorted to soldering twin-lead to balun leads. That seems like a good practice for the home, if a bit inconvenient.

The engineers concluded that F-type connectors "accomplish good coaxial connections if the connectors are properly installed, and no problems should be encountered when frequent disconnections and connections are not required."

Conclusion

In a recent Louis Harris and Associates, Inc., survey, 27% of the households in communities where UHF reception should be possible reported receiving no UHF channels on their TV sets. Nearly six out of ten households interviewed felt that, in general, picture quality was better on VHF channels than on UHF channels. One in three households that received a UHF channel observed snow on the strongest UHF channel that they receive.

There is no need for you to be one of those who report such poor UHF reception. It's easy to improve your UHF reception to get better pictures on the channels you receive now, and to get stations you couldn't get at all before. Up to now, the biggest block to good UHF reception has been lack of information. This report should give you all the information that is necessary to receive UHF channels as well as you receive the VHF ones. R-E

UHF RECEPTION EQUIPMENT

For more information, circle the corresponding number on the Free Information card inside the back cover.

All Channel Products
(Rembrandt)
42-40 Bell Plaza
Bayside, NY 11361
CIRCLE NO. 79

Antennacraft
Highway 34 West
West Burlington, IA 52655
CIRCLE NO. 80

Blonder-Tongue Laboratories, Inc.
One Jake Brown Rd.
Old Bridge, NJ 08857
CIRCLE NO. 81

Channel Master
Ellenville, NY 12428
CIRCLE NO. 82

Colormax Electronic Corp.
180 Northfield Ave.
Edison, NJ 08817
CIRCLE NO. 83

The Finney Company
(Finco)
34 W. Interstate St.
Bedford, OH 44146
CIRCLE NO. 84

GC Electronics
400 S. Wyman St.
Rockford, IL 61101
CIRCLE NO. 85

Olson Electronics
Box 100
Mogadore, OH 44260
CIRCLE NO. 89

Q-BIT
311 Pacific Ave.
Palm Beach, FL 32905
CIRCLE NO. 90

Kay-Townes, Inc.
607 Turner Chapel Rd.
PO Box 593
Rome, GA 30161
CIRCLE NO. 86

Lafayette Radio Electronics
111 Jericho Turnpike
Syosset, NY 11791
CIRCLE NO. 87

Murata Corporation of America
(JFD)
1148G Franklin Rd. SE
Marietta, GA 30067
CIRCLE NO. 88

Radio Shack
1400 One Tandy Center
Ft. Worth, TX 76102
CIRCLE NO. 91

**RCA Distributor and
Special Products Div.**
2000 Clements Bridge Rd.
Deptford, NJ 08096
CIRCLE NO. 92

Sears, Roebuck and Company
Sears Tower
Chicago, IL 60684
CIRCLE NO. 93

**Taco Division-
General Instrument Corporation**
(Jerrold)
1 Taco St.
Sherburne, NY 13460
CIRCLE NO. 94

Winegard Company
3000 Kirkwood St.
Burlington, IA 52601
CIRCLE NO. 95

BUILD THIS

Part 2 BEFORE WE CONTINUE with the construction of the modem, we'll make certain that everything is working properly so far. Have Part 1 handy as we proceed.

Checkout

As always, it is good practice to perform what tests you can before you install the IC's. Specifically you should check supply-pin voltages and grounds. Pin 4 of sockets 1, 2, and 3 should carry +12-volts; pin 11, -12-volts. Pins 5 and 3 on IC3; pins 5, 10, and 12 on IC1 and IC2; and pins 13 and 8 on IC4 should all be at ground potential. Finally, pin 16 of the socket for IC4 should read +5-volts.

If the voltages are correct, it is safe to install the LM348's (IC1-IC3) so that voltages at socket 4 may be checked.

Test each pin of socket 4, checking this time for any voltage that exceeds the 0- +5-volt range by more than one

volt. If pin-1 or pin-5 voltages are negative, one of the Zeners is reversed. If the pin-11 voltage is far out of range, D3 or D4 is reversed. Do not install IC4 until all voltages at socket 4 are within range!

Other likely errors that are detectable at this point are incorrectly connected power supplies, incorrectly run jumpers, and misaligned sockets.

If the socket-4 voltages are acceptable, remove power, install IC4, and supply power again. You should hear a tone from the speaker. Changing S1's position should change the tone.

Now apply a logic-level voltage (high or low) to the TX DATA input. When you change that level you should also hear a change in the tone frequency in both switch positions. If you have jumpered the board for RS-232 operation, your logic levels at that point will be ± 12 -volts. Otherwise your logic-levels will be +5 volts and ground. You should be able to generate four different tones in

all. That indicates that the TX DATA buffer, the modulator section of the MC14412, and the output buffer are working correctly.

To verify the operation of the demodulator section, connect a VOM or logic probe to pin-1 of IC3. The logic state of that pin should change as the speaker is moved closer to the microphone. When the speaker is far from the microphone, the logic level should be high. It should go low as the speaker is moved nearer to the microphone. That verifies that the input buffer, filters, and level detector are working.

Finally place the speaker near enough to the microphone so that its tone just causes the pin-1 logic to change state. Now monitor the state of the RX DATA line while you apply different logic-level signals to the TX DATA line. The RX DATA line should follow the TX DATA line in both switch positions. That verifies that the RX DATA buffer, limiter,

\$60 MODEM

Now that the modem is nearly complete, we'll make sure that everything that's been done to this point is correct, show you an enclosure that's also the acoustic coupler, and begin to look at the software that makes the modem work.

ROBERT WARD

and MC14412 demodulator section are functioning.

The above test procedure is possible because the MC14412 has been connected to demodulate its own transmissions. If it is functioning correctly, set it up to demodulate external signals by adding a jumper at the TEST position on the board. In addition the wiring to switch S1-b must be reversed so that it switches as shown in the schematic.

Troubleshooting

If some test has indicated a problem, check your work carefully. Several likely sources of error have already been mentioned. If you can't spot an obvious cause, replace the microphone. Our experience has been that a faulty microphone is responsible for about 90% of the problems encountered. Do not tinker with the filters. Many of these modems have been built and to my knowledge the filters have not once been a source of trouble.

Many problems involve a failure in the demodulator section. Check to see if a strong signal is reaching the level detector, and whether or not the MC14412 is generating an output.

If you have a 20-volt peak-to-peak signal at the input of the level detector, then pin 5 of the MC14412 should be at ground potential. If it is, the MC14412 RX DATA output-level (pin 7) should be the same as the modulator's TX DATA input-level. (That assumes a close acoustic link from the speaker to the microphones.) Trouble here indicates a problem in the limiter, the switch, the test settings, or the MC14412. If you suspect the limiter, try replacing D1 and swapping IC3. Before you declare the MC14412 to be at fault, you should check the signals at each pin of the IC. Compare what you find with what you would expect, based on the schematic.

It's more likely that the signal is present at the input of the level detector, but that the level detector never switches. Check it and if necessary replace D2, D5, C2, and the LM348 (IC3) (try swapping it with another).

If there isn't a strong enough signal at the input of the level detector at either switch-setting, double check the microphone, the switch, and the input buffer. Again try to clear up the problem by swapping LM348's.

For any thorough debugging, you will need an oscilloscope. Use it to verify the waveforms shown in Fig. 1.

The enclosure and acoustic coupler

In this construction project, since the enclosure also forms the acoustic coupler, it is an integral part of the modem. Unfortunately most low-cost kits usually address this area with a simple "add a crystal microphone and an 8-ohm speaker." If you've ever tried to buy them, you should know that "muffs" (what you put the phone handset into) are not exactly a drug-store

item.

Our solution is to make the muffs out of short lengths of 2¼-inch radiator hose and a tennis ball. Needless to say, those materials are inexpensive and readily available. It may sound crude, but with a little care the results are acceptable.

Using the template provided in Fig. 11, cut two ovals out of Masonite or other thin, rigid material to act as mounting baffles for the speaker and microphone. One of those is drilled to give a grill pattern, and the speaker is glued to its back. A hole is drilled in the other, large enough to mate with the microphone flange. Contact cement is a good adhesive to use.

Cut two 2-inch lengths of radiator hose. Use a hobby tool with a sanding drum to bevel the inside edge of one end of each until you are satisfied with the way the handset from your phone fits them.

Make the base from soft wood. A brace and bit or hole-saw may be used to drill the holes. Both tools will create problems if used on a close-grained hardwood. If your joints mate accurately enough, the enclosure can be glued

together and finished like a piece of cabinetwork. As you will see from the procedure below, a hollow-ground planer blade and a table saw (perhaps a friend has one) will prove very handy.

Begin by cutting all five pieces as shown in Fig. 12. A two-foot length of one-by-five-inch stock will provide enough material for everything. Cut the three pieces with mitered ends slightly wider than the four-inches indicated. Glue these three pieces first. I have found that miter joints may be clamped during gluing with wide masking tape or furnace tape. First, create a hinge at the joint by taping around the outside surface. The joint may now be opened and glue applied, and then taped or tied closed while it dries. Before committing yourself, try the hinge to be certain that the surfaces mate well when the joint is closed. By gluing the three pieces as a unit and leaving a little extra material, you have the option of resawing the edges (again with a planer blade) to insure that they will mate accurately with the side pieces. The side panels may be held in place with any type of weight or clamp while they are being glued.

You will want to make provision for whatever type of switches and connectors you intend to use. Most of them are not designed to be mounted in a panel ¾-inch thick. Thus you may need to back-rout (or merely drill from the back with your brace and bit) until the wood is thin enough to allow the mounting of your components. Alternatively, you can drill large holes and glue mounting plates on the surface.

Insert the muffs—the radiator hose—into the enclosure as shown in Fig. 12 and fasten them with carpet tacks, staples, or more contact cement. Leave about one inch (the end with the bevel) showing above the top surface of your enclosure.

Now cut three or four layers of cardboard into rings about two inches in diameter. Insert a telephone handset into the muffs and, working from the bottom, insert the cardboard spacers. Press in the masonite baffles and the pickup elements until the face of each baffle rides on the spacers. Mount the baffles by gluing around the back edge of the baffle with silicone sealant. Cut a tennis ball so that it will fit into the muff behind the speaker, drill a small hole in it to pass the speaker cable, and glue it in place. Remember to keep the speaker lead accessible from the rear so that it can be resoldered to the board.

Finally, drill mounting holes in each corner of the circuit board. Do this carefully; avoid both components and foil traces! Using plastic washers or other non-conductive standoffs, screw the board to the wood between the muffs. It should just fit. If not, it may be possible to turn it so that it overlaps the bottom of the muff containing the microphone (you may have to trim the bottom of the hose before you can do this.)

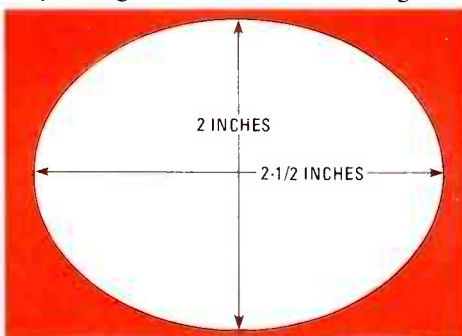

FIG. 11—USING THIS TEMPLATE, cut two Masonite ovals to act as mounting plates for the microphone and speaker.

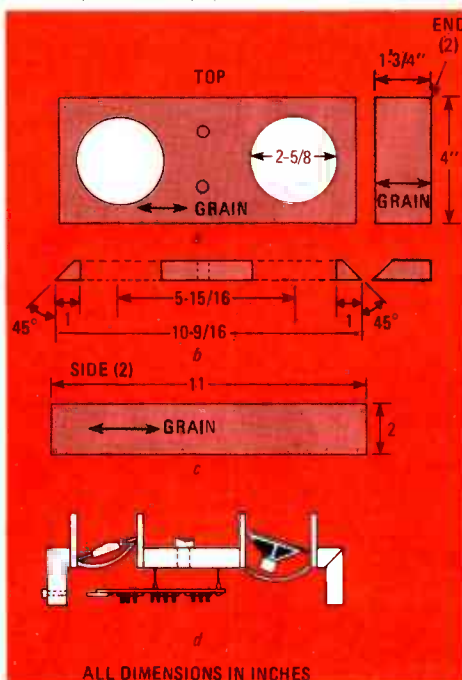

FIG. 12—ALL LUMBER NEEDED FOR THE ENCLOSURE can be cut from a single two-foot length of one-by-five-inch stock.

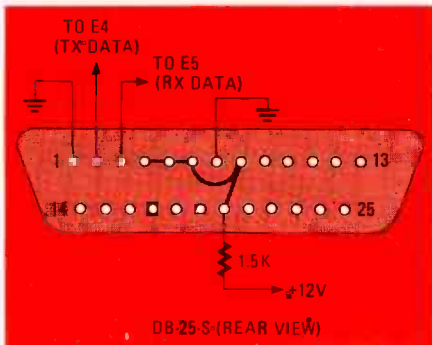

FIG. 13—RS-232 WIRING DIAGRAM for the DB-25-S connector. Tying pins 4, 5, 6, 8, and 20 together as shown eliminates the need for handshaking signals.

Wire the DB-25-S connector as shown in Fig. 13 for standard RS-232 communications. Tying pins 4, 5, 6, 8, and 20 to 12-volts through a 1.5K resistor eliminates the need for "handshaking" signals that are not really necessary in this application. Wire switch S2 and the power connections and you are finished.

Serial Communications

When parts of a computer "talk to" each other, as do the memory and microprocessor, it is usually over only a few inches of transmission line (in this case printed-circuit traces). Because of that, it is practical to enhance the processor's speed by making those communications a parallel process.

Several bits of data are transmitted simultaneously—in parallel—over separate transmission lines. That technique is not practical when two machines wish to talk to each other over long distances, because each bit of the simultaneous transmission would require a separate transmission line. If we were transmitting eight bits (a *byte*), we would require at least eight transmission lines. That is certainly not a practical approach for the hobbyist in San Francisco who wishes to send data to his friend in Philadelphia.

The solution is to send the same eight bits over *one* transmission line, sequentially. To make certain that the parties at both ends of the line can identify the beginning and end of a byte, certain extra *framing* bits (called "stop" and "start") are added. To detect transmission errors a *parity* bit is usually added (see Fig. 14).

The parity bit is used to make the total number of 1's transmitted for each byte either odd or even, depending on whether odd or even parity is used. If,



FIG. 14—DATA BITS are transmitted one-after-the-other in serial communications. Note that framing and parity bits are added.

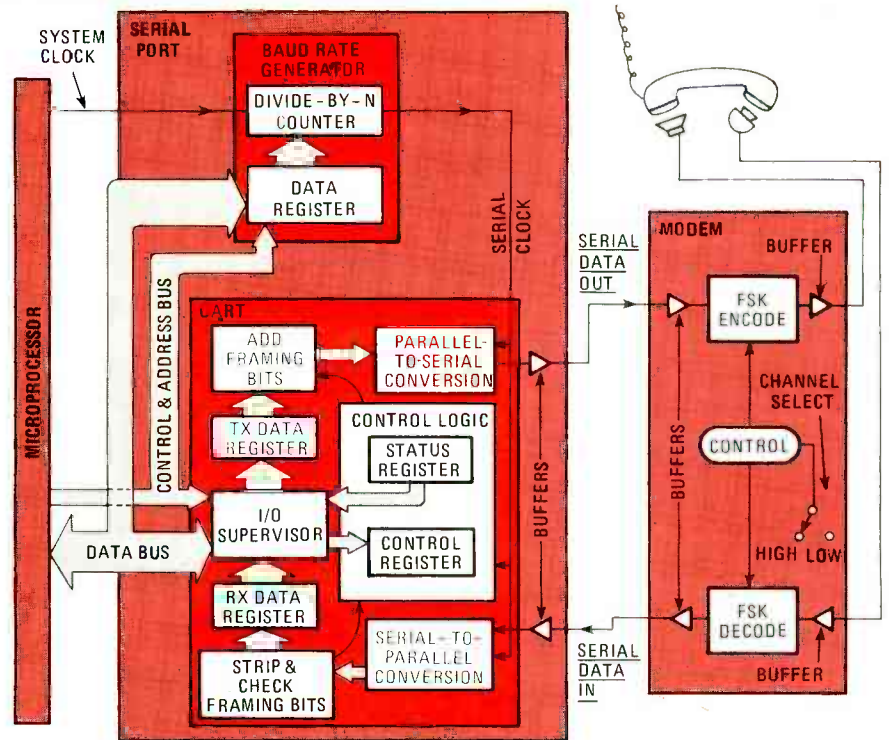

FIG. 15—BLOCK DIAGRAM of a complete serial-communications system. Some control functions have been deleted from the baud-rate generator for simplicity.

when using even parity, a byte appears whose total number of transmitted 1's is odd, we know that an error has occurred.

Figure 14 shows the use of DC logic-levels—a "low" level for a space and a "high" level for a mark. In other words, serial communication can be—and often is—accomplished over a "hard" transmission line without a modem. Only when the data is to be transmitted over a link where DC signals may not be transmitted—the phone line for instance—is a modem necessary.

A block diagram of one end of a serial-communications link is shown in Fig. 15. There are three main components: a microprocessor, a serial-communications port, and a modem. The microprocessor controls the flow of data to and from the serial port.

The baud-rate generator—which may have functions besides those required by the serial port—provides a clock signal that controls the serial-to-parallel-conversion. The higher the output frequency of the baud-rate generator, the faster sequential bits will leave the serial port or be assumed to enter the port.

Most of the rest of the functions are provided by an IC referred to variously

as a UART, USART, or ACIA. (*Universal Asynchronous Receiver/Transmitter; Universal Synchronous/Asynchronous Receiver/Transmitter; Asynchronous Communications Interface Adaptor*). That IC actually performs the serial-parallel conversion and formats or decodes the transmission according to conditions specified in a "control word" written by the processor during initialization.

The rest of the serial port consists of buffering that converts the internal logic levels (normally CMOS or TTL) to logic levels suitable for transmission by a hard-wired link to other machines (the ± 12 -volt levels specified in the RS-232 convention, for example).

The last stage of the communications link is the modem. Our modem complies with the Bell 103 standard for FSK (*Frequency Shift Keying*) audio data-transmission which specifies two channels and conventions for transmitting binary data on each channel.

The standard is full-duplex; it allows simultaneous transmission in both directions over the same transmission line. (Half-duplex permits data to flow in only one direction at a time.) That is accomplished by assigning outgoing transmissions to one channel and incoming transmission to the other. The lower-frequency channel is usually reserved for transmissions from the station initiating the call and is referred to as the *originate* channel. The upper-frequency channel is the *answer* channel and is used for transmissions from the responding station.

Particular frequencies have been specified to represent the two binary states.

GLOSSARY

Asynchronous—Serial communications formats that require new synchronizing information with each new character (start and stop bits) are referred to as asynchronous. Do not be misled. As in all other serial communication, the transmitter and receiver must become synchronized during the data transmission. See **synchronous**.

Baud rate—The rate at which data is transmitted, measured in bits-per-second. The most commonly used rates are: 100, 110, 150 and 300 baud.

Bell 103—Originally one model of modem manufactured by Western Electric (AT&T). The particular tones used in that modem have become a standard in the United States and are used in virtually all low-speed applications. European systems and high-speed modems use different tones and different conventions.

Break—A signal that one station in a serial link may use to "get the attention" of the other station. It consists of a continuous space.

Duplex—In a technical sense, a communications standard that allows simultaneous transmission of data in two directions over one transmission line is called full-duplex. Standards that allow only one station to transmit at any given time are half-duplex. Note that the Bell 103 standard is full-duplex. Even so, most commercial 103-type modems include a switch marked FULL/HALF DUPLEX. That switch has no bearing on the true duplex capability of the modem: instead, it selects the source of the character echo: FULL for remote echo, and HALF for local echo. See **echo**.

Echo—In virtually every system, what the user types on the keyboard is displayed to him on some type of device, usually either a printer or a CRT. That confirming display is called an echo. It may be created locally—by the terminal or modem—or it may be created by having the receiving station transmit back everything it receives. The former is a *local echo*, often inaccurately referred to as half-duplex mode; the latter is *remote echo*, or what is frequently called full-duplex operation. Remote echo has the advantage of giving an immediate and graphic verification that the data was received correctly.

Line-feed delay—A "NULL" or other non-printing character transmitted following a carriage return or line-feed (the former may be distinct in some systems and called a carriage-return delay). The purpose of those characters is to insure that a teletype has time to execute the earlier command characters before receiving any new printable characters.

Mark—The "standby" state in serial communications, a logic "one."

Parity—A quality of a binary number. Numbers having an even number of ones are said to have *even parity*, all other numbers have *odd parity*. A "parity bit" may be added to a binary number, for instance to a 7-bit ASCII character representation, and by selectively setting that added bit high or low, any desired parity may be generated.

Recognition character—A pre-arranged character used to initiate a serial-communications link. Many large time-sharing systems sense the calling station's baud rate from that character. Commonly used characters include "carriage return," "control-C" and "control-A."

RS-232C—A serial-communications standard in which 25 separate control, handshaking, data, and power connections are defined. Logic levels for data transmissions are nominally -12 volts for a logic one and +12 volts for a logic zero. Normally, only a few of the 25 lines are used. A 25-pin "D" connector is standard in this system.

Space—A logic "zero" in serial communications.

Stop bit—A mark (logic "one") that indicates the end of a character in asynchronous serial transmissions. The combination of that bit and the required start bit (a space) guarantees a change of state at least twice per character. Note that 110-baud transmissions frequently require two stop bits. At most other standard speeds, one stop bit will usually be acceptable.

Synchronous—Serial communications in which data is transmitted blocks (usually about 100 characters) with new synchronizing information (framing characters) sent only once with each new block. See **asynchronous**.

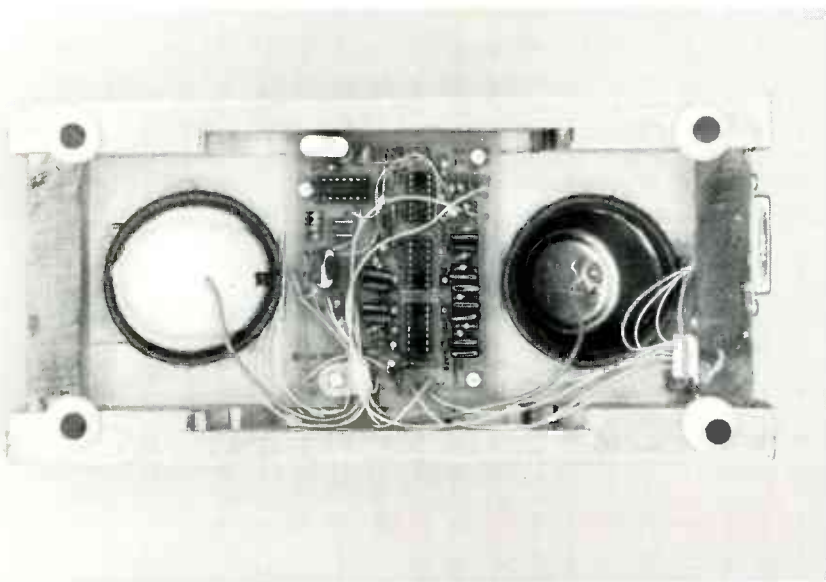

FIG. 16—EIGHT OF THE NINE two-letter commands used in the terminal emulator select the options.

Table 1 summarizes the assignment of frequencies. The modem converts the incoming logic levels into the proper frequencies and vice-versa.

The modem is also equipped with buffers to translate an incoming trans-

mission's signal levels to logic levels compatible with its own circuitry. It also includes filters that enhance the accuracy of the encoding and decoding sections and buffers that convert the output signals to levels compatible with the

TABLE 1

State	Channel	
	Originate	Answer
0 (mark)	1070 Hz	2025 Hz
1 (space)	1270 Hz	2225 Hz

serial port.

Note that the only signal connections between the computer's serial port and the modem are SERIAL DATA IN and SERIAL DATA OUT.

When coupled with a suitable software package, the hardware can provide a wide range of capabilities, from a simple but useful terminal emulator (to be discussed next month) to a slave or master-slave station in a complex data network. The latter includes provisions for dumping large data blocks in both directions over the link and for passing control characters that allow the distant machine to control or be controlled by the local machine.

We'll continue our look at the software needed to control the modem next month. Among the things that we'll present is a terminal emulator to allow your computer to communicate via the modem.

R-E

Error-Correcting Hi-Fi Amplifier

AT THE 65TH CONVENTION of the audio Engineering Society, two engineers from the Sansui Company (1250 Valley Brook Ave., Lyndhurst, NJ 07071), presented a paper entitled "Design and Construction of a Feedforward Error-Correction Amplifier." Some time later, S. Takahashi and S. Tanaka, the two engineers involved, reduced that mathematically complex presentation to somewhat simpler form and, at the Consumer Electronic Show held in Chicago in June 1980, Sansui actually demonstrated a prototype of a "feedforward" amplifier.



Though older than negative feedback, feedforward is the latest in distortion reduction.

LEN FELDMAN
CONTRIBUTING HI-FI EDITOR

In order to understand the concept of feedforward error-correction or distortion-elimination in an audio amplifier, it would be best to make a brief review of the principles behind the better-known negative-feedback techniques that were being used in audio amplifiers before the term "high fidelity" existed. Negative feedback is used in just about every hi-fi amplifier sold today to improve performance. Properly used, negative feedback can improve the signal-to-noise ratio of an amplifier; the damping factor of an amplifier (making it higher); the amplifier's input impedance, and (probably most important of all) it can reduce distortion.

Figure 1 shows how negative feedback, as applied to audio amplifiers, works. Input signal V_1 is amplified by amplifier A. The amplifier also generates a certain amount of distortion, shown in Fig. 1 by the tall spike labelled (1). Negative feedback, applied through network B, returns some of that distorted signal, out-of-phase, back to the input of the amplifier where it is amplified again, partially cancelling the total distortion at the output. The out-of-phase feedback distortion component is labelled (2) in Fig. 1, while the net distortion at the output is designated as (3).

In theory, distortion is reduced to a value determined by:

$$\frac{1}{1 + (A)(B)}$$

where "A" is the gain of the amplifier and "B" the feedback factor (expressed

as a decimal fraction). What that means is that distortion would disappear completely *only* if the amount of feedback, $1 + (A)(B)$ were *infinite*. For one thing, if infinite feedback were applied to an amplifier, it could no longer be called an amplifier because it would have no gain from input to output. Furthermore, for practical amplifier design, a stable application of even moderate amounts of negative feedback requires a phase-compensation circuit consisting of reactive elements such as capacitors. Those phase-compensating networks reduce the effective amount of feedback at higher frequencies. This means that at higher frequencies, distortion is reduced less by negative feedback. Typically, solid-state amplifiers using high levels of negative feedback tend to

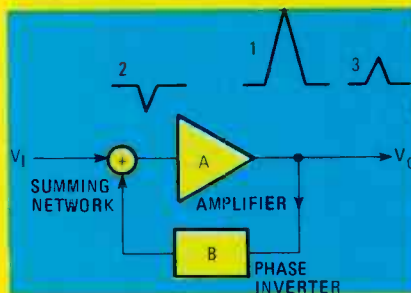

FIG. 1—IN NEGATIVE FEEDBACK, part of the distorted signal is inverted, returned to the amplifier input, and summed with V_1 partly cancelling the total distortion.

have higher levels of distortion at high frequencies than they do at low and mid-frequencies.

It has also been shown in recent studies that, while high levels of negative feedback tend to reduce static forms of distortion—such as harmonic distortion—as predicted by the formulas, they can lead indirectly to the introduction of other, dynamic forms of distortion like TIM (Transient InterModulation) distortion. Dynamic distortion may be more annoying audibly than static distortion; static distortion is more easily measured.

Another technique for reducing distortion in amplifiers, called feedforward,

was postulated by H.S. Black in 1928. That's the same H.S. Black, incidentally, who developed the negative-feedback theory in 1937. The idea of feedforward is actually much older than the more widely known and generally used negative-feedback distortion-correction approach.

Using the feedforward concept in an actual amplifier could not be done, unfortunately, until audio engineers had solved a number of important practical problems. According to the two Sansui engineers who have now come up with a practical feedforward amplifier design, the technique offers the following important advantages:

1. Virtually complete cancellation of many kinds of distortion over a wide frequency range, and,
2. Stable operation with no danger of self-oscillation.

In order to design an amplifier using the feedforward technique, several problems had to be solved. Calculations for complete and correct cancellation of output distortion had never been developed. Earlier theoretical designs of feedforward amplifiers were based upon a bridge or one-pole compensation network, but actual amplifiers use a two-pole compensation network at higher frequencies. It was thought that application of feedforward to output stages would result in a loss of output power. Additionally, it was thought that feedforward could reduce distor-

tion only over a very narrow range of frequencies and therefore that it would not be much better than negative feedback—and perhaps not even as effective.

A solution

Sansui claims to have solved the problems associated with feedforward amplifiers. Their new feedforward amplifier is a hybrid configuration of negative feedback and feedforward techniques and is the first practical use of feedforward theory in an actual working amplifier.

Figure 2 shows the operating principle of Sansui's new feedforward amplifier. Amplifier A is the driver stage (with two-pole compensation). Amplifier A0 is the power stage of the amplifier. Error-correction amplifier A1 provides the feedforward correction signal. (The use of an error-correction amplifier had not been considered previously.) In operation, an input signal passes through the driver stage, through the power-output stage, and to load R_L . The negative feedback loop, B, returns the distortion components of the signal (out-of-phase) to the input of the driver stage as it would in any conventional negative-feedback amplifier. At the output of the driver stage, the feedforward amplifier

A1 picks up the audio and the out-of-phase distortion components. After amplification, they are fed through the combining network Z1. The purpose of that network is to insure correct amplitude and phase relationships between the error-correction amplifier and the output stage over a wide frequency-range.

Any distortion generated in the amplifier-output stage, A0, that has not been cancelled by negative feedback is introduced into the error-correction amplifier A1 with its phase reversed. When the two signals (the main signal and the error-correction signal) are combined in summing networks Z1 and Z2, the distortion components cancel out because the error-correction signal is out-of-phase with—but equal in amplitude to—the remaining distortion components at the output of the power stage A0.

In the actual circuit, Z1 is a capacitive network used to speed up the distortion component while Z2 is an inductor used to delay the output of the main amplifier (see Fig. 3). The design of the summing networks is critical because the phase and amplitude relationships of the distortion components must be uniform over a wide frequency range if proper distortion cancellation is to occur.

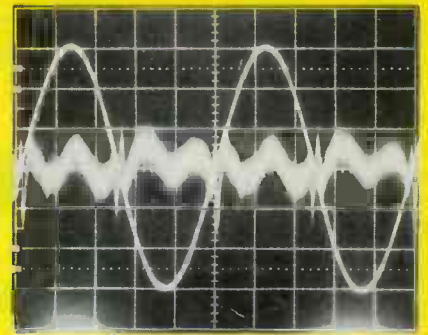

FIG. 4—A NEGATIVE-FEEDBACK AMPLIFIER'S output waveform with residual distortion shown as a secondary trace (at center). The amplifier is delivering 100 watts into an eight-ohm load at a frequency of 20 kHz.

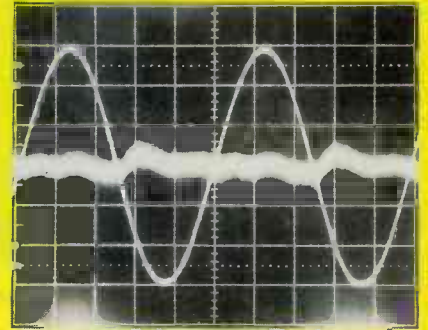

FIG. 5—THE OUTPUT (and residual distortion) of an amplifier using Sansui's feedforward design. The test conditions are the same as in Fig. 4.

A more graphic illustration of what takes place in the feedforward amplifier is shown in Fig. 3. As in Fig. 1, distortion (1) is generated by the power-output stage, A0. Reverse-phase distortion (2) reaches the input of A0 through the normal negative-feedback loop, B, and driver-stage A. Waveform (3) represents the reduced (but not quite eliminated) distortion appearing at the output of power-stage A0 after application of negative feedback.

In addition to the partial correcting effects of the negative-feedback system, error-correction amplifier A1 passes along the detected distortion, as represented by (4). This distortion component is time-aligned and attenuated by the resistance and capacitance elements identified as X1. Meanwhile, the phase and amplitude of the distortion (3) appearing at the output of A0 are adjusted (by the reactive and resistive elements identified as X0) so that the distortion signal is equal in amplitude but opposite in phase to the distortion component (5) appearing at the output of the error-correction amplifier A1 and its summing elements. Addition of the distortion components (3) and (5) results in their complete cancellation at the output point, V_O .

The mathematical impossibility of using ordinary negative feedback to eliminate distortion completely can be shown by the following relationships (refer to Fig. 1):

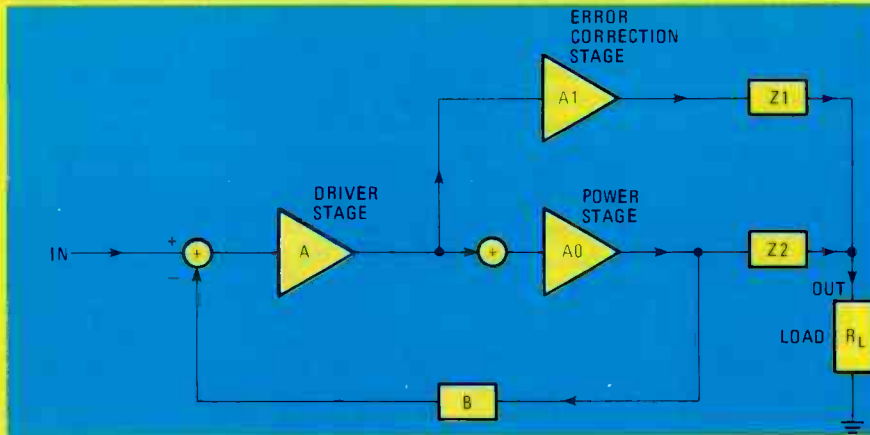

FIG. 2—SIMPLIFIED BLOCK DIAGRAM of Sansui's new amplifier shows that it is a hybrid design, combining feedforward and negative-feedback techniques.

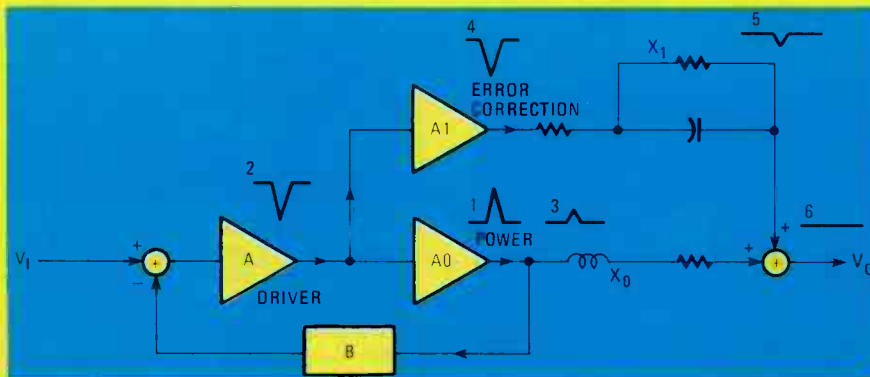

FIG. 3—THE DISTORTION COMPONENTS of the output of amplifiers A1 and A0 are equal in amplitude but opposite in phase. After conditioning by the phase-modification networks, X0 and X1, the outputs are summed, cancelling the distortion.

$$V_o/V_i = \frac{A}{1 + (A)(B)}$$

$$\text{When } A \gg 1, V_o/V_i = \frac{1}{B}$$

Since the ratio of V_o/V_i can never be exactly equal to $1/B$ (but only nearly equal to it) distortion can never be zero.

By contrast, consider the situation that exists in the feedforward circuit represented by Fig. 3.

$$\begin{aligned} V_o/V_i &= \frac{(A)(A1)(X1) + (A)(A0)(X0)}{1 + (A)(A0)(B)} \\ &= \frac{\frac{(A1)(X1)}{X0} + A0}{\frac{1}{(A)(B)} + A0} \times \frac{X0}{B} \end{aligned}$$

When $X0/X1 = (A)(B)$, $A1 = 0$, and $V_o/V_i = X0/B$.

The equations balance, and the distortion is "zero."

Distortion improvement in a practical amplifier

Figures 4, 5, 6, and 7 show several comparisons of amplifier distortion with and without the feedforward circuitry. In Fig. 4 we see a 20-kHz waveform when the amplifier under test is delivering 100 watts of power into an 8-ohm load. The residual distortion present in this output is superimposed on the oscilloscope photo and is represented by the horizontal secondary trace at the center of the screen. In Fig. 5 we see an oscilloscope photo taken under the same test conditions, but this time the test amplifier uses Sansui's feedforward technique. If you were to measure the total distortion, using a meter-type distortion analyzer, the distortion figure would not be that different at this test

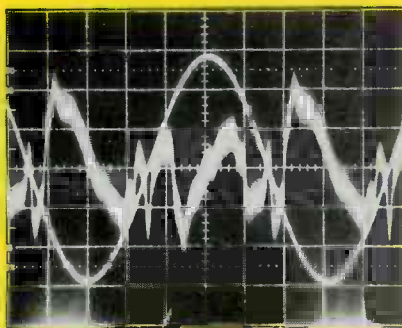

FIG. 6—NOTE THE SEVERE RESIDUAL DISTORTION of a negative-feedback amplifier that has been deliberately driven to very high distortion levels.

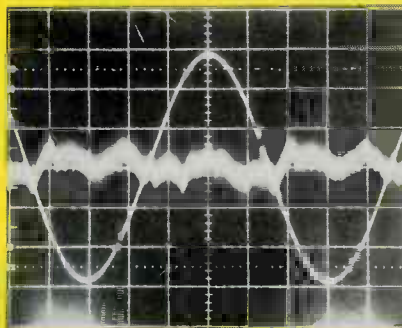

FIG. 7—OUTPUT of a feedforward amplifier when it is driven to the same level as the amplifier in Fig. 6. Note the difference in the residual distortion trace.

frequency, especially if a low-pass filter were placed between the output of the amplifiers and the input to the distortion analyzer. Yet when we compare the actual waveforms of the two amplifiers it is evident that the feedforward amplifier (Fig. 5) shows none of the switching distur-

tion that was evident in Fig. 4 (the spikes that are seen in the waveform every time the output sine wave crosses the zero axis).

Figure 6 shows the same test condition and test signal as the earlier photos, but this time the amplifier has been deliberately driven to higher distortion levels. Figure 6 shows the output of a conventional amplifier with negative-feedback distortion-reduction circuits. Figure 7 shows the output waveform when Sansui's feedforward circuitry is used. Even when deliberately driven to higher levels, distortion has been almost completely cancelled by the feedforward approach.

According to Sansui's engineers, the feedforward technique should find widespread use in audio amplifiers, since feedforward circuitry, added to an amplifier using conventional negative feedback, can help eliminate some of the last vestiges of distortion that remain in most audio amplifiers. Among Sansui's innovations in the design of this new amplifier are:

1. A feedforward configuration based on two-pole compensation that is found in existing amplifiers.
2. An output summing-network designed for exact adjustment of phase and amplitude to achieve full distortion-cancellation.
3. An error-correction amplifier with good linearity to isolate the feedforward circuitry from external loading-factors.

All of that makes this an interesting new amplifier design that other audio equipment manufacturers may well want to investigate for possible use in their products. R-E

What's News

Programmable circuitry aids very large scale integration

A number of factors are now leading to a new generation of semiconductor technology, very large scale integration (VLSI), reports Texas Instruments. The most important one is probably the increasing number of active element groups—logic gates, memory bits, etc.—that can be put on a single chip.

Two factors oppose VLSI. As the complexity of the circuit increases, the time and cost of circuit design multiplies. And as the circuit becomes more sophisticated and complex, the number of applications for it decreases. At the limit of VLSI technology, a special unit would be needed for each application. The high design costs for such sophisticated processors would mean that only applications in which extremely large numbers of identical units could be used would be practical.

Those design costs can be reduced fantastically by a new approach: solid-state programming, says TI. In the new class of programmable components, the architec-

ture of the unit remains essentially the same until the final stage of manufacture. Then the last mask or masks are so designed as to fit the unit to the functional specifications of a required application. That is expected to offer a cost improvement of 15 to 1 over the same system implemented in standard LSI circuitry, but now custom-designed throughout for a given application.

TI sees a situation where "logic-array masters" are produced and stockpiled. The final programming step—the customizing—would be added in the final two metallization steps, with design costs as low as a third that of the custom-designed product.

Where production volumes are very large, the custom logic designs may, of course, continue to hold their own.

Florida seeks improvement in highway speed radar

A special commission set up by the Florida legislature to evaluate its new

police-radar law, and suggest modifications if desirable, has come up with a proposal—by one member of the commission—that the present law should be strengthened, even if it means guidelines more stringent than those that have been developed by the federal government.

Yet some witnesses testified that equipment which can measure up even to those standards is very difficult to find. Professor Lee S. Nichols of the Virginia Military Institute contends that although there are approximately 70,000 radar units in use: "There are no radar units on the road today that will meet the specifications of the federal study."

Operator training was found to be needed as much as equipment improvement. Ron Eagle of the National Traffic Safety Administration stated that the Administration intends to publish a mandatory training program, based on the results of a recent National Bureau of Standards study, that would include 24 hours of classroom instruction and 16 hours of on-the-road practical training. NRTSA also plans to compile a Qualified Products list, which would include only those radar units that meet the Federal specifications established by the NBS study.

EQUIPMENT AND TRAINING NO OTHER SCHOOL CAN MATCH.

**NTS HOME TRAINING INVITES YOU TO EXPLORE MICROCOMPUTERS,
DIGITAL SYSTEMS AND MORE, WITH STATE-OF-THE-ART EQUIPMENT
YOU ASSEMBLE AND KEEP.**

Without question, microcomputers are the state of the art in electronics. And NTS is the only home study school that enables you to train for this booming field by working with your own production-model microcomputer.

We'll explain the principles of troubleshooting and testing your microcomputer and, best of all, we'll show you how to program it to do what you want.

You'll use a digital multimeter, a digital logic probe and other sophisticated testing gear to learn how to localize problems and solve them.

Send for the full color catalog in the electronics area of your choice—discover *all* the advantages of home study with NTS!

NTS also offers courses in Auto Mechanics, Air Conditioning and Home Appliances. Check card for more information.



We believe that training on production-model equipment, rather than home-made learning devices, makes home study more exciting and relevant. That's why you'll find such gear in most of NTS's electronics programs.

For instance, to learn Color TV Servicing you'll build and keep the 25-inch (diagonal) NTS/HEATH digital color TV.

In Communications Electronics you'll be able to assemble and keep your own NTS/HEATH 2-meter FM transceiver, plus test equipment.

But no matter which program you choose, NTS's Project Method of instruction helps you quickly to acquire practical know-how.



Simulated TV Reception

4.

3.

1. The NTS/Rockwell AIM 65 Microcomputer A single board unit with on-board 20 column alphanumeric printer and 20 character display. A 6502-based unit 4K RAM, expandable.
2. The NTS/KIM-1 Microcomputer A single board unit with 6 digit LED display and on-board 24 key hexadecimal calculator-type keyboard. A 6502 based microcomputer with 1K RAM, expandable.
3. The NTS/HEATH H-89 Microcomputer features floppy disk storage, "smart" video terminal, two Z80 micro-processors, 16K RAM memory, expandable to 48K.
4. The NTS/HEATH GR-2001 Digital Color TV (25" diagonal) features specialized AGC-SYNC muting, filtered color and new solid-state high voltage tripler rectifier.

NTS NATIONAL TECHNICAL SCHOOLS

TECHNICAL-TRADE TRAINING SINCE 1905
Resident and Home-Study Schools
4000 SO. FIGUEROA ST., LOS ANGELES, CA. 90037

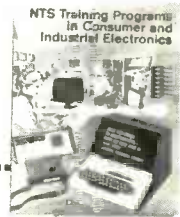

NATIONAL TECHNICAL SCHOOLS

4000 South Figueroa Street, Dept. 206-071
Los Angeles, California 90037

Please rush FREE color catalog on course checked below

- | | |
|---|---|
| <input type="checkbox"/> MicroComputers/MicroProcessors | <input type="checkbox"/> Auto Mechanics |
| <input type="checkbox"/> Communications Electronics | <input type="checkbox"/> Air Conditioning |
| <input type="checkbox"/> Digital Electronics | <input type="checkbox"/> Home Appliances |
| <input type="checkbox"/> Industrial Technology | <input type="checkbox"/> Color TV Servicing |

Name _____ Age _____

Address _____

Apt. _____ City _____

State _____ Zip _____

- Check if interested in G.I. information.
 Check if interested ONLY in classroom training in Los Angeles.

BUILD THIS

Part 2 THIS MONTH WE'LL conclude our look at the Lumitron-4 light sequencer, test the unit, and finish up by giving you some ideas for a lighting display.

Figure 9 shows suggested case dimensions and provides a drilling-guide for holes for the switches, pots, and LED's.

The LED's, used to monitor output-channel activity, are press-fit into their mounting holes and their leads connected to a terminal strip. The 330-ohm current-limiting resistor for each LED is connected directly between the cathode lead and the appropriate location on S6 (refer to Fig. 4).

The last board to be mounted should be the one holding S6. It should be positioned so that switch S6-a is at the left when the switch assembly is viewed from the front of the cabinet. Use spacers at least 3/8-inch long when mounting the switch board in the cabinet.

The power supply (Fig. 10) uses a wall-plug transformer for safety and space-saving reasons. The full-wave bridge rectifier (BR1), filter capacitors, and voltage regulator are all wired to one terminal strip inside the control-unit cabinet. On the same terminal strip is the audio-input coupling capacitor. All audio-circuit connections should be made using shielded cable.

The wiring connections to S6, the panel-mounted components, and the card socket are best made using ribbon cable. For ease of wiring, it is recommended that the socket for the control-

VERSATILE LIGHT SEQUENCER

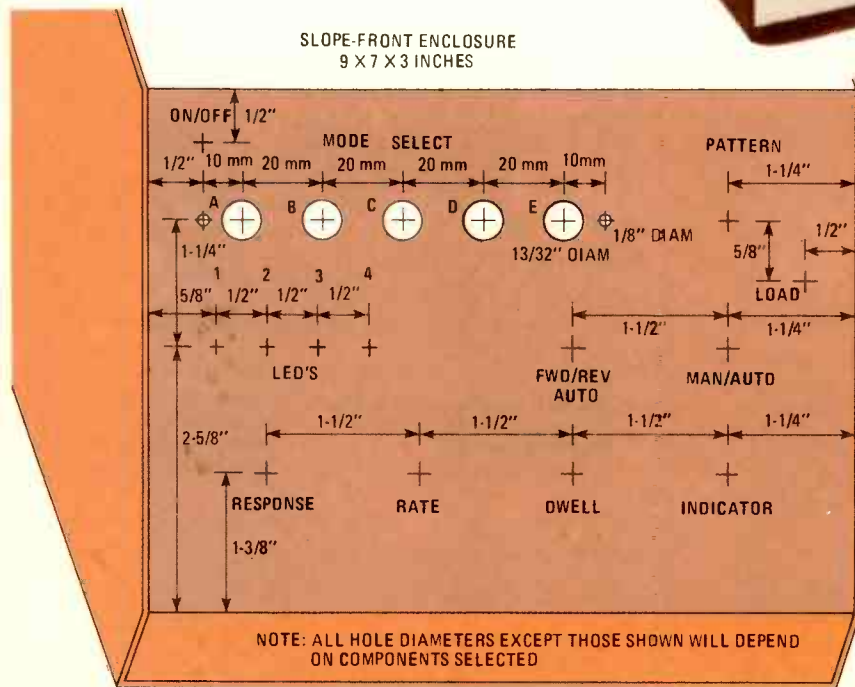

unit board not be mounted until all wiring to it has been completed. In the prototype, the card socket was mounted horizontally using 5/8-inch threaded spacers placed at a height of 5/8-inch from the enclosure bottom. This height was chosen to allow the use of another 5/8-inch threaded spacer to support the center of the circuit card. Figure 11 shows the completed control unit.

The schematic in Fig. 12 shows one of the four power-switching unit sections. A foil pattern for the complete unit is provided in Fig. 13, and a parts-placement diagram in Fig. 14.

The assembled power-switching unit is shown in Fig. 15.

(It is also possible to use solid-state zero-crossing relays in place of the triacs and triac-drivers. In that case, wire all the relays' "+" terminals together and connect them to the +5-volt control-signal lead from the control unit. Connect the "-" terminal of each relay

FIG. 9—USE THIS as a drilling guide for the control unit's front-panel components.

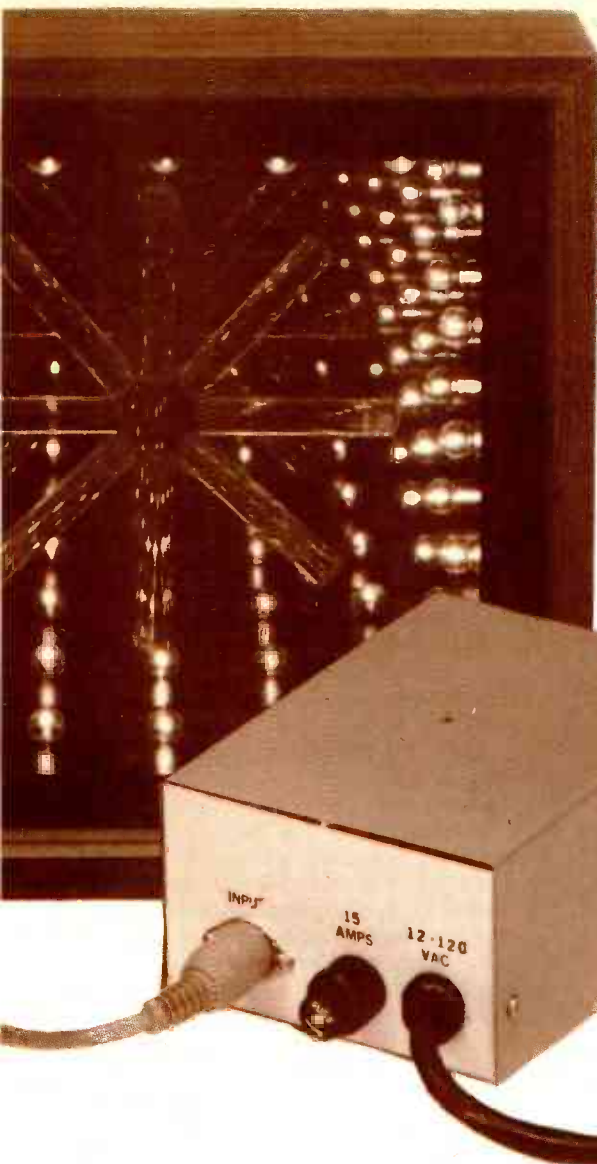

More on the Lumitron-4 four-channel light controller and instructions for building an eye-catching light display.

DAVID L. HOLMES

to the appropriate-channel signal-lead.) As with any construction project, steps should be taken to insure that the Lumitron-4 is safe to operate when completed. Be sure that adequate heat sinking is provided for the triacs. Also be sure that the power source is adequate to power all four channels operating all lights simultaneously. For a 15-ampere, 117-volt circuit, a maximum wattage of 450 watts per channel should be allowed. The permissible wattage increases to 600 watts per channel for a 20-amp circuit. The rating

of fuse F1 should be chosen in accordance with the total load. Under certain conditions, you may wish to operate the light display at less than full intensity. Two circuits that will permit that are shown in Fig. 16. The one in Fig. 16-a changes the brightness of the entire display while the circuit in Fig. 16-b allows independent control of each channel. Standard household-type dimmers may be used but be absolutely certain—especially in the first case—that they can safely handle the power.

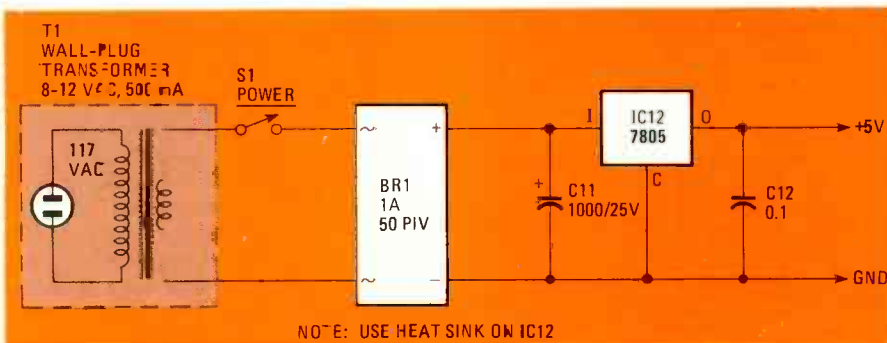

FIG. 10—VE-VCLT POWER SUPPLY for control unit uses wall-plug-type transformer. Supply is built on terminal strip using point-to-point wiring.

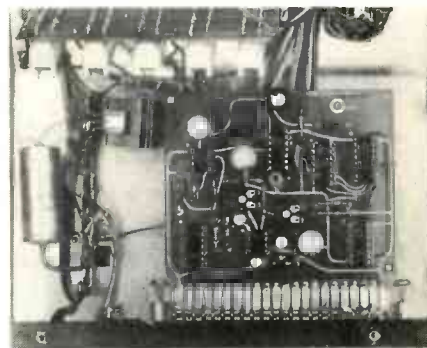

FIG. 11—COLOR-CODED RIBBON CABLE makes connections neater and easier and simplifies signal tracing.

Operation

The control unit may be operated and tested with the aid of the console LED's and does not require connection of the power-switching unit. Before turning on the control unit, rotate all variable controls to their full counter-clockwise position, place the FORWARD/REVERSE switch in the FORWARD position, set the indicator switch to the MANUAL position, set the PATTERN-SELECT switch to pattern "D" and depress MODE-SELECT switch A. Turn the unit on and verify that all console LED's light steadily.

Next, depress MODE-SELECT control switch E and verify that one LED at a time is lit and that the LED's light sequentially in one direction. The rate of movement should vary as the RATE control is rotated clockwise. Moving the PATTERN-SELECT switch to a new position and depressing and releasing the LOAD button should cause a new light pattern to be displayed. The light patterns available include: one light, two adjacent lights, every other light, and three lights. Setting the MANUAL/AUTO switch to the AUTO position should cause the light pattern to change automatically, with the time between changes increasing as the DISPLAY control is rotated clockwise.

The modes controlled by MODE-SELECT switches B, C, and D require an audio signal of at least 50 millivolts for proper operation. With the RESPONSE control still in the full counter-clockwise position, depressing switch C should not affect the light movement. Rotating the RESPONSE control clockwise should eventually cause the light pattern to move in sync with the audio signal. Depressing switch B should cause the intensity of all the LED's to change in sync with the audio signal. When switch D is depressed, the light pattern should move at a constant rate, but the intensity of the display should

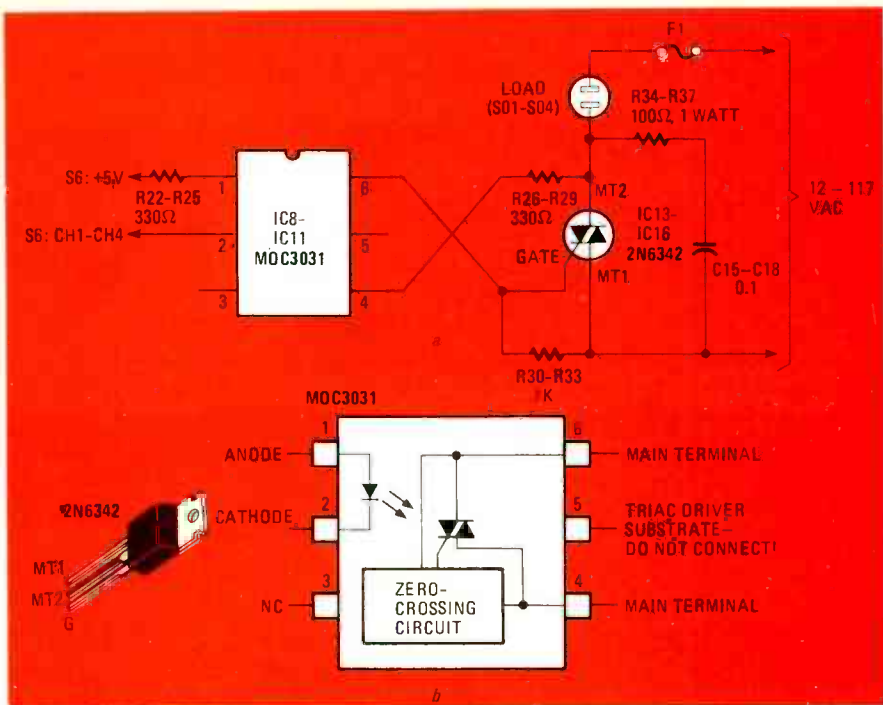

FIG. 12—ONE OF THE FOUR sections of the power-switching unit is shown in a. Pinouts of triac and optoisolated zero-crossing triac driver are shown in b.

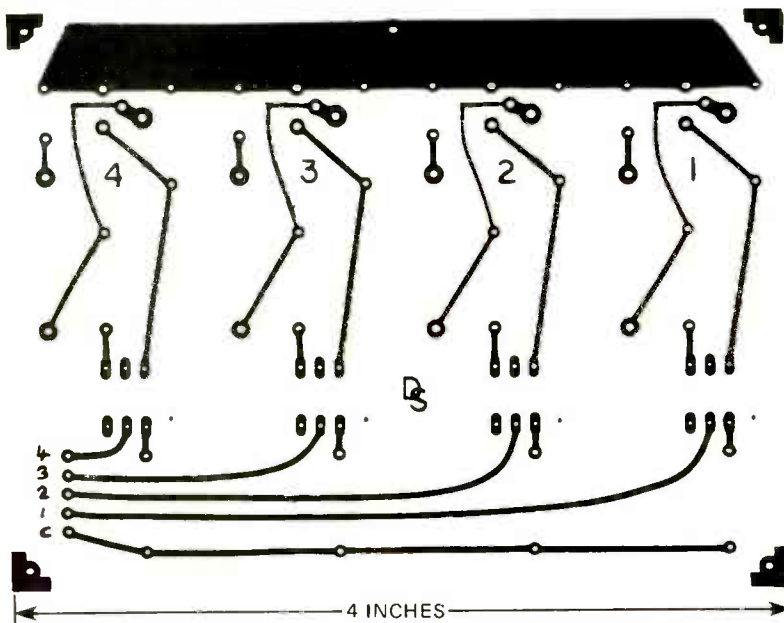

FIG. 13—POWER-SWITCHING UNIT is constructed on single-sided PC board.

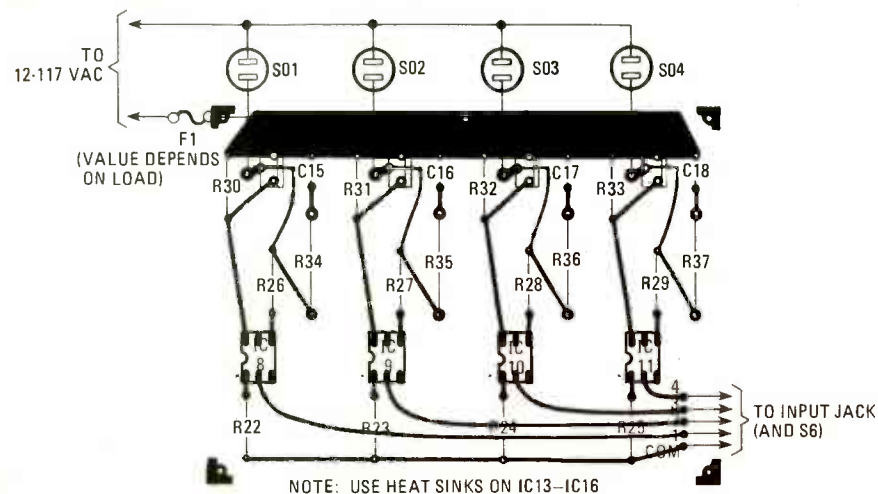

FIG. 14—SIX-PIN TRIAC DRIVERS are inserted into eight-pin IC sockets with pins 4 and 5 removed.

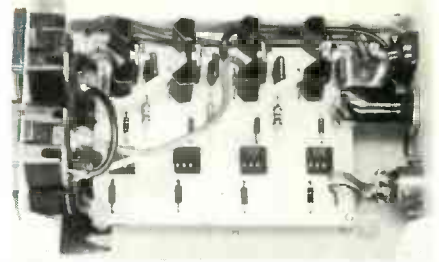

FIG. 15—IT IS IMPORTANT that triacs be heat-sunk, especially if heavy loads are to be driven.

fluctuate with the audio signal. For any mode where the light pattern is moving, positioning the FORWARD/REVERSE/AUTO switch in the AUTO position will cause the pattern to change directions periodically. The DWELL control determines the time interval between changes.

Releasing all MODE-SELECT switches will cause the light display to go off but it will reappear as soon as a mode is selected.

The lowest signal level that the audio section will respond to may be set by adjusting R12. This is useful for normally high-level signals that would otherwise limit the sensitivity control to a very small movement before saturation of the audio section occurred. Potentiometer R10 may be adjusted to obtain the desired balance between sound-sync chase, and intensity of fluctuation, for the same RESPONSE control setting.

After completing the functional check of the control unit, connect the power-switching unit to a light display consisting of at least one light per channel. The power-switching unit should be connected to a voltage source meeting the requirements of the lamps (i.e., 12 volts for 12-volt lamps, 117 volts for ordinary household lamps, etc.). Repeat all previous functional checks and verify that the light display connected to the power switching unit corresponds to the LED display of the console. One thing to keep in mind here is that the LED's may barely be visible when the light display is bright.

Lighting display

Now that you've completed the Lumitron-4 and verified that the unit is operating properly, you need to devise an appropriate light display. The lighting display used with the device requires four separate lighting circuits. The fastest way to create a four-channel display is to obtain four strings of Christmas tree lights and tape them together in a bundle. The strings should be placed, one on top of the other, so that the first bulb of three of the strings fits between the first and second bulbs of the fourth string. The idea is to have every fifth bulb in the composite string on the same circuit.

In creating your own unique display,

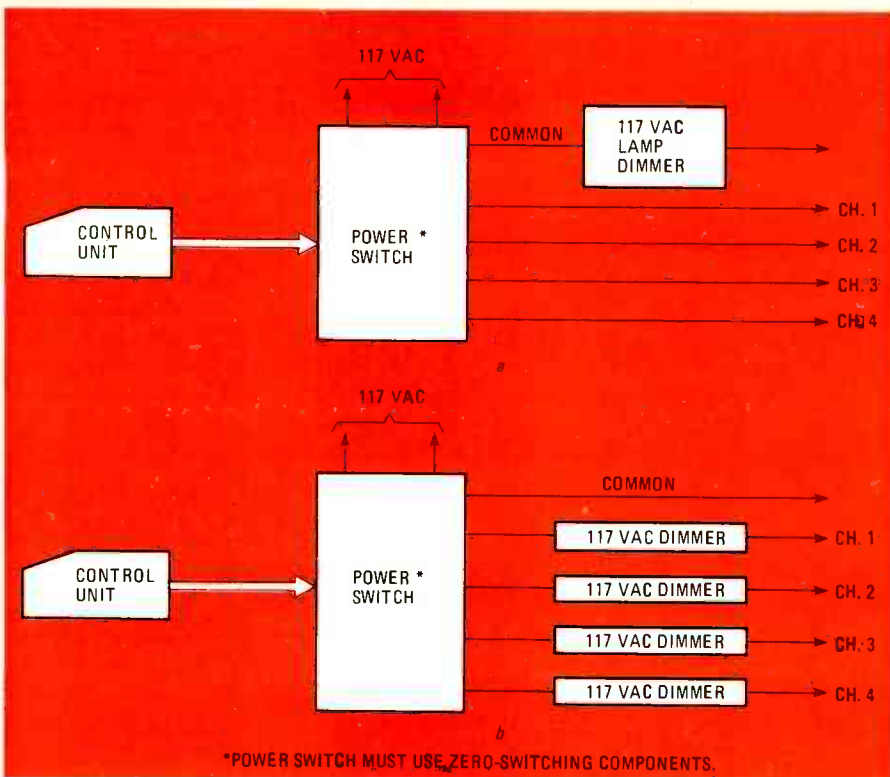

FIG. 16—OPTIONS FOR DIMMING Lumitron-4 display. All-channel dimmer is shown in a; individual-channel unit in b.

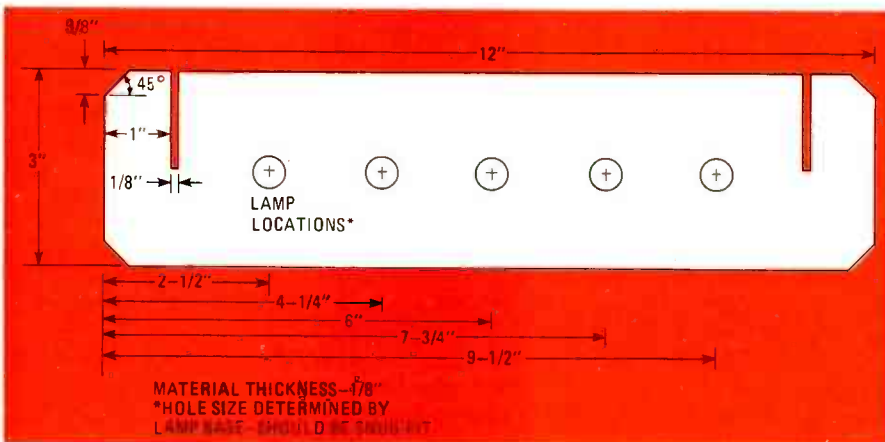

FIG. 17—FOUR OF THESE PIECES should be prepared to make square frame to hold infinity mirror's 12-volt lamps. Masonite is a good material to use.

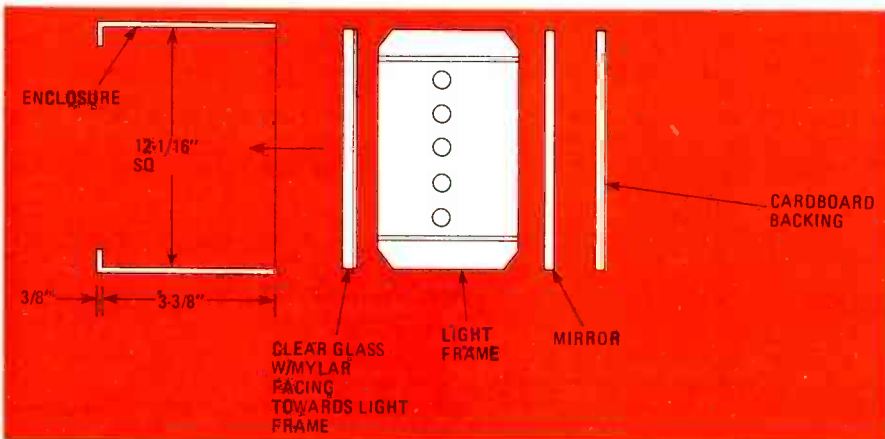

FIG. 18—EXPLODED VIEW of infinity mirror. A small notch will have to be cut or filed in the case to pass lines for lamps.

just remember to have every fifth bulb on the same circuit, and a common wire to all bulbs. Another very im-

portant point is that *the common wire must be able to carry enough current for all four circuits, operating all of the*

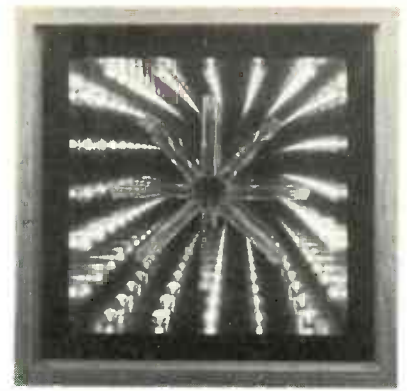

FIG. 19—INFINITY-MIRROR DISPLAY. Lamps may be clear or colored, according to taste.

bulbs simultaneously, when required.

A real eye-catching display that is rather easy to build involves the use of the "infinity-mirror" illusion that can be created with the aid of readily available Mylar sun-reflecting film. To construct the infinity-mirror you'll need a clear piece of glass (double-strength is recommended), a mirror the same size as the glass, a sheet of the Mylar reflecting-film, lights, and a frame to hold them, and a case. A convenient case size has inside dimensions of 12 1/16 x 12 1/16 inches, which allows the use of precut mirror squares and simplifies the construction of the display.

The Mylar film is applied to the glass and is trimmed flush, creating a "one-way" mirror that is placed in the display front with the Mylar film on the inside of the display. The light frame is inserted next, followed by the mirror square. It will be necessary to cut a notch in the case to allow passage of the light-display control leads around the mirror. Place a small piece of electrical tape on the edge of the mirror where it comes in contact with the control leads. Cut a piece of cardboard to fit over the back of the mirror and secure the entire assembly so that all pieces of the display fit snugly together within the case. Refer to Figs. 17 and 18 for construction details. Figure 19 shows the completed infinity mirror light display.

With the display activated, multiple reflections of the lights within the display will create an infinite-tunnel-of-lights illusion. The secret of this illusion is the Mylar film, because it partially transmits light to the outside of the display while reflecting a portion of it to the back mirror for re-reflection. Only the first row of lights seen in the display is real; the rest of the lights are reflections.

A lighting display comprised of multiple infinity mirrors is very effective and will add to your enjoyment of the Lumitron-4.

R-E

Using An Op-Amp As A Versatile Comparator

This simple circuit uses any common op-amp to form a comparator with variable hysteresis between two trip-points—one fixed and one movable.

JERALD GRAEME, Burr-Brown Research Corporation

AN OPERATIONAL AMPLIFIER IS A CONVENIENT DEVICE FOR ANALOG comparator applications that require two different trip points. The operation of a comparator is such that the output is high when the voltage at the positive (+) input is more positive than the voltage at the negative (-) input, and the output is low when the input conditions are reversed. By biasing one of the input terminals, the trip point can be shifted. The addition of a positive-feedback network will introduce a precise variable hysteresis into this switching action.¹ Such feedback develops two comparator trip points centered about the initial trip point that is equal to the reference (bias) voltage.

In some control applications, one trip point must be maintained at the reference level, while the other trip point is adjusted to develop the hysteresis. That type of comparator action is achieved with the modified-feedback circuit that is shown in Fig. 1.

Signal diode D1 blocks positive feedback when the comparator output is low and permits positive feedback through resistor R2 when the output is high. Thus, when the comparator output is low, the trip point of the comparator is determined by the reference voltage E_R . When the comparator output is high, the trip point is shifted by the addition of positive feedback through resistor R2. This second trip point is shifted from the original trip point by:

$$\Delta V = R1 \times (V_Z - E_R) / (R1 + R2)$$

where V_Z , the Zener voltage, is greater than reference voltage E_R . Varying resistor R2 will adjust the hysteresis without disturbing the trip point at E_R .

The circuit's other performance characteristics are similar to the common op-amp comparator circuit. The accuracy of both

Reference:

1. Tobey, G., Graeme, J., and Huelsman, L. *Operational Amplifiers: Design and Applications*, McGraw-Hill (1971)

© Copyright 1973, Burr-Brown Research Corporation
This is a reprint of a Burr-Brown application note entitled "Varying Comparator Hysteresis Without Shifting Initial Trip Point"

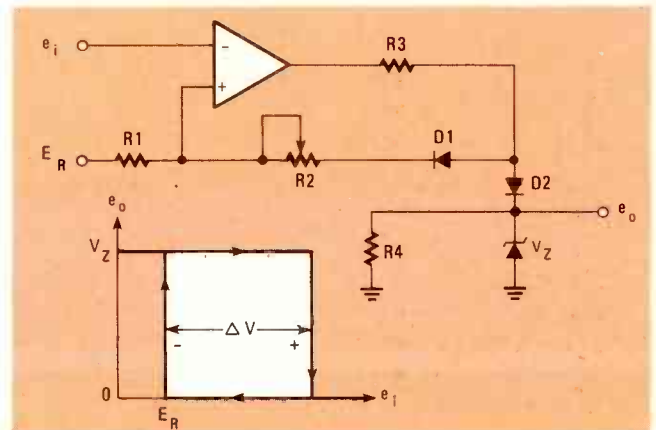

FIG. 1—CONTROLLING HYSTERESIS. Positive feedback circuit for analog op-amp comparator does not shift the initial reference trip point while introducing hysteresis in the second trip point. The voltage difference, ΔV , between the trip points can be adjusted by varying resistor R2. When the output voltage is taken from the Zener diode, as shown, it switches between zero and V_Z , the Zener voltage.

trip points is determined by the op-amp's input offset voltage, input bias current, and finite gain. Resistor R3 limits the current drain through the Zener diode, and resistor R4 provides a discharge path for the capacitance of diode D2.

The output signal can be taken either directly from the op-amp output or from the Zener diode, as shown. With the latter hookup, the output signal voltage alternates between zero and Zener voltage V_Z , which might be desirable for interfacing with digital logic circuits. It should be noted, however, that this output cannot sink current in the 0-volt state.

Switching speed is determined by the op-amp's slewing-rate limit for high-level input-drive signals. When the input drive is a low-level signal, the output rate of change is limited by the gain available to multiply the input signal's rate of change. Both the slew-rate limiting and the gain limiting of switching time are eased if phase compensation is removed from the op-amp. R-E

Radio- Electronics

BUILD FOR LESS THAN \$10
DIGITAL LOGIC PROBE

\$1.25 AUG. 1968

6 audio test accessories to build
Tuning in worldwide CW
Step-by-step TV # signa

**AVAILABLE — COMPLETE
for the FIRST TIME!**



BUILD YOUR OWN ROBOT!

Send today for your 52-page (8½ × 11") booklet containing complete reprints of all eleven articles in the Build Your Own Robot series by Jim Gupton.

This all-inclusive reprint gives you all the data you need to build your own Robot.

■ TELLS EVERYTHING YOU NEED TO KNOW to build the Unicorn-1 Robot without the need for an engineering degree or special equipment.

The robot is fully mobile with manipulator arms to grasp, lift and carry.

■ MANIPULATOR ARMS and end-effectors (hands) are what enable the robot to perform useful tasks. Details of construction techniques and considerations are fully explored.

■ MOBILITY BASE is not a lunar space station. It is the drive system that permits the robot to move from here to there. Full construction details along with a discussion of power sources is included.

■ THE BODY—FRAME AND ROTATION MECHANISM. This is the part that makes Unicorn-1 look like a robot. Wood and Formica are the materials for the body. Motors and gears are what make it function.

■ COMMUNICATIONS. How you can tell your robot what to do. Preprogramming techniques....radio controlcomputer control are all detailed.

■ SENSORS. How to add sensors so your robot doesn't bump into things.

**Radio-
Electronics**

Robot Reprints
200 Park Ave. South
New York, N.Y. 10003

I want to order _____ reprints @\$12.00 plus \$1.00 postage and handling for U.S., Canada and Mexico. Add 96¢ sales tax for New York State residents only. U.S. Funds only.

I want to order _____ reprints @\$12.00 plus \$3.00 Air Postage and handling for all other countries. U.S. Funds only.

Allow 6-8 weeks for delivery.

Please print

(Name)

(Street address)

(City)

(State)

(Zip)

We do not bill, check must be enclosed.

hobby corner

Some answers from our readers and more questions from the mailbag.

EARL "DOC" SAVAGE, K4SDS, HOBBY EDITOR

EVERY NOW AND THEN, IT'S NECESSARY to pause and catch up with your letters and cards. The mailbag has been unusually heavy lately and I don't want the stack to get any higher. So, we'll whittle it down a bit this month. But first I'd like to thank you for the interest that you have shown in Hobby Corner since it first appeared some four years ago. We have covered and uncovered a lot of ground in that time and your expressed interest has had many effects.

Your reactions have influenced the direction and content of this column. They still do so. I hope you will continue to let us know your thoughts, needs, and what you are doing. That way, Hobby Corner will be more likely to have topics that are of special interest to you.

You have always come through with solutions to the problems your fellow readers have encountered. This has been a perfect example of "someone has the answer to every question." Your help is appreciated by those who have the problems, and by the rest of us.

Another effect is a purely personal one. Your cards and letters have been the reason that this column is fun to write. When the fun goes out of something, it becomes just a task to do and get over with. For preventing that from happening: thanks.

On the subject of cards and letters, let me assure you that every one is read carefully and given full consideration. That is true whether the note is a question, an answer, a circuit to share, a complaint, a suggested topic, or anything else. Those of greatest general interest find their way into a future Hobby Corner.

So, keep the cards and letters coming and remember that those of you who enclose a self-addressed stamped envelope are most likely to get a direct reply.

Slave flash

Frank Eatherton asked for your help with a circuit for a wireless tripper for his photographic flash (**Radio-Electronics**, March 1981). Thanks to Mark Cipriano (Fulton, NY), Porter Holman (New York, NY), Harold Dahlquist (Mesa, AZ), and others, we can pass along the following information to all you photographers.

The whole job can be done with a very simple circuit and should cost you just two dollars, as compared with the 20 dollars or more that commercial units cost.

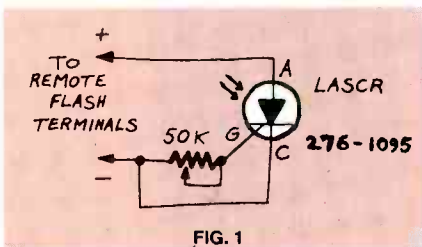

FIG. 1

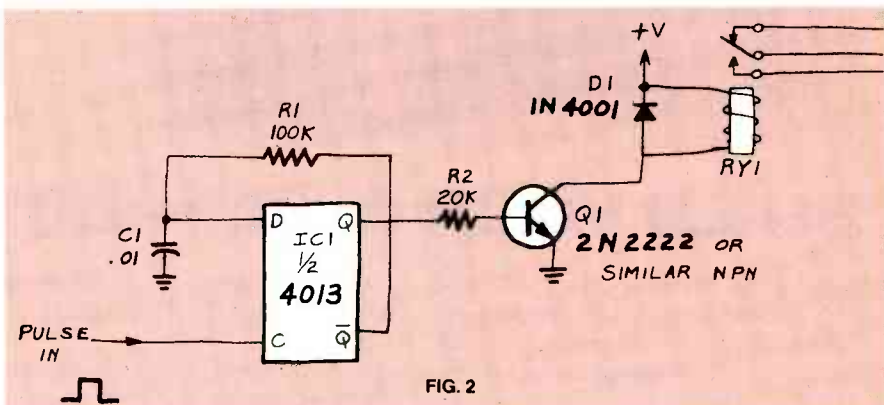

FIG. 2

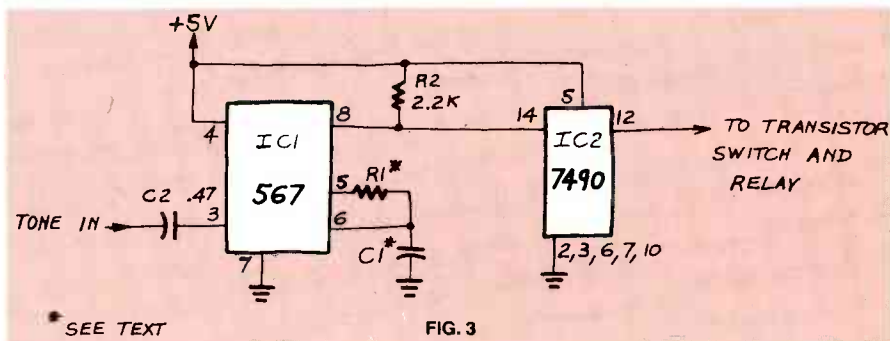

FIG. 3

The trigger circuit shown in Fig. 1 works by light. It is connected to the remote flash and, when the main flash fires, it detects the burst of light and fires the remote unit.

No batteries are required as operating voltage is taken from the flash. The 50K potentiometer lets you adjust the sensitivity of the device. It can be replaced by a fixed resistor if the adjustment feature is not needed. The LASCER (Light-Activated Silicon-Controlled Rectifier) can

be a Radio Shack 276-1095 as indicated or any equivalent 200-volt unit.

Readers have suggested building the trigger in a small film can, or in an opaque plastic or metal tube. H.C. Gernhardt, Jr. (Princeton, WV) suggests that you insulate the leads and put the components in a piece of heat-shrink tubing. One reader embedded his trigger in casting resin. In any event, the LASCER window must be pointed out through a hole in the case. Tom Lillevig (Cedar Rapids, IA) points out that ambient light has less effect if the window is shielded by a short piece of tubing.

In operation, when light of sufficient intensity falls on the LASCER window, it effectively short circuits the flash terminals. That fires the flash or strobe.

There you are, Frank—no wires to trip over even if you have a dozen slave flash-units around the studio.

Alternate on/off

The request from E.M. Shanley for a circuit to alternately open and close a relay on sequential control pulses (**Radio-Electronics**, March 1981) brought forth a barrage of responses. Of special interest is the fact that so many different

continued on page 66



Computer Peripherals



Amateur Antenna Tuner



Oscilloscopes



Giant screen projection TV



Rechargeable Camp Light



Educational Programs



Chart Recording Depth Sounder



R/C Gear



Computerized Weather Station

AI-In-One Computer



Dual Wattmeter



Hand-held Digital Multimeter



Groundtrack Metal Locator



Digital Electronic Scale



Car Thermometer



One-button Phone Dialer



Pro-Series Components



Speedometer/Tachometer



4-band Shortwave Radio

FREE HEATHKIT® CATALOG



400 electronic kits: test instruments, computers, amateur radio gear, electronic educational programs, color televisions, stereo components, R/C gear, home products, energy conservation devices, marine and aviation gear, and more — things you've always wanted and needed, now at low kit prices from Heath.

Discover the fun of kit building — it's a great way to relax in your spare time and share a rewarding

pastime with your whole family. The useful items you build will reflect the pride of your craftsmanship, too. The famous Heathkit illustrated manuals make it easy for anyone to build reliable, professional-quality kits.

SEND FOR YOURS NOW!

The 104-page catalog is Free! If coupon is missing write: Heath Company, Dept. 020-792 Benton Harbor, MI 49022

Heathkit Heath Company, Dept. 020-792 Benton Harbor, MI 49022

Send my free Heathkit Catalog now. I am not currently receiving your catalog.

Name _____

Address _____

City _____ State _____

CL-727 _____ Zip _____

FREE CATALOG

Heathkit products are displayed, sold and serviced at Heathkit Electronic Centers* nationwide. Consult your telephone directory white pages for location. *Units of Veritechnology Electronics Corporation. Some retail prices may be slightly higher.

CIRCLE 11 ON FREE INFORMATION CARD

Remove Vocals

Remove the lead vocal and substitute your own voice with most stereo recordings using our new, low cost VOCAL ZAPPER™. Great for practice, professional demos or just for fun.

WITH THE

VOCAL ZAPPER™



FROM

PAIA Electronics, Inc.

1020 W. Wilshire, Oklahoma City, OK 73116 - (405)843-9626

- Rush my Vocal Zapper Kit, \$24.95 plus \$3 postage & handling enclosed.
- Send assembled Vocal Zapper, \$39.95 plus \$3 postage & handling enclosed.
- Send Free Catalog

name _____
 address _____
 city _____ state _____ zip _____
 Visa MC card no. _____

PAIA Electronics, dept. 7R, 1020 W. Wilshire, Okla. City, OK 73116

CIRCLE 20 ON FREE INFORMATION CARD

RADIO-ELECTRONICS

68

High stability crystals for frequency or time. Use the best.

- CB
- 2 meter
- Scanners
- Industry
- Marine VHF
- CB Standard
- Amateur Bands
- General
- Communication
- Micro processor crystals

Send for our latest catalog
 Write or phone for more details

Jan Crystals
 P.O. Box 0607
 Ft. Myers, Florida 33906
 All phones (813) 936-2397

easy to charge

CIRCLE 19 ON FREE INFORMATION CARD

static dissipation (a grounding lug is included) and long-term, reliable performance. The MDD-series is available in 1, 5, and 10-channel versions.

The model MDD-1 (1 channel) is priced at \$21.85; the model MDD-5 (5 channels) costs \$83.43, and the model MDD-10 (10 channels) is \$160.45.

The WK-7, a new kit of DIP IC extractors to accommodate all IC's from 14-40 pins, consists of extractors EX-1 for 14-16 pin devices, and EX-2 for 24-40 pin chips, plus inserters MOS-1416, MOS-2428, and MOS-40 for 14-16, 24-28, and 36-40 pin IC's respectively. The WK-7 is priced at \$29.95.—OK Machine and Tool Corporation, 3455 Conner St., Bronx, NY 10475.

TELEVISION TUNER SUBSTITUTE, the Mini-Substi-Tuner, is a 300-ohm, VHF testing replacement tuner. It comes with the IF connector cable, plug, and is powered by two 9-volt batteries. There are 12 VHF channels, an on/off switch, AGC control, and an LED indicator. The Mini-



CIRCLE 155 ON FREE INFORMATION CARD

Substi-Tuner will save the TV technician hours of trouble-shooting and repair time where there are tuner problems within the VHF circuit of a television set. The Mini-Substi-Tuner is priced at \$24.95.—Tuner Service Corporation, 537 South Walnut St., Bloomington, IN 47401.

DIGITAL THERMOMETERS, Series 1000, indicate °F and °C and operate over a range of -20°F to 2000°F.

The series consists of three models, two of which operate from standard NiCr/NiAl thermocouples, and a third which uses diodes as its sensor. The model 1003 measures temperature of .1° and 1° accuracy and has a °F/°C switch for direct readout in either scale. The model 1001 has the feature of displaying differential temperature when the DX3 option allows the use of two probes to be connected to the instrument.



CIRCLE 156 ON FREE INFORMATION CARD

All series-1000 models are housed in a small, high-impact case and use an LCD readout that consumes only 800 μA. The series has battery life up to 500 hours.

Models 1001 and 1003 incorporate an automatic cold junction feature. The prices in the series run from \$189.00 to \$229.00, including a glass bead probe and batteries.—Jenway Instruments, Inc., 10080 North Wolfe Road, Suite 372, Cupertino, CA 95014.

TEST INSTRUMENT, the Huntron Compar-A-Trace, model HTR 1005B-1S, is a unique CRT-based instrument for trouble-shooting solid-state components and circuits.

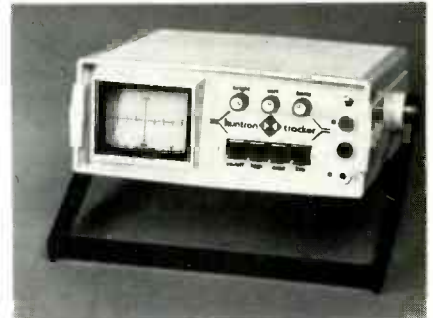

CIRCLE 157 ON FREE INFORMATION CARD

The unit features dual-channel switching, or single-channel operation, for comparison testing of analog or digital devices in, or out of, circuit. Visual displays appearing on the CRT screen indicate the condition of devices or circuits under comparison as they are tested without circuit power applied. A graticule faceplate supplies a reference standard for visual comparison of firing voltages for diodes, discrete components, or IC's. The model HTR 1005B-1S is priced at \$965.00.—Huntron Instruments, Inc., 15123 Highway 99 North, Lynnwood, WA 98036.

DESOLDERING SYSTEM, model 4000, "Hot Vac," contains a built-in vacuum pump, allowing it to be used at any location in a factory, repair center, or field location where normal AC electric power is available.

The solder is melted by the heated long-life tip, and the vacuum is turned on by the convenient switch located on the biomechanically designed handle. The solder that is removed is retained in the built-in solder reservoir, that may be emptied easily—even when the heater is hot.



CIRCLE 158 ON FREE INFORMATION CARD

Tip temperature ranges from approximately 500° F to 1000° F, allowing the model 4000 to be used in a wide variety of applications. The temperature-sensing heater provides instantaneous temperature recovery, and transient spikes are fully suppressed, making it safe for desoldering MOS and other voltage-sensitive components.

The model 4000 includes a built-in handle holder and a convenient handle for easy carrying. A variety of different-sized tips for various applications is also included.

The model 4000 is priced at \$399.00.—Ungar, 100 West Manville St., P.O. Box 6005, Compton, CA 90220.

R-E

communications corner

The diode gives you all-electronic switching without a microprocessor!
HERB FRIEDMAN, COMMUNICATIONS EDITOR

JUDGING BY THE HOOPLA, THE ONLY things worthwhile in life are microprocessor-controlled. Actually, if used properly, a microprocessor can create new applications or provide sophisticated features at a budget price. But as

with all fads, people tend to get carried away with the fad itself, and today we find "computerized" kitchen ovens, sewing machines, and the like. In most of those applications, the user could get along without a home version of a "NASA space probe."

Another aspect of electronic fads is that the excitement they create often obscures important developments for old or routine hardware. The ordinary diode switch is a perfect example of the problem. There is nothing really exciting about an ordinary diode. In fact, the diode is normally a rather dull subject—worth about a day in an average high school electronics course. Yet the diode plays an important part in modern communications equipment by providing a trouble-free substitute for bandswitches and RF-circuit selectors.

Most readers will remember the bandswitches of years past. Whether used in communications receivers, VHF monitors, or TV receivers, the bandswitch was used to switch between RF front-end circuits, including the first local oscillator. As the switch contacts aged or corroded they affected the RF circuits they switched.

Eventually, the user had to "ease" the bandswitch slightly beyond the detent to receive a TV station, or strike the bandswitch to settle the drift in a VHF communications receiver, or use up endless cans of contact cleaner—which usually did a better job of dissolving the plastic cabinet than cleaning the switch contacts.

Today, thanks to the diode, we no longer have to put up with the band-switch. The diode performs noise- and drift-free electronic switching for us. Of course, it does take some sophisticated design work to use diode switching.

Figure 1, a simplified block diagram of part of the Kenwood R-1000 receiver, shows how it's done. Other than the diode bridge used for the power supply, and the AM and AGC detectors, diodes are used throughout the receiver as switches.

Look first at the front end. Instead of the usual tuned input, the antenna signal feeds six bandpass filters. A DC signal from the main band-selector switch (which covers 0-29 MHz in 1-MHz increments) directs the DC control-voltage to the appropriate bandpass control diodes.

The desired mechanical filter is also selected by input and output control diodes that are controlled by a DC sig-

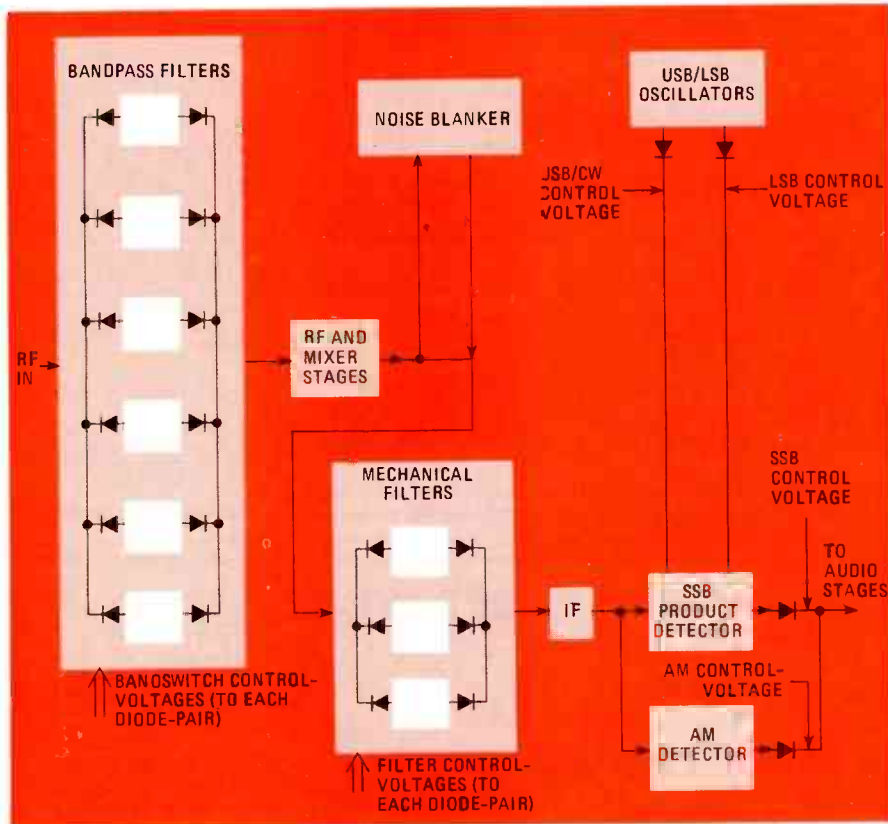

FIG. 1

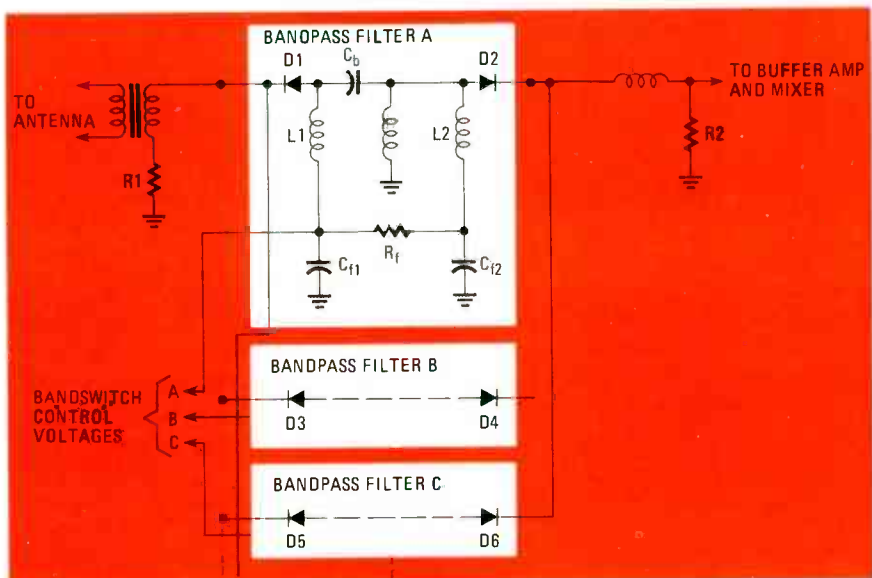

FIG. 2

nal from the AM/USB/LSB selector switches. The diodes that turn on the SSB product detector and the output of the SSB/CW carrier oscillators are also controlled by DC from the AM/USB/LSB selectors. In short, not one single circuit that handles RF has a mechanical switching device. It's all done with diodes.

Whenever I try to explain the RF diode-switch in a class, someone always asks whether the DC control-circuit produces instability. The answer is "no" because the DC is fed into the ground end of the active circuit and is decoupled within its own RF loop. That is illustrated in Fig. 2, a simplified schematic of one R-1000 bandpass filter.

The control-voltage from bandswitch-selector-position A is fed to the junction of C_{f1} and R_f . The positive voltage (or current) through L1 causes diode D1 to conduct (through R1) creating a path for the antenna signal from the RF transformer through D1 to the filter. Capacitor C_{f1} is used as a filter capacitor and establishes an AC ground (or common) at R_f/C_{f1} . The diode control-voltage also passes through decoupling resistor R_f to the junction of $C_{f2}/L2$, and on to diode D2, which also turns on, allowing the signal to flow out of the filter and on to the receiver. Decoupling resistor R_f and filter capacitor C_{f2} —which also places the junction at $C_{f2}/L2$ at AC ground—prevents any input signal to the filter from bypassing the filter to the output by flowing through the DC control voltage circuit.

Diodes D3 and D4 have received no control voltage from the bandswitch so they represent an open circuit to the RF transformer's secondary. When the bandswitch is moved to position B, control voltage is removed from D1 and D2 and applied to D3 and D4, thereby opening the path to the BAND A filter and closing the path to the BAND B (C, D, E, etc.) filter. (Each filter is actually used for several 1-MHz band segments.) Since all switching is done at "AC ground" potential there are no noise or drift problems associated with the bandswitching mechanism.

Don't the diodes rectify the AC signal? No, because once a diode conducts, it will pass an AC signal (or current) in either direction—AC is bi-directional—as long as the peak-signal value of the AC waveform is less than the applied DC voltage. The DC diode control-voltage can be several volts while the RF signal is in microvolts or even millivolts. As far as the AC signal is concerned, a conducting diode is just a low-value resistor.

So there you have it; the Kenwood R-1000. One of the most up-to-date SW receivers with frequency synthesis, bandpass tuning, and all-diode switching—and no microprocessor. I wonder how they accomplished that! R-E

"IN JUST 10 DAYS, I'LL SHOW YOU HOW TO DO
REAL MATH
ON YOUR SCIENTIFIC CALCULATOR!" ★
•Quick. •Easy. •Guaranteed. •Fun, too!

INTRIGUED BY CALCULATORS? Then you can step up your math skills *fast!* Use my *new method* in guidebook form. It's called **CALCULATOR CALCULUS** and comes with this guarantee: *If after 10 days you're not astounded at the problems you're solving on your own calculator, return the guidebook for an immediate refund.*

But the point is - you won't want to send it back. For this is the *easiest, fastest shortcut ever!* The day you receive your copy in the mail you'll want to put it to work. It's that exciting and helpful.

My name is Dr. George McCarty. I teach math at the University of California. I wrote this guidebook to cut through the confusion. It does just that - with worked-out examples, simple exercises and practical problems - all designed to work with precision and magic on your calculator!

POWER METHODS. Need to evaluate functions, areas, volumes - solve equations - use curves, trig, polar coordinates - find limits for sequences and series? It's all here!

If you're in the biological, social or physical sciences, you'll be doing Bessel functions, carbon dating, Gompertz growth curves, half-life, future value, marginal costs, motion, cooling, probability, pressure - and plenty more (even differential equations).

Important numerical techniques? Those algorithms are here, too - rational and Padé approximation, bracketing, continued fractions, Euler's method, Heun's method, iteration functions, Newton's method, predictor-corrector, successive substitutions, Simpson's method and synthetic division.

LOOK AT WHAT USERS SAY: Samuel C. McCluney, Jr., of Philadelphia writes:

"**CALCULATOR CALCULUS IS GREAT!** For ten years I have been trying to get the theory of calculus through my head, using home-study courses. It was not until I had your book that it became clear what the calculus was all about. Now I can go through the other books and see what they are trying to do. With your book and a calculator the whole idea becomes clear in a moment, and is a MOST REFRESHING EXPERIENCE. I program some of the iterative problems you suggest and it always GIVES ME A THRILL to see it start out with a wild guess and

then approach the limit and stop."
Professor John A Ball of Harvard College (author of the book *Algorithms for RPN Calculators*) writes: "I wish I had had as good a calculus course."

Professor H. I. Freedman of the U. of Alberta, writing in *Soc. Ind. Appl. Math. Review*, states: "There can be no question as to the usefulness of this book...lots of exercises...very clearly written and makes for easy reading."

C.B. of Santa Barbara says: "Your book has given me much instruction and pleasure. I do not hesitate to recommend it. **CALCULATOR CALCULUS** is a book that inspires the reader to understand everything down to the last detail. You seem to have put your heart into the teaching."

I WANT YOU TO TRY THIS: So, if you act now, you can invest in **CALCULATOR CALCULUS** for only U.S. \$14.95 (to USA or foreign: add \$1 for shipping, or \$4 by AIR; in Calif. add 90c tax).

★ **GET MY COMPLETE KIT**, with a TI-35 calculator, a 200 p. Student Math Book, AND the guidebook, ALL for \$39.95 (to USA only; add \$2 for shipping, or \$5 by AIR; in Calif. add \$2.40 tax). As pennywise Ben Franklin said, "An investment in knowledge pays the best dividends." **GET STARTED NOW** - Tax deductible for professionals.

NO RISK WHATEVER! Send for it today. Be sure to give me your complete mailing address with your check or money order. If you want to charge it (Visa or MC), tell me your card no. and exp. date. **Prompt shipment guaranteed.** Thank you!

George McCarty

EduCALC Publications, Dept. D6
Box 974, Laguna Beach, California 92652
In California, call 714-497-3600;

elsewhere TOLL FREE 24-hour Credit Card orders:
800-854-0561, Ext. 845; Dept. X-1

TEAR OUT TODAY

RADIO-ELECTRONICS

COVER STORY KITS

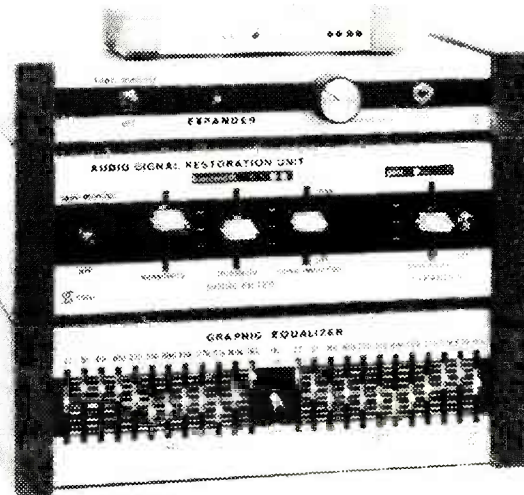

PLM-1 Power Level Meter — \$42.00
February '80 R-E

EX-1 Expander — \$60.00

ASRU Noise Filter/Expander — \$110.00
March/April '81 R-E

EQ-2 Graphic Equalizer, 12 bands/channel — \$100.00
April/May '78 R-E

All our kits feature solid walnut (unfinished) and anodized aluminum, and high-performance circuits. Instruction manuals for the above are available for \$2.50/2.50/3.50/3.00, refundable with purchase.

FREE CATALOG — Circle reader service number or send stamp for faster service; our catalog contains information on these and other audio products.



**SYMMETRIC
SOUND
SYSTEMS**

912 KNOBCONE PLACE
LOVELAND, CO 80537

Phone Orders: (303) 669-1567



Prices include UPS shipping on prepaid orders. U.S. Mail add \$3. Charge cards add shipping plus \$1.00 handling. Canada add \$5.00. U.S. Funds only. Phone orders accepted 10 a.m. to 6 p.m. Mountain Time (303) 669-1567.



stereo products

More information on stereo products is available.
Use the Free Information Card inside the back cover.

SPEAKER, model SM-15, is a wedge-shaped musical instrument speaker designed for club and concert applications where power and response are essential. The specifications for this system include a frequency response of 75 to 20,000 Hz, 8 to 16 ohms impedance, 200 watts power capacity, and a crossover point of 2.5 kHz.



CIRCLE 131 ON FREE INFORMATION CARD

The SM-15 also has a low-frequency driver with a 54-ounce magnet structure weight with 2-inch voice coil, and a large Dhorm high-frequency driver with a 30-ounce magnet structure weight with 1.5-inch voice coil. Price is \$350.—**Heppner Sound**, Belvidere Rd., Round Lake, IL 60073

HEADSETS, models HV-300, SP-800 and SP-805, are designed to incorporate a concept called Stereo Separation Control. That system alters the phase relationship of sound, separating one stereo channel from another, thus eliminating the "inside-the-head" effect and resulting in a concert-hall effect. All models feature a frequency response of 20 to 20,000 Hz, an impedance of 8



CIRCLE 132 ON FREE INFORMATION CARD

ohms, a stereo/monaural switch, and a 10-ft. lightweight cord. High velocity model HV-300 (shown) has tapered Mylar transducers and individual volume controls. Isolation design models SP-800 and SP-805 have slide-type volume and tone controls. Prices: model HV-300 is \$49.95; model SP-800 is \$39.95; model SP-805 is \$79.95.—**Mura Corp.**, 177 Cantiague Rock Rd., Westbury, NY 11590.

TURNTABLE, model LT-5V, manufactured by Mitsubishi Audio Systems. This fully automatic logic-controlled belt-driven turntable is unusual

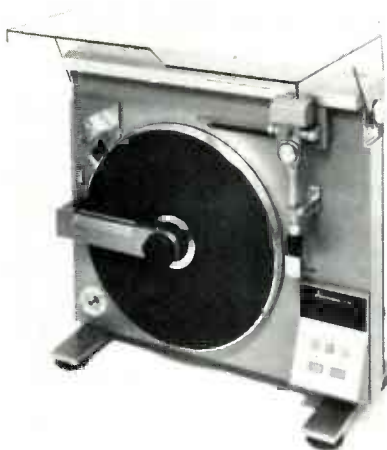

CIRCLE 133 ON FREE INFORMATION CARD

in that it mounts vertically. The platter is driven by a DC servomotor. Speed regulation is accomplished by a phase-locked loop. The aluminum diecast platter measures 12 $\frac{3}{4}$ inches in diameter. The statically-balanced linear-tracking tonearm is the straight-type measuring 8 $\frac{3}{4}$ inches. Manufacturer's specifications include a wow-and-flutter of 0.045% WRMS and a signal-to-noise ratio of 76 dB.

The LT-5V offers an array of automatic functions including tonearm lead-in and lead-out, speed and size change, reject and repeat, lead-in to any point on the record, lift/cue, left and right tonearm movement and cue prevention in the absence of a record. The turntable includes a stroboscopic speed indicator and muting circuitry, acoustic insulator feet to cushion vibration and a detachable dust cover that fits down over the top third of the unit. Suggested retail price is \$450.—**Melco Sales, Inc.**, 3030 E. Victoria St., Compton, CA 90221.

AM/FM/MPX STEREO CASSETTE, model 672, is a compact unit featuring an FM input-noise canceller, FET front-end and pushbutton tuning. The stereo cassette has locking fast-forward/rewind and auto stop. Measuring 7 \times 1 $\frac{1}{16}$ \times 5 $\frac{1}{2}$ inches, the short chassis and flat face fit easily into the dashboard of virtually any import or X-



CIRCLE 134 ON FREE INFORMATION CARD

body car. Suggested retail price is \$169.95.—**J.I.L.-America**, 737 W. Artesia Blvd., Compton, CA 90220.

INTEGRATED AMPLIFIER, model A-60, has overload margins on all its inputs, 36 dB above 2 millivolts on phono to allow use with high-output cartridges without overloading the first audio stage.

Line-level inputs, selected by push-button, in-

A Classroom In Your Mailbox!

STUDY
Two-Way Radio

THROUGH THE
REVISED

MTI

Home Study Course

Send coupon below for free course outline
No obligation - No salesman will call

Professional Training in a Unique Career Field

Providing Training to the Industry Since 1960

study FM two-way radio at home!

I am interested in learning more about professional FM two-way radio. Please send me full details on the MTI training program.

Name _____
Address _____
City/State/Zip _____

MTI

C3G

Mobile Training Institute

Box 735, Camp Hill, PA 17011-U.S.A.

CIRCLE 33 ON FREE INFORMATION CARD



FREE!

1981
DISCOUNT
ELECTRONICS
CATALOG

JOIN THE PAK!

Send for our Free catalog and become a member of our exclusive Pak. Our members receive Poly Paks'

exciting catalog several times a year. We offer:

Penny Sales, Free

Premiums and Low,

Low Prices on a wide variety of

Electronic Products such as Computer Peripherals, Integrated Circuits, Speakers, Audio Equipment, Rechargeable Batteries, Solar Products, Semiconductors, and much, much more! Take advantage of our 25 years as America's foremost Supplier of discount electronics.

RUSH ME YOUR FREE DISCOUNT CATALOG!

NAME: _____

ADDRESS: _____

CITY: _____

STATE: _____ ZIP: _____

CLIP AND MAIL COUPON TODAY TO:

POLY PAKS, INC.

P.O. BOX 942, RA7

S. LYNNFIELD, MA. 01940

(617) 245-3828

CIRCLE 21 ON FREE INFORMATION CARD

clude tuner, tape, and auxiliary, all with 100 millivolts into 100K ohms sensitivity for full output. Signal-shaping controls include treble and bass with 12 dB boost or cut at 15 kHz and 50 Hz respectively, and there is also a high-frequency filter with a 12 dB/octave slope that turns over at 7.5 kHz.



CIRCLE 135 ON FREE INFORMATION CARD

Line-level signal outputs are available at 100 millivolt level for tape and auxiliary at 5K ohm impedance. Headphones of 8-2K-ohm impedance may be driven from front-panel jack or from rear-panel speaker terminals.

The overall performance of the *model A-60* amplifier provides frequency linearity within ± 0.75 dB with both channels simultaneously driven from 20 Hz to 20 kHz at 35 watts continuous into 8 ohms at 0.2% total harmonic distortion. The damping factor is greater than 45 at mid-frequencies and an 8-ohm load. Delayed volt-current limiting with automatic reset protects against short-term overloads, while internal fuses protect against long-term overloads.

The *model A-60* is priced at \$595.00.—**Arcam (USA), Inc.**, 652 Glenbrook Road, Stamford, CT 06906.

SPEAKERS. *model A150* and *model A60* are three-way and two-way systems. The three-way *model A150* uses a 10-inch acoustic suspension woofer, a 4½-inch midrange with ferrofluid, and a 1-inch soft dome tweeter with ferrofluid in a 30½ × 16½ × 8-inch cabinet finished in furniture-grade oak veneer. A 1½-inch black pedestal base is supplied for floor placement. Frequency response is 36-25,000 Hz ± 3 dB; crossover frequencies are 550 Hz and 4000 Hz; sensitivity is 90 dB (1 watt/1 meter) and the impedance is 8 ohms (nominal).

The two-way *model A60* uses a newly designed 8-inch acoustic suspension woofer and a ferrofluid-cooled 1½-inch cone tweeter. Frequency response is 55-22,000 Hz ± 3 dB; crossover fre-



CIRCLE 136 ON FREE INFORMATION CARD

quency is 3000 Hz, and the nominal impedance is 8 ohms. The compact size (18 × 11½ × 7½ inches) makes shelf or wall mounting convenient. It is suitable for use with amplifiers rated at 10-60 watts-per-channel.

The *model A150* is priced at \$270.00; the *model A60* costs \$100.00.—**Boston Acoustics**, 130 Condor St., East Boston, MA 02128. **R-E**



NOW YOU CAN BUILD YOURSELF AN ORCHESTRA

The most advanced — most versatile organ you ever dreamed of is now within most everyone's reach . . . because you build it yourself the exclusive WERSI way.

Expand your instrument according to your taste and budget. With WERSI's 'Building Block' system, you'll never need to trade organs again!

Superior WERSI quality also available in pianos, synthesizers, amps, rhythm units, etc. . . . kit or factory assembled.

Send \$6 for the exciting Sight and Sound package everyone raves about. You'll receive the famous "WERSITIME 2" 12" LP with accompanying libretto as well as a full color, 104 page manual, widely acclaimed as the encyclopedia of organ builders, introducing you to the Wonderful World of

WERSI world leader in quality do-it-yourself instruments

WERSI ELECTRONICS, INC. Dept. M4
P. O. Box 5318, 1720 Hempstead Road
Lancaster, PA 17601

Please send above demo pack @ \$6.00.

Name _____

Address _____

City _____ State _____ Zip _____

FREE 48-Page Catalog

A new, free 48-page catalog is free from Creative Computing and Peripherals Plus. To help buyers make intelligent purchasing decisions, the product descriptions are exceptionally comprehensive and include screen photos in the software section.

The catalog describes 20 books on programming, games, and educational applications; 160 software packages for Apple, Atari, TRS-80, PET, CP/M, TI, Sorcerer and Sol computers; 3 magazines (*Creative Computing*, *Microsystems*, and *SYNC*); 5 graphics and music peripherals; an LP record; board game; 8 T-shirts and an eclectic assortment of other products for the personal computer user.

To get your free copy, simply drop a card or note to the address below.

creative computing

Attn: Charlotte

39 East Hanover Avenue
Morris Plains, NJ 07960

CIRCLE 22 ON FREE INFORMATION CARD

CORDLESS TELEPHONES

continued from page 35

former) to eliminate the 7-kHz tone. The speech is fed through the line transformer to the phone line.

Recall that the transmissions from base to remote units are not continuous, but are interrupted for two 40-millisecond periods each second. Those gaps do not significantly reduce speech intelligibility and they are necessary to allow the base to receive incoming transmissions from the remote.

When the conversations have been completed, the party at the remote unit presses the LINE RELEASE button. That activates the 4.5-kHz oscillator and the portable's transmitter circuits. This 4.5-kHz signal is received at the base unit during the 40-millisecond gaps and applied to the inputs of IC3, IC4, and Q7. The tone is decoded by IC3 and its pin 8 is clamped to ground. That forces the junction of R23 and R24 to ground through D2.

This action brings Q8's base to ground potential so the transistor turns off and releases the relay. Contact RY2 opens and releases the telephone line while contact RY1 opens to remove voltage from the base of Q8 and from the balance of the base unit's circuitry. The base unit is now on stand-by.

The base unit can also be returned to stand-by by pressing the LINE RELEASE switch (S2) on the base front panel. That action, too, takes Q8's base to ground potential so the transistor turns off and the relay opens.

The intercom

To use the *Muraphone* as an intercom for contacts between a party at the base station and a user at the remote unit, the INTERCOM button (S1) at the base must be kept pressed down. That disconnects the telephone line from the circuit. Operating voltage for the base-station circuits is obtained directly from the voltage regulator through S1. The power-on logic circuit (NE1, VR1, Q2, Q3, and Q4) is not used. The balance of the circuit operation is the same as when a call originates outside.

Note that one end of the telephone set connects to ground. The other end goes to B+ through the line transformer primary and relay contact RY2. Thus, excitation current for the carbon microphone cartridge flows when the relay is closed.

The battery for the portable unit is charged through a special circuit in the base station. Transistor Q20, D13, D14, and R63 form a constant-current charging circuit. The battery is charged by connecting the recharge jacks (J1) on the base and portable units through a recharging cable. **R-E**

BOILER CONTROL

THE PURPOSE OF THIS CIRCUIT IS TO CONTROL the water temperature in a hot-water heating system. What it does is to lower the boiler temperature as the outside air temperature increases. For example, if the outside temperature is 0° (Fahrenheit), the boiler temperature would be 180°; if the outside temperature is 50°, the boiler temperature would be 140°, and so on. The result is a savings in fuel consumption.

The circuit is shown in Fig. 1. The op-amp—almost any common type will do—is used as a comparator. Thermistor TH2 and R2 form a voltage divider that supplies a reference voltage to the op-amp's inverting input. Thermistor TH1 is placed inside the boiler and the values of TH1 and R1 should be chosen so that when the outside temperature is 25°, the resistance of the thermistor and resistor are equal.

Resistor R1 and thermistor TH1 make up a voltage divider that supplies a voltage to the op-amp's non-inverting input. Thermistor TH1 is placed inside the boiler and the values of TH1 and R1 should be chosen so that when the boiler's temperature is 160°, their resistances are equal.

The output of the op-amp controls Q1, which is configured as a transistor switch. When the logic output of the op-amp is high, Q1 is turned on, energizing relay RY1. The relay's contacts should be wired so that the boiler's heat supply is turned on when

the relay is *de-energized* and turned off when the relay is energized. An indicator, LED1, glows when the transistor conducts (Q1 is turned on), informing you that the boiler's heat supply is turned off (relay energized).

Circuit operation

As the outside temperature increases, the resistance of TH2 increases. The higher the resistance of TH2, the higher the voltage applied to the inverting input of the op-amp. But as the temperature of the boiler increases, and the resistance of TH1 goes up, the voltage applied to the non-inverting input of the op-amp decreases.

Perhaps the best way to see how that works is with an example. If the temperature in the boiler is 160° and the outside temperature is 25°, the voltages at the non-inverting and inverting inputs of the op-amp are equal. As the boiler heats up, the voltage at the non-inverting input becomes higher than the voltage at the inverting input. That, of course, causes the op-amp's logic output to go high, energizing the relay. When the relay is energized, the boiler's heat supply is turned-off.

As the boiler cools off, and the temperature drops below 160°, the logic output of the op-amp goes low, de-energizing the relay, and turning on the boiler's heat supply. The boiler's on/off point is determined by the voltage at the op-amp's inverting input, which in turn is determined by the outside temperature.—*Scott Busey*

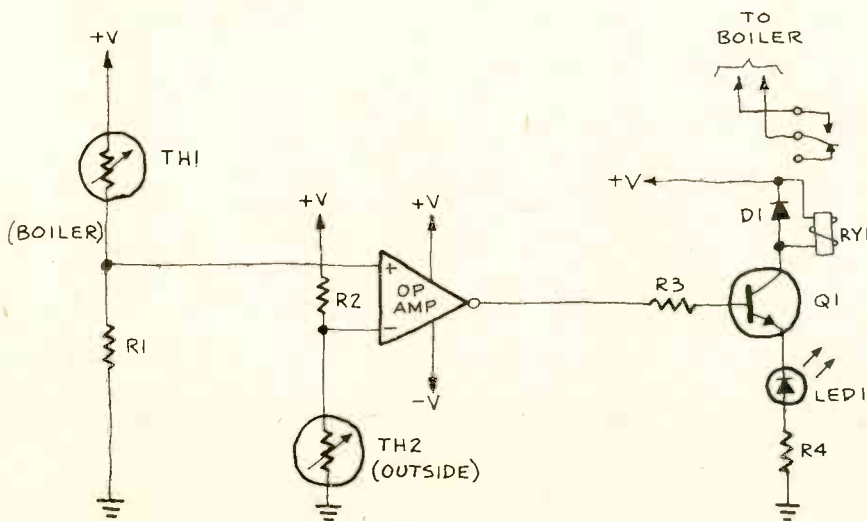
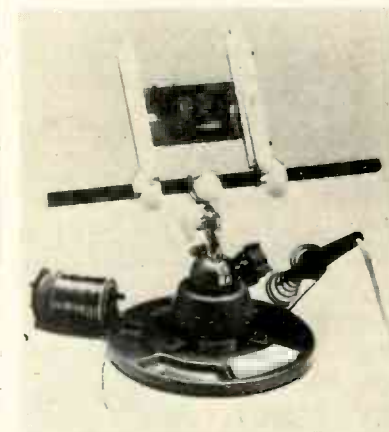

FIG. 1

NEW IDEAS

This column is devoted to new ideas, circuits, device applications, construction techniques, helpful hints, etc.

All published entries, upon publication, will earn \$25. In addition, Panavise will donate their model 324 Electronic Work Center, having a value of \$49.95. It combines their circuit-board holder, tray base mount, and solder station (see photo below). Selections will be made at the sole discretion of the editorial staff of **Radio-Electronics**.



I agree to the above terms, and grant **Radio-Electronics Magazine** the right to publish my idea and to subsequently republish my idea in collections or compilations of reprints of similar articles. I declare that the attached idea is my own original material and that its publication does not violate any other copyright. I also declare that this material had not been previously published.

Title of Idea

Signature

Print Name

Date

Street

City

State

ZIP

Mail your idea along with this coupon to: **New Ideas Radio-Electronics**,
200 Park Ave. South,
New York, NY 10003

Protect Yourself from Intruders

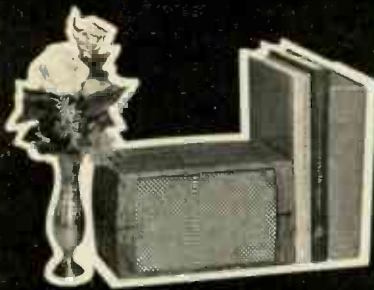

NEW! Battery powered self-contained residential intrusion detector. Simply set in desired location and it protects a 25' x 25' area by sounding a loud alarm when it senses the presence of an intruder. Exit/entry delay allows you freedom. The most reliable and sensitive intrusion protection on the market today with passive infrared technology.

Now only \$99
WE PAY ALL SHIPPING COSTS

MOUNTAIN WEST, Dept. RE-7
4215 N. 16 St., Phoenix, AZ. 85016

Send check or call toll free 1-800-528-6169
VISA/MasterCard Accepted

Name _____

Address _____

City _____ State _____ Zip _____

Please send me a FREE color product catalog.

Offer Expires 8/31/81

CIRCLE 23 ON FREE INFORMATION CARD

SAVE TIME AND MONEY!

6100

UNIVERSAL DESIGNER

- Save on digital bread boarding
- Easy transition from prototype to wiring diagrams
- Aids digital circuit design

Kit \$49.95
Assembled \$59.95

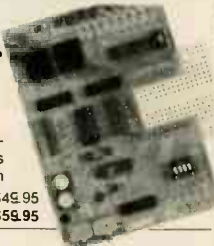

SELF-TEACHING AID:

6101 DIGITAL LOGIC COURSE \$29.95

- Learn digital logic with 26 self teaching experiments.

0101 SOLID STATE CLOCK/CALENDAR UNIT

BIG 2 1/2" DISPLAY!

- 12/24 hour selectable
- Alarm output

Kit \$49.95
Assembled \$79.95
Oak Case \$29.95

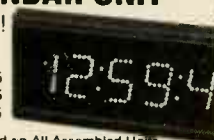

Satisfaction Guaranteed on All Assembled Units

FOR FAST DELIVERY CALL TOLL-FREE
1-800-426-6254 EXT. 17

PACCOM 14905 N.E. 40TH, DEPT RE-7
REDMOND, WA 98052 (206) 883-9200

Please rush me the following:

- 6100 UNIVERSAL DESIGNER KIT \$49.95
- 6100 UNIVERSAL DESIGNER ASSEMBLED 59.95
- 6101 DIGITAL LOGIC COURSE 29.95
- 0101 CLOCK/CALENDAR KIT 49.95
- 0101 CLOCK/CALENDAR ASSEMBLED 79.95
- OAK CASE 29.95

ADD \$3.00 PER ORDER POSTAGE & HANDLING

NAME _____

ADDRESS _____

CITY _____ ST _____ ZIP _____

CREDIT CARD NO _____

EXP _____

SIGNATURE _____

VISA
 MASTERCARD

CIRCLE 17 ON FREE INFORMATION CARD

books

More information on new books is available. Use the Free Information Card inside the back cover

GUIDEBOOK TO SMALL COMPUTERS, by William Barden, Jr. Howard W. Sams & Co., Inc., 4300 West 62nd St., Indianapolis, IN 46268. 127 pp. 5 1/2 x 8 1/2 inch. Softcover. \$4.95.

This book is for the person who may want to invest in a small computer for business or personal use. How does one choose among the many available? Here is a guidebook that will save such a person much time as well as guarding him or her from error on the basis of insufficient knowledge.

The opening chapter deals with basics common to all small computers, then gives a breakdown of types so the reader can form some sort of opinion as to which type of computer is best for his or her needs. Chapters 2 through 11 deal with 21 of the most popular computing systems presently available, from 14 manufacturers. Those are all reputable firms, so the system that seems to offer the best variety of what the buyer wants done is likely to be satisfactory.

Each system is described in terms of hardware and software. The hardware descriptions include the keyboard; display characteristics; CPU type; system bus; memory, cassette and floppy disk storage; line printers, etc. Software descriptions include BASIC interpreters for the system, assembly-language capabilities, disk operating systems, other languages, applications systems, etc. The book ends with a directory of small computer manufacturers.

CIRCLE 111 ON FREE INFORMATION CARD

Z80 INSTRUCTION HANDBOOK, by Nat Wadsworth. SCLEBI Publications, P.O. Box 133 PP STN, Milford, CT 06460. 128 pp. 4 1/4 x 7 1/4 inch. Softcover \$4.95, + 75¢ postage.

This compact reference guide explains in simple terms the capabilities of the powerful Z80 instruction set. Industry standard mnemonics, machine codes (in octal and hexadecimal format), and usage for each Z80 instruction are implemented throughout. An appendix in the back of the book lists instructions alphabetically along with machine codes and timing data.

CIRCLE 112 ON FREE INFORMATION CARD

THE ILLUSTRATED DICTIONARY OF ELECTRONICS. TAB books, Blue Ridge Summit, PA 17214. 868 pp. 5 1/4 x 8 1/4 in. Softcover. \$14.95.

Between "A" and "zymurgy" you will find over 24,000 concise and clearly-presented modern definitions of electronics/computer terms. The type is well chosen for easy reading, and the dictionary well laid out for easy access to whatever term you seek. The dictionary is supplemented by ten pages of tables and data, which include the resistor color code, electronic symbols, wire gauge, temperature conversion, Ohm's law, conversion factors, electric/magnetic circuits, abbreviations, math symbols, math data, numerical data, and the Greek alphabet, both capitals and lower case.

CIRCLE 113 ON FREE INFORMATION CARD

THE BEGINNER'S HANDBOOK OF ELECTRONICS, by George H. Olsen (revised by Forrest M. Mims, III). Prentice-Hall, Inc., Englewood Cliffs, NJ 07632. 305 pp including index. 7 x 9 1/2 in. Hardcover \$17.95; softcover \$6.95.

This book covers virtually every area of electronics in a simplified manner that will be of interest to students and beginners as well as hob-

biysts, experimenters, and technicians. The beginner can learn from it how to use resistors, capacitors, transistors, and the other basic building blocks of today's electronics, in everything from the simplest power amplifiers to the most sophisticated of telecommunications systems.

The broad range of subjects covered here includes the use of such components as integrated circuits and semiconductor devices in record players, radio receivers, airplane guidance systems, physical therapy machines, and many others. At the end of each chapter you will find questions to answer, which will show if you have grasped the material presented, and also a list of suggestions for further reading.

CIRCLE 114 ON FREE INFORMATION CARD

THE 8086 PRIMER, by Stephen P. Morse. Hayden Book Company, Inc., 50 Essex Street, Rochelle Park, NJ 07662. 205 pp including index. 6 x 9 inch. Softcover. \$8.95.

This introduction to the architecture, system design, and programming of the 8086 microprocessor covers all its aspects. The author was the man responsible for the architecture of this first high-performance, 16-bit microprocessor, which was introduced in 1978.

There is a brief review of microprocessors in general, then a detailed description of the 8086. The 8086 is then considered as a circuit component and the reader is shown the fundamentals of designing an 8086-based computing system. The final chapters deal with 8086 assembly-language programming and 8086 high-level-language programming. There are many illustrations and examples, and appendices cover instruction set summary for the 8086, 8086 opcodes, and ASCII codes.

CIRCLE 115 ON FREE INFORMATION CARD

TRANSDUCER INTERFACING HANDBOOK, A Guide to Analog Signal Conditioning, Edited by Daniel H. Sheingold. Analog Devices, Inc., PO Box 796, Norwood, MA 02062. 231 pp. plus appendix, bibliography, device index, and general index. 5 1/2 x 8 1/2 in. Hardcover \$14.50.

This book is about the interfacing of transducers to electrical analog circuitry in preparation for readout, further analog transmission or processing, or conversion to digital form. There is an increasing use of measurement and control in industry to improve efficiency and reduce costs, whether they are environmental, economic, or energy-related. The *transducer* is an essential link in that process, and the present volume deals with the electrical aspects of commonly used transducers that sense temperature, pressure, force, level, and flow.

The book's objective is to bridge the information gap about those matters for specialists on both sides of the interface. Nearly a hundred applications are described, and illustrated with diagrams, charts, and tables.

The 15 chapters cover: transducers as circuit elements, bridges, interference, amplifiers and signal translation, offsetting and linearizing, overall-design considerations, thermocouple applications, RTD applications, thermistor applications, IC temperature transducers, pressure-transducer interfacing, force-transducer interfacing, flowmeter Interfacing, interfacing-level transducers, and an application miscellany.

CIRCLE 116 ON FREE INFORMATION CARD

service clinic

Here's more information about shutdown circuits and some related problems.

JACK DARR, SERVICE EDITOR

problem. Plug the set into a Variac. Monitor the regulated DC-voltage and bring the line voltage up slowly. Let's

WE'VE TALKED ABOUT SHUTDOWN PROBLEMS before, but from the amount of mail I've gotten in only the last three weeks on the subject, maybe it's a good idea to do it again.

Let's go over the basics. Shutdown circuits are used in solid-state TV sets for two reasons: to protect viewers from X-rays, and to help avoid component damage if they're fast enough.

The most common shutdown circuit is called a high-voltage shutdown circuit, although it does not actually sample the high-voltage. Instead, it works from the regulated DC-voltage output of the power supply. The reason is because the high-voltage varies in direct proportion to the DC supply-voltage. If the DC supply-voltage goes up 25%, so does the high-voltage. If the voltage regulator fails in such a way that it doesn't hold the DC supply-voltage down, the high-voltage goes up, and the shutdown circuit triggers—or, at least, is supposed to.

That gives us a good starting point for our tests. Always read the regulated DC-output of the power supply first! If it's too high, and the set is shut down, there is a simple way to isolate the

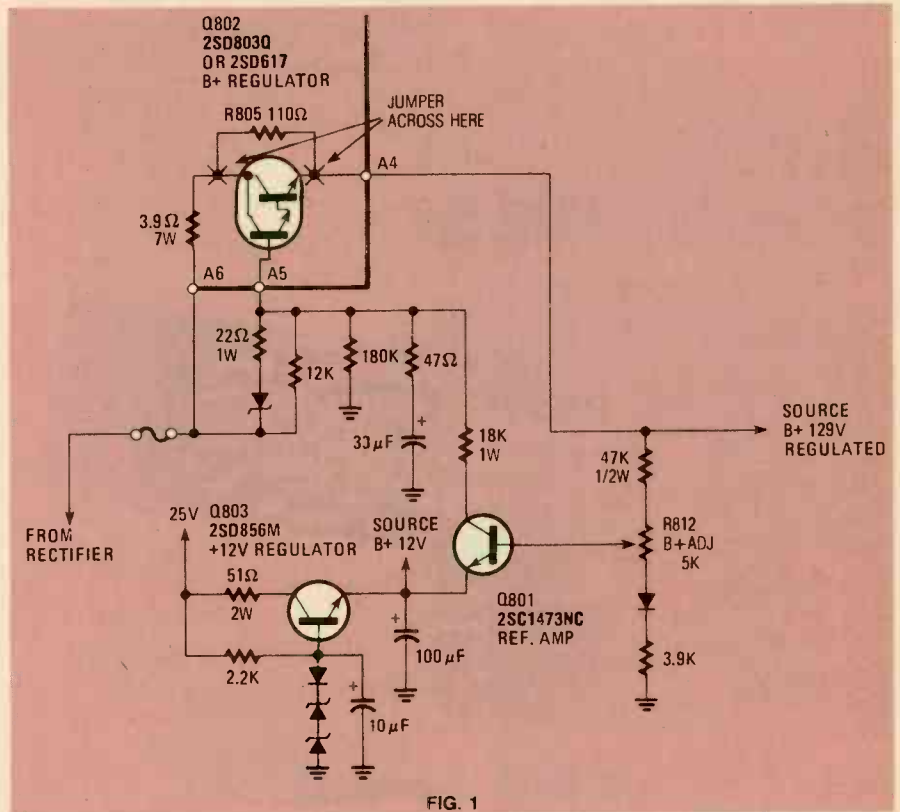

FIG. 1

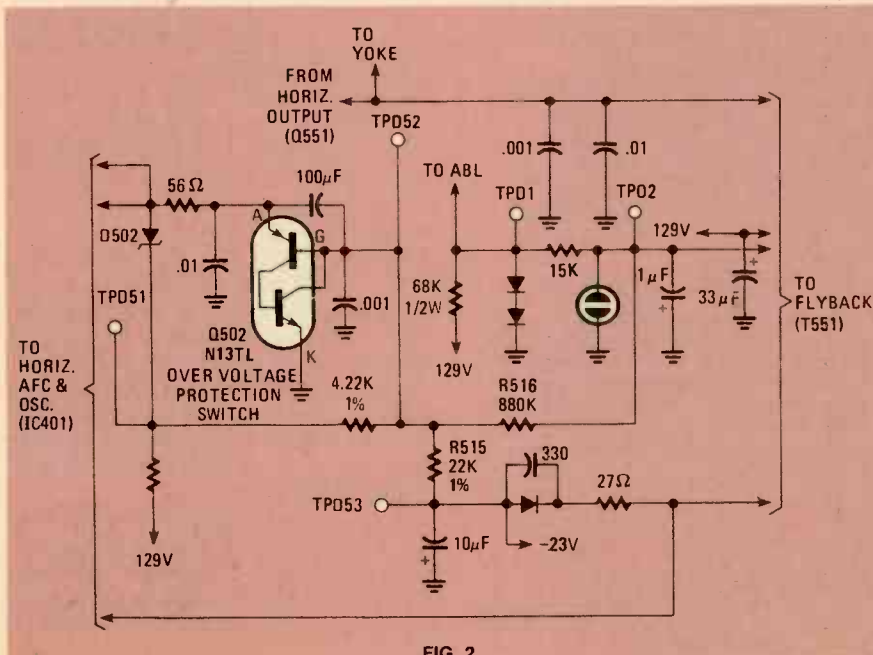

FIG. 2

say that the DC-voltage should be +120 volts, a common figure. See if you can get the DC-voltage to that normal level and then check the set to see if it works. If it does, you have cleared all of the other circuits and the fault is in the voltage regulator.

Most shutdowns do just that—shut the set off entirely. There is no high-voltage and sometimes no sound. But some shutdown circuits do tricks. RCA's shutdowns throw the horizontal oscillator far off frequency so that the set can't be used (although there will still be a raster). Some Admirals use a "pulsing" circuit; the raster and sound will flash on once per second. If you see any kind of odd symptom, check the service data to see if it means that the shutdown circuit has been triggered.

A lot of shutdown circuits use an SCR. One common use for this type is to kill the drive to the horizontal-output stage. Some kill the DC-voltage supply; others short the drive signal to ground.

Either way, the horizontal-output stage has no drive, and should be cut off. If an SCR is used, check the DC voltage on it. Many have a DC voltage on the anode; if the SCR has fired, there will be no voltage at all here. Most of them do latch, and you must turn off the set, wait a few minutes, and then turn it on again. Some sets need a wait of a minute or two, to let a capacitor in the gate circuit discharge.

If turning the set back on lets it start up, work a short time, and then trip again; the problem is still there. Look for faulty transistors, shorted capacitors, and bad diodes on any of the fly-back-device DC-voltage supplies.

Some sets use a transistor for shutdown instead of the SCR. The result is still the same: the transistor is biased off until a fault occurs, then conducts and shorts something out to kill the high-voltage. Look for a leaky transistor in such circuits.

The service data should tell you how to check the shutdown circuits for normal operation. For example, with the Quasar TS-976 chassis, a Variac is used for testing. The voltage regulator is disabled by shunting a clip-lead across the shunt resistor (R805—see Fig. 1) on the pass transistor. The line voltage is then raised slowly while monitoring the high-voltage. Shutdown

should occur just before the high-voltage reaches 31 kilovolts. The ABL (Automatic Brightness Limiter) voltage should be monitored at the same time. (Motorola put a pair of handy test points for monitoring the ABL voltage on the back of the chassis. They are marked TPD1 and TPD2 (see Fig. 2) and the DC voltage across them should not be more than +37.5 volts.)

For the final check, the shunt should be taken off the regulator, and the line voltage raised to 130 volts AC. The shutdown should not trip if the regulator circuit is working as it should. For another test, the regulated DC-voltage output, +129 volts, should be monitored. If this is considerably off, the B+ regulator-adjust, R812, should be replaced. The original is factory-sealed and its setting can't be changed. If parts in the DC power supply or regulator have been replaced, and the B+ won't hold within limits, set the B+ to the correct value with the new regulator-adjust and then seal the control to prevent tampering. If the shutdown circuit itself is suspected, it can be defeated by jumpering a pair of test-points, TPD51/TPD52. The shutdown in the TS-976 is a Darlington transistor, Q502, and is labeled "Overvoltage Protection Switch."

There are quite a few other things that can cause shutdown, particularly in sets using SCR's. Stray arcing in the high-voltage section causes transients and shutdown. A friend ran into a couple of odd ones a while back. The complaint in both cases was: "It goes 'Pow,' then quits!" That didn't happen instantly, but several minutes after turn-on. Oddly enough, both were in the same chassis, an older Quasar. The cause in both cases was an arc from the ultor button of the tube to the shield.

In the first, no apparent cause was found. The owner said: "It only does this in the evenings." After some head scratching, my friend noticed there was an open-flame gas heater in the room. The cause of the arcing turned out to be moisture generated by it condensing on the glass of the bell, around the ultor. A thorough cleaning with alcohol and a good polishing cleared it up.

In the second, the glass around the ultor looked odd and a finger wiped along the glass came off very black! My friend asked the owner if he used a wood-burning heater; he did. Once again, a good cleaning with alcohol fixed the problem. The black was plain old soot that was deposited on the tube because of the high electrostatic potential on the chassis.

Any kind of transient may cause a shutdown: lightning, an arc in the set, or even turning an appliance on or off. If that happens, the shutdown circuit should be checked; it may be just a little "eager!"

R-E

Radio-Electronics

SPECIAL REPRINT
BUILD A BACKYARD SATELLITE TV RECEIVER



**Third Printing: Sold Out!
Fourth Printing—Just Off Press!
Reprints Now Available!**

Don't miss out again!

Send away today for your 36-page booklet containing complete reprints of all seven articles in the series on Backyard Satellite TV Receivers by Robert B. Cooper Jr.

This all-inclusive report gives you all the data you need to build your own Backyard Satellite TV Receiver.

■ TELLS ALL ABOUT domestic satellite communications, with full details on how you can pull those elusive TV signals from space.

■ LEGAL REQUIREMENTS, technical specifications, and how you, the home constructor, can meet them. Find out what mechanical and electronics skills you need.

■ RECEIVER CHARACTERISTICS, technical details and specifications, along with examples of actual receivers built at comparatively low cost.

■ ANTENNAE DESIGN... and exactly how you can build a spherical antennae, while keeping total earth station cost for the complete system under \$1,000.

■ THE FRONT END is critical when you build your own system. We help you explore several different approaches to making one that will work for you.

■ RECEIVER-SYSTEM hardware, and how it goes together to bring you direct-from-satellite TV reception in your own home.

To order your copy:

Complete coupon and enclose it with your check or money order for \$6.00 U.S. We will ship your reprint, postpaid in U.S. and Canada within 6 weeks of receipt of your order. All others add \$4.00 for postage. New York State residents must add 48¢ sales tax.

Radio-Electronics	7/81	Please print
Satellite TV Reprints 45 East 17th Street New York, N.Y. 10003		(Name)
		(Street address)
I want _____ reprints @ \$6.00 U.S. each, postpaid. I have enclosed \$_____ N.Y. State residents must add 48¢ sales tax. WE DO NOT BILL	(City)	(State) (Zip)

computer products

More information on computer products is available.
Use the Free Information Card inside the back cover.

SIGNAL PROCESSOR, the *Compuloder*, is a signal processor that eliminates many of the problems associated with loading programs from cassette tape. It is self-powered and plugs directly into the miniature phone-plug output jack of the cassette recorder. The computer input line

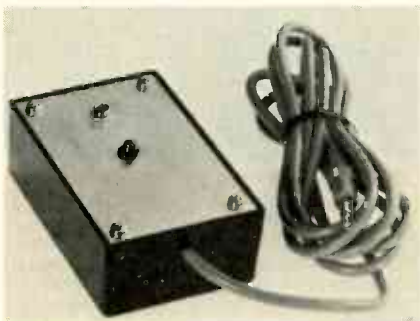

CIRCLE 121 ON FREE INFORMATION CARD

then plugs into it. To use, the recorder output level is turned up until LED glows to indicate that the signal level is high enough to be processed into the computer. The *Compuloder* sells for \$12.95, prepaid or \$14.95 if shipped C.O.D.—**Sound Concepts, Inc.**, P.O. Box 135, Brookline, MA 02146.

SINGLE-BOARD COMPUTER, the *ICB-85*, is designed as an instrument or remote-processing controller. It uses the 8085A processor with up to 16K bytes of ROM, 512 bytes of CMOS RAM, and has capability for expansion through the STD BUS. The CMOS RAM can be battery backed-up with three AA-size batteries to retain data for over two years. The board can accommodate five different PROM's: 2708, 2758, 2716, 2732, and

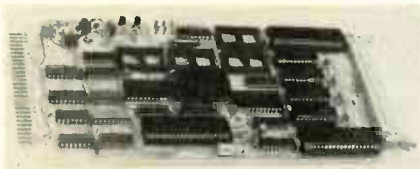

CIRCLE 122 ON FREE INFORMATION CARD

2516. The type of PROM is configured via a jumper block specific to the PROM being used, and four sockets are provided on the *ICB-85* for the PROM's. Two 8255A's are used to give 48 parallel I/O lines. In addition, two serial I/O lines are available from the 8085A. Power requirement is +5V at 750 mA, plus power for the ROM's. The price for the *ICB-85* in 100-unit quantity is \$290; price for a single unit is \$390.—**Trebor Industries, Inc.**, Computer Products Group, P.O. Box 2276, Gaithersburg, MD 20760.

LEVEL II 16K COMPUTER, the *PMC-80*, is a software and hardware compatible equivalent of the Radio Shack *TRS-80 Model I*, Level II computer. It includes a cassette tape recorder, 16K RAM memory, Level II Microsoft BASIC interpreter in ROM, power supply, computer and keyboard all housed in one cabinet. The *PMC-80* will display on either a TV monitor or on a standard TV set



CIRCLE 123 ON FREE INFORMATION CARD

using a built-in VHF Channel-3 modulator. All software available for the *TRS-80* will operate in the *PMC-80* and Level II BASIC or system cassettes will load in this model without volume adjustment. Disk-based programs can also run on the *PMC-80* using the Radio Shack Expansion Interface with all peripherals for the *TRS-80* compatible with the *PMC-80* including speech recognition, printers, RS-232 adapters, etc. Price is \$595 with modulator.—**Personal Micro Computers, Inc.**, 474 Ellis St., Mountain View, CA 94043.

Z-80 CPU BOARD, the *2810*, is designed for use in S-100 systems. It features several user-selectable options enabled by easy-to-configure Berg jumpers. Those options include an RS-232C serial I/O port that can be used for a console interface. The number of bits per word, parity, number of stop bits, and baud rate are all software-selectable, while the serial port's address is jumper-selectable. Other options are I/O address mirroring, a power-on jump to any location in 64K, and M1 wait states.

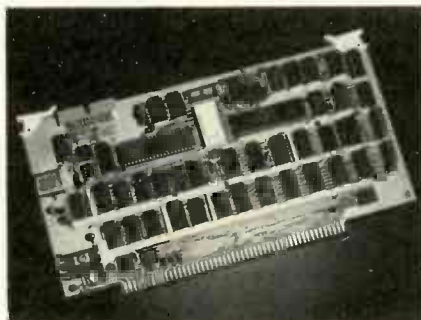

CIRCLE 124 ON FREE INFORMATION CARD

Regular features of the board include a jumper-enabled 2K ROM with monitor firmware. The monitor features an auto-baud select, allowing the serial port to match any baud rate from 2 to 56K baud set at the console. A switch allows the user to select a clock rate of 2 or 4 MHz. The *2810* also features separate crystal control of the CPU and baud rate IC's and LED's to indicate a Halt state, ROM Enabled, and Interrupt Enabled. Sug-

Put Professional Knowledge and a COLLEGE DEGREE in your Electronics Career through HOME STUDY

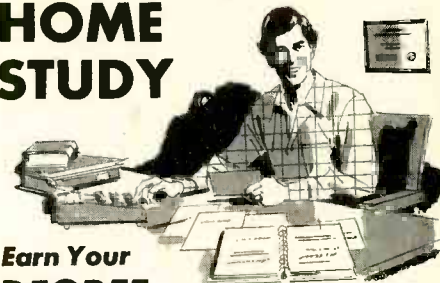

Earn Your DEGREE

No commuting to class. Study at your own pace, while continuing your present job. Learn from easy-to-understand lessons, with help from your home-study instructors whenever you need it.

In the Grantham electronics program, you first earn your A.S.E.T. degree, and then your B.S.E.T. These degrees are *accredited* by the Accrediting Commission of the National Home Study Council.

Our *free* bulletin gives full details of the home-study program, the degrees awarded, and the requirements for each degree. Write for *Bulletin R-81*.

Grantham College of Engineering
2500 So. LaCienega Blvd.
Los Angeles, California 90034

Bearcat® 210XL Super Scanner

Look what you get with the Bearcat 210XL. Exciting, new spaceage styling. No-crystal, pushbutton tuning. New, 18 channel, 6-band coverage of over 6000 frequencies. And features like 2 scan speeds. Automatic Squealch, Search, and Lockout. Direct Channel Access. Selective Scan Delay. And much more. There's never been a Scanner like the Bearcat 210XL.



"TAKE IT FROM A SMART OPERATOR."

Don Adams
BEARCAT 210XL SCANNER
\$229.

Add \$7.00 per scanner for U.P.S. ground shipping in the continental U.S. Send your cashier's check or money order to our address below or order by phone if you have a Visa or Master Charge card.

COMMUNICATIONS ELECTRONICS™

854 Phoenix □ Box 1002 □ Ann Arbor, Michigan 48106 U.S.A.
Call TOLL-FREE (800) 521-4414 or outside U.S.A. (313) 994-4444

CIRCLE 51 ON FREE INFORMATION CARD

gested retail price is \$300.00.—**California Computer Systems**, 250 Caribbean Dr., Sunnyvale, CA 94086.

POCKET-SIZED COMPUTER, the *TRS-80 Pocket Computer*, features a large 24-character LCD display with English-language prompting and BASIC programming, and includes a 1.9K random access memory that retains information for the 300-hour life of its internal batteries. Pre-programmed tapes available for the *Pocket Computer* include real estate, civil engineering, personal finances, aviation, a math drill, and a games pack, and can be loaded with an optional cassette interface. The *TRS-80 Pocket Computer*



CIRCLE 125 ON FREE INFORMATION CARD

can also be used as a calculator—numbers may be edited, stored, reviewed, and placed in mathematical equations with up to 15 levels of parenthesis. The unit weighs six ounces and is less than seven inches long. Suggested retail price is \$249.95 and the optional cassette interface is \$49.00.—**Radio Shack**, 1800 One Tandy Ctr., Fort Worth, TX 76102.

POWER SUPPLY, the *AIM-Mate Power Supply*, is designed to power a complete AIM microcomputer system, such as the *AIM 65*, *Memory-Mate*,



CIRCLE 126 ON FREE INFORMATION CARD

Video-Mate, and *Floppy-Mate*. The supply is 2¼ inches tall, slim enough to fit into many custom enclosures, as well as the *AIM-Mate* case. The 4 X 10 inch unit provides 5 volts at 3.5 amps, 12 volts at 200 milliamps, and 24 volts at .5 amp. For use with either 115 or 230 volts AC input, the supply includes short-circuit and overvoltage protection. The price of the *AIM-Mate Power Supply* (including shipping in U.S.A. only) is \$79.00.—**Forethought Products**, 87070 Dukhobar Rd., Eugene, OR 97402.

STATIC MEMORY BOARD, *model 2032*, provides 32K of memory for S-100 systems and features a flexible bank-select scheme for memory expansion up to 512K.

The *model 2032* is selected when a byte indi-

cating its bank is written to the bank port. Both the bank-port address and the bank(s) in which the board will reside, are jumper-selectable. The bank-select scheme is compatible with Alpha-Micro, Cromemco, and others.

The 32K of memory is divided in four 8K blocks, which are independently jumper-addressable to any 8K boundary in 64K. Each 8K block can be made independent of bank selection, while bank-dependent memory can be jumpered to come up active on power-on and reset. Further flexibility is provided by a jumper-selectable PHANTOM input, allowing byte-by-byte overlay of the *model 2032's* memory, and an MWRITE input that allows front-panel memory deposits. There are no DMA restrictions.

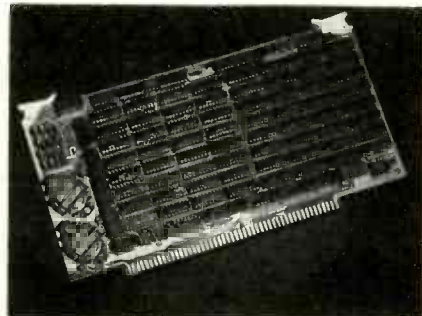

CIRCLE 127 ON FREE INFORMATION CARD

Available with 200-, 300-, and 450-nanosecond RAM's, the *model 2032* can operate at 4 MHz without wait states. Jumper-selectable wait-state generation is provided however, insuring compatibility of the slower RAM's with even the fastest CPU's.

The *model 2032* comes completely assembled, burned-in, and tested for a suggested retail price of \$700.00.—**California Computer Systems**, 250 Caribbean Drive, Sunnyvale, CA 94086. **R-E**



Phoebé Dunn

means a lot of living for her.

Where does your money go, when you give to United Cerebral Palsy? To children. Who need braces to help them walk. Therapy so they can strengthen. Recreational programs, so they can enjoy normal childhood activities. To adults. Who need educational and vocational training,

so they can achieve some measure of independence. To research. To help find ways to prevent brain damage at birth. There is no cure for Cerebral Palsy, but it can be treated. And that takes money. A little giving from you, will mean a lot to all of us.

 UNITED CEREBRAL PALSY

ALBIA Electronics

ALL NEW!

DM-10 LOW OHM METER MODULE

Measures resistance from 10 milliOhms to 20 Ohms. Now you can measure resistance down to 10 milliOhms with this low cost, easy to use DVM module. Check coil resistance, transformers, relays, chokes, printed circuit board copper paths and ground cables. Special zero balance control nulls out input cable resistance to insure accurate readings. Your DVM has to be set to 2V range during operation.

- Resistance range 10 milliOhms to 20 Ohms
- Zero Calibration control
- Battery powered (push to read battery saver circuit). Requires 1.9 Volt Battery (not included).
- Size 6.25" x 3.75" x 2"
- (Input cables not included or available)



Completely assembled and tested! Ready to use!

FREQUENCY METER MODULE LOW COST DM-11, "5Hz to 100MHz"

Measure frequencies from 5Hz to 100MHz on your digital voltmeter with a resolution of 3 1/2 digits — easy to use — perfect for field service — lab testing — home hobbyist! Connect the DM-11 to your DVM, set the DVM to the 2VDC range, connect a signal to the DM-11 via a BNC cable (not included) and measure the frequency of any source. Hi Lo Range LED's insure fast accurate readings.

- Input Sensitivity: < 100Hz < 80MV
- 100Hz — 60MHz < 30MV
- > 60MHz < 70MV
- Size 6.25" x 3.75" x 2"
- External 9V DC power supply included. (Model MMAC-2)
- BNC Input Cable Accessory (Model PSA-2 add \$14.95)

Completely assembled and tested! Ready to use!

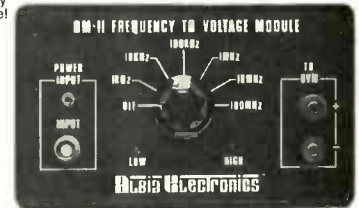

YOUR CHOICE

Any 2 For \$124.99

\$69⁹⁵ EACH

All 4 For \$239.99

8 CHANNEL SCOPE MULTIPLEXER, DM-12

Convert your single channel scope into a 4 or 8 channel instrument, just connect the DM-12, 8 channel scope multiplexer to your scope, clip the 8 input probes to the signals you want to view. Simple, easy, fast — can handle logic level TTL signals from DC to 3MHz. Features separate spacing and trace amplitude controls and selectable sampling rate — all to insure easy clear scope display.

- 8 TTL compatible input channels (1 TTL load per channel) can drive 50 Ohm scope cable.
- Maximum full screen amplitude 1.6 Volts adjustable.
- Trace amplitude and spacing controls.
- 4 or 8 channel selector switch.
- 8 color coded input cable, 24" long with insulated alligator clips.
- External 9 VDC power supply included (Model MMAC-2).
- Size 6.25" x 3.75" x 2"
- BNC Output Cable Accessory (Model PSA-2 add \$14.95).

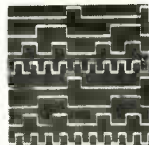
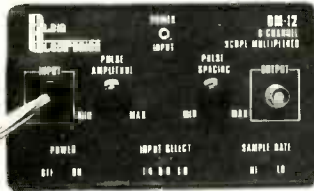

Completely assembled and tested! Ready to use!

LOW COST DM-8 CAPACITANCE METER MODULE

Connect this high quality low cost Capacitance Meter Module, DM-8 to your digital Volt Meter and turn it into a Digital Capacitance Meter — the Low Cost Way!

(When placing order specify the make and model DVM you're using so that factory modifications, if required, may be made before shipment is made.)

Completely assembled and tested! Ready to use!
INSTANT ORDER INFORMATION BELOW!

- Push to read range (button) from 1pF to 20,000µF
- Zero calibration control
- In one easy to use, self-contained package.
- Battery powered, with "push to read" battery saver circuit (9V batteries not included).
- Size 6.25" x 3.75" x 2"



LOW COST HIGH FREQUENCY COUNTER — NOW IN STOCK!!



The Albia Model DM-7, 8 Digit High Frequency Counter is easy to use, switch selectable time base input by a single BNC, nothing to build — nothing more to buy!

- 5 Hz to 550 MHz
- 8 big easy-to-read .43" high intensity LED display
- Crystal (±3 ppm @ 25 C) controlled 0.1 or 1.0 sec. gate times
- Convenient benchtop size (7"x10"x3") durable attractive case

NEVER BEFORE AT THIS LOW PRICE

\$149⁹⁵ Includes Warranty

COMPLETELY ASSEMBLED • PRE-CALIBRATED • PRE-TESTED

REGULATED TRIPLE POWER SUPPLY BARGAIN PRICED ALBIA MODEL DM-6

A fully assembled and tested power supply that provides a solid, fully wired triple power supply including fixed 5V @ 1 Amp, 5V to 15V @ 0.5 Amp, and -5V to -15V @ 0.5 Amp — all supplies regulated, short proof. Each supply has short indicator LED. Complete and ready for use in a durable (8"x6"x3 1/2") metal case.

\$99⁹⁵ Includes Warranty



FREE!!
NEW 1981
SPRING/
SUMMER
CATALOG

Exciting new products! Send today!!



ALBIA SATISFACTION WARRANTY:

if for any reason, whatsoever, you are not completely satisfied with your purchase, return it within 30 days of purchase date for a full refund — it's as simple as that!

FOR FAST AND DEPENDABLE DELIVERY SERVICE

CALL TOLL FREE: 1-800-243-6953 9 A.M. to 5 P.M. E.S.T.

WE ACCEPT MASTER CHARGE, VISA AND AMEX CREDIT CARDS

Connecticut Residents add 7 1/2% Sales Tax • Prices shown in U.S. currency only. Foreign orders add 15%.

ALBIA ELECTRONICS INC

24 Albia St. • New Haven, CT 06512

POSTAGE & HANDLING	
ORDERS	ADD
UP TO \$10.00	\$1.95
\$10.01 - \$25.00	3.75
\$25.01 - \$50.00	4.65
\$50.01 - \$100.00	6.45
ORDERS OVER \$100.00 WITHIN UNITED STATES	7.55



FREE ALBIA "TEMPLATE" WITH EVERY ORDER RECEIVED

market center

CLASSIFIED COMMERCIAL RATE (for firms or individuals offering commercial products or services) **\$1.65 per word prepaid (no charge for zip code)** . . . **MINIMUM 15 WORDS**. 5% discount for 6 issues, 10% for 12 issues within one year, if prepaid.

NON-COMMERCIAL RATE (for individuals who want to buy or sell a personal item) **\$1.00 per word prepaid** . . . no minimum.

ONLY FIRST WORD AND NAME set in bold caps. Additional bold face (not available as all caps) at 10¢ per word. All copy subject to publisher's approval. **ADVERTISEMENTS USING P.O. BOX ADDRESS WILL NOT BE ACCEPTED UNTIL ADVERTISER SUPPLIES PUBLISHER WITH PERMANENT ADDRESS AND PHONE NUMBER.** Copy to be in our hands on the 26th of the third month preceding the date of the issue (i.e., August issue closes May 26). When normal closing date falls on Saturday, Sunday, or a holiday, issue closes on preceding working day.

Satellite TV Receive 200 Channels Anywhere!

That's what the ads say. Is it true? Well, yes & no. You can receive 75 to 200 channels, but not just anywhere. Those ads are written to sell expensive equipment, which you might not even be able to use. Only a complex computer analysis of your location can tell for sure.

We offer an independent computer analysis of your location, anywhere in the world. Our computer will tell you which satellites you can receive, where to point your antenna, & how strong the signals are likely to be.

The cost? Only \$19.95 postpaid (Air Mail \$2.00 extra). We can save you hundreds—even thousands—of dollars. Send Money Order, check, or charge it on VISA or Master Card.

Call Toll Free! 24-hrs. 800-228-2606
In Nebraska, 800-642-8777

Satellite Computer Service
Dept. RE, 1808 Pomona Drive
Las Cruces, NM 88001 U.S.A.

Satellite TV

FOR THE HOME

Sick of Network TV?

Our receiver lets you get over 75 channels of television directly from earth-orbiting cable TV satellites: HBO, Showtime, super stations, sports and movies worldwide.

We don't just sell information! We Manufacture Hardware!

technical information book and catalog gives you all the facts. Inexpensive dishes, feeds, telemetry software, kits and more. Recommended reading by NASA, The Office of Consumer Affairs and quality companies like Rockwell/Collins. Send \$7.95 today!



CALL
24-hrs. C.O.D. Hotline
(305) 339-7600
SPACECOAST
RESEARCH CORPORATION
P.O. Box 442-E, Altamonte Spgs, FL 32701



From offshore oil rigs, data links to hotels and backyard installations, we wrote the book. Constantly updated, our 94 Page

SATELLITE TELEVISION

SATELLITE television...Howard/Coleman boards to build your own receiver. For more information write: **ROBERT COLEMAN**, Rt. 3, Box 58-ARE, Travelers Rest, SC 29690

Enjoy Satellite TV Now



Better than Cable TV—Over 200 TV and radio services. Why waste money? Learn the whole story and build a video system the family can enjoy. No commercials, **FREE** movies, sports and Vegas shows—worldwide, crystal clear reception connects to any TV set. Big (8 x 11 in.) book loaded with details, photos, plans, kits—**TELLS EVERYTHING! Satisfaction Guaranteed.**

Send \$7.95 TODAY! Add \$2.00 for 1st class (air mail) or call our 24 hour C.O.D. rush order line (305) 862-5068.

GLOBAL ELECTRONICS,
P.O. Box 219-E, Maitland, Florida 32751

SATELLITE antenna azimuth and elevation for geostationary satellites in the western hemisphere. Send location (city/state) or distance and direction with \$5.00 to: **ASTRO CHART SERVICES**, Box 1429, Albuquerque, NM 87103

To run your own classified ad, put one word on each of the lines below and send this form along with your check for \$1.65 per word (minimum 15 words) to:

Radio-Electronics, 200 Park Avenue South, N.Y., N.Y. 10003

ORDER FORM

PLEASE INDICATE in which category of classified advertising you wish your ad to appear. For special headings, there is a surcharge of \$10.

() Plans/Kits () Business Opportunities () For Sale
() Education/Instruction () Wanted ()

Special Category: \$10

(PLEASE PRINT EACH WORD SEPARATELY, IN BLOCK LETTERS.)

1	2	3	4	5
6	7	8	9	10
11	12	13	14	15
16	17	18	19	20
21	22	23	24	25
26	27	28	29	30
31	32	33	34	35

PLEASE INCLUDE FOR OUR FILES YOUR PERMANENT ADDRESS AND PHONE NUMBER.

SATELLITE VISION SATELLITE VISION

We manufacture the highest spec 3-meter data & video dish in the world 41db gain! We also sell direct. Immediate delivery or you pick up. Complete details including satellite TV information, BUY DIRECT aiming service and discount schedule. Send \$1.25 for postage & handling to: **TIGER TENNAS**, P.O. Box 561, Casselberry, Florida 32707



BUSINESS OPPORTUNITIES

MECHANICALLY inclined individuals desiring ownership of Small Electronics Manufacturing Business—without investment. Write: **BUSINESS-ES**, 92-R, Brighton 11th, Brooklyn, NY 11235

GROUND floor opportunity with new company! Best marketing plan available in the United States today. A superior product line, better incentives and excellent bonus programs combined, offer the most success-oriented plan yet to be announced. Write or call for free information. **ENHANCE MARKETING GROUP**, (R), P.O. Box 26563, Salt Lake City, UT 84126 (801) 467-0473

\$700 per month earnings possible filling out income tax forms at home or tax office during tax season. We show you how. Simple, quickly learned. Details mailed free. No salesmen. Hurry. Big demand. **FEDERATED TAX**, 2015 Montrose, Chicago, IL 60618

PROJECTION TV . . . Make \$200.00+ per evening assembling projectors . . . Easy . . . Results equal to \$2,500 projectors . . . Your total cost less than \$15.00 . . . Plans, lens & dealer's information \$14.00 . . . Illustrated information free . . . **MACROCOM GKX** Washington Crossing, PA 18977

CRT rebuilding machinery. \$1000/\$3000 weekly possible when you own our patented picture tube rebuilding equipment. Training provided. Phone (312) 583-6565. Write: **LAKESIDE**, 4071 N. Elston, Chicago, IL 60618

COMPUTER SUPPORT CENTER

Zilog

Z80-CPU	2.5 MHz	6.95	Z80-SIO/1	2.5 MHz	22.45
Z80A-CPU	4.0 MHz	9.45	Z80A-SIO/0	4.0 MHz	27.85
Z80-P10	2.5 MHz	5.45	Z80-SIO/2	2.5 MHz	22.45
Z80-P10	4.0 MHz	7.85	Z80-SIO/2	4.0 MHz	27.85
Z80-CTC	2.5 MHz	5.45	Z80-SIO/3	2.5 MHz	16.85
Z80-CTC	4.0 MHz	7.85	Z80-SIO/3	4.0 MHz	21.54
Z80-DMA	2.5 MHz	15.95	Z80-DART	2.5 MHz	11.95
Z80-DMA	4.0 MHz	22.95	Z80-DART	4.0 MHz	14.85

MOS MEMORIES

MOS STATIC RAM's

Part No.		Price
2101-35	1K (256 x 4) 350NS 22 PIN	2.65
2102-25	1K (1K x 1) 250NS 16 PIN	1.25
P2111-45	1K (256 x 4) 450NS 18 PIN	2.98
P2112-35	1K (256 x 4) 350NS 18 PIN	2.65
2114L	Low Power 4K (1024 x 4) 300NS	3.45
2147	4K (4K x 1) 55NS	9.95
2147	4K (4K x 1) 70NS	7.95

UART's

AYS-1013A 40 KHz Single 5V Supply **Special 3.95**

IK CMOS RAM

5101 1K (256 x 4) 450NS 22 PIN Low Power 3.45

4K CMOS RAM

P6504 4K (4K x 1) 550NS 18 PIN 110MW 6.45

P6514 4K (1K x 4) 450NS 18 PIN 110MW 6.45

SHIFT REGISTERS

1403A	(TO-5)	single 512 bit	2.98
1404A	(TO-5)	single 1024 bit	2.98
3341APC	FIFO 1 MHz		4.75
3342PC	64 bit		3.95
3347PC	80 bit		3.45

ECL RAM

10410ADC/HM2106 256 x 1 bit fully decoded 15NS 16 pin 7.95

CLOCK CHIP

MSM5832RS Microprocessor Real-Time Clock/Calendar 12.95

SINGLE BOARD COMPUTERS

ROCKWELL AIM 65 425.00

RE502 BASED MICROCOMPUTER SYSTEM WITH FULL SIZED KEYBOARD, ALPHANUMERIC 20 CHARACTER DISPLAY AND ALPHANUMERIC 20 COLUMN THERMAL PRINTER 1K RAM

SYNERTEK SYM-1 245.00

POWERFUL 6502 8-BIT MICROPROCESSOR 8-DIGIT HEX LED DISPLAY, SINGLE 5V POWER REQUIREMENT.

MICROPROCESSOR CHIP SETS

8035 CPU	5.95	6800 CPU	4.65
8039 CPU	7.95	6802 CPU	8.65
8080A CPU	4.45	6808 CPU	6.45
8085 CPU	6.45	6809 CPU	19.95
8212	1.98	6820	3.65
8214	3.45	6821	2.65
8216	1.98	6845	29.50
8224	3.45	6850	2.65
8228	1.98	6852	2.65
8229	4.98		
8251	4.95	6502 CPU	7.45
8253	7.45	6504 CPU	7.65
8255	4.95	6505 CPU	7.65
8257	7.95	6520	5.72
8259	7.95	6522	7.95
8279	8.45	6532	10.85
8748	36.00	6551	10.95
8755	32.00		

EPROM'S

C1702A	2K 1US	\$ 7.95
C2708	1K x 8 450 ns	\$ 4.75
C2716/TMS2516	(Intel version)	\$ 6.98
C2716	450NS Single 5V Supply	
TMS2532	(T1 Pin Out)	\$ 29.95
C2732	(Intel version)	\$ 18.75
C2732	(4096 x 8) 450 ns	
TMS2564	64K (8K x 8) 450 ns	\$ 140.00

16K STATIC RAM Special \$22.95

TMM2016-3 16K (2K x 8) 300NS

16K MOS DYNAMIC RAM'S (16 PIN)

4116-20 (200NS) \$2.98

4116-30 (300NS) Ceramic Special 2.45

4K MOS DYNAMIC RAM'S

40M060-30 Special 2.65

4K (4K x 1) 300NS 22 PIN

16K CMOS STATIC RAM Special

8116 16K (2K x 8) 150NS 16 PIN \$44.00

64K MOS DYNAMIC RAM

4164 64K (64K x 1) 200NS 16 PIN \$36.00

4164 64K (64K x 1) 150NS 16 PIN \$48.00

PROM'S

74S288	2.50	256 bit, 16 PIN
74S188	2.50	256 bit, 16 PIN
93417/82S129	3.45	1K, 16 PIN
93417/82S126	3.45	1K, 16 PIN
93446/7621	4.95	2K, 16 PIN
93436/7620	4.95	2K, 16 PIN
93453/7643	7.95	4K, 18 PIN
93448/7641	8.45	4K, 24 PIN
93451/82S181	19.95	4K, 24 PIN
82S185/7128	27.95	8K, 18 PIN
8279	8.45	8K, 24 PIN
8748	36.00	6551
8755	32.00	

LINEAR I.C.'S

LM301AN-8	72	LM741CN-8	28
LM307N-8	29	LM747CN-14	50
LM308N-8	88	LM748CN-8	39
LM308CH	95	LM1458N-8	36
LM309K	1.56	LM1488N-14	64
LM310HC	1.48	LM1489N-14	64
LM311CH	7.9	LM1495CN-14	1.95
LM311N-8	4.48	LM1496CN-14	1.34
LM318N-8	1.19	LM2211CN-14	2.75
LM318CH	1.48	LM2240CP	1.50
LM323K	4.65	LM723CH	72
LM324N	4.8	LM723CN-14	48
LM339N	4.8	LM750N-14	48
N8T26N	1.29	LM733CN-14	1.36
N8T28N	3.65	LM739CN-14	1.69
SN76477NF	1.98	LM741CH	59

DUAL-IN-LINE LOW PROFILE I.C. SOCKETS

CONTACTS	PRICE
8 PIN	.07
16 PIN	.11
18 PIN	.13
20 PIN	.19
22 PIN	.22
24 PIN	.23
28 PIN	.27
40 PIN	.39

ANNOUNCING 1981 IC MASTER

• LOWEST PRICES ANYWHERE FOR THE HIGHEST QUALITY, AN UNBEATABLE COMBINATION.

• The one and only complete integrated circuit data selector.

• 3200 pages of technical information.

• Eight master selection guides.

• 50,000 I.C. device listed (14,200 changes from the 1980 edition).

• New Development Systems and Custom I.C. sections.

• Four free quarterly updates.

REGULAR PRICE: \$82.50
SPECIAL PRICE: \$75.00

OPTOELECTRONICS

L.E.D. LAMPS

LED209	T-1 3 mm Red	.09
LED211	T-1 3 mm Green	.14
LED212	T-1 3 mm Yellow	.19
LED220	T-1 1/2 5 mm Red	.11
LED222	T-1 1/2 5 mm Green	.24
LED224	T-1 1/2 5 mm Yellow	.16

DISPLAYS

FND357	375' Common Cathode	.99
FND500	500' Common Cathode	.99
FND507	500' Common Anode	.99
DL1416	4 digit, 16 segment alphanumeric display 16' ht.	25.00

ISOLATORS

ILD74	Dual Opto Isolator	1500V	1.29
ILQ74	Quad Opto Isolator	1500V	3.95
ILQ268	Dual Opto Isolator	1500V	1.12
MCT2	Opto Coupler	1500V	5.4
TIL111	Opto Coupler	1500V	5.4
4N26	Opto Isolator	2500V	5.4
4N33	Opto Isolator	1500V	6.5

SCR's and TRIAC's

CI06D	.34	SCR 5 amp 400V TO-220
TIC44	.36	SCR 0.6 amp 30V TO-92
TIC47	.42	SCR 0.6 amp 200V TO-92
TIC116B	.97	SCR 8 amp 200V TO-220
TIC116D	.99	SCR 8 amp 400V TO-220
TIC126B	1.09	SCR 12 amp 200V TO-220
TIC126D	1.18	SCR 12 amp 400V TO-220
TIC216B	.99	Triac 6 amp 200V TO-220
TIC216D	.99	Triac 6 amp 400V TO-220
TIC226D	1.09	Triac 8 amp 400V TO-220
TIC236D	1.39	Triac 12 amp 400V TO-220
TIC246D	1.45	Triac 16 amp 400V TO-220
TIC263D	2.25	SCR 25 amp 400V TO-220
2N1595	.89	SCR 1 amp 50V TO-5
2N6401	1.56	SCR 16 amp 100V TO-220

METAL CAN SMALL SIGNAL

2N404A	1.20	2N3055	.56	2N3702	.099	2N4402	.079	2N5770	.12	MPSA18	.12
2N667	.29	2N5440	.56	2N3704	.099	2N4403	.079	2N5771	.13	MPSA42	.16
2N706	.29	2N3771	1.29	2N3706	.099	2N4410	.15	2N5772	.08	MPSA43	.16
2N1613	.29	2N3772	1.29	2N3710	.099	2N5087	.12	2N5773	.12	MPSA56	.12
2N1711	.29	2N3773	1.89	2N3904	.069	2N5098	.12	2N5774	.12	MPSA70	.14
2N1893	.29	2N6133	.56	2N3906	.069	2N5220	.12	2N5775	.12	PN2369A	.089
2N2222A	.19	2N6489	1.25	2N3907	.099	2N5221	.14	2N5776	.12	MPSA92	.14
2N2369A	.22	2N6545	4.75	2N4123	.075	2N5223	.14	2N5777	.12	MPSA93	.12
2N2484	.24	2N6598	1.75	2N4124	.075	2N5226	.14	2N5778	.12	MPSA14	.12
2N2905A	.39	2N6655	2.45	2N4125	.075	2N5227	.14	2N5779	.12	MPS2925	.12
2N2907A	.19	2N6679	3.85	2N4126	.075	2N5550	.12	2N5780	.12	MPS2926	.12
2N3053	.29	2N4401	.079	2N4551	.12	2N5551	.12	2N5781	.12	MPS3992	.12
								2N5782	.12	MPS3993	.12

TRANSISTORS

LM061CP	.72	Low Power
LM062CP	.99	Dual Low Power
LM064CN	1.95	Quad Low Power
LM071CP	.54	Low Noise
LM072CP	.96	Dual Low Noise
LM074CN	1.89	Quad Low Noise
LM081CP	.42	J-Fet Input
LM082CP	.85	Dual J-Fet Input
LM084CN	.95	Quad J-Fet Input
LM495CN	4.95	Switch. Volt. Reg. 25mA
LM497ACN	2.98	Switch. Volt. Reg. 500mA
LM4301CP	.69	Adj. Shunt Volt. Reg.
LM431CLP	.78	Adj. Pot. Volt. Reg.

Bi-Fet OP AMPS

74152N	.52	74LS13N	.25
74153N	.52	74LS14N	.25
74154N	.52	74LS15N	.25
74155N	.52	74LS16N	.25
74156N	.52	74LS17N	.25
74157N	.52	74LS18N	.25
74158N	.52	74LS19N	.25
74159N	.52	74LS20N	.25
74160N	.52	74LS21N	.25
74161N	.52	74LS22N	.25
74162N	.52	74LS23N	.25
74163N	.52	74LS24N	.25
74164N	.52	74LS25N	.25
74165N	.52	74LS26N	.25
74166N	.52	74LS27N	.25
74167N	.52	74LS28N	.25
74168N	.52	74LS29N	.25
74169N	.52	74LS30N	.25
74170N	.52	74LS31N	.25
74171N	.52	74LS32N	.25
74172N	.52	74LS33N	.25
74173N	.52	74LS34N	.25
74174N	.52	74LS35N	.25
74175N	.52	74LS36N	.25
74176N	.52	74LS37N	.25
74177N	.52	74LS38N	.2

National Semiconductor Clock Modules

12VDC AUTOMOTIVE/INSTRUMENT CLOCK

APPLICATIONS:

- Indash autoclcks
- After-market auto/RY clocks
- Aircraft-marine clks.
- 12VDC Oper. Instru.
- Portable/battery powered instruments.

Features: Bright 0.3" green display. Internal crystal time-base. ±0.5 sec./day accur. Auto display brightness control logic. Display color filterable to blue, blue-green, green & yellow. Complete—just add switches and lens.

MA1003 Module \$16.95

CLOCK MODULES

MA1023 7" Low Cost Digital LED Clock Module 8.95
 MA1025 7" Dig. LED Alarm Clock/Thermometer 18.95
 MA5036 3" Low Cost Digital LED Clock/Timer 6.95
 MA1002 5" LED Display Dig. Clock & Xformer 9.95

TRANSFORMERS

102-P20 Xformer for MA1023 Clock Modules 3.49
 102-P22 Xformer for MA1025 Clock Modules 3.49
 102-P20 Xformer for MA5036 Clock Modules 3.49

Transistor Checker

The ASI Transistor Checker is capable of checking a wide range of transistor types, either "in circuit" or out of circuit. It has been especially designed to take advantage of the newest concept of dynamic testing under current amplifier conditions. To operate, simply plug the transistor to be checked into the front panel socket, or connect it with the alligator clip test leads provided. No preliminary setup is needed. The unit safely and automatically identifies low, medium and high-power PNP and NPN transistors. The ASI Transistor Checker also permits matching similar transistors in actual operating circuits, and provides a reliable GO/NO GO test of practical collector currents (from 5mA on small signal types to 50mA and more on power types). Match similar type transistors by observing and comparing diode readings; the higher the reading, the higher the gain. Completely assembled battery operated. ("C" cell battery not included)

Trans-Check \$9.95

EPROM Erasing Lamp

Erases 2708, 2716, 1702A, 52030, 52040, etc.
 Erases up to 4 chips within 20 minutes.
 Maintains constant exposure distance of one inch.
 Special conductive foam liner eliminates static build-up.
 Built-in safety lock to prevent UV exposure.
 Compact — only 7-5/8" x 2-7/8" x 2"
 Complete with holding tray for 4 chips.

UVS-11E \$79.95

JOYSTICKS

JS-5K
 JS-100K
 JS-5K 5K Linear Taper Pots \$5.25
 JS-100K 100K Linear Taper Pots \$4.95
 JVC-40 40K (2) Video Controller in case \$5.95

6-Digit Clock Kit

Bright 300 ht. comm. cathode display
 Uses MM5314 clock chip
 Switches for hours, minutes and hold modes
 Hrs. easily viewable to 20 ft.
 Simulated walnut case
 115 V AC input
 12 or 24 hr. operation
 Incl. all components, case & wall transformer
 Size: 6 1/4" x 3 1/8" x 1 3/4"

JE701 \$19.95

JE215 Adjustable Dual Power Supply

General Description: The JE215 is a Dual Power Supply with independent adjustable positive and negative output voltages. A separate adjustment for each of the supplies provides the user unlimited applications for IC current voltage requirements. The supply can also be used as a general all-purpose variable power supply.

FEATURES:

- Adjustable regulated power supplies, pos. and neg. 1.2VDC to 15VDC.
- Power Output (each supply): 5VDC @ 500mA, 10VDC @ 750mA, 12VDC @ 500mA, and 15VDC @ 175mA.
- Two, 3-terminal adj. IC regulators with thermal overload protection.
- Heat sink regulator cooling
- LED "on" indicator
- Printed Board Construction
- Size: 3-1/2" w x 5-1/16" L x 2" H

JE215 Adj. Dual Power Supply Kit (as shown) . . . \$24.95

(Picture not shown but similar in construction to above)
 JE200 Reg. Power Supply Kit (5VDC, 3 amp) . . . \$14.95
 JE205 Adapter Board (JE200) . . . \$9 & \$12 . . . \$12.95
 JE210 Var. Pwr. Sply. Kit, 5-15VDC, to 1.5amp . . \$19.95

MICROPROCESSOR COMPONENTS

8080A/8080A SUPPORT DEVICES

INS580A CPU	6.50
DP212 8-Bit Input/Output	3.25
DP214 Priority Interrupt Controller	6.50
DP216 Bi-Directional Bus Driver	3.49
DP224 Clock Generator/Driver	3.96
DP226 Bus Driver	3.49
DP228 System Controller/Bus Driver	4.95
DP238 System Controller	5.95
INS583 I/O Controller for 8080 Series	5.95
INS580 Asynchronous Command Element	16.95
DP251 Prog. Command I/O (USART)	7.95
DP253 Prog. Interval Timer	14.95
DP255 Prog. Peripheral I/O (DPI)	19.95
DP257 Prog. DMA Control	19.95
DP259 Prog. Interrupt Control	14.95
DP275 Prog. CRT Controller	49.95
DP279 Prog. Keyboard/Display Interface	19.95
DP300 Octal Bus Receiver	6.95
DP302 System Timing Element	6.95
DP304 8-Bit Bi-Directional Receiver	3.95
DP307 8-Bit Bi-Directional Receiver	3.95
DP308 8-Bit Bi-Directional Receiver	3.95

8080/8080 SUPPORT DEVICES

MC8000 MPU	14.95
MC8002 MPU with Clock and RAM	18.95
MC810AP1 128K Static RAM	4.95
MC821 Peripheral Inter. Adapt (MC820)	7.49
MC828 MPU 8-Bit (8MHz)	18.95
MC830L 1024x8-Bit ROM (MC83A0-8)	14.95
MC850 Asynchronous Command Adapter	6.95
MC855 Synchronous Serial Data Adapter	6.95
MC860 6000bps Digital MODEM	10.95
MC862 2400bps Modulator	12.95
MC880A Quad 3-State Bus Trans. (MC87A2)	2.25

MICROPROCESSOR CHIPS

Z80 (780C) CPU (MC880A-3) (8MHz)	13.95
Z80A (780-1) CPU (MC880A-4) (8MHz)	15.95
CDP1802 CPU	19.95
MPU MPU	15.95
IO/M200A CPU—4-Bit Slice (Com. Temp. Grade)	19.95
MC5602 MPU w/Clock (60K Bytes Memory)	11.95
INS582N4 MPU 8-Bit (8MHz)	18.95
INS5809N4 CPU 5-Chip 8-Bit (128 Bytes RAM)	19.95
INS5804N4 CPU (256 Bytes RAM)	24.95
INS5810N4 CPU—54 Bytes RAM	24.95
INS5813N4 CPU w/Basic Micro Interpreter	29.95
P985 CPU	19.95
INS5900 CPU—16-Bit	29.95
TM5900-L CPU—16-Bit	49.95

SHIFT REGISTERS

MM500H Dual 25-Bit Dynamic	5.50
MM501H Dual 50-Bit Dynamic	5.50
MM502H Dual 100-Bit Dynamic	5.50
MM503H Dual 54-Bit Accumulator	5.50
MM504 Dual 256-Bit Dynamic	3.95
MM505H 1024-Bit Dynamic/Accumulator	1.95
MM506H 5000-Bit Dynamic	3.95
MM507N Octal 80-Bit	9.95
MM508N Octal 80-Bit	9.95
2504V (HKA) 1024-Bit Dynamic	3.95
2518N Hex 32-Bit Static	4.95
2527V Dual 132-Bit Static	2.95
2531V 512-Bit Dynamic	9.95
2532V 1024-Bit Dynamic	2.95
2537V Dual 256-Bit Static	2.95
2538V Dual 960-Bit Static	4.00
2539V Dual 240-Bit Static	2.00
2532N Quad 80-Bit Static	2.95
3413PC File (Dual 80)	6.95

DATA ACQUISITION

AF1201CN Universal Active Filter 2.5%	5.95
AF1212CN Touch Tone Low Pass Filter	19.95
AF1213CN Touch Tone Low Pass Filter	19.95
LM308AH Super Gain Op Amp	1.00
LM334 Constant Current Source	1.20
LM335Z Temperature Transducer	1.40
JF136N JFET Input Op Amp	1.10
LM3981 Sample & Hold Amplifier	3.95
LM3994 Temp. Comp. Pres. Ref. (1ppm/C)	2.95
ADC0804CN 8-Bit D/A Converter (1 LSB)	4.95
ADC0805CN 8-Bit D/A Converter (0.75 LSB)	2.25

DATA ACQUISITION (CONTINUED)

ADC0809CN 8-Bit A/D Converter (8-Ch. Multis.)	5.25
ADC0817CN 10-Bit A/D Converter (16-Ch. Multis.)	10.95
DAC1204CN 10-Bit D/A Converter (Micro. Comp. (0.2%)	3.95
DAC1206CN 10-Bit D/A Converter (0.05% Lin.)	8.49
DAC1208CN 10-Bit D/A Converter (0.2% Lin.)	5.95
DAC1212CN 12-Bit D/A Converter (0.2% Lin.)	9.49
CD4515 8-Channel Multiplexer	1.95
AY-5101 30K Baud Rate	3.95

PROMS/EPROMS

1702A 2K EPROM (Erasable PROM)	5.95
2708 8K EPROM	5.95
2716 16K EPROM	10.95
2732 32K EPROM	19.95
2764 64K EPROM (4096) (Single +5V)	14.95
27128 2732 (128K) 2732 (128K) EPROM	19.95
27256 27256 (256K) EPROM (Single +5V)	7.95
27512 27512 (256K) EPROM (Single +5V)	14.95
27128 27128 (128K) EPROM (Single +5V)	14.95
27128 27128 (128K) EPROM (Single +5V)	14.95

ROMS

2513(240) Character Generator (Upper Case)	9.95
2513(302) Character Generator (Lower Case)	9.95
2518N Character Generator	1.95
MM5202N 2048-Bit Read Only Memory	1.95

NMOS READ ONLY MEMORIES

MC16460 128x4 500ns Shifted w/Dread	13.50
MC16461 128x4 500ns Shifted w/Dread	13.50
MC16462 128x4 500ns Shifted w/Dread	13.50
MC16463 128x4 500ns Shifted w/Dread	13.50

MICROPROCESSOR MANUALS

MM-280 User Manual	7.50
MC-COP102 User Manual	7.50
MC-250 User Manual	5.00

SPECIAL FUNCTION

D5052CN Dual MDS Clock Driver (5M2)	3.50
D5053CN Dual MDS Clock Driver (5M2)	1.95
INS1771N Floppy Disk Controller	24.95
INS1861N Communication Chip	19.95
MM5817N Microprocessor Real Time Clock	6.95
MM5817N Microprocessor Compatible Clock	1.95
MC4022N Microcontroller with 4-Digit RAM	6.95
MC4022N Microcontroller with 4-Digit RAM	6.95
MC4022N Microcontroller with 4-Digit RAM	6.95
MC4022N Microcontroller with 4-Digit RAM	6.95

TELEPHONE/KEYBOARD CHIPS

AY-5100 Push Button Telephone Dialer	14.95
AY-5100 Repertory Dialer	14.95
AY-5100 CMOS Clock Generator	4.95
AY-5100 Keyboard Encoder (16 keys)	11.95
AY-5100 Keyboard Encoder (16 keys)	5.95
AY-5100 Keyboard Encoder (16 keys)	5.95
AY-5100 Keyboard Encoder (16 keys)	5.95
AY-5100 Keyboard Encoder (16 keys)	5.95
AY-5100 Keyboard Encoder (16 keys)	5.95

8080/8080 SUPPORT DEVICES

8080/8080 SUPPORT DEVICES

INS580A CPU	6.50
DP212 8-Bit Input/Output	3.25
DP214 Priority Interrupt Controller	6.50
DP216 Bi-Directional Bus Driver	3.49
DP224 Clock Generator/Driver	3.96
DP226 Bus Driver	3.49
DP228 System Controller/Bus Driver	4.95
DP238 System Controller	5.95
INS583 I/O Controller for 8080 Series	5.95
INS580 Asynchronous Command Element	16.95
DP251 Prog. Command I/O (USART)	7.95
DP253 Prog. Interval Timer	14.95
DP255 Prog. Peripheral I/O (DPI)	19.95
DP257 Prog. DMA Control	19.95
DP259 Prog. Interrupt Control	14.95
DP275 Prog. CRT Controller	49.95
DP279 Prog. Keyboard/Display Interface	19.95
DP300 Octal Bus Receiver	6.95
DP302 System Timing Element	6.95
DP304 8-Bit Bi-Directional Receiver	3.95
DP307 8-Bit Bi-Directional Receiver	3.95
DP308 8-Bit Bi-Directional Receiver	3.95

8080/8080 SUPPORT DEVICES

MC8000 MPU	14.95
MC8002 MPU with Clock and RAM	18.95
MC810AP1 128K Static RAM	4.95
MC821 Peripheral Inter. Adapt (MC820)	7.49
MC828 MPU 8-Bit (8MHz)	18.95
MC830L 1024x8-Bit ROM (MC83A0-8)	14.95
MC850 Asynchronous Command Adapter	6.95
MC855 Synchronous Serial Data Adapter	6.95
MC860 6000bps Digital MODEM	10.95
MC862 2400bps Modulator	12.95
MC880A Quad 3-State Bus Trans. (MC87A2)	2.25

MICROPROCESSOR CHIPS

Z80 (780C) CPU (MC880A-3) (8MHz)	13.95
Z80A (780-1) CPU (MC880A-4) (8MHz)	15.95
CDP1802 CPU	19.95
MPU MPU	15.95
IO/M200A CPU—4-Bit Slice (Com. Temp. Grade)	19.95
MC5602 MPU w/Clock (60K Bytes Memory)	11.95
INS582N4 MPU 8-Bit (8MHz)	18.95
INS5809N4 CPU 5-Chip 8-Bit (128 Bytes RAM)	19.95
INS5804N4 CPU (256 Bytes RAM)	24.95
INS5810N4 CPU—54 Bytes RAM	24.95
INS5813N4 CPU w/Basic Micro Interpreter	29.95
P985 CPU	19.95
INS5900 CPU—16-Bit	29.95
TM5900-L CPU—16-Bit	49.95

SHIFT REGISTERS

MM500H Dual 25-Bit Dynamic	5.50
MM501H Dual 50-Bit Dynamic	5.50
MM502H Dual 100-Bit Dynamic	5.50
MM503H Dual 54-Bit Accumulator	5.50
MM504 Dual 256-Bit Dynamic	3.95
MM505H 1024-Bit Dynamic/Accumulator	1.95
MM506H 5000-Bit Dynamic	3.95
MM507N Octal 80-Bit	9.95
MM508N Octal 80-Bit	9.95
2504V (HKA) 1024-Bit Dynamic	3.95
2518N Hex 32-Bit Static	4.95
2527V Dual 132-Bit Static	2.95
2531V 512-Bit Dynamic	9.95
2532V 1024-Bit Dynamic	2.95
2537V Dual 256-Bit Static	2.95
2538V Dual 960-Bit Static	4.00
2539V Dual 240-Bit Static	2.00
2532N Quad 80-Bit Static	2.95
3413PC File (Dual 80)	6.95

DATA ACQUISITION

AF1201CN Universal Active Filter 2.5%	5.95
AF1212CN Touch Tone Low Pass Filter	19.95
AF1213CN Touch Tone Low Pass Filter	19.95
LM308AH Super Gain Op Amp	1.00
LM334 Constant Current Source	1.20
LM335Z Temperature Transducer	1.40
JF136N JFET Input Op Amp	1.10
LM3981 Sample & Hold Amplifier	3.95
LM3994 Temp. Comp. Pres. Ref. (1ppm/C)	2.95
ADC0804CN 8-Bit D/A Converter (1 LSB)	4.95
ADC0805CN 8-Bit D/A Converter (0.75 LSB)	2.25

DATA ACQUISITION (CONTINUED)

ADC0809CN 8-Bit A/D Converter (8-Ch. Multis.)	5.25
ADC0817CN 10-Bit A/D Converter (16-Ch. Multis.)	10.95
DAC1204CN 10-Bit D/A Converter (Micro. Comp. (0.2%)	3.95
DAC1206CN 10-Bit D/A Converter (0.05% Lin.)	8.49
DAC1208CN 10-Bit D/A Converter (0.2% Lin.)	5.95
DAC1212CN 12-Bit D/A Converter (0.2% Lin.)	9.49
CD4515 8-Channel Multiplexer	1.95
AY-5101 30K Baud Rate	3.95

PROMS/EPROMS

1702A 2K EPROM (Erasable PROM)	5.95
2708 8K EPROM	5.95
2716 16K EPROM	10.95
2732 32K EPROM	19.95
2764 64K EPROM (4096) (Single +5V)	14.95
27128 2732 (128K) 2732 (128K) EPROM	19.95
27256 27256 (256K) EPROM (Single +5V)	7.95
27512 27512 (256K) EPROM (Single +5V)	14.95
27128 27128 (128K) EPROM (Single +5V)	14.95
27128 27128 (128K) EPROM (Single +5V)	14.95

ROMS

2513(240) Character Generator (Upper Case)	9.95
2513(302) Character Generator (Lower Case)	9.95
2518N Character Generator	1.95
MM5202N 2048-Bit Read Only Memory	1.95

NMOS READ ONLY MEMORIES

MC16460 128x4 500ns Shifted w/Dread	13.50
MC16461 128x4 500ns Shifted w/Dread	13.50
MC16462 128x4 500ns Shifted w/Dread	13.50
MC16463 128x4 500ns Shifted w/Dread	13.50

MICROPROCESSOR MANUALS

MM-280 User Manual	7.50
MC-COP102 User Manual	7.50
MC-250 User Manual	5.00

SPECIAL FUNCTION

D5052CN Dual MDS Clock Driver (5M2)	3.50
D5053CN Dual MDS Clock Driver (5M2)	1.95
INS1771N Floppy Disk Controller	24.95
INS1861N Communication Chip	19.95
MM5817N Microprocessor Real Time Clock	6.95
MM5817N Microprocessor Compatible Clock	1.95
MC4022N Microcontroller with 4-Digit RAM	6.95
MC4022N Microcontroller with 4-Digit RAM	6.95
MC4022N Microcontroller with 4-Digit RAM	6.95
MC4022N Microcontroller with 4-Digit RAM	6.95

TELEPHONE/KEYBOARD CHIPS

AY-5100 Push Button Telephone Dialer	14.95
AY-5100 Repertory Dialer	14.95
AY-5100 CMOS Clock Generator	4.95
AY-5100 Keyboard Encoder (16 keys)	11.95
AY-5100 Keyboard Encoder (16 keys)	5.95
AY-5100 Keyboard Encoder (16 keys)	5.95
AY-5100 Keyboard Encoder (16 keys)	5.95
AY-5100 Keyboard Encoder (16 keys)	5.95

DESIGNERS' SERIES

Blank Desk-Top Electronic Enclosures

CONSTRUCTION: The "DTE" Blank Desk Top Electronic Enclosures are designed to blend and complement today's modern computer equipment and can be used in both industrial and home. The end pieces are precision molded with an internal slot (all around) to accept both top and bottom panels. The panels are then fastened to 3/4" thick tabs inside the end pieces to provide maximum rigidity to the enclosure. For ease of equipment servicing, the rear/bottom panel slides back on slotted tracks while the rest of the enclosure remains intact. Different panel widths may be used while maintaining a common profile outline. The molded end pieces can also be painted to match any panel color scheme.

Enclosure Model No.	Panel Width	PRICE
DTE-8	8.00"	\$29.95
DTE-11	10.65"	\$32.95
DTE-14	14.00"	\$34.95

\$10.00 Min. Order — U.S. Funds Only
 Calif. Residents Add 6% Sales Tax
 Postage — Add 5% plus \$1 Insurance

Spec Sheets — 25¢
 Each \$2.00 Postage for your
 FREE 1981 JAMECO CATALOG

PHONE ORDERS WELCOME (415) 592-8097

ELECTRONIC TOY MOTORS

Typical Purposes	Operating Voltage Range	TYPICAL CHARACTERISTICS								
		NO LOAD			AT MAXIMUM EFFICIENCY			SMALL TORQUE		
		Voltage	Speed (RPM)	Current (AMP)	Speed (RPM)	Torque (oz-in)	Output (W)	EFF %	QZ IN.	
DRY CELL	1.5-6.0	3.0	9,200	0.20	6,750	0.90	0.260	1.30	57.0	0.97

MABUCHI RE280 \$.99 each . . . /\$7.50 . . . /100/\$50.00

Bourns Potentiometer

3/4 Watt Single Turn (TOP ADJUSTMENT)

Values: 500Ω 1K 2.5K 5K 10K 25K 50K 100K 250K 500K 5Meg

INDIVIDUAL PRICING:

1-49 50-99 100-999 1K-up
 .19 .17 .15 .12

GB174 \$1.95/lot
 (25 pieces all 11 std. values)

To order: Specify Bourns 3355 — (Value desired)

AC and DC Wall Transformers

ideal for use with clocks, games, power supplies or other devices that require AC or DC application

Part No.	Input	Output	Price
AC 250	117V/60Hz	12 VAC 250mA	\$3.95
AC 500	117V/60Hz	12 VAC 500mA	\$4.95
AC1000	117V/60Hz	12 VAC 1 amp	\$5.95
AC1700	117V/60Hz	9 VAC 1.7 amp	\$6.95
DC 900	117V/60Hz	9 VDC 200mA	\$3.25
DC 900	120V/60Hz	9 VDC 500mA	\$3.95

CONNECTORS

DB25P	D-Subminiature Plug	\$2.95
DB25S	D-Subminiature Socket	\$3.50
DBS1226	Cover for DB25P/S	\$1.75
22/44SE	P.C. Edge (22/44 Pin)	\$2.95
UG88/U	BNC Plug	\$1.79
UG89/U	BNC Jack	\$3.79
UG175/U	UHF Adapter	\$.49</

PLANS & KITS

BUILD a frequency standard as accurate as WWV. Use to verify accuracy of your frequency counter. Complete circuit \$8.00. Send stamp for kit information. **DA PRODUCTS**, PO Box 566, Hampshire, IL 60140

UNIQUE electronics plans and kits: 2300 MHz microwave downconverter antenna system. Learn about the latest in television reception! Complete plans, \$10.00; kits \$199.00. Telephone memory dialer, negative ion generator, plans \$4.00 each. Buy any two sets of plans and we'll send a bonus third set free! Plans include detailed instructions and PCB patterns. Parts available. For more information on these and other plans, send \$1.00 and send SASE. COLINS ELECTRONICS, Box 6424, San Bernardino, CA 92412

MICROWAVE HORN ANTENNA KIT

1.7-2.6 GHz Frequency Range 17-19 db Gain. Kit w/Assembly Instructions \$39.95*
Down Converter Board \$19.95* (w/Antenna Kit \$14.95)
Parts Kit for Board \$29.95* (w/Antenna or Board \$24.95)
Complete Package (Antenna, Board & Parts Kit) \$79.95



MICROTENNA ASSOCIATES

2335 South 2300 West, Salt Lake City, Utah 84119
Check or M.O. only — Allow 2-4 Weeks Delivery (Cost includes shipping)
*Utah Residents Please Add 5% Sales Tax

BOOST CB/HAM modulation/range. Free plans/kits catalog. "SKIPPER", Box 130-F7, Paradise, CA 95969

DECODE Morse and RTTY signals off the air with new Morse-a-Word or RTTY reader. Morse keyboard also available. Kits or factory wired. Send for details. **MICROCRAFT**, Box 513R, Thiensville, WI 53092 (414) 241-8144.

FREE KIT Catalog

FUNCTION GENERATOR KIT \$59.95 contains TEST & EXPERIMENTER EQUIP.
Auto-Ranging Cap-meter kit \$79.95
Phone 415-447-3433
Write or Phone for FREE CATALOG.
Average 1 minute Saturday call is 21¢.

DAGE SCIENTIFIC INSTRUMENTS
BOX 1054R LIVERMORE CA 94550

ATV Research ...specialists in CCTV and computer monitors!

Video monitors - color & B/W * TV Cameras, kits, parts & plans * Video-to-RF modulators * Free catalog. Phone or write. (402) 987-3771
13-RE Broadway Dakota City, NE. 68731

FREE catalog. Plans including printed circuit patterns, printed circuit boards, complete kits, and assembled products. **NICOLAS ELECTRONICS**, 15 Bertonna, Nepean, Ontario K2G 0W3

2716 EPROM \$11 programmer, hardware software plans. Send \$9. CARTIER, 6844 Nashville Road, Lanham, MD 20801

SATELLITE television antenna kit \$399.00. Free information. **BRIGHT STAR SYSTEMS**, Box 499-R, McCrory, AR 72101, 501-731-5310

AMAZING ELECTRONIC PROJECTS and PRODUCTS:

Lasers Super Powered, Burning Cutting, Rifle, Pistol, Pocket. See in Dark—Shotgun Directional Mike—Unscramblers—Giant Tesla—Stunwand—TV Disrupter—Energy Producing, Surveillance, Detection, Electrifying, Ultrasonic, CB, Auto and Mech. Devices, Hundreds More—All New Plus INFO UNLTD PARTS SERVICE. Catalog \$1. Information Unlimited, Dept. R8 Box 716 Amherst, N.H. 03031.

PRINTED circuit boards from sketch or artwork. Kit projects. Free details. **DANOCINTHS INC.**, Box 261, Westland, MI 48185

FREE catalog IC's semis, parts. **CORONET ELECTRONICS**, 649A Notre Dame W., Montreal, Que, Canada H3C 1H8 US inquiries

PALOMAR—pride—exclusive repair facility. Factory trained technicians—all work guaranteed. **PALOMAR/PRIDE ELECTRONICS**, 1320 Grand, San Marcos, CA 92069 (714) 744-0720



39⁹⁵

ADD \$2.50 FOR POSTAGE

FREE!

UNUSUAL 96 PAGE ELECTRONIC PARTS & IDEAS CATALOG!

ORDER No. 171AE047
ETCO ROUTE 9N,
PLATTSBURGH, N.Y. 12901
Tel.: (518) 561-8700.

PRINTED circuit boards with running water! Technological breakthrough. Precise reproduction. Ideal for beginners. Free info. **COVAL**, Dept. RE7, 2706 Kirby, Champaign, IL 61820

KITS, plans, and hard to find components for electronic music and audio projects. Send for free info at: **ELECTRONIC MUSIC CONSULTANTS**, 533-R San Blas Place, Santa Barbara, CA 93111

TELEVISION alignment—in minutes—while observing revolutionary pattern. Check RF, IF, video instantly! So simple and inexpensive it's incredible. Complete plans—\$8.00. Free details. **E-Z LINE**, Box 2702R, Clearwater, FL 33517

BUILD low cost, quality parabolic TVRO satellite dish. Plans \$5.00. **HARDEN AND ASSOCIATES**, Box 187, Manteo, NC 27954

PROJECTION TV . . . Convert your TV to project 7 foot picture. Results equal to \$2,500 projector. Total cost less than \$20.00. Plans & lens \$16.00. Illustrated information free. Mastercard/Visa orders: (215) 736-3979. **MACROCOM G. K.** Washington Crossing, PA 18977

CABLE TV converters and equipment, microwave antennas and downconverters. Plans and parts. Build or buy. For information send \$2.00. **C&D COMPANY**, PO Box 21, Jenison, MI 49428

EDUCATION & INSTRUCTION

ELECTRONICS books from world publishers. Lowest prices, ask catalog. **BUSINESS PROMOTION**, Lajpatrai Market, Delhi, India

UNIVERSITY degrees by mail! Bachelors, Masters, PhD's . . . Free revealing details. **COUNSELLING**, Box 317-RE 7, Tustin, CA 92680

BROADCASTING! Start your own radio station at home, school, church! Become DJ-engineer. Free information. "BROADCASTING", Box 130-F7 Paradise, CA 95969

LEARN computer technology—maintenance training from the digital specialists. Free brochure. **INNOVATIVE HOME STUDY**, Box 1046, Indian Rock Beach, FL 33535

PASS FCC EXAMS

The Original FCC Tests—Answers exam manual that prepares you at home for FCC First and Second Class Radiotelephone licenses. Newly revised multiple choice exams cover all areas tested on the actual FCC exam. Plus—Self-Study Ability Test, Proven! \$12.95 postpaid. Moneyback Guarantee.

TESTS—ANSWERS FOR FCC FIRST AND SECOND CLASS COMMERCIAL LICENSE

COMMAND PRODUCTIONS
Radio, Engineering Division P.O. Box 26348 E
San Francisco, CA 94126

ATTENTION ELECTRONIC TECHNICIANS

Highly Effective Home Study BSEE Degree Program for Experienced Electronic Technicians. Our New Advanced-Placement Program grants Credit for previous Schooling & Professional Experience. Advance Rapidly! Our 36th Year! Free Descriptive Literature.

COOK'S INSTITUTE OF ELECTRONICS ENGINEERING
Desk 10 • P.O. Box 20345 • Jackson, MS 39209

WANTED

MIRROR in the lid, spinning disc, and other pre-1946 television sets wanted. Call collect: (203) 521-5280

COMPUTER MARKET CENTER

◀ **COMPUTER MARKET CENTER ADVERTISING RATES** 1" by 1 column (1 5/8") \$55.00. 1 1/2" by 1 column (1 5/8") \$82.50. 2" by 1 column (1 5/8") \$110.00. All ads must be prepaid. Send order and remittances to Computer Market Center, **Radio-Electronics Magazine**, 200 Park Avenue South, New York, New York, 10003. Address telephone inquiries to 212-777-6400. Frequency rates are available. ▶

TEXAS

USED COMPUTER TERMINALS, PRINTERS, MODEMS, SURPLUS ELECTRONIC PARTS. CATALOG \$1.00
RONDURE COMPANY
THE COMPUTER ROOM
2522 BUTLER STREET
DALLAS, TEXAS 75235
(214) 630-4621

ARIZONA

SAVE 90%
Build your own computer. Free Details. Complete Catalog \$1.00 Refundable. **DIGATEK CORPORATION**, Suite 20D, 2723 West Butler Drive, Phx AZ 85021.

CANADA

DYNAMIC INFORMATION TECHNOLOGIES LTD.
P.O. BOX 6553 STN.A.
SAINT JOHN, N.B., CANADA
E2L 4R9 (506) 642-4260
TERMINALS, PRINTERS, MICROCOMPUTERS SOFTWARE.

CALIFORNIA

FREE! INFO-PAK for small computer users mailed twice a year. We sell and broker all kinds of **SMALL COMPUTER SOFTWARE** from S-100 to TRS-80. **SOFTWARE REVIEW**, 704 Solano Ave., Albany, CA 94706 (415) 527-7730.



THIS is only one of hundreds of unusual values . . . Get your **FREE CATALOG** today!
Dept. R
245A Great Road
Littleton, MA 01460

Radio Shack's Model III 16K • \$859
TOLL FREE
1-800-343-8124

computer plus

Take stock in America. Buy U.S. Savings Bonds.

SUPPORT MARCH OF DIMES



Thanks to you,
It works.
For all of us.



United Way

ramsey

the first name in Counters!



9 DIGITS 600 MHz \$129⁹⁵ WIRED

PRICES:

CT-90 wired, 1 year warranty	\$129.95
CT-90 Kit, 90 day parts warranty	
AC-1 AC adapter	109.95
BP-1 Nicad pack + AC Adapter/Charger	3.95
OV-1 Micro-power Oven time base	12.95
External time base input	49.95
	14.95

The CT-90 is the most versatile, feature packed counter available for less than \$300.00! Advanced design features include: three selectable gate times, nine digits, gate indicator and a unique display hold function which holds the displayed count after the input signal is removed! Also, a 10MHz TCXO time base is used which enables easy zero beat calibration checks against WWV. Optionally, an internal nicad battery pack, external time base input and Micro-power high stability crystal oven time base are available. The CT-90, performance you can count on!

SPECIFICATIONS:

Range:	20 Hz to 600 MHz
Sensitivity:	Less than 10 MV to 150 MHz Less than 50 MV to 500 MHz
Resolution:	0.1 Hz (10 MHz range) 1.0 Hz (60 MHz range) 10.0 Hz (600 MHz range)
Display:	9 digits 0.4" LED
Time base:	Standard-10,000 mHz, 1.0 ppm 20-40°C. Optional Micro-power oven-0.1 ppm 20-40°C
Power:	8-15 VAC @ 250 ma

7 DIGITS 525 MHz \$99⁹⁵ WIRED



SPECIFICATIONS:

Range:	20 Hz to 525 MHz
Sensitivity:	Less than 50 MV to 150 MHz Less than 150 MV to 500 MHz
Resolution:	1.0 Hz (5 MHz range) 10.0 Hz (50 MHz range) 100.0 Hz (500 MHz range)
Display:	7 digits 0.4" LED
Time base:	1.0 ppm TCXO 20-40°C
Power:	12 VAC @ 250 ma

The CT-70 breaks the price barrier on lab quality frequency counters. Deluxe features such as: three frequency ranges - each with pre-amplification, dual selectable gate times, and gate activity indication make measurements a snap. The wide frequency range enables you to accurately measure signals from audio thru UHF with 1.0 ppm accuracy - that's .0001%! The CT-70 is the answer to all your measurement needs, in the field, lab or ham shack.

PRICES:

CT-70 wired, 1 year warranty	\$99.95
CT-70 Kit, 90 day parts warranty	
AC-1 AC adapter	84.95
BP-1 Nicad pack + AC adapter/charger	3.95
	12.95

7 DIGITS 500 MHz \$79⁹⁵ WIRED

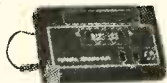

PRICES:

MINI-100 wired, 1 year warranty	\$79.95
AC-Z Ac adapter for MINI-100	3.95
BP-Z Nicad pack and AC adapter/charger	12.95

Here's a handy, general purpose counter that provides most counter functions at an unbelievable price. The MINI-100 doesn't have the full frequency range or input impedance qualities found in higher price units, but for basic RF signal measurements, it can't be beat! Accurate measurements can be made from 1 MHz all the way up to 500 MHz with excellent sensitivity throughout the range, and the two gate times let you select the resolution desired. Add the nicad pack option and the MINI-100 makes an ideal addition to your tool box for "in-the-field" frequency checks and repairs.

SPECIFICATIONS:

Range:	1 MHz to 500 MHz
Sensitivity:	Less than 25 MV
Resolution:	100 Hz (slow gate) 1.0 KHz (fast gate)
Display:	7 digits, 0.4" LED
Time base:	2.0 ppm 20-40°C
Power:	5 VDC @ 200 ma

8 DIGITS 600 MHz \$159⁹⁵ WIRED



SPECIFICATIONS:

Range:	20 Hz to 600 MHz
Sensitivity:	Less than 25 mv to 150 MHz Less than 150 mv to 600 MHz
Resolution:	1.0 Hz (60 MHz range) 10.0 Hz (600 MHz range)
Display:	8 digits 0.4" LED
Time base:	2.0 ppm 20-40°C
Power:	110 VAC or 12 VDC

The CT-50 is a versatile lab bench counter that will measure up to 600 MHz with 8 digit precision. And, one of its best features is the Receive Frequency Adapter, which turns the CT-50 into a digital readout for any receiver. The adapter is easily programmed for any receiver and a simple connection to the receiver's VFO is all that is required for use. Adding the receiver adapter in no way limits the operation of the CT-50, the adapter can be conveniently switched on or off. The CT-50, a counter that can work double-duty!

PRICES:

CT-50 wired, 1 year warranty	\$159.95
CT-50 Kit, 90 day parts warranty	119.95
RA-1, receiver adapter kit	14.95
RA-1 wired and pre-programmed (send copy of receiver schematic)	29.95

DIGITAL MULTIMETER \$99⁹⁵ WIRED



PRICES:

DM-700 wired, 1 year warranty	\$99.95
DM-700 Kit, 90 day parts warranty	79.95
AC-1, AC adaptor	3.95
BP-3, Nicad pack + AC adapter/charger	19.95
MP-1, Probe kit	2.95

The DM-700 offers professional quality performance at a hobbyist price. Features include: 26 different ranges and 5 functions, all arranged in a convenient, easy to use format. Measurements are displayed on a large 3 1/2 digit, 1/2 inch LED readout with automatic decimal placement, automatic polarity, overrange indication and overload protection up to 1250 volts on all ranges, making it virtually goof-proof! The DM-700 looks great, a handsome, jet black, rugged ABS case with convenient retractable tilt bail makes it an ideal addition to any shop.

SPECIFICATIONS:

DC/AC volts:	100uV to 1 KV, 5 ranges
DC/AC current:	0.1uA to 2.0 Amps, 5 ranges
Resistance:	0.1 ohms to 20 Megohms, 6 ranges
Input impedance:	10 Megohms, DC/AC volts
Accuracy:	0.1% basic DC volts
Power:	4 'C' cells

AUDIO SCALER

For high resolution audio measurements, multiplies UP in frequency.

- Great for PL tones
- Multiplies by 10 or 100
- 0.01 Hz resolution!

\$29.95 Kit \$39.95 Wired

ACCESSORIES

Telescopic whip antenna - BNC plug	\$ 7.95
High impedance probe, light loading	15.95
Low pass probe, for audio measurements	15.95
Direct probe, general purpose usage	12.95
Tilt bail, for CT 70, 90, MINI-100	3.95
Color burst calibration unit, calibrates counter against color TV signal	14.95

COUNTER PREAMP

For measuring extremely weak signals from 10 to 1,000 MHz. Small size, powered by plug transformer-included.

- Flat 25 db gain
 - BNC Connectors
 - Great for sniffing RF with pick-up loop
- \$34.95 Kit \$44.95 Wired

ramsey electronics, inc.

2575 BAIRD RD. • PENFIELD, NY 14526

PHONE ORDERS
CALL 716-586-3950

TERMS

Satisfaction guaranteed - examine for 10 days if not pleased return in original form for refund. Add 5% for shipping insurance to a maximum of \$10. Overseas add 15%. COD, add \$2. Orders under \$10, add \$1.50. NY residents add 7% tax

CIRCLE 6 ON FREE INFORMATION CARD

7400

SN7400N	.19	SN74123N	.59	74LS00N	.35	74LS164N	1.19
SN7401N	.22	SN74125N	.39	74LS01N	.28	74LS165N	.89
SN7402N	.22	SN74126N	.44	74LS02N	.28	74LS166N	2.48
SN7403N	.22	SN74128N	.59	74LS03N	.28	74LS168N	1.89
SN7404N	.22	SN74132N	.69	74LS04N	.39	74LS169N	1.98
SN7405N	.23	SN74136N	.89	74LS05N	.39	74LS170N	1.99
SN7406N	.23	SN74139N	.95	74LS06N	.39	74LS173N	.89
SN7407N	.23	SN74141N	.69	74LS09N	.39	74LS174N	.99
SN7408N	.26	SN74142N	2.95	74LS10N	.28	74LS175N	.99
SN7409N	.26	SN74143N	2.95	74LS11N	.39	74LS181N	2.20
SN7410N	.29	SN74144N	2.95	74LS12N	.29	74LS190N	1.15
SN7411N	.29	SN74145N	.62	74LS13N	.47	74LS191N	1.15
SN7412N	.29	SN74147N	1.95	74LS14N	1.25	74LS192N	.98
SN7413N	.39	SN74148N	1.20	74LS15N	.39	74LS193N	.98
SN7414N	.59	SN74150N	.99	74LS20N	.26	74LS194N	1.15
SN7415N	.59	SN74151N	.57	74LS21N	.39	74LS195N	1.15
SN7417N	.29	SN74152N	.67	74LS22N	.38	74LS196N	.89
SN7420N	.22	SN74153N	.67	74LS26N	.39	74LS197N	.89
SN7421N	.35	SN74154N	1.19	74LS27N	.39	74LS221N	1.49
SN7422N	.29	SN74155N	.82	74LS28N	.39	74LS240N	1.95
SN7423N	.29	SN74156N	.89	74LS30N	.26	74LS241N	1.90
SN7425N	.29	SN74157N	.89	74LS32N	.39	74LS242N	1.95
SN7426N	.29	SN74158N	1.65	74LS37N	.79	74LS243N	1.95
SN7427N	.29	SN74160N	.95	74LS38N	.39	74LS244N	1.95
SN7429N	.45	SN74161N	.95	74LS40N	.26	74LS245N	4.95
SN7430N	.23	SN74162N	.89	74LS42N	.79	74LS247N	1.10
SN7432N	.29	SN74163N	.87	74LS47N	.79	74LS247N	1.10
SN7437N	.29	SN74164N	.97	74LS48N	.79	74LS249N	1.69
SN7438N	.29	SN74165N	.97	74LS51N	.26	74LS251N	1.79
SN7439N	.29	SN74166N	1.20	74LS54N	.35	74LS253N	.98
SN7440N	.29	SN74167N	1.95	74LS55N	.35	74LS257N	.98
SN7441N	.79	SN74170N	1.89	74LS57N	.39	74LS258N	.98
SN7442N	.57	SN74171N	5.95	74LS57AN	.59	74LS259N	2.95
SN7443N	.79	SN74173N	.79	74LS57SN	.68	74LS260N	.69
SN7444N	.79	SN74174N	.89	74LS76N	.45	74LS261N	2.49
SN7445N	.79	SN74175N	.89	74LS78N	.65	74LS266N	.59
SN7446N	.79	SN74176N	.85	74LS80AN	.99	74LS273N	1.75
SN7447N	.79	SN74177N	.85	74LS82AN	1.19	74LS274N	4.40
SN7448N	.79	SN74179N	1.80	74LS86N	.45	74LS279N	.59
SN7449N	.23	SN74180N	.75	74LS90N	.75	74LS283N	1.10
SN7451N	.23	SN74181N	1.75	74LS92N	.75	74LS290N	1.29
SN7453N	.23	SN74182N	.75	74LS93N	.75	74LS293N	1.89
SN7454N	.23	SN74184N	1.95	74LS94N	.75	74LS294N	1.10
SN7455N	.29	SN74185N	1.95	74LS96N	.98	74LS298N	1.29
SN7460N	.23	SN74186N	0.95	74LS107N	.45	74LS324N	1.75
SN7470N	.39	SN74188N	1.30	74LS109N	.45	74LS347N	1.95
SN7471N	.34	SN74190N	3.15	74LS112N	.49	74LS348N	1.95
SN7473N	.38	SN74191N	1.15	74LS113N	.49	74LS350N	1.65
SN7474N	.38	SN74192N	.85	74LS114N	.55	74LS353N	1.65
SN7475N	.38	SN74193N	.85	74LS122N	.55	74LS363N	1.49
SN7476N	.38	SN74194N	.85	74LS123N	1.19	74LS365N	.99
SN7479N	.46	SN74195N	.85	74LS124N	1.35	74LS366N	.99
SN7480N	.53	SN74196N	.85	74LS125N	.89	74LS373N	2.75
SN7481N	1.10	SN74197N	.85	74LS132N	.79	74LS373N	2.75
SN7482N	1.10	SN74198N	1.39	74LS136N	.89	74LS374N	2.75
SN7483N	.55	SN74199N	1.39	74LS138N	.89	74LS375N	2.75
SN7485N	.65	SN74221N	1.39	74LS139N	.89	74LS377N	1.95
SN7486N	.79	SN74251N	1.05	74LS141N	1.35	74LS383N	1.95
SN7488N	1.75	SN74273N	1.05	74LS148N	1.49	74LS386N	.65
SN7490N	.39	SN74279N	.89	74LS151N	.79	74LS390N	1.95
SN7491N	.65	SN74283N	2.15	74LS153N	.79	74LS393N	1.95
SN7492N	.52	SN74284N	3.90	74LS154N	2.49	74LS395N	1.70
SN7493N	.49	SN74285N	3.90	74LS154AN	2.49	74LS395N	1.70
SN7494N	.49	SN74290N	1.25	74LS156N	.99	74LS424N	2.95
SN7495N	.55	SN74298N	.95	74LS157N	.99	74LS668N	1.75
SN7496N	.72	SN74365N	.68	74LS158N	.75	74LS670N	2.29
SN7497N	3.10	SN74366N	.68	74LS159N	.98	74LS95N	1.99
SN74100N	.99	SN74367N	.79	74LS160N	.98	74LS95N	1.99
SN74107N	.99	SN74368N	.79	74LS162N	.98	74LS97N	1.98
SN74109N	.53	SN74390N	1.90	74LS163N	.98	74LS98N	1.99
SN74116N	1.95	SN74393N	1.90				
SN74121N	.29	SN74490N	1.90				
SN74122N	.29						

74LS00

SN7400N	.19	SN74123N	.59	74LS00N	.35	74LS164N	1.19
SN7401N	.22	SN74125N	.39	74LS01N	.28	74LS165N	.89
SN7402N	.22	SN74126N	.44	74LS02N	.28	74LS166N	2.48
SN7403N	.22	SN74128N	.59	74LS03N	.28	74LS168N	1.89
SN7404N	.22	SN74132N	.69	74LS04N	.39	74LS169N	1.98
SN7405N	.23	SN74136N	.89	74LS05N	.39	74LS170N	1.99
SN7406N	.23	SN74139N	.95	74LS06N	.39	74LS173N	.89
SN7407N	.23	SN74141N	.69	74LS09N	.39	74LS174N	.99
SN7408N	.26	SN74142N	2.95	74LS10N	.28	74LS175N	.99
SN7409N	.26	SN74143N	2.95	74LS11N	.39	74LS181N	2.20
SN7410N	.29	SN74144N	2.95	74LS12N	.29	74LS190N	1.15
SN7411N	.29	SN74145N	.62	74LS13N	.47	74LS191N	1.15
SN7412N	.29	SN74147N	1.95	74LS14N	1.25	74LS192N	.98
SN7413N	.39	SN74148N	1.20	74LS15N	.39	74LS193N	.98
SN7414N	.59	SN74150N	.99	74LS20N	.26	74LS194N	1.15
SN7415N	.59	SN74151N	.57	74LS21N	.39	74LS195N	1.15
SN7417N	.29	SN74152N	.67	74LS22N	.38	74LS196N	.89
SN7420N	.22	SN74153N	.67	74LS26N	.39	74LS197N	.89
SN7421N	.35	SN74154N	1.19	74LS27N	.39	74LS221N	1.49
SN7422N	.29	SN74155N	.82	74LS28N	.39	74LS240N	1.95
SN7423N	.29	SN74156N	.89	74LS30N	.26	74LS241N	1.90
SN7425N	.29	SN74157N	.89	74LS32N	.39	74LS242N	1.95
SN7426N	.29	SN74158N	1.65	74LS37N	.79	74LS243N	1.95
SN7427N	.29	SN74160N	.95	74LS38N	.39	74LS244N	1.95
SN7429N	.45	SN74161N	.95	74LS40N	.26	74LS245N	4.95
SN7430N	.23	SN74162N	.89	74LS42N	.79	74LS247N	1.10
SN7432N	.29	SN74163N	.87	74LS47N	.79	74LS247N	1.10
SN7437N	.29	SN74164N	.97	74LS48N	.79	74LS249N	1.69
SN7438N	.29	SN74165N	.97	74LS51N	.26	74LS251N	1.79
SN7439N	.29	SN74166N	1.20	74LS54N	.35	74LS253N	.98
SN7440N	.29	SN74167N	1.95	74LS55N	.35	74LS257N	.98
SN7441N	.79	SN74170N	1.89	74LS57N	.39	74LS258N	.98
SN7442N	.57	SN74171N	5.95	74LS57AN	.59	74LS259N	2.95
SN7443N	.79	SN74173N	.79	74LS57SN	.68	74LS260N	.69
SN7444N	.79	SN74174N	.89	74LS76N	.45	74LS261N	2.49
SN7445N	.79	SN74175N	.89	74LS78N	.65	74LS266N	.59
SN7446N	.79	SN74176N	.85	74LS80AN	.99	74LS273N	1.75
SN7447N	.79	SN74177N	.85	74LS82AN	1.19	74LS274N	4.40
SN7448N	.79	SN74179N	1.80	74LS86N	.45	74LS279N	.59
SN7449N	.23	SN74180N	.75	74LS90N	.75	74LS283N	1.10
SN7451N	.23	SN74181N	1.75	74LS92N	.75	74LS290N	1.29
SN7453N	.23	SN74182N	.75	74LS93N	.75	74LS293N	1.89
SN7454N	.23	SN74184N	1.95	74LS94N	.75	74LS294N	1.10
SN7455N	.29	SN74185N	1.95	74LS96N	.98	74LS298N	1.29
SN7460N	.23	SN74186N	0.95	74LS107N	.45	74LS324N	1.75
SN7470N	.39	SN74188N	1.30	74LS109N	.45	74LS347N	1.95
SN7471N	.34	SN74190N	3.15	74LS112N	.49	74LS348N	1.95
SN7473N	.38	SN74191N	1.15	74LS113N	.49	74LS350N	1.65
SN7474N	.38	SN74192N	.85	74LS114N	.55	74LS353N	1.65
SN7475N	.38	SN74193N	.85	74LS122N	.55	74LS363N	1.49
SN7476N	.38	SN74194N	.85	74LS123N	1.19	74LS365N	.99
SN7479N	.46	SN74195N	.85	74LS124N	1.35	74LS366N	.99
SN7480N	.53	SN74196N	.85	74LS125N	.89	74LS373N	2.75
SN7481N	1.10	SN74197N	.85	74LS132N	.79	74LS373N	2.75
SN7482N	1.10	SN74198N	1.39	74LS136N	.89	74LS374N	2.75
SN7483N	.55	SN74199N	1.39	74LS138N	.89	74LS375N	2.75
SN7485N	.65	SN74221N	1.39	74LS139N	.89	74LS377N	1.95
SN7486N	.79	SN74251N	1.05	74LS141N	1.35	74LS383N	1.95
SN7488N	1.75	SN74273N	1.05	74LS148N	1.49	74LS386N	.65
SN7490N	.39	SN74279N	.89	74LS151N	.79	74LS390N	1.95
SN7491N	.65	SN74283N	2.15	74LS153N	.79	74LS393N	1.95
SN7492N	.52	SN74284N	3.90	74LS154N	2.49	74LS395N	1.70
SN7493N	.49	SN74285N	3.90	74LS154AN	2.49	74LS395N	1.70
SN7494N	.49	SN74290N	1.25	74LS156N	.99	74LS424N	2.95
SN7495N	.55	SN74298N	.95	74LS157N	.99	74LS668N	1.75
SN7496N	.72	SN74365N	.68	74LS158N	.75	74LS670N	2.29
SN7497N	3.10	SN74366N	.68	74LS159N	.98	74LS95N	1.99
SN74100N	.99	SN74367N	.79	74LS160N	.98	74LS95N	1.99
SN74107N	.99	SN74368N	.79	74LS162N	.98	74LS97N	1.98
SN74109N	.53	SN74390N	1.90	74LS163N	.98	74LS98N	1.99
SN74116N	1.95	SN74393N	1.90				
SN74121N	.29	SN74490N	1.90				
SN74122N	.29						

1Kb UPGRADE ONLY \$24.95 SPECIFY COMPUTER

NON-LINEAR SYSTEMS, INC. NLS TOUCH-TEST 20 DIGITAL MULTIMETER

The NLS Model Touch-Test 20 is a 2 1/2 digit digital multimeter with capability of measuring 10 parameters including 20 functions and 44 ranges. Features touch testing and auto-ranging. Includes manual and instructions. Includes touch testing and auto-ranging. Includes manual and instructions.

\$319.95

BECKMAN Digital Multimeters

AS LOW AS \$100

The TECH 300 has a 0.5% Vdc accuracy and all the above features, but without auto-ranging. Choice of 7 functions, 29 ranges plus 0.25% Vdc accuracy.

TECH 300 Digital Multimeter... \$110
TECH 310 Digital Multimeter... \$140
TECH 320 Digital Multimeter... \$1

MICROWAVE yagi antenna for MDS complete with hardware, type N connector \$49.95. **SIGNAL ELECTRONICS**, 4027 18th Avenue, Brooklyn, NY 11218

MICROWAVE TV antenna. MDS designed yagi. 18 dB gain \$39.95. Details, plans and tech. data for same \$3.00. **BETA DESIGN GROUP**, POB 164, Airway Heights, WA 99001

Electronic Design Lab CA-18

Save money, time, and trouble with a design lab!

- Two EXP300 breadboards • Sloping metal cabinet
- Variable square wave generator .5Hz-20KHz
- T.T.L. and C.M.O.S. outputs
- Power supplies fixes 5V-1/2 amp output variable dual tracking regulator 0-15V ±, current ± 200M.A., all supplies short circuit proof, noise and ripples less than 20M.V.
- Four logic level indicators • Four data switches
- Excellent for schools teaching electronics, students, hobbyists, engineers and technicians. For testing, prototypes, modifications, circuit changes, ideas, and testing I.C.'s.

Write for a FREE brochure. Complete design lab \$99.95, kit only \$89.95. Shipping and handling (U.P.S.) \$5.00 We will ship C.O.D.

CASCADE LABS, 1261 Sunny Shore Drive Camano Island, Washington 98292 • (206) 387-0912

Colleges shouldn't have to choose between lighting their buildings and enlightening their students.

— Thomas Edison
Inventor

Today, colleges all across America are being hurt by inflation.

So please give generously to the college of your choice. The money you give will make everyone's future brighter.

Help! Give to the college of your choice.



Council for Financial Aid to Education, Inc. 680 Fifth Avenue, New York, N.Y. 10019

Red Cross: Ready for a new century.



A Public Service of This Magazine & The Advertising Council



SIMPLE SIMON PART KITS

SPECIAL FOR JULY!!
MITSUMI UHF TUNER
OVER STOCKED
REG. \$24.95
SALE PRICE \$19.95

(OFFER EXPIRES JULY 31, 1981)
FREQ. RANGE UHF 470V-890MHz
CHANNELS 14-83 OUTPUT CHAN 3

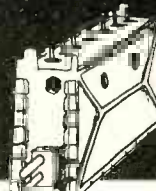

- VT1-SW Varactor UHF tuner, model UES-A55F \$19.95
- CB1-SW Printed circuit board, pre-drilled \$18.95
- TP7-SW PCB potentiometer, 1-20K, 1-K & 5-10K (7 pcs) \$5.95
- FR3-SW Resistor kit: 1/4W, 5% carbon film (32 pcs) \$4.95
- PT1-SW Power transformer: pri.-117VAC, sec.-24VAC, 250mA \$5.95
- PP2-SW Panel-mount potentiometers & knobs: 1-1K B-taper & 1-10K w/w \$5.95
- SS14-SW IC's (7 pcs), diodes (4 ea.), regulators (2 ea.) & heat sink (1 ea.) \$29.95
- CE9-SW Electrolytic capacitor kit (9 ea.) \$5.95
- CC39-SW Ceramic disc capacitors: 50 WV (33 pcs) \$7.95
- C1-SW Variable ceramic trimmer capacitors 5/65 pF (6 pcs) \$5.95
- L4-SW Coil kit: 2 ea. 18µH, 1 ea. 22µH inductances pre-wound and 1 ea. T37-12 ferrite toroid core with 6 ft #26 wire \$5.00
- ICS-SW IC sockets: 1in inlay, soldertail, 5 ea. 8-pin & 2 ea. 14-pin \$1.95
- SR-SW Speaker & enclosure with pre-punched backboard \$14.95
- MISC. Miscellaneous kit includes hardware: 6-32 & 8-32 screws, bolts, wire, ant. terminals, DPDT switch, fuseholder, etc. \$9.95

When ordering all items 1 thru 14 total price is \$139.95



STVA-1 Yagi antenna: 7 element, 75ft. Channels-42-54 11.5 dB gain \$9.95

COAX 75Ω coax cable: RG-59U—11c per foot

F-59 Coax connectors: 30c ea.

Mt-1 Special UHF 75-300Ω matching transformer \$1.45

A-1 Indoor VHF-UHF antenna amplifier 300Ω in-out, 13 dB gain \$19.95

Min. order amount is \$19.95, add 10% shipping & handling. Over \$40 add 5% shipping & handling. Calif. residents add 6% for sales tax. Catalog send \$1.00

Simple Simon Electronic Kits
11850 S. Hawthorne Blvd.
Hawthorne, Calif 90250

Visa-Mastercharge OK. Telephone 213-675-2335

POWER SUPPLY
MODEL #CP198
input → 110/125v
output → 5vdc
At 6amps
\$29.95
ty. price avail.

EPSON MX-80
\$560.00
PPLE INTERFACE & CABLE \$110.00

MISC.

2102	1.20
450NS	2.95
8038	2.95
NE555	.27
AY5-1013A	4.50
1488	1.25
1489	1.25
8T26	1.30
8T28	1.30
8212	2.95
8216	2.95
IS410SCR	.95
IT410TRIAC	.95
7905	.85
7908	.85
7915	.85
7918	.85
7805	.85
7806	.85
7808	.85
7812	.85
MC1330A1P	1.60
MC1350P	1.15
MC1358P	1.50
LM380	1.20
LM565N	.95
LM741	.25
MC1458P	.55
LM720	.30

ATARI® 800™ COMPUTER SYSTEM

400 Computer 8K → \$419.00
800 Computer 16K → \$779.00

***800 COMPUTER w/48K → \$989.00**

Best Buy

ATARI PERIPHERALS:

Printer ("825")	\$775.00	Printer ("822")	\$379.00
Recorder	\$65.00	Disk Drive	\$565.00
Interface ("850")	\$175.00	Modem	\$169.00
Paddles	\$17.00	Joysticks	\$17.00
Star Raiders	\$49.00	Assembler Editor	\$49.00
Space Invaders	\$17.00	Music Composer	\$49.00
Chess	\$32.00	Mailing List	\$17.00
Kingdom	\$12.00	TV Switch Box	\$8.95
Hangman	\$12.00	16K RAM	\$155.00
Blackjack	\$12.00	8K RAM	\$119.00

CONCORD COMPUTER PRODUCTS

1971 SO. STATE COLLEGE ANAHEIM, CALIF. 92806
(714) 937-0637
CHECK — M/O
NO COD

\$10. MIN. ORDER / CA. RES. ADD 6% FRT.

10-495	2.00\$	210-4995	8.00
10-497	4.00\$	500-499	1.00
100-24	7.00\$	100-14	Inquire

send \$1.00 for "81" catalog

LS SALE

Z-80	8.95	74LS00	.26	74LS155	1.15
Z-80A CTC	12.50	74LS02	.26	74LS158	.75
Z-80A CPU	12.50	74LS03	.26	74LS160	.95
Z-80 002 16-64K	129.00	74LS04	.26	74LS161	.85
8085A	11.50	74LS08	.28	74LS162	.95
2901A	12.50	74LS09	.26	74LS163	1.60
MC6800	9.50	74LS10	.26	74LS164	.65
		74LS11	.26	74LS165	.65
		74LS12	.26	74LS170	1.25
		74LS13	.26	74LS174	.75
		74LS14	.26	74LS175	.75
		74LS15	.26	74LS180	.75
		74LS16	.40	74LS181	.75
		74LS17	.26	74LS182	.75
		74LS18	.26	74LS183	.99
		74LS19	.26	74LS184	.99
		74LS20	.26	74LS185	.99
		74LS21	.26	74LS186	.99
		74LS22	.26	74LS187	.99
		74LS23	.26	74LS188	.99
		74LS24	.26	74LS189	.99
		74LS25	.26	74LS190	.75
		74LS26	.40	74LS191	.99
		74LS27	.26	74LS192	.99
		74LS28	.26	74LS193	.99
		74LS29	.26	74LS194	.99
		74LS30	.26	74LS195	.99
		74LS31	.26	74LS196	.99
		74LS32	.32	74LS197	.99
		74LS33	.32	74LS198	.99
		74LS34	.65	74LS199	1.40
		74LS35	.78	74LS200	1.65
		74LS36	.25	74LS201	1.65
		74LS37	.35	74LS202	1.45
		74LS38	.38	74LS203	1.45
		74LS39	.65	74LS204	2.25
		74LS40	.65	74LS205	.95
		74LS41	.44	74LS206	.95
		74LS42	.65	74LS207	.95
		74LS43	.78	74LS208	.95
		74LS44	.25	74LS209	2.85
		74LS45	.35	74LS210	.44
		74LS46	.38	74LS211	.44
		74LS47	.65	74LS212	.44
		74LS48	.65	74LS213	.44
		74LS49	.65	74LS214	.44
		74LS50	.65	74LS215	.44
		74LS51	.65	74LS216	.44
		74LS52	.65	74LS217	.44
		74LS53	.65	74LS218	.44
		74LS54	.65	74LS219	.44
		74LS55	.65	74LS220	.44
		74LS56	.65	74LS221	.44
		74LS57	.65	74LS222	.44
		74LS58	.65	74LS223	.44
		74LS59	.65	74LS224	.44
		74LS60	.65	74LS225	.44
		74LS61	.65	74LS226	.44
		74LS62	.65	74LS227	.44
		74LS63	.65	74LS228	.44
		74LS64	.65	74LS229	.44
		74LS65	.65	74LS230	.44
		74LS66	.65	74LS231	.44
		74LS67	.65	74LS232	.44
		74LS68	.65	74LS233	.44
		74LS69	.65	74LS234	.44
		74LS70	.65	74LS235	.44
		74LS71	.65	74LS236	.44
		74LS72	.65	74LS237	.44
		74LS73	.65	74LS238	.44
		74LS74	.65	74LS239	.44
		74LS75	.65	74LS240	.44

80-COLUMN IMPACT PRINTER
QUEST IN PRICE... HIGHEST IN PERFORMANCE

base2, inc

\$649.00



Apple Expansion Kit
16K Memory Add-On
Includes Instructions
\$19.50

TRS80
16K Add-On
Instructions &
Dip Switches
\$25.95

EPROMS/RAM'S

2716	7.25ea	8 for 6.50ea
5V 450NS		
2708	4.50ea	8 for 4.00ea
450NS		
2732	24.50ea	4 for 19.50ea
4116	300NS 3.00ea	8 for 17.50
200NS	3.75ea	8 for 19.50
2114L	300NS 3.50ea	4 for 13.75
200NS	3.75ea	4 for 14.25

100W CLASS A POWER AMP KIT

Dynamic Bias Class "A" circuit design makes this unit unique in its class. Crystal clear, 100 watts power output will satisfy the most picky fans. A perfect combination with the TA-1020 low T.I.M. stereo pre-amp.

Specifications:

- Output power: 100W RMS into 8-ohm
125W RMS into 4-ohm
- Frequency response: 10Hz - 100 KHz
- T.H.D.: less than 0.008%
- S/N ratio: better than 80dB
- Input sensitivity: 1V max.
- Power supply: $\pm 40V @ 5 amp$
- One channel!



TA-1000 KIT
\$51.95
Power transformer
\$18.00 each

REGULATED VARIABLE D.C. POWER SUPPLY KIT

Uses UA723 I.C. and 2N3055 power transistor as regulator. Output voltages can be adjusted from 0-30V at an internal resistance of less than 0.005 ohm; ripple and noise less than 1 mV; with built on board LED and audible overload indicator. Kit comes with P.C. board; all electronic components, transformer; connectors; 2 panel meters for voltage and amp; a professional look metal cabinet and instructions.

Model TR-88A 0-15V D.C. 3 amp
Model TR-88B 0-30V D.C. 2 amp



\$59.50
per kit

NEW

NEW WHISTLE ACTIVATED SWITCH BOARD

All boards are pre-assembled and tested. Your whistle to its FET condenser microphone from a distance, as far as 30 feet away (sensitivity can be easily adjusted) will turn the switch on, then latched you whistle to it again then it turns off. Ideal for remote control toys, electrical appliance such as lights, coffee pots, TV, Hi-Fi, radio or other projects. Unit works on 9V D.C.



Model 968
\$4.50 each

SUB MINI SIZE FET CONDENSER MICROPHONE

Specification:

- Sensitivity: $-65dB \pm 3db$
- FEQ. Response: 50 Hz - 8 KHz
- Output Impedance: 1K ohm max.
- Polar Pattern: Omni-directional
- Power Supply: 1.5V - 10V D.C.
- Sound Pressure Level: Max. 120dB
- EM4RP \$2.50 ea. or 2 for \$4.50



NEW MARK III 9 Steps 4 Colors LED VU

Stereo level indicator kit with arc-shape display panel!!! This Mark III LED level indicator is a new design PC board with an arc-shape 4 colors LED display (change color from red, yellow, green and the peak output indicated by rose). The power range is very large, from $-30dB$ to $+5dB$. The Mark III indicator is applicable to 1 watt - 200 watts amplifier operating voltage is 3V - 9V OC at max 400 MA. The circuit uses 10 LEDs per channel. It is very easy to connect to the amplifier. Just hook up with the speaker output!

IN KIT FORM \$18.50

2 WATT AUDIO AMP

Pre assembled units. All you need is to hook up the speaker and the volume control. Supply voltage from 9-15V D.C. measures only 2" x 3 1/2", making it good for portable or discrete applications. Comes with hook up data.



BUY 2 FOR
\$4.99

MARK IV 15 STEPS LED POWER LEVEL INDICATOR KIT

This new stereo level indicator kit consists of 36 4-color LED (15 per channel) to indicate the sound level output of your amplifier from $-36dB$ to $+3dB$. Comes with a well-designed silk screen printed plastic panel and has a selector switch to allow floating or gradual output indicating. Power supply is 6-12V D.C. with THG on board input sensitivity controls. This unit can work with any amplifier from 1W to 200W! Kit includes 70 pcs. driver transistors, 38 pcs. matched 4-color LED, all other electronic components, PC board and front panel.



MARK IV KIT \$31.50

NEW

MARK V 15 STEPS LED POWER OUTPUT INDICATOR KIT

All functions same as Mark IV but this is with heavy duty aluminum front plate and case. Can be easily slot into the front panel of your auto, truck or boat. Operates on 12V D.C.



\$41.50 EACH KIT

BATTERY POWERED FLUORESCENT LANTERN

MODEL 888 R

FEATURES

- Circuitry: designed for operation by high efficient, high power silicon transistor which enable illumination maintain in a standard level even the battery supply drops to a certain low voltage.
- 9" 6W cool/daylight miniature fluorescent tube.
- 8 x 1.5V UM-1 (size D) dry cell battery.
- Easy sliding door for changing batteries.
- Stainless reflector with wide angle increasing lamination of the lantern.



\$10.50 EA

30W + 30W STEREO HYBRID AMPLIFIER KIT

Kit includes 1 PC SANYO STK-043 stereo power amp. IC LM 1458 as pre amp, all other electronic parts, PC Board, all control pots and special heat sink for hybrid. Power transformer not included.



\$32.50 PER KIT

5W AUDIO AMP KIT

2 LM 380 with Volume Control

Power Supply 6 18V DC

ONLY \$6.00 EACH



TWO IN ONE PANEL METER D.C. VOLTAGE AND AMP IN ONE

D.C. Volts reads 0-50

D.C. Amp reads 0-3

Meter case made of black plastic with a white scale plate and glass window.

#ST-680 \$12.50 EACH



SPECIAL 0.5" LED ALARM CLOCK MODULE

ASSEMBLED! NOT A KIT!

Features: • 4 digits 0.5" LED Displays • 12 hours real time format • 24 hours alarm audio output • 59 min. countdown timer • 10 min. snooze control.

ONLY \$7.00 EACH

SPECIAL TRANSFORMER FOR CLOCK

\$2.50



CUBO CLOCK CASES



All brand new top quality plastic cases, originally designed for Cubo clocks. Case comes with top and bottom cover with a detachable front red filter for LED readouts. This can be used for many projects such as LED CLOCK, VU METER, LIGHT BOX, FREQ. COUNTER, ETC.
3 Attractive Colors (white, lime green or orange)

BUY 3 FOR ONLY \$2.50

TV GAME BOARD

PLAYS 4 GAMES: TENNIS; HOCKEY; HANDBALL AND JAI-ALAI.

All boards complete with all parts ready to play. Requires 6C size batteries and a small speaker for sound effects. The boards were surplus from a famous game manufacturer. They will play on all US standard black and white or color TV sets.

Regular price for these games were \$39.50 each
OUR PRICE ONLY \$6.50 EACH



PART #57456

TENNIS JAI-ALAI

HOCKEY HANDBALL

MULTI-FINS HEAT SINK



Ideal for high power output. Holes predrilled for 1 to 3 transistor. Made of aluminum with ten radiating fins.

2 FOR \$4.50

PROFESSIONAL FM WIRELESS MICROPHONE

TECT model WEM-16 is a factory assembled FM wireless microphone powered by an AA size battery. Transmits in the range of 88-108MHz with 3 transistor circuits and an omni-directional electric condenser. Element built-in plastic tube type case; mike is 6 1/4" long. With a standard FM radio, can be heard anywhere on a one-acre lot; sound quality was judged very good.

\$16.50



FOR 'BOX' BUILDERS

Pre-Drilled PC Board	\$17.50
Tolrid Coils (Set of 4)	\$ 3.00
Multi Turn Trim-Pots 10K ohm	\$ 2.50
Trimmer Capacitor 6-35pF	\$ 0.60
MC1358	\$ 2.00
MC1350	\$ 2.00
MC1330	\$ 3.50
RC1458	\$ 1.00
LM380	\$ 1.80
LM340T-15	\$ 1.20
NE565	\$ 2.00

We also have transformer, capacitor set, resistors set antenna transformer. Please call for price.

LCD CLOCK MODULE!

• 0.5" LCD 4 digits display • X'tal controlled circuits • D.C. powered (1.5V battery) • 12 hr. or 24 hr. display • 24 hr. alarm set • 60 min. countdown timer • On board dual back-up lights • Dual time zone display • Stop watch function.

NIC1200 (12 hr) ON SALE
NIC2400 (24 hr) \$16.99 EACH

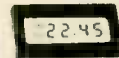

SANYO UHF VARACTOR TUNER

For UHF CH 14-83

Tuning voltage + 1V to + 28V D.C. Input impedance 75 OHM. I.F. band width 7-16 MHz. Noise figure 11.5 dB MAX. Size 2 1/2" x 1 1/4" x 3/4". Supply voltage 15V D.C. Sound I.F. = 58.0 MHz. Video I.F. = 62.5 MHz



All units are brand new from Sanyo.
MODEL 115-B-405A
\$35.00 EACH

FLUORESCENT LIGHT DRIVER KIT



With Case Only
\$6.50 Per Kit

12V DC POWERED
Lights up 8 ~ 15 Watt Fluorescent Light Tubes. Ideal for camper, outdoor, auto or boat. Kit includes high voltage coil, power transistor, heat sink, all other electronic parts and PC Board. Light tube not included!

SUPER FM WIRELESS MIC KIT — MARK III



FMC-105
\$11.50 PER KIT

This new designed circuit uses high FEQ. FET transistors with 2 stages pre amp. Transmits FM Range (88-120 MHz) up to 2 blocks away and with the ultra sensitive condenser microphone that comes with the kit, allows you to pick up any sound within 15 ft. away! Kit includes all electronic parts, OSC coils, and P.C. Board. Power supply 9V D.C.

PRESS-A-LIGHT SELF GENERATED FLASHLIGHT

EXCLUSIVE!! \$3.95 ea
Model F-179



Never worry about battery, because it has none! Easy to carry in pocket and handy to use. Ideal for emergency light. It generates its own electricity by squeezing grip lever. Put one in your car, boat, camper or home. You may need it some time!

ELECTRONIC DUAL SPEAKER PROTECTOR



Cut off when circuit is shorted or over load to protect your amplifier as well as your speakers. A must for OCL circuits.

KIT FORM
\$8.75 EA.

"FISHER" 30 WATT STEREO AMP



Super Buy
Only \$18.50

MAIN AMP (15W x 2)
Kit includes 2 pcs. Fisher PA 301 Hybrid IC all electronic parts with PC Board. Power supply $\pm 16V$ DC (not included). Power band with (KF 1% $\pm 3dB$). Voltage gain 33dB. 20Hz - 20KHz.

SPACE WAR SOUND GENERATOR BOARD



Brand new preassembled module for a toy factory. The board gives out 6 different selectable space sound with LED light effect. Sounds include UFO take-off, space gun blast, wave, and space chime. 7 LED on the board will work with the sound. Requires 9V battery to operate. Speaker not included. SPECIAL \$3.99 EACH SPEAKER \$1.25 EACH

ELECTRONIC PIEZO BEEP BUZZER



Unique surplus $\frac{3}{8}$ " Dia. piezo ceramic disc on circuit board gives a distinct high freq. buzz. Unit contains an I.C., 2 caps, 6 resistors and is already preassembled. Requires 9V battery to operate. SPECIAL 2 FOR \$2.99

2 BIT COUNTER, WARBLE PULSE ALARM BOARD



This new assembly easily converts to a counter, stop watch, warble and pulse alarm generator by adding a few components. We supply the data and typical applications. Requires 9V battery to operate. SPECIAL 2 FOR \$1.99

AUDIO OUTPUT dB METER



Meter made of clear plastic with a silver white face plate. Scale reads from -20 +3dB. Meter also comes with an internal dial light. MODEL: 6F-3
\$6.50 EACH

BATTERIES

PK/\$10.00
2 PK/\$19.00
ILLUSTRATED
LESS COVER



NICKEL CADMIUM
BATTERY
PACK
'D' SIZE

Output: 3.6 Volts @ 3.0 Amp/Hour. Consists of three each, 1.2 Volt 'D' size Nickel Cadmium Cells stacked and plastic film encapsulated. Tabs are provided at each end for electrical connections. The individual cells can be cut apart if des. red. Rated recharge rate is 30 mA, 14-18 hours. Size: $1\frac{1}{4}$ " dia. x 7" long. New. Shpg. Wt. each pack, 1 lb.



9V RECHARGEABLE NI-CD BATTERY

Replace all 006P type 9V battery
Model: GC9

BRAND NEW \$4.50 EACH

NI-CD BATTERY SALE



12V Pack 450 MZ/HR Size 3" x 1" x 2" \$8.00 PER PACK
4 AA Pack 450 MA/HR \$3.50 PER PACK

All above batteries are used but late date code and we guarantee to take back all bad ones for exchange.

GELCELL 6V 9AMP/HR SEALED LEAD ACID RECHARGEABLE BATTERY



Sealed construction permits this battery to be operated in any position. Recharge rate 2.15 amp max. for 14-16 hours. All brand new. Limited quantities. Size of battery $4\frac{1}{2}$ " x $2\frac{3}{4}$ " x $5\frac{1}{2}$ ".

\$16.50 each

ELECTRONIC PIN BALL MACHINE



That sounds and plays like the real thing. All units are brand new but without the case. Functions of the game include double flipper control, kicker control, 1-4 players, 3 speed ball control, tilt switch, automatic score, extra bonus cave and many more. All solid state with LED panel, no moving parts. Requires 9V battery to operate, speaker not included.

A perfect gift for yourself or friends.
SPECIAL \$8.99 EACH
SPEAKER \$1.25 EACH

ULTRASONIC SWITCH KIT



Kit includes the Ultra Sonic Transducers, 2 PC Boards for transmitter and receiver. All electronic parts and instructions. Easy to build and a lot of uses such as remote control for TV, garage door, alarm system or counter. Unit operates by 9-12 DC. \$15.50

TOUCH TONE TYPE SLIM TELEPHONE KEY PAD



KEY 330

Weather proof plastic one piece key-tops. Key numbers from 1-0. All switches momentary. Open one side not connected one side common \$3.50 EACH

SOUND ACTIVATED SWITCH



All parts completed on a PC Board SCR will turn on relay, buzzer or trigger other circuit for 2 - 10 sec. (adjustable). Ideal for use as door alarm, sound controlled toys and many other projects. Supply voltage 4.5V 9V D.C. 2 for \$3.00

REGULATED DUAL VOLTAGE SUPPLY KIT

± 4 30V DC 800 MA adjustable, fully regulated by Fairchild 78MG and 79MG voltage regulator I.C. Kit includes all electronic parts, filter capacitors, I.C., heat sinks and P.C. board.

\$12.50 PER KIT

AA SIZE NI-CD RECHARGEABLE BATTERIES LIMITED QUANTITY AVAILABLE

RECHARGEABLE BATTERIES LIMITED QUANTITY AVAILABLE

CRYSTAL CONTROLLED WIRELESS MICROPHONE SYSTEM

No FCC license required.
OUR PRICE \$49.50
ADDITIONAL MICROPHONE (TRANSMITTER) AVAILABLE AT \$28.00 EACH

Transmitter: FET mic for flat 30 ~ 18 KHz response extra controlled 49 MHz AM Band for drift-free performance. 100 MW output (range approx. $\frac{1}{4}$ mile) for reliable long range transmission. Powered by a 9V radio battery (included).
Receiver: Extra controlled locks on 49 MHz transmitter signal. With on panel VU meter monitors the signal strength from the microphone. Standard phone jack outlet connection to a P.A. or other phone input. 9V battery included. This professional set is ideal for on stage, in field, church, in house or outdoor use.



MURA AMS-49

phone jack outlet connection to a P.A. or other phone input. 9V battery included. This professional set is ideal for on stage, in field, church, in house or outdoor use.

POWER SUPPLY KIT

0-30V D.C. REGULATED
Uses UA723 and ZN3055 Power TR output can be adjusted from 0-30V, 2 AMP. Complete with PC board and all electronic parts.



Transformer for Power Supply, 0-30 Power Supply 2 AMP 24V x 2 \$8.50 \$10.50 each

FLASHER LED

Unique design combines a jumbo red LED with an IC flasher chip in one package. Operates directly from 5V-7V DC. No dropping resistor needed. Pulse rate 3Hz @ 5V 20mA.

2 for \$2.20

BIPOLAR LED RED/GREEN

2 colors in one LED, green and red, changes color when reverse voltage supply. Amazing!
2 FOR \$2.20

ELECTRONIC SWITCH KIT

CONDENSER TYPE
Touch On Touch Off uses 7473 I.C. and 12V relay \$5.50 each



1 WATT AUDIO AMP

All parts are pre-assembled on a mini PC Board. Supply Voltage 6 9V D.C. SPECIAL PRICE \$1.95 ea.



LOW TIM DC STEREO PRE-AMP KIT TA-10 20

Incorporates brand-new D.C. design that gives a frequency response from 0Hz - 100KHz $\pm 0.5dB$! Added features like tone defeat and loudness control let you tailor your own frequency supplies to eliminate power fluctuation!

Specifications: • T.H.D. less than .005% • T.I.M. less than .005% • Frequency response: DC to 100KHz $\pm 0.5dB$ • RIAA deviation: $\pm 0.2dB$ • S/N ratio: better than 70dB • Sensitivity: Phono 2MV 47K/Aux. 100MV 100K • Output level: 1.3V • Max. output: 15V • Tone control: bass $\pm 10dB$ @ 50Hz/treble $\pm 10dB$ @ 15Hz • Power supply: ± 24 D.C. @ 0.5A
Kit comes with regulated power supply, all you need is a 48V C.T. transformer @ 0.5A

ONLY \$44.50
X-former \$4.50 ea.



FORMULA INTERNATIONAL INC.

7/81

	SHIPPING AND HANDLING CHARGES	
Inside California	Under \$50.00 purchase	Over \$50.00 purchase
Outside Calif. (includes Mexico & Canada)	10%	15%
Overseas	15%	20%

Minimum Order \$10.00/Calif. Residents Add 8% Sales Tax
Phone Orders Accepted on Visa or MC ONLY, NO C.O.D./Store Hours 10-7 Mon. thru Sat.

12603 CRENSHAW BLVD., HAWTHORNE, CA 90250
PHONE: (213) 973-1821 • (213) 679-5182

Send \$1.00 For Detailed Catalogue



ELECTRONIC KITS FROM HAL-TRONIX

2304 MHZ DOWN CONVERTERS. TUNES IN ON CHANNELS 2 TO 7 ON YOUR OWN HOME T.V. HAS FREQUENCY RANGE FROM 2000 MHZ TO 2500 MHZ. EASY TO CONSTRUCT AND COMES COMPLETE WITH ALL PARTS INCLUDING A DIE-CAST ALUM CASE AND COAX FITTINGS, REQUIRE A VARIABLE POWER SUPPLY AND ANTENNA (Antenna can be a dish type or coffee can type depending on the signal strength in your area.)

- 2304 MOD 1 (Basic Kit) \$49.95
- 2304 MOD 2 (Basic / Pre-amp) \$59.95
- 2304 MOD 3 (Hi-Gain Pre-amp) \$69.95

POWER SUPPLY FOR EITHER MODEL ABOVE IS AVAILABLE. COMES COMPLETE WITH ALL PARTS, CASE, TRANSFORMER, ANTENNA SWITCH AND CONNECTORS (Kit) \$24.95
 Assembled.....\$34.95
 Slotted Microwave Antenna For Above Downverters.....\$39.95

PREAMPLIFIERS

HAL PA-19—1.5 mhz to 150 mhz. 19db gain operates on 8 to 18 volts at 10ma. Complete unit \$8.95.
 HAL PA-1.4—3 mhz to 1.4 ghz. 10 to 12 db gain operates on 8 to 18 volts at 10ma. Complete unit \$12.95.
 (The above units are ideal for receivers, counters, etc.)

16 LINE TOUCH TONE DECODER KIT WITH P.C. BOARD AND PARTS\$69.95

12 LINE TOUCH TONE DECODER KIT WITH P.C. BOARD AND PARTS\$39.95

16 LINE ENCODER KIT, COMPLETE WITH CASE, PAD AND COMPONENTS ...\$39.95

12 LINE ENCODER KIT, COMPLETE WITH CASE, PAD AND COMPONENTS ...\$29.95

MANY, MANY OTHER KITS AVAILABLE

Send 15¢ stamp or 3 A.S.E. for information and flyer on other HAL-TRONIX products. To order by phone: 1-313-285-1782.



HAL-TRONIX
 P.O. Box 1101
 Southgate, MI 48195

ORDERS OVER \$20.00 WILL BE SHIPPED POSTPAID EXCEPT ON ITEMS WHERE ADDITIONAL CHARGES ARE REQUESTED ON ORDERS LESS THAN \$20.00 PLEASE INCLUDE ADDITION AT \$1.50 FOR HANDLING AND MAILING CHARGES.
CIRCLE 52 ON FREE INFORMATION CARD

Red Cross: Ready for a new century.

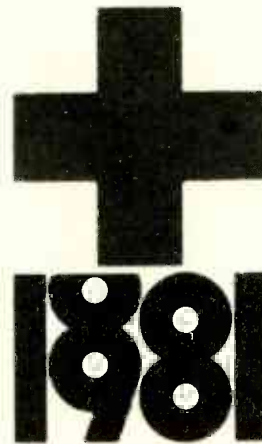

A Public Service of This Magazine & The Advertising Council



arkon electronics ltd KITS

COLOUR MODULATOR \$24.95

This video modulator has been designed to complement the small home computer. It allows the standard colour television to be used as a high quality colour video monitor. Uses state of the art integrated circuit technology. Direct coupling is employed to provide white level compensation in the vestigial sideband output. The gain device of the LM1889's chroma oscillator is used to buffer, level shift, and invert the incoming composite colour input. The signal then passes to the RF modulator where a channel 7 carrier is provided. Requires 12 volt DC for operation.

THE BRUTE 300 WATT AMP

This kit is not recommended for beginners or inexperienced constructors. Power output: 200 watts RMS, 8 ohms, 310 watts RMS, 4 ohm. Input sensitivity, 1V for total output. This kit uses all standard parts and comes complete with instructions and printed circuit board (mono) (transformer required) 100 VCT 5 amps. is available for \$51.00 #167P100. **P.C. Board \$11.25**

ARKON LOGIC PROBE 1 \$24.95

Easy to build Logic Probe kit. A full performance logic probe. With it, the logic levels in a digital circuit translates into light from the HI or LO LED. Pulses as narrow as 300 nano seconds are stretched into blinks of the pulse LED's. Specs — 300 Kohm imp. Power — 30ma at 5 volts, 40ma at 15 volts, 15 volts max. Max. Speed — 300 nano seconds 1.5 MHZ. Input Protection — +50 volts DC continuous, 117 volts AC for 15 seconds. (case included).

LED POWER METER \$24.95

Uses the popular LM3915 display driver. Features switch selectable peak or average peak power level indication. The front end utilizes precision half wave rectification. LED displays included 30 db (-24 db to +3 db) dynamic range.

LED VU/POWER METER \$29.95

Same as LED power meter but uses NSM series display.
 Two types — NSM 3915 — 30 db (-24 db to +3 db power)
 — NSM 3816 — 23 db (-20 db to +3 db VU)

POWER SUPPLY \$16.95

This kit has been designed to satisfy the need for an economical power supply. Provides 5 volt DC at lamp for TTL projects plus a separate floating power supply that is variable from 5 to 35 volt DC at 1/2 amp for CMOS and other uses.

Send certified cheque, money order, Chargex, Master Charge, American Express...include expiry date, card number and signature. Add \$2.50 for 100 page catalogue. We process only prepaid orders. Minimum order \$10.00 Add 5% (minimum \$2.00) for shipping and handling. Ontario residents add 7% sales tax. All prices subject to change. Dealer inquires welcome.

409 QUEEN STREET WEST, TORONTO, ONTARIO CANADA M5V 2A5. TEL. (416) 868-1315

CIRCLE 28 ON FREE INFORMATION CARD

BE SMART!

MAKE THE RIGHT CONNECTION!



JOIN OVER 2000 PROFESSIONAL ELECTRONIC SERVICE DEALERS. NATIONAL ELECTRONIC SERVICE DEALERS ASSOCIATION

THE NESDA CONNECTION GIVES:

1. Insurance
2. 1.6 Bankcard Rates
3. ServiceShop Magazine
4. Electronic Service Industry Yearbook
5. Service Industry Information
6. Legislative Programs
7. Advocate for Better Warranty Practices
8. Business Information

SEND ME INFORMATION ABOUT A GOOD CONNECTION — NESDA

Send to: NESDA, 2708 West Berry ST
 Fort Worth, TX 76129

Name _____

Address _____

City _____ State _____ Zip _____

Name of Business _____

Radio Shack is America's Parts Place™

No Minimum Order! No Waiting! Low Prices!

Low-Priced Precision Wire-Wrapping Tool

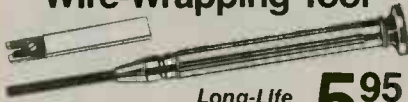

Long-Life Steel Bit **5⁹⁵**

This balanced 4½" all-metal tool speeds wiring of IC projects. It strips, wraps, and unwraps 30-gauge wire. Includes an easy-to-use stripper that stores in the handle. 276-1570

30-Gauge Kynar Wire	Color	Cat. No.	50-ft. Spool
	Red	278-501	2.39
	White	278-502	2.39
	Blue	278-503	2.39

TV RF Modulator Board

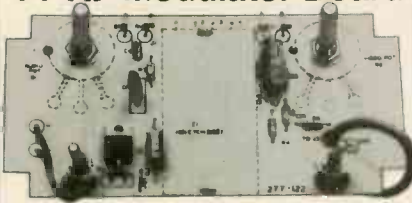

• **Prewired RF Module**
• **Ch. 2 or 3 Output** **16⁹⁵**

Accepts b&w or color video, 30-15,000 Hz audio. With instructions, labeled and drilled board, parts list, RF module and antenna switch. **PARTS EXTRA** — all available at Radio Shack. 277-122 **16.95**
Shown built with recommended parts

20-Range LCD Multimeter

79⁹⁵

• **10-Meg Input**
• **Automatic Zero-Adjust & Polarity**

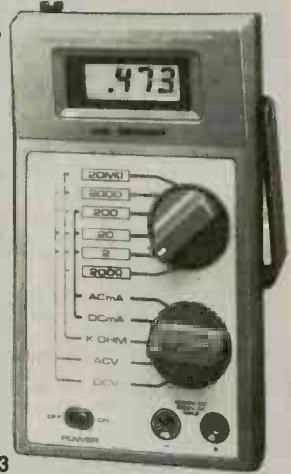

Carry Case

Only **6⁹⁵**
22-153

Easy-to-read 0.4"-tall liquid crystal display with convenient low-battery and over-range indicators. Measures up to 500VAC in 4 ranges; 1000VDC in 4 ranges; 200 mA AC and DC current in 3 ranges each; 20 megohms resistance in 6 ranges. Size: 6¾x3¾x1¼". Leads and manual included. Requires 9V battery or AC adapter. 22-198 **79.95**
AC Adapter. U.L. listed. 273-1431 **4.95**

Resistor Packs



100-Piece Assortments **2⁹⁹** Each

Great buy — keep a pack on hand! The most asked for values. ½W-10%. 271-306 Pkg. 100/2.99
¼W-5%. 271-308 Pkg. 100/2.99

Quad BiFET Op-Amp



2⁹⁹ **13V/μS Slew Rate**

TL084C. Low-noise JFET inputs. Internally compensated. ±18V supply. 14-pin DIP. 276-1714 **2.99**

DPDT Switch

34% Off!

Reg. **2⁰⁹**
3.19

Compact lever-type with contacts rated 6A at 125VAC. Mounts in 7/16" hole. 275-259 Sale **2.09**



6-Amp Triacs

Low As **99¢**

For lamp dimmers, heat element control, AC switching and more. TO-220 cases. 200V. 276-1001 **99¢**
400V. 276-1000 **1.19**



Card Connector

Was 5.95

4⁹⁵

40-Pin. Reusable insulation displacement-type mounts at ends or along length of ribbon cable. Compatible with many microcomputers. 276-1558 **Now 4.95**



Metal-Film Capacitors

Low As **39¢** Each

250VWDC. Aluminum deposited mylar for ultra-low leakage. Epoxy dipped for stability.

μF	Cat. No.	Each
.01	272-1051	.39
.047	272-1052	.49
.1	272-1053	.59
.22	272-1058	.69
.47	272-1054	.79
1.0	272-1055	.89

Micronta® Precision Panel Meters



8⁹⁵ Each

These top-quality meters allow you to monitor critical circuits. Feature easy-to-read faces and D'Arsonval movements for ±5% accuracy, full scale. Require 1½" mounting hole. 0-50 μA DC. 270-1751 **8.95**
0-1 mA DC. 270-1752 **8.95**

Micro Test Clips

NEW! **1⁴⁹**
Package of 2

Insulated push-type — ideal for testing components on crowded boards. One red, one black. 270-370 **Pkg. of 2/1.49**



Quad Timer IC

20% Off!

Reg. 2.49 **1⁹⁹**
Type 558. Four type 555 timers in a single 16-pin DIP. 276-1742 **Now 1.99**



12VDC Reed Relay

Only **99¢**

DPST. Encapsulated type with PC pins. Contacts rated 0.5A at 125VAC. 1½x ¾x 7/16". 275-229 **99¢**



16K Hobby RAM

New Low Price!

Was 13.95 **5⁹⁵**
4116 Dynamic RAM. 100% prime. Our lowest price ever! 276-2505 **Now 5.95**



Voltage Regulator

4⁹⁹

LM317. Adjustable, positive. Up to 1.5A output. TO-3 case. 276-1777 **4.99** **1.2 to 37VDC**



Mercury Switch

NEW! 1¹⁹

Tilt to close circuit. SPST contacts rated 5A at 125VAC. Wire leads. Style may vary. 275-027 **1.19**



Mini Amp with Built-In Speaker

Only **11⁹⁵**

• **200 mW Output**
• **1 mV Sensitivity**
• **10 to 10,000 Hz Response**

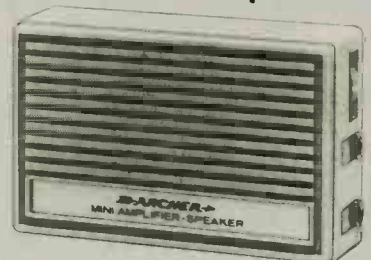

This compact, integrated-circuit amplifier with built-in speaker is ideal for use with a telephone pickup coil, a microphone or electric guitar. Use it as an Intercom, the audio stage of a receiver project — or add a probe and it becomes a handy signal tracer! Has volume control with on/off switch, ¼" jacks for input and external speaker or earphone. 2½x 3¾x 1¼" molded case. Requires one 9V battery. 277-1008 **11.95**

Start Your Next Project at The Shack™

Radio Shack®

A DIVISION OF TANDY CORPORATION • FORT WORTH, TEXAS 76102
OVER 8000 LOCATIONS WORLDWIDE

Retail prices may vary at individual stores and dealers

CIRCLE 56 ON FREE INFORMATION CARD

LOW COST PARTS

KEY SWITCH
S.P.S.T.
RATED 4 AMPS
125 VOLTS
\$ 3.50 EA.



A-B SWITCH
75 OHMS
TO 75 OHMS
\$ 3.50 EA.



D.P.D.T. CENTER OFF MINI TOGGLE
ON-OFF-ON
RATED 5 AMPS @ 120 VOLTS
\$ 2.00 EACH



4PDT PRINTED CIRCUIT 12 VDC
14 pin style
3 amp contacts
BRAND NEW
P.C. Mount
\$ 2.75 EA.



1/4" PHONE JACK
MOLDED PLASTIC
NO SWITCH
10 FOR \$ 1.00
100 FOR \$ 9.00
500 FOR \$ 40.00
1000 FOR \$ 70.00



440/220 TO 110 VOLT TRANSFORMER
SOLA # HT1B2100
Rated 100 VA
440 or 220 volts
to 110 volts
\$ 15.00



TRANSFORMERS
120 volt primaries
6 VOLTS at 150 mA \$1.25
12 V.C.T. at 500mA \$2.50
16.5 V. at 3 AMPS \$6.50



COMPUTER GRADE CAPACITORS NEW
1,700mfd 150 VDC \$2.00
2 1/2" DIA X 3 1/4" H
6,400mfd 60 VDC \$2.50
1 3/8" DIA X 4 1/4" H
11,500mfd 18 VDC \$1.50
1 3/8" DIA X 3 1/4" H HIGH
22,000mfd 15 VDC \$2.50
2" DIA X 2 1/2" H HIGH
52,000mfd 15 VDC \$3.00
2" DIA X 4 1/2" H HIGH
CLAMPS TO FIT CAPACITORS 50c ea.



4PDT RELAY
14 pin style
3 amp contacts
24 volt d.c. or 120 volt a.c. coil
Used but fully tested
\$ 1.70 EACH
specify coil voltage
LARGE QUANTITIES AVAILABLE
SOCKETS FOR RELAY 50c each



COMPUTER GRADE CAPACITORS NEW
1,700mfd 150 VDC \$2.00
2 1/2" DIA X 3 1/4" H
6,400mfd 60 VDC \$2.50
1 3/8" DIA X 4 1/4" H
11,500mfd 18 VDC \$1.50
1 3/8" DIA X 3 1/4" H HIGH
22,000mfd 15 VDC \$2.50
2" DIA X 2 1/2" H HIGH
52,000mfd 15 VDC \$3.00
2" DIA X 4 1/2" H HIGH
CLAMPS TO FIT CAPACITORS 50c ea.



SEND FOR FREE CATALOG!

12 VOLT D.C. ALARM BELL
bright red color
ideal for alarms
6 in. dia. bell
loud ring
\$15.00 ea.



FLASHER L E D
Litronix FRL 4E03
diffused red led with built in flashing unit
1% package
pulse rate 3Hz @ 20ms
2 for \$1.70



SUPER SMALL PHOTO-FLASH
170 MFD 330 VOLT
1 1/4" x 7/8"
2 for \$1.50
10 for \$14.00



SUB MINI L.E.D.
.079" x .098"
20mA at 1.75v
10 for \$1.00
200 for \$18.00
400 for \$32.00
1000 for \$70.00



7-17vdc S.S. BUZZER
STAR #CMB-12
• File dip socket
• CMOS compatible
• Max. current 14mA
• Sound output: 70dB @ 20 cm.
\$1.25 each



BI-POLAR L.E.D.
THREE COLOR IN ONE LED.
RED ON DC, GREEN ON REVERSE DC, YELLOW ON AC.
2 FOR \$1.70



LINE CORDS
TWO WIRE 8 ft. 18/2
3 for \$1.00
THREE WIRE 6 ft. 18/3
\$1.50 ea.
THREE WIRE 18 in. 18/3
2 for \$1.00 10 for \$4.50



40 MFD 350 VOLTS
2 1/8 INCH X 3/4 INCH
2 for \$1.50
22/44 EDGE CONNECTOR
TIN SOLDER TAIL .156" x .200"



ELECTROLYTIC AXIAL CAPACITORS
600 MFD. 100 VDC \$1.00 ea.
2-1/16" long x 1-1/16" diameter
SALE PRICED
8,000 MFD 15VDC
3/78" long x 1-1/16" diameter
\$1.00ea 10/\$9.00



50K SLIDE POT
75c each
Knobs for Slide Pots 20c each
3 1/2 Inch long - 2 3/4 Inch slide



ALL ELECTRONICS CORP.
P.O. BOX 20406
905 S. Vermont Ave.
Los Angeles, Calif. 90006
(213) 380-8000
Mon. - Fri. Saturday
9 AM - 5 PM 10 AM - 3 PM

TERMS
• Quantities Limited
• Min. Order \$10.00
• Add \$2.00 Shipping USA
• Calif. Res. Add 6%
• Prompt Shipping

DISCOUNT TRS-80* DEALER A301
COMPUTER SPECIALISTS



FREE COMPUTER CATALOG UPON REQUEST

\$ DISCOUNT \$ on TRS-80's

26-3001 4K Color.....\$353.00
26-1062 16K III.....865.00
24-4002 64K I DRIVE.....\$440.00

1-800-841-0860 TOLL FREE
MICRO MANAGEMENT SYSTEMS, INC.
Downtown Plaza Shopping Center
115 C. Second Av., S.W.
Cairo, Georgia 31728
(912) 377-7120 Gs. Phone No.

United Way supports a wide range of human service agencies - charities we all know but also less well-known organizations which otherwise might not get the needed finances to carry on their good work.

Thanks to you, it works. For all of us.



United Way
A Public Service of This Magazine & The Advertising Council

INTERNATIONAL ELECTRONICS UNLIMITED

TRANSISTORS		CARBON FILM RESISTORS	
Part No.	Value	Value	Value
MPS46c	10-92 NPN .525 1.65 3.25 12.00 .11ea	1/4 watt (R.0hm R25)	total quantity ea
2N2222A	10-92 NPN .30 1.75 4.00 15.00 .13ea	.095" dia x .250" long (body)	1000- .10 .40 1.60 15.00
2N2222A	10-18 NPN .45 3.50 8.00 29.00 .26ea	1/2 watt (R.0hm R50)	5000- .10 .30 1.70 14.50
2N3053	10-5 NPN .55 5.00 11.75 45.00 .42ea	.146" dia x .354" long (body)	10000- .10 .25 1.50 13.00
2N3904	10-92 NPN .25 1.65 3.25 12.00 .10ea		
2N3906	10-92 PNP .25 1.65 3.25 12.00 .10ea		

DIODES		METAL FILM RESISTORS	
Part No.	Value	Value	Value
1N4001	50V 12/\$1.00 100/\$7.00 1000/\$60.00	1/4 watt	Standard 1% Metal Film Values from 10 Ohm to 1.21 Mohm
1N4007	100V 10/\$1.25 100/\$11.00 1000/\$100.00		
1N4148	18V 15/\$1.00 100/\$5.00 1000/\$40.00		

LED S		SOCKETS	
Value	Value	Value	Value
JUMBO DIFFUSED - .20" dia x .34" H		8 pin	5.20 .18ea .16ea .14ea
Red	1.00 2.25 8.00 .079ea	14 pin	.25 .21ea .19ea .16ea
Clear	1.00 2.25 8.00 .079ea	16 pin	.26 .22ea .20ea .17ea
Green	1.40 3.25 10.45 .10ea	18 pin	.32 .28ea .26ea
Yellow	1.40 3.25 10.45 .10ea	24 pin	.45 .40ea .38ea
White	1.00 2.25 8.00 .079ea	28 pin	.55 .52ea .50ea
		40 pin	.65 .62ea .60ea

CAPACITORS		TANTALUM CAPACITORS	
Value	Value	Value	Value
POLYESTER FILM CAPACITORS - 100V ± 10%		.1uF/35V	.35 .25 4.7uF/25F .48 .40 22uF/19V .52 .42
EA. PK-10 PK-100	EA. PK-10 PK-100	.22uF/35V	.35 .30 5.6uF/10V .48 .40 22uF/35V .65 .60
.001uF \$1.15 .95 6.50 .033uF \$2.20 1.10 10.00		.33uF/35V	.35 .30 6.8uF/6V .40 .35 33uF/6V .60 .50
.0015uF .15 .95 7.50 .047uF .20 1.15 10.50		1uF/25V	.35 .30 6.8uF/16V .50 .40 33uF/16V .65 .55
.0022uF .15 .95 7.50 .068uF .25 1.30 12.00		1.5uF/20V	.35 .30 10uF/20V .50 .40 47uF/6V .65 .55
.0033uF .15 .95 7.50 .1uF .30 1.75 13.50		2.2uF/35V	.40 .35 15uF/5V .50 .40 47uF/15V .70 .60
.0047uF .15 .95 7.50 .15uF .35 2.25 14.00		3.3uF/35V	.45 40 15uF/10V .52 .42 56uF/6V .89 .80
.0068uF .15 .95 7.50 .22uF .40 2.55 20.00		4.7uF/16V	.45 .35 15uF/20V .55 .45
.01uF .15 .95 7.50 .33uF .45 2.75 25.00			
.015uF .15 .95 7.50 .47uF .50 3.50 30.00			
.022uF .15 .95 7.50			

CERAMIC CAPACITORS		TTL	
Value	Value	Value	Value
POLYESTER CAPACITOR KIT 5 ea of the above values \$14.95		7400	5.18 7464 .30 74155 .60
		7401	1.18 7465 .30 74156 .64
		7402	1.18 7470 .49 74157 .60
		7403	1.18 7472 .32 74158 .75
		7404	2.20 7474 .18 74160 .70
		7405	2.25 7475 .49 74161 .79
		7406	2.20 7576 .49 74162 .85
		7407	2.20 7480 .35 74163 .85
		7408	2.27 7482 .25 74164 .85
		7409	2.27 7483 .65 74166 .85
		7410	1.18 7485 .50 74170 .50
		7415	2.29 7486 .42 74173 1.25
		7416	2.20 7489 1.75 74174 1.05
		7417	2.20 7490 .59 74175 .85
		7420	2.20 7491 .64 74176 .70
		7425	3.99 7492 .59 74177 .70
		7426	3.59 7493 .35 74180 .35
		7427	2.25 7494 .59 74181 1.85
		7428	2.25 7495 .75 74182 .35
		7441	5.9 74122 .39 74193 .79
		7437	2.20 74105 .48 74190 1.15
		7438	1.18 74107 .35 74191 1.15
		7440	1.18 74121 .35 74192 .50
		7441	5.9 74122 .39 74193 .79
		7442	3.5 74123 .39 74194 .80
		7443	5.5 74125 .50 74195 .69
		7444	6.0 74126 .50 74196 .60
		7445	5.0 74132 .75 74197 .75
		7446	5.9 74141 .35 74198 1.00
		7448	5.9 74145 .50 74199 1.25
		7450	1.18 74148 1.25 74200 3.75
		7451	2.2 74150 1.35 74209 3.65
		7453	1.18 74151 .50 74216 .60
		7454	1.18 74153 .35
		7460	1.18 74154 1.45

POWER SUPPLY KIT		VOLTAGE REGULATORS	
Value	Value	Value	Value
• 5V, ±12V, ±15V A regulated power supply using a 115V/230V CT transformer, LM310T and 3-LM320T regulators to supply the above voltages. Heat sink provided for +5V.		10% OFF ON \$25.00 15% OFF ON \$50.00	
PARTS INCLUDED Transformer 3 regulators PC board 4 diodes Capacitor 1000 uf Capacitor 500 uf 3 Capacitors 10 uf	ea \$17.50 10- 16.00 25- 15.00 4 shipping	LM320T-5	Negative 5 V reg (7905) 1.19
		LM320T-12	Negative 12 V reg (7912) 1.19
		LM320T-15	Negative 15 V reg (7915) 1.19
		LM340T-5	Positive 5 V reg (7805) 1.19
		LM340T-8	Positive 8 V reg (7808) 1.19
		LM340T-12	Positive 12 V reg (7812) 1.19
		LM340T-15	Positive 15 V reg (7815) 1.19

CLOCK CHIPS		MINIATURE SOLID STATE ELECTRONIC BUZZER	
Value	Value	Value	Value
5316 4 digit, 12-24hr. alarm 50-60Hz, 40 pin 3.95		6 Volt (operates from 4V - 9V) ea	10- 100- 1.00ea

UART		PULSE REGULATORS	
Value	Value	Value	Value
UART 1602B \$3.95ea 10/\$35.00		10% OFF ON \$25.00 15% OFF ON \$50.00	

Payment by check, M.O., UPS/COD, M/C or VISA. Add \$1.25 for shipping/handling in U.S., Canada and Mexico. Additional charge for UPS COD or BLUE LABEL. Other Countries \$1.25 + 5% of order total. California residents add sales tax. Minimum order \$10.00

SCHOOLS AND GOVERNMENT ORDERS ACCEPTED ON OFFICIAL PURCHASE ORDERS.

INTERNATIONAL ELECTRONICS UNLIMITED
435 FIRST ST., Solvang, Ca. 93463
phone 805 688 2747

16K

Memory

8/\$19.95

4116 200ns

ALL MERCHANDISE 100% GUARANTEED!

CALL US FOR VOLUME QUOTES

LS SERIES

74LS00	.32	74LS155	1.19
74LS01	.28	74LS156	.95
74LS02	.38	74LS157	.79
74LS03	.32	74LS158	.82
74LS04	.35	74LS160	.94
74LS05	.28	74LS161	.99
74LS08	.38	74LS162	.99
74LS09	.38	74LS163	.99
74LS10	.32	74LS164	.99
74LS11	.29	74LS165	.99
74LS12	.29	74LS166	2.40
74LS13	.38	74LS168	1.79
74LS14	.99	74LS169	1.79
74LS15	.35	74LS170	1.89
74LS20	.26	74LS173	.82
74LS21	.30	74LS174	1.19
74LS22	.34	74LS175	1.09
74LS26	.40	74LS181	2.19
74LS27	.35	74LS190	1.15
74LS28	.39	74LS191	1.31
74LS30	.35	74LS192	.88
74LS32	.39	74LS193	.98
74LS33	.54	74LS194	1.80
74LS37	.78	74LS195	1.39
74LS38	.39	74LS196	.82
74LS40	.25	74LS197	.82
74LS42	.79	74LS221	1.28
74LS47	.78	74LS240	1.89
74LS48	.78	74LS241	1.89
74LS51	.35	74LS242	.89
74LS54	.35	74LS243	1.89
74LS55	.32	74LS244	1.79
74LS73	.44	74LS245	2.89
74LS74	.48	74LS251	1.32
74LS75	.58	74LS253	.89
74LS76	.50	74LS257	.89
74LS78	.59	74LS258	.89
74LS83	.90	74LS259	2.89
74LS85	1.23	74LS260	.68
74LS86	.45	74LS266	.68
74LS90	.70	74LS273	1.69
74LS92	.82	74LS275	3.39
74LS93	.71	74LS279	.59
74LS95	1.11	74LS283	1.03
74LS96	.86	74LS290	1.25
74LS107	.43	74LS293	1.89
74LS109	.49	74LS295	1.09
74LS112	.48	74LS298	1.24
74LS113	.48	74LS352	1.59
74LS114	.55	74LS353	1.59
74LS122	.55	74LS363	1.39
74LS123	.99	74LS365	.99
74LS124	2.99	74LS366	.99
74LS125	.99	74LS367	.99
74LS126	.88	74LS368	.99
74LS132	.69	74LS373	1.85
74LS136	.58	74LS374	1.81
74LS138	.79	74LS377	1.48
74LS139	.79	74LS385	1.90
74LS145	1.19	74LS386	.65
74LS148	1.39	74LS390	1.90
74LS151	.79	74LS393	1.90
74LS153	.79	74LS395	1.69
74LS154	2.39	74LS670	2.20

TMM 2016 16K STATIC 200ns 19.95ea

8164 64K DYNAMIC 200ns SINGLE SUPPLY 29.95ea

RAMS			
100pcs			
2101	(450ns)	2.49	2.29
2102-1	(450ns)	.99	.95
21L02-1	(450ns)	1.29	1.15
2111	(450ns)	2.99	2.49
2112	(450ns)	2.99	2.79
2114	(450ns)	2.95	2.85
2114L-2	(200ns)	8/29.95	3.10
2114L-3	(300ns)	8/24.95	2.95
4027	(250ns)	4.95	3.95
4116-15	(150ns)	8/21.95	2.65
4116-20	(200ns)	8/19.95	2.35
4116-30	(300ns)	8/18.99	2.00

EPROMS			
8pcs			
1702	(1us)	4.95	4.75
2708	(450ns)	4.95	4.75
2758	(5v) (450ns)	9.95	Call
2716	(5v) (450ns)	7.95	6.95
2716-1	(5v) (350ns)	12.95	10.95
TMS2716	(450ns)	9.95	8.95
2732	(5v) (450ns)	19.95	Call
2532	(5v) (450ns)	21.95	Call

6502

6502	10.95
6522	11.95
6532	19.95

8080

8035	16.95
8039	19.95
8080A	3.95
8085	12.95
8086	99.95
8088	39.95
8741	49.95
8748	59.95
8755	64.95
8155	11.95
8156	11.95
8185	29.95
8185-2	39.95
8202	45.00
8205	4.95
8212	2.75
8214	5.25
8216	2.75
8224	2.95
8226	3.49
8228	4.95
8238	5.50
8243	6.50
8251	6.95
8253	12.95
8253-5	13.95
8255	6.50
8255-5	7.50
8257	16.95
8259	14.95
8275	49.95
8279	15.95
8279-5	16.95
8282	6.50
8283	6.50
8284	5.80
8286	6.65
8287	6.65
8288	24.95
8289	49.95

MISC.

2560	12.85
3242	9.95
1771	24.95
AY5-1013	4.95
TR1602	4.95
IM6402	7.95
8T26	2.49
8T28	2.49
8T97	1.69
8T98	1.69
1488	1.39
1489	1.39

Z80

Z80	9.95
Z80A	12.95
Z80B	19.95
Z80-PIO	7.60
Z80A-PIO	8.60
Z80-CTC	7.65
Z80A-CTC	8.65
Z80-DMA	18.00
Z80A-DMA	25.95
Z80-SIO	21.95
Z80A-SIO	25.95

6800

6800	11.75
6802	17.95
6809	37.95
6810	4.60
6820	5.75
6821	6.40
6828	9.95
6834	19.95
6847	19.95
6850	5.75
6852	5.75
6875	6.95

T.V. CIRCUITS

MC1330	1.89
MC1350	1.29
MC1358	1.79
LM380	1.29
LM565	.99
LM741	.29
LM1310	2.90
LM1800	2.99
LM1889	2.49

ORDER TOLL FREE

800-538-5000

800-662-6233

Cont. USA
in Calif.

7400 SERIES

7400	.19	7450	.19	74123	.59
7402	.19	7472	.29	74151	.69
7404	.24	7473	.34	74153	.59
7406	.29	7474	.35	74154	1.49
7407	.29	7475	.49	74156	.69
7408	.24	7476	.35	74157	.69
7410	.19	7483	.65	74161	.79
7420	.19	7486	.35	74163	.89
7430	.19	7490	.49	74164	.89
7432	.29	7491	.69	74173	1.39
7440	.19	7492	.59	74174	.89
7442	.49	7493	.49	74175	.89
7445	.69	7496	.74	74176	.89
7446	.69	74100	1.19	74192	.79
7447	.59	74107	.34	74193	.79
7448	.69	74121	.34	74196	.79

IC SOCKETS

8 pin ST	10/1.29	8 pin WW	.59
14 pin ST	10/1.49	14 pin WW	.69
16 pin ST	10/1.69	16 pin WW	.69
18 pin ST	10/1.99	18 pin WW	.99
20 pin ST	10/2.89	20 pin WW	1.09
22 pin ST	10/2.99	22 pin WW	1.39
24 pin ST	10/2.99	24 pin WW	1.49
28 pin ST	10/3.99	28 pin WW	1.69
40 pin ST	10/4.99	40 pin WW	1.99

ST = SOLDDERTAIL WW = WIREWRAP

VOLTAGE REG's

7805T	.89	7905T	.99
7812T	.89	7912T	.99
7815T	.99	7915T	1.19
7824T	.99	7924T	1.19
7805K	1.39	7905K	1.49
7812K	1.39	7912K	1.49
78L05	.69	79L05	.79
78L12	.69	79L12	.79
78L15	.69	79L15	.79

T = TO-220 K = TO-3 L = TO-92

TRANSISTORS

PN2222	10/1.00	100/8.99
2N3904	10/1.00	100/8.99
2N3906	10/1.00	100/8.99
2N3055	.79	10/6.99
IN4148		25/1.00
IN4004		10/1.00

LEDS

Jumbo Red	10/1.00
Jumbo Green	6/1.00
Jumbo Yellow	6/1.00
5082-7760 .3"CC	.79
MAN74 .3"CC	.99
MAN72 .3"CA	.99

74S00 SERIES

74S00	.50	74S124	3.95	74S288	4.75
74S02	.50	74S174	1.49	74S387	5.75
74S04	.50	74S188	4.75	74S471	18.75
74S08	.50	74S195	1.95	74S472	18.75
74S37	.55	74S240	2.95	74S474	19.95
74S74	.80	74S260	1.80	74S570	7.80
74S113	.79	74S287	4.75	74S571	7.80

CMOS

4001	.35	4024	.99	4070	.49
4002	.39	4025	.29	4071	.49
4007	.25	4027	.65	4072	.49
4009	.49	4020	1.29	4081	.39
4010	.49	4022	.99	4093	.99
4011	.35	4026	1.79	4098	2.49
4012	.29	4027	2.49	4503	.69
4013	.49	4029	.49	4508	3.95
4016	.59	4050	.69	74C04	.39
4017	1.19	4050	1.39	74C141	.49
4020	1.19	4056	.79		
4023	.29	4059	.39		

LINEAR

LM301V	.34	LM555V	.39	LM1414	1.59
LM308V	.98	LM556	.69	LM1458V	.69
LM309K	1.49	LM565	.99	LM1488	1.39
LM311V	.64	LM566V	1.49	LM1489	1.39
LM317T	2.29	LM567V	1.29	LM1800	2.99
LM318V	1.49	LM723	.49	LM1889	2.49
LM323K	4.95	LM741V	.29	75451V	.59
LM324	.59	LM747	.79	MC1330V1	.89
LM339	.99	LM748V	.59	MC1350V1	.29
LM377	2.29	LM1310	2.90	MC1358	1.79
LM380	1.29				

T = TO-220 V = 8 PIN K = TO-3

DIP SWITCHES

4 position	.99
5 position	1.02
6 position	1.06
7 position	1.09
8 position	1.14

JDR MICRODEVICES, INC.

1101 South Winchester Blvd.
San Jose, California 95128
800-538-5000 408-247-4852
800-662-6233 (Callf.)

TERMS: For shipping include \$2.00 for UPS Ground; \$3.00 for UPS Blue Label Air; \$10.00 minimum order. Bay Area Residents add 8 1/2% sales tax Calif. Residents add 6% sales tax. We reserve the right to limit quantities and substitute manufacturer. Prices subject to change without notice.



CIRCLE 45 ON FREE INFORMATION CARD



Free!

Look at this fantastic offer from Poly Paks!!
BUY SEVEN JUMBO PAKS AND CHOOSE TWO FREE!!

All JUMBO PAKS PRICED AT **\$2.99** ea.
 Indicate your free JUMBO PAKS with letter "F"

- 400-PRE-FORMED 1/4 WATTERS, popular values, some 5 & 10% ers, (#6248)
- 35-UPRIGHT ELECTROS. 100%, assorted values & voltages, marked. (#3226)
- 75-CABLE TIES, 4" non-slip white plastic, like Ty-wrap. (#5218)
- 50-MINI POTS, pc style, single turn, assorted values. (#3345)
- 150-PC. CAPACITOR SPECIAL, asst. mylars, polys, micas, etc. 100% good. (#6264)
- 175-1/4 WATT RESISTORS, asst.d. carbons, carbo-films, some 5%ers. (#5787A)
- 60-POLYSTYRENE CAPS. assorted types, styles & sizes, all good. (#2729)
- SURPRISE PAK Assortment of IC's, caps, pots and parts of every description 175-HALF WATTERS, 100% color coded resistors, asst. values. (#3046)
- 175-MOLEX SOCKETS, "on a strip", make your own pc sockets. (#6255)
- 400-PREFORMED 1/4 WATTERS, assorted values, precut for PC appl. (#6822)
- 24-MINI-BULBS, ASST. VOLTAGES & base styles, some colored. (#6757)
- 75-LONG LEAD DISK, prime, marked caps, assorted material. (#2598)
- 50-SLIDE SWITCHES, various shapes, sizes and types (#2726)
- 25-MICRO MINI REED SWITCHES, 1" long, for alarms, relay systems, etc. (#6263)
- 50-THERMISTORS, various types & styles, neg. coefficient, 100% (#4089)
- 200-PRE-FORMED DISCS, caps w/leads for PC use, mixed values. (#2605)
- 50-AXIAL ELECTROS, asst. values, volts, sizes, what a buy! (#3227)
- 100-PLESSY CAPS, ceramic blocks in assorted sizes & values, (#6221)
- 3-WATCH GUTS, 5-function, LED style, assorted sizes, untested (#6267)
- 6-TIME DELAYS, solid state, asst. from 450 mSec to 8 Sec. (#6758)
- 100-PLASTIC TRANSISTORS, untested, to-92, asst. types (#2604)
- 50-TRANSISTOR ELECTROLYTICS, epoxy encapsulated, asst. values, (#2747)
- 20-SLIDE VOLUME CONTROLS, various values & types, for HI-FI, etc. (#3057)
- 500-PC-HARDWARE SURPRISE, (approx.) 1 lb. asst. screws, washers, etc. (#6271)
- 100-POWER RESISTORS, 3 to 7 power resistors, (#6261)
- 100-2 WATT RESISTORS, assorted carbons, films etc. some 5% ers, (#6238)
- 24-SKINNY TRIM POTS, multi & single turn, asst. values & types, (#6265)
- 15-CRYSTALS, assorted types, some H6/U, some frequency marked. (#6286)
- 200-9V BATTERY CLIPS, snap connector, coded, insulated leads, (#6292)
- 4 HEAVY DUTY LINE CORDS, white, 2 cond. 6ft., 16 gauge. (#4283)
- 200-PRECISION RESISTORS, 1/2 W, 1%, axial (#6229)
- 30-PANEL SWITCHES, assorted rotary, micro, slide, etc. (#6229)
- 20-PAIRS-RCA PLUGS & JACKS, popular for HI-FI, speakers, etc. (#6830)
- 4-2N3055 NPN TRANSISTORS, 115 watts, 15 amps, TO-3, 100% material. (#6833)
- 5-LINE CORDS, heavy-duty, 18 gauge, 6', molded plug, 2-cond. (#6499)
- 20-2N3055 HOBBY TRANSISTORS, manuf. fallout, TO-3, U-test. (#6824)
- 25-PLASTIC POWERS, 25 watt, npn & pnp, 50-200 bycho, TO-220 (#6237)
- 150-"4000" RECTIFIERS, IN4000 series, may include; 50 to 1000V. (#2417)
- 400-PRE-FORMED 1/4 WATTERS, popular values, some 5 & 10% ers. (#6246)
- 30-SCRs & TRIACS, assorted values, 10 Amp TO-220, untested (#6337)
- 60-IN914 SWITCHING DIODES, 4 nsec, axial, glass, untested. (#6832)
- 30-INSTRUMENT KNOBS, for half round shafts, some w/pointers. (#6498)
- 35-STEREO INDICATORS, tiny red 1.5V bulbs, for HI-FI replacement. (#6244)
- 40-EDGE CONNECTORS, asst. 4 & 6 pin, 2-sided, pc leads. (#6364)
- 6-MINI-MOTORS, type RE56, 1.5-6VDC, color-coded wire leads. (#6718)
- 25-NE-2 BULBS, neon, for 110 VAC, requires resistor, (not incl.). (#6213)
- 100-METALLIC RESISTORS, mostly 1/4 watters, asst. val. 1-5% tol. (#6280)
- 4-3AMP 125 VAC GLASS CIRCUIT BREAKERS. (#6295)
- 40-VOLUME CONTROLS, assorted values & types. (#6331)
- 25-2N3904 TRANSISTORS, 100% material. (#6370)
- 28-COLORED 20 MIL FIBERS, 2' lengths, assorted colors. (#6376)

TOXIC GAS TRANSDUCER

- Indispensable In Trailers & Motor Homes
- Ideal Bilge Monitor For Boats!

The Figitox Toxic Gas Sensor utilized advanced semiconductor technology to provide detection, and subsequent warning of toxic gases such as carbon monoxide, methane, natural gases, LPG, butane, etc. Long Life (up to 10 years) High Reliability, and compact dimensions (only 5/8" dia. x 3/8" Requires a stabilized 5V heater supply and circuit voltage not exceeding 24 volts. Comes with complete specs and hookup instructions. Order Today!

Cat. No. 6836
\$7.95 ea. 2 for \$15.00 Qty.

LED BAR GRAPH DISPLAY

- Ideal Replacement For Analog Meters
- More Accurate Than Traditional Meters
- Uses Include: VU Meters, Power Level Indicators, SWR Meters and More!

Unit consists of 10 bright Red LEDs enclosed in a 1 3/8" x 1 1/4" x 3/8" plastic enclosure, and terminating in 316" PC style leads. Common Anode device operates on 2V max. between 20-250mA. Requires driver circuitry appropriate for intended application (not included). Comes with hookup instructions & typical driver circuit schematic. Cat. No. 6922

\$5.98 ea. 2 for \$11. Qty.

MOTOROLA AM AUTO RADIO

Features include 5-station pushbutton tuning, concentric control knobs for ON/OFF/VOLUME & SPRING BALANCE/MANUAL TUNING, as well as an attractive black faceplate with chrome-colored trim. Requires 12 VDC. Neg. Gnd., 4 to 8 ohm speakers.

\$16.88 Cat. No. 6920 Qty.

ELECTRONIC COMPUTER GAME BOARD

- Free Case With Every Purchase
- Different Skill Levels
- Electronic Lights & Sounds
- Includes Microprocessor Chip, plus all Necessary Circuitry Components
- Fully Assembled In Case
- Game plays like "SIMON or EINSTEIN" Board size: 4 1/2" x 7 1/2". Case size: 3 1/2" x 3 1/2" x 1 1/2".

\$6.49 ea. 2 for \$12. Cat. No. 6913 Qty.

POLY PAKS P.O. BOX 942, RE-7
 S. LYNNFIELD, MA. 01940

Total Amount of Order \$ _____

INCLUDE SHIPPING AND HANDLING: U.S., ADD \$3.; FOREIGN, ADD \$7.
 MASS. RES. ADD 5% SALES TAX.

NAME _____

ADDRESS _____

CITY _____

STATE _____ ZIP _____

Enclosed is CHECK, MONEY ORDER
 Charge my MASTERCARD VISA

ACCT. # _____ EXP. DATE _____

Order By Phone 1-617-245-3828

ORDERING INSTRUCTIONS • Indicate quantity on line or box near item desired • Complete coupon section • Cut out Ad and mail to Poly Paks, Inc.
 ■ Send me your FREE catalog.

CIRCLE 26 ON FREE INFORMATION CARD

SURPLUS BUYS of the YEAR!!

The Most Sought After, Most Desirable

DIABLO 10 MEG DISK DRIVES

Model 44B

- 5 Mb Fixed, 5 Mb Removable
- 115 VAC 60 Hz
- Takes 5440 Disk
- Industry Std. Drive
- Daisy chain up to 4
- I/O Data included



- Built-in power supplies
- 200 tracks / inch
 - 256 Bytes per sector
- 24 sectors / track
- 19,583 sectors / platter

REFURBISHED & OPERATIONAL Only **\$2200.00** each Includes 2 FREE DISK CARTRIDGES

MODEL 44A DISK DRIVE 10 Mb, earlier design, same I/O. Used, whole, untested Includes schematics & data. **\$1200.00**

MODEL 43 5 Meg Disk Drive 100 TPI, good cond., used, whole, untested. With data and schematics **\$795.00**

MODEL 429 POWER SUPPLY ±24VDC @ 6 amps, 5V @ 6 amps. Required for both the 44A and 43 drives (above). **\$75.00**

MORE BARGAINS

*SELECTRIC-II Typewriter/Printer

With stepper-driven platen & carrier. Exciting possibilities. Removed from sophisticated word processors. Solenoids (standard electric corresp. code) self contained. Mostly whole; "as-is" with schematics and data. **Only \$399.00**



RO*SELECTRIC-II Printer

"Receive-only" (no keyboard). Features X&Y steppers plus all solenoids & standard IBM Selectric-II printer mechanism. Takes Tech-III ribbon cartridges. Less case and platen, mostly whole. "as-is". Schematics included. **Only \$129.00**

Disk Drives: Add \$30 for Hdq. & Pkg. Pay Shipping on Delivery.
 Selectric Printers: Add \$20 for Hdq. & Pkg. Pay Shipping on Delivery
 *Reg. Trade-Mark of IBM Corp.

CFR Associates, Inc.

MAIL ORDERS: Box 144, Newton, N.J. 03858

PHONE ORDERS: 617/372-8536 (Sorry, No Collect Calls) MasterCharge & VISA Welcome

WAREHOUSE: 18 Granite Street Haverhill, Mass. 01830

CIRCLE 30 ON FREE INFORMATION CARD

4K x 16 MEMORY BOARD with 64 IC chips (2102) in sockets. Super deal at \$50 the complete board.
 16K MEMORY 4116-4 \$2.00 each or 8 for \$14.00

- MPI 8 inch SINGLE SIDE DISC DRIVE \$175.00
 - MPI 8 inch DUAL SIDED DISC DRIVE 350.00
 - SHUGART FLEX DISC DRIVE 5 1/4 inch 150.00
 - MOTOROLA MONITOR 9 inch 115 volt 50.00
 - MOTOROLA MONITOR 12 inch 115 volt 85.00
- Above 2 units accept composite video. No cabinets. Used, OK. 2 units below, have hi volt supply only.
- BALL BROS. 12 inch monitor 50.00
 - BALL BROS. 5 inch monitor in case 50.00
 - SANYO UHF VARACTOR TUNER unused 25.00

DATA STATION CONSOLE w/keyboard 9 inch monitor, power supply. Logic boards broken. \$80
 Send for details on this one.

- TOUCH PAD solid state w/LSI chip. Bell system compatible. For computers & phones \$15.00
- 12 VOLT GEL-CELLS 2.5 AH \$14.00 5 AH \$17.00
- 12 INCH CRT bonded face plate. New with specs. Made for computers. \$25 each 5 for \$100
- IR SCOPE, SEE IN DARK portable \$265.00
- WALKY TALKIES Govt surplus used condition. 47-55.4 mc range. With schematics. Govt AN/PRC-6 \$25 each 2 for \$45. Ant. \$5 each
- ASCII KEYBOARD parallel \$50
- RED LED's 10 for \$1.00
- MIN ORDER \$10.00



Shipping extra on all merchandise
 Meshna Inc., PO Box 62, E. Lynn, Mass. 01904

CIRCLE 15 ON FREE INFORMATION CARD

Low Profile - TIN

1-24	25up	50up	100up
AB2T-TI	\$.17	\$.18	\$.15
1A1ZT-TI	20	19	18
1A1ZT-TI	22	21	20
1B1ZT-TI	29	28	27
3A2ZT-TI	33	32	31
4A2ZT-TI	36	35	34
4A2ZT-TI	37	36	35
4A2ZT-TI	43	42	41
4A2ZT-TI	46	45	44

Standard Solderair - TIN

1-24	25up	50up	100up
ABT	\$.30	\$.29	\$.28
1A1T	36	35	34
1A1T	38	37	36
1A1T	44	43	42
A22T	72	71	70
A24T	52	51	50
A28T	78	77	76
A35T	83	82	81
A40T	1.08	1.07	1.06

Standard Solderair - Gold

1-24	25up	50up	100up
ABG	\$.38	\$.37	\$.36
1A1G	55	54	53
1A1G	63	62	61
1A1G	69	68	67
A22G	81	80	79
A24G	91	90	89
A28G	1.01	1.00	99
A36G	1.41	1.40	1.39
A40G	1.55	1.54	1.53

SOCKETS
WIRE WRAP
Level 3

1-24	25up	50up	100up
ABWG	\$.55	\$.54	\$.53
A10WG	69	68	67
A14WG	71	70	69
A18WG	73	72	71
A18WG	1.09	1.08	99
A20WG	1.23	1.22	1.21
A22WG	1.35	1.34	1.33
A24WG	1.43	1.42	1.41
A28WG	1.83	1.82	1.81
A36WG	1.95	1.94	1.93
A40WG	2.43	2.42	2.41

Wire Wrap - TIN

1-24	25up	50up	100up
ABWT-TI	\$.41	\$.40	\$.39
A14WT-TI	59	58	57
A16WT-TI	63	62	61
A18WT-TI	67	66	65
A20WT-TI	91	90	89
A22WT-TI	99	98	97
A24WT-TI	1.09	1.08	1.07
A28WT-TI	1.39	1.38	1.37
A36WT-TI	1.63	1.62	1.61
A40WT-TI	1.89	1.88	1.87

★ MICROPROCESSOR CRYSTALS ★

FREQ (MHz)	CASE P/N	PRICE	FREQ (MHz)	CASE P/N	PRICE
1.80	HC33 CY18	95.50	4.50	HC18 CY18A	54.75
1.8432	HC33 CO1A	9.50	5.80	HC18 CY17A	6.00
2.00	HC33 CY28	8.25	5.588	HC18 CY58	6.00
2.4576	HC33 CY7A	8.25	5.7143	HC18 CY8C	6.00
3.2768	HC33 CY3D	8.00	6.00	HC18 CY6D	6.00
3.7584	HC33 CY10	8.00	6.164	HC18 CY8C	6.00
4.80	HC18 CY1A	8.00	6.80	HC18 CY28A	8.15
4.434	HC18 CY4C	6.00	10.00	HC18 CY12A	6.75
4.536	HC18 CY4B	8.00	14.31818	HC18 CY10A	8.15

Intersil LED or LCD 3 1/2 DIGIT PANEL METER KITS

BUILD A WORKING DPM IN 1/2 HOUR WITH THESE COMPLETE EVALUATION KITS. Test these new parts for yourself with Intersil's low cost prototyping kits, complete with A/D converter and LCD display (7106) or LED display (7107). Kits provide all materials, incl PC board, for a functioning panel meter. ICL7106EV (LCD) \$34.45 ICL7107EV (LED) \$23.70

8 Digit - 10 MHz Universal Counter Kit

Kit Includes:
 • ICM7226A/IC
 • 10 MHz Quartz Crystal
 • (8) 7 Segment .3" LED Displays
 • PC Board
 • Resistors
 • Capacitors
 • Diodes
 • Switches
 • IC Socket

Order Part Number ICM7226AEV \$74.95

LED BAR GRAPH ARRAYS AND DRIVER

GL-112R3 LED Array is a red LED arranged in a 12 dot bar graph configuration. When used in combination with the IR-2405, linear level indications can be generated. GL-112M2 LED Array same as above except dot graph is arranged as G green and 4 red positions. IR-2406 LED Driver is an integrated circuit LED driver with 12 outputs, on each successive output turns the LED's on in steps equal to: $V_{ref}(Max.) - V_{ref}(Min.)/13$

OEM Prices

GL-112R3	\$4.80
GL-112M2	\$4.80
IR-2406	\$4.80

The Bright TWO-COLOR LED ED95

Both Red-orange and Green LEDs in the same package. Color mixing can be accomplished due to separate anodes.

1-24	\$1.60
25 up	\$1.40
100 up	\$1.10

Universal Oscilloscope Probe

\$36.00

SWITCHABLE X1 and X10 Attenuation Factor KEY ADDITIONAL FEATURES: • 100MHz bandwidth • Heavy duty tip • Break resistant center conductor • Slender, flexible cable • 6ft. cable length • Wide compensation range • Fits all scopes • Ground reference can be activated at tip • Includes SPRUNG HOOK, I.C. TIP, BNC ADAPTOR, INSULATING TIP and TRIMMER TOOL ACCESSORIES.

ANCRONA MAIL ORDER

P.O. BOX 2208R CULVER CITY, CA 90230
 PHONE ORDERS (213) 641-4064

Minimum Order \$10.00. Add \$2.00 to cover postage and handling. Master Charge and VISA welcome. Please include your charge card number, interbank number and expiration date. Some items are subject to prior sale. Not responsible for typos. Store pricing may vary from Mail Order pricing. We reserve the right to substitute manufacturer.

ATLANTA	CULVER CITY	HOUSTON	PORTLAND	SANTA ANA	SUNNYVALE	TUCSON
3330 Piedmont Rd. N.E. Atlanta, GA 30305 (404) 261-7100	11080 Jefferson Blvd. Culver City, CA 90230 (213) 390-3595	2649 Richmond Houston, TX 77098 (713) 529-3489	1125 N.E. 82nd Ave. Portland, OR 97220 (503) 254-5541	1300 E. Edinger Ave. Santa Ana, CA 92705 (714) 547-8424	1054 E. El Camino Real Sunnyvale, CA 94087 (408) 243-4121	4518 E. Broadway Tucson, AZ 85711 (602) 881-2348

74LS... SERIES

74LS00N	23	LM300H	7.70	LM340-12K	1.35	78L15CP	55
74LS03N	23	LM300N	1.95	LM340-15K	1.35	78L18ACP	60
74LS04N	26	LM304H	95	LM340-18K	1.35	78L18CP	55
74LS08N	27	LM305H	75	LM340-24K	1.35	78L24ACP	60
74LS10N	31	LM309H	1.45	LM350K	5.40	78L24CP	55
74LS12N	34	LM309K	1.25	LM353-5	7.50	79L03ACP	1.00
74LS16N	34	LM317H	1.70	LM353-8	7.50	79L03CP	1.00
74LS26N	39	LM317-To220	1.60	LM353-12	7.50	79L05ACP	1.00
74LS27N	39	LM317K	2.45	LM353-15	7.50	79L05CP	1.00
74LS32N	34	LM320-5K	2.20	LM353-18	7.50	79L12ACP	1.50
74LS37N	36	LM320-8K	2.20	LM353-24	7.50	79L12CP	1.00
74LS40N	41	LM320-8K	2.20	LM723CH	50	79L15ACP	1.50
74LS42N	45	LM320-12K	2.20	LM723CN	50	79L15CP	1.00
74LS73N	38	LM320-15K	2.20	78L05ACP	55	79L18ACP	1.50
74LS74N	34	LM320-18K	2.20	78L05CP	55	79L18CP	1.00
74LS86N	45	LM320-24K	2.20	78L08ACP	60	79L18CP	1.50
74LS90N	44	LM323K	4.70	78L08CP	55	79L24ACP	1.00
74LS93N	42	LM340-5K	1.35	78L12ACP	55	MC1463G	4.90
74LS109N	52	LM340-6K	1.35	78L12CP	55	MC1466L	9.90
74LS112N	42	LM340-8K	1.35	78L15ACP	60	MC1468G	5.90
74LS123N	39			78L15CP	55	MC1469G	4.90

VOLTAGE REGULATORS

To20 (Plastic)	To20 (Plastic)	To20 Case	
7805CP	\$.90	7905CP	\$.95
7812CP	90	7912CP	95
7815CP	90	7915CP	95
7818CP	90	7918CP	95
7824CP	90	7924CP	95
IC7800CT, SG7800CP, LM340-AT or 7804UC		IC7800CT, SG7800CP, LM320-AT or 7804UC	

SILICON GENERAL

Linear IC and Voltage Regulator Databook
 214 pages \$4.50

RF TRANSISTORS

MRF314	28.91	MRF314A	28.91
MRF207	5.61	MRF454	26.53
MRF208	16.06	MRF454A	26.53
MRF209	19.27	MRF455	22.34
MRF212	22.48	MRF455A	22.34
MRF215	40.15	MRF475	4.05
MRF216	43.29	MRF801	3.00
MRF221	15.22	MRF904	3.21
MRF222	17.67	MRF911	2.89
MRF223	18.50	MRF8003	2.44
MRF224	21.65	MRF8004	2.93

ANCRONA HAS INTERSIL IC's

IM8100-1PL	\$13.95	ICM7213-1PD	95.35	ICM7227-8U1	14.45
ICM7038-A1PA	3.00	ICM7216-A1J1	32.00	ICM7227-C1P1	12.40
ICM7038-C1PA	3.00	ICM7218-B1P1	26.65	ICM7240-1JE	4.90
ICM7045	14.95	ICM7216-C1P1	26.65	ICM7241-1PA	3.40
ICL71C03-ACP1	13.80	ICM7218-D1P1	21.40	ICM7242-1JA	2.05
ICL7106-CPL	16.50	ICM7217-A1P1	11.25	ICM7250-1CCJ0	6.00
ICL7107-CPL	18.00	ICM7217-B1P1	12.40	ICM7260-1JE	5.25
ICL7116-CPL	18.70	ICM7217-C1P1	10.35	ICM7270-1PL	5.85
ICL7365N	75	ICM7217-D1P1	12.40	ICM7655-1PA	1.20
ICL7367N	1.45	ICM7218-C1J1	10.75	ICM7656-1PD	2.25
ICL7373N	1.35	ICM7220-1PG	13.00	ICM7223-1PL	7.90
ICL7377N	1.40	ICM7206-CJPE	6.15	ICM7224-1PL	11.25
ICL7366N	75	ICM7275-A1P0	8.50	ICM7225-1PL	8.40
ICL7368N	79	ICM7208-1P1	18.00	ICM7228-A1J1	32.00
ICL7373N	1.35	ICM7209-1PA	3.85	ICM7228-B1PL	26.85
ICL7377N	1.40	ICM7211-1PL	8.40	ICM7227-A1P1	12.40

Z-80 SERIES

Z-80-CPU	8.95	MC6800P	5.90	MC6882P	10.80	P6505A	10.70
Z-80-CTC	6.50	MC68011	65.84	MC6875L	11.80	P6506	9.70
Z-80-PIO	6.50	MC6802P	11.50	MC6881P	3.14	P6507	9.70
Z-80-DART	15.45	MC6809B	13.90	MC6882AL	6.13	P6507A	10.70
Z-80-DART-9	13.50	MC6809P	36.50	MC6885P	2.72	P6512A	116.60
Z-80-SIO/0	24.40	MC6821P	3.46	MC6887P	2.72	P6513A	9.70
Z-80-SIO/9	18.20	MC6828P	9.90	MC6888P	2.72	P6514	10.70
Z-80-DMA	20.10	MC6840P	12.22	MC6889P	3.14	P6514A	10.70
Z-80A-CPU	9.95	MC6843P	45.39			P6515	10.70
Z-80A-CTC	7.95	MC6844P	45.39			P6515A	10.70
Z-80A-PIO	7.95	MC6845P	22.00	P6502	6.40	P6520	5.90
Z-80A-DART	18.85	MC6846P	39.90	P6502A(2MHz)	7.90	P6520A	6.40
Z-80A-DART-9	16.50	MC6847P	66.50	P6502B(3MHz)	13.50	P6521	6.80
Z-80A-SIO/0	30.50	MC6850P	3.40	P6503	9.70	P6521A	6.80
Z-80A-SIO/9	23.40	MC6852P	32.20	P6504A	10.70	P6522	6.40
Z-80A-DMA	24.90	MC6854P	9.70	P6504A	10.70	P6532	11.90
		MC6859L	277.90	P6505	9.30	P6532A	10.20

MINIATURE DOT MATRIX IMPACT PRINTER



The Unique New Printer That Gives You All These Exciting Features.

- Low Cost
- Disposable printing head
- Simple interface
- Handles any type font
- Needs only one 12-volt DC power supply
- Uses standard 2 1/4" adding machine tape or carbonless paper
- 21-column printing at 25 lines per second
- Easy to install and maintain

Model DP-822 **\$70.00**

HAMEG

10 Megahertz HM307 SINGLE TRACE OSCILLOSCOPE

IDEAL SERVICE INSTRUMENT

TIME BASE 0.2 μs - 2.0 s/cm Only \$404.25

LPS-TRIGGER COMPACT BUILT-IN COMPONENT TESTER

1-9	10 up	100 up
2114 (200ns)	\$3.45	3.10
2114L3	3.90	3.20
4116 (200ns)	3.90	3.20
2708	5.90	5.30
2716 (5V)	9.90	9.30
2732 (350ns)	21.90	20.90

ANCRONA HAS MOTOROLA IC's

</

**NOW!
A 12 HOUR
TAPE RECORDER
for only \$95.00*** **LONG
PLAY**



High quality AC-DC Cas-
sette Recorder provides
6 continuous hrs. of
recording & play back
of top quality true fi-
delity, distortion free
sound on each side
of cassette for a to-
tal of 12 hrs. Built-in
features incl. • Voice
level control • Auto-
tape stop • Digital
counter • LED indi-
cator, etc. AC Adapter &
TDX DC-180 Cassette incl.

Model
1000LP

PHONE RECORDING ADAPTER
Record incoming and outgoing calls
automatically with this all
state unit connected to your tele-
phone jack and tape recorder.
Starts recording when phone is
lifted. Stops when you hang up. **\$24.50***

VOX VOICE ACTIVATED CONTROL SWITCH
Solid state. Self contained. Adjust-
able sensitivity. Voices or other
sounds automatically activate and
control recorder. Uses either re-
corder or remote mike. **\$24.95***

*Add for ship. & hdlg. Phone Call Adapter & VOX
\$1.50 ea—Recorder \$4.00. Cal. Res. add tax. Mail
order, VISA, M/C, cod's ok. Qty. disc. avail.
Money back guar. Free data. Dir. inq. inv.
AMC SALES, Dept. 19, 9335 Lubec
St., Box 928, Downey, CA
(213) 90421 Phone
869-8519

CIRCLE 16 ON FREE INFORMATION CARD

HAND HELD GAME BOARD SPECIALS
These are the complete functional circuit boards from
popular hand held games — no case or batteries supplied.

Computer Perfect
Has 10 LEDs and tone signals. You try
to guess correct button sequence to
light LEDs in order. Requires two 9V
batteries. With instructions. C24404
\$4.50



Computer Mind
You guess the secret number stored in
computer chip memory. Has 10 LEDs and
keyboard. Requires one 9V battery. With
instructions.
C24405 \$3.75

Starsound Board
Unique board uses IC circuitry and gravity switch to
produce space engine sounds. Point the board
downwards and it produces "idle" sounds. Point
upwards and the sound increases in pulsating
frequency to produce "Blastoff" sounds. Originally
had LED circuitry but this has been removed.
Sound portion is 100% perfect.
Requires 9V battery
and speaker. C24406 \$2.50
2" Speaker for above. C24311 99¢



**120 VAC
Xenon
Strobe Kit**
Complete variable
rate strobe light kit.
Contains
all parts. C23071
PC board,
fine cord
and
instructions. **\$7.50**



**Super LED
Flasher Kit**
Great for Robot projects this
simple to build kit uses IC
circuitry to randomly flash 4
LEDs: 2 red, 1 yellow, 1
green. Complete with all
parts, PC board and
instructions. Size: 2" x 2".
Operates on 9VDC.
C24407 \$4.98

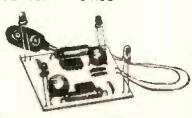

CHANEY
electronics inc.
P.O. BOX 27038
DENVER, COLORADO 80227

Phone Orders 303-781-5750 • Minimum AD Order \$6.00
• Please include \$1.50 for postage
• VISA MC accepted
• Phone orders are welcome

Send for our free catalog of unique items

CIRCLE 18 ON FREE INFORMATION CARD

**MUSICIANS!
BUILD YOUR OWN
MIXING CONSOLE!**

For PA or recording use, building your own
saves money while giving excellent performance
...and the MusiKits™ listed below are what you
need to get going.

These are the same kits described in Craig
Anderton's bestselling book, "Home Recording
for Musicians". These kits include PC board,
quality components, switches, and pots but DO
NOT include instructions since the book
contains all necessary schematics, assembly
procedures, and applications.

"Home Recording for Musicians". Covers
mixing, miking, consoles, noise reduction, how to
build a very high performance monaural mixer, and
much more. 190 pages, softcover; \$9.95.

Project #13-15 - Bipolar ±15 V power supply
suitable for powering the kits described below. Up to
250 mA per side; includes transformer. **\$15.00.**

Project #28 - Main Mixer. You can mix down from
a four or eight track recorder with nothing more than
this module. **\$25.65.**

Project #29 - Cue System Mixer. **\$29.50.**

Project #30 - Reverb System Mixer (does not
include springs). **\$34.50.**

Project #31 - Preamp/Input Selector Module.
\$19.25.

Project #32 - Tone Control Module. **\$19.25.**

Project #33 - Noise Gate Module. **\$33.35.**

Project #34 - Budget Noise Reduction System.
Uses Pre-Emphasis/De-Emphasis technique. With
complete Instructions. \$24/channel, four channels for
\$90.00.

TERMS: Cal res add tax. Allow 5% shipping; excess refunded.
Orders under \$15 add \$2 handling. VISA * and Mastercard * orders
(\$25 min) call (415) 562-0636, 24 hrs. Include street address for
UPS.

GODBOUT
ELECTRONICS
BOX 2355, OAKLAND AIRPORT, CA 94614
CIRCLE 38 ON FREE INFORMATION CARD

**TECHNICIANS WHO USED TO BUY THE BIG NAMES
NOW BUY THE BIG NAME IN LOW PRICES.**

ERS 152	\$1.20
ERS 154	\$1.80
ERS 165	\$3.35
ERS 180	\$4.40
ERS 195A	\$2.00

**EXACT
REPLACEMENT
SEMICONDUCTORS**

ERS

ERS 236	\$2.30
ERS 238	\$4.35
ERS 291	\$1.30
ERS 703A	\$1.35
ERS 712	\$2.25

Smart technicians who want Exact Replacement Semicon-
ductors with prices that let them in on the profits are turning
to ERS. A new and comprehensive series of guaranteed qual-
ity semi's directly distributed by MCM. ERS prices are lower
because MCM cuts out the expensive middleman, and most
parts are sent right to you United Parcel within 24-hours of

your call on the toll-free hotline. And ERS quality is backed
by a replacement or money-back guarantee.

Let yourself in on the profits. Order ERS directly from MCM
today, or call and ask for our complete ERS replacement
parts list.

Distributed directly by MCM. Call Toll-Free Number for immediate UPS delivery.

1-800-543-4330 **mcm** **1-800-762-4315**
National Watts **ELECTRONIC PARTS** Ohio Watts
CIRCLE 53 ON FREE INFORMATION CARD

BULLET ELECTRONICS

P.O. BOX 401244R
GARLAND, TX. 75040
214 · 278-3553

Sound Effects Kit \$18.50

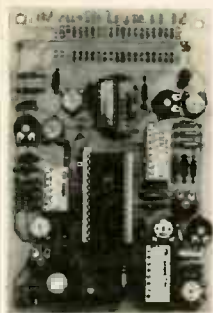

The SE-01 is a complete kit that contains all the parts to build a programmable sound effects generator. Designed around the new Texas Instruments SM76477 Sound Chip, the board provides banks of MINI DIP switches and pots to program the various combinations of the SLF Oscillator, VCO, Noise, One Shot, and Envelope Controls. A Quad Op Amp IC is used to implement an Adjustable Pulse Generator, Level Comparator and Multiplex Oscillator for even more versatility. The 3 1/2" x 5" PC Board features a prototype area to allow for user added circuitry. Easily programmed to duplicate Explosions, Phasor Guns, Steam Trains, or almost an infinite number of other sounds. The unit has a multiple of applications. The low price includes all parts, assembly manual, programming charts, and detailed 76477 chip specifications. It runs on a 9V battery (not included). On board 100mW amp will drive a small speaker directly, or the unit can be connected to your stereo with incredible results! (Speaker not included). 76477 is included. Available separately for \$3.15 each.

AY3-8910 PROGRAMMABLE SOUND GENERATOR

The AY3-8910 is a 40 pin LSI chip with three oscillators, three amplitude controls, programmable noise generator, three mixers, an envelope generator, and three D/A converters that are controlled by 8 BIT WORDS. No external pots or caps required. This chip hooked to an 8 bit microprocessor chip or Bus (8080, Z80, 6800 etc.) can be software controlled to produce almost any sound. It will play three note chords, make bangs, whistles, sirens, gunshots, explosions, bleets, whines, or grunts. In addition, it has provisions to control its own memory chips with two IO ports. The chip requires +5V @ 75ma and a standard TTL clock oscillator. A truly incredible circuit.

\$12.95 W/Basic Spec Sheet (4 pages)

60 page manual with S-100 interface instructions and several programming examples, \$3.00 extra

MANY OTHER COMPONENTS AND KITS AVAILABLE IN OUR COMPLETE CATALOG. CALL OR WRITE FOR FREE CATALOG.

New! Doomsday Alarm

If you have trouble sleeping and you would like the rest of the neighborhood to share your misery then this little kit will be for you! There is no way to accurately describe the unearthly howls, screams and tones that come out of this kit. Four separate tone oscillators are mixed, cancelled and stepped at a varying rate. 10 Watts of crazy sounds. A great fun kit or a practical burglar alarm. Complete with PC board and all necessary components less speaker. For 6-12 VDC.

9.95
KIT

ORDER DA-01

7 Watt Audio Amp Kit \$5.95

SMALL, SINGLE HYBRID IC AND COMPONENTS FIT ON A 2" x 3" PC BOARD (INCLUDED). RUNS ON 12VDC. GREAT FOR ANY PROJECT THAT NEEDS AN INEXPENSIVE AMP. LESS THAN 3% THD @ 5 WATTS. COMPATIBLE WITH SE-01 SOUND KIT.

Overvoltage Protection Kit \$6.95

Protect your expensive equipment from overvoltage conditions. Every computer should have one! Works with any fused DC power source from 10 to 20 volts up to 25 amps.

Super Value Power Transformer

Well made, open frame transformer with mounting ears. Build a +5 and +12 supply with inexpensive parts. Free schematics of several designs. Primary 117VAC. SEC #1 15VAC @ .5A SEC #2 15 VAC @ .5A SEC #3 8VAC @ 2.5A.

ORDER:
BET-0005
\$2.95 Each

- NO C.O.D.'S
 - SEND CHECK M.O. OR CHARGE CARD NO.
 - PHONE ORDERS ACCEPTED ON VISA AND MASTERCARD ONLY.
 - ADD 5% FOR SHIPPING
 - TX. RES. ADD 5% STATE SALES TAX
 - ALL FOREIGN ORDERS ADD 30% FOR SHIPPING CHARGES. U.S. FUNDS ONLY.
- (214) 278-3553

The Greatest Breakthrough In Electronic Music Ever!

The Super Music Maker
REVISION 2
\$24.95
(Basic Kit)

Does not include speaker switches or 2708 ROM.



Now you can play hundreds of songs using the Bullet Super Music Maker. The unit features a single factory programmed microprocessor IC that comes with 20 pre-programmed short tunes. By adding the additional PROMS (2708's) the system can be expanded to play up to 1000 notes per PROM. Just think... a compact electronic instrument that will play dozens, hundreds or even thousands of selections of music. The kit comes with all electronic components (less the PROM), and a drilled, plated and screened PC Board which measures 4" x 4 1/2". The 7 watt amplifier section is on the same PC board and drives an 8 ohm speaker (not included), from a whisper to ear splitting volume. Since the unit works on 12 VDC or 12 VAC, vehicle or portable operation is possible. What do you get for \$24.95? Everything but a speaker, transformer, case, switches, and PROM. Additional 2708 albums containing popular tunes are available for \$15.00 each or you can program your own PROMS using information provided with the kit instructions. Lists of available PROM albums are available on request. (Note: Unit plays electronic music one note at a time, it is not possible to play chords or a melody with harmony simultaneously.)

- * Envelope control gives decay to notes.
- * "Next tune" feature allows sequential playing of all songs.
- * On board inverter allows single voltage (+12) operation.

OPTIONAL ACCESSORIES

DIP Switches One 8 pos., One 5 pos. (Can be directly soldered to PC Bd. to access tunes)	2.00/Set
Rotary Switches Two 5 position (For remote wiring to PC Bd. to access tunes)	2.50/Set
Attractive Plastic Case	6.50
Wallplug Transformer (For operation on 117VAC house voltage)	3.00

HICKOK DIGITAL MULTIMETERS

DMM + Vari-Pitch + Logi-Trax MX-333 Model LX303 \$210.
Model LX304 \$79.50

VIZ Tech DMM 3 1/2-Digit LCD Readout Model WD 747 \$79.95

Beckman DIGITAL MULTIMETERS

Model TECH 300 \$109.95
Model TECH 310 \$140.00
Model TECH 330 \$199.95

Simpson DIGITAL MULTIMETERS

Model 462 \$199.95
Model 463 \$169.95
260 Meter Model 260-7 \$96.
Complete with nickel-cadmium batteries, AC charger/adaptor, test leads

LUXO Magnifier Lamp

Precision ground and polished magnification lens Model LFM-1A \$65.

Casio Calculator-Calendar Watch

Model C-80 \$42.50

BK PRECISION 15 MHz Miniscope

- Rise time 11.7 nS or less
- Built-in signal delay line
- Flat response

Dual Trace 5" 30 MHz Triggered Scope Model 1479A
Autorangeing DMM Model 2845

Digital Pulsar Probe Model DP-100

50 MHz Pulsar Probe Model DP-50

BSR X-10 Remote Control for Lights & Appliances

PK 400 4 Pc Standard Starter Kit • One (1) Standard Command Console • Two Lamp Modules • One (1) Appliance Module \$74.99
PK500 5 Pc Ultrasonic Starter Kit • One (1) Deluxe Ultrasonic Command Console • One (1) Hand Held Remote Unit • Two (2) Lamp Modules • One (1) Appliance Unit \$99.95
LM501 Lamp Module \$13.95
AM501 Appliance Module \$13.95
WS701 Wall Switch Module \$13.95
WS711 Wall Switch Module with independent On-Off power buttons \$15.95

The Timer \$59.95

Model TC201

FIDELITY Sensory Chess Challenger \$110.

Chess Challenger 7 \$79.95 Model BBC
Voice Sensory Chess Challenger \$249.95

WAHL Cordless Soldering Iron \$29.95

Model 7800
Thermal-Spot Circuit Tester Finds faulty components quickly and easily Model 8000 \$29.95

CSC 3 1/2-Digit 0.1% Digital Capacitance Meter

Model 3001 \$233.75

Function Generator Model 2001 \$157.95

Proto Boards Model PB-104 Fully assembled \$59.95
Logic Monitor Model LM-1 HTL, TTL, and CMOS \$59.95

Touch/Test 20 Multimeter

Model TT20 A portable/bench-type meter
15 MHz Dual Trace Triggered Miniscope Model MS-215
30 MHz Dual Trace Triggered Miniscope Model MS-230

YOU NAME IT...WE GOT IT.
AND AT DISCOUNT PRICES.

SEND FOR FREE 180 PAGE CATALOG.

Miniature High Fidelity 3-Way Stereo Speakers \$59.95

Model HF-9

MURAPHONE Cordless Telephone System \$110.

Model 300

Soldering Station Model EC 2000 \$109.50

Model EC 2000

VACO Super Case Model 70260 \$249.95

Model 99-SM

In-Dash Car Stereos

8-Track AM/FM \$52.50 Model JCS 420
Cassette AM/FM \$57.50 Model JCS 505
Digital Cassette AM/FM \$89.95 with Clock Model JCS 607
Graphic Equalizer Model GE 5000 \$39.95

6x9 3-Way \$12.95 ea. Speakers • 20 oz. magnet Model BP2000-69 TRD

FORDHAM

855 Conklin St. Farmingdale, N.Y. 11735
• Master Charge
• BankAmericard
• VISA • C.O.D.
• Money Order
• Check
N.Y. State residents add appropriate sales tax
C.O.D.'s extra

ADD FOR SHIPPING AND INSURANCE	
to \$ 250.00	\$ 3.50
\$251.00 to 500.00	5.00
\$501.00 to 750.00	7.50
\$751.00 to 1000.00	10.00
over 1000.00	12.50

TOLL FREE (800) 645-9518
in N.Y. State call (516) 752-0050

DIGI-KEY CORPORATION

In Mn., Ak., Hi. Call 218-681-6674

Capacitors • Real Time Clock/Calendar • P.F. Johnson • Terminal Strips • T.I. Connectors • Wire Wrapping Supplies • CMOS Rectifiers • Power Sams Books • Diamond Tools • Panavice
 AP Products • Batteries • ZNR's • Books • Zener Diodes • Breadboards • Wire Buzzers • Vices • Templates • Diodes • Switches • Drafting Aids • Soldering Supplies • Edge Connectors • IC Socket
 Enclosures • Resistors • Resistor Networks • Hardware • Power Supplies • Hobby Kits • Photo Plugs & Jacks • Integrated Circuits • Optoelectronics • Audio Multimeters • LED's • Sams Books
 Microprocessors & Support Chips • Clocks • Resistor Clocks • Lithium Batteries • Resistor Clocks • Lithium Batteries • Resistor Clocks • Lithium Batteries • Resistor Clocks • Lithium Batteries

VISA

INTEGRATED CIRCUITS

Part No.	Manufacturer	Part No.	Manufacturer
7400N	TI	7400N	TI
7401N	TI	7401N	TI
7402N	TI	7402N	TI
7403N	TI	7403N	TI
7404N	TI	7404N	TI
7405N	TI	7405N	TI
7406N	TI	7406N	TI
7407N	TI	7407N	TI
7408N	TI	7408N	TI
7409N	TI	7409N	TI
7410N	TI	7410N	TI
7411N	TI	7411N	TI
7412N	TI	7412N	TI
7413N	TI	7413N	TI
7414N	TI	7414N	TI
7415N	TI	7415N	TI
7416N	TI	7416N	TI
7417N	TI	7417N	TI
7418N	TI	7418N	TI
7419N	TI	7419N	TI
7420N	TI	7420N	TI
7421N	TI	7421N	TI
7422N	TI	7422N	TI
7423N	TI	7423N	TI
7424N	TI	7424N	TI
7425N	TI	7425N	TI
7426N	TI	7426N	TI
7427N	TI	7427N	TI
7428N	TI	7428N	TI
7429N	TI	7429N	TI
7430N	TI	7430N	TI
7431N	TI	7431N	TI
7432N	TI	7432N	TI
7433N	TI	7433N	TI
7434N	TI	7434N	TI
7435N	TI	7435N	TI
7436N	TI	7436N	TI
7437N	TI	7437N	TI
7438N	TI	7438N	TI
7439N	TI	7439N	TI
7440N	TI	7440N	TI
7441N	TI	7441N	TI
7442N	TI	7442N	TI
7443N	TI	7443N	TI
7444N	TI	7444N	TI
7445N	TI	7445N	TI
7446N	TI	7446N	TI
7447N	TI	7447N	TI
7448N	TI	7448N	TI
7449N	TI	7449N	TI
7450N	TI	7450N	TI
7451N	TI	7451N	TI
7452N	TI	7452N	TI
7453N	TI	7453N	TI
7454N	TI	7454N	TI
7455N	TI	7455N	TI
7456N	TI	7456N	TI
7457N	TI	7457N	TI
7458N	TI	7458N	TI
7459N	TI	7459N	TI
7460N	TI	7460N	TI
7461N	TI	7461N	TI
7462N	TI	7462N	TI
7463N	TI	7463N	TI
7464N	TI	7464N	TI
7465N	TI	7465N	TI
7466N	TI	7466N	TI
7467N	TI	7467N	TI
7468N	TI	7468N	TI
7469N	TI	7469N	TI
7470N	TI	7470N	TI
7471N	TI	7471N	TI
7472N	TI	7472N	TI
7473N	TI	7473N	TI
7474N	TI	7474N	TI
7475N	TI	7475N	TI
7476N	TI	7476N	TI
7477N	TI	7477N	TI
7478N	TI	7478N	TI
7479N	TI	7479N	TI
7480N	TI	7480N	TI
7481N	TI	7481N	TI
7482N	TI	7482N	TI
7483N	TI	7483N	TI
7484N	TI	7484N	TI
7485N	TI	7485N	TI
7486N	TI	7486N	TI
7487N	TI	7487N	TI
7488N	TI	7488N	TI
7489N	TI	7489N	TI
7490N	TI	7490N	TI
7491N	TI	7491N	TI
7492N	TI	7492N	TI
7493N	TI	7493N	TI
7494N	TI	7494N	TI
7495N	TI	7495N	TI
7496N	TI	7496N	TI
7497N	TI	7497N	TI
7498N	TI	7498N	TI
7499N	TI	7499N	TI
7500N	TI	7500N	TI

TEST INSTRUMENTS

I.C. SOCKETS



Diagram of an I.C. socket showing pin connections and dimensions.

HOBBY-BLOX

NEW MA 1032 Clock

PANASONIC ELECTROLYTIC CAPACITORS

PANASONIC POLYESTER CAPACITORS

NEW KIT

140 CAPACITORS

130 CAPACITORS

120 COMPONENTS

110 COMPONENTS

100 COMPONENTS

90 COMPONENTS

80 COMPONENTS

70 COMPONENTS

60 COMPONENTS

50 COMPONENTS

40 COMPONENTS

30 COMPONENTS

20 COMPONENTS

10 COMPONENTS

5 COMPONENTS

1 COMPONENT

0 COMPONENTS

NO COMPONENTS

NO PARTS

NO KIT

NO KIT

NO KIT

NO KIT

NO KIT

NO KIT

NO KIT

NO KIT

NO KIT

NO KIT

NO KIT

NO KIT

NO KIT

NO KIT

NO KIT

NO KIT

NO KIT

NO KIT

NO KIT

NO KIT

NO KIT

NO KIT

NO KIT

NO KIT

NO KIT

NO KIT

NO KIT

NO KIT

NO KIT

NO KIT

NO KIT

NO KIT

NO KIT

NO KIT

NO KIT

NO KIT

NO KIT

NO KIT

NO KIT

NO KIT

NO KIT

NO KIT

NO KIT

NO KIT

NO KIT

NO KIT

NO KIT

NO KIT

NO KIT

NO KIT

NO KIT

NO KIT

NO KIT

NO KIT

HOBBY-BLOX

NEW MA 1032 Clock

PANASONIC ELECTROLYTIC CAPACITORS

PANASONIC POLYESTER CAPACITORS

NEW KIT

140 CAPACITORS

130 CAPACITORS

120 COMPONENTS

110 COMPONENTS

100 COMPONENTS

90 COMPONENTS

80 COMPONENTS

70 COMPONENTS

60 COMPONENTS

50 COMPONENTS

40 COMPONENTS

30 COMPONENTS

20 COMPONENTS

10 COMPONENTS

5 COMPONENTS

1 COMPONENT

NO COMPONENTS

NO PARTS

NO KIT

NO KIT

NO KIT

NO KIT

NO KIT

NO KIT

NO KIT

NO KIT

NO KIT

NO KIT

NO KIT

NO KIT

NO KIT

NO KIT

NO KIT

NO KIT

NO KIT

NO KIT

NO KIT

NO KIT

NO KIT

NO KIT

NO KIT

NO KIT

NO KIT

NO KIT

NO KIT

NO KIT

NO KIT

NO KIT

NO KIT

NO KIT

NO KIT

NO KIT

NO KIT

NO KIT

NO KIT

NO KIT

NO KIT

NO KIT

NO KIT

NO KIT

NO KIT

NO KIT

NO KIT

NO KIT

NO KIT

NO KIT

NO KIT

NO KIT

NO KIT

NO KIT

NO KIT

NO KIT

NO KIT

NO KIT

NO KIT

NO KIT

NO KIT

NO KIT

NO KIT

NO KIT

NO KIT

HOBBY-BLOX

NEW MA 1032 Clock

PANASONIC ELECTROLYTIC CAPACITORS

PANASONIC POLYESTER CAPACITORS

NEW KIT

140 CAPACITORS

130 CAPACITORS

120 COMPONENTS

110 COMPONENTS

100 COMPONENTS

90 COMPONENTS

80 COMPONENTS

70 COMPONENTS

60 COMPONENTS

50 COMPONENTS

40 COMPONENTS

CPU's & SUPPORT CHIPS table listing various microprocessors and their prices.

RAM's table listing different types of random access memory and their prices.

C/MOS table listing CMOS integrated circuits and their prices.

UART's table listing universal asynchronous receiver/transmitters and their prices.

ROM's table listing read-only memory chips and their prices.

TRANSISTOR SPECIALS table listing various transistor types and their prices.

INTERFACE & DRIVERS table listing interface and driver chips and their prices.

SPECIALS table listing various electronic components and their prices.

TTL IC's table listing TTL integrated circuits and their prices.

SOLID STATE SALES SAVES text describing the benefits of solid state components.

20% Discount 340T and 320T regulators text.

Full Wave Bridge table listing bridge rectifiers and their prices.

PRINTED CIRCUIT BOARD text describing PCB specifications.

CRYSTALS \$3.45 ea. text listing crystal prices.

DIP SOCKETS table listing DIP socket prices.

EPOXY GLASS VECTOR BOARD text describing board specifications.

MINIATURE MULTI-TURN TRIM POTS text listing trim pot prices.

74LS SERIES table listing 74LS series integrated circuits.

DAT'L'S DAC-08EG table listing DAC chips.

SCR's table listing silicon controlled rectifiers.

TRIAC's table listing triacs.

7 WATT LD 65 LASER DIODE IR \$8.95 text.

FP PHOTO TRANS table listing photo transistors.

74LS SERIES table listing 74LS series integrated circuits.

25 watt Infra Red Pulse ISG 2006 equiv. Laser Diode text.

REG. YELLOW, GREEN or AMBER LARGE LED'S table listing LEDs.

74LS SERIES table listing 74LS series integrated circuits.

CLOCK CHIPS table listing clock chips.

FAST RECOVERY DIODE (35ns) 20KV 250MA DIODE text.

74LS SERIES table listing 74LS series integrated circuits.

TANTALUM CAPACITORS table listing tantalum capacitors.

SILICON POWER RECTIFIERS table listing power rectifiers.

74LS SERIES table listing 74LS series integrated circuits.

SANKEN AUDIO POWER AMPS table listing audio power amplifiers.

IN 4148 (IN914) 15/\$1.00 .5V at 800mA SOLAR CELLS text.

LINEAR CIRCUITS table listing linear integrated circuits.

RS232 CONNECTORS table listing RS232 connectors.

7 SEGMENT DISPLAYS table listing 7 segment displays.

REGULATORS table listing voltage regulators.

POSTAGE ADD 5% FOR ORDERS UNDER \$20.00 text.

TERMS: FOB CAMBRIDGE, MASS. SEND CHECK OR MONEY ORDER text.

SEND \$25 FOR OUR CATALOG FEATURING TRANSISTORS text.

SOLID STATE SALES advertisement with contact information and shipping details.

ETCO advertisement for cable TV converters, tuners, and other electronic components.

SURPLUS ELECTRONICS CORP.

7294 N.W. 54th Street
Miami, Florida 33166

WHOLESALE/RETAIL

Phone: (305) 887-8228
TWX: 810-848-6085
We accept MasterCard and Visa.

EQUIPMENT/COMPONENTS/WIRE & CABLE/ACCESSORIES

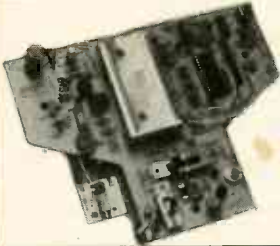

"TANK BATTLE" TV GAME

In just a short time and with a few minor parts, the most novice hobbyist can complete this exciting Tank Battle game. Create a fun-filled evening for the whole family. Two independent tanks rumble thru land mine fields, shoot shells and fragment when hit. Four distinct engine sounds are produced for the different speeds. Sounds of gunfire, shell bursts and tank explosions are realistic. Automatic on-screen scoring. Supplied with schematic drawing.

SOLD AS IS
\$9.95 ea.

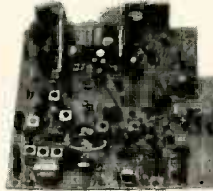

C.B. SPECIAL

CONVERT THESE TO 10 METER FM

New printed circuit board assembly. (Squelch pot, volume control and channel switch not included.) Boards sold as is, the way we bought them from the manufacturer. Board dimensions 6" x 6 1/2"

1-9 **\$7.50** 50-99 **\$6.00**
10-49 **\$6.50** 100-UP **\$5.50**

COPPER CLAD BOARD

(Double Side)
Size 9.25 x 10.75
Thickness .062
\$2.00 ea.

PANEL METERS

25-0-25 VDC, 2 1/4" x 3"
0-25 VDC, 2 1/4" x 2 1/4"
0-25 VAC, 2 1/4" x 2 1/4"
(Shunt required)
\$4.00 ea. 2/\$7.00

E. F. JOHNSON S METER



Edge Meter 250 UA,
fits in 3/8" x 1 3/8" hole.
Black background.
Scale 1-20 Top,
0-5 Bottom.

\$1.25 ea. 5/\$5.00

E.F. JOHNSON SIGNAL STRENGTH METER

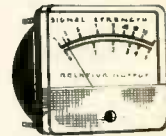

200 UA, 2 1/2" x 2 1/2" Sq.
Scale: 1-30 db top (orange),
0-50 bottom (black)

\$4.95 ea.

DIP SWITCH

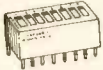

7 POSITION **\$1.30 ea.**
8 POSITION **\$1.50 ea.**
12 POSITION **\$2.00 ea.**

TRIMMER CAP



1.5-20pF (ARCO PC-402)
50¢ ea.

AMP METERS

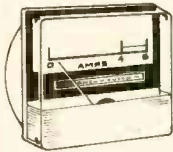

2 1/4" square, no shunt required.
Easy to read dial.
Movement: 0-6, 0-10, 0-17
\$2.50 ea.

SUB-MINI 10K POT

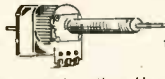

with On-Off
1/4" hole mount,
1/8" D shaft,
3/4" thread section. Hardware included.
4/\$1.00

COAX CONNECTORS

UG-273/U BNC-F/UHF-M **\$2.50**
UG-255/U BNC-M/UHF-F **\$3.00**
UG-146 A/U N-M/UHF-F **\$4.50**
UG-83B/U N-F/UHF-M **\$4.50**
UG-175 RG-58 Adapt **\$.20**
UG-176 RG-59 Adapt **\$.20**
UG-1094 BNC-F/Panel **\$1.00**

USED MUFFIN FANS

3-Blades,
110v AC,
4 1/4" square.



\$5.95 ea.

ASTATIC T-UG8-D104 MICROPHONE

Pre-amp desk-top microphone with crystal element 3-pin plug.

\$35.00 ea.

S0239.60

PL259.60

500 OHM COAX
Low loss = RG 174

\$4.95/100' \$3.00/50'

NEW SPRITE FAN

Mfg. by Rotron Inc.,
Model SU2A5. 115v AC. 19 amps.
(Impedance protected.)
3 1/4" x 3 1/4" x 1 1/4"

\$12.00 ea.

SPEAKER

3" Diam.,
8 OHM,
5 Watts.



\$2.00 ea.

SPEAKER



Weather- & water-proof
(can be used underwater),
mfg. by University Sound,
16 OHM, 25 Watt,
350-10,000 HZ.
6" diam. x 5" deep.

\$25.00 ea.

IC SOCKETS GOLD-PLATED WIRE WRAP

14 pin **40¢ ea.**
16 pin **45¢ ea.**
24 pin **75¢ ea.**
40 pin **\$1.75 ea.**



9 VOLT NiCd RECHARGEABLE BATTERY

NEW. Replaces
the popular 9V
Transistor Battery.



\$4.75 ea.

COMPUTER GRADE ELECTROLYTICS

VALUE/MFD	VOLTS	DIAM./LGTH.	PRICE
63,000	@ 15V	3" x 5 1/2"	\$4.00 ea.
10,000	@ 20V	1 1/2" x 5 3/4"	\$3.00 ea.
2,700	@ 25V	1 1/4" x 2 1/4"	\$2.00 ea.
2,900	@ 25V	1 1/4" x 2"	\$2.00 ea.
3,000	@ 25V	1 1/2" x 4 1/2"	\$2.00 ea.
34,800	@ 50V	3" x 5 1/2"	\$3.00 ea.
450	@ 75V	1 1/4" x 2 1/4"	\$2.00 ea.
500	@ 100V	1 1/2" x 3 1/4"	\$2.00 ea.
240	@ 300V	1 1/4" x 3 1/4"	\$2.00 ea.
50	@ 450V	1 1/4" x 2"	\$2.00 ea.

AXIAL LEAD ELECTROLYTIC CAPACITORS

2 uF @ 15V	12/\$1.00
10 uF @ 15V	12/\$1.00
20 uF @ 15V	12/\$1.00
50 uF @ 15V	12/\$1.00
2.2 uF @ 25V	12/\$1.00
3.3 uF @ 25V	12/\$1.00
1 uF @ 35V	12/\$1.00
2 uF @ 150V	12/\$1.00
25 uF @ 25V	15/\$2.00
3 uF @ 50V	15/\$2.00
5 uF @ 50V	15/\$2.00
10 uF @ 50V	15/\$2.00
250 uF @ 25V	10/\$2.00
100 uF @ 50V	10/\$2.00
50 uF @ 75V	10/\$2.00

C & K SWITCHES

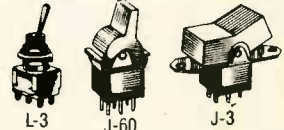

Part #	Movement
J-60 7101	SPDT
J-60 7103	SPDT (center off)
L-3 7108	SPDT (momentary)
J-3 7201	DPDT (special large rocker)

\$1.00 ea. 6/\$5.00

TERMS: All material guaranteed unless otherwise stated. If you are not satisfied with our product, it may be returned within 10 days for a refund (less shipping). Please add \$4.00 for shipping and handling on all orders. COD's accepted for orders totaling \$50 or more. All orders shipped UPS unless otherwise specified. Florida residents please add 4% sales tax. Minimum order, \$15.00. Foreign orders - US funds only, add 20% for shipping and handling.

contact east



Economy V-O-M

- AC/DC—0-10,50,250
- DC Current —0-2.5, 5,25, 250mA
- Measures 1Ω to 500KΩ
- Accuracy—± 3% DC, ± 4% AC
- Comes with Battery, Test Leads, and Manual

VIZ WV-516B \$25.00

TRIPLETT

Miniature V-O-M

- 20,000Ω/V DC Sensitivity
- 5,000Ω/V AC Sensitivity
- 0-20,000-200,000—2MΩ-20MΩ
- ± 3% DC, ± 4% AC Accuracy
- Comes with Battery, Test Leads, and Manual

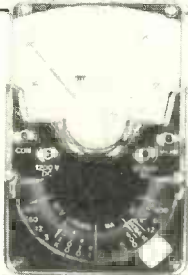

310 \$70.00

FLUKE

“Analyst”

- 26 Ranges / 7 Functions
- Accurate to ± 1%
- Auto Zero / Auto Polarity
- Checks Leakage to 10MΩ
- Comes with Case

8020A \$189.00



Touch/Test 20 Multi-meter

20 Functions ● 44 Ranges. Measures

- AC and DC Voltage and Current
- Resistance
- Capacitance
- Temperature
- Conductance
- Performs Diode/Transistor and Continuity Tests

TT-20

\$435.00



Portable Oscilloscopes

Three Models

- MS-15/15MHz Single Trace Triggered Scope \$389.00
- MS-215/15MHz Dual Trace Triggered Scope 497.00
- MS-230/30MHz Dual Trace Triggered Scope 649.00



Contact East Catalog

- Over 10,000 Products
- Hard-To-Find Tools
- Fully Illustrated
- 160 Pages — Complete Pricing Catalog

\$2.00

Call Toll Free 800-225-5370

In Mass: (617) 272-5051

VISA • MasterCard

Immediate Delivery • We Pay Shipping

Contact East, Dept. 0064

P.O. Box 160, 7 Cypress Drive
Burlington, MA 01803

ADVERTISING INDEX

RADIO-ELECTRONICS does not assume any responsibility for errors that may appear in the index below.

Free Information Number Page

16	AMC Sales	98
—	ATV Research	84
29	Active Electronics	81
—	Advance Electronics	2
3	Advanced Micro Computer Products	86-87
39	Albia Electronics	79
42	All Electronics	94
37	American Antenna	Back Cover
41	Ancrona Electronics	97
28	Arkon Electronics	92
47	B & K Precision	67
—	Karel Barta	88
—	Bullet Electronics	100
30	CFR, Associates	96
—	CIE, Cleveland Institute of Engineering	26-29
49	Cambridge Learning	20
—	Cascade Labs	89
18	Chaney Electronics	98
13	Channelock Inc.	18
—	Command Productions	84
51	Communications Electronics	77
40	Concord Electronics	88-89
14	Contact East	104
—	Cook's Institute	84
22	Creative Computing	72
—	Dage Scientific	84
8	Digi—Key Corporation	101
—	Edu Cai Publications	70
—	Electronic Technology Today	16
31	Etco Electronics	84,102
—	Fanon	88
46	Fluke	7
—	Fordham	100
4	Formula International	90-91
—	Future Tec	19
32	Global Specialties	30
—	Global TV Electronics	80
38	Godbout	98
—	Grantham School of Engineering	77
52	Hal—Tronix	92
43	Hanley Engineering	99
10,11	Heath	23,65
—	Information Unlimited	84
44	International Electronics Unltd.	94
45	JDR, MicroDevices Inc.	95
2	Jameco Electronics	82-83
19	Jan Crystals	68

53	MCM, Audio	98
33	MTI	71
—	McGee Radio	88
—	McKay Dymek	104
15	Meshna Inc.	96
—	Micro Management Systems Inc.	94
—	Micro-tenna Associates	84
23	Mountain West	74
—	NRI, Schools	8-11
—	NTS, Schools	52-55
—	Netronics	24
9	Ohio Scientific	1
34	Omega Sales	13
54	Optoelectronics	Cover 3
17	Pacom	74
20	Paia Electronics	68
—	Philips ECG, Inc.	15
21,26	Poly Paks	71,96
48	RCA	17,21
56	Radio Shack	93
6	Ramsey Electronics	85
—	Sabtronic	25
—	Satellite Computer Services	80
—	Simple Simon	89
35	Solid State Sales	102
—	Spacecoast	80
55	Surplus Electronics	103
57	Symmetric Sound Systems	70
36	Trio-Kenwood	22
24,25	Triplett	Cover 2
7	Vaco	5
—	Wersi	72

NEED A COMPACT ANTENNA?

McKAY SETS THE STANDARD

with the DA100D
Full frequency reception of 50kHz-30MHz

For specs and details contact dealers:

- HARVEY RADIO New York City
- HENRY RADIO Los Angeles CA
- BARRY ELECTRONICS New York City
- GILFER ASSOCIATES Park Ridge New Jersey
- ELECTRONIC EQUIPMENT BANK (D.C. area) Vienna VA
- BRIDGEWATER CUSTOM SOUND Haverhill IL
- AUDIO PERFECTION Bloomington MINN
- STANDARD SUPPLY CO. Salt Lake City Utah
- THE BASE STATION Concord CA
- J-WAR ELECTRONICS Toronto Canada



McKAY DYMEK COMPANY
111 S. College Ave., P.O. Box 5000
Claremont CA 91711 U.S.A.

800/854-7769 Local 714/621-6711
except CA, Alaska, Hawaii TWX 910-581-4990



A LIFETIME GUARANTEE AND 11 OTHER REASONS TO BUY AN "OPTOELECTRONICS" FREQUENCY COUNTER

1. SENSITIVITY: Superb amplifier circuitry with performance that can't be matched at twice the price. Average sensitivity of better than 15 mV from 10 Hz to 500 MHz on every model and better than 30 mV from 500 MHz to 1.1 GHz on the Series 8010A and 8013.

2. RESOLUTION: 0.1 Hz to 12 MHz, 1 Hz to 50 MHz, 10 Hz over 50 MHz.

3. ALL METAL CASES: Not only are the heavy gauge aluminum cases rugged and attractive, they provide the RF shielding and minimize RFI so necessary in many user environments.

4. EXTERNAL CLOCK INPUT/OUTPUT: Standard on the 8010/8013 series and optional on the 7010 series is a buffered 10 MHz clock time base input/output port on the rear panel. Numerous uses include phase comparison of counter time base with WWVB (U.S. National Bureau of Standards). Standardize calibration of all counters at a facility with a common 10 MHz external clock signal, calibrate scopes and other test equipment with the output from precision time base in counter, etc., etc.

5. ACCURACY: A choice of precision to ultra precision time base oscillators. Our ± 1 PPM TCXO (temperature compensated xtal oscillator) and ± 0.1 PPM TCXO are sealed units tested over 20-40°C. They contain voltage regulation circuitry for immunity to power variations in main instrument power supply, a 10 turn (50 PPM) calibration adjustment for easy, accurate setability and a heavily buffered output prevents circuit loads from affecting oscillator. Available in the 8010 and 8013 series is our new ultra precision micro power proportional oven oscillator. With $\pm .05$ PPM typical stability over 10-45°C, this new time base incorporates all of the advantages of our TCXO's and virtually none of the disadvantages of the traditional ovenized oscillator. Requires less than 4 minutes warm-up time, small physical size and has a peak current drain of less than 100 ma.

6. RAPID DISPLAY UPDATE: Internal housekeeping functions require only .2 seconds between any gate or sample time

period. At a 1 second gate time the counter will display a new count every 1.2 seconds, on a 10 second gate time a new count is displayed every 10.2 seconds. (10.2 seconds is the maximum time required between display updates for any resolution on any model listed).

7. PORTABILITY: All models are delivered with a 115 VAC adapter, a 12 VDC cord with plug and may be equipped with an optional ni-cad rechargeable battery pack installed within its case. The optional Ni-Cad pack may be recharged with 12 VDC or the AC adapter provided.

8. COMPACT SIZES: State-of-the-Art circuitry and external AC adapters allowed design of compact easy to use and transport instruments.

Series 8010/8013: 3" H x 7-1/2" W x 6-1/2" D

Series 7010: 1-3/4" H x 4-1/4" W x 5-1/4" D

9. MADE IN U.S.A.: All models are designed and manufactured at our modern 13,000 square foot facility at Ft. Lauderdale, Florida.

10. CERTIFIED CALIBRATION: All models meet FCC specs for frequency measurement and provided with each model is a certificate of NBS traceable calibration.

11. LIFE TIME GUARANTEE: Using the latest State-of-the-Art LSI circuitry, parts count is kept to a minimum and internal case temperature is only a few degrees above ambient resulting in long component life and reliable operation. (No custom IC's are used.) To demonstrate our confidence in these designs, all parts (excluding batteries) and service labor are 100% guaranteed for life to the original purchaser. (Transportation expense not covered).

12. PRICE: Whether you choose a series 7010 600 MHz counter or a series 8013 1.3 GHz instrument it will compete at twice its price for comparable quality and performance.

MODEL 8010A/8013 1.1 GHz/1.3 GHz

MODEL 7010A 600 MHz



MODEL	RANGE (From 10 Hz)	10 MHz TIME BASE			AVG. SENSITIVITY		GATE TIMES	RESOLUTION			EXT. CLOCK INPUT/OUTPUT	SENSITIVITY CONTROL	NI-CAD BATTERY PACK
		STABILITY	AGING	DESIGN	10 Hz to 500 MHz	500 MHz to 1.1 GHz		12 MHz	60 MHz	Max. Freq.			
7010A	600 MHz	± 1 PPM	<1 PPM/YR	TCXO*	15 mV	N/A	.01, .1, 1, 10 sec.	1 Hz	10 Hz	YES OPTIONAL	NO	YES OPTIONAL	
7010.1A		± 0.1 PPM											
8010A	1.1 GHz	± 1 PPM	<1 PPM/YR	TCXO*	15 mV	30 mV	.01, .1, 1, 10 sec.	1 Hz	1 Hz	YES STANDARD	YES	YES OPTIONAL	
8010.1A		± 0.1 PPM											
8010.05A		$\pm .05$ PPM											
8010.05A		OCXO**											
8013.1	1.3 GHz	± 0.1 PPM	<1 PPM/YR	TCXO*	15 mV	30 mV	.01, .1, 1, 10 sec.	1 Hz	1 Hz	YES STANDARD	YES	YES OPTIONAL	
8013.05		$\pm .05$ PPM											

TCXO = Temperature Compensated Xtal Oscillator

**OCXO = Proportional Oven Controlled Xtal Oscillator

SERIES 7010A

#7010A	600 MHz Counter - 1 PPM TCXO	\$199.95
#7010.1A	600 MHz Counter - 0.1 PPM TCXO	\$249.95
OPTIONS:		
#70-H	Handle/Tilt Bail (not shown)	\$2.95
#Ni-Cad-701	Ni-Cad Battery Pack & Charging Circuitry Installed Inside Unit	\$19.95
#EC-70	External Clock Input/Output	\$35.00
#CC-70	Carry Case - Padded Black Vinyl	\$9.95

SERIES 8010A/8013

#8010A	1.1 GHz Counter - 1 PPM TCXO	\$399.00
#8010.1A	1.1 GHz Counter - 0.1 PPM TCXO	\$450.00
#8010.05A	1.3 GHz Counter - .05 PPM Oven	\$499.00
#8013.1	1.3 GHz Counter - 0.1 PPM TCXO	\$550.00
#8013.05	1.3 GHz Counter - .05 PPM Oven	\$599.00
OPTIONS		
#Ni-Cad-801	Ni-Cad Battery Pack & Charging Circuitry Installed Inside Unit	\$49.95
#CC-80	Carry Case - Padded Black Vinyl	\$ 9.95

ACCESSORIES

#TA-100	Telescope antenna with right angle BNC	\$ 9.95
#P-100	Probe 50 Ohm, 1X	\$13.95
#P-101	Probe, LC-Pass	\$16.95
#P-102	Probe Hi Z	\$16.95
#LFM-1110	General Purpose Low Frequency Multiplier X 10, X 100, X 1000	\$119.95
	For High Resolution of Audio Freq.	



Optoelectronics inc

5821 N.E. 14th Avenue, Fort Lauderdale, Florida 33334

1-800-327-5912

FROM FLORIDA (305) 771-2051/2

TERMS: Orders to U.S. and Canada, add 5% for shipping, handling and insurance to a maximum of \$10.00. All other orders add 15%. C.O.D. collection fee \$2.00. Florida orders add 4% state tax. Personal checks must clear before goods are shipped.

CIRCLE 54 ON FREE INFORMATION CARD

In one year our **K40** antenna has become the largest selling CB antenna in the world!

1. It's more expensive ...

2. It's made better...

3. It's proven best!

\$42.50

suggested retail

And when you pay more, you expect more!

MORE PERFORMANCE:

The K40 is guaranteed to transmit further or receive clearer than any antenna it replaces. We know it will. We've tested it with 771 CB'ers just like you for one year.

MORE FLEXIBILITY:

You can fit your K40 to any mounting surface. It will fit any vehicle you'll ever own! That includes choppers, dune buggies, gutters, mirror mounts, luggage racks, trunks, hatchbacks, through roofs, semis, pick ups and RV's.

MORE QUALITY:

It's not imported. It's not made in Taiwan, Korea or Japan. It's American made in an American town. It's made with better materials that cost more and by professional people we pay more. And we designed it right here in the U.S.A.

*Including optional mounts at extra cost.

... This Antenna is so DYNAMITE you receive a ...

DOUBLE GUARANTEE

GUARANTEE I: The K-40 will transmit farther and receive more clearly than the antenna it replaces or the custom or will receive a prompt and full refund from the Registered K-40 Dealer who installed and tuned it.

GUARANTEE II: Unconditionally guaranteed for 12 months. Guaranteed against cracking, chipping, or rusting. Guaranteed against mechanical failure. Guaranteed against electrical failure. Guaranteed against accidental breakage. No exclusions. No gimmicks. For a full 12 months.



...Here's what the leading CB publications said.

CB TIMES: "... it's not often that a product bursts onto the market scene, dominates and improves CB'ing for everyone. American Antenna and the K40 are doing it—repeated tests showed the K40 could out-perform the major competitive brands."

RADIO-ELECTRONICS: "The results of our tests showed that, in three different positions of the monitoring receiver, the model K40 equaled or out-performed the competitive antenna. Apparently, American Antenna's advertising is not merely Madison Avenue showmanship."

PERSONAL COMMUNICATIONS: "... an impressive 95% of the trials, the K40 out-performed the existing mobile antennas. We had to try one for ourselves. "... in every case, the K40 either equaled or out-performed its competitor.

"No ifs, ands, or buts! The K40 Antenna from American Antenna would have to be just about the best antenna around.

CB MAGAZINE: "Introduced in October, 1977, the K40 quickly became the top seller and in mid 1978, became the number one selling antenna in the nation."

...Here's what CB'ers all across the country said.

ANTENNA SPECIALISTS: "... truck driver and CB'er for 10 years ... 50% further than my M410 'Big Momma'."

—J.H. Collett, 207 McFee, Bastrop, LA

AVANTI: "I'm an electronic technician with a Second Class FCC license ... I was able to transmit 70% further and tune the SWR 75% lower than my Avanti."

—H.R. Castro, VRB, Monserrate D-67, Salinas, Puerto Rico

PAL: "... 20% better in transmission and reception than my 5/8 wave Pal Firestik."

—John A. Blum, Box 446, Zelienople, PA

SHAKESPEARE: "... I've been a CB'er for three years and the K40 is the best I've ever had. Better in reception and transmission than my Shakespeare."

—H. Bacher, Jr., 15 King Rd., Park Ridge, NJ

HUSTLER: "Compared to my Hustler XBLT-4, the K40 can consistently transmit 40% further and the reception was better. The K40 is the perfect way to complete a CB system."

—Jerome R. Brown, 7800 S. Linder, Burbank, IL



GOOD STUFF FOR PROS ONLY!

(SPECIAL NOTE) IF YOU'RE A BEGINNER:

Our K40 Dealers will be happy to sell you any of the older style and less expensive antennas that are great bargains for any beginning CB'er.

K40 POWER!

AMERICAN ANTENNA
ELGIN, IL 60120

©COPYRIGHT AMERICAN ANTENNA 1979

... Sold exclusively by 3500 American K40 Dealers throughout the U.S. & Canada.

CIRCLE 37 ON FREE INFORMATION CARD