

TECHNIQUES OF RECORDING WILDLIFE

**RADIO &
TELEVISION
NEWS**

AUGUST

1955

35 CENTS

In U. S. and Canada

World's Leading Electronics Magazine

IN THIS ISSUE

APPLYING VARIABLE DAMPING

**AN AMATEUR
U. H. P. TRANSCEIVER**

**FREQUENCY-MODULATED
WIRELESS RECORD PLAYER**

FIXED CAPACITORS

1955 G-E TEST POINTS

**HI-FI CONTROL AMPLIFIER
WITH "EXPRESSION"**

QRM? GET LOOPED!

THE "TESTUNER"

**TRANSISTORIZED
HEADLIGHT DIMMER**

RECORDING WILDLIFE ➔

(See Page 29)

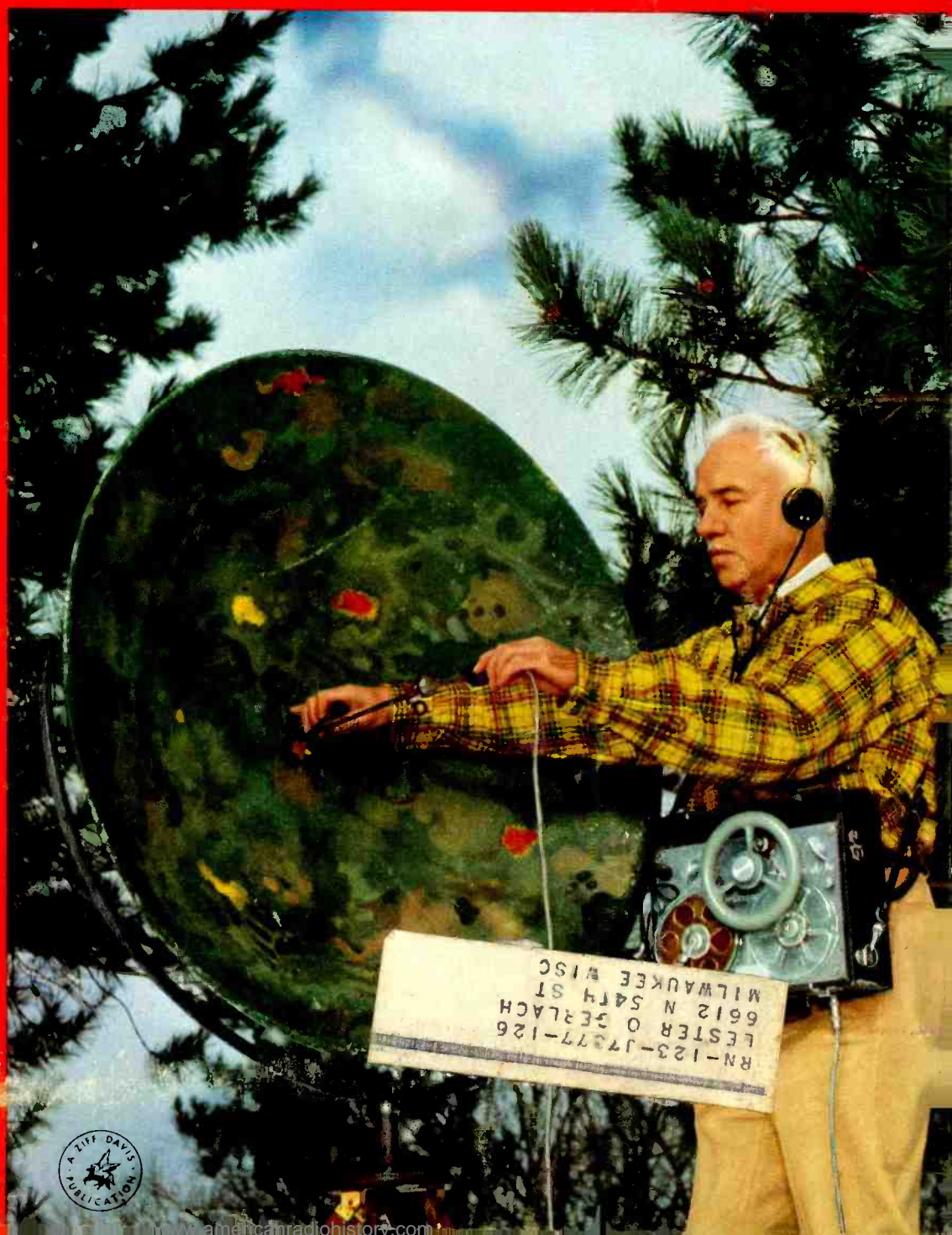

SERVICE DEALERS:

ask your



Tube Distributor for these wonderful sales helps...

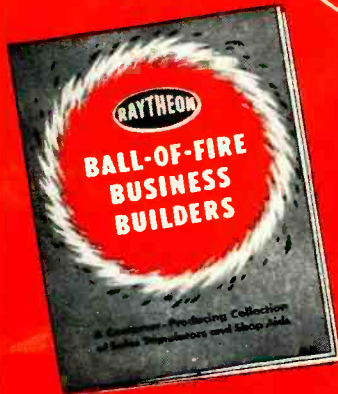

Tube and Tool Carrying Cases
Two sizes — hold both tubes and repair tools



Cardboard Cutout Trucks
With your name — give them to the children



Aluminum Snap-Out-Form Pocket Case
Protects forms, looks businesslike



Triplicate Invoice Sets
Provides 3 copies of each bill



14-Point Check-Up Card
Hang on set to show adjustments made



Drop Cloth
To show customers you care



Illuminated Outdoor Sign
A real traffic stopper



Go-Getter
Picks up small parts where hands can't reach



Window Streamer
Sells check-up service



Window Displays
To sell your service to passersby



You ain't seen nuthin', until you see the sensational collection of sales and shop aids in the new Raytheon BALL-OF-FIRE BUSINESS BUILDERS booklet. Pictured are a few of the new additions to Raytheon's already famous collection of tried and tested promotion items. For years, Service Dealers from coast-to-coast have been relying on Raytheon sales aids to help them get more than their share of business, using Raytheon Shop Aids to help them work more efficiently, and effectively.

Many items are free, the rest are 'way below normal cost. Ask your Raytheon Tube Distributor for a free copy of the new Raytheon Booklet or write to Department A, Raytheon Manufacturing Company, Receiving and Cathode Ray Tube Operations, Newton 58, Mass.



RAYTHEON MANUFACTURING COMPANY

Receiving and Cathode Ray Tube Operations

Newton, Mass. • Chicago • Atlanta, Ga. • Los Angeles, Calif.

Raytheon makes all these:

Receiving and Picture Tubes • Reliable Subminiature and Miniature Tubes
Semiconductor Diodes and Transistors • Nucleonic Tubes • Microwave Tubes



Excellence in Electronics.

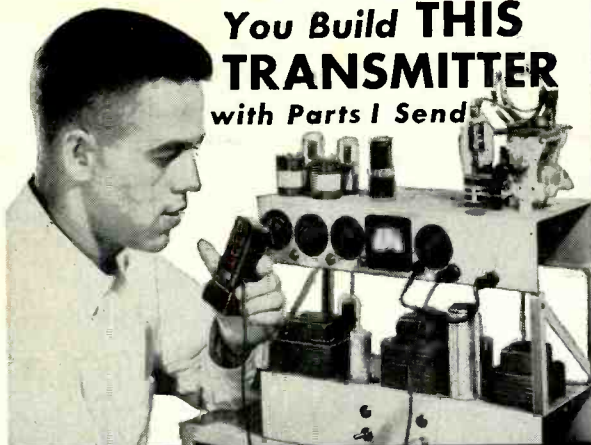

You Build THIS TRANSMITTER
with Parts I Send



I WILL TRAIN YOU FOR YOUR FCC LICENSE

LEARN COMMUNICATIONS by Practicing at Home in Spare Time

Use parts I send for Actual Experience

My Training Leads to Jobs Like These

BROADCASTING: Chief Technician, Chief Operator, Power Monitor, Remote Control Operator. **SHIP AND HARBOR RADIO:** Chief Operator, Radio-telephone Operator. **GOVERNMENT RADIO:** Operator in Army, Navy, Coast Guard, Forestry Service Dispatcher. **POLICE RADIO:** Transmitter Operator, Service Technician. **AVIATION RADIO:** Plane Radio Operator, Airport Transmitter Operator. **TELEVISION:** Pickup Operator, Voice Transmitter Operator, TV Technician.



The Communication Course I offer you is backed by NRI's 40 year record of training men at home. My well-illustrated lessons give you the basic principles you must have to assure success. My skillfully developed kits "bring to life" what you learn from my lessons, give you practical experience on circuits common to BOTH Radio and Television. You build the low-power Broadcasting Transmitter shown above (at left). You put this station "on the air," and conduct procedures required of Broadcasting Station operators. My book shows other valuable equipment you build and keep.

mitter Operators, Remote Control Operators, Service and Maintenance Technicians, etc. Mail Coupon. Find out, without obligation, what I offer. NRI training can assure you more of the better things of life; can help you qualify for high pay and promotion when times are good, enjoy greater security when jobs are scarce. Progressive, ambitious men consider Radio-Television an outstanding field for their life's work. My 64-page book, "How to Be a Success in Radio-Television," gives important facts about America's fast growing industry, shows what my graduates are doing and earning. You see equipment you practice with at home. Also, you get actual sample lesson, see how easy it is to learn at home. I send both FREE.



J. E. SMITH
PRESIDENT,
National Radio Institute
For 40 years, the leader in training men at home.

I TRAINED THESE MEN AT HOME



"I have progressed very rapidly. My present position is Television Studio Supervisor with KEDD Television, Wichita."—Elmer Frewaldt, 3026 Stadium, Wichita, Kansas.



"I did not know a thing about Radio before I enrolled for your training. Now I have a job as Studio Engineer at Radio Station KMMJ."—Bill Delzell, Central City, Nebr.

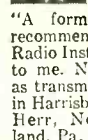

"A former employer recommended National Radio Institute training to me. Now employed as transmitter operator in Harrisburg."—Albert Herr, New Cumberland, Pa.

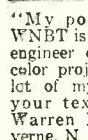

"My position with WNBT is video control engineer on the RCA color project. I owe a lot of my success to your textbooks."—Warren Deem, Malverne, N. Y.



"Am with WCOB. Happy with my job. NRI course can't be beat. Passed exam for 1st class Radio-phone license with no trouble."—Jesse W. Parker, Meridian, Miss.

AVAILABLE TO VETERANS UNDER G.I. BILLS



I Also Have a Course in Radio-TV SERVICING

If you prefer a career in Radio-Television Servicing, I'll train you at home for it. Course includes many Kits of parts. My book shows that many make \$10, \$15 a week EXTRA fixing sets while training.

Television's Rapid Growth Making Good Jobs, Prosperity

Radio is bigger than ever with over 3000 Broadcasting Stations on the air making good jobs for Chief Operators, Recording and Remote Control Operators, Power Monitors, Technicians, etc. Now there's Television, too. About 200 TV Stations are on the air with many more being built, construction of hundreds of additional stations authorized, and new TV Station applications being filed every month. Think of the demand this is creating from coast to coast for Pickup and Voice Trans-

Get Facts Now—Mail Coupon

You don't have to leave home or give up your job to take NRI courses. Many of my graduates make more than the total cost of my training in a few weeks. Mail coupon now. J. E. SMITH, President, National Radio Institute, Dept. 5HE, Washington 9, D.C. OUR 40th YEAR.

Send for FREE 64 Pg. Book

Mr. J. E. SMITH, President, Dept. 5HE
National Radio Institute, Washington 9, D. C.
Mail me 64-page Book FREE. (No salesman will call. Please write plainly.)

Name..... Age.....
Address.....
City..... Zone..... State.....

VETS write in date of discharge.....

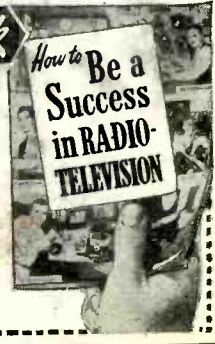

RADIO & TELEVISION NEWS is published monthly by Ziff-Davis Publishing Company, William B. Ziff, Chairman of the Board (1946-1953), at 64 E. Lake St., Chicago 1, Ill. Entered as second-class matter July 21, 1948, at the Post Office, Chicago, Ill., under the act of March 3, 1879. Authorized by Post Office Department, Ottawa, Canada, as second-class matter. SUBSCRIPTION RATES: Radio & Television News—one year U. S. and possessions, and Canada \$4.00; Pan-American Union countries \$4.50; all other foreign countries \$5.00.

Editor and Asst. Publisher
OLIVER READ, D.Sc., W1ET

Managing Editor
WM. A. STOCKLIN, B. S.

Technical Editor
H. S. RENNE, M. S.

Service Editor
CHARLES TEPFER

Associate Editor
P. B. HOEFER

Assistant Editor
J. JUSTER

Television Consultant
WALTER H. BUCHSBAUM

Art Editor
FRANK SAYLES

Draftsman
J. A. GOLANEK
W. K. VAHLSING

Advertising Director
L. L. OSTEN

Advertising Manager
MURRAY GOLDMAN

Midwest Adv. Manager
JOHN A. RONAN, JR.

Western Adv. Manager
JOHN E. PAYNE

RADIO & TELEVISION NEWS

Reg. U. S. Pat. Off.

Radio News Trademark Reg. U. S. Pat. Office • Television News Trademark Reg. U. S. Pat. Office.

First in radio-
television-audio-electronics

Average Net Paid Circulation 246,119

CONTENTS

AUGUST, 1955

EDITORIAL—INDUSTRY NEWS

For the Record.....	O. Read	8
Spot Radio News.....	Washington Correspondent	16
"Vitascan" for Color TV.....		98
New TV Grants Since Freeze Lift.....		108
Improved Transistors Announced by G-E.....		112

HIGH-FIDELITY AND AUDIO

Techniques of Recording Wildlife.....	William Gilman	29
Applying Variable Damping.....	N. H. Crowhurst	32
Frequency-Modulated Wireless Record Player.....	Arthur Trauffer	37
New Hi-Fi Tone Arm.....		45
Hi-Fi Control Amplifier with "Expression".....	Maurice P. Johnson	50
Certified Record Revue.....	Bert Whyte	55
New Line of Home Sound Systems Announced by RCA.....		70
A New Tape Machine for Office Use.....		100
Checking Turntable Speed (Twenty Years Ago).....	William C. Lewis	111
New Hi-Fi-Audio Equipment.....		130

SERVICING

Television-Radio

Fixed Capacitors.....	Walter H. Buchsbaum	34
Marine Electrolysis and Radio.....	Eliot Drake	41
1955 G-E Test Points.....	Jack Najork	42
Oscillator Troubles.....	Sol Heller	48
The "Testuner".....	Angelo Palmieri & Carl Quirk	58
Antenna Mounted U.H.F. Mixers.....	Edward M. Noll	60
Mac's Service Shop.....	John T. Frye	64
Radio-TV Service Industry News.....		118

Test Equipment

Frequency Measurement Adapter.....	Richard Graham	44
A Low-Cost Capacitance Bridge.....	David John Lewis, W1SLE	62

AMATEUR RADIO

An Amateur U.H.F. Transceiver.....	Robert M. Richardson, W4UCH	46
QRM? Get Looped!.....	Elbert Robberson	52

ELECTRONIC CONSTRUCTION

Transistorized Headlight Dimmer.....	Paul Penfield, Jr.	56
Thyratron Power Supply.....	Peter J. Vogelgesang	72

DEPARTMENTS

Within the Industry.....	22	Sales Aids.....	102
What's New in Radio.....	78	New Designs.....	124
Technical Books.....	85	Manufacturers' Literature.....	128

COPYRIGHT 1955

(All Rights Reserved)

ZIFF-DAVIS PUBLISHING COMPANY
WILLIAM B. ZIFF (1898-1953) FOUNDER
Editorial and Executive Offices
366 Madison Ave., New York 17, N. Y.
VOLUME 54 • NUMBER 2



Member
Audit Bureau of
Circulations

SUBSCRIPTION SERVICE: All communications concerning subscriptions should be addressed to Circulation Dept., 64 E. Lake St., Chicago 1, Ill. Subscribers should allow at least four weeks for change of address. Include your old address as well as new—enclosing, if possible, an address label from a recent issue of this magazine.

CONTRIBUTIONS: Contributors are advised to retain a copy of their manuscripts and illustrations. Contributions should be mailed to the New York Editorial Office and must be accompanied by return postage. Contributions will be handled with reasonable care, but this magazine assumes no responsibility for their safety. Any copy accepted is subject to whatever adaptations and revisions are necessary to meet the requirements of this publication. Payment covers all author's, contributor's, and contestant's rights, title, and interest in and to the material accepted and will be made at our current rates upon acceptance. All photos and drawings will be considered as part of the material purchased.



COVER PHOTO: "Shooting" wildlife with a camera and tape recorder is the fascinating vocation and avocation of Dr. Peter P. Kellogg of Cornell University, Ithaca, N. Y.

(Ektachrome by Eleanor Gilman)

ZIFF-DAVIS PUBLISHING COMPANY

President

B. G. DAVIS

Vice-Presidents

H. J. MORGANROTH

M. H. FROELICH

Secretary-Treasurer

G. E. CARNEY

Circulation Manager

M. MICHAELSON

BRANCH OFFICES

CHICAGO (1)

64 E. Lake St., AN 3-5200

LOS ANGELES (14)

Stalder Center, 900 Wilshire Blvd., Mich. 9850

Work with and keep all of this practical, commercial type equipment

"YOU LEARN BY DOING! THAT'S WHY D.T.I. GETS REAL RESULTS!"



21 INCH
Build and keep D.T.I.'s NEW 2 Unit TV Set—ideal for custom installation. (D.T.I. also offers home training without the TV set.)



Television, Radio, Electronics, has created thousands of good jobs; jobs with money, respect, position; jobs you may choose among—if you only had training. DeVRY Training is modern, thorough, practical—followed by a real Employment Service. Thousands have stepped into good pay—why not you? No need to leave home; no need to quit your present job; no special preliminary training required. Fill out coupon below and get the full story. Men 17 to 45 preferred.

Amazingly effective **NEW** home training in
TELEVISION RADIO ELECTRONICS

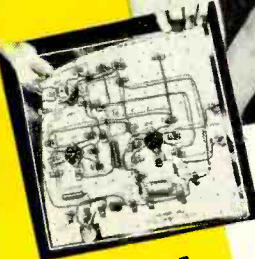

NEW STYRENE ELECTRO-LAB SPEEDS LEARNING

Simply place a pictorial diagram under transparent Styrene base. Follow the diagram. Wiring is tremendously simplified. Work a total of over 300 learn-by-doing projects—a wonderful way to get practical experience.

*Trade-mark

One of America's Foremost Television Training Centers



5 INCH "SCOPE"

Oscilloscope

Vacuum-tube Voltmeter

You build and keep a quality Oscilloscope—almost a necessity for Television servicing. Helps you earn while you learn. You also build and keep a Vacuum Tube Voltmeter—a highly versatile test unit you can use when you are ready to make real money! IF PREFERRED, you may get all your preparation in D.T.I.'s big Chicago training laboratories —among the finest. (See building pictured below.) Valuable information for men subject to military service.

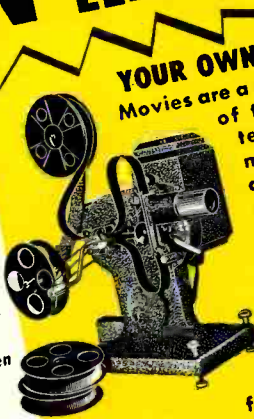

YOUR OWN HOME MOVIES
Movies are a remarkable feature of the D.T.I. System. You use a movie projector and many reels of films. Run off each film as often and as slowly as you want. A wonderful aid to help make important points crystal-clear. Get the full story! Send in that coupon.

DEVRY TECHNICAL INSTITUTE
FORMERLY
DEFOREST'S TRAINING, INC.
CHICAGO 41, ILLINOIS

Mail Coupon Today

DEVRY TECHNICAL INSTITUTE
4141 Belmont Ave., Chicago 41, Ill. Dept. RN-8-L

I would like complete facts including "89 Ways to EARN MONEY in Television-Radio-Electronics."

Name _____ Age _____
Street _____ Apt. _____
City _____ Zone _____ State _____
2 D.T.I.'s training is available in Canada.

89 WAYS TO EARN MONEY IN TELEVISION RADIO ELECTRONICS

On the ocean floor...life begins at 5000 hours

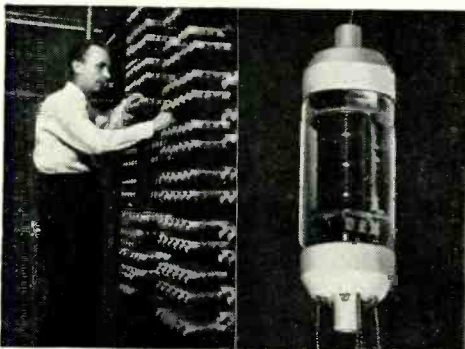
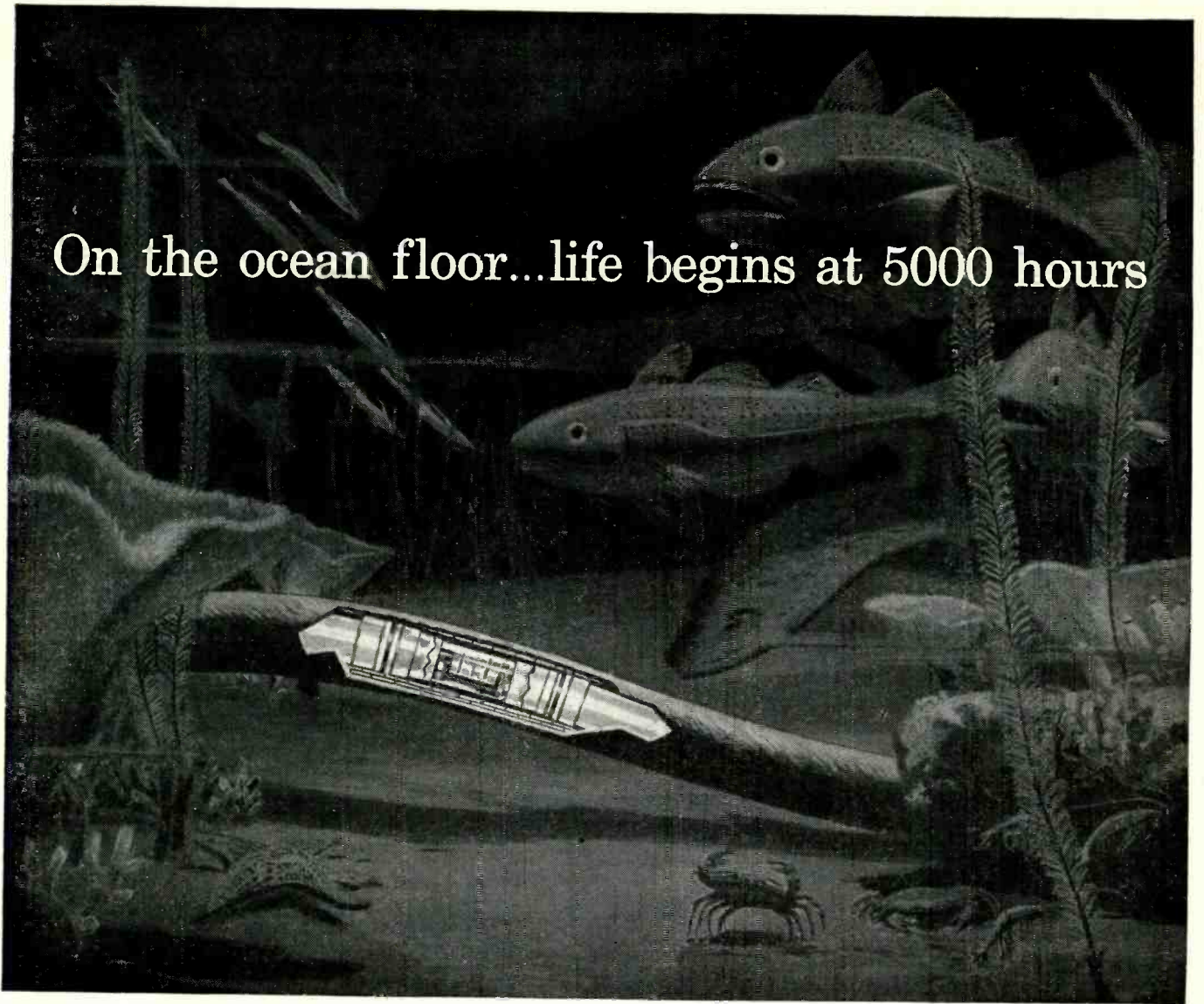

Electron tubes (right) for the Transatlantic Telephone Cable between Newfoundland and the British Isles are being handmade at Bell Laboratories. Life test bank is shown left. The cable system, which can carry 36 simultaneous conversations, is a joint enterprise of the American Telephone and Telegraph Company, the British Post Office and the Canadian Overseas Telecommunications Corporation.

When the world's first transoceanic telephone cable is laid across the Atlantic it will contain hundreds of electron tubes needed to amplify voices. Deep on the ocean floor these tubes must keep on working, year after year, far beyond reach of ordinary repair services.

Bell Telephone Laboratories scientists have developed a tube of unique endurance. Before a tube is even considered for use in the cable it is operated for 5000 hours under full voltage—more than the entire life of many tubes.

But survival alone is not enough. During the test each tube is exhaustively studied for behavior that may foreshadow trouble years later. Tubes that show even a hint of weakness are discarded. For the good ones, a life of many years can be safely predicted.

Bell Telephone Laboratories scientists began their quest for this ocean-floor tube many years ago. Now it is ready—another example of the foresightedness in research that helps keep the Bell Telephone System the world's best.

BELL TELEPHONE LABORATORIES

*Improving telephone service for America provides careers
for creative men in scientific and technical fields*



RADIO & TELEVISION NEWS

Why Guess? There's a Quick, Sure Way to Find TV Set Troubles

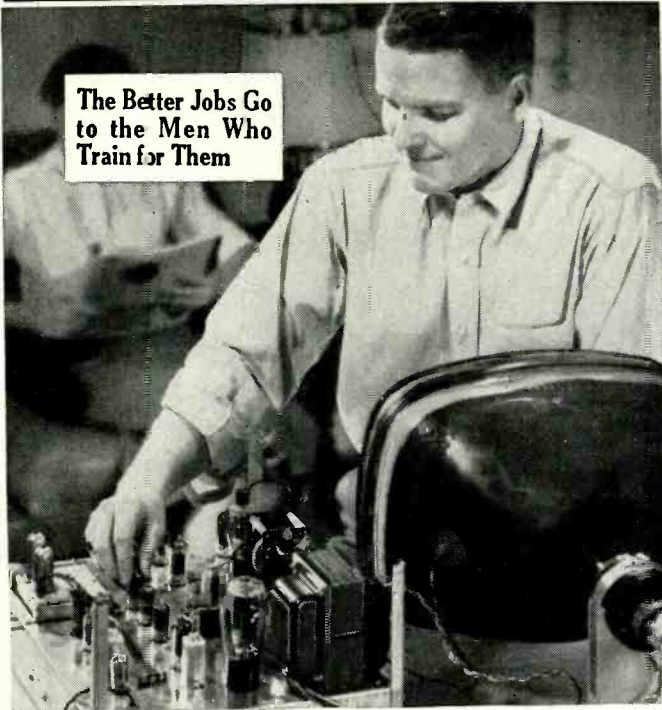

The Better Jobs Go to the Men Who Train for Them

PUT YOURSELF IN THIS PICTURE, experimenting at home with equipment we furnish, getting set to go places in TV servicing. Speed in servicing TV sets means stepped up earnings, greater security for you.

NEW ALL-PRACTICE COURSE Shows How top TV servicemen fix ANY MAKE or model

Home Training includes 17" Picture Tube, components for a TV Receiver, Scope, Signal Generator, HF Probe, all for introductory price under \$200 on easy terms.

ACQUIRE SUPERIOR SKILLS AT HOME IN SPARE TIME

TV Servicing . . . real, professional TV Servicing, pays good money to men with specialized knowledge and training. The exciting, expanding TV industry offers more than just good jobs. It offers success, a career to men qualified to render an essential community service.

Be one of these experienced TV Servicemen. NRI's new course is 100% learn-by-doing, practical training. We supply all the equipment plus comprehensive manuals covering a thoroughly planned program of practice. You learn how experts diagnose TV receiver defects quickly. You learn the cause of defects . . . audio and video . . . accurately, easily. And you learn how to fix them.

ALL LEARN BY DOING

You do more than just build circuits. You get experience aligning TV receivers, isolating complaints from scope patterns, eliminating interference, use germanium crystals to rectify the TV picture signal, adjust the ion trap and dozens of other professional TV Servicing techniques.

Many fellows "go around in circles" trying to isolate TV receiver defects. Don't guess! Learn professional techniques. Take this training now. If you want to go places in TV servicing you will act quickly to find out what you get, what you practice and how you can advance with better practical knowledge through NRI's

new course in Professional Television Servicing. Accept this personal invitation to get a free copy of our booklet which describes this training in detail. Mail the coupon now. Remember, with this course you keep right on working, keep right on earning at your job while you learn through actual practice at home in your spare time.

UHF AND COLOR CREATE GROWING OPPORTUNITIES

To cash in on the present UHF and the coming Color TV boom you'll need the kind of knowledge and experience this Professional Television Servicing Course gives you. There is no other training like this. Here, condensed into a few months of training at home, is everything that TV servicemen learn in months, even years of bench work. You get practice installing front-end channel selector strips

in modern UHF-VHF receivers. You learn UHF servicing problems and their solution. Mail the coupon below. Discover how this new course meets the needs of the man who wants to get ahead in TV Servicing.

NOT FOR BEGINNERS

NRI's Professional All-Practice Television Servicing Course is for men with some knowledge of Radio and TV fundamentals but who need intensive, practical training and actual experience with TV circuits and professional servicing techniques to be self-reliant, confident, expert TV servicemen. Get this book FREE and judge for yourself how NRI's course will further your ambition to reach the top in TV Servicing. Mail the coupon . . . there is no obligation . . . and it can open the door to a better career for you.

MAIL THIS NOW



National Radio Institute, Dept. 5HET, 16th and U Sts., Washington 9, D.C.

Please send me FREE copy of "How to Reach the Top in TV Servicing." I understand no salesman will call.

Name Age

Address

City Zone State

Approved Member National Home Study Council

For the RECORD.

BY THE EDITOR

Industry Plans Week-Long Celebration

OBSERVANCE, by the entire nation, of a week dedicated to "Better Home Entertainment" will begin on September 18th. Julius Haber, of RCA, headed the subcommittee of the public relations section of the *Radio-Electronics-Television Manufacturers Association* in designing a program for the week-long celebration.

Retail stores across the nation will display new television, radio, and hi-fi models to the public backed by distributors and the broadcasters and telecasters. These retail dealers will participate under coordinated efforts of the *National Appliance and Radio-TV Dealers Association*.

The *National Association of Radio and Television Broadcasters* and the *National Association of Electrical Distributors* will promote the theme to the listeners and viewers. The press, as well as national magazines, will run special feature articles covering the history and the development of the radio and television industry. It is planned that regional dinners be held in advance of the week-long celebration and that promotional material be furnished to dealers for their use in publicizing the occasion to their customers and prospects. We urge all of our readers to participate in National Radio & Television Week—dedicated to a theme of "Better Home Entertainment" during the week of September 18.

Hi-Fi in the 90's

THE history and development of the phonograph has captured the whole-hearted interest of this editor. From a modest beginning (an Edison "Gem Phonograph") has grown the fascinating hobby of restoring many early cylinder and disc machines to their original condition.

Our search for these early horn-type reproducers has been taking place for several months. Many hours have been spent in research and in the gathering of early literature and clippings of old ads for an elaborate scrapbook. Many of our friends have combed their attics for certain models we are seeking. A few have been found buried under piles of keepsakes and miscellaneous junk. These have augmented our collection of early cylinder and disc machines (totalling 30) substantially, but many more are needed before we can exhibit an assortment of historical machines at future audio fairs and on other occasions visited by our readers.

It seems that substantial quantities of certain Edison machines were made, for example, and these are fairly com-

monplace throughout the country. They include the Edison "Home," "Standard," "Fireside," and "Amberola" models. Others, such as the Edison "Opera," "Concert," "Balmoral," "Alva," and "Idelia" were not made in great quantity—and are lacking in the collection.

And there were many so-called private brand phonographs made during the 1890's. Generally, they are small spring-wound (by crank or key) machines employing short outside horns. Many of them are of the cylinder type while others, including the *Berliner* disc machines, could be driven directly by means of a crank.

It is hoped that our readers will search their attics and basements for some of these small machines and send us complete descriptions and data appearing on the nameplates.

Our interest has been shared by other collectors to the point that they urge this publication to form a collector's club and to exchange data on the old horn-type phonographs. The greatest demand, both by our readers and from industry, has been for a series of articles giving the history, dates, and mechanical details of the early machines. Our search for a qualified writer has now been satisfied, and a series of articles is now being written by James Riley, who has collected and studied the history of the phonograph for more than twenty years. The information being compiled will be of great interest to the audiophile and to the old-timer who recalls the "acoustical reproducers" of yesteryear.

We will be glad to give consideration to the formation of a collector's club if there is sufficient interest to warrant the time and effort needed to make the project a success. It is suggested, therefore, that all interested readers send in their suggestions for the forming of such a group. We will be happy to give them every consideration.

TV-Radio Servicing \$1.5 Billion Industry

THE most encouraging report revealed by RETMA's service chairman, H. J. Shulman, at the 31st Annual Convention, was the \$1.5 billion paid by 48 million families for TV and radio maintenance during the past 12 months. The figure exceeded the retail dollar value of the 7,900,000 TV sets and 12,500,000 radio sets sold for the same period. Other items which contributed to the \$1.5 billion service bill were component parts, and antennas and their installation. Labor represented about 770 million. The general feeling throughout the convention was that quality of TV service has steadily improved. O.R.

you are invited by
Electro-Voice to...

WIN!

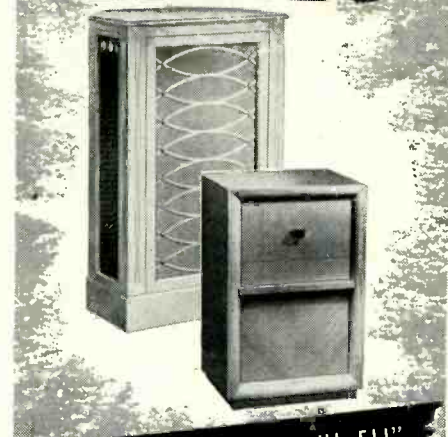

1. "WEEK-END WITH HI-FI!"

2. LIFETIME OF HI-FI MUSIC!

As always, Electro-Voice is FIRST! Now E-V sponsors this unique and exciting contest. For a lifetime after this glorious listening experience you will judge music reproduction equipment by its ability to approach the perfection already achieved by E-V sound matched high fidelity components and loudspeaker systems!

WIN this "Double-Size" FIRST PRIZE!

- ① *Week-End with High Fidelity* ALL-EXPENSE-PAID week-end trip for two . . . from wherever you enter the contest to Electro-Voice—the Home of High Fidelity! Take part in the assembly of your own wonderful prize, if you wish.
- ② *Lifetime of High Fidelity Music* with your own incomparable *Patrician* 4-way audio reproducer and the beautiful *Peerage* console complete with all equipment!

9 MORE PRIZES!

- 3 SECOND PRIZES . . . magnificent E-V 15TRX 15 in. three-way speakers!
3 THIRD PRIZES . . . outstanding E-V 12TRX 12 in. three-way speakers!
3 FOURTH PRIZES . . . powerful E-V 12TRXB 12 in. three-way speakers!

Just two pleasant steps: (A) Hear E-V high fidelity demonstrated by your E-V Distributor. (B) Fill in and mail the official entry blank, provided by E-V Distributor. (Be sure the salesman signs your entry blank.) Contest closes at midnight, September 30, 1955. Starts August 1, 1955.

Electro-Voice ELECTRO-VOICE, INC.
BUCHANAN, MICHIGAN

Gentlemen: I want a chance to win a "Week-End with High Fidelity." Please send me the names of nearest participating E-V Distributors.

Name _____

Address _____

City _____ Zone _____ State _____

My nearest large trading center is _____

**NEW
at
ALLIED**

KNIGHT Low-Cost Test Instrument Kits

Lab Precision Quality...Easiest-to-Assemble Money-Saving Instruments

The greatest value anywhere for your test instrument dollar! Here's more for your money in accuracy, dependability, versatility and professional styling. Here's the last word in easy-to-build convenience. Instruction manuals are a marvel of simplicity for quick assembly without guesswork. You need only a screwdriver, soldering iron and pliers—and you're ready to build these top-quality instruments!



New Knight Tube Tester Kit

Expertly engineered, low-cost tube tester. Tests 4, 5, 6 and 7-pin large, regular and miniature types, octals, loctals, 9-pin miniatures, pilot lamps. Tests cover new 600 ma. series—string types. Checks for emission, shorts, open elements,

heater continuity. $4\frac{1}{2}$ " meter with "Good-Replace" scale. Fast-operating roll chart. Universal socket pin selectors for test tubes with new base arrangements. Blank socket for future use. Choice of 14 fil. voltages from .75 to 117 v. Includes all parts, dark green metal case, gray panel, wire, solder. 9 x 4 x 10". For 110-120 v., 50-60 cy. AC. 14 lbs. **83 FX 143. Knight Tube Tester Kit. Only \$29.75**
83 FX 142. As above but in fabrikoid covered portable case, $6\frac{1}{2}$ x $14\frac{1}{2}$ x $10\frac{1}{2}$ ". Shpg. wt., 15 lbs. Only . . . **\$34.75**
83 F 141. TV Picture Tube Testing Adapter. Only. **\$3.75**



New Knight RF Signal Generator Kit

Provides modulated or unmodulated RF output on long wave, broadcast, short wave, FM and TV frequencies. Ideal for use with VTVM for aligning RF and IF sections of radio and TV sets; use with sweep generator as TV marker generator. Delivers audio output for troubleshooting all

audio stages. RF output: 160 kc to 110 mc on fundamentals; useful harmonic output to 220 mc; modulated at 400 cycles; with jack permitting modulation by external generator. Rated RF output 100,000 mv or greater. Max. audio output, 10 volts. Complete with green metal case (7 x 10 x 5") and gray panel, tubes, all parts, pre-wound coils, wire and solder. For 110-120 v., 50-60 cy. AC. 10 lbs. **83 F 145. Knight RF Signal Generator Kit. Only . . . \$19.75**



New Knight Signal Tracer Kit

Ideal for visual and audible signal tracing of RF, IF, video and audio circuits—at less than the cost of an audio signal tracer alone. Highest usable gain: "magic eye" with calibrated attenuators permits stage by stage gain measurements. 4" PM speaker. With RF probe for checking all stages; includes audio probe tip. Noise test provision.

Built-in wattmeter calibrated 25 to 1000 watts. With gray and green metal case (7 x 10 x 5"), all parts, tubes, probes, precut leads, solder. For 105-125 v., 50-60 cy. AC. 13 lbs. **83 F 135. Knight Signal Tracer Kit. Only \$24.50**



New Knight Audio Generator Kit

Ideal audio frequency source for checking audio circuits and speaker response; fine for Hi-Fi testing. Frequency range: 20 cps to 1 mc in 5 ranges. Output voltage: 10 volts to high imp., ± 1 db to 200 kc. Generator imp., 600 ohms. Less than .25% distortion from 100 cps through the audible

range; less than 1% when driving 600 ohm load at maximum output. Continuously variable step-attenuated output. Complete with green and gray metal case ($8\frac{1}{2}$ x 11 x $7\frac{1}{2}$ "), all parts, tubes, precut leads and solder. 17 lbs. **83 FX 137. Knight Audio Generator Kit. Only . . . \$31.50**



New Knight VOM Kit

Quality 20,000 ohm/volt VOM with $4\frac{1}{2}$ " meter; $\pm 2\%$ full scale accuracy; 1% multipliers; single switch selects: 6 DC ranges—0.25-10-50-250-1000-5000 at 20,00 ohms/volt; 6 AC ranges—0.25-10-50-250-1000-5000 at 5000 ohms/volt; 3 resistance ranges—0-2000-200,000 ohms and 0-200 meg. 4 DC current ranges—0-10-100 ma. and 0-1-10 amps. Complete with bakelite case ($6\frac{3}{4}$ x $5\frac{1}{4}$ x $3\frac{3}{4}$ "), all parts, 4' test leads, batteries, wire and solder.

83 F 140. Knight VOM Kit. Only \$26.50

**Send
10¢**



GET THE PROOF OF KNIGHT QUALITY

Send for complete construction manuals

See for yourself the exceptional quality and super-value represented in Knight Test Instrument Kits. See why KNIGHT offers you more for your money in dependability, precision quality and versatility.

- 38 K 165.** Knight Tube Tester Kit Construction Manual.
- 38 K 170.** Knight Signal Tracer Kit Construction Manual.
- 38 K 168.** Knight VOM Kit Construction Manual.
- 38 K 166.** Knight Signal Generator Kit Manual.
- 38 K 169.** Knight Audio Generator Kit Manual.

Order any of the above construction manuals. Each only **10c**

FREE Supplement No. 148

Send for our latest 56-Page Supplement featuring new releases and special values. Make your selections at ALLIED from the world's largest stocks of tubes, parts, test instruments, Hi-Fi audio equipment, Amateur gear, industrial components—everything in electronics at lowest prices.

ALLIED RADIO

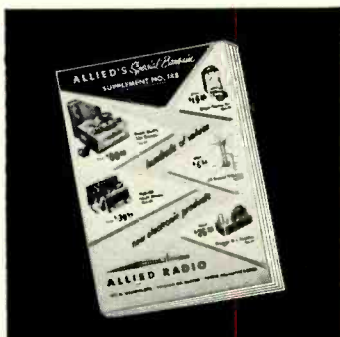

ALLIED RADIO CORP., Dept. 1-H-5
100 N. Western Ave., Chicago 80, Ill.

- Send FREE Supplement No. 148
- Ship the following KNIGHT Kits _____

- Send construction manuals covering the following kits: _____

_____ Amount Enclosed \$ _____

Name _____

Address _____

City _____ Zone _____ State _____

NOW... 3 models to choose from!

C·D·R automatic Rotors
 a type for every need
 ...ALL 40% SHARPER TUNING
 than any other automatic rotor

the famous
 TR-2 now
 available as a
 fully automatic
 model also..

AR-22

Here is the **HEAVY DUTY** rotor that is so popular everywhere...**NOW COMPLETELY AUTOMATIC!** Powerful beyond any TV need...it is tested and proven as the giant of the industry. Uses 4 wire cable.



AR-2

The complete, **AUTOMATIC** rotor with **THRUST BEARING**. Handsome modern design cabinet, uses 4 wire cable. Tested and proven by thousands and thousands of satisfied users, it has everything that could be asked for in a popular rotor.



*and Pre-Sold
 for you on TV
 announcements
 across the country*

AR-1

Same as the AR-2 without the thrust bearing.



CORNELL-DUBILIER
 SOUTH PLAINFIELD, N. J.



THE RADIART CORP.
 CLEVELAND 13, OHIO

AS A DEMONSTRATION...

Will you accept without charge ANY ONE of these high-fidelity MUSIC~APPRECIATION RECORDS

 <p>Richard Strauss' TILL EULENSPIEGEL'S MERRY PRANKS Smetana's THE MOLDAU (ON ONE 12" DISC) George Szell, conducting The Music Appreciation Symphony Orchestra</p>	 <p>Prokofiev's CLASSICAL SYMPHONY Britten's THE YOUNG PERSON'S GUIDE TO THE ORCHESTRA (ON ONE 12" DISC) Alfred Wallenstein, conducting The Music Appreciation Symphony Orchestra</p>
 <p>Wagner's OVERTURES TO TANNHÄUSER and DIE MEISTERSINGER (ON ONE 12" DISC) Norman Del Mar, conducting The London Symphony Orchestra</p>	 <p>Haydn's SYMPHONY NO. 102 IN B FLAT MAJOR Fritz Stiedry, conducting The Music Appreciation Symphony Orchestra</p>
 <p>J.S. Bach's SUITE FOR ORCHESTRA NO. 3 IN D MAJOR George Szell, conducting The Music Appreciation Symphony Orchestra</p>	 <p>Schumann's PIANO CONCERTO IN A MINOR Thomas Scherman, conducting The Little Orchestra Eileen Flissler, Pianist</p>
 <p>Mendelssohn's VIOLIN CONCERTO IN E MINOR Alexander Smallens, conducting Stadium Concerts Symphony Orchestra • Fredell Lack, Violinist</p>	 <p>Beethoven's SYMPHONY NO. 5 IN C MINOR Norman Del Mar, conducting The London Symphony Orchestra</p>

TO HELP YOU UNDERSTAND MUSIC BETTER AND ENJOY IT MORE

SPONSORED BY THE BOOK-OF-THE-MONTH CLUB, this new idea is designed for those who enjoy good music but who are aware, too often, that they do not listen to it with complete understanding and appreciation. There is no doubt about the reason: most of us are not primed about *what to listen for*. Music-APPRECIATION RECORDS meet this need—for a fuller understanding of music—

better than any means ever devised. This form of self-education can be as thorough as the Music Appreciation courses given in many universities.

YOU SUBSCRIBE BUT TAKE ONLY THE RECORDS YOU WANT... A new MUSIC-APPRECIATION RECORD will be issued—for subscribers only—every month. The announcement about each forthcoming record will be written by the noted composer and music commentator Deems Taylor. After reading this descriptive essay you may take the record or not. *You are not obligated to take any specified number of records.* And you may stop at any time!

TWO TYPES OF RECORDS AVAILABLE ... All MUSIC-APPRECIATION RECORDS are high-fidelity, long-playing records of the highest quality—33 $\frac{1}{3}$ R.P.M. on Vinylite. They are of two kinds: first, a

so-called Standard Record—a *twelve-inch* disc—which presents the performance on one side, the analysis on the other. This is sold at \$3.60, to subscribers only. The other is an Analysis-Only Record—a *ten-inch* disc—priced at \$2.40. The latter is made available each month for any subscriber who may already have a satisfactory long-playing record of the work being presented. (A small charge is added to the prices above to cover postage and handling.)

TRY A ONE-MONTH SUBSCRIPTION—WITH NO OBLIGATION TO CONTINUE... Why not make a simple trial, to see if these records are as pleasurable and as enlightening as you may anticipate? The record you choose will be sent to you at once—at *no charge*. You may end the subscription immediately after hearing this record, or you may cancel any time thereafter.



ON ONE SIDE there is a full performance of a great musical work. The records feature orchestras and soloists of recognized distinction in this country and abroad. You listen to this performance first, or afterward, as you desire, and then...



ON THE OTHER SIDE is an illuminating analysis of the music, with the themes and other main features of the work played separately with running explanatory comment, so that you can learn *what to listen for* in order to appreciate the work fully.

PLEASE RETURN ONLY IF YOU HAVE A 33 $\frac{1}{3}$ R. P. M. RECORD PLAYER

MUSIC-APPRECIATION RECORDS R38-8 AS MY FREE DEMONSTRATION RECORD PLEASE SEND ME
c/o Book-of-the-Month Club, Inc.
345 Hudson Street, New York 14, N. Y.

Please send me at once, without charge, the MUSIC-APPRECIATION RECORD checked at the right and enter my name in a Trial Subscription to MUSIC-APPRECIATION RECORDS, under the conditions stated above. It is understood that, as a subscriber, I am not obligated to buy any specified number of records, but may take only those I want. Also, I may cancel my subscription after hearing this first record, or any time thereafter at my pleasure, but the introductory record is free in any case.

- | | |
|---|---|
| <input type="checkbox"/> Strauss' Till Eulenspiegel | <input type="checkbox"/> Prokofiev's Symphony and Britten's Guide |
| <input type="checkbox"/> Smetana's The Moldau | <input type="checkbox"/> Haydn's Symphony |
| <input type="checkbox"/> Wagner's Overtures | <input type="checkbox"/> Schumann's Concerto |
| <input type="checkbox"/> Bach's Suite | <input type="checkbox"/> Beethoven's Symphony |
| <input type="checkbox"/> Mendelssohn's Concerto | |

Mr. _____ }
Mrs. _____ } (Please Print)
Miss _____ }

ADDRESS.....

CITY.....ZONE.....STATE.....

MAR 37

NOW! PHILCO.



MODEL 7100

PHILCO UNIVERSAL Color Bar and Dot Bar GENERATOR

PHILCO TUBES
IMPROVE THE
PERFORMANCE OF
ANY TV OR
RADIO RECEIVER

Puts You in the Color Service Business with One Instrument!

A COMBINED COLOR-BAR AND DOT-BAR GENERATOR PLUS A DYNAMIC WHITE BALANCE TEST

From Philco laboratories comes one compact generator with all Color Bar and Dot Bar Generator features—a new versatile instrument that meets all color service requirements . . . on the bench or in the field! Used in conjunction with present monochrome test equipment, the Philco Model 7100 Universal Color Generator fully equips the service man to completely trouble-shoot circuits associated with color reproduction and make accurate convergence adjustments . . . in any color receiver made. The full-screen 10 bar color pattern was developed to provide rapid, accurate servicing. See the Philco Universal Color Bar and Dot Bar Generator at your Philco distributor's.

Look at These Special PHILCO Features!

1. Signals for checking and setup of: Static and Dynamic Convergence; Dynamic White Balance, Frequency of Color Oscillator; Phase of Demodulators; Matrix Circuits; Color and black and white linearity.
2. Four crystals control picture and sound carriers.
3. Two additional crystals control internally generated color signals and horizontal sync pulses.
4. Fully regulated Power supply.
5. Visual markers simplify identification of color bars.

SAVE UP TO \$130⁰⁰

By buying PHILCO, you save up to \$130.00 over other equivalent types of equipment that give you the same service functions. This compact Philco Color Bar and Dot Bar Generator gives you the features of *two* generators . . . at a much lower cost!

COMPLETE PRICE ONLY

\$269⁵⁰

Compare Value! Performance! Features!

PHILCO CORPORATION *Accessory Division*
"A" & Allegheny Avenue, Philadelphia 34, Pa.



Federal

THE SELENIUM RECTIFIER
WITH THE GREATEST

Manufacturer

Aceptance



When you replace with Federal Selenium Rectifiers you give your radio-TV customers PERFORMANCE that builds *lasting* good will—and PROFITS!

And HERE'S why— point by point:

- LONGER LIFE** ... 5,000 hours life expectancy in approved applications.
- HIGHER OUTPUT VOLTAGE** ... 3 to 6½ higher B+ output volts than competitive selenium rectifiers in conventional doubler circuits.
- LOWER TEMPERATURE RISE** ... 2° C to 10° C lower average operating temperature than competitive selenium rectifiers.
- SUPERIOR HUMIDITY RESISTANCE** ... passes 1,000-hour life test in 95% relative humidity at 40° C.
- PROVEN MECHANICAL CONSTRUCTION** ... brass eyelet or aluminum stud construction used exclusively. Patented "dead-center" construction allows stack to be tightened until rigid, without affecting the pressure-sensitive selenium characteristic.
- UNDERWRITERS LABORATORY ACCEPTANCE FOR 85° C OPERATION** ... Federal's popular radio-TV types have been tested and accepted by UL for operation at cell temperatures of 85° C.
- CONSERVATIVE RATINGS** ... rectifiers offered to the industry are rated only after exhaustive temperature rise and aging tests on minimal grade units to insure full value and satisfaction.
- MORE UNIFORM QUALITY** ... Federal rectifiers are automatically 100% tested and inspected to meet standard forward and reverse current specifications, as well as for dielectric strength.
- LARGEST PLANT CAPACITY** ... production facilities to satisfy any quantity requirement.
- MORE ENGINEERING KNOW-HOW** ... the research and design facilities of the world-wide, American-owned International Telephone and Telegraph Corporation assure continued product leadership.

Federal

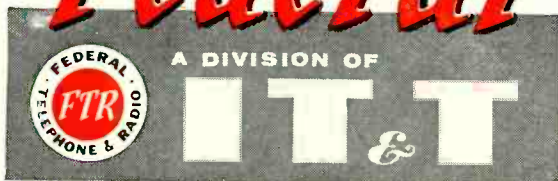

See your Federal Distributor today!

Federal Telephone and Radio Company

A Division of INTERNATIONAL TELEPHONE AND TELEGRAPH CORPORATION
COMPONENTS DIVISION • 100 KINGSLAND ROAD • CLIFTON, N. J.

In Canada: Standard Telephones and Cables Mfg. Co. (Canada) Ltd., Montreal, P. Q.
Export Distributors: International Standard Electric Corp., 67 Broad St., New York

KINGS of the TV FRONTIER!

Unmatched for power and performance!

This extraordinary fringe-area powerhouse is still the most sensitive all-channel antenna made today—bar none! The SUPER RAINBOW's many "years-ahead" engineering features include the triple-powered Tri-Pole, separate high and low band operation, 100% aluminum construction, and "Snap-Lock" pre-assembly. Also in great demand . . .

The RAINBOW, Model No. 330.

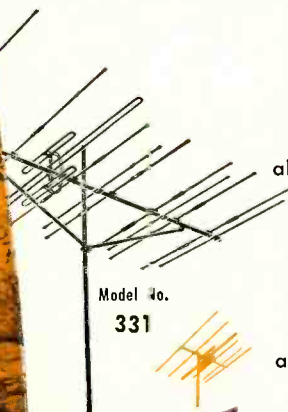

Model No.
331

SUPER RAINBOW

Extra elements, extra performance!

There may be antennas that resemble our TRAILBLAZER, but none can top its blazing performance. The TRAILBLAZER features extra High and Low Band directors, and full-wave directors on the High Band. It installs faster than any similar antenna, and—it's all aluminum! Especially recommended for areas with front-to-back interference problems, particularly on the Low Band. Count the elements . . . then compare the prices!

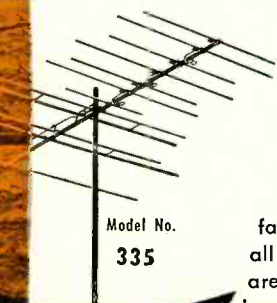

Model No.
335

TRAILBLAZER

Advanced design — and "Super-Sembled"

Look to the LANCERS for Channel Master "extras": extra elements and extra gain — at no extra cost. Completely "Super-Sembled." The SUPER LANCER gives 1½ db more gain on both the Low Band and the High Band than similar types. **The LANCER, Model No. 333**, has an extra director that provides 1½ db more Low Band gain. Count the elements . . . then compare the prices!

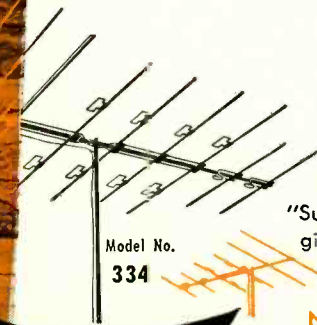

Model No.
334

SUPER LANCER

CHANNEL MASTER®

All-Channel Yagis

Unrivalled for power, popularity and price!

Servicers everywhere are discovering an entirely new answer to the problem of multi-channel fringe-area reception: Channel Master all-channel yagis. These are the antennas that have what it takes to bring top TV performance to the most distant, isolated locations. And, they're ready for color, too!

Today's leading all-channel yagis are designed — and improved — in the Channel Master Antenna Development Laboratories. Isn't it logical to use Channel Master's famous engineering skill to solve your reception problems?



CHANNEL MASTER CORP. ELLENVILLE, N. J.
The World's Largest Manufacturer of TV Antennas and Accessories

INTERNATIONAL



Selenium Rectifiers

the
Replacement
Rectifier
that's
Right!

all
TV
and
RADIO
types
available
from your
parts distributor

INTERNATIONAL

RECTIFIER CORPORATION

El Segundo, Calif. ORegon 8-6281

NEW YORK • CHICAGO

World's Largest Supplier of
Quality Industrial Rectifiers

Spot Radio News

* Presenting latest information on the Radio Industry.

By RADIO & TELEVISION NEWS'
WASHINGTON EDITOR

PAY-SEE TV has run into a rampant snarl—legal and technical—from both the industry and the lawyers. Two definite points of view have appeared. The networks have solidly aligned themselves against any form of subscription television, claiming that such a system is incompatible with American tradition and against the fundamental interpretation of the Communications Act.

Officials of the three networks pointed out in their briefs that pay-TV cannot co-exist with free television and that the law, as it stands today, makes no provision for any form of broadcasting other than free.

The proponents of the three fee-systems strongly deny that fee and free telecasting are mutually exclusive, emphasizing that one would be a special form of tele-broadcasting that would only be in operation at certain fixed hours of the day.

Since the original decoding systems were announced some time ago, using wire or the airways, new methods of attacking the control signal have been proposed; none of these ideas has actually been put into operation. They are all paper plans at the moment. In one proposal, it was suggested that since all codes can eventually be broken and bootlegging can become commonplace, it would be futile to use a coded system.

However, a direct wire, like that used in community TV, could be used, it was said, and a push-button technique applied to control the signal into the TV set. The button would have a key supplied by the system operator or could be a combination mechanism similar to a lock.

It was also suggested that "block-purchase" could be effected and the televiewer would receive a monthly bill for the purchase of such a package. In such an arrangement, the TV viewer would indicate to the operator his desire to receive certain programs so that when they were telecast he could tune them in like a free program.

Such a system, it was noted, could be tested in any of the areas that now have community TV cables. When questioned as to the advisability of wiring up a large metropolitan center for such a test, the sponsors claimed that technically this presents no particular problem since similar systems

have been in operation in London and Amsterdam for quite a while.

They admit, however, that there are a number of municipal and private utility problems that would be encountered in getting approval for the use of existing ducts to carry the wired services.

Another proposal that has appeared on the scene recommends the use of dual transmission on a single channel—one part of which would be used primarily for coded or private signals.

It was agreed that subscription-TV was a legal maze over which the experts would be arguing for many months. The FCC will have to decide whether subscription-TV is broadcasting or common-carrier. In a statement issued last year, the FCC declared in a rather broad report that it believed that pay-TV was a broadcast service and could be operated under the present act. However, a number of Congressmen do not believe that this is so and propose to debate the point thoroughly.

TV SET MAKERS and telebroadcasters, a few weeks ago, found themselves faced with another scheme designed to solve the high-band puzzle; this time a completely new channel-shift plan offered by none other than a member of the Commission, Robert E. Lee. He told engineers at the annual meeting of the National Association of Radio and Television Broadcasters that perhaps a consolidation of the bands into one continuous chain running from 60 to 342 megacycles, sliced up into 47 channels, could remove all of the problems that now appear on the low- and high-band scene. Such a rocking reshuffle would alter completely not only the present allocation program, but the complete philosophy behind the post-war spectrum edict.

According to the Commissioner, his idea, offered as a personal recommendation, would eliminate the need for the varied proposals to demix or set up boosters or satellite stations. To accommodate the combined channels, channel 2 would go; FM, now in the 88 to 108-mc. region, would be moved up to the 342-362 mc. band; and all non-broadcast services would be placed either below 60 mc., or above 362. This would mean that the following services would have to be moved: aero-

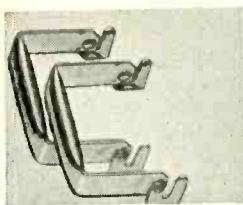

G-C TV CHASSIS SERVICE HANDLES
Safer; sets are easy to carry.
No. 9023 NET \$1.95



G-C PRINT-KOTE SILICONE Resin Spray
Protection for printed circuits.
No. 14-6 NET \$2.17



G-C WEATHER-PROOF SPEAKER CONE DOPE
For drive-in theaters, etc.
No. 9080-8 NET \$0.90



G-C NON-TOXIC ELECTRO-TET Cleaner
Non-flammable, safe, fast drying.
No. 10-G NET \$3.60

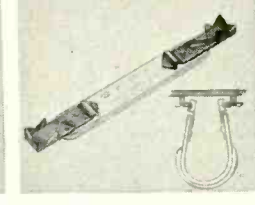

G-C LOW LOSS TV LINE KLIP
One-piece plastic; no springs.
No. 9055 NET \$0.15



G-C TV PICTURE TUBE BOOSTER
Brightens picture tubes.
No. 8910 NET \$1.59

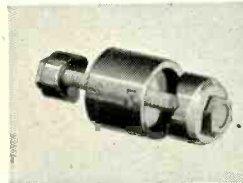

G-C DUAL SHEET METAL PUNCH
Two punches: 7/8" & 1 1/8".
No. 9260 NET \$3.50

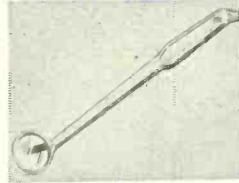

G-C ALL-PLASTIC INSPECTION MIRROR
No danger of shock, shorting.
No. 5090-P NET \$0.36



G-C TEST SOCKET ADAPTER KIT
Contains 4 G-C socket adapters.
No. 9250 NET \$6.75

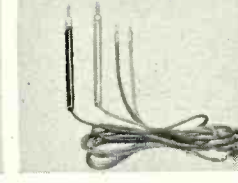

G-C ECONOMY TEST LEADS
Tenite 5" prods. 50" leads.
No. 9190 NET \$0.60



G-C SILVER PRINT
Printed circuit touch-up; pure silver. 1/2 Troy oz.
No. 21-1 NET \$2.37

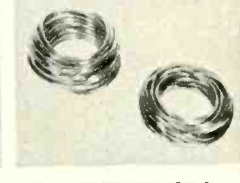

G-C PRINT-KOTE SOLDER
Low melting; non-corrosive flux.
No. 9131 NET \$0.45



G-C 2-WAY HEX RATCHET BOX WRENCHES
Two sizes: 1/4" x 3/8"; 3/8" x 1/2".
No. 9234 NET \$1.95
9235 2.10

GENERAL



CEMENT

Ask For These
RADIO-TV SERVICE AIDS

... at Your Jobber



G-C STANDARD "NO-STRETCH" DIAL CORD
Diameter .028; 25' spool.
No. 88-25 NET \$0.90



G-C PRINT-KOTE SOLDERING FLUX
Liquid flux for printed circuits.
No. 12-2 NET \$0.45

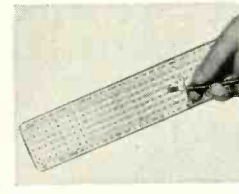

G-C WIRE MARKERS
Self-sticking; pre-cut; 3 strips.
No. 9229 NET \$0.75

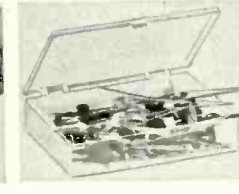

G-C POINTER ASSORTMENT
Includes radial and slide types.
No. 9120 NET \$0.99



G-C TERMINAL STRIP ASSORTMENT
Box of various types.
No. 9129 NET \$0.99



G-C SAFETY SCREWDRIVER
Insulated for hot circuit use.
No. 9209 NET \$0.75



G-C VM 33-1/3 PHONO DRIVE
Replacement set for VM changers.
No. 25-E NET \$0.30

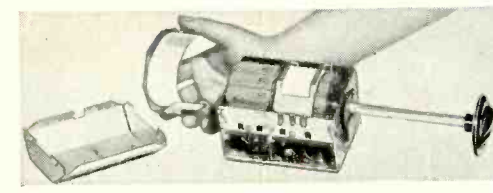

G-C TV TUNER KLEEN-O-MATIC
Cleans, shields Standard coil tuners. Easy to install.
No. 9221 NET \$1.50

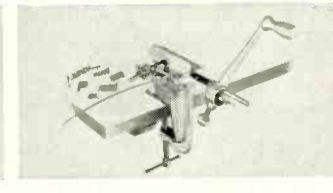

G-C SPEEDEX SPRING WINDER
Make any type spring fast.
No. 5209 NET \$14.95

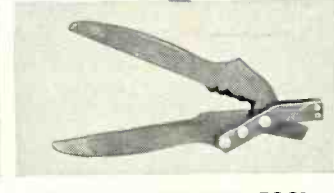

G-C 300-OHM LINE TOOL
Slot, strip, cut twin leads; crimp lugs.
No. 9220 NET \$3.95

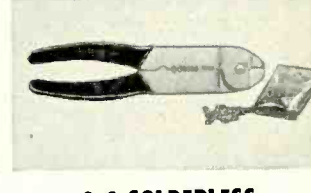

G-C SOLDERLESS TERMINAL REPAIR KIT
Fastener tool and terminals.
No. 8176 NET \$3.95



G-C 6-PC. SCREWDRIVER KIT
Fitted case and complete set.
No. 8615 NET \$1.17

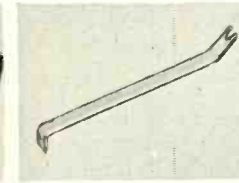

G-C PRY-UP TUBE LIFTER
Protects fingers and tubes.
No. 9213 NET \$0.15

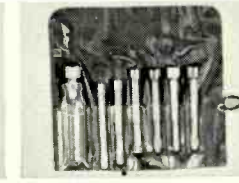

G-C 6-PC. HEX NUT DRIVER KIT
Case with sockets 3/16" to 1/2".
No. 9206 NET \$2.40

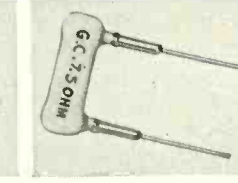

G-C 7.5-OHM FUSE RESISTOR
Replacement for series-wired set.
No. 9207 NET \$0.33

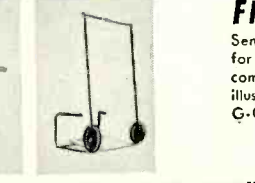

G-C TV "PICTO-VUE" RACK & TRUCK
Easy to use; includes mirror.
No. 9205 NET \$14.95

FREE!
Send postcard for your complete illustrated G-C Catalog

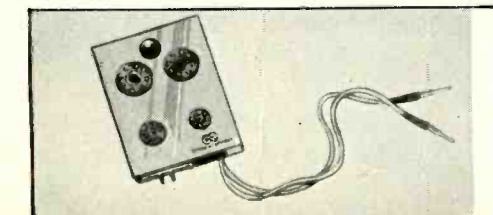

G-C TUBE-CHECKER

Easy-to-use series filament tube checker and continuity tester requires no tube warm-up. Simply plug tube in and get immediate check.
No. 9270 NET \$3.95



GENERAL CEMENT MFG. CO.

904 TAYLOR AVENUE • ROCKFORD, ILLINOIS

ILLINOIS

presents NEW

"HANDEE-PAK" CAPACITOR KITS

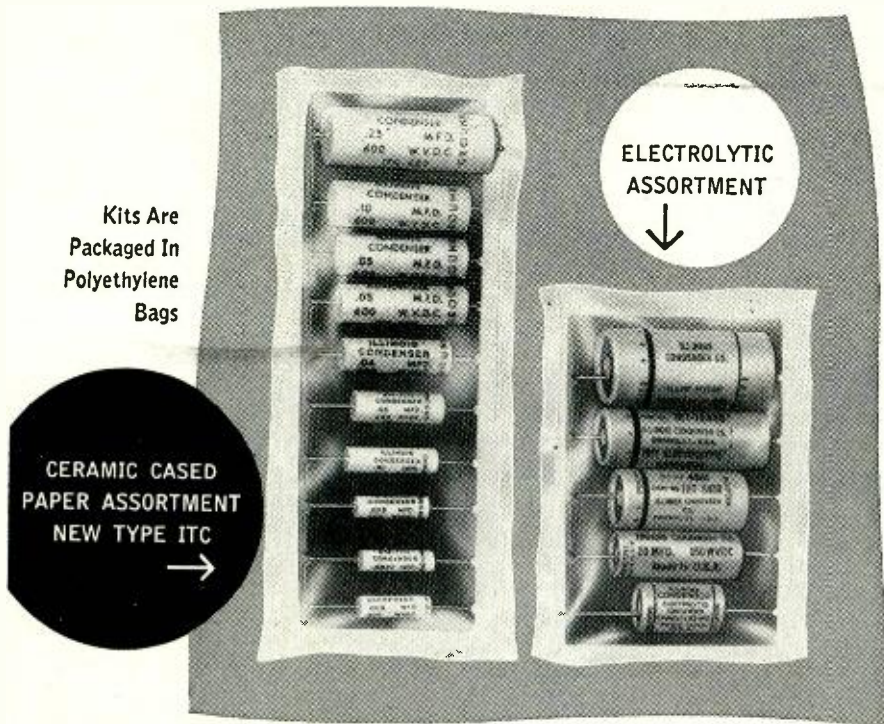

**in popular capacity and voltage ranges—
ultimate in convenience for the serviceman**

Here are two of the new "ILLINI HANDEE-PAK" Assortment Kits now on display at your jobber. Attractively and conveniently packaged on cards and sealed in transparent polyethylene bags, each of the kits contains the most popular capacity and voltage ranges in use by the service industry.

Each of the ELECTROLYTIC "HANDEE-PAK" kits consists of five popular assorted capacitors. The paper capacitor "HANDEE-PAK" kits are made up of ten assorted of the new type ITC oil impregnated ceramic cased capacitors.

These capacitors lead the field in advanced design, superior quality and workmanship and are the ultimate in packaging and convenience. "HANDEE-PAKS" simplify storage, banish shelf-life problems.

A few "HANDEE-PAKS" in your service kit take up little room, serve you by being factory fresh and easily identified. Use them with confidence — millions of capacitors produced to date are your assurance of "Time Tested Quality."

If your jobber cannot supply you at present, drop us a line for full details on the new "HANDEE-PAK" kits. We will also send you latest catalog covering our complete capacitor line.

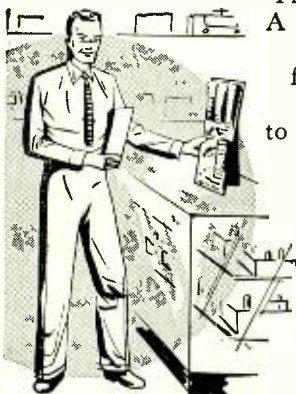

ILLINOIS CONDENSER CO.

1616 N. THROOP STREET. CHICAGO 22, ILLINOIS
THE CAPACITOR LINE OF "Time Tested Quality"

EXPORT 15 Moore Street, New York 4, N. Y. CABLE "Minthorne"

nautical marker beacons and operational fixed, now on 72 to 76 mc.; aeronautical radio navigation and mobile, government, amateur, domestic public, land transportation, industrial, public safety and maritime mobile, now on 108 to 174 mc.; and government, amateur and aeronautical now on 216 to 342 and 342 to 362 mc.

The FCC representative said that he chose 47 channels because during a number of early Commission sessions it was pointed out that a dozen very-high channels and 35 ultra-high channels (each 12 megacycles wide to permit colorcasting) would be sufficient for nationwide coverage. Now that it has been found possible to transmit color on 6-megacycle channels, he felt, the earlier suggestions had even more merit.

Broadcasters didn't seem to feel as optimistic about the move as the Commissioner. One FM operator, who had to change his transmitter when the 45-mc. shift to the 88-mc. zone was authorized, remarked that the new frequency hike would involve an expenditure of well over \$60,000; much too costly for him at the moment. Others said that the Lee plan would seriously affect high-band set sales and conversions and should be shelved immediately, with an official statement from the Commission. As long as the proposal is alive, it was strongly emphasized, we'll have a market slump.

HIGHER POWER and more sensitive receivers were described as the key to the present ultra-high problem by another FCC spokesman; this time the chairman of the Commission, George C. McConaughy.

In an address before another group of NARTB members, he reported that the Commission felt so strongly about the possibilities of super-power and its coverage on the high bands, that the FCC staff had been instructed to initiate rule-making proceedings that would step up the maximum radiated power output from one to five megawatts. The Commission's engineers were also told, he said, to obtain information concerning the possibility of improving the sensitivity of u.h.f. receivers. The broadcasters were informed that these instructions were issued in an effort to . . . "explore the practical possibilities of making u.h.f. and v.h.f. comparable." The rule-making plan, explained the Commissioner, will . . . "offer industry the opportunity to provide practical assistance. . . . These proposals, if successful, offer a potentially more efficient use of the authorized spectrum space."

Noting that he realized that telecasters had been faced with a serious situation, the Commissioner said that he was sure that industry would, in their ever-continuing spirit of cooperation, help develop sound solutions.

"You broadcasters," he recalled, "were beset with many baffling and complex problems in the infancy of broadcasting and you solved them; in
(Continued on page 106)

ROHN NO. 6 TOWER "All-Purpose" Tower

Self-supporting to 50 ft., or guyed to 120 ft. Utilizes mass production techniques to give you lowest prices, yet highest profits for a tower of this type. Ideal for home and industrial requirements. Permanent hot-dipped galvanized coating inside and out. Dependability — a feature customers demand — is assured with the Rohn No. 6 Tower . . . designed to "stand up" for years to the rigors of weather and climatic conditions. Easy to climb for fast, efficient servicing. In 10 ft. sections.

ROHN PACKAGED TOWER "Space Saver" cuts storage space 300% or more!

Popular PT-48 has almost 50' of sturdy tower within a compact 8' x 20" package! "Magic Triangle" design is adapted to a pyramid shape using a wide 19" base with progressively decreasing size upward. Decreases your overhead . . . easy to transport and assemble; cuts shipping costs! Galvanized through-out. Available in heights of 24', 32', 40', 48', 56' and 64'.



Both Towers Feature . . .

1. MAGIC TRIANGLE CONSTRUCTION

Famous wrap-around design with full 1½" corrugated cross-bracing welded to tubular steel legs.

2. INTERLOCKING JOINTS

. . . formed by swaging tower ends so that they overlap each other, becoming a single unit in structure. Proved by tests to be superior.

3. WEATHER SEALED

. . . against condensation and moisture.

4. HOT DIPPED GALVANIZING

. . . both inside and out gives the finest protective coating known. This sales point is one of the best you can offer . . . the finest quality and at lower than competitive prices!

these two **HOT DIPPED GALVANIZED**
Rohn Towers
will satisfy 90% of your TV tower needs!

HEAVY DUTY NO. 30 TOWER

Heights up to 200' or more when guyed
Self-supporting up to 60'

Sturdy communication or TV tower that will withstand heavy wind and ice loading. Heavy gauge tubular steel, electrically welded throughout.

Weather resistant, non-corrosive double coating provides durable finish.

All sections in 10' lengths. Only 2-4 manhours required for installing 50' tower! Tremendous sales potential for you in this tower!

SPECIAL INSULATOR SECTIONS are available to permit the Rohn No. 30 Tower to be used as guyed "series fed" radiators for amateur and commercial uses.

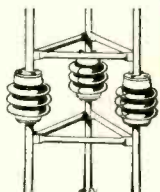

NEW LINE OF ROHN ROOF TOWERS



Four superior designed "Roof Towers" are available for inexpensive, yet sturdy roof installations. 3', 5' and 10' sizes are available. These completely galvanized Rohn Towers have unbeatable sales appeal when this type installation is desired.

for • larger profits • customer satisfaction • greater ease in ordering, handling and shipping

CALL YOUR ROHN REPRESENTATIVE
FOR COMPLETE CATALOG, SALES
LITERATURE AND PRICES — OR WRITE —
PHONE — WIRE DIRECT

HANDLE THE COMPLETE LINE OF ROHN GALVANIZED ACCESSORIES

. . . house brackets, special bases, peak and flat roof mounts, instant drive-in bases, telescoping masts with matching bases, special Rohn Fold-Over Tower, guying brackets, UHF antenna mounts, erection fixtures, variety of mounts and supports for masts or tubing, tower installation accessories, TV service tables, mast and TV hot dipped galvanized tubing, guy rings, etc.

GET ALL YOUR REQUIREMENTS
FROM ONE RELIABLE SOURCE

ROHN Manufacturing Company

116 Limestone Avenue, Bellevue, Peoria, Illinois

The Transistor Age



"Now, where is that audio amplifier?"

You don't need a high powered microscope to examine the "Surprise" trade-in figure offered by Walter Ashe on your used (factory-built) test and communication equipment. For the giant, economy size allowance, get in touch with "Surprise" Trade-In Headquarters today. Wire, write, phone or use handy coupon.

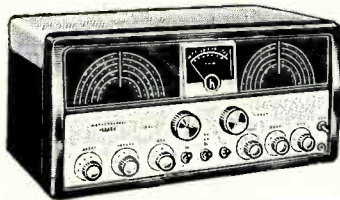

HALLICRAFTERS SX-96
Less speaker. Net \$249.95



HARVEY-WELLS BANDMASTER MATCHING TRANSMITTER AND RECEIVER. Model T-90
Transmitter. 90 watts input. Built-in VFO or crystal. CW and phone. Bandswitching. Six bands 80 through 10 meters. With tubes, less power supply. Net \$179.50

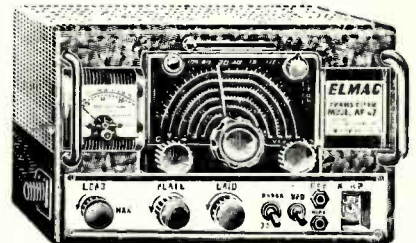

ELMAC AF-67 TRANS-CITER.
Net \$177.00



HAMMERLUND HQ-140X.
Less speaker. Net \$264.50



Model R-9 Receiver. Double conversion. Six bands 80 through 10 meters. 9 tubes. 5 meter. Less speaker
Net \$149.50

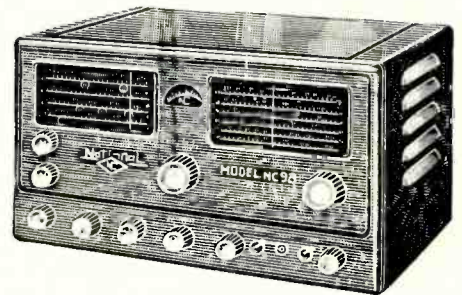

NATIONAL NC-98.
Less Speaker. Net \$149.95

WRITE FOR FULL INFORMATION ABOUT OUR TIME PAYMENT PLAN

All prices f. o. b. St. Louis • Phone CHestnut 1-1125

Walter Ashe
RADIO CO.
1125 PINE ST. • ST. LOUIS 1, MO.

FREE CATALOG!

WALTER ASHE RADIO COMPANY R-8-55

1125 Pine Street, St. Louis 1, Missouri

Rush "Surprise" Trade-In Offer on my _____

for _____
(show make and model number of new equipment desired)

Send latest Catalog.

Name _____

Address _____

City _____ Zone _____ State _____

**Send
for
your
copy
today**

YOU MUST PLEASE
women
YOUR CUSTOMERS
IF YOU WANT
TO MAKE YOUR
BUSINESS GROW

It's a woman you have to please in 76.9% of your service calls.

You'll please more women when you use tubes with the Good Housekeeping Guaranty Seal . . . CBS tubes.



CBS tubes are advertised and merchandized to millions of women in national magazines . . . and on Arthur Godfrey's Talent Scouts over nationwide TV and Radio networks.

More and more women will have greater confidence in you and your service when you use tubes with the Good Housekeeping Seal . . . tubes with the respected name — CBS.

*Ask your distributor for
CBS tubes*





CBS-HYTRON

Danvers, Massachusetts

A DIVISION OF
 COLUMBIA BROADCASTING SYSTEM, INC.

3 *** CR**
MORE NEW
TRIAD
*** CORRECT**
REPLACEMENT
FLYBACKS

These three new flybacks are mechanically correct and electrically correct, ruggedized versions of manufacturer's items — precisely engineered by **TRIAD** for specific makes and models — to give exceptionally high performance and long, trouble-free service.

 D-52 List Price \$7.15 *Correct Replacement for RCA 75519, 75585, 76381.	 D-53 List Price \$7.45 *Correct Replacement for RCA 76501, 76672.	 D-56 List Price \$9.50 *Correct Replacement for Airking, CBS, Silver- tone, 10104, 10107, 10108, 10110, 10126, 10135.
---	--	--



**** COMPOSITE**
REPLACEMENT

Triad flybacks wherever possible are **COMPOSITE** items designed to provide correct electrical and mechanical characteristics for as many television chassis as possible.

Ask your distributor, or write, for Catalog TV-155A

Triad *CR Transformers are listed in Sams Photofact folders and Counter-Facts.



TRIAD
 TRANSFORMER CORP.
 4055 Redwood Ave. • Venice, Calif



Within the
Industry



DANIEL R. VON RECKLINGHAUSEN has been appointed chief research engineer of *Hermon Hosmer Scott, Inc.*, Cambridge, Mass. manufacturer of acoustic measuring instruments and sound reproduction equipment.



He received his degree from Massachusetts Institute of Technology where he was elected to Tau Beta Pi, Sigma Xi, and Eta Kappa Nu, honorary engineering societies.

Prior to his study and work at M.I.T., Mr. von Recklinghausen had experience with *Rohde and Schwarz* of Munich in the design and development of u.h.f. test gear and allied instrumentation. He joined *H. H. Scott, Inc.* in 1951. Until his new appointment, he served as senior project engineer for the firm.

CHARLES GOLEMPAL, vice-president in charge of distributor sales for *Aerovox Corporation*, was elected chairman of the Sales Managers Club of New York.

He was one of the founders of the club in 1935 and served as the organization's chairman for two terms in 1935 and 1937. The Club is one of the sponsors of the annual Radio Parts Show in Chicago.

ROBERT C. OVERSTREET has been elected president of *Tinnerman Products, Inc.*, succeeding George J. Schad who has retired.



He has been associated with the company since 1941 and has served as executive vice-president since 1953. He was named assistant to the vice-president and general manager in 1945 and was made secretary in 1948. He was elected a vice-president and to the board of directors and re-elected secretary in April 1952.

Serving as secretary and treasurer of the firm under Mr. Overstreet is John E. Potter who was formerly comptroller of the firm. He was also named to the board of directors.

NATIONAL ELECTRONIC DISTRIBUTORS ASSOCIATION has moved its headquarters to 4704 W. Irving Park Road in Chicago . . . **ELECTRA MANUFACTURING COMPANY** of Kansas City, Mo. has moved its sales and executive offices to 4051 Broadway. Its engineering and

production facilities have been transferred to a new plant on a 10-acre site at 800 N. 21st Street, Independence, Kans. . . . **ASSEMBLY PRODUCTS INC.** of Chesterland, Ohio is establishing a Southern California plant which will be located on a 40-acre site on Dillon Road, five miles southeast of Desert Hot Springs . . . **LENKURT ELECTRIC CO. OF CANADA, LTD.** is building a new \$200,000 factory and office building in Burnaby near Vancouver, B.C. Completion is scheduled for early 1956 . . . **RUST INDUSTRIAL COMPANY**, manufacturer of remote control units for radio station transmitters, has built a new one-story air-conditioned plant in Manchester, N. H. . . . Construction of a 203,874 square foot plant to be occupied by **RAYTHEON MANUFACTURING COMPANY** has begun in Melrose Park, Illinois. The building will be the nucleus of manufacturing and warehousing facilities the company expects to expand later on the 624,000 square foot site . . . **ESPEY MFG. CO., INC.** has expanded its engineering and production facilities and consolidated these facilities at the firm's Saratoga, N.Y. plant for greater efficiency . . . **TYLER-EVANS, INC.**, manufacturer of transformers and coils, has opened a new factory at Antioch, Illinois.

JOHN M. MILLER, JR. has been named to fill the newly-created position of director of engineering of the television and broadcast receiver division of *Bendix Aviation Corporation*.



The new position was made necessary by the firm's expanding program and added activities in connection with the development of color television.

Formerly chief engineer of the firm, Mr. Miller joined the company eight years ago. During World War II he was a radio and radar engineer at the Naval Research Laboratory and the Navy Bureau of Ships.

He will be assisted in his new duties by Stanley R. Scheiner who has been named second-in-command.

EXPOSITION MANAGEMENT ASSOCIATION has been formed in New York for the purpose of instituting an active public relations program aimed at clarifying and promoting the value of the billion-dollar-a-year trade show industry to exhibitors, trade buyers, and consumers and serving as a management-labor clearing house for its members.

A diversified group of 28 trade show
RADIO & TELEVISION NEWS

PUT YOURSELF IN THE *High-Paying* TELEVISION PICTURE

R
Radio
T
Television
T
Training
A
Association

Today, when demand for trained men is higher than ever before, pay is higher than ever before, you can train AT HOME in your SPARE TIME to become a Television Technician.



L. C. Lane, B.S., M.A.
President, Radio-Television Training Association. Executive Director, Pierce School of Radio & Television.

PREPARE FOR A BRIGHTER FUTURE AS A TV TECHNICIAN

You can hold down a full-time job and still train AT HOME by the same successful methods I used to help hundreds of men—many with no more than grammar school training—master television!

NO EXPERIENCE NEEDED . . . I'LL TRAIN YOU AT HOME IN YOUR SPARE TIME

VETERANS!

My School fully approved to train veterans under new Korean G.I. Bill. Write discharge date on coupon.

**GOOD
SPARE TIME
EARNINGS**

Almost from the very start you can earn extra money while learning by repairing radio-TV sets for friends and neighbors. Many of my students earn up to \$25 a week . . . pay for their entire training from spare time earnings . . . start their own profitable service business.

**EXPERT FM-TV
TECHNICIAN
TRAINING**

My FM-TV Technician Course can save you months of training if you have previous Armed Forces or civilian radio experience! Train at home with kits of parts, plus equipment to build BIG SCREEN TV RECEIVER. ALL FURNISHED AT NO EXTRA COST!

**NEW!
PRACTICAL TV
CAMERAMAN &
STUDIO COURSE**

(For men with previous radio & TV training)
I train you at home for an exciting big pay job as the man behind the TV camera. Work with TV stars in the TV studios or "on location" at remote pick-ups! Available if you want it . . . one-week course of practical work on TV studio equipment at Pierce School of Radio & TV, our associate resident school in New York City.

**OPTIONAL:
2 WEEKS TRAINING
IN NEW YORK CITY
AT NO EXTRA COST**

You get two weeks, 50 hours, of intensive laboratory work on modern electronic equipment of our associate school in New York City — Pierce School of Radio and Television. And I give you this AT NO EXTRA COST whatsoever, after you finish your home study training in the Radio-FM-TV Technician Course and FM-TV Technician Course. However, your home study course is complete even without this two-week laboratory session. It is only one of the many Extras available to you from RTTA if you want it.



C-W Telephone Transmitter



RF Signal Generator



Super-Het Radio Receiver



Public Address System



Combination Voltmeter-Ammeter-Ohmmeter



ENOUGH EQUIPMENT TO SET UP YOUR OWN HOME LABORATORY

As part of your training, I give you all the equipment you need to prepare for BETTER PAY TV job. You build and keep a professional GIANT SCREEN TV RECEIVER complete with big picture tube (designed and engineered to take any size up to 21-inch) . . . also a Super-Het Radio Receiver, RF Signal Generator, Combination Voltmeter-Ammeter-Ohmmeter, C-W Telephone Transmitter, Public Address System, AC-DC Power Supply. Everything supplied, including all tubes.

FREE FCC COACHING COURSE

Qualifies you for Higher Pay! Given to all my students AT NO EXTRA COST after TV Theory and Practice is completed. Helps you qualify for the TOP JOBS in Radio-TV that demand an FCC License! Full training and preparation at home for your FCC License.

MY 4 FREE AIDS SHOW YOU HOW AND WHERE TO GET A BETTER PAY JOB IN TELEVISION.

See for yourself how my simple, practical methods can make success as easy for you as they have for my hundreds of graduates.

MAIL THIS COUPON TODAY! *no salesman will call!*

Mr. Leonard C. Lane, President
RADIO-TELEVISION TRAINING ASSOCIATION Dept. T-8
52 East 19th Street, New York 3, N. Y.

Dear Mr. Lane: Mail me your NEW FREE BOOK, FREE SAMPLE LESSON, and FREE aids that will show me how I can make BIG MONEY IN TELEVISION. I understand I am under no obligation and no salesman will call.

(PLEASE PRINT PLAINLY)

Name _____ Age _____

Address _____

City _____ Zone _____ State _____

I AM INTERESTED IN:

- Radio-FM-TV Technician Course
 FM-TV Technician Course
 TV Cameraman & Studio Technician Course

VETERANS!
Write discharge date

Radio Television Training Association

52 EAST 19th STREET • NEW YORK 3, N. Y.

Licensed by the State of New York • Approved for Veteran Training

August, 1955

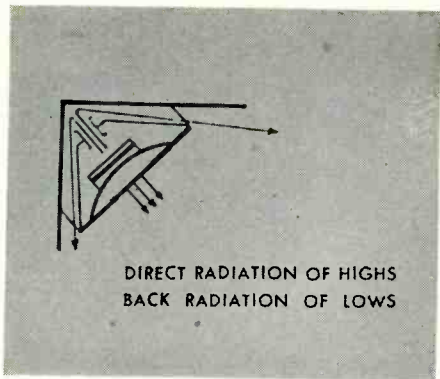

8" or 12" speakers

THE
Rebel* 5

A KLIPSCH CORNER FOLDED HORN OF MINUTE PROPORTIONS!

An amazing 20' high, the Rebel 5 design involves a cavity (capacitance); a slot (inertance) and a corner horn to provide back loading for a direct radiator speaker. The middle and extreme high ranges are preferably reproduced with corresponding horns and the resulting 3-way speaker system can be squeezed into the tiny space.

Reduction in size of speaker structure sacrifices one or more of the following: the maximum wavelength the system can produce; the smoothness of response (reduction of size invariably produces peaks in the bass range); introduction of distortion because of extreme diaphragm excursion if the enclosure is too small (this is usually associated with peaked response). All Rebels necessarily violate these principles. The trick in retaining a high level of quality typical of Rebel design is to coordinate the design of the low-pass filter with the short length of horn exterior to the housing and to introduce an effective cut-off of gradual slope such that the output, instead of becoming highly distorted in the extreme bass range, merely attenuates without presenting frequency doubling and resultant intermodulation of high frequencies.

* Trade Mark

Dimensions: 21" H, 16 5/8" W, 14" D.



truly..
a little
monster

— based upon the same
corner horn principles
as the Klipschorn

KR-5-U Utility	KR-5	KR-5-Portable
Unfinished \$33.00	\$48.00	Leatherette \$48.00

all prices slightly higher west and south

an
exclusive
manufacture



by Cabinart

75 North 11th Street
Brooklyn, N. Y.

managers took part in the organization. *Allen Bryson Associates, Inc.*, 551 Fifth Avenue, New York 17, N. Y. is acting as public relations counsel and clearing house for the new association.

* * *

WALTER A. WEISS has been named general manager of the radio tube division of *Sylvania Electric Products Inc.* at Emporium, Pa. Herbert A. Ehlers has been named to succeed him in the post of general manufacturing manager of the same division.



Mr. Weiss, who had been general manufacturing manager of the division since 1952, succeeds Matthew D. Burns who was recently promoted to the post of vice-president-operations and general manager in charge of the company's electronic tube operations. He will make his headquarters in Emporium, Pa.

* * *

MICAMOLD RADIO CORP. has changed its corporate name to **MICAMOLD ELECTRONICS MANUFACTURING CORPORATION** in order to more accurately reflect the firm's position as a supplier of capacitors to the entire electronics industry. . . . **INSTRUMENTS FOR INDUSTRIES, INC.** will henceforth be known as **INSTRUMENTS FOR INDUSTRY, INC.** No other changes in corporate structure are contemplated. . . . **RADELCO MANUFACTURING CO.**, Cleveland antenna manufacturer, has changed its corporate name to **TENNA MANUFACTURING COMPANY**. Headquarters are at 7580 Garfield Blvd.

* * *

LEONARD C. TRUESDELL has been named vice-president and director of sales for *Zenith Radio Corporation*. He joined the company in 1949 as sales manager in the home instrument field and, until recently, has been vice-president in charge of radio and TV sales.



Prior to joining *Zenith*, Mr. Truesdell served as vice-president in charge of marketing for *Hotpoint* where he completely rebuilt the company's national sales organization within a three-year period.

He succeeds H. F. Bonfig, who recently resigned, in his new post.

* * *

PHILCO CORPORATION has created a new division to be known as the **LANSDALE TUBE AND TRANSISTOR COMPANY** for the manufacture of electron tubes and transistors. The division's main plant is at Lansdale, Pa. . . . A Community TV Cable Service Section has been created by **FEDERAL TELEPHONE AND RADIO COMPANY** of Clifton, N.J. The new section will offer technical information and associated services to

(Continued on page 82)

RADIO & TELEVISION NEWS



...from start



...to finish

...and step by step

Become a top-notch television service technician

Now . . . RCA INSTITUTES offers modern TV KIT with Comprehensive Television Servicing Course

START to build with a TV Kit developed by one of America's foremost radio-tv schools—RCA Institutes. LEARN with simple step-by-step instruction how to build a modern, large-screen receiver. TEST each stage, as you build, and see how it works. Learn how "trouble-shooting" is applied. FINISH your Home Study Course ready and able to service all make and model sets!

Easy-to-follow instructions are planned and prepared for you through the efforts of RCA Institutes' instructors, engineers at RCA Laboratories, and training specialists of the RCA Service Company.

The RCA Institutes' TV Kit utilizes up-to-date circuits including:

- *Synchro-Guide horizontal automatic frequency control circuit.*
- *Horizontal magnetic reaction scanning.*
- *Latest deflection circuits.*
- *FM sound discriminator.*
- *High-gain, low-noise cascode tuner.*

Join the many thousands who have been successfully trained by RCA Institutes for a good job (or business of their own) in television servicing.

BASIC KNOWLEDGE OF RADIO NECESSARY
NO NEED FOR PREVIOUS TV TRAINING



RCA INSTITUTES, INC.
A SERVICE OF RADIO CORPORATION OF AMERICA
350 WEST FOURTH STREET, NEW YORK 14, N.Y.

FREE BOOKLET! MAIL COUPON NOW.

RCA INSTITUTES, INC., Home Study Dept. NK-8-55
350 West Fourth Street, New York 14, N.Y.

With no obligation on my part, please send me a copy of your booklet on the TV Servicing Home Study Course and Kit. I understand no salesman will call.

Name: _____ (Please print)

Address: _____

City: _____ Zone: _____ State: _____

LAFAYETTE'S SPECTACULAR MONEY SAVERS

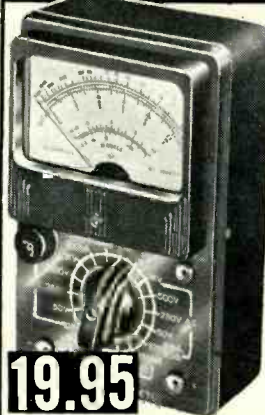

HIGH SENSITIVITY AC-DC MULTITESTER

20,000 ohms per Volt

The new Lafayette High Sensitivity Multitester is a complete instrument (not a kit). Here is an instrument packed with every desirable feature found only in instruments costing twice as much. One of the most sensitive multimeters ever offered. 20,000 ohms per volt DC; 8,000 ohms AC, having a high sensitivity 45 microamps meter. Full scale AC-DC voltage ranges are 0-10V, 0-50V, 0-250V, 0-500V, 0-1000V; DC current ranges 50 microamps, 2.5 ma, 25 ma, 250 ma. Resistance: 0-5K ohms, 0-50K ohms, 0-500K and 0-5 megohms. Decibel range: -20 +5 db; +5 +22 db (0 db -0.775V - 600 ohms). Extreme versatility and accuracy. 1% precision resistors; 3" meter; beautiful plastic front, with metal bottom for ruggedness. Size: 3 3/4" x 5 3/4" x 2 3/4". Complete with batteries and leads. Shpg. wt. 1 lbs.

19.95

Model RW-306 NET 19.95

In lots of 3 19.25

NEW POCKET AC-DC VOM MULTITESTER

1,000 ohms per Volt

This instrument is one of the best buys that Lafayette has ever offered in a wide range AC-DC MULTITESTER. An ideal portable unit that meets the need for a compact, yet rugged test instrument. Has ease of operation usually FOUND ONLY IN MORE EXPENSIVE INSTRUMENTS. Has 1000 ohms/volt sensitivity on both AC or DC. Uses full 3" rectangular meter with large easy to read scale. Uses 1% precision resistors, jeweled D'Arsonval microamp meter movement. Ranges: AC-DC and output volts 0-5, 0-25, 0-250, 0-1000V; DC current 0-1, 0-10, 0-100, MA; Resistance 0-10K and 0-100K ohms. In handsome sturdy bakelite case. Size: 4 3/4" x 3 3/4" x 1 3/4". Supplied complete with test leads and batteries. A must for every serviceman, shop, laboratory or experimenter—and at Lafayette's Price you can afford to own one. Shpg. Wt. 2 1/2 lbs.



9.95

Model RW-27C—Complete In Lots of 3 9.45 Single, ea. 9.95

WEBSTER • GARRARD • COLLARO

3-SPEED—HI-FI RECORD CHANGER

Now Lafayette makes it possible for you to save money on the three most popular makes of 3 speed Record changers.

WEBCOR Diskchanger: It's completely automatic, 33 1/3, 45 and 78 RPM, automatic shut off after last Record, balanced tone arm, etc. Size 13 3/8" x 12 x 8 1/4". Shpg. Wt. 16 lbs.

Stock No. PK-49—With Dual Turnover Cartridge..... 26.50

Stock No. PK-46—With G.E. RPX 050 Triple Play Cartridge... 29.50



COLLARO, THE WORLD'S FINEST 3 SPEED INTERMIX CHANGER: Collaro Model 3/532—3 speed Intermix changer designed and engineered to meet the most exacting requirements of the finest audio systems: While our stocks last. Shpg. Wt. 23 lbs. with G.E. RPX—050 Triple play cartridge...Net 34.50

With G.E. RPX—052A Triple play latest Golden Treasure cartridge with Diamond and Sapphire styli installed Net 44.95

Collaro RC-54: Latest Collaro 3 speed Intermix less cartridge..... Net 47.77

With G.E. RPX—050 Triple play cartridge..... Net 49.95

With G.E. RPX—052A Triple play Golden Treasure cartridge with Diamond and Sapphire styli installed Net 59.95

Garrard Model RC-80 3 speed Record changer less cartridge..... Net 48.51

Model RC-80 with G.E. RPX—050 Triple play Cartridge..... Net 51.95

Model RC-80 with G.E. RPX—052—A latest triple play Golden Treasure cartridge with Diamond and Sapphire styli installed..... Net 62.53

Lafayette Greatest Tape Buy Ever!



1200 FT. REEL
Genuine Plastic Base
RECORDING TAPE
Shpg. Wt. 14 oz.

\$1.89 per roll plus postage (C.O.D. accepted)

LAFAYETTE made a terrific deal with one of the leading manufacturers of recording tape to supply us with their regular tape which sells for almost twice our price. WE GUARANTEE ABSOLUTE SATISFACTION OR YOUR MONEY BACK. The finest, professional-quality recording tape obtainable. Highest performance for thousands of playings. Red Oxide Base in a smooth, uniform coating; greater signal strength; with maximum fidelity; uniform frequency response from 40-15,000 cps.

In lots of 10 rolls - 1.75 ea

REMOTE CONTROL FOR SILENT TV VIEWING

- For Hard-of-Hearing
- For Late Listening

The hard-of-hearing can listen to radio or TV without turning the volume so high that others can't stand the noise. They can listen with loud speaker cut off, or if others want to listen with normal speaker volume. Excellent for noisy programs. Let the Kids listen and view with speaker cut off. Comes complete with miniature phone, fits snugly in ear, 20 feet of cable and instructions.

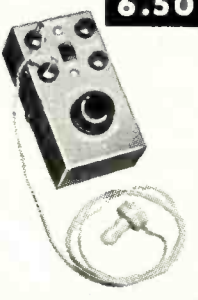

6.50

MS-125 6.50
TWO CAN LISTEN WITH ADDITIONAL EAR PHONE 1.95

High Output Dynamic Microphone

List Price \$47.00
\$12.95

High quality Dynamic microphone exceptionally fine for Public address recording, etc. Flat response 60-10,000 cps. Impedance 40,000 ±15% at 1,000 cps. Output level -55 db. Die cast metal case equipped with 6 ft. of shielded cable. Shpg. wt. 3 lbs.

TOP QUALITY CRYSTAL MICROPHONE

COMPARE IT WITH ANY MIKE AT 2 TO 3 TIMES THE PRICE

A quality crystal Microphone for PA systems, house recorders, etc. Frequency response 30 to 10,000 cycles. Output level -52 db. Provides ample output for use with low gain amplifiers. Complete with 5 ft. of shielded cable. Shpg. wt. 3 1/2 lbs.

LAPEL MICROPHONE

REGULAR \$14.00 VALUE!
• FULL -55 db.
• OUTPUT LEVEL
• IDEAL GENERAL PURPOSE MIKE!

2.95

Specialty engineered crystal Microphone. Attaches to lapel. Only 1 3/8" in diameter. Exceptional frequency response. Output level -55 db. chrome plated case and clip for attaching to lapel. Includes 5 ft. of shielded cable. Shpg. wt. 1 lb.

PM SPEAKERS—FINE QUALITY ALNICO V MAGNET

4" P M—3.2 ohm SK-11	1.59
5" P M—3.2 ohm SK-12	1.69
6" P M—3.2 ohm SK-13	2.19
6 x 9 P M—3.2 ohm SK-17	3.15
12" P M—RCA—12 Watt—6.8 ohm ALNICO V Magnet	5.25
6.8 ohm SK-40	5.25
12" COAXIAL P M SPEAKER SK-22	9.75

SONOTONE 9980-S

TURNOVER CERAMIC PHONO CARTRIDGE WITH DUAL SAPPHIRE NEEDLES

REPLACEMENT FOR COLUMBIA 360—VM—WEBSTER AND CRESCENT RECORD CHANGERS

SPECIFY STOCK NO. PK-40
In lots of 5, each... 3.50 Single, each... 3.98

TRANSISTOR 455KC I.F. 1/2"x1/2"x3/4" M

This tiny I.F. is the same as used in the transistorized sets of the leading manufacturers. Ideal for building miniature equipment.



MS-126—Single, each..... 89c
In lots of 10, each..... 79c

TWO TRANSISTOR RADIO RECEIVER KIT

Essential parts, I-loopstick, 2-gang variable condenser; 2-G.E. 2N107 Transistors, 1 Volume control, 1 Argonne transistor audio transformer, resistors condensers, Batteries and I-Dynamic Ear phone.

KT-50..... 9.74

TRANSISTOR CODE PRACTICE OSCILLATOR KIT

Build your own. Miniature size, code practice oscillator complete parts 1, G.E. 2N107—transistor, 3-1/2 watt resistors, 1-Volume Control, 2-condensers; and Batteries, and instructions.....

Net 2.49

Telegraph Key..... 89c

Dynamic ear phone..... 1.95

RAYTHEON TRANSISTORS

CK-722—Singly, each..... 2.10
—In lots of 10, each..... 1.95



CK-721—Singly, each..... 2.40
—In lots of 10, each..... 2.25

NEW GE TRANSISTOR TYPE 2N107

1.25

HIGH FIDELITY AMPLIFIER KIT

10 WATT — BUILT-IN PREAMPLIFIER For G.E. Reluctance Cartridge

FREQUENCY RESPONSE: 20-20,000 CYCLES

Designed for installations where high quality reproduction is required. Separate tone controls for bass and treble. Inverse feedback circuit. Specifications: Power Output 10 watts or 32 db less than 3% distortion. Frequency Response: 20 to 20,000 cps ± 1 db. Tone Control: produces maximum bass boost of + 8 db at 100 cps. Treble Control produces maximum treble boost + 10 db at 10,000 cycles. Hum: -70 db below rated output. Tube Complement: 1-6SL7, 1-6SL7, 2-6V6GT, 1-3Y3GT. Power Consumption 70 watts 110-120 volts 60 cycles. Shpg. Wt. 15 lbs. Complete with 3D diagrams and instructions.

KT-23—Complete with tubes..... Net 19.95

FREE RADIO CATALOG

send for it

GET LAFAYETTE'S NEW CATALOG PACKED WITH THE LARGEST SELECTION OF QUALITY ELECTRONICS EQUIPMENT AT BARGAIN PRICES.

Lafayette Radio

NEW YORK, N.Y. 100 Sixth Ave.
BRONX, N.Y. 542 E. Fordham Rd
NEWARK, N.J. 24 Central Ave.
PLAINFIELD, N.J. 139 West 2nd St.
BOSTON, MASS. 110 Federal St.

Te-Speed Shipment on Your Order Please Mention

DEPT. RH

Remit by Check or Money Order. Include sufficient money for Postage. We Refund unused amounts.



Carl E. Smith, E. E.
President

Want To DOUBLE YOUR PAY?

How To Pass FCC COMMERCIAL RADIO OPERATOR EXAMINATIONS

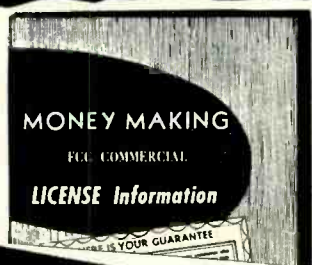

**TELEVISION
ENGINEERING**
Included in our
Training and coaching

GET THIS AMAZING NEW BOOKLET FREE!

TELLS HOW ...

WE GUARANTEE

TO TRAIN AND COACH YOU AT
HOME IN SPARE TIME UNTIL YOU GET

YOUR FCC LICENSE

If you have had any practical experience—Amateur, Army, Navy, radio repair, or experimenting.

HERE IS YOUR GUARANTEE

If you fail to pass your Commercial License exam after completing our course, we guarantee to continue your training without additional cost of any kind, until you successfully obtain your Commercial license.

An Approved Member



TELLS HOW ...

Our Amazingly Effective JOB-FINDING SERVICE

Helps CIRE Students Get Better Jobs

Here are a few recent examples of Job-Finding results:

BROADCASTING

"Your 'Chief Engineer's Bulletin' is a grand way of obtaining employment for your graduates who have obtained their 1st class license. Since my name has been on the list I have received calls or letters from five stations in the southern states, and am now employed as Transmitting Engineer at WMMT."
Elmer Powell, Box 274, Sparta, Tenn.

CIVIL SERVICE

"I have obtained a position at Wright-Patterson Air Force Base, Dayton, Ohio, as Junior Electronic Equipment Repairman. The Employment Application you prepared for me had a lot to do with my landing this desirable position."
Charles E. Loomis, 4516 Genessee Ave., Dayton 6, Ohio

AIRLINES

"Due to your Job-Finding Service, I have been getting many offers from all over the country, and have taken a job with Capital Airlines in Chicago, as Radio Mechanic."
Harry Clare, 4537 S. Drexel Blvd., Chicago, Ill.

Your FCC Ticket is recognized by employers as proof of your technical ability.

TELLS HOW ...

Employers Make JOB OFFERS Like These to Our Graduates Every Month!

Letter from nationally-known Airlines:

"Radio Operators and Radio Mechanics are needed for our company. Periodic wage increase with opportunity for advancement. Both positions include many company benefits such as paid vacations, free flight mileage allowance and group insurance."

Letter from nationally-known Manufacturer:

"We have a very great need at the present time for radio-electronics technicians and would appreciate any helpful suggestions that you may be able to offer."

These are just a few examples of the job offers that come to our office periodically. Some licensed radioman filled each of these jobs . . . it might have been you!

HERE'S PROOF FCC LICENSES ARE OFTEN SECURED IN A FEW HOURS OF STUDY WITH OUR COACHING AT HOME IN SPARE TIME

Name and Address	License	Time
Harry G. Frame, Box 429, Charlestown, W. Va.	2nd Class	13 Weeks
Charles Ellis, Box 449, Charles City, Iowa	1st Class	28 Weeks
Omar Bibbs, 1320 E. 27th St., Kansas City, Mo.	1st Class	34 Weeks
Kenneth Rue, Dresser, Wisconsin	2nd Class	20 Weeks
B. L. Jordan, Seattle, Washington	1st Class	20 Weeks

CLEVELAND INSTITUTE OF RADIO ELECTRONICS

Carl E. Smith, E. E., Consulting Engineer, President
Desk RN-79, 4900 Euclid Bldg., Cleveland 3, Ohio

OURS IS THE ONLY HOME STUDY COURSE WHICH SUPPLIES FCC-TYPE EXAMINATIONS WITH ALL LESSONS AND FINAL TESTS.



MAIL COUPON NOW

CLEVELAND INSTITUTE OF RADIO ELECTRONICS
Desk RN-79—4900 Euclid Bldg.
Cleveland 3, Ohio
(Address to Desk No. to avoid delay.)

I want to know how I can get my FCC ticket in a minimum of time. Send me your FREE booklet, "How to Pass FCC License Examinations" (does not cover exams for Amateur License), as well as a sample FCC-type lesson and the amazing new booklet, "Money-Making FCC License Information."

Be Sure to tell me about your television engineering course.

Name
Address
City Zone State

For prompt results, send air mail.
Special tuition rates to members of the U. S. Armed Forces.

STROMBERG-CARLSON®

Specifies

EICO

TEST INSTRUMENTS

38 KITS — 42 Wired Instruments



NEW #232 Peak-to-Peak VTVM with DUAL-PURPOSE AC/DC UNI-PROBE (pat. pend.)
KIT \$29.95
WIRED \$49.95



VACUUM TUBE VOLTMETER #221
KIT \$25.95
WIRED \$39.95
DELUXE VTVM (with 7 1/2" METER)
#214 KIT \$34.95
WIRED \$54.95

5" PUSH-PULL OSCILLOSCOPE #425
KIT \$44.95
WIRED \$79.95

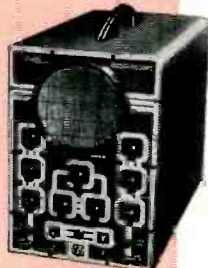

NEW #470 7" PUSH-PULL OSCILLOSCOPE
KIT \$79.95
WIRED \$129.50



CRA...
\$4.50

TUBE TESTER #625
KIT \$34.95
WIRED \$49.95



NEW #944 FLYBACK TRANSFORMER & YOKE TESTER
KIT \$23.95
WIRED \$34.95



RF SIGNAL GENERATOR #320
KIT \$19.95 WIRED \$29.95



TV/FM SWEEP GENERATOR #360
KIT \$34.95
WIRED \$49.95



DELUXE RF SIGNAL GENERATOR #315
KIT \$39.95
WIRED \$59.95

5MC-4.5 MC CRYSTAL
\$3.95 ea.

A PROBE FOR EVERY PURPOSE
KIT—WIRED
\$2.75 and up

©55

COLOR
and Monochrome TV set testing with speed,
accuracy, and economy . . .

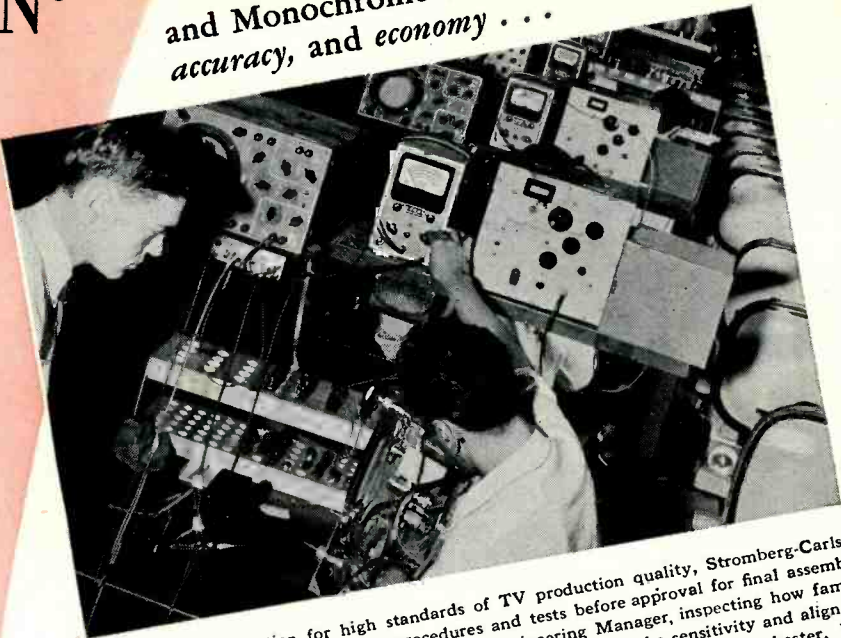

To maintain its reputation for high standards of TV production quality, Stromberg-Carlson subjects its TV receivers to stringent procedures and tests before approval for final assembly. Photo shows Harold P. Field, Test Equipment Engineering Manager, inspecting how famous EICO #221 VTVMs, at all vital TV Alignment Positions, check the sensitivity and align the IF amplifiers of all Color and Monochrome sets—at Stromberg-Carlson's Rochester, New York plant.

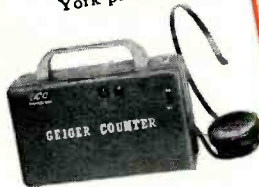

NEW! GEIGER COUNTER #803
KIT \$19.95 WIRED \$29.95
Super-sensitive: detects .05 mr/hr & ore having even .01% uranium. With radioactive sample. (Less 2-67 1/2 v. & 2-1 1/2 v. batteries)



NEW! SENSATIONAL! Wide Band 5" SCOPE #460+
KIT \$79.95 WIRED \$129.50
DC to 5 mc. flat to 4.5 mc. Vert. sens.: 25 mv/in. Push-pull thruout.



NEW! WORLD'S BEST GENERATOR BUY! RF SIG. GEN. #324
KIT \$26.95 WIRED \$39.95
Covers whole range of 150 kc-435 mc. Freq. accuracy: ±1.5%. 6:1 vernier tuning knob & excellent spread.

NEW! BATTERY TESTER #584 KIT \$9.95 WIRED \$12.95

Write for FREE Catalog R-8



MULTI-SIGNAL TRACER #145
KIT \$19.95
WIRED \$28.95



6V & 12V BATTERY ELIMINATOR & CHARGER #1050
KIT \$29.95
WIRED \$38.95



R-C BRIDGE & R-C-L COMPARATOR #950B
KIT \$19.95
WIRED \$29.95



1,000 Ohms/Volt MULTIMETER #536
KIT \$12.90
WIRED \$14.90



20,000 Ohms/Volt MULTIMETER #565
KIT \$24.95
WIRED \$29.95

EICO®

ELECTRONIC INSTRUMENT CO., Inc.
84 Withers Street • Brooklyn 11, N. Y.

Prices 5% higher on West Coast

TECHNIQUES OF RECORDING WILDLIFE

By WILLIAM GILMAN

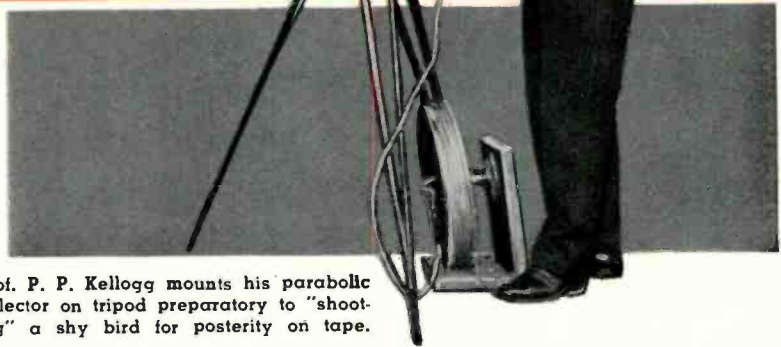

Prof. P. P. Kellogg mounts his parabolic reflector on tripod preparatory to "shooting" a shy bird for posterity on tape.

YEARS ago people discovered that it was as much fun to go "hunting" with a camera as it was with a gun. It was a painless bit of conservation, too, since it was possible to "shoot" the same game over and over again. Now there is an added attraction. Sound is beginning to move in on sight. Thanks to the tape recorder and such special auxiliary equipment as a parabolic reflector, Nature's sounds can be captured with a fidelity that charms the hi-fi fan as well as serves the scientist.

Just as with photography, best results come from those Siamese twins—good equipment and smart techniques. Neither can do the job alone but, fortunately, both can be acquired.

As far as the technique is concerned, there is obviously more to recording wildlife sounds than just pushing a button. Nothing is being handed to you on a platter when you are seeking to record the roar of an alligator, the Spring trill of a toad, the gobble of a wild turkey, or a vocal by a songbird. That shy bird, for example, how can you entice him close enough to the mike? There is no doubt that recording wildlife involves problems but there is a real thrill in licking them.

As far as equipment for such "hunting" is concerned, the choice in recorders has widened considerably in recent years with truly portable units now being generally available. For instance, there are now simple units which weigh under 10 pounds and are powered like hearing-aid units. As small as a lady's handbag, these units are suitable companion pieces to the vacationist's camera kit but, of course, have certain limitations. On the other hand, there are true portables which weigh under 20 pounds yet satisfy such professional requirements as 15 ips speed and dual amplifiers and heads for recording and playback to permit continuous monitoring of the tape.

For the true professional or the serious hobbyist there are fine recorders which are "portable" in the sense that

they can be installed in a car and operated from the auto's power system by means of accessory units. In this way the car becomes, in effect, a "sound truck" which can be parked convenient to the "hunting" grounds.

One of the best ways to learn any new technique is by example. To that end, let's visit Cornell University's Prof. Peter P. Kellogg since this world-famed scientist has blazed the trails for us, having pioneered both the techniques and the equipment.

Prof. Kellogg "explores" the electronics way. Together with his fellow ornithologist, Prof. Arthur A. Allen, renowned for his color photography, Dr. Kellogg has been responsible for a notable series of sound movies, record albums, and "sound books" on birds.

He has hunted in the jungles of Panama, on the rugged coast of Labrador, the barren grounds of Hudson Bay, in the swamps of Florida, in the arid deserts of the Southwest, and in his own back yard. From such safaris he has captured bird twitters, chirps, and assorted twirps besides miscellany of all sorts; alligators bellowing, monkeys howling, thunderstorms raging, and the patter of gentle rains.

At Cornell, Dr. Kellogg edits the tape, preserves it on master discs, and files them in the priceless collection,

Stalking "game" with a recorder offers as many thrills as more conventional hunting—and provides lasting enjoyment.

the only one of its kind, known as the Albert R. Brand Library of Natural Sounds.

The collection has already passed the 20,000 "cut" mark and includes the voices of over 500 wildlife species. One of the prize items is a "vocal" by America's rarest bird, the ivory-billed woodpecker.

During World War II, as a radar and sound expert, Dr. Kellogg was called upon to help the Army—a job that added more footage to the Library. That particular job involved an expedition across Panama and consisted of a study of jungle acoustics designed to build morale among the troops training for southeast-Asian warfare. He came out of the jungles of Panama some months later with 30 solid hours of recorded sound to show jittery GI's that a howler monkey needn't frighten a mouse and that Nip prowlers sounded different from rain-drops pattering through the leaves.

Thus we see that there is a practical aspect to sound hunting as well as just fun. A good tape recording can be as valuable to the missionary as to the tough "private eye". The recorded squeal of a hungry pig is now used to wake up little pigs so that they'll take on another load of food and grow faster. A bustling fellow like New



In his sound studio at Cornell University, Prof. Kellogg listens for tone quality in the sound track he is preparing for a movie on the adventures of "Archy," the ruby-throated hummingbird. Wall decorations are color-photo trophies "bagged" by his fellow-adventurer professor, Dr. A. A. Allen, also of the Cornell U. faculty.

York's Tom Valentino prospers by selling noise by the foot—everything from barnyard clatter to a Model-T bumping along on one flat tire to snake-charm music for cobras.

On a private consultant basis, Dr. Kellogg himself once taped the sound of a moth larva chewing a wool sock. This was used by a radio program advertising a moth repellent.

Any scientist can obtain free service from Cornell's Natural Sounds Library. All he needs to do is send in a roll of tape and his catalogue request. The tape is erased and the correct recording put on it.

Hollywood, on the other hand, has been glad to pay \$100 rental for a certain bird solo, lasting perhaps 30 seconds, needed for a picture. A few seconds of a babbling brook has brought \$50 from a radio network. Such proceeds help to finance the research at Cornell.

Dr. Kellogg feels that this field is wide open. Since such recordings involve the use of electronic equipment, the ideal combination would be a biologist *cum* electronics man. Dr. Kellogg happens to combine those unique attributes and carries the professional title of "Professor of Ornithology and Biological Acoustics."

Twenty-six years ago, when talkies were still in their infancy, a Hollywood movie-maker wanted to prove that his recording system was the best. He sent out two top technicians and a sound truck to capture bird songs.

The birds refused to cooperate. After two weeks of chasing, the hunters drew a complete blank. The expedition final-

ly reached Cornell where, by coincidence, student Kellogg, under Dr. Allen, had just started research on his doctorate thesis, "The Problems of Bird Sound Recording."

Dr. Allen and Dr. Kellogg were glad to lend a hand. The first stop was at a blackberry patch where a song sparrow had staked out three singing perches. The scientists guaranteed results. They told the movie men that they could pick any perch as a bird would be singing there within a half-hour. The equipment was set up and the sparrow came through on schedule!

This performance looked sensational but, in fact, was just an application of the basic technique of knowing the habits of the game being stalked. Generally, it is the male bird who warbles the most spectacular arias and his solos aren't completely spontaneous. Study your "quarry" as you would in any other type of hunting and you will soon note an aspect of what science calls "territorial behavior." The bird always stakes out a home area for himself and his mate. Along its boundaries, he chooses perches for singing. The songs themselves are "No Trespass" warnings to rival males.

Such knowledge is a help to the wildlife sound hunter. One day, in the Florida Everglades, Dr. Kellogg helped a friend set up to record an alligator's bellow, then moved off. When he heard the beast, he returned to listen to the recording but there was nothing on the tape. The recordist reported that all he had heard was the noise of a nearby truck racing its motor to get

out of a mudhole. "That," Dr. Kellogg said sadly, "was your 'gator.'"

Actually, your hunting needn't be far from home. For a starter, your own back yard can be challenging enough. A recent recording by Valentino is intended for the country fellow who gets homesick in the big city. It is a recording of frogs, mooing cows, and other "back home" sounds.

Nature's sounds can be nearer than you imagine. Dr. Kellogg advises that the best place to record the widest variety of bird songs and related sounds is near a pond that is surrounded by brush fading off into woodland. That will be a hangout for all kinds of sound-makers to challenge your ingenuity and know-how. However, hunting down a sound and recording it properly are two different things. Knowledge of the range of frequencies likely to be encountered is important in order to select the proper equipment.

In his early research days, Dr. Kellogg evolved a thorough working knowledge of these ranges by means of conditioned-reflex experiments he performed with the aid of Albert Brand. When a bird heard a certain note it hopped off its feeding tray. Then Dr. Kellogg raised or lowered the pitch until the bird didn't react. This indicated that the note was above or below the bird's auricular range.

This project also revealed that although the canary could see moving lips, he couldn't hear a sound. The horned owl doesn't go hunting for the ruffled grouse nearby because the latter's drumming, down around 80 cycles, is pitched too low for the owl's hearing.

The hi-fi ears of a normal human aren't so crude and we usually demand a wide range of frequencies on our recordings. Outdoors the bass notes of the grouse (down to 80 cps), the staccato trills of a blackpoll (over 12,000 cps) can be heard by the average human ears. There is no bird, however, who can hear higher than humans can. We hear down to 20 cps—four octaves lower than the pigeon can, with our best hearing occurring around 2000 cps.

Another factor in hearing is relative energies. The primary output of a man's voice is around middle C, so it sounds emasculated through a speaker weak on the lower notes. The maximum of a bird's vocal energy comes, on the other hand, just a bit above the piano's highest note. For this reason the average home recorder capable of handling human conversation and song can be overloaded by a bird.

For these reasons, Dr. Kellogg doesn't use equipment which records at less than 7½ ips and he generally works at 15 ips which he considers a fair compromise between perfection and what the industry finds practical.

Now suppose you know where and what to hunt. You have a good recorder. You're not lazy, willing to climb trees, sleep out nights, and rough it to make a rare recording. You have

a good pitcher's arm so you can throw a stone tied to a string, have it loop over the branch just above a bird's song perch, then use it to pull up your mike. You're good at editing so you can take out the hand claps you used to make a bird yell at you.

Even with all this you still have the technique to master. For a good recording, a bird must sound right up front, yelling like an opera singer. It must be remembered, however, that outdoor acoustics are generally bad—too deadening. More important, amplifying the bird's song to obtain the proper volume means that every other background sound is being amplified too. Distant trucks and tractors shatter the solo, an airplane drowns it out, even a mosquito sounds like a bomber and the brook that should babble roars.

As an antidote to all these potential problems, Dr. Kellogg makes use of his extensive knowledge of bird behavior plus a piece of specialized equipment. Years ago, he and M. Peter Keane, now with *Columbia Pictures*, pioneered the use of the parabolic reflector. Engineers told them it wouldn't work. This was at the depth of the depression but Dr. H. D. Reed, zoology head at Cornell, came to their rescue with money for the required parts. The reflector was hand-made out of wire screen and papier-mâché and the big, shallow, cone-shaped "dish" worked splendidly.

Today this earlier parabolic reflector has been replaced by an aluminum unit 40 inches in diameter which has been adapted from a war-time radar dish. One made from reinforced plaster might prove more satisfactory but the aluminum unit is easier to handle because of its light weight. When driving to his recording location, Dr. Kellogg mounts the reflector outside the car's trunk compartment like a bustle.

In Prof. Kellogg's sound lab at Cornell, there is more to making a final recording than using Ampex recorder to edit out bad sounds and piecing together the correct footage. Some of the apparatus he uses is familiar to all radio men and serious audiophiles.



There is no room for back-seat drivers in Prof. Kellogg's "hunting car" where nature's sounds are piped in to the Presto PT-900 tape recorder shown at top right. Other equipment includes volume amplifier (left) and frequency controls at right.

There is only one catch to this equipment and that is that the 40-inch diameter doesn't do much reflecting under 300 cycles. To handle some of Nature's lower pitched sounds the parabola would have to be so large that it would be unwieldy. However, the efficiency increases rapidly with frequency and the parabolic reflector does a better-than-average job.

When a bird won't come near enough to make a top-notch recording, Dr. Kellogg makes a "test" recording with the aid of the reflector. This recording is good enough to arouse the bird's jealousy as he thinks that a rival is singing. Hopping mad, he comes right down to the playback unit and sings full force into the hidden mike. This mild deception has worked so well that it has now become a standard technique with Dr. Kellogg.

Depending on field conditions, Dr.

Kellogg uses the naked aluminum reflector or paints it with camouflaging colors of green, red, yellow, etc.

Dr. Kellogg usually uses a dynamic mike which he has found to be rugged with broad, flat frequency response and a certain immunity to heat and humidity. In addition, its low impedance allows it to be used at relatively great distances from the first amplifier stage.

Most of his footage has been recorded with the car serving as the "sound truck." The rear seat of the car has been given over to the recorder, amplifier, frequency controls, etc. Power is one of the big problems. Dr. Kellogg finally settled on four standard car batteries to operate the power plant which is installed in the trunk compartment. The batteries operate the small converter which provides the

(Continued on page 76)

Happy hunting ground for a sound effects man. Vocals by birds, frogs, alligators, howler monkeys, gathered on far-off expeditions, end in Prof. Kellogg's laboratory for editing and filing in the Library of Natural Sounds. Here he seeks right tape.



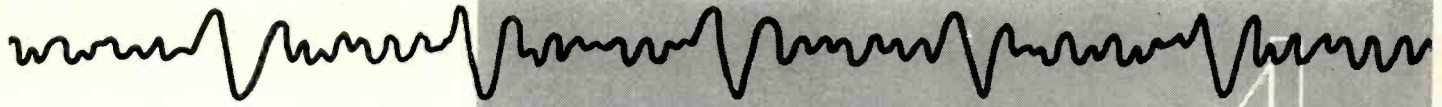

APPLYING VARIABLE

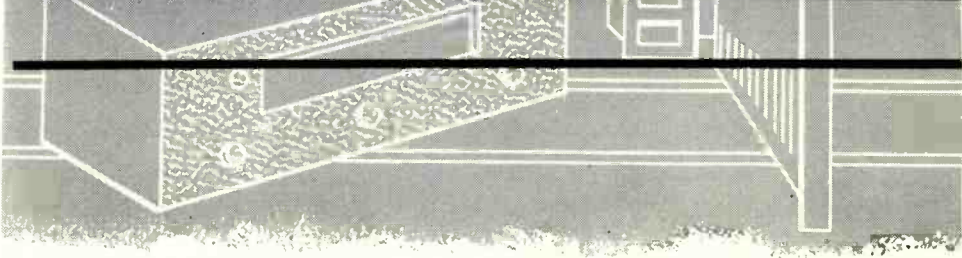

VARIABLE damping is the latest thing to be hailed in the audio field as a panacea. As with an innovation in any field which is hailed as a cure-all, a little time elapses before it is possible to evaluate its true significance. David Hafler's article on the subject ("Control of Amplifier Damping Factor," July, 1955 issue of *RADIO & TELEVISION NEWS*) seems to have been the first attempt so far at making such an evaluation. Earlier writings on the subject have all eulogized this innovation as something that would provide the ultimate in reproduction.

Irrespective of the true worth of this innovation, while the craze is still on, variable damping will undoubtedly sell a great many amplifiers. Now that the trend has started (audio enthusiasts being the fervent species they are) undoubtedly every one will want to verify for himself just what variable damping has to offer.

The author was among the early ones on the variable-damping bandwagon. In fact, some two years ago, when asked what possible changes could be incorporated in amplifier design, this was one that was suggested. In fact, as soon as the opportunity presented itself, the author designed an amplifier incorporating this feature and conducted some experiments in its operation. As a result of these experiments with different loudspeaker units, the company with which the author was then affiliated decided to abandon variable damping as a feature for the present.

This decision was not made because the amplifier into which it was incorporated was not a successful design, but as a result of evaluating the tests made with different loudspeakers. The conclusions drawn from these tests were as follows: (a) With high class loudspeakers, in which the impedance is held reasonably constant throughout the frequency band by efficient acoustic loading of the unit in its enclosure, the variable damping had so little effect that it was extremely difficult to detect any difference in reproduction, between positions of the control corresponding to maximum and minimum damping.

(b) The effect could be detected using a cheaper loudspeaker or a cheaper enclosure, which possessed acoustical resonances that required damping.

Based on this discovery the opinion was expressed that a person who would not be prepared to buy a better class loudspeaker, would scarcely be impressed with the idea of paying more for an amplifier to improve the quality of a cheaper loudspeaker; and the person who buys a better speaker and enclosure does not need it. Whether this decision was justified or not remains to be proven.

More tips for the hi-fi enthusiast, including details on how this feature can be added to your existing equipment.

Meanwhile the boom in variable damping goes on. Many readers of this magazine have still to satisfy themselves, in one way or another, about the precise value of this innovation. The hard way (on most budgets) is to trade in one's present amplifier for a new one incorporating variable damping in one of its various forms. The easier way is to try variable damping out first, by a simple addition to one's existing amplifier, to find out whether it really does something, before investing in a whole new amplifier.

The Essentials

Before describing how to do this, let us take a little time to make sure we have clearly in mind just what we are going to do with the amplifier. We want to make sure that the effect we are testing is really that of variable damping, and not some of the other things that can accidentally get mixed up with it. Unfortunately many of the amplifiers now on the market, advertised as providing variable damping, do other things besides adjust the variable damping, when you turn the damping control knob. But we will discuss that after seeing what is required.

We have to add variable damping to

the amplifier without interfering with its performance in any other respect. The way to introduce variable damping is by modifying the feedback circuit, but in doing this we should be careful about two things:

(1) We want to keep the over-all feedback constant, because changing the *amount* of feedback applied to an amplifier varies its stability margin, and this, in turn, interferes with its frequency response, so it is no longer the same amplifier; and

(2) We need to make sure that the additions to the circuit will not alter the operation conditions of any of the tubes.

Evolving a Practical Method

Take the circuit of Fig. 1 as the essential part of an amplifier to be modified. Here R_1 is the cathode resistor of an early stage, to which the over-all feedback is connected through R_2 and C . The feedback factor is determined by the ratio of R_2 to R_1 , while C is necessary to maintain stability at ultrasonic frequencies. We have to maintain the same feedback factor and stability condition, when we insert our variable damping circuit. Using the method described, it is quite easy to make the calculations necessary to modify the circuit.

Fig. 2 shows the circuit modified to include variable damping. The first stage cathode bias must be maintained. In the original circuit, R_2 did not appreciably shunt R_1 , but in the revised circuit R_2 will have a much lower value. To maintain the same bias, the resistance measured between the cathode and ground must be the same as the original circuit. The easiest way to be sure of this is to just double the original value of R_1 , in arriving at values for R_1 and R_2 in the circuit of Fig. 2.

Now suppose that, in the original circuit of Fig. 1, R_2 was $20 \times R_1$; the

Fig. 1. That portion of a modern feedback amplifier circuit that is to be modified to introduce the variable damping feature.

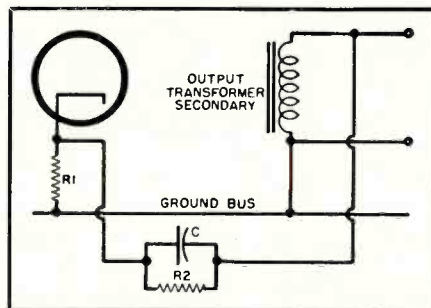

DAMPING

By N. H. CROWHURST

values R_2 and R_1 in Fig. 2 will provide a two to one reduction, so we have to make only a 10 to 1 reduction ahead of resistor R_2 , from the secondary of the output transformer. In addition we must keep this fraction constant as we vary from current feedback to voltage feedback.

To achieve this for current feedback a resistance of one-tenth the load value at the tap used is inserted in the return from the grounded side. This can easily be adjusted by using a wirewound potentiometer for this value. If a resistance meter to measure such a low value is not available, it may be adjusted by estimate, if the potentiometer is of a linear type, to give the resistance required. This resistor will provide the necessary amount of current feedback equivalent to the original feedback.

Now we place a shunt across the output transformer secondary, consisting of two fixed resistors, whose values also have a ratio of 10 to 1. They should be of sufficiently high value not to shunt away appreciable power from the circuit, and at the same time low enough not to interfere with the over-all resistance in the return path of the first stage cathode. Values of 10 and 100 ohms would be quite suitable.

Now we place a low value potentiometer, 100 ohms would do, across the pick-off points for current and voltage feedback, as shown in Fig. 2.

With the slider of this potentiometer all the way over to the junction between the 10- and 100-ohm fixed resistors, the feedback will have the same value as the original circuit and will be entirely voltage feedback; so the damping factor will be identical to the original damping factor of the amplifier, which most likely has a value quite high enough for any practical purpose.

With the slider of the potentiometer moved all the way over, the resistor connected between the output terminal and the transformer secondary will give the same amount of current feedback as the original voltage feedback when the correct load is connected; and the damping factor will be re-

duced, in all probability, to a fractional value.

Positions along the potentiometer between the two ends will adjust the damping factor continuously between these two limits, while maintaining the same over-all value of feedback.

It just remains to see that the capacitor is connected to maintain the same stability condition that was provided in the original amplifier. As we have kept the same combined resistance in the cathode ground return, although the *method* of attenuation in the midband has been modified, the same capacitor will still provide the same boost at the high end (which is beyond the audio spectrum). Connect it between the top end of the transformer winding and the cathode (exactly where it was before).

So the modifications necessary to incorporate variable damping into any normal type of feedback amplifier are quite simple. All the additional components are of fairly low resistance values—lower than the value of R_2 which was removed—so there is no problem of the additional components introducing instability in themselves. But care should be exercised in making the modification, not to interfere with the lead dress of the amplifier as it stands, because this often proves to be important to the stability of the amplifier.

From this example, the reader

Fig. 2. Method of modifying the circuit of Fig. 1 to add variable damping. Note that the values of R_1 and R_2 are changed (see text), and that the other values designated are only illustrative. Method for calculating for your unit is covered in text.

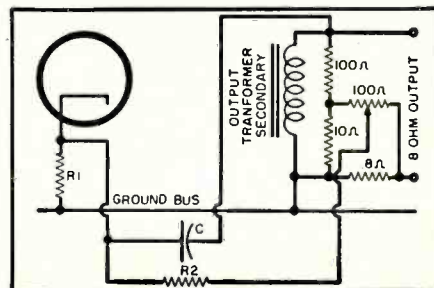

should have no difficulty in applying details from his own amplifier to calculate values for its particular circuit: in all probability, the ratio between R_2 and R_1 will not be quite as convenient as 20 to 1; but whatever it is, the ratio can simply be divided by 2, and the same procedure adopted to calculate the other values in the circuit. The value of the cathode resistor can be doubled in each case, and an equal resistance used for the series feed from the slider of the 100-ohm potentiometer. This will preserve the correct operating condition for the first tube of the amplifier, and also insure that the stabilizing effect of the capacitor already in the amplifier is maintained.

What to Expect

It is suggested that in making these alterations care should be taken not to wreck the circuit, so it can not be put back in its original condition, because the author is strongly of the opinion that most readers, having conducted the experiment, will decide that it is not worth having this extra paraphernalia hanging on the amplifier.

If you have any of the better class loudspeakers, you will find that turning the control from one extreme end to the other will make so little difference in the reproduction, it is rather difficult to detect at all.

If you are using an inferior loudspeaker or enclosure, or both, you may notice a considerable difference and you can then adjust the damping control to give the reproduction that you think sounds most pleasing; or, if you prefer, you can run a square wave through the system, look at the waveform across the voice coil with an oscilloscope, and adjust the damping control until the nearest approach to a square wave is achieved. This procedure has been recommended elsewhere for the adjustment of damping control.

The author will not guarantee, however, that this means ideal damping has been achieved, with an inferior loudspeaker in an inferior enclosure. In fact, it is extremely unlikely to have done so. The reason for this lies in the poor electro-mechanical coupling factor of the inferior loudspeaker unit. This means that the acoustical resonance of the diaphragm in its enclosure is not very well coupled to the electrical circuit of the voice coil. Consequently, although the impedance caused in the electrical circuit by this resonance may be adequately damped by the amplifier, the acoustical vibrations which cause the electrical resonance have not been equally well damped.

A careful examination of this problem shows that the only satisfactory
(Continued on page 109)

FIXED

By **WALTER H. BUCHSBAUM**

Television Consultant
RADIO & TELEVISION NEWS

CAPACITORS

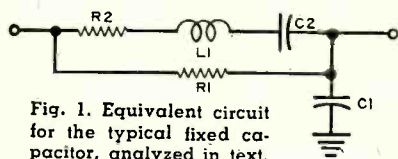

Fig. 1. Equivalent circuit for the typical fixed capacitor, analyzed in text.



Fig. 2. Typical mica capacitor. This one is by El-Menco (Electro Motive Manufacturing Co.).

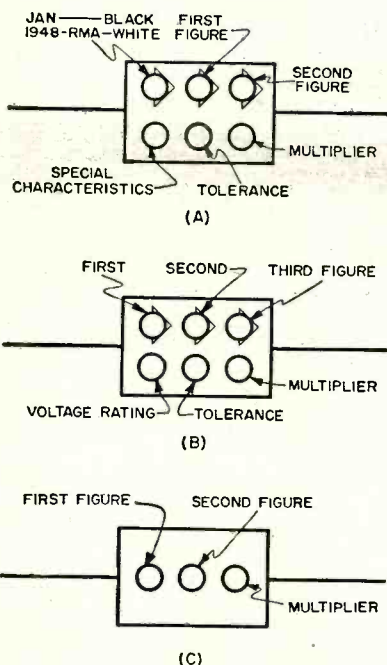

Fig. 3. Three color codes for identifying capacitor values. (A) is the JAN and 1948 RMA mica capacitor code, (B) is the now obsolete 6-dot RMA code, and (C) is the RMA 3-dot code, also now obsolete.

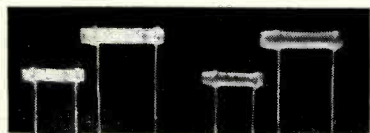

Fig. 4. Some tubular ceramic capacitors, both before and after impregnation. The units shown here are from Centralab.

New types of capacitors and many new uses for standard units call for a reappraisal of the field.

GREAT strides have been made in the development of new types, sizes, and values of capacitors, resistors, and coils which form the bricks in the electronic circuit structure. To acquaint the reader with the present state of the art, this article is devoted to fixed capacitors of all types. The various applications, advantages and disadvantages, ratings, and tolerances will all be covered here.

It is impossible to give complete coverage of every type of capacitor or discuss each individual model and its application in detail in a single article. The most frequently used types are described here and it should be pointed out that in almost every instance several manufacturers offer the same type of capacitor, though sometimes under different names.

To say that a capacitor is a device which is charged up by an electric current, or to call it a d.c. block or an a.c. impedance are all incomplete descriptions from a physical point of view. Fig. 1 shows a true electrical representation of a capacitor which covers all theoretical aspects. R_1 is the shunt or leakage resistance which is usually negligible, except in the case of electrolytic capacitors or some designed for special applications. R_2 represents the series resistance due to the resistance of the wires, the capacitor element, and the dielectric. C_1 represents the capacity to ground which may be considerable in video amplifiers using large coupling capacitors. L_1 is the inductance due to the leads and the foil making up the capacitor plates. This inductance leads to self-resonance of certain types of capacitors at the higher frequencies and also becomes considerable when electrolytic capacitors are used as by-passes for r.f.

C_2 is the actual capacity which is marked on the capacitor. This value can cover quite a large range. Capacitors are available from .5 micromicrofarad up to 2000 microfarads. Although ranges overlap somewhat, Table 1 lists the approximate ranges

in value for the major capacitor types. These types are usually named according to the dielectric material which is used between the capacitor plates.

In addition to the capacity value, the voltage rating of a capacitor is always a necessary specification. There are actually two voltage ratings for a capacitor; one for the maximum a.c. and one for the maximum d.c. voltage which can be applied without causing an internal short. For most practical applications, the d.c. working voltage is the most important criterion since the a.c. rarely is so much higher as to cause damage. It is possible, however, to damage a capacitor with a.c. signals alone, especially when the r.f. dissipation exceeds the limit of the capacitor. This is usually only of concern in transmitters or power oscillators.

One of the confusing aspects of any capacitor catalogue is the value designation. For example, there are .22 μ fd. and .25 μ fd. paper capacitors; and .05 μ fd. will appear together with .047 μ fd. and occasionally, .056 μ fd. paper types. The reason for this is the incomplete acceptance of the standard values recommended by the Radio-Electronic - Television Manufacturers Association (RETMA) for capacitors and resistors. Old values such as .25 and .05 μ fd. or 200 and 500 μ fd. are still manufactured together with the new RETMA values based on a mathematical progression. In actual circuitry, the interchange of values depends on whether a tuned circuit is involved or not.

Tolerance on capacity is another aspect which deserves consideration,

Table 1.

TYPE CAPACITOR	AVAILABLE CAPACITIES	AVAILABLE VOLTAGES
Ceramic	.5 μ fd. to .01 μ fd.	300 to 5000
Mica	1 μ fd. to .1 μ fd.	200 to 5000
Paper	100 μ fd. to 1 μ fd.	100 to 1000
Oil, Dykanol, Pyranol in metal case	.01 μ fd. to 20 μ fd.	400 to 5000
Electrolytics	2 μ fd. to 2000 μ fd.	6 to 600
Transmitting and high voltage	.005 μ fd. to 4 μ fd.	600 to 20,000

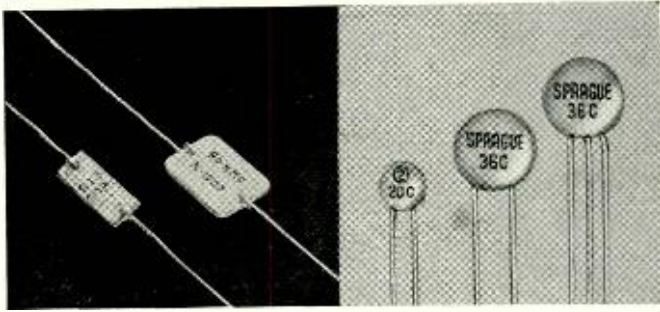

Fig. 5. Typical flat ceramic capacitors. The rectangular ones (the ones shown are by Centralab) are still to be impregnated with a protective coating. The disc ceramic on the right with three leads is a dual capacitor; the center lead is common.

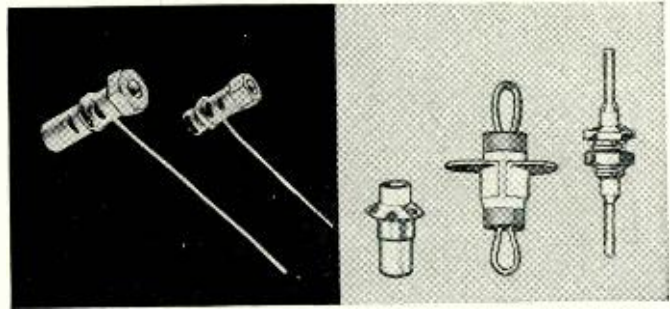

Fig. 6. Shown here are various types of ceramic capacitors used for feedthrough and upright mounting on chassis where space is at a premium and lead length is very critical. The units on the left are by Centralab; on the right, Erie.

especially in critical circuits. Mica capacitors and some small ceramic units have tolerances of ± 5 or $\pm 10\%$ and are so marked. Other types of ceramic capacitors, especially some disc types, are generally specified as having a tolerance of -20% and $+80\%$. This makes them suitable for coupling and bypass applications, but not very reliable for tuned circuits. Paper capacitors usually are rated at $\pm 20\%$ unless otherwise specified, while electrolytics often have a $-20 +50\%$ tolerance. Special types for military or transmitter use are designated with their individual tolerances by the manufacturer.

Before going into a discussion of the small value capacitors, the polarity indicated by the symbol should be mentioned. This polarity becomes important when d.c. is applied across a large capacitor of the electrolytic type or when the capacity to ground of the outer foil becomes a problem. The curved portion of the capacitor symbol indicates the outer foil which should generally be the negatively polarized portion.

Mica Capacitors

In Fig. 2 is shown a mica capacitor. Mica capacitors have been in use practically since the beginning of the electronics industry. They are constructed of thin sheets of mica interleaved with two sets of aluminum, tin, or silver foil. Each set of foil goes to one side terminal and its pigtail wire. The entire assembly is molded into a Bakelite insulator and color coded as to its value. Unfortunately, the color coding of mica capacitors has long been a source of bafflement. This is due to the fact that there are at least three widely-used color codes and it often requires considerable thought to figure out which one is being used on any one unit. Shown in Fig. 3 are the various ways in which a mica capacitor can be marked. It should be pointed out that the color values are the same as in the resistor and other color codes.

Mica capacitors generally come in voltage ratings of 300 volts, 500 volts, 1000 volts, and higher. For transmitting equipment there are large mica capacitors which will be most familiar to the radio amateur and experimenter. These units are designed for consider-

able r.f. dissipation and can be used in power oscillators and r.f. circuits.

Standard mica capacitors are made in three tolerance types. The unmarked capacitors are generally $\pm 20\%$ of indicated value, while a silver dot indicates 10% , and gold stands for a 5% tolerance. Where especially good stability with temperature is required, the use of a silver mica capacitor is indicated. In the horizontal oscillator circuits of many TV sets such silver mica capacitors are used where critical values control the frequency of the oscillator. When making repairs be sure to replace such units with exact equivalents, both in tolerance and in type.

Ceramic Capacitors

This type of capacitor is relatively new and is available in a large variety of values, shapes, and types. One of the advantages of the ceramic dielectric used in these capacitors is the great range of dielectric constants which can be achieved by various chemical mixtures. Thus, there are the "High-K" types which feature relatively large capacitance in very small spaces, the temperature compensating types, and the low inductance types for u.h.f. circuits.

In the ceramic capacitor, the dielectric plate is tinned or silvered on both sides and leads are anchored to these conductors. Usually the capacitor is then coated with some strong protective insulator and that is the whole unit. Tubular ceramics are simply thin ceramic tubes coated inside and outside with a conductor. Wire leads are wrapped around the conducting

Fig. 7. Some extremely small ceramic capacitors. The ones shown are by Stackpole.

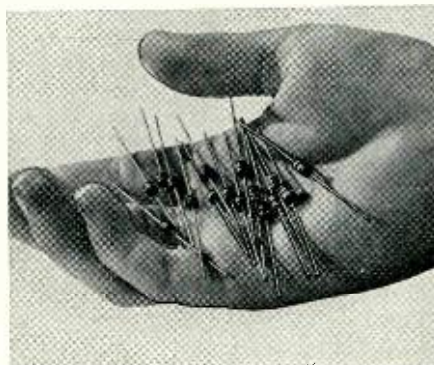

areas and again the entire unit is usually dipped in some insulating material. Typical tubular ceramic capacitors are shown in Fig. 4, both with and without the protective coating.

Flat ceramic capacitors of the rectangular and disc types are shown in Fig. 5. Many times, flat ceramic capacitors consist of multiple sections. These are obtained simply by stacking two single units together and then dipping the assembly in an insulator. The center lead in such a unit is generally the common or ground lead.

Variations of the tubular ceramic types are shown in Fig. 6, and represent feedthrough and r.f. bypass capacitors. This construction is very useful in v.h.f. and u.h.f. circuits where lead lengths are critical. Fig. 7 shows a very special capacitor, ceramic in nature, but available usually in accurate and very low capacitance values. These units are available from $.10 \mu\text{fd.}$ up to about $10 \mu\text{fd.}$ and consist, essentially, of little more than the capacity of the flattened wire itself, embedded in the insulator. Tuners for v.h.f. and u.h.f. and test equipment frequently employ this type of capacitor.

Ceramic capacitors are available with various temperature coefficients. Usually, the tubular type shown in Fig. 4 is used for temperature sensitive circuits, although any of the ceramic capacitors can be made temperature compensating by using the right kind of ceramic material.

The most widely used temperature coefficient is the negative one. Normally, tuned circuits tend to resonate at lower frequencies as the temperature rises. A negative temperature coefficient capacitor has less capacity at higher temperature and, therefore, the frequency of its tuned circuit tends to rise. It is possible to make a tuned circuit quite stable, irrespective of temperature changes, by selecting the right kind of compensating capacitor.

Most ceramics are either of the P, NPO, or N coefficient type. P denotes a positive coefficient, which gives an increase in capacity with temperature. This unit is rarely found in commercial equipment. The NPO type has approximately zero coefficient; it does not vary with temperature. NPO capacitors are most widely used for bypass and coupling purposes. The N

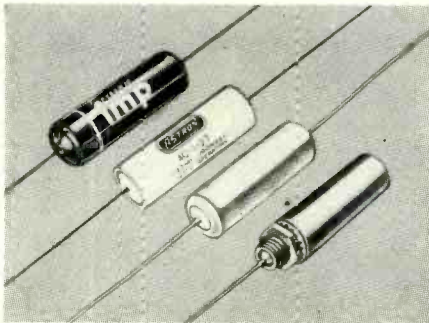

Fig. 8. Various types of paper capacitors are shown here: molded (Pyramid), glass-sealed (Astron), metalized-paper and metal encased (Cornell-Dubilier).

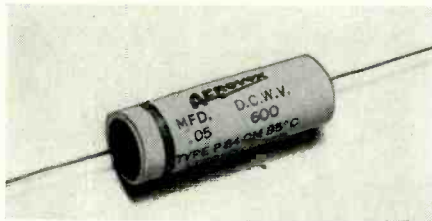

Fig. 9. Ceramic encased paper capacitor.

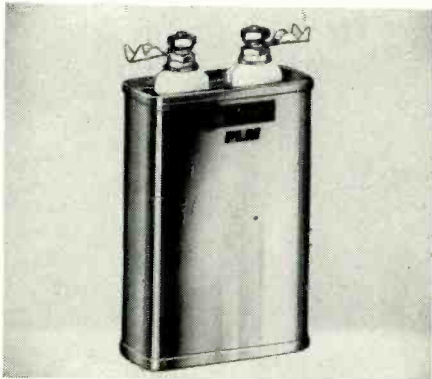

Fig. 10. Typical impregnated capacitor. This unit, by Pyramid, is oil-filled.

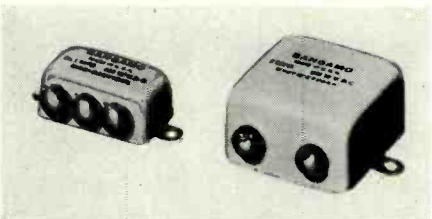

Fig. 11. The "bathtub" shaped containers shown here enclose capacitors whose dielectric is oil. Sometimes such metal containers enclose an electrolytic.

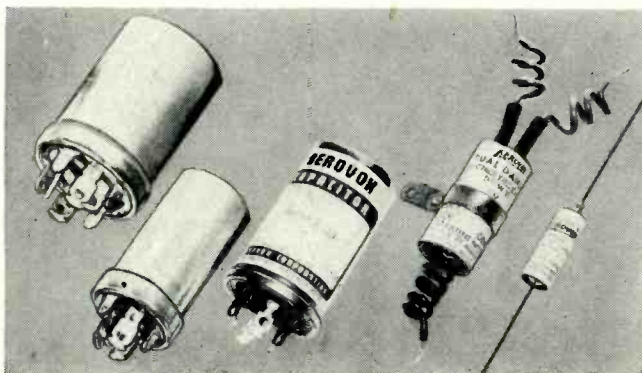

Fig. 12. Shown here are various types of electrolytic capacitors, some in metal cans, others in cardboard containers. The two on the left are manufactured by Mallory.

type capacitor has a negative coefficient and usually has a number designation such as N470 or N1500, indicating the specific variation with temperature. The larger the number the greater the change in capacity.

Additional types of ceramic capacitors include the button type for v.h.f. and u.h.f. bypassing and coupling, and a wide variety of special types for the military equipment manufacturer. Most TV high-voltage capacitors are ceramic as are some of the new transmitting types.

Special advantages of ceramic capacitors include their compactness, very low internal inductance, and good temperature performance. Capacitance tolerances range from special 10% and 20% types to the capacitors generally used in TV and radio sets which have a standard tolerance of +80% and -20%. Often, these capacitors have a guaranteed minimum value (GMV). Temperature coefficient capacitors are most likely found in critical tuned networks such as u.h.f. and v.h.f. oscillators where only exact replacements should be used when necessary.

Paper Capacitors

New versions of the popular tubular paper capacitor include such variations as molded bodies, metallized paper, and metal bodies with glass seals. The latter type is favored for military equipment applications because of its imperviousness to moisture, heat, and fungus. Special models are available which will operate satisfactorily at temperatures as high as 185° centigrade.

For radio, TV, and most radio "ham" receiving equipment, molded paper capacitors are becoming more and more standard since they combine reasonable price with good performance and long life under ordinary operation. Fig. 8 shows typical paper capacitors of various types. Note that on some there is a band around one end of the capacitor. This indicates that the nearest lead is the outside foil and in some circuits should be the side going to ground. The polarity indication in paper capacitors is not the same as in electrolytic types. In the case of paper capacitors the d.c. polarity does not matter. The reason for marking the lead to the outside foil is to allow minimum capacity to ground in certain applications. In audio and video am-

plifier the coupling capacitor often goes from a high to a low impedance and in such cases the outside foil should go to the low impedance side.

Some circuits use ceramic case, paper capacitors like the one shown in Fig. 9. Be sure to replace such a unit with the same type.

In general, paper capacitors of the molded type are rated for operation up to 85° centigrade, which is satisfactory for most radio and TV uses. Where higher temperatures are found, a simple derating method can be applied. As the temperature increases, assume that the voltage rating of the capacitor decreases. For example, a 200 volt capacitor may be good up to 65° centigrade, but if the equipment gets to be 85°, then a 400 volt capacitor should be used.

Voltage ratings of paper capacitors should never be exceeded. A good rule is to use 200-volt capacitors where the d.c. voltage never exceeds 100 volts. Use 400-volt units where the voltage goes up to 250 volts; 600-volt ones are suitable for circuit voltages up to 350 to 400 volts at the most. For higher voltages use 1000- and 2000-volt capacitors.

Impregnated Capacitors

Using such special dielectric materials as "Dykanol," "Pyranol," and various kinds of oil, these capacitors are distinguished by their long life, maintenance of the rated capacity over a relatively wide range of temperatures, and rugged exterior. They are generally contained in metal cans of the type shown in Fig. 10. Capacity values range from about .01 μ fd. up to 20 μ fd. with voltage ranges of 400 to 5000 volts. Some of these capacitors are supplied with special brackets and are mounted with their terminals easily accessible.

In replacing this type of capacitor care should be taken not to break the ceramic or glass-type terminal insulators sometimes used. Such breakage could occur when the mounting brackets are tightened if the capacitor is not properly seated.

Many of these capacitors are used as motor starters, some as filters for low frequency circuits or power supplies, and some for bypass and coupling applications in transmitters. Many find application in test equipment and military gear of all types.

One variation of the oil-filled type shown in Fig. 10 is the "bathtub" capacitor, so named because the case looks like a small metal bathtub. See Fig. 11. These capacitors are supplied not only in the oil-filled variety but also as low voltage electrolytics. Values up to 50 μ fd. at 150 volts are obtainable. They are also furnished as multiple units.

Electrolytic Capacitors

Electrolytic capacitors are so named because their capacity is due to an electrochemical process known as electrolysis. When a potential is applied
(Continued on page 114)

FREQUENCY-MODULATED

WIRELESS

RECORD PLAYER

By ARTHUR TRAUFFER



Two views of the completed frequency-modulated "wireless" record player. A small table model receiver, which is used as the oscillator, is mounted on brackets at rear of turntable.

You can build this phono pickup at home, using a spare table-model radio as the oscillator for the construction.

MOST "wireless" record-players consist of an oscillator which is amplitude-modulated by a crystal phono pickup, the signal being received in the usual manner. By this method, the quality of reproduction is limited mainly by the crystal cartridge, and the bandpass of the i.f. transformers in the receiver.

This article describes a simple and economical wireless record player which is frequency-modulated by a capacitance phono pickup, and received on a standard AM broadcast receiver by "slope detection." By this method, the quality of reproduction is dependent on the audio amplifier and the speaker in the radio.

You can buy a factory-made capacitance phono pickup cartridge, or you can easily build a pretty good one very cheaply, as described in this article. And there is no need to build up a special oscillator and power supply; you can use the oscillator in an old table model superhet! Any small superhet will do, just so the oscillator works and the power supply is well filtered.

How It Works

A capacitance phono pickup is simply a needle or stylus (having the lowest possible amount of mass and mechanical resonance) which is mounted on one side of a stationary metal plate. There is a small air gap between the needle and the plate, thus the two parts serve as the two plates of a small variable capacitor, the needle rides in the record groove, it vibrates from side-to-side in accordance with the waveforms in the groove, causing a corresponding variation in capacitance between the needle and the stationary plate. When the needle and the plate are connected across the tuned circuit of an oscillator, the fre-

quency of the oscillator is shifted up and down (frequency-modulated) accordingly.

Fig. 1A shows the front-end of a typical table model superhet. Note that the capacitance pickup is connected directly across the tuned circuit of the oscillator to frequency-modulate it. When the table radio is placed directly on top, or very near, the large AM radio in your living room, the small radio's oscillator will feed a good FM signal to the large radio and the latter detects it by slope-detection.

Fig. 1B shows how an FM signal can be received on an AM receiver by slope-detection. The incoming FM signal is not tuned in "on the head," but a little off to one side of the i.f. selectivity curve's peak. As the frequency of the FM signal swings up and down over a small range with modula-

tion, these variations in frequency are converted to variations in amplitude and the resulting AM is detected in the usual way. The FM signal is tuned in on one side of the selectivity curve's peak until the audio quality sounds best. If the audio is too weak, the swing of the record player's oscillator should be increased by reducing the air-gap between the needle and plate of the capacitance pickup. If the audio quality is poor ("splashy" with distortion on volume peaks) the swing of the oscillator should be reduced by increasing the air-gap between the needle and plate of the capacitance pickup.

Phono Motor and Cabinet

Chances are, you already have a phono motor and cabinet suitable for this FM record player and don't have
(Continued on page 39)

Fig. 1. (A) Front-end of a typical table model superheterodyne AM receiver, showing how the capacitance pickup is connected across the tuned circuits of the oscillator circuit to frequency-modulate it. (B) How FM signal is received by slope detection.

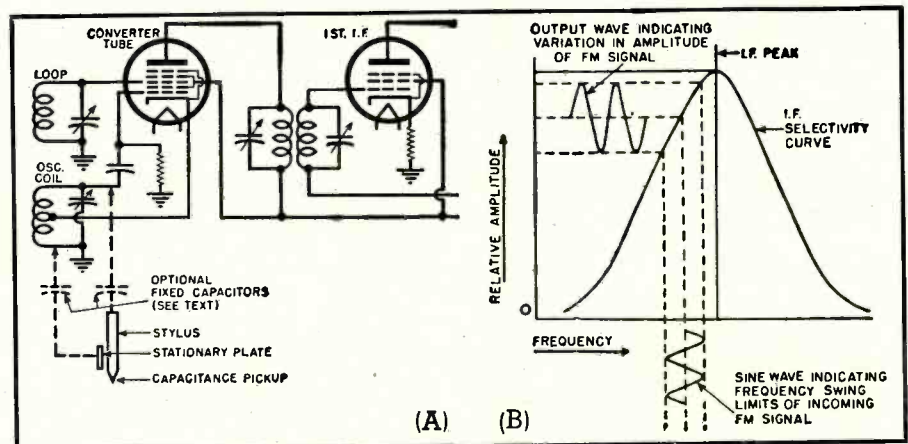

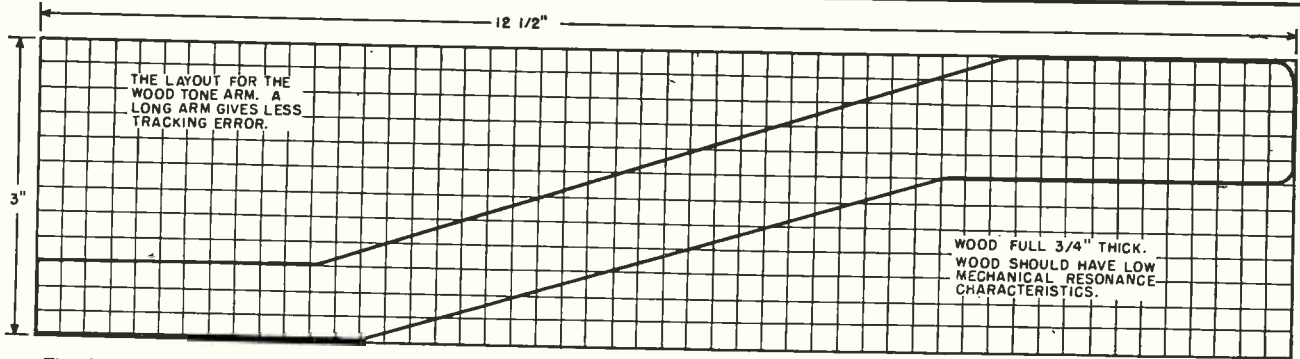

Fig. 2. Layout of the wood tone arm used by author. Pattern can be used for arm for either home-built or commercial cartridge.

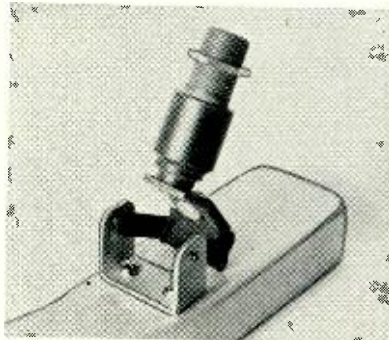

Fig. 3. A U-bracket is used to mount the swivel to underside of tone arm. The swivel is from an old Astatic crystal pickup.

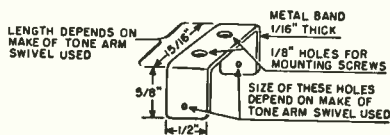

Fig. 4. Details for making U-bracket.

Fig. 5. The two leads from the cartridge end at the two lugs mounted close to U-bracket. Flexible leads with tips go to receiver oscillator.

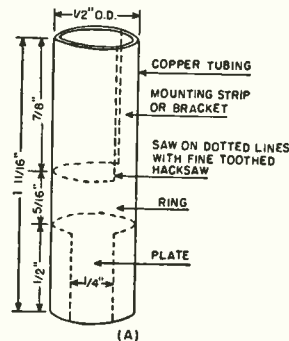
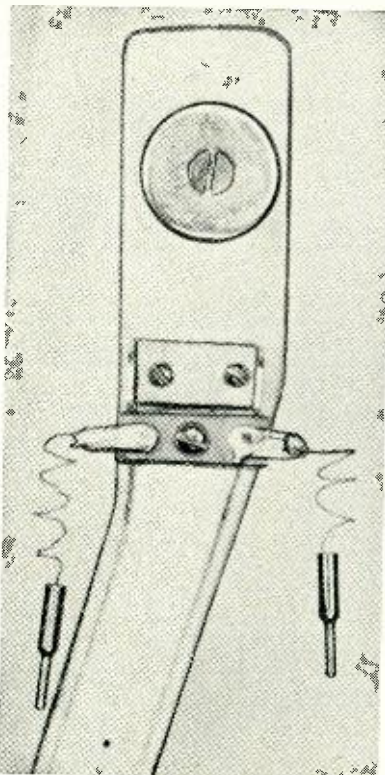

Fig. 6. (A) How home-made cartridge is sawed from $\frac{1}{2}$ " o.d. copper tubing. (B) Cartridge before bending and drilling.

Fig. 7. "Head-on" view of home-made capacitance pickup. Note #38 gauge wire lead from needle to lug at right side of arm. The #28 gauge plate lead is soldered directly to end of mounting bracket. The air gap between needle and plate can be altered by bending the plate as described in the text.

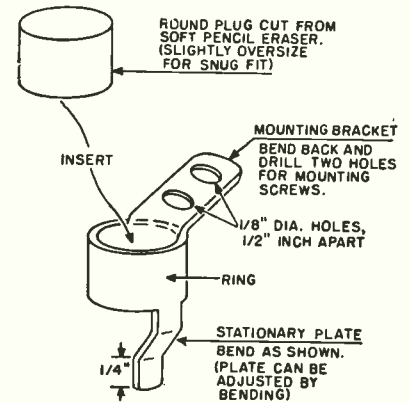
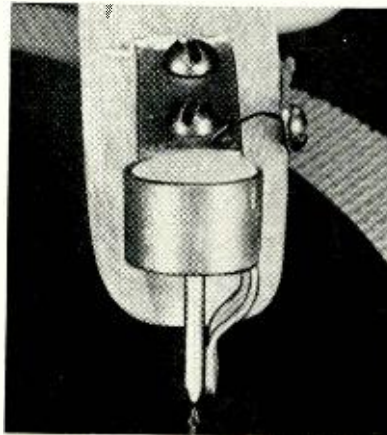

Fig. 8. The completed copper cartridge ready for insertion of the needle. See text on choosing a suitable needle

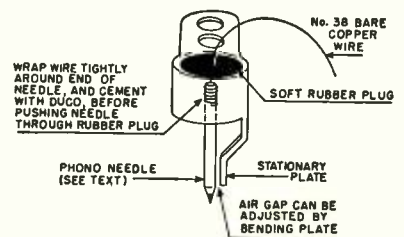
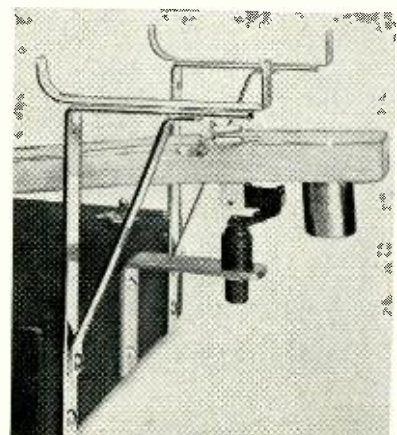

Fig. 9. The capacitance cartridge ready to be screw-fastened to the nose of wood tone arm. Details in article.

Fig. 10. Rear view of the record player with the radio removed from bracket to show two 2-way lugs screw-fastened to the arm to serve as junctions for the leads from cartridge and the leads to radio. Brass L-bracket holds pickup arm and modified shelf brackets support the small AM receiver.



to assemble one. The author's cabinet was home-built and is 12" long, 8" wide, and 2½" high. The framework was made from ¾" lumber securely screwed and glued together. Masonite ½" forms the top panel but ¼" Masonite would have been better. The cut-out in the cabinet top was figured so that the turntable shaft of the motor would set about 4½" back from the front end of the cabinet. The cabinet was sanded smooth, the sharp edges and corners rounded off, and given a coat of flat chocolate brown paint (a lighter color paint would have photographed better!). A chrome-plated drawer-pull was mounted on each side of the cabinet to make it easy to move the cabinet around. The phono motor (45-rpm in the writer's case) was mounted in the usual manner, and wired in series with a s.p.s.t. toggle switch and a 10-foot length of rubber-covered lamp cord and plug.

The Tone Arm

Fig. 2 is the layout for the wood tone arm made by the writer. This pattern can be used for either the fac-

tory-made or the home-made capacitance cartridge. If desired, you can copy the shape of any good transcription arm instead. Select a piece of good quality wood with low mechanical resonance. The wood should not "ring" but should give off a dead "thud" when you hang it by one end and strike it sharply in the center with the knuckle of your forefinger. Basswood and dogwood are two woods with comparatively low resonance. The tone arm should be a full ¾" thick. The writer made his arm pretty long (12½") in order to reduce tracking-error. After jigsawing, the arm should be sanded smooth all around, and all sharp edges and corners rounded off to improve its appearance. The arm can be given a coat of white shellac, followed later by a coat of clear varnish, or you can stain or paint it to match the cabinet.

The swivel used may be one removed from an old crystal pickup arm. Many of these old arms may be found in radio repair shops and may be obtained for as little as 25¢ each! Fig. 4 shows the simple U-bracket made by the writer to fit the swivel to the wood

tone arm while Fig. 3 shows how the U-bracket mounts to the underside of the tone arm by means of two short round-head wood screws. The exact location for the U-bracket will have to be determined later to give lowest tracking-error. Fig. 11 is a diagram of the angle-bracket made from ¾" by ½" brass band which is used to hold the swivel and tone arm to the back end of the cabinet. If desired, you can dispense with this bracket by making your cabinet 15½" long instead of 12" long, and by mounting the swivel directly on top of the cabinet. The writer likes compact cabinets!

Fig. 12 shows the simple counterweight used to counterbalance the tone arm. This weight is simply a 1" or 1¼" length of 1" diameter iron rod, drilled through the center (lengthwise) for the flat-head wood screw used to mount it to the underside of the arm near the back end. After the tone arm is completely assembled and mounted, the counterweight is placed to give a needle pressure of about 5 or 6 grams.

The author used the little capaci-

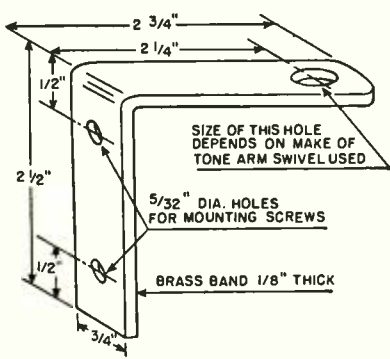

Fig. 11. How to make the angle bracket which is used to hold the swivel unit to the back end of the record player cabinet.

Fig. 15. The scraped ends of the wire leads are wound tightly around the lugs on Motorola cartridge and held with Duco cement. Do not solder! The cartridge is held in groove with Duco and the wire leads are cemented into the grooves as shown in the photo. Be sure not to solder, see article.

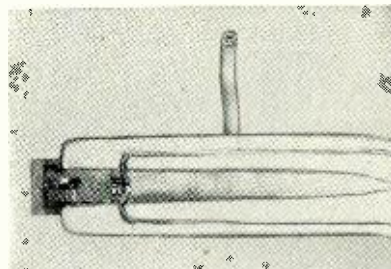

Fig. 14. How the Motorola capacitance pickup cartridge is mounted and wired into the wooden tone arm. Other similar cartridges could be used with slight changes in the mechanical layout of the tone arm groove as shown.

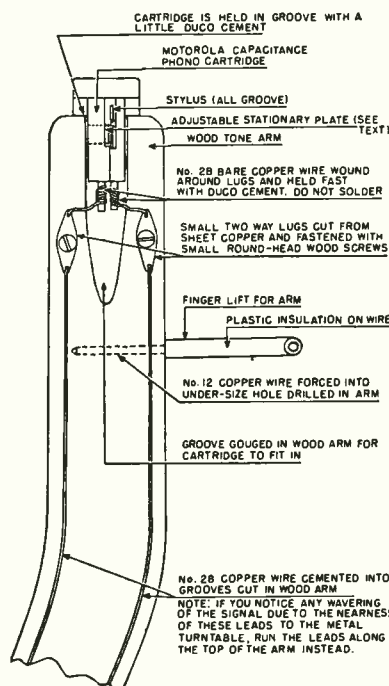

Fig. 16. A groove is filed and gouged in wood arm to accommodate cartridge.

Fig. 17. The pencil points to the soft wax which covers the air-gap adjustment screw. To make changes remove wax. Cartridge is the Motorola replacement number 1C630821 phono unit.

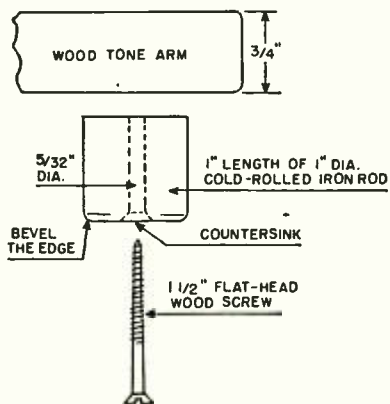
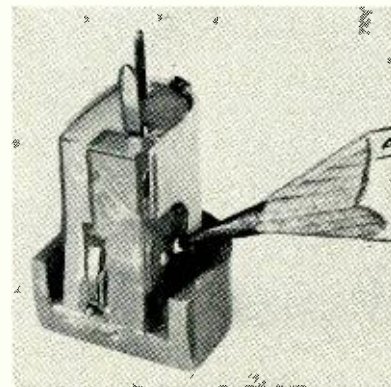
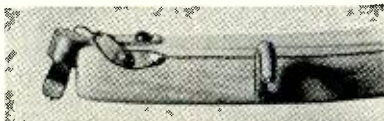

Fig. 12. How to make the counterweight for the wood tone arm. Refer to text.

Fig. 13. Side view of the home-built capacitance phono pickup. Note two-way lug, cut from sheet copper and screw-fastened to side of arm. This serves as a junction for needle lead and lead to oscillator. The plate lead runs in a groove on opposite side and is soldered to bracket.



tance phono pickup cartridge made by *Motorola* for its Models 53F2 and 21F5 high-fidelity phonographs in his installation. This cartridge, *Motorola* part number 1C630821, has a precious-metal needle tip with a diameter of .002" for use with records of all three speeds. The needle has very little mass, which allows it to reproduce a very wide frequency range, and the needle is lightly damped to reduce mechanical resonance to a minimum. These replacement cartridges are available from the company's distributors or service shops. The list price is \$3.45.

A small gob of wax is used to cover the slotted head on the adjustable screw which forms the stationary plate of the pickup. If you want to change the air-gap between the needle and the plate, simply dig out the wax and adjust the screw with a small screwdriver. After the adjustment is made, lock the screw again with a few drops of wax, or *Duco* cement, but be careful not to get any in the air-gap where it will interfere with the free movement of the needle!

Fig. 16 shows how a groove is cut into the bottom of the front end of the wood tone arm, using a rat-tail file and a narrow gouge, to form a socket for the capacitance cartridge. Make the groove $\frac{3}{8}$ " deep and just the right width for a snug fit for the cartridge.

How the cartridge is mounted and wired into the arm is illustrated in Fig. 15. Since no socket is available for the cartridge to plug into, you will have to wrap the wire leads *tightly* around the lugs on the back of the cartridge and then apply a little *Duco* cement to hold the connections securely. The cartridge is secured in the groove with a little *Duco*, and the wire leads are cemented into small grooves

cut along the bottom of the arm, as shown. Keep the leads as far apart as possible to reduce the capacitance between them. Fig. 14 is an improved version of the technique shown in Fig. 15 in that two soldering lugs are placed close to the cartridge to make it easier to wire in a new cartridge when the stylus has worn out on the first one. As shown in the photograph of Fig. 5, the wire leads end at two soldering lugs mounted on the underside of the arm close to the U-bracket for the swivel. The two short flexible leads with phone tips, visible in the photo, go to the oscillator of the table radio.

This same photograph also shows how the counterweight is mounted to the underside of the arm by means of the flat-head wood screw.

The Home-Made Cartridge

The home-made version of the capacitance phono pickup, now to be described, is easy to make, costs very little, and gives nice results when used with a good quality phono needle having low resonance in the audio range. The cartridge consists of a copper ring, a mounting bracket, and an adjustable plate, which are all in one unit hacksawed from a short length of $\frac{1}{2}$ " o.d. copper tubing. A round plug of soft rubber is pushed into the ring, and the phono needle is pushed into the rubber so the needle sets parallel with the metal plate, allowing for a small air-gap between the needle and the plate. The rubber plug serves a dual purpose: it holds the needle, and it gives the needle high compliance. The size of the air-gap between the needle and the metal plate can be adjusted by bending the plate. One wire lead is taken off the top of the phono needle, and the other wire lead is taken off

the mounting bracket. That's all there is to it!

Figs. 6A and 6B show how the combination ring, mounting bracket, and plate are sawed from a short length of $\frac{1}{2}$ " o.d. copper tubing. Use a fine-toothed hacksaw with a thin and narrow blade, and then file the rough sawed edges smooth with a small fine-toothed file. The two projections, shown in Fig. 6B, are pressed flat by squeezing in a vise.

As shown in Fig. 8, bend the mounting bracket back and drill two $\frac{1}{8}$ " diameter holes about $\frac{1}{2}$ " apart; these are for the mounting screws. Now bend the stationary plate as shown; the final adjustment will be made later. Cut a round plug (slightly over-size) from a soft pencil eraser, and push the plug into the copper ring. The plug should have the same thickness as the depth of the ring with which it is used. The rubber eraser should be soft and grit-free. Art gum should not be used because it crumbles easily. The round plug can be cut from the eraser by putting a sharp edge on one end of a metal tube of the right diameter, and then twisting the tube through the eraser. Or you can chuck the metal tube in a drill-press, if the chuck will accept it.

Fig. 9 is an "x-ray view" showing how the small wire lead is connected to the top of the needle, and how the needle is mounted in the rubber plug. Scrape the top end of the needle clean and bright, then scrape the end of a short length of #38 copper wire and wind 6 or 8 turns *tightly* around the end of the needle, as shown, and secure the winding with a little *Duco* cement. The winding should be held firmly until the cement sets. Now, starting at the top of the rubber plug, push the needle down through the plug so it takes the position shown. The air-gap between the needle and the plate can always be adjusted later on.

The quality of reproduction obtained with this capacitance pickup depends largely on the type and quality of the phono needle used in it. The needle should have a straight shank, preferably of uniform cross-section, and it should have the lowest possible amount of mechanical resonance within the audio range. The needle point, preferably diamond or genuine sapphire, should be precision ground and polished. Use a .003" needle point for 78-rpm records only. A .001" needle can be used for both 45-rpm and 33 $\frac{1}{3}$ -rpm records. If you want to play all three speeds, you can use a needle with a compromise point of .002". Of all the needles tried by the writer, the best results were obtained with the *Audio-point* #123 microgroove sapphire-point needle, shown in the illustrations. List-price is \$2.00 or about \$1.25 net at radio mail-order houses. Other makes of straight-shank needles with various point diameters and point materials are available to the experimenter.

Fig. 7 is a "head-on view" of the cartridge screw-fastened onto the nose

(Continued on page 90)

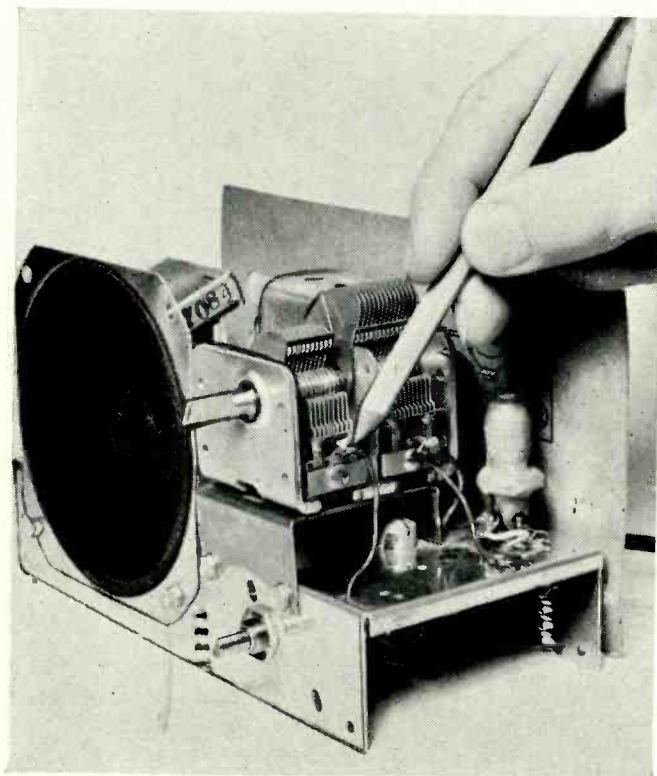

★
Fig. 18. Front-end of a typical a.c.-d.c. table model superhet. The pencil points to the stator lug on the oscillator section of capacitor gang. This is grid side of oscillator to which the needle of the pickup is connected. See text for details on how to determine the correct section of the capacitor gang.



MARINE ELECTROLYSIS AND RADIO

By ELIOT DRAKE

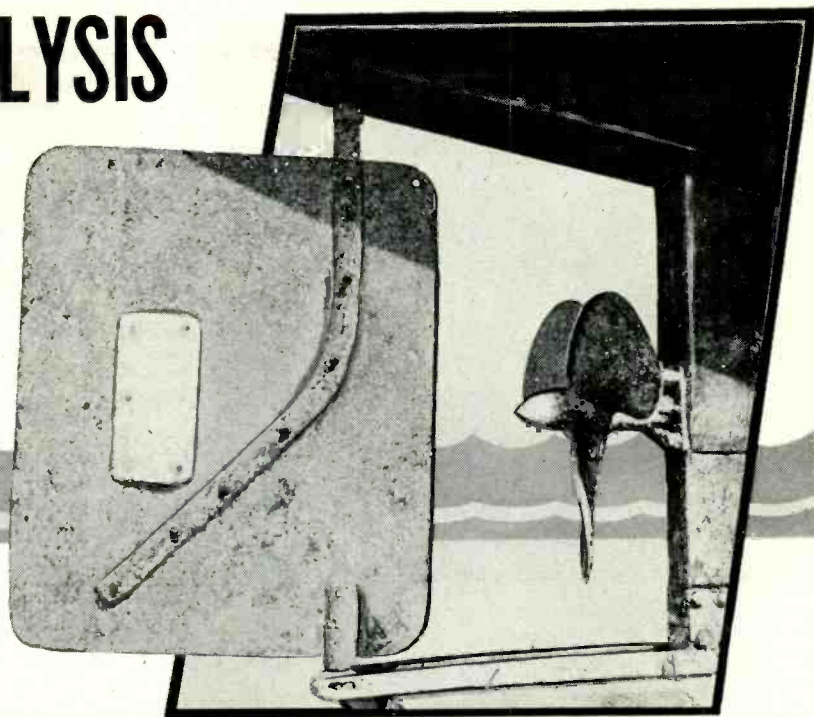

View of a steel rudder facing a bronze propeller showing the metallic decomposition due to the electrolysis between the two metals. The rectangular piece of metal affixed to the rudder is a "protector" plate made of zinc.

ANYONE having anything to do with a marine radio will run into the term "electrolysis" before they have gone very far. If they know the score in this important subject there will be no trouble. But anyone taking on boat work without having full knowledge of the peculiar effects encountered when salt water and electricity are mixed had better learn fast. If you make a mistake working on a TV set, the worst that can happen is that the set might not work. But one mistake on a marine hookup can sink the boat before you have time to get ashore.

Applied to boating, electrolysis is the decomposition of underwater metals due to electrical current flow between them. Put a piece of zinc and a piece of copper in a bowl of brine, connect them together, and the zinc will start disappearing. The life of the zinc electrode depends upon the size of the pieces and their spacing. As the action progresses (the same as in a primary battery cell) bubbles will form on the copper, deterioration of the zinc will tend to slow up, and the cell is then said to be "polarized." However, agitation will jar the bubbles away, depolarizing the cell, and even increasing the speed of action. If the water around a boat is anything, it is agitated, so the consequence is that any simple cells on boats are extremely active.

Electrolytic decomposition takes place between almost any two dissimilar metals in salt water. Which of the two metals will dissolve and how fast depends upon the relative positions of the two metals in the Galvanic Series of Table 1. Base metals lose material to the nobler ones; the farther apart on the scale the metals are, the faster will the base one disappear.

This shows up most rapidly in small pieces of hardware, such as nails and screws. First of all, ferric metals should never be used. Next, the usually noncorrosive common brass screw is a bad actor afloat. This is because common brass is a mixture of copper and zinc—the very materials of the

A radio installation on a boat can sink the craft if precautions are not taken to prevent electrolysis.

active primary cell mentioned previously. Use a brass screw to hold something in contact with salt water, or even salt spray, and a month later the screw may be gone, having "de-zinc'd" or devoured itself through electrolysis.

The same action will occur if a brass screw is used to secure a "nobler" metal, as for instance, stainless steel radio fittings, copper ground plates, etc. It is not necessary that fittings be constantly immersed to be in danger. Occasionally-wet fittings, particularly those in constant exposure to spray or near the waterline of vessels, sometimes deteriorate the fastest due to the high oxygen content of the water under these conditions.

To be safe, use fastenings of exactly the same material as the fitting to be fastened. Marine bronze or "Everdur" are popular for boat hardware.

Ground plates of 12 or more feet of copper are required for marine radio transmitters and other radio installations. Putting a sheet of this fairly noble material on the hull is an un-

avoidable invitation to an increase of primary cell electrolysis which will eat away baser fittings bonded to the ground. With reasonably good fittings, the action will be slow enough to spread the process over so many years it will hardly be noticed. But a bad fitting might start to wear away perilously fast.

Decomposition depends upon the amount of current flow. Measure ground-plate current, upon making such an installation, with a milliammeter connected in series with the ground wire. Some flow will probably be seen, with the ground plate having positive polarity. The seriousness of this flow can be gauged by the fact that each milliamperere has been found to remove about .036 ounce of metal per month in typical installations. Thus, currents of a few milliampere are no cause for alarm but, if the flow approaches an ampere, something is disappearing too rapidly for safety. In this event, the ground plate should be

(Continued on page 113)

Table 1. The Galvanic Series for metals which lists metals in the order of their electrolysis activity. Those on top lose metal to those farther down.

"BASE" OR CORRODED END.

Magnesium
Zinc
Aluminum 2S
Cadmium
Aluminum 17ST
Steel or iron
Cast iron
Chromium-iron (active)
Ni-Resist
18-8 stainless (active)
18-8-3 stainless (active)
Lead-tin solders
Lead
Tin
Nickel (active)
Inconel (active)

Brasses
Copper
Bronzes
Copper-nickel alloys
Monel
Silver solder
Nickel (passive)
Inconel (passive)
Chromium-iron (passive)
18-8 stainless (passive)
18-8-3 stainless (passive)
Silver
Graphite
Gold
Platinum
"NOBLE" OR PROTECTED END.

1955



TEST POINTS

By JACK NAJORK
District Service Supervisor
Electronics Division, General Electric Company

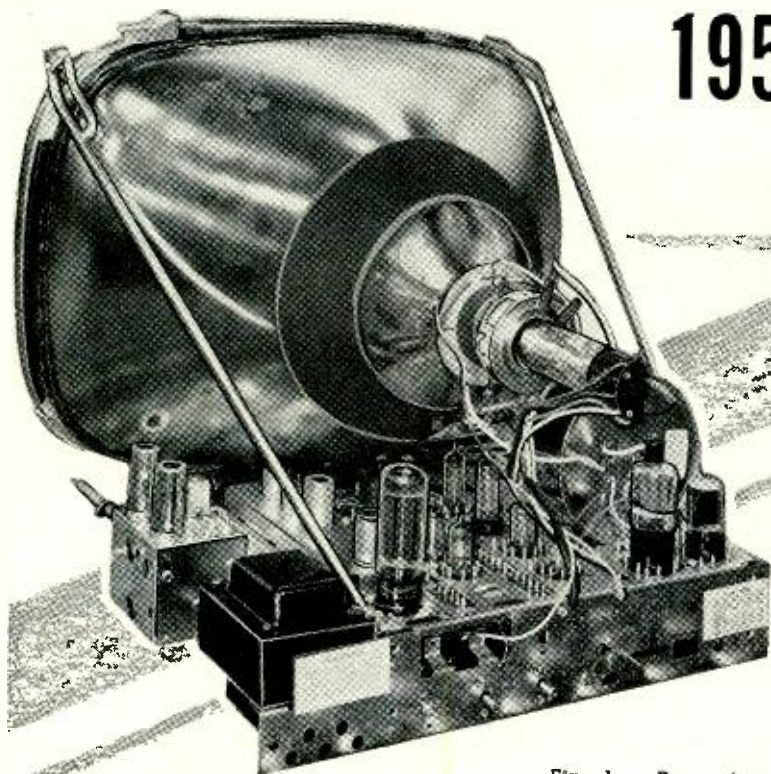

Fig. 1. Rear view of the "K" chassis showing the dip-soldered connections.

The popular dip-soldered "K" chassis has more than the usual number of test points for rapid servicing.

THE dip-solder method of construction used in all recent General Electric television receivers makes available to the technician many more above-chassis test points than usual. As can be seen from Fig. 1, these test points are in the form of projecting, soldered rivets, secured to various ter-

minal boards and to the tube sockets. The most commonly used test points on the "K" chassis which includes models 17T14, 17T16, 21T17, 21T18, 21T28, 21C102, and 21C238, are indicated by Roman numerals in the top view of the chassis in Fig. 2. In addition to the designated test points,

many additional test points are available directly at the projecting tube socket solder joints.

As can be seen from Fig. 1, top chassis shielding is used over the video i.f. and video amplifier circuits to prevent direct signal pickup in these stages, hence these tube socket joints are not exposed. It is a simple matter, however, to remove this shielding to expose tube socket joints in these circuits. When this is done, all tube socket connections except the tuner tubes, the 5U4G rectifier, and the 12BH7 vertical deflection stage, can be reached from the top of the chassis.

Fig. 2. Tube and component layout diagram of the "K" TV chassis with a u.h.f. section added to the v.h.f. tuner. The various test points are shown in roman numerals.

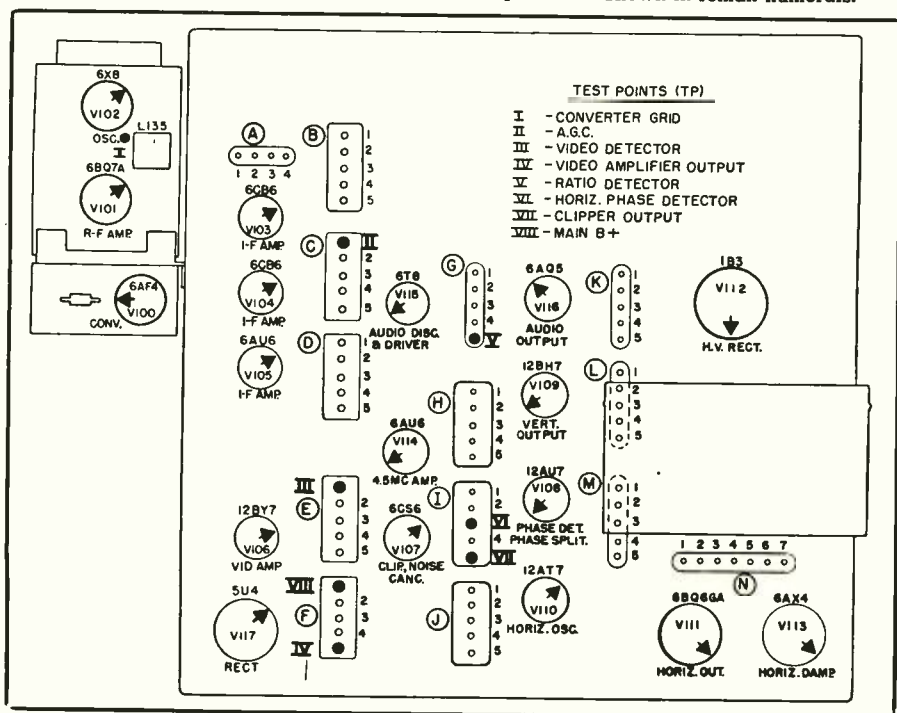

Circuit Description

The "K" chassis employs a 13-position cascode tuner with a 6BQ7A r.f. amplifier and 6X8 mixer oscillator. Test point I, which is in the mixer grid circuit, is useful mainly as a quick v.t.v.m. check to determine if the oscillator section of the 6X8 is functioning. Since this point is isolated from the 6X8 mixer grid by a 15,000 ohm resistor, no external isolation is needed and the d.c. v.t.v.m. probe can be connected directly to this point. A secondary use of this test point is signal insertion for alignment of the video i.f. stages.

The 13th position of the tuner is used for u.h.f. reception, the local oscillator being disabled and the tuner circuits functioning as a 40 mc. amplifier in conjunction with a single-conversion u.h.f. converter which uses a 6AF4 local oscillator and 1N82A diode mixer.

The three-stage 40 mc. video i.f. amplifier uses two 6CB6's and one 6AU6, with one 47.25 mc. trap at the input of the first 6CB6. The first and second 6CB6's are connected in series across the plate supply for power supply economy reasons. Test point II is tied

(Continued on page 96)

Table 1. List of the test points available on the "K" chassis together with a procedure for utilizing them for servicing.

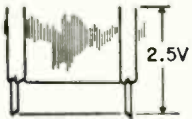
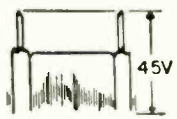
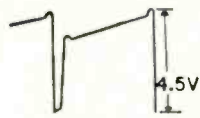
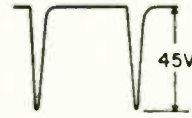
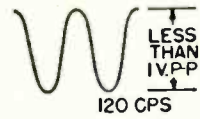
TEST POINT	VOLTAGE READING NORMAL SIGNAL	SCOPE WAVEFORM	TEST PROCEDURE
I—Converter grid	Use v. t. v. m. Always negative, averages -1.5 volts.		Check on oscillator section of 6X8. Zero volts indicates no oscillation. Positive voltage could be caused by gassy tube or internal component failure in tuner. Feed an AM signal through a .001 μ fd. capacitor for video i.f. trap alignment. Feed a sweep signal in through .001 μ fd. capacitor for visual alignment of i.f. amplifier strip.
II—A.G.C.	Use v. t. v. m. Always negative and varies with signal level, from -.5 to -3 volts.		Check a.g.c. action by noting voltage reading with antenna connected and disconnected. Reading should become more negative with increasing signal strength. Positive voltage at this point can be caused by gassy or shorted i.f. tube or internal capacitor leakage. No change in reading with varying signal strength can be caused by leaky or shorted a.g.c. line bypass capacitors. Connect -3 volt battery bias to this point during video i.f. alignment.
III—Video detector	Use v. t. v. m. Always negative and varies with signal level.	 (Scope synced at 1/2 horizontal frequency)	Signal continuity test between antenna terminals and detector. Correct indication here shows tuner and video i.f. amplifier stages OK. Very weak or no indication indicates trouble in one of these sections. Use this point in conjunction with TP IV as described below to check gain of video amplifier. Connect scope to this point through 10,000 ohm resistor for visual indication of trap alignment with AM signal and for video i.f. sweep alignment.
IV—Video amplifier output	Always positive. Varies with setting of brightness control, averages +8 volts.	 (Scope synced at 1/2 horizontal frequency)	Check 12BY7 video amplifier gain by reading peak-to-peak video drive at this point with picture control full on. This reading, divided by peak-to-peak reading obtained at TP III equals 12BY7 stage gain. Normal stage gain should run between 15 and 20. Normal indication at detector with weak or no output from 12BY7 will result in weak or no audio, as well as no picture and no sync.
V—Ratio detector output			Check audio system by touching this point with finger or screwdriver. No output from loudspeaker means trouble in either 6T8 audio amplifier or 6AQ5 audio output stage.
VI—Horizontal phase detector	Use v. t. v. m., +6 volts.	 (Scope synced at 1/2 horizontal frequency)	Connect v.t.v.m. between this point and ground when adjusting horizontal stabilizer coil, L _{250A} . Adjust for +6 volts. In noisy, weak signal areas, adjust for +6 volts and retouch L ₂₅₀ for maximum horizontal picture stability while watching picture.
VII—Output of 6CS6 noise canceller and clipper	+130 volts.	 (Scope synced at 1/2 horizontal frequency)	Check cleanliness of sync pulse by connecting scope to this point. If clean pulse cannot be obtained, be sure "local-distant" switch is not at fault. Too strong a signal with switch in "distant" position will compress sync. Aging 12BY7 video amplifier can cause same effect. Occasionally, a slightly gassy video i.f. tube will have same effect.
VIII—Main "B+"	+275 volts.		Low voltage here, evidenced by reduced picture size and brightness, generally caused by weak 5U4G. Same effect can be caused by low capacity input filter C _{100A} , 60 μ fd. Open or low capacity output filter, C _{100B} , 80 μ fd. will have little effect on voltage reading but will produce hum in picture, and poor vertical sync. Scope reading will show much more than one volt peak-to-peak at TP VIII if this section of capacitor is at fault.

FREQUENCY MEASUREMENT ADAPTER

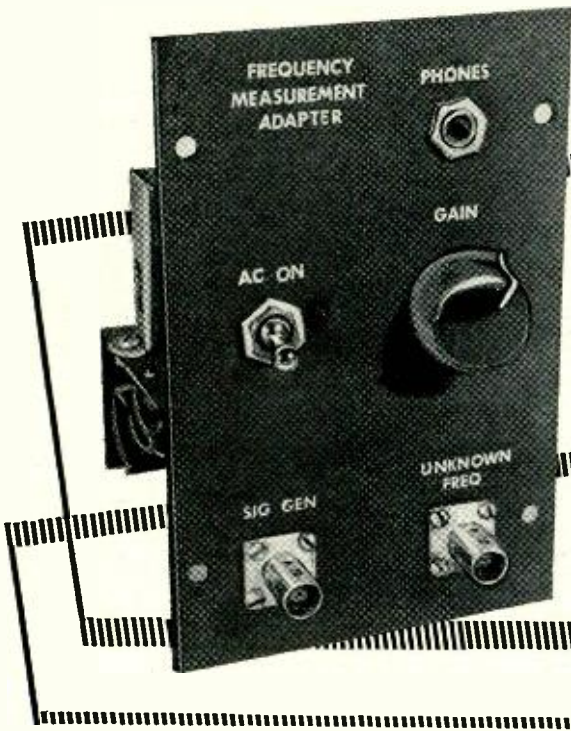

Front view of the author's home-built frequency measurement adapter. It uses a single tube and germanium diode.

By **RICHARD GRAHAM**

Extend the usefulness of your signal generator by building this handy accessory unit for measuring unknown frequencies.

FREQUENCY measurement is of fundamental importance in almost every electronic endeavor—be it servicing, experimenting, or just plain hamming. The degree of accuracy may vary, but the necessity for frequency measurement is still present. Often crude and cumbersome methods must be resorted to—particularly

when the proper frequency measuring equipment isn't available. The frequency measurement adapter described should make life simpler in this respect for it converts the ever-present signal generator into a frequency meter.

The adapter itself is the acme of simplicity, utilizing as its main components a germanium diode mixer and a single-tube, two-stage audio amplifier. This adapter can double the usefulness of any signal generator.

The basic principle of the frequency measurement adapter is quite simple. A block diagram illustrating the operation of the unit is shown in Fig. 1. An unknown frequency is mixed with the known signal-generator frequency. The

signal resulting from the mixing of these two signals consists of four separate frequencies; namely, the sum of the known and unknown frequencies, the difference of these two frequencies, the known frequency, and, lastly, the unknown frequency.

When the two signals (the known and unknown frequency) are within a few hundred cycles of each other, the difference frequency will be an audio signal. The remaining three resulting frequencies will be r.f. signals which can be easily bypassed to ground by a small capacitor. The audio signal is then amplified in two stages and fed to a pair of earphones.

When the known and unknown signals are exactly the same, no audio signal will result since the difference frequency is now zero. However when the known and unknown signals differ by any frequency within the audio range, a tone is heard in the earphones. This process is more familiarly known as zero beating.

The circuit for the adapter is shown in Fig. 2. The coaxial inputs for both the unknown signal and the signal generator are terminated in 47 ohm resistors. These resistors are connected directly at the coax connector. These terminations are important when measuring frequencies in the v.h.f. region with the adapter. The inner conductor terminals of the two coax connectors have 680-ohm isolating resistors in

(Continued on page 91)

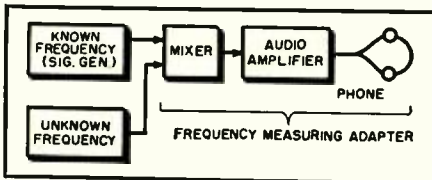

Fig. 1. Block diagram of frequency measuring methods as described in the article.

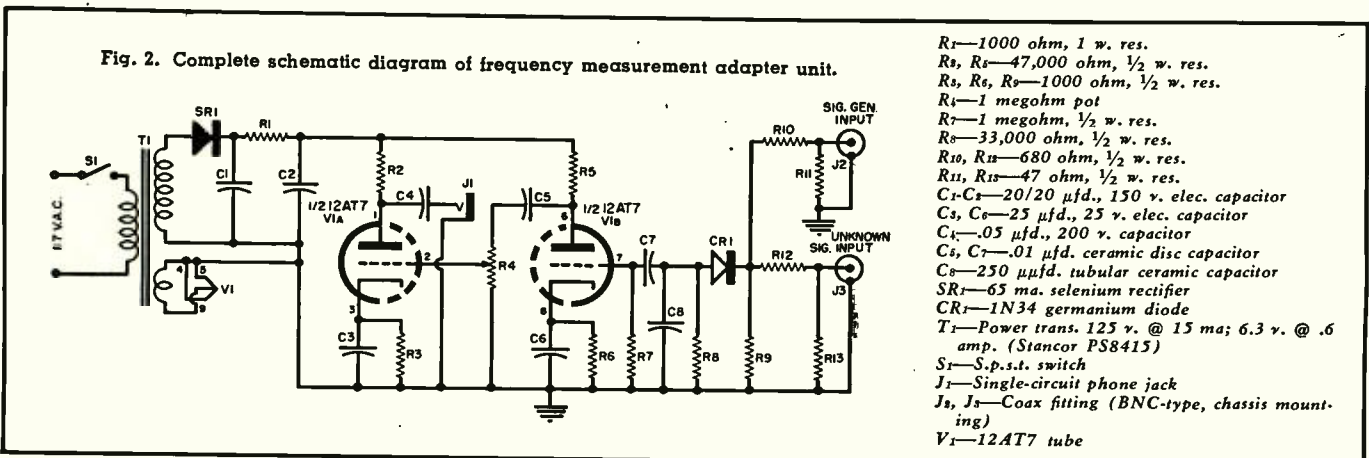
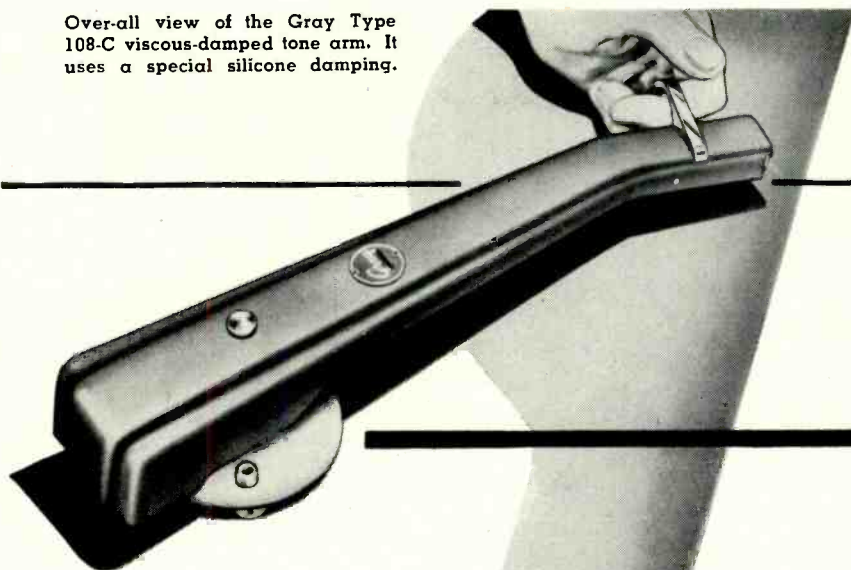

Fig. 2. Complete schematic diagram of frequency measurement adapter unit.

- R₁—1000 ohm, 1 w. res.
- R₂, R₃—47,000 ohm, 1/2 w. res.
- R₄, R₅, R₆—1000 ohm, 1/2 w. res.
- R₇—1 megohm pot
- R₇—1 megohm, 1/2 w. res.
- R₈—33,000 ohm, 1/2 w. res.
- R₁₀, R₁₁—680 ohm, 1/2 w. res.
- R₁₂, R₁₃—47 ohm, 1/2 w. res.
- C₁—20/20 μfd., 150 v. elec. capacitor
- C₂, C₃—25 μfd., 25 v. elec. capacitor
- C₄—0.05 μfd., 200 v. capacitor
- C₅, C₇—0.01 μfd. ceramic disc capacitor
- C₆—250 μfd. tubular ceramic capacitor
- SR₁—65 ma. selenium rectifier
- CR₁—1N34 germanium diode
- T₁—Power trans. 125 v. @ 15 ma; 6.3 v. @ .6 amp. (Stancor PS8415)
- S₁—S.p.s.t. switch
- J₁—Single-circuit phone jack
- J₂, J₃—Coax fitting (BNC-type, chassis mounting)
- V₁—12AT7 tube

Over-all view of the Gray Type 108-C viscous-damped tone arm. It uses a special silicone damping.



New Hi-Fi Tone Arm

OF INTEREST to owners of high-fidelity sound systems is the new tone arm recently released by *Gray Research & Development Co., Inc.* of Manchester, Connecticut.

The Type 108-C viscous damped arm incorporates a silicone damping fluid that is placed at the interface between a ball and socket, as shown in Fig. 1. An adjustable cone-point pivot screw allows the degree of damping to be readily controlled and, at the same time, provides practical freedom from static friction with arm movement. This damping virtually eliminates troublesome low-frequency resonance which frequently causes groove-hopping and distortion on loud passages. Vertical damping also prevents damage to the record and stylus due to accidental dropping of the arm and improves the tracking of warped records.

All of this is made possible by the use of a silicone, which is chemically inert, whose viscosity remains relatively constant over a wide range of temperatures. Unlike most hydrocarbon compounds, it will not oxidize or change its characteristics over a long period of time.

The principle behind this feature is that the viscosity of the liquid controls the arm damping, with additional corrections made possible by various settings of the pivot adjusting screw.

The arm itself is supported by the single needle-point pivot in the center of the ball and socket. See Fig. 1. It is this gap between the ball and socket—a few thousandths of an inch—which is filled with the damping fluid.

The adjustment of the arm's damping is a relatively easy process for the user. He merely holds the arm level and then presses firmly down around the pivot. The pivot screw can then be turned slowly in the clockwise direction until it contacts the cone point of the pivot. A single one-half turn of the screw in the same clockwise direction gives the maximum adjustment for damping.

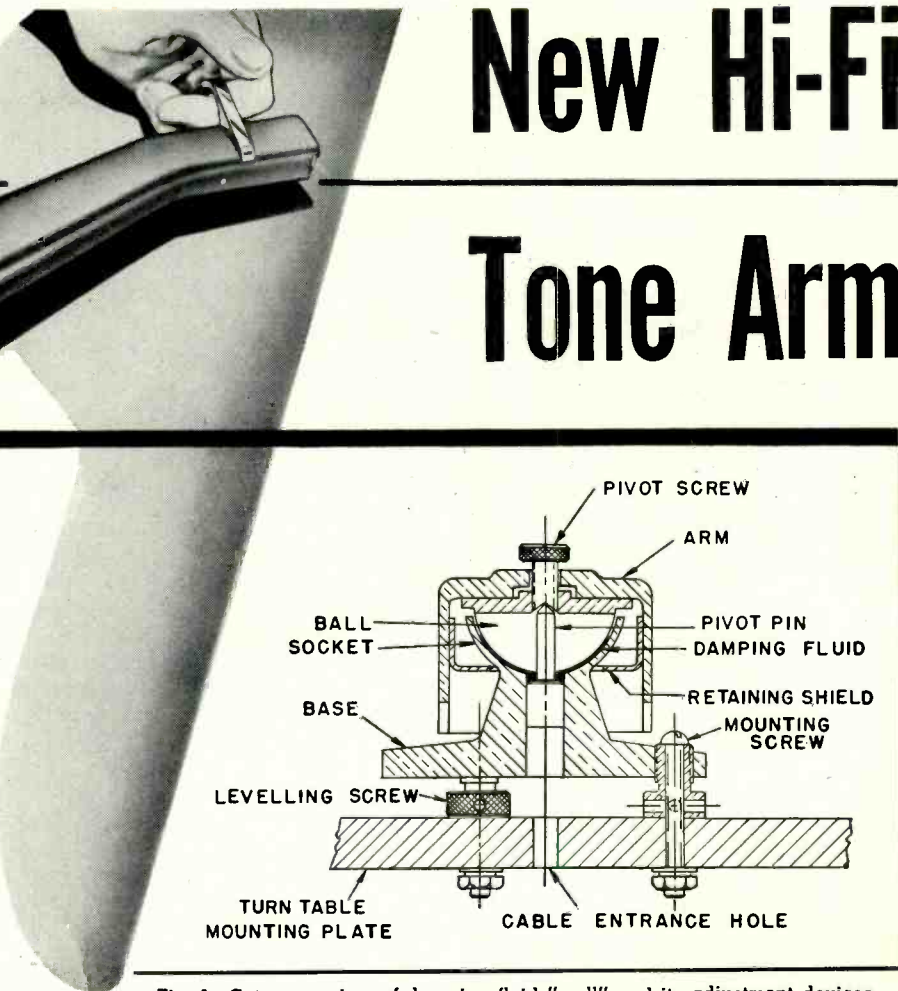

Fig. 1. Cut-away view of damping fluid "well" and its adjustment devices.

The use of a special silicone regulates both vertical and horizontal movement and prevents disc damage from dropping.

The useful range, however, extends about $1\frac{1}{2}$ turns beyond this point. The user merely turns the screw clockwise in one-quarter turn increments, with a delay of about one minute between trials, to achieve the optimum condition whereby it takes about two seconds for the arm (with cartridge in place) to drop one inch to the record.

Each tone arm comes with three cartridge slides of the user's choice. The correct weights for the specific cartridges to be used are included with the arm assembly. The company has developed slides and weights for *Electrosonic* ESL-111; *Fairchild* 215A, 215B, 215C, 220A, 220B, and 220C; *General Electric* RPX-046 and RPX-046 (3 mil); *Pickering* 120, 200, 140, and 240; and *Weathers* cartridges.

The stylus force is adjusted at the factory by lead weight positioning at the back of the arm. Proper force for each cartridge is automatically fixed by the small weight associated with each of the slides. From 6 to 8 grams force is obtained with the combined cartridge-weight-slide assembly. Identical weights are used for the two

Pickering models because the 2.5 and 3 mil cartridges are about 5 grams heavier than the 1 mil model, thus providing proper force.

Three special base levelling screws are provided with the arm and the user, after temporarily inserting the correct cartridge slide, can then make the necessary adjustments to insure that the bottom edge of the arm is parallel to the surface of the record.

All groove widths, all record diameters up to 16", and all normally used stylus forces can be accommodated with this single arm. By utilizing the quick-change slides, cartridge interchange is facilitated. Each slide and cartridge assembly is preset to proper stylus force, reducing to a minimum the danger of unauthorized tampering.

Over-all length of the arm from the stylus end to the center of the pivot screw is $11\frac{1}{16}$ ". By proper placement of the arm, the unit can be used with virtually all sizes of records. The various dimensions for the different types of installations are given in the instructions which accompany each arm.



AN AMATEUR U.H.F. TRANSCEIVER

By
ROBERT M. RICHARDSON, W4UCH
Richcraft Electronic Engineering Company

The author is shown using one of the transceivers.

If you are looking for a new and inexpensive project, here is a compact two-way system that costs less than \$25.00!

THE current lack of activity on the amateur bands above two meters and the supposed difficulties involved when working these frequencies proved to be just enough of a challenge to the author so that he designed and built the pair of 435 mc. transceivers to be described in this article.

After a few weeks of experimenting with standard components, this design was evolved, built, and tested in a matter of hours. No u.h.f. difficulties were encountered and if there was anything unexpected about this construction, it was the lack of trouble in putting this unit together.

The only tools and instruments required to build this transceiver are a screwdriver, a soldering iron, and a pair of Lecher wires which can be made at no cost from six-foot lengths of bare wire, a couple of nails, and a piece of board. The over-all cost of each transceiver was below \$13.00, so a complete "system" is available for \$25.00!

A pair of these units has been used together to communicate up to a mile over favorable terrain. With a dipole distances up to five miles line-of-sight

are entirely possible, the author found.

These units are ideal for Civil Defense and rescue activities where close range communications are needed and the current budget calls for really low-cost transceivers.

All parts required for this construction are easily obtainable from any local radio parts supplier or, in most cases, the necessary components can be dredged out of a well-filled junk box.

Tracing the circuit through operationally, it may be noted that the single-button carbon microphone is supplied mike current from a 1.5 volt standard flashlight cell or from a 1.5 volt tap on the 6-volt filament supply battery.

The combination 1:3 interstage and mike transformer was handmade and is an adaptation of a commercial unit. The core should be removed from a *Stancor* A-35 or similar interstage transformer and 50 turns of #30 d.c.c. solid wire added for the mike winding. It will be found that there is ample room for this extra winding and that no difficulty should be experienced when replacing the transformer laminations. A strip of plastic insulating

tape should be wound around the core after the additional winding is in place to secure all transformer leads.

The first triode of the single 12AT7 is used as an AM modulator while transmitting and as a straight audio amplifier when receiving. The second section of the 12AT7 is used as an oscillator whose cathode is above ground since this was found to be the most stable type of u.h.f. oscillator when subjected to both varying "B+" voltages and AM modulation. When receiving, this triode acts as a self-quenching superregenerative detector with extremely high sensitivity. The quenching frequency is determined primarily by the time constant of the 500 μ fd. capacitor (C_1) and the 2.2 megohm resistor (R_1) grid RC circuit. It is also affected by the plate r.f. choke and bypass capacitor which should be of the values specified.

As shown in the photographs, the grid and plate tuned lines are soldered directly to the grid and plate pins of the oscillator triode and terminate on the two stators of the butterfly tank capacitor. The antenna coupling link is soldered to a terminal strip mounted behind the butterfly capacitor and runs parallel to the grid-plate tuned lines for approximately 2 inches.

A quarter-wave vertical antenna is used on the model shown by grounding the grid side of the antenna link coil and running a short length of RG-59U coaxial cable to the banana plug antenna mount. A half-wave folded dipole antenna may be used if desired and fed with 300-ohm twin-lead from the antenna link, neither side of which should be grounded. Both types of antennas were tried, with the folded dipole having slightly better gain than the quarter-wave vertical but performance with the latter was more than satisfactory, hence it was chosen for size and convenience.

Performance specifications on the home-built u.h.f. transceiver equipment.

Transmitter Power Input.....	2.2 watts
Tuning Range.....	10 megacycles
Weight.....	3 pounds
"A" Battery Drain.....	6 volts @ .3 amp.
"B" Battery Drain (Reception).....	180 volts @ 8 ma.
"B" Battery Drain (Transmitting).....	180 volts @ 20 ma.
Maximum Range.....	Line-of-Sight
Average Cost.....	\$13.00

As shown, all parts are mounted on the front of the case including the tube, transformers, and two slide switches. Since a specially-designed four-pole, double-throw switch would have been required for this unit, two 16 cent double-pole, double-throw slide switches which fit the case perfectly were used instead.

The microphone and headphone, along with their respective plastic mountings, were made from two surplus telephone handsets. This was done by sawing the mounts off of the handset directly behind the cap's threaded mounts. The threaded discs were then drilled and bolted to the face of the transceiver case. The case itself may be made from an aluminum "Minibox" or any other convenient-sized housing.

After all parts are mounted and wired, the two slide switches should be snapped down into the "receive" position and if all wiring is correct the familiar superregenerative hiss should be heard in the earphone. A pair of temporary Lecher wires should then be constructed by using a board about three feet long with two nails at each end, one-half inch apart. Any scrap of bare solid wire can then be strung from end to end. These two wires may then be coupled to the antenna post of the transceiver. By slowly moving a razor blade or knife along these two wires a definite quieting will take place in the receiver. The distance between any two of these quiet points is exactly one-half wavelength of the frequency to which the receiver is tuned. The butterfly capacitor should then be set at the desired frequency and that point marked on the front of the case. It will be found that when the slide switches are placed in the "transmit" position, the same frequency, determined by the Lecher wires, will be transmitted. For the $\frac{3}{4}$ meter band (435 mc.) L_1 and L_2 should be $2\frac{3}{4}$ " long with the distance between Lecher nulls $13\frac{3}{4}$ ".

A selenium rectifier voltage-doubler, 117-volt a.c. power supply with a 6.3 volt filament transformer has been built for use where line power is available to conserve the batteries. It is recommended that two 90-volt flat, snap-on "B" batteries and one 6-volt plug-in battery be used since a small canvas carrying case may then be made for the batteries and the whole thing clipped onto a belt for field use.

Although this transceiver could operate in the Citizens band, FCC regulations require that only type-approved equipment be used in this service. As of this date, models of this unit have not been submitted to the FCC laboratories for test and approval, but it is felt that with minor component changes the frequency stability of the transmitter could meet all of the requirements of 465 megacycles (the Citizens band). Since this unit has not been submitted to the FCC for type approval and there are no current plans for doing so, only licensed radio amateurs should operate the unit under current regulations.

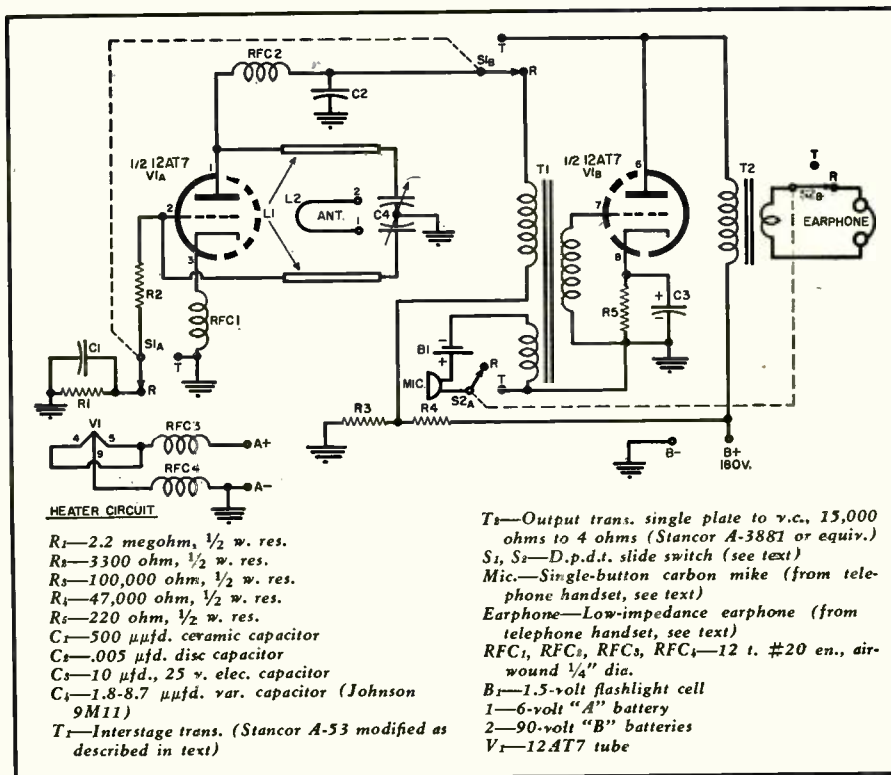

Complete schematic of transceiver. Parts are standard and circuitry non-critical.

Side view of transceiver. The earphone and mike are from salvaged telephone handset.

Rear view of set showing how the various parts are fitted into a compact "Minibox."

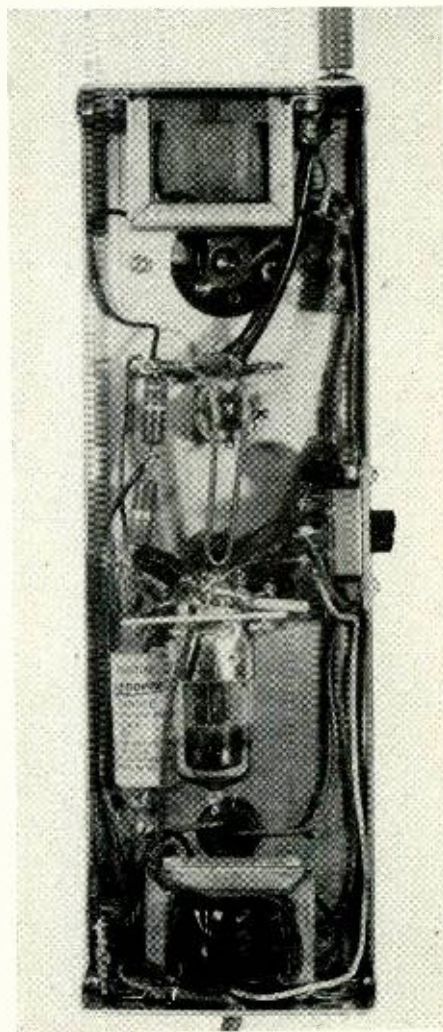
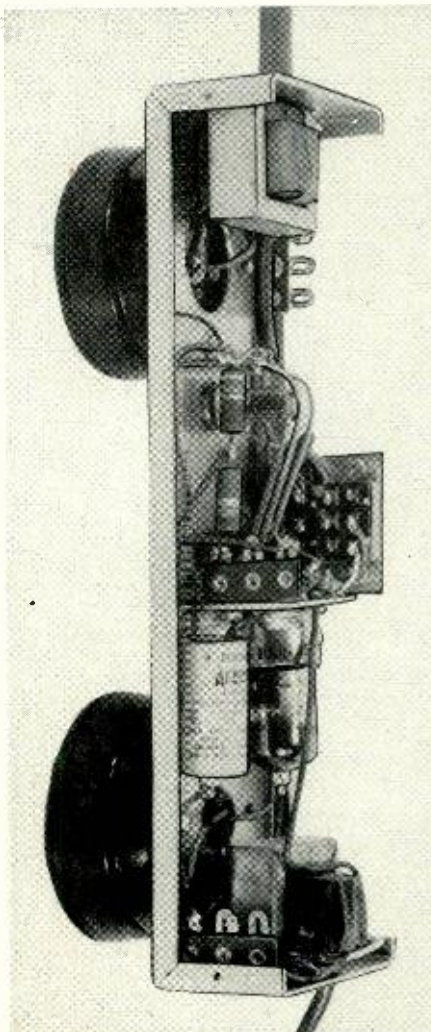

Oscillator

TROUBLES

By SOL HELLER

Many hard-to-service radio and TV troubles originate in the local oscillator—here are a few examples.

TECHNICIANS tend to become slightly apprehensive when it comes to troubleshooting a local oscillator stage. One reason, perhaps, lies in the complex wiring frequently present in this stage. Bandswitching arrangements make such rat's-nest circuitry unavoidable. Another cause of that low-down feeling is the complicated—often unnecessarily complicated—way in which these circuits are presented schematically. When the service technician has, in addition, only a hazy notion about how oscillators operate, a fine inducement to hit-or-miss troubleshooting is set up.

Many oscillator faults are due to defective tubes, loose coil connections, poor grounds, etc. There are other faults, however, which require some knowledge if they are to be readily identified and serviced. A discussion of such troubles, with a review of the theory associated with them, may prove helpful to service technicians whose understanding of oscillators has lost some capacitance, so to speak. Let's briefly consider, first, the kind

Fig. 1. Bottom view of an oscillator tube socket showing the preferred position for a negative-temperature-coefficient capacitor to eliminate drift.

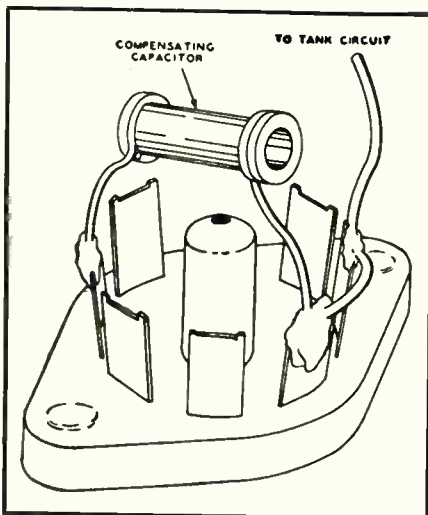

of oscillators the technician is likely to do business with.

The r.f. oscillators used in radio and TV receivers are of the following basic types: tuned plate, tuned grid, Hartley, Colpitts, electron coupled, and ultraudion. Most modern radio receivers use an electron-coupled oscillator. The chief difference among most of the oscillators cited lies in the method of feedback.

Feedback in the tuned-plate oscillator (Fig. 3A) is from plate to grid, through the coupling between plate and grid transformer windings. The same is true of the tuned grid oscillator (Fig. 3B); the grid and not the plate is, however, tuned in this circuit. In the Hartley oscillator (Fig. 3C), plate signal current flowing through L_1 is fed back to the grid by autotransformer action.

In the Colpitts circuit, feedback is capacitive, not inductive (Fig. 3D). Oscillator plate signal voltage developed across C_3 excites the tank circuit, a portion of the resultant voltage built up in the tank is tapped off across C_2 and fed between cathode and grid. The amount of voltage fed to the grid depends on the reactance ratio of C_3 and C_2 .

The ultraudion oscillator (Fig. 3F) is basically a modified Colpitts. The voltage feedback takes place through the interelectrode capacitances in the

Fig. 2. Typical short-wave receiver local oscillator. Insertion of R_1 in series with resistor R_2 reduces tendency of the oscillator to "squeg" (intermittent oscillation and squeal).

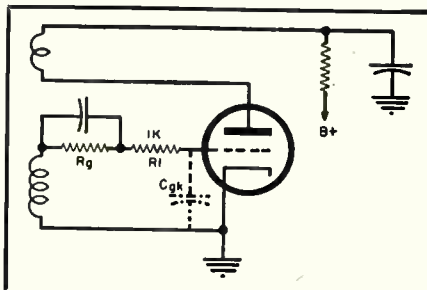

oscillator tube, and not by way of external circuit capacitances. Signal is fed back from plate to grid through the plate-to-grid interelectrode capacitance; feedback signal is also developed between grid and cathode by the passage of the oscillator signal through the cathode-to-grid capacitance.

The electron-coupled oscillator generally uses a converter tube. Coupling between oscillator and radio-frequency signals takes place inside the tube, rather than in an external circuit. In Fig. 3E, a Hartley-type oscillator using electron coupling is shown.

Excessive Output

One of the problems both designer and service technician are concerned with relates to oscillator output. The designer's job is to provide an oscillator with an output large enough to insure an adequately-sized i.f. signal, but not so large that undesired side reactions occur. The service technician has to recognize when excessive oscillator output (not due to design faults) is present, and must know what to do about it.

First, why is excessive oscillator output bad? One reason is that whistles may be produced (in radio sets). Harmonics of the oscillator frequency are stronger than they should be when the oscillator output is too large; when these harmonics beat with harmonics of r.f. signals, spurious frequencies that fall into the i.f. bandpass are produced, and whistles are heard in consequence. The symptoms are most apt to manifest themselves at the high-frequency end of the band, because oscillator output tends to rise with increase in frequency.

In the television receiver, excessive oscillator output may produce "spillover." Among the symptoms possible are jagged vertical lines across the picture, accompanied by a rushing noise in the sound.

Some engineers believe that excessive oscillator excitation can shift the frequency of oscillation. When the proper alignment or tracking of an oscillator cannot be obtained, this possibility is worth checking.

Receiver sensitivity can be reduced when the oscillator output is excessive, if a separate mixer-oscillator is present. The reason for this is that the

control grid of the mixer will be driven positive when the oscillator voltage injected at this point is excessive. The resultant flow of grid current will reduce the signal voltage developed in the r.f. tuned circuit, and will lower the mixer output as well (due to the tube's increase in bias). This condition may be detected by inserting a 0.1 milliammeter between the "cold" side of the mixer grid coil and ground. Now rotate the tuning capacitor throughout its range. If the meter needle moves at any time, either the oscillator output is excessive or the mixer bias is too low.

Still another effect of excessive oscillator output, especially noticeable in the case of TV reception, is the production of interference (via radiation) in other receivers. This may manifest itself in the affected TV set as a herringbone pattern, diagonal lines, or bars. Insufficient shielding as well as other design inadequacies are, of course, more often to blame for such conditions than excessive oscillator output. The latter should not, however, be overlooked as a possible source of TVI.

Finally, excessive oscillator output may promote parasitic oscillations which will be discussed shortly.

How can the service technician determine when the oscillator output is excessive? One of two checks may be used for this purpose. First, the grid-to-ground voltage of the oscillator, as measured with a v.t.v.m. and properly isolated probe, may be compared with the corresponding voltage listed on the set schematic. If no such listing is present, the symptoms present may serve as a guide. If the symptoms previously described can be traced to no other source, and the oscillator grid voltage seems quite high (in excess of 10 volts in a radio receiver, beyond 5 volts in a TV set) the oscillator may be putting out too much signal.

Possible causes of the trouble include: excessive oscillator plate voltage (due to a decrease in a plate dropping resistor, for example); changes in the coupling of the oscillator coil (possible but not likely); increase in the oscillator grid resistance. The presence of a high line voltage in conjunction with any of these circuit and component changes will increase the likelihood of symptoms.

Parasitic Oscillations

Parasitic oscillations take place at a frequency other than that to which the tuned circuit is resonant. They are due, in part, to the resonating of the stray inductance and capacitance in the circuit. Shunting of large capacitors by small ones may help introduce such undesired resonance.

Troubles which may be due to parasitic oscillations are "dead" spots in the tuning range and large fluctuations in the amplitude of the oscillator output. Excessive heating of the oscillator tube, reduced oscillator output, and a general instability of voltages and currents in the oscillator may also result. In a broadcast AM receiver, squeals

and whistles may be heard at the high-frequency end of the band when parasitic oscillations are present. All-wave receivers are more likely to develop the trouble than single-band broadcast sets. In the TV set, the picture may, in some instances, be weak or absent on the channel affected; in other cases, bar interference may be seen on the picture tube.

The trouble may be readily identified by shorting out the tank circuit. If an oscillator grid-to-ground voltage is still present, parasitic oscillations exist. Shortening leads, redressing grid and plate wiring to minimize undesired coupling between the two, and changing the placement of critical components, may be attempted to remedy the condition.

Other Troubles

Squegging is generally a problem on short-wave frequencies, but it may occur on broadcast as well as on TV bands. This trouble develops when an excessive time constant is present in the grid circuit of an oscillator that is putting out a large-amplitude signal. When R_1 or C_1 (Fig. 3) is too high in value, the negative voltage built up across R_1 is excessive. Oscillations may die out in consequence, until the discharge of C_1 through R_1 reduces the bias enough to restore oscillation. Then the cycle repeats. A regular interruption in the oscillator's operation thus tends to take place. If the frequency of the interruption is ultrasonic, i.e., beyond the audio range, a very high noise level in the sound of the radio will be the chief symptom. When the squegging takes place in the audible frequency range, a continual squeal or whistle will be audible. Motorboating, as described later, may also result.

If the r.f. oscillator in a TV set is squegging, lines or parts of lines may be ripped out of the picture during the time the oscillator is cut off, since no video information is reaching the CRT in those intervals.

A good test to determine whether squegging is present is to bridge the oscillator grid resistor with another one of the same nominal value. If the symptoms disappear, squegging is probably present. Suitable tests will readily show whether C_1 or R_1 is of the wrong value.

A resistor of about 1000 ohms is sometimes inserted in series with the grid (see Fig. 2) to prevent squegging on a short-wave band. This resistor, in series with the grid-to-cathode capacitance, shunts and loads down the oscillator tuned circuit on high-frequency bands, reducing the tendency to squegging on these bands. Check the value of this resistor, if such short-wave squegging is present.

Flutter and motorboating. When a strong signal is tuned in, and the regulation of the radio's "B" supply is inadequate, the "B" voltages rise, due to the increase in a.v.c. voltage. The oscillator plate voltage may change appreciably in such a case; the frequency of the oscillator will be shifted in conse-

(Continued on page 101)

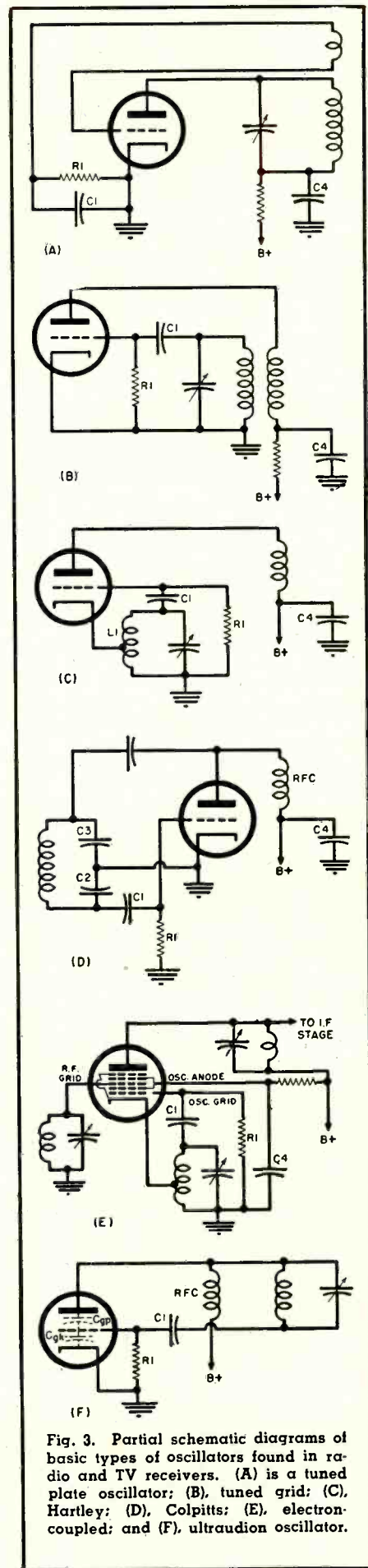



Fig. 3. Partial schematic diagrams of basic types of oscillators found in radio and TV receivers. (A) is a tuned plate oscillator; (B), tuned grid; (C), Hartley; (D), Colpitts; (E), electron-coupled; and (F), ultraudion oscillator.

Author's control amplifier. Controls from left to right: input selector switch, master gain control, expression potentiometer, treble, and bass.



HI-FI CONTROL AMPLIFIER WITH "EXPRESSION"

By **MAURICE P. JOHNSON**

Engr. Dept., Station WAAM

Details on a five-tube unit which features an "expressor" circuit for volume expansion and compression to enhance the dynamic range of reproduction on recorded material.

THE ultimate objective of most audio equipment design is to produce a greater degree of realism in the reproduction of sound. A perusal of past issues of this magazine reveals that considerable material has been published concerning various circuitry germane to achieving this goal. A comparison between present designs and those prevalent only a few years ago will show that much progress has been made. Harmonic and intermodulation distortion in audio amplifiers have been reduced to microscopic amounts. Speaker damping and controlled feedback loops have improved transient response and provided extended linear frequency characteristics. Loudspeakers, enclosures, pickup devices, and preamplifiers have likewise been immeasurably improved. An appreciation of the benefits of "high fidelity" in the home, ambiguous as the term may be, is indicative of the increased interest in high quality sound reproduction, even by the layman.

A major program source for home audio reproduction is derived from recorded material, supplied directly by playing phonograph records, or indirectly via radio broadcasting. The reproduction may well be free from distortion and be "clean," hum and noise may be at a minimum, and still not compare favorably with an original live performance.

The restricted dynamic range of most recorded material is a definite

factor contributing to the destruction of realism of such reproduction. The feeling of "presence" can often be enhanced by artificially increasing the dynamic range of recorded reproduction. An electronic circuit for such action is referred to as a "volume expander." The relative merit of volume expansion in audio reproducing equipment has been the subject of much discussion by engineers and others, but a few basic facts should be mentioned.

Even present-day disc recording techniques are such that the volume range on the record must be restricted in order to prevent excessive cutter swing on peaks which would otherwise overcut the groove. Likewise, the minimum audio level is limited by the signal-to-noise ratio of the finished disc, although this has been considerably improved by modern plastic pressing materials.

Radio stations indulge in "gain riding" even during recorded programs, in order to keep their average modulation high at the transmitter. To this end also, limiting amplifiers are used on the transmitter feed, with the result that these techniques further alter the original dynamic range of the program.

Of course, no electronic circuit to date will restore the exact dynamic range of the original live performance to material that has been subjected to such volume restrictions. Nevertheless, most listeners and audio enthu-

siasts will agree that a degree of volume expansion will do much toward increasing the brilliance and life-like character of the reproduction.

This article will be concerned with a control amplifier which is intended for use with a home audio system, incorporating a versatile expander circuit together with several other desirable features.

The control amplifier was designed with certain specific requirements in mind. The power amplifier to be used in the system, of the Williamson type, requires an audio input of approximately one volt r.m.s. This level was needed from a low impedance output, to allow operation of the control at a point remote from the power amplifier. Such output was obtained by use of a cathode-follower stage, which allows the control and power amplifiers to be separated by almost any reasonable distance without hum pickup or high frequency roll-off due to cable capacity shunting effects. It should be noted that, although the cathode-follower output impedance is low, the input to the power amplifier should be of high impedance, in the neighborhood of 100,000 ohms or more, for proper operation.

The control amplifier functions as a centralized focal point for all signals used with the complete audio system. For such use, it was necessary to include three inputs for relatively high-level signal sources. These three inputs accommodate feeds from the tape recorder playback and an AM-FM tuner, as well as a TV tuner chassis. The inputs require approximately 0.2 to 0.5 volt r.m.s. signals for the proper expander operation, as will be discussed.

A fourth input is included with a simple, yet effective preamp for use with magnetic phonograph pickups capable of outputs of 0.01 volt r.m.s., such as the *Pickering*, *Audak*, and others. A single pentode tube is used in the preamplifier stage, connected in

the conventional manner for a high-gain stage. The equalization to compensate for modern recording characteristics is accomplished by shunting the preamplifier plate load with an RC circuit formed by R_6 and C_6 in series. This method is explained in detail by Herb Matthews, in "Design Considerations for High-Quality Reproducing Systems," Part 2, RADIO & TELEVISION NEWS, May, 1950. A single turnover frequency of 800 cycles, in conjunction with the tone controls to be covered, was found adequate for the majority of recordings. Some persons may desire other turnovers, which can be adjusted by the choice of the value of C_6 . No high frequency roll-off has been included in the equalization, since this can be approximated by proper settings of the treble tone control.

Shunt-type equalizers are encountered in broadcast work and many designers have devised circuitry for exact correction for nearly all recording curves. (See "An Improved Equalizer-Preamp" by Charles Boegli, RADIO & TELEVISION NEWS, April, 1951.) Adherents of feedback-style equalizers may readily modify the stage in the manner illustrated by Lawrence Fleming in *Audio Engineering*, March, 1950 which is further improved by George Augspurger in his article "4 Problem

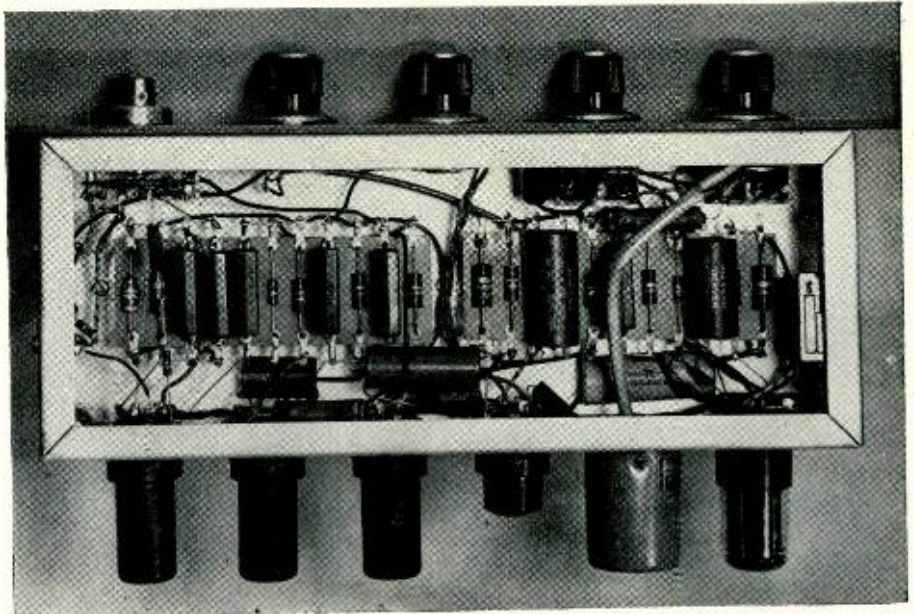

Under chassis view of unit. Note that terminal strips are used in construction to insure short leads. Left-to-right (bottom) are 6SJ7, 6SK7, 6SG7, 6H6, choke, and 6SL7.

Preamps" in RADIO & TELEVISION NEWS, November, 1952.

An input selector switch in the control amplifier is used to choose the desired signal, simultaneously grounding the other feeds to prevent leakage and

crosstalk. The selected signal is thus routed into the heart of the control amplifier which, of course, is the volume expander circuit. Here, three tubes are utilized for both volume ex-
(Continued on page 116)

Complete schematic diagram of the control amplifier. Power for the unit is obtained from amplifier with which it is used.

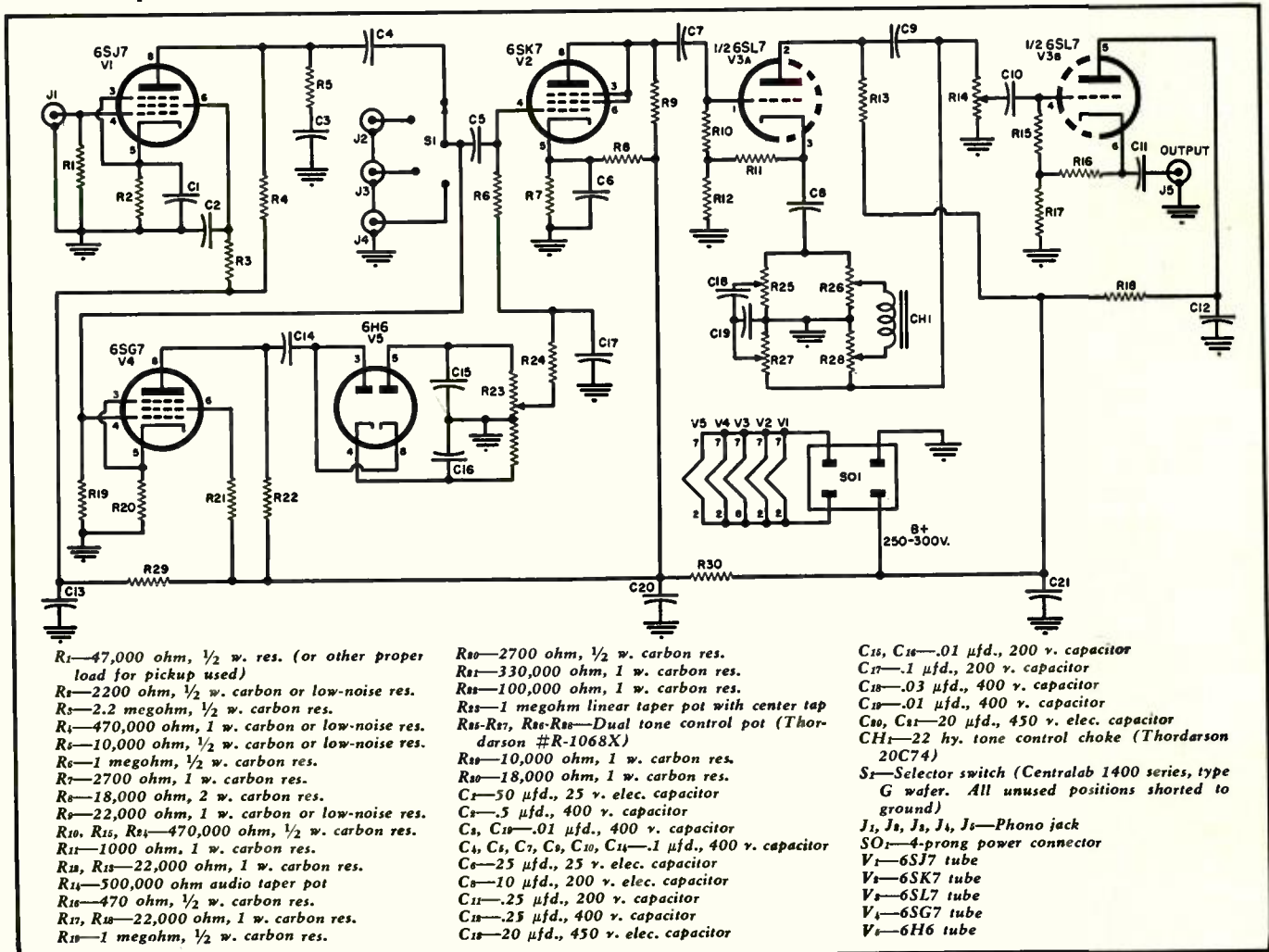

QRM?



Over-all view of receiving loop. Besides the handle for rotating loop, base has two controls on panel—resonating and impedance matching. A two-turn loop should be used if broadcast band reception is desired.

Loop wire is wound through holes in upright and the ends of arm. Note reinforcing block at junction of upright and cross-arm. Only a single-turn loop is used for high-frequency bands.

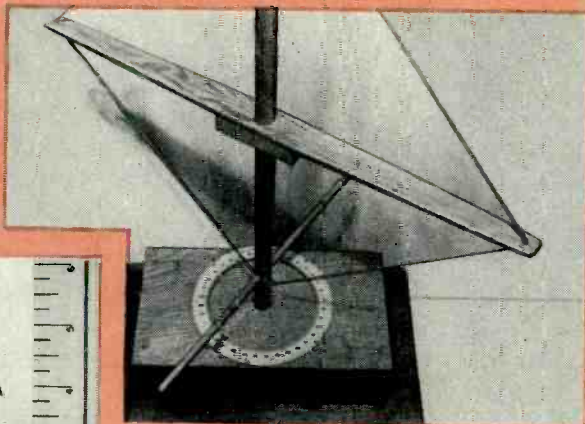

Details of upright. At the center of bottom is a 1/2" #6 round-head brass screw. Alongside, note hole bored axially for distance of about 6". At end of axial hole another hole is drilled into side of dowel, making an intersection. Purpose of hole is to pass the ground lead of unit.

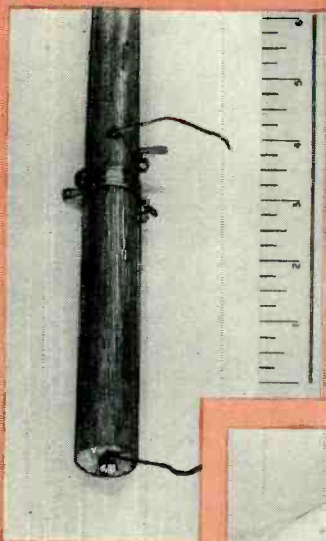

Slip ring and brush detail. Small amount of solder is run into wire wrapping both for rigidity and to prevent the wire spiral from adding reactance to the circuit.

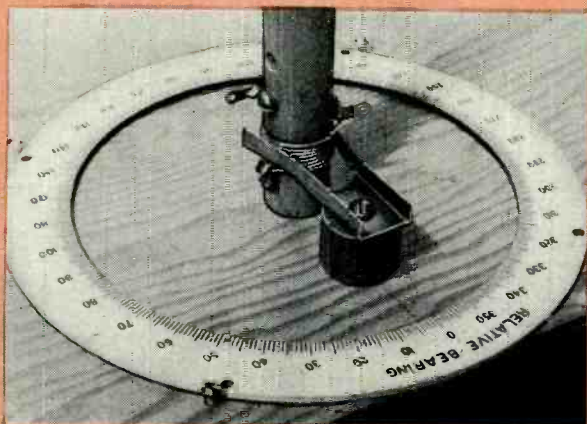

SUPPOSE you are a DX man and have just about snagged a weak squeak from the antipodes that means a record QSO. Or maybe you're an SWL and it has come time for a station break by a broadcaster who makes one announcement a day. Or, if you're a traffic man, you have written down the number, date, and check.

What is next? QRM! It might be a power leak or a strong local, but man, you're dead. Throw in the crystal filter, fiddle with the phasing, cut in the noise limiter and the a.v.c. But this QRM is modulated by QRM! Turn off the set? Take up photography?

Nothing so drastic—instead—get looped! The right way, that is: with a loop antenna for receiving. Using the highly directive properties of such an antenna, you can put down most local QRM and still keep enough signal to stay in business. A loop antenna does for the high- and medium-frequency receiver what the rotary beam does for v.h.f. and u.h.f. operators—provides signals in the wanted direction and a nice quiet hole to drop QRM in.

Most amateurs know about loops and some even try them for a taste of field-day direction finding. Then they usually drop the idea like a hot wire

Stationary contact for loop ground screw is a brass strip set into bottom surface of base. Recess may be cut with chisel or knife so contactor will not project below bottom. The screw is used for the ground.

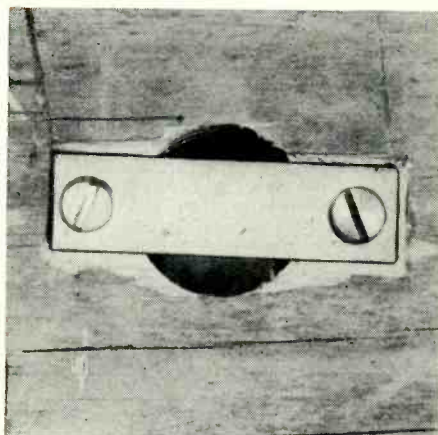

GET LOOPED!

By **ELBERT ROBBERSON**

A loop antenna can do as much for your h.f. and m.f. radio as a rotary beam for v.h.f.-u.h.f.

on a humid day. The common impression is that loops are suitable for commercial direction finders on the other side of the broadcast band, but no good for high frequency.

The way loops are ordinarily built for ham use gives this impression plenty of justification. A random-wound bunch of wire connected to the antenna terminals of the station receiver cannot be expected to perform. Any signals pulled in by such an arrangement are mostly accidental.

Yet, a workable loop is not difficult to construct and can be a most useful QRM cutter. Furthermore, when not in use as a main antenna it can, if suitably connected, be used with the regular external antenna as an additional tuning and impedance-matching element for the receiver front end.

Without going into a tedious amount of theory, the loop receiving antenna may be looked on as a parallel resonant circuit, in which a signal is induced magnetically. Fig. 1A illustrates the simplest workable form, the high-impedance loop. Capacitor *C* resonates the circuit to signal frequency, and output is taken across its terminals. This form of antenna has certain characteristics common to all loop antennas, as follows:

1. The amount of magnetic field intercepted depends upon the loop area. The more the better.

2. The amount of signal induced by the field depends upon circuit "Q." Thus the inductance should be kept high, and the resistance from internal sources low.

But, in addition to these family characteristics, the loop of Fig. 1A (although it is the simplest form) has other characteristics which make it unsuitable for convenient ham use.

The drawback which puts it out of the running is the fact that the terminals and body of the loop are very susceptible to electrostatic excitation. As is commonly the case with any extremely high-impedance circuits, it is strongly affected by even slight capacitive coupling to its surroundings and operator hand capacity. Of course, this can be eliminated by surrounding the loop with a form of Faraday shield

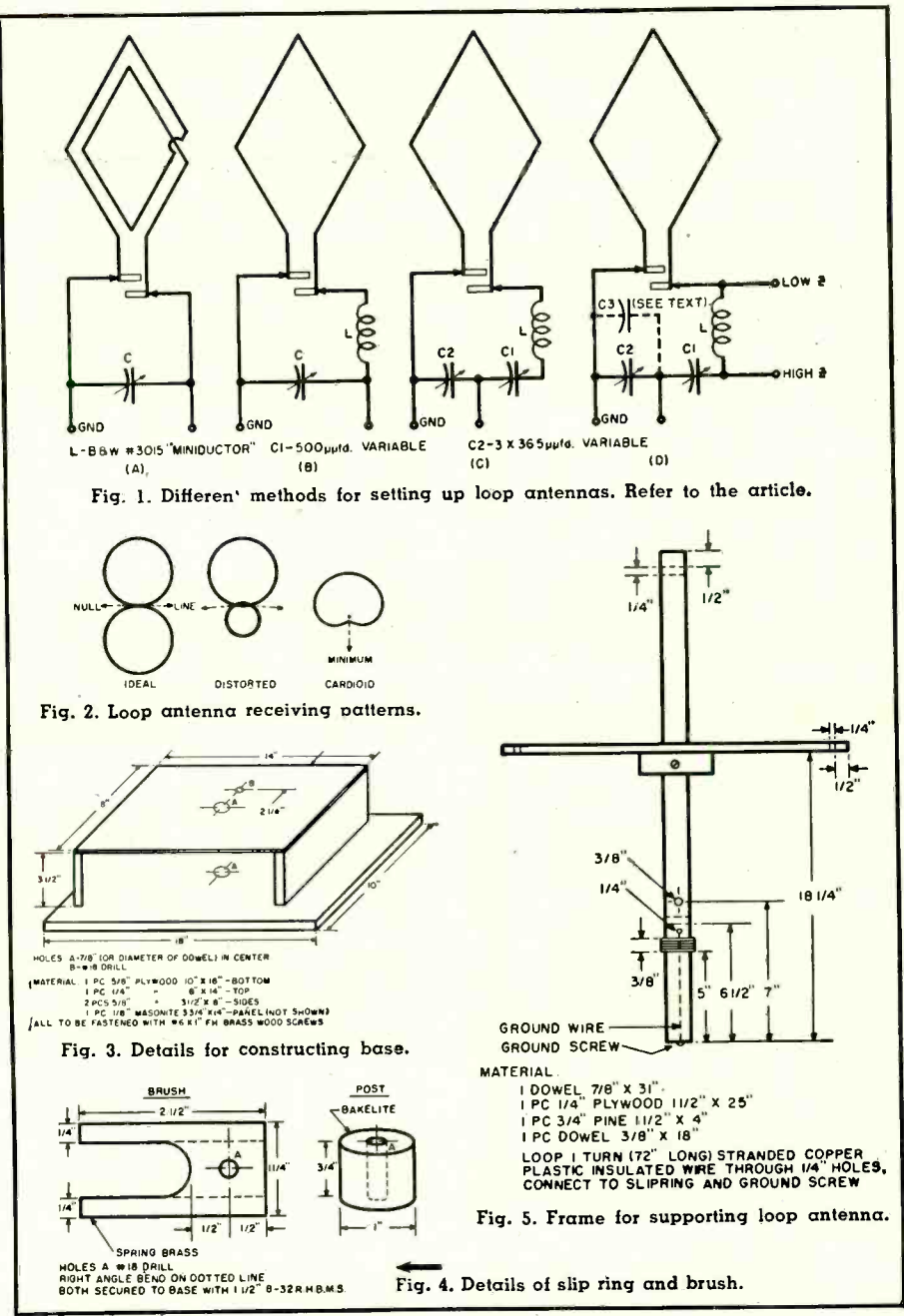

(which is done in commercial equipment); but that puts the antenna out of reach of ham facilities, entirely.

Fig. 1B shows an adaptation in which a low-impedance loop is used in conjunction with an external loading coil of good "Q," the combination of which is tuned to resonance by capacitor *C*. This circuit almost completely does away with the electrostatic pickup and hand capacity, without the mechanically complicated Faraday shield. It almost qualifies for ham use—but not quite.

The main failing of the circuit in Fig. 1B (which was also a secondary and therefore unmentioned fault of the circuit of Fig. 1A) is that the loop-output circuit is of extremely high impedance. With such circuits, the output impedance commonly runs from 10,000 to 50,000 ohms. In commercial direction finders, where the circuits of Figs. 1A and 1B are used, connection

is usually made directly to the grid of the first tube, which has an impedance high enough for satisfactory operation. But if the ordinary ham-receiver antenna circuit, of from 75- to 500-ohms impedance, is connected across such a loop, the result is practically a dead short. It is this fact that accounts for most ham-loop failures—a short-circuited loop cannot work up enough signal voltage to get through the receiver noise.

All of the major difficulties are solved by the circuit of Fig. 1C, in which an impedance-matching output circuit is used to establish loop-circuit resonance and the proper degree of coupling for commercial receivers having any normal value of input impedance.

It is feasible to construct such a loop to operate with good discrimination against ground-wave signals in its null sector for frequencies of from 1.8 mc. to 5 mc., using one set of components.

Then, by switching out half of the loading coil, *L*, or replacing it with a smaller coil, the frequency range can be extended to 10 mc. or higher. By completely short circuiting the loading coil, some operation in the mode of Fig. 1A is possible, up to about 16 mc.; but only experimentation in each particular case will show if any benefit is gained.

Interference arriving by ground wave, or that following the line-of-sight, is readily squelched by the loop antenna, but reflected signals can also be reduced if they are not shifting around too much or made up of strong components from more than one direction. Only experience in operating a loop will show exactly what is to be expected. As an example, at some times a given station—like WWV—may give a well-defined null indication (which may not be in the direction one would expect); then at another time, with the signal fading in and out, no null at all can be found. These are the vagaries of reception by reflection and are to be expected.

So much for principles—now for construction.

The main requisites for the antenna are a frame for supporting the loop, a base on which it is mounted, a bearing for loop rotation, and a slip-ring arrangement for making connections to the loop. They will be taken up in order, and details can be seen in the diagrams.

The loop support (Fig. 5) is made of a vertical member of dowel (formal term for broomstick) with a plywood crossarm. The ends of the crossarm and the upper and lower parts of the upright are drilled for passage of the single turn of plastic-insulated copper wire which forms the low-impedance loop. Ends are soldered at the bottom to lugs secured by wood screws.

The base-and-bearing assembly (Fig. 3) is simply a flat plywood box, open front and back, with a hole the size of the loop dowel bored vertically down through the center of both top and bottom. A brass strap or plate is fastened across the bottom of the hole

in the base for the loop upright to rest upon and also to serve as a contactor for the ground side of the loop circuit. The wood is slightly recessed, with chisel or pocket knife, so the surface of this contactor will be flush with the bottom of the base, and counter-sunk flat-head screws hold it in place. Fastenings are machine screws, and inside the base assembly one of them is used for the ground connection.

The front panel may be made of Masonite or Bakelite. Although the tuning and impedance-matching capacitors may be secured to the panel, hand capacity to the controls can be decreased and tuning made somewhat easier by mounting the two capacitors a few inches to the rear of the panel and driving them by means of extension shafts. At any rate, they should not be installed on a metal panel, since the frame of the tuning capacitor is "hot."

Although it is not necessary for loop operation, a card calibrated in degrees can be mounted on top of the base for determination of the approximate direction of stations or interference. In a high-frequency antenna as simple as this, the directional pattern will not in every instance be true; and it may not even be a figure-eight, such as is obtained from a balanced-loop antenna. More often, the pattern may be a much-distorted figure-eight, with one lobe larger than the other, as shown in Fig. 2, which would put the null points closer together than the ideal 180 degrees. This form of distortion, carried to extreme, will result in the cardioid pattern with only one null point and one broad lobe. Since this antenna is not designed for direction finding, but instead, noise reduction, the exact nature of the response pattern is of no consequence, just so there is at least one sector in which signal pickup drops to a minimum.

The usual stumbling block in rotary antennas is making connections to the turning element. It is ordinarily thought that machine work and complicated construction is required. But it can be made much simpler than it

seems. In this loop, one connection, the ground, is made by a brass screw driven into the bottom center of the upright which rides on the brass set into the bottom of the base. Motion and friction are at a minimum here, so an ideal rotary connection is thus made. The wire running from the loop down to the screw may be run through an axial hole. However, if a long drill is not on hand, a small groove cut in the surface of the dowel with a pocket knife will work every bit as well.

A slip ring for the other connection (Fig. 4) is made by wrapping tinned copper wire tightly around the dowel, then running solder between the turns. The excess may be wiped off with a rag while the solder is hot, and a smooth surface thus formed.

The brush for contacting the slip ring is cut from flat brass stock, then the sides are bent up to make a shallow "U" and the piece mounted in place on a post cut from Bakelite or polystyrene.

The loading inductor is a *B & W* "Miniductor" No. 3015 hung by its connecting lug under the slip-ring brush-mounting screw. If rapid frequency change is desired, a small switch may be used to connect half or the whole coil into the circuit.

With the receiver that is shown in the photograph, input impedance is nominally rated at 300 ohms, so transmission line of that characteristic impedance may be used for receiver connections. Care must, of course, be taken to connect the ground sides of the loop and receiver together. If the station receiver has 75-ohm input, a line of this impedance should be used. The use of shielded cable would tend to decrease the "antenna effect" of the loop and lead-in and would improve the character of the nulls obtained.

If space permits, the loop may most conveniently be placed on top of the receiver, or it can be installed at a little distance. For best operation, it must be kept separated from both the operator's person and metallic objects, or other wiring. With some form of ex-

(Continued on page 126)

View of the rear of the loop base. From center top to bottom are shown the slip-ring brush terminal with loading coil secured to it by solder lug, the loading coil, and screws holding the ground contact. Capacitor to the left is the loop resonator, to the right is the triple-ganged impedance-matching capacitor, with additional fixed mica (see text) visible at the far center.

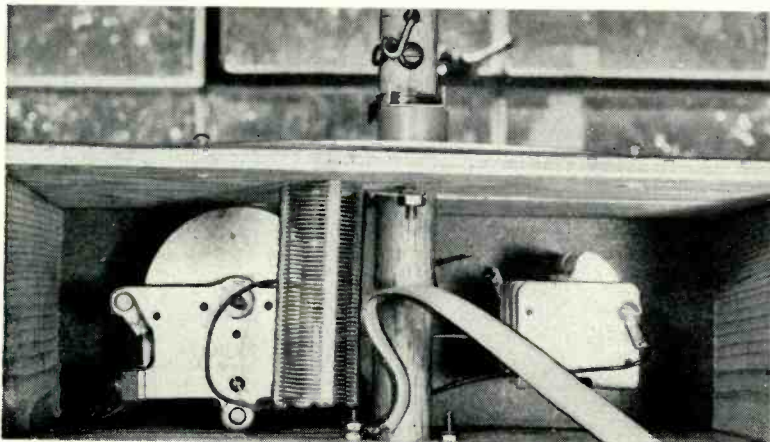

The "brute force" r. f. filter for a. c. line is mounted on back of the receiver at the point-of-line entry. These coils, of #10 enamel wire, are wound around bypass capacitors which makes for the very compact assembly shown here. Refer to discussion in text.

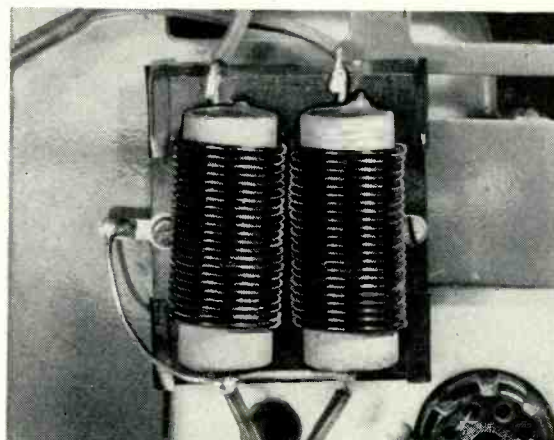

THIS high-fidelity business just cannot be figured. A few years ago, when the summertime came . . . everybody went! Yessir, the audio world just pulled in its horns and grimly waited for the September dawn. The record companies made feeble gestures by releasing a trickle of trivia, which neither titillated anyone's musical desires nor enriched the company coffers. The shipping departments of the hi-fi equipment manufacturers were abodes of peace and quiet. And the hi-fi distributor!! Gadzooks, Cholmondley! . . . those poor blokes were jolly well starvin'! Worse thing was they couldn't even starve in peace. The summer months brought out the characters in force, to beguile our sweating experts with such darbs as, "my *Atwater Kent* hasn't been sounding too good lately . . . d'ja think I might need a new tube or sumpin'?" . . . or . . . "whaddaja mean my needle is worn out? The guy that sold me my Sch magnaHowl said it was a pomainent needle!" And so it was with hi-fi in the good old summertime . . . of yesteryear. Today, things are different.

The record business and the hi-fi business no longer wither on the vine when the heat comes. The growth of the high-fidelity market has been so phenomenal, with its subsequent creation of a new record market, that sales during the summer are at levels that a few seasons back would have seemed like opium dreams. Now don't get me wrong! I'm not inferring that all is universally rosy-hued. The record companies still keep most of their plums in the basket for the fall market, but nevertheless they *do* release a few major items, and a reasonable quantity of other acceptable musical fare. And while police lines to keep back the milling throngs from the hi-fi distributor's door are hardly necessary, the situation is not anything near as bad as it was so short a time ago. Why, we even have audio news of major import in the summertime! For instance, there is good news in the field of pre-recorded tape. As you probably know, this phase of audio activity has been in the doldrums for some time. What seemed like such a bright and promising thing a few years ago, has been considerably devalued in the minds of many people for a wide variety of reasons. The lack of *really* high quality material, as regards both sound and repertoire, the poor signal-to-noise ratios and the unrealistic pricing (especially in the face of reduced record prices) are some of the reasons for the stagnation of this industry.

Not so long ago, the release of pre-recorded tapes by *RCA Victor* was heralded as a major step forward. And it was. While the release contained only a few really first class selections, the general level, both as to sound and repertoire, was far better than anything previously available. Unfortunately, these tapes were priced at such a high level, that they never got off the ground, commercially. Well, I guess a few lessons have been learned by all parties concerned, because I have just received news of a second *RCA* tape release, and while I do not have any details it is my understanding that these new releases will be of first line material and will be substantially reduced in price.

Equally important is the news from *Audio Video Corp.*, a pioneer in the pre-recorded tape field with their *A-V* Tape Library. *A-V* has acquired the rights to release the material of the *Vanguard* and *Bach Guild* companies as well as other material from other as-yet-unnamed independent record companies. This is welcome news indeed, as many of you know some of the smaller independents have a very good reputation for high quality sound. Those who read this column regularly know that I have held the *Vanguard* output in particularly high regard. I have received review copies of some of the first release,

August, 1955

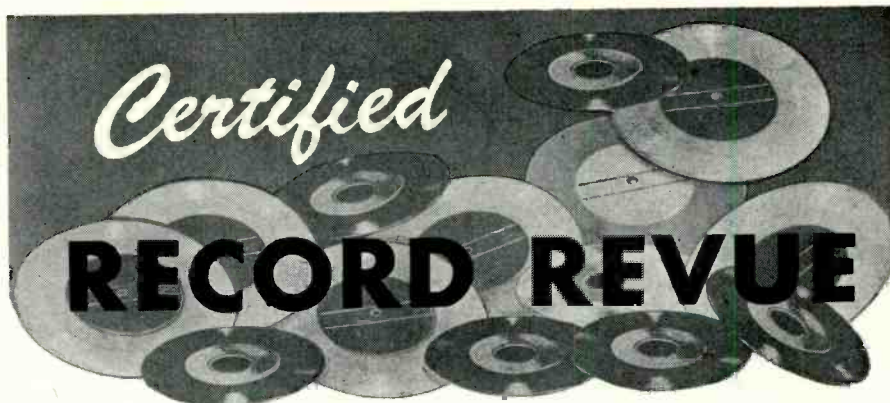

By BERT WHYTE

which we will report on in the tape section. My first reaction is one of enthusiasm and I have been informed that such delectable items in the *Vanguard* catalogue as Prokofiev's "Alexander Nevsky" and Stravinsky's "Les Noces" and "L'Histoire du Soldat" will soon be available.

Eureka! The tape millenium must have arrived. Another as yet unconfirmed report is that some material will be released at 15 inches-per-second! This should placate those rugged individualists who claim that "15 kc. at 7½ in.-per-sec. is for the birds . . . real high fidelity can only be obtained at 15 inches-per-second." This is a matter for considerable debate and something I won't go into here. I have heard fabulously good stuff at "augmented 7½" but must admit most of the real "knock you off your feet" material has been heard at the higher speed. Add to this bright tape picture such recent innovations as a magazine type tape load which eliminates tape threading (a la movie cameras) and the soon-to-be-introduced super thin tape which will permit an hour of full-track recording at 7½ inches-per-second and you can readily see that the Audio Fairs this fall will have much of interest for the tape fan.

Vacation time is here again and for the hi-fi music fan this means "catch up on listening" time. With this in mind I'll try to review as many "goodies" (no connection with the Sam of the same name) as possible. Once again, let me point out that things are different than they used to be in the record world in the summertime. No one tries to feed the public a pabulum of "light material" any more. Indeed with the festivals too numerous to mention, the musical fare is, if anything, on an even more grandiose scale than prevails during the winter. Soooo . . . if you are looking for me to review stuff like "Saccharine Songs for Sultry Sundays," or "Music for Meditation While Burning on a Beach," I jest ain'ta gonna do it!!

Equipment Used this Month: *New Weathers* viscous-damped arm and cartridge; *Components Corp.* turntable; *Marantz* audio consolette; 2-30 watt *McIntosh* amps.; *Jim Lansing* "Hartsfield"; *Jensen* "Imperial." Tape playback via *Ampex* 600.

AUBER

FAMOUS OVERTURES (MASANIELLO, THE BRONZE HORSE, FRA DIAVOLO, THE CROWN DIAMONDS)

L'Orchestre de la Societe Des Concerts du Conservatoire de Paris conducted by Albert Wolff. London LL1137. RIAA curve. Price \$3.98.

Albert Wolff rides herd on these warhorses

with as much verve as his recent "Hungarian Rhapsody." Once again there will be screams and howls from the purists about Mr. Wolff's conductorial eccentricities, but for my dough, this fellow knows how to give these cornballs a new freshness and interest. Or perhaps it is once again the story of Mr. Wolff's approach plus some of *London's* most fabulous sound. And sound you have here in great big glorious gobs. The "Bronze Horse" and the "Fra Diavolo" are the outstanding pieces on the disc. Their glittering brilliant finales are a sonic delight. Good, clean, if somewhat sharp string tone, rousing brass of great weight, sharply accented percussion are notable here. The over-all sound is once again that "big-hall liveness" that makes the orchestra seem much larger than it is. Groove distortion was minimal and the *London* engineers have let the dynamics have full sway. This will find use as a demonstration piece, as it sounds great with hi-fi systems both small and big! The curve did not require adjustment and surfaces were moderately quiet.

STRAVINSKY

PULCINELLA (BALLET SUITE AFTER PERGOLESI) DIVERTIMENTO (LA BAISER DE LA FEE)

Orchestre National de la Radiodiffusion Francaise conducted by Igor Markevitch. Angel 35143. RIAA curve. Price \$4.98. (Thrift pack, \$3.48.)

This is a most attractive disc. The coupling is excellent, the performances estimable, the sound superb. Mr. Markevitch has had considerable success with modern ballet scores and he continues his good work here. His "Pulcinella" must inevitably be compared with the recent *Columbia* effort with Stravinsky himself conducting. He does come off second best, but oddly, not by any great variance with Stravinsky's ideas, but rather through a lack of cohesion in his essayal of these ideas. I think the problem is mainly one of maturity. If Mr. Markevitch were a little surer of his ground, there would be little to choose between his version and Stravinsky's. As it is, it is still a good representation of the score and with the better sound on the *Angel* disc, has its undeniable attractions. The "Divertimento" fares quite well in Markevitch's hands. With this suite derived from more familiar Tchaikovsky material, he gives a well paced, carefully modelled reading. To those of you who are not acquainted with this score and who like the music of Tchaikovsky, I urge you to listen to this work. The melody of Tchaikovsky is always recognizable, but a magic transformation has been wrought by Stravinsky and the result is an utterly delightful fantasy. The sound on this *Angel* disc is more brilliant than is their wont, and with this type of music, it's fine. Strings are still beautifully luminous and clean, wood-

(Continued on page 92)

The opinions expressed in this column are those of the reviewer and do not necessarily reflect the views or opinions of the editors or the publishers of this magazine.

Fig. 1. Close-up view of the lens arrangement mounted on the author's truck. The horizontal image of flashlight shows on photocell.

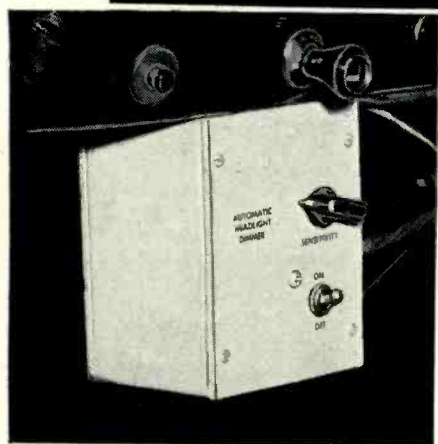
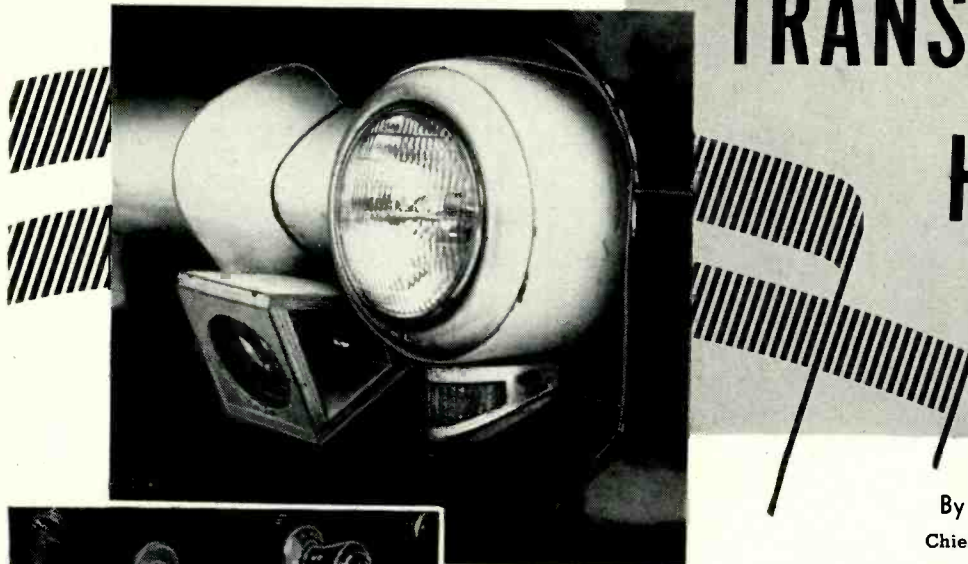

Fig. 2. The box housing the dimmer components is mounted under the dashboard.

THE use of automatic headlight dimmers for automobiles is slowly catching on. These units are designed to automatically switch the car headlights from "bright" to "dim" when another car is approaching, or when street lights provide adequate illumination. The principle of operation is quite simple—the units employ some sort of photocell, with a directive optical arrangement, amplifier, and relay. When light strikes the photocell, either from oncoming cars or from a high background illumination, the impulse is amplified, and the relay fires, dimming the headlights. When the illumination stops, the relay opens, and the bright lights are on again.

Transistorizing such automobile equipment is most natural, since the car battery can supply 6 or 12 volts, enough for most transistor applications. Thus no bulky, expensive high-voltage power supplies are necessary, and heavy filament drain, hard on car batteries, is eliminated. In the near future transistor-operated auto radios, mobile telephones, etc., will result in lower battery drain and subsequent longer battery life. The transistor-operated automatic headlight dimmer is only a first step in this direction.

The requirements for the headlight dimmer appear quite simple on the surface, but are actually rather complicated. It must not merely be able to respond to the proper light intensities by throwing a relay to dim the lights. It must operate only when the car foot switch is in the "bright" position, and must have a switch permitting the driver to shut it off, reverting to normal operation. The unit should preferably be small, have a low battery drain, and should not require the use of special high-voltage power supplies. The fly in the ointment is, of course, the part about "proper light intensities."

The unit should be made to respond to oncoming headlights from as far away as 400-500 feet, often two or three traffic lanes away. This requires the use of a very sensitive photocell. The "field" which the photocell must be able to "see" should extend horizontally about thirty degrees to the left of straight ahead, but should not extend very far in the vertical direction, otherwise the headlights would blink for every street light. Because of the very low light intensities encountered it is necessary to use some light-gathering apparatus, such as a condensing lens with the photocell mounted at its focal point. Use of a condensing lens drastically limits the photocell's "field of vision." Placing the photocell just inside the focal point decreases the sensitivity somewhat, and also broadens the field of vision vertically as well as horizontally. Clearly some means of increasing the illumination and decreasing the vertical field is needed.

This may at first glance seem impos-

TRANSISTORIZED HEADLIGHT DIMMER

By PAUL PENFIELD, JR.
Chief Engr., WAMF, Amherst, Mass.

Construction details on a compact unit which eliminates heavy filament drain and complicated high-voltage power supplies by using readily-available junction transistors.

sible, but it is not. All lenses are subject to an imperfection known as astigmatism. This is simply the tendency of a lens which produces a sharp image for points on the lens axis, to blur the images of points off-axis. As can be seen from Fig. 5, an off-axis point will produce both a vertical and a horizontal image, and various other elongated patterns. In general, the larger the lens, the worse the astigmatism. Some lenses are corrected for astigmatism, and some are not. The amount of astigmatism usually depends on which way the light passes through the lens, so some lenses which are perfect one way will have bad astigmatism the other way.

If our photocell could be placed on the horizontal image of a headlight, the headlight could be anywhere in a large horizontal "field" and still actuate the photocell. This feature is used to produce the elongated field of vision needed for the dimmer. Fig. 1 shows the image produced by a flashlight on the photocell used. This image is about four times as long as it is high.

In practice, the larger the lens, the more light it will gather, and thus the more sensitive the instrument. More than adequate sensitivity was obtained with a 4" diameter war surplus lens, with a 6" focal length, so a smaller one could be used with satisfactory results. The side of the lens with the bad case of astigmatism was located by experiment, and selected as the side to be used.

The photocell is one of the super-sensitive crystal units made by the Clairex Corp. At present, the only other source for these photocells is

Allied Radio Corp., 100 N. Western Ave., Chicago, Ill. When ordering, specify Cat. No. 7E880, \$2.45 each. These units, called the "CL-1 photocell", consist of a piece of cadmium sulfide imbedded in the end of a quarter-inch plastic cylinder. The photo-sensitive area within the cell measures about 2 square millimeters. The operation of the cell depends on the fact that the resistance of the sulfide crystal decreases when light strikes it, thus allowing more current to pass. This effect can be seen from Fig. 4, which shows the electrical characteristics of the photocell.

It was found by actually rigging up the lens and photocell and trying it that, for average driving conditions, a significant increase in photocell current occurred for cars about 700 feet away, this increase being about three microamps. The base current of the photocell, determined both by the "dark current" and the background light, amounted to some two microamperes. Therefore, if a rise in cell current of two microamps above this base current could be made to fire the relay, there would be an adequate safety factor.

The relay used is a surplus 4000-ohm, 1 ma. unit, listed in the bargain sections of some of the large mail-order catalogues, for about \$2.00. Since this sensitive relay cannot handle the heavy headlight current, it was used to fire a second relay mounted under the hood. The relay "on current" is 1.2 ma., and the "off current" 1.0 ma., providing a "relay differential" of 0.2 ma. Since the "input differential" from the photocell is to be 2 microamps, the amplifier must have a current gain of 100 or more. Using CK722 transistors, two stages are necessary.

Fig. 3 shows how the two stages are wired to provide a current gain greater than 100. A base bias current for the first stage of ten microamps is maintained by R_1 . The polarity of B_1 , the photocell battery, is such that when illumination hits the photocell, the base current in the first transistor decreases, rather than increases. With more illumination, thus more photocell current, the base becomes positive with respect to the emitter, so the base-emitter junction is biased backwards, instead of the more usual forward bias. With very little base current, the collector current drops very low, and the transistor is said to be "cut off". If the photocell receives even more light, base-collector current will start to flow, but in comparatively small amounts. The transistor will then remain essentially cut off until the light stops striking the photocell.

The first stage of amplification acts upon the second stage in precisely the same way as the photocell acts upon the first stage. Here R_2 and R_3 are adjusted so that the second stage collector current is just sufficient to throw the relay, that is, about 1.25 milliamperes. Normally, however, the first stage, not being cut off, will have a collector current, which will lower

(Continued on page 122)

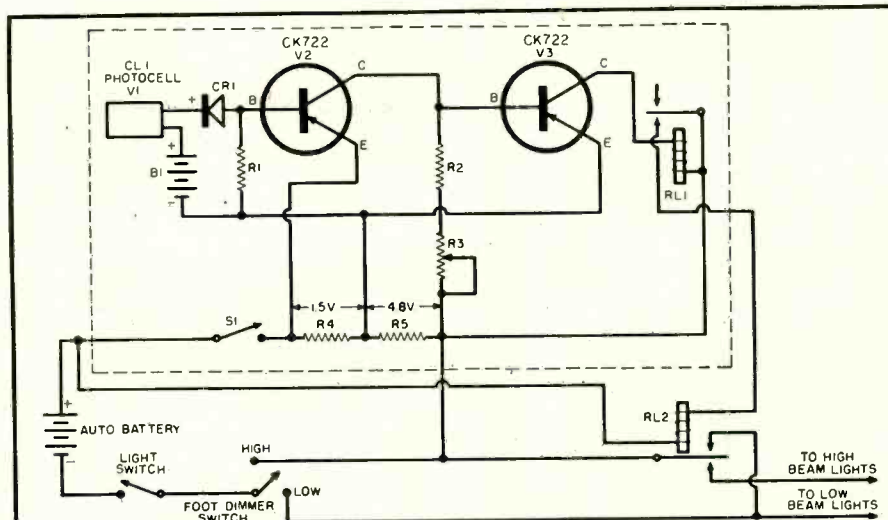

- R_1 —100,000 ohm, $\frac{1}{2}$ w. res.
- R_2 —10,000 ohm, $\frac{1}{2}$ w. res.
- R_3 —25,000 ohm pot ("Sensitivity" control)
- R_4 —70 ohm, $\frac{1}{2}$ w. res.
- R_5 —300 ohm, 1 w. res.
- RL_1 —1 ma. sensitive relay (see text)
- RL_2 —S.p.d.t., 6.3 v. d.c. relay

- S_1 —S.p.s.t. toggle switch
- B_1 —90 v. battery (Burgess #N60, Eveready #490, or equiv.)
- CR_1 —1N91 junction diode
- V_1 —Photocell (Clairex Corp. CL-1, 50 West 26th St., N. Y. 10, N. Y. \$2.50 each)
- V_2, V_3 —Junction transistor (Raytheon CK722)

Fig. 3. The two-stage amplifier is a simple, direct-coupled amplifier. The contacts on the sensitive relay cannot withstand the heavy headlight current, so a second relay, RL_2 , is used to actually switch current. See text.

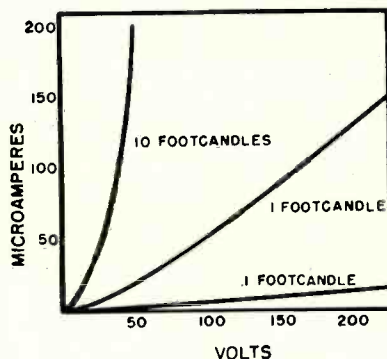

Fig. 4. Graph showing resistance of photocell with varying illumination. The dark current is less than 1/10 of a microampere at one-hundred volts.

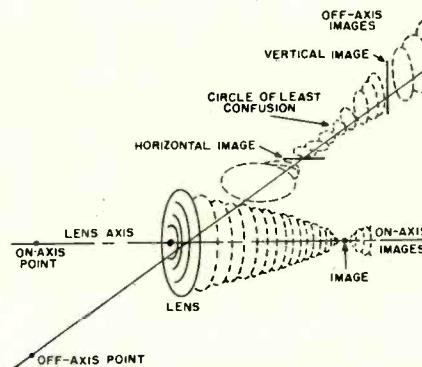
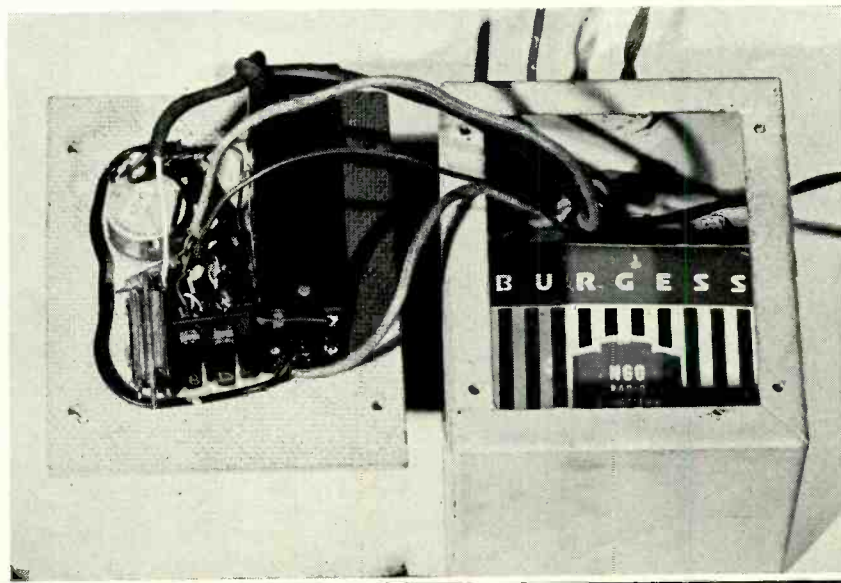

Fig. 5. A lens with astigmatism produces both a horizontal and vertical image at a point off the lens axis, while not distorting points on-axis.

Fig. 6. Internal view of dimmer. Only one bank of the d.p.s.t. switch is used. The transistor sockets are mounted in a universal mounting bracket which was originally intended for use in mounting power transformer units.



THE "TESTUNER"

By ANGELO PALMIERI and CARL QUIRK
Allen B. Du Mont Laboratories, Inc.

Fig. 1. The "testuner," consisting of a turret-type tuner mounted on a suitable power supply with a microammeter.

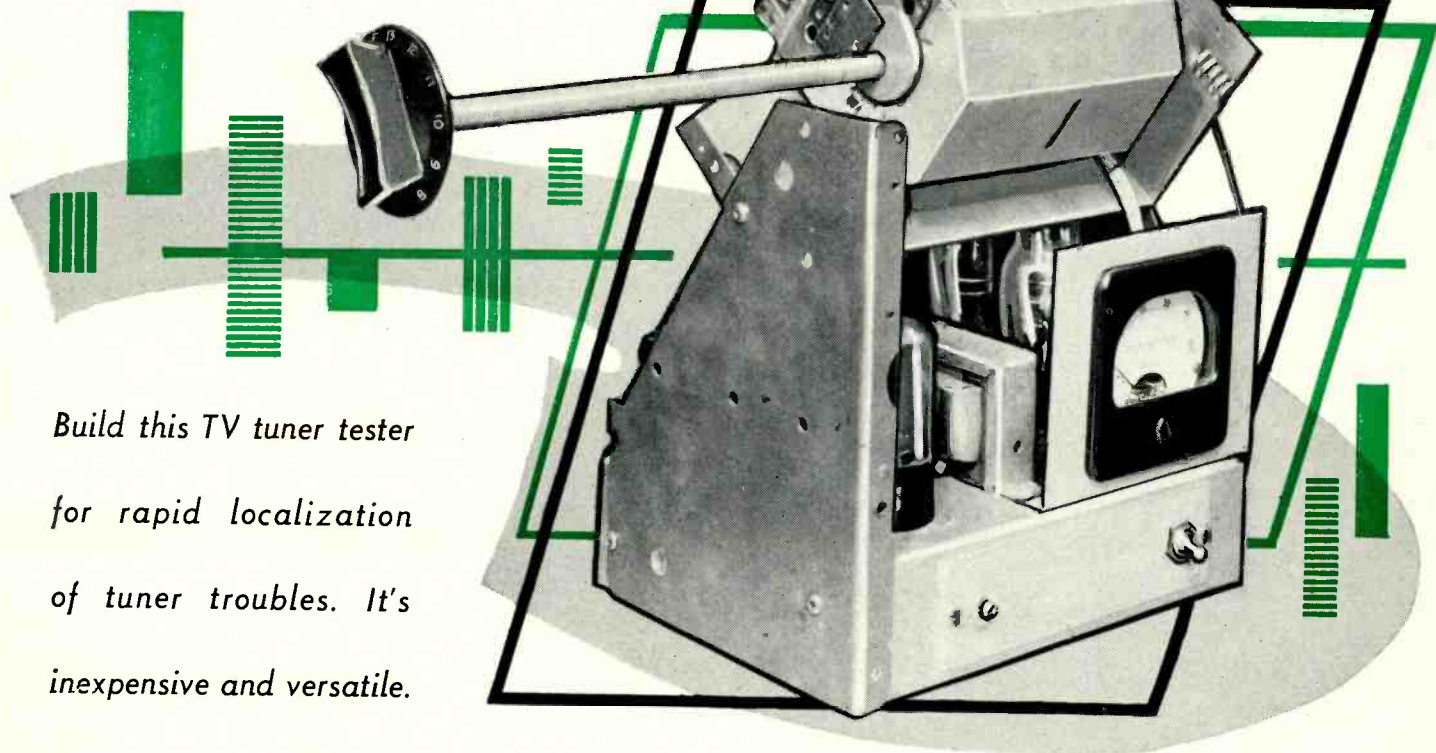

*Build this TV tuner tester
for rapid localization
of tuner troubles. It's
inexpensive and versatile.*

IN THE process of troubleshooting a TV receiver, the service technician tries to localize the difficulty in the over-all circuit. Many troubles, fortunately, are relatively simple to localize. Such things as lack of vertical or horizontal sync, no brightness, insufficient vertical size, and no sound fall into this category.

There are, however, and this is certainly not news, a number of other difficulties that are not as simple. Many of these occur in the tuner.

Interestingly enough, the service technician in the field is not the only one who has trouble due to the tuner. The troubleshooter in a TV factory has a similar problem. The man in the field, however, must procure a replacement, which may take several days. If the replacement fails to cure the trouble, then the service technician is in hot water with the customer.

The "testuner" shown in Fig. 1 consists of a turret-type tuner mounted on an appropriate power supply. A 0-50 microammeter is included for checking u.h.f. crystal mixers. The positive terminal of the meter is connected in series with a 2200-ohm resistor and thence to an alligator clip through a length of hookup wire. The negative terminal is connected through its lead to the TV chassis ground.

Because of its simplicity, the "testuner" should make an ideal piece of test equipment for the service technician's bench, as well as in a cus-

tomers home. With proper use, it should reduce by a substantial amount the time normally required to service u.h.f.-v.h.f. chassis in which the trouble may stem from the tuner.

The schematic diagram of the voltage regulated power supply used for the "testuner" is shown in Fig. 2. The voltage regulation feature, while desirable, is not absolutely essential. The most important consideration is that the voltages fed to the tuner are correct. The 6.3 volt transformer winding, in addition to supplying heater power, is also used in a low voltage power supply circuit to provide a variable bias. This bias is set to the value of the normal a.g.c. voltage for the tuner in the receiver under test.

It is important to note that the utility of the "testuner" depends upon the manner in which the signal from the tuner is physically coupled to the i.f. stages on the main chassis. In the case of the *Du Mont* model RA-307 TV receiver, for example, the tuner output feeds the main chassis through a short length of coaxial cable. This cable plugs into the chassis via a phono-type plug and socket. Thus, it is possible to substitute this "testuner" for the questionable one merely by pulling out the coaxial lead of the original tuner and inserting that from the "testuner" into the receiver chassis. Therefore, with this in mind, it should be mentioned that the output cable of the test unit should be long enough to permit it to

be plugged into or otherwise connected to the chassis with a minimum of physical difficulty. Different lengths of this output cable will affect the band-pass characteristics of the mixer; however, this is relatively unimportant if the main interest is to localize the source of trouble.

As an example of how the "testuner" is used, assume that a u.h.f.-v.h.f. chassis has no signal on v.h.f. It is a simple matter to check the v.h.f. tuner; merely remove the tuner output lead from the i.f. input on the chassis, and in its place insert the "testuner" output lead. Then, connect an antenna to the "testuner" antenna terminals. If the original tuner was defective, normal operation will now be in evidence.

Suppose now that with this same receiver the reception on v.h.f. is OK, but the u.h.f. is unsatisfactory. In this case, the source of trouble may be the u.h.f. tuner, the crystal diodes, the connecting link between the u.h.f. tuner output and the u.h.f.-v.h.f. switch, or the feedthrough strip in the v.h.f. tuner.

Connecting the microammeter to the u.h.f. test point (output of the u.h.f. mixer crystal) will immediately tell whether or not the mixer crystal is defective. In order to determine the proper output signal, an operating receiver can be measured for comparison. The output of the *Du Mont* u.h.f. tuner, for example, should not be less than 6.4 microamperes. This value will vary slightly, of course, depending upon meter calibration.

By injecting an i.f. signal from a sweep or signal generator into the u.h.f. tuner test point and using a detector probe and oscilloscope anywhere in the i.f. strip, an i.f. passband response should be seen. If there is no output observed, then the trouble is between the u.h.f. and v.h.f. outputs. A simple continuity check of the feed-through strip will localize the trouble to either the switch or the strip.

A block diagram showing how most single conversion u.h.f. and v.h.f. tuners tie together appears in Fig. 3. The output signal from the u.h.f. tuner is at the i.f. of the receiver—either 21.25 mc. for sound and 25.75 mc. for video, or 41.25 mc. and 45.75 mc. respectively. Therefore, when the u.h.f. output signal is applied through the u.h.f.-v.h.f. switch, it does not go through any r.f. circuit. Instead, the signal is fed through a special strip known as an i.f. feedthrough strip, which is essentially an i.f. amplifier, generally using a 6BK7 tube.

Although the "testuner" will be useful for a large number of tests, some precautions should be observed. On a particular job, a set exhibited excessive hum in the picture. From an examination of the condition, it was established that the trouble was due to 60-cycle hum. The service technician tried a normal test, which consists of shorting the cathode of each tube in the video and i.f. circuits to ground (60-cycle hum is usually due to a heater-cathode short or leakage in one of the tubes). When he arrived at the tuner in the process of making this shorting test, he decided to try the "testuner." Lo and behold, the condition cleared up when he inserted the "testuner" in place of the regular

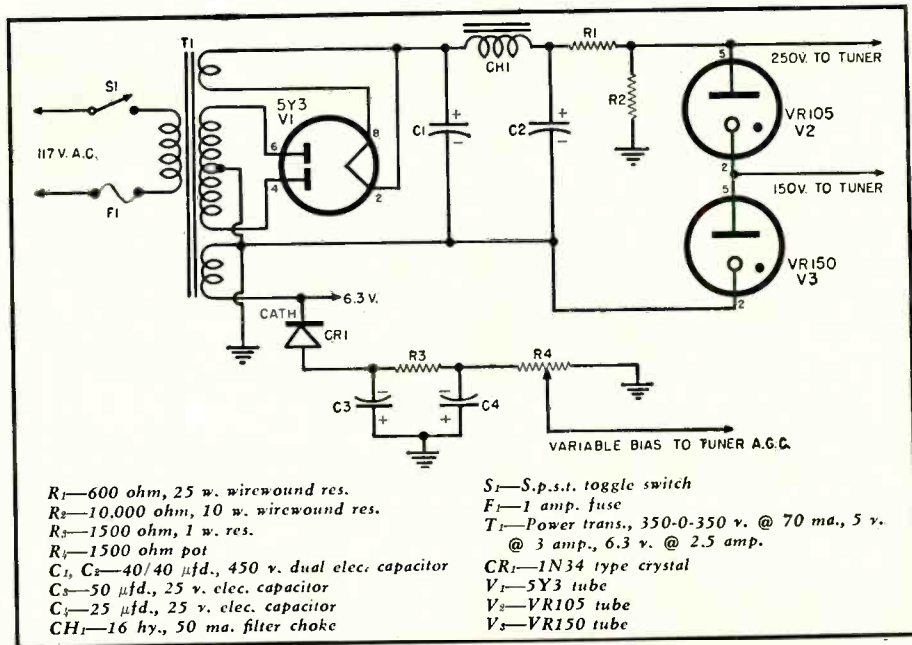

Fig. 2. Schematic diagram and parts list of the "testuner." The output voltages are suitable for the tuner shown in Fig. 1; if another tuner is used requiring different voltages, omit the voltage regulator tubes and change R₂ to a voltage divider.

tuner. He then replaced the original tuner and as he expected, the hum was back again.

He now surmised that the trouble was due to a heater-cathode leakage or short in the r.f. amplifier. (The mixer tube was an unlikely choice since both cathodes were grounded.) However, replacing the r.f. amplifier tube did not solve the problem. The technician happened to have a replacement tuner handy, so he replaced the one in the set—still the problem persisted. A final test was made by short-

(Continued on page 77)

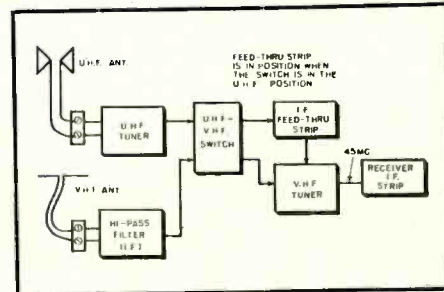
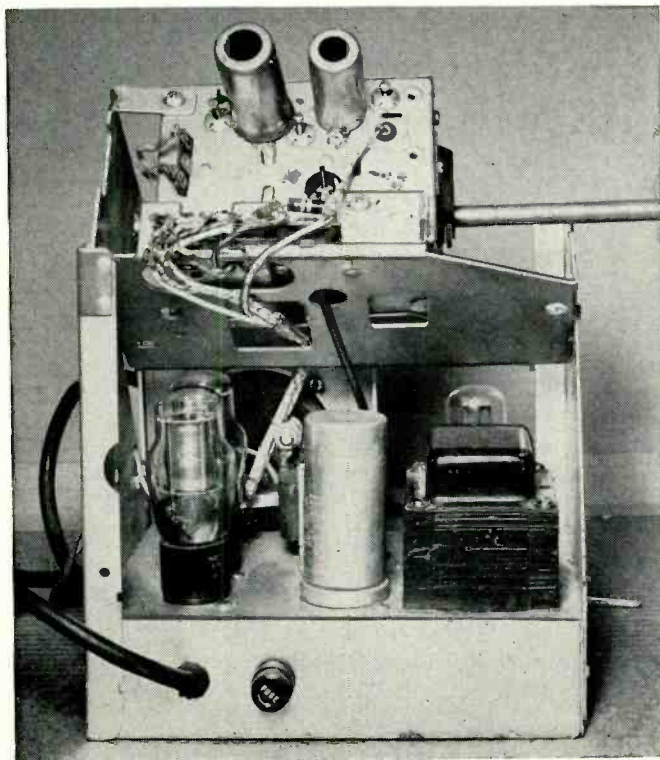
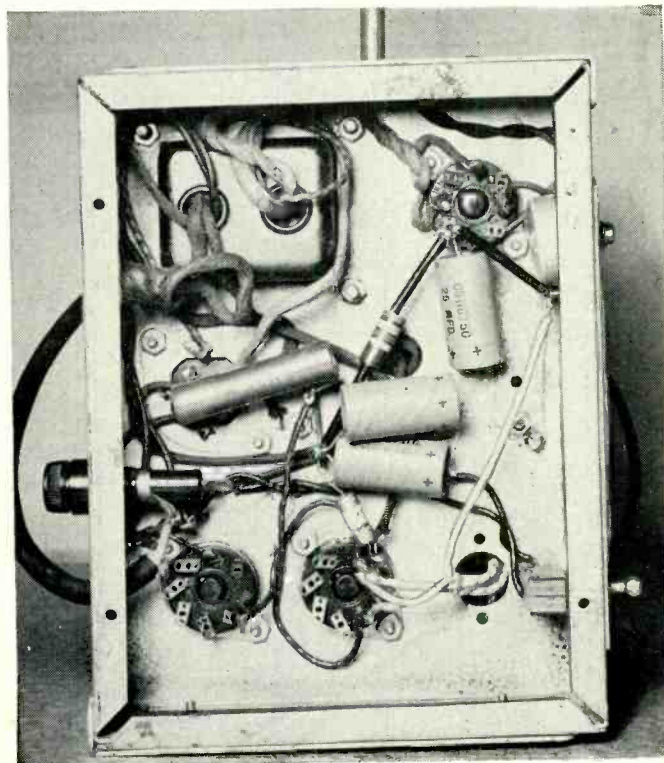

Fig. 3. Block diagram of the usual hook-up between the u.h.f. and v.h.f. tuner sections of a combination TV receiver.

Back view of the "testuner" showing parts layout.



Bottom view of the "testuner" power supply chassis.



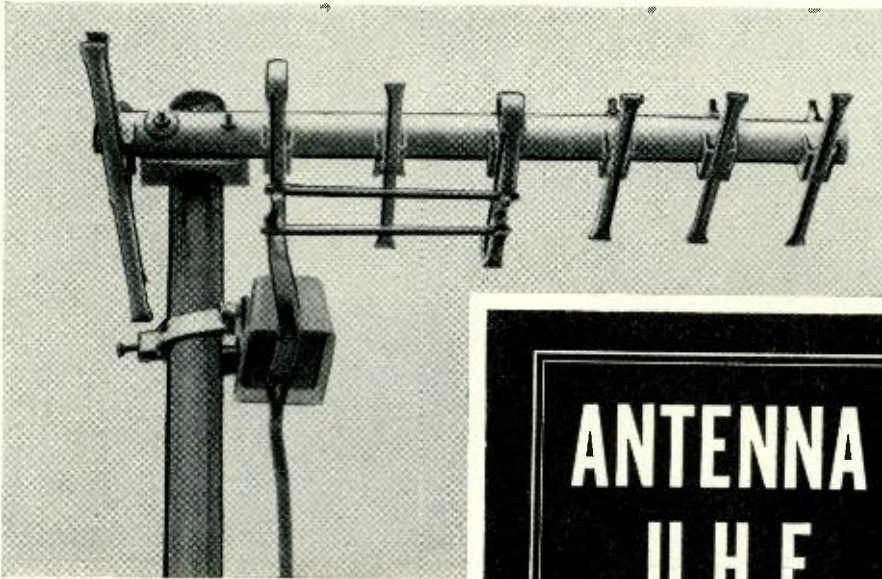

Fig. 1. Antenna-mounted mixer unit containing a high-pass filter and crystal diode for conversion to a v.h.f. signal right at the antenna.

ANTENNA MOUNTED U.H.F. MIXERS

By EDWARD M. NOLL

*New ideas for increasing the signal-to-noise ratio
obtained from u.h.f. TV signals in fringe locations.*

TELEVISION coverage in the u.h.f. bands has been improving steadily with the use of super-power, proper transmitting site location, and better radiators. The use of transmitting boosters and satellites has helped to fill in propagation pockets. Just as important in obtaining peak u.h.f. performance is the receiving equipment and its sensitivity and noise factor. A high-gain, properly positioned and carefully installed u.h.f. antenna is indeed a necessity in most u.h.f. areas. A u.h.f. converter or tuner with a good noise figure is likewise helpful in delivering a clear picture from u.h.f. stations.

It is a fact that more sensitive u.h.f. tuners with exceptionally good noise figures could further extend u.h.f.

coverage. However, additional r.f. amplification ahead of the crystal mixer of the u.h.f. device has presented economical and technical difficulties. There are as yet no inexpensive receiving-type vacuum tubes suitable for r.f. amplifier circuits at ultra-high frequencies. What should be kept in mind is that such an amplifier must have a low noise factor to be effective, and such amplifiers and tubes have not yet been developed for u.h.f. Besides the tube factor, the circuitry itself at these high frequencies would be extremely critical. All of this brings up the cost factor.

True, television and component manufacturers have been able to produce u.h.f. converters and tuners inexpensively; however, these are relatively broadband affairs with no signal-to-noise problems. It is only recently, relatively speaking, that manufacturers have adopted the cascode amplifier circuit for v.h.f. r.f. amplifiers. That they will come up with a similar circuit and inexpensive tube for u.h.f. in the near future is certain. However, the answer to increased sensitivity at u.h.f. must be found elsewhere at the present. There is one economical approach to the sensitivity problem—that is the delivery of a stronger signal to the mixer to obtain a resultant improvement in signal-to-noise ratio.

If the crystal mixer is located at the antenna a better signal-to-noise ratio can usually be established. In this arrangement, improved signal-to-noise ratio is established by permitting the application of a stronger u.h.f. signal to the u.h.f. mixer.

Signal losses at insulators, arresters, fittings, terminations, etc., are great-

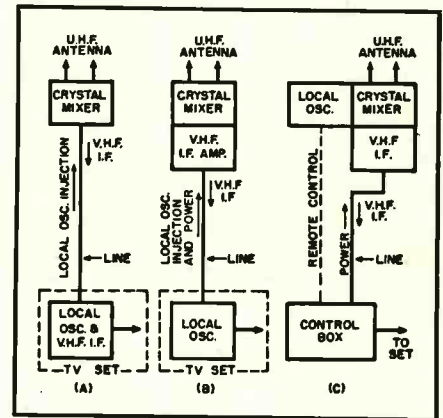
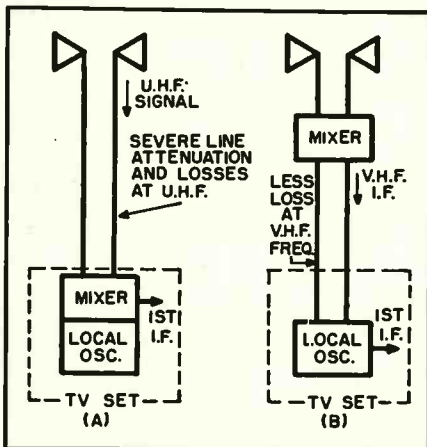

Fig. 3. Three different methods for converting the u.h.f. signal at the antenna to a v.h.f. transmission line signal.



U.H.F. Mixing Methods

There are three basic methods for systems that employ u.h.f. mixing at the antenna, Fig. 3. The simplest method locates the crystal mixer at the antenna and the local oscillator at the receiving point (Fig. 3A). Local oscillations are sent up the transmission line to beat with the incoming u.h.f. signal at the crystal mixer. The difference frequency (in the v.h.f. range) is conveyed down the same line to be applied to a v.h.f. amplifier or to the antenna terminals of a v.h.f. receiver.

In this arrangement it is not necessary to apply any power to the antenna-mounted segment of the u.h.f. converter system. The u.h.f. channel selection is made by varying the frequency of the local oscillations sent up to the crystal mixer. The crystal input circuit at the antenna can be tuned or untuned. If untuned, the entire u.h.f. range can be accepted by varying the local oscillator frequency.

Added selectivity can be obtained by employing a tuned input circuit at the crystal mixer. This limits the bandwidth and confines the u.h.f. frequency range that can be accepted. However, selectivity and noise figure are improved.

A second basic method locates the crystal mixer and a v.h.f. i.f. amplifier at the antenna and the local oscillator (u.h.f.) at the receiver (Fig. 3B). Again, the local oscillations are sent up the transmission line to the mixer. This arrangement is capable of excellent sensitivity because even the v.h.f. difference frequency is amplified before it is applied to the transmission line. The local oscillator is tunable from the receiver location to permit station selection over the entire u.h.f. range.

A third arrangement even moves the local oscillator up to the antenna (Fig. 3C). In this method, the u.h.f. converter is pretuned. Thus, the unit can only be used for single channel reception. A remote tuning mechanism could be devised for tuning such a converter over the entire u.h.f. band.

It is to be anticipated that economical and practical antenna-mounted u.h.f. devices will soon be made available. It is not unlikely that narrow-band antennas will be designed to include tuned circuits and crystal mixers in a completely matched and peaked unit. A coaxial cable will convey v.h.f. i.f. signals down to the TV set; at the same time, the cable will carry the injection signal up to the crystal.

A unit based upon this idea will be described shortly. Of course, although the unit was constructed by modifying a *Regency* u.h.f. converter, other converters may be used. The unit should have a crystal diode mixer however, since this does not require power, either for the heater or plate circuit, for proper operation. When vacuum-tube type mixers are used power must be transported up to the antenna and, while this in itself is not bad, some city ordinances forbid this practice.

One thing should be understood and

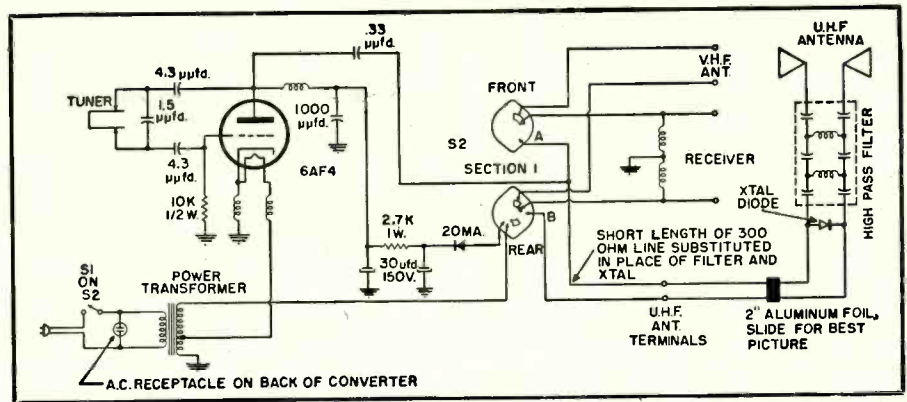

Fig. 4. Schematic diagram of the Regency u.h.f. converter model RC-53 modified so that the high-pass filter and mixer crystal diode are located at the antenna.

that is that placing the mixer at the antenna location makes it more susceptible to interference. While the emphasis in antenna-mounting u.h.f. mixers is placed on sensitivity and noise factor, interference can not be neglected.

Careful shielding at the antenna of the mixer and allied circuitry may provide the answer. Chances are also that interference may not be as important a problem in fringe and other weak-signal areas. The use of a highly directional antenna will also reduce the interference problem, as will a highly selective antenna, such as a u.h.f. yagi, cut for a specific channel or small band of channels. Such an antenna is shown in Fig. 1, together with the antenna-mounted mixer to be described in the following paragraphs.

A Typical Unit

An antenna-mounted mixer unit was made by modifying a *Regency* RC-53 u.h.f. converter as shown schematically in Fig. 4. The high-pass filter and crystal diode were detached at the switch terminals (points "A" and "B"). The whole section between the u.h.f. antenna terminals and points "A" and "B" was detached as a unit, and in its place a small length of 300-ohm line was substituted as shown in Fig. 6.

The detached filter and crystal combination were then mounted in a weatherproof plastic box as shown in Fig. 5. The unit was then fastened across the terminals of the u.h.f. antenna. The transmission line was connected to the output side and run down to the main section of the RC-53 at the receiver. A small section of line links the receiver terminals on the converter to the antenna input terminals of the TV receiver.

Local oscillations are supplied via the $.33 \mu\text{fd}$. capacitor and conveyed up the transmission line to the crystal diode. Here the u.h.f. signal is also introduced to produce a difference signal that is now conveyed down the line to the converter. The difference signal is supplied to the receiver output terminals via points "A" and "B" and the switch contacts.

For very long lengths of line it may be necessary to increase the value of the $.33 \mu\text{fd}$. capacitor to provide a strong enough injection voltage to the

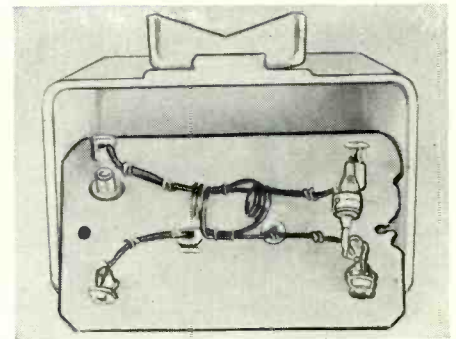
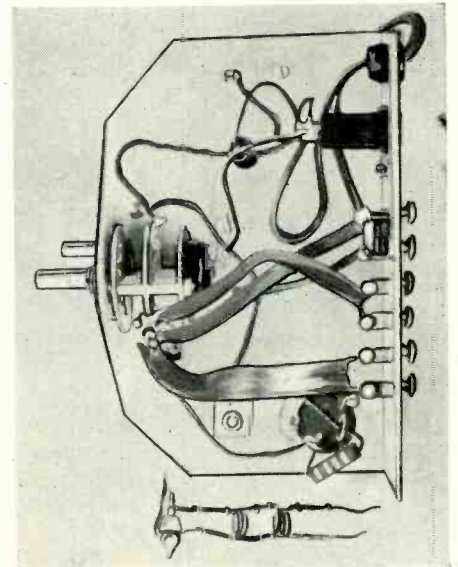

Fig. 5. The high-pass filter and crystal mounted on the base of a plastic box.

crystal. For under 100 feet of 300-ohm line use the $.33 \mu\text{fd}$. capacitor.

Wrap a two-inch length of aluminum foil around the transmission line near the u.h.f. antenna terminals on the converter. By sliding the foil along the transmission line, standing wave conditions along line are shifted, permitting some control of the amplitude of the local oscillator injection voltage reaching the crystal mixer. The foil is adjusted by observing the picture on the TV screen and setting it to the position of best picture.

Fig. 6. View of the modified Regency converter showing the short length of transmission line substituted for the high-pass filter and crystal in the foreground.



A LOW-COST CAPACITANCE BRIDGE

Over-all view of the home-built capacitance bridge. Earphones are used as the null detector to reduce construction cost.

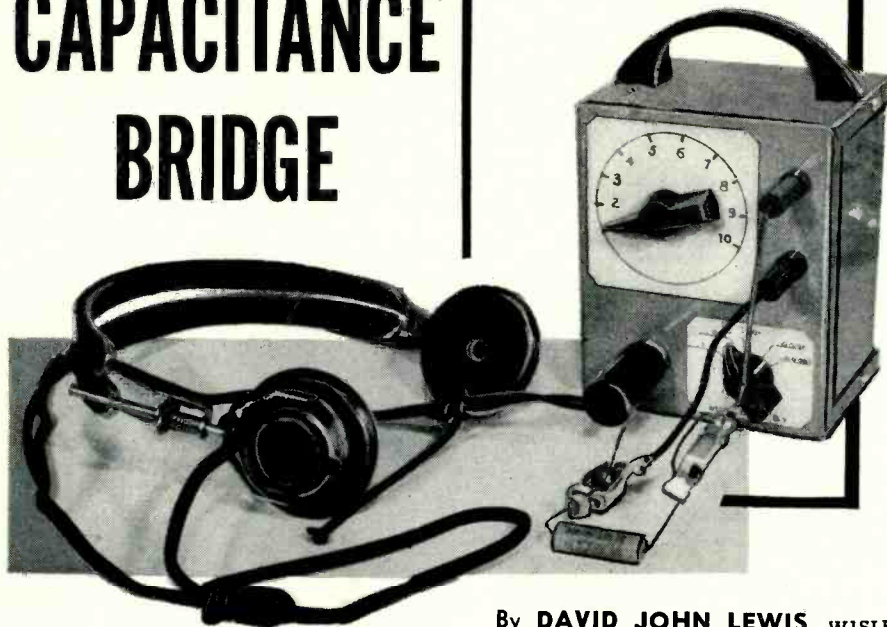

By DAVID JOHN LEWIS, W1SLE

A well-filled "junk box" plus a few spare dollars and you can add this valuable test unit to your workbench.

ALTHOUGH it is one of the fundamental building blocks of electronic circuits, capacitance is probably the least-often measured quantity in the average amateur workshop. The expense of commercial capacity bridges or the time and labor involved in most home-brew projects does not seem to be justified by the amount of service most of us can get from such an instrument.

However, the value of a simple bridge is undeniable, since many of the capacitors in any junk box are apt to be indistinctly marked. Variable capacitors, in particular, pose a problem when the minimum capacity must be known or when some sort of calibration in terms of capacity is required.

The bridge described in this article is designed to meet just this kind of general shop work need. It will handle the most common values of capacitors in its range of from 10 $\mu\text{fd.}$ to 1 $\mu\text{fd.}$, with accuracy sufficient for all but the most critical applications. The unit is self powered and small enough to fit on the most crowded workbench. Since simplicity and low price were considered important objectives, earphones are employed as an inexpensive but sensitive null detector. If all components were purchased new, including jacks, knobs, etc., the cost would be about five dollars but the average junkbox will supply most of the necessary parts and the price should run well below this figure.

Construction is quite simple; an evening's work should finish the job.

The bridge circuit itself is quite simple and straightforward as can be seen from the diagram. The bridge is balanced when the ratio of the unknown capacitor, C_x , to the resistance of the balance arm R_b is equal to the ratio of C_s to R_s . This can be expressed mathematically as $C_x = R_b (C_s/R_s)$. The setting of the balance arm is proportional to the unknown capacity, so a linear calibration can be obtained by using a potentiometer with a straight-line characteristic for R_b .

With C_s equal to .001 $\mu\text{fd.}$ and a variable resistance with a .1 megohm maximum value for R_b , the bridge will read from .1 to 1 $\mu\text{fd.}$ when R_s is 100 ohms, from .01 to .1 $\mu\text{fd.}$ when R_s is 1000 ohms, etc. Five standards of 100, 1000, 10,000, 100,000 and 1,000,000 ohms will enable the bridge to cover its full range. An additional 10 ohm standard will extend the range to 10 $\mu\text{fd.}$ if desired.

The exact values of the bridge components are not extremely critical, but a little extra care expended in getting them right will pay off in improved accuracy. C_s should be a high quality silver mica unit with a fairly close tolerance for best results. An ordinary paper capacitor can be used, but the null may be less clearly defined when the bridge is being balanced.

The five range resistors must be very close multiples of ten unless you are willing to use a different dial cali-

(Continued on page 123)

RADIO & TELEVISION NEWS

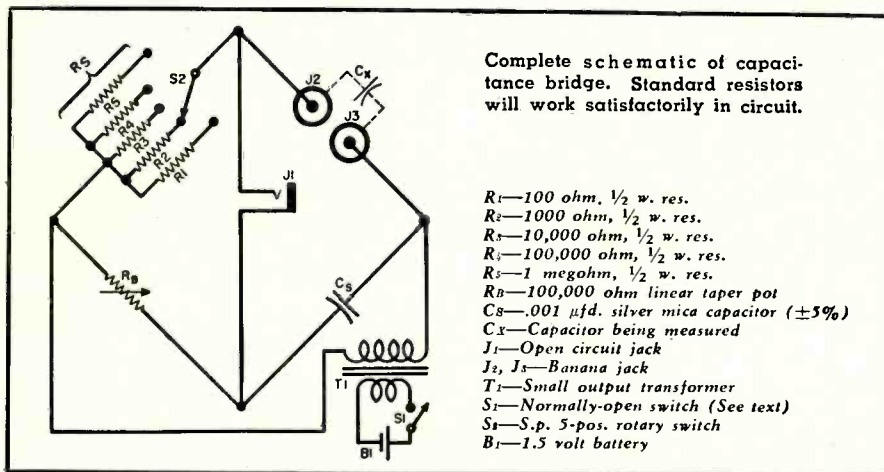

Under chassis view demonstrates the simplicity of wiring and construction.

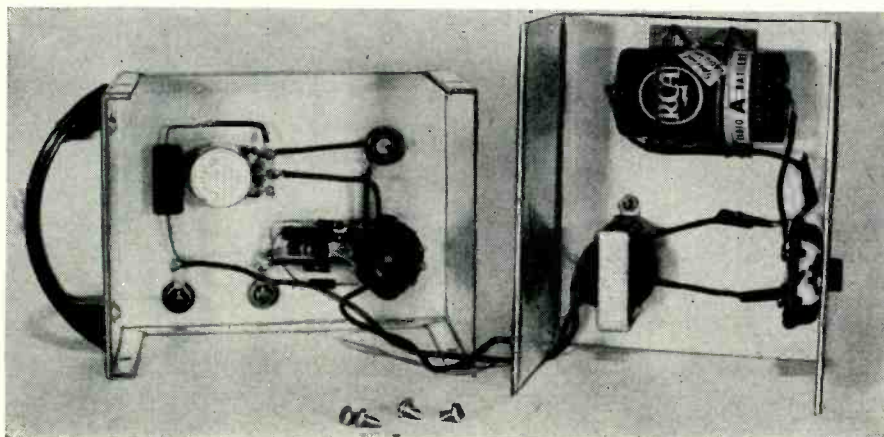



National Schools brings you a new dimension in training for **TELEVISION-RADIO-ELECTRONICS**

YOU CAN LEARN BY HOME STUDY, IF—

- you are ambitious to increase your earning power.
- you want to broaden your knowledge and skill.
- you choose the school with the most complete training and service.

50 Years of Successful Training

National Schools has been training men for success since 1905. Our graduates are located around the globe, in good-paying jobs in servicing, installation and manufacturing... in public and private industry, or in their own businesses. All this experience and background are your assurance of success.

What This New Dimension in Home Study Means to You

As a National Schools student, with Shop Method Home Training, you master *all phases* of the industry—TV, Radio, Electronics—theory and practice. You learn HOW and WHY, in one complete course at one low tuition.

Because National Schools' world headquarters are in Los Angeles—"capital city" of TV-Radio-Electronics—our staff is in close touch with industry. Our lessons and manuals are constantly revised to keep you up-to-the-minute on latest developments. We show you how to make spare time earnings as you learn, and we give you free placement assistance upon graduation. National Schools is approved for G. I. Training. Both Resident and Home Study courses are offered. If you are of draft age, our training helps you achieve specialized ratings and higher pay grades. This *new dimension* enables us to train you as you should be trained at home, regardless of your age or previous education.

Your Course Includes Valuable Units

We send you important equipment, including a commercial, pro-

fessional Multitester... plus parts to build Receivers, Oscillators, Signal Generator, Continuity Checker, other units, and Short Wave and Standard Broadcast Superhet Receiver.

Mail Coupon for Complete Information

Get these two free books about this new dimension in Home Training. A comprehensive, illustrated fact-book and a sample National Schools lesson. No obligation, so mail coupon today.

NATIONAL SCHOOLS

TECHNICAL TRADE TRAINING SINCE 1905
Los Angeles 37, Calif. • Chicago: 323 W. Polk St.
In Canada: 811 W. Hastings St., Vancouver, B. C.



MAIL NOW TO OFFICE NEAREST YOU!

(mail in envelope or paste on postal card)

NATIONAL SCHOOLS, Dept. RH-85

4000 S. FIGUEROA STREET OR 323 W. POLK STREET
LOS ANGELES 37, CALIF., CHICAGO 7, ILL.

Rush FREE BOOK, "Your Future in Radio-TV-Electronics," and FREE LESSON. No obligation, no salesman will call.

NAME _____ BIRTHDAY _____ 19__

ADDRESS _____

CITY _____ ZONE _____ STATE _____

Check if interested ONLY in Resident Training at Los Angeles.

VETERANS: Give date of discharge _____



By JOHN T. FRYE

TRAVEL IS BROADENING

IT WAS Barney's first day back at work after he and his parents had taken a vacation trip out to the West Coast, and he showed up bright and early with a coat of tan so thick it faded his freckles.

"Welcome home, Marco Polo!" Mac greeted him as he came into the service department. "I missed you. You can't imagine how queer it was to find my tools always exactly where they belonged, not to feel your hot breath on the back of my neck when I was working on an interesting 'dog,' and not to go home at night with my ears aching from questions."

"Aw, I'm not that bad," Barney said with a broad grin that said plainly he knew his employer was joking. "And let me confess I missed you and the shop, too. Eager as I am to get out of here every night, I'd never have believed it; but I hadn't got to Tucumcari before I began to miss being out of this electronic birdcage. Still," he went on quickly, "I sure had a good time, and I'm glad I went. You know, to coin a phrase, travel is broadening."

"Yeah," Mac said as he walked around the youth and gazed fixedly at the seat of his trousers, "I thought I detected a certain premature middle-age spread as you waddled through the door."

"You really notice those three pounds I put on?" Barney asked delightedly. He had the ambition of many lanky people—exasperating those who have to diet—to put some pounds on his lean frame. "But that is not what I meant. You see as I read our radio and TV magazines I'm often steamed because they contain several articles not of interest to me personally. I always felt that what didn't interest me wouldn't interest anybody. Now I know better. After that trip I've finally got it through my thick head that there are a lot of angles and problems to this radio and TV business that we never hear or think about at this location. The article I consider dull and a waste of space may be the very thing some other reader has been waiting for."

"Tell me more," Mac urged with interest.

"Well, take that business of figuring out the heights TV transmitting antennas and receiving antennas should be. I surely saw examples of both extremes. Out in Oklahoma City they have the tallest TV transmitting tower in the world. It's even taller than the Empire State Building, and they can really use this height to poke a signal into the pockets and over the tops of the hills in the rough country that falls within the fringe area of this skyscraping tower. On the other hand, you know we are used to the familiar sight of those cement relay towers two or three hundred feet high with a couple of pairs of horn-type antennas on top for relaying telephone messages and TV programs. I always had a hankering to see those antennas up close, and I got my chance out on the Great Salt Flats between Wendover, Utah, and Salt Lake City. Out there I found this whole top antenna assembly sitting right on the ground. There was no need to put it up on a tower, for it had easy line-of-sight contact with other relay stations on mountain tops to the west and east. Sure did look funny, though, to see it squatting out there on the salt flats.

"Then, when we reached Los Angeles, it was very odd not to see any antennas with rotating motors. They have no use for them because all the TV transmitting antennas are on Mount Wilson. You just point your receiving antenna at this and get all the stations—I think there are seven of them. What's more, you get line-of-sight reception for a heck of a distance by our flat country standards. Even though you can't always see the mountain because of haze and the notorious smog, it's there, and the TV signals come right on through. Friends with whom we stayed live better than fifty miles from the mountain, and they just use a simple one-bay conical sitting on the attic floor; but judging by the pictures on their twenty-four inch screen, I'd guess they must be getting three or four thousand microvolts of signal. I'd

imagine that close to the mountain you might have ghost problems and other troubles caused by too much signal. However, I'll bet those technicians skip over the articles on rotating motor maintenance we find so interesting here."

"You must have run into some areas where reception was not so good, didn't you?"

"I'll say. We went up through Bakersfield to the Sequoia National Park, and around Tulare, California, I saw several eight-bay conicals on top of tall towers. The bays were mounted side by side in vertical stacks of four. Judging just from that, I'd guess signal strength was pretty low there. And I also saw several installations that took advantage of 'natural' antenna towers. By that I mean the receiving antenna was up on top of a hill or knob and a long run of open wire line—often up to two or three thousand feet or more—brought the signal down to the house in the valley. I'd read about these, but I never had a chance to see one before."

"Anything else interesting in the TV line?"

"I did notice something I never ran across here. While listening to a weak radio station on the car radio—and there are many places where all signals are weak—I kept noticing a funny heterodyne whistle that would start in low and quickly build up to a loud sound and then die out again. It came and went without any predictable pattern, and I began to think a bypass was opening up in the car receiver; but then I noticed the sound was only heard while passing a house with a TV antenna. What I was hearing was the interference from the TV set's horizontal oscillator. Around here, where we only listen to loud radio signals, you seldom get this; but out there many of the sets would heterodyne that weak radio signal for better than a quarter of a mile in either direction."

"How about radio out there? Is it pretty much of a dead issue?"

"By no means. We passed through many areas in which I should judge, by the lack of antennas, that TV reception was practically impossible; but I'm confident every isolated house had a radio. Radio is much more than just a means of casual entertainment in many of these out-of-the-way places in the mountains and desert. It is a combined newspaper, telephone, church, school, market ticker, and show all rolled into one. In the sheep country we passed several of those little houses on wheels in which the shepherders live, and I saw a portable radio sitting beside the window in two or three of them. In fact, we even saw one herder carrying a portable with him on the saddle as he rode his horse around his flock. It doesn't take much imagination to realize what radio must mean to those lonely fellows."

Barney stopped for a moment and then went on slowly and shyly: "You know around here I practically never

(Continued on page 126)



Heathkit PRINTED CIRCUIT 5" COLOR TV Oscilloscope Kit

MODEL
O-10
\$69⁵⁰
Shpg. Wt. 27 lbs.

The technical specifications for this fine instrument speak for themselves. Vertical channel sensitivity is 0.025 volts RMS/inch at 1 Kc. Vertical frequency response is essentially flat to 5 Mc, and down only 1.5 db at 3.58 Mc. Ideal for Color TV work!

Extended sweep generator range is from 20 cps to 500 Kc in five steps, far beyond the range normally encountered at this price level.

Other features are: plastic-molded capacitors for coupling and by-pass—preformed and cabled wiring harness—Z axis input for intensity modulation—peak-to-peak voltage calibrating source built-in—retrace blanking amplifier—regulated power supply—high insulation printed circuit boards—step attenuated and frequency compensated vertical input circuit—push-pull horizontal and vertical amplifiers—excellent sync. characteristics—sharp, hairline focusing—uses 5UP CRT—extremely attractive physical appearance.

An essential instrument for professional Laboratory, or for servicing monochrome or color TV.

Heathkit PRINTED CIRCUIT 3" OSCILLOSCOPE KIT



This light, portable 3" oscilloscope is just the ticket for the ham, for service calls, or as an "extra" scope in the shop, or lab. Measures only 9 1/4" H x 6 1/2" W x 11 3/4" D, and weighs only 11 lbs.

Employs printed circuit board for improved circuit performance. Vertical amplifiers flat within +3 db from 2 cps to 200 Kc. Vertical sensitivity 0.25 volts RMS/inch peak-to-peak, and sweep generator operates from 20 cps to 100,000 cps. R.F. connection to deflection plates.

\$29⁵⁰
Shpg. Wt. 14 lbs.

Heathkit PRINTED CIRCUIT 5" OSCILLOSCOPE KIT



This full-size 5" Oscilloscope incorporates many outstanding features.

Vertical channel flat within +3 db. 2 inch peak-to-peak sensitivity at 1 Kc. Sweep operation from 20 cps to 100,000 cps. Built-in peak-to-peak voltage calibration—3 step frequency compensated input attenuator—phasing control—push-pull deflection amplifiers. Printed circuits for reliable performance and reduced construction time.

MODEL OM-1
\$49⁵⁰
Shpg. Wt. 26 lbs.

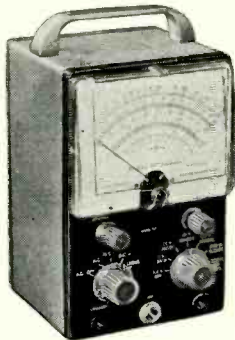

Heathkit PRINTED CIRCUIT VACUUM TUBE VOLTMETER KIT

MODEL V-7

\$24⁵⁰

Shpg. Wt. 7 lbs.

This VTVM has set a new standard for accuracy and reliability in kit-form electronic instruments. Features modern, time-saving printed circuits, and functional arrangement of controls and scales. Includes new peak-to-peak scale for FM and TV work.

Measures AC (RMS) and DC voltage at 0-1.5, 5, 15, 50, 150, 500, and 1500; peak-to-peak AC voltage at 0-4, 14, 40, 140, 400, 1400, and 4000; center-scale resistance readings of 10, 100, 1000, 10,000, 100 K, 1 meg., and 10 meg. DB scale provided also. Zero-center operation within range of front panel controls. Polarity reversal switch—200 μ a 4 1/2 meter-transformer power supply—11 megohm input impedance—1% precision resistors—high quality components used throughout.

Heathkit VOLTAGE

CALIBRATOR KIT

Once calibrated, this instrument provides a known peak-to-peak voltage standard for comparison with unknown voltage values on an oscilloscope. Panel calibrated directly—no involved calculations required. Operates within a voltage range of .01 to 100 volts peak-to-peak.



MODEL VC-2
\$11⁵⁰

Shpg. Wt. 4 lbs



Heathkit 20,000 ohms/volt MULTIMETER KIT

MODEL MM-1

\$29⁵⁰

Shpg. Wt. 6 lbs.

Features comprehensive range coverage. 20,000 Ω /V D.C. and 5000 Ω /V A.C. Ranges: 0-1.5, 5, 50, 150, 500, 1500, and 5000 V. direct current from 0 to 150 μ a., 15 a. in 5 steps. Center-scale resistance of 15, 1500 and 150,000 ohms, and db from -10 to +65.

Uses 1% precision resistors—50 μ a meter—molded bakelite case.

Heathkit DIRECT-READING CAPACITY METER KIT



MODEL CM-1

\$29⁵⁰

Shpg. Wt. 7 lbs.

Extremely valuable where speed and convenience are essential. Quality control work, production line checking, etc. Reads capacity directly on meter scale, from 0-100 mmfd, 1000 mmfd, .01 mfd, and .1 mfd. Residual capacity less than 1 mmfd. Not susceptible to hand capacity.



Heathkit A. C. VACUUM TUBE VOLTMETER KIT

MODEL AV-2

\$29⁵⁰

Shpg. Wt. 5 lbs.

Measures AC voltage only, from 10 cps to 50 Kc. Covers the range from 1 millivolt to 300 volts in 10 steps at high impedance input. Incorporates full 10 ranges of db scale from -52 db to +52 db. Essential in the audio laboratory or for audio enthusiasts and experimenters. Provides sensitivity essential for low level audio measurements.

Heathkit ELECTRONIC SWITCH KIT



MODEL S-2

\$23⁵⁰

Shpg. Wt. 11 lbs.

This device will electronically switch between 2 input signals to produce both signals alternately at the output. Used in conjunction with an oscilloscope, it will permit the observation of 2 signals simultaneously. Provides switching rates from 10 cps to 200 cps.

HEATH Company

A SUBSIDIARY OF DAYSTROM INC.

BENTON HARBOR 15, MICHIGAN

SELECT YOUR NEXT HEATHKIT FROM

Heathkit TUBE CHECKER KIT

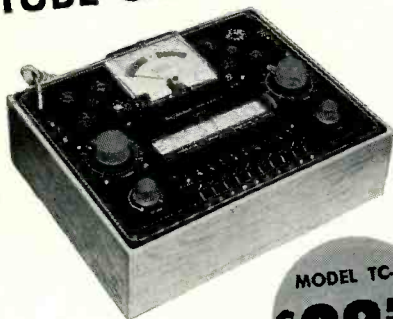

MODEL TC-2
\$29⁵⁰
Shpg. Wt. 12 lbs.

Because of its low price this fine tube tester is available, not only to the service shop and laboratory, but to part-time servicemen, experimenters, and radio amateurs, as well. Will test all tubes commonly encountered in radio and TV service work. Simple "GOOD-BAD" scale on the 4 1/2" meter. Tests for open, short, and quality on the basis of total emission. Includes illuminated roll chart. Fourteen different filament voltage values available. Separate lever switch for each tube element.

Model TC-2P is the same electrically as TC-2, except that it is housed in a beautiful two-toned portable carrying case. Only \$34.50. Shpg. Wt. 15 lbs.

Portable carrying case available separately for Model TC-2, or older model TC-1. Cab. No. 91-8, \$7.50. Shpg. Wt. 7 lbs.
CRT Test Adapter, Model 355 for use with the TC-2, \$4.50. Shpg. Wt. 1 lb.

Heathkit TV ALIGNMENT GENERATOR KIT

Here is the complete R.F. signal source for FM and TV alignment, (both monochrome and color). Provides output on fundamentals from 3.6 Mc to 220 Mc in four bands, with harmonic output usable up through the UHF channels. Electronic sweep circuit eliminates mechanical gadgets and accompanying noise, hum, and vibration. Continuously variable sweep up to 0-42 Mc, depending on base frequency.

Variable marker (19-60 Mc on fundamentals) and crystal marker (4.5 Mc and multiples thereof) generators built-in. Crystal included with kit. Provision for external marker if desired.

Packed with outstanding features. 50 ohm output impedance—exceptionally good linearity—effective AGC action—plenty of R.F. output. An essential instrument for the up-to-date service shop.



\$49⁵⁰

MODEL TS-4
Shpg. Wt. 16 lbs.

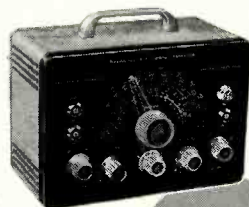

Shpg. Wt. 8 lbs.

MODEL SG-8
\$19⁵⁰

Heathkit SIGNAL GENERATOR KIT

This is one of our most popular kits, and is "serviceman engineered" to fulfill the signal source requirements of the radio serviceman and experimenter.

Covers 160 Kc to 110 Mc on fundamentals (5 bands), with output in excess of 100,000 microvolts. Calibrated harmonics extend usefulness up to 220 Mc. Choice of unmodulated R.F. output, 400 cps modulated R.F. output, or 400 cps audio output. Step-type and continuously variable output attenuation controls.

Coils are prewound, and construction manual is complete. Calibration unnecessary for service applications.

Model RS-1

Heathkit RESISTANCE SUBSTITUTION BOX KIT



Provides switch selection of 36 RTMA 1 watt standard 10% resistors, ranging from 15 ohms to 10 megohms. Numerous applications in radio and TV work.

\$5⁵⁰
Shpg. Wt. 2 lbs.

Heathkit CONDENSER SUBSTITUTION BOX KIT

Very popular companion to Heathkit RS-1. Individual selection of 18 RTMA standard condenser values from .0001 mfd to .22 mfd. Aluminum panel, bakelite case, and includes 18" flexible leads with alligator clips.

Model CS-1
\$5⁵⁰
Shpg. Wt. 2 lbs.



Model DR-1

Heathkit DECADE RESISTANCE KIT

Twenty 1% precision resistors provide resistance from 1-99,999 ohms in 1 ohm steps. Indispensable around service shop, laboratory, ham shack, or home workshop.

\$19⁵⁰

Shpg. Wt. 4 lbs.

Heathkit DECADE CONDENSER KIT

Provides capacity values from 100 mmf to 0.111 mfd in steps of 100 mmfs. +1% precision silver-mica condensers used. High quality ceramic wafer switches for reduced leakage.



Shpg. Wt. 3 lbs.

\$16⁵⁰

Heathkit CONDENSER CHECKER KIT



Model C-3

\$19⁵⁰

Shpg. Wt. 7 lbs.

Measures capacity in four ranges from .00001 to 1000 mfd. Power factor control is provided for indication of electrolytic condenser efficiency. Tests capacitors under actual load conditions. Checks resistance from 100 ohms to 5 megohms. Direct reading scales for all tests. No calculation necessary.



Model T-3

Heathkit VISUAL-AURAL SIGNAL TRACER KIT

\$23⁵⁰

Shpg. Wt. 9 lbs.

This signal tracer features a high-gain R.F. channel and probe to permit signal tracing from the receiver antenna input through the R.F. and I.F. stages. Separate low gain channel for audio circuits. Both visual and aural indication by means of speaker and electron beam "eye" tube.

Also noise locator circuit, wattmeter, and terminals for "patching" output transformer or speaker into external circuit.

Heathkit LABORATORY GENERATOR KIT



Model LG-1

\$39⁵⁰

Shpg. Wt. 16 lbs.

Here is a signal generator for use where high accuracy and metered performance are essential. Covers 150 Kc to 30 Mc on fundamentals in 5 bands. 400 cps modulation variable from 0 to 50%. R.F. output at 50 ohms from 100,000 to 1 uv. Meter reads R.F. output in uv. or modulation percentage. Fixed-step and variable output.



Model M-1

Heathkit HANDITESTER KIT

\$14⁵⁰

Shpg. Wt. 3 lbs.

The M-1 is literally pocket size to fit in your coat pocket, tool-box, glove compartment, or desk drawer. Measures A.C. or D.C. v. in 5 steps from a full scale minimum of 0-10 v. to a maximum of 0-5000 v. Measures direct current at 0-10 Ma and 0-100 Ma, and provides ohmmeter ranges of 0-3000 and 0-300,000 ohms. Sensitivity of 1,000 ohms v. 1% precision divider resistors employed.

HEATH Company

A SUBSIDIARY OF DAYSTROM INC.
BENTON HARBOR 15, MICHIGAN

THESE HIGH QUALITY INSTRUMENTS

Heathkit HARMONIC DISTORTION METER KIT



MODEL HD-1
\$49.50
Shpg. Wt. 13 lbs.

Performs the functions of more elaborate and much more expensive audio distortion testing devices and yet is simple to operate and inexpensive to own. Used with a sine wave generator, it will check the harmonic distortion output of audio amplifiers under a variety of conditions. Essential in audio design work.

The HD-1 reads harmonic distortion directly on the meter as a percentage of the original signal input. It operates from 20 to 20,000 cps in 3 ranges, and incorporates a VTVM circuit for initial reference settings and final harmonic distortion readings. VTVM ranges are 0-1, 3, 10, and 30 volts full scale. 1% precision voltage divider resistors used. Distortion meter scales are 0-1, 3, 10, 30 and 100% full scale. Having a high input impedance the HD-1 requires only .3 volt input for distortion tests.

Heathkit AUDIO GENERATOR KIT

This basic audio reference generator deserves a place in your Laboratory. Complete frequency coverage is afforded from 20 cps to 1 Mc in 5 ranges, and output is constant within ± 1 db from 20 cps to 400 Kc, down only 3 db at 600 Kc., and 8 db at 1 Mc. An extremely good sine wave is produced, with a distortion percentage below 0.4% from 100 cps through the audible range.

Plenty of audio output for all applications; up to 10 v. under no load conditions. Output controllable with a continuously variable or step-type attenuator with settings of 1 μ v, 100 μ v, 1 v, and 10 v. Cathode follower output.



MODEL AG-8
\$29.50
Shpg. Wt. 11 lbs.

Heathkit AUDIO ANALYZER KIT



MODEL AA-1
\$59.50
Shpg. Wt. 13 lbs.

The AA-1 consists of an audio wattmeter, an AC VTVM, and a complete IM analyzer, all in one compact unit. It offers a tremendous saving over the price of these instruments purchased separately. Use the VTVM to measure noise, frequency response, output gain, power supply ripple, etc. Use the wattmeter for measurement of power output. Internal loads provided for 4, 8, 16, or 600 ohms. VTVM also calibrated for DBM units so db gain or loss can be noted quickly.

High or low impedance IM measurements can be made. High (6 Kc) and low (60 cps) frequency generators built-in. Only 4 meter scales are employed, and one of these is in color so that results are easily read on the scale. Full scale VTVM ranges are .01 to 300 volts in 10 steps, full scale wattmeter ranges are .15 mw to 150 w in 7 steps. IM analyzer scales are 1%, 3%, 10%, 30% and 100%.

Heathkit AUDIO OSCILLATOR KIT



MODEL AO-1
\$24.50
Shpg. Wt. 10 lbs.

(SINE WAVE - SQUARE WAVE)

Features sine or square wave coverage from 20 to 20,000 cps in 3 ranges. An instrument specifically designed to completely fulfill the needs of the serviceman and high fidelity enthusiast. Offers high-level output across the entire frequency range, low distortion and low impedance output. Uses a transformer in the second amplifier stage to maintain essentially flat output through the entire frequency range. Produces good, clean square waves with a rise time of only 2 microseconds.

Heathkit BROADCAST BAND RECEIVER KIT



MODEL BR-2
\$17.50
(Less Cabinet)
Shpg. Wt. 10 lbs.

Build your own receiver with confidence. Complete instruction book anticipates your every question.

Features transformer-type power supply, high-gain miniature tubes, built-in antenna, planetary tuning from 550 Kc to 1600 Kc, $5\frac{1}{2}$ " speaker. Also adaptable for use as AM tuner or phono amplifier.

CABINET: Fabric covered plywood cabinet available, complete with aluminum panel and re-inforced speaker grille. Part No. 91-9, Shpg. Wt. 5 lbs., \$4.50



Heathkit VARIABLE VOLTAGE POWER SUPPLY KIT

Model PS-3
\$35.50
Shpg. Wt. 17 lbs.

Provides regulated DC output for B+, and 6.3 v. AC at 4 amps. for filaments. Output variable from 0 to 500 v. DC at no load, linear from 0-10 ma at 450 vdc and 0-130 ma at 200 vdc! Essential for circuit design and development. Voltage or current read on $4\frac{1}{2}$ " meter.



Heathkit "Q" METER KIT

Model QM-1
\$44.50
Shpg. Wt. 14 lbs.

Will measure Q of condensers, RF resistance and distributed capacity of coils, etc. Uses $4\frac{1}{2}$ " 50 μ a meter for direct indication. Will test at 150 Kc to 18 Mc in 4 ranges. Measures capacity from 40 mmf to 450 mmf within ± 3 mmf. Useful for checking wave traps, chokes, peaking coils. Indispensable for coil winding and determining unknown condenser values.

Heathkit IMPEDANCE BRIDGE KIT



Model IB-2
\$59.50
Shpg. Wt. 12 lbs.

Measures resistance, capacitance, inductance, dissipation factors of condensers, and the storage factor of inductance. Employs 2-section CRL dial. D, Q and DQ functions are combined in one control. $\frac{1}{2}$ % resistors and capacitors used in critical circuits. 100-0-100 microammeter for null indications. 1000 cycle oscillator, 4 tube detector-amplifier, and power supply built-in.

Heathkit 6-12 VOLT BATTERY ELIMINATOR KIT



Model BE-4
\$31.50
Shpg. Wt. 17 lbs.

Furnishes 6 or 12 volt output for the new 12 v. car radios in addition to 6 v. models. Two continuously variable output voltage ranges; 0-8 v. DC at 10 A. continuously or 15 A. intermittent, 0-16 v. DC at 5 A. continuously or 7.5 A. intermittent. Output voltage is clean and well filtered by two 10,000 mfd condensers. Panel meters read voltage and current output.

HEATH *Company*
A SUBSIDIARY OF DAYSTROM INC.
BENTON HARBOR 15, MICHIGAN

New

Heathkit DX-100 PHONE AND CW TRANSMITTER KIT



MODEL DX-100

\$189⁵⁰

Shpg. Wt. 120 lbs.

Shipped motor freight unless otherwise requested. \$50.00 deposit required for C.O.D. orders.

This one compact package contains complete transmitter, with built-in VFO, modulator, and power supplies. Provides phone or CW operation—VFO or crystal excitation—and band-switching from 160 meters through 10 meters. R.F. power output 100—125 watts phone, 120—140 CW. Parallel 6146's modulated by push-pull 1625's. Pi network interstage and output coupling for reduced harmonic output. Will match non-reactive antennas between 50 ohms and 600 ohms. TVI suppressed with extensive shielding and filtering. Rugged metal cabinet has inter-locking seams.

The high-quality transmitter is packed with desirable features not expected at this price level. Copper plated chassis—potted trans-

formers—wide spaced tuning capacitors—ceramic insulation—illuminated VFO dial and meter face—remote control socket—preformed wiring harness—concentric control shafts—high quality, well rated components used throughout. Overall dimensions 20 $\frac{1}{2}$ " wide x 13 $\frac{3}{4}$ " high x 16" deep.

Supplied complete with all components, tubes, cabinet and detailed construction Manual. (Less crystals.) Don't be deceived by the low price! This is a top-quality transmitter designed to give you years of reliable service and dependable performance.

Heathkit AMATEUR TRANSMITTER KIT

Enjoy the trouble-free operation of commercially designed equipment while still benefiting from the economics and personal satisfaction of "building it yourself."

This CW Transmitter is complete with its own power supply, and covers 80, 40, 20, 15, 11 and 10 meters. Single knob bandswitching eliminates coil changing. Panel meter indicates grid or plate current for the final. Crystal operation, or can be excited by external VFO. Crystal not included in kit. Incorporates features one would not expect in this price range, such as key-click filter, line-quality components throughout, and high quality components throughout. Instruction Book simplifies assembly. Uses 6AG7 oscillator, 6L6 final and 5U4G rectifier. Up to 35 watts plate power input.



MODEL AT-1

\$29⁵⁰

Shpg. Wt. 15 lbs.



Model GD-1B

\$19⁵⁰

Shpg. Wt. 4 lbs.

Heathkit GRID DIP METER KIT

This is an extremely valuable tool for Hams, Engineers or Servicemen. Covering from 2 Mc to 250 Mc, it uses 500 μ a meter for indication. Kit includes pre-wound coils and rack. Will accomplish literally hundreds of jobs on all types of equipment.

Heathkit ANTENNA IMPEDANCE METER KIT

Use in conjunction with a signal source for measuring antenna impedance, line matching purposes, etc. Will double, also, as a phone monitor or relative field strength indicator.

100 μ a meter employed. Covers the range from 0 to 600 ohms. An instrument of many uses for the amateur.



Model AM-1

\$14⁵⁰

Shpg. Wt. 2 lbs.

Heathkit VFO KIT



MODEL VF-1

\$19⁵⁰

Shpg. Wt. 7 lbs.

Weigh the cost of this kit against the cost of crystals—and consider the convenience and flexibility of VFO operation. This is one of the most outstanding kits we have ever offered for the radio amateur.

Covers 160—80—40—20—15—11 and 10 meters with three basic oscillator frequencies. Illuminated and precalibrated dial scale clearly indicates frequency on all bands and provides more than two feet of dial calibration. Reflects quality design in the use of ceramic coil forms and tuning capacitor insulation, and copper plated chassis. Simply plugs into crystal socket of any modern transmitter to provide coverage of the bands from 160 meters through 10 meters. Uses 6AU6 Clapp oscillator, and OA2 voltage regulator for stability. May be powered from plug on Heathkit Model AT-1 Transmitter, or supplied with power from most transmitters.



Model AC-1

\$14⁵⁰

Shpg. Wt. 4 lbs.

Heathkit ANTENNA COUPLER KIT

Poor matching allows valuable communications energy to be lost. The Model AC-1 will match your low power transmitter to an end-fed long wire antenna. Also attenuates signals above 36 Mc, reducing TVI. 52ohm coaxial input—power up to 75 watts—10 through 80 meters.

Heathkit COMMUNICATIONS RECEIVER KIT

Covers 550 Kc to 35 Mc in 4 bands. Features electrical bandspread—separate R.F. and A.F. gain controls—noise limiter—AGC—BFO—phone jack—5 $\frac{1}{2}$ " PM speaker.

CABINET: Fabric covered plywood cabinet. Part No. 91-10. Shpg. Wt. 5 lbs. \$4.50



Model AR-2

\$25⁵⁰

Shpg. Wt. 12 lbs. (Less Cabinet)

HEATH Company

A SUBSIDIARY OF DAYSTROM INC.
BENTON HARBOR 15, MICHIGAN

Heathkit

DUAL-CHASSIS WILLIAMSON TYPE HIGH FIDELITY AMPLIFIER KIT

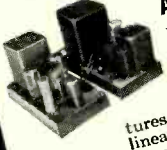

Main amplifier and power supply each have their separate chassis for flexibility of installation. Features the Acrosound "ultra-linear" output transformer. Frequency response within ± 1 db from 10 cps to 100,000 cps. Power output is over 20 watts.

KIT COMBINATIONS

W-3M: Consists of main amplifier and power supply for separate construction. Includes all tubes, components, and complete assembly instructions. \$49.75 Shpg. Wt. 29 lbs., Exp. Only W-3: Consists of W-3M Kit listed above plus Heathkit Model WA-P2 Preamplifier. Shpg. Wt. 37 lbs., Exp. Only \$69.50

Heathkit 6-WATT AMPLIFIER KIT



Model A-7B \$15.50

Shpg. Wt. 10 lbs.

Model A-7B; although not classified as a true high fidelity amplifier, this Heathkit Amplifier provides full 6 watts power output, more than adequate for normal-home installation, and frequency characteristics are $\pm 1 \frac{1}{2}$ db from 20 to 20,000 cps. Push-manual—top-quality parts. Transformer construction transformer—top-quality parts. Output ohms. Bass and treble tone controls provided. Two input channels. MODEL A-7C: Same as Model A-7B except with preamplifier stage. Shpg Wt. 10 lbs., \$17.50

Heathkit ADVANCED DESIGN High Fidelity AMPLIFIER KIT

This advanced-design 25 watt Hi-Fi Amplifier features a new-design Peerless output transformer, improved circuitry, and uses KT-66 output tubes. This results in higher power output; improved bass and high frequency response; and reduced IM and harmonic distortion. Incorporates all the "extra" features that make for real listening enjoyment. Power handling capabilities increased to follow instantaneous power peak of full orchestra. Also new type balancing circuit, and "tweeter saver" to suppress HF oscillation. New physical design results in attractive appearance, suitable for use either in or out of a cabinet.



KIT COMBINATIONS

W-5M: Consists of main amplifier and power supply for single chassis construction. Includes all tubes, components, and complete assembly instructions. \$59.75 Shpg. Wt. 31 lbs., Exp. Only W-5: Consists of W-5M Kit listed above plus Heathkit Model WA-P2 Preamplifier. Shpg. Wt. 38 lbs., Exp. Only \$79.50

Heathkit

SINGLE-CHASSIS WILLIAMSON TYPE HIGH FIDELITY AMPLIFIER KIT



This is the lowest priced Williamson-type Amplifier ever offered in kit form. Main amplifier and power supply on a single chassis. Features Chicago output transformer. Flat within ± 1 db from 10 cps to 100,000 cps. Maximum power output over 20 watts.

KIT COMBINATIONS

W-4M: Consists of main amplifier and power supply for single chassis construction. Includes all tubes, components, and complete assembly instructions. Shpg. Wt. 28 lbs., Exp. Only \$39.75 W-4: Consists of W-4M Kit listed above plus Heathkit Model WA-P2 Preamplifier. Shpg. Wt. 35 lbs., Exp. Only \$59.50

Heathkit 20-WATT HIGH FIDELITY AMPLIFIER KIT



Model A-9B \$35.50

Shpg. Wt. 23 lbs.

Here is your least expensive route to real high fidelity performance. Full 20 watt output—separate bass and treble tone controls—frequency response ± 1 db 20—20,000 cps—four switch-selected, compensated inputs—low hum and noise level—output transformer tapped at 4, 8, 16, and 500 ohms. Single chassis construction combines preamplifier, main amplifier, and power supply in one unit.

Heathkit HIGH FIDELITY PREAMPLIFIER KIT



Model WA-P2 \$19.75

Shpg. Wt. 7 lbs.

Beautiful modern appearance blends with any interior color scheme.

Completely fulfills all the requirements for remote control, compensation, and preamplification for the Heathkit Williamson-type Amplifiers or any conventional Hi-Fi Amplifier. Five separate input channels, each with separate audio level control. Full record equalization accomplished with 4-position turnover and roll-off controls.

Separate bass and treble controls. Overall frequency response within 1 db from 25 cps to 30,000 cps. Hum and noise level extremely low. This brilliant performer will do justice to the finest available program sources.

HEATH COMPANY • Benton Harbor 15, Mich.

ORDER BLANK



MAIL YOUR ORDER TODAY TO THE HEATH COMPANY A SUBSIDIARY OF DAYSTROM INC. BENTON HARBOR 15, MICHIGAN

From

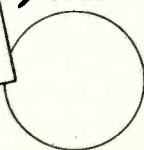

- SHIP VIA Parcel Post Express Freight Best Way

Table with columns: QUANTITY, ITEM, MODEL NO., PRICE. Includes a note: (PLEASE PRINT)

Enclosed find () check () money order for Please ship C.O.D. () postage enclosed for pounds.

On Express orders do not include transportation charges—they will be collected by the express agency at time of delivery. NOTE: ALL PRICES SUBJECT TO CHANGE WITHOUT NOTICE.

ON PARCEL POST ORDERS include postage for weight shown.

ORDERS FROM CANADA and APO's must include full remittance.

TAKE A *Good Look*

The Difference
is Visible to
the Naked Eye!



irish
BRAND
FERRO-SHEEN

has the smoothest surface
of all recording tapes!

What does this super-smoothness mean to you?

- 1. — GREATLY REDUCED HEAD WEAR:** the mirror-smooth FERRO-SHEEN surface virtually eliminates headwear caused by the abrasive surface of ordinary tapes.
- 2. — NO SHEDDING OF OXIDE:** unlike ordinary tapes which shed oxide particles that gum up the heads, the FERRO-SHEEN process bonds the oxide to the base so that it cannot come off.
- 3. — FLATTER FREQUENCY RESPONSE:** the super-smooth surface of FERRO-SHEEN tape makes better contact with the recording head, resulting in higher output and a very flat frequency response.
- 4. — NO "DROPOUTS":** the mirror-like surface of irish FERRO-SHEEN tape contains no nodules or agglomerates which lift the tape away from the head causing "drop-outs."

MAKE THIS TEST YOURSELF . . .
Place strips of each of the four leading tapes side by side for direct comparison—you will SEE the obvious difference. . . **YOU WILL INSTANTLY RECOGNIZE WHY IRISH FERRO-SHEEN TAPE IS THE FINEST TAPE YOUR RECORDER CAN USE!**

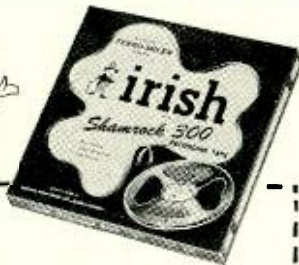

ASK YOUR
DEALER

FOR **irish**
SHAMROCK #300

the FERRO-SHEEN PROCESS TAPE

600'	\$2.40 Hi-Fi Net
1200'	3.80 Hi-Fi Net
2400'	8.60 Hi-Fi Net

Manufactured By

ORRADIO INDUSTRIES, Inc.
Opelika, Alabama

NEW LINE OF HOME SOUND SYSTEMS ANNOUNCED BY RCA



A compact table model phonograph which retails at \$129.95. It has three speakers and three-speed record changer.

Five new units, ranging in price from \$129.95 to \$1600, are included in new line of audio equipment.

IN THE belief that more and more people will want "ready-to-plug-in" sound systems rather than separate components which must be assembled, Radio Corporation of America has recently introduced five new assembled systems which range in price from \$129.95 to \$1600.00.

Top model of the line is the "Mark I" at \$1600 which consists of a twin console with four speakers in a separate cabinet. The instrument includes a tape recorder, three-speed record changer, and AM-FM radio. Maximum output is 25 watts through a range of 30 to 20,000 cycles.

The "Mark II" is a single-cabinet console with three speakers, three-speed changer, and AM-FM radio. Maximum output is 25 watts, 30-20,000 cps. The price is \$595 in mahogany.

The third model, the "Mark III," is also a single-cabinet console with three speakers and three-speed changer in addition to the AM-FM radio. Maximum output is 15 watts, 30 to 20,000

cps. List price is \$325 in mahogany.

The "Mark IV" is a console model with three speakers and three-speed record player. Maximum output is 6 watts, 60 to 20,000 cps. This model will sell for \$169.95 in mahogany.

The final unit in the present series is a table model with three speakers and three-speed changer. Maximum output is 4 watts, 70 to 20,000 cps. This \$129.95 unit is also available with optional legs of matching finish or brass.

One of the new features of the "Mark I" and "Mark II" instruments is the first use of transistor circuits in commercial phonographs. According to the company, this delivers quieter performance and a greatly reduced hum level.

The record changer used in the "Mark I" handles 7, 10, and 12 inch records. It has a weighted and balanced turntable and 4-pole, 4-coil motor, assuring constant speed operation with virtually no hum.

-30-

The "Mark I," the top-of-the-line in the new RCA series. Housed in two cabinets, it features four speakers, 3-speed record player, tape recorder, and AM-FM receiver.



RADIO & TELEVISION NEWS



If you're willing to lose your job tomorrow to a technically-trained man, *turn the page, mister*

But, if you're interested in an honest-to-goodness career in the vigorous young electronics industry, here's how you can step ahead of competition, move up to a better job, earn more money, and be sure of holding your technical job even if the brass is firing instead of hiring.

The "how" is CREI training in radio-television-electronics.

You don't have to be a college graduate. You *do* have to be willing to study—at home. You can do it while holding down a full-time job. Thousands have. Since 1927 CREI has provided alert young men with the technical knowledge that leads to more responsibility, more job security, more money. More than a quarter century of experience qualifies CREI to train you.

What qualifies *you* for CREI? If you have a high school education, you're off to a good start. If you have a knack for math, so much the better. If you are currently working in some phase of the electronics industry, you'll get going faster. But remember this: CREI starts with fundamentals and takes you along at your own speed. You are not held back by a class, not pushed to keep up with others who have more experience or education. You set your own pace. Your CREI instructors guide you through the lesson material and *grade* your written work personally. You master the fundamentals, then get into more advanced phases of electronics engineering principles and practice. Finally you may elect training at career level in highly specialized applications of radio or television engineering or aeronautical radio.

How good is CREI training? Here are a few ways to judge. Ask an electronics engineer if you know one. Ask a high-school or college physics teacher. Ask a radio station engineer.

Check up on our professional reputation: CREI home study courses are accredited by the Engineers' Council for Professional Development; CREI is an approved member of the National Council of Technical Schools. Ask personnel managers how they regard a man with a CREI "ticket." Look at this partial listing of organizations *that pay CREI* to train their own personnel: All American Cables & Radio, Inc., Canadian Aviation Electronics, Ltd., Canadian Broadcasting Corporation, Columbia Broadcasting System, Hoffman Radio Corp., Machlett Labs., Glenn L. Martin Co., Magnavox Co., Pan American Airways, Atlantic Division, RCA Victor Division, United Air Lines. Finally, ask a CREI graduate to tell you about our Placement Bureau, which currently has on file more requests for trained men than we can fill.

What's the next step? The logical one is to get more information than we can cram into one page. The coupon below, properly filled out, will bring you a fact-packed booklet called "Your Future in the New World of Electronics." It includes outlines of courses offered, a resume of career opportunities, full details about the school, and tuition details. It's free.

Note: CREI also offers Resident School instruction, day or evening, in Washington, D.C. New classes start once a month. If you are a veteran discharged after June 27, 1950, let the new GI Bill help you obtain resident instruction. Check the coupon for more data.

CAPITOL RADIO ENGINEERING INSTITUTE
Accredited Technical Institute Curricula • Founded 1927

Dept. 118-B, 3224 16th St., N. W., Washington 10, D. C.

Please send me your course outline and **FREE** Illustrated Booklet "Your Future in the New World of Electronics" . . . describing opportunities and CREI home study courses in Practical Electronics Engineering.

CHECK FIELD OF GREATEST INTEREST

Practical Radio Engineering
 Broadcast Radio Engineering (AM, FM, TV)
 Practical Television Engineering
 Aeronautical Electronics Engineering

I

To help us answer your request intelligently, please give the following information:

EMPLOYED
By

TYPE OF PRESENT WORK

SCHOOL BACKGROUND

ELECTRONICS EXPERIENCE

Name

Street

City..... Zone..... State.....

CHECK: Home Study Residence School Veteran

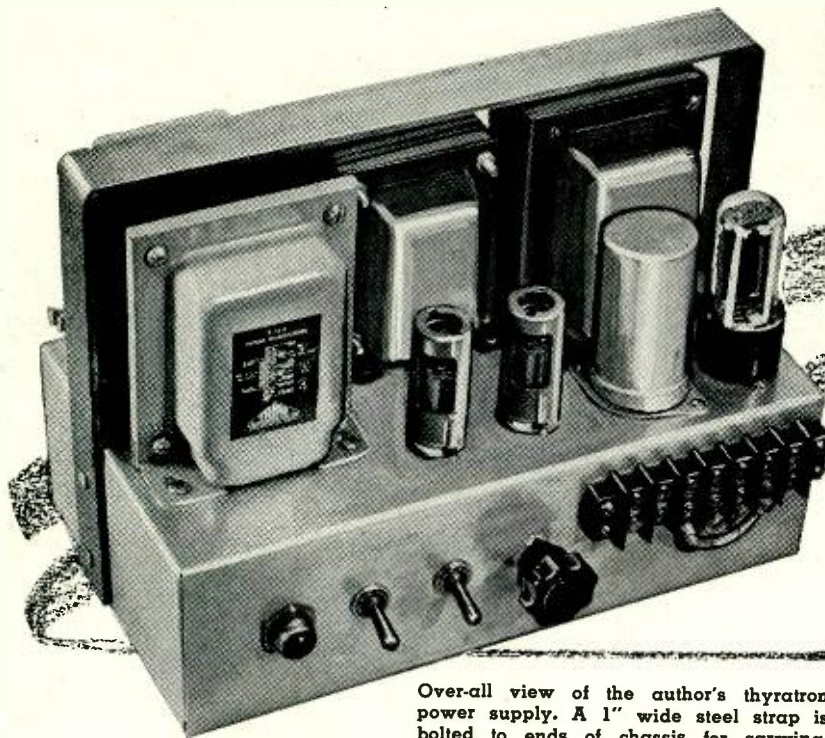

Over-all view of the author's thyatron power supply. A 1" wide steel strap is bolted to ends of chassis for carrying.

Construction details on an unregulated power supply which provides outputs from 30 to 300 volts with single control.

EVERY electronic experimenter or hobbyist needs a good utility power supply. Most power supplies constructed for utility applications are of the voltage-regulated type, not so much because of the voltage regulation they afford, but rather for the feature of output voltage control. For example, an experimenter developing some battery-powered equipment needs a power supply that can be adjusted to the equivalent voltage of the batteries he intends to use. The fact that this voltage might vary a few volts with line or load variations is of little importance, but it is important that the correct voltage be obtained without the use of awkward, hot, and otherwise inadequate dropping resistors.

The power supply shown is not a voltage-regulated supply. The output voltage will change with variations in line voltage and current load. But the output can be varied over a range of 30 to 300 volts with a simple potentiometer control, and voltage variations can be compensated with great ease.

The wide output voltage range is obtained by substituting 2D21 thyratrons for the conventional high-vacuum rectifier used in most power supplies. For those unfamiliar with the thyatron, it is a tube constructed very much like a conventional triode, the greatest exception being the fact that the bulb is filled with an easily ionized gas instead of being evacuated. The cathode of a thyatron emits the total current conducted by the tube, but the

ionized gas greatly minimizes the space charge and gives the tube remarkable current handling capacities. Once the tube is allowed to conduct and the gas is ionized, positive ions surround the grid and neutralize its effect on the electron stream. As a result, a conducting thyatron cannot be cut off by the restoration of grid bias. Instead, the plate voltage must be momentarily removed to allow the gas to de-ionize. The grid can again be used to control the tube when the gas has de-ionized.

Because the thyratrons are grid controlled tubes, they can be made to conduct during only a portion of each positive half-cycle produced by the power transformer. The output voltage is determined by the percentage

Operation of the thyratrons. See article.

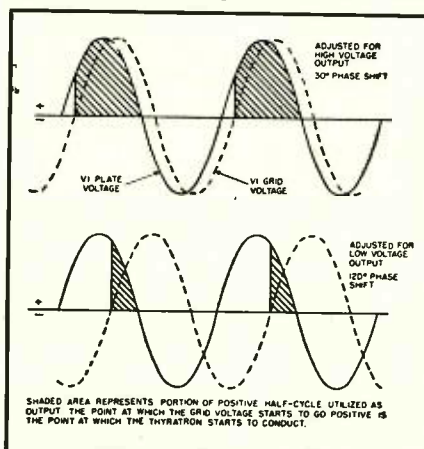

THYRATRON POWER SUPPLY

By PETER J. VOGELGESANG

of each half-cycle that the thyratrons conduct. Adjusted for maximum output, the thyratrons conduct over the entire half-cycle, while for a much lower output voltage they conduct only during the last few degrees of each half-cycle.

The thyratrons are controlled by driving the grids with a voltage that is out-of-phase with the plate voltage. This grid voltage is obtained with a variable phase-shift network composed of R_3 , R_6 , C_1 , and C_2 . As shown in the graph, the thyratrons will not conduct during the first few degrees of each positive half-cycle because the instantaneous grid voltage is well below cut-off during that period. As the phase shift is increased the thyratrons are caused to conduct during a smaller portion of the half-cycle. Since the filter system of the power supply averages the conduction time of the thyratrons, the output voltage will rise or fall as the grid voltage phase shift is decreased or increased. Figs. 1 and 2 illustrate the voltage waveforms at the cathodes of the thyratrons for output voltages of 250 volts and 50 volts respectively.

It is possible to obtain a 90 degree phase-shift in a purely capacitive circuit, but since a purely capacitive circuit cannot be obtained practically, a full 90 degree phase-shift cannot be produced with a simple resistive-capacitive network. The phase-shift network illustrated in the schematic diagram uses two resistive-capacitive sections, each of which is capable of approximately 70 degrees of phase-shift, and, when added, will shift the grid voltage a total of 140 degrees from the plate voltage of the thyratrons. The remaining 50 degrees phase-shift cannot be obtained, and is the limiting factor that determines the minimum output voltage to which the power supply can be adjusted. In the vast majority of applications a minimum output of 30 volts is not acceptable. However, a more elaborate phase-shift system, perhaps one with an amplifier

RADIO & TELEVISION NEWS

or one using both inductive and capacitive sections, could give control even over the range of 0 to 30 volts.

With potentiometers R_5 and R_6 adjusted for minimum resistance, the phase-shift in the circuit is zero. As resistance is added the phase is shifted rapidly but decreases in proportion as more resistance is added. In other words, the phase-shift network is not linear. Linear potentiometers, then, would make the adjustment at high voltages quite critical. Potentiometers with reverse audio tapers overcome the inherent non-linearity of the phase-shift network. They must be connected to the circuit so that minimum resistance change occurs at the most clockwise position of the control knob.

The voltage drop within each thyatron does not exceed eight volts even under maximum load. While this is excellent from the standpoint of voltage regulation, it creates the necessity of using a choke input filter system. A capacitor input filter would cause instantaneous plate currents far in excess of the maximum ratings of the tubes and power transformer. In a conventional high-vacuum, rectifier-type power supply, each half of the rectifier serves to damp the inductive kickback from the input choke because at least one half of the rectifier is conducting at all times. But with thyatrons, short intervals exist when neither tube is conducting, and since during those intervals the impedance at the input to the filter is very high, the input choke will tend to ring. While ringing is not in itself undesirable, it cannot be tolerated in this particular power supply because it disrupts the wave shape at the cathodes of the thyatrons and prevents complete control. Ringing is easily prevented by shunting a 5Y3 rectifier and 5000 ohm resistor across the input choke. Fig. 3 shows how the input choke will ring without damping.

In addition to preventing ringing, the damping rectifier also increases the maximum output voltage of the power supply. In a conventional choke input filter system the inductive kickback from one half-cycle detracts from the following half-cycle, substantially reducing the output voltage. In this circuit, the 5Y3 absorbs the kickback thereby allowing the output voltage to reach more nearly the secondary voltage of the power transformer. The maximum unloaded output voltage of the supply is about 380 volts.

The filaments of the 2D21 tubes must be heated by an independent 6.3 volt filament winding, the center tap of which is returned to the cathodes, so as not to exceed the filament-to-cathode voltage rating of the tubes. Grid voltage is obtained from the 6.3 volt winding of the power transformer. It is fed through the phase-shift network to the primary of the plate-to-grid transformer, T_3 . Capacitor C_2 is connected across the output of T_3 to minimize the inductive reactance of

the transformer. The phase-shift network is a comparatively high impedance circuit and it must work into a non-reactive load. Both the control grids and shield grids of each thyatron are isolated by 100,000 ohm resistors. Since these grids are not merely in an electron stream but rather in a highly ionized gas, they would draw excessive and damaging currents if they were not returned through a high impedance circuit.

The supply is constructed on a 10" x 5" x 3" steel chassis. A piece of 1" wide steel strap is bent in the shape of a "U" and bolted to the ends of the chassis for easy carrying. All voltages are brought to a barrier terminal strip on the front of the chassis. While transformers of other manufacture might work just as well, it is recommended that T_1 be of the manufacture indicated in the parts list. Slight differences in impedance might affect the efficiency of the phase-shift circuit. The correct phase polarity must be observed when connecting the 6.3 volt filament winding of T_1 to the input of the phase-shift network. With R_5 and R_6 set for minimum resistance, the grid voltage should be in-phase with the plate voltage. Correct phase polarity can be achieved with an oscilloscope, but if a scope is not available, trial and error can be used without danger of damaging the thyatrons.

The entire unit is small, compact, rugged, and attractive, and will outperform power supplies twice the size, complexity, and cost. As with any power supply, a very practical addition would be a voltmeter and ammeter at

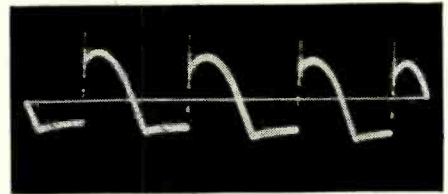

Fig. 1. Waveshape at cathodes of thyatrons with supply adjusted for 250 volt output.

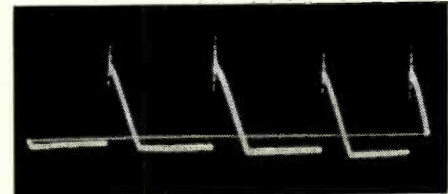

Fig. 2. Same as Fig. 1 only at 50 v. output.

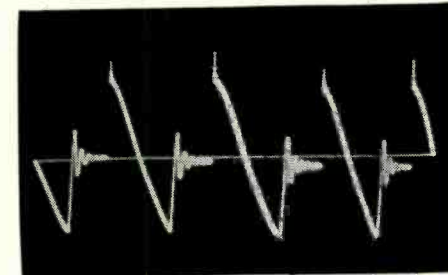
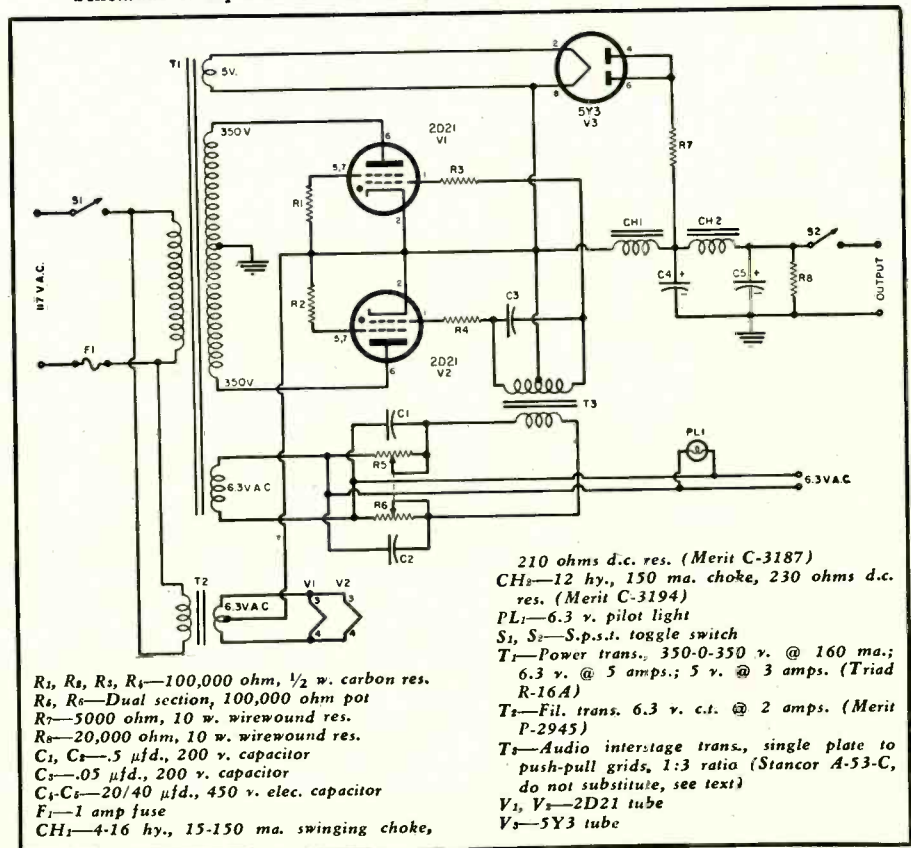

Fig. 3. Waveshape at cathodes of thyatrons with damping rectifier out of the circuit.

unit's high voltage output terminal. If such meters can be spared for permanent installation in the supply's output circuit, they would, of course, offer greater current and voltage measuring flexibility.

Schematic of thyatron power supply. It provides output from 30 to 300 volts.



REGULAR \$59.95 LIST TIMEX MAGNETIC RECORDER McGEE'S SPECIAL PURCHASE SALE **\$29.95**

RECORDS AND PLAYS BACK—PLAYS 16 $\frac{2}{3}$ AND 45 RPM RECORDS

MODEL 40 TIMEX RECORDER \$29.95
CRYSTAL PICKUP HEAD TO PLAY
PHONO RECORDS \$2.95 EXTRA

A product of United States Time Corp. (Timex) A multiple purpose machine made to retail for \$59.95. McGee buys a solid carload and you save by buying now at only \$29.95, plus \$2.95 for a 45 RPM record adaptor and crystal head for 16 $\frac{2}{3}$ or 45 RPM phono records. Records and plays back for 3 $\frac{1}{2}$ minutes on a wafer thin flexible magnetic disc. Make recordings of your family—use for office dictation—dictate records that may be mailed without breaking. Attractive brown plastic case, 9 $\frac{1}{2}$ x 11 $\frac{1}{2}$ x 4 $\frac{1}{8}$ ". Turntable speeds 16 $\frac{2}{3}$ and 45 RPM. Response 100 to 4000 cps. Amplifier has neon level indicator, volume control and selector knob with playback, record and phono positions. Uses 12AX7, 50C5, 6C4 and 35W4 tubes. Built-in 4" speaker. Complete with Shure variable reluctance microphone. Provides faithful reproduction at low volume of voice or music, recorded through the microphone or direct from your radio or TV. As simple to operate as a record player. Stock No. TIM-RI recorder, ship. wt. 13 lbs. Sale price, \$29.95.

Recording discs, package of 6 for 99¢. One blank shipped with recorder.

You may purchase a plug-in crystal phono pickup to adapt this recorder for playing 16 $\frac{2}{3}$ or 45 RPM phono records for only \$2.95 extra.



8" EXTENSION SPEAKER
\$16.95 EXTRA

For \$16.95 extra you can have our regular \$39.95 imperial extension speaker, equipped with an 8" G.E. speaker as described on the opposite page. When you order this with your Timex recorder we install a jack which makes your Timex play 45 RPM records with better tone quality and with the switch in the record position unit doubles as a small public address system.

SALE PRICE \$29.95
MODEL 40 TIMEX

McGEE'S LOW COST HIGH FIDELITY

20 WATT HI-FI AMP
Response 30-15000 CPS. **SALE PRICE \$22.95**
Push-Pull 6L6's Inputs for Mike and Crystal or V.R. Phono Pickup. Twin Tone Controls.

A tremendous High Fidelity amplifier value. Response 30 to 15,000 cps. Electronic bass and treble boost by separate tone controls. Use this amplifier with any record changer, with crystal or variable reluctance cartridge, with phone drawer or high impedance crystal or dynamic microphone 20 watts power output. Use with any 4 or 8 ohm speaker or 250 ohm line. Chassis size, 7 $\frac{3}{8}$ x 10 $\frac{1}{2}$ x 7 $\frac{1}{8}$ " high. Complete with tubes: 2-6L6, 2-6C4, 12AX7 and 5U4G. This is a terrific value. A ready to use high fidelity amplifier at less than the cost of a kit. Ship. wt. 14 lbs. Stock No. HF-20, 20 watt amplifier. McGee's sale price, \$22.95. With our CU-14Y, 12" coaxial PM speaker, \$32.95. With 15" coax. speaker, \$42.95.

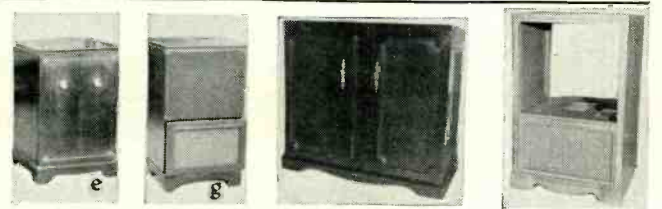

\$29.95 17" FULL DOOR **\$19.95** NRT-21M **\$59.95** BT-210 **\$22.95**
Fig. (e) No. AH-430 Mahogany with full doors. 36" h., 24" w., 17 $\frac{3}{4}$ " deep. Chassis area 22" w., 17 $\frac{3}{4}$ " h., 18 $\frac{1}{2}$ " deep. Blank panel. Holds 17" TV easily. Baffle cut for 10" speaker. Ship. wt. 80 lbs. On sale at less than it cost a famous TV factory. Sale price, \$29.95.
Fig. (g) SE-21, 17" mahogany TV cabinet with phone drawer 48" w., 24" h., 18 $\frac{1}{2}$ " deep. Blank panel. TV chassis area 19" h., 20 $\frac{1}{2}$ " w. Changer drawer 19 $\frac{1}{2}$ " wide, 13" deep. Baffle cut for 10" speaker. Ship. wt. 75 lbs. Sale price, \$19.95.

DELUXE 21" MAHOGANY TV-PHONO CABINET
No. NRT-21M, Deluxe piano finish mahogany combination radio-phonon-TV cabinet for 20" or 21" TV chassis. Beautiful full door style with matching front panels. 37" high, 40 $\frac{1}{2}$ " wide and 22 $\frac{3}{4}$ " deep. Baffle cut for a 12" speaker. TV chassis area 21" high, 23 $\frac{1}{2}$ " wide and 19" deep. Changer shelf 15" x 17" with 9" height clearance. Ship. wt. 90 lbs. No. NRT-21M, mahogany cabinet, sale price, \$59.95. 21" mask and safety glass, \$6.95 extra.
21" BLONDE \$22.95—MAHOGANY OR WALNUT \$19.95
No. BT-210, blonde oak 21" TV cabinet. 37 $\frac{1}{2}$ " high, 24" wide and 20 $\frac{1}{2}$ " deep. TV chassis area 21" high, 23 $\frac{1}{2}$ " wide and 19" deep. Baffle cut for 10" speaker, \$22.95. No. WT-210, walnut 21" TV cabinet, same as above, Sale price, \$19.95. No. MT-210, mahogany 21" TV cabinet, same as above, Sale price, \$19.95.

6-TUBE, 2-BAND RADIO KIT \$14.95
6-18 MC 550-1650 KC
6 tube, 2 band AC-DC radio kit, complete with speaker and plastic cabinet. Popular with schools and colleges for training in radio. Receives broadcast and 6-18 mc shortwave. Full 2 gram superhet with 5" speaker and slide rule dial. A complete kit with tubes: 21K6, 2-12SK7, 12SQ7, 50L6 and 35Z5, diagram and instructions. Cabinet 13" x 6 $\frac{3}{4}$ " x 6 $\frac{3}{4}$ ". Ship. wt. 12 lbs. Model ME6-2, Net \$14.95.

3-SPEED AMPLIFIED PLAYER KIT \$10.95
2 TUBE AMPLIFIER—8" SPEAKER
New, 3 speed amplified record player kit for only \$10.95. Leatherette covered cabinet 9 $\frac{3}{4}$ " x 12" x 11 $\frac{1}{2}$ " high. Wired 2 tube amplifier with separate tone and volume controls. 70L7 and 7E5 tubes. Heavy 8" speaker, all-play pickup, motor and turntable. Cabinet is pre-cut, no screws to drill. Just fasten parts in cabinet. Only a few minutes required to assemble. Complete with simple, easy to follow instructions and all necessary items to build this 3 speed record player. Buy this player kit for less than the cost of the parts. Ship. wt. 15 lbs. Model No. RP-743K. Sale price, \$10.95.

8", 10", 12" SPEAKER-BAFFLE COMBINATIONS
\$3.95 \$4.95 \$6.95
Our most popular speaker-baffle combinations. Brown leatherette covered wood baffle and 8", 2.5 oz. Alnico V magnet speaker. Most economical wall speaker. Stock No. 818-X. Sale price, \$3.95 each. Lots of 3 or more, \$3.79 each.
Brown leatherette covered wood baffle and 10", 3.16 oz. Alnico V magnet speaker, at little more than the 8" size. Stock No. CA-102. Sale price, \$4.95. Lots of 3 or more, \$4.79 each.
Brown leatherette covered wood baffle and 12" RCA PM speaker. A terrific McGee value. Only 500 to sell. You get the baffle and speaker for the value of the speaker only. Stock No. RCA-B-2. Sale price, \$6.95. Lots of 3 or more, \$6.79 each.

TELEVISION BOOSTER CLEARANCE SALE
Clearance sale on VHF television boosters for channels 2 through 13. RMS Model SP-5, metal case, brown wrinkle finish. Continuously variable tuning. SARKS tube. Ideal for late model sets with cascade front end. Sale price, \$4.95.
RMS Model SP-6, brown plastic case. Same as SP-5 except has variable gain control. Sale price, \$4.95.
McMurdo-Silva GB-66, continuously variable, includes FM band. 616 tube, brown plastic case. Sale price, \$5.95.
Standard Coil B-51 printed circuit booster. \$6.95.
GAKS tube, brown plastic case. Sale price, \$6.95.

8 WATT HI-FI PHONO AMP
Push-Pull Output. Thordarson Hi-Fi Output Tran. 12" Woofer and 5" Tweeter. McGee's **SALE PRICE \$19.95**

Another outstanding McGee value. 8 watt low cost Hi-Fi phono amplifier for use with any crystal phono pickup. Approx. 1 volt input gives 8 watts audio. Features push-pull 35C5 output and 12AX7 tubes, 12" dynamic woofer and 5" dynamic tweeter. Voltage doubler power supply gives extra power. Amplifier size, 4" x 9 $\frac{3}{4}$ " x 4 $\frac{5}{8}$ " high. Heavy shielded Thordarson Hi-Fi output transformer. Response 30 to 12,000 cps. Amplifier is ready to use. Complete with tubes and speakers. (Does not have gain for mike.) Use as a record player amplifier. Stock No. HF-8, 8 watt amplifier and speakers. Ship. wt. 14 lbs. Sale price, \$19.95. Model HF-5, similar to HF-8, except 5 watts output and equipped with a single 12" dynamic speaker. Sale price, \$14.95.

MINIATURE BROADCASTING STATION FOR THE HOME
NEW 1955 MODEL WITH CRYSTAL MIKE \$9.95

Sensational new model MCL-E3 miniature broadcasting station for microphone and phonograph. Can be received on any broadcast radio in the home. No wires to connect, tunes in just like a radio station. Has input jacks for crystal mike or record player. Complete with 12K8 and 70L7 tubes and instructions. Operates on 110 volts AC. Simple to operate; one control fades from microphone to record. Frequency can be adjusted so as not to interfere with local radio stations. Miniature broadcasting station, complete with crystal hand mike and instructions. Ship. wt. 4 lbs. Net price \$9.95.

6" SESSIONS CLOCK-TIMER
With Plastic Cabinet \$3.95
6" Sessions Clock-Timer in plastic case 7" x 9 $\frac{5}{8}$ " tall, 3" deep. Was intended for a kitchen clock radio. Lower part of case was used for a small radio chassis. Lower portion has a usable space of 6 $\frac{3}{4}$ " x 4" high and 3" deep with 3" diameter hole in front. Many ways this attractive clock and cabinet could be used, such as mounting a small bell below the clock for use as a kitchen clock and timer. Clock has sweep second hand and 15 amp. 125 volt voltage turn on appliances at any pre-set time. Case available in Ivory, Green or Yellow. Stock No. MCT-63, Sessions Clock Timer with case of your color choice. Sale price only \$3.95.

UHF CONVERTER TUNERS \$2.95
3 FOR \$7.50
Take your choice of any of these three UHF converter-tuners at \$2.95 each, 3 for \$7.50. (1) Mallory inductor-tuner with 6AF4 and 1N72 diode. This is a complete UHF osc-tuner similar to the one used by Mallory in a converter and by many set manufacturers in their UHF TV sets. (2) CBS-Columbia single channel UHF converter intended for use in UH11 and UH12 CBS TV sets. Complete with 6AF4 tube. (3) Small compact UHF converter tuning assembly with 6AF4 tube and diode. Many applications for this in UHF. Your choice of any of these for only \$2.95 each, or 3 assorted for \$7.50.

FAMOUS STANDARD COIL CASCODE TUNERS
TV-2000 series Standard Coil cascode tuners complete with 6J6 and 6BK7 or 6BQ7 tubes. Thousands of TV sets use this famous tuner. Tunes 12 channels (2 thru 13). For 21 mc I.F. circuit. This tuner will give 2 to 1 better reception than the old pentode type. Many servicemen replace all older tuners with our cascode model. Available with either 27 $\frac{1}{2}$ " or 4 $\frac{1}{4}$ " shaft length. A tremendous purchase makes our low \$12.95 price possible. Specify shaft length desired. Stock No. TV-2000-3. Sale price \$12.95 each, 2 for \$25.00. No. TV-4001-7, 41 mc Standard Coil cascode 12 channel tuner with 13th position for use with separate UHF tuner. 6 $\frac{3}{4}$ " shaft. With tubes 6BQ7 and 6J6. Used in Sentinel, MW, Arvin, etc. Sale price, \$12.95.

Matching knobs for Standard Coil tuners. Set No. SCK-2 for fine tuning and channel selector. Set VCK-2, matching volume and contrast knobs. Either set only 59¢ a pair.

TWO-TUBE SARKS-TARZIAN TV TUNER \$8.95 WITH TUBES
New 2 tube Sarkes-Tarzian No. TT-3A, 12 channel TV tuner. 21-25 mc. Popular in many makes. Also, ideal for general replacement use. Has 6J6 and 6BQ5 tubes. Used in CBS, Arvin, Crosley F1770LBU, TOLU, TOLU, F21CDBLH, etc. Also, ideal for general replacement use. A good replacement for one tube tuners. 3 $\frac{1}{4}$ " shaft. No. TT-3A, Sale price, \$8.95. Takes SCK-2 knob set described above.

McGEE RADIO COMPANY F.O.B. KANSAS CITY TELEPHONE VICTOR 5092
SEND 25% OR FULL REMITTANCE WITH ORDER. 1903 MCGEE ST., KANSAS CITY, MISSOURI
BAL. SENT C.O.D.

6 TUBE UNIVERSAL MOUNTING AUTO RADIO \$19⁹⁹

25 WATT HI-FI SPEAKER SYSTEM

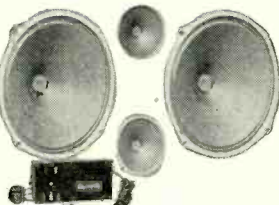

2-12" Woofers
2-5" Tweeters
Power Supply
and L-C Cross-over Network

SALE PRICE \$24⁹⁵

25 watt, High-Fidelity Dynamic Speaker System, complete with 2000 cycle genuine inductance-capacitance cross-over network, two 12" woofer speakers, two 5" high frequency tweeter speakers and separate 110 volt AC power supply, less console baffle for only \$24.95. Frequency response 20 to 18,000 cps. Both the woofers and the tweeters are fine quality dynamic speakers with fields excited to saturation by the power supply. Tweeters are specially made with cones designed to respond only to the high frequencies of the audio spectrum. The 2000 cycle cross-over network is of the high quality inductance-capacitance type which prevents frequencies below 2000 cps from entering the tweeters and eliminates frequencies above 2000 cps from the woofer circuit. The cross-over network system is simple to connect to any 4 or 8 ohm output of your high fidelity audio amplifier or radio. No. SP-12125CR, High Fidelity Dynamic Speaker System, Ship. wt. 15 lbs., Sale price \$24.95, and No. SP-12125, High Fidelity Dynamic Speaker System, as described above, but less the 2000 cycle cross-over network and with a separate attenuator control. Sale price, \$14.95.

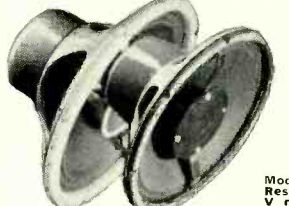

**McGee's Famous
12 AND 15 INCH COAXIAL P.M.
HIGH FIDELITY SPEAKERS**

12-Inch **\$12⁹⁵**
Model CU-14Y

15-Inch **\$23⁹⁵**
Model P15-CR

Model CU-14Y, 12" high fidelity coaxial P.M. speaker. Response from 30 to 17,500 cps. Full 6.8 oz. Alnico V magnet in the woofer. Special coaxially suspended high frequency tweeter. Built-in crossover network. Only two wires to connect to your radio or amplifier. Matches 3.2 to 8 ohm output. Don't confuse this speaker with many cheap speakers that are offered. This is a fine quality speaker. Stock No. CU-14Y. Sale price, \$12.95 each, two for \$25.00. Model P15-CR, 15" high fidelity coaxial P.M. speaker. Response down to 20 cps, and up to 17,500 cps. Full 2 1/2 oz. Alnico V magnet in the 15" woofer. Specially made, coaxially suspended 5" high frequency tweeter. Built-in crossover network. Only two wires to connect. Matches 3.2 to 8 ohm output transformer. A regular \$62.50 list speaker. Model P-15-CR, McGee's Sale Price, \$23.95.

NEW IMPERIAL IV with General Electric

8 in. HIGH FIDELITY SPEAKER **\$19⁹⁵**

New 1955 Model IMPERIAL IV, High fidelity speaker system with General Electric 8" speaker. Housed in a high quality leatherette covered plywood cabinet 10" x 10" x 2 1/2" deep. Fully enclosed; covered on all sides except back. Use as an auxiliary speaker or with any high fidelity radio, amplifier or home music system. The IMPERIAL IV contains a General Electric Model 850 extended range high fidelity 8" PM speaker with 6.8 oz. Alnico V magnet and curvilinear cone with 8 ohm voice coil and a 5" tweeter. Response 50 to 15,000 cps. Model IV Imperial \$19.95.



HIGH FIDELITY SPEAKERS

8" BLUE STREAK \$ 6.95
15" BLUE STREAK WOOFER \$16.95

Model HF-8J, 8" "Blue Streak," High Fidelity wide range speaker. This one speaker properly baffled will give excellent response to both high and low frequencies and terrific response through the very important middle range. Has 6.8 oz. Alnico V magnet with wide range and terrific response essentially flat from 35 to 12,500 cps. Perfect for high fidelity radios, amplifiers and professional music systems. Ship. wt. 15 lbs. Model HF-8J, Sale price, \$6.95.

Model HF-15 J, 15" "Blue Streak," Hi-Fi woofer. Has a 14 1/2 oz. Alnico V magnet with curvilinear cone and 8 ohm voice coil. Will give good response from 50 to 9500 cps. Takes 15 to 20 watt peak. Ship. wt. 12 lbs. Sale price, \$16.95.

9-TUBE HI-FIDELITY

12 Watts Audio **\$39⁹⁵**
Dual Tone Controls **LESS SPEAKER**

RECEIVES BROADCAST 550 TO 1650 K.C.

Jackson AM9A, 12 watt hi-fi audio amplifier and broadcast tuner combined. Less than you would pay for the amp alone. Push-pull 6V6's. Response 30 to 15,000 cps. Inputs for crystal or v.r. phono and crystal or dynamic mike. Separate bass boost and treble tone controls, radio-phonograph switch. Shielded output matches 3.2 or 8 ohm speakers. Heavy duty 150 mil power trans. 9 1/2" illuminated slide rule dial. 3 gang condenser with tuned R.F. and loop ant. Receives 550 to 1650 kc. Size, 13" x 9 1/2" x 6" high. With tubes: 2-6BA6, 6AU6, 6BE6, 6SN7, 6AT6, 2-6V6 and 9 lbs. Sale price, \$39.95. CU-14Y 12" coax speaker, \$10.00 extra; 15" coax speaker, \$20.00 extra.

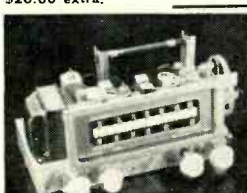

**HI-FI FM-AM TUNER
AND 10 WATT
P.P. 6V6 AMPLIFIER**

BOTH FOR \$49⁹⁵

New Hi-Fi self-powered FM-AM tuner with 10 watt amplifier (push-pull 6V6's) on separate chassis. All you need is a record changer and speaker to have a complete home music system. 3 ft. cable connects tuner to amp. Tuner has input for crystal phono. (If changer with v.r. cartridge is purchased we will include the necessary pre-amp, no charge.) Tuner has 6 tubes: 12AT7, 6BE6, 2-6BA6, 6AT6, 6AL5 and 6X4 rectifier. Amp has 2-6V6's, 6SN7 and rectifier. Full super-circuit with AVC, 3 position tone control, 9" illuminated slide rule dial, escutcheon and knobs. Sock loop antenna for AM. Radio-FM-AM, phono selector switch, tone control, volume control on tuner. Response 50 to 17,500 cps. Receives broadcast 540 to 1600 kc and FM 88 to 108 mc. Output matches any of the speakers shown above. No. FA9-2CR tuner and amplifier complete. Ship. wt. 22 lbs. Sale price, \$49.95. CU-14Y 12" coax speaker, \$10.00 extra; 15" coax speaker, \$20.00 extra.

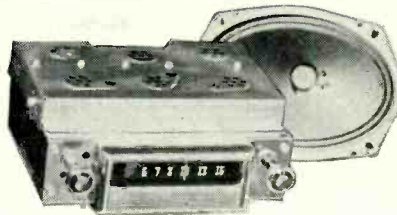

**6-TUBE, 6-VOLT
UNIVERSAL MOUNTING
AUTO RADIO**

**\$19⁹⁹ WITH
6" x 9"
SPEAKER**

- ★ A SENSATIONAL AUTO RADIO VALUE AT A TERRIFIC LOW PRICE.
- ★ MADE BY A BIG NAME MANUFACTURER.
- ★ FULL SUPERHET—WITH TUNED R.F. STAGE—6 TUBES—TONE CONTROL.

McGee makes another tremendous purchase and passes the saving on to you. This universal mounting, 6 tube, 6 volt auto radio is a full superhet with full tuned R.F. stage. Made to sell at a much higher price, by one of America's best known manufacturers. It's very thin and compact construction lends itself to a neat under-dash installation in most any car or truck. Or, you might arrange a place in the dash for custom installation. The front is thin. When mounted under the dash extends only 2 1/4" below. Overall size; 9" wide, 4 1/4" high and 7 1/4" deep. Requires no more room under your auto dash than an ordinary auto radio remote control head. Not intended for an exact custom panel fit, but it lends itself very well for your installation. Has no built-in speaker, but is furnished with a heavy duty 6" x 9" speaker. This is the most popular size auto speaker. Tubes; 6BE6, 2-6B6, 6AV6, 6AQ5 and 6X4. Ship. wt. 10 lbs. Stock No. AM-759. McGee's sale price, \$19.99 for the radio complete with 6x9" speaker. 3 section top cowl antenna, \$2.29 extra.

**CONSOLE HIGH FIDELITY
SPEAKER SYSTEM \$49⁹⁵**

EQUIPPED WITH 3 PM SPEAKERS

12 IN. GENERAL ELECTRIC WOOFER
10 IN. MID RANGE SPEAKER
8 IN. GENERAL ELECTRIC MID-HIGH RANGE

Have Juke Box tone quality in your own home. Strictly High fidelity. Three speakers all connected to a 600 cycle frequency dividing network, so that only 2 wires feed the system from any 4 or 8 ohm radio or amplifier. A variable tone compensating control incorporated in the circuit makes brilliant highs or boomy lows to your own taste. Any amplifier that you now have will give you a much wider selection of acoustical arrangements with this speaker system. The 3-way system is shipped ready to connect to your amplifier or hi-fi radio. Equipped with a General Electric 12" woofer, an 8" famous G.E. 850 plus a 10" mid range speaker. Frequency response 30 to 15,000 cps. Take your choice of cabinets; blonde oak, walnut or mahogany. (Specify finish desired when ordering) 37" high, 24" wide and 20" deep. Ship. wt. 75 lbs. Stock No. HF-336. Sale price, \$49.95.

\$100.00 LIST—1953 BUICK—12-VOLT AUTO RADIO \$39⁹⁵



No. 981323, 8 tube 12 volt Buick radio. Custom made for all '53 Buicks except the Special. Cost over \$100 retail. Magic Electronic single push-button tunes set electronically. Built-in 8" speaker, tone control, PP 12V6 audio. Ship. wt. 20 lbs. Sale price, \$39.95.

TV PICTURE TUBE RESTORER, to rejuvenate the cathode on tubes that have weak picture due to cathode deterioration. Also burns out shorts and welds open electrolytic transformer capacitors. More equipment in this metal cabinet than any restorer that we have offered. This unit will perform like units that sold as high as \$250.00. It is superior to units offered at \$50.00 to \$70.00 today. Tests picture tube, rejuvenates cathode with relay time pulse, to control cycle. Burns out shorts, welds open elements. Effective on 90% of all picture tubes. Stock No. AJ-59. Ship. wt. 20 lbs. Sale price, \$49.95.

**CROSLY
FM-AM TUNER**

**SALE \$19⁹⁹
PRICE**

AUDIO AMPLIFIER IS REQUIRED TO OPERATE A SPEAKER

Model 362-2, 6 tube Crosley FM/AM tuner. Receives broadcast 550 to 1600 kc, FM 88 to 108 mc. With tubes: 3-6BA6, 6BE6, 12AT7 and 6T8. Power this tuner from your audio amplifier or TV set. (6.3 v. filament and 125 to 180 v. at 20 ma. 6" voltage required.) Chassis 5 1/2" x 10 1/2" x 5 3/4" high. Illuminated slide rule dial 8 1/2" long. 4 position switch selects FM, AM, TV or Phono. One-half of 6T8 used as pre-amp for variable reluctance pickup. Has no volume control. Audio is fed to your TV or hi-fi. Complete with escutcheon, knobs, diagram, instructions and parts list. Ship. wt. 9 lbs. Sale price, \$19.99.

Crosley 362-2V6, same as above but has volume control and power supply added to make a self-powered AM-FM tuner. Ship. wt. 10 lbs. Sale price, \$24.99.

Note: An Audio amplifier is required to operate these tuners thru a speaker.

**GARRARD—COLLARO—WEBCOR
3-SPEED RECORD CHANGERS**

\$65.00 LIST COLLARO 3/532 \$38.95

Here are top values in modern up-to-date 3 speed automatic record changers. New Webcor model 114-43, 3 speed automatic changer with RPX-052 Golden Treasure cartridge. 13 1/2" x 12". Ship. wt. 12 lbs. Sale price only \$29.95.

Regular \$65.00 list Collaro model 3/532, 3 speed automatic record changer made in England. Intermixes 10 and 12" records of same speed. Constant speed 4 pole motor and weighted turntable with molded rubber pallet. Compensating spring to shift weight of tone arm for LP and std. records. Plug-in head will hold any popular cartridge. 14 1/4" long, 12 1/4" wide and 4 3/4" above motor board. 2 1/4" below. Available in grey, cream and gold hamper-tone. Ship. wt. 20 lbs. Regular net, \$48.75. Special sale price, \$38.95 less cartridge. Large 45 RPM spindle, \$2.50 extra. 3/532 Collaro changer with G.E. Golden Treasure RPX-052 cartridge, \$58.95.

RC-80 Garrard "Triumph," 3 speed automatic changer, 13 1/4" wide, 15 1/2" deep and RC-80 with G.E. Golden Treasure RPX-052 Golden Treasure cartridge, Net \$68.51.

RC-80 with crystal flip-over cartridge, only \$52.46.

RC-80 Garrard "Crown," 3 speed automatic changer, 13 1/2" x 15 1/2", 5 3/4" above motor board and 3 3/4" below. Net price, less cartridge, \$68.11. With crystal flip-over cartridge, \$72.06. With G.E. RPX052 Golden Treasure, \$88.11. 45 RPM spindle, \$3.43 extra.

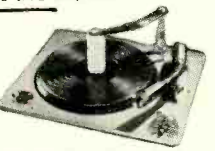

McGEE RADIO COMPANY

PRICES F.O.B. KANSAS CITY
SEND 25¢ OF FUNDING TO
REMITTANCE WITH ORDER.
BAL. SENT C.O.D.

TELEPHONE VICTOR 5092
1903 MCGEE ST., KANSAS CITY, MISSOURI

Recording Wildlife
(Continued from page 31)

standard 115 volts at 60 cycles. One problem is the fluctuating voltage which sometimes drops as low as 100 volts as the batteries discharge.

One answer to the problem was found when the car's generator was replaced by a *Leece-Neville* alternator and associated equipment. Heavy double-pole, double-throw switches connect the batteries in series for recording and in parallel for charging.

This system furnishes 25-35 amps at motor idling speeds and reaches full output at a motor speed equivalent to 12 mph. Under these conditions, the batteries will operate the recorder for four hours at full efficiency and recharge in less time that was needed to discharge them. Normal car operation keeps them fully charged.

Experience has shown that although it is possible to use the dynamic mike over 500 feet away from the recorder in the car, he prefers to use a small, battery-operated preamp when distances over 100 feet are involved. This unit has three stages. The first two stages amplify the microphone signal and provide an output impedance of 500 ohms. The third stage is bridged across the 500 ohm output and serves as a monitor amplifier for the continuous monitoring of the signal being recorded. The unit also provides an amplified version of what the microphone is gathering to enable the operator to "aim" the parabolic reflector more accurately. In addition, it is possible to monitor the signal put on the line back to the car and thus two-way communication can be maintained. With this preamplification setup, Dr. Kellogg has been able to record over an open-wire line a mile long.

When Dr. Kellogg starts "stalking" his prey, he carries 25 pounds of equipment and drags shielded cable from the 500-foot reel. For greater distances, he uses Army-type assault cable.

Recently Dr. Kellogg has been using his portable recorder which eliminates the necessity for using the cable back to the car. His "load" then becomes 17 pounds for the recorder, 13 pounds for the parabolic reflector and its microphone, and 8 pounds for the parabola's tripod.

His portable recorder measures only 11" x 10" x 7" and records at 15 ips. With frequency response of 50 to 15,000 cps, this recorder just about covers all of the primary tones and the harmonics that the human ear is capable of perceiving.

His unit will operate at any angle. Its mechanical "heart" is a spring-wound flyball-governor-controlled motor. The small flashlight-type batteries are rated at 100 hours. An improved version, due shortly, incorporates a second amplifier and head for monitoring and playback.

Back in the lab, Dr. Kellogg uses two *Amplex* 300 recorders for the re-



America's TOP Tuner!

THE FISHER

FM TUNER MODEL FM-80

World's Best by LAB Standards

FOR almost two decades we have been producing audio equipment of outstanding quality for the connoisseur and professional user. In the cavalcade of FISHER products, some have proven to be years ahead of the industry. THE FISHER FM-80 is just such a product. Equipped with TWO meters, it will outperform any existing FM Tuner *regardless of price!* The FM-80 combines extreme sensitivity, flexibility and micro-accurate tuning. Despite its full complement of tubes and components, the FM-80 features an unusually compact chassis of fine design. *Chassis Only, \$139.50*
Mahogany or Blonde Cabinet, \$14.95

Outstanding Features of THE FISHER FM-80

- TWO meters; one to indicate sensitivity, one to indicate center-of-channel for micro-accurate tuning.
- Armstrong system, with two IF stages, dual limiters and a cascode RF stage.
- Full limiting even on signals as weak as one microvolt.
- Dual antenna inputs: 72 ohms and 300 ohms balanced (*exclusive!*)
- Sensitivity: 1½ microvolts for 20 db of quieting on 72-ohm input; 3 microvolts for 20 db of quieting on 300-ohm input.
- Chassis *completely* shielded and shock-mounted, including tuning condenser, to eliminate microphonics, and noise from otherwise accumulated dust.
- Three controls — Variable AFC/Line-Switch, Sensitivity, and Station Selector PLUS an exclusive Output Level Control.
- Two bridged outputs. Low-impedance, cathode-follower type, permitting output leads up to 200 feet.
- 11 tubes.
- Dipole antenna supplied. Beautiful, brushed-brass front panel.
- Self-powered.
- WEIGHT: 15 pounds.
- CHASSIS SIZE: 12¼" wide, 4" high, 8½" deep including control knobs.

Price Slightly Higher West of the Rockies

WRITE TODAY FOR COMPLETE SPECIFICATIONS

FISHER RADIO CORP. • 21-23 44th DRIVE • L. I. CITY 1, N. Y.

quired editing and copying. Tape is spliced with the special miter box known as the "Edi-Tall."

Editing plus skill and imagination often provide some surprising results. Dr. Kellogg's bird-song albums outsell Cornell's Glee Club albums. Often seemingly useless footage can be salvaged, edited, and spliced together to make a truly unique recording. Dr. Kellogg's "Voices of the Night" or "The Calls of 26 Frogs and Toads Found in Eastern North America" is a "best-seller" in its class. One purchaser was a St. Louis husband whose wife had complained that he never bought her anything really different for Christmas. She has it now! —30—

The "Testuner"

(Continued from page 59)

ing the a.g.c. to ground at a point where it entered the tuner. The hum disappeared! This solved the problem of why the hum was present with the regular tuner, but not with the "testuner." The "testuner" uses a fixed bias that it obtains from its own power supply; it does not get a.g.c. from the set. However, the receiver was still not working properly.

Since it had been established that with the a.g.c. grounded at the input to the tuner the hum disappeared, the source of trouble looked like the a.g.c. amplifier. So, the a.g.c. amplifier tube was changed, but the hum still persisted. Next, the tube socket was examined for a possible short. Sure enough, pin 3 had shorted to pin 7 at the terminals, thus tying the heater to the cathode and introducing the hum into the a.g.c. system. Since the a.g.c. voltage is fed to the grid of the r.f. amplifier, it was modulating the incoming signal, and affecting the picture.

While the "testuner" mentioned and described in this article consists of a v.h.f. tuner and power supply, it is possible to use a combination u.h.f.-v.h.f. tuner in such a test setup.

It is hoped that the reader will be able to use such a device as the "testuner" to his advantage in servicing both u.h.f. and v.h.f. sets. The number of conditions presented here falls far short of those that can be solved by the use of this gadget. However, as with other test equipment, the more it is used by the service technician, the greater utility he will find for it. —30—

MILWAUKEE HAM CLUB

THE Milwaukee Radio Amateurs' Club, Inc., has named Emil R. Felber, W9RH, president for the 1955-56 season with Kenneth Eggert, W9MOT and Raymond T. Peschek, W9LJU as first and second vice-presidents respectively.

Vernon L. Fabishak, W9HDH is the new secretary while Charles C. Dawson, W9CUW will serve as treasurer.

Directors are Fred Zolin, W9ONY; E. Belanger, W9MDG; Frank Seboth, W9NLY; Douglas Pavak, W9FDK; Ed. Buchholz, W9VBZ; Dr. I. J. Waldman, W9RXS; and W. E. Herzog, W9LSK.

—30—



It's New! It's Terrific!

THE FISHER Master Audio Control

SERIES 80-C

IT TOOK FISHER to improve on FISHER. When we introduced our Model 50-C Master Audio Control three years ago it was immediately acclaimed the finest instrument of its type. Like its renowned counterpart, the *new* FISHER Master Audio Control, Model 80-C, represents another milestone in engineering excellence, ease and flexibility of use, and workmanship of a quality normally encountered only in broadcast station equipment . . . these are its outstanding characteristics. It took FISHER to improve on FISHER. Chassis Only, **\$99.50** • Mahogany or Blonde Cabinet, **\$9.95**

Remarkable Features of THE FISHER 80-C

- Professional, lever-type equalization for all current recording characteristics.
- Seven inputs, including two Phono, Mic and Tape.
- Two cathode-follower outputs.
- Complete mixing and fading on two, three, four or five channels.
- Bass and Treble Tone Controls of the variable-crossover feedback type.
- Accurately calibrated Loudness Balance Control.
- Self-powered.
- Magnetically shielded and potted transformer.
- DC on all filaments; achieves hum level that is inaudible under any conditions.
- Inherent hum: non-measurable. (On Phono, 72 db below output on 10 mv input signal; better than 85 db below 2v output on high-level channels.)
- IM and harmonic distortion: non-measurable.
- Frequency response: uniform, 10 to 100,000 cycles.
- Separate equalization and amplification directly from tape playback head.
- Four dual-purpose tubes, all shielded and shock-mounted.
- Separate, high-gain microphone preamplifier.
- Push-Button Channel-Selectors with individual indicator lights and simultaneous AC On-Off switching on two channels (for tuner, TV, etc.)
- Master Volume Control plus 5 independent Level Controls on front panel.
- 11 Controls plus 5 push-buttons.
- Three auxiliary AC receptacles.
- SIZE: Chassis, 12 1/4" x 7 1/4" x 4 1/4" high. In cabinet, 13-11/16" x 8" x 5 1/4" high. Shipping weight, 10 pounds.

Prices Slightly Higher West of the Rockies

WRITE TODAY FOR COMPLETE SPECIFICATIONS

FISHER RADIO CORP. • 21-23 44th DRIVE • L. I. CITY 1, N. Y.

What's



New in Radio

I.F. FILTER ADAPTER

A simple mechanical i.f. filter adapter which fits snugly between two i.f. cans in the "Super Pro-600" communications receiver is now available from *Hammarlund Manufacturing Co., Inc.*, 460 W. 34th St., New York 1, N. Y.

This sealed unit consists of an input

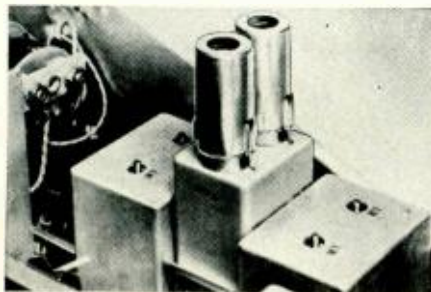

transducer, a resonant mechanical section comprised of a number of metal discs, an output transducer on which is mounted the replaced i.f. tube, and an amplifying tube.

The unit, which is available for bandwidths of .8, 1.2, 3.1, and 6 kc. at 6 db down, can be completely installed in a matter of seconds by simply pulling an i.f. tube and replacing it with the permanently tuned mechanical filter adapter.

SATELLITE TV EQUIPMENT

Adler Communications Laboratories, 1 Le Fevre Lane, New Rochelle, N. Y., is now offering a line of low-power transmitting equipment which provides practical television service for isolated communities of 50,000 population or less.

Three basic systems are available. The Type A system is an on-channel satellite/booster, employing direct amplification and re-radiation of the original signal on the same channel. Type B system is an off-channel satellite/booster with a crystal-controlled translator which shifts the original signal without demodulation to a new channel. Type C system is a complete low-power television broadcasting system which can be programmed locally, off-the-air and/or via a network signal.

Further details, descriptions, and illustrations of this equipment may be secured by writing for the new bulletin entitled "Low Power Television Broadcasting Systems."

PHENOLIC COIL FORM

Cambridge Thermionic Corporation, 445 Concord Ave., Cambridge 38, Mass., is offering a new phenolic coil form designed especially for printed circuitry.

Available in two diameters with four terminals each, the Type SPC is de-

signed to be dip soldered after mounting. This feature is available as a form alone or wound to the required specifications of the user. The unit comes complete with a threaded slug. The terminal collar is securely fastened to the form.

The unit mounts through four holes, as required by the number of terminals. When mounted, the smaller unit is $\frac{3}{8}$ " high by .219" diameter and the larger unit is $\frac{3}{8}$ " x .285" diameter.

Further specifications, application information, and prices are available from the company on request.

INDOOR TV ANTENNA

All Channel Antenna Corporation, 47-39 49th St., Woodside 77, N. Y., has just put a new type, patented indoor television antenna on the market.

Tradenamed the "Rembrandt," the antenna operates on a unique electronic principle. It selectively directs circularly polarized, electromagnetic radar loops and inductively couples them to bi-metallic resonant dipoles.

The antenna utilizes a nine-position, low-loss electronic orientation switch.

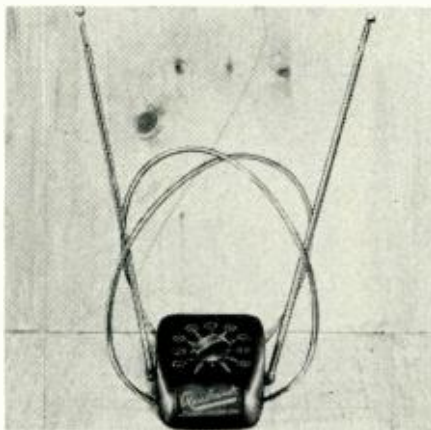

It is currently available in three finishes: gold, ebony and gold, and mottled mahogany.

BEAM POWER TETRODE

Eitel-McCullough, Inc., of San Bruno, Calif., has announced development of the 4X5000A, its first ceramic radial-beam power tetrode.

The new tube is constructed entirely of ceramic and metal, thereby offering greater electron-tube reliability and increased immunity to damage from thermal and physical shock.

With a plate dissipation rating of 5000 watts and a power output of 16 kw. in class C telegraphy service through 30 mc., the new tube fills a power gap in the tetrode field. Especially suitable for single sideband operation, the new tetrode delivers 10 kw. output in class AB₁ service and handles high inputs

without going into the positive grid region.

The simple coaxial structure allows low lead inductance and an integral finned anode permits improved cooling with low air pressure. For further information on the *Eimac 4X5000A*, write the company's Technical Services Department.

RESISTANCE SOLDERER

Vermaline Products Company, P. O. Box 222, Hawthorne, N. J., is now offering a new resistance-type soldering unit which has been especially de-

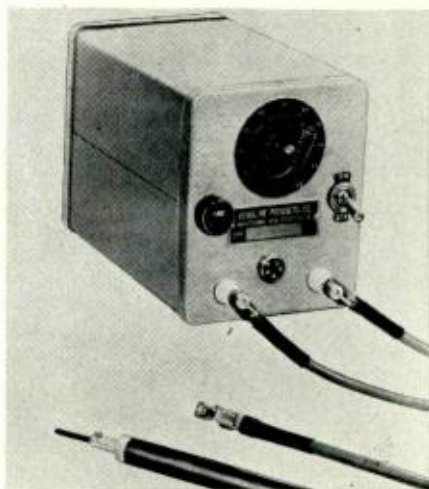

signed for the soldering of printed circuits, germanium diodes, transistors, and other precision and sensitive component parts.

The Model #500 is said to eliminate the danger of overheating and burning of parts. The soldering operation can be controlled by means of the adjustable heat controller. The electrode holder, which is extremely light, has a $\frac{1}{8}$ " diameter tip.

The company will furnish full details on request.

IMPEDANCE MATCHER

Lynmar Engineers, Inc., 1432 N. Carlisle St., Philadelphia 21, Pa., now has available an impedance matching unit which has been specifically developed to provide a better and more economical means of matching TV receivers in community TV systems.

The Type MB units, usable to 1000 mc., offer an inherent blocking effect which helps reduce spurious signals originating on a 300-ohm ribbon lead or on the shielding of coaxial cable.

Type MB-1 is designed for 75 ohm-to-300 ohm (v.h.f.-u.h.f. range) while Type MB-2 is designed for 300 ohm-to-300 ohm (v.h.f.-u.h.f. range) applications.

CLIP-TYPE RECTIFIER

A new snap-in type rectifier featuring a unique clip arrangement which does not require tools for assembly, speeds assembly time, and completely eliminates broken studs has just been announced by *Radio Receptor Co., Inc.*, 240 Wythe Ave., Brooklyn, N. Y.

The new device, known as a "Quiklip," was developed in conjunction
(Continued on page 87)

RADIO & TELEVISION NEWS

*New!
Revolutionary!*

FIVE STAR
General
★★★★★

- ★ The GENERAL has a closely spaced screen (7 inches) to minimize pick up off the rear. With more and more stations coming on the air, on the same channel, this is a major problem of today and tomorrow.
- ★ The GENERAL is completely pre-assembled. By simply tightening three wing nuts, the antenna is ready to mount.
- ★ The GENERAL is light in weight with low wind resistance. Not only easy to put up, but easy to KEEP up.
- ★ The GENERAL is packed in a small carton. This makes the antenna more economical to ship, store, and handle.
- ★ The GENERAL sells for less than comparable products. This gives YOU a better mark up and faster moving merchandise.

**Some Exclusive Territories Available
To Aggressive Jobbers.**

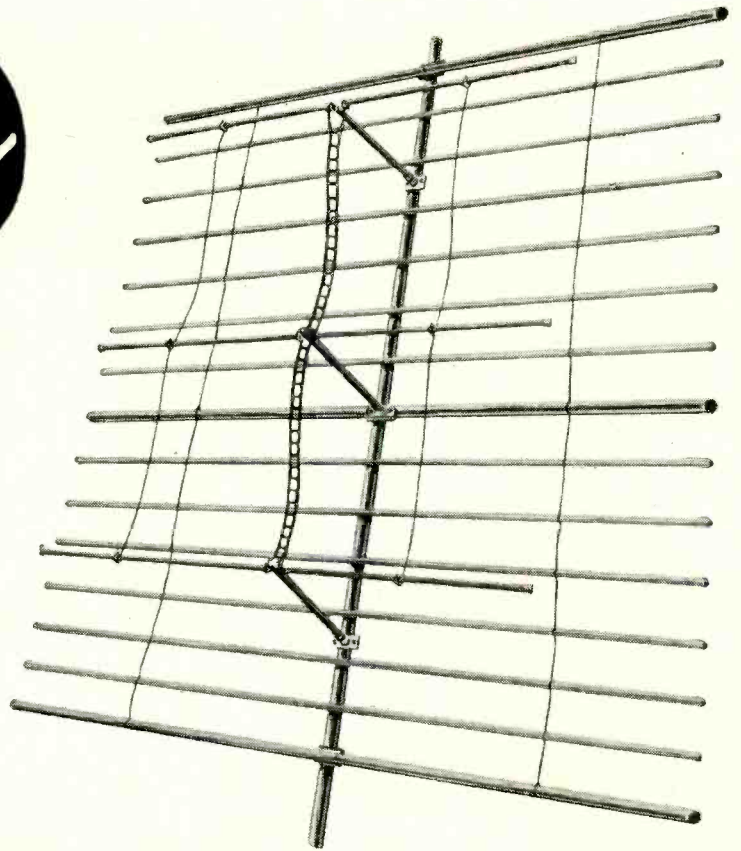

★ The GENERAL is low enough in price to use in the most competitive market and is recommended for all locations.

The GENERAL combines 6½ dipoles in a phased collinear array for super gain on channels 7 to 13 and features an interpolated dipole arrangement on channels 2 through 6 for a small physical size, high gain array on these channels. The GENERAL has peak gains of over 15 D.B. and is recommended for use in the most difficult reception areas.

LIST PRICE 24.95

World's Finest TV Antennas and Towers

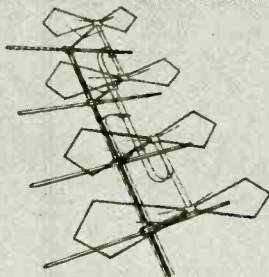

WAYCO, Inc., manufactures a complete line of antennas and towers, priced from \$1.98 list, up. Write for free literature.

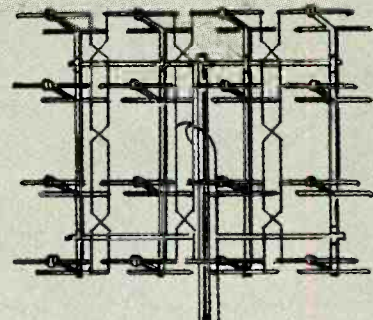

SUPER FRINGE MASTER. Unconditionally guaranteed to out-perform all other UHF antennas or your money refunded. Available in 16 or 32 element arrays. Completely assembled or knocked down.

P. O. Box 115
Phone 7-2981

WAYCO, Inc.

WAYNESBORO
TENNESSEE

Superior's new
Model 670-A

SUPER METER

A COMBINATION VOLT-OHM MILLIAMMETER PLUS CAPACITY
REACTANCE INDUCTANCE AND DECIBEL MEASUREMENTS

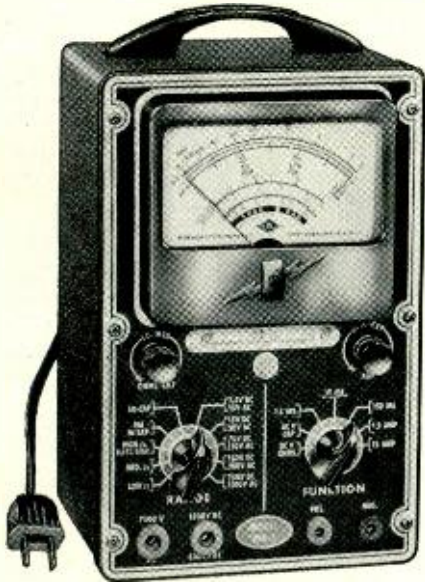

SPECIFICATIONS:

- D.C. VOLTS: 0 to 7.5/15/75/150/750/1,500/7,500 Volts
- A.C. VOLTS: 0 to 15/30/150/300/1,500/3,000 Volts
- OUTPUT VOLTS: 0 to 15/30/150/300/1,500/3,000 Volts
- D.C. CURRENT: 0 to 1.5/15/150 Ma. 0 to 1.5/15 Amperes
- RESISTANCE: 0 to 1,000/100,000 Ohms 0 to 10 Megohms
- CAPACITY: .001 to 1 Mfd. 1 to 50 Mfd. (Good-Bad scale for checking quality of electrolytic condensers)
- REACTANCE: 50 to 2,500 Ohms, 2,500 Ohms to 2.5 Megohms
- INDUCTANCE: .15 to 7 Henries 7 to 7,000 Henries
- DECIBELS: -6 to +18 +14 to +38 +34 to +58

ADDED FEATURE:

Built-in ISOLATION TRANSFORMER reduces possibility of burning out meter through misuse.

The Model 670-A comes housed in a rugged, crackle-finished steel cabinet complete with test leads and operating instructions.

\$28⁴⁰ NET

Superior's New
Model TV-50

GENOMETER

A versatile all-inclusive GENERATOR which provides ALL the outputs for servicing:
A.M. Radio • F.M. Radio • Amplifiers • Black and White TV • Color TV



7 Signal Generators in One!

- ✓ R. F. Signal Generator for A.M.
- ✓ R. F. Signal Generator for F.M.
- ✓ Audio Frequency Generator
- ✓ Bar Generator
- ✓ Cross Hatch Generator
- ✓ Color Dot Pattern Generator
- ✓ Marker Generator

R. F. SIGNAL GENERATOR: The Model TV-50 Genometer provides complete coverage for A.M. and F.M. alignment. Generates Radio Frequencies from 100 Kilocycles to 60 Megacycles on fundamentals and from 60 Megacycles to 180 Megacycles on powerful harmonics.

VARIABLE AUDIO FREQUENCY GENERATOR: In addition to a fixed 400 cycle sine-wave audio, the Model TV-50 Genometer provides a variable 300 cycle to 20,000 cycle peaked wave audio signal.

BAR GENERATOR: The Model TV-50 projects an actual Bar Pattern on any TV Receiver Screen. Pattern will consist of 4 to 16 horizontal bars or 7 to 20 vertical bars.

CROSS HATCH GENERATOR: The Model TV-50 Genometer will project a cross-hatch pattern on any TV picture tube. The pattern will consist of non-shifting horizontal and vertical lines interlaced to provide a stable cross-hatch effect.

DOT PATTERN GENERATOR (FOR COLOR TV) Although you will be able to use most of your regular standard equipment for servicing Color TV, the one addition which is a "must" is a Dot Pattern Generator. The Dot Pattern projected on any color TV Receiver tube by the Model TV-50 will enable you to adjust for proper color convergence.

MARKER GENERATOR: The Model TV-50 includes all the most frequently needed marker points. The following markers are provided: 189 Kc., 262.5 Kc., 456 Kc., 600 Kc., 1000 Kc., 1400 Kc., 1600 Kc., 2000 Kc., 2500 Kc., 3579 Kc., 4.5 Mc., 5 Mc., 10.7 Mc., (3579 Kc. is the color burst frequency).

THE MODEL TV-50 comes absolutely complete with shielded leads and operating instructions. Only

\$47⁵⁰ NET

**SHIPPED ON APPROVAL
NO MONEY WITH ORDER — NO C.O.D.**

Try any of the above instruments for 10 days before you buy. If completely satisfied then send down payment and pay balance as indicated on coupon. **No Interest or Finance Charges Added!** If not completely satisfied return unit to us, no explanation necessary.

MOSS ELECTRONIC DISTRIBUTING CO., INC.

Dept. D-151 3849 Tenth Ave., New York 34, N. Y.

Please send me the units checked. I agree to pay down payment within 10 days and to pay the monthly balance as shown. It is understood there will be no finance, interest or any other charges, provided I send my monthly payments when due. It is further understood that should I fail to make payment when due, the full unpaid balance shall become immediately due and payable.

Model 670-A Total Price \$28.40
\$7.40 within 10 days. Balance \$3.50 monthly for 6 months.

Name

Address

City Zone State

Model TV-50 Total Price \$47.50
\$11.50 within 10 days. Balance \$6.00 monthly for 6 months.

Superior's new
Model TV-11

TUBE TESTER

SPECIFICATIONS:



- ★ Tests all tubes including 4, 5, 6, 7, Octal, Lock-in, Peanut, Bantam, Hearing Aid, Thyatron, Miniatures, Sub-Miniatures, Novals, Sub-minars, Proximity fuse types, etc.
- ★ Uses the new self-cleaning Lever Action Switches for individual element testing. Because all elements are numbered according to pin-number in the RMA base numbering system, the user can instantly identify which element is under test. Tubes having tapped filaments and tubes with filaments terminating in more than one pin are truly tested with the Model TV-11 as any of the pins may be placed in the neutral position when necessary.
- ★ The Model TV-11 does not use any combination type sockets. Instead individual sockets are used for each type of

tube. Thus it is impossible to damage a tube by inserting it in the wrong socket.

- ★ Free-moving built-in roll chart provides complete data for all tubes.
- ★ Newly designed Line Voltage Control compensates for variation of any Line Voltage between 105 Volts and 130 Volts.
- ★ NOISE TEST: Phono-jack on front panel for plugging in either phones or external amplifier will detect microphonic tubes or noise due to faulty elements and loose internal connections.

The model TV-11 operates on 105-130 Volt 60 Cycles A.C. Comes housed in a beautiful hand-rubbed oak cabinet complete with portable cover

\$47⁵⁰
NET

EXTRA SERVICE—The Model TV-11 may be used as an extremely sensitive Condenser Leakage Checker. A relaxation type oscillator incorporated in this model will detect leakages even when the frequency is one per minute.

SUPERIOR'S NEW MODEL TV-40

C. R. T. TUBE TESTER

- ★ A complete picture tube tester for little more than the price of a "make-shift" adapter!!
- ★ Tests all magnetically deflected tubes ... in the set ... out of the set ... in the carton!!



The Model TV-40 is absolutely complete! Self-contained, including built-in power supply, it tests picture tubes in the only practical way to efficiently test such tubes; that is by the use of a separate instrument which is designed exclusively to test the ever increasing number of picture tubes!

EASY TO USE:

Simply insert line cord into any 110 volt A.C. outlet, then attach tester socket to tube base (ion trap need not be on tube). Throw switch up for quality test ... read direct on Good-Bad scale. Throw switch down for all leakage tests.

SPECIFICATIONS:

- Tests all magnetically deflected picture tubes from 7 inch to 30 inch types.
- Tests for quality by the well established emission method. All readings on "Good-Bad" scale.
- Tests for inter-element shorts and leakages up to 5 megohms.
- Tests for open elements.

Model TV-40 C.R.T. Tube Tester comes absolutely complete—nothing else to buy. Housed in round cornered, molded bakelite case. Only.....

\$15⁸⁵
NET

SHIPPED ON APPROVAL NO MONEY WITH ORDER — NO C.O.D.

Try any of the above instruments for 10 days before you buy. If completely satisfied then send down payment and pay balance as indicated on coupon. **No Interest or Finance Charges Added!** If not completely satisfied return unit to us, no explanation necessary.

MOSS ELECTRONIC DISTRIBUTING CO., INC.
Dept. D-151 3849 Tenth Ave., New York 34, N. Y.

Please send me the units checked. I agree to pay down payment within 10 days and to pay the monthly balance as shown. It is understood there will be no finance, interest or any other charges, provided I send my monthly payments when due. It is further understood that should I fail to make payment when due, the full unpaid balance shall become immediately due and payable.

Model TV-11 Total Price \$47.50
\$11.50 within 10 days. Balance \$6.00 monthly for 6 months.

Name
Address
City..... Zone.... State.....

Model TV-40 Total Price \$15.85
\$3.85 within 10 days. Balance \$4.00 monthly for 3 months..

NEW MULTIPHASE
"Rejuva-Tube"*
 CRT REJUVENATOR



Model RE-J

brings "dim-outs"
 back to life



A SENSATIONAL MONEY MAKER
 COMPLETE KIT \$49⁵⁰
 Factory Wired \$5950

Fully 80% to 90% of tubes that have gone dim in service can be reactivated to furnish up to years of "bright as new" service.

GOODBYE BOOSTERS! "Rejuva-Tube" isn't just a gadget to give picture tubes a temporary shot in the arm — even most tubes that have gone "flat" using a booster can be rejuvenated.

PORTABLE — It's compact, light weight and easy to use. Check and rejuvenate picture tubes right in the set in a few minutes.

DEALERS! Now you can sell those "dim-out" trade-ins at a good profit.

SERVICEMEN! Sell rejuvenation service — it's a real money maker. Test and quickly rejuvenate picture tubes in the customer's home. An inexpensive instrument that protects your profit on service contracts.

PROVEN — TIME TESTED! Tubes rejuvenated experimentally over three years ago are still showing good pictures.

COMPARE THESE FEATURES

Welds Open Elements

TESTS — REPAIRS
 TV PICTURE TUBES
 WITHOUT REMOVING
 TUBE FROM SET

- Restores cathode emission and brightness.
- No guesswork — only device that meters cathode activity during rejuvenation. Tells you when to stop rejuvenation to prevent damage to cathode emitting surface. Built-in current limiter prevents accidental cathode ribbon burn-outs!
- Complete tester — detects open or shorted elements and leakage as high as 3 megohms between elements. High quality lab instrument style construction.
- Has special metered circuit to remove "particle" shorts between heater and cathode.
- Checks cathode emission and grid cut-off characteristics.
- Predicts approximate life expectancy of tube — identifies gassy tubes.

*PATENT PENDING

Condensed Instructions
 Printed Inside Case Lid

WRITE FOR MANUAL
 ON REJUVENATION
 WITH THE
 "REJUVA-TUBE"

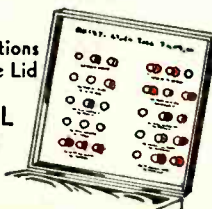

"Rejuva-Tube" By The Designers of

MULTIPHASE
 EQUIPMENT

Central Electronics, Inc.

1247 W. Belmont Ave.

Chicago 13, Illinois

Within the Industry
 (Continued from page 24)

community TV operators . . . **CHEM-ETCHED CIRCUITS INC.** has been formed at 121 S. Cowen St., Garrett, Indiana to design, develop, and manufacture etched circuits by the photoengraving method . . . **SOUTHCO DIVISION** of **SOUTH CHESTER CORPORATION**, Lester, Pa. has purchased the working assets of **LION FASTENER, INC.** which will continue as a wholly-owned subsidiary with headquarters in Honeoye Falls, N.Y. . . . **ZIM PRODUCTS**, manufacturer of record brushes, has been purchased by **PERMO, INC.** of Chicago which will add this line to its present *Fidelitone* and *Permo* record brush line . . . **TEXAS INSTRUMENTS INCORPORATED** of Dallas has purchased the business and assets of **RADELL CORPORATION** of Indianapolis. Operations of the precision resistor firm will be transferred to Dallas in the near future . . . **FAIRCHILD CAMERA AND INSTRUMENT CORPORATION** has acquired all the voting stock of **FREED ELECTRONICS AND CONTROL CORPORATION** of New York, which will be operated as a subsidiary, maintaining its separate corporate identity . . . All divisions of **HYCOR COMPANY, INC.** have now become subsidiaries of **INTERNATIONAL RESISTANCE COMPANY** of Philadelphia . . . **CORNELL-DUBILIER ELECTRIC CORPORATION** has formed a Printed Wiring Division at South Plainfield, N.J. which will be devoted exclusively to the design, development, and manufacture of printed circuitry . . . The Board of Directors of both **STROMBERG-CARLSON COMPANY** and **GENERAL DYNAMICS CORPORATION** have approved a merger which will result in the continuance of the **STROMBERG-CARLSON** identity within the division framework of the parent company . . . **HENRY HINZ ASSOCIATES**, a firm of design engineering consultants, has been formed by Henry Hinz, former chief mechanical engineer for **CBS-COLUMBIA**. Headquarters have been established at 1888 Grant Avenue, East Meadow, Long Island, N.Y.

ARTHUR L. MILK has been elected a vice-president of *Sylvania Electric Products Inc.* He was formerly the company's director of government relations, a post he will continue to handle . . . *Audio & Video Products Corp.* has announced the election of **R. E. HADADY** to the post of vice-president in charge of field engineering and **JAMES U. LEMKE** as vice-president and chief engineer of its *A-V Manufacturing Corp.* division . . . **WALTER W. SLOCUM** has been named assistant to the president of *Daystrom, Inc.* His activities will include research of new products and fields of expansion as well as special assignments relating to the operations of subsidiary companies . . . **ALBERT BENJAMINSON** is the new chief engineer of *Granco Products Inc.* . . . *Airborne Instruments Laboratories, Inc.* has promoted **LAWRENCE J. TORN** to the post of chief elec-

WHAT'S YOUR SERVICE PROBLEM?

FM Radios • Amplifiers and Tuners • Auto Radios • Record Changers

PHOTOFACT HELPS YOU SOLVE IT FASTER, EASIER, BETTER, MORE PROFITABLY!

THE WORLD'S FINEST SERVICE DATA

PHOTOFACT Service Data is the *only* service information based upon first-hand examination of the actual production-run receivers and equipment. It is authentic, uniform data developed through actual study and analysis by service engineers in the Howard W. Sams Laboratories. PHOTOFACT is the *only* data prepared from the practical point of view of the Service Technician.

Thousands of Service Technicians use PHOTOFACT daily for time-saving, profit-boosting service operations. If you've never used PHOTOFACT, you've never realized your full earning power—you've never given such complete customer satisfaction. So get the proof for yourself. Try PHOTOFACT—use it on any job. Your Parts Distributor has the Folder Sets you need for any of the 17,000 TV and radio receivers, changers, recorders, etc., covered in PHOTOFACT. Once you use this great service, we know you'll want the complete PHOTOFACT Library.



THESE GREAT FEATURES ARE EXCLUSIVE IN PHOTOFACT—THEY HELP YOU EARN MORE DAILY, HELP INSURE CUSTOMER SATISFACTION

FULL SCHEMATIC COVERAGE

1. Famous "Standard Notation" uniform symbols are used in every schematic.
2. The same standard, uniform layout is used for each schematic.
3. Diagrams are clear, large, easy to read, easy to handle.
4. Wave forms are shown right on the TV schematics for quick analysis by scope.
5. Voltages appear on the schematics for speedy voltage analysis.
6. Transformer lead color-coding is indicated on the schematic.
7. Transformer winding resistances appear on the schematic.
8. Schematics are keyed to photos and parts lists.

FULL PHOTOGRAPHIC COVERAGE

9. Exclusive photo coverage of all chassis views is provided for each receiver.
10. All parts are numbered and keyed to the schematic and parts lists.
11. Photo coverage provides quicker parts identifications and location.

ALIGNMENT INSTRUCTIONS

12. Complete, detailed alignment data is standard and uniformly presented in all Folders.
13. Alignment frequencies are shown on radio photos adjacent to adjustment number—adjustments are keyed to schematic and photos.

TUBE PLACEMENT CHARTS

14. Top and bottom views are shown. Top view is positioned as chassis would be viewed from back of cabinet.
15. Blank pin or locating key on each tube is shown on placement chart.
16. Tube charts include fuse location for quick service reference.

TUBE FAILURE CHECK CHARTS

17. Shows common trouble symptoms and indicates tubes generally responsible for such troubles.
18. Series filament strings are schematically presented for quick reference.

COMPLETE PARTS LISTS

19. A complete and detailed parts list is given for each receiver.
20. Proper replacement parts are listed, together with installation notes where required.
21. All parts are keyed to the photos and schematics for quick reference.

FIELD SERVICE NOTES

22. Each Folder includes time-saving tips for servicing in the customer's home.
23. Valuable hints are given for quick access to pertinent adjustments.
24. Tips on safety glass removal and cleaning.

TROUBLE-SHOOTING AIDS

25. Includes advice for localizing commonly recurring troubles.
26. Gives useful description of any new or unusual circuits employed in the receiver.
27. Includes hints and advice for each specific chassis.

OUTSTANDING GENERAL FEATURES

28. Each and every PHOTOFACT Folder, regardless of receiver manufacturer, is presented in a standard, uniform layout.
29. PHOTOFACT is a *current* service—you don't have to wait a year or longer for the data you need. PHOTOFACT keeps right up with receiver production.
30. PHOTOFACT gives you *complete* coverage on TV, Radio, Amplifiers, Tuners, Phonos, Changers.
31. PHOTOFACT maintains an inquiry service bureau for the benefit of its customers.

ONLY \$25 DOWN

Puts a Photofact Service Data Library in Your Shop. Ask Your Photofact Distributor—He Has the Full Easy-Pay Details.

FREE PHOTOFACT CUMULATIVE INDEX



Send for it! Your guide to virtually any model ever to come into your shop; helps you locate the proper PHOTOFACT Folder you need to solve any service problem on any model. Once you have the make and chassis number, it takes just 60 seconds to find the applicable PHOTOFACT Folder. Send coupon now for your FREE copy of the valuable Cumulative Index to all PHOTOFACT Folders.

HOWARD W. SAMS & CO., INC.

Howard W. Sams & Co., Inc., Dept. I-H5
2201 E. 46th St., Indianapolis 5, Ind.

Send FREE Photofact Cumulative Index.

Name.....

Address.....

City.....Zone...State.....

HELPS YOU EARN MORE DAILY

~~384,000~~ 650,000*

MOBILE-RADIO RIGS NEED MAINTENANCE

You can have a specialized, high-paying business in this fast-growing field—on contract terms! Send for booklet "HOW TO MAKE MONEY IN MOBILE-RADIO MAINTENANCE".

LAMPKIN METERS are the preferred test equipment!



LAMPKIN 105-B MICROMETER FREQUENCY METER

Heterodyne type. Range 0.1 to 500 MC., all channels. Pinpoint VHF CW signal source. Weight 13 lbs. Width 13". Price \$220.00 net.

*70% increase last year, per FCC Annual Report

MAIL COUPON TODAY!



LAMPKIN 205-A FM MODULATION METER

Indicates FM voice deviation, ± 25 KC. Tunes 25-500 MC. in one band. Has speaker, oscilloscope output. Easy to carry. Weight 13 lbs. Width 12". Price \$240.00 net.

LAMPKIN LABORATORIES, INC.
MFM Division, Bradenton, Florida
At no obligation to me, please send
 Free booklet Data on Lampkin meters

Name _____
Address _____
City _____ State _____

LAMPKIN LABORATORIES, INC.
MFM Division
BRADENTON, FLORIDA

RADIO and TELEVISION ELECTRONICS



in all Technical Phases
New Classes (Day and Evening) Start 1st of Dec., Mar., June, Sept.

Free Placement Service for Graduates
For Free Catalog write Dept. RN55

RCA INSTITUTES, INC.

A Service of Radio Corporation of America
350 WEST 4TH ST., NEW YORK 14, N. Y.

"SNOOPER" GEIGER COUNTER



Super-sensitive! Only 1 1/2 lbs. Fits pocket—uses flashlight battery. Find a fortune in uranium. Order Now! Send \$5.00, balance C.O.D. MONEY BACK GUARANTEE. FREE CATALOG—scintillator and larger uranium and metal detectors. DEALERS WANTED.

2995 COMPLETE

PRECISION RADIATION INSTRUMENTS
4223 RV W. Jefferson Blvd.
Los Angeles 16, Calif.

A NEW PRODUCT

by the makers of the famous **"NO NOISE"** Volume Control and Contact Restorer

NO-NOISE TUNER-TONIC

No NOISE Volume Control and Contact Restorer with Perma-Film
Cleans, lubricates, protects... not a carbon-tet solution. Still available in the new 6 oz. spray can.

Net to servicemen \$2.25
2 Oz. Bottle

Net to servicemen \$1.00
Also available in 8 oz. bottles and quart cans.

Nearest distributor or write direct today.

with **PERMA-FILM**

Cleans, lubricates, restores all tuners including wafer type. Won't change or affect capacities, inductance or resistance, nor harm insulations or precious metals, nor attack plastics. For television, radio and FM. Eliminates all noise, oxidation and dirt indefinitely.

Non-toxic, non-inflammatory, insures trouble-free performance. 6 oz. Aerosol Can.

Net to servicemen.

Extra economical because a small amount does the job!

\$3.25



ELECTRONIC CHEMICAL Corp.

813 Communipaw Avenue Jersey City 4, N. J.

tronics control engineer of its Engineering and Production Division . . . **GRAMER YARBROUGH** has been named sales manager of *American Microphone Company*, a division of *Elgin National Watch Company* . . . **DAN D. HALPIN** has been appointed assistant general manager in charge of marketing and general sales manager of the *Westinghouse Television-Radio Division* in Metuchen, N.J. He was formerly associated with *Allen B. Du Mont Laboratories* . . . The television-radio-phonograph division of *Magnavox Company* has named **LEONARD F. CRAMER** to the post of vice-president and general manager. He was formerly vice-president of *Avco Manufacturing Company* and general manager of its *Crosley radio-television division* . . . **HOWARD W. SAMS**, president of *Howard W. Sams & Co.*, has become eligible for the exclusive "Fathers Over Fifty" Club with the arrival of the son, David Waldemar . . . **JACK L. HOBBY** has been named manager of publicity and institutional advertising for *Raytheon Manufacturing Company* . . . **F. DAWSON BILEY**, 49, founder and president of *Bliley Electric Company*, Erie, Pa. passed away recently. He founded the firm bearing his name in 1930 . . . **L. A. CONNELLY**, for the past 13 years manager of the government department, Engineering Products Division of *Radio Corporation of America*, passed away in his home recently. He was 59 years old . . . **JOHN M. WILSON** has been named chief engineer of the development and design division of the engineering department of the *Brown Instruments Division* of *Minneapolis-Honeywell*. He was formerly chief electrical engineer for the parent firm . . . **FRANK A. HITER**, senior vice-president of *Stewart-Warner Corporation* since 1944 and head of the company's *Alemite* and Instrument Division, died of a cerebral hemorrhage at Chicago's Wesley Memorial Hospital recently . . . **CARL J. HARSHBARGER**, formerly district manager of the *Westinghouse Radio-Television Division*, has been appointed general sales manager of *Kay-Townes Antenna Company*, Rome, Georgia TV antenna manufacturer . . . **GEORGE COHEN** has been appointed director of service sales for *Emerson Radio and Phonograph Corporation*. He has been with the firm since 1933 . . . **C. W. TAYLOR** has been named to the newly-created position of manager, color kinescope marketing, for *RCA's Tube Division*. He has been with the company since 1930 . . . **LOYD DOPKINS** is the new vice-president in charge of sales for *Granco Products Inc.* He was formerly associated with *Crosley* and *Majestic* . . . **A. CRAWFORD COOLEY**, **ROBERT DRESSLER**, and **HOWARD R. PATTERSON** have been elected vice-presidents of *Chromatic Television Laboratories, Inc.* . . . *Pentron Corporation* and *Sound, Inc.* have named **AL SROKA** to the post of industrial sales engineer . . . **DR. HAROLD M. SONNICHSEN**, director of the technical division of *Permacel Tape Corporation*, has been named a vice-president.

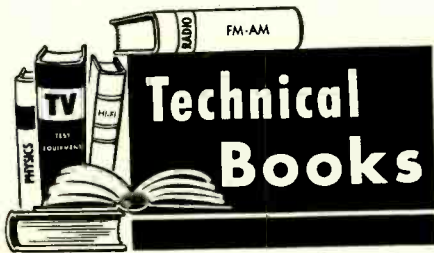

"ATOMIC RADIATION DETECTION AND MEASUREMENT" by Harold S. Renne. Published by *Howard W. Sams & Co., Inc.*, Indianapolis, 198 pages. Price \$3.00. Paper bound.

If the letters received by this magazine are any criterion, every third person in the United States is interested in uranium prospecting—either professionally or as an added fillip to weekend outings or annual vacations.

To this fraternity we can now say—here is your book! Before its appearance the serious "hunter" had to assemble and digest material from widely scattered and often not-too-accessible sources.

The author has performed a real service by collating the available material and presenting it in a thoroughly usable and highly readable form.

The text is divided into ten chapters and five appendices and covers atomic structure, atomic radiation and its effects, radiation detection devices, commercial Geiger counters, scintillation counters, home-built counters, dosimeters, the applications of nuclear science, Civil Defense, and prospecting. The appendices include a manufacturers' directory, a product directory, a listing of standard abbreviations, definitions of terms, and an extensive bibliography.

The readers of this magazine are familiar with the author's lucid style evidenced by the articles he has prepared for this magazine. This same attribute characterizes the text material in his book. Those with a background of high school physics or elementary electronics will experience no difficulty in comprehending the subject matter.

The build-it-yourself fans will find several tested circuits from which to choose the instrument for their expeditions.

* * *

"PICTURE BOOK OF TV TROUBLES" by The Rider Staff. Published by *John F. Rider Publisher, Inc.*, New York. 90 pages. Price \$1.80. Paper bound. Vol. 3.

The third volume in the publisher's "Tell-A-Fault" series covers impedance-coupled video i.f. amplifiers, transformer-coupled video i.f. amplifiers, single-stage video amplifiers, and two-stage video amplifiers.

By means of actual scope traces the authors have presented a means of identifying most of the common faults that occur in video i.f. and video amplifier circuits. Once the technique of locating and identifying circuit faults by means of scope traces is mastered, the technician can simplify and expedite his job, thus enabling him to handle a larger service volume per day.

Those who have used the earlier volumes of this series will welcome the

TOWERS and ANTENNA EQUIPMENT

TRIANGLE TOWER

(Illustrated) Galvanized Steel Tower, 12 1/2" Base, 30 Ft. High—in 10 Ft. Sections. Knocked down. Complete with Hardware, two 50 Ft., one 80 Ft. Guys; three 5 Ft. Anchors, and Base Plate. Each section weighs 45 lbs. Complete with Erection Manual. Shipping Weight: Approx. 350 lbs. F.O.B. **\$31.95** Ky.—Price.

Telescoping Antenna, 18 Ft. \$5.95
Telescoping Antenna, 94" \$1.00
Whip Antenna, with Rigid Base, 5 Ft. \$1.50
Whip Antenna, less Base, 6 Ft. \$1.50

MAST BASES—INSULATED:

MP-22 BASE—Ins. spring action, direction of bracket can be raised or lowered easily. \$2.95
MP-S-33 BASE—Ins. type with heavy coil spring and 5" dia. Ins. Requires 2" hole for mounting. Weight: 9 lbs. \$5.95
MP-37 BASE—Ins. type with heavy coil spring, 7" dia. Ins. Requires 1 3/8" hole for mounting. Weight: Approx. 10 lbs. \$8.95

MAST SECTIONS FOR ABOVE BASES:

Tubular steel, copper coated, painted in 3 ft. sections, screw-in type. MS-53 can be used to make any length with MS-52-51-50-49 for taper. Any section @ 50¢ Each
Larger Diameter Section: MS-54 \$75¢

DYNAMOTORS:

INPUT VOLTS:	OUTPUT VOLTS:	MA.	STOCK No.	PRICES USED:	NEW:
14 VDC	330	150	BD-87	3.95	\$5.95
14	250	50	DM-25	6.95	8.95
14	1000	350	BD-77	14.95	29.95
14	500	500	BD-500	12.95	12.95
14	600	300	BD-86		
14	1030	260			
	515	215	DM-42	8.95	12.95
28	1000	350	PE-73	8.95	
12 or 24	275	110	USA/0516		4.95
12	230	90	PE-133	4.95	6.95
14 VDC	375	150	BD-83	3.95	4.95

6 VDC VIBRATOR POWER SUPPLY

RCA MJ-8—6 VDC input; output 275 VDC 80 MA w/024 Tube, 11 Ft. Batt. & Power Cable. Switch & Fused Line. 4 1/2" x 4" x 6". **\$7.95** NEW:

Address Dept. RN • \$5.00 Order Minimum, & 25% Deposit on C.O.D.'s. • Prices are F.O.B., Lima, Ohio

FM RECEIVER 27 to 38.9 MC

Four Preselected Channels—Frequency Ranges 27 to 29.5—29 to 32—31.5 to 34.4—and 34.4 to 38.9 MC. Complete with 16 Tubes: 1/2SA7; 3/12SG7; 2/12SG7; 2/12SJ7; 1/VR-150; 1/6H6; 1/6SJ7; 2/6SL7; 1/6V6; 2/6AC7; 1/NE-20; and DC-14 Crystal 1000 KC.; Crystal, Calibrator, and Speaker. Power required: 12 or 24 V. DC and 275 V. DC 150 MA. Size: 6 3/4" x 11 1/2" x 11 1/2". **\$34.95**

BC-923 RECEIVER NEW:

BLOWERS:



12/24 VDC-AC CAST ALUMINUM BLOWER—100 CFM: 3" intake; 2" outlet. Shunt Motor 4" x 2", 3000 RPM @ 24 VDC. **\$5.95**

6 VDC SINGLE—100 CFM—No. 6100 \$4.95
6 VDC FLANGE—150 CFM—No. 6150 \$6.95

12 VDC SINGLE—10 CFM—Min.—No. 1210 7.95
24 VDC SINGLE—10 CFM—Min.—No. 2410 5.95
24 VDC DUAL—20 CFM—Min.—No. 2420 7.95
115 Volt 400 cycle—10 CFM. Eastern Air Devices Motor J31A—7200 RPM; 1/100 HP. L-R #2 Blower Assy. Overall Size: 4 1/2" x 3 1/2". No. 3110. **\$5.95**

115 VOLT 60 CYCLE BLOWERS:

115 VAC 60 CYCLE SINGLE TYPE

100 CFM; 2 1/4" intake; 2" outlet. Complete Size: 5" x 6". No. IC939. **\$8.95**
115 VAC 60 CYCLE DUAL TYPE—100 CFM: 4" intake; 2" Dis. Each Side. Complete Size: 8" x 6". No. IC880. **\$13.95**

115 VAC 60 cycle COMPACT TYPE—108 CFM: Motor built inside squirrel cage; 4 1/2" intake; 3 3/8" x 3" Dis. Complete size: 4 1/4" W x 8 3/8" H x 8 1/8" D—No. 2C067. **\$14.50**

115 VAC 60 cycle FLANGE TYPE—140 CFM: 3 1/2" intake; 2 1/2" Dis. Complete size 7 1/2" W x 7 1/4" H x 6 3/4" D—No. IC807. **\$13.95**

115 VAC 60 cycle FLANGE TWIN—275 CFM: 4 1/2" intake; 3 1/4" x 3" Dis. Complete size: 11 3/4" W x 8 3/8" H x 8-1/16" D—No. 2C069. **\$21.95**

ALL ITEMS PREVIOUSLY ADVERTISED ARE STILL AVAILABLE—WRITE FOR LIST!

CLASSIFIED ITEMS:

BC-221/TS-164 Frequency Case: W/V. Reg. Supply, Tubes, Relay, Cable, etc. Shock Mtg. \$ 4.95
BC-442 Antenna Relay Unit, w/Ind. & Vac. Cap. \$ 3.95
BC-1206 BEACON REC. 200-400 KC., w/Tubes. N: 9.95
BC-347 AMPLIFIER—1/6F8C. N: \$3.95—U: 1.95
BC-709 AMP.—Batt. Op.—1 Tube. N: \$3.95—U: 2.95
RT-34 RPS-13 TRANSCEIVER—Less Tubes. U: 3.95
FL-8A Range Filter. U: \$1.49—FL-5 Filter. U: 1.00
TS-9 Carbon HANDSET. U: 3.95
TS-10 Snd. Powrd. Hndset or Hd. & Ch. Set. U: 3.95
BC-229/429 REC., 2500-7700 KC. w/Coils. U: 5.95
BC-230 TRANS., 2500-7700 KC. w/Coils. U: 8.95
BC-745 TRANSCEIVER—3 TO 6 MC. U: 14.95

PRACTICE CODE TAPES & TG-34A KEYS

PRACTICE CODE TAPES—Code Training and Practice Inked Paper Tapes on 16MM 60 Ft. Reels for Telegraph and Radio Operators. Fifteen (15) Reels to a Set—in Wood Case. For use with TG-34A or TG-10 KEYS. **\$14.95**

COMPLETE SET—Price: **\$14.95**

TG-34A KEYS—115 or 230 Volts at 50 to 60 cycles—an automatic unit for reproducing audible code practice signals previously recorded in ink on paper tape. By use of the self contained speaker, the unit will provide code practice signals to one or more persons—or provide a keying oscillator for use with a hand key. Unit is compact in portable carrying case, and complete with Tubes, Photo Cell and Operating Manual. Size: 10 1/8" x 10 1/2" x 15 1/8". Shipping weight: 45 lbs. **\$16.95**

SET OF 15 TAPES and TG-34A KEYS— BOTH: **\$30.00**

RECORDER for CODE TAPES and TAPE PULLER

RECORDER—BC-791 Recorder & Amplifier of Code Signals from Radio Receiver or Local Key sending on 3/8" Paper Tape with Ink Writing Stylus. Tape can be played back on any TG-34 or TG-10 KEYS. 115 Volt 60 cycle operation with Tubes. (No Tape or Tape Puller included.) Prices: NEW: \$9.95, USED: **\$6.95**

TAPE PULLER—MC-310 Tape Puller—Variable speed Motor driven—for use with 3/8" Paper Tape. 115 Volt 60 cycle operation. Complete with Motor Reel, Assy. & Blank Reel. Prices: NEW: \$12.95, USED: **\$9.95**

BOTH BC-791 RECORDER and MC-310 TAPE PULLER—NEW: **\$20.00** or BOTH—USED: **\$15.00**

COPE TAPES—BLANK—For Recorders. 3/8" wide, 400 Ft. Prices: 6 for \$1.00—or 25¢ each.

BROADCAST BAND RECEIVER

NAVY/TYPE—520 to 1500 KC. NEW: **\$24.95**

NAVY/TYPE REC.—1.5 to 3 MC. Less Tubes USED: \$ 9.95

NAVY/TYPE REC.—6 to 9 MC. Less Tubes USED: 3.00

BC-455 REC.—6 to 9 MC. W/tubes.Used: \$4.95

R-28/ARC-5 REC.—100-156 MC. W/tubes.Used: 14.95

Navy Type COMM. TRANS. 2,1—3 MC.U: 8.95

NEW: 12.95

Navy Type COMM. TRANS. 3—4 MC.U: 18.95

BC-458—TRANSMITTER—5.3—7 MC.NEW: 5.95

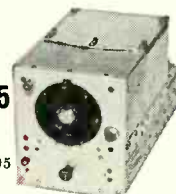

FAIR RADIO SALES 132 SOUTH MAIN ST. LIMA, OHIO

Small
in size and cost
Big
in performance



**American's NEW
TAPE RECORDER
MICROPHONE**

Here's a new standard for high fidelity convenience . . . for the home or small studio. Attractively styled, and available in matching colors, this sensational new lightweight champ delivers a heavyweight performance throughout the entire tone range. Omni-directional pick-up pattern provides uniform fidelity when more than one performer or participant is being recorded at one time.

Versatility underscores the modern functionalism of this new design. It weighs only 2 ounces, only $3\frac{1}{2}$ x $2\frac{1}{4}$ x $\frac{3}{16}$ inches in size . . . can be easily handled and used by standing persons, or it can be rested on a flat surface for conference type pick-up such as conference recording.

Quality in construction means quality in tonal reproduction. The microphone element is shielded, with very low hum pick-up. Model B-203, ceramic type, and Model X-203, crystal type are both available with RCA type or miniature phone plugs.

For high fidelity sound that is reproduced to last, use American tape recorder microphones.



full vision . . .
full sound . . .
where fidelity
speaks for itself!

American
microphone
company

870 South Fair Oaks Ave., Pasadena 1, Cal.

AN ELGIN NATIONAL WATCH
COMPANY AFFILIATE

addition of the present book as covering other important receiver circuitry. Newcomers to this method should find the material helpful.

* * *

"TV FIELD SERVICE MANUAL WITH TUBE LOCATIONS" edited by Harold Alsberg. Published by *John F. Rider Publisher, Inc.*, New York. 152 pages. Price \$2.40. Paper bound. Vol. 4.

This particular volume in the current series covers *General Electric, Hallicrafters*, and *Hoffman* television receivers produced during the years 1947-1953. Like the preceding volumes, this book is intended merely as an adjunct to in-the-home service techniques. It carries tube location guides on each set, details on the picture tube adjustments, front and rear control locations, and drive cord assemblies when such are used.

The possible service faults and symptoms for each set are listed in tabular form with reference to the appropriate service procedure for that particular receiver or to the master listing of troubleshooting procedures.

The book itself is pocket sized and spiral bound to open flat for easy use. The outside technician whose work consists mainly of home repair calls will find this new volume invaluable.

* * *

"THE NEW HIGH FIDELITY HANDBOOK" by Irving Greene & James R. Radcliffe. Published by *Crown Publishers, Inc.*, New York, 185 pages. Price \$4.95.

The lay audiophile who has been staggered by the complexity and technical level of most texts on the subject will welcome the appearance of this authoritative yet easy-to-read treatise.

There are no prerequisites to an understanding and enjoyment of this book. Mathematical treatment has been completely eliminated in favor of explanatory text material. The book itself is divided into fifteen chapters, each a hard-hitting exposition of some phase of the subject. One of the most encouraging things to the lay reader is the authors' realism regarding hi-fi systems. While they set high standards for the assembling of the components of the ideal hi-fi system they are realistic enough to appreciate the fact that not all music lovers have unlimited funds to expend on systems for playing their records. To this end both moderately-priced and high-priced units are analyzed and described.

The budget-minded music lover will also appreciate the large and detailed section covering the construction of speaker enclosures and the techniques required to assemble such cabinets. Troubleshooting, servicing, and maintenance procedures for the owner are also covered in some detail, along with information for building simple test equipment with which to make the requisite checks.

One especially valuable feature of the book is a buyers' guide covering manufacturers and distributors of hi-fi equipment of all types.

This book meets the real need ex-

pressed by that large segment of the audio "fraternity" that enjoys its music but does not have a string of impressive engineering degrees to back up its interest.

* * *

"TELEVISION SIMPLIFIED" by Milton S. Kiver. Published by *D. Van Nostrand Company, Inc.*, New York. 535 pages. Price \$6.75. Fifth Edition.

When any technical publication runs into a fifth edition it is pretty strong endorsement for its efficacy since publishers are rarely in business for their health! The continuing popularity of Mr. Kiver's basic text is fully justified. The presentation of his subject is crystal clear, simple, and complete.

This new edition has been considerably enlarged to reflect the progress which has been made by the industry since the appearance of the fourth edition last year. An entirely new chapter has been added on color television, another on u.h.f. New schematics and new illustrations have been incorporated to keep pace with the output of the engineering departments. Material has been added to the sections on TV tuners, keyed a.g.c. systems, d.c. video amplifiers, and cascode amplifiers. Inter-carrier receiver circuitry has been thoroughly analyzed and the actual operation of late model TV sets is carefully dissected and discussed.

The beginning service technician as well as the "old hand" will find this text invaluable in providing both the requisite background knowledge and in furnishing practical day-to-day "know-how."

* * *

"ELEMENTS OF ELECTRONICS" by Henry V. Hickey & William M. Villines. Published by *McGraw-Hill Book Company, Inc.*, New York. 478 pages. Price \$5.00.

The authors' presentation of the material incorporated in this text is based on their practical experience in the training of naval personnel in basic electronics. The successful application of these techniques has encouraged the authors to make this knowledge available to other would-be students.

Written at the senior high-junior college level, this text is suitable either as a textbook or as a home-study volume. The material has been divided into sections that roughly correspond to a single classroom lesson so that the entire subject can be handled during a ten-week period. For the student studying on his own there are review questions and problems accompanying each chapter. Mathematical treatment of the subject matter has been resorted to only when absolutely necessary and, in those cases, the processes are explained and described.

Twelve appendices are included to obviate the necessity of additional reference books. These appendices cover such subjects as color codes; wire sizes; sine, cosine, and tangent tables; electronic abbreviations and symbols; the Greek alphabet, etc.

For the beginning student this is a well rounded work that should find an enthusiastic acceptance.

-50-

RADIO & TELEVISION NEWS

What's New in Radio

(Continued from page 78)

with the *Tinnerman Products Corporation*. It does not require special sockets for mounting, requiring only two round holes to be snapped into place. In addition, solderless connectors are available for making electrical contact to the rectifier.

PHOTOCONDUCTIVE CELL

Canadian Marconi Company, 2442 Trenton Ave., Montreal 16, P. Q., Can-

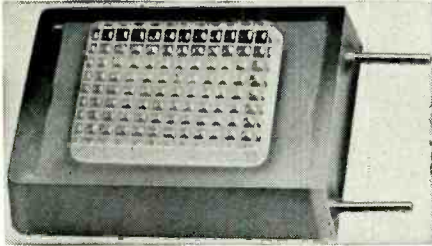

ada, has announced the availability of a new photoconductive cell capable of handling power up to .3 watt.

The new design eliminates the electronic amplifier, the vacuum photocell, and the d.c. power supply. It is designed to operate relays and other devices on voltages from 110 volts to 1.5 volts a.c. or d.c. with incident light values from daylight (1000 footcandles) to moonlight (.020 footcandle). The sensitivity is .4 ampere-per-lumen.

Write Mr. F. Hasell of the company for further information.

"SERVI-SPOT" LIGHT

General Electric Company's Tube Department is offering a new aid to radio and television technicians in the form of a "Servi-Spot" light that plugs into the dashboard cigarette lighter.

Available from the company's tube distributors, the new light throws a powerful beam a quarter of a mile and is invaluable in night emergency calls where outdoor antenna and lead-in work is required. The lamp can also be used to spot house numbers and for other purposes.

A twelve-foot cord permits use of the lamp around any part of the service vehicle. When not in use, the cord is wound around the lamp reflector case and the plug snaps into a space provided on the handle. The light draws only .5 amp. from the car battery.

COLOR CONVERTER

Color Converter, Inc. of Columbia City, Indiana is now offering a relatively inexpensive unit which may be added to any present black-and-white television receiver to provide reception of color telecasts.

Known as the "Col-R-Tel," the new unit causes the monochrome picture to be resized and converted to a fine-textured 14" color picture when color programs are being transmitted. One of the two parts of this system is a small electronic chassis which is per-

August, 1955

It's as EASY as This

TO INSTALL A MASTER TV SYSTEM WITH

B-T LABS Masterline[★] UNITS

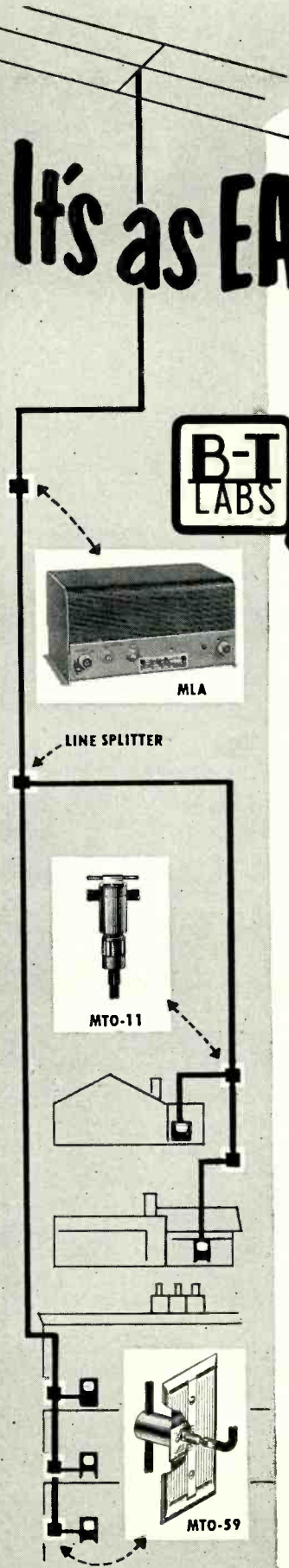

A Connect the antenna line to the INPUT of your Masterline MLA Line Amplifier. The signal is now amplified 37db (70 times).

B Connect a line splitter or line coupler to the OUTPUT of the MLA. You now have 2 or more branch lines for feeding to TV receivers.

C Where the branch line is run out-of-doors, connect a Masterline MTO-11 (outdoor tap-off) wherever a TV set feed line is required.

D Where the branch line serves as a riser inside a building, connect a Masterline MTO-59 (wall-plate-tap-off) wherever an antenna outlet is required.

This is only one example of a Master TV System, to show the flexibility of Blonder-Tongue distribution equipment. There are many more, all covered in the new B-T INSTALLATION MANUAL.

Write for your Free copy to Dept. FH-4

BLONDER-TONGUE LABORATORIES, INC.
WESTFIELD, NEW JERSEY

Manufacturers of TV Cameras, TV Amplifiers, Boosters, Converters, Accessories and Originators of the Masterline and 'Add-A-Unit' Master TV Systems.

SENSATIONAL CHANGER SALE

Repeated by Popular Request
Our Lowest Prices Ever . . .

AUGUST ONLY

Order Now And Save

630 FA9 FOR 24" & 27"
CUSTOM INSTALLATION

- | | |
|--|--|
| (1) 630 FA9 Chassis | (1) 630 FA9 Chassis |
| (2) 24" Sylvania aluminized silver screen pivot tube | (2) 27" Sylvania aluminized silver screen pivot tube |
| (3) Heavy duty tube mounting brackets | (3) Heavy duty tube mounting brackets |
| (4) Knobs, Ion trap, hardware, etc. | (4) Knobs, Ion trap, hardware, etc. |

\$21495

\$23995

with 12" RCA Spkr. with 12" RCA Spkr.

Sensational TV Tuner Value



Because of this low, low price, we can't give the tuner's name. Complete with 6J6 and 6AG5 tubes. Built-in wave trap, removable channel strip, positive click stop. Shaft length 2 7/8". For 21 MC IF circuit. An ideal replacement for all sets. \$7.95 each. Lots of 3 **\$6.95**

TRIPLE PLAY CARTRIDGE
TYPE GE RFX050 **\$4.99**

RECORD CHANGER BASES & BOARDS
Bases—\$3.49 Mounting Boards—\$1.87
VM—Webster—Garrard—Collaro. Give model.

10 Watt Hi-Fi Amplifier
Push-pull, pre-amp., bass, treble. **\$23.95**

FREE CATALOG
Of latest hi-fi equipment
Sent Upon Request

All merchandise is brand new, factory fresh & guaranteed. Mail & phone orders filled on receipt of certified check or MO of 20% of items as a deposit. Balance C.O.D., F.O.B. factory N. Y. Prices & specifications subject to change without notice.

AIREX RADIO CORP., 171 Washington St., N. Y. 7 CO 7-5218

WEBSTER (NEWEST MODEL): Automatic shut off, Hi-fi ceramic cartridge with dual sapphire styli. Heavy duty 2 pole motor. Plays 7-10-12" records. Regularly \$37.50 **\$2387**

VM TRIOMATIC: 3 speed intermix with sapphire dual styli. Reg. \$34.50 **\$2297**

WEBSTER 1121: 3 speed hi-fi changer with GE Reluctance RFX 050 cartridge. Heavy duty 4 pole motor, Automatic shutoff. Reg. \$40.00 **\$2787**

GARRARD RC 80: 3 speed. One of finest British changers. Automatic shutoff. Weighted turntable. 4 pole motor. Complete with plug-in head. Reg. \$50.00 **\$4295**

630 FA4. For 21" TV tubes. Fringe area **\$14995**

chassis. 12" RCA speaker included. **\$34.95**

21" Sylvania Aluminized Picture Tube. **\$34.95**

Send for catalog sheets on 630 FA4 and 630-9 chassis

manently affixed to the back of the TV set, out-of-sight, and wired into it. The other part is the color filter in a 15-pound housing which rests on rubber cushions on top of the black-and-white set. One plug-in connects it. It is



portable and easy to install and may be swung aside when the receiver is to be used for regular black and white reception.

The company claims that the converter is as easy to tune as the monochrome set since there are only three manual controls which must be operated. The converter can be installed by any experienced television technician.

For a brochure describing the system in some detail, write direct to the manufacturer.

TRANSISTOR RECEIVER

Emerson Radio and Phonograph Corporation of Jersey City, N. J. is marketing a combination transistor-vacuum tube portable receiver, the Model 838.

Weighing less than a pound and measuring only 6" in width by 1 3/4" in depth, the new receiver uses two transistors and three vacuum tubes. According to the company, battery life is

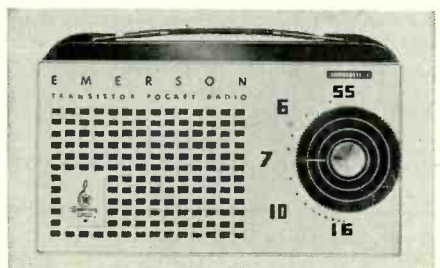

increased tenfold and power output is ten times greater than that of competitive small radios.

The Model 838 comes in a variety of decorator colors.

RCA SERVICE SCOPE

The Tube Division of Radio Corporation of America, Camden, N. J. recently introduced a new television servicing scope which embodies all of the features required in testing black-and-white as well as color TV receivers.

The new oscilloscope (WO-91A) has a dual-band response, with a 4.5 mc. response in the wide-band position. The

RADIO & TELEVISION NEWS

EASY TO LEARN CODE

It is easy to learn or increase speed with an Instructograph Code Teacher. Affords the quickest and most practical method yet developed. For beginners or advanced students. Available tapes from beginner's alphabet to typical messages on all subjects. Speed range 5 to 40 WPM. Always ready—no QRM.



ENDORSED BY THOUSANDS!

The Instructograph Code Teacher literally takes the place of an operator-instructor and enables anyone to learn and master code without further assistance. Thousands of successful operators have "acquired the code" with the Instructograph System. Write today for convenient rental and purchase plans.

INSTRUCTOGRAPH COMPANY

4711 SHERIDAN ROAD, CHICAGO 40, ILLINOIS

BE SHARP! SHARP! SHARP!

Hit your friends with a new brain teaser every day! These scientific puzzlers are the type you enjoy stumping your friends with, but are rarely found. Our 100 Brain Busters assure your popularity and provide weeks of entertainment. All 100 complete with answers for only \$1.00.

ELECTROFACTS, Box 5027, Bossier City, La.

SAVE \$\$\$
THOUSANDS OF BARGAINS
Send Stamp for our
GIANT CATALOG
UNITED RADIO CO.
58A MARKET ST. NEWARK, N. J.

STAN-BURN E-D-A-R-K-E

CATHODE RAY TUBE SPECIALS

One Year Guarantee

G. E.	STAN-BURN
10BP4A \$14.95	10BP4 \$10.20
10FP4A 21.10	12LP4 11.90
12KP4A 24.45	12LP4A 13.95
12LP4A 18.75	12QP4 11.90
12QP4A/B1014	12JP4 11.90
Dumont 25.10	12UP4A 14.50
12UP4B 34.25	14CP4 15.60
14CP4 22.50	15DP4 17.50
15DP4/B1014	16KP4 17.50
Dumont 26.75	16P4 or A 17.50
16P4A (N.U.) 34.25	16JP4 or A 17.50
16P4A (N.U.) 25.25	16CP4 or A 17.50
16GP4 or B 24.20	16P4 17.50
16KP4/16RP4 24.20	16WP4 17.50
16KP4A 29.35	16AP4 17.50
(Aluminum) 27.95	16AP4A 23.00
16JP4A (N.U.) 38.50	16P4A 19.00
16LP4A 28.50	16P4A 23.00
16WP4A 39.75	16P4A 23.00
16GP4B 33.95	16P4A 23.00
17BP4A 27.50	16P4A 23.00
17BP4B 29.75	17BP4 18.50
17CP4 29.95	17CP4A 22.60
17CP4B 38.50	17P4B 22.60
(Aluminum) 39.75	19FP4 23.00
19AP4A 30.00	19P4A 23.00
20CP4 37.50	15AP4 23.90
20LP4 39.75	10AP4A 24.90
21AP4 31.80	20CP4 23.95
21EP4 36.35	21EP4 25.50
21EP4A 36.35	21AP4 26.50
24AP4A 89.75	24AP4 49.00

PRICES SUBJECT TO CHANGE WITHOUT NOTICE

AUTHORIZED DISTRIBUTORS for General Electric, Kenrad, Tung-Sol, Hallicrafters, De Wald, Tech-Master, Automatic and General Motors.

PORTABLE RADIOS

JEWEL—Battery only Net **\$12.99**
Case for same **1.50**
Batteries **1.95**
CABANA 3 way portable. 5 tube **\$16.75**
Batteries **2.50**
JEWEL 5 tube Super Het—Red, Ivory, Walnut and Ebony **\$12.50**
with Clock—5 tube AC-DC
Ivory **\$15.95** Walnut **\$15.45**

RECORD PLAYERS

Manual 3 speed record player—single needle **\$14.50**
Manual 3 speed with flip-over cartridge **\$16.95**
Automatic 3 speed with VM changer **\$37.50**

PENTRON TAPE RECORDERS

Model CT1 **\$ 81.50**
Model TR4 **119.00**
Model HT225 **140.00**
(catalogs on request)

'55 FORD, PLYMOUTH, CHEV. Automatic Radio Manual **\$41.97**
Push Button **45.47**
630 ANSLEY 29 tube Chassis **\$115.00**
TURNER AU phono cartridge—Universal replacement **\$1.59 ea.** 6 @ **\$1.49 ea.**
VM CHANGER—with Ronette flip-over cartridge. BRAND NEW—Hi-Fi original cartons **\$21.49**

We invite export inquiries and offers. Our export department will give special attention to expediting foreign orders at minimum commissions. We are authorized distributors for United Motors, all Delco and Gen. Motors Auto Radio parts in stock. We also carry a complete line of popular makes of Radio Tubes at 50% discount. Also many other special purpose and transmitting types, and all electronic parts and equipment at lowest prices. Send us a list of your requirements for prompt quotations. Terms: 20% with order. Balance C.O.D. All prices F.O.B. NEW YORK Warehouse. Minimum order \$5.00. Write for our latest price list and Hi-Fi catalog to Dept. RN-8

STAN-BURN RADIO and ELECTRONICS CO.
1697 BROADWAY • NEW YORK 19, N. Y.

don't
be
vague...

insist on
SPRAGUE
BLACK
BEAUTY®
TELECAP®
tubulars



SPRAGUE

NORTH ADAMS, MASS.

don't be vague...

insist on
SPRAGUE

TEL-OHMIKE®

**CAPACITOR-
RESISTOR
ANALYZER**

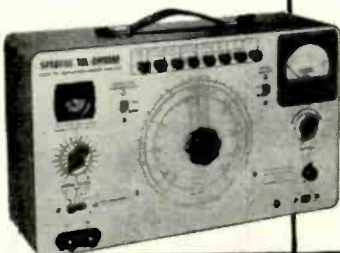

SPRAGUE

NORTH ADAMS, MASS.

August, 1955

vertical amplifier has a voltage-calibrated, frequency-compensated 3-to-1 step attenuator.

Other features include built-in calibration for peak-to-peak voltage measurements; vertical polarity reversal switch for "upright" or "inverted" trace display; sturdy one-piece probe with built-in switch for low capacitance or "direct" operation; pre-set "vertical" and "horizontal" sweep positions for TV troubleshooting, etc.

JFD "ZIP" ANTENNAS

JFD Manufacturing Co., Inc., 6101 16th Avenue, Brooklyn 4, New York has unveiled a new line of twelve "Zip-assembled" deluxe conical antennas.

The new antennas' dipole-heads "zip" the pre-assembled dipole elements into place and lock them there. Absolutely no tools are required. Unbroken electrical continuity from the dipole element through the dipole head to the lead-in insures the maximum transfer of energy.

With this new line there is no "friction" contact between the feed points and no accumulation of dust or mois-

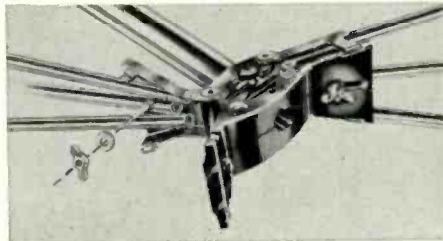

ture which ordinarily dims and shorts out the picture, according to the company. Internal aluminum dowel reinforced elements eliminate vibration and contribute to the strength and rigidity of the assembly.

For full information on the antennas currently available in this new line, write the company direct.

CR "PIN CUSHION"

Sylvania Electric Products Inc., 1740 Broadway, New York 19, N. Y. has designed a new protective cap which fits over the base pins of a TV picture tube and reduces accidental damage to base pins on such tubes.

The "Pin Cushion" is now being used exclusively on the firm's picture tubes. The device is made of plastic, is lightweight, durable, easy to handle, and fits snugly on the picture tube base. The cap prevents bent or broken pins as the base pins are kept in perfect alignment, especially during shipment. In addition, the cap keeps the pins clean, thus assuring maximum electrical contact. It also facilitates installing the ion trap magnet over the tube base.

IRE SUMMER SEMINAR

The Emporium Section of the Institute of Radio Engineers is again sponsoring its annual summer seminar on August 26, 27, and 28 in Emporium, Pa.

Further information on this session is available from Paul M. Bogart, chairman of the publicity committee for the Emporium Section.

don't be vague...

SPRAGUE
36C

insist
on
SPRAGUE

SPRAGUE
29C

*Cera-mite**

ISC

disc ceramics

*Trademark

SPRAGUE

NORTH ADAMS, MASS.

don't

be

vague...

insist

on

SPRAGUE

NORTH ADAMS, MASS.



Gigantic SAVINGS on TUBES and Parts!

- Same Day Service • Full Year Guarantee
- All Tubes Individually Boxed
- 400 Types Always In Stock • For Quality, Performance, Dependability

Type	Price	Type	Price	Type	Price
024M	.65	6AUG	.46	7K7	.69
1A2	.62	6AU7	.61	7N7	.69
183GT	.73	6AV5GT	.73	7Q7	.66
1LA4	.59	6AV6	.40	7E7	.79
1LA6	.69	6AX4GT	.66	7Z4	.69
1LC2	.59	6AX7	.66	12A4	.60
1LC6	.79	6BA6	.49	12AL5	.37
1LE3	.69	6BC5	.54	12A05	.52
1LC5	.69	6B7	.51	12AT7	.72
1LH4	.69	6BE6	.51	12AT7	.72
1LN6	.69	6BG6G	1.25	12AU6	.46
1HS	.52	6BK7	.80	12AX6	.60
1S5	.51	6BJ6	.49	12AV6	.39
1U4	.50	6BK5	.80	12AV7	.73
1U5	.50	6BL7	.91	12AX7	.63
1X2A	.68	6BL7GT	.91	12A4	.60
2AF4	.96	6BN6	.74	12BA6	.49
2A5	.80	6B6GT	.98	12BE6	.51
3AL5	.42	6BQ7	.90	12BF6	.39
3AUG	.46	6BZ7	.90	12RH7	.63
3BC5	.54	6C4	.49	12RQ6	.99
3BN6	.74	6CB6	.54	12RH7	.63
3CB6	.54	6CD6	1.11	12RQ6GT	.99
3C4	.59	6CF6	.64	12RY7	.65
3Q5GT	.69	6CS6	.51	12RZ7	.65
3S4	.58	6HGGT	.41	12CR6	.51
3V4	.80	6J5GT	.48	12C6	.51
4BQ7	.90	6J6	.64	12L6	.51
4R27	.96	6K6GT	.45	12SA7GT	.65
5AR5	.54	6L6	.61	12SJ7M	.67
5AN8	.78	6Q7	.45	12SK7GT	.63
5AT8	.75	6S4	.48	12SL7GT	.57
5AW4	.64	6SA7GT	.59	12SN7GT	.59
5J6	.64	6SH7GT	.50	12SQ7GT	.56
5T8	.79	6SJ7GT	.53	12V6GT	.46
5T8	.79	6SK7GT	.53	12V6GT	.46
5U4G	.55	6SL7GT	.67	12X4	.38
5V4	.78	6SN7GT	.59	14A7	.63
5V6	.75	6SQ7GT	.46	14B6	.63
5X8	.71	6T4	.99	14R7	.79
5Y3GT	.80	6TR	.80	14R7	.79
6AR4	.85	6U8	.78	14R7	.79
6AC7M	.46	6V6GT	.86	14R7	.79
6AD7	.85	6V8	.86	14R7	.79
6AF4	.85	6W4GT	.47	14R7	.79
6AG5	.85	6W6GT	.57	14R7	.79
6AG7M	.85	6X4	.37	14R7	.79
6AH4	.85	6X5GT	.37	14R7	.79
6AH6	.73	7A5	.59	14R7	.79
6AK5	.95	7A6	.69	14R7	.79
6AK8	.95	7B5	.69	14R7	.79
6AL5	.42	7A8	.68	14R7	.79
6AM8	.78	7AG7	.69	14R7	.79
6AN4	.64	7B7	.69	14R7	.79
6AN8	.78	7C5	.69	14R7	.79
6A05	.50	7C6	.59	14R7	.79
6A06	.50	7C7	.59	14R7	.79
6A07	.70	7E7	.59	14R7	.79
6AR5	.45	7F7	.79	14R7	.79
6AS5	.45	7F8	.79	14R7	.79
6AS6	1.49	7H7	.59	80	.43
6AT6	.41	7J7	.79	11723	.45
6AU4GT	.68			11726	.62

TERRIFIC VALUE!!

8 TUBE CAR RADIO



Made for Hudson cars. Can be installed in dash or under dash of most cars. Separate P.M. speaker. Automatic push buttons. Tone control. Push-Pull 6AQ5 output.

- In original Factory Carton
- Contains 2-6AQ5, 2-6BD6, 1-6BE6, 1-6C4, 1-6AV6, 1-6X4, 6 volt cars.
- Complete with knobs, mounting brackets, condensers, fuse, etc.
- \$85 seller

\$29.95

Lots of 3, \$27.95

Write Dept. RN-8 for Free Tube and Parts Catalog Listing Over 400 Tube Types Export Inquiries Invited!



Full Line of Dynamic Speakers

5" to 12" Famous Make 89c each
Asst. of 10 79c each
Available 1700 or 2500 ohms

TERMS: 25% deposit must accompany all orders—balance C.O.D. All shipments F.O.B. Irvington warehouse.

ORDERS UNDER \$5.00—50c HANDLING CHARGE.

PLEASE: Send full remittance. Allow for postage and save C.O.D. charges. Unused money refunded.

Subject to prior sale.

Rad-Tel TUBE CO.

115 COIT ST., IRVINGTON II, N. J.

Wireless Record Player

(Continued from page 40)

of the wood tone arm. The writer used round-head wood screws about $\frac{3}{8}$ " long. A curved groove was filed in the nose of the arm to accommodate the ring of the cartridge. Note the two-way lug, cut from sheet copper, and screw-fastened to the right-hand side of the arm. This lug serves as the junction for the needle lead, and the lead running back along the side of the arm. The pickup's plate lead is soldered directly to the end of the mounting bracket, as shown.

The photograph of Fig. 13 is a view of the right-hand side of the pickup, showing the #38 gauge wire lead from the needle to the two-way lug, and the #28 gauge lead running from the lug back along the side of the arm. The latter is cemented in a groove scribed along the side of the arm near the top, as shown.

The two 2-way soldering lugs, cut from sheet copper, and screw-fastened to the side of the wood arm near the swivel's U-bracket are shown in Fig. 5. These two lugs serve as junctions for the leads from the cartridge, and the flexible leads running up to the small radio's oscillator. Figure 10 shows how the brass L-bracket is mounted to the back end of the cabinet by means of two $\frac{5}{32}$ " diameter bolts $1\frac{1}{4}$ " long. The swivel mounts in the large hole in the L-bracket and is secured by means of a hexagon nut to fit the threaded shank of the swivel, as shown. The swivel's U-bracket is placed to provide the best tracking-angle for the pickup on the record, and the counterweight is placed to give a needle pressure of 5 or 6 grams.

Mounting the Radio

Fig. 10 also shows how two $6\frac{1}{4}$ " by $3\frac{1}{4}$ " chrome-plated shelf brackets are mounted on the back of the cabinet by means of $\frac{5}{32}$ " bolts $1\frac{1}{4}$ " long. These brackets, sold in hardware stores, hold the radio about $3\frac{3}{4}$ " above the top of the record player cabinet, or about $1\frac{1}{4}$ " above the top of the wood tone arm, resulting in short leads from the arm to the radio's oscillator. The two metal strips, seen on the tops of the brackets, were bent by the writer to fit the bottom of the radio used, and the strips were spot-welded to the brackets, as shown. Obtain a length of steel band $\frac{1}{16}$ " thick, and $\frac{3}{8}$ " or $\frac{1}{2}$ " wide, bend to fit the bottom of the radio you use, and then either solder or rivet the brackets to the shelf brackets. The location of the shelf brackets on the back of the cabinet will depend on the length of the small table radio you use.

The flexible leads from the pickup plug into the phone tip jacks mounted on the bottom of the radio. These tip-jacks connect to the tuned circuit of the oscillator in the small radio, as shown in Fig. 1. Use small gauge flexible stranded copper wire for the two

leads from the pickup to the radio, and keep the leads as short as possible without interfering with the free movement of the tone arm. The tip-jacks mount in $\frac{1}{4}$ " diameter holes drilled in the bottom of the radio's cabinet, and when you want to take the chassis out of the cabinet it is only necessary to remove the two outside nuts from the tip-jacks and pull the jacks out of the holes from the inside. Make the lead from the tip-jack to the oscillator's grid as short as possible.

If an a.c.-d.c. table radio is used as the oscillator for this record player, it's wise to isolate the pickup from the radio's chassis to do away with possible shock hazard. Use two .01 μ fd. tubular capacitors connected in the leads as shown in Fig. 1A. Mount the capacitors *inside* the radio, connecting them between the tip-jacks and the oscillator.

The photograph of Fig. 18 shows the front-end of a typical a.c.-d.c. super-heterodyne table radio. The pencil points to the stator lug on the oscillator section of the capacitor gang, which is the grid side of the oscillator to which the needle of the capacitance pickup is connected. You can easily spot the oscillator section as it has the smallest rotor plates, or the least number of plates. Also, the stator plates of the oscillator section are the most sensitive to the touch of the finger, which is another way of checking.

Operating Hints

The small radio used as the oscillator should be placed as close as possible to the receiving radio. Reverse the line cord of either or both radios if the a.c. hum is bothersome. Operate the receiving radio on a quiet spot on the *high-frequency end* of the broadcast band. The frequency-modulated signal from the record player should be tuned-in for best quality, this will be a little to one side of resonance. If your receiving radio uses a "magic-eye" for tuning, ignore it! Switch the receiving radio's tone control to "treble" as the capacitance pickup will give plenty of bass! Too wide a spacing between the needle and the plate will result in a weak signal. On the other hand, if the air-gap is too small, you may have some trouble holding the signal with badly warped records or records with off-center spindle holes. Experiment for best results. Pushing the needle farther into the rubber plug results in less compliance and slightly reduced "high"; on the other hand, if the needle is too far out of the rubber plug the needle will be too compliant and will have too little damping. With some phono motors, you may hear a "scratching" noise with each revolution of the turntable. This is caused by metal-to-metal friction of the turntable shaft in its socket, picked up by the phono pickup and radiated by the oscillator. The writer killed this noise at the source by turning out a duplicate of the turntable shaft from fiber or plastic, using a metal-turning lathe.

Measurement Adapter
(Continued from page 44)

series. The two signals are then fed in parallel across a common 1000 ohm resistor (R_9). The signals are then mixed and rectified by the 1N34 crystal diode. The three higher frequency components are bypassed to ground by capacitor C_8 . The lower frequency audio component is unaffected by C_8 and is fed through coupling capacitor C_7 to the grid of an ordinary two-stage amplifier utilizing a 12AT7. The gain of the amplifier, i.e., the loudness of the beat note, is controlled by potentiometer R_4 . The output of the amplifier is fed into a pair of high-impedance phones plugged into jack J_1 .

Using the frequency measurement adapter is quite simple, but there are a few precautions which must be observed to get accurate results. Since the audio signal is a product of the two signals fed into the device, the strength of these two signals will determine the volume of the audio beat note. If either one is weak then it will follow that only a weak beat note can be heard. Thus when using the adapter turn the amplitude control on the signal generator to maximum output.

Similarly, if the unknown signal is coupled very loosely, the beat note heard in the phones will be very weak. The actual physical placement of the pickup loop in relation to the unknown frequency source depends largely on the source. For example, if the source is the oscillator of a broadcast set, the loop can be placed within an inch or so of the oscillator coil. On the other hand, if the unknown source is a transmitter, the loop can probably be placed three feet away and still get enough coupling into the adapter. A little practice with the adapter will tell more than words here.

As with all heterodyne frequency

Bottom view of the adapter unit chassis.

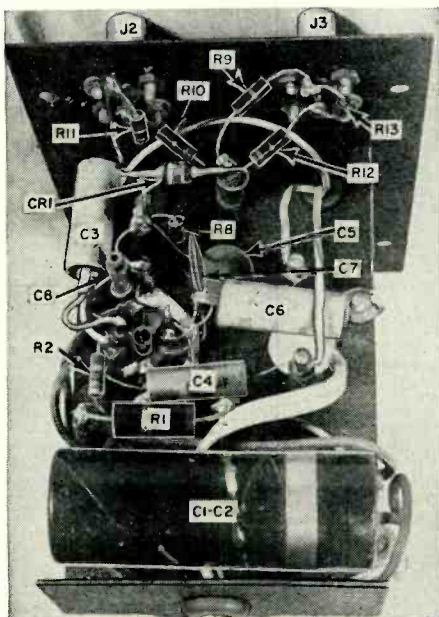

August, 1955

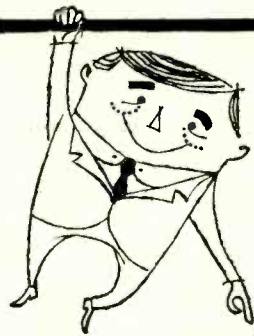

ANNOUNCING!
the
new



HIGH QUALITY
LOW COST
FAIRCHILD 255

25 watt
POWER
AMPLIFIER

Here's a mighty twin to Fairchild's big-power 260 Professional Amplifier. The new 255 delivers a full 25 watts of undistorted power for the finest sound, best reproduction!

This is the ideal power amplifier for the average home or apartment. The Fairchild 255 gives you full power from deepest bass to highest treble, and an instrument especially designed for minimum transient distortion as well as lowest IM and harmonic distortion, resulting in exceptionally true natural sound. Superbly engineered, the 255 has a controlled frequency response of +0 to -1/2 db, from 20 to 20,000 cps. The sound is always right!

You can always restore "new amplifier" performance to the Fairchild 255, even if tubes age unequally, by Fairchild's simple, exclusive distortion-cancelling balance control.

COMPACT: Only 6" x 9 1/2" base and 6 1/2" high

INPUT IMPEDANCE: 100K

POWER GAIN: 42db

HIGH SENSITIVITY: Less than one volt input required for full output

and it's only \$89.50

When you need full 50 watts of power, get the Fairchild 260! **only \$149.50**



8th AVE. & 154th STREET, WHITESTONE, NEW YORK

Terminal Radio

MORE! SOUND VALUES

SUMMER Special!



Model 922

TERMATONE FM-AM RADIO

Incorporates latest features. RF stage on FM for high sensitivity. FM circuit is temperature compensated for minimum drift. Built-in pre-amplifier to permit use of high-fidelity MAGNETIC phono cartridges, and a 3-position equalizer for accurate record playback assure high quality phono reproduction. Tone control • Hum adjustment to balance out residual line-frequency hum • 3.5 watt beam power amplifier delivers excellent audio. Audio Response from 60-13,000 cps. Terminals on rear for any 3.2 or 8 ohm PM speaker. Efficient built-in antennas for AM and FM; Ferrite loopstick plus conventional loop for AM and folded dipole for FM; terminals for outdoor antennas.

Input: Magnetic phonograph. Controls: Off-on-Tone, Volume, Equalizer (LP, AES and European) Function Selector, and Tuning. Handsome gray panel. Easy-to-read, edge-illuminated slide-rule dial. Tubes: 2—6BA6, 6BE6, 6AU6, 6AL5, 12AT7, 6AV6, 12AX7, 6V6GT; 5Y3GT Rectifier. Size: 7 $\frac{3}{4}$ " x 13 $\frac{1}{2}$ " x 10" deep. Auxiliary AC outlet for record player, etc. For operation from 105-125 volts, 50-60 cycles AC. Less Speaker, Shipping wt., 13 lbs. Net **\$49.50**



**SPECIAL
HIGH FIDELITY
UTAH 12"
LOUDSPEAKER
only \$9.95**

Has Special CURVELINER Molded Cone with 8 ohm Voice coil impedance.

6.8 Alnico V Magnet with extremely small voice coil gap gives high sensitivity and handles 12 watts of audio continuously. Clear tone frequency. Response is exceedingly flat and smooth from 40 to 12,000 cps and is down only 5 dB at 15,000 cps. Many customers, visiting our Audio Dept., thought they were listening to a \$50.00 unit when they heard this amazing speaker. Buy now at \$9.95.

Use them in pairs.....2 for only \$17.95

Special quantity prices available for HiFi and PA Dealers Write for quotations.



Unfinished 12"
BASS REFLEX CABINET
Model 7112 SPEAKER CABINET
pre-cut for 12" speaker, $\frac{5}{8}$ " thick select white pine, baffle volume — 6 cut. ft. Acoustically designed, easy to finish. Ideal for Utah Loudspeaker. Net **\$24.00**

Model 8112 SPEAKER CABINET
as above in knock down KIT Form
Only **\$18.00**

Highest Quality
RECORDING TAPE
Red oxide — plastic base — full 1200 ft. reels. Individually boxed, fully guaranteed. A scoop value!
3 reels for only **\$4.98**

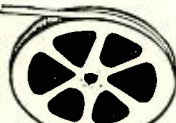

Visit our Sound Studios — ORDER BY MAIL
Send full remittance or 25% on account, balance C.O.D. All prices are FOB our store.

Phone: WOrth 4-3311

Terminal Radio
CORP.

85 CORTLANDT STREET, NEW YORK 7, N. Y.

meters, a beat will be heard at any harmonic relationship between the unknown signal and the signal generator. The loudness of the beat note depends on the amplitude of the harmonics that may be beating together. If the signal generator is harmonic free and the unknown frequency is also free from harmonics, then only one beat note could be heard. However, this is a very unrealistic case. Most service-type signal generators are quite rich in harmonic output. However, since the fundamental frequency signals are much greater in amplitude than their harmonics, it follows that the loudest beat note heard in the earphones will be when the fundamental frequency of the signal generator and the fundamental frequency of the unknown signal are beat together in the adapter. This plus the convenient fact that the frequency of the unknown signal is never truly "unknown" should prevent any real confusion resulting in this manner.

The frequency measurement adapter is coupled to the unknown frequency source by means of a loop at the end of a coax cable. As stated previously, the amount of coupling depends entirely on the strength of the unknown signal. The loop is soldered to a BNC type coax single-hole-mounting chassis fitting. This enables the loop to be changed to fit the physical conditions of measurement. For example, at v.h.f. a smaller loop might be desired to couple into a tight spot in a chassis—such as a TV tuner. Just as conveniently, the loop can be exchanged for a capacity probe to slip into a cavity or waveguide at u.h.f. Then, again, an antenna can be substituted for pick-up from a more distant transmitter. Thus, the frequency measurement adapter can be made to perform in many situations over an extremely wide range of frequencies, the range being limited by the frequency range of the signal generator with which it is used.

Little need be said about the construction of the adapter, since it is quite straightforward. Almost any layout suiting the constructor's fancy can be used. Just keep the grid leads and leads in the r.f. input circuits reasonably short. The layout shown in the photographs can serve as a guide.

Top view of unit with parts identified.

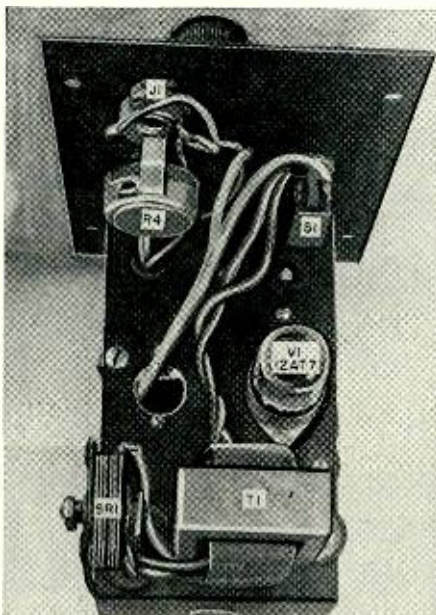

struction of the adapter, since it is quite straightforward. Almost any layout suiting the constructor's fancy can be used. Just keep the grid leads and leads in the r.f. input circuits reasonably short. The layout shown in the photographs can serve as a guide.

-50-

Certified Record Revue

(Continued from page 55)

winds have smooth rather than "breathy" intonation, brass is bright but not weighty and percussion (in the "Divertimento") is cleanly articulate. A very natural "over-all" type of sound, enhanced by the excellent acoustic perspective. Close adherence to the RIAA curve and very quiet surfaces add to a most desirable disc.

PRELUDIOS AND INTERMEDIOS
Orquesta de Camara de Madrid conducted by Ataúlfo Argenta. Montilla LD6, RIAA curve. Price \$4.98.

PRELUDIOS AND INTERMEDIOS
Orquesta de camara de Madrid conducted by Ataúlfo Argenta. London International TW91020. RIAA curve. Price \$4.98.

No, you are not seeing things! This is a prime example of some of the intricate tie-ups that exist in the record business, and how occasionally things can go awry. These are absolutely identical discs as to material, orchestra, and conductor. How come the two different labels? Who stole from whom? Well, nothing like that at all. No connection exists between *Montilla Records* and *London*. But it seems the *Montilla* disc was released in the U. S. first, and then the *Montilla* people sold the rights to the recording to a division of *London Records*, called *London International*. What happened, I don't know. Some of the distribution tie-ups between the different companies border on the fantastic. For instance *HMV* used to sell *Mercury* records in England; *Columbia* and *Victor* were once bedfellows in England under the *EMI* banner, and so on. In any case, the "Music of Spain" can now be had on both the *Montilla* and *London International* labels. Curiously, although the discs were made from the same master, one can detect a slight difference in sound quality. The *London* processing gives a very smooth clean sound, with evidence that the acoustic perspective was somewhat altered from the original. The *Montilla* disc processed in this country (either by *Victor* or *Columbia*) sounds a shade more brilliant and close-to. Sounds like a little mid-range equalization was used. The music itself is derived from eight of the most famous Spanish zarzuelas and is quite interesting. As to which version you would find preferable . . . durned if I know! Maybe you will like the cover design better on one than the other. At any rate, I thought you would find this little mix-up (and the music) quite entertaining.

SCHUMANN CARNAVAL CHOPIN

SONATA #2, OPUS 35
Alfred Cortot, pianist. Victor LHMV 18, RIAA curve. Price \$4.98.

This disc is notable mainly for the splendid piano sound. Which is not to say that the performances are not good. Mr. Cortot does quite well in the main, but it is obvious he is showing his 78 years, with missed notes and a general lack of vigor. His essayal of these difficult works is better than many younger pianists, who have discs in the *LP* catalogue,

RADIO & TELEVISION NEWS

but cannot stand comparison with several others, notably the Novaes/Vox disc. However, many of you will probably forgive Mr. Cortot's occasional falls from grace, for the superb piano reproduction. No harshness or ringing here. Just smooth, "big-boned" piano, with notable lack of wow or flutter. Transients are the bane of much piano recording and it is a pleasure to hear them reproduced so cleanly. Frequency and dynamic range are quite wide and groove distortion was not noticeable. If you want to hear something impressive, listen to the famous "Funeral March" from the Sonata. It never sounded so grim and so big!

ADAM

GISELLE (COMPLETE BALLET)
London Symphony Orchestra conducted by Anatole Fistoulari. Capitol P8306. RIAA curve. Price \$4.98.

The 4th version on LP and the most complete, best performed, and best sounding of them all. Fistoulari has been around ballet scores for a long while and the fluency and easy grace of his performance attests to this familiarity. His pace is just, his dynamic shadings not overblown, and he maintains a superb balance between his various choirs. The reproduction is the best I have heard of the *Capitol International* series. Strings are smooth, brass is nice and bright. Woodwinds are well recorded but lack color in places. Frequency response is broad, but not extreme; dynamics are similar. Little or no pre-echo was present and acoustic environment was reasonable. A very good buy of a standard classic.

BARTOK

BLUEBEARD'S CASTLE
Judith Hellwigh and Endre Kereh, soloists, New Symphony Orchestra of London conducted by Walter Susskind. Bartok 310-311. RIAA curve. Price \$9.96 (two discs).

This is an absolutely fabulous recording. The music is one of the late great Bela Bartok's most thrilling and compelling scores, the performances of all participants are outstanding, and the sound quality is simply phenomenal. I guarantee that those of you who own big, high-quality speaker systems, will be stunned by the fantastic realism of this sound. This realism plus the tremendous emotional content of the score makes for one of the most thrilling musical experiences possible. This quality of course stems from the loving care lavished on every phase of the recording process by Bartok's devoted and dedicated engineer son, Peter. If Peter Bartok's standards of quality prevailed throughout the recording industry, we would have fewer records, that is true, but we would have recordings which could be truly labeled "high fidelity." Which is not to imply that there is no one else turning out recordings as good as those made by Mr. Bartok, for there are many, but few have achieved his stellar results consistently. The odd thing about this recording is that there is very little of the so-called spectacular hi-fi effects which seem out of place here. One is not conscious of a striving for an effect, yet the blast and impact of the bass drum in this recording is quite the most impressive I have ever heard. The same may be said of the high percussion, the organ and even the voices! I think a large part of the answer lies in the extraordinary acoustic perspective with which Mr. Bartok clothes his recording. I have never believed in the pursuit of that elusive will-o-the-wisp, "concert hall sound." Even with stereophonic techniques, it just ain't the same animal. Actually (and if this be blasphemy, sue me) really high quality recorded sound can be better than what is heard from the average seat in the average concert hall! I feel like this, and yet I must admit that this

August, 1955

-THE All New Gun

DESIGNED FROM SCRATCH FOR SERVICE MAN'S REQUIREMENTS

#199



Ideal for 90% of your work

"Quick-Hot" Electronic Soldering Gun

WORKING
IN 2-3
SECONDS

GET THE FEEL OF IT

HEFT IT—TRY IT

You'll know at once

that here is a "right" product—built to work well for years.

- Lightest
- Smallest
- Longest reach
- Longest life
- Most dependable

**OF ALL TRANSFORMER TYPE
SOLDERING GUNS**

You have the satisfaction of knowing when out on the job with this gun that it won't burn out. There'll be no "down" time—no return to the shop for repairs.



LIGHT, HANDY New Model #199

New patented design delivers AMPLE heat fast on 110-120 V. A.C. 60 cycle, 1.1 Amp. Max. Cools quickly too. It's light, (1½ lbs.)—handy, beautifully balanced and smaller—to slip readily into tool kit or pocket. Molded red plastic handle and case. Gun made to withstand

HUNDREDS OF HOURS CONTINUOUS OPERATION

Almost indestructible in ordinary use. New type, steel, extra long reach tips readily replaceable and interchangeable with special purpose tips. Gun fully guaranteed. And that PRICE

Only \$7.95 LIST

FOR HEAVY DUTY you want

the famous **WEN** MODEL #250

Greater volume of heat obtained solders relatively heavy materials. 567 hours continuous operation. Fully guaranteed. Retail \$12.95.



PRODUCTS, INC. CHICAGO 31, ILL.

(Export sales, Scheel International, Inc., Chicago)



**NEW! THE ONLY
COMPLETE BOOK ON
TELECASTING!**
covers every phase

"Principles & Practices of
**TELECASTING
OPERATIONS**"

by HAROLD E. ENNES



**600 PAGES
OF PRACTICAL
INFORMATION
for everyone
interested in
TELECASTING**

Indispensable to the
Engineer, Production Man,
Director, Technician, and
to all Students of
the Video-Audio Art

top reference
on Telecasting

CONTENTS:

A Partial List of Authoritative Chapters:
Basic Telecasting Equipment; The TV Camera;
The TV Control Room; Fundamentals of
TV Studio Lighting and Equipment; Network
Program Relay Systems; TV Operational and
Maintenance Practices; Technical Production
of TV Shows; Field Equipment and Micro-
Wave Relays; Analysis of Video and Audio
Transmitting Plants; Technical Definitions
— PLUS HUNDREDS OF OTHER SUBJECTS

Here, in one complete, easy-to-understand volume is the whole fascinating story of Telecasting operations. Whether you are a Chief Engineer, Production Director or Technical Director; if you are now working in or planning to work in TV, or if you are simply interested in Telecasting, this book is meant for you. Here is practical, useful information that makes you familiar with the equipment and techniques used in Telecasting, tells you *everything*—answers all your questions about TV production and transmission. If you work or are interested in Telecasting, you'll want this vast wealth of reliable information—you'll want this book in your library. Order your copy today!

600 Pages, 450 Illustrations
6" x 9"
Hard Covers **\$795**

**ORDER
TODAY!**

Order from your electronic parts distributor or bookstore, or write direct to Howard W. Sams & Co., Inc. 2203 E. 46th St., Indianapolis 5, Ind.

My (check) (money order) for \$..... enclosed. Send the following:.....copy(ies) of "Telecasting Operations" (\$7.95 per copy).

Name.....

Address.....

City.....State.....

recording comes as close to capturing "concert hall sound" (with a few plus factors of its own) as I've ever heard. Space does not permit me to expound further the virtues of this recording, but let me say this; even if you can't stand Bartok's music, nor speak a word of Hungarian, or you have a complete antipathy to opera or other vocal/orchestral material, don't let that deter you from listening to this outstanding example of recorded music.

**WEBER
INVITATION TO THE DANCE
ENESCO
ROUMANIAN RHAPSODY #1
PROKOFIEV
WEDDING SUITE (FROM STONE
FLOWER)**

New York Philharmonic Symphony Orchestra conducted by Andre Kostelanetz. Columbia ML4957. Old NARTB curve. Price \$3.98.

The prize on this disc as far as I am concerned is the record premiere of the Prokofiev work. This is supposedly the last complete work Prokofiev composed before his death. No particular inferences can be drawn from it as to whether it was written under subservience to political ideology. It is an interesting work which bears Prokofiev's indelible imprint in the orchestration, although the use of more "oriental" coloration in some sections might lead one to suspect that had Prokofiev lived, he was about to embark on some new musical trend. I do not know the score, so any comments on the performance would be superfluous. Mr. Kostelanetz, who can wield a mean baton when he wants to, seems to have all the notes in their right places. Hi-fi fans will like it for the colorful effects obtained. Kostelanetz gives an energetic (perhaps frenetic would be better) reading of the much-played "Roumanian Rhapsody" and does a good job on the Weber piece, not schmaltzing it up as you might expect. Soundwise this is one of the best of recent *Columbias*. The strings still have that typical Kostelanetz edginess, but are not objectionable, the other instruments have good definition and the engineers have not gone overboard on the reverb. Pre-echo still *Columbia's* outstanding problem. The NARTB curve was better with a slight treble cut. Good surfaces.

**DE FALLA
NIGHTS IN THE GARDENS OF
SPAIN
HOMENAJES**

Aldo Ciccolini, pianist with Orchestre de la Radiodiffusion Francaise conducted by Ernesto Halfter. Angel 35134. RIAA curve. Price \$4.98.

The 5th version of the "Nights" on LP and the premiere of the "Homenajes" (Homages) make this a worthwhile coupling. The Ciccolini technique is shown to good advantage in the "Nights," but in spite of this excellent technical facility he insists on dragging tempi, and the work loses much of its effectiveness. Aside from this fault this must be reckoned, if only on the basis of sound alone, as the most desirable version available (or perhaps I should reserve judgment as I understand there is to be a new *London International* disc of the work very soon). The piano is clean-lined, very liquid in sound, virtually no ringing. No wow or flutter was apparent, although my copy was slightly eccentric and exaggerated some of the holds with longer decay periods. I do not know the conductor, Halfter, but he must be complimented on maintaining a good balance between piano and orchestra and for resisting the temptation to jazz up the dynamics of this work as so many of his contemporaries are wont to do. He also plays the game fairly straight in

the "Homages." This is one of De Falla's last works and is an interesting set of four pieces, each dedicated to a composer or mentor he had known or admired. Hi-fi fans will appreciate the first one, "Arbos" more than the rest, as it is most colorfully orchestrated with trumpets, trombones, and percussion. The sound in both works is wide range, distortion-free, and has excellent acoustics. A good buy for those who did not like some of the earlier couplings of the "Nights," with such diverse bedfellows as Mozart and Greig, etc.

**SMETANA
THE HIGH CASTLE
THE MOLDAU
MOZART
SYMPHONY #38 (PRAGUE)**

Chicago Symphony Orchestra conducted by Rafael Kubelik. Mercury MG50042. RIAA curve. Price \$4.98.

This is a recoupling of works from two previous *Mercury* albums. The Smetana material is taken from the monumental "My Fatherland" and combines the ever popular "Moldau" with the lesser known, but stunningly scored "High Castle." The scoring is very thick-textured and makes an almighty sound when heard on big systems at good levels. If you crave the rich deep power-laden bass line, this is for you! The wonderful Mozart is taken from the earlier disc where it shared honors with the #34 in C. This is still one of the best performances of the work extant, and still has no competition in matters of fidelity of sound. Watch your gain on the "Moldau" . . . the dynamic range is terrific.

**DEBUSSY
THE MARTYRE DE SAINT SEBAS-
TIEN**

Suzanne Danco, soprano; Nancy Wough, contralto; Lise de Gontmollin, contralto; Union Chorale de la Tour-de-Peils with L'Orchestre de la Suisse Romande conducted by Ernest Ansermet. London LL1061. RIAA curve. Price \$4.98.

It is amazing how few people know this Debussy work. Written as incidental music to a mystery play by Gabriele d'Annunzio, it is one of the most profoundly beautiful of all Debussy works. If you have never cared for choral works, operas, and other material of a vocal nature, I strongly urge you to listen to this. If you are at all musically minded, you will not be able to resist its blandishments. In this recording you will find Debussy at the top of his form in the writing of his ethereal, other-worldly type of music. Some of the most lovely melody is combined here with choral outpourings of great strength and character. There has been one previous recording on the old *Allegro* label. Victor Allesandro and his Oklahoma City Symphony cohorts did an excellent job on that disc but they are no match for the superbly trained chorus and orchestra conducted by that Debussy champion, Ernest Ansermet. However, in the soprano role, the *Allegro* effort had the services of one Frances Yeend, a young lady with remarkable talent. She has her counterpart in this recording with the illustrious Suzanne Danco. Miss Danco has the better trained and purer voice, but I still find myself liking the more dramatic expressiveness of Miss Yeend. This is really splitting hairs, because this entire production is quite superb from every aspect. The sound is quite remarkable, especially in the choral sections. As heard through two speakers, the articulation and phrasing is so clean, it sounds almost binaural. Ansermet has outdone himself in achieving some fabulous choral/orchestral textures and these are heard with ultra-wide range and impressive

dynamics. The only barb I can throw is the old bug-a-boo of pre-echo which seems to be plaguing everybody. A minor fault in a recording which gave me a great deal of pleasure to review and which will command the attention of my ear frequently. My recommendation is to try it for yourself.

Tape Reviews

Herewith are a few of the new *AV-Vanguard* tape recordings I spoke about earlier in the column.

BACH

CANTATA #78
CANTATA #106

Choir and Orchestra of the Bach Guild conducted by Felix Prohaska. AV-1037. 7½ ips, dual track, Approx. 1 hr.

Choral music, something which has always been pretty miserable on pre-recorded tape is finally heard with high-fidelity sound. Of course, to begin with, the *Bach Guild* has been noted for turning out some very superior discs of Bach cantatas, so the fact that the tape is good is not too surprising. A comparison with the disc reveals that the tape has certain distinct advantages over the disc. Probably the most immediately apparent are the extended frequency response and the vastly superior dynamic range. Good as many cutters are, and good as many phono pickups are, you just can't commercially cut a disc and expect to equal the dynamic range of a good tape. Another rather noticeable feature is the excellent transient response, in this case unlimited by the restrictions of groove cutting. These and other more subtle factors are convincing evidence on behalf of tape. The voices on the tape have a brighter, more natural sound, the instrumental definition is greatly enhanced. For instance, the characteristic hoarse "breathiness" of the Elizabethan recorder is much more discernible and truer than on the disc. A little choral blast and fusion was the only distortion throughout the tape, and of course this occurs in the disc as well. The signal-to-noise ratio was at sufficiently high levels, so that background tape hiss was not noticeable. All in all, this is one of the most "hi-fi" sounding tapes I have yet to hear from a commercial source.

SIR CHARLES THOMPSON SEXTET
"Sir Charles," pianist, and his sextet. AV-702. 7½ ips, Approx. ½ hr. Price \$7.95.

Jazz comes in for its share of the glory in these new tape releases. This is from the highly successful Jazz Showcase Series on *Vanguard*, and features a red hot crew gathered around Sir Charles on the piano. This tape will really make you jazz aficionados flip! This is the first time I've heard a commercial tape that sounded as good and "live" as the prime stuff we get at recording sessions. Recorded close-to, but with a little reverb treatment, the various instruments are heard with precise accurate intonation. The sax has that mellow resonant liveness of a "live" session, the trumpet and trombone are nice and gummy, bright and boisterous. The clean sharp articulation of the traps is really something to hear as well as the solid thud of the bass fiddle. Sir Charles' piano is properly percussive with clean transients. The dynamics and frequency response are far ahead of comparable material on discs and we aren't bothered with pre-echo at all! Through a high class speaker system, this tape sounds like the real thing, and I predict its happy usefulness as a demonstration special.

I'll review more of these new tapes as I receive them, and now that the sound quality seems to be well established, pay attention to the musical values as well. So brace yourselves, there is more to come.

August, 1955

your KEY
TO EXCELLENCE
phastron

"555"

metal-cased MULTIMETER

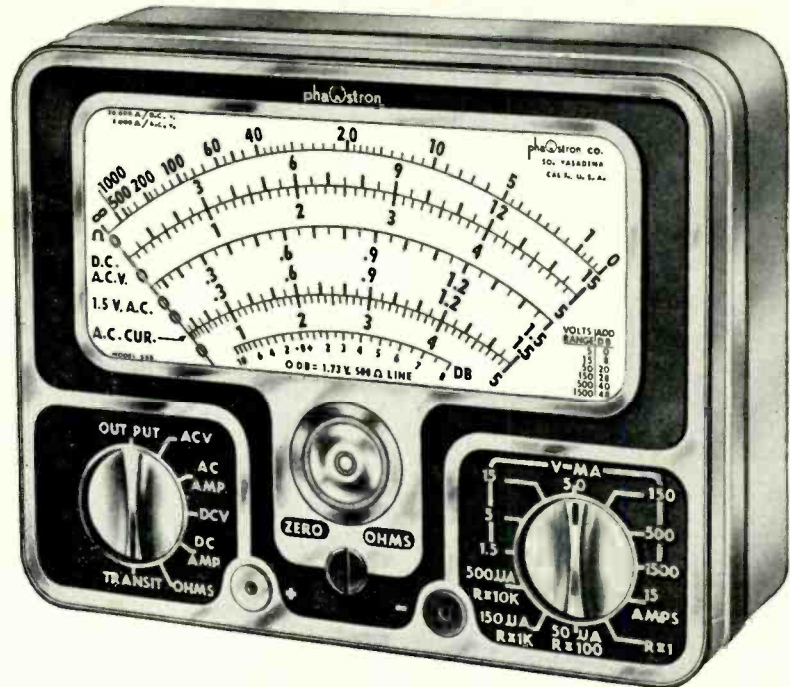

POCKET SIZE WITH A 4 7/8" LENGTH SCALE
an instrument of **PERMANENT ACCURACY**
in a case that **WON'T BREAK**

- ✓ AC CURRENT RANGES
- ✓ SEPARATE RANGE & FUNCTION SWITCHES
- ✓ SIMPLICITY . . . ONLY 2 JACKS
- ✓ EASY-TO-READ, LARGE 4 COLOR SCALES
- ✓ 43 UNDUPLICATED RANGES
- ✓ MAGNETIC SHIELDING
- ✓ 3% DC, 4% AC PERMANENT ACCURACY

Accessories Available

GENUINE LEATHER CARRYING CASE \$5.95

PANEL MOUNTING ADAPTER \$1.50

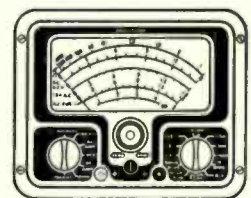
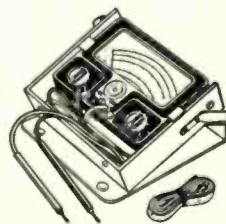

"555" MULTIMETER

\$39.95 complete with probes and batteries
at your **PARTS DISTRIBUTOR**

PHASTRON COMPANY 151 PASADENA AVE., SOUTH PASADENA, CALIF. U.S.A.

SUMMER SPECIALS

SMALL MOBILE DYNAMOTORS

PIONEER GEN-E-MOTOR

5.5 to 6 Volt DC input. Output 400 Volt @ 175 ma cont. or 275 ma intermittent duty complete with A and B filters **\$19.95**
 Same as above with 11.5 to 12 Volt DC input. **\$17.95**

DB METER

2" Bakelite Case, Panel Meter. 600 Ohm imped. range -10 to -6 DB. **\$3.95**

THORDARSON FIL. TRANSFORMER
 110 V. 60 Cy. Pri. Secondary
 6.3 V. @ 10 amps. SPECIAL **\$1.45** ea.

WESTON MODEL 506

2" Round, Bakelite Case, Panel Meter. 100-0-100 Microamperes **\$4.95** ea.
 DC

OIL CONDENSER SPECIALS BRAND NEW

4 MFD 600 VDC \$.75	10 MFD 1400 VDC \$2.50
8 MFD 600 VDC .95	2 MFD 2000 VDC 1.50
10 MFD 600 VDC 1.19	4 MFD 2000 VDC 3.50
1 MFD 1000 VDC .60	1 MFD 3000 VDC 1.85
2 MFD 1000 VDC .85	3 MFD 4000 VDC 5.95
4 MFD 1000 VDC 1.25	5 MFD 330 AC 1.10
8 MFD 1000 VDC 1.50	5 MFD 660 AC 1.95
6 MFD 1500 VDC 1.95	8 MFD 660 AC 2.50

1" MINIATURE METER

Mounts in a 1" hole like a Pilot light. Basic movement 0-10 mils. Can be shunted to any milliamp. range. Manufactured by International Inst. Co.
SPECIAL 0-10 mils. **\$3.95**
 5-0-5 mils. **3.95**

PANEL METERS

Gov't Surplus, G.E., Westinghouse, Western Electric, Simpson, Etc.

2" METERS

0-100 Microamps. \$5.95
0-1 mil. 3.95
0-1 1/2 mil. 2.95
0-50 mil. 2.95
0-300 mil. 2.95
0-9 amps RF. 2.95
0-300 Volts AC. 3.95

3" METERS

15-0-15 mil. \$3.75
0-15 Volts AC. 3.95
0-15 amps DC. 2.95
0-50 mls. 3.95
0-200 mls. 3.95
25-0-25 Volts (basic 1 mil)
0-150 Volts AC. 4.50
0-150 Volts AC Rect. type 6.50

WESTINGHOUSE METER SPECIAL

Type NX35, 3" round bakelite case.
 0-300 MA DC. **\$4.75** ea.
 0-500 MA DC. **4.75** ea.
 (2 FOR \$8.95)

POWER SUPPLY SPECIAL

Completely wired with 80 MFD filter, choke, 120 mil. transf., fuse, 6Y3 tube, humbucking pot. Input 110 Volts AC 60 cy. Output 300 Volts @ 100 mils. Fil. voltage 6.3 @ 4 amp. Made by FAIRCHILD RECORDING CO. Suitable for pre-amp., VFO or speak-amp. LIMITED QUANTITY. A BARGAIN AT. **\$6.95**

ADVANCE ANTENNA CHANGEOVER RELAY—110 V. 60 cy coil DPDT. 3rd add'l contact n.o. Isolantite insul. Ea. **\$2.95**

G. E. RELAY CONTROL

(Ideal for Model Controls, Etc.)

Contains a sigma midget 8,000 ohm. relay (trips at less than 2 MA), high impedance choke, bi-metal strip, neon pilot and many useful parts. The sensitive relay alone is worth much more than the total **\$1.25** Each 10 for **\$9.90**
 low price of.

NON-INDUCTIVE RESISTORS

Glober 9 ohm 100 watt. 6 for. **\$1.45**
 Ohmite wire wound 250 ohm 100 watt **59c**
 Each
 5 for. **\$2.50**

READ 'N' SAVE BARGAINS

500 mmf ceramic condensers. 10 for .50
 15V AC relay SPST 15 Amp contacts. 1.75
 .01 mmf. 1000 VDC Micacs. 5 for .95
 .0004 2500 VDC Micacs. 5 for .95
 .04 600 V Micacs. 5 for .95
 100,000 ohm, 100 Watt resist.45

Min. Order \$3.00—25% with Order—F.O.B. New York.

PEAK ELECTRONICS CO.

66 West Broadway, New York 7, N. Y.
 Phone WOrth 2-5439

1955 G-E Test Points

(Continued from page 42)

to the a.g.c. which is fed to the first video i.f. amplifier and also (through a front-panel area switch) to the r.f. stage of the tuner. The a.g.c. voltage is derived entirely from the second detector; hence, a v.t.v.m. at test point II will serve as a relative signal strength indicator.

The usual germanium diode is employed as a second detector, followed by a 12BY7 video amplifier. The 4.5 mc. audio is picked off at the output of the 12BY7 through a double-tuned 4.5 mc. transformer and fed to the audio section. Composite sync is also picked off at the 12BY7 plate circuit and fed to a 6CS6 which operates as a combination noise canceller and clipper. A three-position front-panel area control switch varies the bias voltage on the control grid of the 6CS6 to prevent sync pulse clipping on strong signals. A second section of the switch also applies a.g.c. voltage to the tuner in the "local" position to prevent overload in this section of the receiver. Test point VII is tied directly to the plate of the 6CS6 and is very useful for checking clipper action by an oscilloscope. A .01 µfd. or larger capacitor should be used in series with the scope lead to this test point to block off the 130 volts d.c. which is present.

One-half of a 12AU7 inverts the sync pulse from the 6CS6 for application to the 12BH7 vertical oscillator output stage. If it becomes necessary to improve the vertical sync stability, connect a 100,000 ohm, 1/2 watt resistor from the screen grid (pin 6) of the first video i.f. tube to ground, using the shortest lead possible. This re-

duces the screen voltage and prevents any tendency toward sync compression in this stage.

The horizontal deflection section employs one-half of a 12AU7 as a phase detector which, in turn, controls a 12AT7 cathode-coupled multivibrator. Test point VI is useful, as indicated in Table 1, to set the optimum operating conditions of the oscillator circuit by means of the rear apron horizontal stabilizer control. The remainder of the horizontal circuit is conventional and uses a 6BQ6GA horizontal output stage, 6AX4GT damper, and 1B3GT high-voltage rectifier.

The low-voltage supply is also conventional, employing the usual power transformer and 5U4GT rectifier.

Fig. 3 is a block diagram of the "K" chassis, including tube line-up and block location of the eight designated test points. Table 1 indicates the exact location of each test point in the circuit, the normal voltage or waveform found at each test point, and the various ways in which the test point can be used for troubleshooting, measuring, aligning, etc.

It is important to note that voltage and waveform indications given for a normal signal require that the receiver be tuned to a station and adjusted for normal brightness, sync, contrast, and sound. Obviously, if the receiver has failed, all of these conditions cannot always be met. In this case, the operating controls should be set in the approximately correct position. The three position front-panel area switch should be set in the appropriate position to prevent signal overload, otherwise erroneous waveforms may result in the video and sync circuits.

A study of Table 1 will show that some test points serve many functions; for example, the second detector point,

Fig. 3. Block diagram of the "K" chassis showing where each of the test points is located in the over-all circuit. Other picture tubes besides the 21YP4 are used.

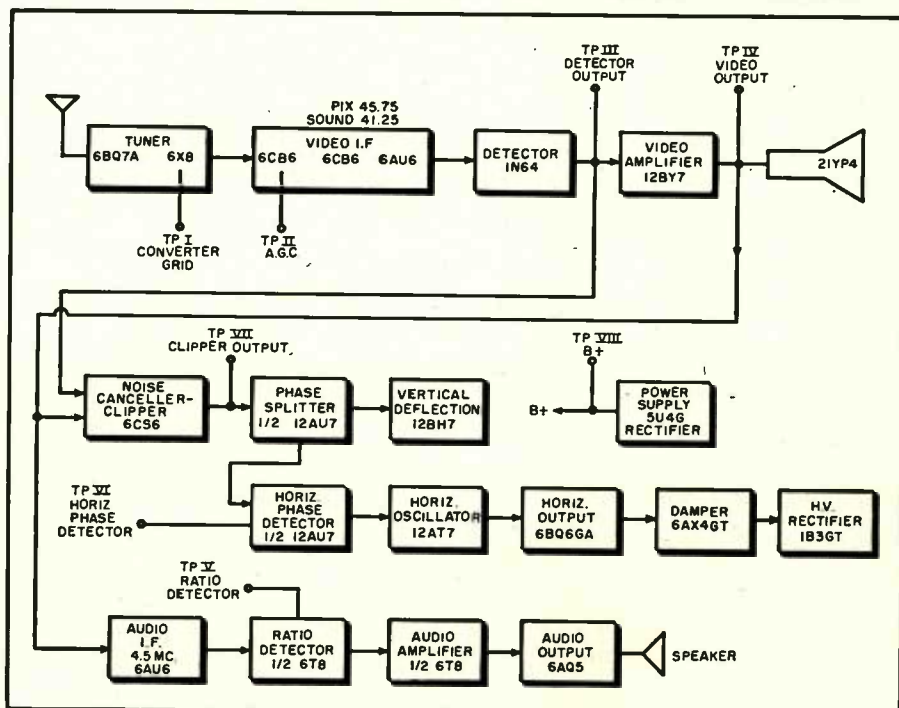

test point III, can be used for signal tracing, for oscilloscope connection, for AM trap and sweep alignment, and for signal injection to test the video amplifier. Although space limitations prevent listing all possible uses of designated test points, the experienced technician will no doubt be able to add to the practical uses that can be made of these points as his experience grows. -30-

OLOFSSON WINS NATIONAL COMPANY CONTEST

CURT OLOFSSON of San Francisco has been named winner of National Company, Inc.'s international amateur contest in which hams were asked to submit their ideas as to the features that an "ideal" amateur receiver should embody.

Thousands of hams around the world submitted suggestions for the receiver since the contest opened last October. Monthly prizes of NC-88 receivers were awarded to Richard R. Pugh of Johnstown, Pa.; Laurence P. Monohan, Ann Arbor, Michigan; Mel E. Buechel, Chicago, Ill.; and Bernard H. Zweifel, Lausanne, Switzerland.

Mr. Olofsson, who topped the field, was awarded the grand prize of a \$1000 ham shack which included a National HRO Sixty with matching speaker, a transmitter with semi-automatic key, a microphone, and a rotary antenna.

He is a member of the Brass Pounders League and received his Advanced Class License in May 1952.

As a result of the amateurs' suggestions, the company is now designing a "dream" receiver incorporating the "most-wanted" features. -30-

TRI-STATE AMATEUR RADIO SOCIETY HAMFEST

THE Tri-State Amateur Radio Society will hold its 9th annual Hamfest on Sunday, August 28th at Bowers Grove, located 8 miles north of Evansville, Ind., and 2 miles west of "Grumpy Pals" on highway 41. Transmitters on 10 and 75 meters will direct comers to the grounds.

Registration fee is \$2.50 per person. For other information, contact Callie Jones, W9UHV. -30-

For **SATISFIED CUSTOMERS**
and **PROFITS too!**

INSTALL

Mosley

TV ANTENNA
ACCESSORIES



Wall-Thru

Cat. No. 625
List Price \$1.95

- New, improved tube is semi-flexible - bends without breaking for easy insertion into wall openings drilled out of line!
- Neat, Convenient, Efficient! Appeals to ALL TV Owners because it's Practical!
- A Sure-Fire Profit Maker For TV Installers!

Ask your Parts Jobber or write direct for your Free copy of the new MOSLEY Catalog 54-55.

MOSLEY ELECTRONICS, Inc.
8622 St. Charles Rock Rd., St. Louis 14, Missouri

August, 1955

RCA INSTITUTES



HOME STUDY COURSE
trains you in the "why" and "how"
of Color TV Servicing

Study Color Television Servicing from the very source of the latest, up-to-the-minute Color TV developments. Train under the direction of men who are experts in this field. Take advantage of the big future in Color TV through RCA Institutes' Home Study Course, which covers all phases of Color Servicing. It is a practical down-to-earth course in basic color theory as well as how-to-do-it TV servicing techniques.

This color television course was planned and developed through the efforts of instructors of RCA Institutes, engineers of RCA Laboratories and training specialists of RCA Service Company. You get the benefit of years of RCA research and development in color television.

Because of its highly specialized nature, this course is offered only to those already experienced in radio-television servicing. Color TV Servicing will open the door to the big opportunity you've always hoped for. Find out how easy it is to cash in on Color TV.



SEND FOR FREE BOOKLET
NO SALESMEN WILL CALL

RCA INSTITUTES, INC.
A SERVICE OF RADIO CORPORATION OF AMERICA
350 WEST FOURTH STREET, NEW YORK 14, N.Y.



DEPT. RN-8-55

Without obligation on my part, please send me a copy of your booklet on the Home Study Course in Color TV Servicing.

NAME _____

ADDRESS _____

CITY _____ ZONE _____ STATE _____



THE NEW
PRECISION MODEL **120**

GIVES YOU WHAT YOU WANTED
IN A
**HIGH SENSITIVITY
MULTI-RANGE TEST SET**

20,000 OHMS PER VOLT D.C.
5,000 OHMS PER VOLT A.C.

The '120' gives you . . .

- ✓ MORE RANGES
- ✓ AN EXTRA-LOW RESISTANCE RANGE
- ✓ AN EXTRA-LOW VOLTAGE RANGE
- ✓ AN EXTENDED LOW CURRENT RANGE
- ✓ A LARGER METER SCALE FACE
- ✓ SIMPLE, POSITIVE RANGE SELECTION
- ✓ POSITIVE CONTACT JACKS and PLUGS

Compare These Wide Spread Ranges
and Special Features:

- ★ 8 DC VOLTAGE RANGES: 20,000 ohms per volt.
- ★ 8 AC VOLTAGE RANGES: 5,000 ohms per volt. 0-1.2-3-12-60-300-600-1200-6000 volts.
- ★ 8 AC OUTPUT RANGES: same as AC volt ranges. Built-in 600 volt blocking capacitor.
- ★ 7 DC CURRENT RANGES: 0-60-300 Microamperes. 0-1.2-12-120-600 Ma. 0-12 Amperes.
- ★ 5 RESISTANCE RANGES: self-contained. 0-200-2000-200,000 ohms. 0-2-20 megohms.
- ★ 8 DECIBEL RANGES: -20 DB to +77DB. 0 DB = 1 Milliwatt, 600 ohms.
- ★ EXTRA LARGE 5¼" RUGGED 'PACE' METER: 40 microamperes sensitivity, 2% accuracy.
- ★ 1% MULTIPLIERS and SHUNTS: Wire-wound and deposited film types.
- ★ TWO JACKS SERVE ALL STANDARD RANGES: Separately identified and isolated jacks provide for extra high ranges.
- ★ "TRANSIT" SAFETY POSITION on range selector protects meter during transport and storage.
- ★ CUSTOM-MOLDED PHENOLIC CASE and PANEL: Compact, laboratory styled Instrument.

MODEL 120... complete with internal ohmmeter batteries, banana-plug test leads and detailed operating manual. Overall case dimensions, 5¼ x 7 x 3¼" Net Price \$39.95

PRECISION APPARATUS CO., INC.

70-31 84th Street, Glendale 27, L. I., N. Y.
Export: 458 Broadway, New York 13, U. S. A.
Canada: Atlas Radio Corp., Ltd., 50 Wingold Ave., Toronto 10

"VITASCAN"*

for Color TV

A flying-spot scanner with
phototube pickup simplifies
color TV studio equipment.

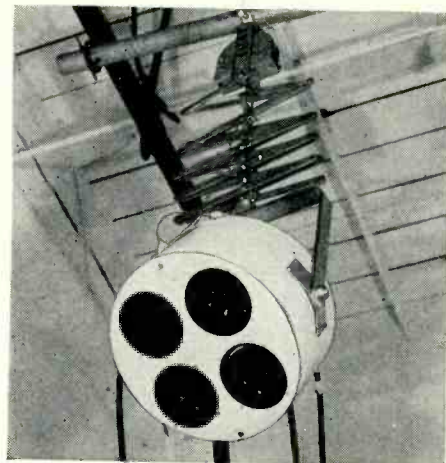

Fig. 1. One of the clusters of photomultiplier tubes used in the "Vitascan" system. Four tubes are employed in each cluster.

COLOR television was given another boost recently with the announcement of the *Du Mont Vitascan Color Studio Scanner*. The *Vitascan* utilizes a beam of light from a cathode-ray tube "flying spot scanner" to scan persons, objects, or action and then picks up the reflected scanned light by means of photomultiplier tubes. These tubes convert the light into an electrical signal which may be passed on to a regular standard color transmitter for broadcast.

Color pictures produced by this equipment are electronically identical with standard color pictures produced by other methods, and result in a standard NTSC color signal. Therefore, any regular color studio or transmitter equipment may be used to broadcast the signal.

The *Vitascan* principle can best be described as a conventional television pickup system in reverse. Here the light source is a flying-spot cathode-ray tube which develops an extremely bright raster—much brighter than that in cathode-ray picture tubes used in

television sets. This light source replaces the camera in a conventional pickup system.

Light from the flying-spot tube is directed by means of a mirror and lens system into the studio and onto the scene being televised and focusing is accomplished in much the same manner as with a regular camera. As this light travels over the scene, point-by-point and line-by-line, it is reflected at each instant from the point on which it is shining. This reflected light is picked up by clusters of photomultiplier tubes which are arranged in groups of four throughout the studio.

To separate the light into three primary colors, the photomultiplier tubes are equipped with selective filters which allow only the desired color to pass. In each cluster of four tubes, one is equipped with a green filter, one with a blue filter, and two with red filters. Two are used for red because the light source is deficient in this end of the spectrum and the phototubes are less sensitive to red than to the other colors. The photomultiplier tubes convert the three colors into electrical signals, amplify these

* Trademark registered by Allen B. Du Mont Laboratories, Inc.

Fig. 2. Proposed studio layout employing the "Vitascan" system. A fixed or portable flying-spot scanner may be used, with a number of "scoops" arranged throughout the studio. General illumination is provided by synchronized stroboscopic lights.

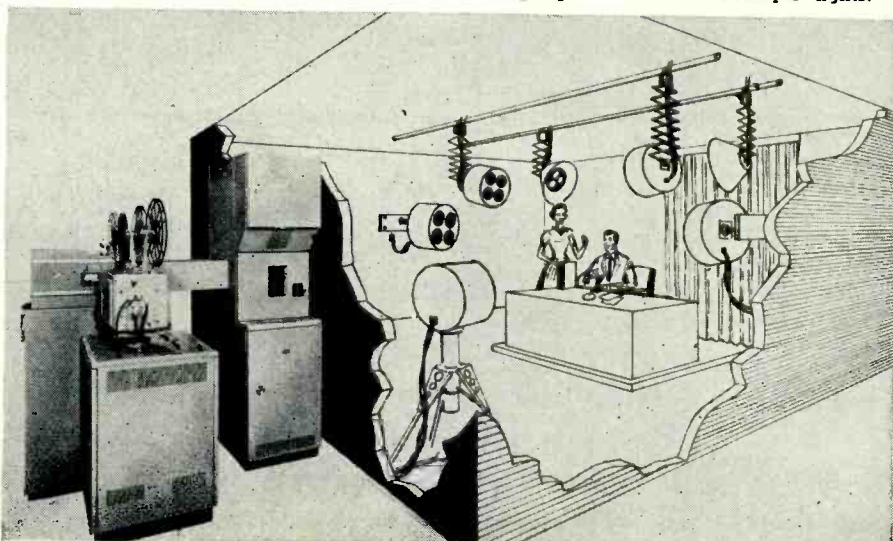

signals many thousands of times, and pass them on to conventional color transmitting equipment.

Color registration is no problem with this system, because the scanning operation has already taken place before the light is split up into its three colors.

Since the *Vitascan* system operates by picking up reflected light from the object being scanned, the light source must be rigidly controlled and very little ambient or stray light can be allowed to reach the pickup tubes. Such light would cause "noise" in the picture. Thus, there is no longer any necessity for the heavy lighting load now required in color television studios. Actors and actresses perform in much greater comfort, and the air-conditioning load is reduced tremendously.

However, some studio lighting is necessary, because the light from the flying-spot scanner is insufficient for normal illumination. To solve this lighting problem advantage is taken of the vertical retrace blanking period, when the flying-spot scanner is blanked out. Stroboscopic studio lights are employed, and are synchronized with the system in such a manner that they flash on only during blanking periods and are turned off when scanning is taking place. In this way, over-all studio illumination is achieved without interfering with the scanning process. Intensity of this illumination can be adjusted to any value.

As mentioned before, several groups of photomultiplier tubes are employed in a studio. Each group of four is assembled into a "scoop" or "bucket," as shown in Fig. 1. The outputs of these scoops are fed to a central control panel, where they are mixed in the proper proportions to produce the desired picture.

These scoops perform a function very similar to that of studio lights used with conventional equipment. In other words, most of the various lighting effects can be obtained by proper scoop location and orientation, and by mixing the scoop outputs in the correct proportion.

Vitascan is expected to fulfill the urgent need of TV stations throughout the country for a dependable means of originating their own live color programs and commercials at minimum expense. In addition, it provides an easy, inexpensive method for producing live closed-circuit telecasts in color, such as televising of sales meetings. The equipment may also be used as a monochrome pickup for black-and-white studio programs, thus providing standby facilities for stations having a limited number of cameras.

Du Mont emphasizes that this system is intended to be an invaluable supplement to live color pickup equipment, and should not be compared point-by-point with conventional TV. Each has its own advantages. *Vitascan* uses a controlled light source; therefore, in its present form, it is not intended for use where light cannot be controlled.

-30-

August, 1955

Apply Your Electronics Experience

ENGINEERS AND
PHYSICISTS WITH
ELECTRONICS TRAINING
ARE NEEDED TO
CONDUCT CLASSROOM
AND LABORATORY
PROGRAMS ON ADVANCED
SYSTEMS WORK IN THE
FIELDS OF RADAR FIRE
CONTROL, ELECTRONIC
COMPUTERS, GUIDED
MISSILES.

The proper functioning of the complex airborne radar and computer equipment produced by Hughes requires well-trained maintenance crews in the field.

At Hughes Research and Development Laboratories in Southern California engineers assigned to this program are members of the Technical Staff. As training engineers they instruct in equipment maintenance and operation for both military personnel and field engineers.

Prior to assignment, engineers participate in a technical training program to become familiar with latest Hughes equipment. After-hours graduate courses under Company sponsorship are available at nearby universities.

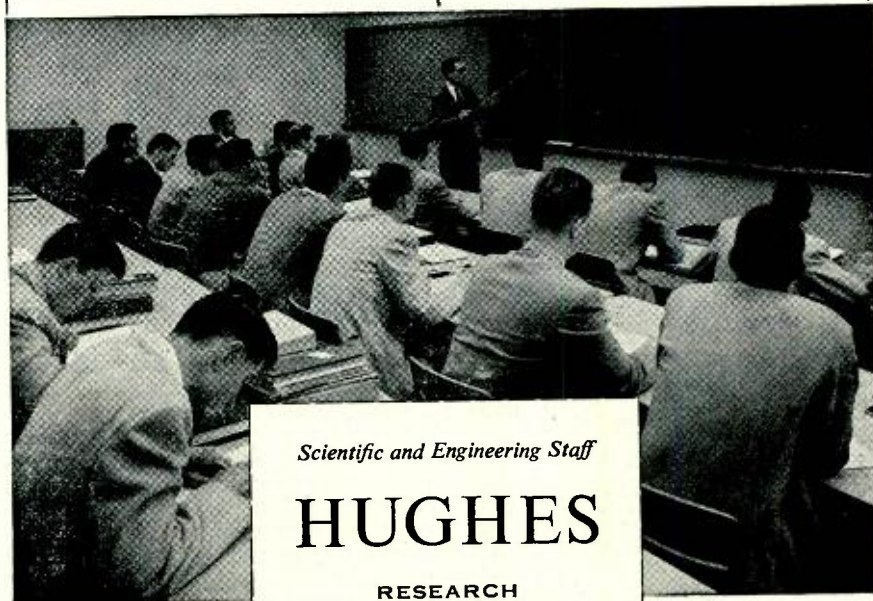

Scientific and Engineering Staff

HUGHES

RESEARCH
AND DEVELOPMENT
LABORATORIES

Culver City, Los Angeles County, California

*Movie Screen Brightness
for Your TV Picture*

Magic
Mirror

TUNG-SOL

**Aluminized
PICTURE TUBE**

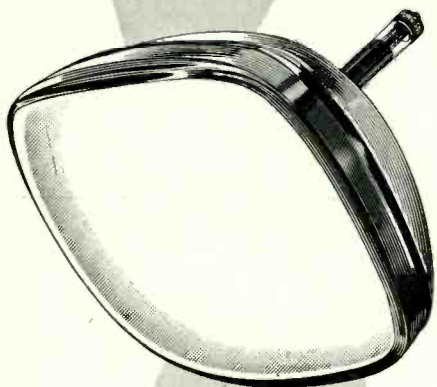

Yes, you can have a sharper, clearer TV picture . . . a picture with all the depth and detail you enjoy on the movie screen.

The Tung-Sol "Magic-Mirror" Aluminized Picture Tube gives you deeper blacks, more brilliant highlights and in-between tones that will make your picture fairly come alive. So treat yourself to new TV viewing pleasure with a Tung-Sol "Magic-Mirror" Aluminized Picture Tube.

The finest TV sets are factory-equipped with receiving and picture tubes made by Tung-Sol —one of America's leading electron tube manufacturers.

TUNG-SOL ELECTRIC INC., Newark 4, N. J.

Sales Offices: Atlanta, Chicago, Columbus, Culver City (Los Angeles), Dallas, Denver, Detroit, Montreal (Canada), Newark, Seattle.

TUNG-SOL

*Automotive
and Electronic
Products*

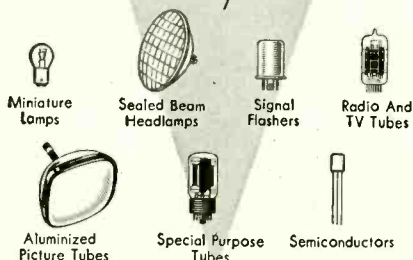

100

A NEW TAPE MACHINE FOR OFFICE USE



Over-all view of DeJur's new lightweight, compact tape recorder for dictation.

A simplified type of tape recorder now offers increased flexibility to meet all office dictating requirements.

A NEW TYPE of magnetic tape dictating machine which has been especially designed for dictation or transcription was recently unveiled by DeJUR-Amsco Corporation of Long Island City, New York.

Tradenamed the "Stenorette," this push-button-operated machine weighs only eleven pounds, 10 ounces. The unit includes a combination microphone-speaker and enough tape for 30 minutes of continuous recording.

The machine employs tone and volume controls to produce a high degree of fidelity for this type of application. Five push-buttons provide simple automatic control of the tape for recording, listening, forward and reverse speed winding, and stopping. Dictation corrections or playback are facilitated by an automatic scale indicator which gives accurate positioning when winding the tape backward or forward. The microphone-speaker is equipped with a "start-stop" button to control the tape during pauses or interruptions while dictating.

The tape can be used and re-used repeatedly for the life of the machine. The microphone used with the recorder is of new design. It can be used as a hand mike or by moving its chrome legs downward, it becomes an equally effective and attractive desk microphone. Located at the side of the microphone and in the most natural position is the "stop-start" control bar. The user merely squeezes or presses the bar lightly to start recording and releases it to stop the recording. There is no lag or coast as the action is instantaneous.

For continuous recording or continuous playback the button above the stop-start bar is pressed in and to the left. To review previous dictation after an interruption or to erase an error, the microphone control bar and "review" button are pressed simultaneous-

ly. In this way the last few words or last sentence are repeated. To make a correction or a change, the user re-records the same area. To dictate, the user presses the "record" button and begins talking in a natural tone of voice. When the dictation is completed, the rewind button is pressed, the tape is removed and placed in the transport folder pocket together with related correspondence and the log page, and sent for transcribing.

For use as a transcribing machine, one of a choice of listening devices is placed in the outlet on the right side of the machine. A choice of either a typewriter or foot control is placed in the outlet at the left side of the machine. Listening devices may be used on either or both ears. The foot and typewriter controls have facilities for starting, stopping, and backspacing. —30—

The "Stenorette" used for transcription. Either foot or hand control is available. The earphone is a small, lightweight unit.



RADIO & TELEVISION NEWS

Oscillator Troubles

(Continued from page 49)

quence. This detuning of the oscillator reduces the i.f. signal and cuts down the a.v.c. voltage. The "B" voltage now drops to normal, and the oscillator tuning becomes correct, causing the signal to revert to normal. The cycle of change now starts once more. A flutter in the sound results from this process. The trouble is largely initiated by the high-amplitude variations that are produced in the current of the audio output tube. These variations are not properly filtered out in the "B" supply, and are consequently fed back to the oscillator plate. Motorboating, or a "putt-putting" sound, may be heard in severe cases of such feedback. The source of the trouble is generally a loss in the capacitance of the output filter capacitor. A loss in the capacitance of the oscillator anode decoupling capacitor (C₁ in Fig. 3) may also be responsible.

In the rare instances when restoration of the normal filter or bypass capacitance does not cure the trouble, smaller coupling capacitors may be used in the audio amplifier section, to reduce the receiver's low-frequency response, and thus cut down the amplification of the low flutter frequencies to a point where feedback is eliminated.

Motorboating or siren-like sounds in TV sets when the receiver is first turned on are generally due to a defective oscillator or converter tube.

Drift, or slow changes in oscillator frequency (necessitating set retuning), sometimes presents troublesome problems to the service technician, particularly in the servicing of FM sets. There are two basic reasons for drift. The first is the heating of the oscillator tube and its socket (causing changes in interelectrode capacitance in the tube); the duration of such drift is short. The second cause of drift is the heating of other circuit components (producing expansion effects) as the chassis temperature rises.

Possible specific causes of drift include bad oscillator tube; oscillator coil which may have absorbed moisture; defective or inferior socket (a mica-filled socket used in place of a Bakelite one will reduce socket-caused drift); or a defective, too small, or improperly positioned negative temperature-compensating capacitor. The preferred positioning of such a capacitor is directly over the socket (see Fig. 1), where it can respond most accurately to the heat generated in the tube and socket.

Some mechanical troubles may result in symptoms similar to those caused by drift. Changes in the dial setting of a radio, due to an excessively tight dial cord, or detent backlash trouble in a TV set (too much play in the detent shaft) or loose oscillator slugs in TV turret tuner coils (cementing these in will help) are examples of this.

-30-



free!

New STANCOR Auto Radio Transformer Replacement Guide, the most complete ever published. This valuable book lists accurate replacement data for over 540 car radios, built or used by over 40 manufacturers. Both vibrator powers and audio outputs are included. It's available FREE from your CHICAGO STANDARD distributor.

REPAIR AUTO RADIOS quickly, easily with STANCOR EXACT REPLACEMENT AUTO VIBRATOR TRANSFORMERS

You can increase your auto radio repair profits by reducing installation time with STANCOR exact replacement vibrator transformers. Like STANCOR flybacks, STANCOR auto vibrator transformers are faithful duplicates of the originals they are designed to replace.



CHICAGO STANDARD TRANSFORMER CORPORATION

3584 ELSTON AVENUE

CHICAGO 18, ILLINOIS

Export Sales: Roburn Agencies, Inc., 431 Greenwich St., New York 13, N.Y.

"HI-STAB" DEPOSITED CARBON RESISTORS

Designed to meet MIL-R-10509A Specs.
100 to 470,000 Ohms—RN15 or RN20—1% Tolerance—1/2 Watt

Hi-STAB

IMMEDIATE
DELIVERY
FROM STOCK

Order by Part No. from table below: Subject to Prior Sale

8¢
ea.

Minimum
Order \$4

All Parts
Brand New

Inter- state Part No.	Resistance (Ohms) 1/2 Watt—±1%	Inter- state Part No.	Resistance (Ohms) 1/2 Watt—±1%	Inter- state Part No.	Resistance (Ohms) 1/2 Watt—±1%
1000F	100	2201F	2,200	4702F	47,000
1500F	150	3301F	3,300	6802F	68,000
2200F	220	4701F	4,700	1003F	100,000
3300F	330	6801F	6,800	1503F	150,000
4700F	470	1002F	10,000	2203F	220,000
6800F	680	1502F	15,000	3303F	330,000
1001F	1,000	2202F	22,000	4703F	470,000
1501F	1,500	3302F	33,000		

Certificate of compliance with each shipment. Mail orders promptly filled. All prices F.O.B. N.Y.C. Rated firms send P.O. Others, 25% with order, balance C.O.D.

INTERSTATE ELECTRONICS, Inc.

227 Fulton Street, New York 7, N. Y. BEekman 3-8780



ATR SHAV-PAK NEW, LOW PRICE!

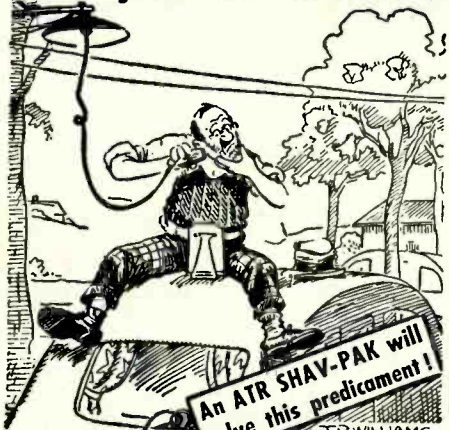

An ATR SHAV-PAK will solve this predicament!



**SHAVE IN THE COMFORT
OF YOUR CAR,
Boat or Plane!**

Specially Designed for Operating Standard A.C. Electric Shavers in Automobiles, Buses, Trucks, Boats, and Planes.

Plugs into Cigarette Lighter Receptacle on Dash

\$ 9.95
LIST PRICE

TYPE	INPUT D.C. VOLTS	A.C. OUTPUT 60 CYCLES	OUTPUT WATTAGE	LIST PRICE
6-SPB	6	115 volts	15	9.95
12-SPB	12	115	15	9.95

Introducing ATR MIGHTY MIDGET portable INVERTER WITH GREATER OUTPUT

Dictate reports accurately-promptly!

make your car, boat or plane a "rolling office"



with ATR INVERTERS for changing your storage battery current to A.C. Household ELECTRICITY Anywhere in your own car!

Plugs into Cigarette Lighter Receptacle on Dash

\$ 19.95
AND UP
LIST PRICE



ATR INVERTERS . . . especially designed for operating standard 110 volt A. C. . . .

- DICTATING MACHINES • TAPE RECORDER
- ELECTRIC RAZORS • WIRE RECORDERS

TYPE	INPUT D.C. VOLTS	A.C. OUTPUT 60 CYCLES	OUTPUT WATTAGE	LIST PRICE
6-DME	6	115 volts	30-40	19.95
6H-DME	6	115 volts	60-75	29.95

Above inverters also available for 12-volt operation.

See your jobber or write factory today for complete information

ATR AMERICAN TELEVISION & RADIO Co.
Quality Products Since 1931
SAINT PAUL 1, MINNESOTA - U. S. A.

Sales Aids

CONNECTOR DISPLAY

Jerrold Electronics Corporation, 23rd and Chestnut Streets, Philadelphia 3, Pa. is now offering a new self-service dispensing display for its line of solderless coax cable connectors, line-tap impedance matchers, and crimping tools.

Utilizing tested merchandising techniques, the new display shows the product, sells the product, and keeps inventory, all without attention from jobber personnel.

The entire display measures only 9"x18" and may be hung on a wall, a post, or stood on a counter. When fully loaded, the display holds over 50 colorful packages of the company's cable system accessories. One of each of the 12 different products is in full view at all times.



PHONO NEEDLE DISPLAY

Jensen Industries, Inc., 7333 West Harrison, Forest Park, Illinois is introducing a new phono needle for the "junior set" which is being merchandised via a gaily-colored "Rumpus" display card.

The new "Rumpus" needle is guaranteed not to bend or break and is especially designed to meet the demand for a sturdy needle to be used

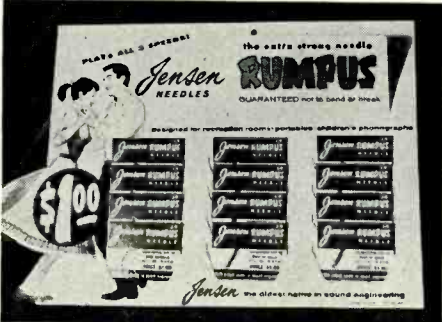

for rugged service. Dealers may obtain the chest by turning in to distributors a total of 20 RCA "Treasure Notes." One of these "Notes" is given to dealers with each purchase of 25 RCA receiving tubes or one picture tube.

For five "Treasure Notes," the company is also making available through distributors a "Multicord," a practical time-saving device for the technician. The device consists of a harness which includes cord connectors to fit all TV receivers; a three-way power output which can be brought up to the chassis for test equipment, soldering gun, and other tools; and a clamp-on work light with "on-off" switch.

Details on the "Treasure Chest" promotion are available from all local RCA tube distributors.

TRANSISTOR KIT

General Transistor Corp. of Jamaica, New York is offering a kit of transistors which includes an assortment of seven of the most commonly used diffused p-n-p junction types.

The assortment of double-sealed transistors covers types for use in



radios, automation, hearing aids, computers, Geiger counters, and instruments. The kit, which is packaged in a functional plastic box, is now being offered at a special introductory price.

Write the company for full information on this kit.

PICNIC-BARBECUE SET

A consumer promotion featuring a 10-piece picnic and barbecue set to be given away with the purchase of one of its TV models has been announced by the television and broadcast receiver division of Bendix Aviation Corporation.

The utensils, worth \$35 at retail, include a charcoal grill, insulated carry-all bag, ice chest, beverage jug, and six grill-cooking implements. A colorful set of window streamers, posters, showcase cards, and ad mats for dealer use has been included in the promotional package.

The company's distributors have complete information on this promotion.

"X-RAY" DEMONSTRATOR

The Magnavox Company, Fort Wayne 4, Indiana is now offering a new and effective selling tool—an "X-ray" demonstration cabinet.

LIFETIME GUARANTEED TUBES

BRAND NEW PICTURE TUBES

- RCA Licensed
- One Year Unconditional Guarantee

Type	Price	Type	Price
10BP4	\$11.90	17BP4	\$20.63
12LP4	\$14.38	19AP4	\$24.81
14BP4	\$16.86	21AP4	\$28.79
16RP4	\$19.38	21EP4	\$28.79
16LP4	\$19.38	24AP4	\$42.50

Picture Tubes shipped F.O.B. Harrison, N. J.

LOOK WHAT YOU GET FREE!

- FREE BONUS BOX** With Every \$25 Order
- | | |
|--|-----------------|
| • 1 RCA Cheater Cord | • 1 6BQ6GT tube |
| • 10 Assorted resistors | • 1 6AU6 tube |
| • 10 assorted 2 color "blank" tube cartons | • 1 6CB6 tube |

FREE CLOCK RADIO With Every \$125 Purchase Within 30 Days

Wakemaster clock radio with famous Sessions clock movement wakes you to music or alarm. May be purchased outright from MAJOR BRAND for \$17.95. In ivory or rust.

FREE GIFT CERTIFICATE* worth \$5 toward the purchase of any of our merchandise on future orders will be sent with any order of \$50 or more.

* Free Gift Certificate cannot be used to obtain another certificate unless order is \$55 or more.

WE PAY ALL POSTAGE on orders shipped in USA, Territories and APO's. Send only purchase price of merchandise. Please include approximate postage on foreign shipments. All orders subject to prior sale. Add 25c handling on orders under \$5.00. Quantity users write for special discount.

Write For **FREE** Tube List—Order Blank—and **FREE** Sample Tube Carton. We want Y-O-U On Our Mailing List!

NEW INDOOR ANTENNA

Both UHF and VHF. Brings better reception than most outdoor antennas. Use on top of TV.

List Price \$9.95

Your Price

Lots of 3 **\$3²⁹**

\$3.99 each

THIS AD IS WORTH M-O-N-E-Y

Clip out this ad and attach it to your order. Three 6SN7GT's will be shipped FREE with any order of \$10 or more.

HERE'S HOW LIFETIME GUARANTEED TUBES SAVE YOU MONEY!

- We Guarantee to Replace Tubes Labeled MAJOR BRAND Forever
- Each Tube Individually Boxed and Guaranteed
- Over A Half Million Tubes Always In Stock
- Immediate Shipment
- Free Postage On All Orders With Full Remittance
- There are fewer "call backs"
- There are no "out of date" tubes
- "Peak Performance" testing in our fully equipped Testing Department before shipment guarantees quality

024	.43	5AW4	.75	6BL7GT	.75	6X4	.34	12SK7	.45
1A4P	.33	5J6	.63	6BN6	.58	6X5	.34	12SN7GT	.56
1A7GT	.43	5L6	.69	6BQ7	.78	6X8	.73	12S07	.37
1C3GT	.41	5U6	.74	6BY5G	.58	7A5	.45	12V6GT	.45
1D5GP	.43	5V4G	.31	6C4	.37	7AG6	.45	14A7	.42
1E6GT	.41	5Y4G	.36	6C5	.35	7A7	.43	14B6	.38
1H4G	.43	5Z3	.37	6D6	.48	7B6	.42	14C7	.37
1H5GT	.43	6A4	.45	6D6G	1.15	7B5	.39	198G6G1.15	
116GT	.47	6AB	.45	6E6	.48	7B6	.42	19T8	.65
11L4	.45	6AB4	.43	6F5	.37	7B7	.41	24A	.39
11L6	.57	6AC7	.57	6F5	.37	7B7	.41	25AV5GT	.78
11A4	.47	6AF4	.79	6F6	.38	7C4	.39	25BQ6GT	.78
11A6	.47	6AG5	.50	6G6	.40	7C5	.42	25EGT	.47
11B4	.57	6AG7	.59	6H6	.38	7C6	.43	25W4GT	.43
11C5	.49	6AH6	.69	6J4	1.79	7C7	.45	25Z5	.37
11C6	.47	6AJ5	.70	6J5	.39	7E5	.45	25Z6	.25
11D5	.57	6AK5	.54	6J6	.47	7E6	.55	35A5	.46
11E3	.57	6AL5	.39	6J7	.43	7E7	.70	35A6	.34
11L5	.57	6AQ5	.46	6K6GT	.37	7F8	.70	35C5	.50
11M4	.64	6AR5	.45	6K6	.47	7G7	.75	35W4	.34
11N5	.47	6AS5	.48	6K7	.39	7G7	.75	35Z3	.39
11SGT	.50	6AS9	.70	6L6	.68	7J7	.75	35Z4	.34
1NS	.42	6AT6	.39	6L7	.60	7K7	.75	35Z5GT	.34
1U4	.50	6AU4GT	.65	6M7	.40	7L7	.50	50C5	.50
1U5	.42	6AU6	.42	6N7	.40	7M7	.50	50EGT	.43
1V2	.65	6AV5GT	.60	6S7	.41	8A2T	.63	50S5GT	.42
2A3	.55	6AX4GT	.60	6S7	.41	12AU6	.63	50Z5	.42
2A5	.57	6AX5GT	.52	6S7	.41	12AV6	.35	76	.42
2A7	.51	6B8	.69	6SK7	.45	12AW6	.67	77	.38
3A4	.51	6BB	.69	6SK7	.45	12AX4GT	.67	78	.38
3A5	.50	6BA	.68	6SN7GT	.55	12AX7	.58	80	.34
3AL5	.46	6BC5	.47	6SN7GT	.55	12B4	.68	84/6Z4	.44
3A6	.54	6BC6	.48	6SRG	.45	12B6	.48	117L7GT	1.09
3B6	.52	6BF5	.40	6T4	.95	12B6G	.46	117N7GT	1.09
3C86	.46	6BF6	.48	6V6GT	.46	12C16	.61	117P7GT	1.09
3Q4	.46	6BF6	1.15	6U8	.75	12B7	.65	117Z3	.35
3S4	.47	6BH6	.50	6V3	.80	12B7	.61	117Z6GT	.63
3V4	.47	6BJ6	.46	6V6GT	.46	12C16	.61		
4B27	.89	6BK5	.68	6W4GT	.39	12A7	.45		
4B27	.95	6BK7	.76	6W6GT	.53	12J7	.45		

Write Dept. 8-RN

MAJOR BRAND

Romano Bldg. ESsex 4-1106

TUBE CO.

Harrison, N. J.

MAMMOTH CRYSTAL CLEARANCE SALE!

SAVE MONEY—ORDER IN PACKAGE QUANTITIES!

Shipment made same day order received. All crystals tested and guaranteed to oscillate. Please include 20c postage for every 10 crystals or less. Minimum order \$2.50. No C.O.D.'s.

PACKAGE DEAL NO. 1

25 Assorted FT-243 45 Assorted FT-241A
15 Assorted FT-171B 15 Assorted CR-1A

100 CRYSTALS \$8.95

Assorted Regular Value \$66.00

PACKAGE DEAL NO. 2

FT-241A Crystals for single Sideband
370 KC—538 KC

35 CRYSTALS \$3.49

Assorted Regular Value \$14.00

PACKAGE DEAL NO. 3

HAM BAND CRYSTALS—FT-243

For operating on 80, 40, 20, 15, 10, 6 and 2 meters—on either fundamentals or harmonics.

25 CRYSTALS \$6.95

Assorted Regular Value \$20.00

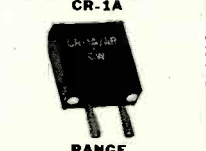

INDIVIDUAL CRYSTALS

Indicate 2nd choice—Substitution May Be Necessary

Low Frequency—FT-241A for SSB, Lattice Filter, etc., 0B3 Pin, 486 SPC, marked in Channel Nos. 0 to 79, 54th Harmonic and 270 to 289, 72nd Harmonic. Listed below by Fundamental Frequencies, fractions omitted.

49c each—10 for \$4.00 79c each—10 for \$6.50

370	392	412	436	501	522	400	459
372	393	413	438	502	525	440	461
374	394	414	481	503	526	441	462
375	395	415	483	504	527	442	463
376	396	416	484	505	528	444	464
377	397	418	485	507	530	445	465
379	398	419	487	508	531	446	466
380	401	420	488	509	533	447	468
381	402	422	490	511	534	448	469
383	403	423	491	512	536	450	470
384	404	424	492	513	537	451	472
385	405	425	493	514	538	452	473
386	406	426	494	515		453	474
387	407	427	495	516		454	475
388	408	431	496	518		455	476
390	409	433	497	519		456	477
391	411	435	498	520		457	479
						458	480

79c each—10 for only \$6.50

CR-1A SCR 522-1/2 Pin, 4 SP	FT-171B—BC-610 Banana Plugs 1/2 SPC					
5910	7350	2030	2220	2360	3202	3945
6370	7380	2045	2258	2390	3215	3955
6450	7390	2065	2260	2415	3237	3995
6470	7480	2082	2282	2435	3250	
6497	7580	2105	2290	2442	3322	
6522	7810	2125	2300	2532	3510	
6547	7930	2145	2305	2545	3520	
6610		2155	2320	2557	3550	

TG 34A CODE KEYS
AUTOMATIC CODE PRACTICE
SENDING AND KEYING OSCILLATOR.
115 or 230 V @ 50-60 cycles.

Portable. Built-in speaker and amplifier. Variable speed from 5 to 25 w.p.m. Uses inked tapes.

Brand new. **\$19.95**

Set of three tapes. Sold with Keyer only. Nos. 2, 8, 11. **\$3.75**

FT-243—.093" Dia.—486 SPC

49c each—10 for \$4.00

4035	5385	5892	6700	7575	7850
4080	5397	5900	6706	7583	7873
4165	5435	5966	6725	7600	7875
4190	5450	5925	6740	7606	7900
4280	5485	5940	6750	7625	7906
4330	5500	5955	6773	7640	7925
4340	5582	5973	6775	7641	7940
4397	5660	6206	6800	7650	7955
4445	5675	6225	6825	7660	7970
4450	5677	6240	6850	7673	8240
4490	5700	6250	6875	7675	8250
4495	5706	6273	6900	7700	8270
4535	5740	6275	6925	7706	8280
4695	5750	6300	6950	7710	8300
4735	5760	6306	6975	7725	8306
4840	5773	6325	7450	7740	8310
4852	5775	6340	7473	7750	8316
4938	5780	6350	7475	7766	8320
4950	5806	6373	7500	7773	8325
5038	5840	6375	7506	7775	8630
5205	5850	6400	7520	7800	8683
5295	5852	6406	7525	7806	8690
5305	5873	6425	7540	7825	
5327	5875	6673	7550	7840	
5360	5880	6675	7573	7841	

79c each—10 for \$6.50

1015	6100	6540	7150	8150	8500
3655	6106	6550	7250	8173	8525
3680	6125	6573	7300	8175	8550
3735	6140	6575	7306	8200	8558
3800	6150	6600	7325	8225	8566
3885	6173	6606	7340	8340	8575
3940	6175	6625	7350	8350	8583
3990	6186	6640	7375	8360	8600
6009	6200	6650	7400	8370	8625
6096	6440	7000	7425	8375	8650
6025	6450	7025	7440	8380	8680
6040	6473	7050	8000	8383	8700
6042	6475	7075	8025	8400	8733
6050	6500	7100	8050	8425	
6073	6506	7125	8100	8450	
6075	6525	7140	8125	8475	

SUN

PARTS DISTRIBUTORS, LTD.

514 TENTH ST., N. W. Washington 4, D. C. Dept. N

MERIT FILAMENT TRANSFORMERS

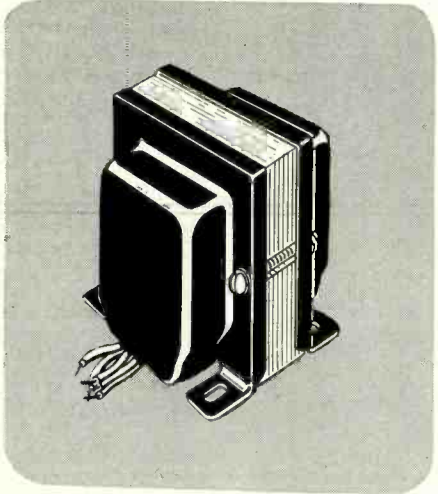

Do you want them?
 from 2½V—24V or
 from 1 amp. to 30 amps.
**We have them in
 stock**
 see your jobber
 for immediate delivery

MERIT

COIL AND TRANSFORMER CORP.
 4427 N. Clark Street
 Chicago 40, Illinois

The lucite cabinet permits the dealer salesman to point out the salient features of the company's television chassis. The demonstration cabinet is shipped completely assembled with top

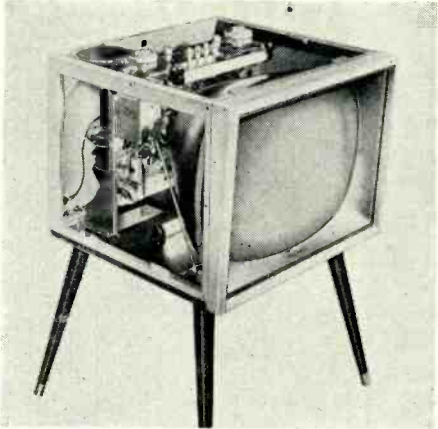

lamp in place. The user installs the safety glass and mask in the lucite cabinet frame and mounts the speaker on top of the cabinet. The demonstrator will house the company's standard MV or U121LC chassis.

For full details and ordering information, write T. C. Wyatt of the Advertising Department.

SPRAY DISPLAY

General Cement Mfg. Co., 919 Taylor Avenue, Rockford, Illinois has developed a complete package deal which includes 25 different products and colors in pressurized spray cans plus a self-service display rack.

Such products as the company's "Spray-Kleen," "De-Ox-Id" contact cleaner, "Spra-Koat" high-gloss enamels, varnish, and other finishes, and



printed circuit resin are available in this compact rack dispenser which holds 156 cans.

For full information on display Deal No. 3612, write the company direct.

WESTINGHOUSE MOVIE

The Film Division, Westinghouse Electric Corporation, P. O. Box 2278, Pittsburgh 30, Pa. has produced a new 30-minute movie which shows historic scenes from Atomic Energy Commission plants in Idaho and Pittsburgh.

Entitled "A Dawn's Early Light" and filmed in both color and black-and-white, the picture stars Fred MacMurray and features Fay Wray and

Jack Diamond. Actual scenes of the construction of the nuclear power plant for the U.S.S. Nautilus are included in the film.

The movie is suitable for showing to social, service, and school groups; civic organizations; and professional groups. It is available on loan without charge or can be purchased outright. Information on booking or buying the film is available from the company.

ASTATIC "TWELV-PAK"

The problem of "which cartridge to stock" has been neatly solved for the average dealer by The Astatic Corp. of Conneaut, Ohio.

The new "Twelv-Pak" cartridge replacement kit consists of the 12 units found most in demand in everyday servicing, as determined by actual sales records. Included with the kit, at no extra cost, are two "bonus" extras: (1) a jeweler's screwdriver which is offered as a time and temper saver when working with tiny cartridge knob and needle set screws, and (2) a newly compiled eight-page master cross-index replacement chart which



lists every cartridge ever made by all manufacturers, along with its current replacement.

Dept. TP of the company will supply full details on this kit upon request.

TV ALIGNMENT CRYSTALS

To make the distributor's selling of crystals easier, quicker, and more profitable, Electronic Instrument Co., Inc., 84 Withers Street, Brooklyn 11, N. Y., has designed and distributed to jobbers a package display merchandiser for its Eico TV alignment crystals.

Printed in blue and red, the display holds five each of the company's 4.5 and 5 mc. crystals, applicable to practically all TV sweep generators and marker oscillators. The display measures only 7"x10" and may be placed on the counter or hung on a wall.



SUN BATTERY DISPLAY

International Rectifier Corporation, 1521 East Grand Ave., El Segundo, California has recently introduced a self-service merchandising unit for its line of B2M "Sun Batteries."

The unit consists of an attractive 4"x6" card which displays the B2M in a protective transparent plastic bubble.



The reverse side of the card gives full information, specifications, and typical applications for the battery. The company has also designed a self-service counter display for this item.

"BELL COW" PROMOTION

Raytheon Manufacturing Company of Chicago has initiated a unique promotional program which has been nicknamed the "Bell Cow."

The series provides hard-selling, factory-created, factory-paid, page-dominant newspaper advertising which each distributor may assign to run over the logotype of his "Bell Cow" dealer. The term is the company's designation for the leader of the herd chosen to wear the bell.

The advertisements in the promotion feature the company's new "StarMonic" all-metal 17" and 21" table model TV sets. The first ad in the series promoted the low end of the "StarMonic" line while the second ad promoted the top end of the line.

ANTENNA DISPLAY

Snyder Mfg. Co. of Philadelphia, Pa. has developed a colorful new antenna display board for merchandising its line of top cowl auto antennas.

Decorated in blue, black, fluorescent green, and white for counter and window display, the new board will fit the company's TC3, TC3B, TC8, and TC9 models, all 1955 antenna designs, which are currently available.

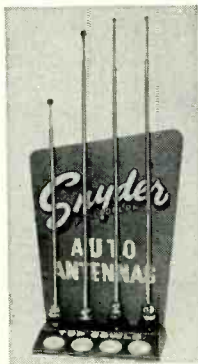

EGYPTIAN CLUB HAMFEST

THE Egyptian Radio Club, Inc. of 700 S. Chouteau Slough Road, Granite City, Illinois has announced that its Annual Hamboree will be held this year on September 25th.

Special attendance prizes will be awarded out of town guests.

Those wishing additional details can contact Elmer Ford, WØMPF, at 7013 Page Blvd., St. Louis, Mo. either by mail or by giving him a call. All hams will be welcomed.

August, 1955

NEW STOCK OF PRE-TESTED TELTRON TUBES GUARANTEED! . . . LOWEST PRICES EVER!

All tubes individually boxed . . . unconditionally guaranteed for one year!

GIFT OFFER!
One 6BG6 tube will be shipped FREE with any order accompanying this ad

We have thousands of tube types too numerous to list here. On ordering types not listed take 75% off current list price for cost of tube.

FREE Bonus Offer!



MODEL 625K

- Illum. gear-driven "Speed Rollechart"
- New lever-action switches for individual testing of every element
- Tests all conventional and TV tubes

May be bought outright from Teltron for \$34.95

This Eico Tube Tester is yours FREE when you buy \$199 worth of tubes or more within 60 days at Teltron.

Type	Price	Type	Price	Type	Price	Type	Price
024	.45	6BA7	.58	6T8	.71	12SQ7	.38
1A7GT	.53	6BC5	.48	6U8	.76	14A7	.43
1H5GT	.51	6BC7	.75	6V3	.80	14B6	.36
1L4	.51	6BE6	.46	6V6GT	.48	14Q7	.52
1L6	.51	6BF5	.48	6W4GT	.43	19B6G	1.48
1LC6	.49	6BF6	.48	6W6GT	.53	19T8	.71
1N5GT	.51	6BG6G	1.18	6X4	.37	25L6GT	.41
1R5	.51	6BH6	.51	6X5GT	.38	25BQ6GT	.82
1S5	.43	6BJ6	.51	6X8	.80	25W4GT	.43
1T4	.51	6BK5	.75	6Y6G	.61	25Z5	.55
1U4	.51	6BK7	.78	7A8	.46	25Z6GT	.36
1U5	.43	6BL7GT	.78	7C5	.44	35A5	.48
1X2	.65	6BN6	.90	7F7	.59	35B5	.48
1X5	.65	6BQ6GT	.83	7F8	.77	35C5	.48
3Q5GT	.61	6BQ7	.85	7N7	.52	35L6GT	.41
3S4	.48	6BY5G	.60	12AT6	.37	35W4	.33
3V4	.48	6C4	.41	12A7	.71	35Y4	.42
5R4	.95	6C5	.46	12AU7	.58	35Z3	.41
5V4	.49	6CD6G	1.63	12AV6	.42	35Z5GT	.33
5Y3	.30	6CU6	.95	12AV7	.73	37	.59
5Y4G	.37	6D6	.59	12AX4GT	.60	43	.55
6A8	.40	6E5	.60	12AX7	.61	45	.55
6AB4	.43	6F5	.44	12AZ7	.61	45	.55
6AC7	.65	6F6	.42	12B4	.72	50A5	.49
6AG5	.52	6H6	.50	12BA6	.46	50B5	.48
6AH4GT	.65	6J5	.49	12BA7	.58	50X6	.53
6AF4	1.02	6K5	.60	12BE6	.46	75	.44
6AK5	.96	6K6GT	.39	12BH7	.61	77	.55
6AL5	.43	6K7	.40	12BY7	.65	80	.40
6AQ5	.48	6L6	.78	12H6	.50	84	.46
6AR5	.48	6Q7	.40	12J5	.40	117GT	1.20
6AS5	.52	6S4	.41	12K7	.40	117L7GT	1.20
6AU5GT	.60	6S8GT	.65	12Q7	.48	117N7GT	1.20
6AV5GT	.60	6SA7	.45	12S7	.45	117P7GT	1.20
6AV6	.37	6SK7	.45	12S7L	.45	117Z3	.33
6AX4GT	.60	6SJ7	.45	12SL7	.60	117Z6GT	.65
6AX5GT	.60	6SQ7	.40	12SN7GT	.56	1629	.39

FREE \$7.20 list value Bonus Box of three 6SN7 tubes and 25 assorted resistors with each order of \$25 or more.

SAME DAY SERVICE

48 Hour Postal Delivery To West Coast

NEW LIBERAL TERMS

NO MINIMUM ORDER ALL POSTAGE PAID ON ORDERS OVER \$10.00 IN U.S.A. A.P.O.'S AND TERRITORIES. 10% DEPOSIT ON C.O.D.'S TO OUR CANADIAN AND FOREIGN FRIENDS. PLEASE SEND APPROXIMATE FREIGHT. EXCESS WILL BE REFUNDED. ORDERS SUBJECT TO PRIOR SALE.

WE WANT NEW ACCOUNTS

If you are rated, your credit is good with us.

Send for Free complete tube listing and monthly specials! Get on our mailing list.

We are "Eico" distributors. Write us about special deals on test equipment.

SPECIALS!—TILL SEPTEMBER 1

Type	Reg.	Special	Type	Reg.	Special
024	.45	.39	6K6GT	.39	.35
1B3GT	.62	.59	6SN7GT	.60	.55
1R5	.51	.47	6V6GT	.48	.42
3S4	.48	.44	6W4GT	.43	.35
5U4G	.43	.39	12AT7	.71	.66
6AG5	.52	.48	12AZ7	.61	.54
6AL5	.43	.38	12SN7GT	.56	.49
6BA6	.56	.45	25L6GT	.41	.37
6BQ6GT	.83	.72	35L6GT	.41	.37
6J6	.61	.42	50L6GT	.50	.45

TELTRON ELECTRIC COMPANY

428 Harrison Ave.,

Harrison, N. J.

Dept. RN-8

Phone HUmboldt 4-9848

KARLSON "8" FOR 8" SPEAKERS

Complete line of Models
FIR PLYWOOD \$1790
KIT (Model 8K)

ASSEMBLED
PLYWOOD UNIT \$2844
(Model 8U)

PEBBLE-TONE
FINISHED UNIT \$3450
(Model 8P)

KARLSONITE
FINISHED UNIT \$4950
(Model 8B & 8M)

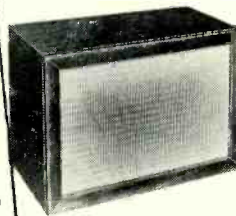

DESIGNED FOR THE BOOKSHELF

Size 17 1/4" x 11 1/4" x 10"

Volume: Only 1 Cubic Ft.

KARLSON ULTRA-FIDELITY ENCLOSURES

INCREDIBLE!

- Cleanness of Response
- Bass Response
- Dispersion Of The Highs

KARLSON ASSOCIATES, INC.

DEPT. UA

1610 Neck Road, Brooklyn 29, New York

Please send copy of your latest book "The Karlson Enclosure" to

Name _____

Address _____

City _____ State _____

DC VOLT OHMMETER

Basic Movement—0-100 Microampere 3/30/300/600 VDC 0-1 Meg. Ohm Govt. acquisition cost \$40.00. Complete w/probes, **\$6.95** ea. less btlys.—new

LORAN EQUIPMENT

Marine or Airborne Long Range Navigational equipment! Determine the exact geographic position of your boat or airplane! AN/APN4 Loran set. Frequency range 1700-2000 KC, complete with 1DBM/APN4 indicator, R93/APN4 receiver, crystal and plugs. **\$129.50** Complete. Brand New

NAVY RECEIVER TYPE ARB

Four band. 105 to 9050 kc. Low freq., ship broadcast—40 to 80 meters. Includes tubes and dynamotor, for 24 volt operation. Easily converted for 110 V. or 6 V. Schematic included. Excellent condition. Overall 8 1/4" x 7 1/4" x 15 1/4". Wt. 30 lbs. **\$16.95** Special Complete with Remote Controls—Shafts—Connectors \$24.95

Command Equipment (274N-ARC5, ATA)

Model	Less Tubes As Is	Excellent Used	Brand New
RECEIVERS			
190-550 KC	\$6.95	\$ 9.95	
520-1500 KC		19.95	\$24.95
1.5-3.0 MC	6.95	9.95	14.95
3.-6 MC	3.95	5.95	
6-9 MC	2.95	4.95	
100 MC-156 MC		13.95	
TRANSMITTERS			
2.1-3 MC		9.95	
3.-4 MC		14.95	
4.-5.3 MC		5.95	
5.-7 MC		3.95	
7.-9 MC		6.95	
100-156 MC		22.50	29.50
BC 456 Modulator		2.95	4.95
MD 7 Modulator		7.95	
BC 450			
3 Rec Control		1.50	2.50
BC 451—			
XMTR Control		1.00	1.50

Radio Receiver 11-tube UHF tunable 234-258 MC receiver with schematic. Complete with tubes 3 ea. of 6AK5, 7 ea. of 9001, 1 ea. of 12A6. Like new. **\$6.95** Control Box, New. \$1.50 Less Tubes. \$2.95—2 for \$5.00

A Sweet Oscilloscope Deal

INDICATOR UNIT. For conversion to test scope, panadapter, analyzer, etc. Double deck chassis. 6CP1 mounted in tube shield. Less small tubes and crystal, but complete with 6CP1. **\$9.95** Exc. cond. each

25 watt phone—CW 5 tube transmitter. Frequency range 2-9 MC. Two 815 tubes in circuit. One as modulator and one as RF output. Ideal for C. A. P. Mobile. Excellent condition, with tubes. Less TU's. **\$9.95** Wt. 24 lbs.

APX IFF EQUIPMENT

This transceiver is a treasure-house of tube sockets, coaxial fittings, resistors, condensers, microswitches, amphenol connectors and a raft of other parts. Also contains DC motor w/gear train, easily convertible to 110 VAC. **\$3.95** Less tubes. ONLY—Special. Two for \$7.00

HEADPHONES

Model	Description	Excellent Used	BRAND NEW
H5-23	High Impedance	\$1.89	\$4.35
H5-33	Low Impedance	1.79	5.45
H5-30	Low Imp. (featherwt)	1.49	2.29
CD-307A	Cords with PL 65 plug and J6 26 Jack.79	1.29
T5-F1	Handset	2.49	
T5-9	Handset—Complete with cord & Butterfly switch. Brand New Original Cartons 10 for		6.95 60.00
T-26	Mobile Chest Mike. Brand new		1.29
BC375	—100 Watt Xmtr. Excellent.	\$14.95	
TU26	—5-9-10 Tu's for above. Excellent.	\$1.95	

DYNAMOTORS

Type	Input	Output	Used	New
DD-83	12 VDC	375-150 MA.	1.95	4.95
DM-35	12 VDC	625 VDC 225 MA.	9.95	
DM-64	12 VDC	275 VDC 150 MA.	3.95	5.95
DM-65	12 VDC	440V 400 MA.	8.45	12.95

MOBILE HEAVY DUTY DYNAMOTOR: 14 V. INPUT-output: 1030 VDC 260 MA. Tapped 515 V. 215 MA. use @ 6 V DC INPUT-500 V. 175 MA. While they last—DM-42-Excel. Condition. **\$8.45** Brand New \$12.95

METER—3"-0-5 Ma. 270° Indication—By Pass Shunt and add scale. Excellent Condition. **\$1.75** 3 for 5.00

ALL ITEMS F.O.B. CHICAGO
25% Deposit required with orders
WRITE FOR NEW BULLETIN AND PRICES.

R W ELECTRONICS

Dept. N, 2430 S. Michigan Ave., Chicago 16, Ill.
PHONE: CAIumet 5-1261-2-3

Spot Radio News (Continued from page 18)

most cases without the intervention of Washington. And I am sure that you will continue to do so in the future. . . . In those areas where we in the Commission have been given the responsibility of assisting the industry for the public good, we pledge our wholehearted cooperation and assistance. With very little help, you have come a long way toward reaching the common goal of all of us; of providing a broadcasting service that fills the needs and desires of the American people."

Continuing his appraisal of the nation's broadcasting industry, the FCC's headman said: "Yours is a young, virile, rapidly changing industry. Your opportunities to render a great public service to the people of America are fabulous. I am positive that I bespeak the sentiments of the members of the FCC and the staff when I say that we not only consider it our duty, but a privilege to work with you to the end that this country will continue to enjoy the greatest broadcasting service in the world."

BROADCASTERS AND set makers at the annual Washington conclave were not only privileged to listen to the members of the Commission, but for the first time, the President of the United States, appearing in person. Twenty-four years ago, a President had addressed the group—Herbert Hoover—but by remote control.

On this historic occasion, the President talked face to face with the conferees. Noting that this was a first, the President reminded his listeners that governments . . . "notoriously move slowly and sometimes, this is a virtue." But, he added . . . "after this length of time, it is safe to make a tentative conclusion that radio and television are here to stay, and a President, therefore, can afford to take them quite seriously. . . . Actually, not only here to stay, but a mighty force in our civilization; one that is certain to grow and . . . be more powerful in its influence upon all of us."

Commenting on the freedom of the air, the President said that . . . "to remain free, the government does have to interfere or to intervene, possibly in your industry more than it does in those that deal with the printed word. . . . After all, there seems to be only one canopy of air over the United States and the rest of the world, and so there must be some means of deciding who is to use the various channels available. We shall always hope, of course, that that is done fairly and without any relationship of partisan politics or any other inconsequential factor, so far as this great medium and problem is concerned. . . . But beyond that one necessary intervention and the enforcement . . . of the rules of decency . . . my only plea is this: That you take thought and counsel among

yourselves to insure that this medium . . . remain free . . . completely free of domination of any unfair kind."

In his message, over two decades ago, on the occasion of the ninth annual convention of the broadcasters, former President Hoover also reviewed the development of national politics, but of course, only in relation to radio and the official rules that had been issued then to halt chaotic conditions. Emphasizing that the decisions reached at that time had been monumental, the former chief executive said: "The determination that radio channels were public property and should be controlled by the government; the determination that we should not have governmental broadcasting supported by a tax upon the listener, but that we should give license to use of these channels under private enterprise where there would be no restraint of programs, has secured for us far greater variety of programs and excellence of service without cost to the listener. . . . This decision has avoided the pitfalls of political and social conflict in the use of speech over the radio which would have been involved in government broadcasting. . . . It has preserved free speech in the country. . . ."

Describing the significant importance of radio, the ex-White House resident said that radio's . . . "dissemination of entertainment, of knowledge, and of public opinion and topics of public welfare, has become an essential element in the intellectual development of our country. . . . It has brought most of the supposed values, which were formerly available exclusively to life in the cities, to every home throughout the land; for the treasures of music, entertainment and information have been brought to the loneliest farm and the most remote hamlet. . . . It is an incalculable extension of happiness and contentment."

THE DOMINANT ROLE that automation will play soon in radio was highlighted at the Washington session of broadcasters. On display were several types of tape equipment that make it possible to program automatically for up to eighteen consecutive hours per day.

In one demonstration two playback magnetic units were operated; one contained all of the program material, while the other was used to supply commercials. Slow-speed reversible tapes were employed; sub-audible tones, impressed on the tapes, served to activate controls which switched program information on the air.

In describing the virtues of this new approach to broadcasting, a representative of a tape maker said that automation will make it possible for an announcer to record a day's announcements in but a few hours, freeing him for other duties. The system would also permit a disc jockey to record an all-night show during the day, and allow him to relax during the wee hours of the morning.

Also shown was an automatic video item, called a TV communications sequencer, which also featured a tape device. In this instance, tape imprinted with a series of tones, offered voice over film or slide show, providing an automatic feed of announcements or commercials.

AN INEXPENSIVE method for equalizing and stabilizing the voltage characteristics of cold-cathode gas diodes, such as neon indicator lamps, found to be ideal for electronic computers, has been developed by two data-processing-system experts at the Bureau of Standards.

The cold cathode diode was selected for the program because it was found to require little power, can handle large currents momentarily, and is small, light, rugged and cool in operation. Life for the normal indicator operation was said to be over 10,000 hours. In electronic computers, with few passive elements, the tube can be used as an *and-gate*, an *or-gate*, an indicator-type memory bit, a flip-flop, an oscillator, or an indicator. It lends itself to visual or photoelectric output, as well as electrical output of either polarity.

Up to now, four major defects in the operation of this component limited its use. Because the tube is manufactured as an indicator, only one characteristic—the maximum firing voltage—is controlled, and this can have a large tolerance. This leads to the first defect; in a batch of tubes, a wide range of firing and holding voltage has been common. Selection might be used to overcome this difficulty. And here is where the second defect appears. The characteristics of any one tube vary unpredictably with use. The other two major defects have been found to be associated with use and circuitry. The normally-long de-ionization time limits speed of operation, and the need for a continuous path to maintain ionization has been found to make the selection circuits a very difficult problem to the engineer.

The circuit for the equalizing process consists of a large number of tubes in parallel, connected to a pulse power source through a common resistor. Pulses are continually applied until the firing potentials and holding potentials of all the tubes rise to common terminal values. Further processing produces no additional change. In the stability check, all of the tubes are subjected to identical conditions. Providing a separate resistor for each tube was found to minimize mutual interaction, while the power supply and environmental changes are common to all tubes.

In this system, the first characteristic potential to be considered was the firing voltage—the minimum voltage necessary to start conduction in a tube which has been off a long time compared to its de-ionization time. The second was the holding or maintaining voltage—the voltage drop across the tube when it is carrying its rated current. For the tubes investigated (the

August, 1955

a LIVE-WIRE'S check-list of prospects for RCA SOUND

- BOWLING ALLEYS
- CONSTRUCTION JOBS
- BUS TERMINALS
- DANCE HALLS
- EXCURSION BOATS
- FAIR GROUNDS
- GARAGES
- LAUNDRIES
- LODGES
- LUMBER YARDS
- MOTELS
- NIGHT CLUBS
- OFFICES
- PARKING LOTS
- PLAYGROUNDS
- POLITICAL RALLIES
- RESTAURANTS
- STORES
- SUMMER CAMPS
- SUPERMARKETS
- SWIMMING POOLS

YOUR RCA DISTRIBUTOR has everything you'll need in matched sound products to do the kind of job you and your clients will be proud of. One stop, one quality—RCA—the name known the world over. You can recommend and install it with confidence.



AMPLIFIERS

For all types of public address systems. 6, 15, 30 and 50 watts.



INTERCOM SYSTEMS

Time and money savers for motels, stores, offices, plants. Available with from 5 to 30 station buttons.



SPEAKERS

Both portable and fixed. For indoors or out, ceiling or wall.

MICROPHONES

- Aerodynamic
- Velocity
- Pressure
- Announce
- Miniature



SOUND PRODUCTS
RADIO CORPORATION of AMERICA
 ENGINEERING PRODUCTS DIVISION
 CAMDEN, N.J.
 In Canada: RCA VICTOR Company Limited, Montreal

USED RECORDING TAPE (PLASTIC BASE)

ATTENTION: Radio Stations, electronic calculators, industrial users: We have the new 1 1/2 or 2 mil mylar, "sound-plate," "lifetime," or "P.E." tapes and we will buy or exchange your present

- 1 mil mylar or plastic tapes.
- 1.79 for 7"—1200 foot
- .93 for 5"—600 foot
- .53 for 4"—300 foot
- .27 for 3"—150 foot

★ ★ ★ ★ ★

USED "MYLAR" TAPE (1 Mil)

- 900 ft. (5" reel) 1.69
- 1800 ft. (7" reel) 2.99

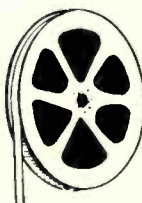

New empty plastic reels in boxes for easy labeling. 3" 10c; 4" 22c 5" 24c; 7" Professional reel (2 1/2" hub) 29c ea. 10" Aluminum Reel \$2.24. EMPTY BOXES: 3" 3c; 4" 5" 7" 5c ea.

Send for new Price List. "Tape Recording" magazine and back issues available.

Please Include Sufficient Postage

COMMISSIONED ELECTRONICS CO.
 2503 Champlain St. N.W. Washington 9, D. C.



110V, AC POWER SUPPLY FOR ANY 274-N RECEIVER

Just plug it into the rear of your 274-N RECEIVER . . . any model. Complete kit and black metal case, with ALL parts and diagrams. Simple and easy to build in a jiffy. Delivers 24 volts plus B voltage. No wiring changes to be made. Designed especially for the 274-N receiver. Only \$8.95. Filament trans. for 274N receivers. Pri. 110V, 60 cy. AC. Sec. 24V @ .6A. An excellent buy at \$1.95 ea.

SPLINED TUNING KNOB FOR 274N RECEIVERS

An exclusive O-R item manufactured for us. Fits BC-453, BC-454 and other 274N receivers. This is a really hard-to-obtain item. Only . . .89c ea.



OFFENBACH-REIMUS
 1564 Market Street, San Francisco, Calif.

TECH-MASTER CUSTOM-BUILT Kits

TELEVISION—RADIO and
HI-FI AUDIO EQUIPMENT

- QUALITY COMPONENTS
- ADVANCED DESIGN
- SIMPLIFIED INSTRUCTIONS

DELUXE 630-TYPE TV KIT

World's
Finest
TV Receiver:

for picture tubes up to
24" (70° defl.), 29 tubes.
All principal components mounted

Model 630D24: Complete with all components,
tubes, brackets, and quality speaker. (Less
kine, wire and solder).....Net \$159.50



AC/DC TV KIT

High Quality TV
at Low Cost:
for rectangular
tubes up to 21"

Model 5116: Complete with tubes, hardware
and mounting brackets. (Less kine, wire and
solder).....Net \$99.95

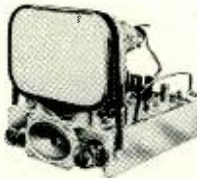

WILLIAMSON-TYPE 20-WATT AMPLIFIER KIT

Famous Williamson
circuit with full 20
watt output.

Specially-wound, quality output transformer.

Model TM-15A, complete with tubes...Net \$49.95



4-CHANNEL, PRE-AMPLIFIER- EQUALIZER KIT

With cathode follower output.
Inputs for FM tuner, phono, tape recorder and
other signal sources.

Model TM-17P (with Cabinet).....Net \$19.95



AC/DC SUPERHET RADIO KIT:

Receives all
standard AM
broadcasts, 550-
1720 KC. 5 tubes
including rect.
Super-sensitive
high gain cir-

cuit with built-in loop antenna.

Model 3B5-K: Complete with all tubes, and
handsome bakelite cabinet.....Net \$19.95



Write for latest catalog
of complete Tech-Master line



TECH-MASTER CORPORATION

Television — Radio — Audio

75 Front Street, Brooklyn 1, N. Y.

NEW TV GRANTS SINCE FREEZE LIFT

Continuing the listing of construction permits granted by FCC since lifting of freeze. Additional stations will be carried next month.

STATE	CITY	CALL	CHANNEL	FREQUENCY	POWER*
Louisiana	Shreveport	12	204-210	316
Mississippi	Hattiesburg	9	186-192	28.2
North Dakota	Bismarck	12	204-210	13.2
Kansas	Goodland	KWGB-TV	10	192-198	204
Washington	Ephrata	43	644-650	13.2
Wisconsin	Milwaukee	WFOX-TV	31	572-578	21.4

NEW CALL LETTER ASSIGNMENTS

STATE	CITY	CALL	CHANNEL	FREQUENCY
Florida	Ft. Pierce	WTVI	19	500-506
Puerto Rico	Mayaguez	WORA-TV	5	76-82
Nebraska	Hastings	KTVR	5	76-82
Nevada	Reno	KAKJ	4	66-72
Washington	Yakima	KRSM	23	524-530
Virginia	Petersburg	WXEX-TV	8	180-186

CALL LETTER CHANGES

Delaware	Wilmington	WPFR (Formerly WDEL-TV)	12	204-210
Georgia	Macon	WOKA (Formerly WNEX-TV)	47	668-674

*ERP=(effective radiated power, kw.)

..... Call letters to be announced

NE-2 and NE-51), the values were found to be about 90 and 75 volts, respectively, for the first type, and about 5 volts lower, for the second tube.

Since equalizing the tubes consists mainly of operating them beyond their normal operating range, some means of obtaining pulsed operation was required. Two methods were used here. For very large overloads, a relay pulser was employed. The length of the pulse was determined by the break time of a set of relay contacts. When desired, this time could be lengthened by the use of an RC circuit, but usually it was held to a minimum. The "off" time was set by a timing relay, also operated with a variable RC circuit. Two relays were used to obtain fail-safe operation, insofar as the tubes were concerned. For tests at higher cycles, full or half-wave 60-cycle voltage is used. To keep the over-all duty cycle low, a clock-driven switch was used to obtain 25 or 75 per-cent duty cycles over approximately 100-second periods.

It was said that many tubes can be equalized at the same time, as long as not too much current is drawn by one or a few tubes. To prevent such an overload, a power supply with poor regulation was used to operate both tubes and relays. A high current load was used to lower automatically the duty cycle and the pulse voltage.

THE OFFICIAL SENATORIAL ultra-high investigation, dogged by delays since Congress convened this winter, will finally sweep into action during the late summer months, according to the chairman of the committee charged with the study; Senator Warren G. Magnuson.

The hearings, which are expected to begin soon after the first session of the 84th Congress ends, will, it is expected, convene with the FCC as the opening witness. The committee expects to explore not only the high- and low-band

situation, but the state of competition in the industry, and the complete allocation plan. A parade of engineering talent will be called on to testify, present plans indicate.

The see-saw debate continued to nettle those planning to enter the TV arena, and as a result station-grant schedules were slim once again. Those authorized, as we went to press, appear in table above. L.W.

TEXAS ELECTRONICS FAIR

THE third annual radio and TV service clinic and electronics fair sponsored by the Texas Electronics Assn. will be held at the Gunter Hotel in San Antonio on August 26, 27, and 28.

As at the two previous clinics, there will be a varied program of technical and business talks designed to improve both the technical efficiency and the business acumen of visiting service technicians and dealers. Subjects to be presented are color TV, transistors, service management, and test equipment. There will be plenty of exhibits as well. -30-

HAMFESTERS' PICNIC

THE Annual Picnic and Airmobile Meet of the Hamfesters Radio Club, Chicago has been set for Sunday, August 14th at Mance Park, ¼ mile east of Route 45 and ¼ mile south of Route 66 (Stinson Airport).

This 21st annual get-together will follow the pattern of the successful affairs of other years. Food, ice cream and beverages will be available at the picnic grounds. Games and contests have been arranged for both adults and children. There will be plenty of tables and free parking space. Donations are \$1.00 in advance and \$1.25 at the gate. Tickets are available from Jesse P. Markham, W9YNV, 37 N. Lotus Ave., Chicago 44, Illinois.

Those flying to the meet can home on WTAQ (1300 kc.) as the four towers at the station are 190 feet tall. Free parking for planes but pilots must bring own tie-downs. -30-

RADIO & TELEVISION NEWS

Applying Variable Damping

(Continued from page 33)

remedy for acoustical resonances is to attack them acoustically, by correct design of the enclosure for the loudspeaker unit, and *vice versa*. As most readers probably do not want to get into this problem of loudspeaker and enclosure design, by far the simplest solution is to pay somewhat more for the loudspeaker, and get a good one in which the acoustic problems have been adequately solved by the original speaker designer.

When such a unit is tested on an amplifier adapted in the manner described, the effect of damping control is extremely difficult to detect, and it is considered that an average amplifier with a damping factor somewhere between 3 and 10 is suitable for driving a unit of this type.

What About Commercial Claims?

Before leaving this interesting subject, there are a couple of further aspects of it, not covered in Mr. Hafler's article, that the author would like to draw to the reader's attention.

The first concerns the circuitry used by most of the variable damping amplifiers presently on the market. The modification described gives true variable damping. Admitted, it does not provide for going into the negative region, but Mr. Hafler's article showed good reasons why this is seldom necessary.

Most of the circuits employed by commercial amplifiers do not take the precaution, which this circuit takes, of maintaining a constant total amount of feedback. They only adjust the current feedback over a range extending from negative into the positive region, while not varying the voltage feedback directly. Actually, the negative feedback re-adjusts itself, due to interaction between the two kinds of feedback, one loop being inside the other loop. But this means that the stability criterion of the amplifier will alter at different settings of the damping control, although the over-all gain may not noticeably change. And consequently the frequency response will vary with the setting of the control, in a manner that is not too easy to predict, especially when a loudspeaker load is used in place of the dummy load used for testing the amplifier.

Another variant of this departure from true damping control occurs in some designs where, to avoid interference with the stability criterion, especially at the high end, the effect of damping control is restricted to the low frequencies. This is achieved by making the current feedback frequency selective, and only feeding back the lower frequencies in the vicinity of the fundamental resonance of most loudspeakers. The argument given for doing this is that this range of frequencies is where damping controls the movement of the loudspeaker diaphragm. At the higher frequencies,

August, 1955

A sound investment

STEPHENS

Coronado

is scaled to smaller
rooms and limited budgets



If yours is a cozy room where you'd like to pull the sound in around you, choose the Stephens "Coronado". Sides and back of cabinet are completely enclosed: sound radiation comes from within the enclosure, permitting the Coronado to function independently of its location in the room. Makes any good speaker sound better... or with the recommended Stephens Speaker 112FR, you get quality that can't be beat for the modest price.

• Choice of modern blonde or rich deep mahogany hand-rubbed finish. 21" wide, 29½" high, 14" deep. Cabinet 620 alone, Net \$78.00. Shipping Weight: 43 lbs.

Speaker is Stephens 12" full range speaker, Model 112FR. Speaker alone, Net \$31.50. Shipping Weight 11 lbs.

Enclosure (Model 620) with Model 112FR speaker installed, Net \$109.50.

STEPHENS
IRL-SONIC

STEPHENS MANUFACTURING CORPORATION
8538 Warner Drive • Culver City, California

Cable Address: "Morhanex", Export Address: 458 Broadway, New York 13, New York

Send For Our Latest Catalogue
Illustrating 39 Professionally
Designed and Engineered Kits

- AM/FM Tuner
- Television
- Geiger Counter
- Long and Shortwave Radio Kits
- Experimenters Construction
- Phonographs and Record Changer
- FM Tuner
- HI-FI Amplifier
- Test Equipment

ARKAY KITS WORLD'S FINEST

RADIOS PHONOGRAPHS TV
TEST EQUIPMENT HI-FI

Write for FREE Brochure

RADIO KITS, INC. • 120 Cedar St., N. Y. 6

A ... Always
B ... Buy
C ... Columbia

**420 MC & CITIZEN'S BAND
PACKAGE DEAL**

- 1 brand new complete APS/13 Transceiver with all tubes and dynamotor. With manual. \$12.95
- 1 brand new BC-761 Signal Generator. Freq. range: 400-500 MC. \$3.95
- 1 Pair Antennas for 420 to 465 MC range. 95c
- SPECIAL COMBO— ALL THREE **\$16.50**

New Free Summer Bulletin
Truckloads of tremendous values!

GET YOUR FREE COPY TODAY!

Columbia

ELECTRONICS
2251 W. WASHINGTON BLVD.
LOS ANGELES 18, CALIFORNIA

109

ARROW SALES

SPECIAL TELEVISION TRANSMITTER
12 tube, UHF. Used in aircraft. Frequency range: 264-372 MC. Receiver and amplifier. Receives and transmits video, sync and blanking signals. Mixes video, sync and blanking signals and transmits a modulated RF carrier which is generated by an oscillator. Complete. Has 3 video stages, 2 oscillators, 2 power amplifiers. Like new, with tubes. Wt. 35 lbs. **\$15.75**

APS-13 UHF TRANSMITTER-RECEIVER
Freq. range 415-420 MC. 5 stages of 30 MC. 1F amplifier. Complete with R.F. and I.F. sections. Less dynamotor, tubes, and tube shields. RF conversion data. Excel. cond. Weight 14 lbs. ea. **\$3.95**
2 for \$6.00

BENDIX DIRECTION FINDER
MN-26-C. 12-tube remote control Navigational Direction Finder and communications receiver. 150 to 1500 Kc in 3 bands. 28 V. DC input. Ideal for commercial navigation on boats and planes. Complete installation complete. **\$12.95**
MN-20-E Rotatable Loop **\$6.95**
MN-52 Azimuth Control Box **2.95**

BC-375 and BC-191 XMITTERS
200 to 500 KC., 1500 to 12500 KC., using plug-in units. 100 Watts. Voice and C. 300 complete with tubes. Less tuning unit. Used, good cond. **\$15.95**
Your Choice, either type. Each.

BEACON RECEIVER BC-1206-C
Complete with 5 tubes. Tunes 195 KC to 420 KC. IF Frequency—135 KC. Receiver Sensitivity—3 Microvolts for 10 Milliwatts output. Output Impedance—300 Ohms and 400 Ohms. Volume Control—RF Control. Power Supply—24-28 Volts Aeroplane Battery. Current—75 Amperes. **\$9.95**
BRAND NEW, with Tubes.

Q-5'ER NAVY TYPE BEAM FILTER
Can be used same as FL-8, FL-30. This unit has selector knob which will select or reject a 1020 cycle note. Two phone jacks for plugging your headphones in series with the receiver. Wt. 3 lbs. New. **\$1.95**
with schematic. Ea. 2 for \$3.75

ISOLATION TRANSFORMERS
For isolating line noise, AC-DC sets, etc. Electrostatic shielding. 2000 V. brekdown test. 6 cord, female receptacle. Primary 110-120 V. 50/60 cycles. Secondary 110-120 V. Mfg. by UTC. **\$9.95**
Model No. R-76 1.200 W. New condition.

46-ACJ UHF (ASB) RECEIVER
13-tube, double conversion receiver. Freq. range: 450-600 MC. Employs 448-A Lighthouse Tubes in RF section, mixer, and oscillator circuits. First IF freq. of 55 MC has 2 stages of amplification; 2nd IF freq. of 16 MC has 4 stages of amp. Two video stages follow. 2nd of 3. Volume Control—RF Gain tubes: 8-6AC7, 3-446, 1-6AG7, 1-6HG6. **\$9.95**
Like new. Wt. 15 lbs. Only **\$6.95**
LESS 8-6AC7 tubes. Like new. Only

MD-7 MODULATOR Provides plate and screen modulation for any transmitter of the AM, ARC-5 equipment. With 28 VDC plug-in dynamotor. Has receptacles for cables to the receiver mounting rack and all units of transmitting equipment. With 4 tubes and 400 watt dynamotor. Excel. cond. Shlp. wt. 21 lbs. **\$7.95**

SPRING COIL CORD
3-conductor mike cable with lugs in both ends. Normal length: 18 in. Expands to over 5 ft. 95c
Heavy rubber casing. Excel. **\$5.00**
6 for

FM WOBULATOR CAPACITOR
Frequency modulation unit with a permanent magnetic field and a moving coil mechanism driving a metal diaphragm supported at its rim. This diaphragm acts as a moving plate of the frequency modulator capacitor. With schematic. (See Dec. Radio TV News for data). **\$4.95**
BRAND NEW **\$2.75**
2 for only

COMMAND SPECIALS
BC-458 Xmtr. 5.3-7 MC. Excellent. **\$ 3.95**
BC-459 Xmtr. 7.9-11 MC. Ex. **9.95**
BC-696 Xmtr. 3-4 MC. Ex. **14.95**
The Lazy Q 5'er Recvr. 10-55 MC. Ex. **9.95**
BC-454 Recvr. 3-8 MC. Excellent. **\$7.95**; New **12.50**
BC-455 Recvr. 6-9.1 MC. Excellent **3.95**; New **5.95**

SEND FOR NEW FREE FLYER!

TS-182/UP
SIGNAL GENERATOR AND TEST SET. Complete. For checking power output, receiver sensitivity, pulse shapes and recovery time. Equipment consists of a pulsed R-F oscillator with calibrated frequency dial and attenuator dial, built in power supply which operates from 110 V. 60 to 1200 cps. Unit has a 2A1P scope tube and 10 other tubes. Freq. range: 150-240 MC. Like New. **\$42.50**
Wt. 50 lbs.

MOBILE COMBO SPECIAL
BC-430 TRANSMITTER
Companion aircraft transmitter to receiver below. 12 or 24 V. Contains two type 10 and two type 45 tubes. 0-1.5 amp R.F. Ammeter and power output approx. 25 W. Freq. range 195-13,975 Kc. **\$3.50**
Wt. approx. 13 lbs. Used, good condition.

BC-429 RECEIVER
If you can afford ANY receiver, you can buy this one! Made to operate from 24 VDC. Dynamotor supply not supplied but an AC or mobile supply can be readily adapted. Uses six tubes. Used, good condition, supplied with 1 coil. Wt. approx. 13 lbs. Special only. **\$3.50**

MOBILE COMBINATION SPECIAL 6.50 Wt. 26 lbs. BOTH UNITS FOR ONLY

SPECIAL! 234-258 MC RECEIVER
11-tube UHF tunable receiver with schematic. Excel. cond. **\$7.95**
Wt. 10 lbs. **\$3.50**
Back **\$1.50**
Control Box

ARROW SALES, INC.
Western Mailing Address—
BOX 3878, NORTH HOLLYWOOD, CALIF.
Central Mailing Address & Sales-Showroom
2441 S. MICHIGAN AVE., CHICAGO 16, ILL.

Visit our Western Sales Showroom
2005 EMPIRE AVE. BURBANK, CAL.
Phone: Victoria 9-2834

damping is unimportant to the operation of the loudspeaker.

This is quite true, but what is overlooked in using this approach is the fact that adjustment of feedback at one end of the frequency response only will modify the frequency response independent of its effect on damping factor. This means the frequency response of the amplifier, measured working into the nominal resistance load for which the amplifier is designed, will change with adjustment of the damping control.

Because of this, it is impossible to differentiate between the effect on performance due to change in the response and that due to variation of the damping factor.

The circuit described in this article will prove that a good loudspeaker shows very little difference in performance as the damping factor is changed. However when this frequency-selective circuit is used a considerable difference would still be noticeable—not due to damping factor at all, but due to the effect of the control on frequency response.

Loudspeaker Distortion

Finally, a claim made in respect to variable damping, particularly what is termed ultimate damping, needs clarifying: that ultimate damping eliminates distortion due to the loudspeaker. Mr. Hafler's article tackled this in some measure, but there are further aspects he did not cover.

The most obvious source of this kind of distortion in the cheaper loudspeakers is the nonlinear distribution of the magnetic flux in the air gap through which the voice coil travels. This nonlinearity means that the

same current will not produce the same driving force on the diaphragm at different positions in the air gap. Consequently a sinusoidal driving current will not produce a sinusoidal driving force applied to the diaphragm and the diaphragm will not move with true sinusoidal motion.

Let us assume, however, that the diaphragm does move faithfully according to the driving force applied to it, although not sinusoidally: because the movement of the voice coil is in the same nonlinear magnetic flux which is producing the driving force, the back e.m.f. induced in the voice coil will be subject to the same nonlinear influence; and the two effects will cancel, so the back e.m.f. produced by the voice coil will still be sinusoidal. This means that no amplifier can possibly have any means of telling, through ultimate damping or any other kind of device, that the voice coil is not moving in an undistorted fashion. Such distortion cannot possibly be eliminated by any purely electrical means.

Mr. Hafler's comments relative to nonlinear movement due to other causes, such as nonlinear compliance of the cone edges, will apply in respect to the restoring force produced by feedback—the effect just described only complicates matters a little further, and shows that any form of damping control circuit can produce all kinds of effects on distortion originating in the loudspeaker itself.

By far the safer approach is to get a good design of loudspeaker, in which distortion has been reduced to the minimum to start with, and forget about trying to improve the loudspeaker's distortion by means of the amplifier. -30-

REPAIRING TV TUNER CONTACT SPRINGS

By HYMAN HERMAN

Shown in Fig. 1 is a method of repairing the contact springs used in turret-type television receiver tuners. These contacts, being made of brass, lose their springiness with repeated use, flattening out and causing poor contact between the slug contacts on the drum of the tuner and the rest of the circuit.

To effect a lasting repair, insert a piece of polystyrene spaghetti tubing, 1/8 inch in diameter, through the center of the spring contacts after the latter

have been brought back to normal shape with long-nose pliers. The spaghetti tubing prevents the contact springs from flattening out again.

If any of the contact springs are found to be broken, the entire contact plate should be replaced and the spaghetti inserted through the contact springs before installation.

It is good practice to remove all unused channel slugs so that the springs can "stretch" between channels. -30-

Fig. 1. Spring contact plate used in turret-type TV tuners. Shown in dotted lines is the spaghetti tubing that is inserted through the contact springs to open them.

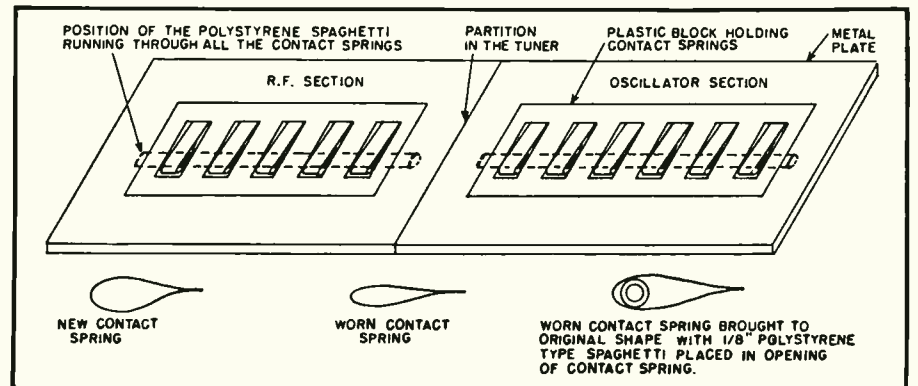

CHECKING TURNTABLE SPEED (TWENTY YEARS AGO)

By WILLIAM C. LEWIS

WHILE looking through some collected junk recently, the author unearthed the device shown in Figs. 1 and 2. A friendly radio oldtimer explained that this device was used to check the speed of turntables in the long gone days of single-speed players.

This ancestor of the present-day stroboscopic disc operates by the centrifugal force created by spinning a weight mounted on one end of a pointer about a central axis. At a certain speed the weight will move a certain distance.

This moves the horizontal indicator or pointer down until it aligns itself with a fixed point over the axis of the circle. When it is in perfect alignment the table is going at the correct speed of 78 rpm. When the moving indicator is above the fixed point the table is slow and when it is below the table is fast.

This device could be expanded to operate on three-speed turntables but it certainly would clutter up a service kit. There are less involved ways of handling this little chore!

Fig. 1. This device was used to check the speed of record turntables in the heyday of the 78 rpm disc. See Fig. 2 on its use.



Fig. 2. The indicator in use. The turntable speed is evidently correct since the pointer is exactly horizontal here.

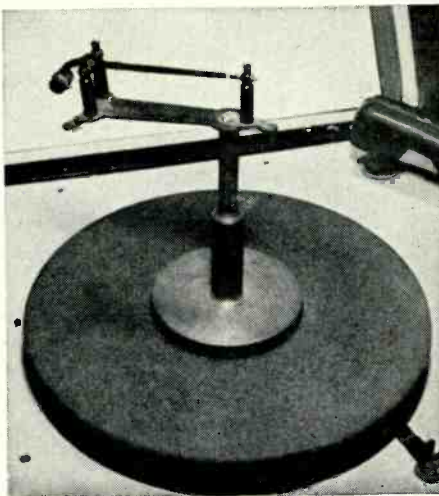

PLATT ELECTRONICS ANNOUNCES

ITS NEW HOME AT
141 LAKEVILLE Road
New Hyde Park, L.I., N.Y.

PHONE: FLoral Park 2-4087

We would like to express our appreciation to our many customers and friends who have made this expansion move possible. Be sure to watch our next ads for the best buys ever! Or better still, why not pay us a visit at our new home.

HOW TO GET TO NEW PLATT HEADQUARTERS

BY L. I. RAILROAD—34th St. Pennsylvania Station to New Hyde Park Station. Short taxi ride to building.

BY AUTOMOBILE—34th St. Midtown Tunnel to Queens Blvd., turn right to Grand Central Parkway, turn left to Cross Island Parkway, turn right to Jericho Turnpike. Proceed to Lakeville Road, turn left 1 block to No. 141.

News of SUPREME Radio & TV Manuals

Just Out



RADIO DIAGRAMS

Here is your best complete source of all needed RADIO diagrams and service data. Covers everything from most recent radios to pre-war old-timers; home radios, auto sets, combinations, changers, and portables. Sensational values. Still sold at pre-Korean prices. Only \$2 for most volumes. Every Radio manual contains large schematics, all required alignment facts, parts lists, voltage values, trimmers, dial stringing, and helpful service hints. All volumes are large in size, 8 1/2 x 11 inches, about 190 pages. See coupon below for a complete list of these low-priced manuals.

TELEVISION SERVICING COURSE

Let this new course help you in TV servicing. Amazing bargain complete, only \$3, full price for all lessons. Giant in size, mammoth in scope, topics just like a \$200.00 correspondence course. Lessons on picture faults, circuits, adjustments, short-cuts, UHF, alignment facts, hints, antenna problems, trouble-shooting, test equipment, picture analysis. Special, only **\$3**



SIMPLIFIED RADIO SERVICING BY COMPARISON

Fix any radio easily. New, different COMPARISON method finds faults quickly. Covers every radio set—new and old models. Introductory training included. Simple picture suggestions tell you where to look for faults. No testers needed for most jobs. Data on all tubes. Manual form, 96 large pages, 8 1/2 x 11". Special price, only..... **\$1.50**

RADIO SERVICING COURSE

Here is your most amazing bargain in radio training. For only \$2.50 (full price) you can obtain a practical radio course of 22 easy-to-follow lessons. Covers every topic in radio. Review fundamentals, learn new servicing tricks, prepare for television. Compares lesson-by-lesson with the best \$150.00 home-study correspondence courses. With self-testing questions. Large size: 8 1/2 x 11". New 1955 edition. Price, only..... **\$2.50**

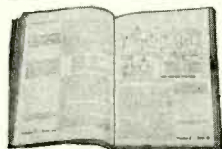

New

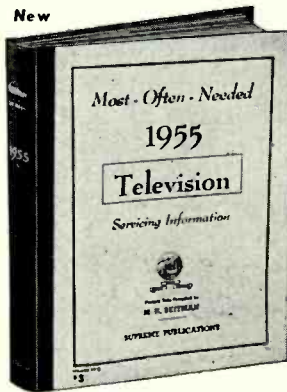

New 1955 TV manual covers all important sets of every make. Includes all data needed for faster TV servicing. Amazing bargain. A whole year of service material for only..... **\$3**

ALL NEEDED TV DATA

Supreme TV manuals have all needed service material on every popular TV set of every important manufacturer. Here is helpful, practical, factory-prepared data that will really make TV servicing and adjustment easy for you. Only one low-priced manual for each year from 1947 to 1955. These giant TV manuals have complete circuits, alignment facts, test patterns, response curves, service hints, all recommended changes, voltage charts, waveforms, and many double-page diagram blueprints.

AMAZING BARGAIN

Here is your TV service material to help you do more expert work quicker; and priced at only \$3 and \$2 per manual covering a full year of material. Be ready to repair any model by having in your shop all nine TV volumes listed in coupon below. Or try the new 1955 TV manual to see what an amazing bargain you get for only \$3.

NO-RISK TRIAL ORDER COUPON

SUPREME PUBLICATIONS, 1760 Balsam Rd., Highland Park, ILL.

Radio Diagram Manuals

- 1955 Radio Manual, \$2
- 1954 Radio Manual, \$2.50
- 1953 Diagrams
- 1952 Radio
- 1951 Diagrams
- 1950 Manual
- 1949 Radio
- 1948
- 1947
- 1946
- 1942 Manual
- 1941
- 1940
- 1939
- 1926-1938 Manual, \$2.50
- Radio and TV Master Index, 25¢

PRICED AT ONLY **\$2** EACH

- Rush RADIO and TV manuals checked in coupon.
- New Television Servicing Course, complete... \$3.
 - Simplified Radio Servicing by Comparison... \$1.50
 - Radio Servicing Course (all 22 lessons)... \$2.50
 - New 1955 Television Manual, \$3.
 - 1954 TV, \$3.
 - 1953 TV Manual, \$3.
 - 1952 Television Manual, \$3.
 - 1951 TV, \$3.
 - 1950 Television Manual, \$3.
 - 1949 TV, \$3.
 - 1948 TV, \$3.
 - 1947 TV & FM, only \$2.

- I am enclosing \$..... Send postpaid.
- Send C.O.D. I am enclosing \$..... deposit.

Name:

Address:

Supreme Publications
Sold by All Leading Parts Jobbers

CRYSTALS

ALL CRYSTALS TESTED FOR ACTIVITY! 1-DAY SERVICE! Satisfaction Guaranteed!

NEW! E-X-T-E-N-D-E-D NOVICE BAND CRYSTALS!

Individually Each \$1.25
Lots of 10 or more Each 99c

YOUR CHOICE OF FREQUENCIES

80 METERS

3701, 3702, 3703 through 3748
in steps of 1 KC.

40 METERS

7151, 7152, 7153 through 7199
in steps of 1 KC.

DOUBLING TO 40 METERS

3576, 3577, 3578 through 3599 in steps
of 1 KC.

CRYSTAL PACKAGE SPECIALS! SATISFACTION GUARANTEED

Pick Your Favorite Package Deal!

PACKAGE NO. 1. 100 crystals. Consists of 80 FT-243, 10 FT-171 and 10 DC-34-35.

Ship. wt. 6 lbs. **\$9.95**

PACKAGE NO. 2. 5 choice crystals. Zenith Model DC-18-A; SR-5 Bliley, 10,000 Kc.; FT-243, 5,000 Kc.; FT-241, 200 Kc.; FT-241, 500 Kc. POSTPAID.

\$8.95

PACKAGE NO. 3. 36 FT-241 Low Frequency Crystals. FOR SINGLE SIDE BAND.

\$3.95

POSTPAID
PACKAGE NO. 4. ALL CRYSTALS IN PACKAGES 1, 2, and 3 ABOVE. POSTPAID.

\$19.95

PACKAGE NO. 5. 22 FT-241 Crystals. SINGLE SIDE BAND LATTICE FILTER PACKAGE including two 455 Kc. IF Transformers.

\$9.95

POSTPAID
PACKAGE NO. 6. 80 FT-241 Low Frequency Crystals. FOR SINGLE SIDE BAND.

\$14.95

POSTPAID
PACKAGE NO. 7. 120 FT-243 Crystals. Complete with storage box. Ship. wt. 9 lbs.

\$24.95

PACKAGE NO. 8. 120 FT-243 Crystals. Different frequencies from Package No. 7. Complete with storage box. Ship. wt. 9 lbs.

\$24.95

PACKAGE NO. 9. 240 FT-243 Crystals. (Package No. 7 PLUS Package No. 8.) Complete with 2 storage boxes. Ship. wt. 18 lbs.

\$39.95

PACKAGE NO. 10. 483 Crystals. (Consists of Packages No. 1, 2, 3, 5, 6, 7, 8.)

\$89.50

Ship. wt. 30 lbs.

PACKAGE OFFER 3 RECEIVERS

Consists of 75 MC Receiver, 6-9 MC Command Receiver, and 3-6 MC ARC-5 Receiver. ALL THREE, used, good cond. Wt. 40 lbs.

\$9.95

RK-65 RAYTHEON TETRODE TUBE. 500 W. Ideal for Single Side Band. Brand new. Wt. 3 lbs.

\$9.95

Only
For Full Information About Above Package Deals & Lists of Frequencies—See Our Ads in June & July/55 Issue of Radio TV News and C.Q. Magazine.

SEND FOR FREE FLYER!

Gives complete listing of crystal frequencies.
TERMS: All items subject to prior sale and change of price without notice. Minimum order: \$2.50. ALL orders MUST be accompanied by check, cash or M.O. WITH PAYMENT IN FULL. NO C.O.D. Postpaid shipments made in U. S. and possessions only. Calif. buyers add sales tax. ADD SHIPPING COSTS FOR ALL PACKAGES OTHER THAN THOSE SENT POSTPAID.

U. S. CRYSTALS, INC.

805 S. Union Ave. Los Angeles 17, Cal.

IMPROVED TRANSISTORS ANNOUNCED BY G-E

Versatile component's usefulness extended by new process which increases the frequency range, improves performance.

THE Electronics Division of *General Electric Company* has announced the development of a revolutionary new method of producing the crystal "hearts" of transistors.

The transistors are now being produced by the new "meltback" process which enables them to operate efficiently at frequencies five times higher than ordinary transistors. At these high frequencies, according to the company, these new transistors show greatly improved power-amplification characteristics.

Developer of the new "meltback" principle is Dr. Robert N. Hall, the young *G-E* scientist who also developed the well-known "rate-growing" process for making junction transistors.

"Meltback" significantly improves the control of impurities in the thin layers of germanium or silicon crystals from which transistors are made. These crystals are smaller than a grain of wheat, and some layers must be as thin as 1/5000th of an inch for satisfactory performance at high frequencies.

In previous processes, crystals were formed from a pool of molten metal, and the layers created by cycling the rate of growth. Scientists have been faced with the problem of keeping

materials in different layers from contaminating each other during the 20 minutes it takes the molten mass to solidify and cool to room temperature. This has meant thicker separating layers than are desirable for high-frequency use. In the new process, cooling time is greatly shortened, there is less intermixing between layers, and the layers therefore can be thinner. Thin layers allow electrons to travel more quickly from one side of the crystal to the other, thus increasing the frequency at which the transistor can operate.

Commercial methods previously available for making transistors involved the production of cigar-sized crystals of germanium or silicon and cutting them into thousands of tiny pieces. The new method uses thin, wire-like crystals and because of the reduced cross-section, the melting back is accomplished quickly and cooling takes place in less than a second. Thus the entire cycle of melting, cooling, and removal of the finished pellet takes only a fraction of a minute.

These new units were developed by the company's Schenectady laboratory and can be used in TV, radar, short-wave radio, and other electronic devices for high-frequency use. —50—

Dr. Robert N. Hall, left, who has devised a new method of growing the tiny crystal "hearts" of transistors from thin wires of silicon, demonstrates the equipment to R. I. Scace, another *G-E* scientist. The transistors made by the new "meltback" process can be used in TV, radar, short-wave radio, and other devices where high frequencies are used. Frequencies up to five times higher than standard units can now be handled.

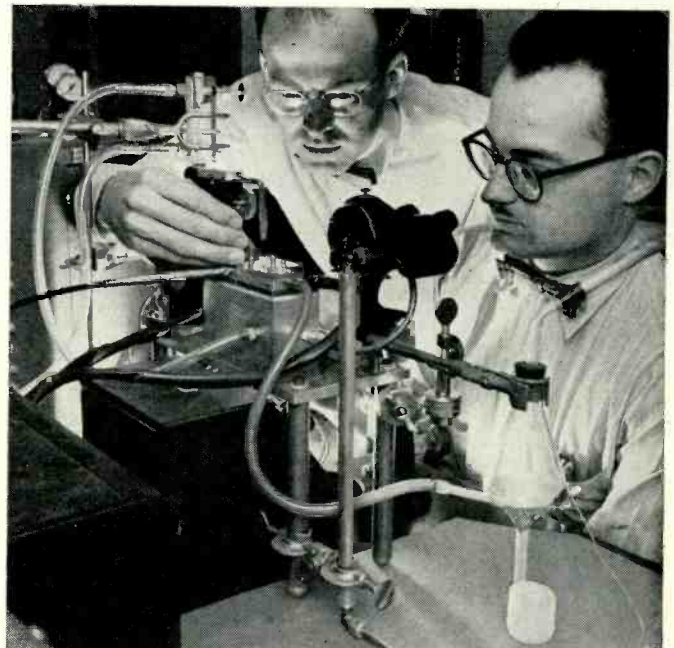

Marine Electrolysis (Continued from page 41)

disconnected until the defect can be remedied.

The remedy for heavy primary cell flow is a shipyard operation, since the boat must be hauled out for underwater inspection. If the action has been taking place for long, etching on the affected parts will be visible to the eye. Sometimes, zinc "protector" plates, due to their increased susceptibility, could cause a heavy ground current, donating themselves to the action without any great loss in near-by fittings. Dissolution of "protectors" is normal, and indicative of their functioning in the manner intended.

If excessive primary ground current is measured, and no rapid etching is readily apparent, comparatively base, and therefore dangerous, fittings can be detected by testing with the setup of Fig. 1 while the boat is out of the water. Moisten the two sponges with salt water; press one to the ground plate and the other to the various fittings on the hull. By maintaining pressure, area of contact, and the cleanliness and moisture content of the sponges at a standard level, dangerously active metals can be spotted. The safest course is to remove any offending hardware before it drops off of its own accord at a very inconvenient time.

Primary-cell electrolysis usually takes months to advance to a serious stage but electrolysis due to the external application of a voltage between fittings can destroy a fitting in an hour! This dangerous condition occurs from the "cross grounding" of shipboard electrical equipment.

Usually, one side of the battery is grounded in the small-boat electrical system. Now, if some other device such as a radio connected to a ground plate or to a guy-wire antenna, is connected with the opposite polarity grounded, full battery e.m.f. appears between the engine ground (sea fittings, propeller and shaft, and bilge water) and the second grounded object. Current flow in amperes is common, and the positively-grounded end of the underwater circuit will disappear in a distressingly short time.

Equipment should *never* be cross connected, even if it does not require grounding. Too many times, a chassis or framework is accidentally grounded

Fig. 1. Setup for detecting electrolysis paths between boat fittings. Saturate the sponges with salt water and apply to the underwater metal parts.

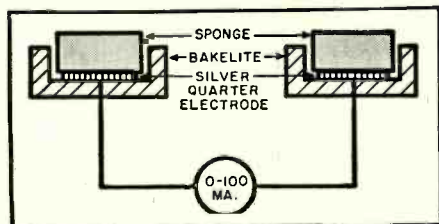

August, 1955



WE'VE GOT THE

NEWEST EQUIPMENT

FROM **hallicrafter** . . . AT

"The World's Largest Distributor of Amateur Radio Equipment!"



THE HT-30
Xmtr./Exciter
Only
\$26.98
Per Month

Cash Price: \$495.00 Pay Just 10% Down

Delivers AM, CW and Single Side Band suppressed carrier transmission. Built-in VFO, with provision for quartz crystal, calibrated directly in Kc. Bandswitching for 80, 40, 20 and 10 M. Built-in voice control. 35 watt peak output on S. S. B. TVI suppressed, control circuits and AC power lines filtered. Bias supply for Final outboard amplifier. Unwanted sideband at least 40 db. down or more. Contains 20 tubes. Many other top-notch features. Compact: 18x9x12". Write for complete specification sheet!



THE HT-31
Linear Power
Amplifier
Only
\$21.53
Per Month

Cash Price: \$395.00 Pay Just 10% Down

Full bandswitching linear power amplifier employing two 811-A zero bias triodes in parallel; highly stable, extremely versatile. Power input: 500-510 watts. Continuous frequency coverage from 3.4 Mc. to 30 Mc. Pi-network output for efficiency harmonic and TVI suppressed. Major TVI suppression built-in. No antenna tuner required; — feeds loads from 50-600 ohms. Full metering of all important circuits. Satin black cabinet with brushed chrome trim: 20x12x17 1/4".



THE SX-100
Receiver
Only
\$16.08
Per Month

Cash Price: \$295.00
Pay Just 10% Down

Latest Receiver, containing Tee-Notch; — a stable non-regenerative system for reducing heterodyne interference and steepening the already excellent 50 Kc. IF pass band. Other superior features: antenna trimmer, 100 Kc. crystal marker, new precision dial, gear drive dial system, selectable side band operation, low drift and others. Contains 15 tubes. Frequency range: 538 Kc.-1580 Kc., 1720 Kc.-34 Mc. For full details, write today! Grey black steel cabinet: 18 1/2x8 1/2x10 5/8".

We Carry the Complete Line
of Hallicrafter Equipment!
Write for Detailed Info Today!

AVAILABLE SEPTEMBER 1st

The New 1956 Catalog!
Your Guide . . .

to over 15,000 of the latest items for the amateur, the experimenter, the industrialist and the Hi-Fi fan. Makes it easy to do business with WRL.



Please rush me: Your latest FREE catalog and information on items checked below! Quote your top trade offer for my _____ (present equipment)



on your _____ (New WRL Eqpt. Desired)
 HT-30 HT-31 SX-100
 Other Hallicrafter Models
Name: _____ R-8
Address: _____
City & State: _____

TV TUNER REPAIRS 48-HOUR SERVICE

Defective tuners rebuilt to factory standards. New tuner guarantee. Ship prepaid.

RADIO PRODUCTS CO.

15-20 122nd Street • College Pt. 56, N. Y.
We carry a full line of Replacement Tuners for all makes of T.V.

30-
15,000
Cycles
+!

VIKING
Full Fidelity 75
TAPE DECK
See ad in next month's issue

GET INTO ELECTRONICS



You can enter this uncrowded, interesting field. Defense expansion, new developments demand trained specialists. Study all phases radio & electronics theory and practice; TV; FM; broadcasting; servicing; aviation, marine, police radio. 18-month course. Prepare for good pay. Graduates in demand by major companies. High School or equivalent required. Begin January, March, June, September. Campus life. Write for catalog. **VALPARAISO TECHNICAL INSTITUTE** Dept. RD Valparaiso, Indiana

A TERRIFIC BUY!

TS-100/AP 'SCOPE

One of the most sensational values ever offered! Circular sweep, rate: 1.5 microseconds per inch, 12.2 microseconds per revolution. Linear sweep, rate: 12, 120 and 360 microseconds for 3" sweep. Self-contained in metal case 8"x12 1/2"x16 1/2" deep. For 110V 50 to 1200 cycles AC. Demilitarized, NEW, with all tubes including crystals and C.R. Tube.



\$34.50

OUR LOW PRICE

NAVY RECEIVER TYPE ARB

Four Band, 105 to 9050 kc. Low Freq., Ship, Broadcast—40 and 80 meters. Includ. tubes and dynamo, for 24 volt operation. Easily converted for 110 V., 110 V. or 6 V. Schematic included. Excellent Condition. Overall: 8 1/2" x 7 3/4" x 15 1/4". Wt. 30 lbs. Special **\$18.65**

BC-221 FREQ. METER CASE



Aluminum case for BC-221 or TS-184 Freq. Meters. With rolt. reg. supply using VR105 2 ballast tubes, relay, cable, etc. Inside front: 9 3/4"x7 3/4"x7 7/8". Inside rear: 2" deep. Shock-mounted.

BRAND NEW, in original packing!

\$3.95

TG-34A CODE KEYS

Self-contained automatic unit, reproduces code practice signals recorded on paper tape. By use of built-in speaker, provides code practice signals to one or more persons at speeds from 5 to 25 WPM.

BRAND NEW, in original carton.

\$16.88



MICROPHONES—HEADPHONES

Model	Description	Excellent Used	BRAND NEW
T-17	Carbon Hand Mike	\$5.45	\$7.95
HS-23	High Impedance Headphones	\$2.25	\$4.05
HS-33	Low Impedance Headphones	\$1.79	\$4.65

FAMOUS BC-645 XMITTER-RECEIVER

Makes wonderful mobile rig for 420-500 Mc. Easy to convert for phone or CW 2-way communication. CONVERSION DIAGRAM INCLUDED. This swell rig originally cost over \$1000—yours for practically a song! You get it all, in original factory carton. BRAND NEW, complete with 17 tubes, less power supply. Shpg. wt. 25 lbs. **\$29.50**

PE-101C DYNAMOTOR for BC-645, has 12-24V input (easy to convert for 6V Battery operation) only **\$6.95**

UHF ANTENNA ASSEMBLY, for 1K-645 **\$2.45**

CONVERSION BOOKLET. Instructions for most useful surplus rigs. **\$2.50**



AGFA ANSCO Bubble Sextant

Made for U. S. Armed Forces. Actually worth \$150 or more! Has illuminated averaging disc for nighttime use. Complete with carrying case, recording discs, flashlight with rheostat for using sextant at night, 2X telescope for faint stars, and Allen wrench. Only. **\$9.95**

Complete

WILLARD 6-VOLT MIDGET STORAGE BATTERY

3 Amp. Hour. BRAND NEW. 3 3/8"x1-13/16"x2 3/8". Uses Standard Electrolyte. Only **\$1.85**

SPECIAL OFFER! 2-VOLT "PACKAGE"

1-2V, 20 Amp. Hr. Willard Storage Battery. **\$1.95**
 1-2V, 7 prong Synchronous Plug-in Vibrator **1.49**
 1-Quart Bottle Electrolyte (for 2 cells) . . . **1.49**
 ALL BRAND NEW! Total Value **\$4.89**
G & G Combination Price, Only \$3.99

Please include 25% Deposit with order—Balance C.O.D. MINIMUM ORDER \$3.00. All Shipments F.O.B. Our Warehouse N.Y.C.

G & G Radio Supply Co.

Dept. N-8
 51 Vesey St., New York 7, N. Y., CO 7-4605
 Branch: 544 So. Broadway St., Dayton, Ohio

in such a case, and this can lead to disaster. A dangerous current can flow even through wet wood!

Cross grounding can be detected by measuring ground-plate current, as described before, or by turning off all fixtures and measuring for leakage current flow in a battery lead. As with primary-cell current, a flow of a few milliamperes is not harmful, and is to be expected in many boats. However, heavy flow should be stopped at once, by cutting out circuits until the flow stops, then finding the leak to ground in the power circuit of the faulty item.

When a.c. fixtures or equipment are used on boats, special care must be taken. For instance, radio equipment with transformer power supplies might have filter capacitors bridged across the a.c. input. The filter acts as a capacitive voltage divider which places the chassis at one-half the line voltage above ground. Accidental grounding of this chassis will put about 55 volts between the underwater fittings, which is underwater dynamite. Small radios without transformers are most dangerous, because they can heat up ground circuits to the full 110 volts. Another unsuspected culprit is the type of battery charger which employs an auto-transformer. Any such equipment is absolutely unsafe unless it has a reliable isolating transformer.

Even installing a.c. equipment on a dock or float can cause electrolysis on boats alongside if ground faults exist. Ground-leakage current from dock fixtures can take the low-resistance path through a boat ground system rather than through the comparatively resistive water, resulting in trouble.

Everyone connected with electronics who services a boat is likely to be asked about the danger of electrolysis resulting from his work. The answer is that correctly performed electronic work is not dangerous, although some of it might result in slightly increased primary activity. Such work will have nothing whatever to do with already-existing primary cells underwater, or with metals not bonded into the ground system. Installation of a ground plate

The propeller blade shown here is made from an inferior alloy and is decomposing due to the action of electrolysis.

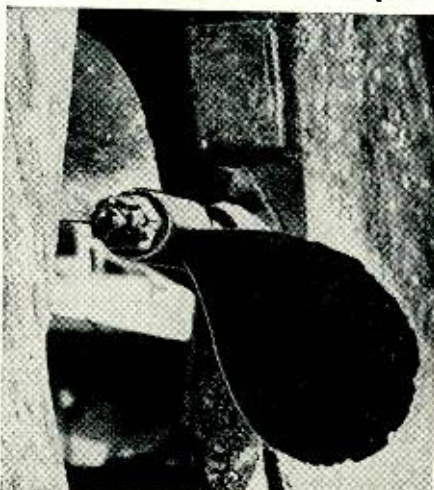

may speed the deterioration of "protectors," but this is the inevitable result of putting base metals underwater, whether they are called "protectors" or not. The fear that a correctly installed radiotelephone transmitter will cause electrolysis is without foundation.

One of the most important services the electronics man can perform for boat owners is to stress the importance of having any work connected with the electrical system performed *only* by persons who are thoroughly conversant with electrolysis, and who have the instruments for detecting and measuring it. Follow the principles outlined in this article and *you* can be this qualified man. The way boating is spreading, this can be a very good position to occupy!

-30-

Fixed Capacitors

(Continued from page 36)

between two plates submerged in an electrolyte, a thin film will form on one side of the positive plate. This film is the dielectric. In actual manufacture, the electrolytic film is formed under high current conditions and then the unit is enclosed. Because the electrolytic film is so thin it is possible to roll long pieces of aluminum foil into relatively small cans and obtain large capacities. On the other hand, application of a voltage with the wrong polarity to the capacitor causes breakdown of the film and the capacitor is ruined. Another cause of failure is minute impurities in the electrolyte or the aluminum foil which result in pin holes in the electrolytic film at which points breakdown or internal arcing occurs. Once such a minute hole exists, the defect spreads and the capacitor usually goes bad.

There are other types of capacitor failure. Excessive shelf time or heat can cause the electrolyte to deteriorate so that the leakage between the two terminals becomes appreciable. Occasionally, the seal is not perfect and the electrolyte leaks out.

Fig. 12 shows some familiar types of electrolytics used in home instruments as well as commercial gear. The aluminum can, cardboard tube, and small metal tube units all operate on the electrolytic film principle. While some types use a liquid electrolyte, most electrolytic capacitors contain a paste or semi-dry material. For commercial equipment and government use plug-in type dry electrolytics are available which fit into a regular octal socket. The use of plug-ins permits rapid replacement in case of failure.

Referring again to Fig. 1, the electrolytic capacitor suffers from a relatively large leakage, meaning a lower shunt resistance, and also a high series inductance. Where the capacitor is used in a filter or for bypassing at frequencies higher than 10 kc., a small value paper capacitor should be shunted across the electrolytic to reduce the series inductance.

Sometimes, when replacing an electrolytic in a radio or TV set, the mounting tabs can not be bent back properly because solder has been applied. Heating the chassis in the area of the capacitor with a soldering iron will melt the solder sufficiently to permit straightening the tabs and removing the unit properly.

Never connect an electrolytic capacitor without observing the polarity. Be especially careful when using an electrolytic as a coupling capacitor for low frequency signals. A typical instance is in the output of a cathode follower where the cathode is positive and the positive terminal of the electrolytic must be connected there. A unit having a deformed can is likely to be defective or else will go bad soon. Excessive shelf life should be avoided. Heat destroys the electrolyte even faster when the capacitor is not used.

Occasionally, capacitors can be reformed when their leakage appears high. Simply connect the capacitor across a high current source with about 1/2 of its rated voltage. A typical 40 µfd., 450 volt unit can sometimes be reformed with 250 volts and 300 milliamperes applied for a few hours. The current will be greatly reduced after a short time when the film has formed again. If there is no change after a half hour the capacitor cannot be salvaged.

There are many other types of capacitors in use for special applications and many new varieties are being developed constantly. Typical of the new types is the mica glass-seal capacitor currently being introduced by *Corning Glass*. Other new types are the "My-lar" dielectric units and the tantalytic subminiature units permitting large capacity at low voltage in a very small space.

Components for the electronic equipment of tomorrow will be somewhat different from the capacitors and resistors we know today just as the parts used years ago are only rarely found in the sets now in use.

HARVARD RADIO SYSTEM

PETER SCHNEIDER, chief engineer of Station WHRM, Harvard Radio Broadcasting Company, Inc., Cambridge, Mass., has written to say that Harvard's campus station serves a potential audience of 7000 and at times has 3500 or so actual listeners.

Mr. Schneider points out that Purdue ("Campus Carrier-Current System," May, 1955) is not the only station to tie in its off-campus houses. Harvard has tied in its medical school which is several miles away and it is reported that Brown and Pennsylvania have, to a greater extent, tied in numerous fraternity houses with considerable success.

He points out that this conflict in information is due, in part, to the fact that Purdue and Harvard belong to different and independent networks which do not communicate freely with each other.

From this and other letters we have received, it is obvious that campus stations are really "big business."

Remember QUALITY CANNOT BE UNDERSOLD

TUBES PREMIER Unconditionally Guarantees All Tubes for One Full Year
VERY BEST BRANDS AVAILABLE FOR IMMEDIATE DELIVERY, INDIVIDUALLY BOXED.

1A5GT 1A6 1A7GT 1B3GT 1D8GT 1F4 1F5G 1H5GT 1H6G 1L4 1LA4 1LA6 1LC5 1LC6 1LD5 1LM4 1LN5 1N5GT 1P5GT 1Q5GT 1R5 1S5 1T4 1U4 1V 1X2A 2A7 2X2 3A4 3B7 3C4 3Q4 3Q5 5U4G 5Y3GT	5Z3 6A7 6ABGT 6AB4 6AB7 6AC5GT 6AC7 6AG5 6AK5 6AK6 6AL5 6AQ5 6AU5GT 6AU6 6AV5 6AV6 6AX4GT 6AX5GT 6B4G 6BA6 6BD6 6BE6 6BF6 6BG6G 6BQ6GT 6BY5G 6C4 6C5GT 6C6 6C8G 6CB6 6CD6G 6D6 6D8G 6F6GT	6G6G 6J6 6K6 6LG6 6P5GT 6Q7GT 6S4 6SA7GT 6SD7GT 6SF5 6S7GT 6SH7GT 6SK7GT 6SL7GT 6SN7GT 6SQ7GT 6SS7 6U7GT 6U8 6V6GT	6V7 6W4GT 6W6GT 6X5GT 7A5 7A6 7A7 7A8 7AD7 7B6 7B7 7B8 7C4 7C5 7C6 7C7 7E5 7E6 7E7 7F7 7L7	7N7 7Q7 7W7 7X7 7Y5 7Y7 12AT7 12AU6 12AU7 12AV7 12AX4GT 12AX7 12AY7 12BA7 12BD6 12BE6 12BH7 12F5GT 12J7GT 12Q7GT 12S8GT 12SA7GT 12SC7 12SG7 12SK7GT 12SL7GT 12SN7GT 12SQ7GT 12X4 12Z3 14B6 14B8 14Q7 14W7 14X7 24A	25A6 25AC5GT 25BQ6GT 25C6G 25W4GT 25Y5 25Z5 26 27 32L7GT 35/51 35A5 35B5 35C5 35L6GT 35Y4 35Z5GT 39/44 41 42 43 45 45Z5GT 46 47 50AX6 50L6GT 56 58 70L7GT 77 78 14Q7 117L7GT 117Z3 117Z6GT
---	--	---	---	---	--

**100 TUBES
\$44.50**

ANY ASSORTMENT—TAKE WHAT YOU WANT
5c per tube extra FOR ORDERS LESS THAN 100 TUBES

NEW TV PICTURE TUBES

SIZE	PRICE	SIZE	PRICE
10BP4B	11.95	17LP4	21.95
126LP4A	13.95	17TP4	21.95
12UP4A	18.95	19AP4B	27.95
14BP4	18.95	19DP4B	26.95
14CP4	17.95	20CP4	26.95
16AEP4	19.95	20HP4	28.95
16AP4A	19.95	21AP4	27.95
16EP4A	17.95	21EP4	28.95
16GP4A	17.95	21FP4	29.95
16JP4A	17.95	21MP4	27.95
16KP4	19.95	21WP4	28.95
16LP4A	17.95	21YP4	27.95
16RP4	19.95	21ZP4	49.95
16TP4	19.95	24CP4	68.50
16WP4A	17.95	27EP4	69.50
17BP4A	21.95	27GP4	69.50
17CP4		27LP4	
17GP4		27NP4	
17HP4		27RP4	

ALL TUBES THROUGH 21" GUARANTEED 1 YEAR
24" AND 27" GUARANTEED 6 MONTHS

One Hundred Assorted Resistors
\$1.89 All Good Values and Sizes.
1/2—1—2 Watt Insulated.

PICTURE TUBE BRITNERS

95c Each
10 for \$7.50



FREE! SOLDERING IRON

WITH ORDERS
OF \$20.00
OR MORE

10 lbs. Net of Reliable Radio and T. V. Parts—Each Kit includes a new Radio Cabinet—Good for 5 to 8 Tube Chassis.

ALL FOR \$1.98

WRITE FOR FREE BARGAIN CATALOG FLYERS

PREMIER TV RADIO SUPPLY

3239 West North Avenue, Chicago 47, Illinois
ARmitage 6-5550

25% DEPOSIT with order, balance C.O.D. ALL shipments F.O.B. Chicago. ORDERS LESS THAN \$5.00—\$1.00 SERVICE CHARGE. CABLE ADDRESS: CONTULAB. prices subject to change.



Amazing home or office intercom

TALK O'RADIO CONVERTER KIT

Easily installed—using your radio. The compact converter provides excellent intercom service. Color-coded leads—complete instructions—normal radio use. Money Back Guarantee

Specify: Wireless Direct Wire Dealerships Available
RA-TECH LABS 177 ROYAL POINCIANNA WAY PALM BEACH, FLORIDA

45 DB
Signal
to
Noise!

VIKING
Full Fidelity 75
TAPE DECK
See ad in next month's issue

MORE JOBS than graduates

Demand for our engineering graduates exceeds supply. Effective placement service. Study in this world-famed college established 1884. Quarters start Sept., Jan., March, June. Approved for Veterans.

Bachelor Science degree in 27 months
Complete Radio Eng. course includes TV, UHF and FM. Also Mech., Civil, Elec., Chem., Aero. and Adm. Eng.; Bus. Adm., Acct. Small classes. Well-equipped labs. Modest costs. Prep. courses. Write Jean McCarthy, Director of Admissions for Catalog, View Book and "Your Career" Book.



TRI-STATE COLLEGE

1685 College Avenue, Angola, Indiana

SURPLUS BARGAINS

MONEY BACK GUARANTEE

"CUTIE"—A 1" METER

A tiny meter of the highest quality. Mounts into 1" hole. Anodized aluminum case. Made by International Inst. Co. 10 mill basic movement, easily shunted to other ranges. We will supply manganin shunt wire FREE with each meter. BRAND NEW, in ORIGINAL BOXES. \$3.95 ea.

Your choice 0-10 mills.....
5-0-5 mills.....

FAIRCHILD RECORDING METER

—20 to +4 db, 500 ohm line, 2" Sq. bakelite case..... \$3.95 ea.

FAIRCHILD POWER SUPPLY

Made by Fairchild Recording for preamp use. Delivers 300 vdc at a cool 100 mills and 6.3 V @ 4A. Well filtered plus hum cancelling pot. Ripple less than 5 M.V. RMS. Pri. 115 volt 60 cy. Fused. Compact chassis shelf 4 3/8" x 6 1/2". Complete with 5Y3 tube and diagram. NEW, IN ORIGINAL BOX..... \$6.95 ea.

PIONEER MOBILE DYNAMOTORS

Designed for commercial service. Compact and efficient. The 400 Volt dynamotors are mounted on a base containing A, B and RF filters. All have internal cooling fans and brush filters. Jones receptacle and Plug supplied FREE.

5.5 to 6 VOLT DC INPUT				
Output	Int. Duty	Cont. Duty	Filter	Price
400 VDC	275 mills	175 mills	with	\$19.95
425 VDC	375 mills	275 mills	with	24.95
11.5 to 12 VOLT DC INPUT				
Output	Int. Duty	Cont. Duty	Filter	Price
400 VDC	275 mills	175 mills	with	17.95
500 VDC	300 mills	200 mills	with	21.95
500 VDC	300 mills	200 mills	less	18.95
400 VDC	175 mills	125 mills	less	9.95

PANEL METERS

WESTINGHOUSE, WESTON, G.E., SIMPSON, etc.	
2" METERS	
0-100 microamp. \$5.95	0-200 microamp. \$6.95
100-0-100 micro-amp. 4.95	0-500 microamp. 5.95
0-1 milliamper. 3.95	0-1.5 MA. 2.50
0-1.5 milliamper. 2.95	0-150 MA. 4.50
0-50 milliamper. 2.95	0-10 milliamper. 3.95
0-100 milliamper. 2.95	0-500 milliamper. 4.50
10-0-10 amp DC. 2.95	0-300 milliamper. 4.50
-10, +6DB, 500 ohm 3.95	0-500 milliamper. 4.50
0-15 DB, 8 ohm. 2.95	0-50 Volts AC. 3.95
0-300 Volt AC. 3.95	0-150 Volts AC. 4.95
	0-15 Amps DC. 2.95
	0-5 Amps RP. 6.95

BRAND NEW OIL CONDENSER BARGAINS

1 mfd 600 VDC. \$.25	6 mfd 1500 vdc. \$1.95
2 mfd 600 VDC. .45	10 mfd 1400 vdc. 2.50
4 mfd 600 vdc. .75	2 mfd 2000 vdc. 1.50
8 mfd 600 vdc. .95	3 mfd 2000 vdc. 2.25
10 mfd 600 vdc. 1.19	4 mfd 2000 vdc. 2.95
1 mfd 1000 vdc. .50	1 mfd 3000 vdc. 1.85
2 mfd 1000 vdc. .95	3 mfd 4000 vdc. 5.95
4 mfd 1000 vdc. 1.25	8 mfd 600 vdc. 1.95
8 mfd 1000 vdc. 1.50	1 mfd 6 KV DC .95
10 mfd 1000 vdc. 1.95	5 mfd 660 VAC. 1.10

G. E. RELAY CONTROL

(Ideal for Model Controls, Etc.) Contains a sigma magnet 8,000 ohm relay (trips at less than 2 MA), high impedance choke, bi-metal strip, neon pilot and many useful parts. The sensitive relay alone is worth much more than the total \$1.25 Each 10 for \$9.90 FREE Model Control Book with Purchase of 10. 6 Volt DC Relay, DPDT, extra 75c ea. SEST contact.....

WESTON MODEL 506 2" SQ. METERS
Genuine Weston—In orig. Boxes.
0-40 Volts DC..... \$3.95
0-120 Amp DC with ext. Shunt..... 3.95
SET OF 2..... \$7.50

A HUSKY BABY

Commercial grade filter choke made by Chicago Transf. Co. 6 Henry at 1.2 amperes, 30 ohms, DC res. 12, 500 V. Ins. \$22.50 ea. Type FS Case. A BARGAIN AT

ODDS 'N' ENDS BARGAINS

THORDARSON FIL TRANS. 110V. 60cy. Sec 6.3 VCT @ 10A..... \$1.49
Kit of 25 WIRE WOUND RES. 5 to 50 watt. 1.95
Kit of 10 TRANSFORMING MICAS..... 1.00
9 Ohm 100 watt Non-inductive resistors. 6 for 1.45
350 Ohm 100 watt Non-inductive resistors 5 for 1.95
.01 1000 VDC xmitting mica cond. 5 for .95
100,000 ohm, 100 watt bleeder res. 2 for .89
Cardwell 100 mmf variable, micalex. 2 for .89
Sangamo F21 Mica .001 5000 VDC..... .79
500 MMF CERAMIC CONDENSERS. 10 for .50
100 MMF APC Variable condenser. 4 for .95

Min. Order \$3.00—25% with order F.O.B. New York

POST ELECTRONICS COMPANY
69 BARCLAY STREET, NEW YORK 7, N. Y.
Worth 4-2526

Hi-Fi Control Amplifier

(Continued from page 51)

pansion and compression, hence the circuit function is called "expression."

The principle of operation is quite easily understood. A signal amplifier stage makes use of a remote cut-off, variable-mu tube. This tube characteristic is due to the special construction of the grid. Very little stage gain is needed, so the tube is triode-connected by joining together the plate, suppressor, and screen. A rather stiff fixed-bias is supplied to the cathode from the ten-volt point of a voltage divider. Under these conditions, the tube (which is a 6SK7, incidentally) will act as a conventional low-gain audio amplifier.

To obtain the "expression" effects, an additional bias voltage is applied to the grid along with the signal. This bias varies in direct accordance with the signal, thereby changing the stage gain as a function of the applied signal. This control bias is generated by the remaining two tubes of the "expressor" circuit.

In addition to feeding the 6SK7 signal amplifier, the signal input is also applied to the 6SG7 side amplifier. This pentode operates as a high-gain stage to amplify the signal, which is then connected to a twin-diode 6H6 rectifier. The amplified signal is fed to the plate of one section and to the cathode of the other section of the 6H6. The remaining plate and cathode connect to the extremes of a center-tapped potentiometer, with the tap grounded. The signal is rectified by the twin diode, while the potentiometer allows selection of the resulting positive and negative voltage used as d.c. control bias for the 6SK7 tube. Positive bias counteracts some of the initial fixed bias, increasing the stage gain to provide expansion. Naturally, the negative control bias is responsible for compression when desired. The degree of expansion or compression is determined by the setting of the control arm, or the effect can be removed completely at the midsetting of the potentiometer. At this setting, no control bias will be fed to the 6SK7 stage. The RC values in the control bias circuits are such that the bias follows the general audio levels, rather than the audio itself. The time constants of the circuit are rather critical and are best chosen by careful listening tests. The attack or "build-up" time is determined largely by R_{24} and C_{17} , while the release or "fall-off" time is controlled by R_{23} , C_{15} , and C_{16} as well. The values indicated have been found suitable for the usual program material.

In addition to the phonograph equalization already covered, it is desirable to have control over the bass and treble portions of the audio spectrum, to adjust the response for room acoustics, speaker characteristics and, of course, listener preferences. Both boost and cut are required at each end of

the range, with independent control, so dual tone controls are needed. Boegli has discussed fully the degenerative-type tone control in the June, 1951 issue of RADIO & TELEVISION NEWS, and in fact has included such a circuit in his "Improved Kappler Amplifier" which appeared in the October, 1953 issue of this magazine.

A degenerative tone control, with dual potentiometers utilizing Thordarson components, is included in this control amplifier. The action of the circuit has been well covered in the literature, and will not be repeated here. Suffice it to say that 16 db boost to 28 db attenuation at 60 cycles is possible, and 18 db boost or 35 db cut at 10 kc. is attained. At the mid-frequencies the stage operates with unity gain from the half 6SL7 used in the control stage. This results in approximately one to two volts r.m.s. output at this point. The master gain control is located after the tone control in order to improve the signal-to-noise ratio of the degenerative circuit.

Although miniature equivalents are available, metal tubes were used in the control amplifier with the exception, of course, of a glass 6SL7 output tube. Metal tubes were considered more desirable because they have, in general, proved to be less microphonic, longer lived, less subject to gas troubles, and are shielded inherently.

The inclusion of the compression action may be questioned by some readers. As stated, expansion of the dynamic range is the logical use of the "expressor" for playback purposes. However, this control amplifier is occasionally used to feed a disc recorder, and for this mode of operation the compression is advantageous. It may also find application as an automatic volume control for late evening listening or for background music when full dynamic range may be undesirable. However, such operation is definitely not to be misconstrued as "high fidelity" playback.

Construction

The complete control amplifier, as discussed, was constructed for developmental work. Reference to the photographs will show how this unit was built. A 13 x 5 x 3 inch aluminum chassis was used, attached to a 3 1/2 x 19 inch rack panel. Symmetrically spaced along the back side of the chassis are the tubes and tone control choke. These are arranged in the order of their appearance in the circuit, i.e., 6SJ7, 6SK7, 6SG7, 6H6, choke, 6SL7. Four RCA phono connectors are used for the inputs, located along the pre-amplifier end of the chassis. A similar connector for the output, as well as a four-prong power connector occupies the opposite chassis end. Controls on the front panel are (from left to right): input selector switch, master gain control, expression potentiometer, treble control, and bass control.

Beneath the chassis, terminal strips are attached along the center of the open area between front and rear

edges of the chassis. Most components going to ground are wired directly to the associated sockets, while the terminal boards support interstage coupling capacitors, plate resistors, decoupling networks, and the like. Parts placement is not too critical, although layout is directed toward short leads as much as possible. Shielded wire is used for the volume control and tone choke leads.

Operation

A few comments on operation of the control unit may be in order. Power for the unit is obtained from the power amplifier. Approximately 250-300 volts should be supplied, as well as 6.3 volts a.c. for the filaments. Current drain is low and no motorboating has been encountered with the usual well-decoupled supply. The tone control choke can pick up hum from power transformers or turntable motors, so it is advisable to keep it isolated from strong a.c. fields.

As previously mentioned, amplifier input levels should be correct for the proper "expressor" operation. Signals at the selector switch should be 0.2 to 0.5 volt, while at the phono pickup jack a voltage of at least 0.01 volt is required. Voltages less than these values will be insufficient to create enough control bias for maximum expansion. On the other hand, voltages in excess of the stated amounts may create such a great bias that distortion can be caused at extreme settings of the expression control.

Proper input levels can generally be obtained by use of the volume controls in the tuners and tape recorder, or the inputs may be padded down to the correct value. Alternatively, level-setting potentiometers could be incorporated into the control amplifier itself, if so desired.

With input levels of the required values, a maximum control bias of five to eight volts should be developed on peaks, which will act against the ten-volt fixed bias on the 6SK7. This will produce more than usable amounts of expansion without driving the grid positive. Likewise, the same amounts of additional negative bias are available for compression. It is quite possible to adjust the compression bias to produce a constant peak level at the output. This particular a.g.c. action might be of interest to hams, since much can be said in favor of compression rather than peak clipping for automatic modulation control for amateur transmitters.

The finished control unit has been more than satisfactory in its intended operation, and very definitely serves to increase the "presence" in reproduction of recorded program material. Most listeners have considered the expansion a desirable addition to the home audio system.

While this control unit might appear to be a rather elaborate unit—most audiophiles will agree that it's worth the time and trouble involved in its construction.

E-Z Way Communications Towers

Width 25"	20"	14"	10½"	10"
Legs 2" Pipe	1½" Pipe	1" Pipe	¾" Pipe	½" Pipe
Wt. Per ft. 20 lb.	14 lb.	8.0 lb.	5.5 lb.	4.5 lb.
Guy Space 80 ft.	60 ft.	40 ft.	33 ft.	27 ft.
Max. Ht. 320 ft.	250 ft.	200 ft.	150 ft.	120 ft.
Diagonal Brace ½" Pipe	Double ¾" Rod	¾" Rod	5/16" Rod	5/16" Rod
Horizontal Brace 1" Pipe	¾" Pipe	¾" Pipe	½" Rod	½" Rod
C-25	C-20	C-15	C-12	C-10

The E-Z Way one shot erection method saves you time, money and eliminates hazardous climbing.

With E-Z Way's new portable gin pole, it's easy to erect a 120 ft. tower in one piece. Everything is done on the ground. Our hurricane-proof towers are made of such strength that this one shot erection can be done safely and quickly. When recommended height and guy spacing is not exceeded, E-Z Way towers will stand a wind load of 50 lbs. per square ft.

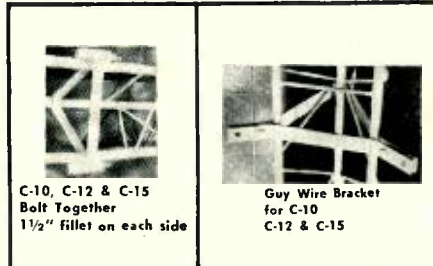

C-10, C-12 & C-15 Bolt Together 1½" fillet on each side

Guy Wire Bracket for C-10 C-12 & C-15

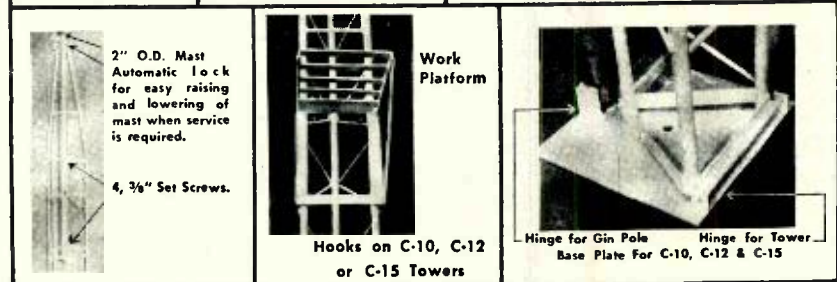

2" O.D. Mast Automatic Lock for easy raising and lowering of mast when service is required.

4, ¾" Set Screws.

Work Platform

Hooks on C-10, C-12 or C-15 Towers

Hinge for Gin Pole Hinge for Tower Base Plate For C-10, C-12 & C-15

Write for free catalog. Specify height of tower and type of antenna you intend to use. E-Z Way also manufactures free standing, crank-up and tilt-over towers for "Ham" rotary beams and TV antennas. Some of these towers can also be used for communications antennas.

E-Z WAY TOWERS, INC.

P. O. Box 5491
5901 E. Broadway

Phone 4-3916
Tampa 5, Florida

CODE SENDING SPEED RECEIVING SPEED

Be a "key" man. Learn how to send and receive messages in code by telegraph and radio. Commerce needs thousands of men for jobs. Good pay, adventure, interesting work. Learn at home quickly through famous Candler System. Qualify for Amateur or Commercial License. Write for FREE BOOK. **CANDLER SYSTEM CO.** Dept. 2J, Box 928, Denver 1, Colo., U.S.A.

Negligible wow or flutter!

VIKING Full Fidelity 75 TAPE DECK

See ad in next month's issue

AUTO RADIO PARTS
Factory Distributor For
Ford-Bendix Delco Colonial
—SPECIALS—

Custom Pushbutton Radios for '55 Ford—
Chev.—Plymouth \$45.47
6 Volt Vibrators, Standard 4 Prong 1.19
12 Volt Vibrators, 3 prong for Delco, etc. 1.59
6" x 9" P.M. Auto Speakers 2.39
Rear Seat Speaker kits complete with grille, wire, 3 way switch and 6" x 9" speaker 4.49

—SOUND EQUIPMENT—
27 Watt 6V-110V 3 speed Mobile Amplifier 114.00
25 Watt Weatherproof outdoor speakers 41.70
Hi-Fi Amplifier—20 Watts—20,000 cps 99.50
Hi-Fi Amplifier—10 Watts—20,000 cps 63.75
Hi-Fi Amplifier—8 Watts—20,000 cps 35.85
Hi-Fi Speaker—8"—20 Watt—50-12,500 cps 10.80
Hi-Fi Speaker—12" Co-Axial 12.95

Write for Information—25% deposit on CODs

LYTRON DISTRIBUTING COMPANY
1338 W. North Ave. Baltimore 17, Maryland

COMPLETE TRAINING

FOR BETTER RADIO-TV SERVICE JOBS



Let these two great new Ghirardi training books teach you to handle all types of AM, FM and TV service jobs by approved professional methods—and watch your efficiency and earnings soar!

Completely modern, profusely illustrated and written so you can easily understand every word, these books pave the way to fast, accurate service on any type of home radio-TV-electronic equipment ever made. Each book is brand new, each contains the latest data on the latest methods and equipment—NOT a re-hash of old, out-of-date material. Each is co-authored by A. A. Ghirardi whose famous RADIO PHYSICS COURSE and MODERN RADIO SERVICING were, for 20 years, more widely used for military, school and home study training than any other books of their type!

THE NEW Ghirardi RADIO-TV SERVICE LIBRARY

Almost 1500 pages and over 800 clear illustrations show step-by-step how to handle every phase of modern troubleshooting and servicing.

1—Radio and Television Receiver TROUBLESHOOTING AND REPAIR

A complete guide to profitable professional methods. For the beginner, it is a comprehensive training course. For the experienced serviceman, it is a quick way to "brush up" on specific jobs, to develop improved techniques or to find fast answers to puzzling service problems. Includes invaluable "step-by-step" service charts. 820 pages, 417 illus., price \$6.75 separately. (Outside U.S.A. \$7.25)

2—Radio and Television Receiver CIRCUITRY AND OPERATION

This 669-page volume is the ideal guide for servicemen who realize it pays to know what really makes modern radio-TV receivers "tick" and why. Gives a complete understanding of basic circuits and circuit variations; how to recognize them at a glance; how to eliminate guesswork and useless testing in servicing them. 417 illus. Price separately \$6.50 (outside U.S.A. \$7.00).

New low price...you save \$1.25!

If broken into lesson form and sent to you as a "course," you'd regard these two great books as a bargain at \$50 or more! Together, they form a complete modern servicing library to help you work faster, more efficiently and more profitably. Completely indexed so you can look up needed facts in a jiffy.

Under this new offer, you save \$1.25 on the price of the two books—and have the privilege of paying in easy installments while you use them! No lessons to wait for. You learn fast—and you learn right!

STUDY 10 DAYS FREE!

Dept. RN-84, RINEHART & CO., Inc.
232 Madison Ave., New York 10, N. Y.

Send books below for 10-day FREE EXAMINATION. In 10 days, I will either remit price indicated or return books postpaid and owe you nothing.

Radio & TV Receiver TROUBLESHOOTING & REPAIR (Price \$6.75 separately)

Radio & TV Receiver CIRCUITRY & OPERATION (Price \$6.50 separately)

Check here for MONEY-SAVING COMBINATION OFFER . . . Save \$1.25. Send both of above big books at special price of only \$12.00 for the two. (Regular price \$13.25 . . . you save \$1.25). Payable at rate of \$3 after 10 days if you decide to keep books and \$3 a month for 3 months until the total of \$12 has been paid.

Name

Address

City, Zone, State

Outside U.S.A.—\$7.25 for TROUBLESHOOTING & REPAIR; \$7.00 for CIRCUITRY & OPERATION; \$13.00 for both books with order, but money refunded if you return books in 10 days.

RADIO-TV Service Industry News

AS REPORTED BY THE TELEVISION TECHNICIANS LECTURE BUREAU

"OUR biggest problem," a TV service businessman said recently, "is not in getting technicians capable of repairing sets. It is in finding men who are competent to deal with customers."

In another city, where receiving tube sales through drug stores are hurting the TV service business, one of the service shop operators remarked that, "This development is part of the price we are going to have to pay for the thoughtless ways we have handled TV service customers in the past.

"We have dashed into homes," he continued, "quickly replaced one or two tubes which experience indicated were probably the reason for the set's failure, turned on the set and found it OK, collected \$8.75 for the work (\$5.00 for the service call and \$3.75 for the tube), and hurried on to the next call. The total amount of time it required was probably less than fifteen minutes. We used no test instruments and did nothing to indicate to the customer that we were using profound knowledge in working on a highly complex piece of equipment.

"Our major objective was to complete as many service calls during the day as we could. We gave no thought to the customer's reaction to the apparently simple and easy way the set was fixed. That \$8.75 she paid was important money to her and no doubt, she burned inwardly over having to pay so much for so little.

"After set owners discover that, in three out of every four times their sets need servicing, all that is needed is two or three tubes, many of them quickly grab at the chance to fix their sets when they learn where they can buy the tubes.

"Most of the troubles of the TV service industry are due to our own carelessness and negligence. We need to study and understand the fundamentals of good customer relations and use them in every contact with our service customers."

Customer Relations

Good customer relations are an absolute *must* for electronic service businesses because they are selling a product that the customer does not want to buy. No one *wants* to buy service.

Most people are put out when they do have to buy service.

An effective customer relations program starts at the telephone where service calls are received, and it is continued in all contacts with the customer in person, by phone, and by mail. Electronic servicing is not a technical business—it is a *sales business*.

Good customer relations include the studied use of subtle showmanship, particularly in servicing sets in the home. Neat, attractive uniforms, a pleasant demeanor under the most exacting conditions, and a neat appearance are essential parts of studied service showmanship. The regular use of complex looking test instruments, whether or not they are needed to locate the trouble, is excellent showmanship. The customer may think her TV set is a simple device, but she will have a feeling of respect for the man who knows how to use those, to her, mysterious looking gadgets.

One can learn a lot about customer relations by listening to set owners talk about their experiences with TV technicians. Recently a visitor to your editor's office noticed a picture of a v.t.v.m. lying on a table. "My TV service technician uses one of those," she said. "The first man we called when our set needed service changed a couple of tubes. He didn't have anything with him except a case with tubes and a few tools in it. About three weeks later our set went out again, so we decided to try another man. This man brought a little machine like that with him and made all kinds of tests on our set. Since then we have always called him because he knows what he is doing."

Cautious inquiry brought forth the names of the two men involved. The first one is a top-flight, "natural" electronics technician. He is an unusually competent circuit analyst who can spot the cause of a circuit failure quickly and apparently without effort. He is now out of business.

The second man is the "plugger" type. He uses test instruments regularly because he needs the information they develop on the average service job. Unknowingly, he used good showmanship. He has built up an excellent business with loyal customers.

Amazing Conical Bargain

2-BAY, 16-ELEMENT ARRAY

ONLY \$4.99 EACH IN LOTS OF 3

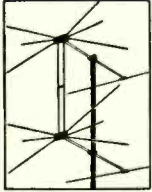

Here IS a Bargain! This powerful conical is being offered you at the lowest price in the country. The 2-Bay Array provides ultra-fine Fringe reception, and includes sixteen 3/16" airplane type aluminum elements, including hi-band adapters for greater gain on the hi channels—Is complete with one pair of stacking bars per array. Packed in cartons of three 16-element arrays, with tie rods, at \$14.95 per carton. Money Back If not Satisfied.

When purchased in single 16-element arrays, separately boxed—your cost is \$5.30 each
6 single arrays per carton—no tie rods, \$13.50 carton
4 Bay Ultra-fringe stacking assembly for above Model 4-B \$1.95 set

360° Super Directronic

ELECTRONICALLY ROTATES IN ALL DIRECTIONS VHF-UHF CHANNELS 2-83.

Powerful, 24 element 2 bay Directronic antenna is electronically beamed to any transmitter in fringe area by 6-position selector switch. No motors or electricity. Extremely high gain. COMPLETE WITH 6-POSITION DIRECTRONIC BEAM SELECTOR, 7' TUBULAR TRI-X CABLE, UNIVERSAL U-CLAMPS. Order model AX-524. Money Back if not satisfied.

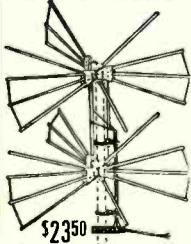

\$2350

\$50 WORTH OF TV KNOBS Only \$2.19 (A 50-knob Asst.—Guaranteed to satisfy)

6-wire Parallel Electrostatic or Magnetic—Individually boxed 89c ea.

FAMOUS MAKE 6 x 9 REAR DECK AUTO SPEAKER KIT. Complete with bezel, grille, switch, speaker and harness—a \$10 value \$4.40 ea. Same as above, 5 x 7 speaker—ONLY 3.95 ea.

TWIN LEAD BARGAIN

#55-mil good quality 500' reel \$5.75
1000' reel 9.95
#100-mil 10-strand fringe type low-loss polyethylene 1000' reel \$18.95

Snyder 3-section TV indoor antenna (rab. bitear) 89c ea.
Lots of 79c ea.
TV Cheater Cord, Only 22c ea.
TV Cheater EXT. Cord Only 29c ea.

National Electronics OF CLEVELAND

THE HOUSE OF TV VALUES

6608 Euclid Ave., Dept. N-8, Cleveland 3, O.

LEARN

Television-Radio Electricity

REFRIGERATION-ELECTRONICS IN THE GREAT SHOPS OF COYNE

TRAIN QUICKLY! OLDEST, BEST EQUIPPED SCHOOL of ITS KIND in U.S.

Come to the Great Shops of Coyne in Chicago. Get practical training in opportunity fields—TELEVISION—RADIO—ELECTRICITY—ELECTRONICS. Prepare now for a better job and a real future.

Approved for Veterans

Finance Plan—Enroll now, pay most of tuition later. If you need part-time work to help out with living expenses we'll help you get it. Advanced education or previous experience not needed.

FREE BOOK Clip coupon for Big Free Illustrated Book. No obligation and No Salesman Will Call. Act NOW.

B. W. Cooke, President

COYNE ELECTRICAL SCHOOL
A TECHNICAL TRADE INSTITUTE OPERATED NOT FOR PROFIT
Established 1899
500 S. Paulina, Chicago
ELECTRICITY ★ TELEVISION
RADIO ★ REFRIGERATION ★ ELECTRONICS

B. W. COOKE, Pres.
COYNE Electrical School
500 S. Paulina St., Chicago 12, Ill. Dept. C5-85H

Send FREE BOOK and full details on:

TELEVISION-RADIO ELECTRICITY

NAME.....
ADDRESS.....
CITY..... STATE.....

In today's market, the first man, the "natural" technician, is too smart for his own good. He makes electronic service look too simple and easy. His customers do not think his services are worth the money that he charges for them.

To the service technician, technical "know-how" is important from a production standpoint. In the customer's eyes, it is the technician's dress, bearing, and what he does and says that determines whether he will be called the next time service is needed.

A warm, friendly voice to greet customers when they phone for service is one of the most important elements in building a following of loyal customers. Many service operators fail to realize the importance of this element in service business operation. A girl with a good telephone personality can pave the way for pleasanter contacts for home service technicians. Properly coached on all of the information that is needed for efficient routing, she will get enough information about the location to make it easy for a technician to find the home without trouble. In short, a competent girl with a good telephone personality can help build a service business.

Cooperation

The nature of an independent service business is such that it is a rugged, individualistic activity. It uses parts, supplies, and equipment made by hundreds of manufacturers, and it services products made by hundreds of other manufacturers. There is no close liaison between an independent service business and one or even a small number of manufacturers.

Parts distributors on the whole do not concern themselves with the welfare of the legitimate service businesses in their trade areas. Although parts distributors have benefited greatly from the cooperation of their suppliers in building their businesses, few of them have realized the long-range insurance value in helping their customers—the independent service business—in building a healthier atmosphere for service in their communities.

These factors have led service businessmen to form service associations as a means of pooling their efforts to publicize their shops as honestly operated, competent service businesses. In some areas, associations have been highly successful in keeping their cities comparatively free from unethical and "gyp" service companies. This is especially true where association officers have been able and willing to devote a lot of their time to the planning and carrying out of programs and activities.

In our present economy, the independent business operator, working alone, wages a losing battle against the various forces that constantly threaten to change the character of the business. In service work, it usually is the activities of "gyps" or men of easy conscience who play havoc with the ethically operated service business.

One of a series on what makes one magnetic recording tape better than another



50% Extra Playing Time

Extra Strength Mylar® Base

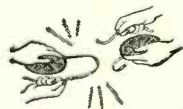

Full Depth Oxide

Micro-Polished®



Lubricated Both Sides...

YET COSTS NO MORE!

PLUS 50 Magnetic Recording Tape—newest in the famous Soundcraft line—brings you a combination of superior qualities that no other tape possesses. Qualities that let you capture and hear the true sense of violin strings, all the brilliance of brass, the color of wood winds... that faithfully echo the human voice in all its varied subtleties.

Plus 50's uniform output, inherently low signal-to-noise ratio, its 50% extra playing time, added strength and flexibility... its dimensional stability in any climate. These are the special qualities that make it the choice of professionals and amateurs, alike, wherever tape recording perfection is required.

And Soundcraft Plus 50 adds this special bonus: Its "Mylar" base assures virtually a lifetime of smooth, trouble-free service—at no more cost per foot than other quality tapes. Like Soundcraft "Red Diamond" Tape, Plus 50 is engineered and made by tape recording specialists. Get some at your dealer today.

*Trade-Mark for DuPont Polyester Film

The tape that has EVERYTHING!

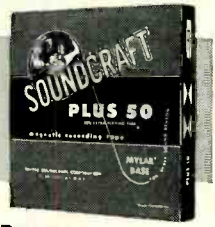

For Every Sound Reason

REEVES **SOUNDRAFT** CORP.

Dept. U 8, 10 East 52nd St., New York 22, N.Y.

HERE ARE THE GREATEST TUBE VALUES OF THEM ALL!

Top Quality Tubes, Lab tested, Individually boxed, and
FULLY GUARANTEED FOR ONE YEAR

This is only a small sampling from our gigantic stocks, all types, all competitively priced! Order ALL types you need—we'll ship immediately from stock! Send for our COMPLETE free listing.

Type	Price	Type	Price	Type	Price	Type	Price
OZ4	.54	6AQ5	.49	6SN7GT	.59	12SK7	.62
1A7GT	.53	6AS5	.50	6T4	.95	12SL7GT	.57
1AX2	.69	6AT8	.72	6T8	.79	12SN7GT	.58
1B3GT	.69	6AU6	.45	6U8	.79	12SQ7GT	.56
1D8GT	.77	6AV6	.40	6V6GT	.47	19B6G6	1.35
1H5GT	.43	6AX4GT	.59	6W4GT	.45	19T8	.79
1L4	.49	6BA6	.49	6W6GT	.56	25AV5GT	.84
1LA4	.59	6BC5	.54	6X4	.39	25BQ6GT	.89
1P5GT	.56	6BD6	.49	6X8	.79	25L6GT	.49
1Q5GT	.57	6BE6	.49	7A5	.59	25Z6GT	.48
1R5	.54	6BG6G	1.24	7A8	.59	35L6GT	.49
1S4	.58	6BK5	.69	7B4	.44	35W4	.43
1T4	.55	6BK7	.96	7B5	.59	35Z5GT	.47
1U4	.53	6BL7GT	.89	7B6	.59	50A5	.55
1U5	.48	6BN6	.79	7C4	.58	50B5	.49
1X2A	.69	6BQ6GT	.95	7E5/1201	.59	50C5	.49
3A4	.44	6BQ7A	.92	7H7	.59	50L6GT	.61
3A5	.90	6BZ7	.92	7R7	.65	75	.49
3AL5	.43	6C4	.41	7Z4	.49	807	1.39
3AU6	.47	6C8G	.85	12AT7	.73	2051	.95
3B7	.39	6C86	.57	12AU7	.58	9001	1.48
3BC5	.55					9002	.98
3BN6	.75					9004	.97
3CB6	.55					9006	.68
3D6	.39						
3Q4	.55						
3S4	.56						
3V4	.58						
4BQ7A	.90						
4BZ7	.96						
5AM8	.76						
5AN8	.79						
5AT8	.73						
5J6	.65						
5U4G	.55						
5U8	.76						
5V6GT	.51						
5X8	.73						
5Z3	.44						
6A8	.69						
6AB4	.51						
6AC5GT	.99						
6AC7	.89						
6AF4	.89						
6AF6	.75						
6AG5	.56						
6AG7	.95						
6AJ5	.89						
6AK5	.79						
6AL5	.41						
6AM8	.75						
6AN8	.78						

EXTRA BONUS!

Our special goodwill offer to you; these two most popular replacement TV receiving tubes
1-6J6 and 1-6AG5
FREE
with every order for \$10. or more!

Type	Price	Type	Price
6CD6G	1.49	12AV7	.72
6CF6	.64	12AX4GT	.68
6CS6	.51	12AX7	.63
6F6	.45	12AY7	.89
6F8G	.99	12BA6	.49
6G6G	.65	12BD6	.49
6H6	.49	12BE6	.49
6J5GT	.40	12BH7	.65
6J6	.59	12BY7	.69
6J7	.49	12BZ7	.65
6K7	.39	12C8	.34
6N7	.98	12F5GT	.35
6R7	.49	12J7GT	.58
6S4	.49	12K8	.58
6SA7	.54	12Q7GT	.59
6SF7	.59	12SA7GT	.64
6SG7	.49	12SF5	.49
6SH7	.60	12SG7	.75
6SK7	.49	12SH7	.75
6SL7GT	.59	12SJ7	.59

SPECIAL PURPOSE TUBES

Only a typical sampling listed here. Prices in our listing will speak for themselves!

Type	Price	Type	Price
211	2.21		
304TL	5.95		
801A	.39		
803	2.90		
815	3.90		
49	1619		.35
1625	.29		
1626	.49		
1629	.44		

SEND FOR OUR FREE LISTING! EXPORT INQUIRIES INVITED

Minimum order \$10. Please include 25% deposit with order. Prices subject to change without notice. All prices F.O.B. our warehouse NYC. Write for types not listed.

ELECTRON TUBE CORP OF AMERICA

580 Broadway, N.Y. 12, N.Y., Tel.: WOrth 6-2091

RADIO ENGINEERING DEGREE IN 27 MONTHS

Radio engineering is a big field. There's room for you in it—if you're good. Get first-class training at Indiana Tech. Intensive, specialized course including strong basis in mathematics and electrical engineering, advanced radio theory and design, television, electronics, Modern laboratories. Low rate. Also B.S. DEGREE IN 27 MONTHS in Aeronautical, Chemical, Civil, Electrical and Mechanical Engineering. G.I. Government approved. Enter September, December, March, June. You can earn part of your expenses right here in Fort Wayne while you are studying.

INDIANA TECHNICAL COLLEGE

985 E. Washington Blvd., Fort Wayne 2, Indiana
Please send me free information on B.S. Engineering Degree in 27 months as checked.

- Radio-Television Aeronautical
 Civil Mechanical Electrical

Name
Address

120

For instance, the man that advertises home service calls at \$1.50 or \$2.00 and makes up the difference in inflated tube and parts charges, poses a real threat to the businesses that honestly charge each element of their service fees at their true values.

Many men who advertise low service charges and make up the difference in padded parts bills, defend their actions by claiming their total bills are no larger than those of shops that make a legitimate labor charge and get list prices for the tubes and parts needed to effect the repairs. These men fail to realize that one dishonest act leads to another and that sooner or later, when they need money badly, they will start charging on the basis of "all the traffic will bear." Records of service shop failures indicate that the easy-conscience operators lead the mortality parade.

When service dealers in Indianapolis found that some low-cost service advertisers were charging two and three times the regular list prices for replacement tubes, the Indianapolis Television Technicians Association employed a professional advertising agency to prepare a mailing piece for them that included the average list prices of the most commonly used receiving-type tubes. These attractive folders carried copy about the ITTA and what it stands for. Members bought varying quantities of these folders, imprinted with their individual names and telephone numbers for distribution in their servicing areas.

With these tube price sheets in the hands of thousands of TV set owners, any service technician who attempts to charge more than regular list for tubes might find himself in the tough spot of trying to defend his charges to a "price-wise" set owner.

This type of action is only possible when a number of ethical service businessmen pool their efforts to pay for the material and its distribution. While an individual service business man could do it on a small scale, the limited coverage he would achieve would not have the impact necessary for the plan to be effective.

Regional and national public relations programs have not been possible because the memberships of present associations have been unable to finance programs of that magnitude. It would be possible to put over a tremendous national campaign in the interests of independent service shops if there was some way to get all ethically operated service businesses to participate in it. The cost-per-business would be very, very low.

Although the country is said to be going through a period of unusual prosperity, independent service shops generally have not been sharing in it. Service work has been far below par since the first of the year. This situation has intensified interest in cooperation through association, with the result that dozens of new associations have been formed since the first of the year.

During this period, service attention

has been focused sharply on the numerous factors that have been instrumental in bringing about the present highly unstable state in the independent electronic servicing industry. The feelings of thousands of service shop operators were crystallized recently by Murray Barlowe, president of the Radio Television Guild of Long Island.

Writing to the membership of his organization in a hard-hitting, down-to-earth analysis of the problem facing his and other groups, Mr. Barlowe had this to say:

"Cut-throat competition, bait advertising, licensing, distributors' over-the-counter sales to consumers, and competent and ethical personnel leaving the profession, allowing the incompetents and opportunists to take over.

"Does this sound like the description of a healthy, up and coming young industry, where the dollar volume has reached new peaks (the predictions for '55 are staggering)—an industry that stands now on the threshold of a new era, color TV? Or does it sound more like an industry whose outward growth knows no bounds, but whose innards are slowly but surely being destroyed by an internal, cancerous growth?

"Bad public relations, cut-throat competition, bait advertising—these are the ingredients that have been poured into the pot over the years. Many of these were provided by the service technician himself, in his blind, disorganized approach to the problems that confront him. Where do we go from here? Where is the recognition, the compensation, the satisfaction that should be ours as members of a new and vital profession?

"Let's step back and take a long look at ourselves. Many of us have been in this electronics business a long time. Many of us have spent long years at different schools learning this business. Quite a few of us have college backgrounds. We have a good sized investment in expensive equipment and parts inventories. We still attend technical meetings regularly to keep abreast of the new developments. Why shouldn't our profession acquire its true stature as a respected element of the industry? The answer to this is simple:

"We are not organized!"

"We are too busy being 'small' men, fighting among ourselves. We have hundreds of small service associations throughout the country, instead of one 'American Television Association' with local chapters. We have too many personality clashes and too much petty jealousy which prevents us from joining together for our mutual objectives. We all know what's right and we all know what we want, but some of us are afraid that we might get lost in the shuffle that would ensue in the formation of a new and powerful national group.

"Let's recognize the situation as it exists; let's read the handwriting on the wall; let's make this a worthwhile profession, where there is room for the competent and the ethical, rather than the present chaos that exists, where

SPECIAL SURPLUS BARGAIN

MODEL GF-11 AND RU-16

RADIO TRANSMITTER AND RECEIVER SETS

A tremendous Gov't Surplus Bargain. ALL NEW in original box. Consists of a type CW-52063A Transmitter - 2000 to 9050 KC, a CW-4051A Receiver - 195 to 13575 KC range plus all transmitter and receiver coils and boxes, a Dynamotor-Filter unit, Antenna Relay, Transmitter Control Box, Receiver Switch Box, Receiver Remote Tuning Control, Test Meter, Antenna Loop Control, plus all tubes and spares. Complete and ready to operate on 12 Volt current. Has 71 page manual and all wiring diagrams. Made by Western Electric for the U.S. Navy. **9950**



T17 HAND MIKE
USAF type. Highly sensitive. Has thumb control button on handle. Can be used for recording, public address, etc. Comes with 2 ft. rubber cord and plug. Used but checked out and serviceable. **395**

GOV'T SURPLUS E.E.B SIGNAL CORPS FIELD TELEPHONE



A private phone or intercom system. Easy to operate. Use any place that portable, 2-way communication is desired. Gives clear reception up to 15 miles. Operates on two standard batteries. Several phones may be used on the same line. Set contains a ringing generator, leather carrying case and phone. Each set is reconditioned & checked-out. **1495 EA.**
Complete circuit - Set of 2 **2950**

T-26 Chest Phones and Ear Phones for use with above set. Plug into field phone. Leaves hands free. Has a 3-way switch. New. \$7.50.

Navy Sound Powered Phones. Ideal for any 2-communication within a radius of one-half mile. Each set includes 2 phones on chest plate, 2 head sets, switches, and approximately 35 feet of cable. \$9.95 per set.

Pay by Money Order or Check. P.O.'s accepted from D&B firms. 50% deposit with C.O.D.'s. Prices F.O.B. Los Angeles.

PALLEY SUPPLY CO. 2263 E. VERNON AVE., DEPT RT-8
Los Angeles 58, California

WHILE THEY LAST!



10" TV REMOTE "SLAVE" SETS
HERE'S YOUR CHANCE TO GET THAT EXTRA SET FOR PLAYROOM, BEDROOM, KITCHEN, ETC.!!

These are COMPLETE OPERATING slave units. Hook up to any standard TV receiver (only 4 soldered connections) to reproduce any tuned TV channel. COMPLETE SCHEMATIC & HOOK-UP DATA SUPPLIED. Operates on 10V. D.C. consumption data included.

FEATURES:

- 19 TUBES including 10FP4. ALL HANDSOME WALNUT VENEER & LEATHERETTE CABINET 20 1/2" x 17" x 14 1/2"
- 4" HVV. DUTY PM SPEAKER.
- MAJOR STANDARD PARTS INCLUDE: Def. Yoke, Focus Coil, Horiz. & Vert. Outputs two 10H-100 mA Chokes, 150ma Sel. Rect., Electrolytics, Controls, etc.
- HANDSOME WALNUT VENEER & LEATHERETTE CABINET 20 1/2" x 17" x 14 1/2"

11 PARTS ALONE WORTH SEVERAL DOLLARS. **\$23.95**
TIMES THE PRICE!! Perfect Condition
-used. Shipped Railway Exp. (Sorry No C.O.D.'s).

SCOPE PARTS!

- 5" CR Tube front bezel. \$0.98
- 5" CR tube sponge rubber front gasket. \$0.69
- 3/4" clear convex lens; rotund. ea. 39c; 6 1.98
- HANDBY CARBON MIKE (RS-83) Press-to-talk. 2.49
- With 5 ft. rubber cord and plug.
- EXPERIMENTAL TUBES - All filament tested. 1.98
- Kit of 40 assorted recvg. types. 4.00
- SPEAKER CABINET - Walnut veneer; with plastic grille cloth. ea. \$1.49; 3 4.00
- TUNGAR BULBS - Brand New; orig. cartons. 1.49
- 0.8 Amp (GE #280881). ea. 2.95
- 15 Amps. (Geron CE-235). ea. 2.95

!! A WHALE OF A BUY !!

"Jumbo Radio-Electronics Parts Kit"
Loaded with inventory odds & ends of new and surplus stocks. TO SAVE YOU \$88! 17 LBS. CHECK-FULL OF: SWITCHES, CONTROLS, RESISTORS, CONDENSERS, WIRE, PHOTOFACTS, SPEAKER ACCESSORIES, COILS, KNOBS, PLUS DOZENS OF OTHER ITEMS (shpg. wt. 20 lbs). **\$3.95**
ALL FOR.....

!! ALNICO MAGNETS !!

Just a few of the many types always in stock

- POLISHED BAR - 9/16" x 7/32" x 3/32" \$1.00; 100 \$7.50
- "U" TYPE - 3/4" x 5/8" x 1/4" ea. 49c; 12 \$5.00
- ROUND BAR - polished - O.D. 9/16" x 1/4" L. ea. 69c
- RING TYPE - 1 1/16" O.D. 3/8" I.D. 5/16" deep. ea. 79c
- ALNICO MAGNET KIT - Powerful Bar, Block, U, Rod, Ring, etc. Kit of 10 assorted. \$1.98

Min. Order \$3.00 - 20% dep. req. on C.O.D.'s
Please add sufficient postage - excess refunded.

LEOTONE RADIO CORP.
67 Dey Street
New York 7, N. Y.

the attraction and the rewards are greater for the shady operator. And let's do it *before* the Color Era, or it will be too late!"

Summer Business

While the subject of organization for mutual help and protection receives the attention of a growing number of service businessmen, the immediate problem of getting a big enough volume of business to tide them through the summer months is of top concern to most business operators. The light volume of business during the winter and spring months prevented many service shop operators from building up the needed reserves to carry them through the summer. This makes it mandatory to keep plugging hard for business throughout summer months.

While the larger TV service businesses have turned to air conditioner installation and maintenance as a summertime business cushion, smaller shops have taken a new look at the volume possibilities in servicing AM radios, battery-operated portables, and radio-phonographs. One TV service operator who was swamped with AM radio repair business when he ran a "special" last summer, claimed that radio service was far more profitable than TV service when the shop was geared up to handle it.

In the south, room air conditioners are changing the complexion of the TV service industry in many areas. On hot nights people prefer to stay in their comfortably conditioned homes rather than drive around on crowded highways to stir up a breeze. The result is that TV service volume stays at a profitable level throughout the summer months. Perhaps it would increase if broadcasters kept top-flight shows on the air throughout the summer months.

A fertile field for exploitation during the summer months is the maintenance and replacement of outdoor antennas. Many shops have discovered the possibility of fill-in volume by offering summertime inspections of outdoor antenna installations at special prices. Their sales of new antennas, transmission line, and antenna accessories make this kind of a promotion worthwhile.

In offering an antenna check-up as a summer special, the service operator should be sure to outline in detail what the special consists of. Several years ago, TTLB editors prepared a step-by-step plan for a thorough antenna check-up program. Details of this plan may be obtained by sending a stamped, addressed envelope to: TTLB Special Services Dept., P. O. Box 1321, Indianapolis 6, Indiana, and requesting the "Antenna Check-up Plan."

Radio-controlled garage door mechanisms offer a new field for summertime business. Promotion-minded service shop operators can capture a lot of interest with dual promotions of radio controls for garage doors and their facilities for handling radio-TV service.

want COLOR TV KNOW-HOW?

Get this new book

"Color Television for the Service Technician"



another great book by Albert C. W. Saunders

Here is Saunders at his best, employing his vast teaching experience to prepare the Service Technician for practical Color TV servicing. The entire subject is treated in easy-to-understand language, supported by a wealth of clear illustrations. Major emphasis is placed on Color Receiver installation and servicing. Here are the fact-packed chapters:

CHAPT. 1. Colorimetry: Discussion of color, hue, saturation, purity, brightness, color matching, color terminology.

CHAPT. 2. Color TV: Origin and content of the color signal; transmission; the color TV transmitter and camera; the luminance signal.

CHAPT. 3. Color Carrier: The chrominance signal, bandwidth, modulation, color sync signals; obtaining I and Q signals; transmission of luminance, chrominance and sync signals.

CHAPT. 4. Color Signal Analysis: The Color Signal; formation of Y, I and Q signals; scalar and vector quantities; doubly-balanced modulators.

CHAPT. 5. Tricolor Picture Tube: Types of color picture tubes; how they operate, construction and characteristics.

CHAPT. 6. Color Receivers: Descriptions of current color circuits; convergence adjustments and procedures; installation adjustments for specific models.

Prepare for Color TV with the help of this practical, valuable book. 116 pages. Fully illustrated. 8 1/2 x 11".

ORDER SC-1 **\$2.50** Only

ORDER TODAY!

HOWARD W. SAMS & CO., INC.

Order from your Parts Jobber today, or write to Howard W. Sams & Co., Inc., 2203 E. 46th St., Indianapolis 5, Ind.

My (check) [money order] for \$..... enclosed. Send copy(ies) of "Color TV for the Service Technician" (SC-1, \$2.50).

Name.....

Address.....

City..... Zone..... State.....

(outside U.S.A. priced slightly higher)



LEKTRON SPECIALTIES ONE BUCK BUYS!

**KIT
OF THE
MONTH**

10 PANEL SWITCHES—
for all uses. Selected
shop assortment of most
popular toggle, but not
die, momentary contact,
micro. Rated up to 25
A. SPST etc. Wt. 1 lb.
Reg. \$11.

50 CERAMIC CONDENSERS. Scoop! Tubular, disc, button types. 20 selected values. 2 to 3000 mmf. Shop must! Wt. 1 lb. Reg. \$13.

60 MICA CAPACITORS. Rare bargain! Postage stamp type, .00001 to .01 mf. Many silver, 5% tool 20 values. Wt. 1 lb. Reg. \$17.

15 SWITCHES. Rotary and push types. Experimenters, hotel Wt. 3 lbs. Reg. \$12.

125 CARBON RESISTORS. 40 selected values, unisolated, 100 ohms to 1 meg.; 1/2, 1/2, 1 & 2 w. Many 5%, too! Top makers—a rare buy! Wt. 1 lb. Reg. \$21.

60 TUBULAR CONDENSERS. .00035 to 1 mf. up to 1600V. 20 types. Wt. 2 lbs. Reg. \$10.

25 OIL CAPACITORS. Bathub and tubular. 1 to 2 mf. up to 600V. Well-known mfrs. Wt. 4 lbs. Reg. \$17.

10 ELECTROLYTICS. Tubular and FP units. 8 to 1000 mf. up to 450V. Multiple sections, too. Wt. 2 lbs. Reg. \$11.

60 RESISTORS. 56 ohms to 20 megs.; 1/2, 1 and 2 watts. 35 values. Many 5% insulated. Wt. 1/2 lb. Reg. \$15.

1500 PIECES SPAGHETTI tubing. lengths to 4". Ass'd. sizes. Reg. \$7.

TEN 25-ft. ROLLS WIRE. Plastic & cloth insulated; solid & stranded. #18 to 24, ass'd. colors. Wt. 2 lbs. Reg. \$5.50.

50 RF COILS, CHOKES and slug-tuned coils for TV, radio, lab. 20 types. Wt. 1 lb. Reg. \$15.

10 BATHTUB OILS. Long-lasting bathtub capacitors. .05 to 2 mf. up to 600VDC. Selected values. Some worth \$3.50 each. Wonderful lab assortment! Wt. 3 lbs. Reg. \$25.

25 TUBE SOCKETS. Up to 9 pin, some w/shield base, some ceramic. 10 types. Handy for shop. Wt. 1 lb. Reg. \$6.50.

200 COIL FORMS. 50 sizes & shapes. Bakelite & ceramic. Experimenters' must! Wt. 2 lbs. Reg. \$14.

10 RADIO CHASSIS. 5, 6 & 7 tube punched chassis New! Workshop must! Wt. 8 lbs. Reg. \$8.50.

75 KNOBS. TV and radio. Some worth 25c ea. 15 types, push-on, set screw. Wt. 2 lbs. Reg. \$8.50.

THREE LBS. HARDWARE. Assorted. Over 2000 pieces: screws, nuts, lugs, etc. Reg. \$6.50.

50 PILOT LITE SOCKETS. Bayonet base. Wt. 2 lbs. Reg. \$6.

R/CASSEMBLY on term. strips: 70 moulded, paper & mica capacitors, .0001 to .047 mf., 400V.; 45 1/2-watt resistors, leads 1/2 to 1" long. Brand new. Wt. 2 lbs. Reg. \$15.

20 W.W. RESISTORS. Power, candohm & 'dog-bone' types. 5 to 10000 ohms, 5 to 50 watts. 20 values. Wt. 2 lbs. Reg. \$11.

15 CONTROLS. Up to 1 meg. Some w/switch. 12 selected TV & radio values. Wt. 2 lbs. Reg. \$12.

70 TERM. POSTS & STRIPS. Builders' special! Ass'd. binding posts, screw & lug type terminal strips (10 to 10 terms.) Wt. 1 lb. Reg. \$4.50.

10 PRECISION WW RESISTORS. 10 different 1/2 & 2% values. IRC WW 2, 4, 10, 20, 50, & 1 watt. Wt. 1/2 lb. A \$25 value!

25 VARIABLES. Erie & Elmenco mica & Ceramic trimmers. Singles & duals from 3-12 to 8-300 mf. Wt. 1 lb. Reg. \$16.

NUTDRIVER KIT. 7-piece, w/long handles. 3/16, 1/4, 5/16, 3/8, 7/16, 1/2. Wt. 1/2 lb.

SUMMER CLEARANCE BUY-LINES!

- 2 H @ 200ma choke: strap mtd. Reg. \$3.50
- .45c ea. 3 for \$1
- XFMR. In/115; Out/180V @ 15ma; 6.3 @ 6A
- .65c ea. 2 for \$1
- Pilot lite assembly, enclosed, amber.
- Reg. 85c ea.
- Erie trimmers: 3-12, 7-45, or 8-50. .58 for \$1
- Reg. 97c ea.
- Any 12 for \$1
- Darkroom or parts tray: 9x11x1 1/2". Wt. 5 lbs.
- Reg. \$3
- Sealed relay, 24VDC/300 ohms, DPDT. 2 1/2 x 1 1/2 x 1 1/2". Reg. \$11.
- Veeder-Root counter, 0-9,999. Reg. \$6.50. \$1
- 25 slug-tuned coils, ass'd. TV, radio. Reg. \$9. \$1
- 0 to 20 min. timer, bell rings end of cycle.
- Reg. \$4.50
- 3" sq. meter, measures 0-10VDC. Reg. \$8. \$1.88
- Full-wave rect./18VAC to 12VDC @ 250 ma.
- Reg. \$4
- Dual variable, 15 mmf per sec. w/2" drum. 3 for \$1
- Reg. \$1
- Mobile slug-tuned assembly, BC band, push control. 3 for \$1
- Anti-capacity or lever switch (CTS), 4P4T. 79c
- 50 or 60 degree yokes. Any two for \$1
- RCA type 21T5 flyback transformer.
- Reg. \$5
- 115/1 60 to 6V @ 6 amps. transformer. \$1.25
- Reg. \$4
- 500mmf @ 10KV ceramic cartwheel condenser. Reg. \$2.50.
- Record changer bases, 13x13x3 1/2", wood. 10 for \$1
- Reg. \$4

Please send check or MO. Include postage. C.O.D. orders 25% down payment. Rated accounts NET 30.

LEKTRON SPECIALTIES, Dept. R8
Chelsea 3-6325
28 Gardner Street Chelsea, Mass.
WRITE FOR OUR LATEST BARGAIN-FILLED BULLETIN

Headlight Dimmer (Continued from page 57)

the second-stage collector current, releasing the relay. However, when light strikes the photocell, the first stage goes toward a cut-off condition, and therefore the collector current of the second stage increases, and the relay is thrown on, dimming the lights. R_3 is made variable as a sensitivity adjustment. R_2 , which together with R_3 comprise the base resistor for the second stage, protects the second transistor from burning out in case R_3 is turned too low.

The junction diode CR_1 , which is biased backwards, does not affect the operation a bit at low photocell currents, but tends to limit the current at higher illumination levels. It is provided to lengthen the life of battery B_1 , but can be omitted if desired. With it in the circuit, this battery will last close to its normal shelf life, despite the fact that it is conducting current 24 hours a day. Including a switch to shut off this battery when the unit is not in operation proved impractical, due to the long life of the battery.

Construction of the optical system, including the mounting of the photocell and lens, depends, of course, on the lens used, and the space available for mounting. Fig. 1 shows the author's unit, with one side panel removed, mounted on the front of his truck. Satisfactory results have been obtained mounting the same arrangement behind automobile grilles. A pattern typical of that produced by headlights is shown hitting the photocell at the rear of the plywood box. The best angle of tilt for the lens and spacing between lens and photocell is determined by experiment, keeping in mind the elongated pattern desired, and the light intensities needed. The box housing the lens and photocell should have one side panel removable for final adjustments. The photocell is most simply mounted by forcing it into a quarter-inch hole in the rear of the cabinet.

Another box housing the photocell battery, the relay, transistors, resistors, and controls was mounted under the dashboard, as shown in Fig. 2, and wires run from this box to the photocell, and to the headlight circuit. Fig. 6 shows the inside of the control box. The wiring is straight-forward, except that the transistors were adapted to fit into sockets, instead of being wired permanently into place. Soldering transistors is likely to overheat the junctions, letting the small amounts of impurities, on which transistor operation depends, diffuse from one element to another, thus ruining the transistor. The leads are rather fragile anyway, and the best arrangement is to use standard subminiature tube sockets. Pins 2 and 4 are pulled out of the socket, and one end is painted red to correspond to the red dot on the transistor next to the collector lead. The transistor leads are cut to about a

quarter of an inch, with the base lead left slightly longer. The two transistor sockets fit snugly into one side of a power transformer mounting bracket, neatly and compactly.

The final adjustment of the position of the lens-photocell arrangement is essential. The easiest procedure is to park just off the side of a busy, straight, level highway some night, and remove the panel from one side of the box, so that the photocell is visible. Adjust the vertical tilt of the box so that the images of the passing headlights and tail-lights go through the photocell. Then adjust the aim so that oncoming cars about 1000 to 1200 feet away illuminate the photocell. Two or three adjustments may be necessary for this, each time testing it by driving. Only actual road-testing is reliable for this adjustment. Incidentally, it is a good idea while making this adjustment to have an indicator light of some sort to tell when the relay is thrown on, rather than having the unit actually dim the headlights.

The unit should operate pretty satisfactorily, dimming for cars about 600 feet away or so. Once in a while a car with dim headlights, or with one burned out or out of adjustment, will get within 400 feet before tripping the relay. The relay differential not only delays re-brightening, but also holds the lights dim for a car just outside the sensitivity range. Both these features, however, are advantageous. In addition, operation in towns at night generally dims the lights because of the bright background illumination. Brightly-lighted highways and tunnels often dim the lights, too, so expect such operation.

The unit can be "fooled" under some circumstances. Cars coming around a curve sometimes don't hit the photocell until too late. A street light just visible over the top of a hill looks for all the world like a headlight even to human eyes, and the unit will fire on this. However, it does not seem to be sensitive to roadside signs, partly because most of them are neon, and the photocell is not too sensitive to red-dish light. There are other situations where manual control is necessary or desirable: for instance, following another car too closely puts the lens in a shadow, and the unit will not work.

Most states require dimming of lights when approaching another car, several specifying certain distances, usually 400-600 feet. Commercial automatic headlight dimmers which satisfy this requirement cost anywhere upwards of fifty dollars, and the experimenter can build the unit described here for less than twenty dollars.

Needless to say, the builder can "dress up" his unit in any way he sees fit—making it match his paint job or contrast, according to his taste.

Since the author's unit was used on his truck, no elaborate decorative schemes were deemed necessary but it would be a good idea to allow the device to "fade into the background" by a neat job of camouflaging. —30—

NEW! SELL MORE TUBES... SAVE SERVICE TIME



INDISPENSABLE ON EVERY TV SERVICE CALL... STORES IN TUBE CADDY—

\$29.95
SLIGHTLY HIGHER IN WEST

PORTABLE GRID CIRCUIT TUBE TESTER

SECO

MODEL GCT-5, EQUIPPED WITH A FILAMENT VOLTAGE SELECTOR!

Now, quickly and positively check the grids of over 40 tubes in the critical AGC, RF, IF and Sync. circuits... performing a service no other tester can perform!

Speed Check "Foresees" Tube Trouble 4 Ways:

1. Control grid emission (Exclusive Feature!)
2. Grid to cathode shorts.
3. Gaseous condition in tube.
4. Cathode to heater shorts.

See your Jobber or write for information

SECO MFG. CO. 3013 PENN. AVE. S. MINNEAPOLIS, MINN.

Capacitance Bridge
(Continued from page 62)

bration for each range. It was found, however, that it was possible to get adequate accuracy using ordinary ten per-cent tolerance resistors by checking through a handful of the required values with an ohmmeter. One can alternatively correct available resistors to the desired value by adding more resistance in either shunt or series. It is not necessary to use a bridge to select these parts, but the ohmmeter must be used as carefully and accurately as possible.

The balance arm potentiometer can be any reliable make with a linear taper.

The signal source for the bridge consists of an ordinary flashlight cell and a small audio output transformer. The battery is connected in series with a switch in the low impedance side of the transformer and the two remaining leads are fed to the bridge. Each time the switch is tapped, a click will be heard in the earphones. In use, the bridge is then adjusted for minimum volume.

The switch, of course, is a luxury and could be easily replaced by a simple probe arrangement. If a switch is used, it should be one that makes very little noise in operation as a mechanically noisy switch can be very annoying when the exact null is approached. A dime store push-button worked very well.

If the standard capacitor C_s and the five range resistors have been accurately chosen, it will be necessary to calibrate the bridge on only one range. This can be done very easily with an ohmmeter as follows: Connect the ohmmeter across R_n . Starting from zero resistance, turn R_n to the maximum position marking off each increase of 10,000 ohms on the dial face. The first mark is numbered one, the second two, and so forth up to ten. With S_2 in the 100-ohm position, these marks will correspond to capacities of .1 μ f., .2 μ f., etc. When S_2 is in the 1000-ohm position, the marks will indicate capacities of .01 μ f. through .1 μ f. The other switch positions follow the same pattern, and multiply the dial reading by factors of .001, .0001, and .00001.

This method will be inadequate if the bridge components are not fairly exact, and it may be necessary in such a case to calibrate the dial separately on each range with capacitors of known value.

The parts layout is unimportant and can be arranged to suit one's taste. The author used a standard 3 x 4 x 5 inch metal box as a cabinet and dressed it up with a dime store handle. The dials are cardboard cemented to the panel and covered with plastic to prevent smudging.

For the cash and energy expended, this bridge is a very rewarding construction project.

For the first time...



Model 1012 Amplifier/Preamp
Everybody can own HI-FI with

NEWCOMB
COMPACT
AMPLIFIERS
and FM-AM TUNERS
EXPENSIVE BUILT-INS
UNNECESSARY

Here is an entirely new concept in high fidelity enjoyment created by Newcomb, the originator of the "compact" design. Amplifier/preamp units and AM-FM tuners in beautiful new satin gold finish, so small they fit your convenient chairside table top. Makes expensive built-ins unnecessary. No technical knowledge necessary to connect. Performance to please the most ardent hi-fi fan. Combination amplifier/preamp units available in 10, 12, or 20 watt output, with all the exclusive recognized Newcomb features. Not only technically superb but audibly better.

Economical high-efficiency AM-FM tuner, or deluxe model with many advanced features available in matching design.

THE YEAR'S GREATEST HI-FI SENSATION

NEWCOMB
THE SOUND OF QUALITY SINCE 1937

SEE YOUR NEAREST DEALER OR WRITE FOR DETAILS NOW!

[Handwritten signature]

NEWCOMB, Dept. F-8
6824 Lexington Ave., Hollywood 38, Calif.

- Enclosed is 25c. Please send me new booklet "HI-FI is for Everybody."
- Send name of nearest Newcomb dealer and complete details about the Newcomb Compact.

NAME

ADDRESS

CITY..... STATE.....

RCA TV CAMERA!
New! Surplus! Only \$197.50!

for Labs!
Export!
Industrials!
Medicine!

Closed Circuit TV!



Labs, hobbyists, industries, TV technicians—set up your own telecast system! It's a "mechanical eye" for factories, prisons, swim pools, closed circuit TV—100's other uses! 1346 cone scope, 6-stage video amplifier and clipper. Write for complete technical data.

ICA TV ALIGNMENT TOOL KIT
MODEL 994 DE LUXE. Consists of 14 tools which telescope into each other forming 6 separate tools. Includes: screwdriver with flex shaft alignment tool, alligator wrench, 5/16" and 1/4" nut wrench, 1/4" square nut wrench, 1/4" hex wrench, 2 1/2" long 1/4" hex slotted insulated wrench and screwdriver, 3/16" insulated hex nut wrench, 2 1/2", 3" and 6" screwdrivers insulated. Leatherette carrying case. Wt. 8 oz. Brand new. List \$9.00. Only \$249. Discounts to quantity buyers. Postpaid

ELECTRICIAN'S TOOL SET
18 PIECES! Includes hack saw, chisels, files, hammer, knife, pliers, rule, tape, wrenches, etc. PLUS AC-DC ALL VOLTAGE TESTER COMPLETE WITH LEADS! How about that TESTER alone is \$14.95 worth the price! In canvas carrying case... Postpaid

SCINTILLATOR TUBE SHIELD
HYDROGEN-ANNEALED MU-METAL! Fits RCA 6991 and similar types. Diam. 2 3/4" x 5 5/8" long. \$350. Can also be used for 3BP1 and similar type cathode ray tubes. \$30.00 value. ONLY... Postpaid

NEW 24 V TRANSFORMER & RECTIFIER COMB.
a basic 24V. DC power supply of 110V AC primary. 24V secondary and Rectox Rectifier. Operates intermittently up to 1 or 2 amps. \$295. Ship. wt. 3 lbs. With instruction data....

1-222 SIGNAL GENERATOR-MICROVOLTER
Freq. range: 8-15 Mc. & 150-230 MC. Complete with all tubes and 5 MC Calibrating Crystal. Self-contained 110 V. and 60 cycle power supply. With Schematic. Excellent cond. AND \$50-1500 Kc. approx. \$3995 \$700.00. ONLY.....

ADF AUTOMATIC DIRECTION FINDER RECEIVER
Model CAATC-980. Mark I mfg. by Sperry Gyro-scope. Self-contained. 12 V. vibrator supply. This unit is used by major airlines. Wt. approx. 200-300 Kc. AND 550-1500 Kc. Complete with all tubes. Used, good cond. Ship. wt. \$2495 65 lbs.

STOP & SWAP! We buy items! What have you?

All items F.O.B. Whse., subject to prior sale and change of price without notice. NOTE NEW ADDRESS! Send for FREE Catalog!

Harjo Sales Co.

Mailing Address: Box 1187-R8 MAGNOLIA PARK STATION, BURBANK, CALIF.
Office-Warehouse: Dept. R-8, 503 N. VICTORY BLVD., BURBANK, CALIF.

**A-HOY! MARINE MEN—
BOAT OWNERS!**

NEW, MINIATURE ECHO SOUNDER: (Fathometer) Specify 6, 12, 24 or 32 VDC and signal your depth down to 80 feet! It's a terrific deal. **\$167.95**
Write right now for info.....

AN/APT-2 RADAR TRANSMITTER

Amazing storehouse of parts! 931-A Photo Multiplier Tube, 2-14GY, 2-6AC7, 6AC7, 80T, 2X3, 2-368AS, 703A, bandswitching motor, Veeder Root counters, gears, knobs, micas, resistors, sockets, etc., etc. Freq. 450-710 MC. With manual yet! **\$9.95**
How kin you go wrong?.....
TRIPLE ARC-5 TRANSMITTER RACK..... \$3.95

NEW SCR-522 TRANSMITTER-RECEIVER. 100-156 MC. With tubes. Excel. cond. (Antenna plugs missing on some units.) **\$32.50**
A sweet buy!

TRY 10 & 6 METER PORTABLE TRANSCEIVER. With vibrator power supply, battery, head and chest set. Excellent condition..... **\$29.95**

75 MC COMBINATION

MARKER BEACON RECEIVER. 75 MC. With relay. Terrific for garage door unit. **\$3.49**
Excellent
RADIOSONDE. 75 MC. Here's a \$25.00 gadget! Transmits temperature, humidity, and barometric pressure in upper atmosphere. With tube and relay. Brand new **\$1.98**
BOTH UNITS! COMBO SPECIAL..... \$4.95

**MODEL 27-C
TESTER**

(Made in Japan)

\$9.95



RANGES: AC and DC volts 0-5/25/250
1,000, DC MA
0-1/10/100 Ohms
0-10K, 100K, Beige bakelite panel, metal case. Manufacturer claims extreme accuracy and our spot checks show them to be within 1%!

\$45.00 HI-FI HEADSET AT \$7.95

Uses annular grooved plastic fibre cones with voice coils as in speakers and padded chamois ear muffs to obtain spacing for correct acoustical load. Gives finest music reproduction. 600 ohms. Checked out with freshly laundered ear pads and long flexible fabric cord with phone tips. (Shpg. wt. 3 lbs.) **\$7.95**

DC ROTARY VOLTAGE CHANGER. 6 VDC to 12 VDC @ 10 A.; 12-24 VDC @ 5 A.; 24-12 VDC @ 10 A.; 12-6 VDC @ 15 A. Suitable for car, marine, aircraft, radio receivers. No need to change dynamotor, band change motor, relays, etc. **\$17.95**

→ note → new → address ↓

G. L. ELECTRONICS, INC.

1632 Venice Blvd. Los Angeles 6, Calif.
Minimum Order \$2.50 Total. 25% Deposit Required
All Prices F.O.B. Los Angeles, Calif. Buyers Add Sales Tax
GET ON OUR MAILING LIST

**SCHEMATICS—CONVERSIONS
FOR SURPLUS GEAR**

NEW LIST! MANY ADDITIONS!

Send stamped, self addressed envelope for List C. Add 25c for chart explaining AN nomenclature.

R. E. BOX 1220
GOODHEART BEVERLY HILLS, CAL.

*Don't just say
"capacitors"*

Ask For Sprague By Catalog Number

Know what you're getting
... get exactly what you
want. Don't be vague ... in-
sist on Sprague. Use com-
plete radio-TV service cata-
log C-610. Write Sprague
Products Company, 51
Marshall Street, North
Adams, Massachusetts.

SPRAGUE®

WORLD'S LARGEST CAPACITOR MANUFACTURER

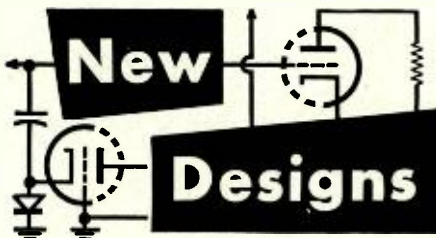

AN INTERESTING sidelight on television receiver development is that circuit design has always been held back by the lack of tubes which would enable designers to achieve a maximum of driving power with a minimum number of stages. Within recent months, however, a number of modifications have been made in existing tubes which will render them more suitable for television receiver operation.

The tubes have been strengthened mechanically while their electrical characteristics have been upgraded. The 6SN7-GTB is a good illustration of the changes which have been made.

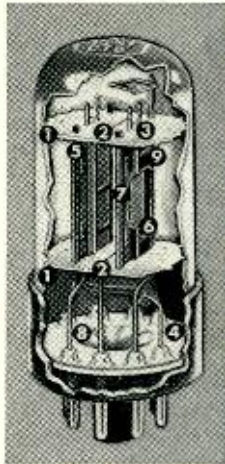

This tube is the third in a line that started with the 6SN7-GT, proceeded through the 6SN7-GTA and is now at the newly released 6SN7-GTB. Actually, the main difference between the A and B versions is the controlled heater warm-up time of the latter tube. Series heater operation has always been attractive to set designers because it permits them to eliminate the expensive power transformer. However, with conventional tubes, not all heaters reach operating temperature at the same time. This will cause temporary shifts in the distribution of the applied line voltage, with the tubes having the shortest warm-up time developing higher instantaneous voltages than those tubes which take a longer time to warm up. As a result of these voltage stresses, tubes were found to fail quite frequently. By constructing tubes so that all those possessing similar voltage and current ratings had the same warm-up characteristics, the extent of the initial voltage and current surges were minimized and failure from this source was reduced.

The difference between the 6SN7-GT on the one hand and its A and B versions on the other include a significant number of mechanical (i.e., structural) and electrical changes. Here are the more important of these changes (these are keyed with the numbered points in the illustration).

- (1) Bumper point mica top and bottom. Mount is held rigid in bulb to reduce vibration and microphonics.
- (2) Slot in mica to reduce leakage between sections.

(3) Cathode pinched above top mica for tighter mica cathode fit—lower microphonic level.

(4) Short strong leads support mount at several points.

(5) All plate tabs pinched or welded above mica and below bottom mica to strengthen mount.

(6) Improved grid design for sharper cut-off.

(7) High conductivity grid winding wire to eliminate grid emissions.

(8) Short leads, direct to pins.

(9) Strict control of plate diameters for uniform characteristics.

The change in physical characteristics may not be visually apparent to the technician but the effect, electrically, is quite evident from an examination of the data charts for the 6SN7-GT and its A and B versions. For example, the maximum plate voltage rating of the earlier tube is 330 volts while the improved types carry a 450-volt rating. Plate dissipation of the 6SN7-GT is 2.5 watts per section; in the A and B types it is 3.5 watts. And so it goes, for many other ratings. As far as usage is concerned, the 6SN7-GTB can be used wherever 6SN7-GT or GTA tubes are used. And the 6SN7-GTA can be substituted for the 6SN7-GT. But if replacements are to be made in the reverse order, then close examination of the circuit should be made or tube failure may occur.

The 6SN7-GT is one of a number of tubes for which improved versions are now available. These include such types as the 1B3GT, 5U4GA, 5U4GB, 5X3-GT, 6AX4GT, 6AV5-GA, 6BG6-GA, 6BQ6-GA, 6BX7-GT, 6CD6-GA, 6J6, 12SN7-GTB, 25BQ6-GA, etc. Whenever tube replacement is to be made, it might be a good idea to use an improved version, if one is available. This will not only benefit the customer, but reduce service call-backs as well.

**SECO GRID CIRCUIT
TUBE TESTER**

THE condition of the control grid in a vacuum tube has an important bearing on the ability of the tube to oper-



ate properly. Circuit design is based upon a high grid-to-cathode impedance and any defect which lowers this impedance will lead to such troubles as poor picture contrast; twisting, bend-

ing or pulling of the picture; vertical jitter or bounce; sync buzz in sound, etc.

The Seco "Vacuum-Tube Grid Circuit Tube Tester" was designed to enable the service technician to locate any tube in which the grid-to-cathode impedance is not as high as it should be. A high lead resistor is placed in the control grid circuit of the tube to be tested and the voltage which develops across this resistor is applied to a d.c. amplifier which, in turn, drives an electron-ray tube indicator. Any condition which lowers the grid-to-cathode impedance, such as leakage, grid contamination, or gas, produces enough voltage difference across the grid resistor to cause the indicator eye to open.

The use of a d.c. amplifier makes this a sensitive instrument which enables it to bring to light tubes which might otherwise be overlooked in normal tests on conventional tube testers. In using this instrument, it is suggested that the tube be well heated because in a number of instances the defect does not appear until the tube has reached full operating temperature.

Operation of the tester is quite simple, with only two controls to be set. Initially, the tester is allowed to warm up for about half a minute. Then a "Zero" set knob is adjusted until the indicator eye just closes. Next, the filament selector switch is turned to the proper voltage setting. The tube to be tested is then plugged into an appropriate socket, as indicated by the listing associated with that socket. If the grid-to-cathode impedance is below its normal value, the eye will gradually open. If the tube is good, the eye will remain closed. If the eye flashes as the tube is tapped, it indicates that the tube has an intermittent short. Finally, if the green light of the tube blacks out, the tube has a short to "B plus."

The instrument is small and compact so that it may be carried, along with other service tools, on outside calls. It does not check cathode emission or mutual conductance. Its chief concern is with the condition of the control grid in its relation to the cathode. However, it will also reveal cathode-to-heater shorts, plate-to-suppressor shorts, or plate-to-heater shorts. The latter defects occur infrequently but the instrument designers found that these tests could be incorporated along with the control grid tests. —30—

PITTSBURGH HAMFEST

THE South Hills Brass Pounders and Modulators will hold its 17th annual hamfest on Sunday, August 7th at the Totem Pole Lodge in South Park, Pittsburgh, Pa.

Tickets are \$2.00 each and may be obtained by writing William E. Guthrie, 4949 Roberta Drive, Pittsburgh 39, Pa. All ticket holders will be eligible to compete for the various valuable prizes. Attendance is not required to win.

Contact W3PIQ, the club station, for full details. —30—

August, 1955

more
Cannon lines
now available
at jobbers'
shelves!

get the full story...

Write for ICC
and RJC catalogs TODAY!



Twenty pages of information on 14 different lines of Cannon connectors, including list prices on more than 850 individual items.

130 illustrations. Audio, military, general industrial. Get your copies... NOW!



AN3108B Plug AN3102A receptacle

"AN" (Air Force-Navy) Series Connectors

Proved in military service. World-wide standard. Lightweight. Uniform in quality. Interchangeable inserts. Threaded coupling nut. Rapid and easy disconnect. Cable clamps and other accessories.

typical lines newly offered...



K-21C Plug K-32S receptacle

Cannon "K" Series

All-purpose... Adapted to a variety of general electrical and electronic applications. Special Acme thread. Rugged. 220-contact layouts available.

When you write for our catalogs... Please refer to this magazine or Dept. 145

CANNON PLUGS



CANNON ELECTRIC COMPANY
3209 Humboldt St., Los Angeles 31, California
Factories in Los Angeles; East Haven; Toronto, Canada; London, England. Representatives and distributors in all principal cities.

SAVE UP TO 90% OFF LIST PRICES ON PARTS and TUBES

Introducing Stanley's Sensational "Cannon Premium Offer!"
For every dollar you spend for parts or tubes you'll receive a coupon redeemable for FREE gifts! These gifts include electrical appliances in your own home or sell them over the counter!

- All tubes individually boxed
- All tubes RTMA guaranteed for one full year
- Same day service

PARTS SPECIALS

Unconditionally Guaranteed! **CONDENSERS**
Molded Tubulars:
600 V. 10c ea.
Lots of 10, 8c ea.
.01 MFD—
600 V. 12c ea.
Lots of 10, 10c ea.
All sizes available at lowest prices!

4" PM SPEAKER
With Matching Output Transformer former Alnico 5 magnet. Output terminals for meter matches 50L6, etc.... **\$1.57**

21" TV SET TABLE MODEL
Reg. **\$149.95. \$115**

Send for Free premium catalogs—but better yet place your order with Stanley NOW and start collecting these valuable coupons!

Picture Tube **BRIGHTENER**
Lots of 3... **\$1.19**
ea.

70° COSINE
Popular TV deflection yoke. New cosine type for anti-astigmatic focusing. Complete with leads. **\$2.99**
ea. List \$10.30!

CERAMICON KIT
Assortment of 50 ceramic condensers. Popular sizes. List price \$10. **\$1.89**
Lots of 5. **\$1.99** ea.

AC-DC SUPER-HET JEWEL 5-TUBE RADIO
Terrific buy! Special Stanley price! Reg. list price \$22.95! **\$14.95**

Several or one of these brands will be supplied on your order... Hallcrafters, Admiral, Stewart-Warner, Zenith, Emerson, Philco, Stantron, Crosley, Motorola, Sonora, American, Muntz.

TUBE SPECIALS
TILL SEPT. 1

1A7GT 35A
1T5GT 6AQ5
1L4 6AV6
3Q4 7E5
50A5

39¢ ea.

Special Purpose Transmitting and Cathode Ray TUBES

FREE with each \$25 or more order! 5-Pc. Sylvia Repair Kit. Value \$4.95. Includes: flashlight head, Phillips screwdriver, flat head screwdriver, alignment tool and polystyrene case.

FREE with EVERY order regardless of size! Combination kit of resistors, condensers, volume control and line cords—retail value \$2.95.

SEND FOR PARTS AND TUBE LISTING

TERMS: 25% deposit required on all orders, balance C.O.D. Orders under \$5.00, \$1 service charge. Postage paid in USA on all orders accompanied by full remittance. All unused money refunded with order.

Open Account to Rated Firms
Dept. RN-8 GRegory 1-2498

TYPE	PRICE	TYPE	PRICE	TYPE	PRICE	TYPE	PRICE
OZ4	.45	6A55	.50	6SC7	.50	12SH7	.47
1B3GT	.79	6AS6	2.00	6SG7	.43	12SJ7GT	.50
1L4	.56	6A57G	2.25	6SH7	.45	12SK7	.50
1L6	.60	6AT6	.40	6S7GT	.45	12SL7GT	.69
1LA4	.66	6AU5GT	.70	6SK7	.50	12SN7GT	.60
1LB4	.66	6AU6	.46	6SL7GT	.70	12SQ7GT	.44
1LC6	.66	6AV5GT	.85	6SN7GT	.60	14A5	.59
1LD5	.66	6AX5GT	.59	6SQ7GT	.44	14A7	.45
1LE3	.66	6BA6	.49	6V6GT	.48	14B6	.40
1LG5	.66	6BA5	.49	6W4GT	.40	14Q7	.52
1LH4	.66	6BC5	.55	6W6	.60	19BG6G	1.18
1LN5	.49	6BE6	.50	6W6GT	.56	19J6	.66
1NSGT	.55	6BG6G	1.18	6X4	.35	19T8	.70
1R4	.66	6BH6	.61	6X5	.39	25A7GT	1.50
1R5	.67	6BJ6	.49	6X5GT	.35	25AV5GT	.80
1S4	.65	6BK5	.70	6X8	.75	25BG6	.98
1S5	.65	6BK7A	.78	6Y6G	.63	25BQ6GT	.90
1T4	.65	6BN6	.59	7A4-XXL	.47	25Y5	.45
1U5	.50	6BL7GT	.77	7A5	.55	25Z5	.38
1V	.57	6BQ6GT	.88	7A6	.47	25Z6GT	.42
1X2A	.79	6BQ7A	.80	7A7	.45	35A5	.48
2D21	1.00	6BZ7	.90	7A8	.46	35B5	.52
2V3G	.80	6BY5G	.60	7B5	.41	35C5	.51
2X2A	1.00	6C4	.39	7B7	.43	35L6GT	.48
3D6	.45	6C5	.36	7B8	.47	35W4	.39
3LF4	.80	6C5	.50	7C4	.40	35Y4	.40
3Q4	.62	6C6G	.55	7C5	.44	35Z3	.41
3Q5GT	.63	6C6G	1.18	7C6	.45	35Z5GT	.39
3V4	.65	6D5	.50	7E8	.70	50B5	.52
5T4	.70	6E5	.46	7F4	.35	50C5	.51
5U4G	.49	6F8	.40	12AT6	.46	50L6	.48
5V4G	.71	6H4GT	2.00	12AT7	.68	50L6GT	.45
5Y3GT	.39	6J4	2.00	12AU6	.48	75	.44
5Y4G	.43	6J5GT	.40	12AU7	.60	77	.39
5Z3	.47	6J6	.49	12AV6	.46	78	.39
5Z4	.54	6J7	.45	12AX7	.70	80	.35
6A7	.59	6K7	.40	12AX7	.70	83V	.60
6A8	.59	6K6GT	.39	12AY7	.90	117L7GT	2.00
6B4	.48	6L7	.44	12B6A	.48	117N7GT	2.00
6AF4	.80	6N7	.61	12B6	.48	117P7GT	2.00
6AG5	.56	6Q7	.45	12BE6	.50	117Q7GT	2.00
6AH6	.80	6S4	.48	12B7	.70	117Z3	.37
6AK5	.80	6S7G	.47	12B7	.68	117Z6GT	.65
6AL5	.44	6S7GT	.50	12SA7	.52		
6AL7GT	.70	6SA7GT	.50				

Stanley ELECTRONICS CORP.
935 MAIN AVENUE - PASSAIC, N. J.

**CONCORD'S
— EXPANSION
CELEBRATION! —**

Bigger SELECTION
Larger QUARTERS
More SAVINGS



FREE CATALOG

Thousands of Fabulous
"CELEBRATION BONUS
BARGAINS" for:

Servicemen Schools
Industrials Experimenters
Amateurs Youth Groups

NEW ADDRESS—45 WARREN ST. N Y 7, N.Y.

Please send your Big New "Festival of Bargains" Catalog. I understand that it is ABSOLUTELY FREE OF CHARGE.

Name
(Please Print)

Address

City State.....

Concord Radio • Digby 9-1132
45 WARREN ST., NEW YORK 7, N.Y.

LONG-PLAYING 33 $\frac{1}{2}$ R. P. M. HIGH-FIDELITY

10 MASTERPIECES FREE!



Mail the coupon below and you can have these 10 complete masterpieces FREE—no obligation to buy any records from us ever! We want you to hear these brilliant performances by world famous artists reproduced with amazing fidelity on our distortion free discs. Best of all, with these selections you receive a Trial Membership in the Musical Masterpiece Society with full privileges.

HOW CLUB OPERATES— Future selections are described in advance of release. You may audition any of these for 5 days FREE. Only those you keep are billed at the Members low price of only \$1.65 per 10" long-playing disc—saving you 40% off the usual retail price. Mail coupon with 25¢ to cover postage—NOW!

- CHOPIN**
Fantaisie-Improvis., Opus 66
- BETHOVEN**
Piano Sonata No. 24 in F Sharp, Opus 78
- DUKAS**
Sorcerer's Apprentice
- BRAHMS**
The Academic Festival
- MOZART**
Symphony No. 26 in E Flat, K. 184
- BACH**
Tocatta and Fugue in D Minor
- MUSSORGSKY**
Night on Bald Mountain
- WAGNER**
Die Meistersinger, Prelude, Act 1
- BERLIOZ**
The Roman Carnival
- VIVALDI**
Concerto in C for Two Trumpets and Orch.

The Musical Masterpiece Society, Dept. 47-8
43 West 61st Street, New York 23, N. Y.

Enclosed is 25¢ to cover postage for the 10 masterpieces listed above. Enroll me as a Trial Member. Privileges: No purchase obligation ever! Advance notice of releases, 5 day free trial on any discs. I may reject records before or after receipt; may cancel membership at any time. For future discs I keep, I'll pay only \$1.65 each plus shipping. Limit: Only one sample package to a customer.

Name.....

Address.....

City..... Zone..... State.....

Canada, address: 105 Bond St., Toronto 2, Ont.

QRM? Get Looped!

(Continued from page 54)

tensions on the controls, the loop could even be installed in the attic or on the roof.

Choice of the impedance-controlling capacitor, C_2 , depends upon receiver-input impedance. This figure is given in the engineering data for the receiver. If a means of measuring the actual impedance is available, the value should be verified. Impedance is usually given a wide tolerance and depends upon the frequency setting and other things. As an example, the instruction book for the author's receiver puts its input impedance at 400 ohms. Measurement shows the actual value to vary between 210 and 500 ohms. To match this, a triple-ganged 365 $\mu\text{fd.}$ capacitor with all sections in parallel, is used in the unit shown, with an auxiliary fixed capacitor of 1000 $\mu\text{fd.}$, C_3 , which may be shunted in as required.

Although an exact match is not essential, a decent approximation improves performance enough to make some experimenting with different values of capacitance worthwhile. As a starting point, give capacitor C_2 a value having a reactance at the desired frequency which is the square root of the impedance figure which we desire.

Taking 3.5 mc. as the desired operating frequency, C_2 would thus have a capacity of slightly over 200 $\mu\text{fd.}$ for a 400-ohm input. Part of the desired value can be made up of fixed capacitors with a large-size variable taking it from there.

If it is desired to use the loop circuit as additional tuning for the input when operating on the regular station antenna, it is only necessary to provide terminals at the back of the unit, connected as shown in Fig. 1D. A doublet, or a quarter-wave antenna, would be connected to the terminal marked "low-Z;" while an end-fed Hertz or any wire of random length would be connected to the "high-Z" terminal. The added selectivity will then help image rejection, and the degree of impedance matching afforded should greatly improve receiver performance. If loop reception alone is desired, the external antenna is disconnected.

It may be necessary to doctor the receiver a little if the power-input or headphone circuits are not adequately filtered. In this case, signal pickup will occur from the power line: or the operator and headset may act as a small antenna. "Back-door" signals are not good with any type of antenna—with a loop, this goes double. A small "brute-force" r.f. filter can be installed in the offending lines to make sure that the only signal getting inside the box comes through the antenna wire.

Conventional r.f. chokes may be used in the headphone line, but the power-input chokes must be of heavy enough

wire to pass the receiver a.c. current without voltage drop. If desired, they may be home-wound of #10 wire, or commercial chokes such as the Mallory RF-583 may be used.

A welding shop down the street used to have me licked every time the workmen struck an arc—but no more. My loop antenna can be set so the welders are in the null, and the stations that otherwise would have been obliterated now roll in clean as a whistle.

So, if local QRM has you stopped—get looped!

—30—

Mac's Service Shop

(Continued from page 64)

listen to my car radio. It seems a little too much like that business of the postman's taking a walk on his day off. Well, I listened to the radio a lot on this trip. You get a kind of funny feeling out there in the desert and mountains. I kept thinking of something Lafcadio Hearn wrote in which he described a place as one in which 'nothing existed but grass and the glory of God.' There's not even grass out there although there certainly is plenty of that other thing in the sight of those snow-capped mountains, the beautiful colors of the desert, and the fantastic shapes of the wind-carved sandstone. Still you feel awfully alone—sort of cut off from everything and everybody—and it helps somehow to keep the radio going as you cruise along."

"I think I understand," Mac said gently; "but what did you mean by saying that radio was a 'telephone' to the people out there?"

"I was thinking of how much they used two-way mobile equipment. Service trucks and official's cars of all kinds have whip transmitting antennas as a matter of course. After all, out there in the desert you can't just step to a telephone at the corner drugstore when you want to call the office or the bulk plant. At first, every time I saw a center-loaded whip, I snapped to attention and blasted out a CQ on the horn, thinking I was meeting another ham; but after getting a few puzzled stares from drivers who would not know CQ from Dixie, I stopped that. I'll bet you, though, that maintaining mobile equipment is quite a thing in the service business out there.

"And oh yeah, one other thing:" Barney went on. "I found out what happens to the small-screen TV sets that are traded in. They go into motels. Several places where we stopped had TV sets, and the largest screen I saw was seventeen inches. Some of the others were ten and twelve inches. The fact of the matter is that those small screens are plenty big enough. In the average small motel room you can't get very far away from the set if you try, and a large screen simply exaggerates the line structure. The motel owners, though, would do well to realize that a TV set that performs poorly is worse

RADIO & TELEVISION NEWS

PHOTOCON SALES

417 N. Foothill Blvd. SY camore 2-4131
Pasadena 8, Calif. RY an 1-6751
CABLE: Photocon, Pasadena

LORAN EQUIPMENT

AN/APN4B Loran with 1D6B Indicator, R9B Receiver, crystal, mounts, plugs, and manual New **\$129.95**
PE-206 Inverter **14.95**

BC-221 Frequency Meter 125kc.-20mc. with cal. book and crystal. **\$99.50**
Weston Model 686 Tube Manual Conductance Vacuum Tube Analyzer. **450.00**
Esterline-Angus Graphic Voltmeter 0-10 vdc. scale, 400 ohms. Model AV. **150.00**
BC-1306 Transceiver with PE-237 Vibrator Power Unit 6, 12, 24 vdc. input Exc. BC-683 FM Receiver with tubes 27-38.9 mc. **PUR***
BC-684 FM Transmitter 27-38.9 mc. 35 W. output. **49.50**
Drafting Machine 16" designed for single horizontal scale (less scale) **17.50**
..... **24.50**

PHOTOFLASH SPECIALS

FT-524 General Electric 3200 watt-second Photoflash tube **\$20.00**
80 mfd. 400 v. 640 watt-second Photoflash capacitor **50.00**

Q-Meter Boonton Model 170 A 30-200 mc. **350.00**
BC-611 Handie-Talkie Transmitter-Receiver 3825-5500 kc. **PUR***
Crystal and Coil sets for BC611—3825, 4280, 5327.5, 5437.5, 5500—kc. (2 crystals & 2 coils per set) **2.95**
Set BD-71 Switchboard 6 stations with ringer Exc. **39.50**
HS-33 600 ohm Headset. **2.50**
New **5.95**
HS-23 8000 ohm Headset. **2.50**
New **5.95**
CD-307 Extension Cords with PL55 and JK26 **1.00**
AM-215A/U A.F. Amplifier 110 v. AC. 60 cy., by Hoffman Radio **42.50**
PUR*—Price upon request.

We have one of the largest and most complete electronic stocks in the country . . . thousands of tubes, capacitors, plugs, accessories, transmitters, receivers, test equipment, etc.
WRITE FOR OUR 1955 CATALOG!

ASK TO SEE IT!

AUTO MECHANICS GUIDE

Every Mechanic needs AUDELS AUTO GUIDE. Saves Time & Money. Highly Endorsed. Covers Whole Subject. 1. Principles. 2. Construction. 3. Ignition. 4. Service. 5. Repairs. Handy Size. Easily Understood. New Fluid Drive. Hydraulic Shift & Diesel Engines fully covered. Over 1700 pages—1540 illustrations showing inside Views of Modern Cars, Trucks & Buses with instructions for Service Jobs. Ask to see it on 7 days Free Trial. Mail Order Today. \$4. Complete. If O. K. Pay Only \$1. a Month until paid. AUDEL, Publishers, 49 W. 23rd St., New York 10, N. Y.

★ ★ ★ ★ ★

800 PAGES
500 ILLUS.

HOW TO FIX

AUDELS HOME APPLIANCE SERVICE GUIDE

PRACTICAL SERVICE INFORMATION

new

ELECTRIC RANGES TOASTERS IRONERS ROASTERS DRYERS BROILERS VACUUMS HEATERS WIRING MOTORS WASHERS CASSEROLES OIL BURNERS PERCOLATORS FOOD MIXERS REFRIGERATORS ALSO MANY OTHER GAS AND ELECTRIC APPLIANCES

A Shop Companion & Ready Reference for Electric & Gas Home Appliance Servicemen, Mechanics & Dealers covers Servicing & Repairs. Tells How to Locate Troubles, How to take Appliances Apart, How to Repair, How to Assemble & Connect. Gives testing methods, wiring diagrams & complete service data. Answers Your Questions. **EASY TO READ**

\$4 COMPLETE • PAY \$1 A MO.
TO GET THIS ASSISTANCE FOR YOURSELF SIMPLY FILL IN AND MAIL COUPON TODAY.

AUDEL, Publishers, 49 WEST 23rd ST., New York 10, N. Y. Mail AUDELS HOME APPLIANCE SERVICE GUIDE (\$4) for free examination. If O.K. I will send you \$1 in 7 days; then remit \$1 monthly until \$4 is paid. Otherwise, I will return book promptly.

Name _____
Address _____
Occupation _____
Employed by _____ R N

August, 1955

than no TV set at all. It creates a feeling of annoyance and ruins the good impression that may have been produced by the rest of the motel. Periodic checks by a good service organization, supplemented by daily checks for proper operation by motel personnel, would take care of this. What say I visit the motels around town this week and try to get some of this business for us?"

"Fine," Mac agreed; "and if you get any appreciable amount of business, I'll see you get a little bonus."

"I could use it after that vacation," Barney said wryly. "Before I sign off and go to work I want to mention that I have a much better feeling toward the whole electronic field and my job in it than I had before starting on this trip. Now I fully realize what a big and growing thing this electronic business really is, and I'm tickled to death I have such a good start in it. When I recall the radar installations I saw on the ships in the harbors, the tremendous military radio installation just south of San Francisco with its acres and acres of 'antenna farm,' of the electronic gear I glimpsed in the huge planes being built at the *Lockheed* plant, and the fantastic investment in television that ranges all the way from recalling the picture of that wonderful new *CBS* TV Center in Los Angeles to the memory of a tiny Indian hogan out in New Mexico with a TV antenna perkily sticking out the top—when all these things go through my mind, I am extremely proud to be a small but important cog in such a whopping big machine."

"You know," Mac reflected, "You weren't kidding when you said this trip broadened your outlook. When a fellow comes home thinking more of his job than when he went away, his vacation has really done him some good." —30—

Harold H. Rainier (right), manager of distributor sales, accepts the annual "NATESA Friends of Service Management" plaque for 1954 on behalf of Sylvania Electric Products Inc. The award, presented annually by the National Alliance of Television and Electronic Service Associations, is given to that company, which in the judgement of NATESA, rendered services to the industry beyond normal functions. This is Sylvania's fourth such award. Fred S. Colton, East-Central vice-president of NATESA (left) presents plaque as Frank J. Moch, NATESA president, watches proceedings.



LEARN PRACTICAL RADIO

Construction, Servicing, Theory

At Home with the New Improved PROGRESSIVE RADIO "EDU-KIT" **\$19.95** Complete

Build 15 Receiver, Code Oscillator, Transmitter, Signal Tracer Circuits

- Attractively Gift Packaged
- Free Soldering Iron
- Absolutely No Knowledge of Radio Necessary
- No Additional Parts Needed
- Excellent Background For Television
- 30-day Money-Back Guarantee
- School Inquiries Invited
- Used in 79 Countries
- Learn High Fidelity



WHAT THE PROGRESSIVE RADIO "EDU-KIT" OFFERS YOU

You will learn how to identify Radio Symbols and Diagrams; how to build radios, using regular radio schematics; how to wire and solder in a professional manner. You will learn proper chassis layout. You will learn the basic principles involved in radio reception, transmission and audio amplification. You will learn how to service and trouble-shoot radios. You will learn code. You will receive instructions for F.C.C. Novice license. In brief you will receive a practical basic education in Radio, worth many times the small price you pay.

THE KIT FOR EVERYONE

It is not necessary that you have even the slightest background in science or radio. The "Edu-Kit" is used by young and old; by radio schools and clubs; by Armed Forces personnel and Veterans. No instructor is required. Instructions are complete, simple and clear.

PROGRESSIVE TEACHING METHOD

The "Edu-Kit" uses the principle of "Learn by Doing." Therefore you will build radios, perform jobs, and conduct experiments to illustrate the principles which you learn. You begin by learning the function and theory of each of the radio parts. Then you build a simple radio. Gradually, in a progressive manner, you will find yourself constructing more advanced multi-tube radio sets, and doing work like a professional Radio Technician. The "Edu-Kit" Instruction Books are exceedingly clear in their explanations, illustrations and diagrams. These sets operate on 105-125 V. AC/DC. For use in foreign countries having 210-250 volt source, an adapter for 210-250 V. AC/DC is available.

The Progressive Radio "EDU-KIT" is Complete

You will receive every part necessary to build fifteen different radio circuits. The "Edu-Kit" contains tubes, tube sockets, variable electrolytic and paper condensers, resistors, the strips, coils, hardware, tubing, Instruction Manuals, etc. No solder or hook-up wire included. A soldering iron is included as well as Electrical and Radio Tester. Complete, easy-to-follow instructions are provided. All parts are guaranteed, brand new, carefully selected and matched. In addition, the "Edu-Kit" now contains lessons for servicing with the Progressive Signal Tracer, High Fidelity, F.C.C. Novice Instructions, quizzes.

TROUBLE-SHOOTING LESSONS

Trouble-shooting and servicing are included. You will learn how to recognize and repair troubles. You will build and learn to operate a professional Signal Tracer. You will receive an Electrical and Radio Tester, and learn to use it for radio repairs. While you are learning in this practical way, you will be able to do many a repair job for your neighbors and friends and charge fees which will far exceed the cost of the "Edu-Kit."

FREE EXTRAS

- ELECTRICAL & RADIO TESTER • SOLDERING IRON • HI-FI GUIDE • TV BOOK • QUIZZES
 - CONSULTATION SERVICE
- PROGRESSIVE "EDU-KITS" INC.,
497 Union Av., Brooklyn 11, N. Y.

MAIL TODAY—Order shipped same day received. 30-Day Money-Back Guarantee INCLUDE ALL FREE EXTRAS

- "EDU-KIT" Postpaid. I enclose full payment of \$19.95
- "EDU-KIT" COD—I will pay \$19.95 plus postage (USA only)
- Outside USA: Enclose \$20.95. "Edu-Kit" sent postpaid
- Outside USA: 210-250V. AC/DC Adapter. Enclose \$2.50
- More details on "EDU-KIT" Free—
- No Obligation
- FREE Radio-TV Servicing Literature.
- No obligation

NAME _____
ADDRESS _____

PROGRESSIVE "EDU-KITS" INC., 497 Union Av., Room 510D, Progressive Building Brooklyn 11, N. Y.

Build your own PRE-AMPLIFIER!



Mail coupon below for free article "Pre-Amp with Presence" by C. G. McProud, Audio Magazine— together with other pre-amplifier circuits featuring the outstanding

Genalex Z729

lowest hum, lowest noise, high-gain input Pentode on the market.

About the Z729...

- Total hum voltage infinitesimal... actually less than 1.5 microvolts.
- Expressly designed for use as first stage of high gain amplifier or tape recorder.
- Internal shield completely surrounds tube elements.
- Fits standard 9 pin miniature socket.



Quality Endorsed Product of the British Industries Group.

British Industries Corp. Dept. RTZ8-5
164 Duane St., New York 13, N. Y.

Please send Circuit Design and literature on the Z729

Name

Address

City..... Zone.. State.....

when there's a soldering job to be done...



On industrial assembly lines ... in home workshops ... in electronic labs ... for production, repair, maintenance ... the world's most versatile family of pencil soldering irons is on the job, doing a better job! No wonder they're called "Ungar's Little Angels!"

- Interchangeable tips for every soldering need from repair to high-speed production soldering.

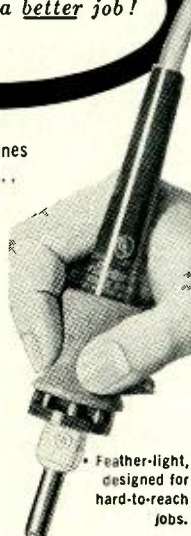

Write for Catalog U-15



UNGAR ELECTRIC TOOLS, INC.
P. O. Box 312, Venice, California



TRANSISTOR CIRCUITRY

Sylvania Electric Products Inc., 1100 Main St., Buffalo 9, N. Y., has issued a new manual covering the practical applications of junction transistors, entitled "28 Uses for Junction Transistors."

The 48-page booklet is designed primarily for the experimenter and hobbyist but several of the circuits will be of interest to engineers and technicians.

The contents of the booklet are divided into five chapters covering elementary transistor theory, transistorized amplifiers, transistorized oscillators, transistorized control devices, and transistorized instruments. The text is profusely illustrated with charts and diagrams.

The price of the manual is 25 cents and orders should be sent direct to the company.

TV ALIGNMENT GEAR

Hickok Electrical Instrument Company, 10524 Dupont Avenue, Cleveland 8, Ohio is making a limited-time offer of an 8-page booklet covering TV alignment equipment.

Of special interest to service technicians are the reprinted articles on the use of the Model 691 Marker Adder and the Model 690 Marker Generator in TV alignment and conversion of the Model 650 video generator to the color-compatible Model 650C.

The booklet is free to those who make their requests prior to August 31st.

PRINTED CIRCUITRY

Cornell-Dubilier Electric Corporation's Printed Wiring Division, South Plainfield, N.J. has published a new 8-page booklet entitled "Printed Circuitry."

The new 8½x11" illustrated booklet describes in detail the application, uses, and advantages of printed circuits in various electrical products and equipment, as well as technical information to aid in the design or planning of printed circuitry.

The booklet explains simply and authoritatively the different types of base material, laminate characteristics, and circuit designs. Other chapters explain how to prepare master drawings, soldering techniques, and pricing variables.

PYRAMID FLIP CHART

A new 21-page flip chart which describes its new "Kool-Sel" selenium rectifier line in detail is now available from *Pyramid Electric Company*, 1445 Hudson Blvd., North Bergen, N. J.

The chart is available for sales

meetings in a 16" x 24" size and in pocket-size form for use by representatives, jobbers, and jobber counter men. The chart is printed in black, yellow, and white for maximum visibility.

The company's representatives are handling distribution of the chart or it may be obtained by writing Jack K. Poff, jobber sales manager of the company.

TRIAD CATALOGUES

Triad Transformer Corporation, 4055 Redwood Ave., Venice, California has just issued two new catalogues of interest to the industry.

The general catalogue, TR-55, lists 685 items, 79 of which are new to the line. Included among the new items are a series of subminiature audio transformers, several additions to the series of high-fidelity output transformers, power components, geomformers, replacement power and audio transformers, dry disc rectifier transformers, and TV replacement items.

The second publication, TV-155, lists the correct replacement transformer for television use, showing *Triad* items recommended for replacement in over 5800 models of TV receivers.

Copies of either or both catalogues are available from the company's jobbers or from the company direct.

RELAY CATALOGUE

Relay Sales, 4721 W. Madison Street, Chicago 44, Illinois has announced the availability of its new 18-page 1955-C6 catalogue which lists the specifications and prices of hundreds of types of standard brand relays which are immediately available from stock.

The catalogue carries data in tabular form for easy reference with photographs of the relays and contact diagrams included for additional information.

RESISTANCE DATA

International Resistance Company, 401 N. Broad Street, Philadelphia 8, Pa. is now offering comprehensive data on the construction, dimensions, machining technique, tolerances, resistance values, power and voltage ratings, temperature coefficients, voltage coefficients, etc. of its resistance strips and concentric disc resistors.

A copy of Catalogue Data Bulletin T-1, a 4-page publication containing charts and graphs, is available without charge on request.

EQUALIZERS

Cinema Engineering Company Division of Aerovox Corporation, 1100 Chestnut Street, Burbank, California has issued a 16-page catalogue, No. 12E, completely illustrated with response charts for its equalizers and wave filters.

The 20-page catalogue covers all applications of this type of equipment in sound and sound recording with more than a score of items outlined. A novel adaption in the compilation is the section devoted to case studies, where-in concrete problems, with solutions,

are given. The data was selected from actual case histories furnished by the company's customers.

METERS AND PYROMETERS

Assembly Products Inc., Chesterland, Ohio is now offering copies of its new panel meter and pyrometer catalogue, Bulletin G-9.

The new 8-page publication lists various types of clear plastic case panel mounting meters as well as black Bakelite case styles. Also shown are some of the new ruggedized and sealed models.

Indicating pyrometers, both panel mounting and portable types, are also included.

TUNING LOCK DATA

A special bulletin describing the "Trak" automatic tuning lock, an auxiliary device designed for frequency-shift communications receivers, has just been published by the manufacturer, CGS Laboratories, 391 Ludlow Street, Stamford, Conn.

The new tuning lock automatically maintains a frequency-shift signal in tune despite drift from any cause, receiver temperature changes, or any other contributing factor, and in effect provides greater efficiency in reception from a poorly stabilized receiver.

RECEIVER BROCHURE

Hammarlund Manufacturing Company, 460 West 34th Street, New York 1, N. Y. is now offering a new brochure which describes the company's new amateur and professional communications receiver, the Pro-310.

This 2-color, 4-page booklet describes in detail the specifications, design, and performance characteristics of this receiver. The instrument, which makes use of a rotary turret and has continuously calibrated bandspread from 550 kc. to 35.5 mc., is available in a choice of two cabinet colors.

COAX USAGE

Microdot Division, 1826 Fremont Avenue, South Pasadena, California has issued a four-page illustrated folder entitled "This is Microdot."

The new publication explains in detail how to use the company's micro-miniature coaxial cable. Photographs and line drawings are included along with complete specifications on the line.

ASTRON CAPACITORS

Astron Corporation, 255 Grant Avenue, East Newark, New Jersey has just released a new four-page bulletin, No. AB-21, on its "Comet," the first molded plastic tubular metallized paper capacitor to be developed.

Printed in two colors with illustrations and tables, the new publication contains full details, descriptions, performance characteristics, and test specifications.

SCINTILLATION SYSTEM

A new two-color, eight-page brochure describing the DS-7 Scintillation Counting System for aerial or ground

August, 1955

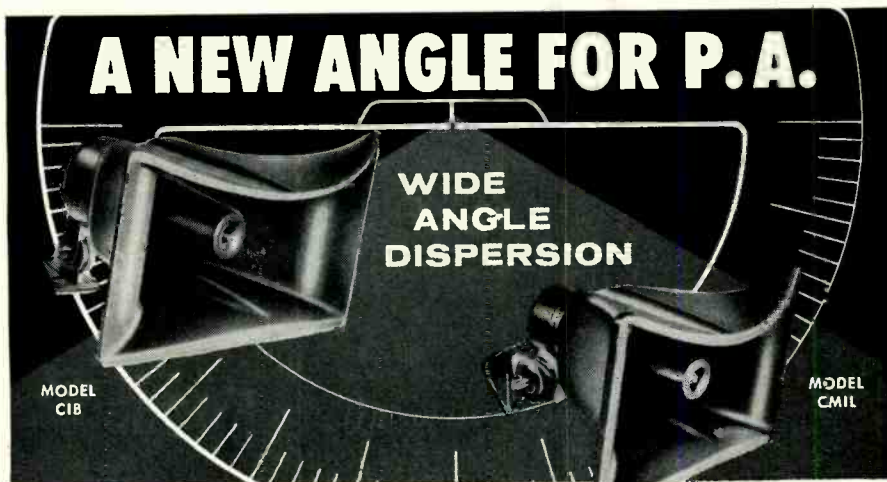

Never before has such P. A. quality and design been integrated as in the compact construction of the new University Model CIB and Model CMIL. Their unique design provides the user with the limitless benefits of • Wide Angle Dispersion • Uniform Response • High Efficiency • Sensitive Talk-Back.

Better Articulation — crisp, clear speech reproduction penetrates the din and clatter of high noise level areas.

Greater Economy — Inherent high conversion efficiency cuts down the need for expensive high powered amplifiers. Dependable . . . Weather-Resistant — whatever the P. A. application — whatever the weather, these speakers will meet the necessary technical or physical requirements.



DURABLE CONSTRUCTION

1. Wear-Resistant Bell — one piece mold of extra-thick gauge reinforced fibreglass/polyester resin.
2. Full length steel bead imbedded into the mold at the mouth of the bell.

UNIQUE ADJUSTABLE MOUNTING

3. Exclusive 'Positive-Lok' of specially serrated teeth on each side of bracket secures speaker position.
4. Convenient wing-nut operation permits adjustment for optimum coverage.

For more complete information write Desk 93 for technical Bulletin T176.

University LOUDSPEAKERS
80 South Kensico Avenue, White Plains, N. Y., Inc.



SAVE WITH THE NEW

ERIE DISC and GP CERAMICON Kits

HERE'S WHAT YOU GET

- 1 100 High Stability ERIE Disc or Tubular Ceramicons
- 2 18 Popular Values
- 3 Handy, Convenient 18 Section Plastic Storage Case
- 4 Exceptional Value

HERE'S WHAT YOU SAVE

REGULAR PRICE

100 ERIE Disc or Tubular Ceramicons . . . \$15.00
18 Section Plastic Case . . . 1.75
Total Value \$16.75

YOU PAY \$10.65
YOU SAVE \$ 6.10

ORDER NOW
From Your
ERIE
DISTRIBUTOR



ERIE ELECTRONICS DISTRIBUTOR DIVISION
ERIE RESISTOR CORPORATION
Main Offices: ERIE, PA.
Factories: ERIE, PA. • LONDON, ENGLAND • TRENTON, ONTARIO

NEW! IMPROVED!

AM/FM PLUG-IN TUNERS
for your **CAR** or **HOME**

\$13.95 FM BROADCAST TUNER
88 to 110 MC MUSIC

OTHER MODELS FOR:

• **110-170 MC**

police and aircraft

• **30-50 MC**

police, fire, civil def.



AMATEUR BANDS SPECIAL
2-6-10 METERS



LOOK!
NEW 110 V.
Complete RECEIVERS for use
also AMPLIFIERS for use
with PLUG-IN TUNERS

NOW! 2 METER
and VHF BANDS
Model 293

only **\$1395** low priced

Write for literature • Territories open

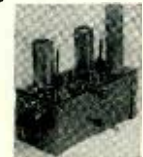

Kuhn ELECTRONIC PRODUCTS
20 Glenwood • Cincinnati 17, Ohio

LEARN TV
the practical way..



BUILD the New
TRANSVISION
TV KIT

\$15.00
ONLY gets you started*

- PROFIT 3 WAYS:**
- 1 Learn TV
 - 2 Save up to 50%
 - 3 Prepare for COLOR TV

FREE
CATALOG

Shows 8 Great TV Kits:
EXCLUSIVE: Only Transvision TV Kits
are adaptable to UHF. Ideal for
FRINGE AREAS. No Previous Technical
Knowledge required. Write now!
TRANSVISION
THE OLDEST NAME IN TV KITS
NEW ROCHELLE, N. Y.

MAIL THIS COUPON TODAY
TRANSVISION, INC., NEW ROCHELLE, N. Y. Dept. N-8

I'm enclosing \$_____ deposit. Send standard kit
PACKAGE #1, with all instruction Material. Balance C.O.D.

Send FREE copy of your new TV Kit Catalog.

Name _____
Address _____
City _____ State _____

surveying for oil or uranium deposits is available from the *Nuclear Instrument and Chemical Corporation*, 229 West Erie Street, Chicago 10, Illinois.

The text material is lavishly illustrated with line drawings and photographs.

DRY CELLS AND BATTERIES

The National Bureau of Standards has issued a new circular covering specifications for dry cells and batteries.

This 17-page publication which includes 5 halftone illustrations and 19 tables is available from the Government Printing Office at Washington 25, D. C. for 25 cents in cash.

This is the sixth edition of this standard and covers specifications approved on August 19, 1954. It supersedes the previous specification which was approved in 1947.

RETMA-BBB BOOKLET

Publication of the third edition of its consumer-education booklet which is designed as a guide to the purchase and service of black-and-white and color television receivers has been announced by the Radio-Electronics-Television Manufacturers Association and the Better Business Bureau.

The booklet, "Things You Should Know About the Purchase and Servicing of Television Sets," was prepared by the Association's Service Committee in cooperation with the radio-television committee of the Association of Better Business Bureaus.

Distribution of the booklet is being made through local television sales and service organizations and Better Business Bureaus.

SHIELDED ENCLOSURES

Ace Engineering & Machine Company, 3644 N. Lawrence Street, Philadelphia 40, Pa. has issued a comprehensive catalogue covering engineering and application data on r.f. shielded enclosures.

Every type of screened and sheet metal standard enclosure is covered individually, with insertion loss or attenuation curves for each room and complete construction details illustrated by cutaway drawings. Engineering specifications and standard room size availability are presented in simple, easy-to-use form.

Copies of this catalogue, of special interest to the electrical, medical, electronic, architectural, and dielectric heating fields, are available on request.

EIMAC DATA SHEETS

Eitel-McCullough, Inc., San Bruno, California has published revised editions of its *Eimac* 4-400A radial-beam power tetrode and 4-400A/4000 air system socket data sheets and Application Bulletin #3, "Pulse," dealing with pulse applications of the company's tubes.

The material has been mailed to *Eimac* catalogue holders but is available to others on request. Write the Technical Services Department of the company.

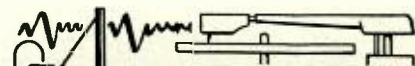

New Hi-Fi-Audio



Equipment

NEW TAPE RECORDER

James Instrument Laboratories, 9110 S. 52nd Court, Oak Lawn, Illinois, is in production on a new tape recorder, the V-12.

The new unit features a three-motor mechanism with a two-speed hysteresis

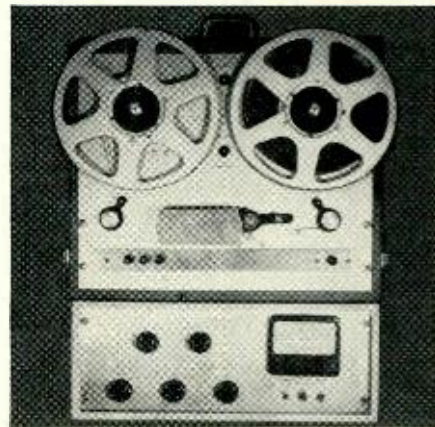

synchronous motor for flutter-free tape drive. It will handle reels up to the 10½" NARTB size without adapters and employs electrodynamic braking for smooth and safe stoppage.

All tape motion is controlled by electrically interlocked push-buttons with automatic stop in case of tape breakage or run-out. The tape guides automatically release the tape from contact with the heads and accidental erasure is prevented by an electrically interlocked "Record" button. Tape speeds are 7½ and 15 ips with three speeds available on special order.

The recording amplifier has separate circuits for recording and playing back, permitting monitoring from tape while recording, standard NARTB playback equalization, 10-watt push-pull monitoring and playback amplifier, cathode-follower output for external amplifier, mixer for two inputs, and a 4-inch vu meter. Over-all frequency response is 40 to 15,000 cps at the 7½ ips speed.

BROCINER 10-WATT AMPLIFIER

Brociner Electronics Laboratory, 344 East 32nd Street, New York 16, N.Y.

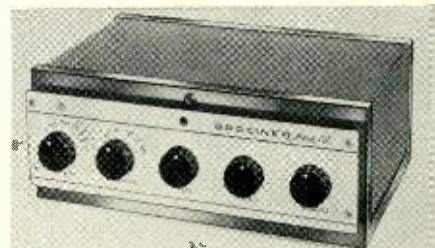

has added the "Mark 10" to its line of amplifiers.

The unit includes in one compact

RADIO & TELEVISION NEWS

housing a rugged power amplifier, bass and treble controls, selector switch, record compensator, and phonograph preamplifier. The equipment is suitable for use with AM, FM, and TV tuners, all types of high-quality phonograph pickups, and for tape recording and playback. A simplified record compensator affords convenient selection of record equalization and includes a special provision for noisy records. A rumble filter, controlled from the front panel, permits the use of record changers, without background noise.

The use of printed circuitry permits an extremely compact construction. The amplifier measures only 4 1/4" high, 10 7/8" long, and 8" deep from front panel to clearance over jacks on the back panel. It is adjustable for use on panels up to 3/4" thick.

"KNIGHT" AM-FM TUNER

Allied Radio Corporation, 100 N. Western Ave., Chicago 80, Illinois has released a new, low-cost Model 728 AM-FM tuner which has been designed especially for home music systems.

Tuning of FM stations is made simple and accurate by an a.f.c. circuit that locks in stations as their dial setting is approached. This feature eliminates drift while the tuner is warming up. The Model 728 has only two controls; tuning and function selector, which makes it a good choice for use with amplifiers or preamps having full sets of controls.

A removable gold-finished escutcheon is provided for simple, behind-panel

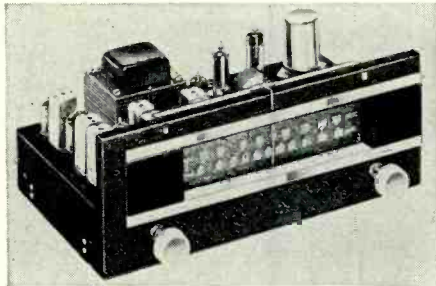

custom installation. For complete literature and specifications, write the company direct.

SPEAKER SYSTEMS

University Loudspeakers, Inc., 80 South Kensico Ave., White Plains, N.Y. recently demonstrated its new "Module Plan" for theater speaker systems.

Featuring exceptional flexibility, each of the "Module" sections is a deluxe three-way compression driven horn-loaded reproducing system. A front folded horn works in conjunction with a rear baffle chamber to effect a "compression type" low-frequency driver assembly, independent of auditorium acoustics and capable of reproducing bass notes with unusual efficiency and realism.

The speaker and network components installed in a single "Module" section are the company's C15W 15" woofer, "Cobreflex" 2/T30 mid-range speaker, HF-206 super-tweeter, and

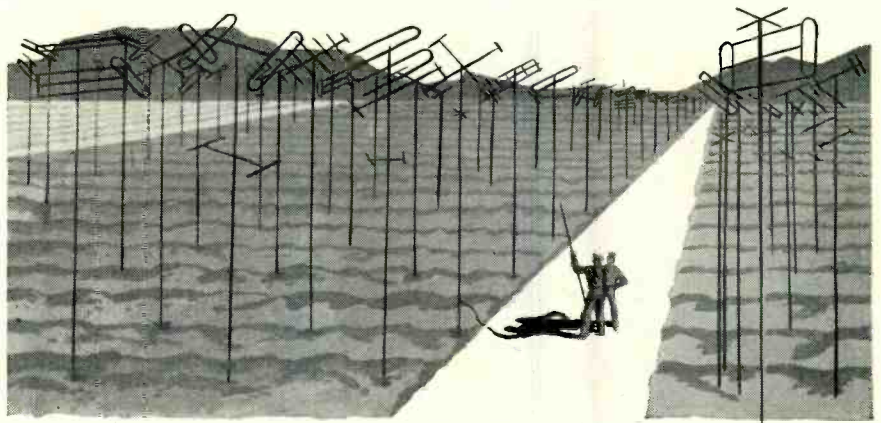

ALL TV MASTING IS NOT THE SAME

SPECIFY

**WHEATLAND
WHETHA-TUBE**

HOT DIP GALVANIZED ELECTRIC WELD STEEL TUBING

SEALED IN MOLTEN ZINC FOR COMPLETE RUST PROTECTION

WHEATLAND TUBE COMPANY • BANKERS SECURITIES BUILDING • PHILADELPHIA, PA.
MILLS: WHEATLAND, PENNSYLVANIA, DELAIR, NEW JERSEY

**STAY ON THE AIR
WHEN POWER FAILS...with
an ONAN Electric Plant**



**AUTOMATIC
START & STOP**

Model 10HQ-10KW A.C.

When storms, floods, or fires interrupt electricity and force you off the air, you lose listeners and income. Guard against loss, assure vital public service during emergencies by installing an Onan Electric Plant. Onan Standby Electric plants serve many network and private stations. Gasoline driven automatic models to 50,000 watts.

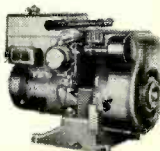

**PORTABLE ELECTRIC PLANTS
FOR MOBILE RADIO USES**
Supply A.C. power for broadcasting at scene of events. Light in weight. Can be carried by hand or in trunk of car. A.C. models: 500 to 10,000 watts.

Write for **FREE Folder**

D. W. ONAN & SONS INC.
3387 University Avenue
Minneapolis 14, Minnesota

**NOW
COYNE
TRAINS YOU
IN SPARE TIME
AT HOME**

**TELEVISION
RADIO-ELECTRONICS**

Only from famous COYNE do you get this modern up-to-the minute TV Home Training. Easy to follow instructions—fully illustrated with 2150 photos and diagrams. Not an old Radio Course with Television tacked on. Includes *UHF* and *COLOR TV*. Personal guidance by Coyne Staff. *Practical Job Guides* to help you **EARN MONEY QUICKLY IN A TV-RADIO SALES AND SERVICE BUSINESS—part time or full time. COSTS MUCH LESS—pay only for training—no costly "put together kits".**

SEND COUPON FOR FREE BOOK
SEND COUPON BELOW for *Free Book* and full details including *EASY PAYMENT PLAN. NO COST OR OBLIGATION—NO SALESMAN WILL CALL.*

B. W. COOKE, Pres. **COYNE** FOUNDED 1899
ELECTRICAL SCHOOL
A TECHNICAL TRADE INSTITUTE OPERATED NOT FOR PROFIT
500 S. Paulina Dept. C5-HT5 Chicago 12, Illinois

COYNE ELECTRICAL SCHOOL
Television Home Training Div.
500 S. Paulina St., Chicago 12, Ill., Dept. C5-HT5
Send **FREE BOOK** and details of your Television Home Training offer.

Name _____
Address _____
City _____ State _____

**Joe
Serviceman
says:**



**"You can't get somethin'
for nothin', especially
Quality and Reliability"**

QUIETROLE

TRADE MARK REG. U.S. PAT. OFF.



the original lubricant and cleaner for quieting noisy controls and switches, costs little more than the cheapest imitations, but the name assures you are getting the best.

INSIST ON QUIETROLE

THE CHOICE OF
BETTER SERVICEMEN
"EVERYWHERE"

manufactured by

**QUIETROLE
COMPANY**

Spartanburg, South Carolina



NO MOTORS! ELECTRICITY! ROTATES ELECTRONICALLY

No roof orientation, no ghosts. It's electronically beamed by 6-position Directonic Selector Switch on or near TV set. Around the compass, 360° electronic rotation gives bright, sharp pix on all channels. Nine hi-tensil 1/8" aluminum elements, dowel reinforced. Includes Selector Switch, 75 ft. 3 cond. cable. Performance guaranteed.

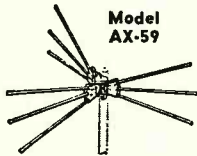

Model
AX-59

995

Complete
360° Reception of VHF
Channels 2-13. Record
low price!

Model TX-59 same as AX-59, except includes 2 3/2 ft. masts, guy ring and mfg. base. Only..... **\$11.95**

SYLVANIA

5AXP4 5" Universal Test Pic Tube

Handiest, safest, fastest all purpose test tube. Checks performance of ANY TV set, any size, make or model. 5" dia. **\$2200**



CHECKS ALL RADIO & PIC

TUBE FILAMENTS FAST

VISULITE MODEL 101C

Tests fuses, lamps, resistors, motors, appliances, etc., for continuity. Operates on 110V. ac or dc. Complete with test leads **\$395**

Write for FREE FYI Bulletin 230

**WHOLESALE
RADIO PARTS CO., Inc.**

311 W. Baltimore St. • Baltimore 1, Md.

the N-3 three-way LC dividing network. Crossovers are effected at 350 and 5000 cycles.

"CUB-CORDER"

Bell Sound Systems, Inc., 555 Marion Road, Columbus 7, Ohio has unveiled



its new portable, battery-powered, dual-track tape recorder, the "Cub-Corder."

Utilizing a rechargeable, non-spill wet battery and a 67½ volt "B" battery, the new unit will record for one hour at 3 1/2 ips or 30 minutes at 7 1/2 ips on a single 5", 600 ft. reel of tape. The 7 1/2 ips speed provides a wide frequency response. The machine is also available with capstans for 1 1/2 ips and 3 1/2 ips and, using the new long-playing tapes at 1 1/2 ips, it will record three hours.

Housed in a handy carrying case, approximately the size of the average brief case, the "Cub-Corder" weighs only 12 1/2 pounds and may be carried by a handle or shoulder strap. The entire operation is controlled by a switch on the microphone, permitting complete freedom on the part of the operator.

COMPACT AMPLIFIER

Newcomb Audio Products Co., Inc., 6824 Lexington Avenue, Hollywood 38, California is now offering a new line of amplifiers which has been designated as the "Compact 1000" series.

The new models incorporate both amplifier and preamplifier in a single decorator-styled, satin-gold cabinet which is small enough to fit on a chair-side table. Currently the company is offering 10, 12, and 20 watt models.

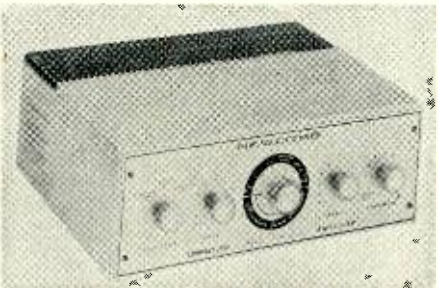

The Model 1010 is a 10-watt amplifier-preamp which measures only 3 3/16" high, 7 7/8" deep, and 9 1/4" wide. Smaller than most preamp control units alone,

it provides response from 20 to 20,000 cps ± 1 db with distortion below 1 per-cent at 10 watts.

Controls include a six-position recording curve selector, separate continuously-variable bass and treble controls, input and rumble filter selector switch, and loudness control and power switch. Six inputs are provided, in addition to an "output to tape" jack which permits recording while listening.

ASTATIC "DYNAMIKE"

The Astatic Corp., Conneaut, Ohio is now marketing a versatile, wide-range dynamic microphone which combines modern styling with low price.

The "Dynamike" is light, slender, and compact, measuring only 1 1/4" across the top and weighing only 7 1/4 ounces. The housing is die-cast alloy, with a glareproof satin black finish and brushed chrome trim.

Response of the microphone is 50 to 10,000 cps. It comes equipped with a standard 5/8"-27 thread which is readily adaptable for floor stand, desk stand, or hand use. It is available in either high or low impedance models with or without an "off-on" switch adapter.

FLUTTER BRIDGE

Telectro Industries Corp., 35-18 37th Street, Long Island City 1, N.Y. is now offering a new "Flutter Bridge" which has been specifically designed to measure flutter and wow in turntables, tape recorders, wire recorders, and motion picture equipment.

Suitable for either service shop



work or in the engineering laboratory, the instrument uses a unique sensitive bridge circuit and an accurate band-pass filter for the elimination of noise and hum. Accurate measurements of flutter and wow are taken as simply as voltage measurements. Measurements in either the 0-.5 per-cent or 0-2 per-cent ranges are indicated clearly on the large 4" square meter.

The "Flutter Bridge" requires no external power source, is lightweight, portable, and rugged. It is housed in a 13" x 8" x 6" metal case.

5-WATT "COBRA-JECTOR"

Atlas Sound Corp., 1451 39th Street, Brooklyn 18, New York has announced the availability of its new Model CJ-14 "Cobra-Jector" for paging, talkback, intercom, industrial, marine, and mobile applications.

The design provides a wide angle of dispersion for crisp, sharp, penetrating articulation for effective coverage of

★
**Don't just say
 "capacitors"**

Ask For Sprague By Catalog Number

Know what you're getting . . . get exactly what you want. Don't be vague . . . insist on Sprague. Use complete radio-TV service catalog C-610. Write Sprague Products Company, 51 Marshall Street, North Adams, Massachusetts.

SPRAGUE®

WORLD'S LARGEST CAPACITOR MANUFACTURER

0-1 3-INCH MILLIAMP METER. 270° indication. By-pass shunt and add scale. Only . . . **\$1.95**

100 MICROAMP METER. 3" rd. Used. Excellent condition. **\$3.49**

FREE CATALOGUE! Get your copy of latest issue

J. J. Glass Electronics Co.
 1615 S. Main Street Los Angeles 15, Calif.

PHOTOGRAPHERS!

10c

**BRINGS YOU
 105 EASY-TO-FOLLOW
 "PHOTO TIPS"**

Here's a roundup of over 100 ideas, hints, tips and suggestions for making your photo chores easier, faster and a lot more fun—right out of the pages of **POPULAR PHOTOGRAPHY**—the top magazine among camera fans everywhere.

"PHOTO TIPS" will save you time, money and effort—particularly in the darkroom. It's full of "how-to-do-it" illustrations that will improve your technique—help you get more fun from photography. Send for your copy of "PHOTO TIPS" today—only 10c!

POPULAR PHOTOGRAPHY, Box RN
 366 Madison Avenue, New York 17, N. Y.

Here's my 10c. Please send me a copy of "PHOTO TIPS" containing over 100 photo ideas.

Name _____

Address _____

City _____ Zone _____ State _____

★ areas of high noise level, adverse wind conditions, etc. The fiber glass construction of its main flare assures lifetime durability under all climatic conditions.

Input impedance is 8 ohms, input power is 5 watts, and response is 400 to 9000 cps. Front opening size is 9½x5½" with over-all length 8½" including the bracket.

NATIONAL AM-FM TUNER

National Company, Inc., Malden, Mass. is now offering a new model of its "Horizon Criterion" AM-FM high-fidelity tuner.

The new unit offers, among other features, calibrated AM-FM logging



scales, "lock-in" tuning (broad and non-critical without meters, eyes, or other complicated tuning indicators), adjustable "Mutamatic" tuning which eliminates all hiss and noises, and bin-aural or simultaneous AM-FM tuning.

The tuner's .8 capture ratio makes sensitivity usable for fringe area reception in areas formerly inaccessible to FM signals by rejecting all interfering signals up to 80 per-cent as strong as the desired signal, making signals ghost or reflection free.

"STATICMASTER"

Nuclear Products Company, 10173 E. Rush Street, El Monte, California has developed a special record brush especially for use with hi-fi discs.

The "Staticmaster" rotates over the record surface removing fine dust particles and eliminating the surface static electricity. This neutralization of the ever-present static prevents the attraction of other dust and lint. The ionizing agent, polonium, sealed in the brush ferrule, does the trick; the soft

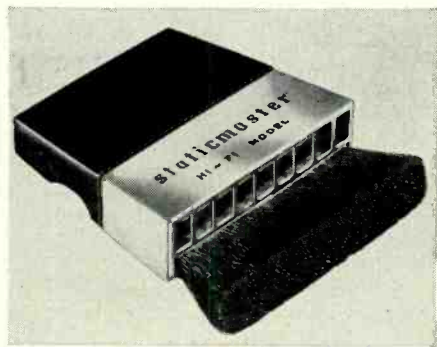

camel hair bristles gently remove the released dust.

Write the company direct for additional information on this equipment.

WIDE-ANGLE SPEAKER

A new concept in wide-angle paging and talkback speaker design has been

Become an
ELECTRICAL ENGINEER

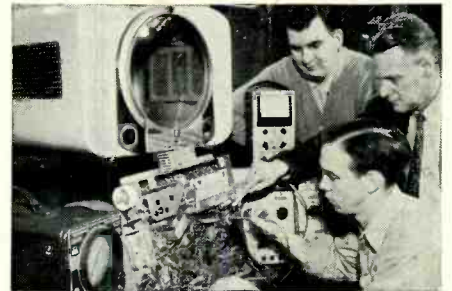

**Major in Electronics or Power
 BS Degree in 36 months**

Prepare now for a career as an electrical engineer or engineering technician — and take advantage of the many opportunities in these expanding fields.

You can save a year by optional year 'round study. Previous military, academic, or practical training may be evaluated for advanced credit.

**Enter Radio and Television
 — courses 12 to 18 months**

You can be a radio technician in 12 months. In an additional 6-months you can become a radio-television technician with Associate in Applied Science degree. Color television instruction is included in this program.

These technician courses may form the first third of the program leading to a degree in Electrical Engineering. Twenty-one subjects in electronics, electronic engineering and electronic design are included in these courses.

Courses also offered: radio-television service (12 mos.); electrical service (6 mos.); general preparatory (3 mos.).

Terms—Sept., Jan., Apr., July

Faculty of specialists. 50,000 former students—annual enrolment from 48 states, 23 foreign countries. Non-profit institution. 52nd year. Courses approved for veterans. Residence courses only.

MS-6A



**MILWAUKEE
 SCHOOL OF ENGINEERING**

MILWAUKEE SCHOOL OF ENGINEERING
 Dept. RN-855, 1025 N. Milwaukee Street
 Milwaukee 1, Wisconsin

Send FREE illustrated booklets
 Career in Electrical Engineering
 Career in Radio-Television.

I am interested in _____
 (name of course)

Name _____ Age _____

Address _____

City _____ Zone _____ State _____

If veteran, indicate date of discharge _____

NOW!

**Step ahead faster
as an
INDUSTRIAL
ELECTRONICS
TECHNICIAN**



Turn your experience into a big, new better-paying career!

Day by day industrial plants are adding more electronic devices—for sorting, counting, checking almost any control job you can name. Cash in on industry's great need for men who can keep these devices in top working order. Make more money, feel more secure, doing work that is second nature to you. With what you already know about electronics you have a long head start in a field just beginning to boom. GET INTO IT RIGHT NOW with the help of

**PRACTICAL INDUSTRIAL
ELECTRONICS LIBRARY**

No long sessions on math or theory! These 4 practical volumes show you how to keep the plant's electronic equipment working . . . how to locate and correct tube and circuit troubles . . . how to install, service, and maintain even brand new equipment without being stumped by new circuits.

- 4 volumes (1390 pp., 1050 illus.):
- Chute's Electronics in Industry
- Miller's Maintenance Manual of Electronic Control
- Markus & Zeluff's Handbook of Industrial Electronics Circuits
- Henney & Fahnestock's Electron Tubes in Industry

FREE TRIAL—EASY TERMS!

McGraw-Hill Book Co., 327 W. 41 St., NYC 36
Send me the Practical Industrial Electronics Library for 10 days' examination on approval. In 10 days I will send \$2.50, then \$4.00 a month until \$22.50 is paid. (A saving of \$3.50 under the regular price of \$26.00.) Otherwise I will return books postpaid. (Print)

Name

Address

City

Zone

State

Company

Position

RTN-8

This offer applies in U.S. only.

**When ordering by mail
please mention
RADIO & TELEVISION NEWS**

**Grips
the screw!**
Drives it too!

**Quick-Wedge
SCREW-HOLDING
SCREWDRIVER**



2" to 14" blades, 4 bit sizes
Unconditionally Guaranteed

ASK FOR IT AT YOUR DEALER
Kedman Co., 233 So. 5th W., Salt Lake City

developed by *University Loudspeakers, Inc.* of 80 S. Kensico Ave., White Plains, New York.

The Model CIB and the Model CMIL both feature a reflexed "cobra" air column for wide-angle horizontal dispersion of sound. Designed for paging and talkback with efficient "pickup and delivery" providing crisp, clear reproduction of music and speech, these speakers are designed to provide dependable operation in any sort of weather or in noisy, dusty, and wet locations.

The Model CIB is rated at 12 watts continuous duty with a response of 300 to 13,000 cps. The Model CMIL is rated at 3 watts continuous duty with a response of from 400 to 13,000 cps. A free illustrated brochure on these units is available from Department NR-1 of the company.

FAIRCHILD AMPLIFIER

Fairchild Recording Equipment Company, 154th Street and 7th Avenue, Whitestone, N.Y. has added a 25-watt power amplifier to its line of audio equipment.

The Model 255 provides full power output over the complete audio spectrum with minimum noise and distortion, good transient response and stability, according to the company. Intermodulation distortion at 25 watts is less than 2 per-cent and less than 5 per-cent at 22 watts. In addition the



amplifier contains the company's exclusive distortion-cancelling control for balancing the output stages without the use of external test equipment.

The Model 255 measures 6" wide by 9" long.

TAPE PREAMPLIFIER

Fenton Company, 15 Moore Street, New York 4, New York has recently introduced a tape preamplifier which is especially designed to provide record amplification and playback preamplification as well as a bias-erase oscillator stage for the company's "Motek Audiophile Tape Deck."

The TPR-1 consists of two separate chassis, one for the preamp proper and the other for the power supply. The two chassis are interconnected by a 7-conductor cable which permits remote installation of the power supply to reduce hum.

There is a special adjustable hum balance control. The equipment features two high-impedance inputs, one for mike and the other for the phono,

tuner, radio, or hi-fi amplifier tape output. Tubes used include the 6E5, 6X5GTA, 6AQ5, 12AT7, and 5879, the last two being shock mounted.

The preamplifier is currently available in factory-assembled and kit form. Write the company for full details.

BERLANT RECORDER

Berlant Associates, 4917 West Jefferson Boulevard, Los Angeles 16, California is now offering a new model tape recorder, the BRX-1.

The new unit may be had with two speeds, 7½ and 15 ips or 3¾ and 7½

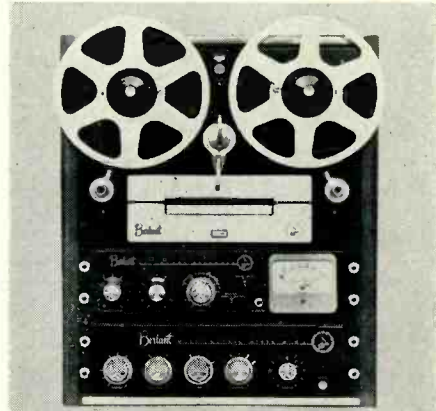

ips. The unit consists of a separate matched drive mechanism and amplifier. Three motors are employed including a hysteresis synchronous drive motor for perfect timing accuracy and two continuous heavy-duty motors for take-up and supply.

Other features include a two-channel input mixer, Cannon connectors, tape motion regulator, single-track erase and record heads, and dual-track playback head to play both single and dual-track tapes.

UNIVERSAL TEST SPEAKER

Authorized Manufacturing Company, 919 Wyckoff Avenue, Brooklyn 27, New York is now in production on the Model #401 "Unispeak" universal test speaker.

Designed as a service aid in television and radio troubleshooting, the new unit incorporates a socket which



provides speedy connection for most sets. An adapter cable is made up and plugs into the speaker and/or the set. This feature eliminates the need for pulling a speaker from the cabinet when a chassis is removed to the shop. Single-ended or push-pull output

RADIO & TELEVISION NEWS

Don't just say "capacitors"

Ask For Sprague By Catalog Number

Know what you're getting . . . get exactly what you want. Don't be vague . . . insist on Sprague. Use complete radio-TV service catalog C-610. Write Sprague Products Company, 51 Marshall Street, North Adams, Massachusetts.

SPRAGUE®

WORLD'S LARGEST CAPACITOR MANUFACTURER

Horn Type Phonos Wanted

Will pay cash or trade Hi-Fi or test equipment for old horn style phonographs made prior to 1906. Want Berliner, Victors, Columbia Graphophones, Pathe, Edison Models (Opera, Concert, Balmoral, and Idelia), and coin machines.



Old cylinder and disc phonographs with outside horns.

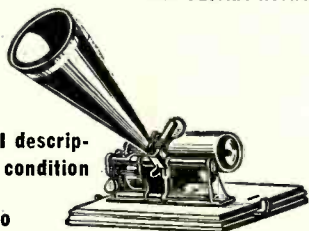

Write full description and condition

to

RADIO & TELEVISION NEWS, Box 50
366 Madison Ave., N. Y. 17, N. Y.

TELEVISION

PREPARE FOR A GOOD JOB!
BROADCAST ENGINEER
ELECTRONICS RADIO SERVICING

Television Servicing

(Approved for Veterans)
SEND FOR FREE LITERATURE
BALTIMORE TECHNICAL INSTITUTE
1425 EUTAW PLACE, BALT. 17, MD.

transformer circuits are accommodated as well as direct voice coils through the "Vari-Z" switch. The transformer is a universal type and allows impedance matching of all tubes.

The "Unispeak" is housed in a gray hammertone case, 8" x 8" x 3½" with a handle for easy portability.

TRIPLE-PURPOSE MIKE

American Microphone Company, an affiliate of Elgin National Watch Company, Pasadena, California has developed a new triple-purpose microphone for home tape recorders.

Smaller than a cigarette package, the microphone is tailored to fit comfortably in the hand. The speech opening has been designed at an angle for direct line-of-sound pickup whether the instrument is held in the hand, placed on a table, or fastened to the lapel.

The microphone is now available in beige, red, black, or grey and can be made in any color desired. The unit will be marketed to both the original equipment and replacement industries.

PERMOFLUX "STEREO-VOX"

Permoflux Corporation, 4900 W. Grand Ave., Chicago 39, Illinois has developed a new unit which provides a stereophonic effect from a monaural source.

Known as the "Stereo-Vox," the new unit is designed to be used with present records, tapes, phonographs, and AM or FM receivers. It can be used with any type of sound reproducing equipment. The equipment is designed around a balanced acoustic delay system, which provides the requisite reverberation to give the "three-dimensional" effect even if this quality is not provided on the original source material.

PHOTO CREDITS

Page	Credit
42, 112	General Electric Company
45	Gray Research & Development Co., Inc.
46, 47	Richcraft Electronic Engineering Co.
58, 59, 98	Allen B. Du Mont Laboratories, Inc.
70	Radio Corporation of America
100	DeJur-Amsco Corporation
127	Sylvania Electric Products Inc.

ERRATUM

The article "A Most Unusual Oscillator" (May 1955) contains an error in the schematic diagram on page 54. The screen grid of the 6V6 (pin 4) was incorrectly shown as floating. Many of our readers have apparently failed to connect the screen grid in the circuit. Since the tube is used as a triode, pin 4 should be connected to the plate of the tube.

Alternatively, it could be connected to the control grid rather than the plate. In some cases the two grids together oscillate easier than with the screen grid tied to the plate.

Now there are 2

Rondine Jr.

2-SPEED 12" TURNTABLES
by REK-O-KUT



Model L-34 for 45 and 33½ rpm records

And the NEW

Model L-37 for 78 and 33½ rpm records



\$49⁹⁵

Slightly higher on West Coast

SEE THEM BOTH
AT YOUR SOUND DEALER

or write for complete details to Dept. LH-12
REK-O-KUT COMPANY
38-04 Queens Blvd., Long Island City 1, N.Y.

HARVEY for SSB, AM and CW EQUIPMENT

New COLLINS 75A-4 Receiver

Designed for AM, CW and selectable SSB reception. Covers 160, 80, 40, 20, 15, 11 and 10-meter bands. Features include: double conversion —hermetically sealed VFO — mechanical filter in IF strip — separate detectors for SSB and AM — band-pass tuning — new noise limiter — bridged-T rejection notch filter — built-in crystal calibrator — provision for 3 Collins plug-in mechanical filters.

Complete with tubes (less speaker).....\$59500

Model 312A-1 Control/Speaker for above in matching cabinet..... 37.50

New COLLINS KWS-1 Transmitter

A top performing transmitter having 1kw power input on CW or single tone test SSSC operation, and 650 watts on AM with carrier and 1 sideband. Consists of Collins 32W-1 Exciter with its power supply replaced by a 367A-1 Linear RF Power Amplifier, plus a 428A-1 High Voltage Supply and 429A-1 Low Voltage Supply housed in supporting cabinet. Covers 80, 40, 20, 15, 11 and 10-meter bands. Pi-L tank circuit designed for continuous tuning over entire frequency range. RF amplifier employs 4X150A tubes operating push-pull AB₁. Other features identical to those of 32W-1.

Complete with tubes.....\$199500

CENTRAL ELECTRONICS New BROAD-BAND LINEAR RF AMPLIFIER Model 600L

Has no tuning controls except a single knob band selector from 10 thru 160 meters. Requires only 2 watts effective or 4 watts peak envelope drive power for 500 watts dc input. New band-pass couplers provide 60 to 65% linear efficiency. Uses single 813, class AB₁ and has automatic relay to protect 813 and RF couplers.

New meter reads: input power directly in watts . . . grid current . . . output in RF amperes . . . reflected power with mismatched load . . . input level for AM, PM and CW.

Has built-in power supply with regulated bias and screen voltages. Effectively TVI-suppressed. Has shielded RF compartments.

Available in either table or rack model.
Complete (factory-wired).....\$34950

CENTRAL ELECTRONICS Model 20A MULTIPHASE EXCITER

20 watts peak output on AM, PM, CW and SSB. Has single switch for sideband selection . . . VOX on AM, PM and SSB, plus break-in operation on CW . . . band-switching, 160 thru 10 meters . . . magic eye indicator for carrier null and peak modulation . . . plus many other features. Choice of table or rack model.

Wired.....249.50 Kit.....\$19950

New ELDICO VFO 10/20A

Variable frequency oscillator designed for Central Electronics SSB Exciters 10A, 10B and 20A covers 80 and 20 meter bands. Has 6-inch dial with 5 inches of bandspread on 75-meter phone band and 3 inches on 20-meter phone. Electrically stable circuit employs high-Q inductor and a precision geared tuning condenser. There are no tubes in the VFO proper to cause drift. An oscillator unit plugs into octal socket on C.E. Exciters. Single coax line connects exciter to the VFO.

Factory Wired 49.95 Complete Kit \$3995

Write for HARVEY's Free
HAM CATALOG

NOTE: Prices Net, F.O.B., N.Y.C.
Subject to change without notice.



Established 1927
Harvey
RADIO COMPANY, INC.

103 W. 43rd St., N. Y. 36. N. Y. • JU 2-1500

INDEX OF Advertisers

AUGUST
1955

[While every precaution is taken to insure accuracy, we cannot guarantee against the possibility of an occasional change or omission in the preparation of this index.]

ADVERTISER	PAGE	ADVERTISER	PAGE
Airex Radio Corp.	88	McGee Radio Company	74, 75
Allied Radio Corp.	9	McGraw-Hill Book Co.	134
American Microphone Company	86	Major Brand Tube Co.	103
American Television & Radio Co.	100	Mallory & Co., Inc., P. R.	4th Cover
Arkay Radio Kits, Inc.	109	Merit Coil & Transformer Corp.	104
Arrow Sales, Inc.	110	Milwaukee School of Engineering	133
Ashe Radio Co., Walter	20	Mosley Electronics, Inc.	97
Audel Publishers	127	Moss Electronic Distributing Co., Inc.	80, 81
		Music-Appreciation Records	11
		Musical Masterpiece Society, The	126
Baltimore Technical Institute	135		
Bell Telephone Laboratories	6	National Electronics of Cleveland	119
Blonder-Tongue Laboratories, Inc.	87	National Radio Institute	3, 7
British Industries Corp.	128	National Schools	63
		Newcomb	123
CBS-Hytron	21		
Cabinart	24	Offenbach-Rejmus	107
Candler System Co.	117	Onan & Sons, Inc., D. W.	131
Cannon Electric Company	125	Orradio Industries, Inc.	70
Capitol Radio Engineering Institute	71		
Central Electronics, Inc.	82	Palley Supply Co.	121
Channel Master Corp.	15	Peak Electronics Co.	96
Chicago Standard Transformer Corporation	101	Phaotron Company	95
Cleveland Institute of Radio Electronics	27	Philco Corporation	12, 13
Columbia Electronics	109	Photocon Sales	127
Commissioned Electronics Co.	107	Pickering and Company, Incorporated	3rd Cover
Concord Radio	126	Platt Electronics	111
Cornell-Dubilier	10	Post Electronics Company	116
Coyne Electrical School	119, 131	Precision Apparatus Company, Inc.	98
		Precision Radiation Instruments	84
DeVry Technical Institute	5	Premier TV Radio Supply	115
		Progressive "Edu-Kits," Inc.	127
Electrofacts	88		
Electronic Chemical Corp.	84	Quietrol Company	132
Electronic Instrument Co., Inc. (EICO)	28		
Electron Tube Wholesalers	120	R.C.A. Institutes, Inc.	25, 84, 97
Electro-Voice	8	RW Electronics	106
Erie Resistor Corporation	129	Radiart Corp., The	10
E-Z Way Towers, Inc.	117	Radio Corporation of America	107
		Radio Products Co.	113
Fair Radio Sales	85	Radio-Television Training Association	23
Fairchild Recording Equipment	91	Rad-Tel Tube Co.	90
Federal Telephone and Radio Company	14	Ra-Tech Labs	115
Fisher Radio Corp.	76, 77	Raytheon Manufacturing Company	2nd Cover
		Reeves Soundcraft Corp.	119
G & G Radio Supply Co.	114	Rek-O-Kut Company	135
G. L. Electronics, Inc.	124	Rinehart & Co., Inc.	118
General Cement Mfg. Co.	17	Rohn Mfg. Company	19
Goodheart, R. E.	124		
		Sams & Co., Inc., Howard W.	83, 94, 121
Harjo Sales Co.	123	Seco Manufacturing Co.	123
Harvey Radio Company, Inc.	136	Sprague Products Co.	89, 124, 133, 135
Heath Company	65, 66, 67, 68, 69	Stan-Burn Radio and Electronics Co.	88
Hughes Research & Development Laboratories	99	Stanley Electronics Corp.	125
		Stephens Manufacturing Corporation	109
Illinois Condenser Co.	18	Sun Parts Distributors, Ltd.	103
Indiana Technical College	120	Supreme Publications	111
Instructograph Company	88		
International Rectifier Corp.	16	"TAB"	138
Interstate Electronics, Inc.	101	Tech-Master Corporation	108
		Teltron Electric Company	105
J. J. Glass Electronics Co.	133	Terminal Radio Corp.	92
		Transvision, Inc.	130
Karlson Associates, Inc.	105	Triad Transformer Corp.	22
Kedman Co.	134	Tri-State College	115
Kuehne Mfg. Co.	137	Tung-Sol Electric, Inc.	102
Kuhn Electronic Products	130		
		U. S. Crystals, Inc.	112
Lafayette Radio	26	Ungar Electric Tools, Inc.	128
Lampkin Laboratories, Inc.	84	United Radio Co.	88
Lektron Specialties	122	University Loudspeakers, Inc.	129
Leotone Radio Corp.	121		
Lytron Distributing Company	117	Valparaiso Technical Institute	113
		Viking	113, 115, 117
		Wayco, Inc.	79
		Wen Products, Inc.	93
		Wheatland Tube Company	131
		Wholesale Radio Parts Co., Inc.	132
		World Radio Laboratories	113

Classified

Rate 50c per word. Minimum 10 words

RADIO ENGINEERING

COMPLETE radio, electronics theory & practice; television; broadcasting; servicing; aviation, marine, police radio. 12 or 18 months. Catalog. Valparaiso Technical Institute, Dept. N, Valparaiso, Ind.

FOR SALE

FOR Sale: Equipment for complete Community Coaxial Cable Television System. Address inquiries to P. L. Bowes, P. O. Box #84, Mount Carmel, Pa., or Telephone Mount Carmel 1540.

TAPE Recorders, Accessories. Catalog of best values. Pre-recorded tapes. Will quote on hi-fi components. Boynton Studio, 1018 Pennsylvania, Tuckaheo, N. Y.

CODE practice Oscillators, Year Warranty. \$4.00 Postpaid. Details free. Stout, 2241 E. Broadway, Muskegon, Mich.

PANORAMIC Adapter AN/APA-10 Tech. Manuals \$2.75 Postpaid in U. S. A., Electronicraft, Bronxville, N. Y.

LEARN Code 1 Minicode Practice Oscillator, Codes, Warranty \$4.00 Postpaid. Details Free. Giant Assortment Standard Radio Parts \$8.50 Value, \$3.00 Postpaid. Stout, 2241 E. Broadway, Muskegon, Mich.

QUALITY Geiger Counters at unbelievably low prices. Write for Illustrated literature. Dept. 5, Electronics Division, Roberts Manufacturing Company, Cleburne, Texas.

TV sets \$14—Tubes 25c. Jones, 1115 Rambler, Pottstown, Pa.

TV Trade-In sets. Philco, R.C.A., Emerson, others. List available. 10"—\$17. 12" to 17"—\$20 up. Washtek Service Co., Dept. R, 956 Southern Blvd., Bronx, N. Y.

UHF Wavemeter Lavoie Model 105, 300-600 Mcs., RCA WR-59A TV Sweep Generator, RCA WR-39B TV Calibrator. All like new. Arthur Inman, Box 128, Tunkhannock, Penn.

SCINTILLATION Crystals. Sodium Iodide. Thallium activated hermetically sealed, tested. 1"x1" \$75. 1 1/2"x1" \$120. 1 3/4"x2" \$250. Shelby Instrument. 1701 Magnolia, Long Beach, Calif.

FIDELITY Unlimited: Authorized Distributors of High Fidelity Components. Shipments Prepaid and Insured. Specials: New Collaro RC-54 with Mounting Board, 45 Spindle, dual Blank Heads, \$38.75. Accessories: RPX-050, dual sapphires, \$6.50. Diamond and Sapphire Stylus, \$10.75. Write Us Your Hi-Fi Requirements. Free Audio Guide. Complete Stock. Fidelity Unlimited, 63-03 39th Ave., Woodside 77, N. Y. Dept. RN.

SCINTILLATION Crystals. NE-101 Plastic Phosphors have distinct advantages over sodium iodide: Cost is low. Sensitivity is high. Not affected by moisture. Unbreakable. Easy to attach. Mrs. and individuals are adopting their use. Write for details. Western Radiation Laboratory, 1107 West 24th Street, Los Angeles 7, California.

DIAGRAMS for repairing radios \$1.00. Television \$2.00. Give make, model. Diagram Service, Box 672-RN, Hartford 1, Conn.

BUY Government Surplus radios, electronic equipment supplies. Bulletin \$1.00. Box 1842G, Hartford 1, Connecticut.

COMPLETE VHF Radio Terminals. These are designed for telephone service in the 72-76 mc. band, and are ideal for setting up a communication system along a pipeline, railroad, or in mountainous or bush country. Each terminal consists of the following: 1—Link Radio Type 1498T Transmitter; 1—Link Radio Type 1498P Power Supply; 1—Link Radio Type 1498R Receiver; 1—Budelman 200 watt Power Amplifier; 1—Type PP13 Power Supply; 1—Federal Type 101B V-F Ringer; 500 ft. —Type RG 8U Coaxial Cable; 2—Welded steel Yagi Antennas—5 element; 1—Lister Diesel-Generator set, 2KW. P. J. Plishner, 550 Fifth Avenue, New York City.

DIAGRAMS—Radio \$1.00; record changers, recorders \$1.25. Television with service data \$2.00. Where model unknown, give part numbers. Kramer's Radio Service, Dept. S53, 36 Columbus Ave., New York 23, N. Y.

PARTS, meters, gadgetry, oddities. List Free. Art Sorrell, Riverdale, Maryland.

TV-FM antennas. All types including UHF. Mounts, Accessories. Lowest prices. Wholesale Supply Co., Dept. H, Lunenburg, Mass.

TUBES and equipment bought, sold and exchanged. For action and a fair deal write B. F. Gensler, W2LNI, 512 Broadway, New York 12, N. Y.

TAPE Recorders, Tapes, Accessories. Unusual Values. Dressner, Box 66R, Peter Stuyvesant Station, N. Y. 9.

WANTED

WANTED "Radiola IV," "Radiola 16," "Radiola 25," "Radiola Grand," Kolster Decimeter and Patent SLF Condenser. Will pay cash. Write Box 547 % Radio & Television News.

AN/APR-4, AN/APR-9, other "APR," "ARR," "TS," "ARC-1, ARC-3, ART-13, everything surplus; Tubes, Manuals, Laboratory equipment. Describe, price in first letter. Engineering Associates, 434 Patterson Rd., Dayton 9, Ohio.

WANTED: SX62A, SX42, NC183D reasonable, cash. Adriance, Navy 115, Box 23, Fleet P. O., N. Y.

CYLINDER and old disc phonographs. Edison Concert, Balmoral, Conqueror, Opera, and Oratorio models. Berliner Gramophones and Zono-phones, Columbia disc and cylinder Graphophones, Bettini micro-reproducer. Want old catalogues and literature on early phonos prior to 1919. Will pay cash or trade late hi-fi components. Box 50 % Radio & Television News.

HELP WANTED

TELEVISION Jobs—Names and addresses of companies to contact. \$1.00. Fitzgerald (Chicago Division), Dept. A-14, 815 Countryside Drive, Wheaton, Illinois.

INSTRUCTORS, well-versed in Radio and Television. Send complete resume of education and experience to Educational Director, Electronics Institute, Inc., 21 Henry Street, Detroit 1, Mich.

INSTRUCTION

RADAR, Loran, Sonar. Study At Home. Prepares For Endorsement, High Paying Job In Uncrowded Field. Write For Details. Progressive Electronics Institute, P. O. Box 543, Akron 9, Ohio.

BUSINESS OPPORTUNITIES

\$200 weekly cleaning Venetian Blinds. Free Book. Burt, 2434CE, Wichita 13, Kansas.

TV. Sales And Service Established 6 Yrs. Lease. \$4000. E. Weeks, 2209 1/2 Fla. Ave., Tampa, Fla.

CORRESPONDENCE COURSES

USED Correspondence Courses. Educational Books Bought, Sold, Rented. Catalog Free. Educational Exchange, Summerville, Ga.

USED correspondence Courses and Books sold and rented. Money back guarantee. Catalog free. (Courses bought.) Lee Mountain, Pisgah, Ala.

RECORDS

PHONOGRAPH Records 20c. Catalogue. Paramount, N-313 East Market, Wilkes-Barre, Penna.

MISCELLANEOUS

ALL types TV Tuner serviced within 36 hours. For information write Dan's TV Laboratory, 2 West 183rd St., New York 53, N. Y.

MATHEMATICS Service, problems, calculations. Electronics, mathematics. Reasonable rates. Mathematics Service, Box 6671, Orlando, Florida.

TEST Equipment Repaired and Calibrated by Factory staff. All makes. Superior, Simpson, Triplett, etc. Free estimate. Our nineteenth year. Douglas Instrument Laboratory, 176 Norfolk Avenue, Boston 19, Mass.

HIGH Fidelity Speakers Repaired. Amprite Speaker Service, 70 Vessey St., New York 7, N. Y.

SPEAKER Reconciling 48-Hour Service. Mc's, 506 North Ward Street, Benton, Illinois.

A TOWER OF STRENGTH

- Safe in gales up to 80 m.p.h. without ugly, hazardous guy wires
- Free-standing to 50 feet high
- No rusting, ripping or weakened holes
- Big, safe, steel gird-around ties
- Easy installation and dismantling
- Sturdy, safe... on roof or ground
- Electro-plated with durable zinc for high lustre, permanent finish.



TELEVISION TOWERS

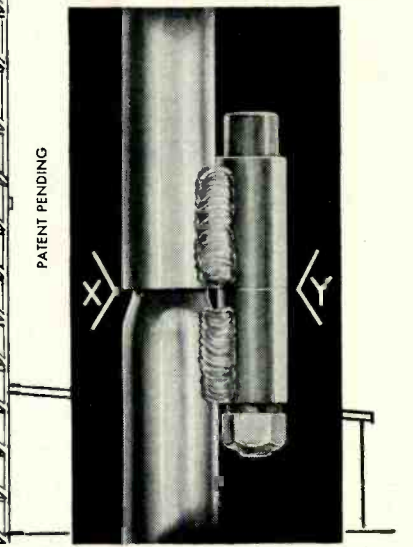

Exclusive! LATERAL LOAD-BEARING JOINTS
 No dangerous rust. Arrow "X" shows open-joint section. Moisture cannot get in tubing to cause interior rust.
 No hazardous holes. Arrow "Y" shows lateral load bearers lifetime welded to side of each section leg with twin 1 1/8" fillets. Sections are bolted vertically. Bear 100% of load! No load on joints. No horizontal bolts to tear through. Nothing stronger or safer. Only Kuehne has it!

KUEHNE MFG. CO.
 TV TOWER DIVISION
 MATTOON, ILLINOIS
 * Say "Kee Nee"
 For catalog sheets, see your "Kee Nee" Man or write direct.

When you order by mail . . .
 please print your name and address clearly, be specific in your order, enclose proper amount, allow ample time for delivery.

PICKERING models **220** / cartridges
240

*The Most Nearly
Perfect Phono Pickups
Ever Produced*

... they are sold separately for all standard arms or mounted back-to-back to make up the famous PICKERING 260 TURNOVER PICKUP.

MODEL 220—for 78 rpm records diamond or sapphire stylus



MODEL 240—for 33 1/3 and 45 rpm records diamond stylus only

MODEL 260—turnover cartridge for 78 or 33 1/3 and 45 rpm records (the 220 and 240 back-to-back)



The **220** and **240** are engineered to maximize performance. By comparison they are without equal . . .

The **220** and **240** are
Lighter—5 1/2 grams
Smaller—5/8 by 3/4 by 3/8 inches

The **220** and **240** have
Highest Output—30 millivolts/10cm/sec.
More Compliance with Less Tracking Force
Lower Overall Distortion
Less Moving Mass
Wider Frequency Response
Mu-Metal Shielding for Less Hum

These characteristics have real meaning to those who understand that maximum performance depends upon components which meet professional standards. If you want the best that high fidelity can offer, ask your dealer to demonstrate the 220, 240 and 260 Pickering cartridges . . .

The Most Nearly Perfect Phono Pickups Ever Produced

PICKERING and company incorporated • Oceanside, L. I., New York



PICKERING COMPONENTS ARE PROFESSIONAL QUALITY

“For those who can hear the difference”

... Demonstrated and sold by Leading Radio Parts Distributors everywhere. For the one nearest you and for detailed literature; write Dept. C7

P. R. MALLORY & CO. INC.
MALLORY
APPROVED PRECISION PRODUCTS

P. R. MALLORY & CO. INC.
MALLORY
APPROVED PRECISION PRODUCTS

P. R. MALLORY & CO. INC.
MALLORY
APPROVED PRECISION PRODUCTS

Extra Vibrator Performance... without Extra Cost

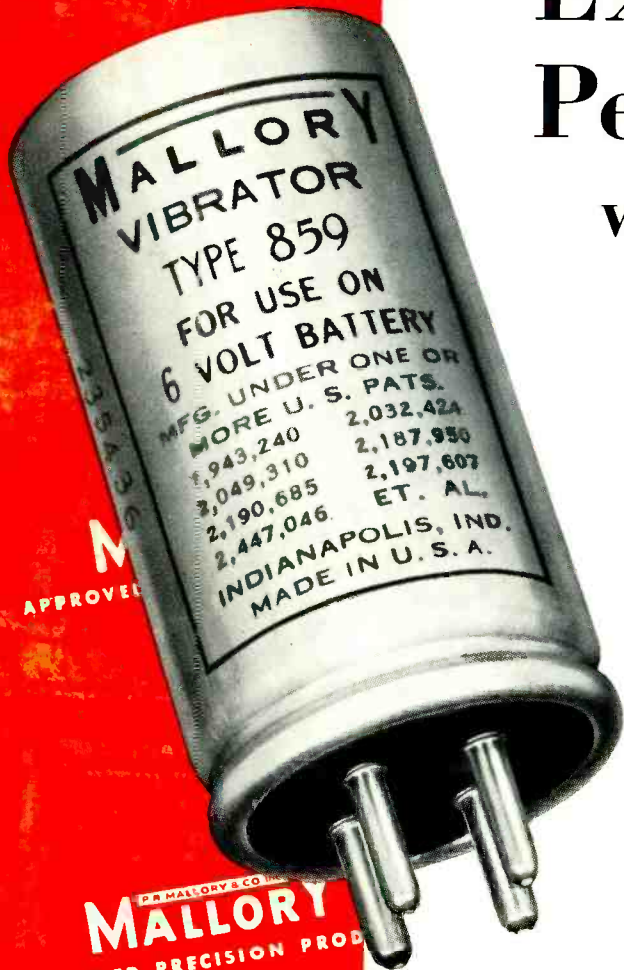

IN THE MALLORY 25th ANNIVERSARY VIBRATOR,* mechanical hum has been squelched right at its source. In any mounting position . . . prongs up, side-wise, or prongs down . . . this is the quietest vibrator ever. And it costs no more than the previous Mallory vibrators which it replaces!

TOP ELECTRICAL PERFORMANCE—for hundreds of hours. These test oscillograms show how Mallory vibrators are adjusted to excellent wave form, and continue to produce this performance for hundreds of hours. Note that even after long service, the 'scope shows complete freedom from hash, off-frequencies or variations in amplitude . . . no evidence of contact chatter or bounce.

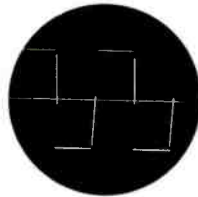

Ideal vibrator wave form

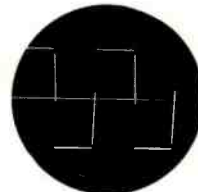

New Mallory vibrator

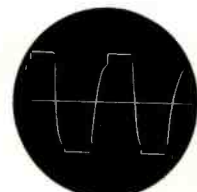

Mallory vibrator after hundreds of hours of service

In every respect, the new Mallory vibrators live up to the reputation for long, dependable service which has made Mallory vibrators the leading choice of servicemen and manufacturers.

Your Mallory distributor carries the new models, with part numbers identical with those you've been using. Call him soon . . . and order your supply of the quietest vibrators you've ever used.

*Patent Applied For

P. R. MALLORY & CO. INC.
MALLORY
APPROVED PRECISION PRODUCTS

APPROVED PRECISION PRODUCTS

APPROVED PRECISION PRODUCTS

P. R. MALLORY & CO. INC.
MALLORY
CAPACITORS • CONTROLS • VIBRATORS • SWITCHES • RESISTORS
RECTIFIERS • POWER SUPPLIES • FILTERS • MERCURY BATTERIES
APPROVED PRECISION PRODUCTS

P. R. MALLORY & CO. Inc., INDIANAPOLIS 6, INDIANA

P. R. MALLORY & CO. INC.
MALLORY
APPROVED PRECISION PRODUCTS

P. R. MALLORY & CO. INC.
MALLORY
APPROVED PRECISION PRODUCTS

P. R. MALLORY & CO. INC.
MALLORY
APPROVED PRECISION PRODUCTS