

Electronics In Modern Hospitals

Testing and Replacing Varactors, Zeners and Silicon Rectifiers

Picture Tube Repairing

MAY 1974 • 75 CENTS  A HARCOURT BRACE JOVANOVIH PUBLICATION

ELECTRONIC TECHNICIAN/DEALER

WORLD'S LARGEST TV-RADIO SERVICE & SALES CIRCULATION

11484 IM
 SV 7V6978- MV
 7V6978- MV
 AS 8753AL
 FRIM556344
 -27-6486655
 FRIM556344
 -27-6486655
 WILLIAM W. FRISSE
 1171 W. GALE RD
 ATLAS
 9771A

PTS ELECTRONICS

Precision Tuner Service

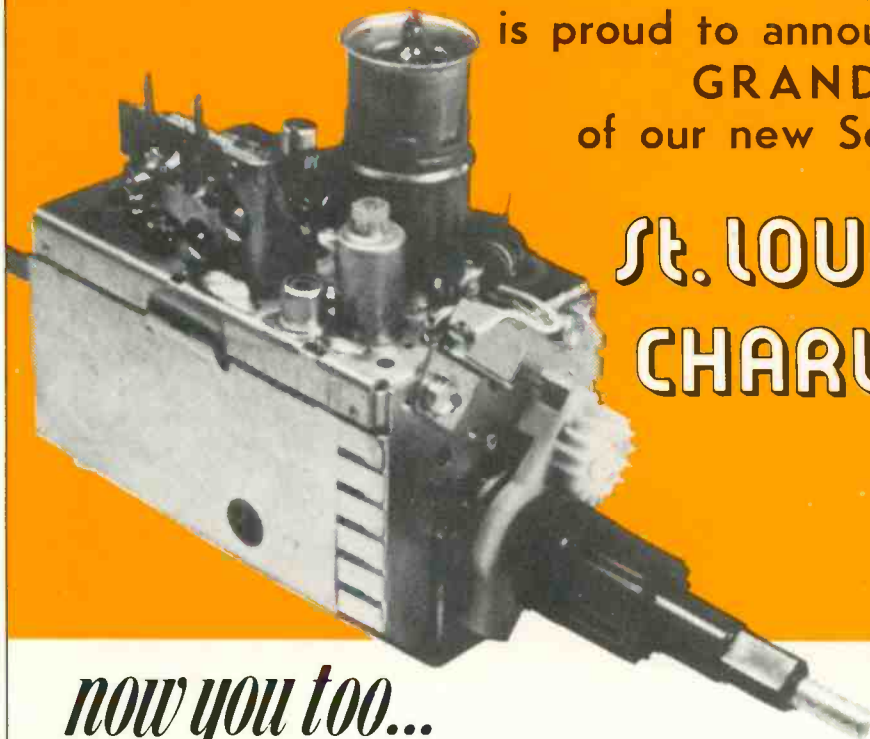

is proud to announce the
GRAND OPENING
of our new Service Centers in

St. LOUIS, MO.
CHARLOTTE, N.C.

now you too...
...get Fast 8 hr. Service!

\$9⁹⁵

1 YEAR GUARANTEE

ALL PTS BRANCHES are wholly owned subsidiaries of PTS ELECTRONICS, INC. (NO FRANCHISES!) and report directly to the Home Office in Bloomington, Indiana. Only this way can we guarantee the same quality—PRECISION TUNER SERVICE—that made PTS the leader in this field. PTS is proud to be the only tuner service to publish a **TUNER REPLACEMENT PARTS CATALOG**. (New 4th Edition; over 100 pages of tuner blow-ups. Tuner—antenna coil—and shaft replacement guides available for \$2.00.)

WE OFFER MORE.
SERVICE IS EVERYTHING WITH US.
WE ARE DYNAMIC AND FAST.
TRUSTWORTHY.

YOU AND US—A TRUE PARTNERSHIP.



PTS ELECTRONICS, INC. is recommended by more TV manufacturers and overhauls more tuners than all other tuner services combined!

Color • Black & White • Transistor
• Tubes • Varactor • Detent UHF
All Makes

VHF, UHF \$ 9.95
UV-COMBO 16.95
IF-SUBCHASSIS 12.50

Major parts and shipping
charged at cost.
(Dealer net!)

over 4000 exact tuner replacements available for \$14.95 up
(new or rebuilt)



HOME OFFICE—INDIANA:
5233 S. HWY. 37
BLOOMINGTON, IND. 47401
TEL. 812, 824-9331

CALIFORNIA—NORTH:
4611 AUBURN BLVD.
SACRAMENTO, CALIF. 95841
TEL. 916, 482-6220

CALIFORNIA—SOUTH:
5111 UNIVERSITY AVE.
SAN DIEGO, CALIF. 92105
TEL. 714, 280-7070

COLORADO:
4958 ALLISON ST.
ARVADA, COLO. 80001
TEL. 303, 423-7080

FLORIDA:
1918 BLANDING BLVD.
JACKSONVILLE, FLA. 32210
TEL. 904, 389-9952

INDIANA:
5233 S. HWY. 37
BLOOMINGTON, IND. 47401
TEL. 812, 824-9331

KANSAS:
3116 MERRIAM LNE.
KANSAS CITY, KANSAS 66100
TEL. 913, 831-1222

LOUISIANA:
2914 WYTCWOOD DR.
METAIRIE, LOUISIANA 70033
TEL. 504, 885-2349

MARYLAND:
1105 SPRING ST.
SILVER SPRING, MD. 20910
TEL. 301, 565-0025

MASSACHUSETTS:
191 CHESTNUT ST.
SPRINGFIELD, MASS. 01103
TEL. 413, 734-2737

MINNESOTA:
815 WEST LAKE ST.
MINNEAPOLIS, MINN. 55408
TEL. 612, 824-2333

MISSOURI:
8456 PAGE BLVD.
ST. LOUIS, MO. 63130
TEL. 314, 426-1299

NEW YORK:
993 SYCAMORE ST.
BUFFALO, N.Y. 14212
TEL. 716, 891-9355

N.Y. CITY—NEW JERSEY:
158 MARKET ST.
E. PATERSON, N.J. 07407
TEL. 201, 791-6380

NORTH CAROLINA:
724 SIEGLE AVE.
CHARLOTTE, N.C. 28205
TEL. 704, 332-8007

OHIO:
5682 STATE RD.
CLEVELAND, OHIO 44134
TEL. 216, 845-4480

OKLAHOMA:
3007 N. MAY
OKLAHOMA CITY, OKLA. 73106
TEL. 405, 947-1013

OREGON:
5220 N.E. SANDY BLVD.
PORTLAND, OREGON 97213
TEL. 503, 282-9636

PENNSYLVANIA—EAST:
1921 S. 70th ST.
PHILADELPHIA, PA. 19142
TEL. 215, 724-0999

PENNSYLVANIA—WEST:
257 RIVERVIEW AVE. W.
PITTSBURGH, PA. 15202
TEL. 412, 761-7648

TEXAS—NORTH:
MOPAC LANE
LONGVIEW, TEX. 75601
TEL. 214, 753-4334

TEXAS—EAST:
4324-26 TELEPHONE RD.
HOUSTON, TEX. 77032
TEL. 713, 644-6793

PTS-NUMBER ONE

AND STILL TRYING HARDER!

(NOT A FRANCHISE COMPANY)

... for more details circle 124 on Reader Service Card

Stocking these 9 ECG™ semiconductors is like having hundreds of high-voltage rectifiers on hand.

Just nine Sylvania ECG high-voltage rectifiers and triplers can replace hundreds of other types that are lurking under manufacturers' part numbers in many different TV sets.

We've also put together a brand-new cross-reference guide (ECG-212E) that makes it easy for you to find out which ECG semiconductor replaces which manufacturer's number.

And the guide isn't just limited to rectifiers and triplers. It covers over 75,000 part numbers in all, including industrial replacements.

Because so few Sylvania ECG components replace so many others, it's easy for you to have the part your customer wants.

When he wants it.

GTE SYLVANIA



Take your pick. Our entire line from the Mallory Money Tree is ripe and ready!

Now is the season to take advantage of the values available from the Mallory Money Tree. You'll find all the great Mallory products there — at prices that will whet your appetite!



Take your pick;

Capacitors, Resistors, Security Products, Controls, Switches, Batteries, Mallobins®, Easy Time Timers, Sonalert®, LED's, PTC Semiconductors, Duratape® Cassettes.

See your Mallory Distributor. Our product harvest is there.

MALLORY

MALLORY DISTRIBUTOR PRODUCTS COMPANY

a division of P. R. MALLORY & CO. INC.

Box 1284, Indianapolis, Indiana 46206; Telephone: 317-261-1501

Batteries • Capacitors • Controls • Security Products • DURATAPE® • Recorders • Resistors • Semiconductors • SONALERT® • Switches • Timers
DURATAPE®, MALLOBIN® and SONALERT® are registered trademarks of P. R. Mallory & Co. Inc.

... for more details circle 122 on Reader Service Card

ELECTRONIC TECHNICIAN/DEALER

MAY 1974 • VOLUME 96 NUMBER 5

J. W. PHIPPS

Editor
1 East First Street
Duluth, Minn. 55802
(218) 727-8511

ALFRED A. MENEGUS

Publisher
757 Third Avenue
New York, N.Y. 10017
(212) 572-4839

TOM GRENEY

Publishing Director

JOSEPH ZAUHAR

Managing Editor

DEBRA BOOTH

Production Manager

JOHN PASZAK

Graphic Design

LILLIE PEARSON

Circulation Fulfillment

GENE BAILEY

Manager, Reader Services

MANAGERS

DAVE HAGELIN

43 East Ohio Street
Chicago, Ill. 60611
(312) 467-0670

CHUCK CUMMINGS

Ad Space South/West
613 North O'Connor
Irving, Texas 75060
(214) 253-8678

KEN JORDAN

DONALD D. HOUSTON
1901 West 8th Street
Los Angeles, Calif. 90057
(213) 483-8530

CHARLES S. HARRISON

CY JOBSON
57 Post Street
San Francisco, Calif. 94104
(415) 392-6794

ROBERT UPTON

Tokyo, Japan
C.P.O., Box 1717

FEATURES

23 TEKLAB REPORT—Sylvania Color TV Chassis E06

Analysis of the features and circuitry of Sylvania's newest all-solid-state, small-screen color TV receiver, which is equipped with a new in-line picture tube and a tilt-out, nonmodular chassis. By Joseph Zauhar.

28 MODERN SERVICING TECHNIQUES—Semiconductor Diode Theory, Testing and Replacement

The characteristics of varactors, zeners and silicon rectifiers with which technicians should be familiar, plus procedures for testing them. By B. B. Dee.

33 TECH BOOK DIGEST—Picture Tube Repairs

A description of the mechanical construction and electrical operation of black-and-white and color TV picture tubes followed by an analysis of the common causes of picture tube failures and how some of these failures can be corrected by rejuvenation, installation of a brightener, opening of a short between elements or electrical "welding" of an open gun. Reprinted from *TV Bench Servicing Techniques*, by Art Margolis, TAB BOOKS, 1974.

36 ELECTRONICS IN MODERN HOSPITALS—A VARIED AND VITAL ROLE

This overview of the electronic equipment used by a modern Ohio hospital and the maintenance program and electronic technicians staff required to service it provide insight into why the electronic technician's skill has become an integral part of today's medical-care effort. By J. W. Phipps.

40 TEST INSTRUMENT REPORT—TeleMatic Tuner-Mate Substi-Tuner Model KT 730

Features, operation and typical applications of TeleMatic's battery-powered, portable, substitute TV tuner. By J. W. Phipps.

42 MANAGING TO LEARN AND LEARNING TO MANAGE

A continuing series in which problems involving business management and/or shop operations are presented for ET/D readers to resolve. Solutions to the problem presented in the January issue are analyzed this month. By Ray Sawyer.

TEKFAX—Admiral Ch. T28K8, General Electric Ch. MVA, Philco-Ford Ch. 4CY90, Sylvania Ch. E06-2, Zenith Ch. 23EC15.

DEPARTMENTS

- | | |
|----------------------------------|-------------------------|
| 9 LETTERS | 50 NEW PRODUCTS |
| 10 READER'S AID | 56 DEALER SHOWCASE |
| 15 ELECTRONIC ASSOCIATION DIGEST | 59 TECHNICAL LITERATURE |
| 16 NEWS OF THE INDUSTRY | 60 ADVERTISERS' INDEX |
| 46 COLORFAX | 61 READER SERVICE |
| 48 TECHNICAL DIGEST | |



A HARCOURT BRACE JOVANOVIICH PUBLICATION



HARCOURT BRACE JOVANOVIICH PUBLICATIONS: James Milholland, Jr., Chairman; Robert L. Edgell, President; Lars Fladmark, Senior Vice President; Richard Moeller, Treasurer; John G. Reynolds, Vice President; Thomas Greney, Vice President; Ezra Pincus, Vice President; Bruce B. Howat, Vice President; James Gherna, Vice President.

ELECTRONIC TECHNICIAN/DEALER is published monthly by Harcourt Brace Jovanovich Publications. Corporate Offices: 757 Third Avenue, New York, New York 10017. Advertising Offices: 43 East Ohio Street, Chicago, Illinois 60611 and 757 Third Avenue, New York, New York 10017. Editorial, Accounting, Ad Production and Circulation Offices: 1 East First Street Duluth, Minnesota 55802. Subscription rates: One year \$6, two years \$10, three years \$13, in the United States and Canada. Other countries: one year \$15, two years \$24, three years \$30. Single copies: 75¢ in the U.S. and Canada; all other countries \$2. Second class postage paid at Duluth, Minnesota 55806 and at additional mailing offices. Copyright © 1974 by Harcourt Brace Jovanovich, Inc. All rights reserved. No part of this publication may be reproduced or transmitted in any form or by any means, electronic or mechanical, including photocopy, recording, or any information storage and retrieval system, without permission in writing from the publisher.

POSTMASTER: Send form 3579 to ELECTRONIC TECHNICIAN/DEALER, P.O. Box 6016, Duluth, Minnesota 55806.

hand in hand

in the best electronic circles...



For years, Weller Soldering Tools and Xcelite Hand Tools ...top professional equipment in the business...have been keeping company in the best electronic circles... on the assembly line, service bench, in the field, and on leading distributors' shelves.

Now they are part of the *same company*... Weller-Xcelite Electronics Division, The Cooper Group.

It's a natural union...two leading American-made, quality lines have joined hands to offer you the principal tools you need for joining and fastening electronic components...soldering irons, guns and stations... screwdrivers, nutdrivers, pliers, wrenches, tool cases and kits...all from a single source.

Weller-Xcelite...a good name to remember when you buy, sell, or use electronic hand tools.

Weller® soldering tools Xcelite® hand tools

Visit Booths F18 & G17
NEW/COM '74



Weller-Xcelite Electronics Division
The Cooper Group APEX, N. C. 27502



... for more details circle 134 on Reader Service Card



FLAME PROOF.

Put safety first with flameproof film resistors ... new from RCA Parts and Accessories

If you have a genuine concern about safety in consumer instruments, you should be using RCA flameproof film resistors. They won't flame or short under the most severe overloads. Although designed for use as "exact replacements" in RCA instruments, they can be used as general purpose replacements in consumer instruments of any make.

We even mark them as "safety" parts in RCA service data, designated by a star, to insure their use by service technicians. RCA's flameproof film resistors have a 2% tolerance and are available in 1/2 watt,

1 watt, and 2 watt ratings in attractive blister packs. There are 61 standard resistance values, ranging from 10 ohms through one megohm, in each wattage rating. That adds up to 183 flameproof film resistors to choose from.

Right now three dealer "starter" packages, one for each wattage rating, are available from your authorized RCA Parts and Accessories distributor. Call him today and place your order.

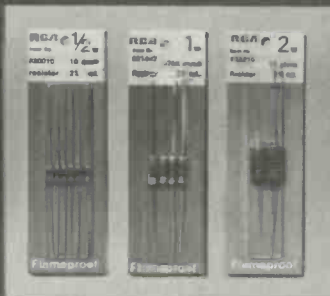

RCA

LETTERS

Consumer Operation of Substitute Tuner

It appears that there are instances of the Castle TV Tuner "Subber" being left connected to the customer's TV receiver for use as a temporary replacement while the original tuner is sent away for repair. . . . This is a questionable practice, and could prove to be a very expensive mistake.

A little investigation will reveal that any major changes in the operating controls or construction of the TV receiver from the design which received Underwriters' Laboratories (U.L.) approval may well modify such approval. It follows that some of the product hazard liability, which the TV manufacturer sought to diminish by U.L. approval, may then be transferred to the technician or service dealer responsible for the changes. Using a substitute tuner, with any wiring brought out of the receiver to connect the tuner, certainly constitutes a major change, and in many cases could be a serious hazard. For this reason, all Castle TV Tuner "Subbers" have carried a warning label discouraging such "consumer" use.

Possibly there are many service technicians who are unaware of the risks and legal responsibilities which they could face as a result of such practice, and a warning against this practice is probably appropriate and timely—particularly timely in face of today's "consumerism" and the increasing public awareness of "product hazards."

CEDRIC WESTERN

President

Castle TV Tuner Service, Inc.

The caution voiced by you is valid for substitute tuners which are not designed specifically for consumer use, and hopefully it will be heeded by technicians.

To determine whether or not your caution should apply to substitute tuners designed specifically for consumer use, I called Jack Craig, General Manager, PTS Electronics, Bloomington, Indiana. PTS markets a substitute tuner specifically for consumer use. Jack stated that the factors you mention in your letter were considered during the design of the PTS Model 3001 Port-A-Tuner, and to avoid the possibility of shock hazard, the ground connection of the IF input cable of the Model 3001 is isolated from the receiver chassis by a caprisitor, the control shafts are insulated and the power supply is isolated.—Ed. ■

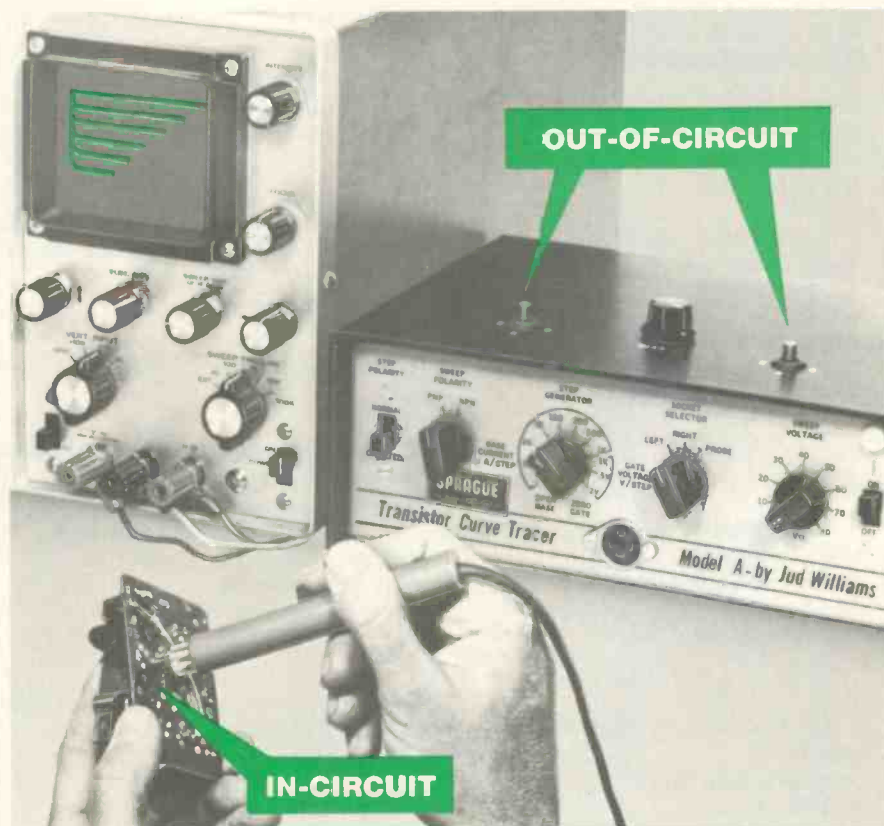

The fastest, easiest, most-reliable, least-expensive way to test transistors

Sprague's Model A Transistor Curve Tracer by Jud Williams Incorporates Dynamic Signature Pattern™ Servicing Technique

Eliminate transistor damage.

Did you ever unsolder a transistor to test it, find it defective, then wonder if it was ruined in removal? Or, if the device tested OK, how about the ticklish job of resoldering without damage to either transistor or board? The solution to such problems is in-circuit testing with the "Signature Pattern" technique.

What are Signature Patterns?

They are scope readouts of the dynamic impedance of in-circuit transistors. With this unique test method, the transistor under test is actually turned on, not merely made to oscillate, as with conventional techniques. The "Signature Pattern" method of trouble-shooting has these definite advantages: (1) Quick, decisive, "good-or-bad" tests of suspect transistors; (2) Discovery of defective components within transistor circuits even when transistors are good; (3) Elimination of damage to transistors and other components; (4) Safe testing with system power removed.

Quick, accurate tests.

By observing the family of curves, you can determine at a glance such parameters as gain, linearity, saturation, avalanche point, and leak-

age. No zeroing or balancing is necessary. The Model A also performs the all-important breakdown voltage test. It will identify a transistor type as either silicon or germanium. In addition, it will analyze an FET as either junction-type or insulated gate, as well as determine the pinch-off voltage.

Service modules profitably.

With more and more set-makers switching to modular circuitry, it becomes economically difficult for service shops to stock a variety of plug-in panels in quantity . . . not to mention excessive costs to your customers when panel replacements are made. Also, you waste valuable time processing paper work and preparing modules for shipment to the factory for repair or credit. The practical solution is to quickly and economically repair defective modules in your own shop with the "Signature Pattern" test technique.

Low-cost testing.

When the Sprague Model A Curve Tracer is connected to any general-purpose scope, you have the most complete semiconductor testing facility possible at a budget price . . . only \$149.50.

Get the Sprague Model A Transistor Curve Tracer from your Sprague distributor now. Or, ask him for Brochure M-957. If his supply of brochures is depleted, write to Sprague Products Co., 65 Marshall St., North Adams, Mass. 01247.

SPRAGUE
THE MARK OF RELIABILITY

... for more details circle 125 on Reader Service Card

MAY 1974, ELECTRONIC TECHNICIAN/DEALER | 9

READERS' AID

Space contributed to help serve the personal needs of you, our readers.

Trade

I will trade a new Eico 635 Portable Tube Tester, still in original box, for a good used CRT Tester and Rejuvenator.

CHESTER W. BARRETT
R.F.D. 3
Wapakoneta, Ohio 45895

Wanted

Sams Photofacts, Hi-Fi, and auto radio manuals.

NORMAN F. ROUND
29 Elmwood Rd.
Methuen, Mass. 01844

Used oscilloscope and dot-bar generator.

ADRIAN J. VAN HALE
650-7th Ave. So.
So. St. Paul, Minn. 55075

Good used motor for Roberts Model 1055, Tape Recorder, 1/50 HP,

1800 RPM, Hyst Sync Part No. HSM-1, 3 wire.
W. R. DAVIS
2655 West Park Dr.
Baltimore, Md. 21207

Schematic diagram and recent tube charts, or other data on an ANKO Tube Tester, Model 360 62-A.

KEVIN PARKANSKY
1300 22nd St.
Menominee, Mich. 49858

Schematic or any service information on Precision Apparatus Co. Oscilloscope, Series ES-500 and McMurdo, Model 906, Signal Generator.

HENRY J. BAZURA
345 West 86th St.
New York, N.Y. 10024

Schematic for a Commodore TV set Model PTV-12.

FREDS TV
108 W. Trident Blvd.
Neptune, N.J. 07755

Flyback transformer for a Curtis Mathes television, Part No. 1A182, chassis 14. Also, an on/off switch for

a Hoffman television, chassis 345.
JOHN C. COX
1329 Devonport Drive
Lexington, Ky. 40504

Schematic or service manual for a Precision Sweep Generator, Model E-400, Serial No. 6816.

WILLIAM TUCKER
1965 S. Ocean Dr. # 185
Hallandale, Fla. 33009

Schematic and other service data for an RCA Model C11-1 radio.

LAIRD A. SCOTT
Rt. 1, Box 71-A
Jefferson, Wis. 53549

Service instructions or schematic for a Supreme Model 385, Automatic Tube Tester.

LARRY LADUC, JR.
484 Arleta Ave.
San Jose, Calif. 95128

Schematic diagram for Zenith Radio, Model HF1180R and HF1182E.

VAL BORYSIEWICZ
23329 Alexander Rd.
North Olmsted, Ohio 44070

continued on page 12

Everything you need for complete tape recorder testing. Ferrograph RTS-2 with Auxiliary Unit

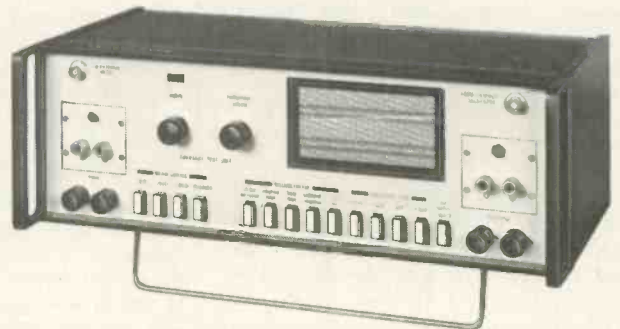
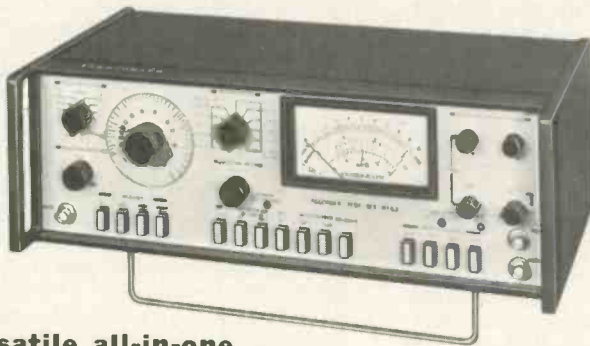

Versatile all-in-one precision test system

It's a Sine Wave generator . . . Millivoltmeter . . . Wow & Flutter bridge . . . Harmonic Distortion analyzer that you can learn to use in minutes. Requiring only two leads, setup time is minimal. Pushbutton controls provide rapid, precise operation. Compact and lightweight, it's ideal for recording and broadcast studios, testing labs and service shops.

Vastly expanded operation

By combining the RTS-2 with the ATU Auxiliary Unit, you're ready for the most sophisticated audio testing. • Monitors pre-recorded test alignment tape with

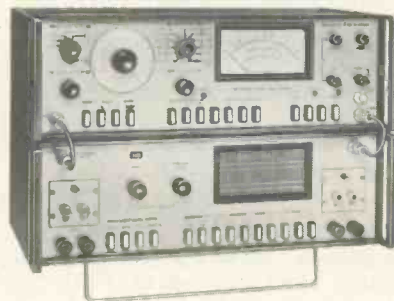

RTS-2 Test Set — \$1500
ATU Auxiliary Unit — \$600
Carrying cases optional

built-in speaker unit • Balanced and unbalanced input/output. Switches between left/right input/output channels. Provides matching impedances for 8 Ω , 200 Ω , 600 Ω impedances, or unloaded. • Compares Input/output signals • NAB weighted noise filter network for S/N measurements • Oscillator output may be set in 10dB increments over 40dB range by pushbuttons • Designed for use with virtually any test equipment.

New, Convenient Leasing Plan!

Try this unique, complete test system Free for 30 days. Write for details.

ELPA MARKETING INDUSTRIES, INC., New Hyde Park, N.Y. 11040

for more details circle 113 on Reader Service Card

Now you can get "XR" glass tubes in our economy line.

You know the EIA guidelines. Replace like with like.

That used to mean that all you could offer in "XR" glass tubes were the a-l-new, more expensive types.

Now, Sylvania has changed all that.

We've added 19 of the "XR" glass types to our Color Screen 85 economy line, and another 5 types to our medium price Color Bright 85® RE line. You can tell them by the

"V" designation in the type number. For example 23 VANP22. And of course, you've got all types in our Color Bright 85® "XR" new tube replacement line.

Three lines to offer. Three prices to offer.

That should eliminate a lot of your customer's inhibitions.

Electronic Components Group, GTE Sylvania, 100 First Avenue, Waltham, Mass. 02154.

Another first from the leader

GTE SYLVANIA

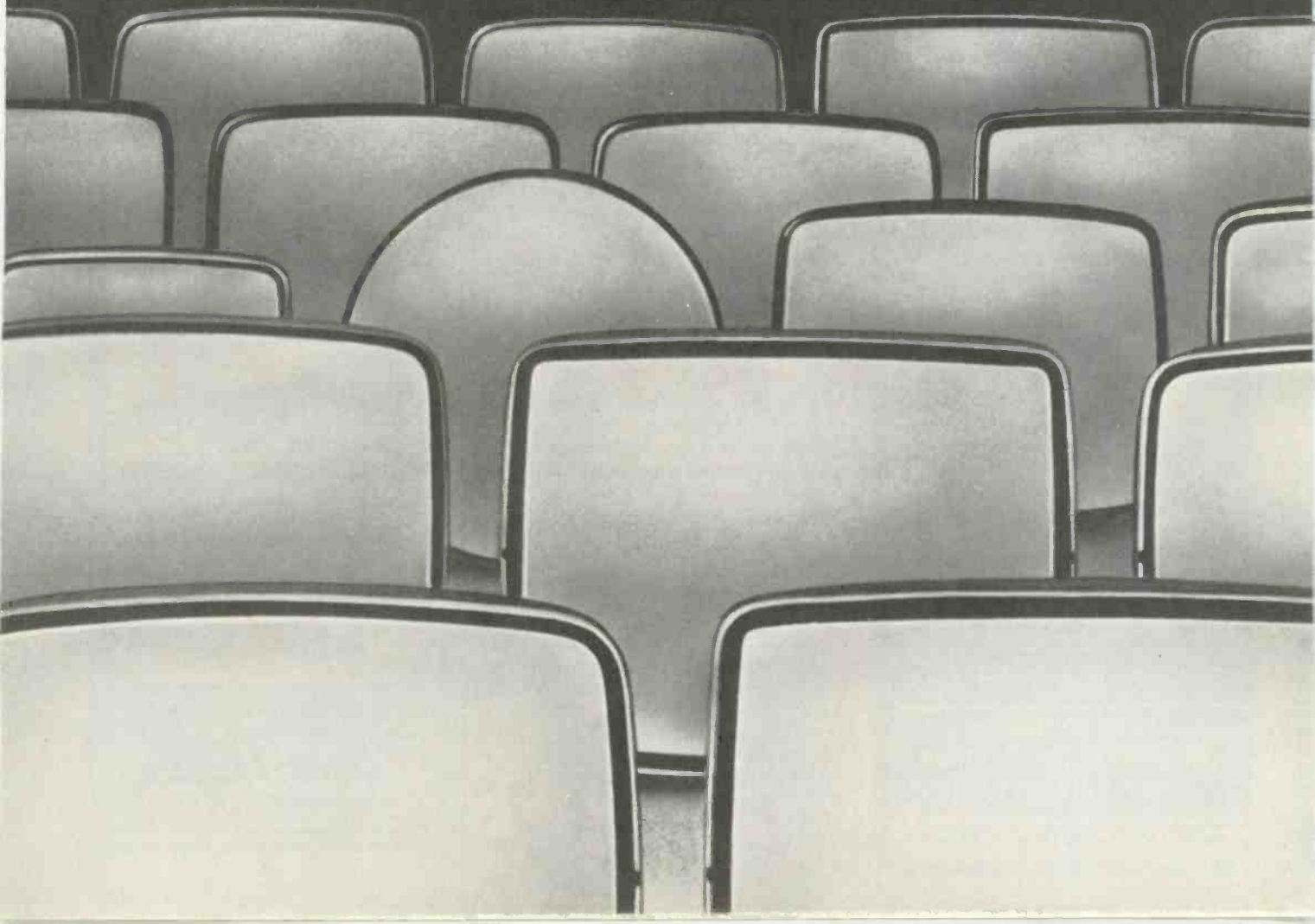

T & T VALUE SALE

IEC NEW JOBBER (BOXED) 90% OFF LIST

- | | |
|---------------------------------------------|----------------------------------------------|
| <input type="checkbox"/> 3DT6 10 for \$3.70 | <input type="checkbox"/> 25BQ6 10 for \$4.40 |
| <input type="checkbox"/> 3CB6 10 for \$3.05 | <input type="checkbox"/> 35Z5 10 for \$3.75 |
| <input type="checkbox"/> 5BC3 10 for \$3.85 | <input type="checkbox"/> 6BQ5 10 for \$4.40 |

IEC NEW JOBBER (BOXED) 80% OFF LIST

- | | |
|--------------------------------------------|--------------------------------------------|
| <input type="checkbox"/> 6GH8 5 for \$3.55 | <input type="checkbox"/> 6FQ7 5 for \$3.35 |
| <input type="checkbox"/> 6DW4 5 for \$4.20 | <input type="checkbox"/> 8FQ7 5 for \$3.35 |

ICC NEW JOBBER (BOXED) 77% OFF LIST

- | | |
|--------------------------------------------|---------------------------------------------|
| <input type="checkbox"/> 1V2 5 for \$3.11 | <input type="checkbox"/> 6BK4 5 for \$9.60 |
| <input type="checkbox"/> 2AV2 5 for \$4.08 | <input type="checkbox"/> 6GJ7 5 for \$3.91 |
| <input type="checkbox"/> 3A3 5 for \$5.23 | <input type="checkbox"/> 6HA5 5 for \$4.95 |
| <input type="checkbox"/> 3AT2 5 for \$5.06 | <input type="checkbox"/> 6JE6 5 for \$11.44 |
| <input type="checkbox"/> 3GK5 5 for \$5.00 | <input type="checkbox"/> 6JS6 5 for \$9.54 |
| <input type="checkbox"/> 3HA5 5 for \$4.95 | <input type="checkbox"/> 12GN7 5 for \$7.19 |

RCA NEW JOBBER (BOXED) 75% OFF LIST

- | | |
|---------------------------------------------|----------------------------------------------|
| <input type="checkbox"/> 6DW4 5 for \$5.25 | <input type="checkbox"/> 6JE6 5 for \$12.44 |
| <input type="checkbox"/> 6FQ7 5 for \$4.19 | <input type="checkbox"/> 6JS6 5 for \$10.35 |
| <input type="checkbox"/> 6GH8 5 for \$4.37 | <input type="checkbox"/> 6KT8 5 for \$7.63 |
| <input type="checkbox"/> 6BK4 5 for \$10.44 | <input type="checkbox"/> 31LQ6 5 for \$11.31 |

TRANSISTORS XACT. REPLACEMENT (BOXED) 80% off LIST

- | | |
|----------------------------------------------|----------------------------------------------|
| <input type="checkbox"/> SK3006 5 for \$2.35 | <input type="checkbox"/> SK3035 5 for \$9.15 |
| <input type="checkbox"/> SK3009 5 for \$3.90 | <input type="checkbox"/> SK3039 5 for \$3.30 |
| <input type="checkbox"/> SK3018 5 for \$2.25 | <input type="checkbox"/> SK3040 5 for \$3.75 |
| <input type="checkbox"/> SK3020 5 for \$2.20 | <input type="checkbox"/> SK3041 5 for \$4.20 |
| <input type="checkbox"/> SK3024 5 for \$3.15 | <input type="checkbox"/> SK3042 5 for \$6.20 |
| <input type="checkbox"/> SK3025 5 for \$4.50 | <input type="checkbox"/> SK3054 5 for \$4.50 |
| <input type="checkbox"/> SK3026 5 for \$3.00 | <input type="checkbox"/> SK3114 5 for \$2.40 |
| <input type="checkbox"/> SK3027 5 for \$5.25 | <input type="checkbox"/> SK3122 5 for \$2.20 |

GENERAL

- | | |
|---------------------------------------------------------------------------------|--------------------|
| <input type="checkbox"/> 3.58 crystal osc. | 6 for \$3.00 |
| <input type="checkbox"/> 6500 PIV ITT Focus Rect. | 10 for \$4.00 |
| <input type="checkbox"/> Zen. Voltage Tripler 212-136 ea. | \$3.95 |
| <input type="checkbox"/> Blue Lateral Magnets incl. P.R. | 2 for \$2.50 |
| <input type="checkbox"/> 2.5 amp 1000 PIV IR170 | 20 for \$3.00 |
| <input type="checkbox"/> Color Burst Boost Rect. | 7 for \$2.00 |
| <input type="checkbox"/> 66 meg res. <input type="checkbox"/> 53 meg res. | 10 for \$3.00 |
| <input type="checkbox"/> 19" & 25" Color Boosters. <input type="checkbox"/> 21" | Color Boosters |
| <input type="checkbox"/> 110" Sylvania Boosters | 2 for \$2.00 |
| <input type="checkbox"/> AC Adapter for 6, 7.5, 9 volts | @ 300 ma |
| <input type="checkbox"/> IC 500 F.E.T.-Multimeter w/Deluxe | Case-Boxed \$39.75 |

ANTENNA SUPPLIES

- | | | |
|--------------------------------------------------------------|------------------------|---------|
| <input type="checkbox"/> Finco MATV Mod. G922 300 Ohm | Input 4-300 ohm output | \$29.95 |
| <input type="checkbox"/> Finco #3020 2 Way Signal Splitter | UHF VHF | \$1.75 |
| <input type="checkbox"/> Saxton Signal Splitter UHF VHF | | \$1.50 |
| <input type="checkbox"/> JFD Signal Splitter 82 Channel SS21 | | \$1.50 |
| <input type="checkbox"/> JFD BC2 Two Set Coupler | | \$1.50 |
| <input type="checkbox"/> 72 ohm to 300 ohm matching | transformer | \$1.75 |
| <input type="checkbox"/> 2 set 72 ohm coupler | | \$2.95 |
| <input type="checkbox"/> 1000 ft. foam wire Columbia #22 | | \$19.95 |
| <input type="checkbox"/> 500 ft. Coax White 72 ohm | | \$14.95 |

AUDIO

- | | |
|----------------------------------------------------------|---------------|
| <input type="checkbox"/> Equiv. Shure N91E Needle | \$2.95 |
| <input type="checkbox"/> Equiv. Shure N77 Needle | \$2.95 |
| <input type="checkbox"/> Equiv. Shure N44 Needle | \$1.95 |
| <input type="checkbox"/> Equiv. Pickering V15 Needle | \$1.95 |
| <input type="checkbox"/> Ast Cart. #148 | 5 for \$5.00 |
| <input type="checkbox"/> Ast Cart. #142 Equiv. | 5 for \$7.50 |
| <input type="checkbox"/> Varco TN02 Equiv. | 3 for \$4.50 |
| <input type="checkbox"/> Varco TN4B Equiv. | 5 for \$7.50 |
| <input type="checkbox"/> 12-60 Min. Irish Cassette Tapes | 12 for \$4.00 |

Quantities Limited

Minimum Order \$35—F.O.B. Brooklyn
Catalogs \$1—Refundable upon your order

T & T SALES CO.

4802 AVENUE K
BROOKLYN, N. Y. 11234
Phone: (212) 241-5940

READERS AID ...

continued from page 10

Schematic for a Curtis Mathes Color TV set Model No. 55M4540, Serial No. 031502, Style 00.

GUSTAVE D. FORSYTHE
15 Furneaux Lane
Hilo, Hawaii 96720

Schematic and operating instructions for a TEK Model MPN3H22 VHF-FM Mobile Transceiver. I would also like to obtain modules 7 and 16.

WILLIAM JOHNSON
1158 Newark Lane
Hoffman Estates, Ill. 60172

For Sale

Riders Radio Manuals, back issues of Radio-Technician, P. F. Reporter, Correspondence Courses, and some test equipment. Write for details.
BLACKFORD RADIO & TV SERVICE
P.O. Box 52
Brodhead, Wisc. 53520

Sams Photofacts from No. 1 to No. 1340, with three, four drawer cabinets. Also, AR and TR and other Tech data manuals.
KERMIT A. DRESSLER
R.D. 1, Lewisberry, Pa. 17339

B & K Test equipment Telematic Test Jig, and other test equipment in like new condition. Send for list and price.

J. E. ANDREWS
3313 Killarney Rd.
El Paso, Texas 79925

Complete set of Sams Photofact No. 1 to No. 1367, with file cabinets for which we have no further use, as we now service one line only. Will take best offer.

RUSSELL G. SNOW
150 Center St.
Auburn, Me. 04210

Eico Scope, Precision Sweep Generator, Precision Tube Tester, Superior Signal Generator, Superior VTVM with probes and manuals. Also, quantity of tubes and Sams FFS.

M. JEFFREY
601 W. 115th St.
New York, N.Y. 10025

continued on page 14

SERVICE NEW 110° COLOR and 90° IN-LINE TV CHASSIS

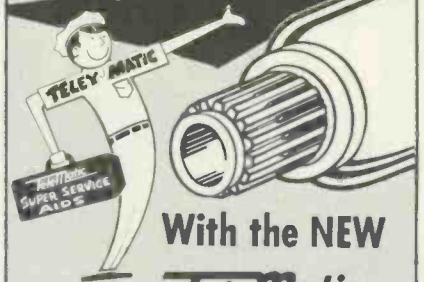

With the NEW

TeleMatic

110° COLOR ACCESSORY KIT!

PA-222
KIT
CONTAINS:

ONLY
\$25⁰⁰



CR-280
C.R.T. BRIGHTENER



CR-115
REPLACEMENT SOCKET

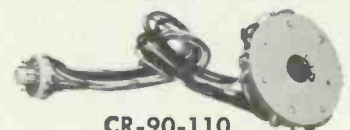

CR-90-110
TUBE TEST ADAPTOR



CR-110-90
CHASSIS SERVICE ADAPTOR



CR-110
SERVICE EXTENSION

AVAILABLE INDIVIDUALLY

FREE Reference Charts.

TeleMatic

Brooklyn, N.Y. 11207



\$9.95

ALL PARTS INCLUDED
EXCEPT TUBES & TRANSISTORS

ONE YEAR GUARANTEE

SERVICE CORPORATION

YOU WITH A
SERVICE FOR
TELEVISION
REQUIREMENTS.

REPAIR

Any Type \$9.95.
Combo \$15.00.

Since all parts are included, tubes, diodes, and nuvistors are charged at this price does not cover mutilated

Efficient service at our conveniently located service centers. Tuners ultrasonically cleaned, repaired, tested and air tested.

REPLACE

Universal Replacement Tuner \$12.95 (In Canada \$15.95)

This price buys you a complete new tuner built specifically by SARKES TARZIAN INC. for this purpose.

All shafts have a maximum length of 10½" which can be cut to 1½".

Specify heater type parallel and series 450mA or 600mA.

CUSTOMIZE

Customized tuners are available at a cost of only \$15.95; (with trade-in \$13.95) (In Canada \$17.95/\$15.95)

Send in your original tuner for comparison purposes.



HEADQUARTERS	BLOOMINGTON, INDIANA 47401	537 S. Walnut Street	Tel. 812-334-0411
ARIZONA	TUCSON, ARIZONA 85713	1528 So. 6th Street, P.O. Box 4534	Tel. 602-791-9243
CALIFORNIA	NORTH HOLLYWOOD, CALIF. 91601	10654 Magnolia Boulevard	Tel. 213-769-2720
	BURLINGAME, CALIF. 94010	1324 Marster Road	Tel. 415-347-5728
	MODESTO, CALIF. 95351	123 Phoenix Avenue	Tel. 209-521-8051
FLORIDA	TAMPA, FLORIDA 33606	1505 Cypress Street	Tel. 813-253-0324
GEORGIA	ATLANTA, GEORGIA 30310	938 Gordon Street S.W.	Tel. 404-758-2232
ILLINOIS	CHICAGO, ILLINOIS 60621	737 West 55th Street	Tel. 312-873-5556-7
	SKOKIE, ILLINOIS 60076	5110 West Brown Street	Tel. 312-675-0230
INDIANA	HAMMOND, INDIANA 46323	6833 Grand Avenue	Tel. 219-845-2676
	INDIANAPOLIS, INDIANA 46204	817 North Pennsylvania St.	Tel. 317-632-3493
KENTUCKY	LOUISVILLE, KENTUCKY 40208	2920 Taylor Boulevard	Tel. 502-634-3334
LOUISIANA	SHREVEPORT, LOUISIANA 71104	3025 Highland Ave.	Tel. 318-861-7745
MARYLAND	BALTIMORE, MD. 21215	5505 Reisterstown Rd., P.O. Box 2624	Tel. 301-358-1186
MISSOURI	ST. LOUIS, MISSOURI 63132	10530 Page Avenue	Tel. 314-429-0633
NEVADA	LAS VEGAS, NEVADA 89102	1412 Western Ave. No. 1	Tel. 702-384-8235
NEW JERSEY	JERSEY CITY, NEW JERSEY 07307	547-49 Tonelle Avenue HWY 1&9	Tel. 201-792-3730
	TRENTON, NEW JERSEY 08638	901 N. Olden Ave.	Tel. 609-393-0999
OHIO	CINCINNATI, OHIO 45216	7450 Vine Street	Tel. 513-821-5080
	CLEVELAND, OHIO 44109	4597 Pearl Road	Tel. 216-741-2314
	TOLEDO, OHIO 43624	119 North Erie Street	Tel. 419-243-6733
OREGON	PORTLAND, OREGON 97210	1732 N.W. 25th Avenue	Tel. 503-222-9059
TENNESSEE	GREENEVILLE, TENNESSEE 37743	1215 Snapps Ferry Road	Tel. 615-639-8451
	MEMPHIS, TENNESSEE 38111	3158 Barron Ave.	Tel. 901-458-2555
TEXAS	DALLAS, TEXAS 75218	11540 Garland Road	Tel. 214-327-8413
VIRGINIA	NORFOLK, VIRGINIA 23502	4538 East Princess Anne Rd.	Tel. 703-855-2518
CANADA	ST. LAURENT, MONTREAL, QUEBEC H4N-2L7	305 Decarie Blvd.	Tel. 514-748-8803

FOR INFORMATION ON FRANCHISE, CONTACT HEADQUARTERS

... for more details circle 131 on Reader Service Card

LEADER...

outduals them all!

LBO-505
5" DUAL TRACE
DUAL CHANNEL
TRIGGERED SCOPE

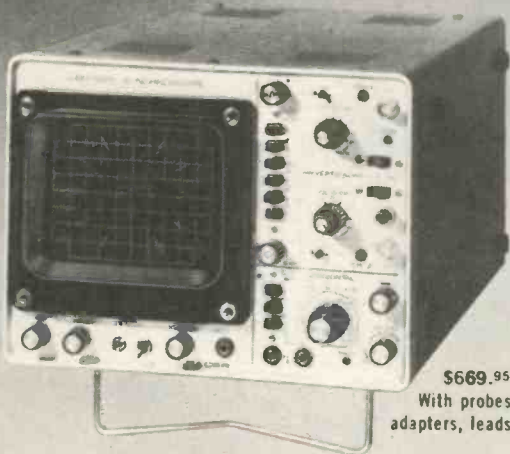

Compact, economical, solid state accuracy. For prod'n, field maintenance, quality control, lab, design & testing.

Features —

- 15MHz bandwidth
- Trig. & auto. sweep — from 100 nanosec/cm (10X mag.) to 0.5sec/cm, 17 steps calibr'd.
- AC/DC coupling per chan.
- Separate or simultaneous sweep display of ch 1 & 2 — alternating, chopped, algebraically added & vector (X-Y).
- 10mVp-p/cm vert sensitivity.
- Cont. scale illumination w/front panel control.
- 7³/₈" H x 9⁷/₈" W x 15" D, 14 lbs.

\$669.95

With probes, adapters, leads.

"Put us to the test"

LEADER
INSTRUMENTS CORP.

151 Dupont St., Plainview, L.I., N.Y. 11803 (516) 822-9300

... for more details circle 120 on Reader Service Card

REPAIRER'S AID ... continued from page 12

Business
TV service owner. It should show with low down complete details.
BRUCE KRAMER
9350 Gallardo St.
Coral Gables, Fla. 33130

Business for Sale

Modern home and attached presently housing a television and beauty shop. Please write.

ROBERT DE HAAN
Marion, Mich. 49665

Five-year-old television shop Tampa, Florida. A good location no other business within a mile. Owner is moving to Australia. Please write for details.

S. BARTON KRUGER, JR.
P.O. Box 81
Sydney, Fla.

Small electronic repair shop. For sale because of health. Please write for details. All new equipment.

LESLIE CHARLTON
21616 Norwalk Blvd.
Hawaiian Gardens, Calif. 90716

Established electronic sales and service business. Dealer franchise for RCA and Electrohome Ltd. Located in northern Ontario. Grossed approximately \$80,000.00 in 1973. Please write for details.

RICHARD LAUDE
P.O. Box 474
Wawa, Ontario, Canada ■

We help him make it easier for you.

Your GE tube distributor is always there when you need him. With a complete line of GE entertainment receiving tubes, replacement semiconductors and ULTRACOLOR® or all-new Spectra-Brite® picture tubes.

Competitively priced. With fast delivery assured by his balanced inventory and the GE tube warehouse network. Along with all the technical information, business and technical aids you'll ever need. You can depend on him and GE tube products.

Tube Products Department,
General Electric Company,
Owensboro, Kentucky 42301

We're in this business together.

GENERAL  ELECTRIC

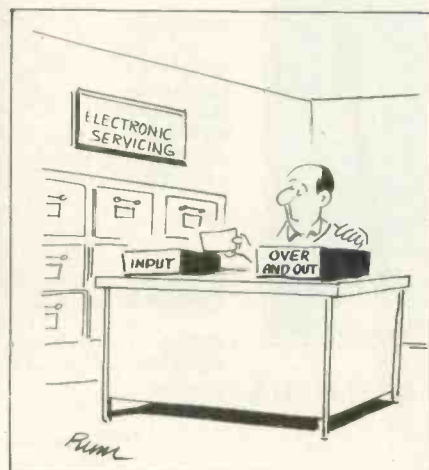
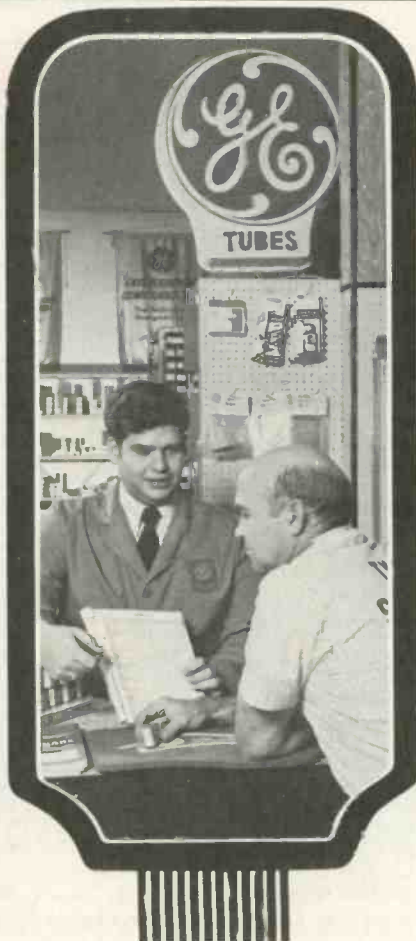

ELECTRONIC ASSOCIATION DIGEST

Information about the activities of national, state and local associations of electronic servicers, dealers and manufacturers. Material for publication in this department should be addressed to: Service Association Digest, ET/D, 1 East First St., Duluth, Minn. 55802.

New York City Electronic Technicians Organize New Association

The Consumer Electronic Technicians Association of New York recently was chartered by a state-wide association of electronic servicers, the ESFETA. Officers of the new association are: Ron Palluth, CET, president; Ken Parese, vice president; Dick Jones, secretary; Al Szajer, treasurer; and Bruce Yerka, recording secretary.

Eastern Illinois Servicers Form New Association

A group of electronic service dealers in the central Eastern area of Illinois have formed a new association, the Electronics Service Dealer Association of East Central Illinois. The new association, formed at a meeting of dealers in Urbana, Illinois, in January, elected Jerry Martin, Champaign, to the position of president. Other officers elected at the meeting are: William Wageng, Champaign, vice president; Warren Bandy, Champaign, treasurer; and William J. Young, Cissna Park, secretary.

NATESA Annual Convention

The annual convention of the National Alliance of Television and Electronic Service Associations will be held at the Chicago Sheraton Hotel, Chicago, August 16-18. Information about hotel accommodations and convention registration can be obtained by writing: NATESA, 5908 South Troy St., Chicago, Illinois 60629.

Colorado Association Adopts New Constitution, Elects New Officers

The Colorado Professional Electronics Association, in a Constitutional Convention in Loveland, Colorado, in February, adopted a new constitution which abolished their state board of directors and replaced it with a house of representatives comprised of an executive committee and representatives from each local area. The number of representatives from each local area is determined by the percentage of members in the local area in relation to the total membership of the State Association. Representatives are to be elected by the members of their local chapter.

New officers of the State Association are: Charles H. Littlejohn, CET, president; Robert Kavan, vice president; Alan Evanston, CET, recording secretary; William K. Parker, treasurer. The newly formed executive committee consists of the preceding elected officers plus the executive director, who has no vote.

Kentucky Association Successfully Discourages Consumer Association Support of Shop Licensing

The Kentucky Electronic Technicians Association (KETA) has been successful in its attempt to discourage the Consumer's Association of Kentucky from proposing and supporting a bill which, if passed by the Kentucky leg-

continued on page 45

BEFORE YOU BUY A SWITCH... CONSIDER THIS—ELECTROGRAFT GIVES YOU ...

- More than 120 switches and accessories of all types and styles
- All displayed on one fixture for easy selection
- Also available in bulk put-ups for quantity users.

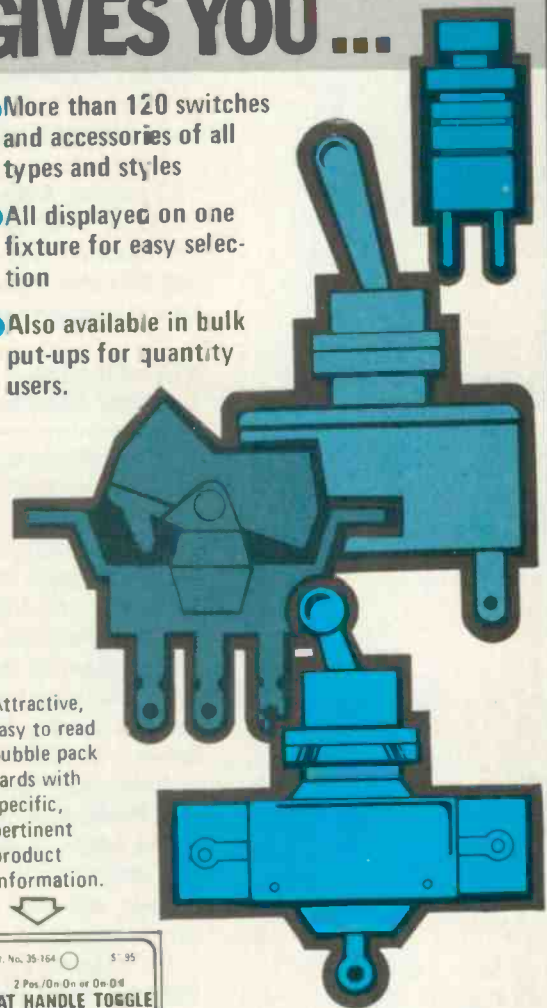

Attractive, easy to read bubble pack cards with specific, pertinent product information.

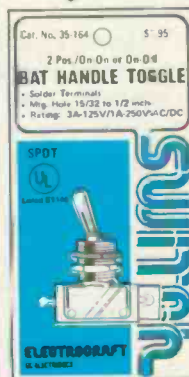

48 page catalog complete with technical specs, templates and cross reference also available



GC ELECTRONICS
DIVISION OF HYDROMETALS, INC.
ROCKFORD, ILLINOIS 61101 U.S.A.



... for more details circle 116 on Reader Service Card

MAY 1974, ELECTRONIC TECHNICIAN/DEALER | 15

NEWS OF THE INDUSTRY

1974 Summer CES—June 9-12

The eighth annual Consumer Electronics Show will be held June 9-12 at McCormick Place, Chicago. Sponsored by the Electronic Industries Association, the annual show includes exhibits of the latest consumer electronic products and a variety of industry-oriented seminars and events.

Imports of Monochrome TV and Phonographs Decreased in 1973, All Other Consumer Electronic Imports Increased

Monochrome TV imports decreased 1.3 percent and phonographs 1.2 percent in 1973 over imports in 1972, according to statistics released recently by the Electronic Industries Association's Marketing Services Department. All other consumer electronic imports increased.

Imports of color television increased 6.1 percent in 1973 over 1972. Total television imports finished the year 0.2 percent ahead of imports in 1972.

Home radio imports increased 1.9 percent in 1973 while automobile radio imports increased 52.5 percent. Audio tape imports increased 2.6 percent while the smaller video tape category increased 544.9 percent.

Transceiver imports increased 31.1 percent in 1973 over 1972. Automatic record changers and turntable imports increased 3.6 percent while the smaller manual record players and turntable imports increased 113.8 percent.

EIA's Electronic Servicing Instructors Workshop Kicks Off Summer Seminar Program

Thirty college-level electronic instructors and representatives from four of the Electronic Industries Association's Consumer Electronic Group (EIA/CEG) minority training centers have completed a 40-hour workshop at Zenith's Service Training facilities in Niles, Illinois.

The instructors, who teach EIA's Consumer Electronics Group sponsored Summer Seminars, received in-depth information about the industry's latest technical developments and teaching techniques from training specialists representing fifteen major consumer electronic companies. Donald E. Perry (GE), chairman of EIA/CEG, said they also upgraded their teaching skills with training ideas by two authors of EIA/CEG's thirteen textbooks and lab manuals.

The workshop included a panel discussion on the industry's position on repair or replacement of modules; the state of the art in picture tubes; cause and cures for IC and solid-state failures; six separate sessions on new test equipment uses by leading test equipment manufacturers; new tuner developments, and techniques of symptom diagnosis. Dr. Robert Adler, Vice President-Director of Research, Zenith Radio Corporation, provided a detailed projection on the future of flat screen television and video tape systems. A panel discussion on what the service dealer expects from the new employee featured representatives from large, medium, and small service shops. A field trip to Zenith's module fabricating plant rounded out the session.

The instructors will be teaching 23 classes in consumer electronics servicing to more than 500 high school vocational and industrial arts teachers this summer, Perry said.

The 500 high school teachers will, in turn, present the possibility of a consumer electronic servicing career to more than 25,000 young high school and vocational arts students by the end of the year.

Complete RCA 1975 Color TV Line to Be All Solid-State

RCA has announced that its 1975 color TV line, to be introduced to distributors and dealers this month, will consist entirely of all-solid-state models.

The 1975 XL-100 color TV receiver line will be 100 percent solid-state in all screen sizes, and all receivers will feature negative black matrix picture tubes and automatic fine tuning. The new color TV line will consist of only five screen sizes—15, 17, 19, 21 and 25 inch (diagonal)—and all receivers, regardless of size or price, will be covered by a one-year Purchaser Satisfaction warranty.

William C. Hittinger, RCA Executive Vice President, Consumer and Solid-State Electronics, who recently announced RCA's decision to become the first domestic manufacturer to offer a color TV line consisting entirely of solid-state models, said the changeover to exclusive production of all-solid-state receivers is scheduled to begin June 7, when the last tube-type color

TV set will be manufactured at RCA's Bloomington, Indiana, facility.

RCA also plans to discontinue the "instant-on" feature in its black-and-white and color TV receivers in response to the need for energy conservation.

Sales of RCA television, audio products, records, tapes, parts and accessories plus activities of the RCA Service Company relating to consumer products totaled \$1,149,000,000 in 1973, compared to sales of \$1,090,000,000 in 1972, according to the corporation 1973 annual report. Net profit for this grouping of RCA consumer products and services in 1973 was \$48 million, down from \$57.7 million in 1972. Part of the profit decrease reportedly was caused by losses by RCA Records as a result of rising labor and material costs. The consumer activity, according to the annual report, made a larger contribution to the corporation's sales and profits than any other group—26.8 percent of sales and 26.1 percent of net profit.

Motorola Engineers to Accompany Technicians on Home Service Calls

Color TV design engineers from the Consumer Products Division of Motorola are scheduled to accompany service technicians on home service calls several times each year as part of a new program recently announced by Richard Kraft, vice president and director of color operations for Motorola's consumer products division. The purpose of the visits by the engineers are to collect product planning and product evaluation information and to provide an additional method of two-way communication with the consumer.

St. Louis Journeymen Technicians Will Receive \$5.50 Hourly Wage Effective November 1, Master Technicians to Receive \$6.25

Under the terms of a new two-year contract recently agreed to by employers and members of the Electronic Specialists and Technicians Union of Greater St. Louis, Local No. 1, Journeymen Technicians, who now receive \$5.10 per hour, will receive a \$5.50 hourly wage, and Master Technicians, who now receive \$5.85 per hour, will receive \$6.25 per hour, effective November 1, 1974.

The new contract, which covers the period from November 1, 1973 to November 1, 1975, also provides minimum wage increases for the following technician classification: Student Employee, starting wage of \$2.00 per hour, with a 10-cent increase every 90 days until he reaches the apprentice level; Apprentice Technician, starting wage of \$2.85 per hour, with a 10-cent increase every 90 days. The Student Employee is a new classification.

Admiral, Rockwell Merger Proceeds

The board of directors of Admiral Corporation and the board of Rockwell International Corporation recently agreed to a 10 percent reduction of the share ratio through which Admiral stock will be converted to Rockwell common stock when the two firms merge. The new ratio is .5 shares of Rockwell common for each share of Admiral stock outstanding. The ratio previously announced when the two firms reached an agreement in principle for the merger last October was .56.

Ross D. Siragusa, Sr., chairman of the board of Admiral, said the revised ratio was agreed to because the "results of operations for the year ended December 30, 1973, were lower than had been anticipated at the time the initial ratio was set, and because of adverse developments in the latter part of 1973 in the markets for consumer electronics and home appliances."

Admiral stockholders are scheduled to vote on the merger in a special meeting April 9.

Regional Consumer Electronics Trade Show Scheduled for Denver

The 1st Rocky Mountain Consumer Electronics Dealer Show, reportedly the first wholesale trade show for the consumer electronics market to be presented in the Rocky Mountain region, is scheduled for August 25-27 at the Hilton Inn-Airport, Denver, Colorado.

Invitations to the show are being offered to home entertainment electronic retailers in Colorado, Wyoming, Western Nebraska, Western Kansas, Western North and South Dakota, Southeast Idaho, Eastern Montana, New Mexico and Northern Texas.

The show is being planned and promoted by Show World Productions of Denver. ■

An Extraordinary Offer

to introduce you to the benefits of Membership in

ELECTRONICS BOOK CLUB

for a limited time only you can obtain

ANY 3 OF THESE UNIQUE BOOKS ... yours for only **99¢** each
... with Trial Club Membership (Combined List Price \$40.85)

May we send you your choice of any three books on the facing page as part of an unusual offer of a Trial Membership in Electronics Book Club?

Here are quality hardbound volumes, each especially designed to help you increase your know-how, earning power, and enjoyment of electronics.

These handsome, hardbound books are indicative of the many other fine offerings made to Members... important books to read and keep... volumes with your specialized interests in mind.

Whatever your interest in electronics—radio and TV servicing, audio and hi-fi, industrial electronics, communications, engineering—you will find Electronics Book Club will help you.

With the Club providing you with top quality books, you may broaden your knowledge and skills to build your income and increase your understanding of electronics, too.

How You Profit From Club Membership

This special offer is just a sample of the help and generous savings the Club offers you. For here is a Club devoted exclusively to seeking out only those titles of direct interest to you. Membership in the Club offers you several advantages.

1. Charter Bonus: Take any three of the books shown... plus the FREE Bonus book worth \$7.95 (combined values to \$40.85) for only 99¢ each with your Trial Membership.

2. Guaranteed Savings: The Club guarantees to save you 15% to 75% on all books offered.

3. Continuing Bonus: If you continue after this trial Membership, you will earn a Dividend Certificate for every book you purchase. Three Certificates, plus payment of the nominal sum of \$1.99, will entitle you to a valuable Book Dividend which you may choose from a special list provided members.

4. Wide Selection: Members are annually offered over 50 authoritative books on all phases of electronics.

5. Bonus Books: If you continue in the Club after fulfilling your Trial Membership, you will receive a Bonus Dividend Certificate with each addi-

SPECIAL FREE BONUS

... if you act now!

Yes, if you fill in and mail the Membership Application card today, you'll also get this Bonus Book, FREE!

TV TROUBLESHOOTER'S HANDBOOK

Revised Second Edition

A completely updated quick-reference source for solutions to hundreds of tough-dog troubles.

Regular List Price \$7.95

tional Club Selection you purchase. For the small charge of only \$1.99, plus three (3) Certificates, you may select a book of your choice from a special list of quality books periodically sent to Members.

6. Prevents You From Missing New Books: The Club's FREE monthly *News* gives you advance notice of important new books... books vital to your continued advancement.

This extraordinary offer is intended to prove to you, through your own experience, that these very real advantages can be yours... that it is possible to keep up with the literature published in your areas of interest... and to save substantially while so doing.

How the Club Works

Forthcoming selections are described in the FREE monthly *Club News*. Thus, you are among the first to know about, and to own if you desire, significant new books. You choose only the main or alternate selection you want (or advise if you wish no book at all) by means of a handy form and return envelope enclosed with the *News*. As part of your Trial Membership, you need purchase as few as four books during the coming 12 months. You would probably buy at least this many anyway... without the substantial savings offered through Club Membership.

Limited Time Offer!

Here, then, is an interesting opportunity to enroll on a trial basis... to prove to yourself, in a short time, the advantages of belonging to Electronics Book Club. We urge you, if this unique offer is appealing, to act

promptly, for we've reserved only a limited number of books for new Members.

To start your Membership on these attractive terms, simply fill out and mail the postage-paid airmail card today. You will receive the three books of your choice for 10-day inspection. **SEND NO MONEY!** If you are not delighted, return them within 10 days and your Trial Membership will be cancelled without cost or obligation. Electronics Book Club, Blue Ridge Summit, Pa. 17214.

Typical Savings Offered Club Members on Recent Selections

Cassette Tape Recorders	List Price \$7.95; Club Price \$4.95
Introduction to Medical Electronics	List Price \$9.95; Club Price \$6.95
MATV Systems Handbook	List Price \$7.95; Club Price \$4.95
Pictorial Guide to Color TV Cir. Troubles	List Price \$7.95; Club Price \$4.95
10-Min. Test Tech. for PC Servicing	List Price \$7.95; Club Price \$4.95
Understanding & Using the Oscilloscope	List Price \$7.95; Club Price \$4.95
How to Repair Small Gasoline Engines	List Price \$8.95; Club Price \$4.95
Miniature Projects for Elect. Hobbyists	List Price \$6.95; Club Price \$3.95
Acoustic Techniques for Home & Studio	List Price \$7.95; Club Price \$4.95
Svcng. New Modular Color TV Recvrs. (2 Vols.)	List Price \$15.90; Club Price \$7.95
Everyman's Guide to Auto Maintenance	List Price \$7.95; Club Price \$4.95
Pictorial Guide to CB Radio Inst./Repair	List Price \$7.95; Club Price \$4.95
Zenith Color TV Service Manual—Vol. 3	List Price \$7.95; Club Price \$4.95
Mobile Radio Handbook	List Price \$7.95; Club Price \$4.95
Understanding & Using the VOM & EVM	List Price \$7.95; Club Price \$4.95
125 Typical Elect. Cir. Anal. & Repaired	List Price \$7.95; Club Price \$4.95
Jap. Radio/Rec./Tape Player Serv. Man.	List Price \$7.95; Club Price \$4.95
Marine Electronics Handbook	List Price \$7.95; Club Price \$4.95
Basic Electronic Test Procedures	List Price \$9.95; Club Price \$6.95
Troubleshooting Solid-State Amplifiers	List Price \$7.95; Club Price \$4.95
How to Repair Musical Inst. Amplifiers	List Price \$8.95; Club Price \$5.95
Kwik-Fix™ TV Service Manual	List Price \$8.95; Club Price \$5.95
How to Build Solid-State Audio Circuits	List Price \$8.95; Club Price \$5.95

SEND NO MONEY! Simply fill in and mail postage-paid Airmail card today!

How to Use Color TV Test Instruments



Here's an opportunity to close whatever gaps there are in your ability to use modern, up-to-date equipment designed specifically to save you time and money. You'll quickly grasp the author's common-sense approach to using the right instruments, thereby getting the most out of your investment in test gear. You'll improve your ability to use an oscilloscope, color bar generator, alignment generators, vectorscope, TV Analyst and sine, square-wave generators. The author also has included a description of his "curve tracer." With this simple scope attachment, you can rapidly assess the condition of diodes, transistors—even ICs—in or out of the circuit. 256 pps., over 230 illus. Hardbound. **List Price \$7.95 • Order No. 577**

Installing Hi-Fi Systems



The world of high fidelity doesn't stop with the purchase of equipment. This book explores the many aspects of in-the-home music reproduction, from acoustical considerations to structural requirements. Now in its fourth printing, this timeless and ever-popular guidebook has helped thousands to achieve studio quality sound at home. Includes details on building your own hi-fi furniture, setting up a sound room, eliminating interference and hum, how best to route wires and interconnecting cables, speakers, and speaker enclosures (with information on how to build your own), and much more. Tells all you need to know. 224 pps., 153 illus. Hardbound. **List Price \$8.95 • Order No. 86**

Radio & Television: Principles & Applications



A complete electronics library in a single volume! From raw ac and dc fundamentals to advanced hi-fi, short-wave, and TV theory, the complete spectrum of electronics is covered in depth. Prepared in Great Britain, this book amounts to a full course in electronics—and it's written in extremely readable language. It starts with a description of the manner in which current flows, progresses to wave generation, electron activity in tubes and transistors, and then into the more advanced principles of electronics, its practical applications. Includes comparative descriptions of U.S. and British standards. 400 pps., 286 illus. Hardbound. **List Price \$8.95 • Order No. 296**

Fire & Theft Security Systems



A handy guidebook on the selection, installation, and general maintenance of home and business security devices and systems. Describes many newly introduced systems from simple door and window switches to ultra-sensitive microwave sensing systems. There's also a wealth of information for those who would like to get into sales, installation, and maintenance services—how to design the most effective and economical installation for any situation. And you'll know where to find the components needed for fire and theft protection, because the equipment section includes data on a myriad of devices, with most of the principal suppliers represented. 176 pps., over 100 illus. Hardbound. **List Price \$7.95 • Order No. 556**

How to Solve Solid-State Circuit Troubles



A troubleshooter's "dreambook"—complete with 161 circuit descriptions and step-by-step troubleshooting procedures—for anyone who occasionally or regularly services solid-state entertainment equipment of any kind—TV receivers, AM-FM radios (including auto radios), tape recorders, record players, etc. Very probably the most complete work of its kind ever published, it will serve as an excellent reference and study guide for those desiring to learn more about solid-state circuits and how they work. Hobbyists and experimenters alike can use it to design and build complex solid-state circuits. 304 pps., 5 1/4 x 8 1/4, 161 illus. Hardbound. **List Price \$8.95 • Order No. 624**

Small Appliance Repair Guide



Learn to repair dozens of small household appliances with the use of this authoritative, low-cost handbook. Profusely illustrated, it tells how to find the cause of trouble in minutes, and how to go about making the required repairs. You'll also pick up helpful hints on disassembly, one of the real "tricky" aspects of many appliance repair jobs. General troubleshooting procedures are explained to familiarize you with the techniques of appliance repair. Succeeding chapters deal with thermostats, skillets, sauce pans, irons, toasters, coffee makers, blankets, mixers, knives, deep fryers, hair driers, electric shavers, and small motors found in countless appliances. 11 Chapters, 224 pps. Over 150 illus. Appendix and Index. **List Price \$7.95 • Order No. 515**

Electronic Circuit Design Handbook



New Fourth Edition—A brand-new, enlarged edition of the ever popular circuit designer's "cookbook" now containing over 600 proven circuits, for all types of functions, selected from thousands on the basis of originality and practical application. Now you can have, at your fingertips, this carefully planned reference source of tried and tested circuits. Selected on the basis of their usefulness, this detailed compilation of practical design data is the answer to the need for an organized gathering of proved circuits... both basic and advanced designs that can easily serve as stepping stones to almost any kind of circuit you might want to build. 416 pps., 19 big sections, over 600 illus. 8 1/2" x 11". **List Price \$17.95 • Order No. T-101**

Dictionary of Electronics



You'll find this huge volume extremely useful in whatever connection you have with electronics. This dictionary of electronics defines most all of the electronic terms you will run across in your everyday reading... from alpha particles through zoom lens terms you need and use most often, including those found in radio, TV, communications, radar, electronic instrumentation, broadcasting, industrial electronics, etc. It provides full, complete and easily-understandable explanations of thousands of specific electronics terms... from alpha particles, acoustic feedback, alpha particles, beat oscillator, final audio, electrostatic lens, nonlinear resistance, etc.). 420 pps., 487 illustrations. Hardbound. **List Price \$8.95 • Order No. 300**

The Fascinating World of Radio Communications



Covers the romance of short-wave listening, DXing, specialized bands such as the Coast Guard, radio amateurs, the broadcast band, foreign broadcasts, etc. It also delves into the fascinating developments of radio pioneers... Tesla, Loomis, Voita, Galvani... and shows how their discoveries worked to bring us radio as it is today. Also described are the interesting installations of the National Bureau of Standards, plus WWV services used by industries, citizens and even governments all over the world. Citizens Band? You bet... and how to get your license, what to look for in CB, and how to pick a CB receiver. 176 pps., illus. **List Price \$6.95 • Order No. 586**

Sylvania Monochrome TV Service Manual



Complete service, alignment, parts and schematic data for all Sylvania black-and-white sets introduced during the last 5 years—from the A01 through B14, and 572 through 578 chassis. Contains everything you need including techniques for setup, preliminary adjustments, tuner alignment, and repair and system alignments. Also, included are the latest factory-recommended modifications to help you eliminate "bugs." 19 complete schematic diagrams are printed on big double foldout sheets with waveform illustrations. 196 pps., 8 1/2 x 11", including 36-page schematic foldout section; and complete parts list for all chassis. Leatherette cover. **List Price \$7.95 • Order No. 599**

Practical Color TV Servicing Techniques



This brand-new updated and expanded second edition contains troubleshooting guidelines and case histories on the latest solid-state receivers, including a 4-color section with 32 trouble-symptom photos and a foldout section with 6 complete TV receiver schematics. Now included are service tips and techniques on RCA, Motorola and Zenith solid-state chassis, plus a host of case histories and current data on G.E. chassis. In fact, each of the 12 chapters is filled with information applicable to virtually any brand of color TV receiver, enabling you to solve tough-dog troubles quickly. 404 pps., 250 illus. Hardbound. **List Price \$8.95 • Order No. 436**

Amateur Radio General-Class License Study Guide



A new and unique text—the only one entirely devoted to the subject—for anyone who wants to pass the FCC General-Class exam successfully. Each question is dealt with individually, and the answers are explained in depth at a level that can be easily understood by relatively inexperienced readers. Even if you have no interest in "ham" radio, you'll find the content of this well-written text is an excellent source of information of value to anyone in electronics. Pertinent facts are grouped into palatable, easy-to-assimilate doses, and the conversational style keeps the material fresh and interesting from the first page to the last. 320 pps. Hardbound. **List Price \$8.95 • Order No. 551**

Reliable Electronic Assembly Production



Here is one of those rare books which successfully bridges the gap between design and production techniques, thereby providing guidelines for choosing the best design to achieve the least expensive and most reliable product. The content provides information on material and methods employed in mass production, giving the designer in-depth knowledge of the broad range of processes he should consider in evolving a final product concept. Not only does the content define the best materials for each given application, and detail the best choice for fabricating, but it also points out incompatibilities which may evolve between design and production. 208 pages. Hardbound. **List Price \$12.95 • Order No. 287**

Practical Electronic Servicing Techniques



Here is a new and unique handbook that will sharpen your electronics troubleshooting ability. Yes, you can learn to whip those tough dogs and prepare yourself for any electronic gear that comes your way with the "inside" information presented in this handbook. You'll be surprised how simple and logical the professional techniques really are. Begins with an analysis of what troubleshooting really is; to condition your thinking (which is part of the secret). The author begins with the analysis of troubleshooting logic; then he tells you how to think like a tough-dog expert. Also logical service approaches to DC circuits, tube circuits, and transistor circuits. 266 pps., 138 illus. Hardbound. **List Price \$7.95 • Order No. 547**

Transistor Projects for Hobbyists & Students



If building useful electronic gadgets and projects turns you on, your imagination will be triggered into conduction the moment you pick up this book. Build all sorts of devices with SCR's, LASCRs, transistors, Triacs, Diacs, Triacs, and integrated circuits. The first section offers suggestions for building or breadboarding these circuits. Sections 2 through 4 describe a wide range of devices for your car, home office, or wherever electronics can serve you. Section 5 describes Triacs and how to use them in a variety of circuits for switching and control functions. Section 6 is devoted to integrated circuits. 192 pps. Over 100 illus. Hardbound. **List Price \$7.95 • Order No. 542**

Hi-Fi for the Enthusiast



Expert practical guidance for the audiophile who wants to achieve first-class reproduction from radio, tape or records. Content is truly unique—main emphasis is on the efficient selection, assembly and use of modern commercial hi-fi units, modules and construction kits; you will be able to build a system that both suits your individual needs, and gives a high standard of reproduction at an economical price. Room acoustics, amplifiers, pickups and loudspeakers, links with visual sources such as TV, film and slides, are dealt with in detail. Technicians, too, will find this book packed with invaluable advice. A practical book, written by a hi-fi professional. 176 pps., 42 illus. Hardbound. **List Price \$6.95 • Order No. 596**

AN EXTRAORDINARY OFFER...

... for more details circle 105 on Reader Service Card

the only prime time test pattern.

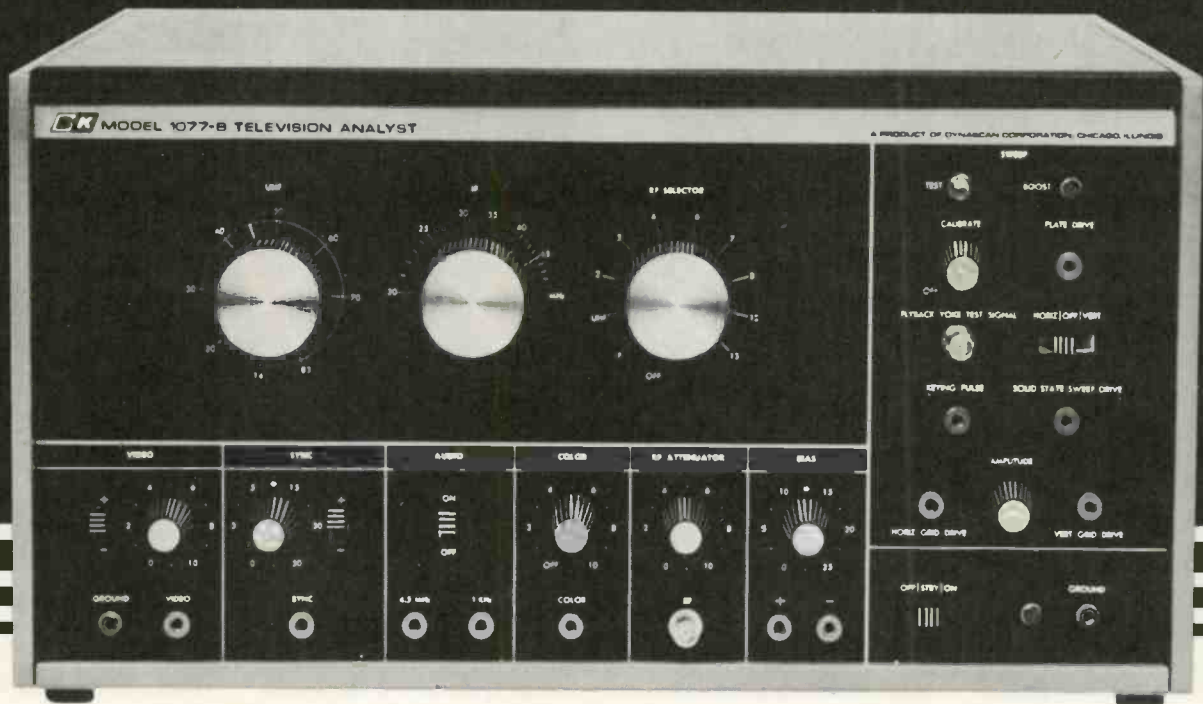

Model 1077B
\$425

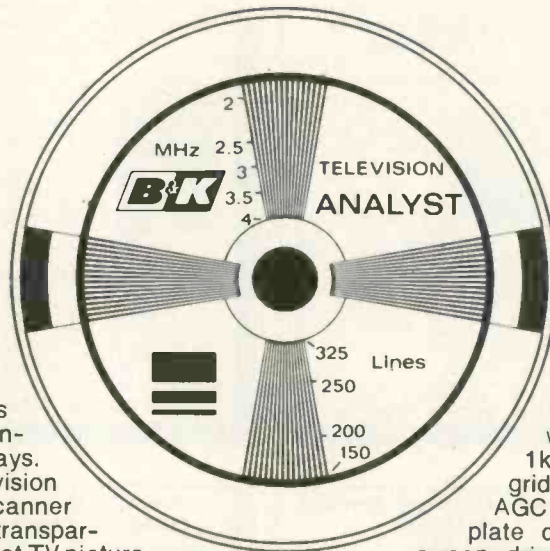

Remember the test pattern? Here's how to use that old standby to cut your troubleshooting time in half.

Broadcast test patterns are available only at very inconvenient times these days. So our Model 1077B Television Analyst has a flying-spot scanner that transforms any 3"x4" transparency into a broadcast-format TV picture. We even supply you with a test pattern slide.

A test pattern provides valuable information about picture size, linearity, focus, resolution, ringing (overshoot), low-frequency phase shift (smear) and frequency response. Unless the TV receiver isn't working, of course.

That's why the 1077B provides signal-substitution outputs to let you inject the test pattern anywhere in the chain from the flyback all the way back to the antenna terminals. You can pinpoint the problem in minutes instead of hours, check-

ing the quality of each stage as you go.

Outputs include: IF, 8 VHF channels, all UHF channels, video, sync, 4.5MHz sound subcarrier with 1kHz FM modulation, 1kHz audio, chroma, vertical grid drive, horizontal grid drive, AGC keying pulse, horizontal plate drive, horizontal solid-state sweep drive, vertical plate drive and vertical solid state sweep drive.

There's also a built-in dot/bar/crosshatch generator for color TV chroma and convergence adjustments. Plus positive or negative bias supply and B+ boost indication. All level controls are conveniently located on the front panel.

There's nothing else like it.

Ask your distributor for Model 1077B, the latest in over 20 years of television analysts—in stock now or write Dynascan.

B&K PRODUCTS OF
DYNASCAN

1801 W. Belle Plaine Ave. • Chicago, IL 60613 • Phone (312) 327-7270

Complete Line of Analog and Digital Multimeters, Oscilloscopes, Signal Generators, Semiconductor Testers, Power Supplies, Probes, Tube Testers and Substitution Boxes.

... for more details circle 103 on Reader Service Card



TEKLAB REPORT

by Joseph Zauhar

GTE Sylvania's E06 Color TV Chassis

An analysis of this manufacturer's new small-screen, all-solid-state, nonmodular, tilt-out chassis with plug-in semiconductors and a new in-line picture tube

■ U.S. sales of color television receivers to dealers in 1973 was up 10.6 percent over the sets sold in 1972, according to the Electronic Industries Association (EIA). The largest percentage of sales increase was noted in the small screen, or personal portable, category of color TV receiver.

To increase their sales in the small screen category, Sylvania has introduced a 13-in. (measured diagonally) color TV with an in-line pic-

ture tube. This new color TV receiver, Model CA4115W, uses the new E06-2 color TV chassis. Features of this new receiver are:

Simplified tuning system—The GT-Matic self-adjusting circuits make this TV set almost totally automatic, eliminating many of the former customer controls. The circuits are so automatic that most of the controls are located inside of the set or locked behind a hidden panel on the top rear of the cabinet. The VERTI-

GTE Sylvania's Model CA4115W Portable Color TV, which is equipped with the E06-2 chassis.

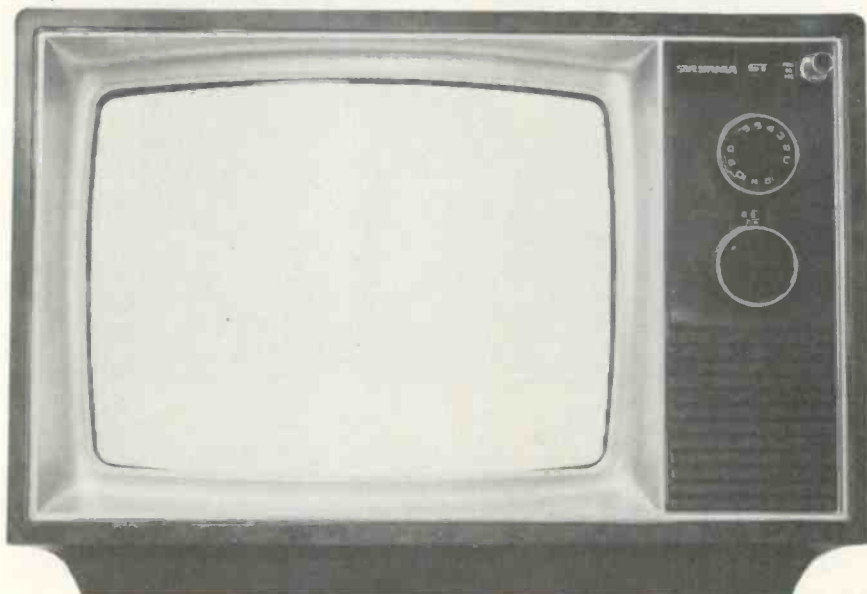

CAL HOLD control has been eliminated and the HORIZONTAL control is factory set. The only customer controls located on the front of the cabinet are the VHF and UHF SELECTOR knobs, VHF FINE TUNING, and the ON/OFF switch and VOLUME control.

Chassis serviceability features—The "U" shaped solid-state chassis is designed with many plug-in features. The transistors and integrated circuits are mounted in sockets to simplify replacement and to permit troubleshooting by using the substitution method. Most of the components are located on one main circuit board which is mounted horizontally in the receiver. This board is clearly roadmapped on both the top and bottom with component and test point numbers. After the cabinet of the TV set is removed, the underside of the circuit board is

completely exposed, for component removal if required. To make servicing of the chassis even easier, it can be tilted down by loosening two screws on the side support brackets—the front of the chassis is mounted on a hinge-type bracket. Complete removal of the chassis is simplified by plugs which connect the deflection yoke, convergence assembly, speaker and degaussing coils to the main-chassis circuitry. This chassis is equipped with eight integrated circuits, which, in turn, reduces the number of single components, providing more service flexibility.

In-line picture tube—The in-line gun system permits a less complicated dynamic convergence system, because of more precise gun alignment. Only the red and blue guns, which are on the outside, are aligned. Green, the inside gun, falls in the center and is not moved.

Tuner and Video IF System—The VHF tuner employed is quite conventional except that the three transistors used are plugged into sockets, permitting the substitution method of troubleshooting.

The UHF tuner is a detent-type, which makes channel selection as easy as VHF tuning. The UHF channel numbers appear in an illuminated window above the UHF channel selector.

The four-stage Video IF system used is fully shielded against 40-MHz interference, with adjacent picture and sound traps for rejecting upper channel picture and lower channel sound interference. This video IF shield snaps tightly into place without the need for soldering.

Some of the circuits employed in the new EO6 chassis are similar to those in the EO5 chassis. However, major changes have been made in a number of the circuits. These are analyzed in the following paragraphs. During the analysis, you can refer to the simplified schematics included or you can refer to Tekfax Schematic No. 1526 (ET/D, May, 1974), which covers the complete circuitry of this new Sylvania chassis.

Regulated Power Supply Circuit

The B+ voltage at the emitter of transistor Q502 (Figure 1) is established by the setting of control R514, which is referenced to zener diode SC514. The voltage appearing at the wiper of R514 will be the voltage at the emitter of Q502, neglecting transistor and diode junction voltage drops, because both transistor Q500 and Q502 operate as emitter followers.

The resistive network consisting of R516, R519 and R520, in the base circuit of Q500, provide the necessary isolation for injection of pincushion correction voltage and functions as a clamp circuit for low line-voltage operation.

The low line clamp circuit consists of voltage divider resistors

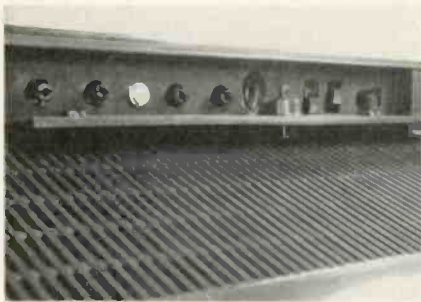

Top rear edge of the cabinet showing the GT-Matic controls, which are located behind the tilt-down door.

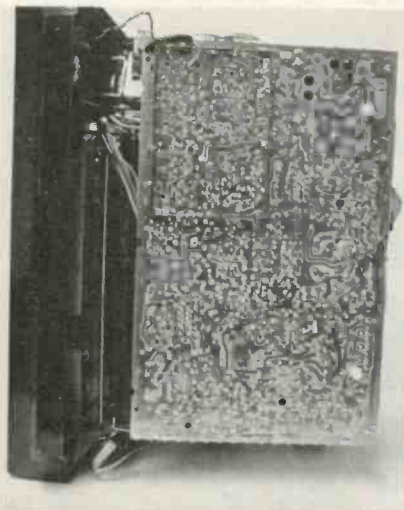

When the back cover of the TV set is removed, the complete underside of the chassis is exposed.

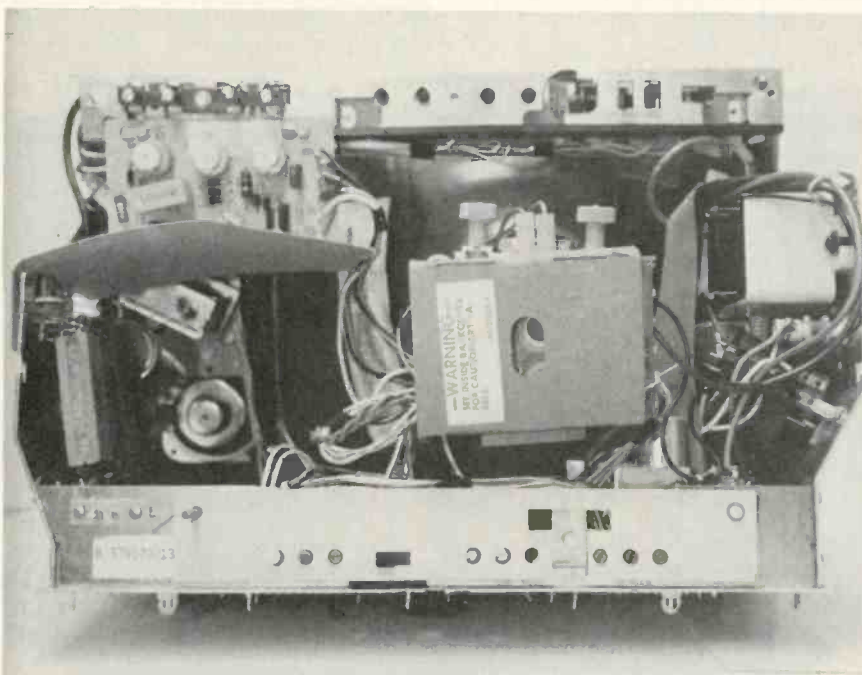

Rear view of the chassis showing the service and GT-Matic controls.

R505 and R507 which are connected to the collector of Q502. Under normal operating conditions, diode SC512 is reverse biased, and the voltage on the wiper of R514 determines the conduction of Q500 and Q502 and, therefore, the B+ voltage. When the voltage at the junction of R505 and R507 drops lower than that at the junction of R516 and R519, the diode becomes forward biased, and the base of Q500 tracks the collector voltage of Q502. The purpose of this circuit is to keep Q502 active at low line voltage.

The 170v supply voltage (Figure 2) is obtained by adding approximately 60v, which is obtained from a flyback winding, to the 107v supply. The additional 60v is produced by rectification of the flyback pulse by switching diode SC510.

The low B+ supply voltage is from the horizontal-output transformer winding, terminals 3, 8, and 10.

This winding is also used as the emitter circuit for the horizontal-output transistor, Q402 (Figure 3). When transistor Q402 is turned on, a 27v peak pulse voltage is developed across winding terminals 8 and 10. During trace, this pulse is rectified by diode SC530, producing the DC voltage for the 27v source. The filtering action of capacitors C530, C528 and the dividing action of resistors R437 and R530 produce the 24v supply voltage.

Transistor Q504 (Figure 2) functions as a current limiter to aid in the shut down of the 27v line if current overload occurs. Current in excess of 1.5a through resistor R532 turns on Q504. Conduction through its collector resistor, R437, places a positive voltage at the junction of R437 and R436. This positive voltage is applied to the gate of SCR430, triggering it on. During conduction, the SCR pulls the junction of R430, R438 to a ground potential. This action kills the drive pulses to the horizontal driver and holds the horizontal-output transistor off. Without Q402 conducting, the pulse source for the 27v supply is absent and the 27v does not develop.

Shutdown diode SCR430 is also controlled by zener diode SC434. This 120v zener conducts when the 107v source rises above 120v, causing current flow through R437,

R436 and SC434 to the high B+ voltage source. The resultant positive voltage across R437 turns on the SCR, which again, kills the drive pulse to the horizontal driver, Q400. This, in turn, cuts off Q402. With Q402 cut off, the flyback pulse in T400 is no longer present, and no high voltage is developed. The 170v source then drops to 107v. This action provides a good test for checking regulator transistors Q502, Q500 and SC514 (Figure 1). The 170v source is used for the collector voltage on the R, G and B color amplifiers—Q906, Q908 and Q910.

The 170v source uses a fast recovery diode, SC510, to rectify the pulse riding on the 107v line. This pulse is present during retrace and charges capacitor C506C to peak voltage. The loading on this supply is moderate, and the repetition rate of the pulse produces limited regulation.

The horizontal-output transistor, Q402, is centered across the primary winding of transformer T400. Instead of being single ended as a conventional output transistor, its position permits the use of a toroidal yoke, reducing the corona content in the yoke wires.

A split primary winding in transformer T400 causes the ground reference to shift in this sweep system. However, all waveforms, current and voltage, appearing at the collec-



The high-voltage system is mounted vertically on the right side of the main chassis.

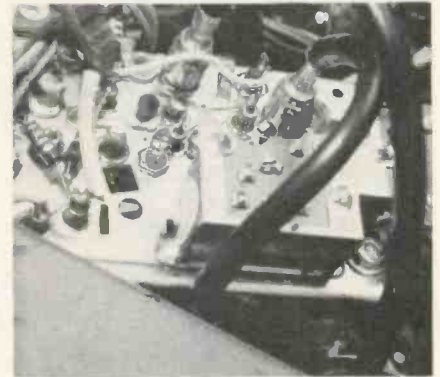

Top view of the VHF tuner showing plug-in transistors.

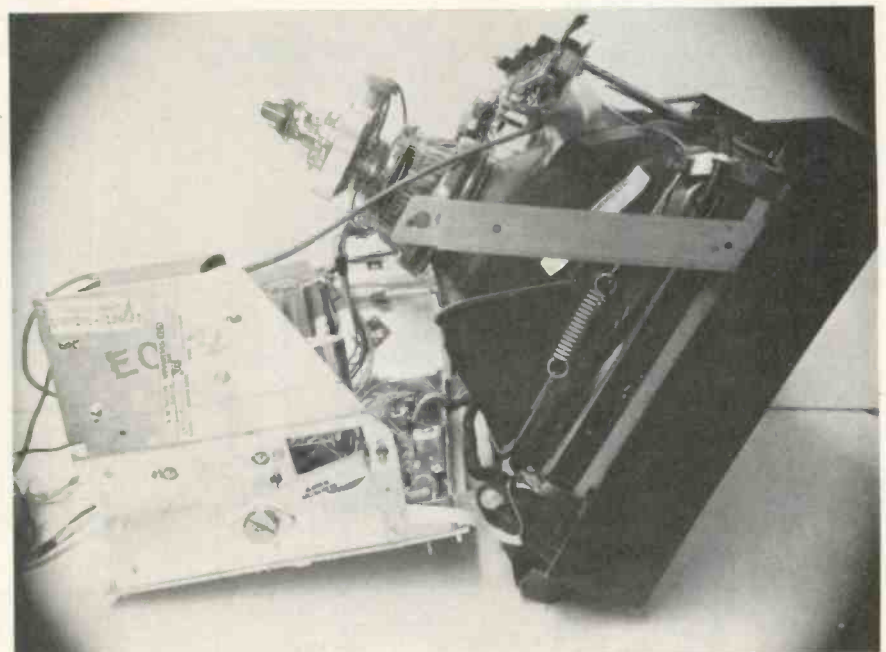

After loosening of two screws and removal of the picture tube socket, the chassis tilts down to provide easy access to components.

tor and emitter of Q402, are equal in amplitude and opposite in polarity with the positive referenced collector.

Pincushion Circuit

Normally, the regulated +107v system has very little, if any AC rip-

ple. However, the pincushion system in this chassis causes the horizontal supply voltage (+107v) to appear as hum, but the "hum" is actually the pincushion modulation voltage, which increases and decreases the sweep output to correct for pincushion error.

Side pincushion correction is accomplished by modulating the regulated 107v with a vertical parabola, which is developed by integrating the vertical waveform through R828 and capacitor C826 (Figure 1). This integrated vertical waveform is coupled to transistor Q800 and, after being amplified and inverted, it is capacitively coupled to the base of Q500, the regulator driver. The amount of pincushion correction voltage is adjusted by resistor R820.

Horizontal Scan and High-Voltage System

A pulse locked oscillator clocks the countdown integrated circuit, IC300, providing the vertical and horizontal drive pulses. The hori-

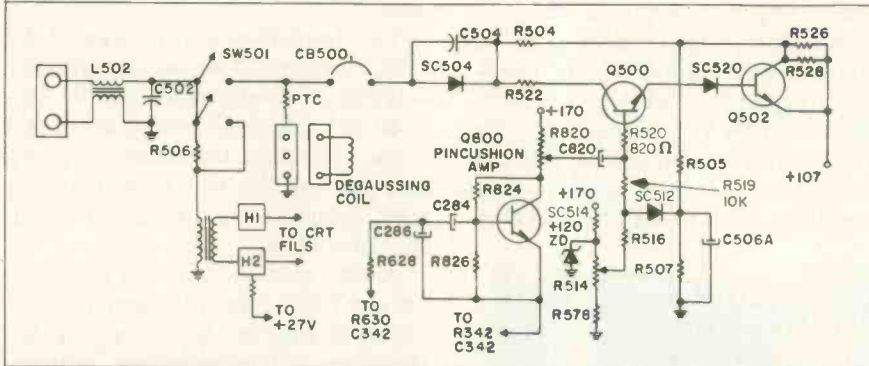

Fig. 1—Schematic diagram of the 107v regulated power supply and side pincushion correction circuits. Courtesy of GTE Sylvania.

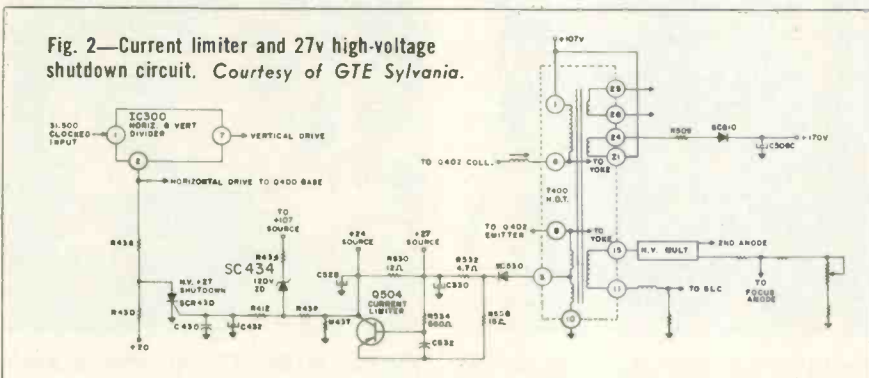

Fig. 2—Current limiter and 27v high-voltage shutdown circuit. Courtesy of GTE Sylvania.



The B+ regulator transistor heat sink, on which the conveniently grouped voltage divider resistors are also mounted.

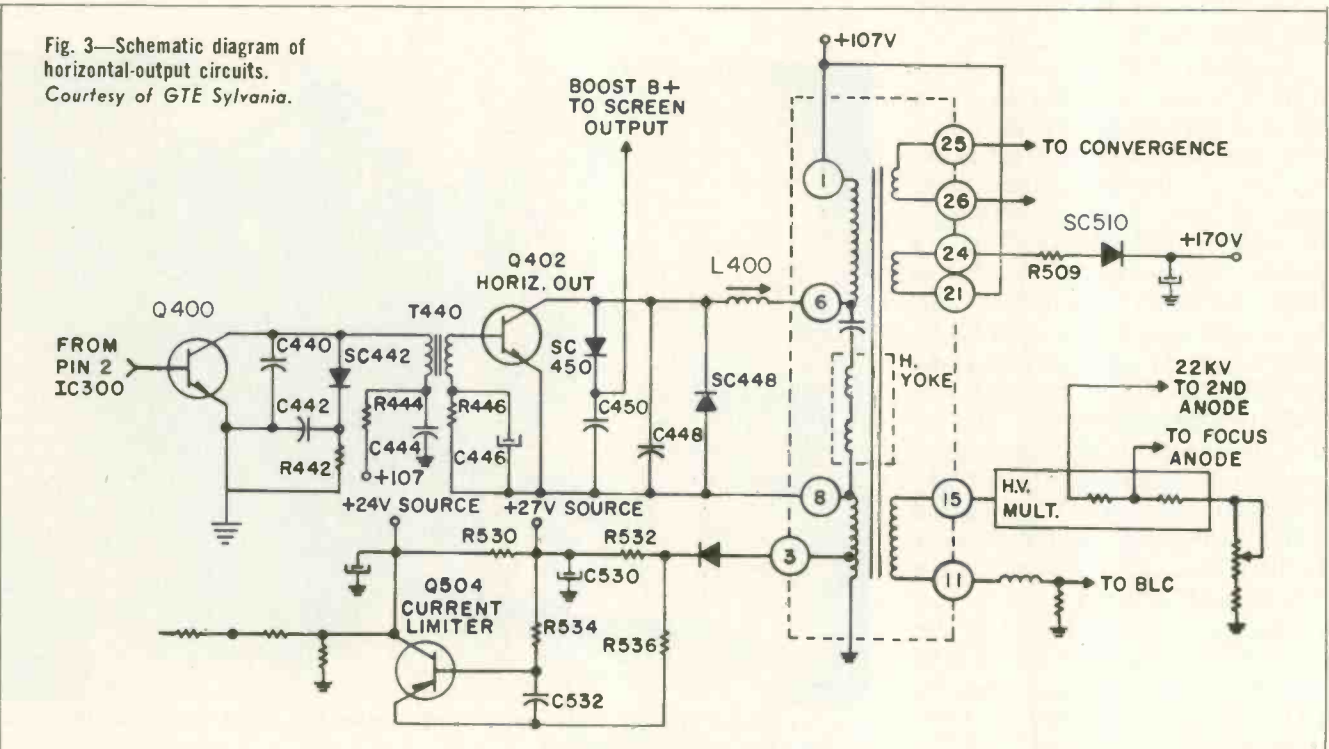

Fig. 3—Schematic diagram of horizontal-output circuits. Courtesy of GTE Sylvania.

Semiconductor Diode Theory, Testing and Replacement

by B. B. Dee

Technician-oriented facts about rectifiers, varactors and zeners

■ The service technician today is faced with a proliferation of semiconductor devices, each with its special characteristics and advantages. A two-terminal device is no longer "just a diode." It may be a four-layer switch, a tuning diode, a zener diode, a tunnel diode, or one of several other devices. But the situation is no different than that faced by technicians thirty years ago during the explosive and diverse growth of the vacuum tube from a simple triode to pentagrid converters, beam tubes, quadrature detectors, klystrons, etc. Lest you forget, semiconductors that amplify have been commercially available for about twenty-five years. It is time they became specialized and sophisticated. And, it is time that the service technician knows what they are, how they work, how to test them, and how to replace them. After all, what could be more basic in this solid-state age?

The Basis of All Semiconductor Diodes—The PN Junction

The semiconductor diode has seldom received the attention it deserves in service literature. Because it has but one junction, it is deceptively simple in appearance. Yet, most semiconductor devices in use today are based on that PN Junction. It is therefore necessary that you understand the basic principles involved. PN junction theory will be explained here, simply, without mathematics, in a form readily useful to service technicians.

To form the common PN junction, a crystalline semiconductor material is used. Two different impurities are then introduced into the material to make P or N type materials. If the impurities introduced produce an excess of free, mobile

electrons, the resultant material is labeled N type. If the impurities produce a deficiency of electrons, leaving "holes," or spaces, where electrons are missing from atomic orbits, the result is P type material. In both cases, the electrons or holes are mobile, or free to move about.

When a single piece of crystalline material has two adjacent areas "doped" with impurities, one being P material, the other N material, a PN junction is formed. Mobile holes from the P area diffuse into the N material, where there is a low concentration of holes, while free electrons from the N area diffuse into the P area, where there is a deficiency of electrons.

In the P material, there is a high concentration of holes, and so they are called "majority carriers," while electrons are "minority carriers." In N materials, the situation is the reverse, with electrons the majority carriers and holes minority carriers.

When the majority carriers

(holes) in the P material diffuse into the N material they are minority carriers in the N material, and, as a result, combine with (neutralize) the N material majority carriers. Simply stated, the excess holes are filled with the excess electrons from the opposite polarity material. This process is called *recombination*, and takes a certain small interval of time to complete. This recombination time has important effects in semiconductors, and will be discussed later.

Not all of the carriers recombine, however. Those close to the PN junction combine; those further away can not diffuse, and, hence, do not combine. See Figure 1. Notice that in the immediate area of the junction there are no mobile carriers left, because of recombination. This is called the *depletion region* (sometimes called "space charge region"), and forms the junction barrier. This junction therefore has no current flow through it until a forward bias is applied. When a reverse bias is applied with the polarity shown in Figure 2, any remaining uncombined carriers will be attracted away from the junction area towards the external electromotive force (voltage), widening the depletion barrier region. Because this insulating barrier effectively prevents current flow, the diode is nonconductive when reverse bias is applied.

Varactor Theory

You already know that two con-

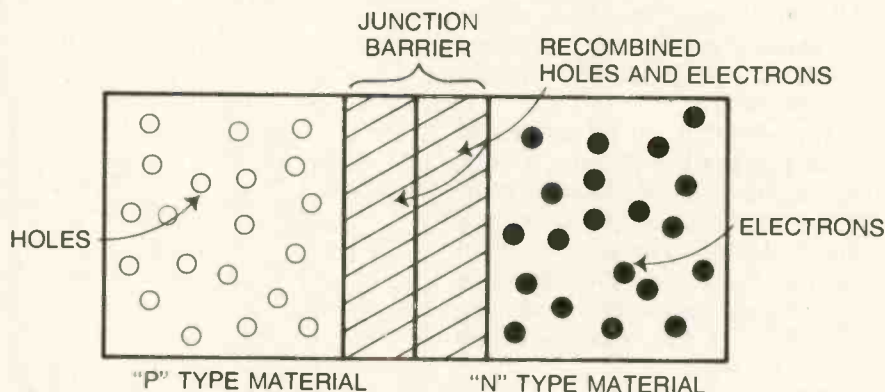

Fig. 1—Graphic representation of PN junction showing condition with no external voltage applied across it. P type material has deficiency of electrons, creating "holes" in atomic structure; these serve as majority carriers. N type material has an excess of electrons. The excess, or "free," electrons serve as majority carriers in N Type material. Recombination of holes and electrons in the immediate vicinity of the area where the two types of material join produces a "barrier," which opposes further recombination of holes and electrons until an external voltage of the correct polarity is applied across the PN junction.

ductors separated by an insulator form a capacitor, and that the capacitance varies if the thickness of the insulation varies. It is obvious that a reverse-biased PN junction forms a capacitor, and that the capacitance can be varied by varying the amplitude of the reverse bias. Maximum capacitance occurs at very low values of reverse bias, but, unfortunately, the "Q" (quality factor) also varies, and is at its lowest at maximum capacitance. As reverse bias increases, the junction widens, capacitance decreases and Q increases, up to the point where the reverse-voltage design limit of the

junction is approached.

Such a PN junction produces a voltage-variable capacitor, which is called a *varactor*.

The PN junction can be fabricated to produce different capacitance values, but there are practical limits on the ratio of minimum to maximum capacitance that can be achieved in a particular varactor. A typical curve of capacitance versus applied voltage is shown in Figure 3. It is important to note that the curve is not linear, but instead, nearly logarithmic. Because such curves vary among varactor types, it is not practical to substitute one varactor

for another, particularly when tracking or calibration is important. Whenever possible, an *exact* replacement should be made. Because, like all semiconductors, varactors are temperature sensitive, location is important when replacing them.

Varactor Tests

How can you tell if a varactor is defective? Because the capacitance of a varactor is varied by an applied bias, you first check the bias with a high-impedance VTVM or FETVOM, rotating the control which changes the bias while monitoring the bias voltage. (Note: In a high-frequency circuit, the varactor bias is applied through a filter such as a choke or high-value resistor. To prevent affecting the tuned circuits involved, the bias should be measured on the *source* side of the filter. A quick check should be made to assure that the filter is neither open nor shorted.) Normal voltage is a reverse bias of a few volts.

If the voltage seems normal, a small trimmer capacitor of suitable range can be substituted for the varactor and adjusted with an insulated tool. This should produce normal operation of the set if the varactor is defective. Ohmmeter tests will reveal an open or shorted varactor, as they will with any other diode, but they will not test the capacitive characteristics of the device.

Solid-state sets now under design and test are equipped with matched sets of varactors for RF, mixer and oscillator stages.

As with any diode, exceeding the reverse voltage limit of a varactor causes a reverse current flow which can damage or destroy the device.

Zener Diode Theory

Reverse current through a reverse-biased PN junction remains very low as the voltage is increased, until *breakdown level* is reached, after which a further small increase in voltage produces a very rapid increase in current. A principal cause of this effect is the fact that the higher voltage increases the speed of movement of some of the carriers. When the speed is high enough, those fast carriers that collide with other atoms in the crystal structure are able to knock loose other car-

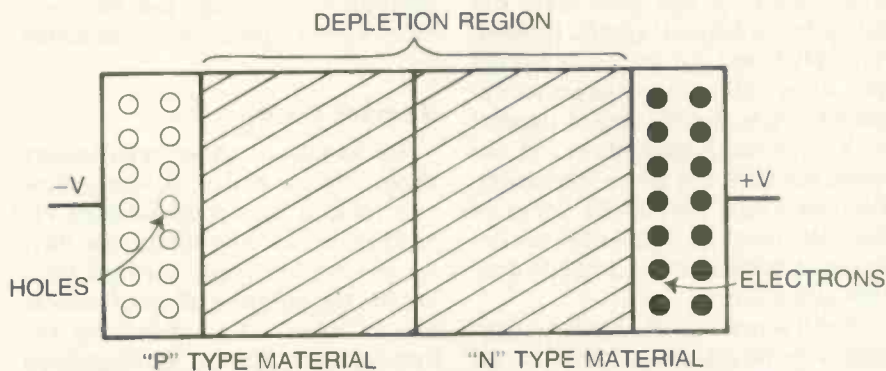

Fig. 2—Graphic representation of PN junction showing the condition which exists when a reverse bias is applied across the junction. Holes in P type material are attracted toward negative external voltage, and electrons in N type material are attracted toward positive external voltage. This action broadens the depletion region, preventing the flow of majority current carriers through the junction, and, consequently, only a small, "reverse" current flows in the external circuit.

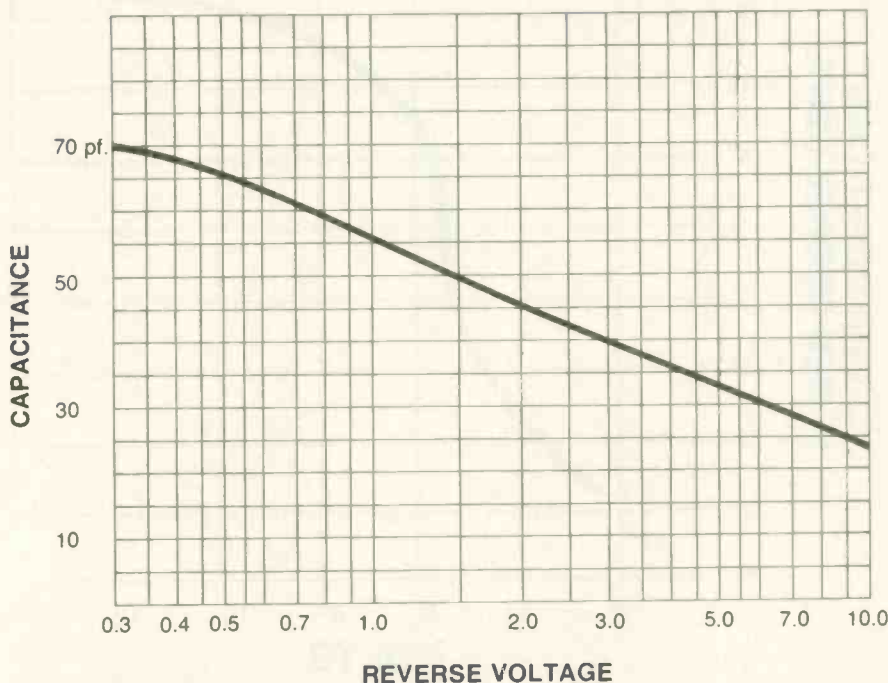

Fig. 3—Graph which illustrates how the capacitance of a typical varactor diode is changed by varying the amount of reverse bias applied to it.

riers, which in turn hit other atoms, freeing still more carriers. These mobile carriers produce a rapidly increasing reverse current condition called *avalanche breakdown*, which is the principle on which zener diodes operate.

Because the reverse current increases extremely rapidly with increasing voltage, a zener diode will destroy itself unless sufficient series resistance is used to limit the current to a specific rated maximum. Zener voltage is fixed at a specific value by impurity concentration, processing and selection during manufacture. Again, being a PN junction, zeners are temperature sensitive. And this is a good point at which to discuss junction *temperature coefficients*.

Both germanium and silicon forward-biased diodes have *negative* temperature coefficients, which cause the forward voltage drop to *increase* between one and two millivolts for each centigrade degree that the temperature *decreases*. (This level of increase is too small to measure with service-type instruments, but will be quite important when we cover transistors in a later issue.) The temperature coefficients of reverse-biased zener diodes vary, depending on the zener voltage, as shown in Figure 4. At low voltage, the coefficient approaches -0.1 percent per degree centigrade, goes through zero at about five volts, and approaches $+0.1$ per degree at higher voltages. Thus, a 24-volt zener would change nearly 6 percent, or about 1.5 volts, from a cold start at a room temperature of 25 degree centigrade to a normal junction operating temperature of about 85 degrees. This kind of change is not an indication of a defective zener. Voltage below rated value is not necessarily an indication of a defective zener either, because the zener is a shunt type of regulator and can only *decrease* the applied voltage by drawing current; it cannot increase an abnormally low supply voltage. If the applied voltage is low, the zener simply stops conducting, and the voltage is no longer regulated.

Zener Diode Tests and Replacement Selection

Open or shorted zeners may be easily spotted with an ohmmeter, but

degraded zeners cannot be verified in this manner. Two simple tests in the set will reveal degraded zeners: First, check the zener operating voltage. If it is within limits, vary the power supply voltage with a variac or by some other means and observe the shift in voltage across the zener. If it is very small, the zener is regulating. (Opening one of the loads on the zener regulated line will achieve the same purpose by varying the load.)

Defective zeners often produce broad-band "white noise," which is amplified by audio, video, chroma, sync, and even IF amplifiers, and which can appear in the most unlikely places. If you have never run into a noisy zener, it can be baffling. The quick test for this is to bypass the zener with a noninductive capacitor, or a .01-mfd disc in parallel with a 10-mfd electrolytic. If the noise vanishes, the zener is probably the cause and should be replaced because there is a correlation between unusually noisy semiconductors and failures.

Small zeners can be replaced with two or more zeners connected in series to obtain the correct voltage rating. Larger zeners pose a problem

because of the necessity of heatsinks.

Some zener-like devices are really "references" which consist of both negative and positive temperature coefficient diodes in one package. They are not intended for use as regulators, but rather are designed to run at a constant current and deliver a constant voltage output for reference voltage purposes. They can be tested only by observing the output voltage as the temperature is changed. Because of the very small changes in the operating current, laboratory type instruments are required to detect the few millivolts of change that occur. They are encountered only in test and measuring equipment, etc., and are best serviced by the equipment manufacturer.

Rectifier Theory

Up to now we have been talking about reverse-biased devices. Now let's look at the forward-biased PN junction of a conventional rectifier. As you might expect, forward biasing has the opposite effect of reverse bias. Carriers are repelled by the forward bias source, forcing them across the depletion barrier region. When they cross, more carriers are

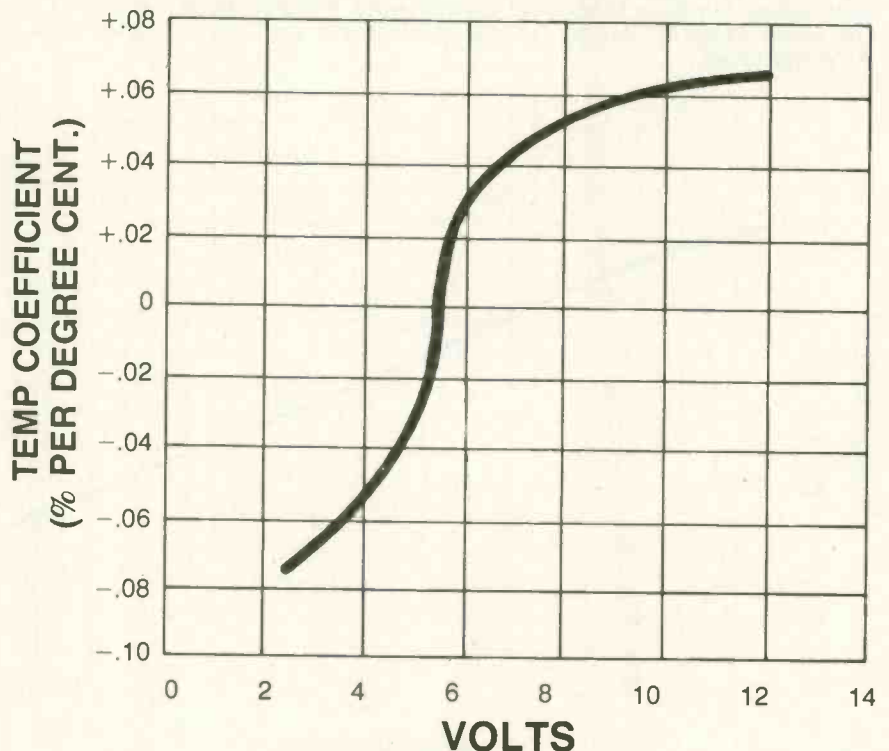

Fig. 4—Graph which illustrates that the temperature coefficient of a zener diode depends on the amount of voltage applied to it.

supplied from the external power source, keeping up a steady flow of current.

It would seem that a conventional forward-biased semiconductor rectifier is a simple device compared to varactors and zeners, but this is only because it is the diode with which you are most familiar. Varactors and zeners are always reverse biased, and never switch at all, while the rectifier must turn on and off with each cycle, which leads to some difficult problems.

Consider a rectifier running at the horizontal sweep rate of nearly 16

KHz, with a period of 60 microseconds. A half wave is only 30 microseconds. Let's examine what happens if the rectifier takes ten microseconds to turn on and ten more to turn off. Look at the common rectifier configurations of Figures 5 and 6. Note that if any two opposing rectifiers (labeled "A" and "B" in Figure 6) are on simultaneously, there is a short circuit directly across the power source. Further, it is undesirable, from both the efficiency and waveform viewpoints, to have a diode that fails to switch properly when the input polarity reverses.

Earlier, when we were discussing carrier recombination, it was pointed out that recombination takes a specific amount of time to complete. Because of this characteristic, a PN junction does not instantly create the insulating *depletion region barrier* needed for blocking action. Even worse, if heavy current is flowing through the diode, all the carriers in the depletion region produced by the current must also be "swept out" before the diode can return to the blocking state. The time needed to accomplish this is called *turn off time*, and is more in large junctions and with higher currents. Turning on the diode takes time too, and there are also capacitance effects, which can be appreciable in large junctions.

Rectifier Replacement

Now you can see that the common rectifier is really a switching device with a specific characteristic switching time. At 60 cycles this is no problem, and you can substitute one of those "bargain" rectifiers you have in stock. But the new sets are using 16-KHz power supplies to provide rectified DC as well as deflection. And computers, mobile radio, aircraft, and other fields are using 20-KHz power to reduce size and weight. For these, you need a rectifier diode designed for fast turn-on and turnoff. Such diodes cost more, but they are available from several semiconductor manufacturers. For these applications, you should not use "bargain" rectifiers.

In low-voltage, high-current power supplies, such as in autos and computers, the voltage drop across the rectifier is an appreciable percentage of the output voltage and, thus, an appreciable percentage of the power. This means big, heavy, costly heatsinks, and wasted power. In such cases, Schottky diodes, which have about .5 volt forward drop at high current, are used. With present technology, they can be made only for relatively low voltages. Replacing a Schottky type rectifier with a conventional silicon rectifier will cause severe heating of the silicon device. The two types look alike, but you can tell them apart by the low voltage drop across the Schottky rectifier. ■

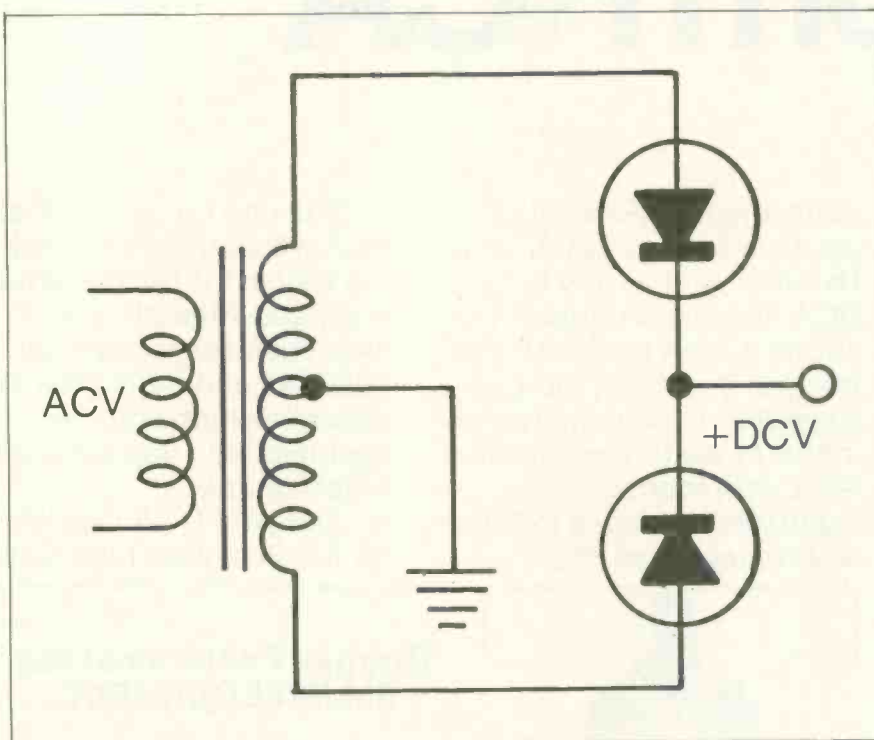

Fig. 5—Full-wave rectifier circuit.

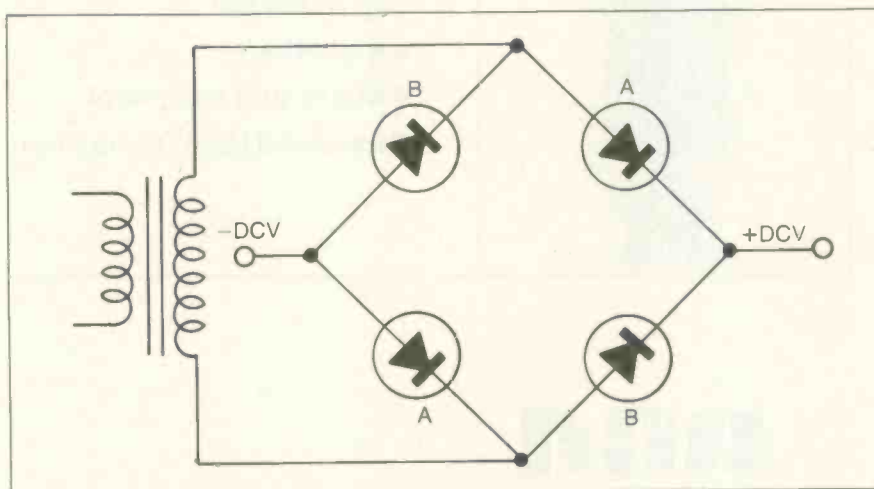

Fig. 6—Bridge type rectifier circuit.

Another advance in tube technology from RCA

RCA, the leading manufacturer of receiving tubes, continues to introduce new types to satisfy the needs of the replacement market. We can do this because RCA has unique design capability that comes only with years of tube design and manufacturing experience. This means that when you install RCA-made tubes, you're selling quality tubes with the newest and best innovations in design and performance.

First in a new series of dynamic approaches to receiving tube technology, geared to the rigorous demands of the replacement market, RCA's exclusive, new 6MJ6/6LQ6/6JE6C brings added reliability to horizontal deflection cir-

cuits, the most critical in your customer's set. Manufactured exclusively by RCA, this new rugged horizontal output tube with the integral envelope-top-cap assembly, which totally eliminates loose top-cap problems, represents another significant advance in tube technology from RCA.

You can be certain that RCA will continue to lead the way in the receiving tube business. After all, *your* tube business is *our* tube business and we expect to share this high volume business with you for a long time to come.

See your RCA distributor for all of your tube needs.

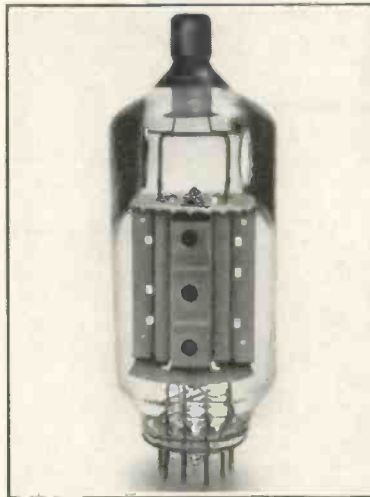

Rugged Features of the 6MJ6/6LQ6/6JE6C

- Integral-Envelope-Top-Cap Assembly
- Rigid Cage
- Stable grid alignment
- Excellent Heat Dissipation

RCA

RCA/Electronic Components/Harrison, N.J. 07029

Material in this department is condensed from a single chapter of a recently introduced TAB book, by permission of TAB BOOKS, Blue Ridge Summit, Pa. 17214

Picture Tube Repairs

by Art Margolis

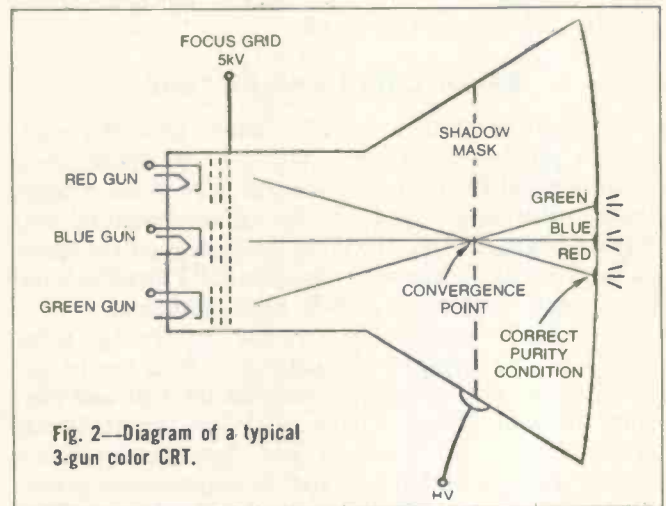
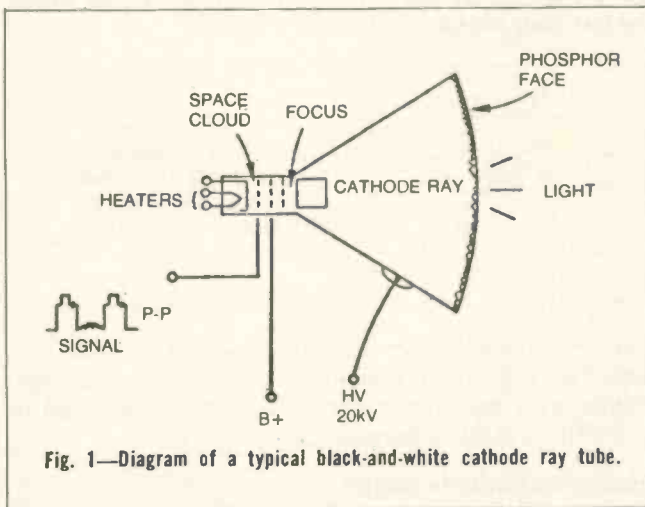

■ Replacing a picture tube in a TV is a mechanical job that is delicate and time-consuming. It is the repair the customer dreads most—it is never inexpensive. Consequently, if you can rescue a dying CRT with a fairly permanent repair, you are performing a valuable service.

Picture tube repairs actually boil down to correcting problems in the electron gun. There is nothing you can do to a burnt phosphor screen, to a slipped shadow mask, or to an air leak near the anode well. When you see burn marks on the phosphor, polka dots due to a slipped mask, changing purity and convergence due to unwanted expansion and contraction of the mask, or evidence of a loss of vacuum, the only recourse is to replace the defective CRT.

On the other hand, if you find low brightness due to low cathode emission, loss of Y signal due to a heater-to-cathode short, or other gun troubles, it's quite possible you can effect a repair. But you must have a good CRT rejuvenator-tester.

BLACK-AND-WHITE CRT's

A black-and-white CRT consists of a glass envelope, electron gun, high-voltage anode and a phosphor screen (Fig. 1). Like any small vacuum tube, a filament in the gun heats the cathode. The cathode emits electrons, forming a space cloud. The screen grid has a positive B-plus voltage that draws the electrons through the control grid. The electrons then pass through a focus anode that squeezes them together so that they form a fine beam instead of a spread-out one.

Attached to the high-voltage anode is a positive voltage of about 20 Kv. This high potential is distributed around the entire large bell end of the glass envelope.

The negative electrons in the beam attain a high velocity as they speed toward the anode. When the beam hits the phosphor screen, the phosphor emits light. The finer the electron beam, the sharper the focus will be.

The control grid, which is modulated with the picture signal, is powered with a voltage, in contrast to a speaker that needs a large current to drive the voice coil. The voltage on the grid at any instant determines the actual intensity of the cathode ray, thus forming different shades of gray on the phosphor as the beam scans the CRT screen.

COLOR CRT's

In a color CRT, instead of a coating of white phosphor spread evenly over the screen, there are three phosphors arranged in groups of three dots (triads). Each triad is composed of a red, green and blue dot. There are about 333,333 dot triads, adding up to about a million dots on the average color screen. Some picture tubes use triads of stripes or long narrow ellipses instead of dots. Whatever the actual arrangement, there are three separate phosphors.

There are three guns in a color CRT (Fig. 2), one for each color. The red gun is aimed at the red dots, the blue gun at the blue dots, and the green gun at the green dots. Each gun receives the appropriate color signal, which varies the intensity of each beam to provide the right mixture of the three primary colors on the screen.

To insure that each of the three cathode rays strikes

(From Chapter 6, *TV BENCH SERVICING TECHNIQUES*, by Art Margolis, TAB Books, Copyright 1974. A review of the complete book follows this article.)

the correct dot, a shadow mask is installed between the electron guns and the phosphor. There is one hole in the shadow mask for each group of three dots. The electron guns are angled slightly so that the electrons converge at the shadow mask hole and then deconverge on the other side as they speed to their individual destinations. When the cathode rays hit the right dots, the color purity is correct. If a part of a beam strays to a wrong dot, the purity will be off where that occurs.

When the three cathode rays converge at the correct shadow mask hole, the convergence is correct. Should they converge in front of the holes or not converge at all, the convergence will be off.

BRIGHTENING THE PICTURE

Getting enough light from the screen phosphor is always a problem. In a new CRT, a heavy space cloud forms around the fresh cathode and each beam is more intense. But as a tube ages, the cathode material oxidizes and wears away, lowering the density of the space cloud. As a result, the most common CRT trouble is old age, and its symptom is a lower brightness level.

Fortunately, most of the cathode "poisoning" takes place on the surface of the cathode. There are procedures to "cure" the cathode material the first and possibly the second time it happens. When the brightness drops for the third or fourth time, there usually is not much cathode material left, and the rejuvenation procedure stops working. To alleviate the situation, a CRT tester is attached to the heaters of the suspect electron gun. In a monochrome TV, it is the only gun. In a color CRT, when one color loses brightness, that gun becomes suspect.

From the CRT tester, about 10v is applied to the heater (Fig. 3). Since the heater is designed typically to operate at 6.3v, 10v causes a higher current flow, and the heater becomes abnormally hot. As a result, the cathode material overheats and some of the poisoning is boiled off. Then, the heaters are turned off and a button is pressed. The button connects a filter capacitor, charged to about 1000v, between the cathode and control grid of the gun. The electrons that are settling back to the cathode material as it cools are suddenly pulled away from the cathode. This knocks off more of the "poisoned" material. In many cases, the cathode is only a few molecules thinner, but the fresh cathode material is capable of much better emission. For all intents, the CRT has a new lease on life.

This procedure works well on older black-and-white picture tubes, but is less effective on newer black-and-white and color picture tubes. But if the CRT is going to be replaced anyway, it's worth the try.

After the CRT rejuvenator has done its job, it is quite often useful to attach a brightener. This is a small stepup transformer that typically increases the heater input voltage from 6.3v to about 9v (Fig. 4). Brighteners come in all socket types to match the bases of most picture tubes.

RELIEVING GUN SHORTS

The electron gun, like any tube, is susceptible to shorts between elements. The short can be the result of

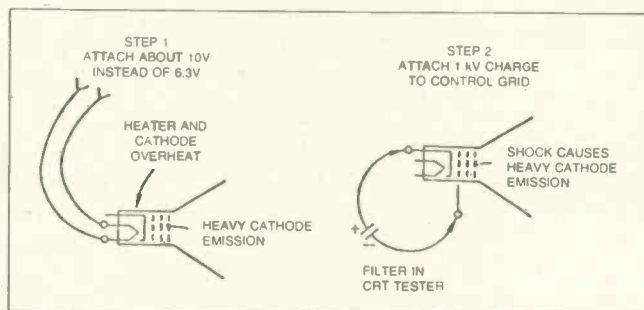

Fig. 3—There are two ways to rejuvenate a CRT: Overheat the filament and draw heavy cathode current for a brief interval.

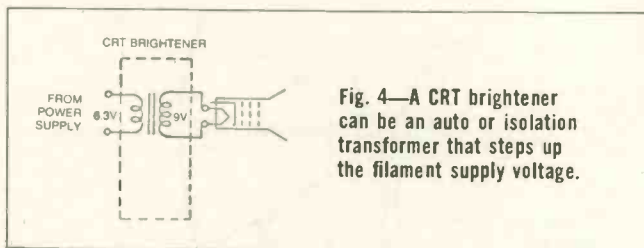

Fig. 4—A CRT brightener can be an auto or isolation transformer that steps up the filament supply voltage.

two elements actually touching each other, or some foreign material can become lodged between the elements. Either way, many times the short can be eliminated or relieved to make a permanent repair.

Heater-to-Cathode Shorts

Between the heater and cathode there is a ceramic sleeve (Fig. 5A). The heater and cathode both touch the sleeve but are insulated from each other by it. Between the other elements, such as cathode and control grids, or control and screen grids, there is nothing but a vacuum. When a heater-to-cathode (H to K) short develops, it requires a different technique than that needed for shorts between other elements.

The symptoms of an H-K short in a black-and-white CRT are usually fixed brightness and a defocused beam. Normally, the cathode operates with about 150v and the heaters at 6.3v AC. A break or a carbon path sometimes develops in a ceramic sleeve between the heater and cathode. If the resistance of the short is low enough, the 150v B-plus is reduced to near ground level, leaving the control grid just a few volts positive. At any rate, if the cathode voltage drops, the difference between the cathode and grid narrows, making the bias near zero. With no bias, the cathode ray is turned on completely and an overly bright picture results. Adjustment of the brightness control has little or no effect. Due to the increased intensity of the beam, it spreads a bit, causing defocusing. Since there is no bias between the cathode and the control grid, the retrace becomes visible. The CRT tester will reveal the presence of a short with neon lights or some other indicator.

The repair is simple and sure. Install a 1:1 isolation transformer between the heater supply and the heaters (Fig. 5B). Also available are isolation brighteners that attach between the CRT base and the socket. The isolation transformer simply supplies the heaters with 6.3v, but without the ground reference. The 6.3v heater floats at the cathode potential. For all practical purposes, the short to ground is eliminated.

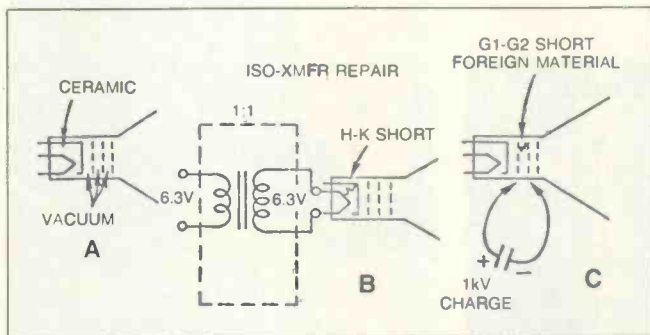

Fig. 5—Heater-cathode shorts are relieved with an isolation transformer (B) while K-G and G1-G2 (C) shorts are blasted away with a capacitor charge.

While most of the time this isolation cure is sure and permanent, on occasion the cathode is broken at the point where the short exists. The cathode is still operative in such cases because it is returned to ground through the heater supply. But when you install the isolation transformer, you not only isolate the heater from the source but the cathode as well. With the open cathode, emission ceases. To get around the open, simply attach the cathode socket pin to one of the heater pins.

A second complication occurs when the isolation transformer causes a mismatch between the CRT input circuit and the cathode. The video response is limited, and a smeary picture results. You can try a couple of different iso-brighteners, but usually this problem can't be solved easily. A new CRT is the only solution.

In a color CRT, a heater-to-cathode short can develop in one or more of the guns. The symptoms are usually a loss of Y signal and a smeary color picture. The repair is handled the same as with a single-gun CRT.

Cathode-to-Grid Shorts

A CRT tester will reveal other shorts in the gun structure. A cathode-to-control-grid short will eliminate bias, of course, and produce the same raster symptoms as a heater-to-cathode short. A control-grid-to-screen short usually causes a complete loss of brightness due to the loss of the screen B-plus.

Most of the time these shorts are caused by foreign material lodged between the elements (Fig. 5C). Often, you can "blast" the short away with the charged filter in the CRT tester. Press the button and the 1-Kv charge is placed on the control grid. If there is any foreign material between the elements, the charge usually will disintegrate it. This produces a permanent cure (Fig. 5C). If the elements are actually touching, the technique will not be effective. But, since the CRT will have to be replaced anyway, it is worth the attempt; there is nothing to lose.

REPAIRING AN OPEN GUN

Any of the electron gun elements are subject to detachment from the gun structure or the base connecting leads. If the heaters open, the trouble is quickly noticed. They can open either inside the glass envelope or outside where they attach to the CRT socket.

If the open is outside, a drop of solder produces a

permanent cure. Even just squeezing the pins where the solder has corroded will get the heaters back on. The same simple repair can be made if there is a poor connection to any of the other elements.

However, when the open is inside the glass, the situation becomes difficult. An open cathode kills the raster, of course (unless there is also a heater-to-cathode short).

An open control grid can produce a blurry raster. An open screen grid kills the raster, since there is no B-plus to attract the cathode ray. On occasion, an open screen grid produces a lower brightness level. In those cases, the second anode is still able to attract some of the cathode ray, but not with full intensity.

The CRT tester will tell you which elements are open. The repair attempt is a hit-and-miss affair, but it's worth a try. The idea is to try to weld the detached elements back onto the gun structure. Usually, it is only separated by a tiny space and is still generally in the right spot. Sometimes the element is not actually detached but loose enough for a resistance to exist between the element and gun.

A CRT tester has a heater voltage of about 10v, which is applied to the filaments. With this extra voltage applied, the entire gun will become very hot. After the gun has heated, steadily tap the neck of the tube with a pencil or ruler. This will cause the gun to vibrate. Hopefully, the detached element will start bouncing against the connecting point. If, during the heat and vibration, you start applying the 1-Kv filter charge again and again, you might get the charge into the gun just as the detached element strikes the gun structure. If that happens, a flash will occur and the loose element will re-weld itself in place. There is a possibility that you might blow something else in the process, but there is nothing to lose with a CRT that is scheduled for replacement.

TECH BOOK REVIEW

Title: TV Bench Servicing Techniques (TAB BOOK No. 682)

Author: Art Margolis

Price: \$7.95, hardbound
\$4.95, paperbound

Published: January, 1974

Size: 228 pages, over 177 illustrations

For the "roadman" who wants to graduate to the TV bench, here is an extremely useful and thoroughly interesting book. It will acquaint the reader with the basics he needs to take his place on the bench, or help the ambitious entrepreneur step up the output of a one-man shop. The text explains the setup of a typical, efficient shop, outlines shop repair methods, and provides troubleshooting procedures for each section of color and black-and-white receivers.

The author, who has many years of bench experience in every situation—from one-man shops to large service organizations—devotes the first chapter to the role of a benchman. He explains how a benchman should approach a TV repair, how he should analyze the trouble in a receiver and the methods he should use to find the cause of it. Another chapter details what is

continued on page 44

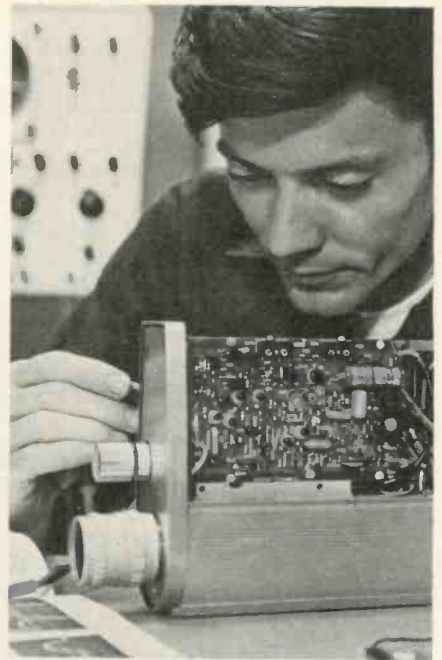

The TV camera shown here is part of the two complete closed-circuit TV systems which the two electronic technicians at St. Rita's must maintain.



Shown here are central station heart monitors which are interfaced with the telemetry system used to monitor the heart activity of post-coronary patients while they are away from their beds.



Senior Medical Electronics Technician Jim Marshall tests the cable and leads which connect a patient to the heart monitor mounted on the wall beside the bed.

Electronics in Modern Hospitals—A Varied and Vital Role

by J. W. Phipps

A look at some of the many applications of electronics in a progressive Ohio hospital

■ Few other types of businesses or institutions depend on a more diversified group of electronic instruments and systems than do modern hospitals. Nor is safe, accurate operation of equipment more vital. If a home TV or radio fails, it causes only inconvenience. However, if a heart monitor in the coronary care unit of a hospital fails, it can mean the difference between the survival or the death of the patient.

The use of electronics in today's medical facilities has increased the speed and accuracy of diagnostic functions and has permitted closer monitoring of the condition of acute-



Bench servicing of a video tape recorder in the electronic service facility located in a "penthouse" atop the hospital.



Maintenance of the medical laboratory electronic equipment is also a responsibility of the two electronic technicians employed full time by St. Rita's. Jim Marshall is shown here testing a 12-channel blood analyzer in the medical laboratory.



Gordon Branstetter, Administrative Engineer at St. Rita's, is responsible for the development and administration of the hospital's maintenance program, which requires a 40-member maintenance staff, including two full-time electronic technicians and an electrician.

ly ill patients. It also has contributed to the development of new surgical and treatment techniques as well as improving existing ones. Equally as important, the many applications of electronics has helped increase the productivity of our country's overburdened medical facilities and personnel, without sacrificing the quality of care.

St. Rita's Hospital, Lima, Ohio, is typical of the progressive medical institutions in our country which, with the help of a variety of electronic instruments and systems, not only have continued to meet their communities accelerating medical-care

needs but, at the same time, have continued to improve the quality of care offered.

St. Rita's, which is the largest medical-care facility within a 70-mile radius of Lima, has 439 beds, and each month treats over 2,000 patients in its emergency out-patient clinic. In 1971, this hospital received national acclaim when its staff, after an 11-week effort, saved the life of a six-year-old boy who had been infected with rabies by a rabid bat. It is the first documented recovery of a human infected with rabies.

THE ROLE OF ELECTRONICS AT ST. RITA'S

The varied and vital role of electronic equipment and systems in modern medical institutions is revealed by the following partial list of those used and maintained by the staff of St. Rita's:

CCTV and VTR's

Two complete closed-circuit television (CCTV) systems are operated and maintained by St. Rita's. One is an RF system which provides entertainment and educational services to patients via 229 televiewers. The CCTV system provides patients a variety of live and taped programs throughout the day, including religious services from the hospital chapel. In addition, a CCTV camera in the lobby and a related telephone communications system permits parents to visit each weekday evening with their children, who are not permitted on the patients' floors.

A video CCTV system provides live and taped educational programming to hospital personnel and the

medical staff via televiewers in eleven locations throughout the hospital.

Included in the CCTV systems are five cameras, nine monitors and a variety of special-effects equipment plus video tape recording and playback systems. The video recorders are controlled from the hospital's PBX switchboard on a 24-hour basis.

Intercom Systems

Extending throughout the hospital is a complete communications system to which is connected the nurse call system and an intercom network consisting of 60 master and 147 staff units, plus a variety of entertainment facilities, including AM/FM radio, eight commercial TV channels and the RF CCTV channel.

Coronary Care Unit Equipment and Systems

The coronary care unit of the hospital is equipped with 8 patient cardiac monitors which are connected to four complete central station monitors with alarms and eight channels of graphic recording.

The cardiac arrest, or Code 99, alert system used by St. Rita's was designed by the staff of the hospital. When the cardiac rate computer detects that the cardiac activity of a patient has deviated from acceptable limits, the following sequence of actions occurs: 1) an elapsed-time clock starts; 2) the nurse-call system activates a green light at the patient's room and at other strategically located positions, and an audible tone sounds; 3) the nurse checks the patient and, after confirming that a cardiac arrest actually has occurred, presses the Code 99 button; 4) the

Code 99 signal causes the green visual alarms to change to red, initiates another audible alarm and alerts the PBX switchboard; 5) communications personnel announce the Code 99 situation to the medical staff via the public-address system and a two-way radio network. A public-address monitor in the coronary care unit confirms to the attending nurse that the rest of the medical staff has been alerted.

Post-Coronary Care Telemetry

Patients in the post-coronary care unit have regularly scheduled periods of controlled exercise which require that they be away from their bedside cardiac monitors. To assure that their cardiac activity continues to be monitored during these exer-

cise periods, a telemetry transmitter only slightly larger than a package of cigarettes is attached to them. Their cardiac activity is transmitted back to a receiver and is displayed on the patient and central monitors. If their cardiac activity deviates beyond acceptable limits, an alarm sounds to alert the medical staff, and a graphic recorder starts.

Fire Alarm and Suppression Equipment

St. Rita's is equipped with a coded fire alarm system which automatically transmits an alarm signal to the Lima Fire Department. This complex but vital system consists of 93 break-glass stations, 70 alarm locations, two master control panels and two 3-fold master units. Back-

ing up this system are a dialless, direct-ring telephone system and two-way radio communications to the fire department.

A Halon 1301 Fire Suppression System also is installed in St. Rita's. This system provides quick suppression of fire in four areas of the hospital: the dietary range hood, the telephone equipment room, volatile solution storage and the data processing section. Each of these four subsystems are triggered by heat and smoke sensors, except the volatile solutions storage system, which is triggered by an ultraviolet detector.

Vital Liquids and Gases Alarms

To assure that the quantities of vital liquids and gases are maintained at levels and pressures con-

MONITOR INSPECTION

Location Serial Number
Model Manufacturer

INSPECTION

Attachment plug
Line cord and strain reliefs
Cables and connectors
Fuse
Condition of controls, indicators and meters
General condition with instrument
Electrode pads
Position of controls

OPERATION

Leakage current to chassis	Circle Unacceptable Valves	
	OFF	ON
Properly grounded μ A μ A
Ungrounded, correct polarity μ A μ A
Ungrounded, reverse polarity μ A μ A
Rate indicator		
Calibration		
Function switch		
Graphic recorder controls		
Video controls		
Alarm indicator		
Affix Appropriate Tag, i.e., Safe, Unsafe and Date Tag		

Checklist used by Senior Medical Electronic Technician Jim Marshall during daily inspection of heart monitors.

The thoroughness with which medical electronics equipment is regularly checked is revealed by this list of operational checks and inspection performed on heart defibrillators. (The defibrillator is a high-voltage device which is used to literally shock an erratic heart muscle back into a regular rhythm.)

DEFIBRILLATOR

Location Serial Number
Model Manufacturer

INSPECTION

Attachment plug
Line cord and strain reliefs
Paddles, cables and connectors
Fuse
Condition of controls, indicators and meter
General condition of instrument
Electrode pose on saline pads
Position of controls

OPERATION

Leakage Current to Chassis	Circle Unacceptable Valves	
	OFF	ON
Properly grounded μ A μ A
Ungrounded, correct polarity μ A μ A
Ungrounded, reverse polarity μ A μ A
Leakage Current to Paddles		
	OFF	ON
Properly grounded μ A μ A
Ungrounded, correct polarity μ A μ A
Ungrounded, reverse polarity μ A μ A
Charging Time to Maximum Energy Setting		
..... Seconds to .. Watts Seconds	Previous Value Seconds
Internal discharge of stored energy		
Output energy (watts seconds)		
Control setting	Indicated energy
Delivered energy	Previous value
Change		
Energy delivered after one minute		
Maximum setting watt seconds	
Synchronize operation		
Comments and description of deficiencies		
Affix appropriate tag on equipment, i.e., Safe, Unsafe and Date Tag		

sistent with the normal and emergency needs of the hospital, various measuring and alarms systems are employed to indicate when the levels should be replenished. For example, the oxygen needs of the hospital are provided from a large, spherical bulk liquid oxygen tank. The liquid oxygen in the tank is fed to a liquid-to-gas converter, from which the oxygen, now in gas form, is fed under pressure to those areas of the hospital which require it. The level of liquid in the main storage tank and the pressure in the distribution system are monitored by alarms in the PBX switchboard, powerhouse, surgery, intensive care and cardiac units, and the post operative care area.

Other vital gases, such as nitrous oxide, which is used in anesthesiology, and nitrogen, which is used to power surgical tools, are monitored by alarms in the powerhouse, at the PBX switchboard and in the surgical control center.

Blood-needed alarms are connected among the blood banks in the laboratory and surgery area and to the PBX switchboard and powerhouse.

Powerhouse Alarm and Surveillance System

The two principal types of powerhouse equipment which require electronic servicing are the standby power generators and a complex equipment surveillance system.

To provide emergency power, three 438 KVA generators are automatically started whenever normal power to the hospital is interrupted.

An automated equipment surveillance system continually surveys the operational status of the hospital's environment conditioning equipment, such as heating and air conditioning systems, either on a time-interval basis or whenever a critical function fails. For example, if an air handler shuts down because of a momentary interruption of voltage input, the surveillance system initiates an alarm and presents to powerhouse personnel digital and printed readouts which tell them exactly what equipment has shut down and why. The powerhouse or maintenance

personnel can correct the defect, if corrective action is needed, and then can initiate another surveillance scan to verify that the air handler is again functioning properly.

The equipment surveillance system receives inputs from about 240 remote sensing devices, including pressure switches (water and steam), pressure sensitive switches (air), thermocouples (temperature, air and water), thermostats (temperature, air and water), manometers (filter condition) and flow switches (water flow). All of these devices require frequent testing to insure reliability.

ELECTRONIC MAINTENANCE

Two electronic technicians and an electrician are employed full time by St. Rita's to maintain all of the electronic instruments and equipment used by the hospital. They are part of a 40-member maintenance staff which operates under the supervision of Ben Pursley, Director of Maintenance, and Gordon Branstetter, the Administrative Engineer.

A well-equipped electronic service facility is located in a "penthouse" atop the hospital. This location was chosen to provide electrical isolation between the service facility and the other electronic equipment operating in the hospital complex.

All of St. Rita's electronic equipment is maintained in accordance with an electronic maintenance program developed by Gordon Branstetter and James Marshall, the Senior Medical Electronics Technician, with guidance from the Emergency Care Research (ECR) Institute, an independent agency in Philadelphia which helps medical institutions establish standards of operation and maintenance. Under the program, which includes both preventative and requested maintenance, all hospital electronic equipment maintenance is grouped into one of three classifications according to how vital the equipment is: Priority 1 is given to critical equipment, Priority 2 is given to noncritical but important equipment, and Priority 3 is for maintenance of all other types of hospital electronic equipment.

To augment the electronic service staff of the hospital, service engineers and/or technicians from the manufacturers of the equipment used by the hospital inspect their equipment on a quarterly basis. These factory representatives, and personnel from Lima Radio Parts Co., Inc., Lima, Ohio, which supplies much of St. Rita's non-medical electronic components and test instruments, also are available to assist the hospital electronics service staff if the workload becomes excessive or if a particularly difficult problem is encountered.

Preventive maintenance is performed in accordance with schedules and checklists provided by the Emergency Care Research Institute and/or the equipment manufacturers. For example, heart monitors receive daily visual and operational inspection to insure that they produce clear, accurate pattern complexes and accurate heart rate digital displays. Graphic recorders are tested for acceptable trace qualities. All systems and equipment performance is reviewed by both the Senior Medical Electronic Technician and the Charge Nurse. (Samples of heart monitor and defibrillator checklists are shown in an accompanying illustration.) After inspection, a dated tag which indicates that the equipment either is safe or unsafe for use is attached to the equipment.

SUMMARY

This brief look at some of the electronic equipment and systems used by St. Rita's Hospital, Lima, Ohio, provides a general overview of the diversified and vital role electronics is now performing in modern hospitals throughout our country. It also provides some insight into the technical skills and methodical maintenance procedures which are necessary to insure that the complex electronic equipment and systems continue to operate both accurately and safely. And it introduces a relatively new breed of electronics technician—the medical electronics technician—whose skill is an integral part of the efficient, modern hospital. ■

TeleMatic Tuner-Mate Substi-Tuner Model KT730

by J. W. Phipps

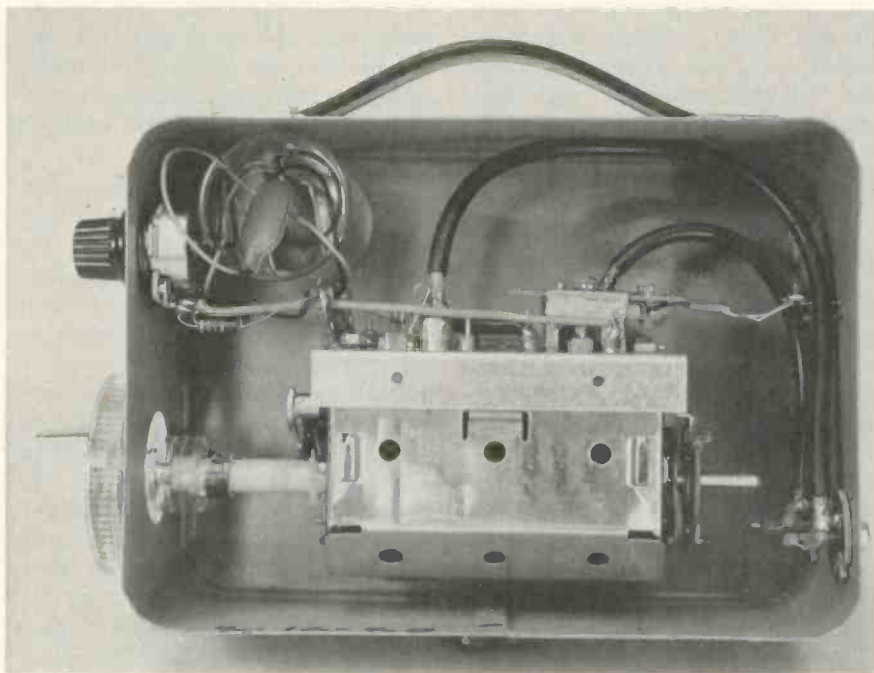

Sideview of Model KT 730 with side cover removed. The VHF tuner is a strip-type, fully-shielded, solid-state unit capable of receiving all 12 VHF TV channels and, when used with a receiver's UHF tuner, all UHF TV channels. Two 9v batteries which power the unit are placed in a round plastic holder in the upper left corner.

■ TeleMatic's Model KT 730 Tuner-Mate is a battery-powered, portable substitute tuner which can be used in place of the VHF tuner in any black-and-white or color TV receiver equipped with a 40-MHz video IF system.

GENERAL DESCRIPTION AND FEATURES

The Tuner-Mate is equipped with a fully-shielded, strip-type, solid-state VHF tuner powered by two 9v batteries (Eveready No. 216, or equivalent). The tuner, which is enclosed in a metal case with a collapsible vinyl handle, provides reception of all 12 VHF TV channels (2-13) and, when used in conjunction with the UHF tuner of the set being serviced, it also provides reception of all UHF TV channels.

VHF channel selection and fine tuning are accomplished by standard detent-type TV tuner controls on the front panel of the instrument. UHF reception is selected by placing the channel selector in the U position.

The gain of the tuner can be varied by a control on the front panel. Minimum gain is 25dB on all VHF channels and 40dB in the UHF mode. Although maximum gain figures were not included in the specifications furnished us by TeleMatic, during our lab tests of the unit it provided sufficient gain to overload a Sylvania E06-2 color TV chassis, without rotating the Tuner-Mate gain control beyond the $\frac{3}{4}$ position. (Before connecting the Tuner-Mate to the E06-2 chassis, the AGC of the receiver was adjusted to provide a normal color picture with an in-

put of 1000 microvolts to the tuner of the receiver.)

VHF input to the Tuner-Mate is through a conventional screw-type 300-ohm antenna terminal on the back of the unit. The 40-MHz IF output of the tuner is fed through a shielded cable to a standard IF cable jack on the back panel, labeled I.F. Input from a UHF tuner is via a second standard IF cable jack on the back panel, labeled U.H.F.

TYPICAL APPLICATIONS

Testing Receiver VHF Tuner by Substitution

To determine whether or not the VHF tuner in a receiver is defective, substitute it with the Tuner-Mate in the following manner:

- 1) Disconnect the VHF antenna lead-in from the receiver and connect it to the ANTENNA terminals on the back of the Tuner-Mate.
- 2) Disconnect the receiver IF cable from the receiver tuner and plug it into the I.F. jack on the back of the Tuner-Mate. (A shielded extension cable with alligator clips on one end is provided with the Tuner-Mate for use with receivers which are not equipped with a plug-in-type IF cable connection on the tuner.)
- 3) Turn on the TV receiver and the Tuner-Mate. (The Tuner-Mate ON/OFF control is located on the upper left of the front panel and is in the ON position when pushed up. A pilot lamp to the right of the ON/OFF switch lights when the switch is in the ON position.)
- 4) Rotate the CHANNEL SELECTOR of the Tuner-Mate to an active channel, then adjust the FINE TUNING and GAIN controls as required to produce a normal picture. (Rotating the GAIN control clockwise increases the tuner gain.)

If a normal picture is produced with the Tuner-Mate connected to the receiver, the tuner in the receiver or the tuner AGC circuit probably is defective. However, it is also possible that a defect in the receiver AGC circuit or IF section is preventing correct AGC action. Because the variable gain of the Tuner-Mate might be compensating for slightly inadequate or slightly excessive RF or IF AGC, it is advisable to check the chassis AGC circuit before deciding that the receiver tuner is defective. The procedure for using the Tuner-Mate to check the AGC action of a chassis is presented next.

Testing Receiver AGC Action

The following procedure for using the Tuner-Mate to check the AGC action of a receiver eliminates the need for an external bias supply:

- 1) Disconnect the VHF antenna lead-in from the receiver and connect it to the ANTENNA terminals on the back of the Tuner-Mate.
- 2) Disconnect from the receiver VHF tuner the cable to the receiver IF input, and leave it disconnected.
- 3) Rotate the receiver channel selector to an inactive channel.
- 4) Plug the Tuner-Mate extension cable with alligator clips into the I.F. jack on the back of the Tuner-Mate. Connect the alligator clip of the red lead to the grid or base of the first video IF stage which is not AGC controlled. Connect the alligator clip of the black lead to a chassis ground point.
- 5) Turn on the receiver and the Tuner-Mate.
- 6) Rotate the Tuner-Mate CHANNEL SELECTOR to an active channel and adjust the Tuner-Mate FINE TUNING and GAIN controls to produce a normal picture.
- 7) Measure the receiver RF and IF AGC voltage. If they are not within the limits specified by the manufacturer's service literature, troubleshoot the receiver AGC circuitry.

Testing Receiver Video IF's

If substituting the receiver VHF tuner with the Tuner-Mate does not produce a normal picture on the receiver screen, use the following procedure to test the receiver video IF section:

- 1) Perform steps 1, 2 and 3 listed under the procedure for *Testing Receiver AGC Action*.
- 2) Plug the Tuner-Mate extension cable with alligator clips into the I.F. jack on the back of the Tuner-Mate. Connect the alligator clip of the red lead to the grid or base of the IF stage *immediately preceding* the video detector. Connect the black lead to a chassis ground point near the red lead connection.
- 3) Turn on the receiver and the Tuner-Mate.
- 4) Rotate the Tuner-Mate CHANNEL SELECTOR to an active channel and adjust the Tuner-Mate FINE TUNING and GAIN controls to produce a normal picture.
- 5) If a normal picture is obtained, proceed to step (6). If a normal picture is not obtained, and adjust-



Rear view of Tuner-Mate and Sylvania small-screen color TV receiver showing interconnections for VHF tuner substitution.



TeleMatic Model KT 730 Tuner-Mate. For more information about this instrument, circle 900 on the Reader Service Card.

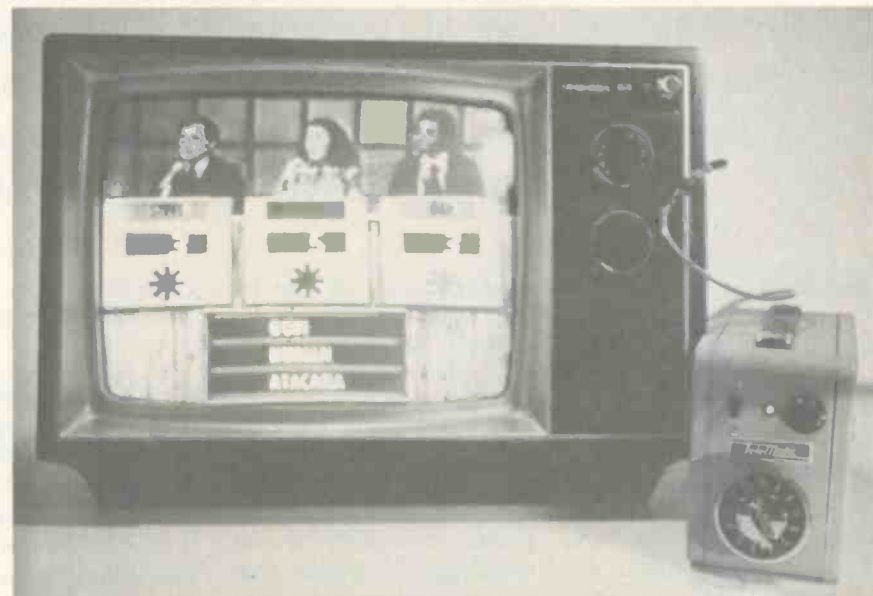

During lab tests of the Model KT 730 Tuner-Mate, we connected it to a new 13-inch (diagonal) Sylvania color TV receiver and obtained the high-quality reception shown here.

ment of the receiver AGC control does not produce a normal picture, the trouble is in the final video IF stage, video detector or video amplifier(s) following the video detector.

- 6) If a normal picture was obtained in step (5), use the red lead of the Tuner-Mate extension cable to inject the IF signal from the Tuner-Mate into the grid (or base) or plate (or collector) of each of the other video IF stages, proceeding *back toward* the first video IF stage. The point at which a normal picture is no longer produced is the site of the defect.

Testing the UHF Tuner by Elimination

The Tuner-Mate can be used to determine, by the process of elimination, whether or not the UHF tuner is the cause of inadequate or no

continued on page 49

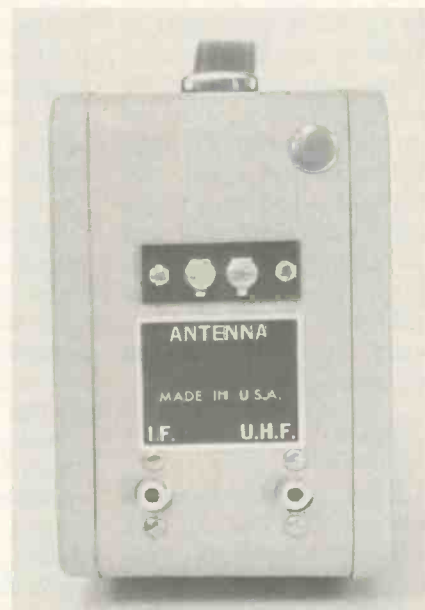

Rear view of Tuner-Mate showing antenna and UHF inputs and IF output jack.

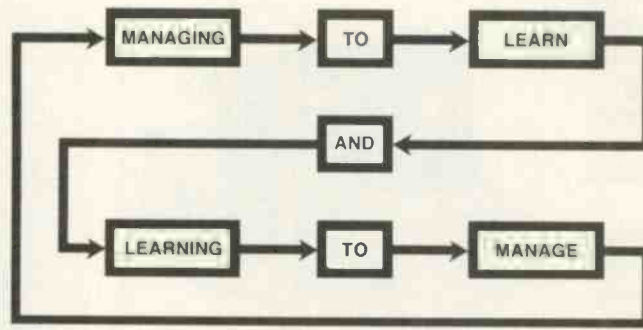

by Ray Sawyer

In this series, problems or situations involving business management and/or shop operations are presented for ET/D readers to resolve. The action taken to resolve the situation described in the January, 1974 issue is presented this month along with reader responses representative of those received about this situation.

Situation

Bill, an outside technician employee of a sales/service shop, has caught up on all outside calls and to keep busy has selected a set which he had brought in to the shop, and has completed the repair of it. Under a new system of assigning specific sets to specific inside technicians, the set Bill has repaired had been assigned previously by the service manager to John, an inside technician. Upon learning that Bill already had repaired the set previously assigned to him, John became upset and complained about it to the service manager. Bill and John both demanded credit for the repair. (Both inside and outside technicians are on an incentive pay plan.)

Solutions suggested by readers

I would give Bill the credit for the work he did, but I would inform him that, in the future, he should ask the service manager for work assignments, and if he doesn't, he will not

receive credit for the inside work he does.
 Marc V. Burdeck
 Long Beach, Calif.

The service manager should "take the heat" in this mixup because the new procedure he has instituted obviously is not working. To insure that the situation does not happen again, when a set is assigned to a particular inside technician it should be tagged with his name or it should be put in a work or storage area designated for that particular technician. All technicians should be informed about this procedure, and the technicians should be cautioned against using procedures which are in conflict with standard shop procedures. Also, the service manager should make it clear that if an unusual situation should occur which is not covered by a standard shop policy, he should be consulted, and if he is absent, the technicians should proceed with whatever course of action is most accommodating to the customer.

Calvin Cillay
 Bethesda, Maryland

The service manager should inform Bill that he is not to infringe in an area that is not assigned to him and that he is not to repeat this mistake. John then should be assured that Bill has been warned.
 James B. Snider
 Youngstown, Ohio

If the temperaments of Bill and John permit it, the service manager should call both of them into his office together and point out to John that any wrong done was not intentional and that an additional set will be assigned to him to make up for the set Bill repaired. The service manager then should give Bill credit for the work he did and explain the "inside" system to him. Both men should be assured that a general meeting of all personnel will be held to make sure that everyone understands the new system. The service manager should ask them if they have any other suggestions about how the shop can be

made more efficient and then thank both of them for their cooperation in making the shop more efficient.

Charles V. Feeley, Jr.
 Brookfield, Ill.

Outside technicians should be allowed to request additional work from the inside men when they have time to work inside and the work should be done on a 50/50 arrangement, to promote efficiency and increase the bench experience of outside technicians.

E. R. Oswals
 Livingston, New Jersey

Actual solution

This episode revealed to the service manager that the new shop procedure for assigning inside work had not been explained thoroughly to all outside technicians as well as inside men. To clear up the immediate problem and to avoid further conflict between Bill and John, the service manager first talked to each individualy. He explained the new

continued on page 44

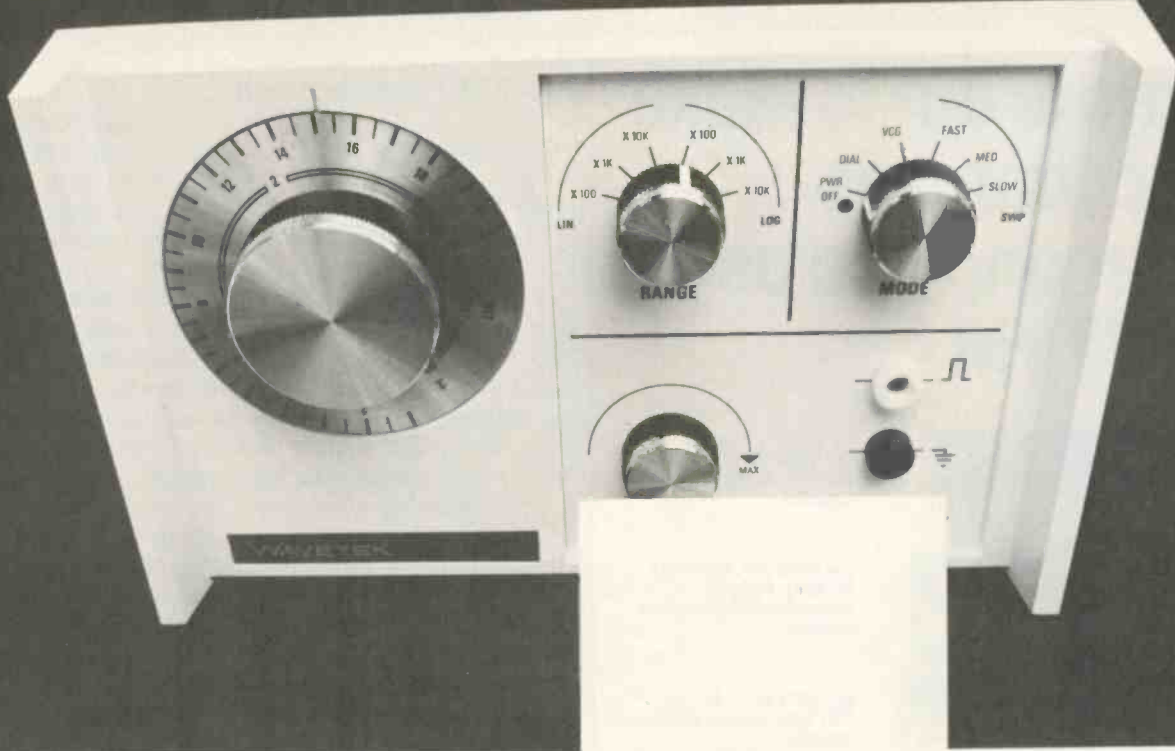

**This Model 30
portable function generator
goes from
2 Hz to 200 kHz with
sines, squares, triangles,
and linear
or log sweeps.**

**And it goes for
\$149.⁹⁵**



WAVETEK®

P.O. Box 651, San Diego, Calif. 92112
TWX 910-335-2007, Tel. (714) 279-2200

... for more details circle 133 on Reader Service Card

Heath is out to make the counter as commonplace as the VTVM



the \$169.95*, IB-1100
30 MHz, 5-digit kit-form
counter

the \$225.00*, SM-118A
30 MHz, 6-digit
assembled autoranging
counter

the \$229.95*, IB-1101
100 MHz, 5-digit kit-form
counter

the \$299.95*, IB-1102
120 MHz, 8-digit kit-form
counter

the \$325.00*, SM-128A
110 MHz, 7-digit
assembled autoranging
counter

the \$379.95*, IB-1103
180 MHz, 8-digit kit-form
counter

the \$395.00*, SM-128B
110 MHz, 7-digit,
assembled high stability,
autoranging counter

the \$495.00*, SM-110A
200 MHz, 7-digit,
assembled counter

the \$625.00*, SM-110B
200 MHz, 7-digit,
assembled high stability,
programmable counter

the \$795.00*, SM-110C
600 MHz, 7-digit,
assembled high stability,
programmable counter

HEATH

Schlumberger

Heath Company
Dept. 24-5
Benton Harbor, MI 49022

- Please send latest Heathkit catalog.
 Please send latest assembled instruments catalog.
 Enclosed is \$_____ plus shipping.
 Please send model(s)_____

Name _____

Address _____

City _____ State _____ Zip _____

*Mall order prices; F.O.B. factory. TE-307

Picture Tube Repairs ...

continued from page 35

called "bench flow"—the manner in which each receiver is handled from the time it arrives in the shop until the repair is completed. The procedure described is practical and will enable a new benchman to understand modern service philosophy and techniques.

The book examines the basic operation of tube-type, solid-state, and modular receivers, and tells how to cope with the fundamental, inherent characteristics of each type from a troubleshooting standpoint. Also included are detailed instructions for picture tube tests and repairs, and color picture setup adjustments, including purity, convergence, and high-voltage.

The remaining 17 chapters are devoted to individual receiver sections. In each case, there is a simplified explanation of operation, adjustment and troubleshooting techniques. Revealed are many servicing secrets, as well as the principal trouble causes, and cures for each section. In addition, the detailed troubleshooting procedures described will help the technician locate the cause of those elusive problems that can baffle most beginning technicians.

CONTENTS: How to Get Started—Bench Production—Vacuum Tube Receivers—Solid-State Receivers—Modular Receivers—Picture Tube Repairs—Color Picture Setup—Power Supplies—Tuners—UHF & Varactor Diodes—Remote Control Tuning IF Strip—Overall IF Alignment—Video Detector & Video Input Stages—Video-Output Circuits—Sync Circuits—AGC Circuits—Audio Circuits—Vertical Sweep Systems—Horizontal Sweep Systems—High-Voltage Systems—Color IF Circuits—Color Demodulators—Color-Output Amplifiers—Color Sync—Index. ■

Managing to Learn ...

continued from page 42

inside work assignment system to Bill and made sure that Bill realized that, although he was being given credit for the work this time, in the future he would not be given credit if he deviated from established shop policy. During his conference with John, the service manager explained that Bill previously did not understand the new shop procedure and had repaired the set without knowing that it was assigned to John. He assured John that he had since explained the new system to Bill and that John would be assigned an additional set to make up for the one Bill repaired and received credit for. The service manager then called John and Bill into his office together and, over coffee, apologized to both of them

for not taking sufficient action to insure that all outside and inside technicians thoroughly understood the new shop policy.

The episode also revealed to the service manager that the new shop work assignment policy had been implemented without specific procedures to avoid such conflicts. Consequently, he instituted the following new procedures:

- a) To make sure that all shop personnel were aware of what set was to be repaired by who, he affixed to each set a tag which clearly showed to which inside technician the set was assigned.
- b) To assure that outside technicians re-

ceived bench experience whenever the outside workload permitted, and yet protect the work volume of each inside technician, the outside men were instructed to check with the service manager for all inside work assignments. The service manager then would determine which inside technician had the heaviest workload or needed help to catch up and would assign the outside technician work from that inside technicians workload on a 50/50 basis after

first clearing it with the inside technician. This particular situation has made clear the need for shop operating policies which include specific procedures that protect both the shop's and the technician's interests. It also points up the need for insuring that all shop personnel, both inside and outside, thoroughly understand policies and procedures. Equally important, it points out a characteristic which all managers should practice — when you make a mistake, admit it and take immediate action to correct it. ■

Assn. Digest . . .

continued from page 15
islature, would have required the licensing of consumer electronic repair shops in that state, according to a report in *Forward Thrust*, the official publication of KETA.

Upon learning that the Consumer's Association planned to submit a repair shop licensing bill, Gene Dillingham, President, KETA, immediately urged the KETA membership to take action to discourage the proposal of such a bill and, instead, promote support of an Electronic Technician's Licensing Act then before the Kentucky House of Representatives.

KETA then formulated and adopted a resolution which made clear its members' opposition to the shop licensing bill and its support of the Electronic Technicians Licensing Act. The resolution was sent to Kentucky Governor Wendall Ford, state legislators and all consumer groups, including the Consumer's Association.

After receipt of the KETA resolution, the Board of the Consumer's Association, in a subsequent meeting, voted to support the Electronic Technician's Licensing Act. In a letter to KETA's Dillingham, the president of the Consumer's Association said, "I know how long and hard your association has worked on this needed legislation and express hope (that) the support of the Consumer's Association will be instrumental in its enactment during the upcoming Session of the General Assembly." ■

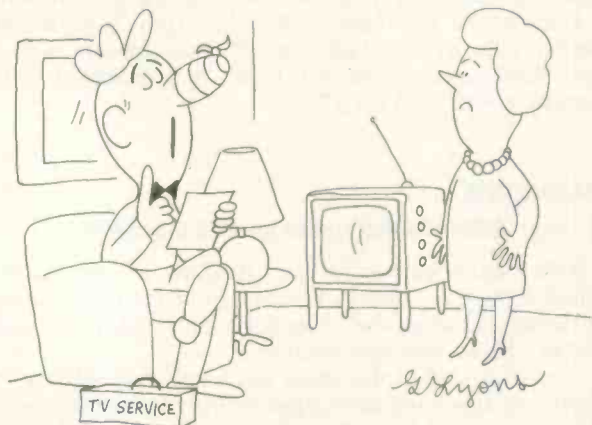

"We have a new policy—if I give anybody credit, the Boss punches me in the nose!"

NEW! INSTANT CONTACT CLEANER

NO RESIDUE • NON-FLAMMABLE
NON-TOXIC • NON-CONDUCTOR

A CHEMICALLY PURE CLEANING AGENT
WITH:

1. **SELECTIVE CLEANING POWER** — removes greases, oils, dirt and organic soils with no effect on the article being cleaned.
2. **EXCELLENT PENETRATING AND WETTING ACTION** — Its high density and low surface tension permits maximum penetration of most minute crevices where its superior wetting action then cleans even most difficult materials.
3. **PURITY** — evaporates completely — leaves NO residue.
4. **SAFETY** — Non-explosive, non-flammable, non-toxic.
5. **STABILITY** — does not react chemically with other materials.

SEND FOR FREE SAMPLE

Available in 7 & 16 oz. aerosols with "Snorkel Tubes"

LPS RESEARCH LABORATORIES, INC.
2050 COTNER AVENUE, LOS ANGELES, CALIFORNIA 90025
PHONE: (213) 478-0095

. . . for more details circle 121 on Reader Service Card

WINEGARD AMPLIFIED PRODUCTS PROVEN IN OVER 1,000,000 INSTALLATIONS.

CASE IN POINT: WINEGARD PREAMPLIFIERS.

For quality and dependability in antenna preamplifiers, look to Winegard. You know they're good. Because our preamplifiers deliver the best reception and the best reliability in the industry today.

Winegard preamplifiers come in 12 different broad-band models and a complete range of single channel models. With Winegard preamplifiers you get all these features:

- work with any TV antenna
- 75 or 300 ohm output
- solid-state, printed circuit cartridge
- unique lightning protection circuit
- switch selectable FM trap
- pre-amp and downlead connections 100% protected from weather and industrial deposits
- power supply included in all models

Best TV products for Best TV reception

Winegard Company • 3000 Kirkwood Street • Burlington, Iowa 52601

. . . for more details circle 135 on Reader Service Card

COLORFAX

The material used in this section is selected from information supplied through the cooperation of the respective manufacturers or their agencies.

ADMIRAL

Color TV Chassis T15K10/T41K10 Series—Intermittent or No Video and No Sound with White Raster

One possible cause for this problem is a leaky or shorted CCI capacitor (.02 μ f); replace with Admiral Part No. 65A422-203-3.

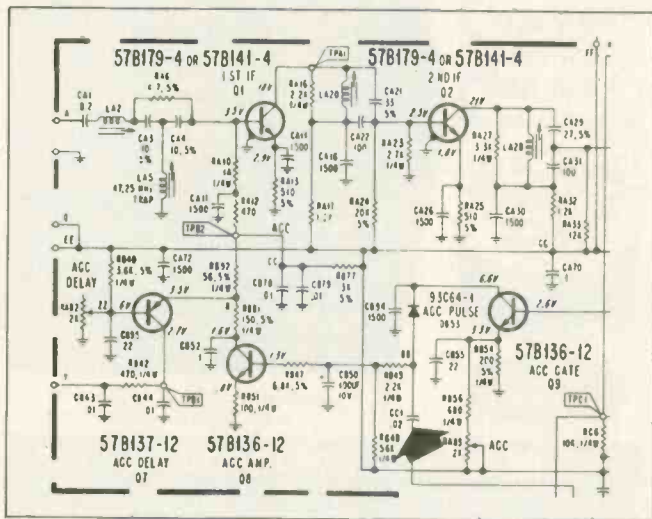

Intermittent failure of this capacitor has been reported in cases in which the set operated for a few minutes or a few hours before the loss of picture and sound occurred. When the AGC section malfunctions, the AGC voltage to the base of the 1st IF transistor increases, shutting off the transistor.

Color TV Chassis K18, K19 Series—Horizontal Bending or Pulling in Picture

This condition may be caused by a leaky capacitor, C500, .0022mfd. When this capacitor is defective, the effect on the picture may be similar to another problem which caused bending in the picture and which was corrected by redressing the orange lead away from the delay line. This

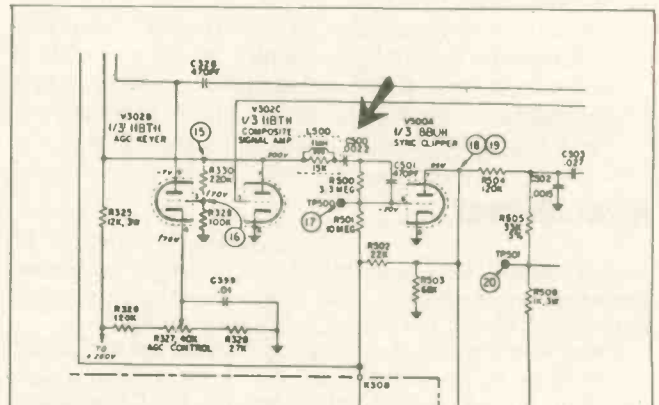

SECTION OF K18 SCHEMATIC SHOWING C500 AND SYNC CLIPPER

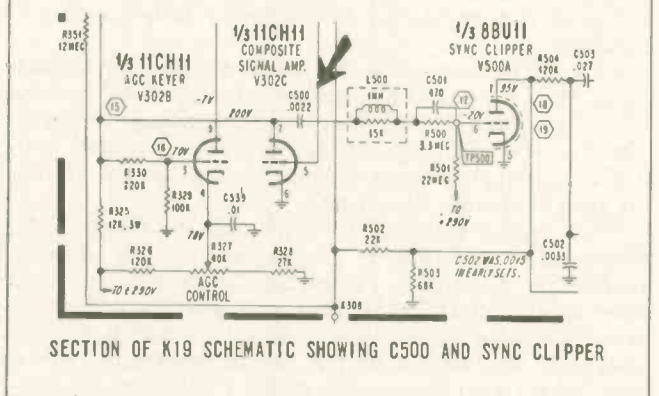

SECTION OF K19 SCHEMATIC SHOWING C500 AND SYNC CLIPPER

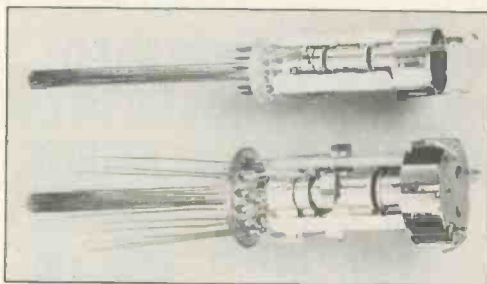

Cusack CRT Gun Mounts Are Your Best Buy!

CRT REBUILDERS:

- **One Source for Guns and Supplies:** Order supplies as well as guns, on one order. We stock bases, basing cement, chemicals, Dag, carbon paddles, Mira cloth, spark coils, etc.
- **The Prices Are Right:** Our manufacturing know-how pays off for you—with lower costs. Let us quote on your next gun order and you'll see why we say, "Cusack CRT Gun Mounts Are Your Best Buy..." Or request our latest catalog.

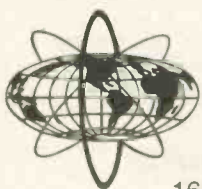

Big enough to serve you...
Small enough to appreciate you.
Cusack Electronics Inc.

Specialists in the Manufacture
of Electronic Gun Mounts

16525 Van Dam Rd. So. Holland, Ill.
312-333-2002 Cable-CUSALECT

problem is similar—video in the sync circuits—but with capacitor C500 defective, the condition can be more severe.

Observe the waveform at the plate (pin 7) of the sync clipper tube. If any video information appears with the sync information, capacitor C500 is probably defective; replace it with 65A417-222-1.

MAGNAVOX

"D" Panel 703505-1 Vertical Problem and Yoke Capacitor C16

Two pigtail connectors are attached to this panel to bridge terminals 5 and 7. They are attached to the foil side of the panel and should be mated with chassis pins 5 and 7 on the chassis mounted connector.

Capacitor C16 at the upper left hand corner of the "D" panel is charged and discharged by the horizontal yoke current. It is a special capacitor and may not be substituted by a general purpose capacitor. It was discovered that a run of these capacitors fell below minimum specifications.

You are requested to help the manufacturer locate and remove these capacitors from service by visually inspecting the unit any time you have occasion to service a T979 chassis. The faulty components are identified by the letters MF on the capacitor body. For example: Pactron, 1.0 μ f +10%, MF200v.

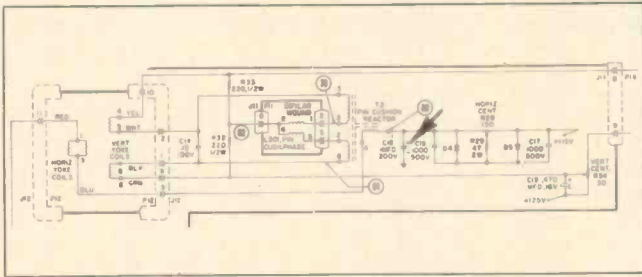

If you discover one of these capacitors in service, replace the "D" panel. Credit will be issued to you when the panel is returned to the Magnavox Parts Center. Approved capacitors are identified by an MPC, HA or MF (with an accompanying white dot).

Color-TV Chassis T958—Hum Bar

A strong hum bar that would occur intermittently on a T958 chassis was traced to a poor solder ground at the filament of V204, 6MU8 on the Video IF board. The SER-

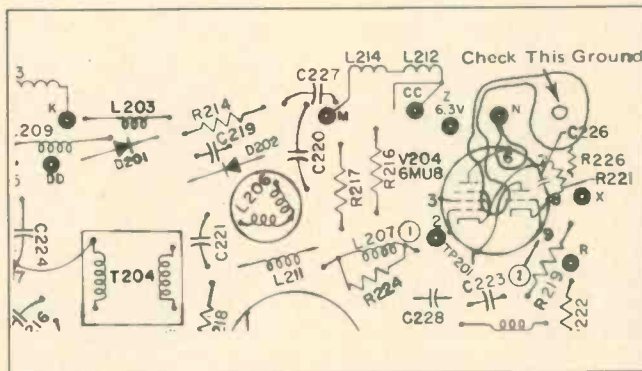

VICE SWITCH in this instance proved to be a valuable service aid when it was noted that the bar was still visible in the PURITY position of the switch. The ground point is shown in the illustration.

Audio Output Module 612046-202

A .0068 μ f capacitor has been bridged from B+ (pin 10) and ground (pin 3) on the module to preclude the possi-

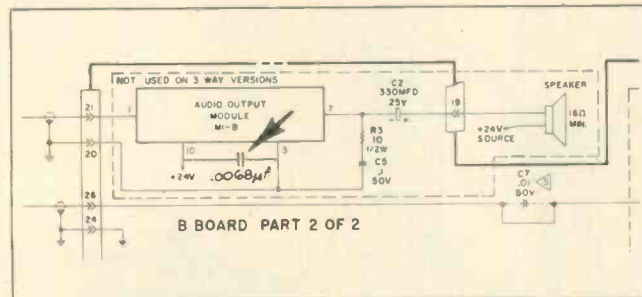

bility of oscillations occurring in the module. In addition, a pigtail is attached on the ground land surface at terminal 3. This lead is to be brought around the board and attached to pin 20 on the chassis. □

4 Money-saving reasons to buy EICO's Solid State Test Equipment.

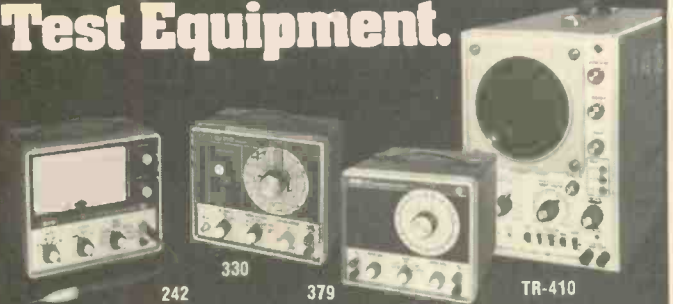

EICO 242 FET-TVOM. Peak-to-peak measurements of AC volts and milliamps. 6 1/2" meter. 7 non-skip ranges. High input impedance. Low 1 volt scale. DC/AC Multi-Probe. AC or battery operated. Kit \$84.95, Wired \$119.95

EICO 379 Sine/Square Wave Generator. Simultaneous sine and square wave outputs. Covers 20 Hz to MHz in five ranges. Low distortion sultzer feedback circuit. Square wave rise time better than 0.1 microseconds. Kit \$79.95, Wired \$119.95

EICO 330 RF Signal Generator. 5 bands cover a range from 100 kHz to 54 MHz. 100% solid state. DC to 10MHz bandwidth. Calibrated modulation adjustment control. 400 Hz audio output. Provision for modulating RF with internal or external signal source. Kit \$69.95. Wired \$109.95

EICO TR-410 Triggered Sweep Scope. 100% solid state. DC to 10MHz bandwidth. Sweep synchronized gate output. Z-Axis input. Use as vector scope for color TV servicing. One probe for direct and 10:1 measurements. Wired \$429.95

FREE 32 PAGE EICO CATALOG

For latest catalog on Eico Solid State Test Equipment, Automotive and Hobby Electronics, Burglar-Fire Alarm Systems, Stereo, and name of nearest EICO Distributor, check reader service card or send 25¢ for fast first class mail service.

EICO, 283 Malta Street, Brooklyn, N.Y. 11207



... for more details circle 111 on Reader Service Card

SOLDERING + DESOLDERING + RESOLDERING =

SOLDERABILITY

ELEMENTARY TO ELITE
WORLD'S MOST PRACTICAL SOLDER HANDLING TOOLS

meets industries demands.....

with a COMPLETELY PORTABLE SOLDERING/DESOLDERING/RESOLDERING SYSTEM



EDSYN

15958 ARMINTA STREET
VAN NUYS, CALIFORNIA 91406
PHONE (213) 989-2324
TELEX NO. 65-1469 EDSYNEX VAN

Send for our FREE 16 page
SOLDERABILITY
manual

Ads in EEM, OTS, EBG,
AE, TR, and EPAC Catalogs

... for more details circle 110 on Reader Service Card

TECHNICAL DIGEST

The material used in this section is selected from information supplied through the cooperation of the respective manufacturers or their agencies.

MAGNAVOX

Eight-Track Tape Player Model VE15-01, 02, 05, 06—Slow or Erratic Tape Speed

A condition of slow or erratic tape speed may be caused by the track sensor switch assembly. This condition can be corrected by replacing this part with a new assembly, Part No. 16N001-32.

BOTTOM VIEW OF TRACK SENSOR AND POWER SWITCH ACTUATOR

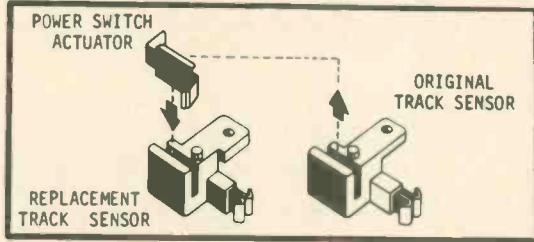

The new assembly has been designed to correct this condition by repositioning the mounting pin and screw hole to relocate the track sensor 1/16-inch further away from the tape.

After installation, be sure to check the adjustment of the cartridge pressure spring.

SYLVANIA

Simplified Operation of Flip-Flop

Herb Grossman, GTE Sylvania, Field Service District Manager, New York City

FLIP-FLOPS (BI-STABLE MULTIVIBRATOR)

A flip-flop is an electronic circuit analogous to a relay. The relay has two positions; the flip-flop has two stable states, and is able to switch from one state to the other at a very high rate of speed. Like the relay, the flip-flop is suitable for control and storing functions.

The flip-flop has two stable positions: set and reset. It must be in one of these positions, never balanced in between. It requires a definite pulse to switch it from the reset to the set position and a pulse in the opposite direction to put it back into the reset position. However, once the flip-flop is placed in the desired position, it remains there indefinitely.

The flip-flop has two pulse inputs and two output levels. A positive-going pulse on the set (S) input provides a static high level on the "1" output. A positive-going pulse on the reset (R) input provides a static high level on the "0" output. Notice that the two outputs are always at opposite voltage levels (logic 1 and 0).

In the DC state, one transistor is cut off and the other is conducting. When Q1 is cut off, Q2 is conducting and the voltage at the collector of Q1 is clamped at -6 volts. The voltage distribution across R1 and R2 causes the base of Q2 to be slightly negative in respect to ground, and Q2 is conducting. The potential at the collector of Q2 is approximately 0 volts and the voltage distribution across R3 and R4 causes the base of Q1 to be positive in respect to ground, keeping Q1 cut off.

When pin 5 is at 0 volt level and pin 7 changes from -6 to 0 volts, capacitor C4 discharges through R7. The

discharge current through R7 produces a differentiated voltage which is positive at the anode of CR4 with respect to ground. Diode CR4 is forward biased and the positive voltage appears at the base of Q2, turning it off. The collector voltage of Q2 changes to -6 volts, which is coupled back through R4 to the base of Q1, turning it on. The collector of Q1 rises to 0 volts which is applied to the base of Q2 through R3, keeping it turned off. Conversely, when

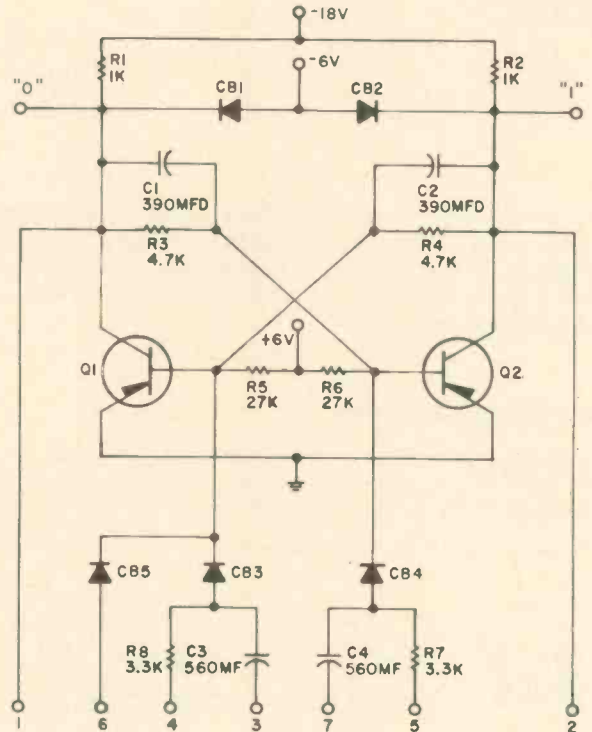

input 5 is -6 volts and a positive voltage change of less than 6 volts is applied to input 7, CR4 remains reverse biased and does not conduct. The positive level at the base of Q2 does not change, and it remains cut off. When the same levels are applied to inputs 3 and 4, the results are the same and Q1 is cut off. When a differentiated positive-going voltage is applied to input 6, Q1 is turned off, if it was conducting previously. ■

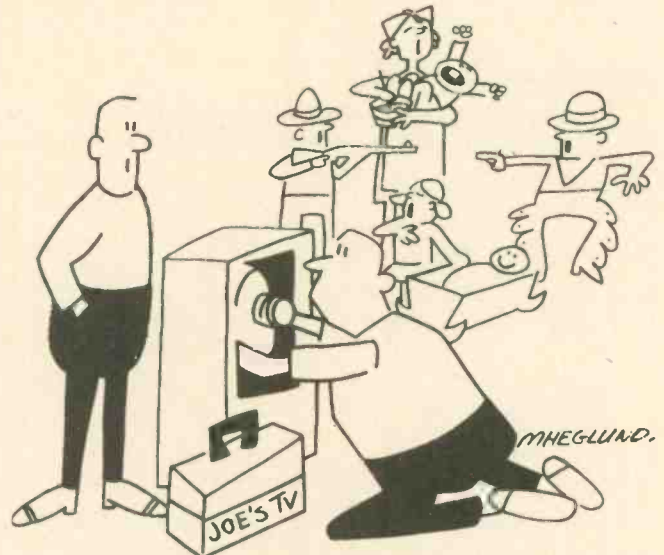

"I didn't notice that the sound wasn't working."

Test Instrument Report...

continued from page 41

UHF reception.

- 1) Leave the UHF antenna lead-in connected to the UHF antenna terminals or jack on the receiver.
- 2) Disconnect from the receiver VHF tuner the IF cable and plug it into the I.F. jack on the back of the Tuner-Mate.
- 3) Disconnect from the receiver VHF tuner the cable from the UHF tuner and plug it into the U.H.F. jack on the back of the Tuner-Mate.
- 4) Rotate the Tuner-Mate and receiver VHF tuner CHANNEL SELECTORS to the U position.
- 5) Turn on the receiver and the Tuner-Mate.
- 6) Rotate the receiver UHF tuner CHANNEL SELECTOR to an active channel and fine tune it to produce a normal picture. (If the UHF tuner of the receiver is equipped with a "hot carrier" diode mixer, the "normal" picture quality produced using this test setup might be slightly less than that normally produced by the receiver operating alone.)

If a relatively normal picture is obtained using this procedure, the UHF tuner probably is *not* defective. In such a case, the "UHF amplifier" section of the receiver VHF tuner or antenna system are prime suspects.

If a relatively normal picture is *not* obtained, the UHF tuner is defective, assuming that an adequate signal level is applied to the input of the receiver UHF tuner.

CONCLUSION

From the foregoing descriptions of the features and typical applications of the TeleMatic Model KT 730 Tuner-Mate Substi-Tuner, it should be obvious that it is a very versatile and effective test instrument for localizing troubles to the VHF and UHF tuners, video IF stages and AGC circuitry of both black-and-white and color TV receivers. The time it will save a technician during two or three service calls or bench jobs should be worth more than its \$45 price. Thereafter, the time and frustration saved by the Model KT 730 is all profit. ■

MOVING?

Be sure to let us know your new address. Please enclose a complete address label from one of your recent issues.

These new IR devices make replacing Zenith Semiconductors a local buy... everywhere!



Now you can buy International Rectifier's "Guaranteed" replacements for the most popular Zenith semiconductors right at your local IR distributor. Besides cutting days from the usual ordering-shipping cycle, they're priced locally too — more than competitive with the Zenith pricing structure.

Like everyone, we recognize Zenith's equipment is top quality, and we're not about to compromise their name, or ours. We analyzed circuits and devices for five months before we guaranteed that IR's devices will match, and meet or exceed Zenith's electrical and physical parameters in all applications.

Right now you can pick up a kit* of 23 IR semiconductors, and save an additional 10%.

Add it all up: Local availability. Local price. Guaranteed IR replacements for Zenith semiconductors. You can't lose.

* 13-Transistors; 5-ICs; 3-Rectifiers; 1-Diode; 1-Crystal.

INTERNATIONAL RECTIFIER

Semiconductor Division



233 Kansas Street, El Segundo, California 90245, Phone (213) 678-6281

... for more details circle 118 on Reader Service Card

NEW PRODUCTS

Descriptions and specifications of the products included in this department are provided by the manufacturers. For additional information, circle the corresponding numbers on the Reader Service Card in this issue.

MATCHING TRANSFORMER 701

For all-channel indoor or outdoor use

A 300-ohm to 75-ohm, all-channel, indoor-outdoor matching transformer is designed by Jerrold. Completely weather sealed for outdoor use, the Model T-3789 easily attaches to any 300-ohm output antenna, matching it

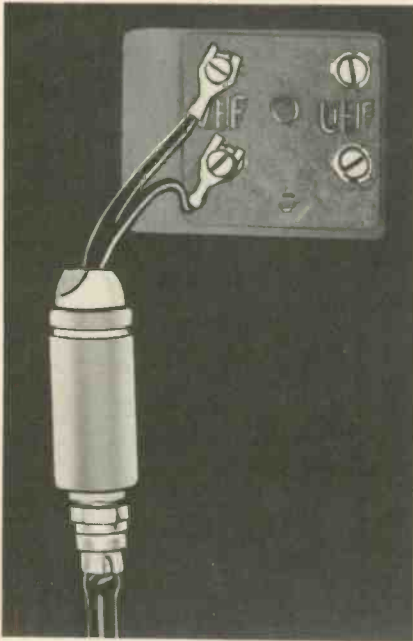

to 75-ohm coaxial cable. It also can be used on the back of a TV set, to match coaxial cable to the receiver input. Insertion loss of the unit is 0.5dB at VHF and 1.0dB at UHF frequencies, and it provides both AC and DC isolation. Price is \$2.05.

DIGITAL VOM 702

Combines the advantages of both digital and analog displays

A new 460-2 VOM, from Simpson Electric Co., combines the advantages of both digital and analog displays in a portable instrument. Designed as an all-purpose instrument, it operates either from AC line voltage or automatically recharging internal batteries. The primary readout is a 0.33-inch-high, nonblinking, 3½ digit LED display with automatic blanking of nonsignificant zeros. The display is large and bright, visible even in direct sunlight. The analog readout is a dual-scale ro-

tating drum meter that complements the digital display by making it easy

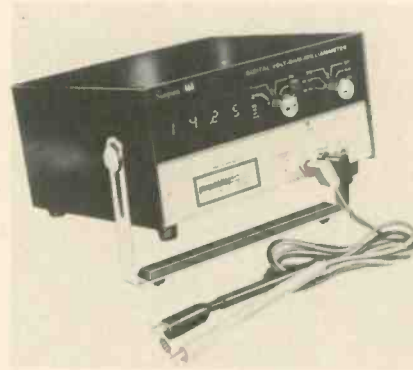

to scan peaks or nulls on its linear lower scale. The upper analog scale provides dB readings. Twenty-six ranges are provided: five each for AC and DC voltage and current, and six for resistance measurements. Accuracy on DC ranges is ± 0.1 percent of reading ± 1 digit for voltage, and ± 0.2 percent ± 1 digit for current. Price is \$375.00 for the 115v AC-powered version.

SELF-ADJUSTING WIRE STRIPPER 703

Automatically adjusts for different wire sizes

A new stripper and cutter that automatically adjusts for different wire sizes is introduced by ITT Holub Industries. It is an "end type" stripper, designed for use with No. 18-10 free stripping wire, solid or stranded and two-conductor lamp cord of the separable type. The wire to be stripped is held in the end of the tool, between the cutting blades. Squeezing the handles causes grippers to hold the wire, cutting blades to cut through the insulation and move approximately 5/8 inch, which pulls the insulation loose. Maximum stripping length is 1½ inch. The tool has plastic handle grips and a latch to hold the handles together when not in use. Overall length is 6¾ inch.



SUBSTITUTE TUNER 704

Operates on all VHF channels with variable RF output

The TeleMatic Tuner-Mate Portable Substi-Tuner KT 730 is the latest addition to the Kaddy-Mate line. This fully shielded, compact substitute tuner

operates on all VHF channels (2-13), with the capability of checking the output of the existing UHF tuner by the process of elimination. This unit can be used on the bench or in the field, with variable RF output to pin-



point trouble in the antenna, tuner or any stage of the Video IF. The tuner is powered by two 9v batteries. Price is \$45.

AC LEAKAGE TESTER 705

Detects potential shock hazards in electrically operated equipment

A new easy-to-use test instrument which is designed to check for potential shock hazards in electrically operated home appliances, television receivers and equipment is introduced by RCA Electronic Components. The Model WT-540A AC Leakage Tester can be used by TV and appliance service technicians to assure that a serious shock hazard is not present in the

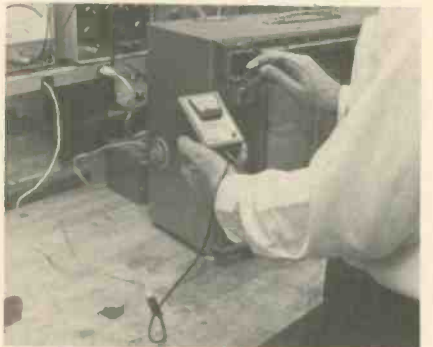

customer's electrically operated appliance or other home electronic equipment. This easy-to-use instrument has no switches, dials or other controls and is used by simply connecting the black test lead to a suitable ground point and the red test probe to the metal parts of the product under test. There is only one range and one meter scale, color coded red and green to indicate safe and unsafe leakage levels. The rec-

ommended leakage limits of 0.5ma and 0.75ma are clearly indicated. The unit requires no batteries and is completely portable, measuring 2 $\frac{1}{2}$ inches by 4 inches by 2 inches and weighing only 9 $\frac{1}{2}$ ounces.

SOLDER 706

A low-melting-point, thin solder

A new, low-melting-point, thin solder in a convenient, self-feed plastic dispenser is introduced by GC Electronics. Especially designed for today's printed-circuit needs, Fine Line Solder,



Cat. No. 9132, is 60/40 rosin core type and .032 inches in diameter—excellent for kit construction and other applications. The self-feed dispenser holds over 12 feet of solder and is made of clear plastic so that the amount of remaining solder can easily be seen.

DIGITAL MULTIMETER 707

Automatic range selection for five functions

The Model 168, Autoranging Digital Multimeter is a new addition to Keithley's line of digital multimeters. The unit automatically selects the proper range and moves the decimal point into the correct position. Also,



the direct-reading LED display of the unit automatically indicates all information pertinent to a reading—including function—in unambiguous terms. The input has just two terminals for all

continued on next page

TUN-O-POWER RESTORES TUNERS!



Take a really bad tuner. The contacts are so dirty you have to wiggle the knob to pull in a channel.

Remove the tuner cover and spray in TUN-O-POWER. Rotate the tuner a couple of times. Then stand back and admire the results.

The tuner contacts are not just clean, they're shined to a high luster. And they're coated with a long lasting lubricant that makes detent action smooth as silk.

TUN-O-POWER is available from your Chemtronics Distributor.

Try it. You'll love it.

CHEMTRONICS
INCORPORATED
1260 RALPH AVE., BROOKLYN, N.Y. 11236
Our business is improving yours.

... for more details circle 107 on Reader Service Card

measurements on all functions. The five functions are selected by front-panel pushbuttons and cover a total of 24 different ranges. Included are five ranges of AC and DC voltage, six ranges of resistance, and four ranges of AC and DC current. Basic DC accuracy is ± 0.1 percent of reading. The five functions span 100 microvolts to 1000v DC, 100 microvolts to 500v RMS AC, 100 milliohms to 20 megohms, and 100 nanoamperes to 1 ampere AC and DC. The basic AC voltage accuracy of ± 0.5 percent of reading is guaranteed down to 20 Hz. Price is \$299.

METRIC HEX SOCKET SCREWDRIVERS

708

Contained in a handy roll-up kit

A line of fixed-handle hex socket screwdrivers in a wide range of metric sizes is available from Xcelite. The LN-8MM set consists of eight drivers, with black plastic handles and hex tip sizes from 1.27mm to 6mm, contained in a handy roll-up kit that keeps tools together and in order whether carried in the pocket or a tool caddy. Blades, measuring 101.60mm (four inch), are protected by a black oxide finish. Handle dimensions are $\frac{7}{8}$ inch by $2\frac{5}{8}$ inch

for the smaller drivers and $1\frac{1}{16}$ inch by $3\frac{1}{8}$ inch for the larger. Overall screwdriver lengths are $6\frac{3}{8}$ inch and

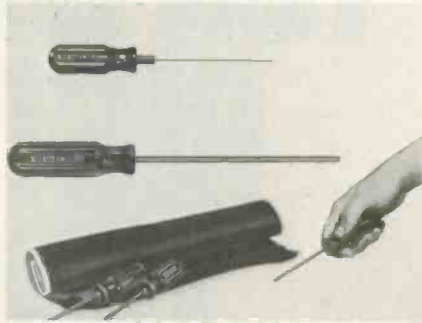

$7\frac{1}{8}$ inch, respectively. The drivers may be purchased either singly or in sets.

DIGITAL MULTIMETER

709

$3\frac{1}{2}$ digit, portable unit with built-in battery charger

Digitec's Model 2110 Multimeter is a $3\frac{1}{2}$ digit, bi-polar, portable unit. All printed-circuit boards, integrated circuits and readouts are plug-in, for easy replacement. Provision is also made for the convenient field insertion of internal rechargeable batteries, to facilitate portability. DC ranges extend from 199.9mv F.S. to 1kv F.S. with a

basic accuracy of 0.1 percent of reading. AC voltages can be measured from 1.999v F.S. to 500v F.S. with an accuracy of 0.5 percent of reading. Resistance ranges extend from 199.9 F.S. to 19.99M F.S. with a basic accuracy of 0.5 percent of reading. All functions are selected by pushbutton switches, while the ranges are selected by a rotary switch. The display utilizes easy-to-read LED's. Input signals which exceed the selected range are

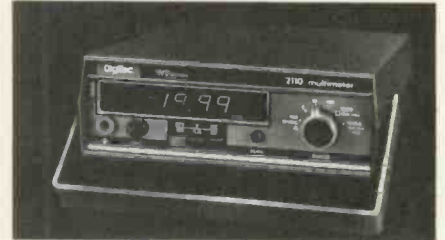

indicated by blanking of all numerals except the decimal point, preventing erroneous reading. Price is \$219.

OSCILLOSCOPE

710

Features DC-3MHz bandwidth and 20mv/cm vertical sensitivity

The Systems Model 57 triggered oscilloscope can operate on either 110 or 220v, 50-60Hz and has a vertical

Rack up extra profits on the QT.

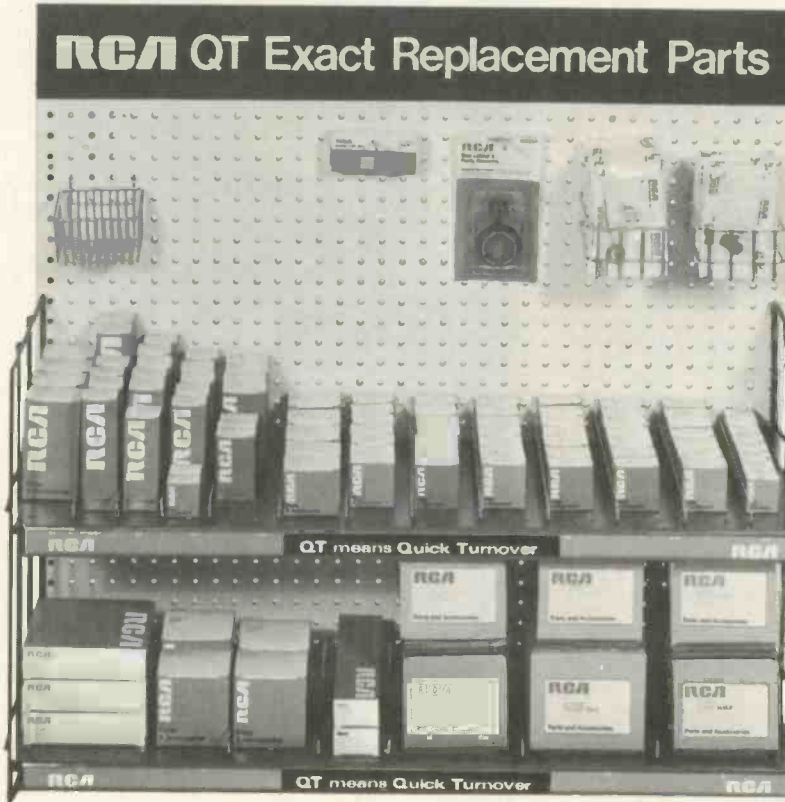

New RCA "QT" Rack stores your fastest-moving TV replacement parts within easy reach.

The new RCA "QT" (Quick Turnover) Inventory Selector Rack is the most efficient way to store the most-frequently used RCA TV replacement parts. It puts the parts you need most at your fingertips, for easier control, faster servicing.

Re-designed with two shelves, ample pegboard space for hanging blister-packaged parts, and two wire baskets for neatly holding film-wrapped items, this new "QT" rack makes it handier than ever to stock parts and find them quickly. It's sturdy, but light enough to be safely hung on a wall.

Your RCA "QT" Parts Distributor has a parts inventory system designed to meet your needs. See him soon. Or contact RCA Parts and Accessories, P.O. Box 100, Deptford, N.J. 08096.

RCA

... for more details circle 139 on Reader Service Card



bandwidth of DC to 3MHz, a vertical sensitivity of 20mv/cm, plus a 1µsec/cm to 0.5sec/cm sweep speed coverage in 11 calibrated steps. Other specifications are: vertical deflection factor—20mv/div. to 10v/div. in nine steps; input impedance—1M shunted by 30pF; maximum input—400v; X5 horizontal deflection sweep expansion. The control panel features a metallic-brush anodized face that includes blue and red coded legends to identify the vertical and horizontal deflection controls. Encased in an insulated, vinyl-finish-protective aluminum cabinet, it weighs 15 lb. and measures 4½ in. high x 9¾ in. wide, and 12¼ in. long. Price is \$275.

HIGH-VOLTAGE TEST PROBE

Reads high voltage to **711**
36 Kv, with self-contained meter

A new, advanced version of the self-contained picture tube high-voltage test probe, Model 4000, with built-in meter, is designed by Pomona Electronics. The probe can be used to test all existing black-and-white and color television receivers, including new and future models with voltages up to 36 Kv. It can be used to make high-voltage adjustments in the home without the need for extra equipment, and is small enough to be carried in a tube caddy. To use, simply ground the instrument, contact the high-voltage anode with the probe tip, and read voltage from the self-contained meter. Price is \$24.95.



CABLE SHEATH STRIPPER 712

Strips all sizes of plastic and fabric-covered cables

A tool for stripping the jacket from all sizes of plastic and fabric-covered cables is introduced by P. K. Neuses, Inc. The rigid, red, phenolic handle is *continued on next page*

INTRODUCING TWO PRODUCTS YOU KNEW WE HAD BUT DIDN'T KNOW WE HAD

BLUE SHOWER FLYBACK CLEANER & BLUE SHOWER CHASSIS CLEANER



Yes, we know the can says BLUE SHOWER FOR TUNERS . . . that's because all three products are one and the same.

BLUE SHOWER TUNER CLEANER has been around for a long time, but since some technicians just use it for cleaning tuners we wanted to let them know they're missing a good bet. BLUE SHOWER cleans up dusty high voltage cages that are arcing, fuzzy tube sockets losing signal, dirty controls, chassis and PC boards. It cleans quickly, leaves no residue and is handy as can be, especially since it comes in

TWO SIZES — In addition to the 24 ounce bench size can we also have a 12 ounce caddy size can which just fits into a tube caddy — Ideal for carrying into the home where you can use it to

SAVE MONEY — Every minute you or your men can save on house calls is money in your pocket. Besides saving you time and money BLUE SHOWER can help make the set run better which isn't going to hurt your image a bit.

Let us help you save Time and Money — Put a caddy sized can of BLUE SHOWER in your tube caddy today . . . At better distributors everywhere.

**TECH
SPRAY**

P. O. Box 949 • Amarillo, Texas 79105

TO INTRODUCE YOU TO THESE NEW USES WE'RE OFFERING . . .

A Special Pack of:

2 cans 24 oz. BLUE SHOWER at 3.59 7.18
2 cans 12 oz. BLUE SHOWER at 2.19 4.38

AT MOST

Regular Total 11.56

**TECH
SPRAY**
DISTRIBUTORS

FOR JUST 9.99

Attend the NESDA and ISCT Conventions — August — Hawaii.

. . . for more details circle 127 on Reader Service Card

3 ways to deliver the clearest TV picture

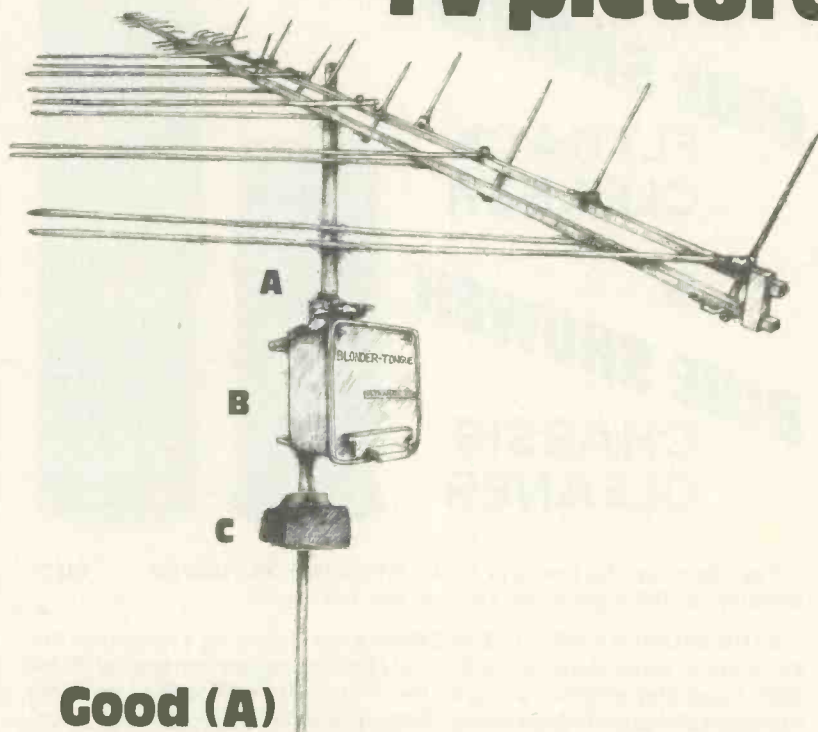

Good (A)

The all-channel Prisametric 0719 combines super-sharp VHF pick-up with high gain and flat response on all channels for top color performance. Uses 21 UHF reception elements for ghost-free and interference-free directivity. One of eleven Prisametric models, color certified for suburban and fringe areas.

Better (A+C)

Add the Horizon, ultra low-noise VHF two set amplifier to the Prisametric 0719. It's back-matched for clearer color pictures. Patented ICEF circuit delivers wide dynamic range so strong signals won't overload weak ones. Solid-state, trouble-free circuitry, four-way lightning and surge protection. Temperature compensation for all-weather reliability. Two individual amplifier circuits, one for channels 2 to 6, the other for 7 to 13.

Best (A+B+C)

A dynamic trio. The Prisametric 0719, the Horizon and Blonder-Tongue's new Ultramatic 1000 automatic rotator. Combines highest turning power of any unit on the market with ultra-precise positioning. Solid-state motor power switching eliminates moving contacts for greater reliability and repeatability. Motor uses filtered DC power supply for 1/3 higher starting and running torque. The differential amplifier in the servo loop insures accuracy within 2°.

These and other TV reception outdoor products are now a part of the Blonder-Tongue Product of the Month promotion. Get details, Blonder-Tongue Laboratories, Inc., One Jake Brown Rd., Old Bridge, N.J. 08857.

BLONDER-TONGUE

... for more details circle 104 on Reader Service Card

equipped with a razor blade at one end, with an "L" shape hardened steel guide and blade guard. The handle is shaped to fit the worker's hand and is so constructed that the hand is fully protected from skinned knuckles



through contact with the cable jacket. The N-2878 stripper has a stainless steel saddle with heavy nickel-plated screw bushings which hold the guide and blade in place. The cable jacket is slit neatly and cleanly, without damage to wire or insulation. Blades are reversible for new cutting edges.

MOBILE SHELF CARRIER 713

Provides strength and versatility

SGL Waber Electric has added a new heavy-duty shelf carrier to its line of material and instrument transports.

The carrier, Model LOW-13, is constructed of one-inch square steel tubing with a durable, easy-to-clean, chromium plated finish. It offers the convenience of four sturdy shelves, with the two middle shelves adjustable in one and

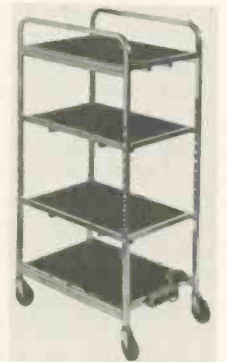

a half inch increments. Each shelf is constructed of half-inch plywood with a thick-ribbed, non-slip, laminated top. The shelf size is 20 inches by 29 inches with an overall carrier height of 60 inches. It also features 5-inch, heavy-duty rubber casters; an electrical outlet strip with three "U" ground outlets; pilot light; on/off switch; and fuse protection. Price is \$180.

SOLID-STATE TUBES 714

Exact replacements for industrial rectifier tubes

A new line of plug-in, solid-state "tubes" which are exact replacements for industrial rectifier tubes are intro-

duced by EDI. These silicon solid tubes will replace most regular gaseous and vacuum rectifier tubes with ratings up to 1750ma and 60kv. Higher voltages and currents are available as specials. The tubes have any number of



advantages: No need for filament transformers, solid-state reliability, constant output, long life, no heat generation, compact construction, and fast warm-up.

WIRING TOOL AND CRIMPER

Measurement markings for bolt and wire strip length

715

A completely new wiring tool and crimper, called the "Wireplier," is introduced by Vaco Products Co. The tool has several new features that include a crimping die for 6- and 8-gauge noninsulated terminals, a 7mm crimping die for ignition terminals, stripping dies for 6- and 8-gauge wire, and measurement markings for bolts and wire strip length. These features are in addition to a wire cutter, stripping dies (10-22 AWG), crimping dies



for insulated or noninsulated solderless terminals (10-22 AWG) and five bolt cutting dies (4-40, 6-32, 10-24 and 10-32). The tool measures 8 7/8 inches long, and has a black oxide finish with white markings and giant cushion grip handles for a comfortable squeeze. Price is \$7.95. ■

NOW



Original Replacement Parts

for

Radio ■ Stereo ■ Television

All Out-of-Warranty Replacement Components

Available from your local
J. W. Miller Distributor



Sanyo National Representative

BELL INDUSTRIES / J. W. Miller Division

19070 REYES AVENUE • P.O. BOX 5825 • COMPTON, CALIFORNIA 90224

... for more details circle 102 on Reader Service Card



PERMA-CLEAN®
TUNER TABS

STOP!
ERRATIC
TUNERS



**"AUTOMATION" FOR
TUNER CLEANING IS HERE!**

Sulfurs, oxides and other films have caused chronic cleaning problems for years. Perma-Clean Tuner Tabs "Automatically" cleans the tuner contacts everytime the channel selector is rotated.

The cells of Tuner Tabs are impregnated with "Perma-Clean" a non-evaporating cleaner that will not cake or harden.

DEALER NET

\$9.95 PER/CARD OF 12 TABS

Designed For B/W
and Color Strip
Type VHF Tuners

INSTALL 2 TABS THE OTHER 10 ARE YOUR PROFIT

See your local parts distributor or write to

In Canada:

len finkler ltd

25 Toro Road, Downsview, Ontario

UNIVERSAL TUNER TABS MFG., INC.
12400 Minnetonka Blvd.
Hopkins, Minn. 55343

... for more details circle 132 on Reader Service Card

ARROW AUTOMATIC STAPLE GUNS

CUT WIRE & CABLE INSTALLATION COSTS

... without cutting into insulation!

SAFE! Grooved Guide positions wire for proper staple envelopment! Grooved Driving Blade stops staple at right depth of penetration to prevent cutting into wire or cable insulation!

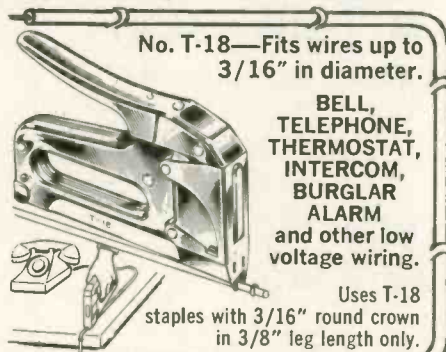

No. T-18—Fits wires up to 3/16" in diameter.

BELL, TELEPHONE, THERMOSTAT, INTERCOM, BURGLAR ALARM and other low voltage wiring.

Uses T-18 staples with 3/16" round crown in 3/8" leg length only.

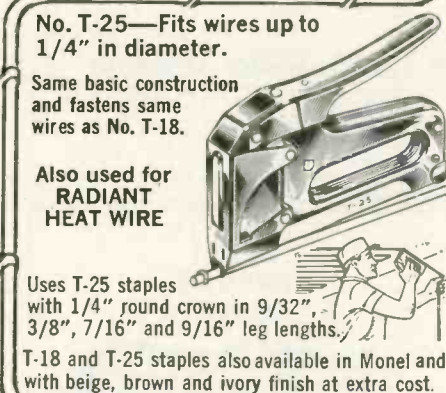

No. T-25—Fits wires up to 1/4" in diameter.

Same basic construction and fastens same wires as No. T-18.

Also used for RADIANT HEAT WIRE

Uses T-25 staples with 1/4" round crown in 9/32", 3/8", 7/16" and 9/16" leg lengths.

T-18 and T-25 staples also available in Monel and with beige, brown and ivory finish at extra cost.

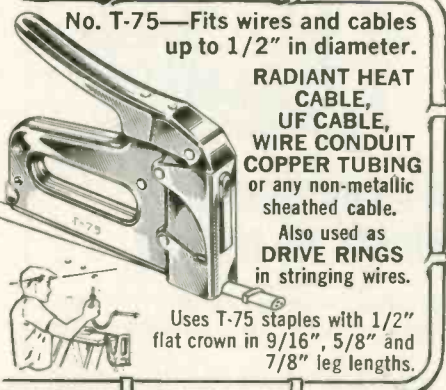

No. T-75—Fits wires and cables up to 1/2" in diameter.

RADIANT HEAT CABLE, UF CABLE, WIRE CONDUIT COPPER TUBING or any non-metallic sheathed cable.

Also used as DRIVE RINGS in stringing wires.

Uses T-75 staples with 1/2" flat crown in 9/16", 5/8" and 7/8" leg lengths.

Arrow Automatic Staple Guns save 70% in time and effort on every type of wire or cable fastening job. Arrow staples are specially designed with divergent-pointed legs for easier driving and rosin-coated for greater holding power! All-steel construction and high-carbon hardened steel working parts are your assurance of maximum long-life service and trouble-free performance.

Ask your Electrical Supply Dealer or write for further details.

ARROW FASTENER COMPANY INC.
Saddle Brook, New Jersey 07863
"Pioneers and Pacesetters
For Almost A Half Century"

... for more details circle 101 on Reader Service Card

DEALER SHOWCASE

Descriptions and specifications of the products included in this department are provided by the manufacturers. For additional information, circle the corresponding numbers on the Reader Service Card in this issue.

CASSETTE RECORDER 716

Battery operated with built-in microphone

The General Electric Model M8710 miniature pushbutton cassette recorder measures only 1-3/4 in. x 5-3/4 in. x 4-3/8 in. and weighs 2 lb. The unit is equipped with a sensitive built-in condenser microphone and uses standard size tapes. There is a combination



play/record button for easy one-hand use. The tiny recorder uses four "AA" type batteries and features a jack for an optional AC power adapter. An earphone jack is provided for transcribing or for private listening. A built-in erase guard prevents accidental erasure of pre-recorded tapes. Price is \$54.95.

PHONOGRAPH NEEDLES 717

Six kits cover most major brands

EV Game presents a merchandising program termed "Caddi-Kits" which is designed to give the servicing dealer the diamond needles he requires to service phonographs that are popular in his area. There are six kits, each containing an assortment of 12 diamond needles, to cover the major brands of phonographs. The initial six kits are designed to replace the popular needles used by GE, RCA, EV, Magnavox, Zenith, BSR, Astatic and

Varo. Also included is a universal kit which contains one each of the twelve fastest selling diamond needles. The

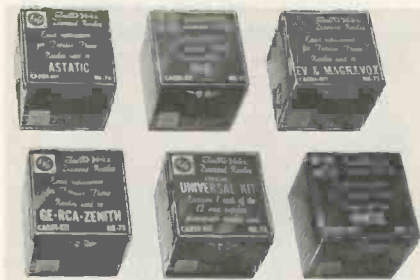

Caddi-Kits are available individually or by the sampler kit, SNK-6, which is one each of the six kits packaged for sales presentations. Each assortment is packed in a clear plastic box approximately 2 1/2 in. sq., with a self-inventor and cross-reference label that is color coded for ease of identification.

TURNTABLE 718

Heavy belt-driven platter with 4-pole synchronous motor

The Model SR-212, two-speed turntable, introduced by Sansui Electronics Corp., features a heavy belt-driven, 12-

FREE CATALOG

HARD-TO-FIND PRECISION TOOLS

Lists more than 2000 items—pliers, tweezers, wire strippers, vacuum systems, relay tools, optical equipment, tool kits and cases. Also includes ten pages of useful "Tool Tips" to aid in tool selection.

JENSEN TOOLS
4117 N. 44th Street, Phoenix, Ariz. 85018

... for more details circle 119 on Reader Service Card

DISCOUNT TEST EQUIPMENT SPECIALISTS

B&K
SENCORE
EICO® Leader

COMPLETE LINE OF ELECTRONIC SUPPLIES
ICC/Mullard & Raytheon Tubes
Telematic Test Rigs

FREE CATALOG

FORDHAM
Radio Supply Co., Inc.
558 Morris Ave., Bronx, N.Y. 10451
Tel: (212) 585-0330

... for more details circle 137 on Reader Service Card

inch, aluminum alloy platter. The motor is a stable 4-pole synchronous design that maintains constant speed regardless of line voltage variations. The cueing device is damped going up as well as down. There is no chance for tone-arm snap-up and loss of correct position when just a pause in play is desired. The tone-arm is an S-shaped design with an anti-skate counterbalance in addition to the conventional



style force counterbalance weight. The unit comes complete with walnut base, from which it is isolated by a special anti-howling suspension system. Price is \$149.95.

TRAVEL ANTENNA

719

*No cranks or gears
and operates from inside*

The ACA Model AC800K Custom Travel-Tron TV antenna is designed for motor homes, campers and boats. The combination VHF/UHF/FM antenna opens and closes like an umbrella and is operated from the inside of the vehicle. The compact unit is weatherproof and uses an automatic roof cap to seal out the weather when the antenna is down and in the travel position. The unit includes all mounting hardware, 75-ohm coaxial cable with fittings, and back-of-set UHF/VHF band separator with matching transformer. Price is \$39.95.



SSB/AM CB TWO-WAY RADIO

*Has 25w input, 12w
PEP output power*

720

The Diamond 60, by Tram Corp., has the new higher FCC power limit
continued on next page

When the big name companies fail you, come to the solid state of Workman.

It happens. Boy, does it ever happen.

Well, next time call Workman. Off-the-shelf delivery and prompt, attentive service has been our stock in trade for years.

And our new WEP semi-conductor line is going to carry on the tradition. It's got a few other things going for it too:

The packaging does a lot of work for you—cross-referenced to all major lines right on the face of the card. The back of the card has basing diagram and full specifications with symbol and ratings.

About 200 WEP numbers offer one-for-one replacement against competitive lines and our complete cross referencing enables them to replace up to 1000 numbers in other lines.

The whole line is fully warranted and we've designed it to make life as easy as possible for you.

Which is a pretty good reason for not waiting for someone else to flop before you call us.

After all, things are complicated enough today.

Workman. Your first second resource for replacement components.

Workman Electronic Products, Inc. Box 3828, Sarasota, Florida 33578
A subsidiary of IPM Technology, Inc.



on each of its 46 SSB channels and 23 AM channels. The hazard of transmitter final RF amplifier transistor failure has been eliminated by an auto-



matic fail-safe protection circuitry. The radio combines a comprehensive mix of features that includes power and SWR metering, microphone gain control, true RF noise blanking, RF gain control, public-address paging and a theft-deterrent mounting system. It is designed to provide base station performance for the mobile user.

Specifications indicate high receiver sensitivity (.1 microvolt for 10dB S +N/N), adjacent channel rejection (60 dB) and wide transmitter frequency control (± 800 Hz). Price is \$349.95.

FM/AM/RADIO/CASSETTE- 721 RECORDER

Includes built-in condenser microphone and auto shut-off

A portable Cassette-Corder AM/FM radio, Model CF-310, from Sony, has a built-in condenser microphone for on-the-go recording, plus a jack to accommodate an external microphone. Primary features include a variable monitor, permitting the user to adjust speaker volume without affecting record level, and automatic shutoff. Also

featured is a recording control for hands-off recording convenience, a record-level/battery strength indicator, and locking fast forward and rewind



The case for more profitable service calls:

RCA's new bigger, better Module Caddy



It has more than twice the capacity of the previous Module Caddy. And that lets you carry a greater variety and larger supply of the modules used most in color TV repairs. So you can make more service calls — and more profit — on each trip out of the shop.

The new Module Caddy has plenty of storage space in the lid, as well as in the bottom of the case. A special flip-divider snaps in place between lid and case to keep things in order.

With the Caddy come the 12 most-used modules for servicing RCA XL-100 sets. But there's plenty of room for extra modules of your own choosing, the XL-100 components kit, the RCA Home Service Handbook, and some small tools.

Even with all its extra capacity, the new Caddy is only 8 inches thin, making it easy to handle. And it has the same rugged construction as RCA's original Module Caddy.

See your RCA Distributor, or contact RCA Parts and Accessories, P.O. Box 100, Deptford, N.J. 08096.

RCA

... for more details circle 140 on Reader Service Card

control. Portability is provided by its 3-way powering capability: AC, DC, or through built-in recharging circuitry in conjunction with an optional rechargeable battery pack. Price is \$119.95.

ELECTRICAL PLUG LOCK 722

Prevents the unwanted use of electrical equipment

A device that literally "locks up" electric equipment is being marketed by Mercury Manufacturing. Smaller than a pack of cigarettes, Plug Lock contains a plug receptacle and three



numbered dials. Simply insert the plug into the unit, twirl the dials and the equipment is inoperative. To remove, just dial the three number combination. The unit fits both two- and three-prong 110v power plugs and has a plastic strap for attaching to power cords. It comes in an attractive counter display box with six units to a box. Price of the Plug Lock is \$2.50. ■

For more information
concerning
DEALER SHOWCASE
Use pages 61 & 62 for
READERS SERVICE

a 26 year PRICE FREEZE

In spite of rising production costs, labor, materials, freight, etc. Electronic Chemical still maintains the same high quality and low price as in our very first year.

Volume Control and Contact Restorer

For special attention to volume controls, push button assemblies, band switches, relays and other electrical contacts.



For Color and B/W

Tuner Tonic

Cleans and lubricates tuners (incl. wafer type) -- economical, a little does a lot.

No-Noise products guaranteed non-flammable, no carbon tet, non-toxic - safe for plastics.



Super Spray Bath

Dissolve and flush away grease, dirt, oil and oxidation. Used for magnetic heads, computers, relays and switches, Tel & Tel equipment, switchboards and switching devices, record changers, timers, automotive and aircraft equipment, printed circuit boards.



Often imitated but never duplicated

Other "No-Noise" Products:

- EC-44 Super Lube
- Frigid Air
- Tape-Reco Head Cleaner

ELECTRONIC CHEMICAL CORP.

813 Communipaw Avenue Jersey City, N. J. 07304

... for more details circle 112 on Reader Service Card

endeco Soldering and Desoldering KITS



Model 500K
12-piece
desoldering kit
\$21.55 NET

- Soldering kits • Desoldering kits
- Soldering-Desoldering kits

Everything needed to solder or desolder, or both. Featuring new Endeco soldering and desoldering irons with safety light ... the irons professionals really appreciate. Tips, stand, desoldering head and cleaning tool included, as required, all in a metal box with hasp. \$21.55 to \$39.65.

To locate your nearest distributor call toll-free 800-645-9200



5127 EAST 65TH ST.
INDIANAPOLIS,
INDIANA 46220
PHONE 317/251-1231

enterprise
development
corporation

... for more details circle 114 on Reader Service Card

TECHNICAL LITERATURE

Automotive Fuse Replacement Guide

A 44-page, all-in-one, automotive fuse replacement guide covers both domestic and foreign automobiles, taxis, trucks, sports cars, and school buses. Listed are manufacturer, year and model, protected circuits and accessories, fuse, fuse description, and normal mounting and location of the fuseholder. The back cover features full-size illustrations of AG, SFE, and foreign car fuses for fast visual checks, permitting quick identification and correct replacement of blown fuses. Dept. PR, Littelfuse, Inc., 800 East Northwest Highway, Des Plaines, Ill. 60016.

RF Tuning Diodes

A 6-page brochure contains specifications and application data for variable capacitance tuning, band switching and AFC diodes. It also contains charts of Diode Capacitance vs Reverse Voltage for all 12 types, outline drawings of the five different package configurations available, and a sample schematic diagram of the front end of an FM auto radio showing the use of three of the diode types. Amperex Electronic Corp., Solid State and Active Devices Div., Slatersville, Rhode Island 02876.

Radio and TV Manuals

For years Supreme Publications' manuals remained at their "unchangeable" prices. But no more, we have just been informed that prices are being changed, and again they prove to be different, raising most prices but reducing some. A new catalog price list is now available. Supreme Publications, 1760 Balsam Road, Highland Park, Ill. 60035.

Panel Meters

A new catalog describing their complete line of miniature and subminiature panels is available. About two dozen different styles are illustrated, ranging in size from less than 1 inch to 4.75 inch wide. The meter designs include many varied shapes and styles such as edge reading, flat, round, square, keystone, oblong, etc. Mura Corporation, 50 So. Service Rd., Jericho, N.Y. 11753. ■

World's best Multimeter

93 Ranges. $\pm 1.5\%$ Basic Accuracy
100M Ω Impedance. FET Input.
Frequencies to 1GHz



MASTERANGER®

gives you 61 built-in ranges with $\pm 1.5\%$ accuracy or better:

- 0-1.5mV to 0-1500V AC & DC
- 0-0.15 μ A to 0-1.5A AC & DC
- 0-10k Ω to 0-10,000M Ω , output <24mV
- -60dBm to +60dBm in 10dBm steps
- Galvanometer & Null Detection

32 additional ranges with optional accessories:

- 0-1.5kV to 0-50kV AC & DC @ $\pm 1.5\%$ acc.
- 0-5V to 0-1500V AC (P-P) @ $\pm 1.5\%$ acc.
- 0-1.5V to 0-500V RF & VSWR @ $\pm 5\%$ acc.
- 0-5A to 0-150A AC & DC @ $\pm 5\%$ acc.
- -150°C to +500°C in 5 ranges @ $\pm 1.5\%$ acc.

More ranges, better accuracy than Triplett, HP, and others. Send now for brochure and address of local sales office.

\$245. MONEY BACK if not satisfied for any reason in first 30 days



Durable
INTERNATIONAL, INC.
Instrument Division

3-01 Twenty-Seventh Ave.,
Long Island City, N.Y. 11102 (212) 726-1200

... for more details circle 109 on Reader Service Card

**Your
Centralab
Distributor has
just the right one**

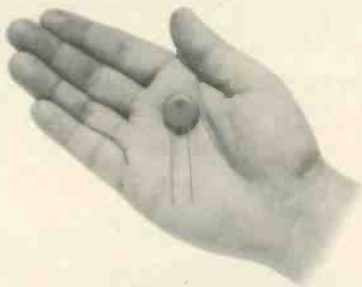

or all of them



Your Centralab Distributor has the most complete line of ceramic capacitors available. He's your best supplier of just the right capacitor for fast, reliable replacement service.

Choose from low voltage, semiconductor type, general purpose, high voltage and Gap-Kap® Ceramic disc capacitors. Available with voltage ratings from 3 V to 6000 V in values from .75 pf to 2.2 mf.

Your Centralab Distributor stocks other highly reliable special application ceramic capacitors including feed-thru and transmitting types. He's also your source for a wide range of polystyrene capacitors and miniature electrolytics in both axial and radial lead styles. Check your parts stock, then call your Centralab Distributor. He has just the capacitors you need.

DISTRIBUTOR PRODUCTS



CENTRALAB
Electronics Division
GLOBE-UNION INC.

5757 NORTH GREEN BAY AVENUE
MILWAUKEE, WISCONSIN 53201

READERS SERVICE INDEX

ADVERTISER'S INDEX

101	Arrow Fasteners	56
102	Bell Industries	55
103	B & K Division, Dynascan	22
104	Blonder-Tongue	54
105	Book Club—Tab Books	18-21
106	Centralab Distributor	60
107	Chemtronics, Inc.	51
108	Cusack	46
109	Durable Instruments	59
110	Edsyn, Inc.	47
111	Eico	47
112	Electronic Chemical	59
113	Elpa Marketing	10
114	Enterprise Development Corp.	59
115	Finney	60
137	Fordham Radio Supply Co.	56
116	GC Electronics	15
	General Electric—Tube Div.	14
	GTE Sylvania Consumer Renewal	3, 11
117	Heath Company	44
118	International Rectifier	49
119	Jensen Tools & Alloys	56
120	Leader Instruments	14
121	LPS Research Labs	45
122	Mallory Distributor Products	4
123	Panasonic—Service Div.	Cover 3
124	PTS Electronics, Inc.	Cover 2
138	RCA	8
139	RCA	52
140	RCA	58
	RCA Picture Tubes	32
125	Sprague Products Co.	9
126	T & T	12
127	Tech Spray	53
128	Tech Spray	60
129	Telematic	12
130	Triplet Corp.	Cover 4
131	Tuner Service Corp.	13
132	Universal Tuner Tabs	55
133	Wavetek	43
134	Weller-Xcelite	6-7
135	Winegard Co.	45
136	Workman Electronic Products	57

NEW PRODUCTS

701	Matching Transformer	50
702	Digital VOM	50
703	Self-Adjusting Wire Stripper	50
704	Substitute Tuner	50
705	AC Leakage Tester	50
706	Solder	51
707	Digital Multimeter	51
708	Metric Hex Socket Screwdrivers	52
709	Digital Multimeter	52
710	Oscilloscope	52
711	High-Voltage Test Probe	53
712	Cable Sheath Stripper	53
713	Mobile Shelf Carrier	54
714	Solid-State Tubes	54
715	Wiring Tool and Crimper	55
716	Cassette Recorder	56
717	Phonograph Needles	56
718	Turntable	56
719	Travel Antenna	57
720	SSB/AM CB Two-Way Radio	57
721	FM/AM/Radio/Cassette-Recorder	58
722	Electrical Plug Lock	58

FINCO

Handy-Helper DOLLY

For MOVING and LIFTING

• TV • APPLIANCES • FURNITURE • LARGE CARTONS

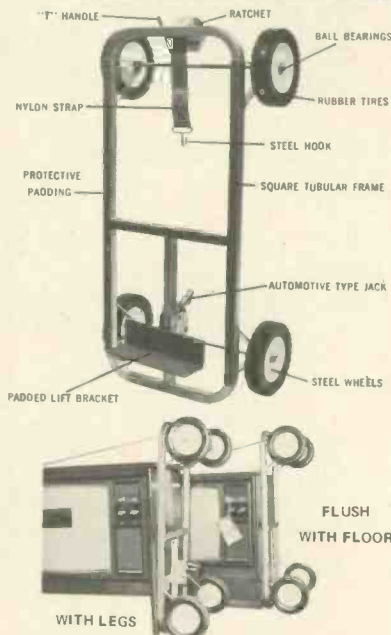

Model TC-1 DEALER NET

WRITE FOR CATALOG 20-621, Dept. ET/D 5/74

The FINNEY Co.
34 West Interstate Street
Bedford, Ohio 44146

... for more details circle 115 on Reader Service Card

BLUE STUFF FOR TUNERS

A MONEY MAKER...
any way you look at it

**TECH
SPRAY**

P. O. Box 949
Amarillo, Texas 79105

... for more details circle 128 on Reader Service Card

READER SERVICE INFORMATION CARD 5-74

This card is usable until August 1, 1974.

For more information on products or services mentioned in this issue, simply circle the appropriate numbers below, type or print your name and address, apply postage, and drop in the mail.

ADVERTISED PRODUCTS							TEST INSTRUMENTS			NEW PRODUCTS					
101	109	117	125	133	141	149	900	908	916	700	708	716	724	732	740
102	110	118	126	134	142	150	901	909	917	701	709	717	725	733	741
103	111	119	127	135	143	151	902	910	918	702	710	718	726	734	742
104	112	120	128	136	144	152	903	911	919	703	711	719	727	735	743
105	113	121	129	137	145	153	904	912	920	704	712	720	728	736	744
106	114	122	130	138	146	154	905	913	921	705	713	721	729	737	745
107	115	123	131	139	147	155	906	914	922	706	714	722	730	738	746
108	116	124	132	140	148	156	907	915	923	707	715	723	731	739	747

NAME _____ POSITION _____

COMPANY _____ STREET _____

CITY _____ STATE _____ ZIP CODE _____

Please describe your type of business or industry _____

Your signature _____

PLACE
STAMP
HERE

Reader Service Department

ELECTRONIC TECHNICIAN/DEALER

POST OFFICE BOX 6016, DULUTH, MINNESOTA 55806

For those countries outside the U.S., please apply appropriate postage before mailing



PERSONAL SUBSCRIPTION CARD

GET A FREE BONUS WITH YOUR PERSONAL
SUBSCRIPTION TO ELECTRONIC TECHNICIAN/DEALER!

- 3 Years \$13 2 Years \$10 1 Year \$6*
 Payment Enclosed Bill Me

*BONUS: With a 2 or 3 year subscription, you receive both TEKFAQ 110 and the COLOR TV GUIDEBOOK free! If you are subscribing for 1 year, please indicate your choice of either:

- TEKFAQ 110 COLOR TV GUIDEBOOK



PLEASE CHECK BELOW:

1. In the TV, Radio and other consumer products fields, is your firm
 PRIMARILY a: (please check most descriptive item)
- Retailer with service department Industrial electronics service firm
 Service/repair firm with some retail Manufacturer
 Service/repair firm with no retail Other (please describe)
2. Title (please check one)
- Owner, manager, buyer, other executive
 Service manager
 Service repairman or other employee

NAME _____ STREET _____

FIRM _____ TITLE _____

CITY _____ STATE _____ ZIP _____

If you are renewing your subscription, check here and attach your address label. If you renew your subscription for 2 to 3 years, you are still eligible to receive your free bonus.

Circle
the
Reader
Service
numbers
of those
items of
interest
to you.

GET
MORE
FACTS

Your own
personal
copy
for
only
pennies
per issue

PLACE
STAMP
HERE

Reader Service Department

ELECTRONIC TECHNICIAN/DEALER

POST OFFICE BOX 6016, DULUTH, MINNESOTA 55806

GET MORE FACTS

READER SERVICE INFORMATION CARD 5-74

This card is usable until August 1, 1974.

For more information on products or services mentioned in this issue, simply circle the appropriate numbers below, type or print your name and address, apply postage, and drop in the mail.

ADVERTISED PRODUCTS

101	109	117	125	133	141	149
102	110	118	126	134	142	150
103	111	119	127	135	143	151
104	112	120	128	136	144	152
105	113	121	129	137	145	153
106	114	122	130	138	146	154
107	115	123	131	139	147	155
108	116	124	132	140	148	156

TEST INSTRUMENTS

900	908	916
901	909	917
902	910	918
903	911	919
904	912	920
905	913	921
906	914	922
907	915	923

NEW PRODUCTS

700	708	716	724	732	740
701	709	717	725	733	741
702	710	718	726	734	742
703	711	719	727	735	743
704	712	720	728	736	744
705	713	721	729	737	745
706	714	722	730	738	746
707	715	723	731	739	747

NAME _____ POSITION _____

COMPANY _____ STREET _____

CITY _____ STATE _____ ZIP CODE _____

Please describe your type of business or industry _____

Your signature _____

Circle the Reader Service numbers of those items of interest to you.

BUSINESS REPLY MAIL

NO POSTAGE STAMP NECESSARY IF MAILED IN THE UNITED STATES

FIRST CLASS

PERMIT NO. 665

DULUTH, MINNESOTA

POSTAGE WILL BE PAID BY

Circulation Department

ELECTRONIC TECHNICIAN/DEALER

POST OFFICE BOX 6016, DULUTH, MINNESOTA 55806

Your own personal copy for only pennies per issue

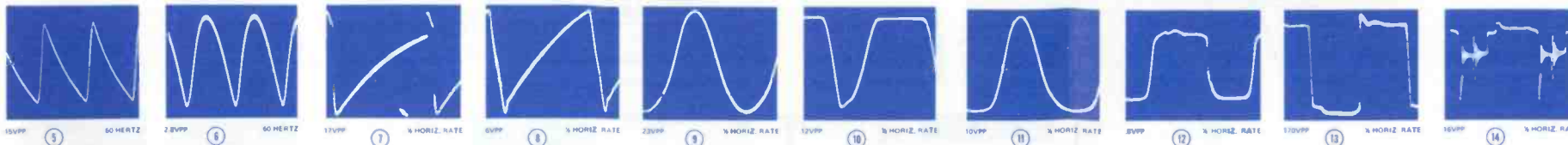

SYMBOL	DESCRIPTION	GENERAL ELECTRIC PART NO.
	control-triple	ES49X61
R210	—height, 85K	
R215	—vert size, 16K	
R218	—vert lin, 2.5K	
R232	—thermistor assembly	ES41X5
R233	—thermistor, 650 Ω, 10%	ES14X27
R307	—VDR 180-200V	ES13X3
C403A	—300 μf, electro, 175V	ES31X38
C403B	—300 μf, electro, 150V	
C403C	—300 μf, electro, 150V	
C403D	—200 μf, electro, 50V	
L106	—coil 44MHz trap, 35.7 μf	ES36X84
L109	—coil 4.5MHz trap	ES36X120
L251	—coil horiz osc	ES36X88
L254	—coil width	ES36X121
	deflect yoke 19 in.	ES76X13
T201	—xformer vert output	ES64X11
T251	—xformer horiz buffer	ES64X12
T252	—xformer high voltage	ES77X19
T301	—xformer audio output	ES64X13

deflect yoke 19 in. ES76X13
fuse 4a, fast blo, pigtail, 250V F401

PRODUCT SAFETY NOTICE

PRODUCT SAFETY SHOULD BE CONSIDERED WHEN A COMPONENT REPLACEMENT IS MADE IN ANY AREA OF A RECEIVER. THE SHADED AREA OF THIS SCHEMATIC DIAGRAM AND THE PARTS LIST DESIGNATE COMPONENTS IN WHICH SAFETY CAN BE OF SPECIAL SIGNIFICANCE. IT IS PARTICULARLY RECOMMENDED THAT GENERAL ELECTRIC CATALOGED PARTS BE USED FOR COMPONENT REPLACEMENT IN THE SHADED AREAS OF THIS SCHEMATIC.

USE OF SUBSTITUTE REPLACEMENT PARTS WHICH DO NOT HAVE THE SAME SAFETY CHARACTERISTICS AS RECOMMENDED IN FACTORY SERVICE INFORMATION MAY CREATE SHOCK, FIRE OR OTHER HAZARDS.

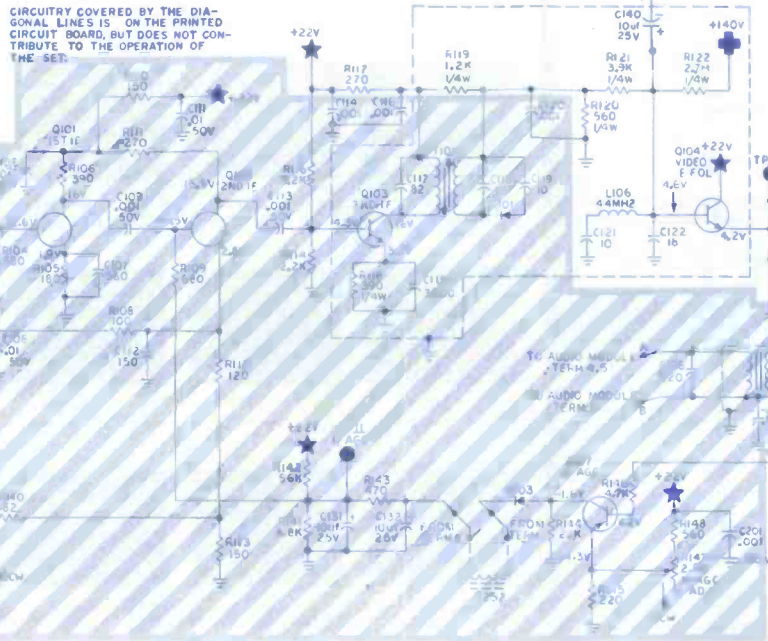

DISCONNECT ANY EXTERNAL SIGNAL SOURCES BEFORE CHECKING THESE WAVEFORMS.

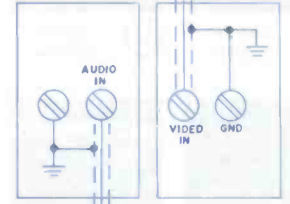

CAUTION

THIS IS NOT A TV RECEIVER. THIS DEVICE MUST ALWAYS BE CONNECTED TO AN ISOLATION TRANSFORMER AS A SOURCE OF 120 VAC. THE INPUT TERMINALS ARE CONNECTED TO THE POWER LINES.

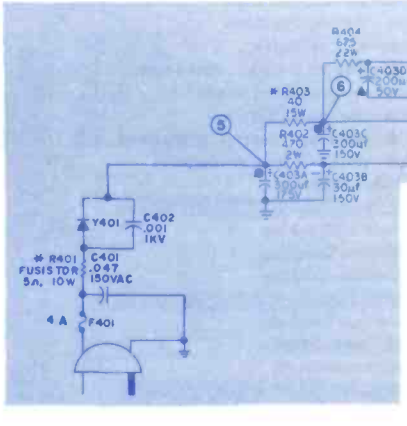
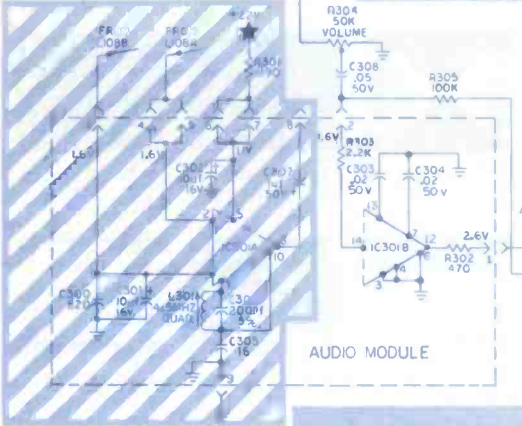

UNLESS OTHERWISE NOTED
K = 1000 M = 1,000,000
CAPACITOR MORE THAN 1 μf = μf
CAPACITOR LESS THAN 1 μf
RESISTORS ARE 1/2 WATT

VOLTAGE MEASUREMENTS MADE WITH A VOM WITH RESPECT TO CHASSIS GROUND.
MEASUREMENTS MAY VARY ±10% AT 120V A.C. LINE VOLTAGE.
#NEW CRITICAL VALUES.

OPERATING THIS DEVICE AT REDUCED HORIZONTAL SCAN RATES CAN CAUSE EXCESSIVE HIGH VOLTAGE. FOR CONTINUED PROTECTION AGAINST X-RADIATION, DO NOT OPERATE AT HORIZONTAL SCAN RATES LOWER THAN 14,750HZ.

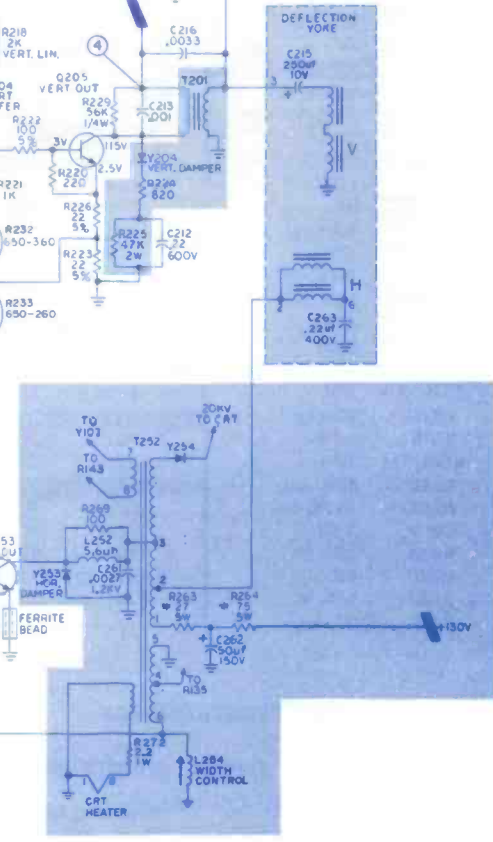

ZENITH
Color-TV Chassis
23EC15

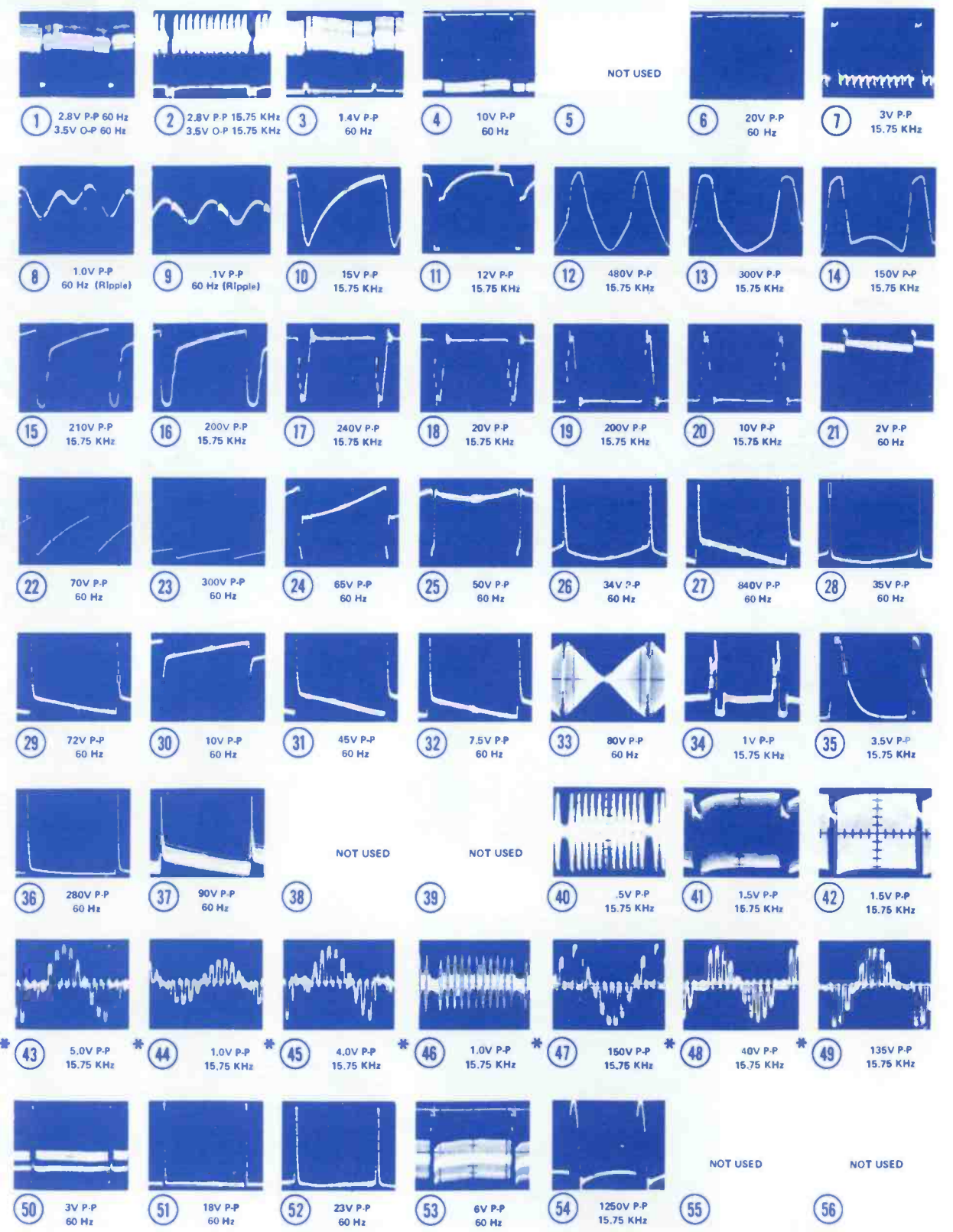
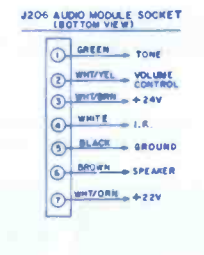
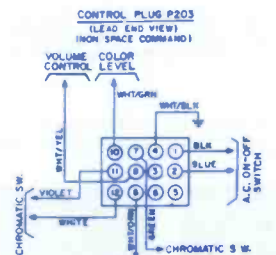
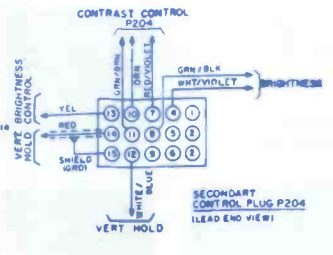
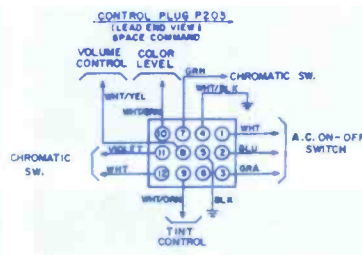
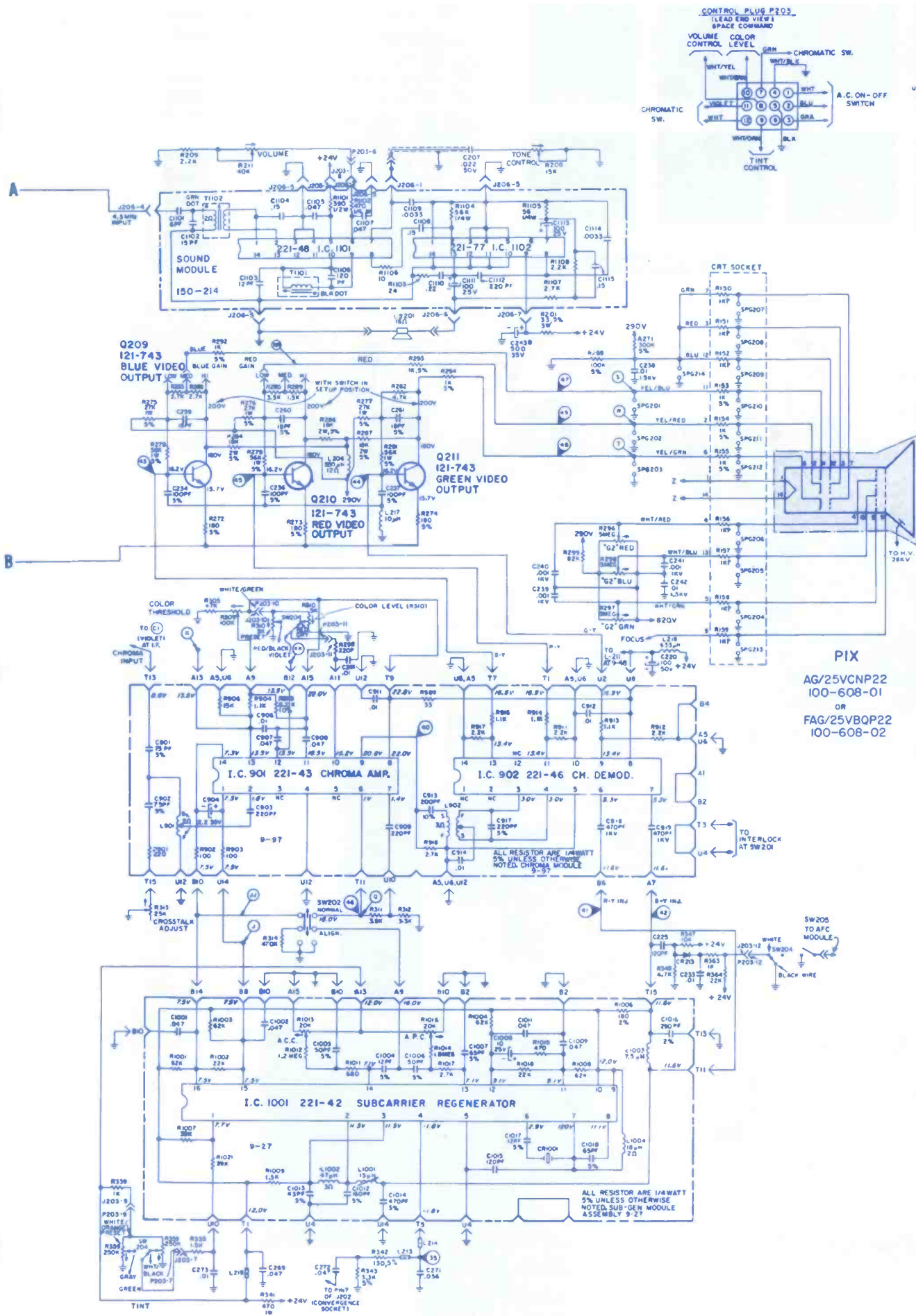

* FOR WAVEFORMS 43 THROUGH 49, BYPASS TEST POINT "D" WITH 1.0 MF CAPACITOR.

SYMBOL	DESCRIPTION	ZENITH PART NO.
C243A	—30µf electrolytic cap 400v	
C243B	—500µf electro cap 35v	22-7066
C243C	—500µf electrolytic cap 50v	
C276A	—150µf electrolytic cap 400v	22-7237
R219	—3K AGC delay control 1/2w	63-9116
R230	—contrast control	63-9193
R238	—5K brite control	63-9927
R244	—300n peak picture control	63-9119
R248	—3.5M vert size control	63-9115
R258	—750K vert hold	63-9194

R259	—1K vert lin control	63-9066
R309	—100K killer threshold control	63-8501
R333	—voltage dependent resist 5%	63-8688
R338	—50n brite limiter control	63-8989
R344	—thermistor	63-8687
R353	—focus divider	63-9897
R354	—thermistor	63-10180
R365	—voltage dependent resist 5%	63-8688
R1013	—20K ACC control	63-8576
L105	—41.25MHz trap	20-3287
L113	—4.5MHz trap	20-3287
L209	—horiz osc coil	S-86164
L216	—filter choke	

T202	—vert output xformer	95-3083
T203	—saturable reactor	95-3004
T204	—power xformer	95-3116
T205	—horiz sweep xformer	S-90754
T206	—deflect yoke	S-89750
T207	—AC line choke	S-2964
T1102	—4.5MHz input coil	95-2620
F201	—2.25a bel fuse	136-92
F202	—3a pitagail fuse	136-47
F204	—.5a bel fuse/with leads	S-90985
F205	—heater fuse link	91-2061
	VHF tuner	175-2201-40
	UHF tuner	175-2201-50

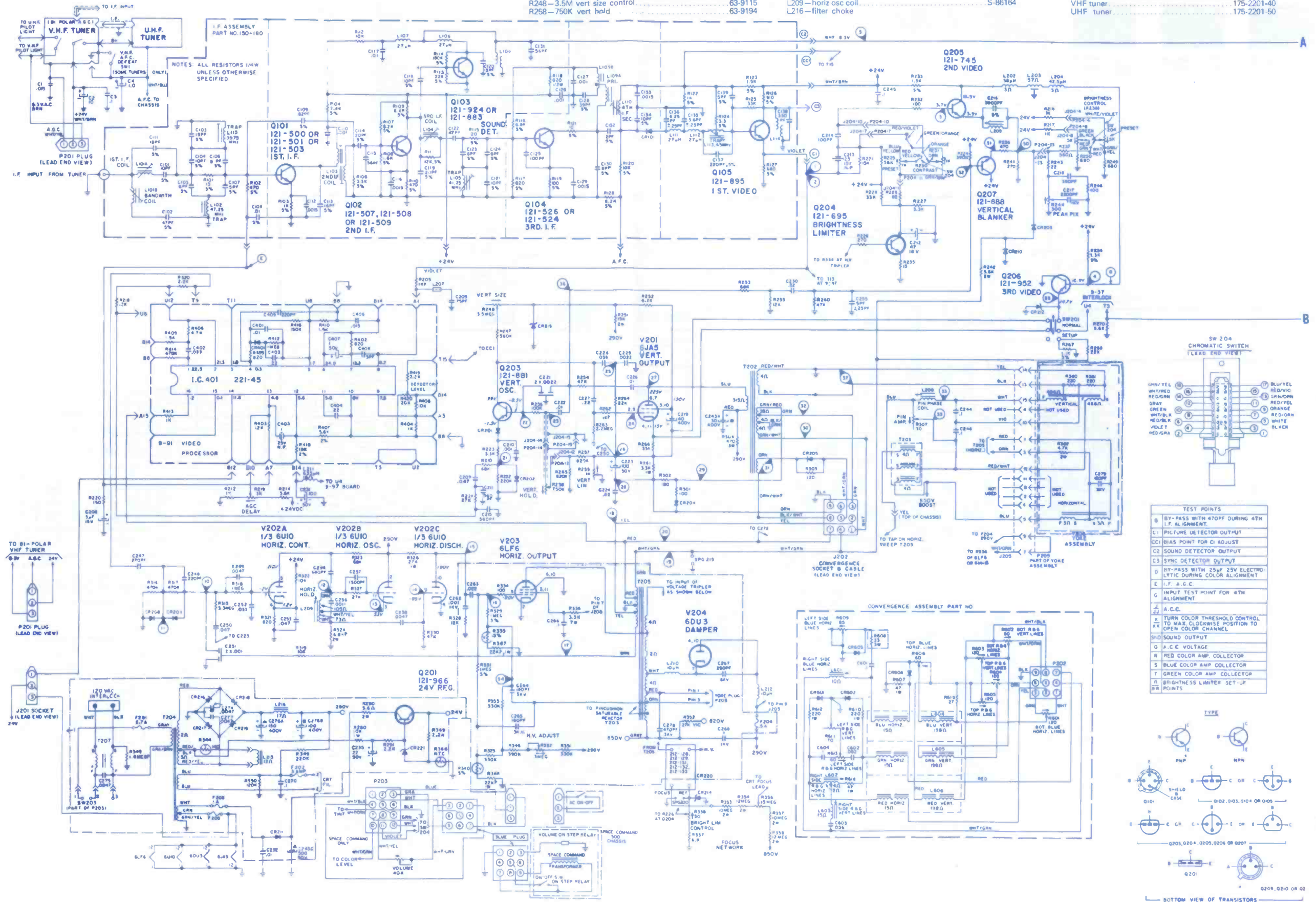

TEST POINTS

- B BY-PASS WITH 470PF DURING 4TH I.F. ALIGNMENT
- C1 PICTURE DETECTOR OUTPUT
- DC1 BIAS POINT FOR CI ADJUST
- C2 SOUND DETECTOR OUTPUT
- C3 SYNC DETECTOR OUTPUT
- D BY-PASS WITH 25V 25V ELECTROLYTIC DURING COLOR ALIGNMENT
- E I.F. A.C.C.
- G INPUT TEST POINT FOR 4TH ALIGNMENT
- J A.C.C.
- K TURN COLOR THRESHOLD CONTROL TO MAX. CLOCKWISE POSITION TO OPEN COLOR CHANNEL
- SRD SOUND OUTPUT
- O A.C.C. VOLTAGE
- R RED COLOR AMP. COLLECTOR
- S BLUE COLOR AMP. COLLECTOR
- T GREEN COLOR AMP. COLLECTOR
- U BRIGHTNESS LIMITER SET-UP POINTS

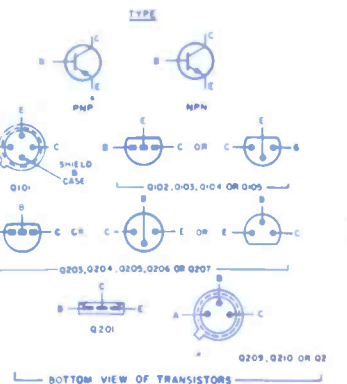

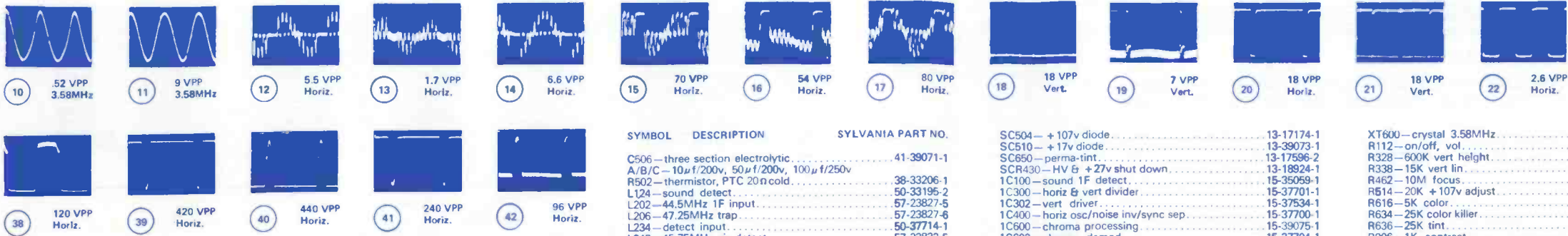

SYLVANIA
Color-TV Chassis
E06-2

SYMBOL	DESCRIPTION	SYLVANIA PART NO.
C506	three section electrolytic	41-39071-1
A/B/C	10µf/200v, 50µf/250v, 100µf/250v	
R502	thermistor, PTC 20 cold	38-33206-1
L124	sound detect.	50-33195-2
L202	44.5MHz 1F input	57-23827-5
L206	47.25MHz trap	57-23827-6
L234	detect input	50-37714-1
L242	45.75MHz pix detect	57-23832-5
L244	4.5MHz trap	50-35305-1
L400	flyback tuning	50-39163-1
L418	horiz driver xfomer	50-39121-1
L502	line choke	50-29833-3
L648	3.58 freq adj	50-39052-1
L648	tint centering	50-39053-1
SC448	dampner	13-33172-1
SC504	+107v diode	13-17174-1
SC510	+17v diode	13-39073-1
SC650	perma-tint	13-17596-2
SCR430	HV B + 27v shut down	13-18924-1
1C100	sound 1F detect	15-35059-1
1C300	horiz & vert divider	15-37701-1
1C302	vert driver	15-37534-1
1C400	horiz osc/noise inv/sync sep	15-37700-1
1C600	chroma processing	15-39075-1
1C602	chroma demod	15-37704-1
T100	4.5MHz sound input	50-39084-1
T400	high voltage xfomer	50-39010-1
T400	horiz driver xfomer	56-39101-1
T500	filament xfomer	50-39078-1
CB500	circuit breaker	29-33346-13
DL920	delay line	32-37710-1
SW600	switch perma tint	33-16011-15
XT600	crystal 3.58MHz	26-39051-1
R112	on/off, vol	37-39081-1
R328	600K vert height	37-33036-17
R338	15K vert lin	part of R328
R462	10M focus	37-17320-8
R514	20K + 107v adjust	37-35059-18
R616	5K color	37-15904-2
R634	25K color killer	37-14576-19
R636	25K tint	37-33036-11
R906	1K contrast	37-15902-5
R908	50K brite	part of R906
R921	25K brite range	37-14576-19
R988	2.5M blue screen	37-33036-11
R990	2.5M green screen	part of R988
R992	2.5M red screen	part of R988
	tripler HV	32-39091-1
	VHF	54-37901-1

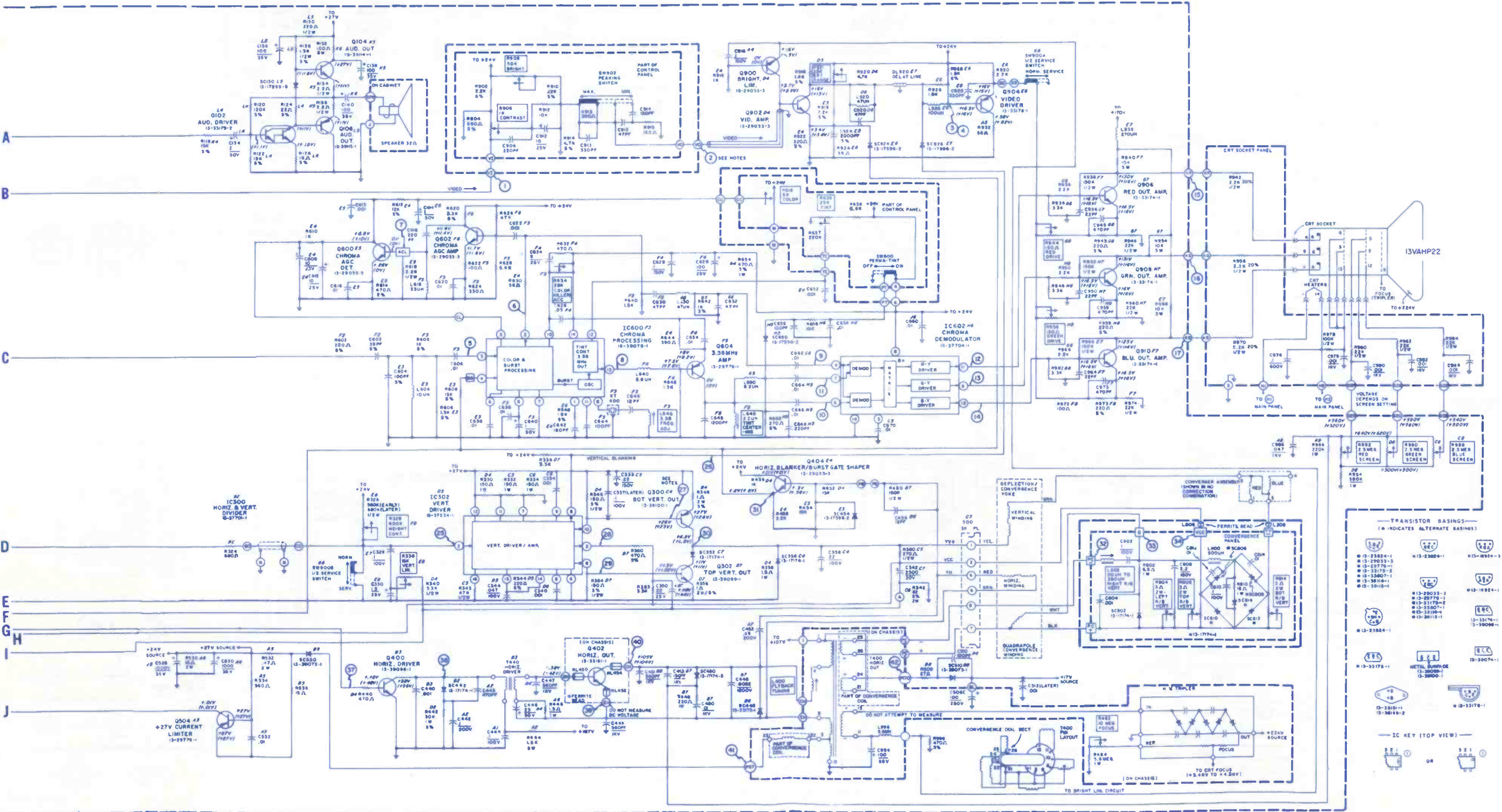

1526

SYLVANIA

Color-TV Chassis
E06-2

ELECTRONIC TECHNICIAN/DEALER **TEKFAK**

MAY • 1974

COMPLETE MANUFACTURERS' CIRCUIT DIAGRAMS
AND TECHNICAL INFORMATION FOR 5 NEW SETS



1 2.8 VPP Horiz.



2 1.8 VPP Horiz.



3 12.5 VPP Horiz.



4 100 VPP Vert.

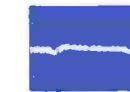

5 .22 VPP Horiz.



6 .42 VPP Horiz.



7 10.4 VPP Horiz.



8 .22 VPP 3.58MHz



9 4 VPP Horiz.



23 1.8 VPP Vert.



24 5.8 VPP Vert.



25 4.8 VPP Vert.



26 25 VPP Vert.



27 2 VPP Vert.



28 4 VPP Vert.



29 1.8 VPP Vert.



30 26 VPP Vert.



31 4.8 VPP Horiz.



32 40 VPP Horiz.



33 72 VPP Vert.



34 4 VPP Vert.

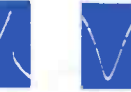

35 8 VPP Vert.



36 10 VPP Vert.



37 3.2 VPP Horiz.

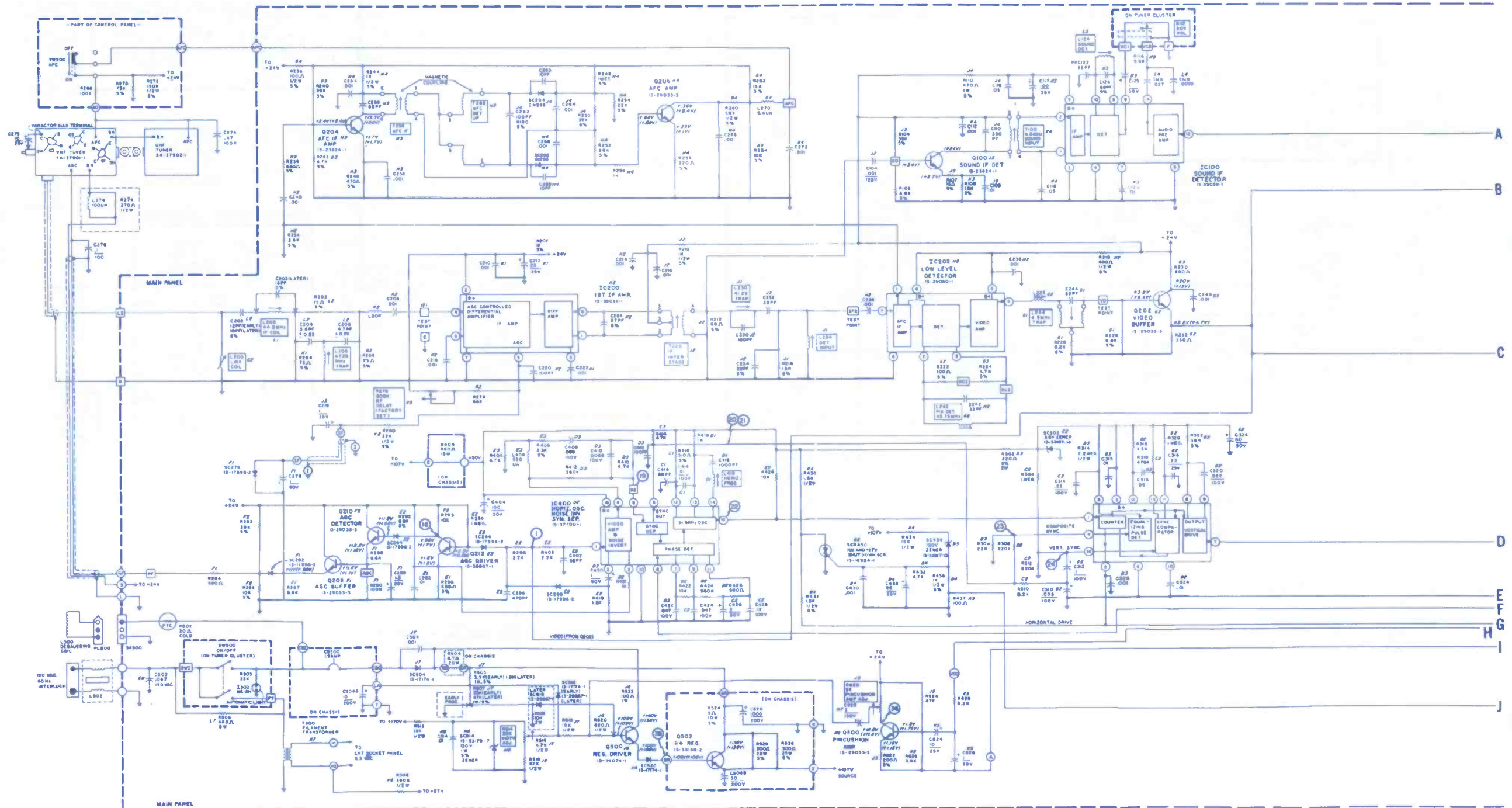

yoke assembly	76-14328-2
SW1L—Philcomatic, push-push, switch	42-2181-1
T102—power xformer	32-10198-1
VR101—12M, focus adjust	33-5655-19
VR201—15K, volume slide	33-5656-2
VR202—color, A-15K/service pre-set, B-5K/customer	33-5644-22
	33-5644-11
VR203—vert hold, A-1M horiz hold, B-20K	33-5644-8

VR204—tint, A20K/service preset, B-100K/A/B—customer	33-5644-23
	33-5644-10
VR205—contrast, 800 n	33-5655-7
C101—500 μf/150v, 500 μf/50v, 240 μf/200v	
B/C/D—B+ filter	30-2616-33
C102—250 μf/300v, 50 μf/300v, 160 μf/250v	
A/B/D—B+ filter	30-2626-14
L3W—horiz centering coil	32-4979-4

SW1W—vert centering switch	42-2178-1
T2W—high volt regulator	32-10183-1
T4W—HV xformer	32-10181-2
VR2W—680K, height	33-5654-5
VR1V—1.5M, 3 sect red, green, blue	
A/B/C—screens	33-5645-6
VR2V—10K, color killer	33-5628-25
VR3V—200 n, 3 sect, red, green & blue	
A/B/C—drives	33-5654-1

PHILCO-FORD
Color-TV Chassis
4CY90

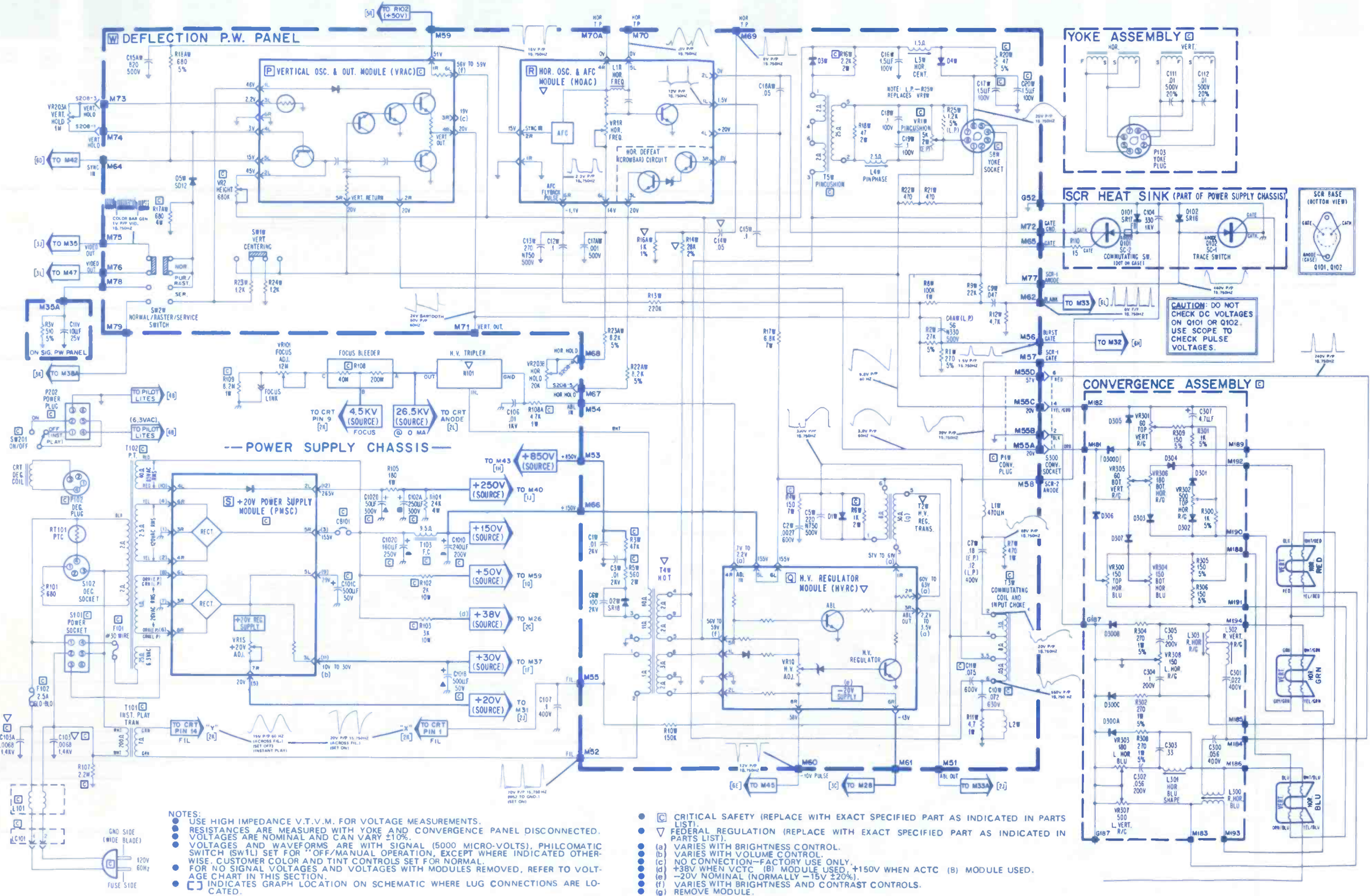

SCHEMATIC DIAGRAM—DEFLECTION PW PANEL, POWER SUPPLY, & CONVERGENCE PANEL—4CY90 (25") CHASSIS

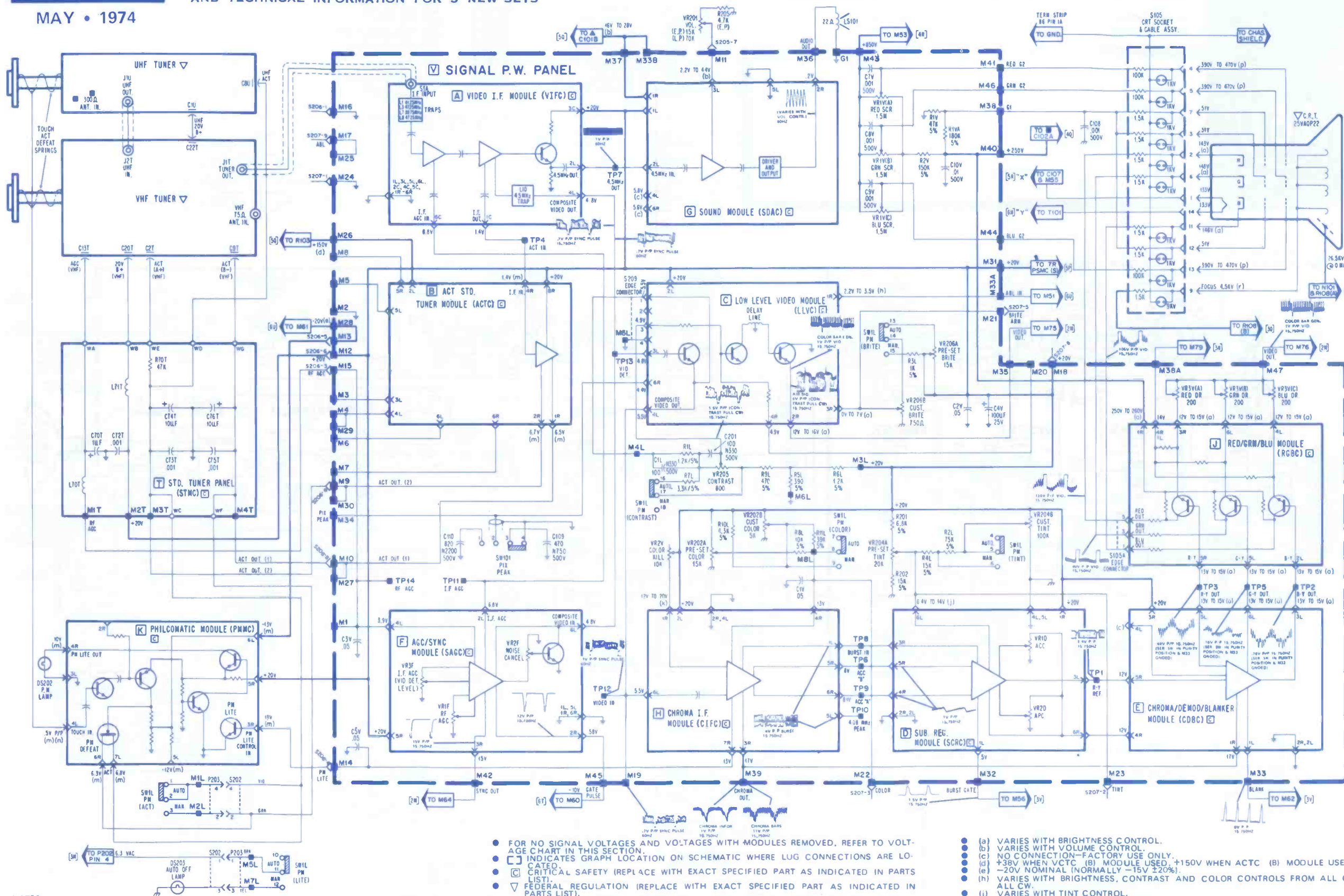

NOTES:
 ● USE HIGH IMPEDANCE V.T.V.M. FOR VOLTAGE MEASUREMENTS.
 ● RESISTANCES ARE MEASURED WITH YOKE AND CONVERGENCE PANEL DISCONNECTED.
 ● VOLTAGES ARE NOMINAL AND CAN VARY ±10%.
 ● VOLTAGES AND WAVEFORMS ARE WITH SIGNAL (5000 MICRO-VOLTS). PHILCOMATIC SWITCH (SW1) SET FOR "OFF/MANUAL" OPERATION, EXCEPT WHERE INDICATED OTHERWISE. CUSTOMER COLOR AND TINT CONTROLS SET FOR NORMAL.

● FOR NO SIGNAL VOLTAGES AND VOLTAGES WITH MODULES REMOVED, REFER TO VOLTAGE CHART IN THIS SECTION.
 ● [] INDICATES GRAPH LOCATION ON SCHEMATIC WHERE LUG CONNECTIONS ARE LOCATED.
 ● [C] CRITICAL SAFETY (REPLACE WITH EXACT SPECIFIED PART AS INDICATED IN PARTS LIST).
 ● [F] FEDERAL REGULATION (REPLACE WITH EXACT SPECIFIED PART AS INDICATED IN PARTS LIST).
 ● COMPONENTS AND LUGS ON SCHEMATIC WHICH END IN "L", SUCH AS R1L, M1L, ETC., ARE LOCATED ON THE PHILCOMATIC SWITCH PANEL.
 ● PHILCOMATIC SWITCH (SW1) SHOWN IN "ON/AUTOMATIC" POSITION.

SCHEMATIC DIAGRAM—SIGNAL PW PANEL & STANDARD TUNERS—4CY90 (25") CHASSIS

● (a) VARIES WITH BRIGHTNESS CONTROL.
 ● (b) VARIES WITH VOLUME CONTROL.
 ● (c) NO CONNECTION—FACTORY USE ONLY.
 ● (d) +38V WHEN VCTC (B) MODULE USED, +150V WHEN ACTC (B) MODULE USED.
 ● (e) -20V NOMINAL (NORMALLY -15V ±20%).
 ● (f) VARIES WITH BRIGHTNESS, CONTRAST AND COLOR CONTROLS FROM ALL CCW TO ALL CW.
 ● (j) VARIES WITH TINT CONTROL.
 ● (k) VARIES WITH COLOR KILLER CONTROL.
 ● (m) PHILCOMATIC SWITCH SET FOR "ON/AUTOMATIC" OPERATION.
 ● (n) HAND ON FINE TUNE KNOB.
 ● (p) VARIES WITH SCREEN CONTROL.
 ● (r) VARIES WITH FOCUS CONTROL.

COMPLETE MANUFACTURER'S CIRCUIT DIAGRAMS
AND TECHNICAL INFORMATION FOR 5 NEW SETS

GROUP
261

	SCHEMATIC NO.	SCHEMATIC NO.
ADMIRAL TV Chassis T28K3	1524	SYLVANIA Color-TV Chassis E06-2 1526
GENERAL ELECTRIC Display Device Chassis MUA	1528	ZENITH Color-TV Chassis 23EC15 1527
PHILCO-FORD Color-TV Chassis 4CY90	1525	

SYMBOL	DESCRIPTION	ADMIRAL PART NO.
R208	1M vol control T28K3	75A149-10
R311	25K, contrast control T28K3	75A149-9
R313	100K, brite control T28K3	75A149-8
R411	5M height, triple control	75A129-3
R417	1.2M vert hold, triple control	75A129-3
R421	500K, vert lin, triple control	75A129-3
C503A	250 μ f, 165v, electrolytic	67A30-11
C503B	150 μ f, 150v, electrolytic	67A30-11
C503C	200 μ f, 150v, electrolytic	67A30-11
L201A,B	sound 1F & phase shift coil	72C301-4
L202	ratio detect	72C132-82
L301	47.25MHz trap	72C308-8
L401	horiz lock coil	94D17-19
L501	filter choke	74A18-63
T201	audio output xformer	79C124-3
T303	sound take off coil	72C185-7
T401	vert output xformer	79C139-5
T402	deflect yoke assembly	700C1089-12
T403	horiz output	79A138-20
F501	2.5a fuse	84A7-14
S501A,B	on/off switch	77A221-1
	UHF tuner	94A465-2
	VHF tuner	94A363-2

MODEL CHART					
MODEL	FINISH	CRT	VHF	UHF	CHASSIS
16P617	Walnut	16VARP4	94A363-2	94A465-2	T28K3-1A
19P807	Walnut	19VBP4	94A363-2	94A465-2	T29K3-1B
SK 19P837C	Walnut	19VBP4	94A363-2	94A465-2	T29K3-1B

RUN CHANGES
Start of production.

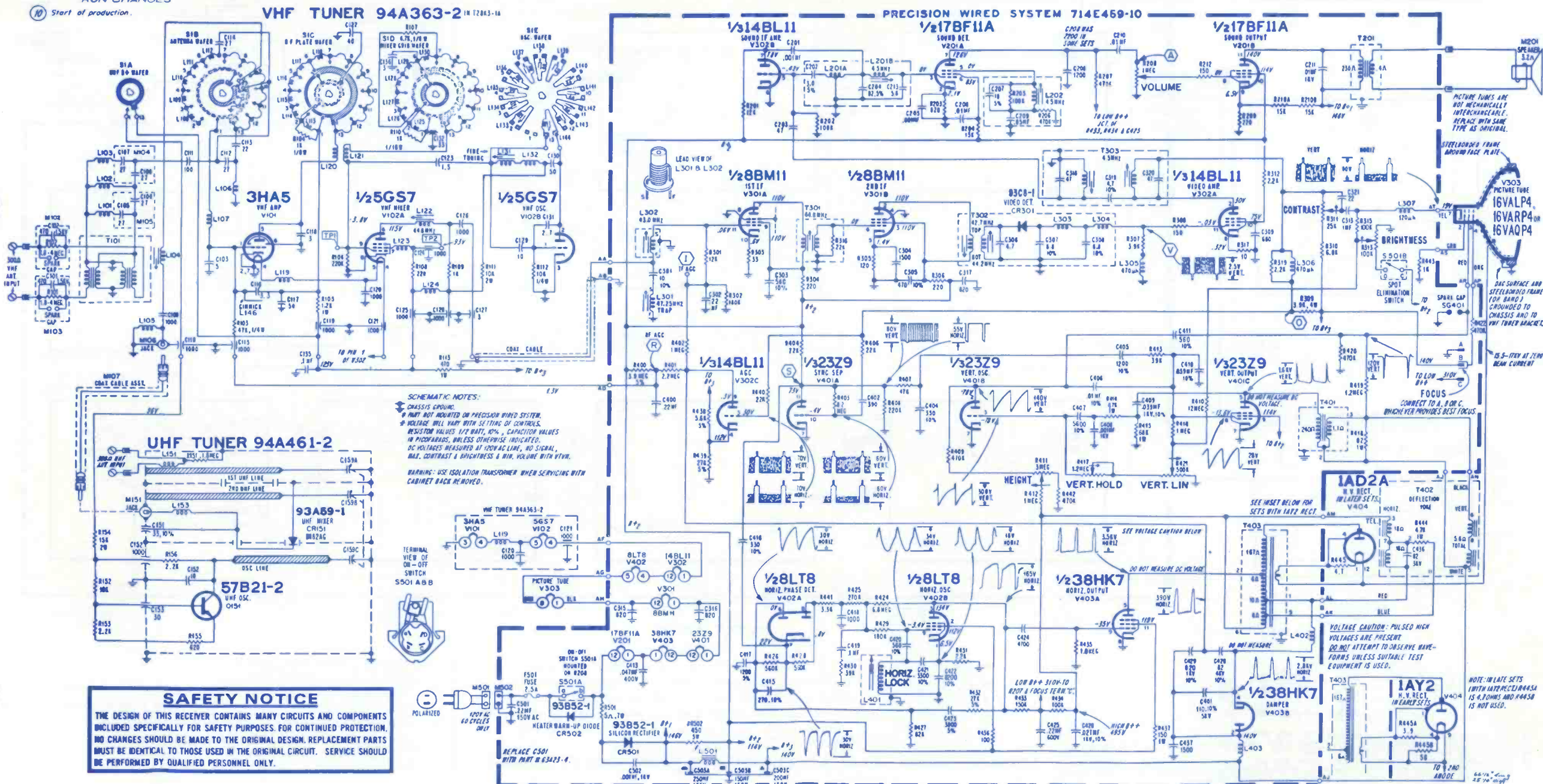

Announcing the Panasonic Parts Hot Line.

In 48 hours we can ship you anything we've got.

The New Panasonic Parts Hot Line is a performance promise: 24-hour-a-day, 7-day-a-week service. Now, if you have a problem getting the part you need, just call one central number.

Then things start happening fast: we'll ask our computer to locate your part (or parts) by searching all five regional Panasonic parts depots. In just seconds. Electronically. Then we'll telex an order to the depot which has the part you need and within

48 hours, your order is on its way!

And we can make this promise with confidence, because our warehouses are now fully automated. We've got the 2,000 fastest moving parts on electronic order pickers. At the touch of a button any of these high-traffic parts is at our fingertips.

To become a member of the Panasonic Parts Hot Line, call the toll-free number below. We'll send you a bright red emblem imprinted with the hot line num-

ber for your particular region.

We'll also send you an easy-reference booklet that gives you the names of authorized Panasonic parts distributors in your area, and information on other Parts Division services.

We know that your business depends upon having the right parts at the right time — when your customer needs them. Our business is standing right behind your business, with quality parts for over 1,000 products.



Panasonic
Parts
Hot Line
8-4712

Panasonic
just slightly ahead of our time

Call toll-free anywhere in the U.S. 800-523-5336. (in Pa. 800-562-5395)

*Of course we cannot ship on weekends and holidays.

Our 630-PLK won't die of shock.

The Model 630-PLK V-O-M is priced at just \$119.

Does everything you'd expect of a high-quality general purpose V-O-M. An exclusive, patented, transistorized switching circuit gives the Triplett Model 630-PLK virtually fail-proof protection against overloads. That makes it very popular with teachers and students, and with professionals where constant switching invites overload errors.

Look at these features:

1. Burnout-proof solid-state overload protection; suspension movement; 2% DC accuracy.
2. Single range switch minimizes error; DC polarity-reversing switch.
3. 4 ohmmeter ranges with a 4.4 ohms center scale.

Want all this, but with laboratory accuracy? Then consider the Triplett Model 630-APLK. Exactly the same ranges and protection circuit plus 1½% DC accuracy, a mirrored scale, and a rugged suspension-type meter. Priced at \$129.

If you don't need overload protection,

take a look at Triplett's Model 630-PL at only \$77, or the 630-APL (with 1½% accuracy, mirrored scale, and suspension-type meter) at \$87.

For more information or a free demonstration, call your Triplett distributor or sales representative. For the name of the representative

nearest you, dial toll free (800) 645-9200. New York State, call collect (516) 294-0990. Triplett Corporation, Bluffton, Ohio 45817.

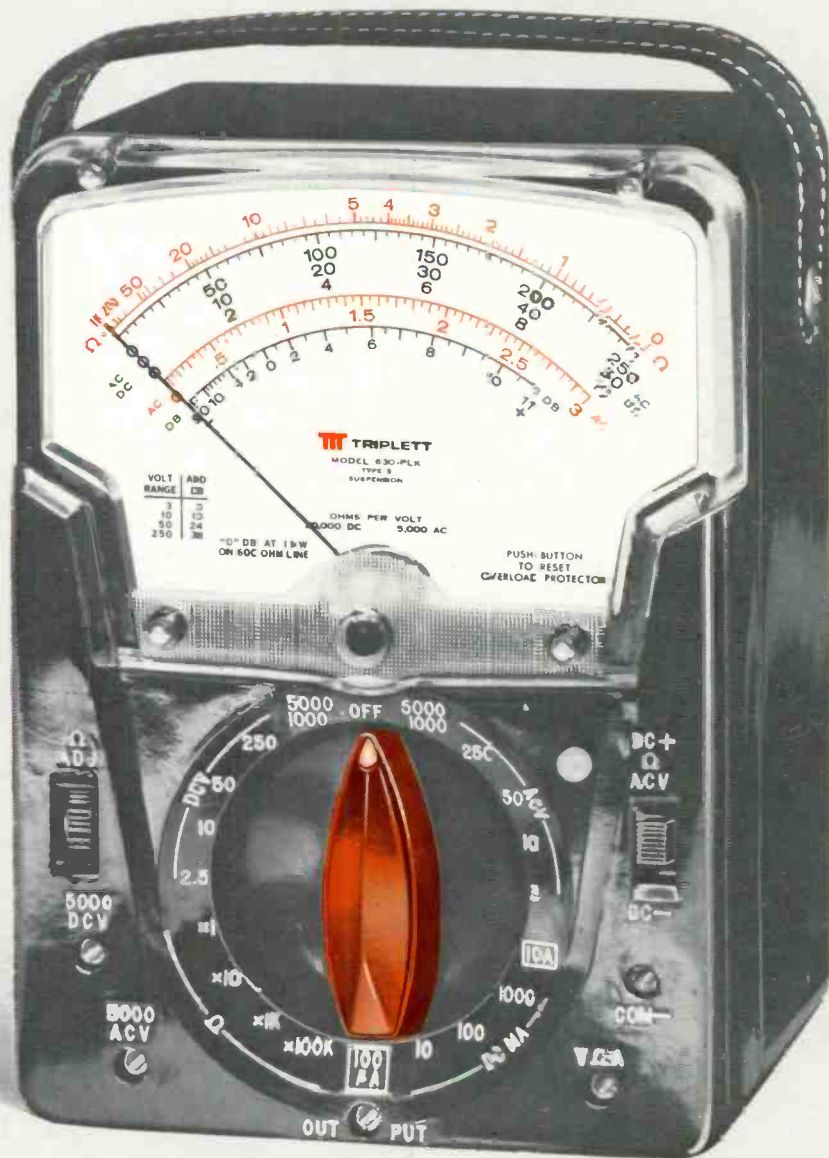

TRIPLETT
ALL YOU'LL EVER NEED IN V-O-M's.

Triplett. The easy readers.