

SERVICE

VOL. 22

THE TECHNICAL JOURNAL OF THE TELEVISION-RADIO TRADE

JULY
1953

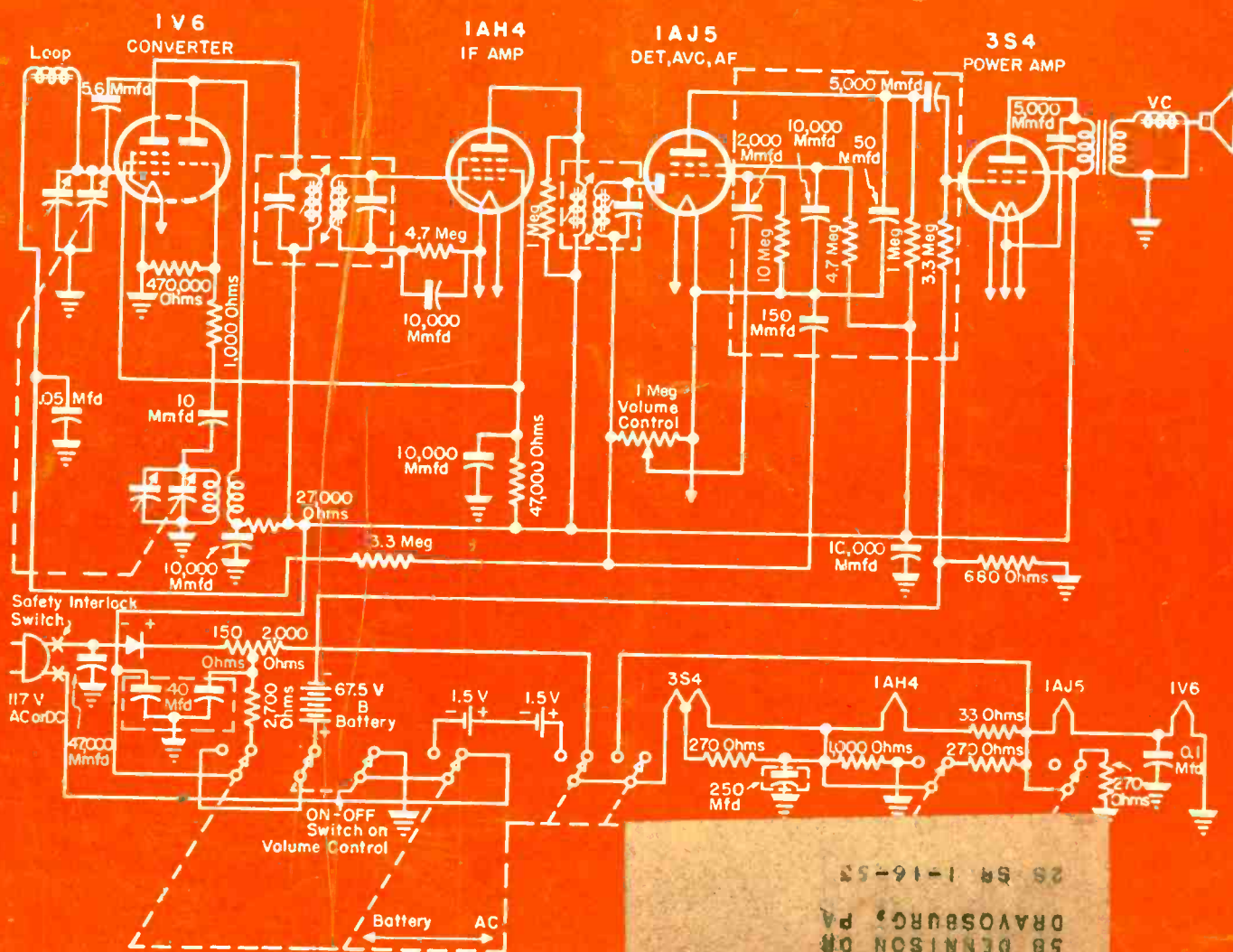

Portable 3-way clock-radio with subminiature tubes and parts.
[See page 2]

28 SR 1-16-53
C F McCULLOUGH
58 DENNISBURG, PA
1-55

In a Class
by Itself



the C·D·R Rotor

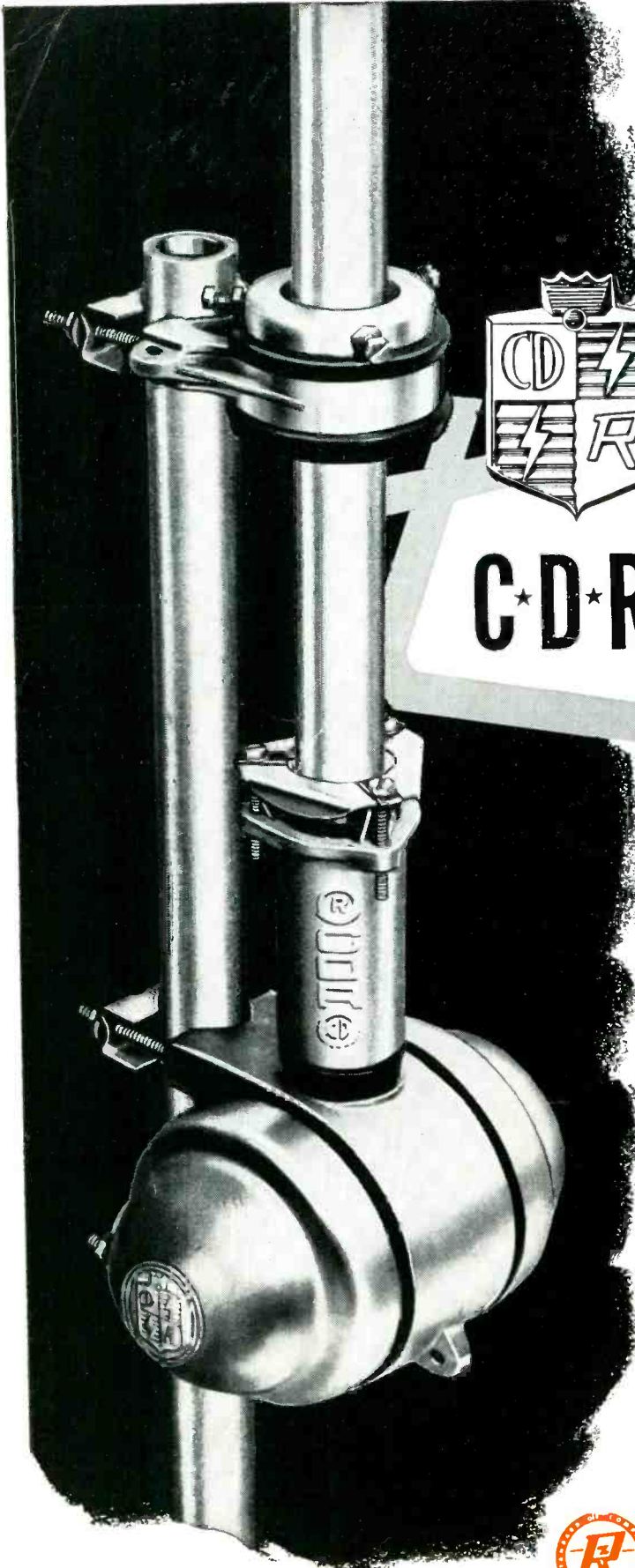

Speedy Installation ... the servicemen's dream come true! No loose parts to assemble... no kits with loose washers, nuts and bolts... quick mounting antenna mast collet plus four wire cable hookups!

Dependable ... experience has proven that once a CDR ROTOR is up... it's THERE TO STAY! No costly call-backs! Completely weather-sealed and streamlined... it's the outstanding value in the field!

Powerful ... sturdy in design to support and TURN ANY TV ANTENNA array... never a worry about the CDR rotor working! Locking instantly it will not drift! Instantly reversible... makes a complete revolution in 45 seconds!

MODEL TR-12 A special combination value consisting of complete rotor including thrust bearing... handsome modern design plastic cabinet with meter control dial, only..... \$47.95

MODEL TA-6 Thrust bearing accessory, separately.... \$4.95

MODEL TR-11 Same as TR-12 without thrust bearing.. \$44.95

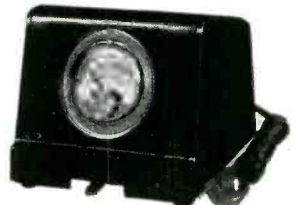

THE **RADIART** CORPORATION
CLEVELAND 13, OHIO



CORNELL-DUBILIER
SOUTH PLAINFIELD, NEW JERSEY

NEW



TIGHTEST SEAL

LOCKS IN PERFORMANCE

TOUGHEST SHELL

LOCKS OUT TROUBLE



ATTRACTIVE YELLOW MOLDED PLASTIC SHELL

Non-inflammable. Will not burn or melt under soldering iron or flame.

BONDED SEAL

Positive, heat resistant, non-inflammable bond seals leads and shell, locks out humidity.

FIRMLY SECURED LEAD
Can't be pulled out, even under soldering iron heat.

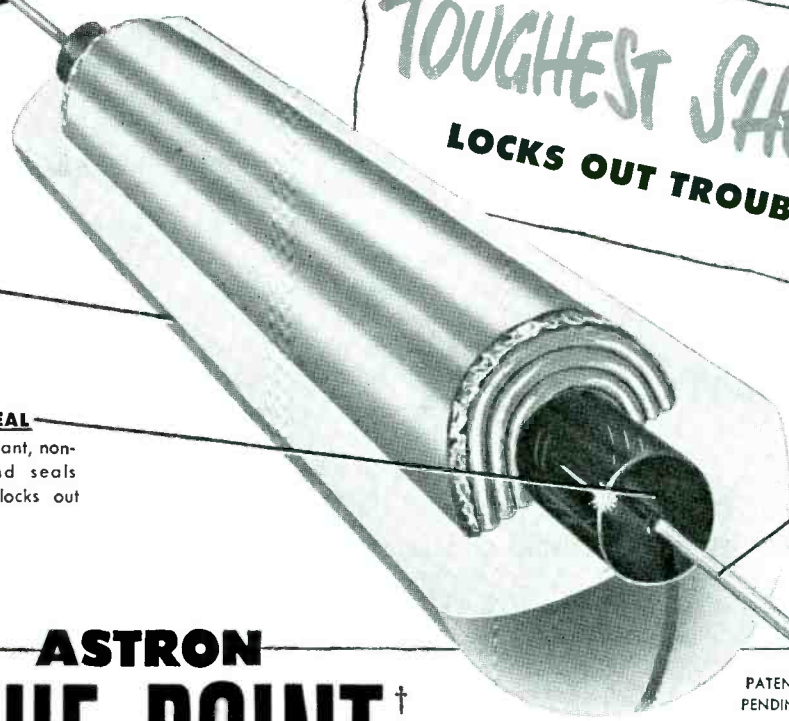

PATENT PENDING

ASTRON BLUE-POINT[†]

MOLDED PLASTIC PAPER

Capacitors

THE NEWEST ADDITION
TO THE **SM[†]** LINE

Yes, the ASTRON BLUE-POINT's *tighter seal* and *tougher shell* give you heat and moisture protection to a degree never before possible—providing a longer life and greater dependability than has ever been achieved in a molded plastic capacitor! BLUE-POINT is a capacitor you can rely on *completely*, under every condition.

BLUE-POINT is suitable for continuous operation at 85°C. The bonded seal uses a special thermo-setting, heat-resistant, non-inflammable bonding agent—*positive* protection

against moisture. Solder leads as close to the capacitor as you like—they *won't* pull out! Every BLUE-POINT is clearly marked with voltage and capacitance, bears outside foil identification. Every BLUE-POINT is *tested* and *guaranteed*. Look for the ASTRON BLUE-POINT when you buy capacitors from your jobber, or if he doesn't carry it, send us his name. Insist on ASTRON BLUE-POINT, the capacitor you *know* you can depend on. Order a supply today.

For complete performance characteristics, specifications and listings, write for Bulletin AB-20A

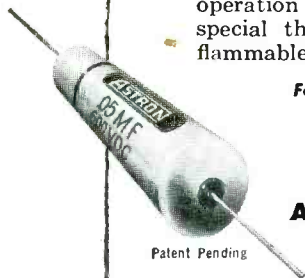

Patent Pending

DEPEND ON—INSIST ON

ASTRON CORPORATION



255 Grant Ave., E. Newark, N. J.

†Trade Mark

Safety Margin capacitors for every radio, television and electronic use.

specified by top radio
manufacturers for
**SERVICING
AUTO RADIOS**

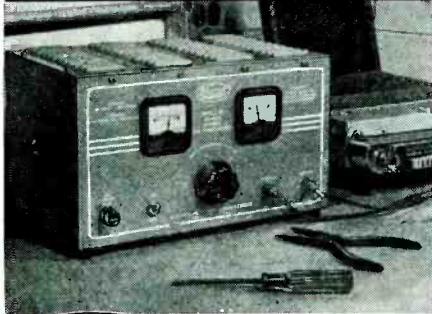

MODEL "B"

FILTERED

DC POWER SUPPLY

Patent 2,599,748

here's why . . .

Withstands High Overloads, gives rugged, life-long service.

Cooler Operation—selenium rectifier application and conduction cooling dissipate over 3 times the heat.

Twice the Rectifier Power Rating with EPL patented design.

Lowest Cost Per Ampere Output.

Operates 2 Auto Radios with push-button solenoids at same time.

Output 1 to 20 Amps. continuous duty, 35 amperes at peak rating. Use 2 units in parallel if 6 volts at 40 amperes required.

Other Money-Making Uses. Tests phone circuits, relays, instruments, low voltage devices. Charges batteries. Electroplating.

new model C-12

Serves both 12-v. and 6-v. auto radios—0-16 v. from 0-8 amperes continuous output. Only 3% ripple at top load.

See Your Jobber or Send Coupon to
ELECTRO PRODUCTS LABORATORIES

4501-Sb N. Ravenswood Ave., Chicago 40, Ill.
Canada: Atlas Radio Corp., Ltd., Toronto, Ont.

- Send FREE bulletin on "B."
 Send FREE bulletin on "C-12."

Name _____
Firm _____
Street _____
City _____ Zone _____ State _____

Vol. 22, No. 7



July, 1953

LEWIS WINNER
Editor

**B. BLOCK
F. WALEN**
Assistant Editors

Including SERVICE—A Monthly Digest of Radio and Allied Maintenance; RADIO MERCHANDISING, and TELEVISION MERCHANDISING. Registered U. S. Patent Office.

Association News	40
Audio Equipment Test and Measurement. By Mark Vino	36
Audio Installation and Service (Hi-Fi Phono Chassis). By Kenneth Stewart	28
In the Field (Video Amplifier Response Waveforms)	24
Portable and AC/DC Clock Radios (Cover). By Wyn Martin	22
Ser-Cuits (Channel 2 to 83 Chassis Design). By M. W. Percy	34
Service . . . The National Scene	17
Servicing Helps (Curing TV Chassis Troubles). By M. A. Marwell	32
Ten Years Ago	40
Tube News (Vibration Generators . . . Transistor Dip Oscillator). By L. M. Allen	30
TV Antenna Digest (UHF Tubular Line Sealing . . . Product Review). By Ralph G. Peters	26
UHF Signal Surveys (Report on Field Tests in Portland, Atlantic City, York and South Bend). By Donald Phillips	10
UHF-VHF Antenna Installation. By Henry R. Hesse	20
Views and News. By Lewis Winner	15

AUDIO INSTALLATION AND SERVICE

Acoustic Lens Enclosures	28
Hi-Fi Phono Chassis	28
Stroboscope 3-Speed Changers	28

CIRCUITS

Admiral 19 Schematic Revised to Prevent Fuse Failure	32
Admiral 22 Chassis Modified to Shield Horizontal Lock Coil	32
Arvin 657T Electric-Clock Circuitry	22
Emerson U/V Chassis Front End	34
Motorola 53LC (Cover)	22
Test-Record Intermodulation-Distortion Percentage Setup	36

COVER

Portable-Clock Radio (Motorola 53LC)	22
--	----

SERVICING HELPS

Eliminating Horizontal Ripple	32
Preventing Fuse Failure in TV Chassis	32

Index to Advertisers

	56
--	----

Manufacturers

Catalogs and Bulletins	48
Jots and Flashes	56
News	44
New Parts . . . Tools . . . Instruments	46
On Book Row	41
Personnel	42
Rep Talk	43
TV Parts . . . Antennas . . . Accessories	50



Entire contents Copyright 1953, Bryan Davis Publishing Co., Inc.
Published monthly by Bryan Davis Publishing Co., Inc.

52 Vanderbilt Avenue, New York 17, N. Y. Telephone MURray Hill 4-0170

Bryan S. Davis, Pres. Paul S. Weil, Vice-President F. Walen, Sec. A. Goebel, Cir. Prom. Mgr.
Mid-West Representative: Stuart J. Osten, 333 N. Michigan Ave., Chicago 1, Ill. Telephone: DEarborn 2-3507
East-Central Representative: James C. Munn, 2253 Delaware Dr., Cleveland 6, Ohio. Telephone: ERievlew 1-1726
Pacific Coast Representative: Brand & Brand, 1052 W. Sixth St., Los Angeles 14, Calif. Telephone: MICHigan 1-732
Metropolitan District Manager: Donald C. Weil, 52 Vanderbilt Ave., New York 17, N. Y.

Entered as second-class matter June 14, 1932 at the Post Office at New York, N. Y., under the Act of March 3, 1879. Subscription price: \$2.00 per year in the United States of America and Canada; 25 cents per copy. \$3.00 per year in foreign countries; 35 cents per copy.

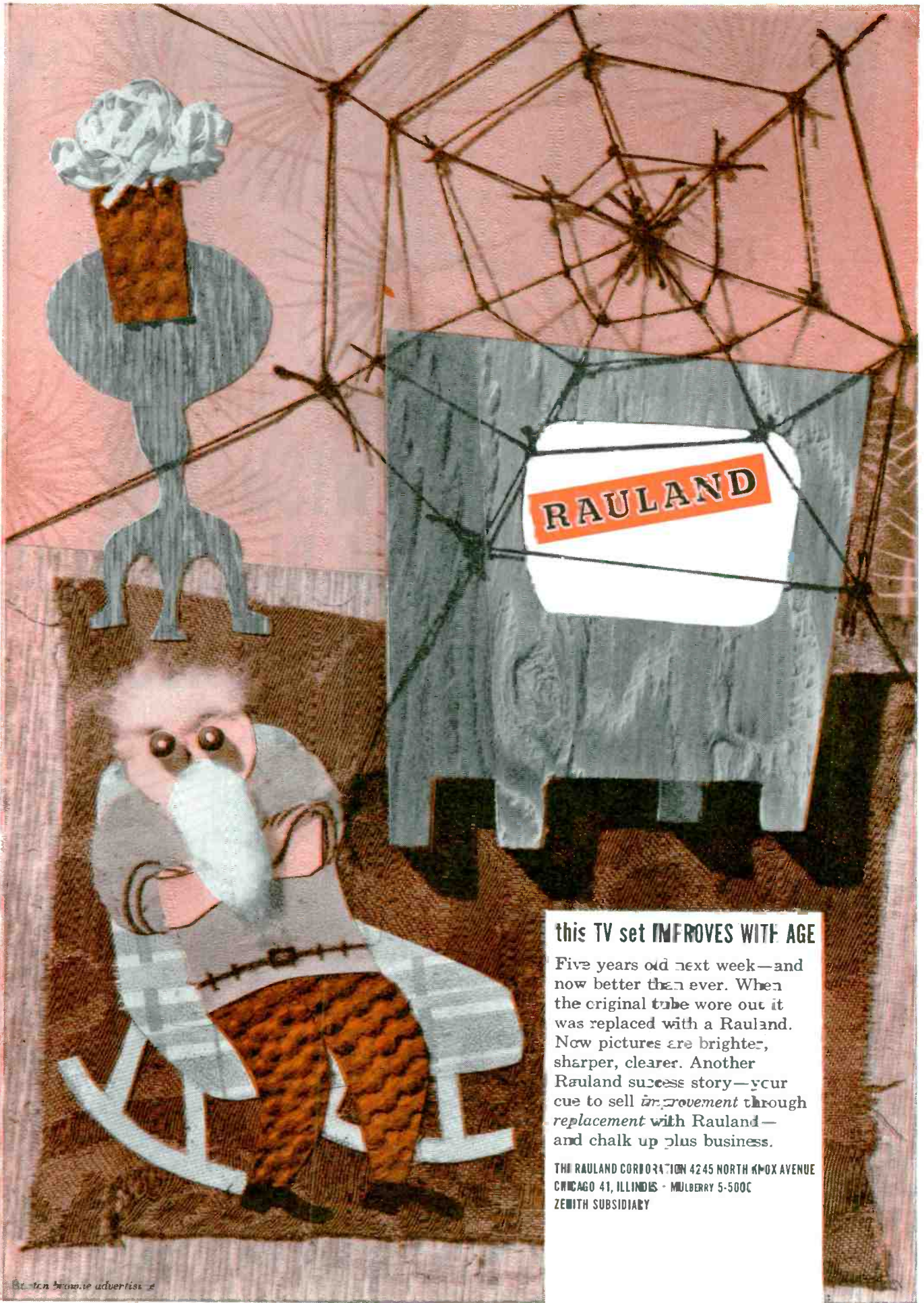

this TV set IMPROVES WITH AGE

Five years old next week—and now better than ever. When the original tube wore out it was replaced with a Rauland. Now pictures are brighter, sharper, clearer. Another Rauland success story—your cue to sell *improvement* through replacement with Rauland—and chalk up plus business.

THE RAULAND CORPORATION 4245 NORTH KNOX AVENUE
CHICAGO 41, ILLINOIS • MULBERRY 5-5000
ZENITH SUBSIDIARY

See ten more ads...

ONLY TELCO UHF ANTENNAS HAVE THE "WISHBONE"

TELCO

UHF

"WISHBONE" HIGH DI-ELECTRIC INSULATOR

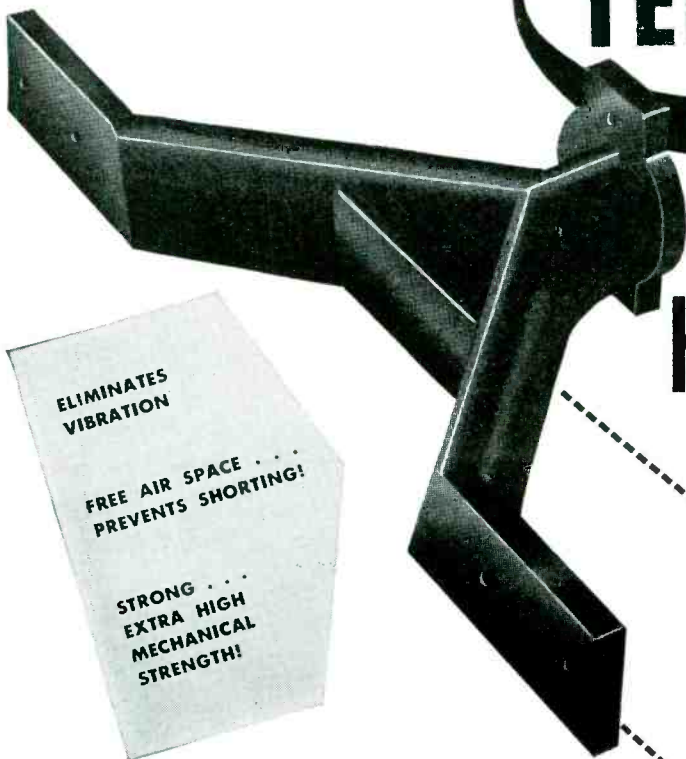

ELIMINATES
VIBRATION

FREE AIR SPACE . . .
PREVENTS SHORTING!

STRONG . . .
EXTRA HIGH
MECHANICAL
STRENGTH!

- EASY TO INSTALL
- ELIMINATES GHOSTS
- VERY HIGH GAIN

THAT'S RIGHT . . . Only TELCO'S got this remarkable new free air insulator . . . the "Wishbone" . . . that absolutely prevents shorting out under any conditions. Sturdy vibration-proof reflector and rugged aircraft aluminum elements are fastened to the "Wishbone" to prevent vibration and shaky pictures. Antenna performance is proved by actual UHF field testing . . . assures high gain on all channels. Better buy TELCO . . . your all-ways best UHF Antennas!

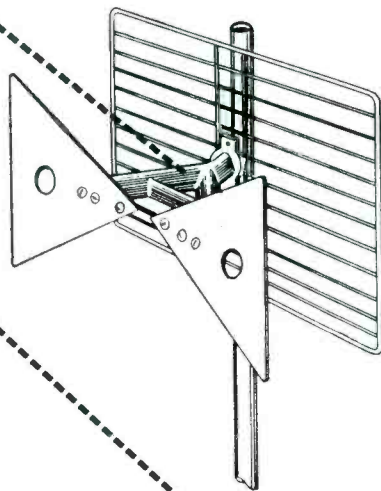

No. 8965-Butterfly
Wishbone Antenna,
complete with
stacking bar.
List \$7.50

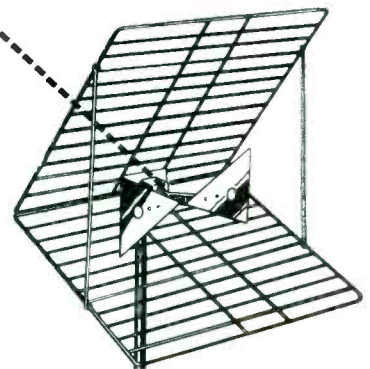

No. 8984 Wishbone
Corner Reflector.
List \$14.50



FREE! WRITE TODAY for all-new 32-page
TELCO Catalog. Send Postcard.

TELEVISION HARDWARE MFG. CO.
DIVISION OF GENERAL CEMENT MFG. CO.
901 TAYLOR AVENUE • ROCKFORD, ILLINOIS

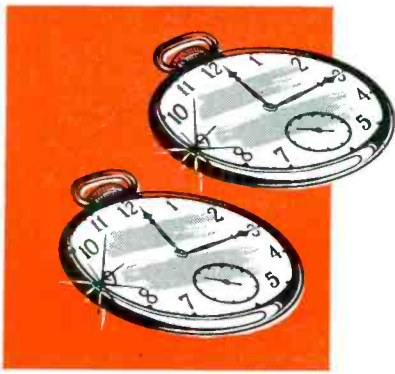

Watches may look alike in shape and size
The big difference in time-keeping performance depends on the "works" inside the watch.

**It's what's
inside that
counts...**

- in Radio Batteries too



It's what's inside a radio battery that makes the big difference in long-lasting performance, too. Take RCA's new Alkaline "B" Battery (VS216) for instance.

The Alkaline principle of operation makes possible more efficient utilization of the cell's active materials. Result: it is practical to reduce the size of both cell and battery.

The "crown-type" cell of RCA's new Radio "B" Battery is a compact, self-contained unit which delivers more useful energy per unit of volume than do

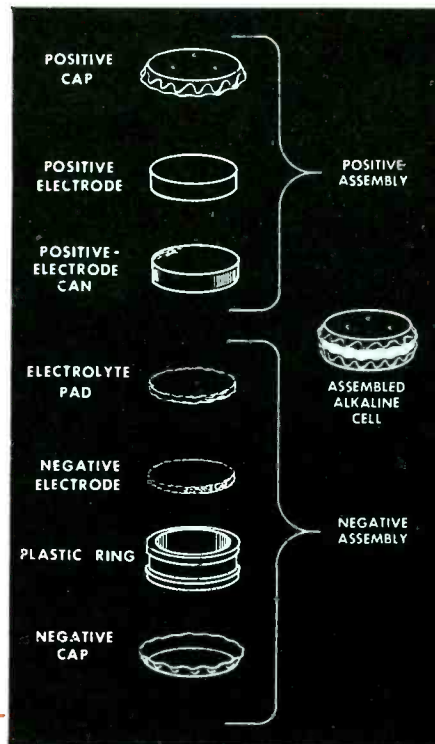

The cells in RCA's new Alkaline "B" Battery, VS216, resemble two shallow soda bottle caps. Sandwiched between the two "bottle caps" are the elements shown in the sketch above. One cap serves as the positive terminal; the other, the negative.

conventional types of cells. Result: the RCA VS216 is 22 per cent smaller than conventional "B" Batteries formerly used in personal portables—YET it plays a new-design personal portable TWICE AS LONG as conventional 67½-volt types.

It's smart to sell RCA Radio Batteries—they're *radio engineered* for extra listening hours. RCA Radio Batteries are sold principally through Radio Dealers and Service Men.

Call your RCA Radio Battery Distributor and cash in on the big radio battery replacement market.



RADIO CORPORATION of AMERICA

RADIO BATTERIES

HARRISON, N. J.

SERVICE, JULY, 1953 • 5

This name spells Quality and Profits



UNBEATABLE quality is built into every Sylvania product. Even beyond that, Sylvania quality goes back to its essential metals, chemicals, and materials.

Sylvania quality is fundamental

Sylvania grinds and formulates its own phosphors, and applies them by improved methods which assure maximum uniformity and fine picture-tube performance. Sylvania draws its own high-quality tungsten filaments and winds and tests its own coils.

Naturally, this far-reaching quality control results in an enviable nation-wide reputation. Today 7 of the top 10 television set makers use Sylvania Picture Tubes and Receiving Tubes. Naturally, too, Sylvania quality pays off in fewer call-backs, more satisfied customers . . . and *more profits for you.*

You'll find your friendly Sylvania Distributor a mighty high quality man to do business with, too. Call him today!



Be sure to install Sylvania Picture Tubes and Receiving Tubes in all the sets you service. Your customers know about Sylvania's fine quality and they'll appreciate your selection of Sylvania products for their sets.

SYLVANIA

Sylvania Electric Products Inc., 1740 Broadway, New York 19, N. Y.



**LIGHTING • RADIO
ELECTRONICS • TELEVISION**

In Canada: Sylvania Electric (Canada) Ltd., University Tower Bldg.
57, Catherine St., Montreal, P. Q.

Be Sure of Your Installations

Get the *Aptitude-Tested*
**RG/U TRANSMISSION
 LINE CABLES**

● You know what you are doing when you use Belden RG/U Transmission Line Cables—they're aptitude rated. They are designed to provide desirable electrical characteristics, and rigid control assures constant quality. Specify Belden Radio Wires.
 Belden Manufacturing Co., 4615 W. Van Buren St., Chicago 44, Ill.

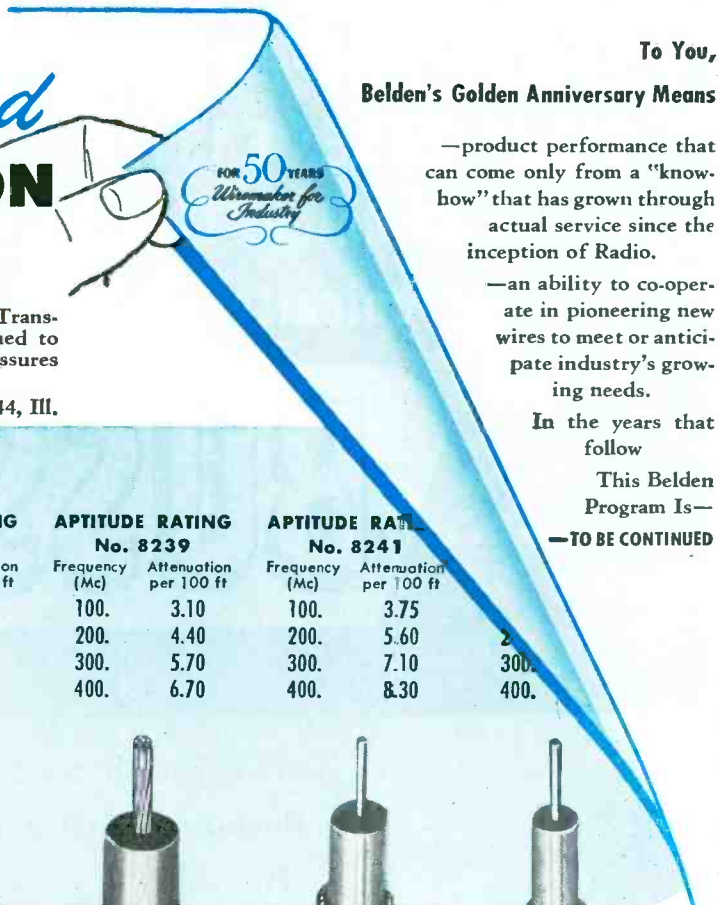

To You,
 Belden's Golden Anniversary Means

—product performance that can come only from a "know-how" that has grown through actual service since the inception of Radio.

—an ability to co-operate in pioneering new wires to meet or anticipate industry's growing needs.

In the years that follow

This Belden Program Is—
 —TO BE CONTINUED

APTITUDE RATING No. 8236		APTITUDE RATING No. 8237		APTITUDE RATING No. 8238		APTITUDE RATING No. 8239		APTITUDE RATING No. 8241	
Frequency (Mc)	Attenuation per 100 ft	Frequency (Mc)	Attenuation per 100 ft	Frequency (Mc)	Attenuation per 100 ft	Frequency (Mc)	Attenuation per 100 ft	Frequency (Mc)	Attenuation per 100 ft
100.	2.65	100.	2.10	100.	1.90	100.	3.10	100.	3.75
200.	3.85	200.	3.30	200.	2.85	200.	4.40	200.	5.60
300.	4.80	300.	4.10	300.	3.60	300.	5.70	300.	7.10
400.	5.60	400.	4.50	400.	4.35	400.	6.70	400.	8.30



Belden
Radio WIRE

The
Aptitude-Tested **LINE**

**YOU'LL FIND THE
RIGHT FUSE, FASTER
in the Complete Line
of Electronically
Tested**

BUSS FUSES

**for Television • Radio •
Radar • Instruments • Controls •
Avionics**

You'll save time and trouble when all your fuse needs are supplied by one, dependable source. The complete BUSS line makes it easy for you to select the fuse to do the job right.

The makers of BUSS fuses insist on perfection. Every fuse is electronically tested in a sensitive device that rejects any fuse not properly calibrated, properly constructed and right in all physical dimensions.

Take advantage of the profit-saving efficiency that you can gain by standardizing on the complete line of BUSS fuses.

MAIL THIS COUPON TODAY . . .

BUSSMANN Mfg. Co. (Division of McGraw Electric Co.)
University at Jefferson, St. Louis 7, Mo.

Please send me bulletin SFB containing facts on BUSS small dimension fuses and fuse holders.

Name _____

Title _____

Company _____

Address _____

City & Zone _____ State _____ **S-753**

Plus
A COMPLETE LINE OF FUSE CLIPS,
BLOCKS AND HOLDERS



IT'S GOOD BUSINESS to stock and use BUSS fuses. Your customers know the name BUSS . . . famous for protection in homes, on farms and in industry for 39 years. When you use BUSS, they know you've used the finest fuses available.

BUSSMANN Mfg. CO., Division of McGraw Electric Co.
University at Jefferson, St. Louis 7, Missouri

Here's how to increase your Auto Radio Repair Business!



There's one sure way to get ahead in the car radio repair business, and that's to be in a position to tap the vast market of Delco Radio-equipped cars and trucks that daily passes your door! To do this you need only sign up with Delco Radio, through your United Motors Electronics Distributor. Then, automatically, you have a reliable source for Delco Radio original equipment replacement parts, and for universal replacement parts. You will regularly receive monthly issues of "Testing Tips," a bulletin giving the very latest factory information on testing and repairing Delco car radios. So if you want to increase your business—permanently—get on the Delco Radio team. Don't delay . . . contact your United Motors Electronics Distributor right away!

DISTRIBUTED BY
ELECTRONICS
WHOLESALERS
EVERYWHERE

DELCO RADIO
DIVISION OF GENERAL MOTORS CORPORATION, KOKOMO, INDIANA

A GENERAL MOTORS PRODUCT   A UNITED MOTORS LINE



AMPHENOL VHF ANTENNAS

dependable performers
PROVEN BY EXPERIENCE

AMPHENOL's complete line of VHF antennas includes three top performers: the famous INLINE*, the INLINE Stacked Array and the Piggy-Back. Whatever the particular reception problems in any area, city, suburban or fringe, from among these three quality antennas can be found the exact antenna answer.

AMPHENOL INLINE* Broadbanded to cover all VHF channels, the INLINE is the finest VHF antenna now being made—a front position that it has held since first introduced four years ago. The INLINE's radiation patterns show a wide single forward lobe on all channels with no side lobes and negligible back lobes. Excellent front-to-back and front-to-side ratios plus high gain on both the low and high frequencies make the INLINE a perfect choice for major signal areas. In addition to its superb electrical characteristics, the INLINE is mechanically very strong.

*Reissue patent 23,273

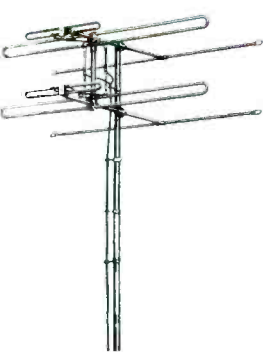
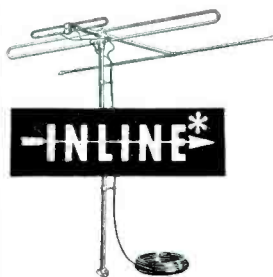

AMPHENOL STACKED ARRAY Added gain for suburban and fringe areas is achieved in this stacking of two INLINES. Each bay of the Stacked Array embodies the same superior construction and performance features of the INLINE. Radiation patterns have excellent uniformity of lobes for both high and low frequencies while the gain curves show approximately 2 db gain over that of the single INLINE. For extended distance reception, even greater gain may be had by the harnessing of two Stacked Arrays.

AMPHENOL PIGGY-BACK An antenna designed with separate dipoles and reflectors for the low and high band, which can be oriented independently. The Piggy-Back assures good reception in areas where the TV stations are in different locations. The harness connecting the two dipoles permits proper phasing for minimum interference. Easy to install, the Piggy-Back is another sturdy AMPHENOL constructed antenna.

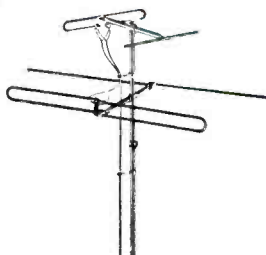

UHF Signal

SURVEYS of signal strength have always been fruitful not only to the broadcaster, but to the Service Man, saving time and money, and insuring good reception.

There are many interpretations as to what constitutes a signal survey. It can be a simple listing of general signal conditions in a given area, or it can be a complete engineering analysis of station performance. The methods of measuring and recording the information can vary to the same degree. Information wanted by the Service Man differs greatly, of course, from that required by the FCC as *proof of performance*. With so many conditions to satisfy, most signal survey results will apply only to the specific purpose for which the survey was designed.

Usefulness of Survey Data

Service signal surveys in an area of operation are valuable since they reveal what antenna might produce good pictures on one street, or how tall a mast and stacked array might be required all along another avenue. Such information is vital in assuring customer satisfaction and eliminating costly delays. If this information is available soon enough, hours of trial and error tactics can be eliminated.

The UHF Problem

With the advent of commercial *uhf*, some questions about signal behavior at these frequencies were still unanswered. The theory of *uhf* performance and practical experience, gained during operation of the Bridgeport and Washington stations was available. But these were experimental, and to an extent limited operations, and it was felt that some of the theories on *uhf* signal propagation and station coverage, should be studied under typical commercial broadcasting conditions. Accordingly, when Washington announced that *uhf*-station approvals would be forthcoming, an extensive field survey program was set up. The project was considered of such importance that measurements began within the first minute of operation of KPTV, Portland, and continued through the initial phases of *uhf* service in Atlantic City, South Bend, and York.

The basic purpose in these areas was to determine actual transmitter performance as compared with theoretical calculations, to observe and measure the effects of terrain and obstructions on the signal, to check performance of receiving antennas and transmission lines, and to provide as much information as possible on reception conditions generally.

Value of Maps

Before starting a field survey, it is an accepted practice to spend some time studying maps of the area. Aeronautical charts, topographical section maps, and simple road maps provide considerable information about the area. From an analysis of these maps, one is able to determine where efforts should be concentrated, where problems can be expected, and what the theoretical signal should be at a given location. On a road map, one determines and lays out the radials from the transmitter along which measurements will be made. In these tests, six to eight radials provided sufficient information. The procedure, in this instance, revolved about traveling along the radials selected and making measurements of the field intensity.

Two types of vehicles were used in these surveys. One, a survey-tower truck, carried a readily collapsible tower that

insist on **AMPHENOL** for

Surveys[†]

by DONALD PHILLIPS

Report On Equipment Used and Results Obtained During UHF Field Tests in Portland, Atlantic City, York, and South Bend

could be extended from 20' to 70'. This tower permitted measurement of the signal at various antenna heights. In most areas, it was not possible to travel any great distance with the antenna extended, due to overhead wires and other obstructions. To overcome this, a shorter mast, about ten feet above ground, was mounted on the vehicle to observe and measure signals while in motion. Picture quality was observed on a standard receiver-selector combination. A *uhf* field intensity meter was used for actual signal level measurements. Gasoline generators provided the power to operate the equipment. The other type of vehicle contained similar equipment, except that a recorder was installed to record the signal level while in motion. Since this vehicle was used only for measurements in motion, when allowable height was limited, no tower was employed. The receiving antenna was mounted on top of the truck. Orientation was accomplished by rotating the mast from inside the vehicle.

Equipment Calibration

Equipment was calibrated to read field intensity in microvolts per meter, rather than the signal at the receiver input. This method provided a standard that could be used for comparison purposes and in calculations. The FCC order under which all TV stations are now licensed defines signal levels in microvolts per meter at a receiving antenna height of 30'. By making measurements under these conditions, it was possible to apply readings directly to theoretical calculations. From the practical standpoint, 30' is about the average antenna height in the customer's home, and it requires only a simple calculation to convert microvolts per meter to the amount of signal at the receiver with any antenna and transmission line.

Antenna Height Studies

Some measurements were taken above and below 30'. This was done to study the effects of obstructions on the signal and determine whether layers of signal existed. From the information obtained, it was possible to determine the type of installation required in a given area. In flat open country it was found that, in the main, the signal strength did not double as the antenna height was doubled. For all practical purposes, increased receiving antenna height yielded little improvement in reception. Behind obstructions, increased antenna height was often the only means of obtaining sufficient signal.

The recorder proved valuable in making a permanent record of the signal along each radial. As these particular measurements were made at the specific height of but

(Continued on page 53)

[†]From a report reviewing surveys made by RCA Service Co. in Portland, Atlantic City, York and South Bend.

AMPHENOL UHF ANTENNAS

a complete line...

Rivaling the quality of the famous VHF INLINE are the new AMPHENOL UHF antennas. These are engineered to meet the many new requirements of UHF reception: high gain, rejection of unwanted signals off the back, broadbanding ability, and specific designs for major signal areas and fringe areas.

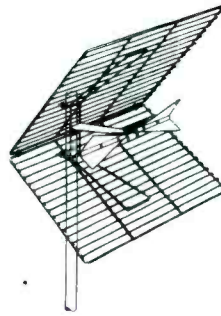

AMPHENOL CORNER REFLECTOR The high ascending gain of the CORNER REFLECTOR and its single forward lobe radiation patterns give assurance of excellent UHF reception, channels 14 to 83, in fringe areas. Precise spacing between the bow tie and the reflector screens contributes to the high gain. The CORNER REFLECTOR, from its V bracing, also has a unique self-locking feature for added strength.

AMPHENOL BO-TY with Reflector. This new antenna has excellent front-to-back ratio, high signal gains and rejects reflected signals off the back and sides. Broadbanded for all-channel UHF reception, the BO-TY has a single forward lobe and has proved itself as an ideal antenna for major signal areas.

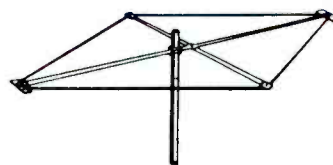
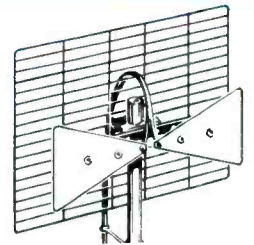

AMPHENOL RHOMBIC Because of its narrow forward lobe, the RHOMBIC is particularly recommended for areas troubled by reflections. The RHOMBIC has a rapidly rising gain across the entire UHF band, making it another good antenna for fringe areas. It also has a strong braced construction.

AMPHENOL STACKED-V The STACKED-V is an all-channel VHF-UHF antenna designed primarily for strong signal areas. With excellent gain on UHF and good gain on VHF, it can be set to three different angles between the V's: 50° for UHF only, 90° for VHF only and 70° for both UHF and VHF.

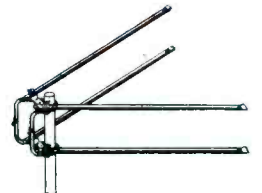

AMPHENOL YAGI The YAGI is available in 11 custom models for peak performance in specified channels groups. A high-gain antenna, ideal for fringe areas, the YAGI's narrow forward lobe gives excellent directional response.

AMPHENOL

better TV picture quality

TAKE YOUR PICK

EITHER OF THESE VALUABLE SERVICING ITEMS...YOURS AT NO EXTRA COST...with purchases of Federal Picture Tubes!

1

THIS TOOL and TUBE CADDY or...



CADDY FACTS: An attractive convenience — for tools and tubes—you'll be proud to carry on all service calls. Sturdy wood construction covered with simulated alligator leather (blue). Over-all size: 18¾ inches long, 13¼ inches high, 9 inches wide. Brass-finished lock, hinges, catches and corner guards. Compartments hold approximately 75 receiving tubes of various sizes. Opens into three separate, easily-accessible sections. \$9.50 value! (A \$14.95 list value).

2

THIS 135-WATT WELLER SOLDERING GUN



GUN FACTS: Weller Model WD-135 (135 watts). Ideal for all types of soldering and dozens of household jobs. Instant heating. Dual heat increases tip life. High or low heat as desired. Exclusive tip-fastening feature—full, constant heat. Low-cost, replaceable tips. Pre-focused spotlight. Longer reach—perfect balance. Shatter-proof plastic housing. \$10.95 value! (A \$14.90 list value).

We want you to know the Quality, Long-Life Performance and Replacement Profits in

Federal PICTURE TUBES



How to get your choice—

With every purchase of a Federal "Best-in-Sight" Picture Tube, your participating Federal Distributor gives you one Federal Certificate. There are no restrictions on type of tube. You may buy one tube at a time, or as many as you need.

As soon as you have accumulated 10 certificates, deliver them to the distributor from whom you purchased your Federal Picture Tubes and he will exchange them for the Combination Tool and Tube Servicing Caddy OR the Weller Soldering Gun. (If you wish, both Caddy and Soldering Gun will be given in exchange for 20 Federal Certificates.)



See your Federal DISTRIBUTOR For Federal Tubes and Certificates!

This offer is void wherever prohibited or wherever any tax, license or other restriction is imposed.

(This offer expires August 31, 1953)

TV SET MANUFACTURER TEST SHOWS OVER

99% HIT THE BULL'S-EYE FOR QUALITY!

Here's proof that it pays to replace with Federal. Here's assurance of customer satisfaction... of less time wasted on call-backs... of more dollars of profit.

Join the trend to Federal "Best-in-Sight" Picture Tubes... outstanding for *quality*, because they are made by a world leader in broadcast tubes.

Federal's line of popular-size tubes will take care of over 90% of all TV replacements!

Start Ordering Federal Picture Tubes—Start Saving Federal Certificates!

Federal Telephone and Radio Corporation



VACUUM TUBE DIVISION • 100 KINGSLAND ROAD, CLIFTON, N. J.

In Canada: Federal Electric Manufacturing Company Ltd., Montreal, P. Q.
Export Distributors: International Standard Electric Corp., 67 Broad St., N. Y.

Centralab Controls —

always within reach . . . always right!

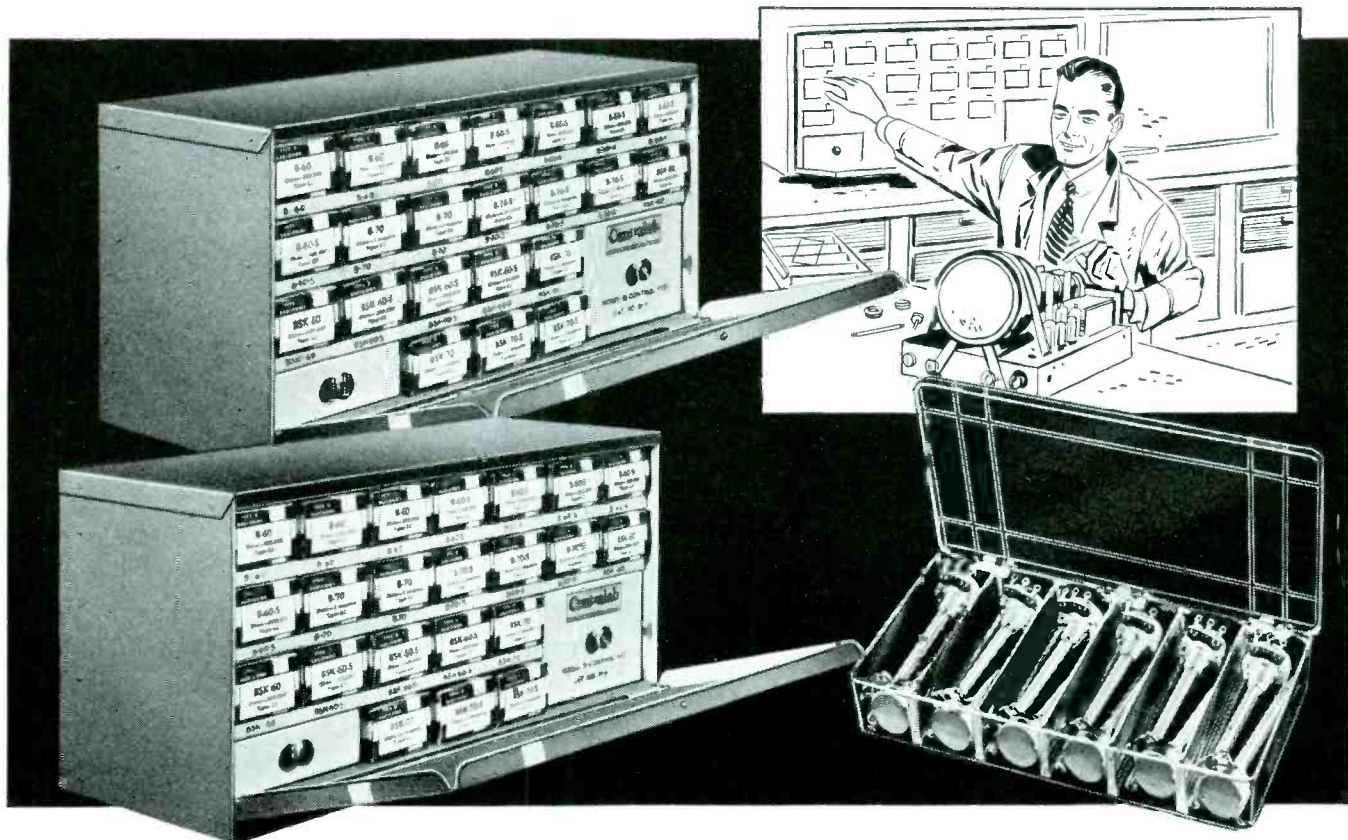

These handy Blue Shaft* Kits help take "parts hunting" out of repair service

If you're like thousands of other busy Service Engineers, you can't afford to sacrifice profit time — hunting for repair parts. The smart, sure way to faster service is to have your Centralab controls on hand when you need 'em — in these handy Blue Shaft Control Kits. Assortments contain values you use every day, in plain or switch types. Switches are factory attached and tested for immediate installation. Included are *exact* service replacements for popular radio and TV sets.

Three kit deals are available: B-A Kit contains 22 controls (8 types) in 1/2 and 1 megohm. All units C2 (audio) taper. Newest, revised Kit B-B has 22 controls (15 different types), plus 4 "Fastatch"* type KB line switches. Ten handy Plasti-Pak Kits of 12 controls each also save time. You pay for parts only — no charge for containers.

You can count on your Centralab Distributor for exact Blue Shaft replacements to keep kits well stocked. So see him soon — he'll be glad to supply the kits you need.

Trade Mark

Centralab

A Division of Globe-Union Inc.

Milwaukee 1, Wisconsin

In Canada, 635 Queen Street East, Toronto, Ontario

FAST MOVERS . . . NO "SLEEPERS"

Kit Deal B-A — 22 controls. 1/2 meg and 1 meg, B types have standard 3" shafts, full-length fluted mill. BSK types have 2 1/8" split-knurled shafts. In handy metal cabinet.

PLAIN TYPE				SWITCH TYPE			
3	B-60	1/2 meg.	C2	5	B-60-S	1/2 meg.	C2
2	B-70	1 meg.	C2	3	B-70-S	1 meg.	C2
2	BSK-60	1/2 meg.	C2	3	BSK-60-S	1/2 meg.	C2
2	BSK-70	1 meg.	C2	2	BSK-70-S	1 meg.	C2

Plus one metal cabinet

Kit Deal B-B (Revised) — 22 controls and 4 "Fastatch" switches. All have standard 3" shafts, full-length fluted mill. In handy metal cabinet.

PLAIN TYPE				SWITCH TYPE			
1	B-5	1,000	C1	2	B-83	2.5 megs.	C1
1	B-10	5,000	C1	1	B-84	3 megs.	C1
1	B-26	25,000	C1	1	B-87	5 megs.	C1
2	B-31	50,000	C1	3	B-60-S	1/2 meg.	C1
2	B-40	100,000	C1	1	BSK-60-S	1/2 meg.	C2
1	B-59	500,000	C1	2	B-70-S	1 meg.	C2
2	B-69	1 meg.	C1	1	BT-80-S	2 megs.	C1
1	B-75	2 megs.	C1	1	T-600K		C13

Plus one metal cabinet

Handy Plasti-Paks — 12 controls. 10 individual kits, also B type. Plain and switch type. C2 (audio) taper. Split-knurled shafts. In useful plastic containers.

"FASTATCH" SWITCHES

2	KB-1	SPST
1	KB-2	DPST
1	KB-3	SPDT

CENTRALAB, A Division of Globe-Union Inc.

908 G. E. Keefe Ave., Milwaukee 1, Wisconsin

Please send me complete details on Centralab Radio-TV Kits as found in the new 32-page Catalog No. 28.

Name.....

Firm.....

Address.....

City..... Zone..... State.....

HERE'S A WINNING CARD...

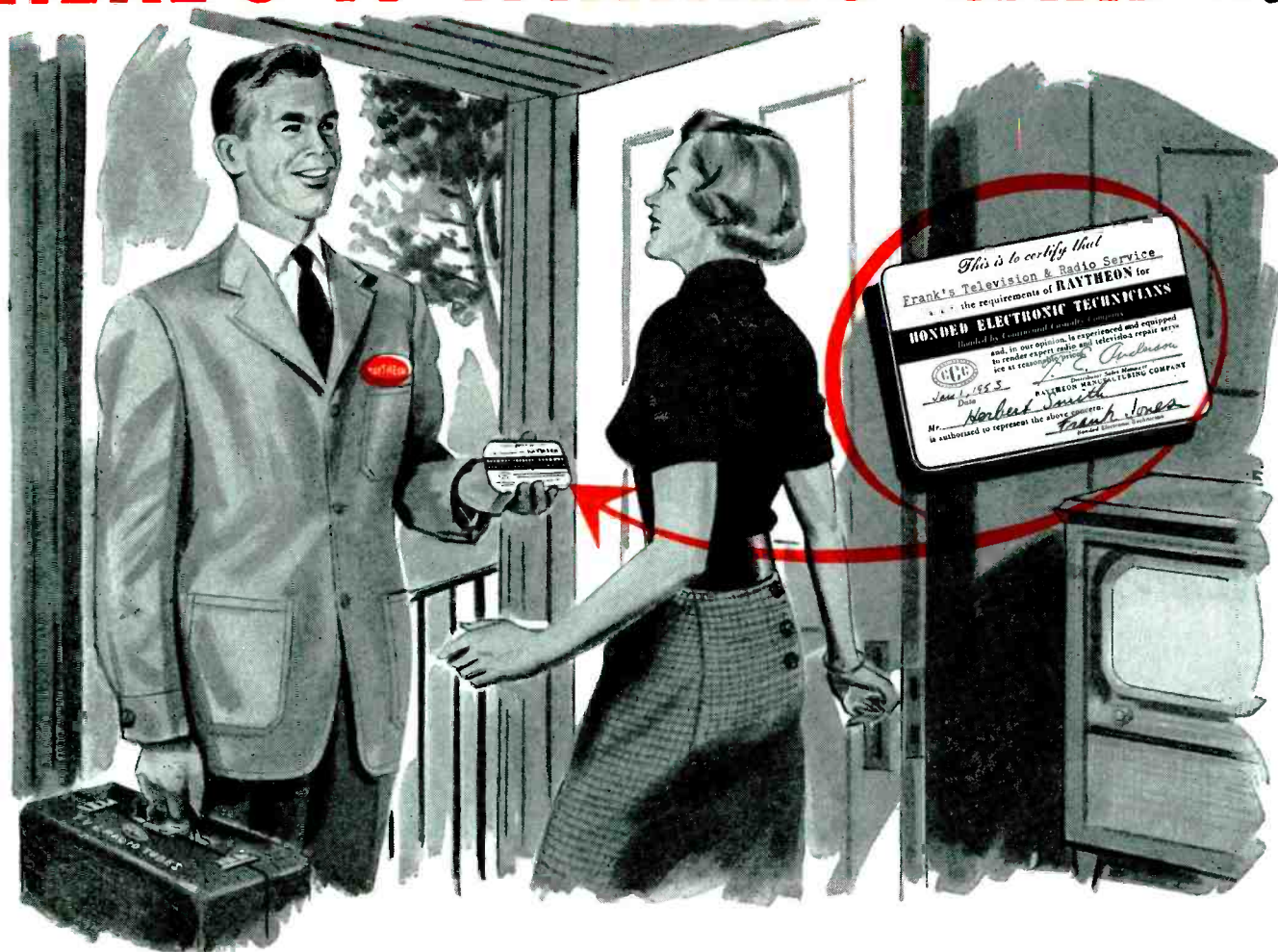

The **RAYTHEON** Bonded Electronic Technician's Identification Card

is mighty important to customers. It instantly identifies the bearer as an expert technician representing a reputable company — lends reassurance to the apprehensive set owner.

But this is only one of the ways the *Raytheon Bonded Electronic Technician Program* helps you. The cash-protection of the Raytheon Bond (backed by

Continental Casualty Company), the Raytheon "Code of Ethics" and the sound, sensible business methods the code suggests all help to create customer confidence and good will. That means more business now, and more business in the future from a steadily increasing backlog of satisfied customers.

This potent weapon in the war against consumer mistrust is yours *without cost* if you can qualify for it. It is Raytheon's investment in *your* future. Call your Raytheon Tube Distributor today, and ask him if you can become a *Raytheon Bonded Electronic Technician*.



RIGHT...FOR SOUND AND SIGHT



RAYTHEON MANUFACTURING COMPANY

Receiving Tube Division
Newton, Mass., Chicago, Ill., Atlanta, Ga., Los Angeles, Calif.

Excellence in Electronics

RAYTHEON MAKES ALL THESE:

RECEIVING AND PICTURE TUBES • RELIABLE SUBMINIATURE AND MINIATURE TUBES • GERMANIUM DIODES AND TRANSISTORS • NUCLEONIC TUBES • MICROWAVE TUBES

RADIO · TELEVISION · ELECTRONIC
SERVICE

A Humble Plea, Mr. Setmaker‡

IN THE PRODUCTION of every radio and TV model, management spends many, many dollars for thousands of hours of painstaking research and development. Every effort is made to create an item which will attract, please and perform as none others have before. The best in hardware is selected, the finest in cabinetry is purchased, packaging receives the closest attention, and, of course, circuitry and parts involved are subjected to minute scrutiny and test.

The product, dictates the front office, must be one of which everyone will be proud; company, distributor, dealer and consumer.

About two years ago, setmakers *discovered*, as a result of a running needling campaign, that something was missing from this ideal approach in the marketing of a product; something which could briskly damage the reputation of all their products, even though they performed well, very well in the lab, in the store, and in the home, for awhile. Yes, they *discovered* that even the best of receivers will break down now and then, and when they do, it must be possible to service the chassis without resorting to mechanical and electrical gymnastics to effect the repair. Thus, engineers in these plants were told to consider the problems of service and maintenance in *all* their design plans.

As a result, some chassis appeared with a number of innovations; layouts were streamlined, cabling was improved, and cabinet housings were simplified. The effort brought cheers from the boys in the field and in the shop.

But, unfortunately, the words *service* and *maintenance* have begun to disappear from many of the bluebooks of good design. And Service Men are once again plagued by part, wiring and cabling puzzles that not only confuse and delay repairs, but build up service bills to the chagrin of the setowner and Service Men, too. For Service Men are reluctant to charge for time required to trace and juggle because of service-design weaknesses, and yet, they must to keep those ledgers in line.

Oddly enough, none of the modifications required to simplify and speed

servicing are involved or costly, a study conducted by a service group revealed recently. To illustrate: It is often necessary to repair the horizontal circuit, and adjust phasing here. In many receivers, this circuit is deeply buried so that the entire chassis must be pulled out to perform this comparatively simple operation. Tarnished contacts on tuners are a constant source of grief; and to effect a repair here, once again the chassis must be pulled. It should be possible to clean tuner contacts while the chassis remains in the cabinet. Some setmakers have recognized this problem and repositioned front ends.

Because of space problems, and often a lack of imagination, speakers have been placed everywhere but in their proper position—up front. Some have positioned them so that the cones face the top, and serve as perfect dust and grime collectors. Others have placed them on the sides and in the corners, making it necessary to place the cabinets in an awkward position away from furniture, drapes or other articles that might muffle or affect distribution of sound.

It should be possible to align a receiver topside. Coupling into a circuit and out should be a pleasure instead of a chore, and all that's required to ease the problem is a little forethought in design.

Diagrams of heater strings and functional layouts of tubes should appear somewhere with every chassis. The layout pattern has been quite a common item with radio sets, but somehow has disappeared from the TV chassis housing. Heater-string diagrams are very helpful in locating open heaters in series-parallel circuits. And, functional tube layouts can expedite the replacement of tubes, particularly the dual-function types.

Tubes and fuses should not be hidden behind other components, or underneath chassis. It should be possible to remove and replace them without wandering through a forest of entanglements.

For years Service Men have been campaigning for a removable picture-tube safety glass, so that it could be cleaned easily, and the tube could be inspected or replaced, if necessary, without pulling the chassis and speak-

er, and uncoupling a radio and phono in the operation. Some alert and friendly setmakers have subscribed to this cause, but, regretfully, there are scores and scores of chassis that still have fixed glass plates up front. To perform the simple operation of cleaning a glass plate, the poor Service Man has to remove nuts and bolts, pull out a series of coupling plugs, and hoist the husky chassis to the floor, being sure to place the receiver so that neither the lady of the house nor children running about might stumble over it.

It would be a pleasure to service receivers featuring properly identified coils with standardized coded primary and secondary leads. Some have begun to follow this practice, and one hopes it will be widespread soon.

The interlock idea, providing for an *ac* line disconnect when the rear panel is removed, would be welcomed for standard radios. One manufacturer has already adopted the practice for his table model lines. The problem of dangling and frayed cords would be eliminated, and a source of shorts would be minimized.

The tiny, but all-important, dial light has been found to be another irksome problem-child. For it is normally so positioned that chassis pulling is often required to effect a replacement.

Accidents might also be avoided if small mounts were available for coiled surplus *ac* cord that normally is found hanging loosely.

These represent but a few of the justifiable gripes of Service Men today. The list was longer a few years ago, and it is hoped that it will just disappear soon, very soon. Receivers offering excellence in circuitry design, plus streamlined servicing features, chassis-wise and cabinet-wise, will win the admiration of consumers, who will laud the product that not only works so well, but can be serviced so quickly and efficiently. And, Service Men will certainly be equally enthusiastic in their praise of those chassis now *engineered* to simplify and expedite maintenance and servicing.—L. W.

‡ With apologies to M. Martyneec and A. von Zook.

GO TESCO!

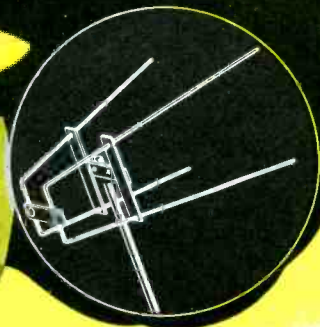

ULTRA V-TENNA
Model 703



ULTRA BOW-TENNA
Model 704

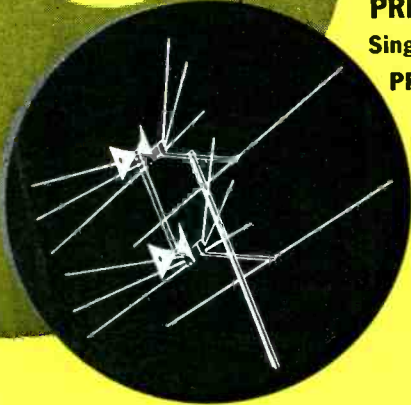

**VHF-UHF
ULTRA-ROCKETENNA**
for
channels 2-83
PRL-742
Single Bay
PRL-721

ULTRA-TENNA series

For Complete **UHF** Coverage

For maximum gain in UHF, Tesco engineers have developed the **ULTRA-TENNA** series—ideal for either combined VHF-UHF reception (The ULTRA-ROCKETENNA) or for addition of UHF to present VHF installations (ULTRA BOW-TENNA, ULTRA V-TENNA, etc.)

Tesco designed ULTRA-TENNAS mean **stronger signal, more rugged construction, quicker installation.**

NEW YORK TO 'FRISCO...IT'S TESCO

Visit Us At Booth 107 At The May Parts Show

TESCO

TV PRODUCTS CO.
SPRINGFIELD GARDENS 13, N.Y.



it's the cats whiskers... and just as sensitive!

The Complete Line of VHF and UHF Antennas and Mounts

SERVICE... The National Scene

COMPATIBLE COLOR-SET DESIGNS DISCLOSED IN FCC PETITION FOR STANDARD OKEH--The first complete report on the characteristics of tricolor receivers, developed for compatible operation, appeared recently in a 697-page petition, filed with the Federal Communications Commission, asking for approval of new standards for color broadcasting.* . . . Featured in the new chassis, that will undoubtedly become standard for color-set design, are an intercarrier 41.25-mc if system, high-level second detector for maximum linearity, noise-inversion sync separation, electrostatic convergence and focus along with dynamic modulation of the picture-tube anodes, quartz-crystal afc color synchronization, low-level color demodulation using quadrature techniques, picture-tube grid drive with dc restoration, and a color killer to disable the color channel during black and white transmission.

The picture if amp, a 6-stage affair designed for a 45.75-mc picture carrier, provides for a 42.17-mc color subcarrier, and 41.25-mc sound carrier. Tubes used include one 6BQ7A, four 6CB6s and one 6CL6.

The video in these new color models consists of three separate functions; luminance channel, chrominance channel, and a matrix which serves to combine the two channels. The luminance channel (which will be referred to as a Y channel) amplifies the luminance information which is applied to the picture tube via the matrix. The chrominance channel, it was noted, recovers the color-difference information contained in the color subcarrier and accompanying sidebands. By the process of synchronous detection in phase quadrature, two independent signals, it was explained, are recovered from the color subcarrier; these signals will be known as I (in phase) and Q (quadrature phase). The Q channel can pass information up to approximately .5 mc, and the I channel has been designed to pass information up to approximately 1.8 mc. . . . It was noted that the tricolor picture tube requires simultaneous excitation with red, blue and green signals: It is the matrix which provides these simultaneous signals by combining predetermined proportions of Y, I and Q information.

In a review of matrix operation, the report said that a fixed resistive mixing type of feedback amplifier is used to combine the red, green and blue signals. One triode section of a 12BH7 is used with the matrix resistors. Added luminance and chrominance signals are amplified by the second half of the triode sections of these tubes and serve as a drive for each of the three grids of the picture tube. It was pointed out that unequal drives are required, due to the unequal phosphor efficiencies of a tricolor picture tube; red being in the order of 100 volts, while green and blue require 50-70 v drive.

To recover color information contained in a compatible signal, it is necessary to generate a local subcarrier of proper frequency and phase. To accomplish this, phase-reference information must be transmitted as a component of the composite color video signal. This color sync information is sent out in the form of a burst of approximately 8 cycles of the color subcarrier frequency, and appears immediately following each horizontal sync pulse in the composite signal. The burst is separated from the composite video signal and is used to establish two continuous wave signals of color subcarrier frequency, having a 90° phase displacement from each other. In the receiver, there is provided a color sync channel, which includes a keyed burst amplifier stage, phase detector--3.579-mc driver and color-phasing amplifier, crystal oscillator, reactance tube and quadrature 3.579-mc amplifier.

A thorough study of all of the design features of these new color receivers will appear next month in SERVICE. Featured, too, in this issue, will be a comprehensive discussion of the new techniques that will have to be applied to service compatible color-TV sets.

*Color standards were proposed by RCA and said to be technical signal specifications approved in February by engineers and scientists of industry, and members of RCA-NBC staffs through NTSC. Another standards petitions will be filed by NTSC in a few weeks.

SERVICE... *The National Scene*

10-15 MILLION SUBSCRIBERS FORECAST FOR COMMUNITY TV--Community-TV installations, expected to serve 350,000 subscribers by '54, will ultimately reach 10-15 million viewers by 1960, experts declared during the second annual meeting of the National Community TV Association in New York City recently. According to the prexy of one community-TV equipment maker, there are at present 63 systems serving 120,000 homes. . . . Many unusual methods are being employed to pipe in signals. In Casper, Wyoming, an 85-mile microwave jump from Laramie, Wyo., is in operation beaming signals from Denver, 140 miles away. . . . In Ventnor, N. J., provision is being made to feed reception from three Philadelphia vhf stations and a uhf channel in Atlantic City. The antenna for this system is atop a 150' tower. . . . The systems use specially-designed types of amplifiers and accessories'. In some systems, broadband amplifiers, capable of serving up to seven channels, are being used. Available, too, are radiation-proof cables which not only prevent absorption tap offs, but eliminate interference to non-subscriber chassis.

TV CALLED FACTOR IN HOME BUILDING--Television has introduced a new vogue in small-home construction. According to a recently-completed survey, new homes are now featuring a second living room for TV, and builders have reported that the additional room has been a boon to house sales. In one northern New Jersey real estate development, extending over an area of 20 acres, a realty group has announced that its homes have second living rooms, and with specially-constructed TV outlets available. For improved appearance, and as a barrier against hazards, leadin wires are being installed in ducts within the walls, and in some instances, cutouts are provided for wall-mount installations.

SETMAKER'S SERVICE MANAGER PRAISES SERVICE MEN--Vigorously applauding Service Men for an outstanding job in mastering TV service, the service manager of a large setmaker in the midwest declared during a recent dealer convention that Service Men are to be complimented for their ability, and sincerity. The average TV or radio Service Man, he said, has a fervent desire to do a good job, and if he has any fault, it is that he too frequently does not charge what his service is worth. Lashing out against licensing, he pointed out that control does not insure honesty or diligence. In his opinion, people can and will judge and always reward the competent and honest with patronage.

EAST AND MIDWEST WIN NEW STATION GRANTS--Kansas City, Mo., and New Haven and Stamford, Conn., will soon have new vhf and uhf stations in operation. In the midwest, Midland Broadcasting and WHB Broadcasting have been authorized to share channel 9, and operate with 316-kw outputs. . . . Connecticut Radio Foundation has been granted channel 59 for New Haven, and the Stamford-Norwalk TV Corp. has been authorized to operate a station in Stamford on channel 27.

110-MILLION RADIO SETS NOW PERKING--About 5 million more have become radio set owners since last year, bringing the total receiver ownership to over 110 million, according to a probe recently completed by the research departments of the four networks. . . . Specifically, as of the first of the year, there were 44,800,000 total radio homes; 30 million extra sets in homes; 26,200,000 sets in private passenger cars, and 9 million receivers in barracks, dormitories, eating places, hotels, offices, business and service establishments, taxis, trucks, and in use as personal portables, too. . . . It was also revealed that actually 11 million new sets were sold in '52, representing a volume substantially greater than the sale of new cars, refrigerators or TV sets or home appliances, and reflecting a resounding interest in listening-in. . . . Radio continues to be a robust youngster, reaching new heights of popularity and acceptance yearly.--L. W.

¹SERVICE; January and February, 1953.

TRIPLET
650 VTVM

There's Nothing finer for

Television



This combination of features explains why

- Complete frequency coverage with one probe, 20 cps to over 110-mc. Insulated and shielded RF tube probe, found usually only with laboratory instruments, is included.
- Peak to Peak ACV and RF with one probe.
- One volt full scale reading on AC & DC.
- One main selector switch, all ranges.
- ACrms—Peak to Peak
- 32 Ranges
- Zero center mark for FM discriminator alignment plus any other galvanometer measurements.
- High input impedance 11 megohms on DC.

Suggested U.S.A. Dealer Net \$69.50 • Prices subject to change without notice.

TRIPLET ELECTRICAL INSTRUMENT CO., BLUFFTON, OHIO

Triplet

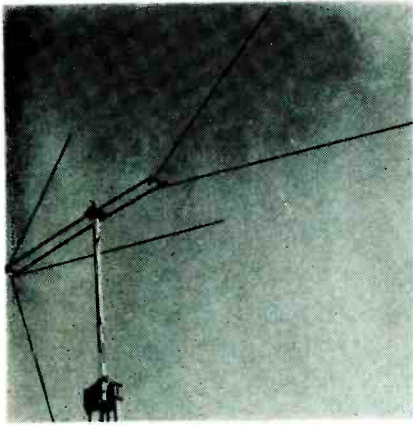
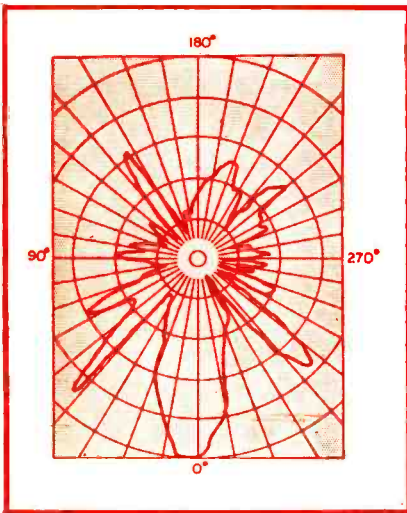

Fig. 1. A double-V antenna.

(Below)

Fig. 2. Directivity pattern of double-V at 710 mc.



(Below)

Fig. 3. Directivity pattern of trombone at 710 mc.

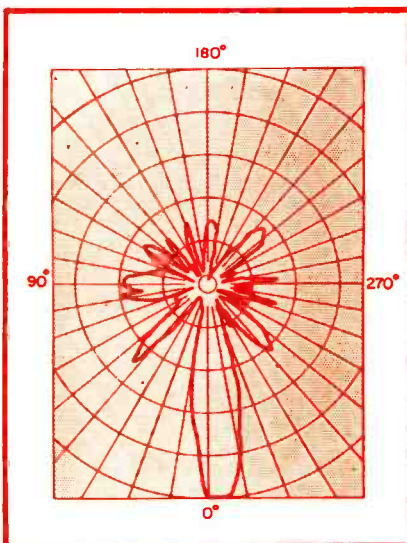

At UHF, antenna height, distance from the station and ghost conditions are more critical than on the standard TV bands, and thus it is particularly necessary to study closely the area in which an installation is to be made and the specific type of antenna to be used.

Especially helpful in an evaluation of the antenna are polar patterns. Such patterns reveal antenna response throughout a complete circle. Antennas with numerous response points just slightly lower than the main response will be found satisfactory in high signal areas; usually there is a sacrifice of main lobe antenna gain in side lobe response. Even in high signal areas this type of antenna might give trouble; ghosts appearing because of side lobe response. Patterns also show gain over a dipole versus frequency. Generally, gain increases with frequency, partly compensating for any deficiencies in receiver performance at the higher frequencies. Some antennas are peaked at one frequency and are thus suitable only for single channel reception.

At *uhf* the high losses encountered in some transmission lines can reduce the efficiency of even good outdoor antennas.

Orientation of an antenna presents no problem when only one station is to be received, but problems do arise where many stations lying in different directions are involved. In the latter instance, it is a good rule to use an antenna with comparatively poor directivity and then orient for the weakest station. Where more than one station is quite weak, there is no alternative but to use a very directive an-

tenna and an antenna rotator motor; this is good practice in fringe areas.

Mapping Locations

Familiarity with locations of transmitting antennas of the TV stations is very helpful. Such knowledge coupled with the use of a map protractor and directivity patterns will simplify installation. In some cases, a transparent trace of a pattern placed over a map will show the direction of the best response for an antenna. By moving the transparent trace of the directivity pattern around, it might be found that certain antennas have large side lobes

Antenna Type	Voltage Gain		General Remarks
	Front	Back	
Stacked bowtie with reflector	21	3	Very small minor lobes
Stacked vee	20	11.5	3 minor lobes (60% average)
Double vee	15	9.5	Many minor lobes (60% average)
Trombone	12.5	8	Many minor lobes (40% average)
Parabolic or corner reflector	12.5	4.5	Small minor lobes
Stacked bowtie	11	10	Bidirectional
Single bowtie with reflector	8	2	Small minor lobes
Single bowtie	6.5	5.5	Bidirectional

Table 1
Voltage gain for a number of common types of antennas.

Below: Fig. 4. Stacked V antenna.

Fig. 5 (right). Directivity pattern of stacked V at 710 mc.

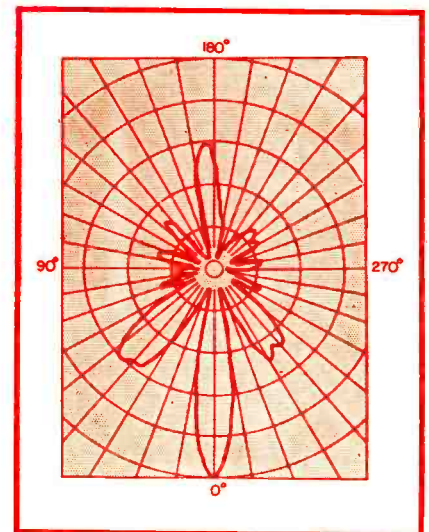
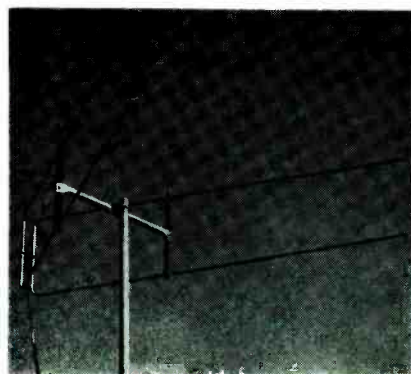

Antenna Installation

Comprehensive Discussion of Low and High Band Transmission Lines and Antennas and Their Installation

that are correctly oriented to receive all the stations receivable in your locality.

Transmission Lines

Transmission lines do become quite lossy at *uhf* and losses increase rapidly when the line is wet. Installation of transmission lines close to buildings can also introduce losses because of absorption of energy from the line into the building. Special care must be taken in *uhf* installations to keep the line loss as low as possible and the impedance of the line as nearly constant as possible. In installation of transmission lines, it is wise to use a few transmission line guides to keep the line clear of all parts of a building or roof. And it is a good practice to install a second guide about 4" away (approximately 1/4 wavelength) which will partly compensate for the shunt capacitance introduced by the guide. A shunt capacitance across a 300-ohm transmission line of but 1 mmfd can increase the *swr* of a matched line to 2 at 500 mc or 4 at 1,000 mc.

In table 2 the losses of various transmission lines at *uhf* are shown. It will be noted that losses cover dry and wet conditions.

Summary

Summarizing the transmission line characteristics at *uhf*, 300-ohm flat

Type of Line	At 500 mc		At 1000 mc		Remarks
	Dry	Wet	Dry	Wet	
450-ohm open line	0.8	...	1.2	...	Support clear of building; matching transformer
300-ohm tubular	3.0	6.8	4.6	10.0	Best 300-ohm line
300-ohm flat	3.2	20.0	5.0	30.0	Use short lengths only
RG-59/U	9.4	9.4	14.2	14.2	Use short length; may lay on roof*
RG-11/U	5.0	5.0	7.6	7.6	Quite bulky and expensive*

Table 2
Transmission line losses in db per 100'.

twinlead should only be used in short lengths and in strong signal locations; 300-ohm tubular line can be used where signals are weak. Both 300-ohm line types must be supported well, clear of all objects. Where the transmission line cannot be kept clear of buildings coax cable should be used with a balun to transform to 300-ohm balanced. The RG-59/U should be used for short runs in strong signal areas and RG-11/U in long runs or in weak areas. The 450-ohm open line will be found effective in fringe areas; it should be used with a transformer.

*Balun required in these instances.

(All illustrations courtesy Du Mont)

Fig. 6 (below). Stacked bowtie with a reflector.

Fig. 7 (left). Directivity pattern of stacked bowtie without reflector at 710 mc.

Fig. 8 (right). Directivity pattern of stacked bowtie with reflector at 710 mc.

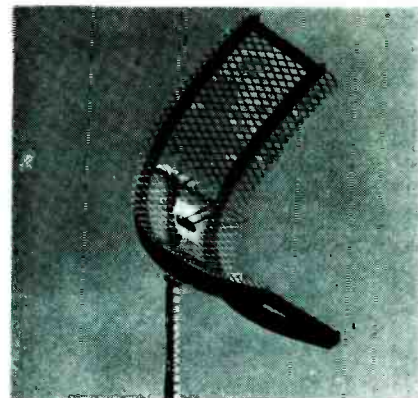
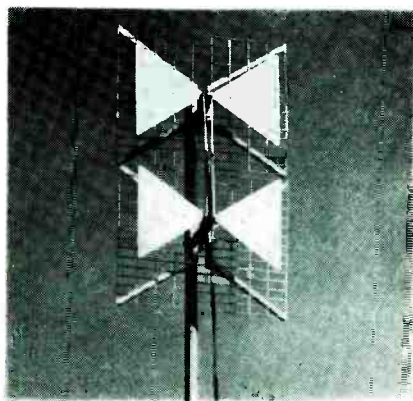
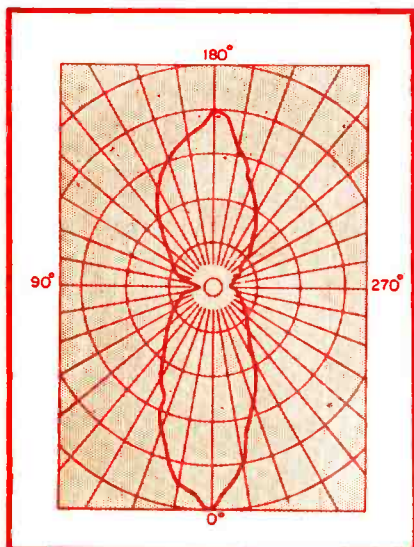
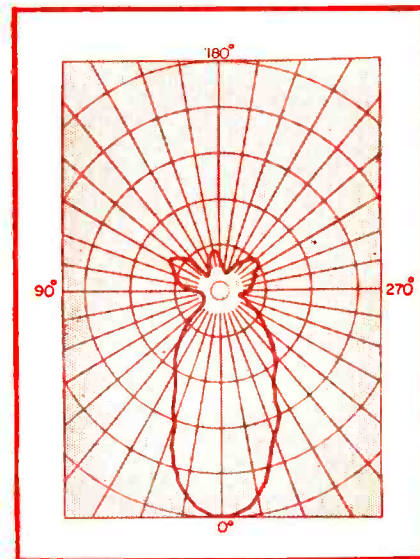
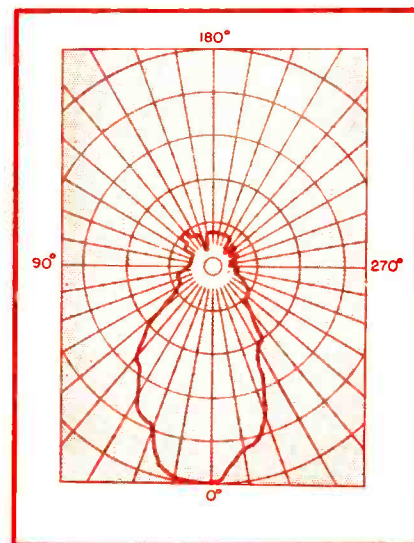

Fig. 9. Corner or parabolic reflector type of antenna.



(Above)

Fig. 10. Directivity pattern of parabolic type antenna at 710 mc.



PORTABLE and AC/DC CLOCK RADIOS

[See Front Cover]

by WYN MARTIN

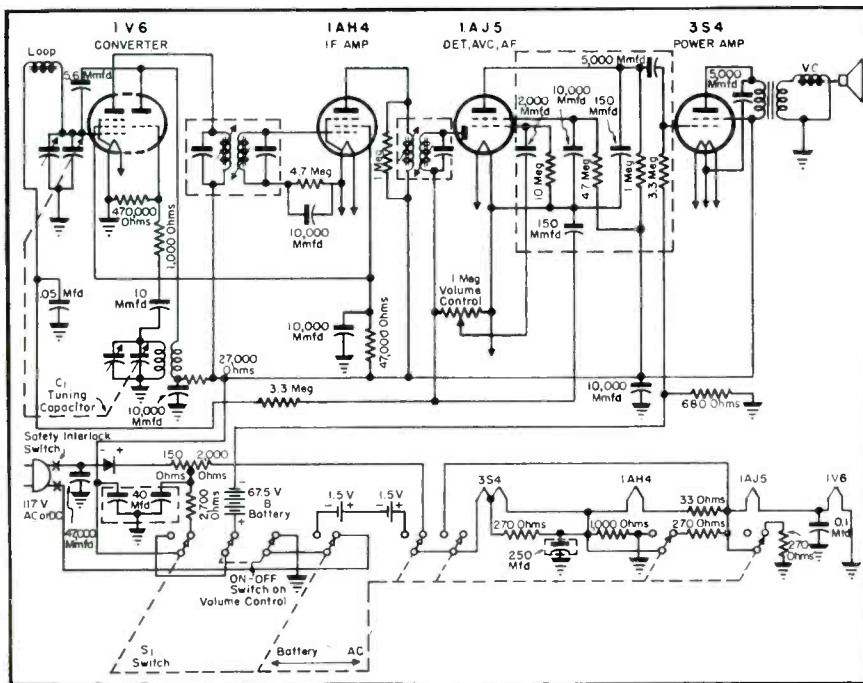

Fig. 1. Schematic of three-way portable clock radio, which uses subminiature tubes and components; Motorola 531C models.

CLOCK RADIOS, which had been considered a pure novelty item for years, have suddenly emerged as a sparkling member of the receiver family. Whereas in the past, clocks were included in a few special models, today they appear in complete lines, even

portables, as illustrated on the front cover and in Fig. 1.

The portable is particularly unique in its design, featuring not only a special clock (wind-type) to fit into the small area available, but for the first

† *Audio Broadcasting*, editorial, SERVICE, June, 1953.

time, subminiature tubes and components.

This model, the *Motorola 531C*, uses three subminiatures: a 1V6 converter, a 1A4H4 *if*, and a 1A1J5 serving as detector, *avc* and audio amplifier. A 3S4 power tube and a selenium rectifier complete the tube complement.

This carry-model enjoys still other firsts. Not only is it the first clock portable, but the first portable using an inverted oval speaker† (5 x 7 as compared to the usual 3½" size), and the first to use subminiature *if* coils.

The set operates on *ac*, *dc*, or long-life batteries which, it is claimed, will last longer because of the lower current drain of the subminiatures.

Clock Operation and Adjustment¹

The increased use of clocks has spurred interest in their design, adjustment, and repair.

The operation and adjustment of the wind clock models used in the battery portable normally follows standard practices. If, for instance, the clock loses or gains time, a small thin object should be inserted through the slot in the dial crystal and the speed control moved toward *F* or *S*. One precaution: One should not exceed the depth of the speed control lever or damage to the clock will result.

Electric clock adjustments and repairs are more a critical operation; however, there are many types of repair that can be performed by Service Men.

In servicing radio timers, two factors must be considered: in-warranty and out-of-warranty. In-warranty returns, it is said, must be serviced by the authorized service stations located in most of the principal cities throughout the country.²

Simple out-of-warranty repairs can be performed by the Service Man; such as the replacement of broken crystals, damaged bezels and knobs,

(Continued on page 54)

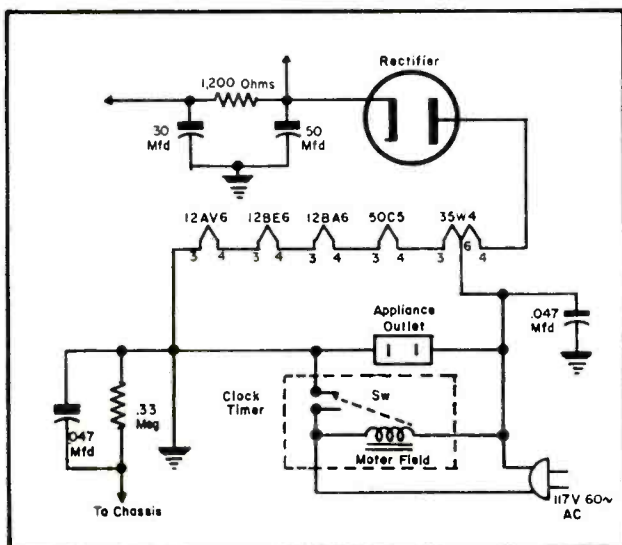

Fig. 2. Circuitry of electric-clock hookup in typical *ac-dc* chassis using 12BE6 mixer, 12BA6 *if*, 12AV6 first audio and detector, 50C5 audio output, and 35W4 rectifier; Arvin 657T.

¹From notes prepared by E. C. Pease, Telechron.

²A complete list of Telechron's authorized service stations will be mailed, free of charge, upon request to Product Service, Telechron Department, General Electric Company, Ashland, Mass.

You wanted it... *here it is*

THE RCA "SERVI-CHEST"

the truly portable "workshop"
you'll be proud to take into the home

YOURS FOR JUST 30

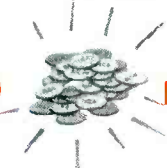

RCA SILVER TOKENS!

Look at these features!

- 1 GIANT SERVICE MIRROR—Top-quality glass. 11" x 16" working surface. Removable hinges for flexibility of use. Wedges provided for adjustment of mirror angle.
- 2 SOLDERING GUN COMPARTMENT—Will accommodate all popular makes of soldering guns or irons.
- 3 UTILITY DRAWER—Roomy enough for tools, flashlight, large capacitors, high-voltage probes, etc.
- 4 RESISTOR DRAWER—Will hold large assortment of popular resistor sizes.
- 5 CAPACITOR DRAWER—Plenty of space for working supply of radio and TV types.
- 6 SPARE PARTS DRAWER—Suitable for small components and tools.
- 7 VOLTMETER COMPARTMENT—Designed to accommodate the popular RCA "Volt-Ohmyst"®. Instrument can be operated without removal from compartment.
- 8 UTILITY COMPARTMENT—Suitable for socket wrench kit, drop cloth, carrying strap, etc.



DELUXE CONSTRUCTION
Measures 13 1/4" high,
9" deep, 18 1/4" wide.

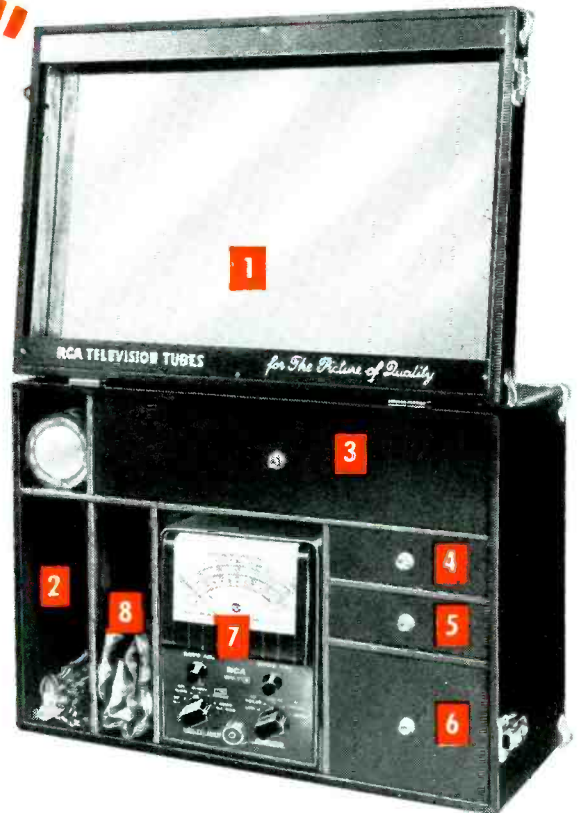

How to get your RCA "SERVI-CHEST"

IT TOOK SIX MONTHS TESTING in the field to develop just the right kind of carry-all case for you... the RCA "SERVI-CHEST." It's the "little black bag" that identifies you as a "professional" Radio and Television Service Technician. The "SERVI-CHEST" is just what you asked for... and you can get yours *without cost.*

During the next three months, you will receive one RCA Silver Token from your *RCA Tube Distributor* for each RCA Kinescope or for each 25 RCA Receiving Tubes you purchase. When you have collected 30 Silver Tokens, present them to your *RCA Tube Distributor* and receive, *without cost*, the complete RCA "SERVI-CHEST." Start earning yours today.

PLUS THIS BIG BONUS

With every RCA "SERVI-CHEST" you earn, you get these seven RCA Technical Publications.

1. "Service Parts Directory for RCA Victor Radios."
2. "This Business of Radio and TV Servicing."
3. "RCA Receiving Tubes" booklet.
4. "RCA TV Replacement Guide."
5. "TV Servicing Supplement."
6. "RCA Kinescopes" booklet.
7. "TV Servicing."

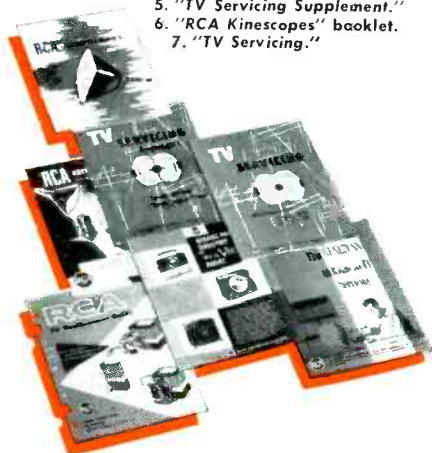

Now you can earn
an RCA Drop Cloth and Carrying Strap

For only 3 Silver Tokens each, you can earn these two valuable servicing aids. See your RCA Tube Distributor.



Now available from your RCA Tube Distributor... The famous RCA "TREASURE CHEST" a perfect companion piece to the RCA "SERVI-CHEST"



See your RCA Tube Distributor today for full details



RADIO CORPORATION of AMERICA
ELECTRON TUBES
HARRISON, N. J.

In The Field ‡

IN DETERMINING the condition of a video amplifier involving sweep-frequency and square-wave tests how does one identify the related patterns on the 'scope and proceed to interpret them?

The best way to learn how to analyze 'scope patterns is to observe the correlation between pattern variations and circuit defects, as shown in Figs. 1, 2, 3, 4 and 5.

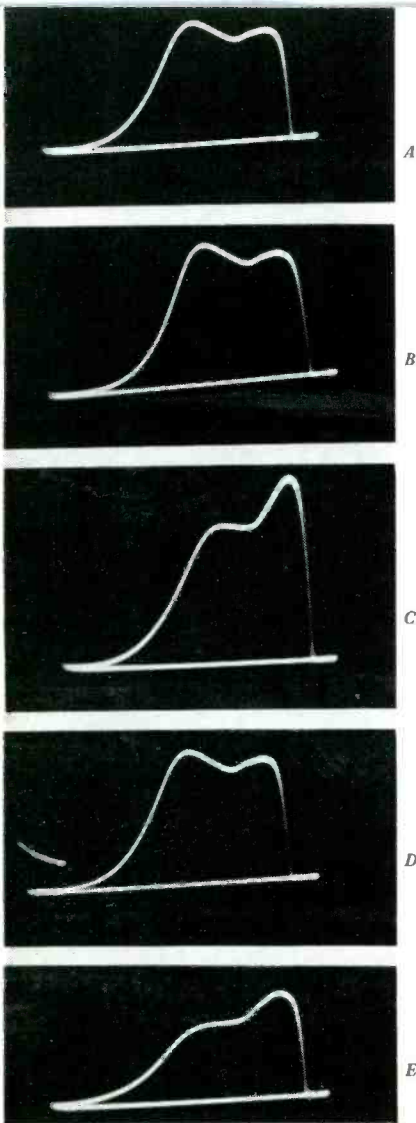

(Left)
Fig. 1. How variations in component values affect the shape of the video response curve: In (a) picture-detector and video-amplifier load are normal; (b) illustrates picture-detector load double normal value and video-amplifier load normal; in (c) the picture-detector load is normal and video-amplifier load double normal value; at (d) the resistive loads are normal, but the picture-detector shunt peaking coil is shorted; and at (e) the resistive loads are normal, but the picture-detector shunt and series peaking coils are shorted.

(Below, left)
Fig. 2. Typical square-wave response of a video amplifier in which a 1,500-ohm plate load resistor has decreased from 1,500 to 500 ohms; (top) 10,000 pps; (center) 100,000 pps; and (bottom) 500,000 pps.

(Below)
Fig. 3. Typical square-wave response of a video amplifier in which a plate-load resistor has increased from 1,500 to 4,500 ohms; (top) 10,000 pps; (center) 100,000 pps; (bottom) 500,000 pps.

(Right, top)
Fig. 4. Typical square-wave response of a video amplifier in which a plate-load resistor has increased from 1,500 to 7,500 ohms; (top) 10,000 pps; (center) 100,000 pps; (bottom) 500,000 pps.

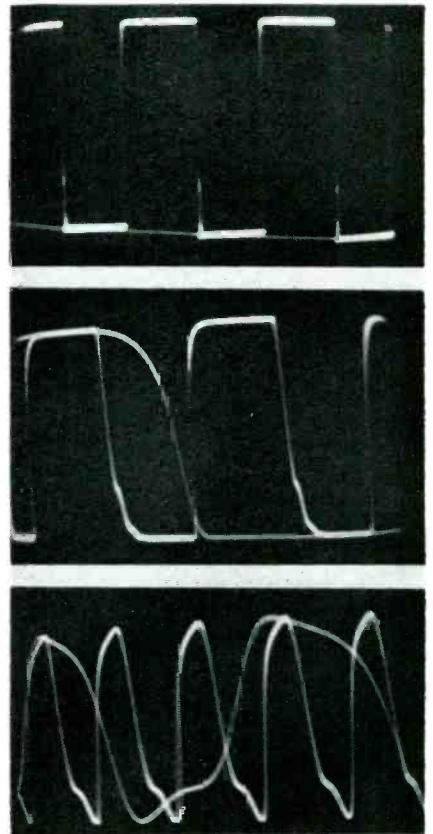

(Below)
Fig. 5. Typical square-wave response of a video amplifier in which a 1,500-ohm plate resistor has increased from 1,500 to 50,000 ohms; (top) 10,000 pps; (center) 100,000 pps; (bottom) 500,000 pps.

‡Based on questions posed during meetings conducted by R. G. Middleton, senior engineer at Precision Apparatus Co., Inc., and author of *TV Trouble-Shooting and Repair Guide Book*, published by John F. Rider.

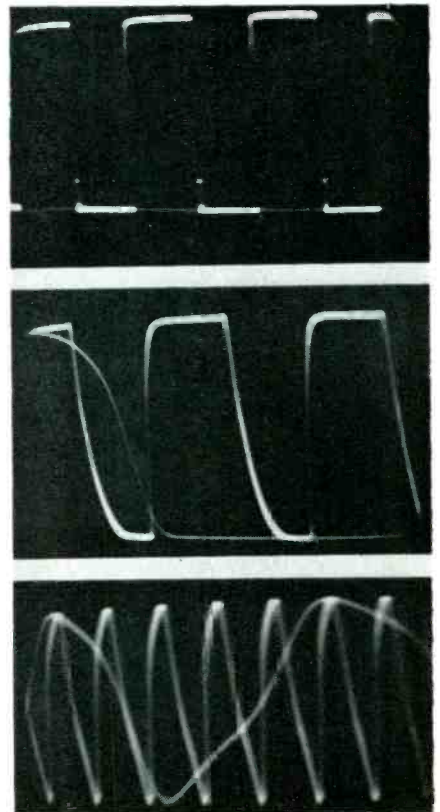
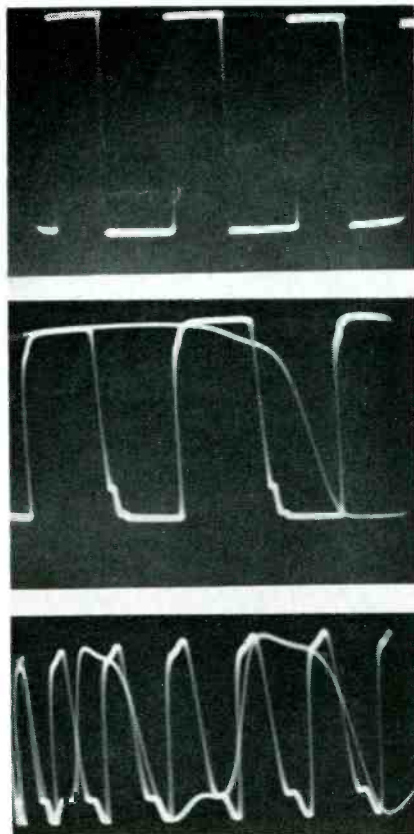
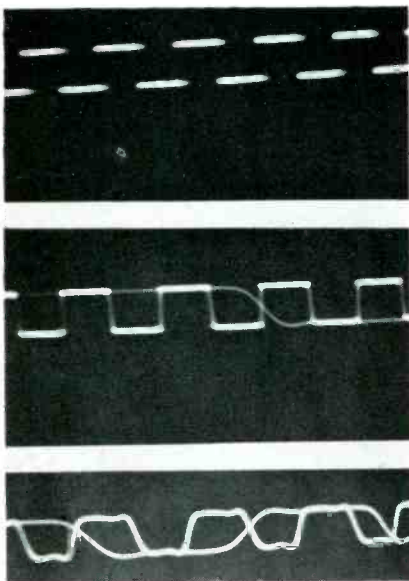

At Last! a YAGI for the ENTIRE LOW BAND!

CHANNEL MASTER'S Newest futuramic

Completely covers every low band channel—2 through 6

Now the extraordinary high gain of a Yagi . . . the razor-sharp directivity of a Yagi . . . Not on just one channel — but clear across the entire Low Band!

Designed for service TODAY and TOMORROW in these 3 booming VHF markets:

Areas in which present VHF stations are changing channels (on the Low Band).

The Futuramic Yagi provides better reception than conventional Yagis on the present channels — and when the shift occurs this superior reception will continue on the new channel WITHOUT INTERRUPTION. And you can make your change-over installations NOW.

Areas in which a new VHF station is being added to the present one (on the Low Band).

The great number of single channel Yagis now in use will not bring in the new channel. If an additional Yagi is installed it will have to be tied into the present installation with separate leads and a switching system. However, one Futuramic will do the job of BOTH antennas — at lower cost — with better results on BOTH channels.

Areas served at present by two or more VHF stations on the Low Band.

You no longer have to compromise between conventional broad band antennas, and separate Yagis for each channel. The Futuramic gives you the full advantages of both. It combines highest gain and sharpest directivity with simple, economical installation.

horizontal polar pattern (relative voltage)

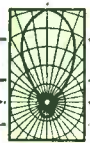

gain above tuned reference dipole

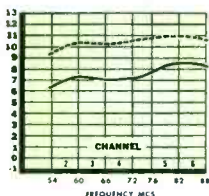

model no. 1126

A high-low Futuramic combination is the most sensitive array ever designed for all-channel VHF reception. Just combine models 1173 and 1126.

Now — 6 great Futuramic models, designed for every reception area:

model no.	channels covered	list price
1173	7 — 13	\$20 ⁸³
1124	2, 3, and 4	
1125	2, 3, 4, and 5	
1136	3, 4, 5, and 6	\$40 ⁹⁷
1146	4, 5, and 6	
1126	2, 3, 4, 5, and 6	

CHANNEL MASTER engineering pays off on VHF!



CHANNEL MASTER CORP. ELLENVILLE, N. Y.



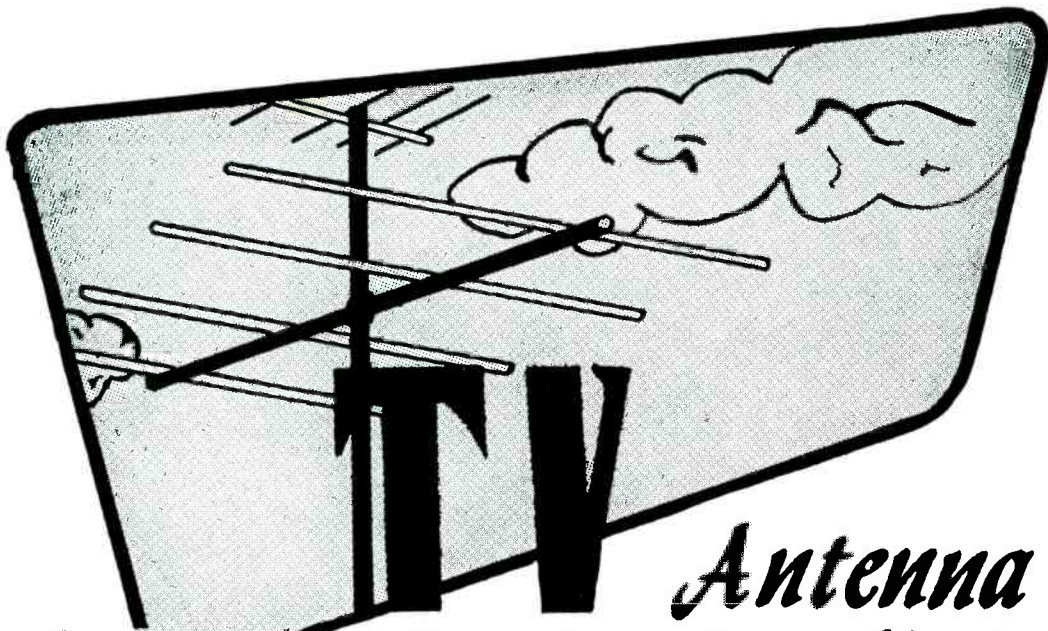

Antenna Digest

design.. application.. installation.. service

by RALPH G. PETERS

TRANSMISSION LINE LOSSES at the ultrahighs are much greater than on *vhf* since losses increase with frequency. Attenuation losses on ordinary 300-ohm flat line increase tremendously when wet, and is far more severe on *uhf*. Therefore, on new *uhf* installations, 300-ohm flat line should be avoided, if possible, particularly when long lengths are required.^{1, 2}

A minimum distance of four-inch separation from all surrounding objects must be adhered to to prevent signal absorption loss. In cases where this is impossible, coax may be used; RG-59/U or RG 11/U. The total attenuation loss may be actually less than the 300-ohm flat or tubular line under this condition; however, in normal installations, coax lines should not be used on long runs due to the large losses per foot.

When installing 300-ohm tubular line, the end connected to the antenna

must be sealed against moisture, either by using a tape or fusing the insulation together with a soldering iron as shown in Fig. 1.

Drainage Loop

A drainage loop should be made in the line just before it enters the house, and a hole punched at the bottom of the loop to release moisture condensation; Fig. 3.

Open-wire line is reported to have the lowest attenuation loss per foot of all lines used. In some instances, it is difficult to handle due to its physical construction. Its characteristic im-

pedance of 450 ohms may prove to be a problem, too, in some cases. The transmission line must not be coiled or have any *kinks* anywhere between the antenna and the tuner itself. The transmission line should always be cut so that it will just reach the receiver, not allowing any extra length to lie behind the receiver. When checking the leadin, the short line inside the receiver should also be

Fig. 1. Preferred method of sealing ends of 300-ohm tubular transmission line: (a)—two inches of bare wire are left for necessary connections; (b)—insulation is cut allowing approximately 3/4" flaps to remain on each side; (c)—flaps are folded in as shown and (d) heat applied to seal seams . . . heat will melt insulation and cause it to fuse together—either a match or soldering iron should be used as shown.

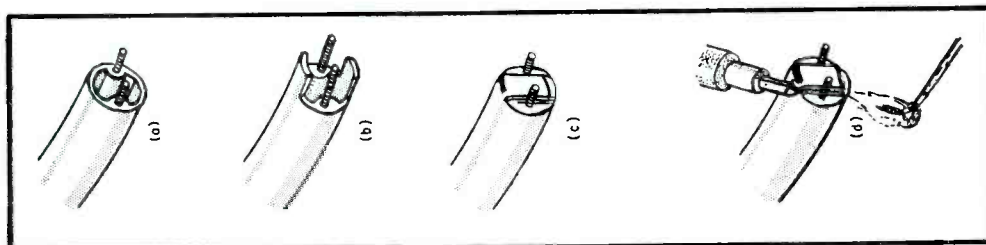

¹Based on service notes prepared by Admiral.

²See Henry Hesse article, this issue, p. 20.

Fig. 2 (right). Alternate method of sealing: (a)—two inches of bare wire left for connections; (b) rubber or Scotch Brand electrical tape used to seal the open end; (c) wrapping continued around top end and wire until operation is complete.

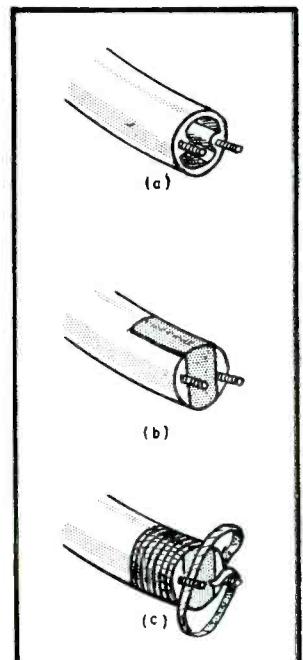

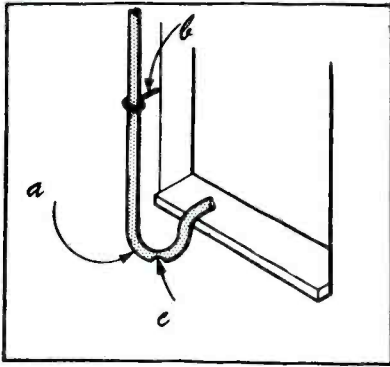

Fig. 3. Tubular transmission line setup at point of entry: Standoffs providing a 4" separation from the wall (b); loop formed (a) to release condensation, and, (c) a 1/4" hole pierced in the leadin before bringing it through the window or wall.

checked, and any kinks, folds, or turns should be removed.

Standing Waves

Attenuation of the incoming signal may be the result of standing waves on the transmission line. To check for standing waves, the leadin should be held at various points along the line, starting from the receiver antenna terminals up to a point about three feet out along the line. If picture contrast changes at any point, standing waves are present. To correct this condition, the transmission line should be wrapped with a strip of tinfoil, varying its position along the line until a point of maximum picture

Airspaced and Twistube TV leadin.† The former uses only one common covering tube which surrounds and is fused to spiral cords from about 180° to 270° of a circle. Latter lead is also air-spaced and is said to incorporate an added feature of being transposed to equalize the average proximity, and thus the capacity, of both conductors in relation to the mast and other grounded objects. The twin conductors are uniformly transposed like the spiral threads of a gun barrel. **Twistube** now being marketed is produced with a hollow, five-point star-shaped, polyethylene former; 20 awg conductors are transposed around the former and sheathed with a polyethylene tube. (*Fentube Airspace and Twistube; Fenton Co.*)

† Pat. Pending.

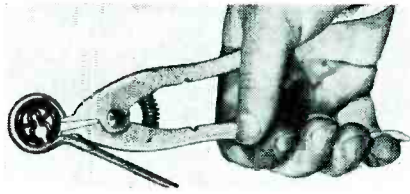
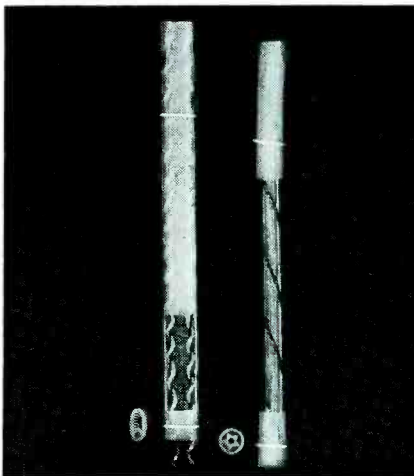

Stand-off eye-opener tool, to open metal bail on TV standoffs so that larger leadin lines can be accommodated. Bail is then squeezed to original position to hold the line tight. (No. 8450; General Cement.)

contrast is obtained. However, it must be remembered that this method is frequency selective and, therefore, may attenuate other frequencies. A compromise adjustment can be made if more than one channel is to be received.

Sharpening Masonry Drills*

In drilling masonry, carbide-tipped drills are often used, and on occasion it becomes necessary to resharpen the drills and restore the original 118° included angle. The drills should be sharpened when a 1/64" or more flat develops on the cutting edge.

To resharpen, the drill should be brought against the side of the grinding wheel at a 20° angle. This angle must be maintained; otherwise the drill will not cut properly. Then, using moderate pressure, the drill should be moved back and forth across the wheel to avoid overheating. If overheating should occur, do not drop the drill into liquids to cool. The two cutting edges of the drill should be

(Continued on page 53)

* From data supplied by Carboly Department, G.E.

Hand-held floating-pressure wire-measuring unit that can measure wire, rope, fabric, sheet metal, glass, linoleum, screen wire, etc., in any length from 1" to 1,000' and in sizes up to 3/8". The gauge will either add or subtract and has a reset knob which will turn back to zero with a simple twist of the dial. (*Tel-Ryte; Rytel Electronics Mfg. Co.*)

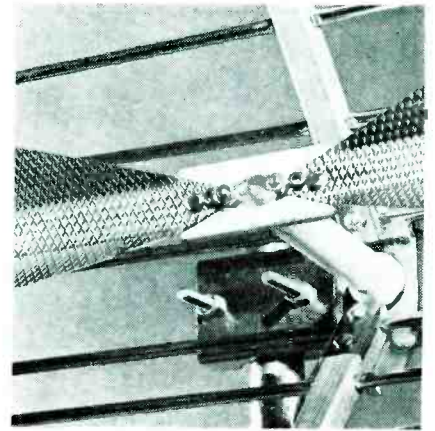
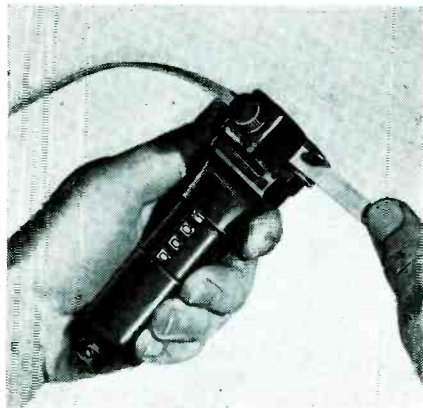

Hollow X-77 insulator developed for use on Walsco corner reflector and reflecto-fan antennas. Insulator is said to allow leadin wire to pass through the center; this feature, it is claimed, keeps the wire out of the field pattern. Hollow design was also said to eliminate broken wires caused by strain on the antenna terminals. Insulator is non-hygroscopic, and silicone treated to shed dust and moisture.

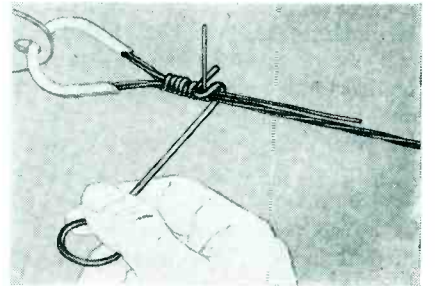

Tool for dead-ending non-rusting radio and TV guy strand. With this tool, wires of the strand itself can be wrapped or served forming a neat-finished dead-end without the use of clamps or clips. Dead-ends made with this device are said to develop full strength of strand and will not pull free. (*Copperweld*.)

Uhf-uhf line which features the use of foamed polyethylene, in a one-piece, cellular construction. Line consists of two high-strength conductors firmly enclosed and accurately spaced within new compound. (*ATV-270 Foam; Anaconda Wire and Cable*.)

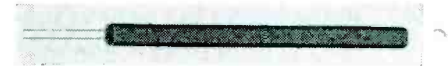

Resistor outlet box designed to provide isolated TV outlets in master TV systems. Unit will tap off from RG/11U or 59U with, it is claimed, 1/2 db insertion loss. Signal attenuation of 17 db at TV outlet terminal said to prevent interaction among sets in the system. A detachable face plate contains all cable connections and will fit standard outlet boxes. Screw terminals provide one 75 or 300-ohm outlet. Center conductors are attached to inner screw terminals, and coax shields are grounded by the clamp. (*Model ROI; Blonder-Tongue Labs.*)

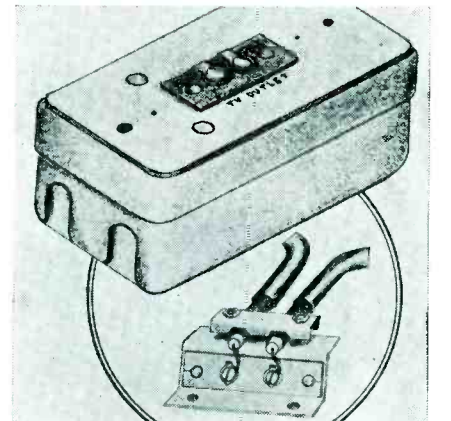

AUDIO installation and service

Phono-Tape-Wire-PA-Amplifiers-Speakers

by KENNETH STEWART

LAST MONTH, it was noted that set makers were busy planning lines of phonos with *hi-fi* features. During the past few weeks several models boasting matched high-fidelity components have appeared. In one instance¹ the amplifier has been equipped with a dual range tone control to provide shading and tone blending, and the tone arm supplied with a pressure-sensitive pickup coupled to the needle tip through a neoprene rubber shock-absorbing element.

The speaker in this phono has a thirteen-ounce Alnico magnet.

Stroboscope Included

And to permit visual adjustment of the turntable to play all makes of phono records a stroboscope has also been included, with a speed control.

In operation, a row of dots on the stroboscope indicator appears to stand still when synchronization is perfect. Any variation starts the dots moving; to the left, if the turntable is revolving too slowly and to the right, if too fast.

The changer can be regulated to any speed from 10 to 85 rpm, including a

Hi-fi changer which features die-cast aluminum tone arm (rigid and resonance-free to eliminate tonal distortion), two plug-in tone arm heads (less cartridges) for 78 and *lp* cartridges, laminated turntable mounted on three-ball thrust bearing with mirror-finished surfaces, four-pole, four-coil motor, and a muting switch. Plays all three sizes and speeds automatically (twelve 10", ten 12" or fourteen 7" records) with intermix of any ten 12" and 10" records of the same speed. Offers flat, air-cushion drop to the turntable after the records are lowered to the spindle shelf. Also features a 45 spindle attachment which allows automatic play of up to 14 large center-hole records; has its own receptacle with a self-closing lid in the changer base plate. (Model 936HF; V-M Corp.)

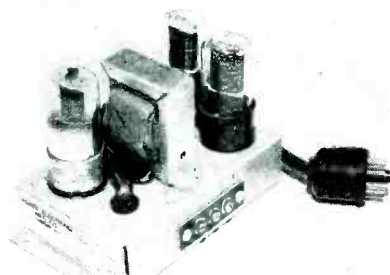
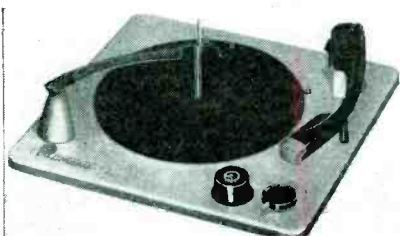

TV push-pull 2-tube amplifier that can be attached to TV receiver. Output is matched for most *hi-fi* speakers. Receiver sound output tube can be either 6V6, 6K6, or 6Y6. To install, output tube is removed from set and amplifier plug inserted in the open socket. (Model A-131; Vidair Electronics.)

new talking book speed of 16 $\frac{3}{4}$ rpm.

The model also has an air cushion turntable, which it is said not only eliminates record slippage by providing a firm, adhesive traction for the

Cartridge dispenser which will hold 50 crystal cartridges, 10 each of five different models. Dispenser is made of metal and may be hung on the wall or placed on counter or shelf. The five cartridge models, it is said, will enable jobber to replace over 250 types of cartridges. Among the models offered are the *WS*, single needle, dual output cartridge for 78 rpm records; the *AX*, a lightweight, two needle, twist cartridge for all speeds; the *BX*, for RCA automatic changers and Columbia players; the *CX*, a high output, single needle cartridge for flange, clip, bracket or stud mounting and 78 rpm or three-speed application, and the *FX*, a new lightweight, two needle cartridge for installation in Webster or Astatic twist mechanisms. A shunting capacitor gives choice of high or low output. Each cartridge is individually packed in a plastic container with all necessary parts and instructions. A replacement chart on heavy cardboard is included with each dispenser. (Webster Electric Co.)

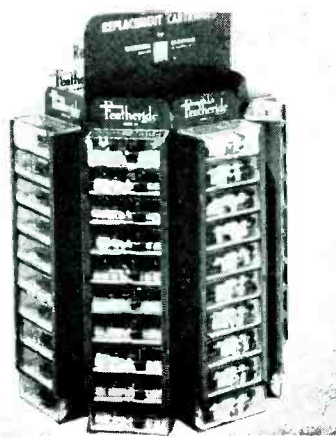

bottom of the disc, but saves them from unnecessary chipping and cracking.

Acoustic Lens Cabinet

In another phono series² a novel type of cabinet design has been developed. In this instance, it was announced sound is diffused by a slot-type opening called an *acoustic lens*; a modified bass-reflex approach. There is no door to open for the sound chamber. Cabinet also has a *visual tone blender* that shows the range of sound level through the use of bass and treble notes on an illuminated scale. This scale, it was said, permits critical setting to match recording characteristics of *hi-fi* records.

Balanced Rotor Motor

The record changer has a constant speed motor with an electronically balanced rotor that drives the turntable on polished bearings.

¹Zenith. ²Philco.

FM-AM 10-tube receiver which is said to have an output of 10 watts at 3 per cent distortion; features separate bass and treble tone correctors. The FM circuit has a triode *rf* amplifier and mixer, and balanced ratio detector. Sensitivity is claimed to be 7 microvolts input for 30 db quieting. For AM operation, chassis is equipped with a low-impedance loop antenna matched by a high *Q* ferrite input transformer. Has a push-pull amplifier. Equipment provides detector output at the rear of the chassis and inputs for television and phono. FM-AM tuner, also available, incorporates separate bass and treble controls, 2-stage *af*, *afc* and a compensated preamp for use with magnetic phono pickups. Also provides detector output, and television and phono inputs. The FM section employs a triode *rf* amplifier and mixer with a Foster-Seeley discriminator. (Models RP500 and R300; David Bogen Co.)

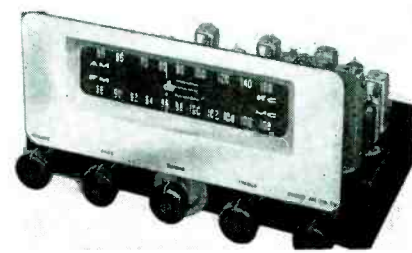

WE BELIEVE Norman Foster's recent advertisement in the Chicago "TV Guide" is of interest to the entire television and radio industry. Consequently, with Mr. Foster's permission, we are reprinting it here as a public service for every television and radio service technician in America.

Harry Kalker
(HARRY KALKER, President)

SPRAGUE PRODUCTS COMPANY
(Distributors' Division of the Sprague Electric Company)
North Adams, Massachusetts



NORMAN FOSTER

UNFORTUNATELY

Because of the Greed of a Few,

THE ENTIRE TV SERVICE INDUSTRY MUST SUFFER

HERE IS WHAT I HAVE DONE TO GUARANTEE YOU HONEST TV SERVICE

1. The name, Foster Television is not taken from a street, a deck of cards, or a country, and it is not an adjective. It comes from the name of its sole owner, Norman Foster. I have spent 22 years in the Radio, Electronics and Television service business, and in these years I have worked for just about every type of Operator, good, bad and indifferent. When the time came that I could open my own business, I decided that because of the reputation that the Radio and Television repair business has always had, a company operating so honestly that they could invite their customers into the shop to watch their work being done could be a success. The volume of business we did last year proves I was right.

2. The reason that a service man would attempt to sell you something you do not need is because he had something to gain personally. Many Television service operators hire men, driving their own cars, on a percentage basis. This is advantageous because the service company can be in business with practically no investment. Under these conditions if this man needs money, it's only human nature that he is going to want to do the thing to your television set that will make him the most money—whether it be 5 tubes or haul it to the shop.

3. Every man that I have, works by the hour and punches a time clock. He drives a company owned new truck bearing my name and his equipment and uniforms are furnished to him without charge. He has orders to repair your set in your home whenever possible. He receives the same amount of money whether he repairs 1 set or 10, and whether he charges \$1 or \$10. His rate of pay and his advancement are based on the number of sets he can repair in the home.

4. Our service call price is a flat \$3 and covers all labor necessary to make any repair possible in your home except cleaning a screen, for which we charge \$1 extra. It is evident that on this basis we do not make money on every job, but with the large volume of business we do, it has averaged out to a modest profit at the end of the year. You can bring your set into our shop and not only save this service charge, but also see it repaired while you wait. There is no minimum charge on this service. You pay only for the actual time spent on your set.

5. How fast can service be? I have a large fleet of trucks operating throughout Chicago from 9:30 A.M. to 11:00 P.M. I do not advertise one hour service and I do not believe that anything but a coincidence could give such fast service. Because it is impossible to predict in advance how long each job will take a man, the best we can do is to offer same day service. Occasionally at this time of the year, bad weather causing slow driving, makes it necessary to postpone calls received late, until the next day.

6. Quality of parts. I use only nationally advertised tubes and parts. Every tube I sell is new, fresh and cartoned, bearing a name and a date, and is coded by the manufacturer to indicate that it is a tube manufactured and guaranteed for replacement use. I do not use bulk or surplus tubes. Every picture tube I sell bears a serial number and has a factory registration certificate to guarantee that it is a new first quality tube. I do not sell rebuilt or rejuvenated picture tubes. I use only Sprague plastic sealed condensers, which are far superior to the parts used in many TV sets.

7. I guarantee every part I replace for 90 days. If a part or tube I have replaced fails, it is replaced at absolutely no charge to you. Our guarantee is further underwritten by the American Mutual Liability Insurance Co. by arrangement with the Raytheon Manufacturing Co.

8. I have not satisfied everybody and I do not claim to. I cannot repair a set that needs a new picture tube for \$3 and I cannot give a \$60 service contract with each call. Nothing less would satisfy certain people. However, if you hear a complaint against Foster Television, that same person will generally have one against the plumber, the auto mechanic, the dentist and nearly everyone else who is unfortunate enough to do business with him. I need and value your patronage and I will sincerely respect it.

Norman Foster



Open 9:30 am-8:30 pm

- Home Service to 11 pm
- Sundays 11 am-3 pm
- H U M B O L D T 9-0911

YOU CAN DEPEND ON

FOSTER TV

2922 MILWAUKEE AVENUE
CHICAGO

SERVICE, JULY, 1953 • 29

TUBE

News

IN TUBE design, vibration control has always been a particularly important factor. In addition to being strong enough not to fail mechanically, the tube must be low in microphonics; spurious electrical signals generated by vibration of the tube must be low in relation to the desired signal that the tube is handling. In ordinary receiving tubes, microphonics may easily be a thousand or even a million times greater than the intrinsic tube noise. Tube microphonics can be a particularly difficult problem in miniaturized equipment.

To study closely vibrations, their varied microphonic effects and means that might be used for control, three specialists¹ at the National Bureau of Standards have developed a tube vibrator that produces accelerations up to 20 times that of gravity and is flat within 20 per cent over the unusually wide range of 100 to 10,000 cps. The tube under study is fitted into a hole in the vibrator's moving element, or armature: The armature is a cylindrical block of nonmagnetic material with a *voice coil*, for the *af* driving voltage, at its lower end. Two flexible metal strips hold the armature centered in an electromagnetic field structure powered by 40 watts of 120-volt *dc*. Although the model of the tube vibrator was built to accommodate subminiature-type tubes, the design, it is said, could be modified for microphonic studies of miniature or octal tubes.

Commercially available vibration generators of the mechanically-driven

type have upper frequency limits of only about 300 cps; they are primarily vibration fatigue testers and have been found to have irregular waveform, lacking the flexibility required for development work. Commercial vibrators of the electrodynamic or *loud-speaker* type are seldom useful at frequencies above 3,000 cps. The moving coil in this type of vibrator is usually fastened to a drive rod that typically has objectionably sharp resonances in the neighborhood of 2,000 cps.

In the NBS vibrator the upper frequency limit is raised by making the armature of a material having a high ratio of rigidity to weight. Linen bakelite, which is only moderately good in this particular respect, was used for the present armature because of its convenience and availability. The fundamental resonance occurs in the neighborhood of 18,000 cycles; response begins to rise at about 10,000 cycles. Use of a material with a higher rigidity-to-weight ratio would substantially raise the frequency of fundamental resonance and thus the upper limit of flat response.

Development of the NBS tube vibrator was dependent upon the previous development of a small barium-titanate accelerometer capable of measuring vibration frequencies to 20 kc at acceleration levels of 0.2 to 10,000 *g*. One of these accelerometers is mounted on the armature of the vibrator to sense the vibration amplitude.

Another barium-titanate accelerometer, similar in shape and weight to
(Continued on page 39)

by L. M. ALLEN

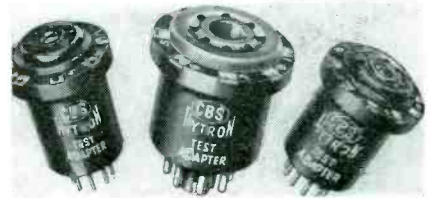

A 9-pin miniature test adapter and 8-pin octal test adapter, which permit testing sockets top-side. (CBS-Hytron.)



Experimental *grid-dip* oscillator built around a single 2N33 point-contact transistor, and powered by a miniature 22½-volt hearing aid battery. The device, developed as a private project by Clarence A. West, an amateur (W21YG, Roselle, N. J.), is used to determine the resonant frequencies of tuned circuits. The complete unit, together with power supply, is contained within a metal case measuring 5" high, 2¼" wide, and 2¼" deep. Instrument's power consumption is 25 milliwatts. (Courtesy RCA.)

A multi-use video tube brightener and rejuvenator, that operates with either series or parallel connected picture tube filaments, and can be used to isolate the tube filament or to increase tube filament voltage or both, via a simple switching device. (Crestrite; Crest Transformer Corp.)



¹J. D. Rosenberg, W. B. Hillstrom and L. T. Fleming.

**RCA VICTOR
SERVICE PARTS**

Made to play together...

... the only crystals and jewel sapphires specifically designed for the RCA "45"

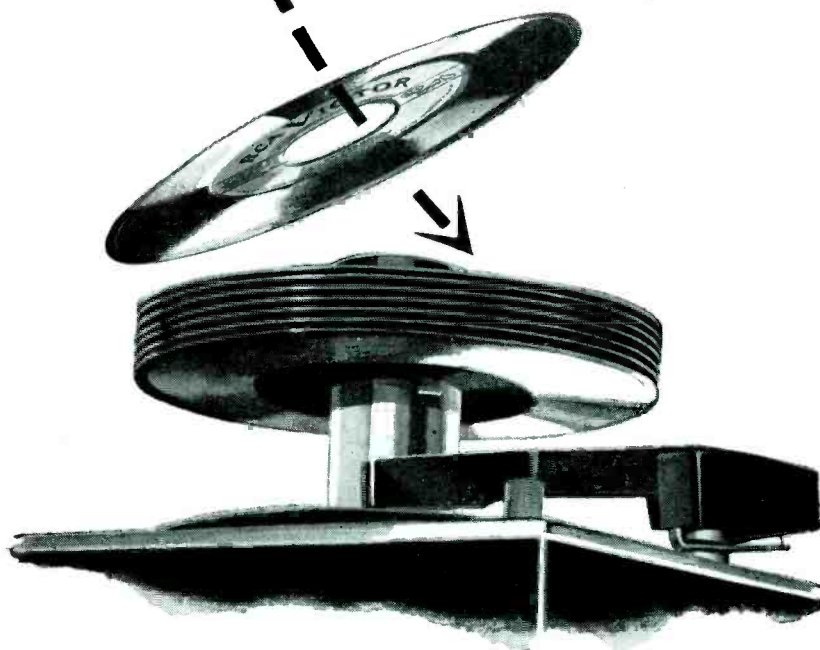

RCA Crystal Cartridges in RCA "45" record players have the precise weight for proper tracking

RCA Crystal Cartridges are designed specifically for RCA "45" pick-up arms. Together, they provide the correct weight for proper tracking—optimum lateral stylus compliance to minimize record-wear. Exact dimensions make them easy to install in any RCA Victor "45" record changer.

There's an "original" RCA Crystal Cartridge specially designed for every model RCA Victor record changer made. Use *genuine* RCA Crystal Cartridges and avoid replacement problems.

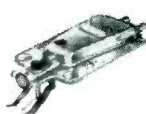

Jewel-polished RCA Sapphire Styli are microscopically shaped for "45" grooves



RCA jewel sapphires are rouge-polished to a super-fine finish, and have the proper tip radius for "45" records. Record and stylus are designed to play together.

Genuine RCA jewel Sapphire Styli, with correct tip radius, are available for replacement in all type RCA Crystal Cartridges designed for RCA Victor 45, 78, 78-33, and 3-speed changers.

RCA Crystals and Styli are made better—cost no more



Because they're mass-produced by precision methods, RCA Crystal Cartridges and Styli meet the highest quality standards, yet cost no more. Smart packaging makes them easy to sell... handy dispensers make them easy to display.

Remember... customers count on you to return their RCA Victor record changers to their *original* high performance standards... by using *genuine* RCA Crystal Cartridges and Styli. Order a model inventory today from your *RCA Parts Distributor*.

Genuine RCA Victor Service Parts are readily available from your RCA Parts Distributor



RADIO CORPORATION of AMERICA
ELECTRONIC COMPONENTS **HARRISON, N. J.**

Servicing Helps

Eliminating Horizontal Ripples ... Preventing Fuse Failures on TV Chassis

by M. A. MARWELL

HORIZONTAL RIPPLE, moving up or down in the picture, is usually due to a power source frequency difference between the transmitter and the TV receiver. It is caused by some of the sixty-cycle power source voltage feeding into the horizontal oscillator. This *ac* voltage can come from the *B* plus supply, through the horizontal sync discriminator, and thus be applied to the control grid of the oscillator, or from flux leakage around the power transformer.

In one series of chassis,¹ it has been found that the most common cause of horizontal ripple is flux leakage around the power transformer (even though it has a copper band) to the horizontal lock coil. In some models² the power transformer is mounted at a different position on the chassis and the trouble may not appear.

To shield the horizontal lock coil from the power transformer, it will be necessary to make the changes illustrated in Fig. 1 and described below:

- (1) Disconnect the red lead from the lug on the horizontal lock coil (L_{401}), reroute it away from all chassis components, and reconnect the red lead to the lock coil lug.
- (2) Replace the 5,600-ohm resistor, connected between the lug of the lock coil and pin 2 of V_{405} (6SN7), with a new 5,600-ohm, $\frac{1}{2}$ -watt resistor having longer leads, or splice a wire to one lead of the

existing 5,600-ohm resistor to lengthen it. Cover the resistor leads with spaghetti.

- (3) Remove the horizontal lock coil from the rear chassis apron by placing the fingers on the end of the coil form nearest the rear of the chassis and pulling the coil toward the front of the chassis. This will leave the slug and part of the assembly still attached to the chassis.
- (4) Procure a metal shield can, preferably an *if* can that is *not* made of aluminum; test to see that the can will take solder before installing.
- (5) Slip the shield can over the slug; the hole through the top of the can should be $\frac{7}{16}$ " diameter or larger.
- (6) Insert the lock coil through the shield can, over the slug, and back into its original assembly.
- (7) Solder the shield can to the mounting bracket of the assembly. Be sure to clean and tin thoroughly the surfaces to be soldered to insure a good electrical connection.
- (8) Check operation of the receiver and readjust the horizontal lock slug if necessary.

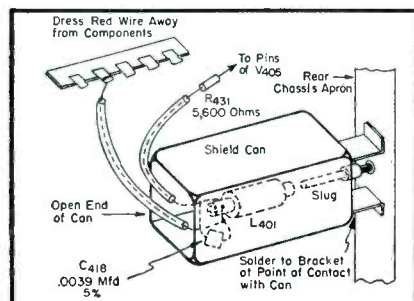

¹Admiral 22A2, 22A2A, 22M1, 22Y1, 22C2, and 22E2 chassis.

²Admiral 22F2, 22P2, 22M2.

³Admiral 77B43. †All Admiral 19 series with built-in radios stamped *R1018* or above have this change.

Fig. 1 (Left). Modifications required in Admiral 22 series chassis to shield horizontal lock coil from power transformer and prevent horizontal ripple.

Fig. 2 (Right). Partial schematic of Admiral 19 chassis illustrating circuitry changes that will prevent fuse failure.

Preventing Fuse Failures

In some Admiral 19E1, 19G1 and 19N1 chassis, the $\frac{3}{8}$ amp fuse (M_{401}) may blow when the function switch is rotated from the radio to the TV position.

This will occur because in some function switches,³ the rotor contact of the switch section is wide, and during rotation of the switch there is one position where all contacts on this section may short, resulting in a surge of current that blows the fuse.

If the $\frac{3}{8}$ amp fuse blows when rotating the function switch from the radio to the TV position, the difficulty can be corrected *without replacing* or modifying the switch, by making a circuit revision, consisting of changing the circuit location of the fuse, as illustrated in Fig. 2.†

To make the change, the blue wire from lug number 4 of terminal strip *A* must be disconnected; this is the blue wire from terminal *g* of the switch section. Then the blue wire removed from lug 4 of terminal strip *A* should be connected to pin 3 of the speaker socket. Now, the red wire that goes to the fuse should be disconnected from the positive terminal of the 80-mfd electrolytic, C_{502} ; two red wires are connected to this capacitor. Only the red wire connected to the *fuse* should be disconnected.

The red wire removed from the positive terminal of the electrolytic should now be connected to lug number 4 of terminal strip *A*.

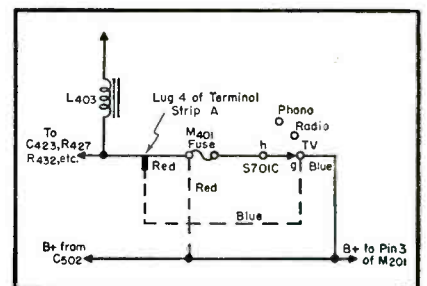

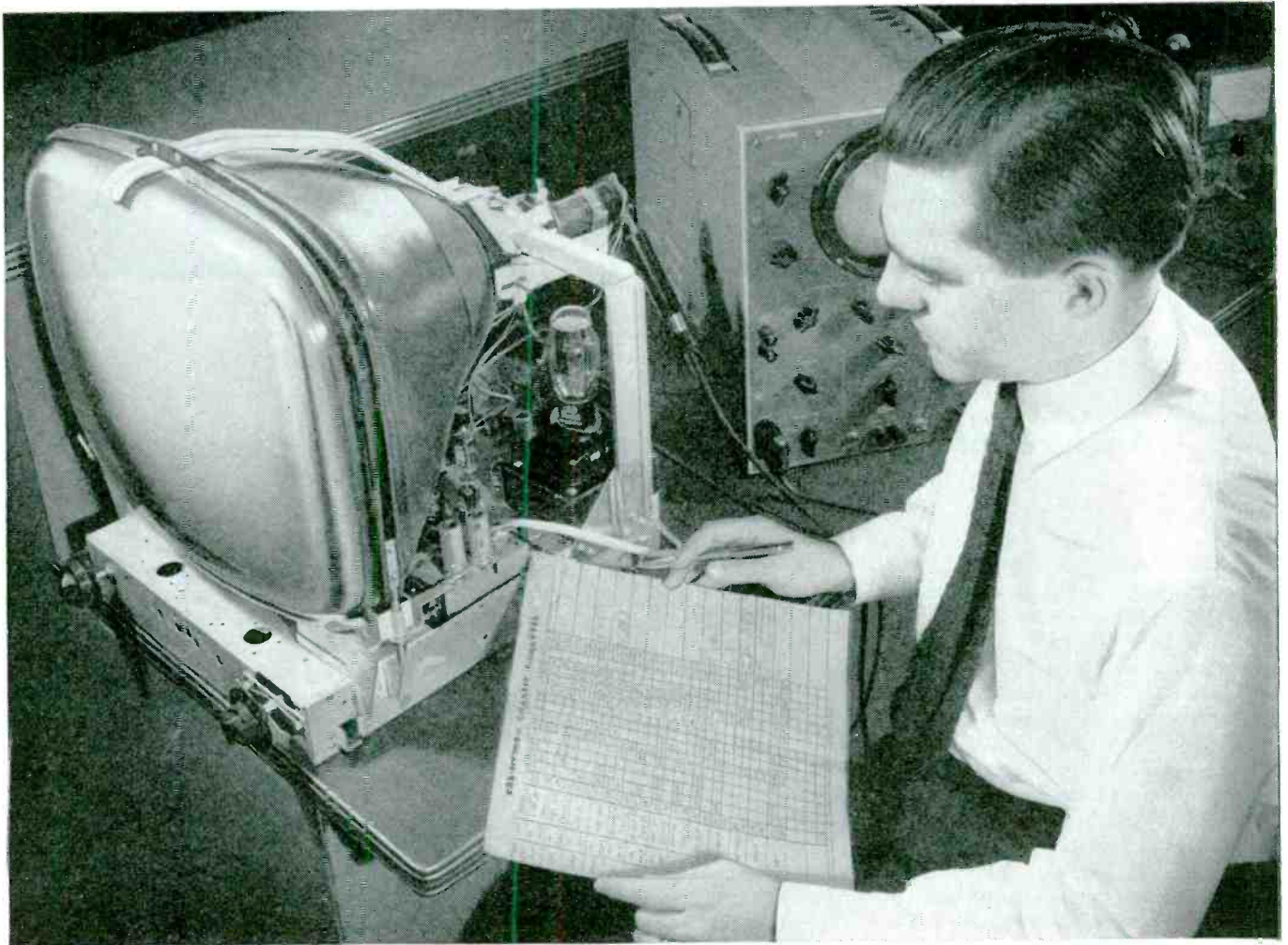

Bring back that New-Set Sparkle with Performance-Tested Tubes

Meet John Cunningham, a CBS-Hytron Commercial Engineer. John is beginning at the beginning for you. Socket by socket, he is analyzing the tube requirements of a brand-new TV set design.

John knows the superior performance demanded. He concentrates his know-how on insuring top tube operation within standard specification limits. He tests sample tubes . . . checks analysis data. Working hand-in-glove with the set designer . . . and with CBS-Hytron engineers . . . he assures control of the characteristics of all tubes for this new chassis. Finally he achieves . . . from rectifiers to picture tube . . . the perfect performance all of this engineering team (and you) seek.

Constantly CBS-Hytron carries on teamwork like this. Socket by socket analysis. Day in, day out — with 9 out of 10

leading TV set makers. Both tube and set engineers pool their specialized skills. Scores of the nation's foremost TV set engineers help make endless CBS-Hytron improvements. Help assure you of unsurpassed performance in virtually *all* leading TV sets.

Small wonder that your CBS-Hytron replacement tubes recapture that new-set sparkle. Please *your* customers. Cut *your* call-backs. Profit more. Take advantage of CBS-Hytron engineering. Demand CBS-Hytron . . . your logical replacement tube, because it is performance-tested all the way . . . from original to replacement.



Manufacturers of
Receiving Tubes Since 1921



CBS-HYTRON Main Office: Danvers, Mass.

A Division of Columbia Broadcasting System, Inc.



Now
**CBS-
HYTRON,**
MIRROR-BACK

ALUMINIZED PICTURE TUBES
27EP4 and 24TP4 . . . both
mirror-backed, spherical, elec-
tromagnetic types.

Leading TV set makers demanded maximum brightness from their large-screen sets. Without strain on component parts. For them, CBS-Hytron introduced its *Mirror-Back* picture tubes. Mirror-like effect of their aluminumized backing steps up light output. Adds sparkling brilliance to the picture. Gives greater contrast and freedom from screen discoloration. You, too, will want CBS-Hytron *Mirror-Back* tubes for replacement. Because your customers can *see* them recapture that bright, new-set sparkle. Order the performance-tested 27EP4 and 24TP4 from your CBS-Hytron distributor.

RECEIVING . . . TRANSMITTING . . . SPECIAL-PURPOSE AND TV PICTURE TUBES • GERMANIUM DIODES AND TRANSISTORS

SERVICE, JULY, 1953 • 33

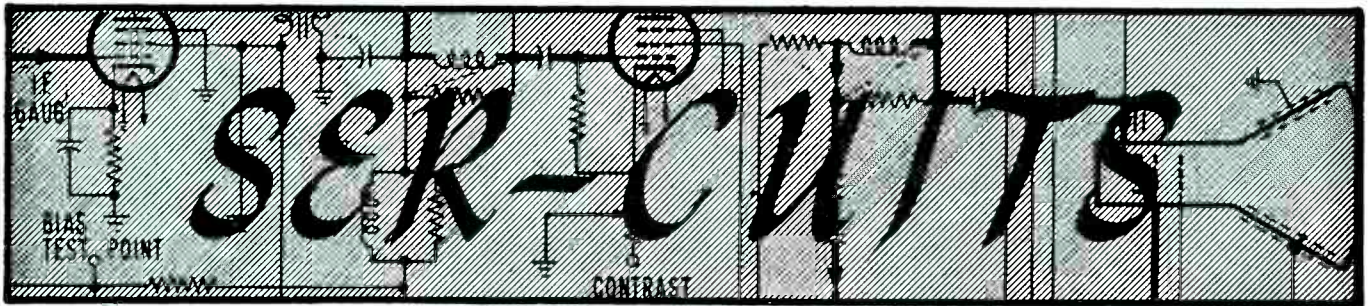

by M. W. PERCY

Analysis of Circuitry in U/V (Channel 2 to 83) Chassis

ABOUT A YEAR AGO, all eyes were focused on Portland, Oregon, when commercial ultrahigh TV came to life. Since then, many cities have become *uhf* centers, and it seems as if very soon we'll have as many stations on the upstairs channels as on the standard bands. In view of this trend set-makers have begun to produce *u/v* chassis which cover the 2 to 83-channel span, as regular items in their line. An interesting example of the circuitry used in one series of *u/v* chassis† appears in Fig. 1.

Combination *vhf/uhf* tuning is achieved through the use of two tuners which are connected to the same tuning knobs. The *vhf* tuner is a cascode turret type with 13 positions, 12 being used for *vhf* reception, while the 13th, or *uhf* position, is used to activate the proper *uhf* circuits and provides additional amplification for a converted 40-

mc *uhf* signal. The *uhf* tuner is a continuous type mounted adjacent to the *vhf* tuner, and coupled to a fine-tuning control of the *vhf* tuner by a dial cord.

The *uhf* tuning system is designed for a single conversion; the *if* frequencies (40-mc range) are the same from both the *vhf* and *uhf* tuners.

In the *uhf* position, the turret-tuner strips in the *vhf* tuner are designed to accept 40-mc signals. Thus the 40-mc *if* signal from the *uhf* tuner is amplified further by the *vhf* tuner which acts as an additional two-stage low-noise cascode amplifier preceding the receiver's *if* system.

Operation of VHF/UHF Switch

A *uhf/vhf* switch is automatically operated by a cam located on the *vhf* tuner shaft.

†Emerson 752B, 755B, 752H, etc.

In the *uhf* position, the *vhf* antenna is connected through the switch to the input of a high-pass filter. The output of this filter is connected to the input of the *vhf* tuner through this same switch. Plate voltage is supplied to the *uhf* tuner through a 100,000-ohm resistor, preventing it from oscillating, but allowing some current to flow through the 6J6 so that its cathode will not be poisoned during long periods of inoperation.

In the *uhf* position, the *vhf* antenna or combination *vhf/uhf* antenna is disconnected from the *vhf* tuner and connected to the input of the *uhf* tuner through the switch and terminals 3 and 4 (providing they are connected). If a separate leadin is used for *uhf*, then terminals 3 and 5 are not connected to the *uhf* antenna terminals.

The single-ended output of the *uhf* tuner is fed through the switch to the input of the *vhf* tuner. The 100,000-ohm resistor is shorted out by the switch so that full *B+* is applied to the *uhf* tuner. Since the *vhf* mixer tube functions as a 40-mc amplifier when tuned to *uhf*, fixed grid bias is applied to it through the switch.

UHF Tuner Circuit

The tuned elements in this tuner are of the modified coax transmission-line type. The *uhf* incoming signal is tuned by means of two *rf* preselectors, which are quarter-wave end-tuned coax lines. Capacitive tuning is employed at the open ends to adjust electrically the line to quarter wavelength, and, therefore, effect a resonant condition at any frequency within the *uhf* band. Two identical preselector circuits are coupled together to provide the proper bandpass characteristic. Ganged variable capacitors adjust the two preselector lines and are similar to those

(Continued on page 39)

Fig. 1. Schematic of *uhf* tuner used in Emerson all-wave TV receivers. On some tuners coupling (at A) is achieved by the use of two coupling loops instead of a cutout in the shield as shown.

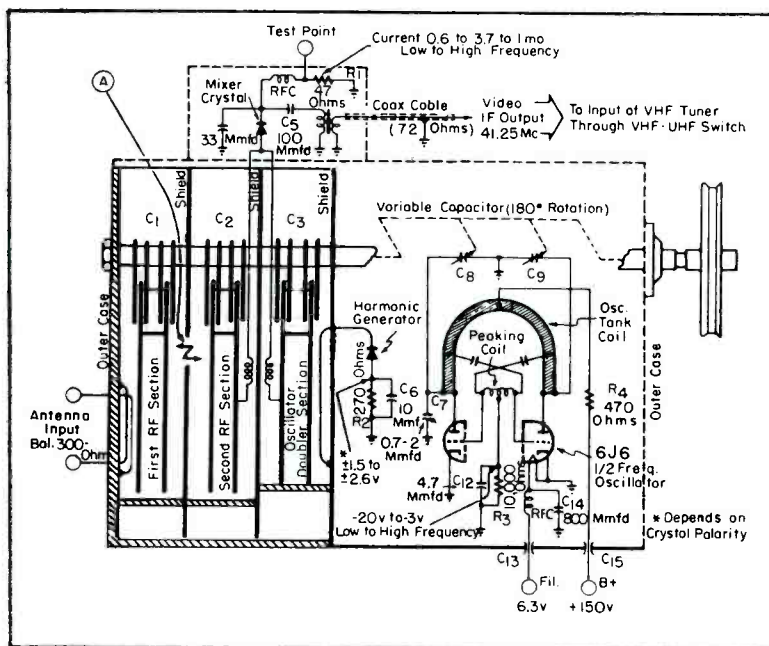

**Build Your Service-
Sales Future on a Firm
Foundation with . . .**

**PRECISION
TEST EQUIPMENT**
Standard of Accuracy

**... These 5 Matched "PRECISION"
Instruments provide a Complete
MODERN SERVICE LABORATORY for
TV-FM-AM at only moderate cost.**



SERIES E-200-C
SIGNAL and MARKING GENERATOR
for A.M., F.M., and TV alignment.
Exceptional Accuracy and Stability • 1000 pt. vernier calibrating scale • 0-100% Modulation • A.V.C. — A.G.C. substitution-override network • Direct reading 88KC to 120 MC • Complete with Coaxial output cable and technical manual • In matched, heavy gauge steel case 10½ x 12 x 6".
Net Price: \$78.50

SERIES E-400
SWEEP SIGNAL GENERATOR
Direct Reading from 2 to 480 MC.
Narrow and Wide Band Sweep for F.M. and TV, 0-1MC and 0-15MC • 1500 pt. vernier calibrating scale • Multiple Crystal Marker • 8 tubes including V.R. and rectifier • RG/62U Coaxial Terminated Output cable • Complete with 2 crystals • In matched copper-plated case 10½ x 12 x 6".
Net Price: \$139.75

SERIES ES-500A
**High Sensitivity, Wide Range
5" C.R. OSCILLOGRAPH**
Push-Pull "V" and "H" amplifiers • 1 MC Band Width • High impedance, compensated "V" input Step Attenuator • Z axis modulation • 12 tubes incl. V.R. and 2 rect. • Light Shield and Mask • Heavy Steel Case, 8½ x 14½ x 10".
Net Price: \$173.70

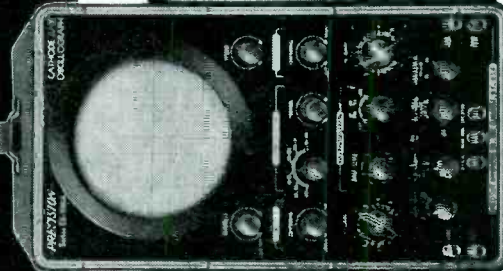

SERIES EV-10A
True Zero-Center VTVM—MEGOhmmETER
with large 7" meter.
58 ranges to 6000 Volts, 2000 Megs, +70DB, 12 Amps • Direct Reading R.F. VTVM scales via optional RF-10A High Freq. probe • Voltage Regulated bridge type circuit • Constant 13½ Megs input resistance to 600 V., 133½ Megs at 6000V • Complete with test cables • In matched steel cabinet 10½ x 12 x 6".
Net Price: \$99.75



SERIES 612
**Modern Free-point TUBE TESTER, and
dynamic A-B-C Battery Tester.**
Incorporates RTMA recommended circuit principles • 10 lever free-point element selection • Built-in roller chart • Dual short-check sensitivity • Noise, Ballast and Pilot Tests • Free replacement tube test data chart service • Complete, ready to operate • In matched heavy-gauge steel cabinet 10½ x 12 x 6".
Net Price: \$76.75



BUY PERFORMANCE — NOT SPECIFICATIONS!
PRECISION PERFORMANCE, ACCURACY, WORKMANSHIP and VALUE have been setting a world-wide standard of comparison for over 20 years.
Every **PRECISION** instrument is guaranteed for one full year against mechanical or electrical defects.

OTHER MATCHED COMBINATIONS
The instruments shown above illustrate one of many possible **MATCHED COMBINATIONS** of **PRECISION** Test Equipment for the modern TV-FM-AM service bench. Each combination provides a selected, basic and efficient Laboratory at moderate cost.

SERIES TV-4—Super-High Voltage Safety Test Probe.
Extends range of Series EV-10A (above) to 60 KV direct reading, with full safety to operator and equipment. Multiplier cartridges also available to match most VTVM's and 20,000 ohms per volt test sets.
Series TV-4: — Complete, for use with EV-10A.
Net Price: \$14.75

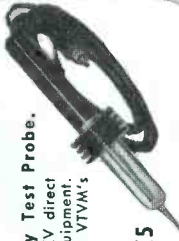

TV • AM • FM • TV • AM • FM • TV
PRECISION Performance-Engineered Instruments are on display at leading radio parts and equipment distributors.



PRECISION APPARATUS CO., INC.
92-27 Horace Harding Boulevard, Elmhurst 6, New York
Export Division: 458 Broadway, New York 13, U.S.A. • Cables: Manhattan
In Canada: Atlas Radio Corp., Ltd., 560 King Street, W., Toronto 2B

TV • AM • FM • TV • AM • FM • TV
Convenient **PRECISION** Purchase Terms can be arranged with your favorite authorized **Precision Distributor.**

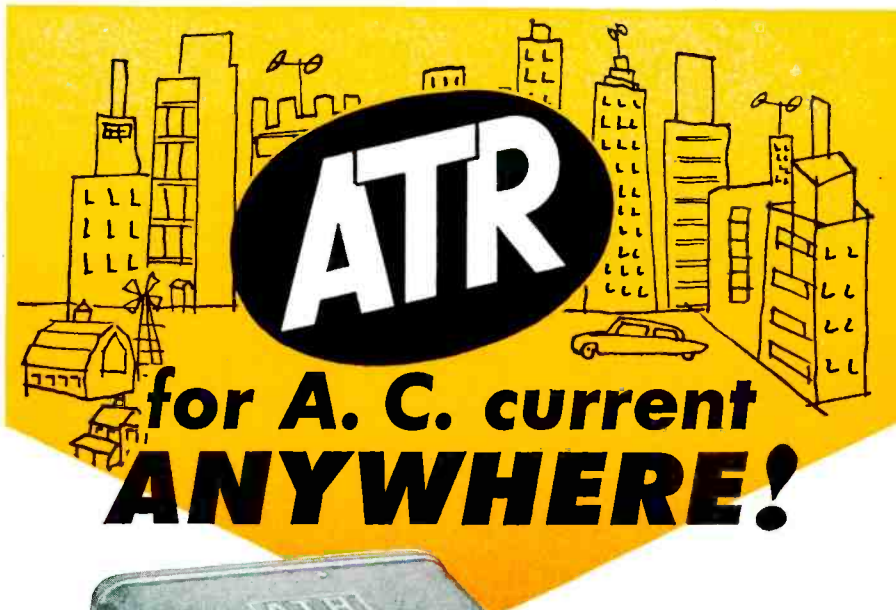

for A. C. current
ANYWHERE!



AT NEW
LOW COST

\$25⁵⁵
And Up
Retail Price

INVERTERS

For Inverting D.C. to A.C. . . . Specially Designed for operating A.C. Radios, Tape Recorders, Wire Recorders, Record Changers, Television Sets, Amplifiers, Address Systems, Radio Test Equipment and most small electrical and electronic devices from D. C. Voltages in Vehicles, Ships, Trains, Planes and in D. C. Districts.

Type	Input DC Volts	A.C. Output 60 Cycles	Output Int.	Wattage Cont.	Consumer Net Price
6-LIF	6	110 volts	40	35	\$25.55
12-LIF	12	110	50	35	25.55
* 6-RSD	6	110	85	75	39.25
*12-RSD	12	110	125	100	39.25
32-RSD	32	110	150	100	39.25
110-RSD	110	110	250	150	39.25
*12T-HSG	12	110	250	200	96.45
110AT-RHE	110	110	325	250	56.95

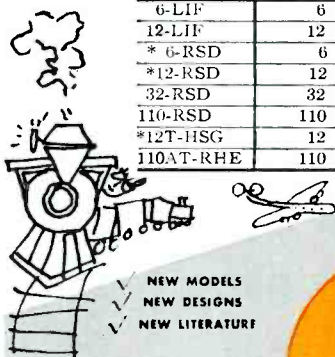

NEW MODELS
NEW DESIGNS
NEW LITERATURE

See your jobber
or write factory



There is an ATR model for most any application.
* Available with leather carrying handle
at \$1.00 additional—optional.

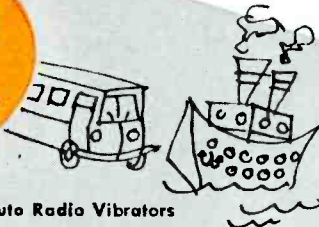

"A" Battery Eliminators, DC-AC Inverters, Auto Radio Vibrators

AMERICAN TELEVISION & RADIO Co.

Quality Products Since 1931

SAINT PAUL 1, MINNESOTA—U. S. A.

AUDIO Equipment Test and Measurement

by **MARK VINO**

REVIEWING the value of listening tests, in the initial installment of this report last month, it was noted that such tests can also reveal the transient quality of an audio system. If, for instance, transient response is poor, bass notes will tend to *smear* onto each other, and speech will sound as though it had been produced in a rainbarrel. The pitch of very low notes will be difficult or impossible to distinguish. Good transient response, on the other hand, will produce a *clean* bass in which the extreme bass notes do not sound like reverberant thumps, but have a clearly identifiable musical pitch.

Testing for Distortion

Most equipment for testing harmonic distortion is both specialized and expensive. Although the signal furnished by test records may be projected on a 'scope screen, and the

Fig. 1. Method of measuring approximate percentage of intermodulation distortion, using *IM* test record. The high-pass filter keeps the bass signal out of the 'scope. Values shown are approximate for typical commercial *IM* test records.

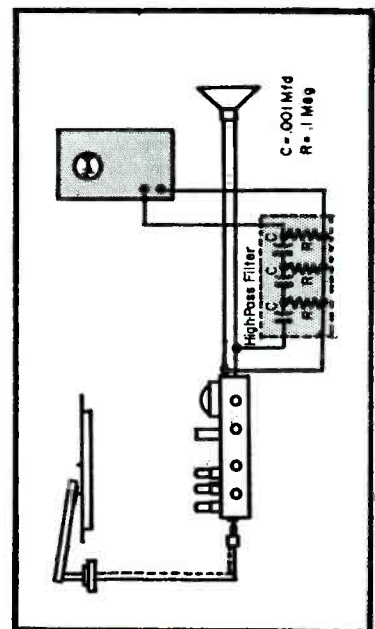

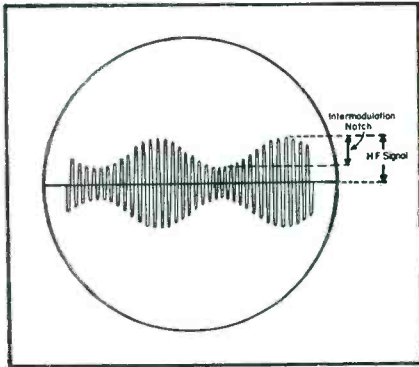

Fig. 2. 'Scope pattern produced by the method of Fig. 1. The per cent of intermodulation is equal to the height of the high-frequency signal divided by the height of the intermodulation notch.

waveform examined for distortion of the sine-wave shape, this procedure is only a very rough test. It is difficult, with waveform visual inspection, to detect distortion which is as low as five per cent, and generally impossible to detect distortion of lower percentage.

The sweep-frequency test record reveals distortion in the higher ranges by the presence of jagged streaks or lines of light, running through the body of the upper frequency waves.

Intermodulation distortion is generally of the order of three to four times the percentage of harmonic distortion, and therefore can be measured with less difficulty. Commercial test records are available for intermodulation measurement. They provide two steady-tone signals, one in the bass and one in the treble, which are recorded simultaneously. Intermodulation of the treble signal may be measured by filtering out the bass signal (Fig. 1) and observing the extent of amplitude modulation, at the bass frequency, of the treble signal.¹ This effect produces a pattern like the modulated output of an AM transmitter, and is illustrated in Fig. 2.

The per cent of intermodulation is estimated as the relative amplitude of the notch in the treble group of cycles to the maximum height of the pattern above the screen center line. Intermodulation test records usually contain an inherent intermodulation distortion of two to four per cent, but since eight per cent intermodulation, in general, represents quite a low figure for distortion, especially when the pickup is included in the system being measured, this inherent limitation is not particularly troublesome.

Measurement of Hum

A listening test for hum reveals more than a purely electrical measurement at the amplifier output, since it

(Continued on page 38)

SERVICE TOOLS YOU NEED!

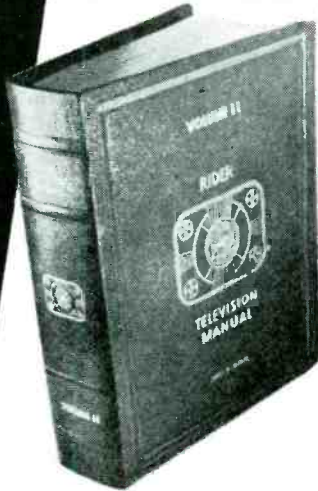

RIDER SERVICING DATA AND BOOKS

RIDER'S 11 TV MANUALS are vital tools for servicing... just as important as your test equipment and other bench tools. RIDER TV MANUALS give servicing data that's factory-authorized, factory-approved on a total of more than 5000 TV models. All you need to know about different production runs and changes, circuits, voltages, schematics, chassis views, tube layouts, alignment—everything necessary for speedier, easier, more profitable servicing. For easier radio servicing, use RIDER'S famous 22 AM, FM radio manuals.

DEPENDABLE REPLACEMENT PARTS LISTINGS STARTING WITH TV 10 AND RADIO VOLUME 23

TV MANUALS				AM-FM MANUALS			
Vol.	Pages	Cover	Price	Vol.	Pages	Year	Price
11	2,200	Oct. 52 - Feb. 53	24.00	23	now in preparation		
10	2,350	Mar. 52 - Sept. 52	24.00	22	1,520	50-51	18.00
9	2,136	Oct. 51 - Feb. 52	24.00	21	1,648	49-50	21.00
8	2,688	June 51 - Sept. 51	24.00	20	1,776	1949	21.00
7	2,352	Sept. 50 - June 51	24.00	19	2,122	48-49	22.50
6	2,320	Aug. 50 - Jan. 51	24.00	18	2,036	1948	22.50
5	2,320	Mar. 50 - July 50	24.00	17	1,648	47-48	19.80
4	2,296	Oct. 49 - Feb. 50	24.00	16	768	46-47	9.90
3	2,032	Jan. 49 - Oct. 49	24.00	15	2,000	42-46	22.50
2	1,896	Jan. 48 - Jan. 49	24.00	14	1,376	1942	19.80
1	2,000	Up to Jan. 48	19.80	13	1,672	41-42	19.80
PA MANUAL Coverage from 1938 to 1948. 147 Manufacturers. PA systems, intercom, school, hotel, theater, etc. sound systems. Complete data. 204 pages with HOW IT WORKS book and index. Only \$18.00				12	1,648	40-41	19.80
				11	1,652	39-40	19.80
				10	1,664	38-39	19.80
				9	1,672	37-38	19.80
				8	1,650	36-37	19.80
				7	1,600	35-36	19.80
				6	1,240	34-35	15.00

TEK-FILE

TAILOR-MADE FOR EASY TV SERVICING

Factory-approved servicing information—the same as in the Rider TV Manuals—except that it is in packaged form. About 3000 models covered in 83 individual packs. New packs monthly (free index available). Try a pack and prove to yourself the value of Tek-File... if you're not completely satisfied, return the pack within 7 days; your money will be refunded. Only \$2.00 per pack!

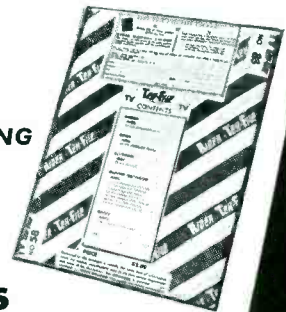

LATEST RIDER BOOKS

We know your needs and are publishing books which will keep you up-to-date on everything you need to know about TV, Radio, Electronics!

TV MANUFACTURERS RECEIVER TROUBLE CURES

- Vol. 1, 115 pages (5¼ x 8¼")... \$1.80
- Vol. 2, 117 pages (5¼ x 8¼")... 1.80
- Vol. 3, 119 pages (5¼ x 8¼")... 1.80
- Vol. 4, 115 pages (5¼ x 8¼")... 1.80
- Vol. 5 — COMING SOON!

OBTAINING AND INTERPRETING TEST SCOPE TRACES

Over 140 pages (5¼ x 8¼").....\$2.40

HOW TO USE SIGNAL AND SWEEP GENERATORS Over 120 pp., (5¼ x 8¼")..... 2.10

HOW TO USE METERS

Over 140 pages (5¼ x 8¼")..... 2.40

TV SWEEP ALIGNMENT TECHNIQUES

123 pages (5¼ x 8¼"), illus..... 2.10

BUY THESE BOOKS NOW FROM YOUR JOBBER OR LOCAL BOOK STORE

If unavailable from these sources,

JOHN F. RIDER

PUBLISHER, INC.
480 Canal Street, New York 13, N. Y.

Export Agent:
Roburn Agencies, Inc.
39 Warren Street
New York 7, New York

In Canada,
Charles W. Pointon
1926 Gerrard Street, East
Toronto, Ontario

West Coast Office:
4216-20 W. Jefferson Blvd.
Los Angeles, California

Cable Address:
Roburnage N. Y.

WHEN
EVERYTHING
ELSE FAILS . . .

TRY

DURANTITES!

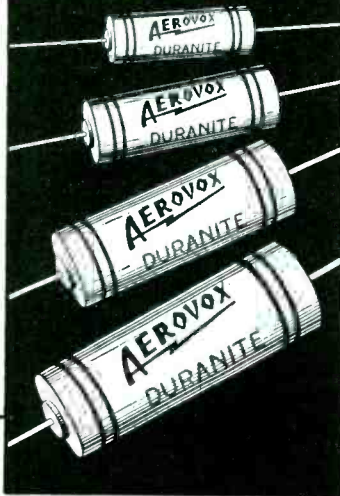

Proven best by any test! Plastic tubulars in permanent "rock-hard" casings. Drop 'em; bang 'em; scratch 'em; burn 'em — NO DAMAGE. Leads firmly anchored — won't pull out.

And just as rugged electrically. Aerolene impregnant eliminates the stocking of both oil and wax types. No shelf deterioration. Excellent high-temperature characteristics. Satisfactory operation from sub-zero to over 212° F.

Ask your distributor for Aerovox Duranites — the toughest capacitors ever offered.



FOR RADIO-ELECTRONIC &
INDUSTRIAL APPLICATIONS

AEROVOX CORPORATION
NEW BEDFORD, MASS., U. S. A.

In Canada: AEROVOX CANADA LTD., Hamilton, Ont.
Export: 41 E. 42nd St., New York 17, N. Y.

(Continued from page 37)

takes into consideration such factors as the efficiency of the speaker system, the masking noise level in the room, and the frequency content of the hum (hum components of 120 cycles or higher are much more noticeable than 60-cycle hum). However, it is often desirable to determine the amount of electrical hum, relative to the signal, at the output of the amplifier.

An extremely sensitive voltmeter would be required to measure hum at the secondary winding of the output transformer. It is therefore more convenient to take the voltage reading across the primary, and even here the voltage may be expected to be of the order of only a few tenths of a volt. A 'scope of known sensitivity, in volts-per-inch of vertical pattern, can be used to get a fairly accurate reading.

The hum output must be measured with the transformer secondary loaded by a resistor rather than by the loudspeaker. This resistor must have a value equal to the rated impedance of the speaker, and must be correctly matched to the secondary.

The *ac* voltage across the transformer primary,² with no signal input to the amplifier, is used to calculate the noise power. This is done by squaring the voltage; that is, multiplying it by itself, and then dividing the result by the impedance presented by the transformer primary winding. For example, if a noise voltage of .2 volt has been measured across the primary of an output transformer, with a plate-to-plate impedance rating of 5,000 ohms, the hum power can be calculated as follows:

$$.2 \text{ volt} \times .2 \text{ volt} = .04 \text{ volt} \\ 5,000 \text{ ohms} / .040000 \text{ volt} = .000008 \text{ watt}$$

The noise-power output of the amplifier is therefore .000008 watt, or 8 microwatts. There is a simple rule that can be used to determine whether the hum level is low enough to conform to the FCC legal requirements for FM

TOMORROW'S ANTENNA

Patented

TODAY

NOW! 32 ELEMENTS



THE
SKYLINE
UHF-VHF

- ONE LEAD-IN
- ALL CHANNELS
- ALL FREQUENCIES

The only antenna of its type with separate, built-in UHF-VHF circuits.

Parts Warranty
Lasting Performance Warranty
Nationally Advertised

SKYLINE MFG. CO.

1458A10 EAST 17th ST.
CLEVELAND 14, OHIO

SPEAKER

Sounds Crazy?

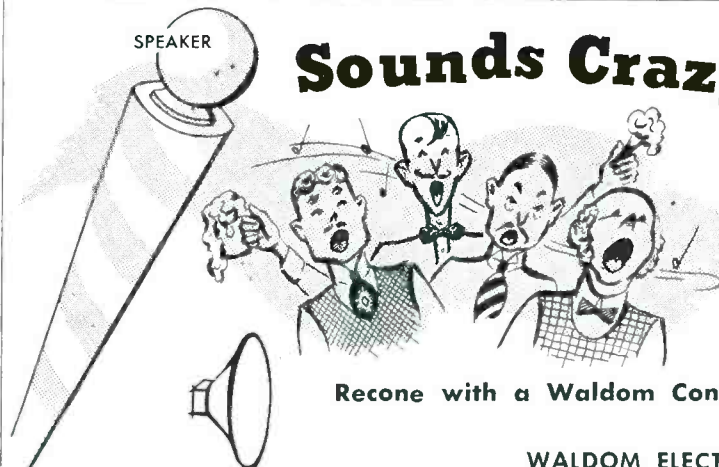

Reconcile with a Waldom Cone

Send for FREE MANUAL

WALDOM ELECTRONICS INC.

909 N. LARRABEE ST., CHICAGO 10, ILLINOIS

broadcast stations. The hum power in *microwatts* should be compared to the signal power output of the amplifier in *watts*. If the number of microwatts of hum is no greater than the number of watts of signal output, the hum level is at least 60 db below the maximum signal, which meets the FCC requirements.

¹McProud, C. G., *Simplified Intermodulation Measurement, Audio Engineering*; May, 1947.

²The ac meter must be of a type which has no response to dc.

Tube News

(Continued from page 30)

a T3 subminiature tube, was developed expressly to meet needs arising in the development of the vibrator. The problem was how to design a convenient tube holder for the vibrator, sufficiently free from stray compliances and resonances to assure that the motion of the tube would conform closely to the motion of the vibrator up to at least 10 kc. The subminiature-tube-type accelerometer facilitated the design of a tube holder meeting this requirement. [Transistor circuitry data next month]

Ser-Cuits

(Continued from page 34)

used in conventional low-frequency circuits. Each line is tuned by four rotor plates. Capacitor trimmers are located behind the coax line to preset the high-frequency end of the *rf* preselectors. The antenna input in this tuner is coupled to the first preselector circuit and is designed to match a balanced 300-ohm transmission line. The output from the preselector stages is fed through an *rf* choke to a mixer crystal.

The *uhf* local oscillator uses a 6J6 in a conventional push-pull circuit using lumped circuit constants. This oscillator operates at half the desired frequency which stabilizes the circuit. The two outer oscillator capacitor plates are slotted to allow for factory corrections of pass-band characteristics.

The output from this oscillator is loop-coupled to the oscillator doubler section. A crystal diode is employed in series with this coupling loop to provide rectification of the oscillator signal and thus effect more efficient doubling action. The output from this doubler is fed to a mixer crystal, where it beats with the preselected incoming *uhf* signal.

EASIEST USING, EASIEST READING VACUUM TUBE VOLT-OHM METER



Model 709

New TELE-VOLTER by Jackson

The **BIGGEST** little instrument of its kind

The 7"-square meter, with hair-line pointer, provides all the voltage (AC-DC) and ohm ranges you could possibly want or need. Meter is electronically protected against overload.

Controls consist of on-off circuit switch, zero adjust, ohms adjust, besides switches built into probes for changing from DC to AC or ohms.

High voltage accessory probe gives readings to 30,000 volts DC.

Dealer net price ... \$95.00

Ask your electronics distributor for information, or write us.

JACKSON

JACKSON ELECTRICAL INSTRUMENT CO.
DAYTON 2, OHIO

"SERVICE ENGINEERED" TEST EQUIPMENT

IN CANADA: THE CANADIAN MARCONI CO.

Associations

for
easy
tuning -

Silverline

UHF CONVERTER

S-P-A-C-E-S

ALL CHANNELS EVENLY
around the dial . . .

14 - 25 - 35 - 45 - 55 - 65 - 75 - 83

Compare the SILVERLINE converter to any other on the market today and see how SILVERLINE eliminates difficult tuning or channel "bunching." Only SILVERLINE is designed to spread the channels evenly around the dial—SILVERLINE offers *straight line frequency dial calibration*. Other UHF converters make available (as illustrated) less than one third or one quarter of the dial to channels 45 to 83. This makes tuning extremely difficult in the upper half of the UHF bands. Easiest tuning . . . simplest installation . . . SILVERLINE outperforms all other UHF converters.

For the finest UHF converter — SILVERLINE!

Jobbers:—Some choice territories still remain open.—
Write for details.

General Instrument & Appliance

CORPORATION

Subsidiary of GENERAL INSTRUMENT CORPORATION • 829 Newark Avenue • Elizabeth 3, N. J.



32 Channels cramped
into 1/4 of dial
Manufacturer A



40 Channels
cramped into
1/3 of dial
Manufacturer B



70 Channels
cramped into
1/2 of dial
Manufacturer C



33 Channels cramped
into 1/4 of dial
Manufacturer D

RTS-N. J.

HAROLD B. RHODES has been reelected president of the Radio and Television Servicemen of New Jersey, Inc.

Also elected were: Fred E. Berdy, vice president; J. Palmer Murphy, executive secretary-treasurer; Jerome J. Gelman, counsel. Named to the board of trustees for terms of two years were Harry Weinberg, Norman Goodman, A. Auerbach, and H. A. Shelladay. Other members of the board of trustees are Aaron Edelman, Kenneth Smith, Edmund Trifari, and Herbert Mandl.

In an annual report, Rhodes pointed out that an association must offer services to members, guide members in public relations and meet industry-wide problems, if it is to be successful and worthwhile. For the coming year Felix Bremy was named chairman of a committee on industry relations.

RTS, Utah

A NEW ASSOCIATION has been formed in the Rocky Mountain area: the Utah Association of Radio and Television Servicemen, with headquarters at 418 Frick Building, 23 E. 1st South, Salt Lake City 1, Utah.

Officers are: J. F. Burns, (Midvale), president; James W. Neilsen (Murray, Utah), vice-president; Robert J. Magness (South Salt Lake), secretary-treasurer; Dean Pieper, formerly of San Diego, California, general manager.

The group will incorporate as a non-profit educational association. A broad public relations campaign is now being planned to acquaint the general public with the problems in the electronics service field.

Membership is open to radio and television service shops, Service Men, students, distributors and dealers.

TSDA, Philadelphia

THE FIRST OF A SERIES of business education programs was offered at a recent meeting of the Television Service Dealers Association, Philadelphia, Pa.

J. Preston, a certified public accountant, discussed *simplified bookkeeping systems and how to watch for hidden costs*. Copies of the system were distributed by the educational committee, who have arranged additional lectures to cover business management, advertising, servicing merchandising, legal facts about Service business, and insurance and public relations in the Service business.

The membership will receive a printed binder with copies of these talks.

The organization decided to join the Federation of Radio Servicemen's Association of Pennsylvania.

The meeting also featured election of officers and Louis J. Smith was elected prexy. Others named included Charles Knoell, vice president; Harrison Neel, treasurer; and Martin Bernoff, secretary.

FRSAP

THE FEDERATION of Radio Servicemen's Associations of Pennsylvania voted, at a recent meeting, to reinstate the Philadelphia Radio Servicemen's Association to membership in the Federation. Representing PRSMA were Samuel Brenner, president; Al Haas, and Stanley Meyers.

A committee for jobber relations was set up with the following members: Austin Renville, Wilkes-Barre; Bert Breggenzer, Pittsburgh; Henry Govan, Scranton; and William Deardorff, Chambersburg.

NETSDA

THE NATIONAL ELECTRONIC Technician and Service Dealers Associations held a meeting recently at 165 E. Broadway, headquarters for the local chapter. In attendance were delegates from Pennsylvania, New Jersey, New York and Long Island. Roger Haines, president, presided.

Final details for a charter of incorporation were discussed at the session.

TEN YEARS AGO

LOW POWER PHONOS and *af* amplifiers were analyzed by Alfred Ghirardi. . . . A *uhf* converter designed to extend test instrument frequency range was reviewed by William Carroll. . . . S. I. Cole, president of Aervox Corp., was elected a member of the executive committee of RMA. . . . Lawrence Handler, a former Service Man, received an award from the Westinghouse Lamp division for a suggestion that boosted production of radio tubes. . . . Paul V. Galvin was reelected president of RMA. Others elected included Ray E. Sparrow, M. F. Balcom, R. C. Cosgrove, Thomas A. White and W. P. Hilliard as vice presidents. Leslie F. Muter was reelected treasurer and Bond Geddes was also reelected to his RMA posts. . . . Richard Hume was appointed department supervisor and stores manager of Universal Microphone Co. . . . Joe Marvey was named city sales manager of Lafayette Radio Corp., Chicago. . . . Army-Navy E Awards were won by: Cannon Electrical Development Co., Los Angeles; General Instrument Corp., Elizabeth, N. J.; General Electric Co., plastics department, Pittsfield, Mass.; and Radio Speakers, Inc., Chicago. . . . Federal Manufacturing and Engineering Corp., Brooklyn, N. Y., was awarded a white star for their Army-Navy E pennant. . . . Harry Ward, Jr., reported that approximately 85,000 handbills, calling attention to *What You Should Know About Radio Service During the National Emergency*, were distributed to radio stores by the Radio Technicians Association, Long Beach, Calif.

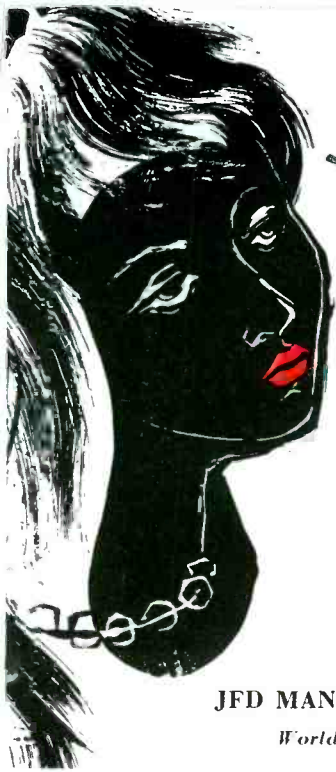

the secret is in the LIPS!



the only lightning arresters with the strain relief lips are made by JFD. A patent is its proof!

JFD MANUFACTURING CO., INC. BROOKLYN 4, N.Y.
World's largest manufacturer of TV antennas and accessories



**"Little Giant"
LIGHTNING
ARRESTER**

for flat and oval jumbo twin lead
No. AT105 (with hardware for wall or window sill mounting) \$1.25 list
No. AT105S (with stainless steel strap for universal mounting) \$1.50 list

Burton Browne advertising

TV RECEIVER TROUBLE CURES . . . VOLUME 4: Receiver manufacturers' cures for TV receiver performance bugs in this volume contains data from the following set manufacturers: Philharmonic, Pilot, Radio and TV (Brunswick), RCA Victor, Remington (Rembrandt), Scott, Sears Roebuck, Sentinel, Setchell-Carlson and Shaw TV.—115 (5½" x 8½") pages paper bound, priced at \$1.80; John F. Rider, Publisher, Inc., 480 Canal St., New York 13, N. Y.

On Book Row

TELEVISION INTERFERENCE . . . BY P. S. RAND: Third edition, book now offers 30 articles analyzing all phases of TVI. Material consists of reprints from leading technical magazines, including SERVICE. Articles are arranged chronologically in the table of contents, beginning with May, '53, and ending with December, '48. Subjects included are: causes and cures of TVI; improved shielding with copper screening; low-cost low-pass filters using standard mica capacitors; an effective TVI probe; and TVI photos.—Priced at \$.25; Remington Rand, Inc. (Miss Anne Smith), 315 Fourth Ave., New York 10, N. Y.

ELEMENTS OF ELECTRICITY . . . BY WILLIAM H. TIMBIE AND ALEXANDER KUSKO: A fourth edition, this text presents useful electrical engineering material in a physical way, without depending heavily on mathematics. Extensive revisions have been made. Covered are ceramic capacitors, transistors, radar, TV, dry and gaseous rectifiers.—631 pages, priced at \$5.50; John Wiley and Sons, Inc., 440 Fourth Ave., New York 16, N. Y.

TELEVISION AND RADIO REPAIRING . . . BY JOHN MARKUS: A basic book for the radio-TV beginner, providing simple instructions for testing, repairing, and replacing TV and radio parts. Some of the topics covered in the book's 22 chapters include: tools needed for servicing; how TV and radio sets work; how to use a multimeter; testing tubes without a tester; how to solder; power-supply troubles; testing and replacing carbon resistors, wire-bound resistors, controls and switches, capacitors, coils and transformers; repairing tuning devices and loudspeakers, and cabinets; and installing and repairing radio and TV antennas.—556 pages, priced at \$7.95; McGraw-Hill Book Co., Inc., Trade Book Dept., 330 W. 42nd St., New York 36, N. Y.

ELECTRONIC CIRCUITRY FOR INSTRUMENTS AND EQUIPMENT . . . BY MILTON H. ARONSON: A complete home-study text and course with 458 multiple-choice home-study test items on basic electronic circuitry for instruments, communications, TV, and lab apparatus. Subjects include: circuit elements; impedance and resonance; tubes; rectification; amplifier circuits; transistor circuits; oscillator circuits; electrical and electronic test equipment; communication and TV; and scientific and industrial instruments.—310 pages, priced at \$4.00; Instrument Publishing Co., 921 Ridge Ave., Pittsburgh 12, Pa.



**Introducing
The New
HUSH Jr.
KIT
SERVICER**

*The Amazing, New
TV-Tuner Cleaner
That Sprays On!*

The new, "handy" size for TV and Radio Service Men to pack right along in their tube kits. So convenient on home service calls.

HUSH Jr. KIT SERVICER—\$1.25
2-ounce bottle, complete with 24 karat gold plate spray attachment.
8-ounce refill bottle only \$1.95

HUSH is made by the manufacturers of EVER QUIET—for volume controls—contact restorer.
EVER KLEER—for cleaning and keeping TV tubes clean.

Ask your local distributor for HUSH or write:

**CHEMICAL ELECTRONIC
ENGINEERING, INC.**
283 Main St. Matawan, N. J.

**TEST
PICTURE TUBES
in a jiffy**

- ACCURATE
- INEXPENSIVE
- POCKET SIZE

Test picture tube without removing it or chassis from cabinet.

KINE-TEST



4.95
dealer net

- ELIMINATES GUESSWORK
- TESTS ALL STANDARD TUBES
- SIMULTANEOUSLY CHECKS:

FIRST ANODE VOLTAGE	VIDEO SIGNAL
FILAMENT VOLTAGE	BIAS VOLTAGE

Sold only through VIDAIRE distributors
Write for Catalog A

Vidaire Electronics Mfg. Co.
Mfrs. of TV color equipment, TV amplifiers, Electronic Devices

 Factory: Lynbrook, L. I., N. Y.
Nat'l. Sales Office: 6 E. 39 St.
N. Y. 16, N. Y. - LE 2-7372

Let these antenna experts help you

To be sure of getting the most out of the antenna system at any site, use Noll and Mandl's



Television and FM Antenna Guide

Both a practical installation handbook and a clear, understandable text on v.h.f. antenna theory, this book gives you all the information you need to choose the best antenna for a particular site and install it for best performance.

You'll be equipped to deal with the many individual problems you meet in weak signal and fringe areas and other difficult sites. You'll know, without trial and error and with minimum testing, which type of antenna will give best reception, how to place it to best advantage, and how to reduce interference, overcome ghost reception, boost signal strength, etc.

The authors, both well known writers on TV service problems, have made extensive tests on antennas. The data they give here on antenna characteristics and comparative performance is complete and ACCURATE.

Is this book on your work shelf?



Mandl's Television Servicing

THE NEW REPRINT of this widely used service guide includes new data on the cascade tuner, servicing newer types of i.f. systems, automatically focused tubes, UHF station listing and antenna calculations, transistors and other recent developments. All faults likely to occur, including those hard-to-find troubles, are dealt with in the clearest, most practical way. A master index enables you to turn directly to procedures for locating and correcting any particular flaw in sound or picture.

SEE THEM ON APPROVAL

The Macmillan Company, 60 Fifth Ave., N. Y. 11

Please send me the book(s) checked below. I will either remit the full price plus small delivery charge, or return the book(s) in 10 days. (Save: Enclose check or money order and we pay delivery charge).

TV & FM Antenna Guide, \$5.25 Mandl's TV Servicing, \$5.50

Signed

Address

This offer good only within continental limits of U.S.A.

PERSONNEL

WILLIAM A. READY has retired as chairman of the board of directors of the National Co., and has been succeeded by RAYMOND C. COSGROVE, formerly executive vice president of the Avco Manufacturing Corp., and president of RTMA. Ready had been an official of the company for 38 years prior to his retirement. . . . CHARLES C. HORNBOSTEL remains as president of the company.



William A. Ready



Raymond C. Cosgrove

* * *

RALPH R. SHIELDS has been named to a newly created post of product sales manager of TV picture tubes of Sylvania Electric.



Carl A. Odening



Ralph R. Shields

CARL A. ODENING, superintendent of the Columbia, Tenn., plant of the National Carbon Co., has been awarded an Alfred P. Sloan Fellowship under the executive development program at M.I.T. Fellowship provides a year's training in industrial management studies.

* * *

J. K. POFF is now sales manager of the jobber division of the Pyramid Electric Co., North Bergen, N. J.



J. K. Poff

* * *

EDWARD WERSHEY has been appointed chief engineer of the electrolytic department by Aerovox Corp., New Bedford, Mass. . . . J. HARVEY PICKETT has become chief engineer of the capacitor division. . . . ABRAHAM G. KALSTEIN is now assistant chief engineer for Aerovox.

* * *

WEBSTER E. BARTH, formerly New England sales manager for Reynolds Metals Co., has been appointed general sales manager for LaPointe Electronics, Inc.

for dependable sound, INDUSTRY relies on ATLAS



DR Double-Reentrant Projectors



Paging & Talk-Back Speakers



ALNICO-V-PLUS Driver Units



Dual Speakers



FULL-GRIP, VELVET-ACTION Mike Stands

DEPENDABLE QUALITY:

The latest electro-acoustic research and engineering—and over 20 years of manufacturing know-how—are behind every ATLAS product.

DEPENDABLE SERVICE:

Coast-to-coast and around the world today—in every Industrial, Marine, Railroad, Military, Educational, Civic, U.S. and Foreign Government application—under every kind of climate and noise condition—ATLAS sound equipment is famous for highest efficiency and durability. That's the proof of ATLAS performance dependability.

DEPENDABLE DELIVERY:

Yes, ATLAS gives our Government highest priority. And yes, we too feel the pinch of material shortages. But our customers will continue to get our usual dependable delivery—because we believe in equitable and dependable distribution to all ATLAS users.

DEPENDABLE PROFITS:

Completeness of line, excellence of product, dependable delivery, right prices—that's the ATLAS combination that means high, steady Industrial Sound profits for You!

JUDGE for yourself. COMPARE ATLAS at your local Jobber today. See why ATLAS is the preferred line for utmost dependability. Write NOW for FREE latest Catalog 751.

ATLAS

SOUND CORP.

1442-39th Street, Brooklyn 18, N. Y.
In Canada: Atlas Radio Corp., Ltd., Toronto, Ont.

WANTED

WE NEED YOUR SURPLUS ELECTRONIC EQUIPMENT

WE PAY TOP \$\$\$ FOR:

- ★ TUBES
- ★ TRANSFORMERS
- ★ COILS & PLUGS
- ★ ARC-1
- ★ ARC-3
- ★ ART-13
- ★ CLAMPS
- ★ RELAYS
- ★ RESISTORS

- ★ CONNECTORS
- ★ RADIO RECEIVERS
- ★ TRANSMITTERS
- ★ CONTROL BOXES
- ★ INDICATORS
- ★ CORDS
- ★ TELEPHONE MATERIALS

WE BUY ANYTHING!

Write. Wire today! Tell us what you have.

TALLEN CO., Inc., Dept. F

159 Carlton Ave., Brooklyn 5, N. Y.

Rep Talk

RUSS DIERTHERT, of the Chicagoland chapter, has been elected national president of The Reps. *Wally B. Swank*, Empire State chapter, was named first vice president; *Dean A. Lewis*, California chapter, was elected second vice president, and *Ross Meychant*, Wolverine chapter, third vice president. Others elected to national posts include: *Ronald G. Bowen*, Rocky Mountain chapter, secretary; *George Pettit*, Chicagoland, treasurer. *Mose S. Branum*, Southwestern chapter, was elected to serve on the board of governors for a three-year term. Other members of the national board include: *Leroy W. Beier* (Chicagoland), subsequently reelected chairman; *R. W. Farris* (Missouri Valley); *B. C. Landis* (New York); *D. N. Marshank* (Los Angeles); *M. K. Smith* (Dixie), and *W. S. Trinkle* (Mid-Lantic). . . . *Jack Beebe*, Chicagoland rep, died recently. . . . Copies of the 1953 *National Membership Roster*, are available from the national office of The Reps, 600 S. Michigan Ave., Chicago 5. . . . A refresher course in the theory and practice of TV sweep components (yokes, flybacks, vertical output and blocking oscillator transformers, linearity and width coils), under the tutelage of chief engineer Victor Markosian and national field engineer Al Friedman, has been instituted by Ram Electronics for all its reps. . . . *M and E Sales*, a new rep firm, has established offices at 267 Arcadia St., Pasadena 5, Calif. *Margaret Gleeman* is manager of the sales division. . . . *Sam Biulek* (New York metropolitan area) and *Jack Perlmuth* (Perlmuth-Colman and Associates, Los Angeles, Calif.) were honored recently for their 25-year service by Clarostat, and received gold lapel pins, testimonial scrolls and gold wrist watches. . . . *Peysner and Co.*, 1501 N. Weber St., Colorado Springs, Colo., has been appointed rep for the David Bogen Co., in Utah, Colorado, Wyoming and New Mexico. . . . Industrial Development Engineering Associates, Indianapolis, Ind., recently conducted a two-day sales meeting for its reps, which featured a tour of *uhf* boosters and *uhf* converter assembly lines at the plant. . . . *Jack Carter*, 317 N. Sycamore Dr., Los Angeles, Calif., has been named rep for Davis Electronics, in southern California. . . . *L. H. Harriss*, L. H. Harriss Sales Co., 383 Brannan St., San Francisco, Calif., formerly general sales manager for Burgess Battery Co., has been named rep for RMS in northern California and northern Nevada. *Frank A. Emmet Co.*, 2834 W. Pico Blvd., Los Angeles, Calif., will represent RMS in southern California, southern Nevada and Arizona.

L. H. Harriss

Frank A. Emmet



I.D.E.A. reps watching assembly work during recent tour of plant, left to right: Joe Murphy, Cunningham & Mitchell, Indianapolis; Everett Bean, Cartwright & Bean, Memphis; Edward C. Tudor, I.D.E.A. president; and Harry Maas, Max Heidenreich Co., Dallas.



Kenneth A. Hathaway, life-time national honorary member of the Reps, being presented with a membership pin by Russ Diether, newly-elected national president.

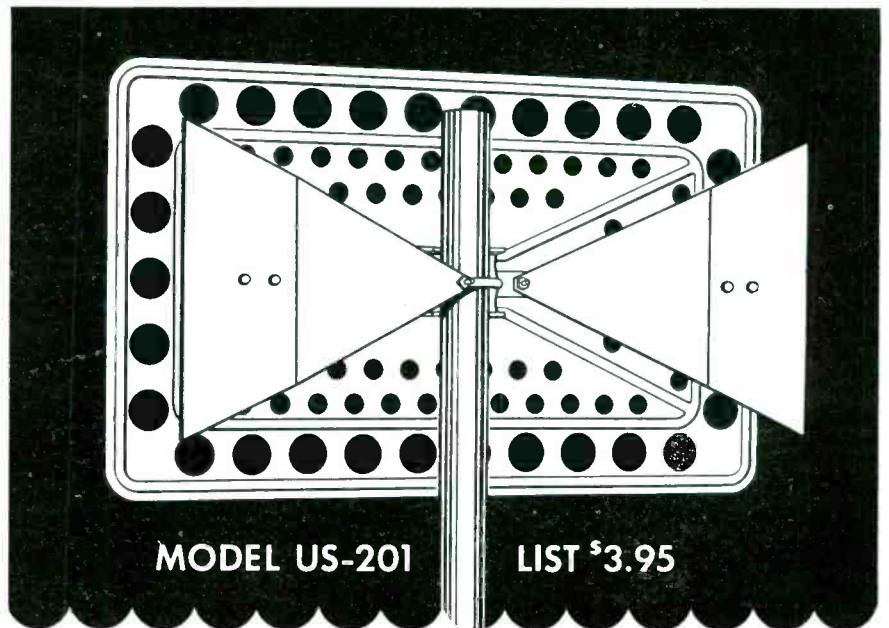

MODEL US-201

LIST \$3.95

"IT'S A REAL BO-NANZA!"

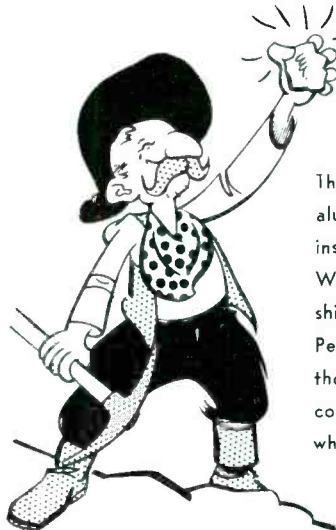

New RADELCO UHF "BO-NANZA" Antenna Offers You a Bonanza in UHF Profits!..

The new Radelco Bo-nanza US-201 UHF Antenna is of aluminum, all metallic construction with no plastic insulators to absorb moisture and weaken the signal. Works equally well in both wet and dry weather. It is shipped pre-assembled and is very light in weight. Performance characteristics are equal to or better than those of any other bow-tie reflector type antenna. Its compact size and high gain make it ideal for locations which have UHF service only. Attractively priced!

Model US-201

Single stack, less mast
List \$3.95

Model US-202

Double stack with Q-bars
List \$8.25

ORDER FROM YOUR NEAREST PARTS JOBBER!



7580 GARFIELD BLVD. • CLEVELAND 25, OHIO



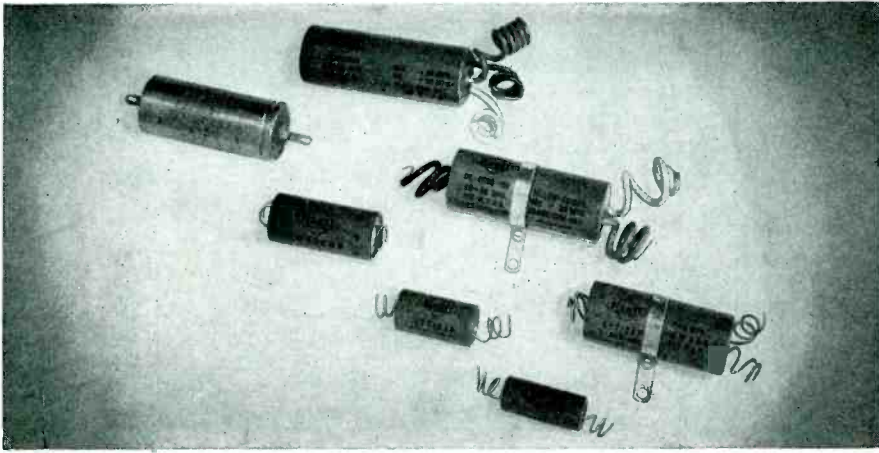

Planet Capacitors "Engineered for Quality"

1 year service guarantee

Custom engineered to your specifications or supplied from stock, Planet capacitors meet the highest standards of the industry. Every capacitor is tested mechanically and electrically throughout its manufacture.

This rigid system of quality control makes our unconditional one-year guarantee possible. But making Planet capacitors right from the start means reasonable prices too!

PLANET MANUFACTURING CORPORATION

225 BELLEVILLE AVENUE
BLOOMFIELD, N. J.



WRITE for Catalog 206-B, listing specifications on stock items.



RMS ADDS WAREHOUSE FACILITIES

Addition of an 18,000-square-foot warehouse has been announced by Radio Merchandise Sales, Inc., 2016 Bronxdale Ave., New York 60, N. Y.

Albert Brand, secretary-treasurer, is in charge of plant operations, and will have additional offices in the new building at 945 Cortlandt Ave., New York, N. Y.

Reuben Agdern will be in charge of antenna production at the West Farms and Southern Boulevard factories. Agdern recently celebrated his 14th year with the company.



Reuben Agdern



Martin Bettan

MARTIN BETTAN ELECTED AMA PREXY

Martin Bettan, director of sales and engineering for RMS, has been elected president of the Antenna Manufacturers Association.

Ben Snyder, Snyder Manufacturing Company, is now vice president, and *Edward Finkel*, JFD, will serve as secretary-treasurer of the association.

RIDER BOOK DISPLAYS

A wire book-display rack, and cabinets for *Tek Files*, have been announced by John F. Rider Publisher, Inc., 480 Canal St., New York 13, N. Y.

Book display is a collapsible steel wire unit which holds approximately 70 books with display space for more than 15 different titles. Rack is 32" high, 20" wide and 14" deep. Bottom of rack has a holder for 3" x 5" circulars. In addition, there is a slot for displaying new Rider book posters.

Gray hammertone steel cabinet, for housing monthly-released *Tek-File* Packs, holds 80 packs packaged in boxes, or 160 packs packaged in envelopes. Cabinet is said to be tilt-proof; drawers have a nickel-plated holder marking its contents.

Book display rack fits on top of the cabinet.

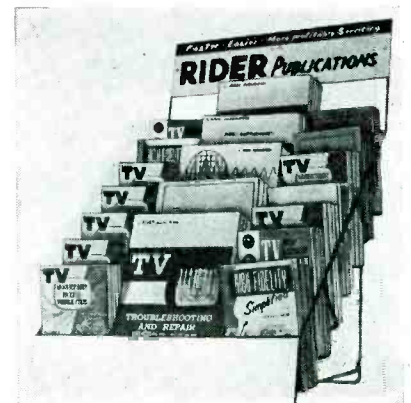

BE WISE...

YAGI-IZE

YOUR INSTALLATIONS

WITH TACO FIELD TESTED
MULTI-CHANNEL YAGIS

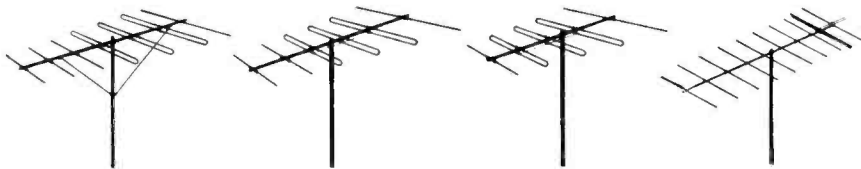

CAT. 1840

Triple-Driven
Seven-Element Yagi.
Five Channels - 2 thru 6

CAT. 1836

Triple-Driven
Six-Element Yagi.
Four Channels - 3 thru 6

CAT. 1824

Triple-Driven
Five-Element Yagi.
Three Channels - 2 thru 4

CAT. 1860

Bazooka-Tuned
Eleven-Element Yagi.
Seven Channels - 7 thru 13

**YOUR TACO DISTRIBUTOR
HAS COMPLETE DETAILS**

TECHNICAL APPLIANCE CORPORATION • SHERBURNE, NEW YORK

In Canada: Hackbusch Electronics, Ltd., Toronto 4, Ontario



"Mr. Elkins, this floors me...
a genuine JENSEN
DIAMOND NEEDLE!"

CHICAGO TRANSFORMER AND STANCOR MERGE

Consolidation of the Chicago Transformer division of Essex Wire Corp., with plants located at Chicago, Ill., and Zanesville, Ohio, with Standard Transformer Corp., Chicago, Illinois, has been announced.

Combined operations will now be known as Chicago Standard Transformer Corporation, with following officers: president, Addison Holton; vice president, Arni Helgason; vice president, J. J. Kahn; vice president, L. S. Racine; secretary, W. F. Probst; and treasurer, M. A. Roesler.

* * *

RAYTHEON TRANSISTOR CONTEST

A \$10,000 transistor application contest, to be handled exclusively through Raytheon special purpose tube distributors, with the closing date set at midnight August 31, 1953, has been announced by the Raytheon Manufacturing Co., receiving tube division, Newton, Mass.

A first prize of \$5,000, second prize of \$2,000, third prize of \$1,000, fourth and fifth prizes of \$500 and \$300, respectively, and sixth to seventeenth prizes of \$100 each, are being offered. A \$100 prize will be given to the distributor salesman selling the winner of the first to the fifth inclusive prizes.

Requirements are that a contestant must obtain a Raytheon CK722 from his tube distributor, devise and build a piece of electronic equipment which employs one or more CK722 transistors, and mail a photograph of the unit, a completed official entry blank, and a 500-word minimum, 1,000-word maximum, constructional article on the equipment.

* * *

T-V PRODUCTS MOVES

T-V Products Co., formerly located at 152 Sanford St., Brooklyn, N. Y., has moved its factory and offices to 145-68 228th St., Springfield Gardens 13, N. Y.

* * *

PICTURE-TUBE PROMOTION

TV SERVICEMEN...

TAKE YOUR PICK!

We want you to KNOW the quality and long-life performance of



Poster announcing TV picture tube promotion featuring offer (through month of August) of tool and tube caddy and a 135-watt pistol-type soldering gun. During campaign Service Men ordering a Federal TV tube from distributor will receive a gold gift certificate along with it; ten such certificates will entitle him to his choice of the caddy or the soldering gun.

A Quarter of a Century

... of leadership
in the design and manufacture
of quality electronic products
represents experience and
know how that means
consistently highest quality...
and more profit for you.



INSIST ON
American
Replacement
Crystal
CARTRIDGES

more profit...
more satisfied customers

Handy-5-Pak with cartridge
replacement chart on back
available now.



Send for Free Catalog 46

American

MICROPHONE CO.

370 S. FAIR OAKS AVE., PASADENA 1, CALIF.

South River

NEWS

**CHIMNEY
UNI-MOUNT
MODEL
UM-1**

Riveted, heavy-gauge, galv. steel with wide, flared-lip, snap-in mast holders. 18" spacing between mast holders for firm support. Available with one heavy-gauge stainless steel strap, Kwik-Klip banding closure and Chimney Corner Guards.

Model UM-2... same as UM-1 with 2 heavy-gauge stainless steel straps.

Write for our new 1953 catalog.

In Canada—A.T.R. Armstrong Co., Toronto

**SOUTH RIVER METAL
PRODUCTS CO., INC.**
SOUTH RIVER, N. J.

PIONEER AND OUTSTANDING PRODUCER
OF FINEST LINE OF ANTENNA MOUNTS

for ALIGNING UHF FRONT ENDS

A LOW COST UHF SWEEP GENERATOR



Here are the essential specifications:

Frequency Range . . . 450 to 900 mc
(Single Range)
Sweep Width . . . 0 to at least 30 mc
over entire band
Output Voltages . . . 0.01 to 1.0 volts
into a 75 ohm load
A balun is available for
300 ohm balanced load

\$265

f.o.b. New London, Connecticut

At last the service man gets a break! Most laboratory instruments are priced so high that anyone without a big company backing him can only dream of them.

Not so New London's Model 130! Combining laboratory precision with practical design, the 130 is priced so you can afford it.

Moreover, the 130 is easy to use. Frequency is in a single range. A minimum of controls are provided. And the return sweep is blanked, thus providing a zero level baseline.

*for further details
or to place your order
write to*

New London Instrument Company
P. O. BOX 189
NEW LONDON, CONNECTICUT

Tools . . . Instruments Parts . . .

SIMPSON VOLT-OHM-MILLIAMMETER

A volt-ohm-milliammeter, model 262, featuring a sensitivity of 20,000 ohms per volt *dc*, 5,000 ohms per volt *ac*, has been introduced by the Simpson Electric Co., 5200 West Kinzie St., Chicago 44, Ill.

Instrument has 33 ranges; measurement accuracy is said to be 3% *dc* and 5% *ac* of full scale deflection. It has a handle that may be used to support the instrument at a convenient viewing angle on a bench top, and a 7" dial. Includes test leads, removable alligator clips, and 4,000-volt *dc* multiplier.



Simpson 262

PRECISION PARTS CABINETS

All steel cabinets, *Little Gem*, for small parts storage, have been announced by Precision Equipment Co., 3714 Milwaukee Ave., Chicago 41, Ill.

Have two 1½" high drawers in a one-piece welded frame; overall size 3¼" h x 11" d x 11" w. Each drawer is furnished with 8 dividers. Tabs turn up and engage shelf above to prevent tipping when used as an insert in shelving. Available in baked green finish.

Small parts cabinets are designed for insertion in Precision all-steel standard parts cabinets, which consist of 18 drawers, each 11⅞" x 5⅜" x 3⅞". Each drawer has two dividers adjustable on 1" centers. Label holders are on every drawer and divider.

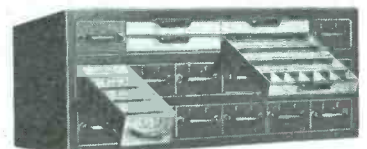

KESTER

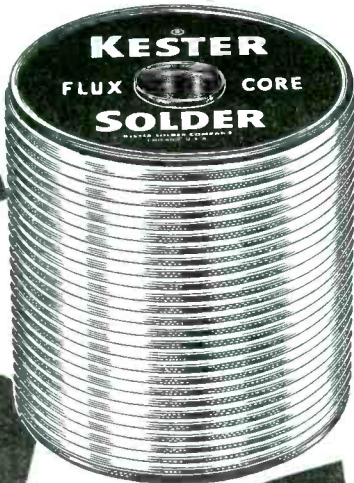

Since the most important single step in Radio-Television Servicing is soldering . . . it's just plain good sense to use the best — KESTER SOLDER . . . Key Name in Solder for More Than 50 Years.



KESTER SOLDER COMPANY
4248 Wrightwood Avenue • Chicago 39, Illinois
Newark 5, New Jersey • Brantford, Canada

SOLDER

LITTELFUSE FUSE KITS

A revised *One Call Kit* of fuses for TV Service Men has been announced by Littelfuse, Inc., 1865 Miner St., Des Plaines, Ill.

Kit represents the latest usages of fuses as indicated by set manufacturers and Service Men, and is said to handle 95 per cent of service needs.



Littelfuse TV Fuse Kit

* * *

IRC VARISTORS

A line of non-linear resistors, *Varistors*, has been introduced by the International Resistance Company, 401 N. Broad St., Philadelphia 8, Pa.

Units can be used where sharp variation of resistance with applied voltage is required; available in 5 cell sizes in a variety of enclosures. Designed to conform with MIL and JAN specifications on humidity, shock, vibration, temperature cycling, solder pot, fungus resistance, etc., non-linear resistors are said to have a low shunt capacitance and can be used effectively in *rf* circuits.

* * *

CARLCO RESISTOR-CAPACITOR KITS

Five kits, including resistors, and tubular, mica, ceramic, and electrolytic capacitors, have been introduced by Carl Cordover and Co., 100 Warren St., New York 7, N. Y.

Resistor kit, *RK-100*, contains 100 resistors, 35 different ohmages (minimum), 1 ohm to 20 megohms. Assortment: 10 two-watt; 20 one-watt; 70 one-half watt. Ceramic capacitor kit, *CK-35*, contains 35 ceramic capacitors; 15 different capacities (minimum). Complete ceramic capacitor detachable color code chart included on every package. Mica kit, *MK-50*, contains 50 mica capacitors, 10 different capacities (minimum): 5 to 1,000 mmfd. The molded tubular capacitor kit, *TK-25*, contains 25 molded tubulars; 400 to 600 volts, 12 different capacities (minimum) up to .1 mfd. Low-voltage electrolytic kit, *LV-10*, contains ten assorted low-voltage electrolytics including FP's; voltage up to 50.

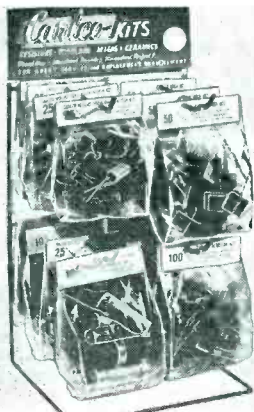

STOP

BLACK BORDERS ON TV PICTURE

use a
"B" Plus Booster
Model 5TV4 Replaces 5U4G



NO SIDE BORDER



NO TOP-BOTTOM BORDER



NO ALL 'ROUND BORDER

Anytime!

Pulling a Tube beats Pulling a Chassis

- More Height • More Width
- More Gain • Better Overall Performance

Built-in Time Delay to Protect TV Set

Sold Through Authorized Distributors Only. List Price \$6.60.

THE 5TV4 GETS RESULTS

- SUPPLIES EXTRA 30-40 VOLTS TO LOW VOLTAGE SUPPLY
- GIVES FULL SIZE PICTURE WHEN LOW LINE VOLTAGE OR WEAK TUBES CUT PICTURE SIZE.
- GIVES EXTRA GAIN NEEDED IN FRINGE AREA



STANDARD R.T.M.A. GUARANTEE
PAT. APPLIED FOR

WORKMAN TV INC.

TEANECK, NEW JERSEY

KEARNEY RUST REMOVER

A rust-cutting oil that can be sprayed from an aerosol can is now available from James R. Kearney Corp., 4236 Clayton Avenue, St. Louis 10, Missouri.

After a short spray from a distance of six to eight inches, the manufacturer says, a two-minute wait usually permits the compound to eat into the rust so nuts, bolts, washers, etc., can be loosened.

Du Pont Freon fluorinated hydrocarbon, the same chemical that acts as the cold-making agent in refrigerators, freezers, and air-conditioning systems, serves as the propellant in the aerosol can.



Right: Kearney Rust Cutter

The Ideal Combination for BETTER TV RECEPTION...

WINCHARGER ROOF MOUNT TOWER and Telescoping ANTENNA SUPPORT

...one man
can install!
Telescoping TV
ANTENNA SUPPORT

No more "high climbs" with this rugged, modern Telescoping Mast. One man does the job from the bottom 10' section! Gets the antenna as high as you want with either 20', 30', 40' or 50' lengths available.

HOT-DIPPED GALVANIZED for maximum rust resistance. 18 gauge welded tubing, hardware plated.

Exclusive 3-point SAFETY CLAMPING RING prevents tubes twisting and loosening.

AUTOMATIC SAFETY CLIP warns with a "click" when tube is pulled to correct position.

TV Roof Mount Towers

This combination can't be beat for fast, simple installation and satisfactory performance. The Roof Mount is made in 5 ft. and 10 ft. sizes — all steel, withstands winds up to 100 M.P.H. One man with a pair of pliers can easily assemble and install. Adjustable feet mount on any slope roof, without danger of damage to roof or chimney. Self-supporting up to 20' . . . up to 50' with simple guying.

Ask your jobber for profitable details and prices, or write direct to us.

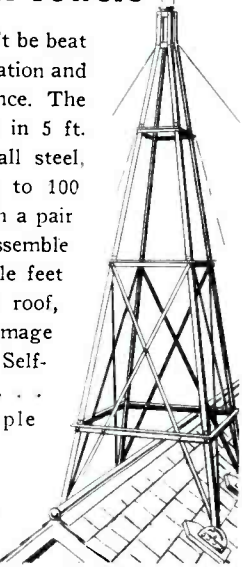

WINCHARGER CORPORATION, 2119 E. 7th Street Sioux City 2, Iowa

CATALOGS, BULLETINS ETC.

ALLEN B. DuMONT LABS., INC., Cathode-Ray Tube Division, 750 Bloomfield Ave., Clifton, N. J., has published a 32-page guide of original TV parts and picture tubes for replacement in DuMont TV receivers. Guide also includes electrical values of the components. . . . A picture-tube data chart, listing complete specifications for more than 150 types of all manufacturers, is also available. The eighth edition, chart, covers 21-, 24- and 27-inch tubes, and magnetic-focus and electrostatic-focus types. Data featured includes basings, bulb dimensions, deflection angle, radius of face curvature, envelope and contact, ion trap magnet, and application notes. . . . A spiral-bound service information book, containing schematics of all DuMont TV receivers, is now available from parts distributors. Book also contains complete parts lists, alignment data and other service data. Priced at \$1.50.

SPRAGUE PRODUCTS Co., North Adams, Mass., has issued a 20-page revised replacement parts catalog, C-609, detailing standard stock capacitors—paper, ceramic, electrolytic, mica—and Bulplate printed circuits.

ELECTRO-VOICE, Inc., Buchanan, Mich., has released bulletin 182 describing *uhf* converters and *vhf* boosters. . . . Another bulletin, 197, providing details on the CDP compound diffraction projector, a *pa* loudspeaker system designed to improve voice penetration, is also available.

P. R. MALLORY AND Co., Inc., 3029 E. Washington St., Indianapolis 6, Ind., has released '53 catalog 553, that lists and describes more than 2,200 items, mostly replacement components.

PYRAMID ELECTRIC Co., 1445 Hudson Blvd., North Bergen, N. J., has prepared a 20-page catalog, PG-3, containing engineering data, performance curves, construction styles and sizes, capacitance and voltage listings for subminiature *Glasealed* tubular paper capacitors, which are hermetically sealed in tubular metal cases with glass-to-metal end seals. Units impregnated with Halowax are available in capacitances ranging from .001 to 1 mfd., in 100, 200, 300 and 400-volt *dc* types. Mineral oil and synthetic oil impregnated *Glasealed* are also available in capacitances from .001 to 1.0 mfd., and in 100, 200, 300, 400 and 600-volt *dc* types.

THORDARSON-MEISSNER, Dept. C. Mt. Carmel, Ill., has published an *Automobile Radio Replacement Guide, J-645*, listing replacements for vibrator, interstage output, input *if*, output *if* and ratio-detector *if* transformers, and oscillator coils, for all makes of auto radios.

RADIO MERCHANDISE SALES, 2016 Bronxdale Ave., New York 60, N. Y., has issued a 36-page catalog, 54, describing TV antennas and accessories. A technical data section is also included. Items described include bowties, corner arrays and yagis for *uhf*; multi-channel yagi series for *vhf*; leadins; lightning arresters; and hardware.

BUILD YOUR OWN

Heathkit TEST EQUIPMENT

Heathkits are completely engineered instruments supplied unassembled. Every kit goes together smoothly and easily. All drilling, punching, and painting has already been done for you. All parts are furnished and are of highest quality.

Detailed construction manual shows clearly where each wire and part goes and tells exactly how to build the kit. Write for free catalog.

AUDIO GEN. KIT
\$29.50

R. F. SIGNAL GEN. KIT
\$19.50

5" SCOPE KIT
\$43.50

T.V. ALIGN. GEN. KIT
\$39.50

SIGNAL TRACER KIT
\$22.50

VACUUM TUBE VOLTMETER KIT
\$24.50

BATTERY ELIMINATOR KIT
\$24.50

IMPEDANCE BRIDGE KIT
\$69.50

TUBE CHECKER KIT
\$29.50

GRID DIP METER KIT
\$19.50

CONDENSER CHECKER KIT
\$19.50

HEATH COMPANY

BENTON HARBOR 11, MICHIGAN

EXPORT AGENT
ROCKE INTERNATIONAL CORP.
13 East 40th Street
NEW YORK CITY (16)

ERIE RESISTOR CORP., Dept. S., Erie, Pa., has released a 16-page catalog, *D-53*, describing resistors, *pc* units, variable controls, etc.

* * *

CHANNEL MASTER CORP., Ellenville, N. Y., has published a 12-page manual, *TV Antenna Handbook for VHF and UHF*, illustrating and describing more than 60 different *vhf* and *uhf* antennas, and detailing their applications. Antenna accessories are also covered.

* * *

BRACH MANUFACTURING CORP., 200 Central Ave., Newark, N. J., has released a 16-page catalog, *53-T*, describing *vhf* and *uhf* antennas, multi-set couplers and auto antennas.

* * *

ASTRON CORP., 255 Grant Ave., East Newark, N. J., has issued a 4-page bulletin, *AB-19*, containing performance characteristics and test specifications on high-temperature metallized paper capacitors, *Hy-Mets*. . . . A 4-page bulletin, *AB-20A*, describing *Blue-Point* molded plastic capacitors is also available.

* * *

COLUMBIA WIRE AND SUPPLY CO., 2850 Irving Park Rd., Chicago 18, Ill., has released a 28-page catalog, *103*, for radio and TV parts jobbers, which describes their line of radio TV wires and cables.

* * *

HALLDORSON TRANSFORMER CO., 4500 Ravenswood Ave., Chicago 40, Ill., has issued a special '53 catalog which describes complete line of transformers. Also includes output transformer chart, mounting dimension data, etc.

* * *

SIMPSON ELECTRIC CO., 5200 W. Kinzie St., Chicago 44, Ill., has published a 32-page booklet, *How to Use the Simpson 479-480 for UHF Alignment*, written by Lloyd J. Austin, Simpson sales engineer. . . . A 50-page booklet, *1001 Uses for the Model 260 volt-ohm-milliammeter*, has also been released. Features review of technical features of model, explaining its operation in various applications.

* * *

ATLAS SOUND CORP., 1449 39 St., Brooklyn 18, N. Y., has released a 12-page catalog which illustrates and lists specifications for projectors, radials, pagings, talkbacks, tweeters, baffles, driver units, transformers, microphone floor stands, desk stands, boom stands, boom brackets, sky hooks, cable hangers, etc.

* * *

INTERNATIONAL RESISTANCE CO., 401 N. Broad St., Philadelphia 8, Pa., has published a 12-page bulletin, *C-1*, with data on characteristics, dimensions, derating, insulation, specifications, tolerances, windings, etc., of tubular and flat power wire-wound resistors, with photos, detailed charts and graphs.

* * *

WARD PRODUCTS CORP., division of the Gabriel Co., 1148 Euclid Ave., Cleveland, Ohio, has published an 8-page TV antenna catalog describing bowties, rhombics, 3X3 nine-element beams, corner reflectors and ten-element yagis. Also covered are *pc* diplexers for *uhf/vhf* lead-in feeds.

Next Month

THE CONCLUDING installment of the *Geist* picture-tube fault chart report and the *Beamer* service-engineering review of 2-way FM systems will appear in the August issue of SERVICE.

designed for High Fidelity



V-M 935HF Record Changer 936HF on metal pan "all the music is all you hear"



triomatic® 935HF

HIGH FIDELITY RECORD CHANGER

V-M makes high fidelity easier to sell, with such features as:



Exclusive aluminum die cast tone arm. Balanced, resonance-free!



Two plug-in tone arm heads of die cast aluminum. Adaptable to these cartridges*: GE "turn about" RPX050, GE RPX040, GE RPX041, Pickering single-play and turnover, and Clarkstan.



Exclusive laminated turntable with precision-formed concentricity for smooth operation.



Exclusive 4-pole, 4-COIL motor assures constant-speed, wow-free performance.



Muting switch for silent change cycle.

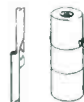

Gentle tri-o-matic spindle lowers records to spindle shelf, holds them flat for silent, air-cushion drop.

V-M automatic 45 Spindle included.

*Pre-amplification stage required.

SEND FOR COMPLETE DETAILS!

MAIL COUPON TODAY!

V-M Corporation, Benton Harbor 5, Michigan

Please send me all data and illustrated literature on the new V-M 935HF high fidelity record changer.

Name _____

Address _____

City _____ State _____

OSCAR TO RADIO PIONEER

In honor of his fifty years of accomplishments in the areas of radio-electric pioneering and scientific prognostication, Hugo Gernsback (left) was presented with a silver globe testimonial trophy at the recent parts show banquet in Chicago, at which Sam Baraf (right), show prexy, presided. The presentation was made by Austin C. Lescarbourea. Trophy, a hand-wrought relief globe, mounts on a base on which were inscribed the facsimile signatures of 97 individual sponsors and 33 leading companies and organizations, along with the names of prominent scientists, both living and deceased, who have furthered the radio-electronic art. In accepting the trophy, the pioneer expressed hope that the award might be established as a sort of *Oscar* for outstanding achievements in the field of radio-electronics. In keeping with this wish, he is presenting the trophy for permanent display, and arranging for a miniature replica award to be presented annually. A committee of industry leaders will select each year's winner.



are you
**BURNED
UP?**



**TRIAD
DEFLECTION
YOKES**

will cool
you off



If you are tired of blasting cooked yokes off of picture tubes—then switch to Triad Deflection Yokes. They have a molded high-temperature plastic insulation between vertical and horizontal coils, reducing chances of cooking and simplifying servicing. Triad's new 1953 Catalog features 18 new items which have been added to an extensive line of TV replacements—every item designed for long trouble-free service, and to ease and speed the serviceman's job.

Write for Catalogs TR-53C and TV-53C



**TV Parts . . .
Accessories**

RCA CLOSED-CIRCUIT TV SYSTEM

A closed-circuit TV system, *TV-Eye*, that features a Vidicon camera weighing four pounds, and a compact control unit which includes a transistorized power supply, has been developed by the Engineering Products Dept., RCA Victor, RCA, Camden, N. J.

System employs a standard type receiver as a monitor and utilizes a free channel which can be tuned, it is said, without interfering with reception on other channels.

Any standard 16-mm camera type-C mount lens can be used. There are no operating controls on the camera. Control unit and camera employ standard receiver tubes except for *Vidicon*. Several systems may be connected to the same receiver with the desired picture selected by turning the receiver channel selector; the system is adaptable to audio signal by means of a kit.

* * *

REGENCY TV REMOTE CONTROL

A remote control for TV that operates on a single connecting cable has been introduced by the Regency division, Industrial Development Engineering Associates (I.D.E.A.), Indianapolis, Ind.

Remote control, it is claimed, will work with any existing TV set at any practical distance. Unit performs four major functions; selects stations, adjusts fine tuning, and controls contrast and volume.

* * *

**INTERNATIONAL RECTIFIER
SELENIUM LINE**

A line of selenium rectifiers for use in radio, TV, TV boosters, and *uhf* converters, has been announced by the International Rectifier Corp., 1521 E. Grand Ave., El Segundo, Calif.

Units are rated for 130 volts *rms* maximum input for load currents of 20, 30, 40, 50, 65, 75, 100, 150, 200, 250, 300, 350, 450 and 1,000 ma.

Rectifier shown is a RS75E, and is rated as follows: maximum input, 130 volts *rms*; maximum peak inverse, 380v; maximum output current, 75 ma. A series resistor of at least 22 ohms is recommended as a current limiter when used with a capacitive filter. Overall dimensions of this rectifier are 1" wide by 1 1/4" high by 3/4" deep and is provided with a clearance hole for a No. 8 machine screw for mounting.

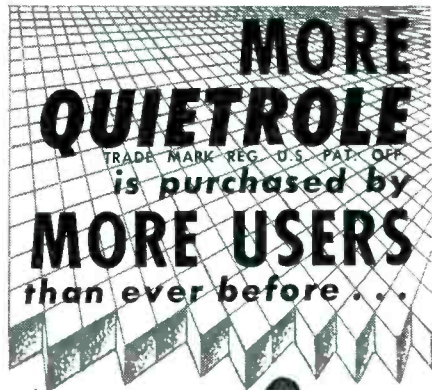
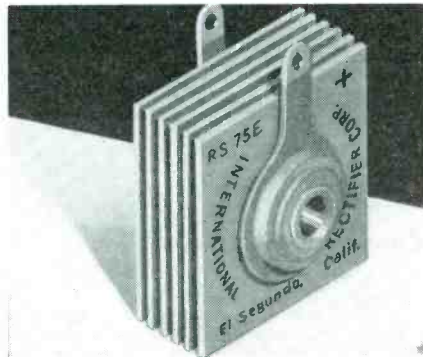

Because it does more for the user than any other product of its kind. It is the original non-conductive, non-flammable liquid that works magic on noisy TV and radio controls and switches. The choice of those who want the best, the standard since 1947. Keeps customers happy, puts money in your pocket.



Carried by leading jobbers everywhere!



manufactured by

**QUIETROL
COMPANY**

Spartanburg, South Carolina

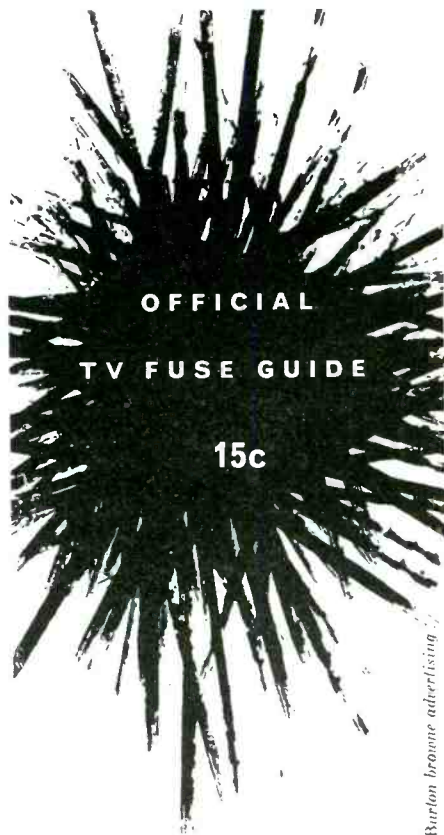

LITTELFUSE
Des Plaines, Ill.

Burton Browne Advertising

MERIT SELENIUM RECTIFIER FILAMENT TRANSFORMERS

Ten filament transformers, for use with selenium rectifier applications, have been introduced by the Merit Coil and Transformer Corp., 4427 North Clark St., Chicago 40, Ill.

Included in this group are units which match the all-purpose Federal assembly kit.

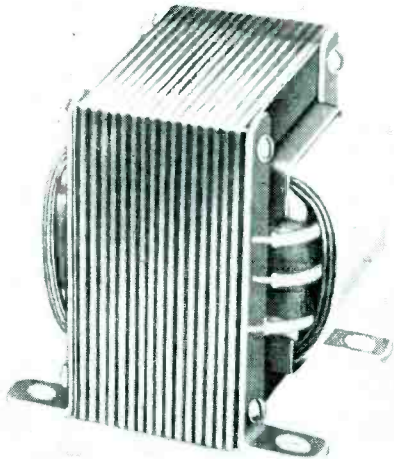

Merit Selenium Rectifier Transformer

* * *

WORKMAN B-PLUS BOOSTER AND FILAMENT RESISTOR KIT

A B-plus booster, 57174, that is said to replace the 5U4G in TV receivers to provide more height, width and gain, has been introduced by Workman TV, Inc., 306 Queen Anne Rd., Teaneck, N. J.

Unit features a built-in time delay (patent pending) that acts as a choke input.

A filament resistor replacement kit, FK2, for G. E. TV receivers, is also available. Kit consists of two temperature-sensitive filament resistors, and when used singularly or in combination, are said to replace all filament resistors used in G. E. sets.



* * *

HOBBS ADJUSTABLE TV BASE

An all-steel slide-construction TV base, X-pando, has been announced by Guy Hobbs, Inc., Dallastown, Pa.

Base, which expands from 19" to 26" in width, is available in two model sizes, one 20" deep and the other 22" deep. Has five-ply construction with five-coat mahogany and blond finish, and a metal grille in front.



Don't spoil the reflection

Your reputation as a skilled Service Man depends a great deal on your choice of replacement parts. The performance of replacement speakers reflects upon your ability and knowledge. Be sure the reflection is favorable. Specify Utah* speakers—and your customers will say "That Service Man Knows His Business!"

*All Utah speakers have exclusive Utah Universal Angle Mounting.

FREE . . . WRITE TODAY FOR THE NEW UTAH REPLACEMENT SPEAKER CATALOG S201

Export Dept. Rocke International Corporation, N. Y. C.



RADIO PRODUCTS CO., INC.
HUNTINGTON, INDIANA

A WHOLLY OWNED SUBSIDIARY OF NEWPORT STEEL CORPORATION

TRANSVISION COIN-TV CHASSIS

A coin-TV chassis, C-1, featuring a free viewer device, has been introduced by Transvision, Inc., Inc., New Rochelle, N. Y.

Model employs 26 tubes with an over-size chassis on straight ac operation, and uses a 17" rectangular picture tube. Twenty-five cent coin boxes provide a half-hour viewing. Free-viewer device permits a teaser view of program for a few minutes at beginning, shutting off automatically if no coin is inserted.

For hospital use, sets have rubber casters and separate pullout remote control boxes.

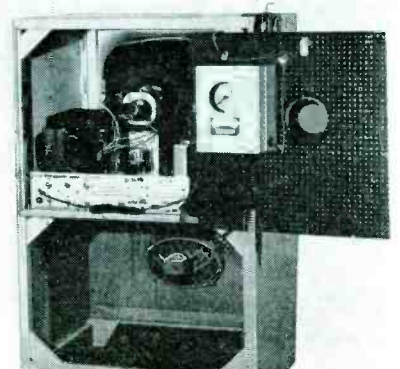

Right: Transvision Coin TV Chassis



be an expert on AUTO RADIO SERVICING!

Get the only authoritative compilation of its kind—complete Auto Radio Service Data coverage of all important models since 1946—in 3 great PHOTOFACT Manuals! All data complete, accurate, uniform—based on lab analysis of the actual auto radios covered. Helps you service any model quicker, easier—for greater profits. Get the complete Library!



VOL. 1. AUTO RADIO SERVICE MANUAL

Covers over 100 models made from 1946 to 1949 by 24 manufacturers. Each receiver is completely covered in uniform format; includes schematics, chassis photo views, replacement parts data, service hints, etc. All data based on actual lab analysis. 396 pages, 8½ x 11".

ORDER AR-1. Only \$4.95



VOL. 2. AUTO RADIO SERVICE MANUAL

Covers 60 different chassis (40 models) used in 1948, 1949 and 1950 auto radio receivers. Authoritative, complete service data that makes your work quicker, easier and more profitable. 288 pages, 8½ x 11".

ORDER AR-2. Only \$3.00



VOL. 3. AUTO RADIO SERVICE MANUAL

Covers 47 different chassis (80 models) used in 1950, 1951 and 1952 auto radio receivers. Absolutely the most complete, accurate and easy-to-use data available—uniform and practically presented to make you an expert on the repair of any auto radio. 288 pages, 8½ x 11".

ORDER AR-3. Only \$3.00



SPECIAL OFFER!

All 3 Volumes, Yours for Only \$9.95
Save on the Complete Library—
see your PHOTOFACT Distributor

HOWARD W. SAMS & CO., INC.

Order from your Parts Jobber today, or write direct to HOWARD W. SAMS & CO., Inc. 2207 E. 46th Street, Indianapolis 5, Ind.

My (check) (money order) for \$. . . encl. Send:

AR-1 \$4.95 AR-2 \$3.00 AR-3 \$3.00
 Complete 3-Volume Library \$9.95

Name

Address

City..... State.....

RCA SERVI-CHEST

A carrying case, *Servi-chest*, designed to accommodate parts, tools, and test equipment required on house calls, has been announced by the tube department of RCA Victor Division, RCA, Harrison, New Jersey.

Kit is offered to radio and TV Service Men, under a three-month sales promotion program (June 1-August 1), with purchase of 750 RCA receiving tubes or RCA television picture tubes. Chest measures 13½" high, 9" deep, and 18¼" wide. Constructed with a wood frame, strengthened in each corner with metal braces, and covered with leatherette. Included is a service mirror which features a working surface measuring 11" by 16". Internal construction includes separate compartments for soldering gun, *vtvm* and servicing tools; three separate drawers for storing resistors, capacitors and spare parts; and a utility drawer for probes, flashlight, larger tools and parts.

A silver token will be given with each purchase of 25 receiving tubes or one picture tube. Each token will bear the identification number of the distributor, who will exchange a *Servi-chest* for 30 tokens bearing his number when presented.

* * *

COOPER ALL-STEEL WORK TABLES

A line of heavy-duty steel work tables, with reinforced steel in-channel formation heavy, heingorced steel panels. Drawers, introduced by Cooper Industries, 4953 West Fullerton Ave., Chicago, Ill.

Tops are all-steel with ¼" masonite hard surface, which is cement bonded to heavy, reinforced steel panels. Drawers, ledges, risers and shelves are also available. There are 20 stock sizes ranging 4', 5', 6', and 8' long with widths in multiples of 6"; heights of 30" and 35" with 2¾" leg adjustment. Tables may be set end to end to form a continuous working surface, and may be dismantled, and the legs removed for storage. All tables are finished in baked-on olive green enamel.

* * *

IMPERIAL UHF OPEN LEADIN

Open transmission line, for both *uhf* and *vhf* installations, has been announced by Imperial Radar and Wire Corp., 4342 Bronx Blvd., New York 66, N. Y.

Leadin, with nominal impedance of 250-275 ohms, and available with either 4½" or 6" spacing, is said to have a .35 db dry-line loss in 100' at 500 mc. Line consists of 2 No. 18 gauge 30%-40% copper-weld wires supported by polystyrene spacers. Wire is also available with formvar coating, in 100' and 250'spools.

FREE! U.H.F. and "THE VERSATILE CRYSTAL PROBE"

Solve your U. H. F. ANTENNA PLACEMENT and ORIENTATION problems the easy way!

Get maximum picture strength - eliminate ghosts - no more roof-top shouting - no expensive field strength meters needed!
ONE MAN CAN DO IT!

Write for FREE bulletin today and other information about KLIPZON products.

UNITED TECHNICAL LABORATORIES
207 LITTLETON RD. ★ MORRISTOWN, N. J.



PERFECTION ION TRAPS

- Simplest to Install
- No Wobble
- Now Standard Equipment on All Leading TV Sets

Order today from your supplier!

PERFECTION ELECTRIC COMPANY
2635 South Wabash Ave., Chicago 16, Illinois

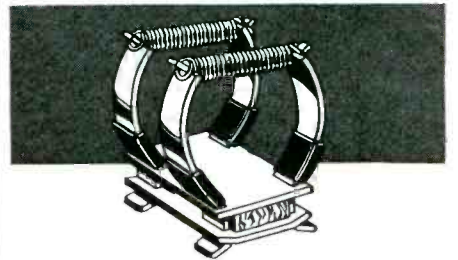

HICKOK

Model 650

VIDEO GENERATOR

Does in minutes many TV Service Jobs that normally take hours by usual methods.

Ask for a demonstration at your nearest Jobbers' . . . or write today for descriptive literature.

THE HICKOK ELECTRICAL INSTRUMENT CO.
10521 Dupont Avenue, Cleveland 8, Ohio

TV Antennas

(Continued from page 27)

kept of equal length while sharpening. If one edge varies in size, the drill will make oversized cuts. Repeated resharpenering of the drill will reduce the clearance between the carbide tip and the steel shank. When necessary, one should grind away the steel from behind the carbide tip so the steel is nowhere closer than 1/32 inch to the working surface of the carbide blank.

The drills can be sharpened on either a pedestal or bench type grinder. If the drill must be sharpened while on the job, a portable drill can be mounted on a stand and a small silicon carbide wheel used.



Display at Chicago parts show, used to introduce promotional campaign by TV Products Co., Springfield Gardens, N. Y., manufacturers of Tesco antennas. Elliot March and David Fox, Tesco owners, are shown here discussing details of the campaign with ad agency head, Ed Conti of Conti Advertising Agency, Inc.



UHF converter which features high-gain and low-noise factor. (Conpaire; Alliance)

Twin-tuned yagis peaked for channels 2 and 5. The antenna, featuring a transformer-type dipole, is said to have a gain of 6½ db on channel 2 and about 8 db on channel 5, for a single bay. (Model 525; Channel Master.)



(Right)

Pigmy-size two-set coupler which employs an iron-core network. (ZZ-2; RMS.)

NOW...

a three-speed
phonomotor
designed for

HIGH-FIDELITY REPRODUCTION...

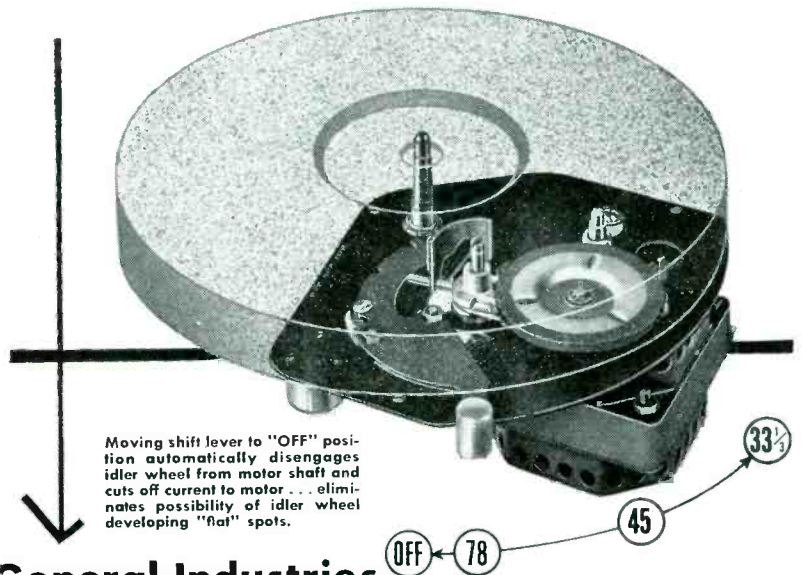

General Industries

MODEL DSS (4-pole) PHONOMOTOR

Here's a three-speed phonomotor that was designed expressly to meet the requirements of high-fidelity reproduction. From its dependable, heavy-duty 4-pole motor to its unique step-shaft speed change mechanism, this new GI Model DSS Phonomotor represents the ultimate in phonomotor engineering, design and construction.

Specifications, quantity price quotations on this or its companion, the new Model SS, with 2-pole motor, will be furnished promptly upon request.



THE GENERAL INDUSTRIES CO.
DEPARTMENT MF • ELYRIA, OHIO

UHF Surveys

(Continued from page 11)

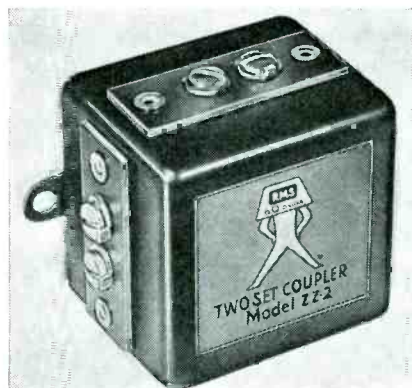

only 10', it can be considered that there will be more signal strength at the normal home installation height. This method of obtaining information is valuable in locating reduced signal areas and determining shaded areas. In Portland, the shaded area south and north of the station was defined by simply riding along and observing the picture. By this easy method it was possible to determine within a few blocks the border line between good and poor pictures.

[To Be Continued]

The **NEW JSC** Tubular Twin Lead...

The best low loss, low cost 300 ohm lead-in for UHF and VHF television.

Rain, snow, dirt or salt deposits do not materially affect impedance and electrical efficiency.

JSC tubular construction contains and protects the concentrated field of energy and reduces to a minimum high ratio signal losses.



Manufactured under license of Amphenol Pat. 2543696

JUST SEND \$1

FOR YOUR CHOICE OF THESE BARGAINS!

CRYSTAL HEARING AID MIKE..... ONLY \$1
 40 MICA CONDENSERS (Assorted)..... ONLY \$1
 45 CERAMIC CONDENSERS (Assorted)... ONLY \$1
 75 RESISTORS (Assorted) ONLY \$1

Send check or money order
 WE PAY POSTAGE

PHILIP GLICK & CO.
 256 GREENWICH ST.
 NEW YORK 7, N. Y.

NOW! SEE THE

Scala

VOLTAGE DOUBLER PROBE (BZ-4)

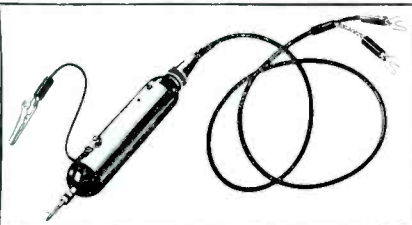

No probe marketed in this price field offers a range anywhere near the range of the BZ-4..... \$10.75

Check with your distributor about the BZ-4 and other Scala Probes:

BZ-1 Signal Tracing Probe.....	\$9.75
BZ-2 Low Capacity Probe.....	\$9.75
BZ-3 100:1 Voltage Divider.....	\$9.75

SCALA RADIO CO. 2814 19th St., San Francisco 10

NEW

Mueller

INSULATOR



for "60 Series" ALLIGATOR CLIPS!

No. 62 Flexible Vinylite Insulator in

Red and Black Specially designed to fit Mueller Alligator Clips Nos. 60S, 60-CS and 60

AVAILABLE NOW!

Here for the first time is an insulator which will completely cover and insulate the popular Mueller Alligator Clip leaving only the nose of the jaw exposed.

SEND FOR SAMPLES & CATALOG 810 CLIP SPECIALISTS SINCE 1908

Mueller Electric Co.

1565 S. 31st St., Cleveland 14, Ohio

Clock Radios

(Continued from page 32)

replacement of inoperative rotors, open coils, and vibrator or alarm adjustments. Other mechanical defects such as out-of-time, defective frictions or switches and defective gears should be replaced by an authorized service station because of their specialized knowledge and experience.

Various manufacturers occasionally supply their own appearance items such as crystals, bezels and knobs. These items are not available through authorized service stations. These specialty items usually can be secured directly from distributors or the manufacturer of the clock-radio combinations.

Typical repairs which can be performed by Service Men are illustrated in Figs. 3 and 4; these views show the re-

(Right)

Fig. 3. (a)—Screwdriver pointing to rotor, which runs timer. (b)—Removing two screws to remove the rotor. (c)—Lifting out rotor, field and coil assembly in one piece. (d)—Pressing with thumb on neck of rotor which will permit it to slip out smoothly and easily from the field. (e)—Disassembled field and coil assembly at left; the rotor that runs the timer is at right. Occasionally oil will leak out, or wears sets in and it becomes necessary to replace rotor. (Courtesy Telechron)

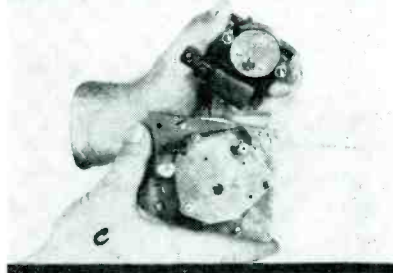
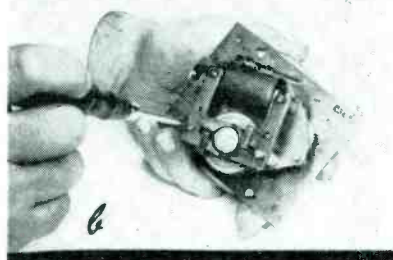
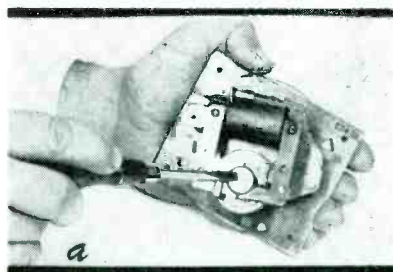



TUNG-SOL statistical quality control methods produce the industry's most reliable tubes for all uses.

Tung-Sol makes: All-Glass Sealed Beam Lamps, Miniature Lamps, Signal Flashers, Picture Tubes, Radio, TV and Special Purpose Electron Tubes.

TUNG-SOL ELECTRIC INC.
Newark 4, N. J.

Sales Offices: Atlanta, Chicago,
Culver City (Los Angeles),
Dallas, Denver, Detroit, Newark

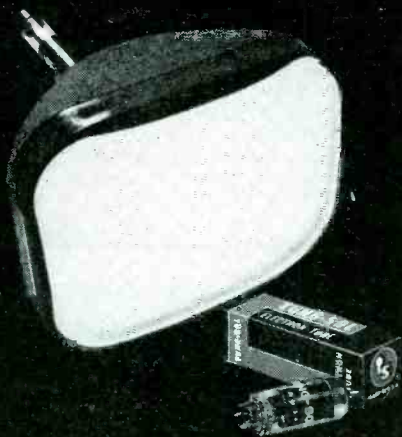

TUNG-SOL
RADIO, TV TUBES, DIAL LAMPS

placement of a rotor unit and vibrator adjustment after the timer has been removed from the radio cabinet.

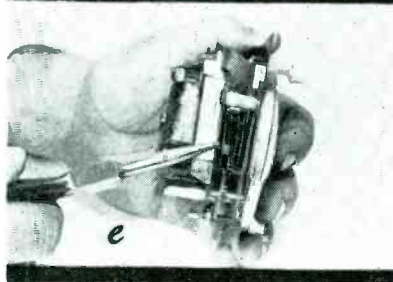
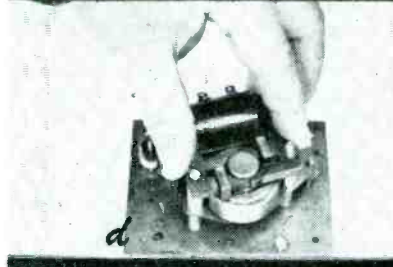
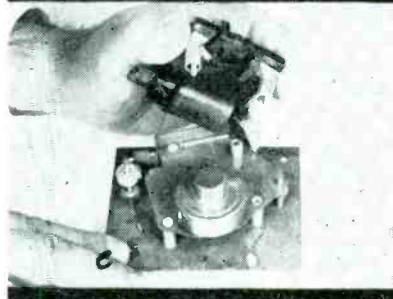
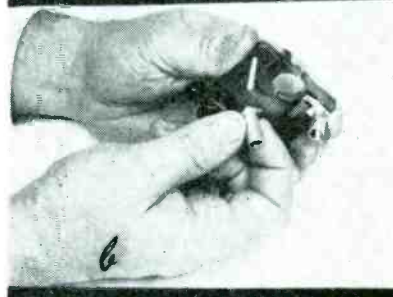
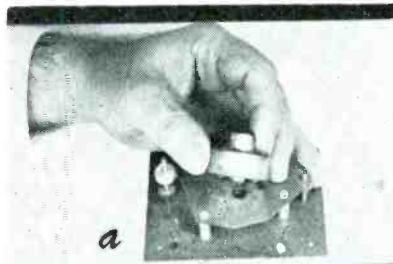
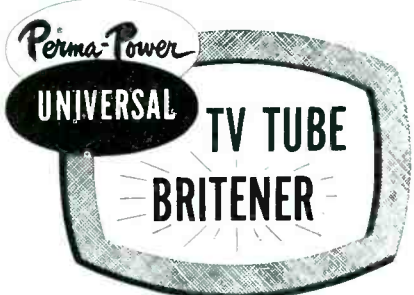

Fig. 4: (a)—Fitting the rotor in position on the movement base plate. The gears must mesh first. If not done this way gears will jam up and the timer will fail to run. (b)—Aluminum spacers used to hold the field in the correct position. (c)—Fitting the field down over the rotor, holding aluminum spacers with fingers, so they won't slip off. (d)—Pressing into position and completing job by replacing holding screws. (e)—Alarm adjustment. Long nosed pliers should be placed on the horizontal flat of the vibrator for adjustment; the field should then be energized. Bending the vibrator slightly up or down will increase or decrease the tone to the proper sound. (Courtesy Telechron).

Perma-Power
merchandise
sells!



Our Newest
Catalog is
Now Available



Here is Engineering
at its Peak!

- IT'S PARALLEL!
- IT'S SERIES!
- IT'S ISOLATION!
- IT'S ELECTROSTATIC!
- IT'S UNIVERSAL!

List Price
\$4.45

Sold Through Better Jobbers

manufactured by
Perma-Power COMPANY
Chicago 25, Ill.
Manufacturers of Electronic Equipment Since 1928

Industrial
Television Inc.

TECHNI-TOPICS

By W. TYMINSKI

THE USE OF THE IT-126A TENNA-COUPLER IN VHF-UHF INSTALLATIONS

Contrary to the advertising claims made by some major television receiver manufacturers, the modification of a VHF receiver to receive UHF signals cannot be accomplished satisfactorily by an untrained set owner through the mere addition of a UHF converter, tuner or turret strips. In some cases, through a happy set of coincidences, a satisfactory UHF signal may be received; but in most cases a UHF antenna must be installed by technically trained personnel.

The addition of a UHF antenna to an existing VHF installation introduces the problem of an additional transmission line for UHF, or the use of an antenna coupler at the mast and a single transmission line. At the receiver another antenna coupler is often found necessary.

The IT-126A Tenna-Coupler is a printed circuit low-pass and high-pass filter housed in a case designed for mounting directly at the receiver. The filter circuit configuration was chosen over tuned circuit arrangements because of the more constant impedance match obtainable in the pass band. Because outside couplers are subject to heat, cold, rain, snow, high humidity, salt spray, smoke, etc., the use of an outdoor coupler should be avoided if possible. The indoor mounting eliminates the possibility of variable reception due to the weather conditions, and replacement due to weathering of the unit is also avoided.

SOME APPLICATIONS OF THE IT-126A TENNA-COUPLER ARE:

1. To combine UHF and VHF transmission lines into a single common input as found on receivers using turret tuners for both VHF and UHF reception.
2. To separate UHF and VHF signals from a common transmission line into the individual inputs encountered when separate UHF and VHF tuning units are employed.
3. To separate and combine when a VHF or UHF booster is to be used in a common transmission line feeding a single VHF-UHF input.
4. As a high-pass filter preceding a UHF tuner or converter to suppress strong VHF signals and eliminate intermodulation and beats.
5. As a low-pass filter following a UHF converter to suppress the UHF local oscillator at the VHF terminals and thus eliminate possible spurious signals.

For additional copies of this and earlier issues of *Techni-Topics*, catalog sheets on all ITI products and free sample of *Tenna-Clip*, write, on your letterhead, to Industrial Television, Inc.

Industrial Television, Inc.

369 LEXINGTON AVENUE CLIFTON, N. J.
GRegory 3-0900

JOTS AND FLASHES

THE THREE-D and panoramic dimensional screen vogue fashioned by Hollywood has become quite a factor in the TV world, too. Set producers have begun to market chassis which will offer, they say, pictures with real depth. Receivers of one manufacturer will feature *deep dimensional* viewing, and another *ultra-vision*. In most instances picture detail has been improved to provide an illusion of depth. This has been done through an increase in bandwidth to 3.75 mc or more, use of mirror-back picture tubes and also transit time modifications. Analyses of receivers featuring these developments will appear soon in *SERVICE*. . . . 40,000 copies of a *How's Your Business?* questionnaire have been mailed to Service Men in every major television area in the country by the tube replacement division of G. E. According to *John T. Thompson*, manager of the division, the survey will give individuals a *bench mark* by which they can better evaluate their own operation. . . . *Glen McDaniel*, who served as the first paid president of RTMA has been elected temporary president pending the selection of another full time paid president. He also will continue as general counsel of the Association. . . . The RTMA board of directors also elected *Robert C. Sprague*, as chairman of the RTMA board for the next fiscal year. . . . The RCA Victor Division will begin construction soon of a new 150,000 square foot plant at Findlay, Ohio, for the manufacture of parts for radio and TV home receivers. . . . *Bruce Burlingame*, founder of Burlingame Associates, died recently. . . . *B. Michael Treman* has become president of Treman Electronics and Manufacturing Corp., Main and Brooklyn Sts., New Cassel, L. Is., N. Y. . . . Jersey Specialty Company Inc., Little Falls, N. J. has announced that it has been granted a license to manufacture 300-ohm twin tubular lead under Amphenol patent 2543969. Peter Hagedoorn, president of JSC, predicts that this license will enable his company to increase its transmission cable production to 5-million feet each week. . . . *Howard Levy*, formerly sales manager of Oak Ridge Products, is now with Land-C-Air Sales Co., 42 Oak Avenue, Tuckahoe, New York. . . . *Eugene W. Ritter*, vice president of Westinghouse Electric, in charge of the electronic tube division, has been elected to the board of trustees of Elmira College. . . . *Donald E. King* has been appointed district sales manager for G. E. communications equipment, with headquarters at 110 N. Illinois St., Indianapolis. . . . *Charles H. Caine*, Cornell Dubilier vice-president in charge of midwest sales, died recently. . . . The cathode-ray tube division, Allen B. Du Mont Laboratories, Inc., has set up a stock of replacement type picture tubes at its Chicago warehouse.

DU MONT HONORED

Dr. Allen B. Du Mont (center), president of Allen B. Du Mont Laboratories, Inc., receiving award for distinguished service to the American people in the field of communications from H. Gregory Shea, at annual dinner of New York Chapter of New York State Society of Professional Engineers. At right, Rodney D. Chipp, director of engineering of Du Mont television network.

ADVERTISERS IN SERVICE

JULY, 1953

Aerovox Corp.	38
American Microphone Co.	45
American Phenolic Corp.	10, 11
American Television & Radio Co.	36
Astron Corp.	1
Atlas Sound Corp.	42
Belden Mfg. Co.	7
Bussmann Mfg. Co.	8
CBS-Hytron Div. Columbia Broadcasting System	33
Centralab Div. Globe-Union, Inc.	13
Channel Master Corp.	25
Chemical Electronic Engineering Co.	41
Delco Radio Div. General Motors Corp.	9
Electro Products Labs.	2
Federal Telephone & Radio Corp.	12
Foster TV	29
The General Industries Co.	53
General Instrument & Appliance Corp.	40
Philip Glick & Co.	54
The Heath Co.	48
Hickok Electrical Instrument Co.	52
Industrial Television, Inc.	56
JFD Mfg. Co., Inc.	41
Jackson Electrical Instrument Co.	39
Jensen Industries, Inc.	45
Jersey Specialty Co.	54
Kester Solder Co.	46
Littelfuse, Inc.	50
The MacMillan Co.	42
P. R. Mallory & Co., Inc. Inside Back Cover	
Mueller Electric Co.	54
New London Instrument Co.	46
Perfection Electric Co.	52
Perma-Power Co.	55
Planet Mfg. Corp.	44
Precision Apparatus Co., Inc.	35
Quietrole Co.	50
Rad-E-Co Mfg. Co.	43
The Radiart Corp. Inside Front Cover	
Radio Corporation of America	5, 23, 31, Back Cover
The Rauland Corp.	3
Raytheon Mfg. Co.	14
John F. Rider Publisher, Inc.	37
Howard W. Sams & Co., Inc.	52
Scala Radio Co.	54
Skyline Mfg. Co.	38
South River Metal Products Co.	45
Sprague Products Co.	29
Sylvania Electric Products Inc.	6
T. V. Products Co., Inc.	16
Tallen Co., Inc.	42
Technical Appliance Corp.	44
Television Hardware Mfg. Co. Div.	
General Cement Mfg. Co.	4
Triad Transformer Mfg. Co.	50
Triplett Electrical Instrument Co.	19
Tung-Sol Electric Inc.	55
United Technical Labs.	52
Utah Radio Products Co., Inc.	51
V-M Corporation	49
Vidaire, Inc.	41
Waldom Electronics, Inc.	38
Wincharger Corp.	48
Workman TV, Inc.	47



Depend on Mallory
for
Approved Precision Quality

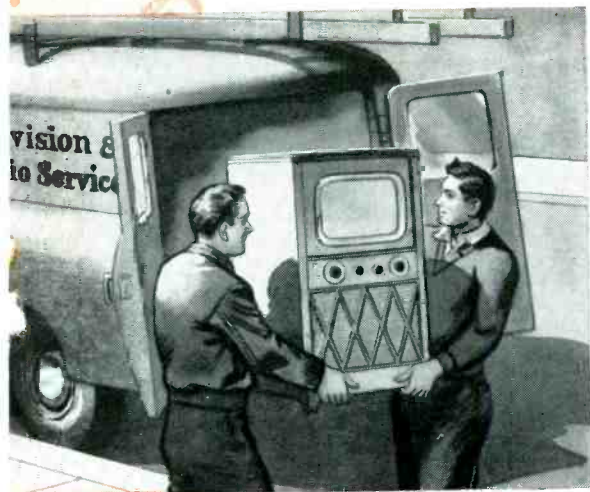

This Service Job Will Stay "Sold"!

For good reason, too. Mallory FP capacitors were used. They are engineered to duplicate the electrical characteristics of the original part in any TV or radio set that comes into your shop. They will give performance that's equal to . . . and often better than . . . the original equipment. You can count on Mallory FP's for precision quality . . . no call-backs.



Mallory FP's are the only fabricated plate capacitors available to the replacement market. They'll give you long lasting performance at high temperatures and greater ripple currents . . . even at 185° F. (85° C.).



When you use Mallory FP capacitors for all your service work, you can be sure that every job is right the first time. It just doesn't pay to take chances on capacitor performance. Always specify *brand* as well as rating when you order . . . ask for Mallory and watch your call-backs fall away to nothing. It costs no more to be sure with Mallory.

For plastic tubular replacements, ask your distributor for Mallory Plascaps®. They will put an end to premature shorts . . . leakage . . . off center cartridges . . . and unsoldered leads.

P. R. MALLORY & CO. Inc.
MALLORY

CAPACITORS • CONTROLS • VIBRATORS • SWITCHES • RESISTORS
• RECTIFIERS • VIBRAPACK® POWER SUPPLIES • FILTERS
*Reg. U. S. Pat. Off.

APPROVED PRECISION PRODUCTS

P. R. MALLORY & CO. Inc., INDIANAPOLIS 6, INDIANA

MAIL
1951
serviceman's

"best friend" is an RCA Tube

An RCA Tube starts working for you from the instant the customer first sees the familiar red, black, and white carton. You have her confidence from the start, because she knows and respects the RCA trademark.

But the big payoff to you begins when the tube goes to work. For, experience has proven that the superior quality of RCA Receiving Tubes and Kinescopes is your best measure of protection against premature tube failures. With RCA Tubes, you can be sure the job is well done.

Helping you to safeguard your reputation is a vital, everyday service of RCA Tubes. And that protection is yours at no extra cost.



UNLOCK
THE DOOR TO
BIGGER
PROFITS

Here's *your* key to better business... RCA's dynamic Dealer Identification Program. Ask your **RCA Tube Distributor** for your copy of the colorful, 16-page booklet "A Magic Pass-Key to Customer Confidence." It tells you how you can become a Registered Dealer... and get *extra* sales benefits.



RADIO CORPORATION of AMERICA
ELECTRON TUBES

HARRISON, N. J.