

electronics today

ISSN. 0142-7229

INTERNATIONAL

JANUARY 1981 60p

**ELECTRONICS IN
PHOTOGRAPHY**
an in-camera examination

**High-Quality
FM Tuner
Project**

**Universal
Digital
Tacho**

**Computer
Interface—
Micro to
Mainframe!**

**Astable
Design—
A Fresh
Approach**

**OVER
20
CIRCUITS
TO BUILD
INSIDE!**



...NEWS... PROJECTS... MICRO...

8K ON BOARD MEMORY!

5K RAM, 3K ROM or 4K RAM, 4K ROM (link selectable). Kit supplied with 3K RAM, 3K ROM. System expandable for up to 32K memory.

2 KEYBOARDS!

56 Key alphanumeric keyboard for entering high level language plus 16 key Hex pad for easy entry of machine code.

GRAPHICS!

64 character graphics option — includes transistor symbols! Only £18.20 extra!

MEMORY MAPPED

high resolution VDU circuitry using discrete TTL for extra flexibility. Has its own 2K memory to give 32 lines for 64 characters.

KANSAS CITY

low error rate tape interface.

PSI comp 80

Z80 Based powerful scientific computer design as published in **WIRELESS WORLD**

Cabinet size 19.0"x15.7"x3.3".

Television not included in price.

The kit for this outstandingly practical design by John Adams published in a series of articles in *Wireless World* really is complete. Included in the PSICOMP 80 scientific computer kit is a professionally finished cabinet, fibre-glass double sided, plated-through-hole printed circuit board. 2 keyboards PCB mounted for ease of construction, IC sockets, high reliability metal oxide resistors, power supply using custom designed toroidal transformer. 2K Basic and 1K monitor in EPROMS and, of course, wire, nuts, bolts, etc.

KIT ALSO AVAILABLE AS SEPARATE PACKS

For those customers who wish to spread their purchase or build a personalised system the kit is available as separate packs eg. PCB (16" x 12.5") £43.20. Pair of keyboards £34.80. Firmware in EPROMS £30.00. Toroidal transformer and power supply components £17.60. Cabinet (very rugged, made from steel, really beautifully finished) £26.50. P.S. Will greatly enhance any other single board computer including OHIO SUPERBOARD for which it can be readily modified. Other packs listed in our FREE CATALOGUE.

PSI COMP 80 Memory Expansion System

Expansion up to 32K all inside the computer's own cabinet!

By carefully thought out engineering a mother board with buffers and its own power supply (powered by the computer's transformer) enables up to 3 8K RAM or 8K ROM boards to be fitted neatly inside the computer cabinet. Connections to the mother board from the main board expansion socket is made via a ribbon cable.

Mother board:

Fibre glass double sided plated through hole PCB 8.7" x 3.0" set of all components including all brackets, fixing parts and ribbon cable with socket to connect to expansion plug
£39.90

8K Static RAM board

Fibre glass double sided plated through hole PCB 5.6" x 4.8" **£12.50**
Set of components including IC sockets, plug and socket but excluding RAMs **£11.20**
2114L RAM (16 required) **£5.00**
Complete set of board, components, 16 RAMS **£89.50**

8K ROM board

Fibre glass double sided plated through hole PCB 5.6" x 4.8" **£12.40**
Set of components including IC sockets, plug and socket but excluding ROMs **£10.70**
2708 ROM (8 required) **£6.00**
Complete set of board, components, 8 ROMs **£68.50**



2 MICROPROCESSORS

Z80 the powerful CPU with 15B instruction, including all 7B of the 8080, controls the MM57109 number cruncher. Functions include +, -, ., /, squares, roots, logs, exponentially trig functions, inverses etc. Range 10⁻²⁰ to 9 x 19²⁰ to 8 figures plus 2 exponent digits.

EFFICIENT OPERATION

Why waste valuable memory on sub routines for numeric processing? The number cruncher handles everything internally!

RESIDENT BASIC

with extended mathematical capability. Only 2K memory used but more powerful than most 8K Basics!

1K MONITOR

resident in EPROM.

SINGLE BOARD DESIGN

Even keyboards and power supply circuitry on the superb quality double sided plated through-hole PCB.

**COMPLETE KIT
NOW ONLY
£225 + VAT**

★ ETI VOCODER ★



Panel size 19.0" x 5.25". Depth 12.2".

**14 CHANNELS!
NOISE GENERATOR!
LED PPM METERS!
SLEW RATE CONTROL!**

**2 OSCILLATORS!
VOICED/UNVOICED
DETECTOR!**

COMPLETE KIT ONLY £195 + VAT

Kit includes FREE foot control and test oscillator!

Like all our kits the ETI VOCODER really is complete — fully finished metal work, professional quality components (all resistors 2% metal oxide), nuts, bolts, etc. — even a 13A plug! Kits also available as separate packs — See our Free Catalogue.

POWERTRAN

**OUR CATALOGUE IS FREE! WRITE OR PHONE NOW!
POWERTRAN ELECTRONICS**

PORTWAY INDUSTRIAL ESTATE
ANDOVER, HANTS SP10 3NM

ANDOVER
(STD 0264) 64455

PRICE STABILITY: Order with confidence. In respect of any price changes we will honour in this advertisement until February 28th, 1981. If this month's advertisement is mentioned with your order. Errors and VAT rate changes excluded.
EXPORT ORDERS: No VAT. Postage charged at actual cost plus £1 handling and documentation.
U.K. ORDERS: Subject to 18% surcharge for VAT. No charge is made for carriage, or at current rate if changed.

SECURICOR DELIVERY: For this optional service (U.K. mainland only) add £2.50 (VAT inclusive) per kit.
SALES COUNTER: If you prefer to collect kit from the factory, call at Sales Counter, 9 a.m. - 12 noon, 1-4.30 p.m. Monday-Thursday.

MANY MORE KITS ON PAGE 8

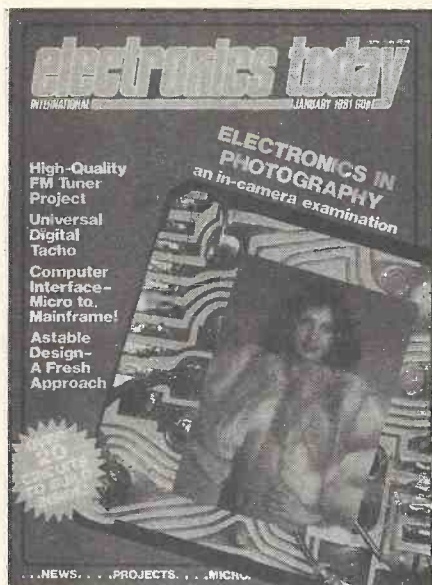

Watch the birdie p.88

electronics today

JANUARY 1981 VOL 10 NO 1 INTERNATIONAL

FEATURES

- DIGEST 9 New news is good news
- MICROBASICS 17 Monitoring programs
- SPOT DESIGNS 27 And a couple of other spots
- AUDIOPHILE 29 Sound seasonal ideas
- I/O INTERFACE 43 Computer talk
- ASTROLOGUE 54 Win The Spaceflight Directory
- READERS SURVEY 57 Audience participation
- DESIGNER'S NOTEBOOK 72 555 astables
- SLR ELECTRONICS 88 Watch the LED birdie
- TECH TIPS 96 Circuits from your very own selves
- ELECTRONICS TOMORROW 102 See-SAW filters

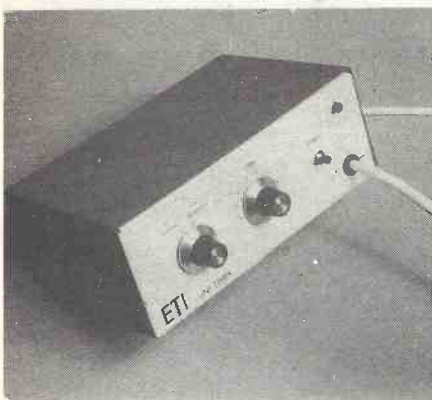

Once upon a time p.36

PROJECTS

- MULTI-OPTION SIREN 22 Noises and infinitum
- UNIVERSAL TIMER 36 Seconds out
- LED TACHO 49 Light up your revs
- AUDIOPHILE FM TUNER 62 Spot the tuning
- POLYSYNTH 77 The makings of a motherboard
- FOIL PATTERNS 110 Rub down foils

INFORMATION

- NEXT MONTH'S ETI 15 What's in February
- BINDERS 19 Issue protection
- ETIPRINTS 109 Rubbing down PCBs
- COME AND JOIN US 112 Calling all camera operators



Spot the tuning p.62



The hi-fi supermarket p.29

EDITORIAL AND ADVERTISEMENT OFFICE

145 Charing Cross Road, London WC2H 0EE. Telephone 01-437 1002/3/4/5

Ron Harris B.Sc. Editor
 Ian Graham B.Sc. Assistant Editor
 Tina Boylan Editorial Assistant
 Paul Wilson-Patterson Group Art Editor
 Paul Edwards Drawing Office Manager
 Ray Marston Project Editor
 Christopher Sargenor Group Advertisement Manager
 Steven Rowe Advertisement Manager
 Roy Perryment Advertisement Representative
 T.J. Connell Managing Director

OVERSEAS EDITIONS and their EDITORS
 AUSTRALIA - Roger Harrison
 CANADA - Halvor Moorshead
 GERMANY - Udo Wittig
 HOLLAND - Anton Kriegsmann



Member of the Audit Bureau of Circulation



PUBLISHED BY Modmags Ltd, 145 Charing Cross Road, WC2
 DISTRIBUTED BY Argus Press Sales & Distribution Ltd, 12-18 Paul Street, London (British Isles)
 Gordon & Gotch Ltd (Overseas)
 PRINTED BY QB Limited, Colchester
 COVERS PRINTED BY Alabaster Passmore

Electronics Today is normally published on the first Friday in the month preceding cover date. © MODMAGS LTD 1980. All material is subject to worldwide copyright protection. All reasonable care is taken in the preparation of the magazine contents, but the publishers cannot be held legally responsible for errors. Where mistakes do occur, a correction will normally be published as soon as possible afterwards. All prices and data contained in advertisements are accepted by us in good faith as correct at time of going to press. Neither the advertisers nor the publishers can be held responsible, however, for any variations affecting price or availability which may occur after the publication has closed for press. Subscription Rates UK £10 including postage. Airmail and other rates upon application to ETI Subscriptions Service, PO Box 35, Bridge Street, Hemel Hempstead, Herts.

Why the Sinclair ZX80 is Britain's best-selling

Built: £99.95

Including VAT, post and packing, free course in computing, free mains adaptor.

Kit: £79.95

Including VAT, post and packing, free course in computing.

This is the ZX80. A really powerful, full-facility computer, matching or surpassing other personal computers at several times the price. 'Personal Computer World' gave it 5 stars for 'excellent value'. Benchmark tests say it's faster than all previous personal computers.

Programmed in BASIC—the world's most popular language—the ZX80 is suitable for beginners and experts alike. And response from enthusiasts has been tremendous—over 20,000 ZX80s have been sold so far!

Powerful ROM and BASIC interpreter

The 4K BASIC ROM offers remarkable programming advantages:

- * Unique 'one-touch' key word entry: the ZX80 eliminates a great deal of tiresome typing. Key words (RUN, PRINT, LIST, etc.) have their own single-key entry.
- * Unique syntax check. A cursor identifies errors immediately.
- * Excellent string-handling capability—takes up to 26 string variables of any length. All strings can undergo all relational tests (e.g. comparison).
- * Up to 26 single dimension arrays.
- * FOR/NEXT loops nested up to 26.
- * Variable names of any length.
- * BASIC language also handles full Boolean arithmetic, condition expressions, etc.
- * Randomise function, useful for games and secret codes, as well as more serious applications.
- * Timer under program control.
- * PEEK and POKE enable entry of machine code instructions.
- * High-resolution graphics.
- * Lines of unlimited length.

Unique RAM

The ZX80's 1K-BYTE RAM is the equivalent of up to 4K BYTES in a conventional computer—typically storing 100 lines of BASIC.

No other personal computer offers this unique combination of high capability and low price.



The ZX80 as a family learning aid. Children of 10 years and upwards are quick to understand the principles of computing—and enjoy their personal computer.

The Sinclair teach-yourself BASIC manual

If the specifications of the Sinclair ZX80 mean little to you—don't worry. They're all explained in the specially-written 128-page book (free with every ZX80). The book makes learning easy, exciting and enjoyable, and represents a complete course in BASIC programming—from first principles to complex programs.

Kit or built—it's up to you

In kit form, the ZX80 is pleasantly easy to assemble, using a fine-tipped soldering iron. And you may already have a suitable mains adaptor—600 mA at 9V DC nominal unregulated. If not, see the coupon.

Both kit and built versions come complete with all necessary leads to connect to your TV (colour or black and white) and cassette recorder. Plug in and you're ready to go. (Built versions come with mains adaptor.)

personal computer.

Now available for the ZX80... New 16K-BYTE RAM pack

Massive add-on memory. Only £49.95.

The new 16K-BYTE RAM pack is a complete module designed to provide you – and your Sinclair ZX80 – with massive add-on memory. You can use it for those really long and complex programs – or as a personal database. (Yet it can cost as little as half the price of competitive add-on memory for other computers.)

For example, you could write an interactive or 'conversational' program to show people what your ZX80 can do. With 16K-BYTES of RAM, they could be talking to your computer for hours!

Or you can store a mass of data – perhaps in a fairly simple program – such as a name and address list, or a telephone directory.

And by linking a number of separate programs together into one giant, but modular, program, you can achieve the same effect as loading several programs at once.

We're also confident that it won't be long

before you can buy cassette-based software using the full 16K-BYTE RAM. So keep an eye on the personal computer magazines – and brush up your chess perhaps!

The RAM pack simply plugs into the existing expansion port on the rear of the ZX80. No wires, no soldering. It's a matter of seconds and you don't need another power supply. You can only add one RAM pack to your ZX80 – but with 16K-BYTES who could want more!

How to order

Demand for the ZX80 exceeds all other personal computers put together! So use the coupon to order today for the earliest possible delivery. All orders will be despatched in strict rotation. We'll acknowledge each order by return, and tell you exactly when your ZX80 will be delivered. If you choose not to wait, you can cancel your order immediately, and your money will be refunded at once. Again, of course, you may return your ZX80 as received within 14 days for a full refund. We want you to be satisfied beyond all doubt – and we have no doubt that you will be.

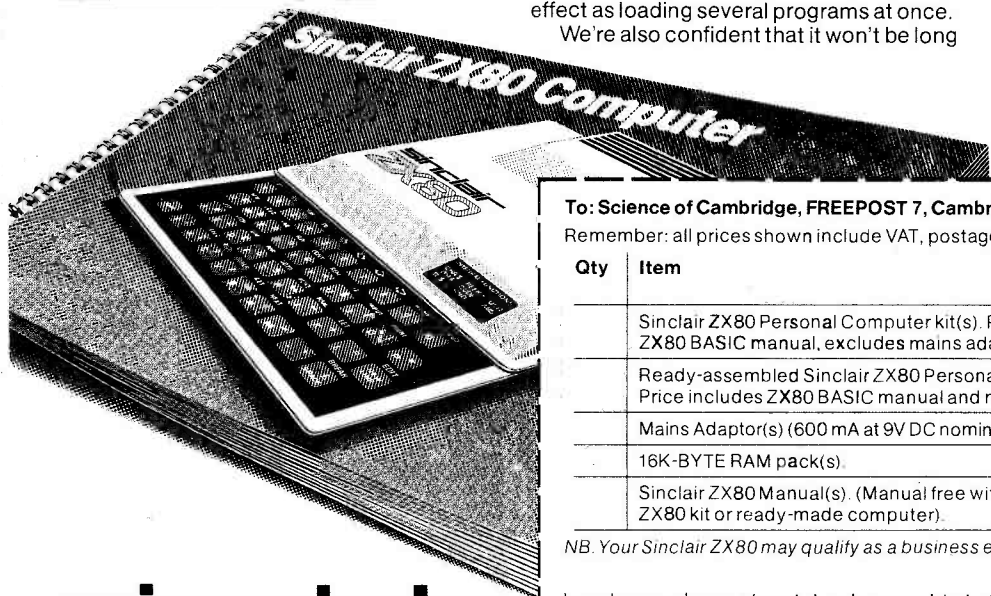
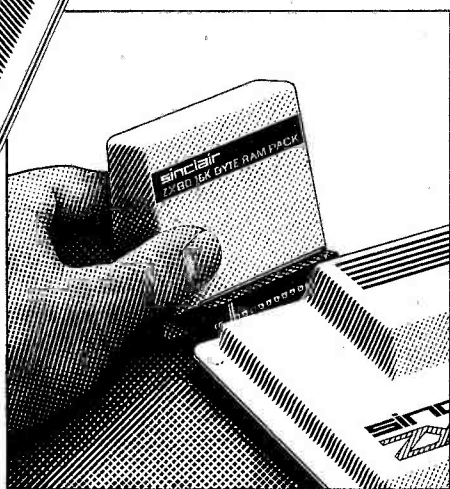

To: Science of Cambridge, FREEPOST 7, Cambridge CB2 1YY.

Remember: all prices shown include VAT, postage and packing. No hidden extras. Please send me:

Qty	Item	Code	Item price £	Total £
	Sinclair ZX80 Personal Computer kit(s). Price includes ZX80 BASIC manual, excludes mains adaptor.	02	79.95	
	Ready-assembled Sinclair ZX80 Personal Computer(s). Price includes ZX80 BASIC manual and mains adaptor.	01	99.95	
	Mains Adaptor(s) (600 mA at 9V DC nominal unregulated).	03	8.95	
	16K-BYTE RAM pack(s).	18	49.95	
	Sinclair ZX80 Manual(s). (Manual free with every ZX80 kit or ready-made computer).	06	5.00	

NB: Your Sinclair ZX80 may qualify as a business expense.

TOTAL: £

I enclose a cheque/postal order payable to Science of Cambridge Ltd for £ _____

Please print

Name: Mr/Mrs/Miss _____

Address _____

FREEPOST – no stamp needed.

ETI/1

sinclair ZX80

Science of Cambridge Ltd.

6 Kings Parade, Cambridge, Cambs., CB2 1SN.
Tel: 0223 311488.

WATFORD ELECTRONICS

33/35 CARDIFF ROAD, WATFORD, HERTS, ENGLAND
MAIL ORDER, CALLERS WELCOME
Tel. Watford (0923) 40588/9

ALL DEVICES BRAND NEW, FULL SPEC. AND FULLY GUARANTEED. ORDERS DESPATCHED BY RETURN OF POST. TERMS OF BUSINESS: CASH/CHEQUE/P.O. OR BANKERS DRAFT WITH ORDER. GOVERNMENT AND EDUCATIONAL INSTITUTIONS' OFFICIAL ORDERS ACCEPTED. TRADE AND EXPORT INQUIRY WELCOME. P&P add 40p to ALL ORDERS UNDER £10. OVERSEAS ORDERS POSTAGE AT COST. AIR/SURFACE. ACCESS ORDERS WELCOME.

VAT

Export orders no VAT. Applicable to U.K. Customers only. Unless stated otherwise, all prices are exclusive of VAT. Please add 15% to all prices.

We stock thousands more items. It pays to visit us. We are situated behind Watford Football Ground. Nearest Underground/BR Station: Watford High Street. Open Monday to Saturday. Ample Free Car Parking space available.

ELECTRONIC CAPACITORS: (Values are in μF) 500V: 10 50p; 47 78p; 250V: 100 65p; 63V: 0.47 1.0 1.5 2.2 3.3 4.7 5.8 8p; 10 15 22 22p; 32 47 50 12p; 63 100 27p; 50V: 50 100 220 25p; 470 32p; 200 30p; 40V: 2 33 8p; 100 12p; 2200 33p; 85 4700 98p; 35V: 10 33 7p; 33p; 470 32p; 25V: 10 22 47 10p; 16 220 25p; 15p; 470 25p; 64 100 35p; 1500 40p; 2200 45p; 3300 77p; 4700 85p; 16V: 10 47 20p; 100 125 85p; 220 330 140p; 200 35p; 1500 1500 30p; 2200 36p; 10V: 10 22 47p; 50 12p; 100 22p.

POLYESTER CAPACITORS: Axial lead type
400V: 1nF, 1n5, 2n2, 3n3, 4n7, 6n8, 10n, 15n 9p; 18n 10p; 22n, 33n 11p; 47n, 68n 14p; 100n 17p; 150n, 220n 24p; 330n, 470n 41p; 680n 48p; 1.1 1.5 6.4p; 2.2 8.2p.

POLYESTER RADIAL LEAD CAPACITORS: 250V:
10n, 15n, 22n, 27n 6p; 33n, 47n, 68n, 100n 7p; 150n 10p; 220n, 330n 13p; 470n 17p; 680n 19p; 1.1 2.2p; 1.5 3.0p; 2.2 3.4p.

TANTALUM BEAD CAPACITORS:
35V: 0.1 0.22 0.33 0.47 0.68, 1.0, 2.2 5F, 3.3, 4.7, 25V: 10 20V 6.8 16V: 2.2 4.7, 10 15p; 16V: 2.2 28p; 47, 100 50p; 220 80p; 10V: 15p, 22p, 33 22p; 100 35p; 6V: 47, 68, 100 28p; 3V: 100 25p.

MYLAR FILM CAPACITORS:
100V: 0.001, 0.002, 0.005, 0.01 5p 0.015, 0.02, 0.04, 0.05, 0.056 7p 0.1 1.5F, 50V: 0.47 12p

CERAMIC CAPACITORS 50V:
Range: 0.5p to 10,000pF 4p
0.015pF, 0.022pF, 0.033pF 5p
0.047pF 5p, 0.1 1.5F, 0.2 2.5F 7p

SILVER MICA (Values in pF): 3, 3.3, 4.7, 8.2, 10, 12, 18, 22, 33, 47, 50, 68, 75, 82, 85, 100, 120, 150, 220, 1 1p each 250, 270, 300, 330, 360, 390, 470, 600, 800, 820 16p each 1000, 1200, 1800, 2000 26p each

POLYSTYRENE CAPACITORS:
10pF to 1nF 8p; 1.5nF to 47n 10p

MINIATURE TYPE TRIMMERS:
2.5-50pF, 3-10pF, 10-40pF 22p
5-25pF, 5-45pF, 60pF, 88pF 30p

COMPRESSION TRIMMERS:
3-40pF, 10-80pF, 25-190pF 30p
100-500pF 45p 400-1250pF 58p

GAS & SMOKE DETECTORS:
TGS 812 & 813 415p; Socket 30p

JACKSONS VARIABLE CAPACITORS:
DILCON 205p 2 x 2.365pF with slow motion Drive 450p
500pF 250p 0.0208/176 35p

RF CHOKES:
1 1/4, 4.7, 10, 22 33 47, 100 200 470 750, 1m 7.5, 5, 10 43m 10 60p each

VERO BOARD:
0.1 0.15 0.1 (aluminium clad) 30p
2 1/2 x 3 86p 50p 47p
2 1/2 x 3 75p 65p - -
3 1/4 x 5 86p 93p 72p
2 1/2 x 17 225p
3 1/4 x 17 255p 260p 210p
4 1/2 x 17 390p

VERO WIRING:
PAP + Spool 350
Spare Spool 85
Ferris Chloride 7

FERRIS CHLORIDE:
1 lb bag Anhydrous 225p - 40g 78p

ULTRASONIC TRANSDUCER:
40KHz 360p pr

COPPER CLAD BOARDS:
Fibre Single-Sided SRBP
Glass sided 5 1/2" x 8 5/8" 95p
6" x 12" 90p 110p 95p
8" x 12" 150p 195p

DIL PLUGS (Leaders):
14 pin 35p; 15 pin 40p
24 pin 85p; 40 pin 295p; available

SOLDER SOCKETS (TEXAS): Low Wire Prof. Wrap
8pin 10p 25p
14pin 12p 35p
16pin 13p 46p
18pin 16p 52p
22pin 22p 65p
22pin 25p 70p
24pin 30p 75p
28pin 35p 85p
36pin - 105p
40pin 40p 105p

EDGES CONNECTORS:
10 way - 1.156
2x10 way - 85p
2x15 way - 99p
2x18 way 115p 120p
2x22 way 130p 135p
2x25 way 148p 160p
2x28 way 170p
2x36 way 194p
2x48 way 210p
2x40 way 232p

DIL SOCKETS (TEXAS): Low Wire Prof. Wrap
8pin 10p 25p
14pin 12p 35p
16pin 13p 46p
18pin 16p 52p
22pin 22p 65p
22pin 25p 70p
24pin 30p 75p
28pin 35p 85p
36pin - 105p
40pin 40p 105p

DIAC: 20
7E SERIES: 350
12A100V 75150 140
12A200V 75150 160
12A300V 75150 160
12A400V 75150 160
12A500V 75150 160
12A600V 75150 160
12A700V 75150 160
12A800V 75150 160
12A900V 75150 160
12A1000V 75150 160
12A1100V 75150 160
12A1200V 75150 160
12A1300V 75150 160
12A1400V 75150 160
12A1500V 75150 160
12A1600V 75150 160
12A1700V 75150 160
12A1800V 75150 160
12A1900V 75150 160
12A2000V 75150 160

DIAC: 20
7E SERIES: 350
12A100V 75150 140
12A200V 75150 160
12A300V 75150 160
12A400V 75150 160
12A500V 75150 160
12A600V 75150 160
12A700V 75150 160
12A800V 75150 160
12A900V 75150 160
12A1000V 75150 160
12A1100V 75150 160
12A1200V 75150 160
12A1300V 75150 160
12A1400V 75150 160
12A1500V 75150 160
12A1600V 75150 160
12A1700V 75150 160
12A1800V 75150 160
12A1900V 75150 160
12A2000V 75150 160

DIAC: 20
7E SERIES: 350
12A100V 75150 140
12A200V 75150 160
12A300V 75150 160
12A400V 75150 160
12A500V 75150 160
12A600V 75150 160
12A700V 75150 160
12A800V 75150 160
12A900V 75150 160
12A1000V 75150 160
12A1100V 75150 160
12A1200V 75150 160
12A1300V 75150 160
12A1400V 75150 160
12A1500V 75150 160
12A1600V 75150 160
12A1700V 75150 160
12A1800V 75150 160
12A1900V 75150 160
12A2000V 75150 160

DIAC: 20
7E SERIES: 350
12A100V 75150 140
12A200V 75150 160
12A300V 75150 160
12A400V 75150 160
12A500V 75150 160
12A600V 75150 160
12A700V 75150 160
12A800V 75150 160
12A900V 75150 160
12A1000V 75150 160
12A1100V 75150 160
12A1200V 75150 160
12A1300V 75150 160
12A1400V 75150 160
12A1500V 75150 160
12A1600V 75150 160
12A1700V 75150 160
12A1800V 75150 160
12A1900V 75150 160
12A2000V 75150 160

DIAC: 20
7E SERIES: 350
12A100V 75150 140
12A200V 75150 160
12A300V 75150 160
12A400V 75150 160
12A500V 75150 160
12A600V 75150 160
12A700V 75150 160
12A800V 75150 160
12A900V 75150 160
12A1000V 75150 160
12A1100V 75150 160
12A1200V 75150 160
12A1300V 75150 160
12A1400V 75150 160
12A1500V 75150 160
12A1600V 75150 160
12A1700V 75150 160
12A1800V 75150 160
12A1900V 75150 160
12A2000V 75150 160

DIAC: 20
7E SERIES: 350
12A100V 75150 140
12A200V 75150 160
12A300V 75150 160
12A400V 75150 160
12A500V 75150 160
12A600V 75150 160
12A700V 75150 160
12A800V 75150 160
12A900V 75150 160
12A1000V 75150 160
12A1100V 75150 160
12A1200V 75150 160
12A1300V 75150 160
12A1400V 75150 160
12A1500V 75150 160
12A1600V 75150 160
12A1700V 75150 160
12A1800V 75150 160
12A1900V 75150 160
12A2000V 75150 160

DIAC: 20
7E SERIES: 350
12A100V 75150 140
12A200V 75150 160
12A300V 75150 160
12A400V 75150 160
12A500V 75150 160
12A600V 75150 160
12A700V 75150 160
12A800V 75150 160
12A900V 75150 160
12A1000V 75150 160
12A1100V 75150 160
12A1200V 75150 160
12A1300V 75150 160
12A1400V 75150 160
12A1500V 75150 160
12A1600V 75150 160
12A1700V 75150 160
12A1800V 75150 160
12A1900V 75150 160
12A2000V 75150 160

TRANSISTORS

AC125	25	BC182L	10	BF154	25	MJE360	54	TP120	90	2N2905A	26	2N5459	36
AC126	35	BC183L	10	BF155	25	MJE370	100	TP121	90	2N2906	26	2N5458	36
AC127	25	BC184L	10	BF170	27	MJE371	100	TP122	90	2N2907	26	2N5777	45
AC128	25	BC181	20	BF171	27	MJE372	100	TP141	120	2N2907A	26	2N5879	190
AC129	25	BC182	20	BF172	30	MJE373	100	TP142	120	2N2908	26	2N6207	32
AC130	25	BC183	20	BF173	30	MJE374	100	TP143	120	2N2909	26	2N6207 3/2	32
AC131	30	BC187	26	BF174	35	MJE375	100	TP144	120	2N2910	26	2N6368	150
AC132	30	BC182	10	BF180	38	MJE376	100	TP145	120	2N2911	26	2N6369	75
AC133	30	BC121	10	BF181	38	MJE377	100	TIP3055	60	2N2912	26	3N128	112
AC134	28	BC212L	10	BF182	38	MJE378	100	MPP102	66	2N2913	26	3N140	112
AC135	28	BC213	10	BF183	38	MJE379	100	MPP103	36	2N2914	26	3N155	48
AC136	28	BC214	10	BF184	38	MJE380	100	MPP104	36	2N2915	26	3N160	60
AC137	28	BC215	10	BF185	38	MJE381	100	MPP105	36	2N2916	26	3N165	60
AC138	28	BC216	10	BF186	38	MJE382	100	MPP106	36	2N2917	26	3N170	60
AC139	28	BC217	10	BF187	38	MJE383	100	MPP107	36	2N2918	26	3N175	60
AC140	28	BC218	10	BF188	38	MJE384	100	MPP108	36	2N2919	26	3N180	60
AC141	28	BC219	10	BF189	38	MJE385	100	MPP109	36	2N2920	26	3N185	60
AC142	28	BC220	10	BF190	38	MJE386	100	MPP110	36	2N2921	26	3N190	60
AC143	28	BC221	10	BF191	38	MJE387	100	MPP111	36	2N2922	26	3N195	60
AC144	28	BC222	10	BF192	38	MJE388	100	MPP112	36	2N2923	26	3N200	60
AC145	28	BC223	10	BF193	38	MJE389	100	MPP113	36	2N2924	26	3N205	60
AC146	28	BC224	10	BF194	38	MJE390	100	MPP114	36	2N2925	26	3N210	60
AC147	28	BC225	10	BF195	38	MJE391	100	MPP115	36	2N2926	26	3N215	60
AC148	28	BC226	10	BF196	38	MJE392	100	MPP116	36	2N2927	26	3N220	60
AC149	28	BC227	10	BF197	38	MJE393	100	MPP117	36	2N2928	26	3N225	60
AC150	28	BC228	10	BF198	38	MJE394	100	MPP118	36	2N2929	26	3N230	60
AC151	28	BC229	10	BF199	38	MJE395	100	MPP119	36	2N2930	26	3N235	60
AC152	28	BC230	10	BF200	38	MJE396	100	MPP120	36	2N2931	26	3N240	60
AC153	28	BC231	10	BF201	38	MJE397	100	MPP121	36	2N2932	26	3N245	60
AC154	28	BC232	10	BF202	38	MJE398	100	MPP122	36	2N2933	26	3N250	60
AC155	28	BC233	10	BF203	38	MJE399	100	MPP123	36	2N2934	26	3N255	60
AC156	28	BC234	10	BF204	38	MJE400	100	MPP124	36	2N2935	26	3N260	60
AC157	28	BC235	10	BF205	38	MJE401	100	MPP125	36	2N2936	26	3N265	60
AC158	28	BC236	10	BF206	38	MJE402	100	MPP126	36	2N2937	26	3N270	60
AC159	28	BC237	10	BF207	38	MJE403	100	MPP127	36	2N2938	26	3N275	60
AC160	28	BC238	10	BF208	38	MJE404	100	MPP128	36	2N2939	26	3N280	60
AC161	28	BC239	10	BF209	38	MJE405	100	MPP129	36	2N2940	26	3N285	60
AC162	28	BC240	10	BF210	38	MJE406	100	MPP130	36	2N2941	26	3N290	60
AC163	28	BC241	10	BF211	38	MJE407	100	MPP131	36	2N2942	26	3N295	60
AC164	28	BC242	10	BF212	38	MJE408	100	MPP132	36	2N2943	26	3N300	60
AC165	28	BC243	10	BF213	38	MJE409	100	MPP133	36	2N2944	26	3N305	60
AC166	28	BC244	10	BF214	38	MJE410	100	MPP134	36	2N2945	26	3N310	60
AC167	28	BC245	10	BF215	38	MJE411	100	MPP135	36	2N2946	26	3N315	60
AC168	28	BC246	10	BF216	38	MJE412	100	MPP136	36	2N2947	26	3N320	60
AC169	28	BC247	10	BF217	38	MJE413	100	MPP137	36	2N2948	26	3N325	60
AC170	28	BC248	10	BF218									

COMPUTER CORNER

- **SUPERBOARD II** Ready-built and tested Only £150
- **PSU 5V/3A** (for above incl. RF Modulator) £25
- **610 Expansion Board** (8K RAM) expandable to 24K £150
- **CHALLENGER 1P** (Superboard cased with PSU) £180
- **Extra 4K RAM** (8x2114) £18
- **Plastic Case Black**, fits UK101 Superboard, NASCOM II etc £25
- **SUPERPRINT 800**, 80 column High Performance Impact Printer, Ideal for PET, NASCOM, UK101, Superboard, TRS80 etc. only £325
- **VIDEO GENIE** based on TRS80. Utilises 280, 12K level II Basic 16K RAM incl. Cassette Deck £290

- **STRINGY FLOPPY**. Combines economy of Cassette with speed & reliability of DISC (incl. 20 waters) £169
- **SOFTY**. Intelligent SPROM Programmer Connects directly to TV. Develop, copy, Burn EPROMS Kit £99
- Ready-built & tested £120
- PSU for above (Built) £214
- **UHF Modulators** 6MHz 280p
- **UHF Modulators** 8MHz 450p
- **KEYPADS** 4 x 4 matrix 350p
- **Full ASCII** coded 56 Key Keyboard Mod. 756 £40
- **10x C12 Cassettes** in Rack £5.50
- (P&P is extra on all items) Call in at our shop for Demo. or write in for leaflets.

SWITCHES TOGGLE: 2A, 250V, SPST 33p DPST 34p DPDT 44p 4 pole on/off 54p SUB-MIN TOGGLE SP changeover 60p SPST on/off 54p SPDT biased off 105p DPDT 6 tags 75p DPDT centre off 88p DPDT biased off 145p Push to break 20p	SLIDE 250V: 1A DPDT 14p 1A DPDT c/over 15p 1/2A DPDT 13p 4 pole 2-way 24p PUSH BUTTON DPDT Black Body 12p Red, Blue, Grn., Yell. 14p SRL Latching 125p SRM Momentary 125p MINI. Non Locking Push to Make 15p Push Break 25p DIL SWITCHES (SPST) 4 way 85p ; 6 way 95p ; 8 way 115p	ROTARY: Make your own multiway Switch. Adjustable Stop Shifting Assembly. Accommodate up to 6 Waters 65p Mains Switch DPST to fit Break Before Make Waters. 1 pole/12 way. 2p/6 way. 3p/4 way. 4p/3 way. 6p/2 way 56p Spacer and Screen 6p ROTARY: (Adjustable Stop) 1 pole/2 to 12 way, 2p/2 to 6 way, 3 pole/2 to 4 way, 4 pole/2 to 3 way 45p ROTARY: Mains 250V AC. 4 Amp 56p 'D' CONNECTORS (Cannon type) Plugs Sockets Covers 9way 95p 128p — 15way 135p 195p 150p 25way 198p 284p 170p 37way 290p 398p 185p
---	--	--

CRYSTALS 100KHz 323 455KHz 383 1MHz 323 1.008M 395 1.28MHz 392 1.6MHz 323 1.8MHz 323 1.8432MHz 362 2.4576MHz 323 3.2768M 323 3.57954M 195 4.000MHz 290 4.032MHz 323 4.433619M 135 5.0MHz 358 5.195M 323 5.24288M 425 6.0MHz 323 6.5536M 220 7.690M 323 8.0MHz 692 8.08333M 362 8.867237M 362 9.375M 323 10.0MHz 323 10.7MHz 323 12MHz 392 14.31818M 362 18MHz 323 18.432M 323 20.0MHz 323 27.648M 323 38.8667M 350 48.0MHz 323 100.00MHz 323	TRANSFORMERS (Mains Prim. 220-240V) 6-0.6V; 9-0.9V; 12-0-12V 100mA 95p 3VA: 0-6V 0.6V (PCB mounting) 150p 8VA: 6V-5A 6V-5A; 9V-4A 9V-4A; 12V-3A 12V-3A; 15V-2.5A 15V-2.5A 215p 12V: 4.5V-1.3A 4.5V-1.3A; 6V-1.2A 6V-1.2A; 12V-0.5A 12V-0.5A; 15V-0.4A 15V-0.4A; 20V-0.3A 235p (30p p&p) 20V-3A 235p (30p p&p) 24VA: 6V-1.5A 6C-1.5A; 9V-1.3A 9V-1.3A; 12V-1A 12V-1A; 15V-8A 15V-8A; 20V-6A 20V-6A 320p (55p p&p) 50VA: 6V-4A 6V-4A; 9V-2.5A 9V-2.5A; 12V-2A 12V-2A; 15V-1.5A 15V-1.5A; 20V-1.2A 20V-1.2A; 25V-1A 25V-1A; 30V-0.8A 30V-0.8A 365p (60p p&p) 100VA: 12V-4A 12V-4A; 15V-3A 15V-3A; 20V-2.5A 20V-2.5A; 30V-1.5A 30V-1.5A; 40V-1.25A 40V-1.25A; 50V-1A 50V-1A 695p (74p p&p). (NB: p&p charge to be added above our normal postal charge.)	ALUM. BOXES WITH LID 3x2x1" 55 2 1/4x5 1/4x1 1/4" 75 4x4 1/2" 75 4x2 3/4x1 1/2" 75 4x5 1/4x1 1/2" 100 4x2 1/2x2" 80 5x4x2" 107 6x4x2" 110 7x5x2 1/2" 185 8x6x3" 185 10x7x3" 240 10x4 1/2x3" 228 12x5x3" 239 12x8x3" 275	PANEL METERS FSD 445p each 60x46x 575 35mm 575 0-50µA 675 0-100µA 675 0-500µA 675 0-1mA 675 0-5mA 675 0-10mA 675 0-50mA 675 0-100mA 675 0-500mA 675 0-1A 675 0-2A 675 0-25V 675 0-50V AC 675 0-300V AC 675 "S" 675 "VU" 675 4 1/4x3 1/4x1 1/2" 595p each
---	--	--	---

VOLTAGE REGULATORS 1A TO3 5V 7805 145p 7905 220p 7912 220p 12V 7812 145p 7912 220p 15V 7815 145p 18V 7818 145p 1A TO220 Plastic Casing 5V 7805 60p 7905 65p 12V 7812 60p 7912 65p 15V 7815 60p 7915 65p 18V 7818 60p 7918 65p 24V 7824 60p 100mA TO92 Plastic Casing 5V 78L05 30p 79L05 65p 6V 78L02 30p 9V 78L02 30p 12V 78L12 30p 79L12 65p 15V 78L15 30p 79L15 65p	OPTO LEDs with Clips TL208 Red 13 4 1/4x3 1/4x1 1/2" TL211 Grn. 17 0-50µA TL212 Yel. 18 0-100µA TL220 2" Red 14 0-500µA 2" Green, Yellow or Amber 18 7 Segment Displays TL307 123 10 Green, Yellow 30 TL312 3" CA 105 LD271 Infra Red 40 TL313 3" CC 105 SFH205 Detector 90 TL321 5" CA 115 TL32 infra Red 65 TL322 5" CC 115 TL78 Detector 75 DL704 3" CC 99 BARGRAPY Red 10 DL707 3" CA 99 segments 225 DL747 6" CA 180 LS400 255 8" Orange CA 250 OCP71 125 FND357 Red 120 ORP12 65 FND500 115 ORP61 85 3" Green CA 150 ZNS577 45 3" Green CA 150 2" Red CA 150 3" Green CA 150
--	--

ETI Projects: Parts available for: Digital Test Meter, DM90, 60W Amplifier System. Send SAE plus 5p for list.	LM300H 170p LM337 27p LM305H 140p LM723 30p LM309K 135p TAA550 50p LM317K 350p TBA6258 95p LM323K 550p TDA1412 150p LM325N 240p 78H05 + 5V 65p LM326N 240p 78H05 + 5V to +25V 85p	ISOLATORS IL74 55 DVM176 1885 TL111/2 85 LCD 3 1/2 Digits 775 TL114 95 LCD 4 Digits 875 TL117 110 LCD 6 Digits 980	<table style="width: 100%; border-collapse: collapse;"> <tr> <td style="width: 25%;">LS245</td> <td style="width: 25%;">350</td> <td style="width: 25%;">LS373</td> <td style="width: 25%;">150</td> <td style="width: 25%;">4016</td> <td style="width: 25%;">35</td> <td style="width: 25%;">4054</td> <td style="width: 25%;">130</td> <td style="width: 25%;">4175</td> <td style="width: 25%;">120</td> <td style="width: 25%;">4522</td> <td style="width: 25%;">150</td> </tr> <tr> <td>LS247</td> <td>135</td> <td>LS374</td> <td>150</td> <td>4017</td> <td>70</td> <td>4055</td> <td>130</td> <td>4194</td> <td>115</td> <td>4526</td> <td>98</td> </tr> <tr> <td>LS248</td> <td>135</td> <td>LS375</td> <td>150</td> <td>4018</td> <td>76</td> <td>4056</td> <td>135</td> <td>4408</td> <td>790</td> <td>4527</td> <td>125</td> </tr> <tr> <td>LS249</td> <td>135</td> <td>LS377</td> <td>199</td> <td>4019</td> <td>48</td> <td>4057</td> <td>2850</td> <td>4409</td> <td>790</td> <td>4528</td> <td>100</td> </tr> <tr> <td>LS251</td> <td>130</td> <td>LS378</td> <td>140</td> <td>4020</td> <td>85</td> <td>4059</td> <td>575</td> <td>4410</td> <td>750</td> <td>4529</td> <td>150</td> </tr> <tr> <td>LS253</td> <td>95</td> <td>LS379</td> <td>215</td> <td>4021</td> <td>90</td> <td>4060</td> <td>110</td> <td>4411</td> <td>950</td> <td>4530</td> <td>90</td> </tr> <tr> <td>LS257</td> <td>95</td> <td>LS384</td> <td>250</td> <td>4022</td> <td>85</td> <td>4061</td> <td>1225</td> <td>4412F</td> <td>1250</td> <td>4531</td> <td>130</td> </tr> <tr> <td>LS258</td> <td>120</td> <td>LS385</td> <td>420</td> <td>4023</td> <td>24</td> <td>4062</td> <td>995</td> <td>4412V</td> <td>1520</td> <td>4532</td> <td>120</td> </tr> <tr> <td>LS259</td> <td>160</td> <td>LS386</td> <td>85</td> <td>4024</td> <td>60</td> <td>4063</td> <td>120</td> <td>4415F</td> <td>480</td> <td>4534</td> <td>510</td> </tr> <tr> <td>LS261</td> <td>450</td> <td>LS390</td> <td>405</td> <td>4025</td> <td>24</td> <td>4066</td> <td>46</td> <td>4415V</td> <td>850</td> <td>4536</td> <td>310</td> </tr> <tr> <td>LS266</td> <td>75</td> <td>LS393</td> <td>140</td> <td>4026</td> <td>180</td> <td>4067</td> <td>430</td> <td>4419</td> <td>280</td> <td>4538</td> <td>145</td> </tr> <tr> <td>LS273</td> <td>180</td> <td>LS395</td> <td>210</td> <td>4027</td> <td>45</td> <td>4068</td> <td>26</td> <td>4422</td> <td>570</td> <td>4539</td> <td>120</td> </tr> <tr> <td>LS275</td> <td>320</td> <td>LS396</td> <td>199</td> <td>4028</td> <td>92</td> <td>4069</td> <td>22</td> <td>4432</td> <td>1050</td> <td>4541</td> <td>150</td> </tr> <tr> <td>LS279</td> <td>88</td> <td>LS398</td> <td>275</td> <td>4029</td> <td>98</td> <td>4070</td> <td>30</td> <td>4435</td> <td>850</td> <td>4543</td> <td>150</td> </tr> <tr> <td>LS280</td> <td>250</td> <td>LS399</td> <td>220</td> <td>4030</td> <td>55</td> <td>4071</td> <td>25</td> <td>4440</td> <td>999</td> <td>4549</td> <td>395</td> </tr> <tr> <td>LS283</td> <td>90</td> <td>LS445</td> <td>140</td> <td>4031</td> <td>185</td> <td>4072</td> <td>25</td> <td>4450</td> <td>350</td> <td>4553</td> <td>399</td> </tr> <tr> <td>LS290</td> <td>130</td> <td>LS447</td> <td>195</td> <td>4032</td> <td>125</td> <td>4073</td> <td>25</td> <td>4503</td> <td>65</td> <td>4564</td> <td>192</td> </tr> <tr> <td>LS293</td> <td>130</td> <td>LS490</td> <td>245</td> <td>4033</td> <td>175</td> <td>4075</td> <td>23</td> <td>4452</td> <td>350</td> <td>4555</td> <td>85</td> </tr> <tr> <td>LS295</td> <td>215</td> <td>LS668</td> <td>105</td> <td>4034</td> <td>213</td> <td>4076</td> <td>85</td> <td>4490F</td> <td>350</td> <td>4556</td> <td>60</td> </tr> <tr> <td>LS298</td> <td>215</td> <td>LS669</td> <td>105</td> <td>4035</td> <td>95</td> <td>4077</td> <td>30</td> <td>4490V</td> <td>750</td> <td>4557</td> <td>425</td> </tr> <tr> <td>LS299</td> <td>420</td> <td>LS670</td> <td>270</td> <td>4036</td> <td>275</td> <td>4078</td> <td>28</td> <td>4501</td> <td>28</td> <td>4558</td> <td>174</td> </tr> <tr> <td>LS300</td> <td>175</td> <td>LS673</td> <td>750</td> <td>4037</td> <td>115</td> <td>4081</td> <td>26</td> <td>4502</td> <td>65</td> <td>4559</td> <td>450</td> </tr> <tr> <td>LS302</td> <td>175</td> <td>LS674</td> <td>850</td> <td>4038</td> <td>110</td> <td>4082</td> <td>25</td> <td>4503</td> <td>65</td> <td>4560</td> <td>199</td> </tr> <tr> <td>LS320</td> <td>270</td> <td></td> <td></td> <td>4039</td> <td>299</td> <td>4085</td> <td>90</td> <td>4506</td> <td>75</td> <td>4561</td> <td>104</td> </tr> <tr> <td>LS323</td> <td>460</td> <td></td> <td></td> <td>4040</td> <td>85</td> <td>4086</td> <td>90</td> <td>4507</td> <td>48</td> <td>4562</td> <td>525</td> </tr> <tr> <td>LS324</td> <td>200</td> <td></td> <td></td> <td>4041</td> <td>80</td> <td>4089</td> <td>150</td> <td>4508</td> <td>325</td> <td>4566</td> <td>195</td> </tr> <tr> <td>LS325</td> <td>320</td> <td>CMOS</td> <td>14</td> <td>4042</td> <td>70</td> <td>4093</td> <td>95</td> <td>4510</td> <td>85</td> <td>4568</td> <td>298</td> </tr> <tr> <td>LS326</td> <td>330</td> <td>4000</td> <td>14</td> <td>4043</td> <td>80</td> <td>4094</td> <td>210</td> <td>4511</td> <td>95</td> <td>4569</td> <td>195</td> </tr> <tr> <td>LS327</td> <td>315</td> <td>4001</td> <td>15</td> <td>4044</td> <td>80</td> <td>4095</td> <td>95</td> <td>4512</td> <td>84</td> <td>4572</td> <td>38</td> </tr> <tr> <td>LS346</td> <td>185</td> <td>4002</td> <td>15</td> <td>4045</td> <td>175</td> <td>4096</td> <td>95</td> <td>4513</td> <td>225</td> <td>4580</td> <td>495</td> </tr> <tr> <td>LS347</td> <td>150</td> <td>4006</td> <td>76</td> <td>4046</td> <td>96</td> <td>4097</td> <td>340</td> <td>4514</td> <td>220</td> <td>4581</td> <td>320</td> </tr> <tr> <td>LS348</td> <td>180</td> <td>4008</td> <td>76</td> <td>4047</td> <td>98</td> <td>4098</td> <td>150</td> <td>4515</td> <td>250</td> <td>4582</td> <td>135</td> </tr> <tr> <td>LS352</td> <td>185</td> <td>4009</td> <td>40</td> <td>4048</td> <td>65</td> <td>4099</td> <td>150</td> <td>4516</td> <td>90</td> <td>4583</td> <td>105</td> </tr> <tr> <td>LS353</td> <td>185</td> <td>4010</td> <td>48</td> <td>4049</td> <td>38</td> <td>4101</td> <td>115</td> <td>4517</td> <td>415</td> <td>4584</td> <td>55</td> </tr> <tr> <td>LS365</td> <td>65</td> <td>4011</td> <td>18</td> <td>4050</td> <td>38</td> <td>4161</td> <td>115</td> <td>4518</td> <td>90</td> <td>4585</td> <td>140</td> </tr> <tr> <td>LS366</td> <td>65</td> <td>4012</td> <td>24</td> <td>4051</td> <td>86</td> <td>4162</td> <td>115</td> <td>4519</td> <td>80</td> <td>40106</td> <td>99</td> </tr> <tr> <td>LS367</td> <td>65</td> <td>4013</td> <td>43</td> <td>4052</td> <td>86</td> <td>4163</td> <td>115</td> <td>4520</td> <td>90</td> <td></td> <td></td> </tr> <tr> <td>LS368</td> <td>65</td> <td>4014</td> <td>80</td> <td>4053</td> <td>86</td> <td>4174</td> <td>110</td> <td>4521</td> <td>210</td> <td></td> <td></td> </tr> <tr> <td>LS369</td> <td>65</td> <td>4015</td> <td>82</td> <td></td> <td></td> <td></td> <td></td> <td></td> <td></td> <td></td> <td></td> </tr> </table>	LS245	350	LS373	150	4016	35	4054	130	4175	120	4522	150	LS247	135	LS374	150	4017	70	4055	130	4194	115	4526	98	LS248	135	LS375	150	4018	76	4056	135	4408	790	4527	125	LS249	135	LS377	199	4019	48	4057	2850	4409	790	4528	100	LS251	130	LS378	140	4020	85	4059	575	4410	750	4529	150	LS253	95	LS379	215	4021	90	4060	110	4411	950	4530	90	LS257	95	LS384	250	4022	85	4061	1225	4412F	1250	4531	130	LS258	120	LS385	420	4023	24	4062	995	4412V	1520	4532	120	LS259	160	LS386	85	4024	60	4063	120	4415F	480	4534	510	LS261	450	LS390	405	4025	24	4066	46	4415V	850	4536	310	LS266	75	LS393	140	4026	180	4067	430	4419	280	4538	145	LS273	180	LS395	210	4027	45	4068	26	4422	570	4539	120	LS275	320	LS396	199	4028	92	4069	22	4432	1050	4541	150	LS279	88	LS398	275	4029	98	4070	30	4435	850	4543	150	LS280	250	LS399	220	4030	55	4071	25	4440	999	4549	395	LS283	90	LS445	140	4031	185	4072	25	4450	350	4553	399	LS290	130	LS447	195	4032	125	4073	25	4503	65	4564	192	LS293	130	LS490	245	4033	175	4075	23	4452	350	4555	85	LS295	215	LS668	105	4034	213	4076	85	4490F	350	4556	60	LS298	215	LS669	105	4035	95	4077	30	4490V	750	4557	425	LS299	420	LS670	270	4036	275	4078	28	4501	28	4558	174	LS300	175	LS673	750	4037	115	4081	26	4502	65	4559	450	LS302	175	LS674	850	4038	110	4082	25	4503	65	4560	199	LS320	270			4039	299	4085	90	4506	75	4561	104	LS323	460			4040	85	4086	90	4507	48	4562	525	LS324	200			4041	80	4089	150	4508	325	4566	195	LS325	320	CMOS	14	4042	70	4093	95	4510	85	4568	298	LS326	330	4000	14	4043	80	4094	210	4511	95	4569	195	LS327	315	4001	15	4044	80	4095	95	4512	84	4572	38	LS346	185	4002	15	4045	175	4096	95	4513	225	4580	495	LS347	150	4006	76	4046	96	4097	340	4514	220	4581	320	LS348	180	4008	76	4047	98	4098	150	4515	250	4582	135	LS352	185	4009	40	4048	65	4099	150	4516	90	4583	105	LS353	185	4010	48	4049	38	4101	115	4517	415	4584	55	LS365	65	4011	18	4050	38	4161	115	4518	90	4585	140	LS366	65	4012	24	4051	86	4162	115	4519	80	40106	99	LS367	65	4013	43	4052	86	4163	115	4520	90			LS368	65	4014	80	4053	86	4174	110	4521	210			LS369	65	4015	82								
LS245	350	LS373	150	4016	35	4054	130	4175	120	4522	150																																																																																																																																																																																																																																																																																																																																																																																																																																																																												
LS247	135	LS374	150	4017	70	4055	130	4194	115	4526	98																																																																																																																																																																																																																																																																																																																																																																																																																																																																												
LS248	135	LS375	150	4018	76	4056	135	4408	790	4527	125																																																																																																																																																																																																																																																																																																																																																																																																																																																																												
LS249	135	LS377	199	4019	48	4057	2850	4409	790	4528	100																																																																																																																																																																																																																																																																																																																																																																																																																																																																												
LS251	130	LS378	140	4020	85	4059	575	4410	750	4529	150																																																																																																																																																																																																																																																																																																																																																																																																																																																																												
LS253	95	LS379	215	4021	90	4060	110	4411	950	4530	90																																																																																																																																																																																																																																																																																																																																																																																																																																																																												
LS257	95	LS384	250	4022	85	4061	1225	4412F	1250	4531	130																																																																																																																																																																																																																																																																																																																																																																																																																																																																												
LS258	120	LS385	420	4023	24	4062	995	4412V	1520	4532	120																																																																																																																																																																																																																																																																																																																																																																																																																																																																												
LS259	160	LS386	85	4024	60	4063	120	4415F	480	4534	510																																																																																																																																																																																																																																																																																																																																																																																																																																																																												
LS261	450	LS390	405	4025	24	4066	46	4415V	850	4536	310																																																																																																																																																																																																																																																																																																																																																																																																																																																																												
LS266	75	LS393	140	4026	180	4067	430	4419	280	4538	145																																																																																																																																																																																																																																																																																																																																																																																																																																																																												
LS273	180	LS395	210	4027	45	4068	26	4422	570	4539	120																																																																																																																																																																																																																																																																																																																																																																																																																																																																												
LS275	320	LS396	199	4028	92	4069	22	4432	1050	4541	150																																																																																																																																																																																																																																																																																																																																																																																																																																																																												
LS279	88	LS398	275	4029	98	4070	30	4435	850	4543	150																																																																																																																																																																																																																																																																																																																																																																																																																																																																												
LS280	250	LS399	220	4030	55	4071	25	4440	999	4549	395																																																																																																																																																																																																																																																																																																																																																																																																																																																																												
LS283	90	LS445	140	4031	185	4072	25	4450	350	4553	399																																																																																																																																																																																																																																																																																																																																																																																																																																																																												
LS290	130	LS447	195	4032	125	4073	25	4503	65	4564	192																																																																																																																																																																																																																																																																																																																																																																																																																																																																												
LS293	130	LS490	245	4033	175	4075	23	4452	350	4555	85																																																																																																																																																																																																																																																																																																																																																																																																																																																																												
LS295	215	LS668	105	4034	213	4076	85	4490F	350	4556	60																																																																																																																																																																																																																																																																																																																																																																																																																																																																												
LS298	215	LS669	105	4035	95	4077	30	4490V	750	4557	425																																																																																																																																																																																																																																																																																																																																																																																																																																																																												
LS299	420	LS670	270	4036	275	4078	28	4501	28	4558	174																																																																																																																																																																																																																																																																																																																																																																																																																																																																												
LS300	175	LS673	750	4037	115	4081	26	4502	65	4559	450																																																																																																																																																																																																																																																																																																																																																																																																																																																																												
LS302	175	LS674	850	4038	110	4082	25	4503	65	4560	199																																																																																																																																																																																																																																																																																																																																																																																																																																																																												
LS320	270			4039	299	4085	90	4506	75	4561	104																																																																																																																																																																																																																																																																																																																																																																																																																																																																												
LS323	460			4040	85	4086	90	4507	48	4562	525																																																																																																																																																																																																																																																																																																																																																																																																																																																																												
LS324	200			4041	80	4089	150	4508	325	4566	195																																																																																																																																																																																																																																																																																																																																																																																																																																																																												
LS325	320	CMOS	14	4042	70	4093	95	4510	85	4568	298																																																																																																																																																																																																																																																																																																																																																																																																																																																																												
LS326	330	4000	14	4043	80	4094	210	4511	95	4569	195																																																																																																																																																																																																																																																																																																																																																																																																																																																																												
LS327	315	4001	15	4044	80	4095	95	4512	84	4572	38																																																																																																																																																																																																																																																																																																																																																																																																																																																																												
LS346	185	4002	15	4045	175	4096	95	4513	225	4580	495																																																																																																																																																																																																																																																																																																																																																																																																																																																																												
LS347	150	4006	76	4046	96	4097	340	4514	220	4581	320																																																																																																																																																																																																																																																																																																																																																																																																																																																																												
LS348	180	4008	76	4047	98	4098	150	4515	250	4582	135																																																																																																																																																																																																																																																																																																																																																																																																																																																																												
LS352	185	4009	40	4048	65	4099	150	4516	90	4583	105																																																																																																																																																																																																																																																																																																																																																																																																																																																																												
LS353	185	4010	48	4049	38	4101	115	4517	415	4584	55																																																																																																																																																																																																																																																																																																																																																																																																																																																																												
LS365	65	4011	18	4050	38	4161	115	4518	90	4585	140																																																																																																																																																																																																																																																																																																																																																																																																																																																																												
LS366	65	4012	24	4051	86	4162	115	4519	80	40106	99																																																																																																																																																																																																																																																																																																																																																																																																																																																																												
LS367	65	4013	43	4052	86	4163	115	4520	90																																																																																																																																																																																																																																																																																																																																																																																																																																																																														
LS368	65	4014	80	4053	86	4174	110	4521	210																																																																																																																																																																																																																																																																																																																																																																																																																																																																														
LS369	65	4015	82																																																																																																																																																																																																																																																																																																																																																																																																																																																																																				

MUSICAL MICRO 24 TUNE DOOR BELL

BUILD THE WORLD FAMOUS CHROMA-CHIME

Give your friends a warm welcome. Yes, think how delighted and amazed they will be to hear the musical Chroma-Chime play when they press your button!

The Chroma-Chime uses a microcomputer to play 24 well-known tunes. The kit is simplicity itself for ease of construction. Absolutely everything needed is supplied, including:

- ★ Resistors, Capacitors, Diodes, Transistors, I.C. Socket and all hardware
- ★ Texas Instruments TMS 1000 microcomputer
- ★ Comprehensive kit manual with full circuit details
- ★ Ready drilled and legended PCB included

ONLY

£11.95

+ 75p p&p
UK ONLY

Plays 24 well-known tunes including:
 Star Spangled Banner; William Tell Overture; Greensleeves; Rule Britannia; Colonel Bogey. Oh come all ye faithful; plus many other popular tunes.

- ★ No previous microcomputer experience necessary
- ★ All programming retained is on chip ROM
- ★ Fully guaranteed
- ★ Ideal present any time

TMS 1000N



MP0027A Micro-computer chip available separately if required. Full 24 tune spec device fully guaranteed.

This unique chip can be used not only for electronic door chimes, but for other projects requiring maximum output.

Car Horns Musical Boxes Alarms Amusement Machines Public Address etc

£4.95

Please send me ETI 1/81

TO: CHROMATRONICS, RIVER WAY, HARLOW, ESSEX
 Telephone: (0279) 418611

NAME

ADDRESS

I enclose cheque/PO value £
 or debit my ACCESS/BARCLAYCARD account no.

Signature

CHROMATRONICS

TRANSCENDENT 2000 SINGLE BOARD SYNTHESIZER

Deigned by consultant Tim Orr (formerly synthesizer designer for EMS Ltd.) and featured as a constructional article in ETI, this live performance synthesizer, is a 3 octave instrument transposable 2 octaves up or down giving sweep control, a noise generator and an ADSR envelope shaper. There is also a slow oscillator, a new pitch detector, ADSR repeat, sample and hold, and special circuitry with precision components to ensure tuning stability amongst its many features.

The kit includes fully finished metalwork, fully assembled solid teak cabinet, filter sweep pedal, professional quality components (all resistors either 2% metal oxide or 1/2% metal film) and it really is complete — right down to the last nut and bolt and last piece of wire! There is even a 13A plug in the kit — you need buy absolutely no more parts before plugging in and making great music! Virtually all the components are on the one professional quality fibreglass PCB printed with component locations. All the controls mount directly on the main board, all connections to the board are made with connector plugs and construction is so simple it can be built in a few evenings by almost anyone capable of neat soldering! When finished you will possess a synthesizer comparable in performance and quality with ready-built units selling for many times the price.

Comprehensive handbook supplied with all complete kits! This fully describes construction and tells you how to set up your synthesizer with nothing more elaborate than a multi-meter and a pair of ears!

**COMPLETE KIT ONLY
£168.50 + VAT!**

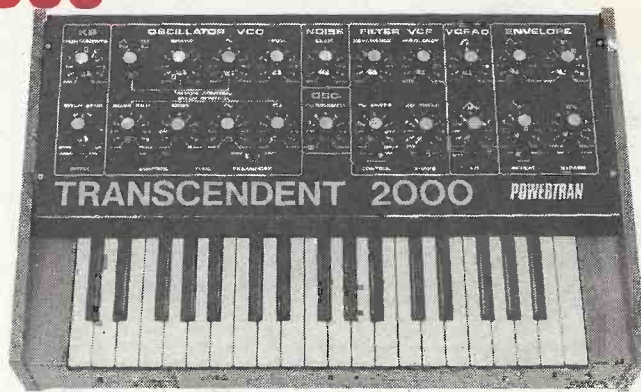

Cabinet size 24.6" x 15.7" x 4.8" (rear) 3.4" (front)

NEW! TRANSCENDENT POLYSYNTH

EXPANDABLE POLYPHONIC SYNTHESIZER

**AS FEATURED IN
THIS ISSUE!**

COMPLETE KIT from £320 + VAT

By brilliant design work and the use of high technology components the Polysynth brings to the reach of the home constructor a machine whose versatility and range of sounds is matched only by ready-built equipment costing thousands of pounds. This latest addition to the famous Transcendent family is a 4 octave (transposable over 7 octaves) polyphonic synthesizer with internally up to 4 voices making it possible to play simultaneously up to 4 notes. An add-on unit permits expansion up to 8 voices. Each voice is a complete synthesizer in itself with 2 VCOs, 2 ADSRs, 1VCA and 1 VCF. Being voltage controlled all voices can be adjusted simultaneously by master controls yet their own pitch and gate signals mean each voice can be operated independently from the keyboard.

Although using very advanced electronics the kit is mechanically very simple with minimal wiring, most of which is with ribbon cable connectors. All controls are PCB mounted and the voice boards plug into PCB mounted sockets. The kit includes fully finished metalwork, solid teak cabinet, professional quality components (resistors 2% metal oxide or 0.5% and 0.1% metal film), nuts, bolts, etc. Complete kit with 1 voice £320, 2 voices £368, 4 voices £464, expansion unit to extend to 8 voices £295 (all prices subject to V.A.T.). A mere fraction of what you would have to pay for a ready-built comparable instrument!

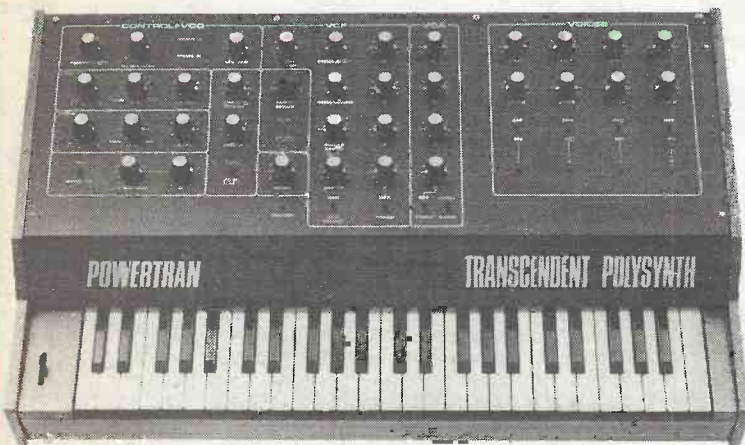

TRANSCENDENT DPX

MULTI-VOICE SYNTHESIZER

Another superb design by
synthesizer expert Tim Orr
published in
Electronics Today International

**COMPLETE KIT
ONLY
£299 + VAT!**



Cabinet size 36.3" x 15.0" x 5.0" (rear) 3.3" (front)

The Transcendent DPX is a really versatile 5 octave keyboard instrument. These are two audio outputs which can be used simultaneously. On the first there is a beautiful harpsichord or reed sound—fully polyphonic, i.e. you can play chords with as many notes as you like. On the second output there is a wide range of different voices, still fully polyphonic. It can be a straightforward piano as a honky tonk piano or even a mixture of the two! Alternatively you can play strings over the whole range of the keyboard or brass over the whole range of the keyboard or should you prefer — strings on the top of the keyboard and brass as the lower end (the keyboard is electronically split after the first two octaves) or vice-versa or even a combination of strings and brass sounds simultaneously. And on all voices you can switch in circuitry to make the keyboard touch sensitive! The harder you press down a key the louder it sounds — just like an acoustic piano. The digitally controlled multiplexed system makes practical touch sensitivity with the complex dynamics law necessary for a high degree of realism. There is a master volume and tone control, a separate control for the brass sounds and also a vibrato circuit with variable depth control together with a variable delay control so that the vibrato comes in only after waiting a short time after the note is struck for even more realistic string sounds.

To add interest to the sounds and make them more natural there is a chorus/ensemble unit which is a complex phasing system using CCD (charge coupled device) analogue delay lines. The overall effect of this is similar to that of several acoustic instruments playing the same piece of music. The ensemble circuitry can be switched in with either strong or mild effects.

As the system is based on digital circuitry digital data can be easily taken to and from a computer (for storing and playing back accompaniments with or without pitch or key change, computer composing, etc., etc.).

Although the DPX is an advanced design using a very large amount of circuitry, much of it very sophisticated, the kit is mechanically extremely simple with excellent access to all the circuit boards which interconnect with multiway connectors, just four of which are removed to separate the keyboard circuitry and the panel circuitry from the main circuitry in the cabinet. The kit includes fully finished metalwork, solid teak cabinet, professional quality components (all resistors 2% metal oxide), nuts, bolts, etc., even a 13A plug!

POWERTRAN

**MANY MORE KITS ON PAGE 115. MORE KITS AND ORDERING
INFORMATION ON INSIDE FRONT COVER**

All projects on this page can be purchased as separate packs, e.g. PCBs, components sets, hardware sets, etc. See our free catalogue for full details and prices.

DIGEST

Hitachi MAGic

Hitachi have developed an experimental colour video camera combined with a video tape recorder — provisionally christened the 'MAG Camera'. Using high density recording techniques, the combination is little bigger than an 8 mm cine camera. The cassette, using 1/4" tape, is almost as small as an audio cassette and allows two hours of recording/playback. The complete unit weighs only 2.6 kg, including a rechargeable battery pack. Watch this space for news on development of the MAG Camera.

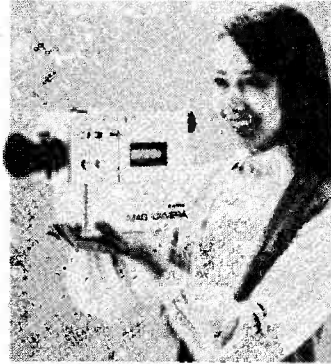

Hitachi have also launched a new portable VHS video recorder. The VT 7000 is one of the lightest in the world — just 5.9 kg. All the controls are of feather touch 'IC logic' operation, with a remote control facility. The recorder can be linked up with the VT TU 70 video tuner, which also doubles as an AC power source/charger for the recorder.

If you don't feel like getting up for a bowlful of breakfast telly, you can amuse yourself in bed with Hitachi's new K 2300 portable monochrome set combined with a quartz clock. The set has a 4 1/2" tube and receives both VHF and UHF. Its

four way power source means that the K 2300 can be used virtually anywhere — bedroom (mains/battery), car, caravan, garden or Santa's grotty (sorry) grotto.

The quartz clock can be used to switch the TV on or off, so you can use it as a snooze switch at night and a telly alarm in the morning. Also featured is an audio output socket, so that sound recordings can be made (naughty).

Now what about the pound notes? The VT 7000 is £579, the VTTU 70 £159 and the K 2300 £115. All prices include VAT.

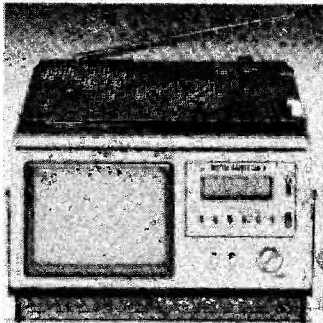

Hitachi's new MAG camera (top) combines video camera and recorder. The K2300 portable telly (left) is also an alarm clock. Their new VHS video recorder (below) is one of the lightest portables available.

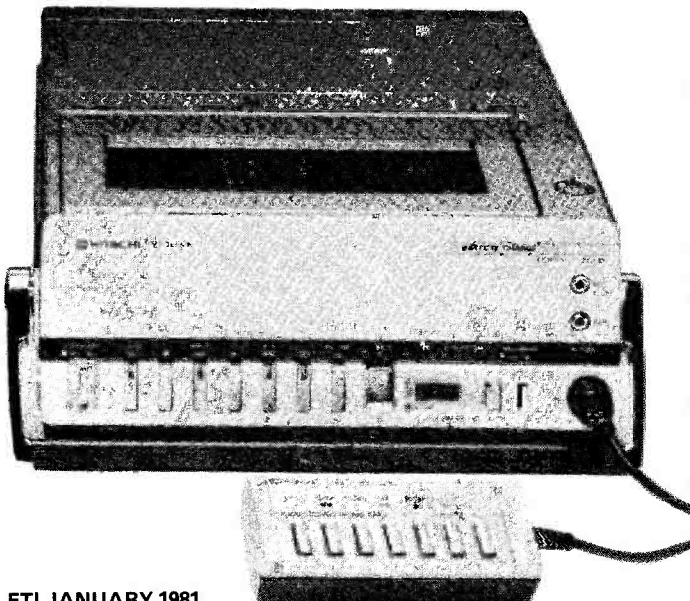

Welsh Chip Shop

Within the next year construction work is to begin on the first Inmos large scale production facility in Newport, Gwent. Production of advanced very large scale integrated semiconductor devices for worldwide distribution should begin in 1982. Inmos is a subsidiary of the National Enterprise Board.

Ace Move

Business must be booming in Batley — Ace Mailtronix Ltd has moved into larger premises at 3a Commercial Street, Batley, West Yorks. WF17 5HJ. The Ace component catalogue, listing approximately 1,000 items, is available for 30p (refundable on orders above £5) to mail order customers. If you're passing through Batley (as one does), call into Ace and collect your copy free.

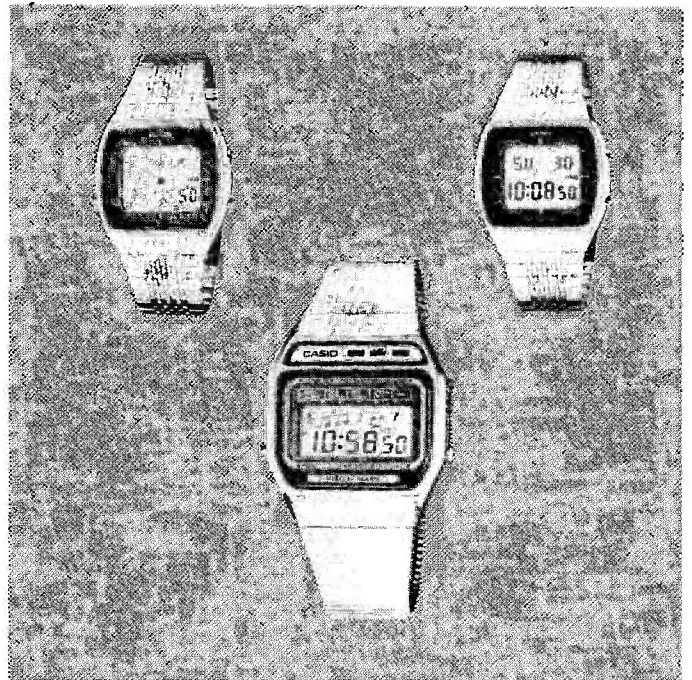

Anne O'Log Watches

Poor old Anne O'Log died a death when digital watches took off, but now she's in demand again. Casio's new AA81 is a digital watch with hands — nothing strange in that, you may say. However, the AA81 has no moving parts. It's all done with LCDs.

The display offers a choice of digital hours, minutes and seconds plus day and date (automatic calendar) OR hours and minutes on 'hands' plus digital seconds. There is also a wristful of extra features — stopwatch (to 1/100th of a second), daily alarm with variable tone pitch and count-down alarm/timer up to 60 minutes.

The Casio M12 doesn't have a hand in sight. Its speciality is playing tunes — a different one for every day of the week, if you feel the need. Its repertoire includes 'Happy Birthday',

'Wedding Bells' and 'Jingle Bells' for those special days in the year. It will also play the Big Ben chimes every hour.

The digital display shows hours, minutes, seconds, AM/PM (or 24 hour clock), month, date and day (not all at once, of course). When it's sounding off, a musical stave magically appears on the display as the melody is played. AND the M12 features a countdown alarm/stopwatch function.

The Casio AA81 with chrome case, stainless steel bracelet and 18 month lithium battery costs £34.95. The AA83 (same features with stainless steel case and bracelet) costs £49.95 and the AA81G (gold plated) costs £54.95. The M12 costs £26.95 with resin case and strap or you can buy the same watch packaged in a stainless steel case and bracelet for £34.95 (the M1200). Casio's recommended retail prices are the maximum you can expect to pay, so shop around for bargains.

NEW

PRACTICAL ELECTRONICS PROJECT 125 WATT POWER AMP KIT

SPECIFICATIONS

Max. Output power 125 watt RMS
 Operating voltage (DC) 50-80 Max
 Loads 4-16 ohms
 Frequency response Measured at 100 watts 25Hz-20kHz
 Sensitivity for 100 watts 400mV @ 47K
 Typical T.H.D. @ 50 watts 4 ohms load 0.1 %
 Dimensions 205 x 90 and 190 x 36 mm

The P.E. power amp kit is a module for high power applications—disco units, guitar amplifiers, public address systems and even high power domestic systems. The unit is protected against short circuiting of the load and is safe in an open circuit condition. A large safety margin exists by use of generously rated components, the

output stage uses four 115 watt transistors normally only two would be used, result, a high powered rugged unit. The PC Board is backprinted, etched and ready to drill for ease of construction, and the aluminium chassis is preformed and ready to use. supplied with all parts and circuit diagrams.



AS FEATURED IN PRACTICAL ELECTRONICS OCTOBER ISSUE

125 watt power amp kit **£9.50** plus £1.00 p&p

ACCESSORIES

Suitable L.S. coupling electrolytic **£1.00** plus 20p p&p
 Suitable Mains Power Supply Unit **£7.50** plus £2.75 p&p
 sufficient for one power amp

DIY STEREO BARGAIN PACKS FEATURING FAMOUS BUILT MULLARD PREAMP MODULES

MULLARD STEREO PREAMP MODULES AND TWO 12 WATT POWER AMPS KITS.

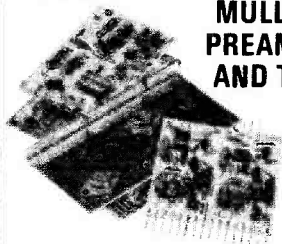

In easy to build form P.C.B.s backprinted, etched and drilled ready to use.

BUILD A 12 WATTS PER CHANNEL STEREO AMPLIFIER ACCESSORIES AND L.S. KIT EXTRA (not available separately)

£6.00

DIY PACK 1 2 x power amp kits LP1182 / preamp module, suitable for ceramic and auxiliary inputs. **£6.00** plus £1.10 p&p
DIY PACK 2 2 x power amp kits LP1184 preamp module suitable for magnetic ceramic and auxiliary inputs. **£8.50** plus £1.15 p&p
DIY SPEAKER KIT Two 8" x 5" approx. 4 ohm bass. **£3.50** plus £1.70 p&p

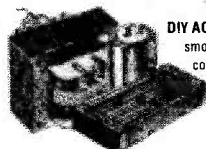

DIY ACCESSORIES Mains transformer smoothing capacitor rectifier 4 x slider controls, for base, treble and volume

£3.00 plus £1.60 p&p

ACCESSORIES: Available only at time of purchase of Bargain Packs

12 + 12 WATT AMPLIFIER KIT

NOTE: for use with 4 to 8 ohms speakers.

With up-to-the-minute features. To complete you just supply screws, connecting wire and solder. Features include din input sockets for ceramic cartridge, microphone, tape or tuner. Outputs—tape, speakers and headphones. By the press of a button it transforms into a 24 watt mono disco amplifier with twin deck mixing. The kit incorporates a Mullard LP1183 pre-amp module, plus 2 power amplifier assembly kits and mains power supply. Also featured 4 slider level controls, rotary bass and treble controls and 6 push button switches. Silver finish fascia panel with matching knobs. Easy to assemble teak simulate cabinet and ready made metal work. For further information instructions are available price 50p. Free with kit. Size 9 3/4" x 8 3/4" x 4" approx.

£13.95

NOTE: for use with 4 to 8 ohms speakers. plus £2.55 p&p

BSR chassis record deck with manual set down and return, complete with stereo ceramic cartridge

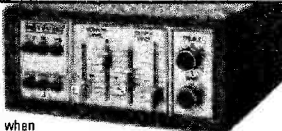

£8.50 plus £2.75 p&p when purchased with amplifier. Available separately **£10.50** plus £2.75 p&p.
8" SPEAKER KIT. 2 Philips 8" approx. speakers. **£4.75** per stereo pair plus £1.50 p&p when purchased with amplifier. Available separately **£6.75** plus £1.50 p&p.

STEREO MAGNETIC PRE-AMP CONVERSION KIT all components including P.C.B. to convert your ceramic input on the 12 + 12 amp to magnetic. **£2.00** when purchased with kit featured above. **£4.00** separately inc p&p

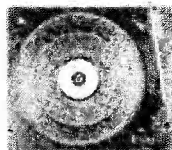

BSR Manual single play record deck with auto return and cueing lever. Fitted with stereo ceramic cartridge 2 speeds with 45 rpm spindle adaptor ideally suited for home or disco use.

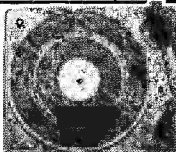

£12.25 OUR PRICE plus £2.75 p&p Size approx 13" x 11"

PHILLIPS RECORD PLAYER DECK GC037

Size approx 15 1/4" x 12 1/4"



Hi Fi record player deck, 2 speed, damped cueing, auto shut-off, belt drive with floating sub chassis to minimise acoustic feedback. Complete with GP401 stereo magnetic cartridge—**LIMITED STOCK. UNBEATABLE OFFER AT**

£27.50 complete plus £2.75 p&p

OFFER! SAVE MONEY by purchasing 12 + 12 amp kit, BSR record deck and speaker kit together for only

£25.50 p&p £4.50

PRACTICAL ELECTRONICS CAR RADIO KIT

£10.50

(Constructors pack 7) plus £1.75 p&p



2 WAVE BAND MW LW

- * Easy to build * 5 push button tuning
- * Modern styling design * All new unused components
- * 6 watt output * Ready etched & punched P.C.B.
- * Incorporates suppression circuits * Now with tape input socket

All the electronic components to build the radio, you supply only the wire and solder as featured in the Practical Electronics March issue. Features: Pre-set tuning with five push button options, black illuminated tuning scale, with matching rotary control knobs, one, combining on/off volume and tone-control, the other for manual tuning, each set on wood simulated fascia. The P.E. Traveller has a 6 watts output, neg ground and incorporates an integrated circuit output stage, a Mullard IF module LP1181 ceramic filter type, pre-aligned and assembled and a Bird pre-aligned push button tuning unit. The radio fits easily in or under dashboards. Complete with instructions.

CONSTRUCTORS PACK 7A

Suitable stainless steel fully retractable locking aerial and speaker (approx. 6" x 4") is available as a kit complete **£1.95** p&p £1.00

Pack 7A may only be purchased at the same time as Pack 7.

NOTE: Constructor's pack 7A sold complete with radio kit **£15.20** including p&p.

FEATURED PROJECT IN PRACTICAL ELECTRONICS.



30 + 30 WATT STEREO AMPLIFIER BUILT AND TESTED

Viscount IV unit in teak simulate cabinet silver finished rotary controls and pushbuttons with matching fascia, red mains indicator and stereo jack socket. Functions switch for mic magnetic and crystal pickups, tape and auxiliary. Rear panel features fuse holder. DIN speaker and input socket 30 + 30 watts. RMS 60 + 60 watts peak for use with 4 to 8 ohm speakers. Size 14 3/4" x 10" approx.

READY TO PLAY £32.90 plus £3.30 p&p



323 EDGWARE ROAD, LONDON, W.2
 21E HIGH STREET, ACTON W3 6NG
 ACTON. Mail Order only. No callers.

ALL PRICES INCLUDE VAT AT 15 %

All items subject to availability. Price correct at 1.11.80 and subject to change without notice

For further information send for instruction booklet 20p plus stamped addressed envelope

NOTE:

Persons under 16 years not served without parent's authorisation

BARGAIN OFFER!!



ARISTON PICK UP

Ariston pick-up arm manufactured in Japan. Complete with headshell. Listed price over £30.00

£11.95

OUR PRICE plus £2.50 p&p

100 WATT MONO DISCO AMPLIFIER

Brushed aluminium fascia and rotary controls. Size approx 14" x 4" x 10". Five vertical slide controls, master volume, tape level, mic level, deck level. PLUS INTER DECK FADER for perfect graduated change from record deck No. 1 to No. 2, or vice versa. Pre fade level controls (PRL) lets YOU hear next disc before fading it in. VU meter monitors output level. Output 100 watts RMS 200 watts peak.

£76.00

plus £4.00 p&p

50 WATT MONO DISCO AMPLIFIER

Size approx 13 3/4" x 5 1/4" x 6 3/4". 50 watts rms. 100 watts peak output. Big features include two disc inputs, both for ceramic cartridges, tape input and microphone input. Level mixing controls fitted with integral push-pull switches. Independent bass and treble controls and master volume.



£30.60

plus £3.20 p&p

Here



NOW

ELECTROVALUE CATALOGUE '81

as included FREE with December issue of
PRACTICAL ELECTRONICS

It's work-bench size for keeping alongside your favourite journal for instant reference to stock and technical data.

**NEW
LARGE
FORMAT**

With more to choose from than ever - all the items you have learned to depend on being obtainable from Electrovalue PLUS MANY NEW ONES to bring Catalogue '81 bang up to date. The V.A.T. inclusive price list that goes with it will hold for at least 4 months before the next one is issued.

Yes - you will enjoy dealing with Electrovalue - prices are keen - service is tops.

**FREE
FOR THE
ASKING**

Write, phone or call if you haven't yet got Catalogue '81 - and you will receive yours by return. (We pay postage).

AND YOU GET BONUS DISCOUNTS AND FREE U.K. POSTAGE TOO, WHEN YOU BUY FROM ELECTROVALUE.

ELECTROVALUE LTD. (Dept. ET1), 28 St. Judes Road, Englefield Green, Egham, Surrey TW20 0HB. Telephone: (STD 0784) (London 87) 33603 Telex: 264475.

Please send me my FREE COPY OF ELECTROVALUE CATALOGUE '81.

Name

Address

Rapid Electronics

■ Guaranteed same day Despatch

■ Quality Product

■ Free Catalogue

■ Vast Stocks

■ Competitive Prices

Pack		Price	Pack		Price
A10	10 PP3 battery leads	50p	F11	10 BC108 trans.	90p
A72	10 3.5mm jack plugs	80p	F26	10 2N3704 trans.	80p
A73	10 3.5mm jack sockets	80p	F27	10 2N3819 trans.	190p
A74	10 Std. jack plugs	130p	H11	20 1N4002 diodes	75p
A75	10 Std. jack sockets	170p	H50	20 0A91 diodes	110p
A84	10 5 pin 180 DIN plug	120p	H60	100 1N4148 diodes	180p
A85	10 5 pin 180 sockets	100p	H70	5 C106D thyristors	200p
C20	10 Min. slide switch	130p	J10	20 0.2in. red LEDs	170p
C30	10 Push to make sw.	130p	J15	50 0.2in. red LEDs	400p
C31	10 Push to break sw.	170p	J20	100 0.2in. red LEDs	750p
C40	Pair Ultrasonics	350p	J30	20 0.2in. green LEDs	280p
C32	Submin. SPST toggle	60p	J50	20 0.2in. yellow LEDs	280p
C33	Submin. DPDT toggle	80p	J80	4 FND500 CC displays	350p
C50	20 Texas 8 pin sockets	170p	K5	5 741 op amps.	90p
C51	20 Texas 14 pin sockets	200p	K40	1 LM324 op amp.	50p
C52	20 Texas 16 pin sockets	220p	K20	5 CA3140 op amps.	225p
E10	Resistor kit. 10 ea value $\frac{1}{2}W$ 4.7 Ω 1M.650 resistors	480p	K85	5 NE555 timers	110p
E34	10 10u 25V radial elec	50p	L8	5 4011 CMOS	130p
E37	10 100u 25V radial	75p	L9	4013 CMOS	40p
E44	10 1u 35V tantalum	100p	L11	4017 CMOS	75p
E54	10 0.1 C280 polyester	50p	L19	4049 CMOS	45p
			M20	Dalo pen	80p

■ For quality components at competitive prices by return of post Rapid Electronics must be your first choice!

All prices include VAT. Please add 50p postage and packing Send SAE for our complete catalogue.

Rapid Electronics Limited
Hillcroft House, Station Road, Eynsford, Kent

DISCO LIGHTING KITS!!!

First class constructional projects, c/w glass fibre P.C.B.'s & full instructions. No extra components needed to make a top rate working unit.

LK1 £9.90	3 channel sound-to-light. 300 w/channel 1v - 100w input	LK2 £17.90	3 channel 3kW zero voltage firing 200mV - 100 watts input.
LK3 £15.50	2kW slider dimmer suitable for clubs/pubs. A professional unit c/w FACE PLATE	LK4 £16.50	4 channel 4kW audio - forward/reverse auto - two speed ranges.

ALL KITS C/W
circuit, comprehensive
instructions & full
parts guarantee



Carriage on above 70p

Suitable case for
LK 1/2/4 £3.50
100w spots ES or BC
£1.50.
Coloured pigmy lamps
65p.
8m rope lights
£40

UNREPEATABLE HI-FI BARGAIN

3 WAY LOUDSPEAKER KIT C/W BAFFLE (pre-cut)

Comprises:
★ 6.4" linen surround bass unit
★ 5" mid-range unit
★ 3" tweeter
★ 3 way crossover, fixing screws & baffle
★ 20 watts handling capability.
Full instructions provided
Must be heard to be believed!!

£10.50 or 2 kits for £20 Carr. £1 per kit

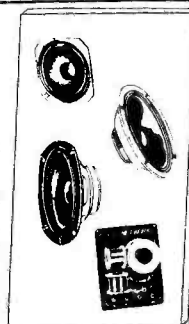

SAXON ENTERTAINMENTS (ET1)

327-333 Whitehorse Rd., Croydon, Surrey CR0 2HS.

(01) 684 8007

Order by phone - Access/Barclaycard/C.O.D.
Open Mon. - Sat. 9am - 5pm.

NEW THE TUSCAN S100

A Z80 based S100 Computer System.

TUSCAN main board. The heart of the system with Z80, video, Ram, Rom, and I/O plus five S100 slots for expansion.

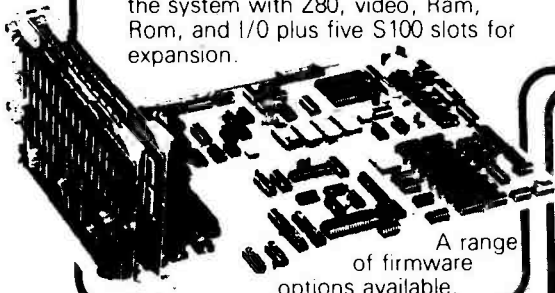

A range of firmware options available.

Available in Kit Form or Assembled. All components available separately.

Houses two 5 1/4" drives for a compact business system

Professional case will house the complete system

Two keyboard options

Hinged lid for easy access

Stylish finish ideal for office or home.

ex-stock

On Demonstration NOW

Complete Business System 48K Two 5 1/4" drives

KITS from

£235 + VAT

£1481.00

NASCOM-2

MICRO-KIT COMPUTER WITH IMPROVED 16k B RAM Board

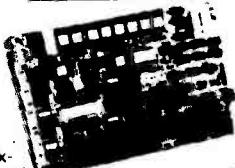

POWER SUPPLY £29.50

Ex-stock

only £335 + VAT

Full after sales service

Firmware & MOS ICs Software
Zeap Assembler (4, 1Kx8 EPROMS) £50
Nas Pen text editor (2, 1Kx8 EPROMS) £30
Expansion boards (in kit form)
 48K RAM £210 ● 32K RAM £175.00
 16K RAM £140

EPROM CARD (NASCOM compatible) KIT. Suitable for 16 x 2708 or 16 x 2716 or mixed 1 x NASCOM 8k BASIC ROM £66.00. BASIC programmers aid. Self locating tape £14.96.

NASCOM-1

12" x 8" PCB carrying 5LSI MOS packages, 16 1K MOS memory packages and 33 TTL packages. There is on-board interface for UHF or unmodulated video and cassette or teletype. The 4K memory block is assigned to the operating system and video display leaving a 1K user RAM. The MPU is the standard Z80 which is capable of executing 158 instructions including all 8080 code.

Nascom-1 Kit Price **£125** Plus VAT
 + P&P £1.50

Built price £140 + VAT.

£325



NASCOM IMP

PLAIN PAPER £325 PRINTER Fully built and housed in a stylish enclosure for just £325 plus VAT. INTERFACES WITH ALL MICRO COMPUTERS

The Nascom IMP (Impact Matrix Printer) features are

- 60 lines per minute. 80 characters per line.
- Bi-directional printing. ● 10 line print buffer.
- Automatic CR/LF. 96 character ASCII set (including upper/lower case, \$, £). ● Accepts 8 1/2" paper (pressure feed). ● Accepts 9 1/2" paper (tractor feed). ● Tractor/pressure feed. Baud rate from 110 to 9600. ● External signal for optional synchronisation of baud rate.

IDEAL FOR WORD PROCESSING

THE HENELEC DISK SYSTEM

FOR NASCOM and any other Z80 8080 Microcomputer with an uncommitted P10

DISKS

● The Henelec controller card plugs direct into a Z80 P10 and controls up to 3 double-sided mini-floppy drives giving a maximum 480K system.

● General Purpose FDC control software for simple DOS or for CPM.

● Simple DOS software for NASCOM 1/2 under NAS-SYS

● OR ROM CB10S for CPM on NASCOM 1/2 incorporating the major NAS SYS features. Maximum 60K CPM system

● New MD prom supplied for N2/CPM

TWO SYSTEMS

● SIM-DOS "Floppy Tape Recorder" with 1 drive PSU firmware, etc. Double sided £380 plus VAT

● CPM System with 1 drive, double sided PSU firmware, etc. £450 plus VAT

● Additional Drives with PSU £205 plus VAT

Professional ASCII Keyboards

ONLY £28.95 + VAT Add Post £1.50. SCOP



The 'APPLE' Computer Keyboard

- 52 key 7 bit ASCII coded
- Positive strobe +5V -12V
- Full ASCII characters
- Parallel output with strobe
- Power light on control
- National mn 5740 chip. TTL output
- Superbly made. Size 12x5.5x1.5ins.
- Black keys with white ledgers
- Escape, shift, return and reset keys

Complete with circuit and data. Ideal for use with Tangenne, Triton, Tuscan, Apple and most computers.

Ex stock from HENRY'S

This is definitely the **BEST BUY**. Supplied **Brand New** in manufacturer's original jacking (anti-static). Just post remittance total £35.95 (incl. VAT and Post)

TANGERINE

COMPUTER SYSTEMS

"MICRON"

EX-STOCK

the latest line in superb products on demonstration from your London stockist

£395.00 inc. VAT BRITISH DESIGN

- 6502 based microcomputer
- VDU alpha numeric display
- Powerful monitor TANBUG
- 8K RAM
- 32 parallel I/O lines
- 2 serial I/O lines
- RS 232 C/20mA loop, with 16 programmable Baud rates
- Four 16 Bit counter timers
- CUTS cassette recorder interface
- Data bus buffering
- Memory mapping control
- 71 Key ASCII Keyboard, including numeric keypad and with auto repeat
- Including metal cabinets for both keyboard and modules
- Including power supply
- 10K Microsoft BASIC

CENTRONICS QUICK PRINTER

List Price £459 incl. VAT



OUR PRICE plus VAT

EXCLUSIVE TO HENRY'S 50% OFF MAKER'S PRICE £195

for: Software selectable 20, 40 and 80 column using 120mm aluminium-ised paper. 1 roll supplied. 150 lines per minute.

NASCOM Centronics parallel data interface for Nascom, Tandy, etc. 240 volt mains input. ASCII character set Paper feed, and on/off select switches 'BELL' signal Weight 10lbs Size: 13" x 10 1/2" x 4 1/2"

MONITORS New and Reconditioned FROM £35

Microtan 65 kit £69.00
 Microtan 65 assembled 79.00
 Lower case option 9.48
 Graphics option 6.52
 20 way keypad 10.00
 Full ASCII keyboard 49.00
 Tanex kit 43.00

Tanex assembled 53.00
 Tanex (expanded) kit 106.50
 Tanex (expanded) assmbld 116.50
 Serial I/O option 12.87
 Tanram kit 34.00
 Tanram assembled 44.00
 Tanram (expanded) assbld 190.00

TANGERINE

LONDON STOCKISTS

MPS1 power supply 23.00
 Mini Mother board 10.00
 Mini Rack 43.00

10K extended Microsoft in ROM £39.00

10K extended Microsoft in EPROM 49.00

SEND FOR COMPLETE COMPUTER BROCHURE FREEPOST TO ADDRESS BELOW

MEMORIES Discounts 10% for 4, 15% for 8, 20% for 16. ADD VAT.

MK 3890 (N280)	7.50		
MK 3890-N4 (Z80A)	7.95	2708	5.00
MK 4116 16K x 1 dy RAM	4.50	2716	12.50
MK 4027 4K x 1 dy RAM	2.25	IM6402 UART	4.50
2102 1K x 1 static RAM	1.00	2114 1K x 4 static RAM	2.95
4118 1K x 8 static RAM	12.75	8080A	5.25

ADD VAT 15%

TO YOUR ORDER EXCEPT WHERE STATED



HENRY'S

Computer Kit Division

404 Edgware Road, London, W2, England I.E.D. 01-402 6822

Official Export & Educational Orders Welcome Our telex: 282284 Mono Ref. 1400 Transonics

ELECTRONICS TOMORROW

Dave Raven of Metac Electronics reports on the development and applications of Surface Acoustic Wave devices.

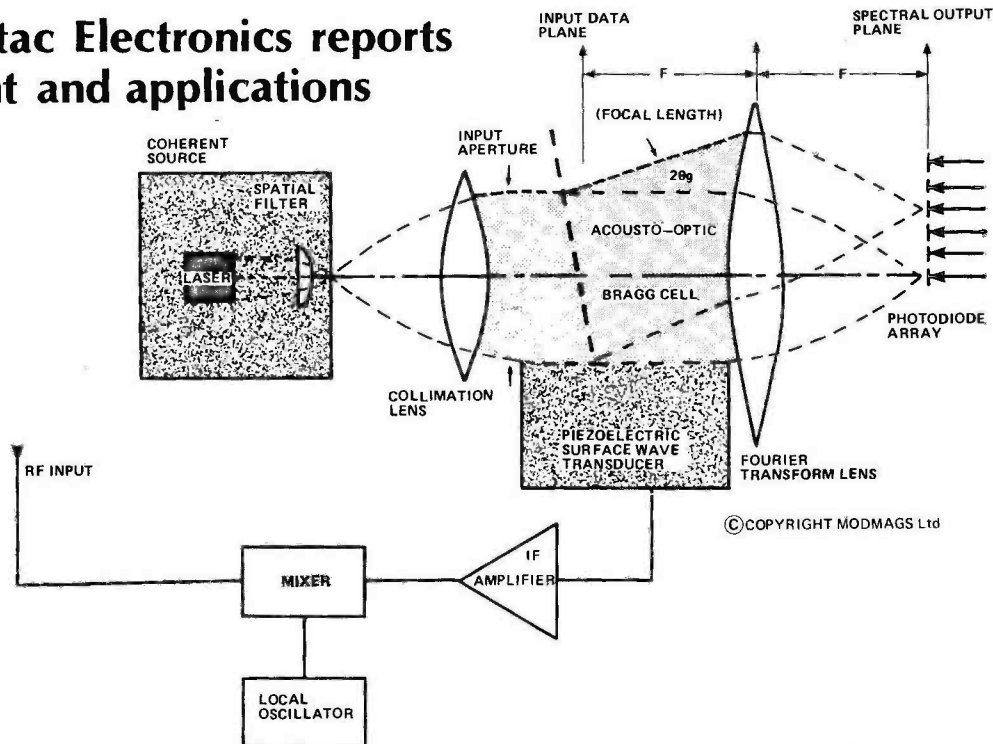

Fig. 1 An integrated optical spectrum analyser incorporating an acousto-optic Bragg cell.

It was at HMS Vernon (the Royal Navy's experimental station at Portsmouth) that wireless staff produced the first "Tuned Shunts" receiving circuit at the beginning of the 1900s. Ever since there has been an increasing demand for higher frequency tuners, filters and delay lines. Surface acoustic wave (SAW) devices have been with us now for over 10 years and are in common use for colour television receivers. They can be incorporated in bandpass filters for radio-frequency receivers, TV intermediate-frequency amplifiers and frequency synthesisers. Others serve as dispersive delay lines in linear frequency-modulated chirp radar, microscan receivers, as tapped delay lines in biphase-coded waveform generators and correlators and as convolvers with memory and programmable matched filters. Most of the applications for SAW devices occur in the high-frequency range. Crystal and LC filters both overlap the bandwidth and frequency range of SAW filters.

However, in the frequency region of 30 to 500 MHz and bandwidth range of 0.1% to 30% only SAW filters simultaneously offer reproducibility, reliability, low cost, selectivity and small size. The techniques used for producing SAW devices are similar to other solid-state devices so that low cost and high repeatability can be achieved. Once the mask has been designed, filters from one production to the next can be easily produced with identical characteristics. On the other hand, LC and discrete crystal filters require laborious tuning procedures.

Under The Surface

Until recently most SAW devices were fabricated on two particular substrate materials, lithium niobate and ST-cut quartz. Lithium niobate can achieve a large coupling coefficient but it has poor temperature stability. Frequency shifts are -90 parts per million per $^{\circ}\text{C}$. So it is used mostly for wider fractional bandwidth devices. A reasonable range of bandwidths is from 3% to 50% of centre frequency.

Quartz has a zero temperature coefficient at room temperature, but a low coupling coefficient. Minimum loss filters can be fabricated for bandwidths below 4%. Wide band devices are less desirable in quartz due to the much higher insertion loss. The physical constraints of the size of the substrate rule out filters at low frequency. A filter with a 100 MHz centre frequency, 40 dB side lobes, and a 0.1% bandwidth would require a four inch long substrate.

Thin Films

When comparing the fabrication of SAW devices to other solid-state devices, it should be pointed out that single crystal piezoelectric materials are not as easily produced in the same manner as, say, silicon slices for microchip production. The surface states of these materials are critical and, to enable cheaper volume production of SAW devices, development work is being carried out to produce thin film piezoelectric material. Research at Nottingham University in the Department of Electrical and Electronic Engineering is being carried out on

producing thin film piezoelectric materials. One such material, zinc oxide, is of particular interest.

In addition to producing SAW devices it is possible to exploit both the optical and piezoelectric properties of zinc oxide. Work at Nottingham on producing thin film material using silicon with a layer of zinc oxide sputtered onto the surface has further shown that high quality device structures can be produced. Suggested applications are integrated optical spectrum analysers, acoustically scanned image devices, convolvers with surface controlling junctions and storage correlators. One other piezoelectric material which showed promise was gallium arsenide. Work has been carried out to produce a tapped delay line and, incorporated on the same slice, a field effect transistor which could be modulated by the surface acoustic wave.

Integrated Optics

The development of electro-optical components is a major new area for thin film technology and during the next 10 years integrated optics will become as familiar as integrated electronic circuitry. Once again it is at the materials stage that most of this work is taking place and it will be largely determined by the fabrication techniques and suitable film structures. It has been known for some time that techniques normally used in the production of electronic devices can also be used to form optical waveguides and components. The waveguiding is based on the creation of a localised region having a higher refractive index than the surrounding medium, leading to modes of propagation in which the light undergoes total reflection at each interface. Here once again, gallium arsenide is a promising material for the development of integrated optics and, as with attempts to combine an acoustic device with an electrical one, gallium arsenide fulfills the vast majority of requirements for optical circuits, in the emission and detection of light as well as modulation and guiding. Further, it should be possible to integrate the optics and electronic circuitry.

The Generation Game

Integrated optics can best be described as a kind of second-generation optical fibre telecommunications. The first generation employs multimode fibres and electroluminescent diodes. The evolving field of integrated optics combines single-mode fibres with laser diodes to increase information handling capacity, with control also at the optical level. The basic building blocks for an integrated optical circuit have reached an advanced state of development, where complete circuits are being attempted.

As always in high technology, a major role for integrated optics is seen in electronic warfare. An integrated RF spectrum analyser is used to detect RF pulsed signals from a dense signal spectrum. A leading application of integrated optics is in coherent optical signal processing. One approach to an integrated optical spectrum analyser incorporates most of the techniques discussed throughout the article, a piezoelectric zinc oxide transducer and integrated optics. A radio frequency signal is mixed with a coherent optical-signal carrier in a device known as an acousto-optic Bragg cell. The heterodyned RF signal is converted by a transducer into a surface elastic wave that travels through the Bragg cell. The wave alters the refractive index, producing a grating effect that deflects the optical beam. An array of photo detectors provides individual responses for each frequency—resolution cell.

SAW devices and integrated optics promise some very exciting developments in the next decade and once again it demonstrates how important and closely related the whole subject of physics is to electronics.

ETI

IDEAL FOR XMAS

COMPUTER CHESS

CHESS CHALLENGER "7" (7 Levels of game)	£73.00
SARGON . The most advanced chess game yet with add on module availability for other games (Our price inc. FREE rechargeable battery pack)	£234.00
Super System 3 (as recommended by ETI)	£134.75
CHESS TRAVELLER	£62

SENSORY CHALLENGER B . The latest Chess Computer from America now in stock	P.O.A.
SENSORY CHALLENGER "VOICE" . The updated and more sophisticated version of the popular 'Voice' Challenger	P.O.A.

*** SPECIAL OFFER**
TEXAS T159 together with PC100C
(Complete as manufacturer's specifications)
£305

TEXAS/HP Accessories available	£166.50
*TEXAS T159 (Card prog 960 prog steps of 100 mem)	£86.00
*TEXAS T158 (Key prog 480 steps of 60 mem)	£160.00
*TEXAS PC100C (Printing Unit for T158/159)	£25.00
*TEXAS T157 (Key Prog 8 mem. 150 Keystrokes/50 Prog Steps)	£25.00

T.V. GAMES

ATARI Console, complete with joy-stick controllers, mains adaptors e/c plus 27 game cartridge	£82
PHILIPS console complete with all controls plus game cartridge	£84
MOST GAMES CARTRIDGES AVAILABLE	P.O.A.

*TEXAS T1 PROGRAMMER (Hexadecimal Oct)	£46.50
*TEXAS T151/II (10 mem 32 Prog Steps Stat/Sci)	£28.50
TEXAS T150 LCD (Sci/Stat. 2 Con Mem)	£23.00
TEXAS T125 LCD (Sci/Stats)	£17.00
TEXAS T93 (Sci 32 Prog Steps-Coa Mem + 80 Prog List Applications book)	£25.00

LEARNING FUN GAMES

TEXAS DAYAMAN (Number Games-Table learning etc. 5/10 yrs)	£19.00
TEXAS SPELLING B (Spelling Games ideal 5/10 years)	£22.50
TEXAS SPEAK AND SPELL (for older children 8/13 years)	£39.95

LANGUAGE TRANSLATORS

LEXICON with 6 Long Modules — French/Italian/German/Spanish etc.	£110
TEXAS SPEAKING TRANSLATOR (complete with one Long Module)	£88
(Other Modules available for German/French/Italian/English)	

Make more of your
Texas T158/59 Calculator
MATHS/UTILITIES MODULE

If you write your own programs this library is for you! Most programs in this library are designed to be used either on their own or as subroutines of your programs. Applications range from utility programs such as printer formatting and large-scale plotting to advanced mathematical routines.

Module includes:	£58.00
*TEXAS T158 with Maths/Utilities	£156.50
*TEXAS T159 with Maths/Utilities	£78.00
*TEXAS T158 with Applied Statistics	£325.00
*TEXAS T159 with PC100C & Applied Statistics	

CORDLESS TELEPHONES

The most up-to-date models from	£126.95
ANSWER PHONES from	£99.00

SINCLAIR/THANDAR METERS

All prices in this section include VAT.
SC110 £145.25; PFM200 £52.20; PD135 £32.80; TM352 £56.80; TM35 £112.30; TM353 £86.40; TF200 £188; TG105 £86.50; TF200 £149.50; TP600 £43 (Prescaler increases PFM200 up to 800MHz); DM235 £55; DM350 £76.50; DM450 £102.

WINTER SALE

*TEXAS T159 Calculator (complete as manufacturer's spec. master module, charger, etc.) PLUS statistics module and extra set of 40 Blank Prog. Cards with wallet, etc.	Only £199
---	------------------

*TEXAS T158C Continuous program facility on all 480 Program steps/80 mem even when calculator switched off	£72.00
*TEXAS T158C (complete plus Applied Stats. Module)	£82.00
*TEXAS T158C + PC100C	£228.00

*HP32E (8 mem. Pro Sci/Stat)	£28.50
*HP32C (as above but con. mem)	£69.50
*HP32E (Advanced Sci with Statistics)	£28.50
*HP34C (Sci Prog 20 Mem)	£59.00
*HP67A (K Prog 224 Steps 28 Mem)	£172.00
*HP67A (Fully prog with Printer)	£264.25
HP11C (the newest calculator from HP)	£167.43
HP11C Card Reader/Printer etc. Modules	Now in stock

IDEAL FOR STUDENTS

ALL WITH LCD DISPLAY	
TEXAS T120 (Jun Sci + Con Mem)	£13.00
TEXAS T138 (Sci/Stat C Mem)	£17.00

GOODS FULLY GUARANTEED PRICES EXCLUDE VAT (ADD 15%)

Company/Hospital and Government orders accepted by phone

Barclaycard/Visa/Access accepted by phone

Export orders welcome. Air Freight/Air Post Delivery. Quotations on request

TEL. 01-455 9823

MOUNTAINDENE

22 Cowper St., London, EC2

THE REMOTE CONTROL STORY

ONCE UPON A TIME



If you wanted to control any equipment remotely you had to buy a dozen logic ICs, chase around the shops for crystals and expensive ultrasonic transducers and then spend a few days getting the unit to work. Then one day TK began stocking a new system. All you required was one IC, a couple of transistors, resistors and a keyboard for the transmitter and a couple of ICs plus a few capacitors for the receiver, to give you up to 16 on/off (digital) outputs or 10 channels plus three analogue (0-10V) outputs. The SL 490 transmitter/encoder accepts inputs from a keyboard (up to 32 way) and encodes these into a pulse train which may be transmitted using infra red, ultrasonic, radio or even wire links. For the receiver you may use the SL480 pre-amplifier if you want an infra red link or a suitable pre-amplifier for ultrasonic or radio links, and one of the ML920 series decoders depending on the number and type of outputs required. The only adjustment you need to make is to set one preset (by trial or with a 'scope) and that's it.

LD271 IR Emitting Diode	38p	ML926 16-channel receiver/4 momentary binary outputs	1.40
SFH205 Photodiode Detector	85p	ML928 16-channel receiver, 4 latched binary outputs	1.40
SL480 IC Pulse Amp	1.70	ML929 16-channel receiver, 4 latched binary outputs	1.40
SL490 32 Command Encoder/transmitter	2.40		
ML922 10-channel receiver + 3 analogue outputs	4.20		

NEW ML925. A decoder designed for model/toy control, providing a 2-speed drive motor and three position latched steering system or a vehicle with momentary action steering and a third motor, eg. gun turret, winch, etc. Outputs also available for other facilities such as horn, turn indicators, headlights, etc. **2.10**

To make things **EVEN EASIER**, we have designed several new kits —
MK6 — Simple Infra Red TRANSMITTER. A Pulsed infra red source which comes complete with a hand held plastic box. Requires a 9V battery. **4.20**
MK7 — Infra Red RECEIVER. Single channel, range approximately 20 ft. Mains powered with a triac output to switch loads up to 500W at 240Vac, but can be modified for use with 5 to 15V dc supplies and transistor or relay outputs. **9.00**
 (Special Price) MK6 and MK7 together. Order as RC500K **12.50**

MK8 — Coded Infra Red TRANSMITTER. Based on the SL490, the kit includes 2 IR LEDs, measures only 6x21.3cms and requires a 9V (PP3) battery. **5.90**
MK9 — 4 Way KEYBOARD. For use with the MKB kit, to make a 4 channel remote control transmitter. **1.80**
MK10 — 16 Way KEYBOARD. For use with the MKB kit, to generate 16 different codes for decoding by the ML926 or ML928 receiver (MK12) Kit. **5.40**

MK12 — 16 Channel IR RECEIVER. For use with the MKB kit with 16 on/off outputs which with further interface circuitry, such as relays or triacs, will switch up to 16 items of equipment on or off remotely. Outputs may be latched or momentary, depending on whether the ML926 or ML928 is specified. Includes its own mains supply. **11.95**

Now you can buy all the components you require for your infra red system or complete kits from one supplier, at unbeatable prices, and live happily ever after.



CT4000 CLOCK/APPLIANCE TIMER KIT

The CT4000 has been designed to preset the state (on or off) of four outputs at four times per day for up to 7 days in advance, enabling the unit to control tape recorders, appliances, central heating, lights, etc. The times are set on a 0.1" high red LED display by means of a keyboard and the output states are displayed on four LEDs. Each output can switch up to 20mA at 9V. For mains loads use our Solid State Relay Kit (MK2). The kit includes a PCB, keyswitches, IC, a dual LED display, transformer, plus all other components and a printed and drilled box which can also accommodate up to 4 Solid State Relay Kits. **£25.25**

Size: 10.12 x 4.5 cms
Colour: Black.



24HR CLOCK/APP. TIMER KIT

Switches any appliance up to 1KW on and off at preset times once per day. Kit contains AY 5-1230 IC, 0.5" LED display, mains supply, dual LED display, transformer, plus all other components and a printed and drilled box which can also accommodate up to 4 Solid State Relay Kits. **£25.25**

CT1000K Basic Kit **£14.90**

CT1000KB with white box (56; 131 x 71mm) **£17.40**

Ready Built **£22.50**

DIGITAL VOLT/METER/THERMOMETER KIT

Based on the ICI 7106. This kit contains a PCB, resistors, presets, capacitors, diodes, IC and 0.5" liquid crystal display. Components are also included to enable the basic DVM kit to be modified to a Digital Thermometer using a single diode as the sensor. Requires a 3mA 9V supply (PP3 battery) **£19.50**



MINI KITS

These kits form useful subsystems which may be incorporated into larger designs or used alone. Kits include PCB, short instructions and all components.

MK1 TEMPERATURE CONTROLLER/THERMOSTAT
 Uses LM3911 IC to sense temperature (80 C max) and triac to switch heater. 1KW. **£4.**

MK2 SOLID STATE RELAY
 Ideal for switching motors, lights, heaters etc. from logic. Opto-isolated with zero voltage switching. Supplied without triac. Select the required triac from our range. **£2.80**

MK3 BAR/DOT DISPLAY
 Displays an analogue voltage on a linear 10-element LED display as a bar or single dot. Ideal for thermometers, level indicators etc. May be stacked to obtain 20 to 100 element displays. Requires 5.20V supply. **£4.75**

MK4 PROPORTIONAL TEMPERATURE CONTROLLER
 Based on the TDA1024 Zero voltage switch this kit may be wired to form a 'burst fire' power controller or a 'proportional temperature' controller enabling the temperature of an enclosure to be maintained to within 0.5 C. **3KW. £5.55**

MK5 MAINS TIMER
 Based on the ZN1034E Timer IC this kit will switch a mains load on (or off) for a preset time from 20 minutes to 35 hours. Longer or shorter periods may be realised by minor component changes. Maximum load 1KW. **£4.50**

TRIACS

3A	49p	16A	95p
8A	58p		
12A	85p		
8A with trigger	80p		
6A isolated tab	65p		
Diac	18p		

LIGHTING CONTROL KITS

Directly replace conventional light switch and control up to 300W of lighting. No mains rewiring. Insulated touchplates. Easy to follow instructions.

T0300K TOUCHDIMMER. Single touchplate with alternate action. Brief touch switches lamp on and off; longer touch dims or brightens lamp. Neon lamp helps find the switch in the dark. **£8.50**
TDE/K Extension kit for T0300K for 2-way switching, etc. **£2.00**

TSA300K TIME DELAY TOUCHSWITCH
 Turns off after preset delay (2 secs. to 3½ mins.) **£4.30**
LD300K Conventional Lightdimmer **£3.20**

DISCO LIGHTING KITS

Each unit has 4 channels (rated at 1KW at 240V per channel) which switch lamps to provide sequencing effects, controlled manually or by an optional opto isolated audio input.

DL 1000K
 This kit features a bi-directional sequence, speed of sequence and frequency of direction change being variable by means of potentiometers. Incorporates master dimming control. **£14.80**

DL21000K
 A lower cost version of the above, featuring unidirectional channel sequence with speed variable by means of a preset pot. Outputs switched only at mains zero crossing points to reduce radio interference to minimum. **£8.00**
 Optional Opto Input **DLA1** **60p**



AND NOW A DIMMER THAT MAKES TOUCH DIMMERS OBSOLETE

Two years ago TK Electronics launched a touchdimmer kit, the T0300K, which made knob controlled dimmers obsolete. This was such a great success that many magazines and more retailers soon produced similar designs. **SO THAT OTHERS MAY FOLLOW.** TK have designed a touch dimmer kit with an Infra Red Remote control enabling you to switch and control the brightness of your lights from the comfort of your armchair etc. (as well as manually by touching the frontplate or by using the TDE/K extension kit.)
 As with all our kits, these come complete with all components including RFI suppression, frontplate, a neon to help you find the switch in the dark and a neat box for the transmitter. The plastic frontplate has no metal parts to touch ensuring complete safety and enabling the plate to be covered with a decorative finish to blend with your room decor.

We have designed the light dimmer unit to fit a standard wall box, the transmitter to fit your hand and the price to fit your pocket.

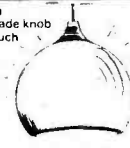

In two years time everyone will be selling remote control dimmers but you can have your TDR300K kit NOW for only **£14.30** for the dimmer unit and **£4.20** for the transmitter.
 For the more athletic of you the T0300K is still available at **£6.50** and the TDE/K at **£2.00**. **DON'T FORGET** to add 40p P&P and 15% VAT to your total purchase.

INTEGRATED CIRCUITS

555 Timer	21p
741 Op. Amp	18p
AY 5-1224 Clock	£2.60
AY 5-1230/2 Clock/Timer	£4.50
AY 3-1270 Thermometer	£8.20
ICL7106 DVM (LCD drive)	£7.00
LM37/ Dual 2W Amp	£1.40
LM375 Dual 5W Amp	£3.50
LM380 2W Audio Amp	80p
LM382 Dual/low noise Preamp	£1.00
LM386 250mW low voltage Amp	75p
LM1830 Fluid Level Detector	£1.50
LM2901 1/4 Converter (8 pins)	£1.40
LM2917 1/4 Converter (14 pins)	£1.60
LM3909 LED Flasher/Oscillator	80p
LM3911 Thermometer	£1.20
LM3911 Dvt/Bar Driver	£2.10
MM74C911 4 digit display controller	85p
MM74C915 7 segment BCD converter	96p
MM74C926 4 digit counter with 7 seq. n/p	£4.50
556B6 Touchdimmer	£2.50
59263 Touchswitch 16 way	£4.85
SN76477 Complex Sound Generator	£2.52
TBA800 5W Audio Amp	88p
TBA810AS 7W Audio Amp	£1.00
TDA1024 Zero Voltage Switch	£1.20
TDA2020 20W Audio Amp	£2.85
ZN1034E Timer	£1.80

All ICs supplied with data sheets. Data Sheets only 10p each device.

MINI TRANSFORMERS



Standard mains primaries 240V a.c.		
100mA secondaries		
6.0 6V	80p	
9.0 9V	85p	
12.0-12V	90p	

LEDs	
0.1" Red	9p
0.1" Green	12p
0.1" Yellow	12p
0.2" Red	9p
0.2" Green	12p
0.2" Yellow	12p
0.2" clips	3p
Rectangular Red	18p
Rectangular Green	20p
Rectangular Yellow	21p

DISPLAYS



DL304 Red 0.3" c.c. pin comp.	
patible with DL704	75p
DL307 Red 0.3" c.c. pin comp.	
patible with DL707	75p
DL727 Dual 0.5" c.c. Red	£1.50

CMOS

4000	17p	4019	42p	4069	19p
4001	18p	4023	22p	4070	19p
4002	18p	4025	21p	4071	18p
4007	17p	4026	£1.30	4072	26p
4011	19p	4027	40p	4081	20p
4012	17p	4028	50p	4083	54p
4013	38p	4029	80p	4081	24p
4015	75p	4049	38p	4511	90p
4016	35p	4050	40p	4514	£1.80
4017	70p	4060	£1.08	4516	£1.80

BOXES

Moulded in high impact ABS. Supplied with lids and screws. Black.

82	95 x 71 x 35mm	85p
83	115 x 95 x 37mm	95p



RESISTORS

ZENER DIODES		1/4W 10ohm-10M	£12.
400mW 3V-30V	8p	PACK of 10 (one value)	10p
1.3W 7.5-27V	15p	10 Packs (10 values)	80p

D.I.L. I.C. SOCKETS

8 pin	8p	18 pin	17p
14 pin	12p	28 pin	24p
16 pin	14p	40 pin	36p
Soldercon Pins			50p/100

CAPACITORS

Polyester 250V			
D.01	6p	0.22	12p
0.002	6p	0.33	12p
0.033	7p	0.47	15p
0.047	7p	0.68	18p
0.068	7p	1.0	24p
0.1	7p	1.5	27p
0.15	12p	2.2	31p

Electrolytics A Axial R Radial				
63V	10 R	5p	16V 10 R	5p
	2.2 R	5p	22 R	5p
	4.7 R	6p	33 R	5p
	10 R	7p	47 R	6p
	47 R	12p	100 R	6p
25V	22 A	8p	220 R	11p
	47 A	10p	470 R	14p
	100 A	14p	1000 R	20p
	110 A	15p	10V 47 A	8p
	470 A	24p	100 A	8p
	1000 A	34p	220 A	12p

Tantalum (bead)			
35V 0.1	9p	10V 22	20p
0.22	9p	6.3V 33	20p
0.47	9p	47	27p
1.0	9p	3V 100	27p
25V 2.2	10p		
4.7	14p		
10	20p		

Ceramic 50V		1,000pF	4p
100pF	4p	2,200pF	4p
220pF	4p	4,700pF	5p
470pF	4p	10,000pF	5p

VOLTAGE REGULATORS

Available in 5V, 12V & 15V versions.
 78L series 100mA pos **26p**
 79L series 100mA neg **60p**
 78 series 1A pos. (10 values) **80p**

LM317T adjustable 1.2V-37V 1.5A **£1.80**

RECTIFIERS

1N4001 1A/50V	4p
1N4004 1A/400V	8p
1N5401 3A/50V	8p
1N5404 3A/400V	10p
1A 50V Bridge	19p
1A 400V Bridge	22p
3A 50V Bridge	48p
3A 400V Bridge	58p
(Bridge rectifiers are miniature PCB mounting types)	

VMOS POWER FETS

VN10KM 0.5A/60V (T092)	52p
VN66AF 2A/60V (T0220)	88p

TRANSISTORS

BC108	8p	BFY50	20p
BC182	8p	TIP31A	40p
BC182L	8p	1IP32A	40p
BC212	9p	2N3055	45p
BC212L	9p	2N3442	90p
BC337	16p	2N3819	20p

ALL COMPONENTS ARE BRAND NEW AND TO SPECIFICATION. ADD VAT AT CURRENT RATE TO ABOVE PRICES. 40p P&P MAIL ORDER — CALLERS WELCOME BY APPOINTMENT

TK Electronics
 (ETI), 11 BOSTON ROAD
 LONDON W7 3SJ. 01-579 9794



8 Watt Audio Amplifier

Using a modern audio power amplifier IC, it is easy to produce an amplifier giving several watts of output with quite good quality. This amplifier is based on the TDA2006 and gives about 8 W RMS into an 8R speaker, or 12 W when using a 4R load. At most output powers the distortion is typically only a fraction of one percent, but it does rise significantly at higher output levels.

The TDA2006 is in many ways like an operational amplifier, but it has a class B power output stage. In this circuit it is used in the inverting amplifier mode with R1 and R2 forming a potential divider that biases the non-inverting input to half the supply voltage. C1 filters out hum and noise which might otherwise be coupled from the supply lines to the non-inverting input via the bias circuit. The inverting input is biased by R4 and together with R3 this resistor forms a negative feedback circuit, which sets the voltage gain and input impedance of the amplifier. As would be the case with an operational amplifier, the voltage gain is equal to R4 divided by R3 and the input impedance is equal to R3. With the values shown this gives a voltage gain of 27 times and an input impedance of 100k. However, within reason these figures can be modified by changing the values of R3 and R4. RV1 is the volume control and does of course shunt the input impedance of the circuit as a whole (down to as little as 50k with the specified values).

As the TDA2006 has a supply ripple rejection ratio of 50 dB, it is not essential to use a very well smoothed supply, but it is important that the device's 30 V maximum supply voltage rating is not exceeded. The maximum average supply current is a little over 500 mA when using an 8R speaker and about 800 mA when using a 4R load. The TDA2006 should be mounted on a substantial heatsink, but has thermal shutdown circuitry, which protects it against overheating. It also incorporates output current limiting circuitry.

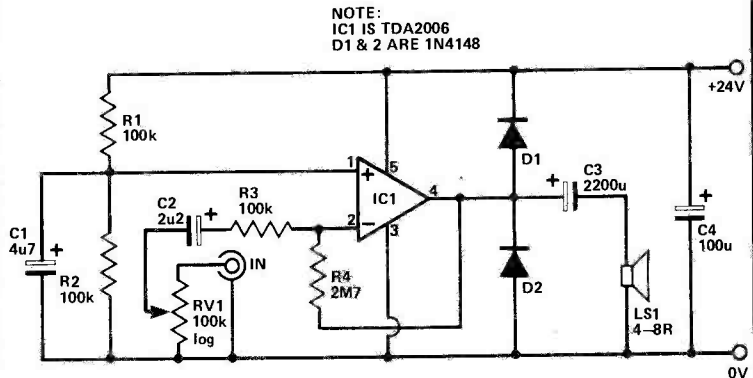

©COPYRIGHT MODMAGS Ltd

The facts of the case

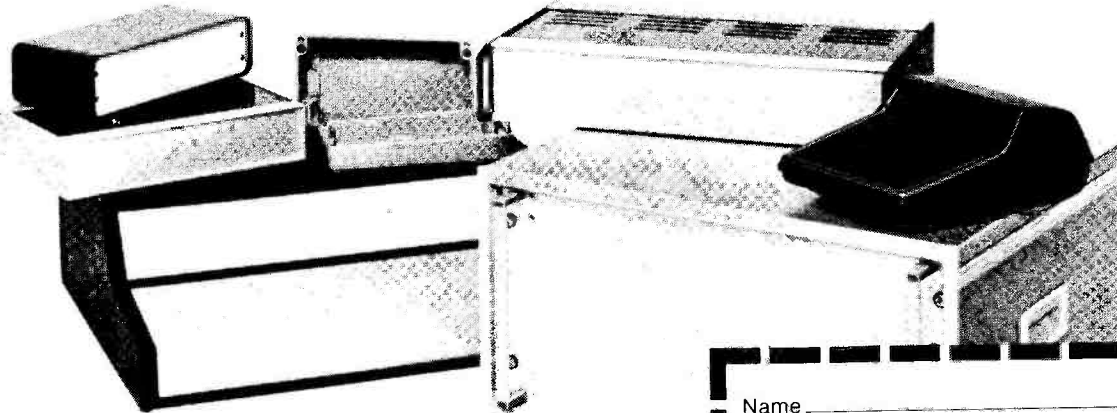

West Hyde have one aim in life, to provide a practical solution to the problem of electronic packaging. The fact of the matter is that we have an ideal case for almost every project featured in this magazine. In this advertisement it is impossible to show you our whole range of nearly 1,000 different instrument cases, or our extensive collection of tools and accessories. Please complete the coupon and, in turn, we will send you our free 80-page catalogue and price list.

Name _____

Address _____

WEST HYDE

West Hyde Developments Limited, Unit 9,
Park Street Industrial Estate, Aylesbury, Bucks., HP20 1ET
Telephone: Aylesbury (0296) 20441/5

KEELMOOR

Quality.. at Keener Prices

LADIES WATCHES
5 function - Hours, mins, secs
day, date, back light, auto cal-
endar. Only 6mm thick. Eleg-
ant matching metal bracelet.
Dress £8.95 Day £5.95

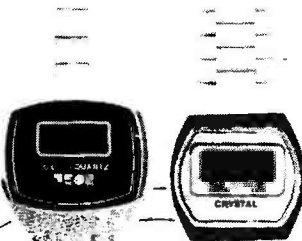

**QUARTZ LCD
ALARM.** 6 digit
hours, mins, secs,
day, date, 24-hour
alarm with on/off
indicator.
ONLY £8.95

**QUARTZ LCD
Alarm / Chrono-
graph.** 22 func-
tions. Hours, mins,
secs, day, date,
month, 1/10 sec
stopwatch, split &
lap modes, 12 &
24 hour alarm.
ONLY £12.95

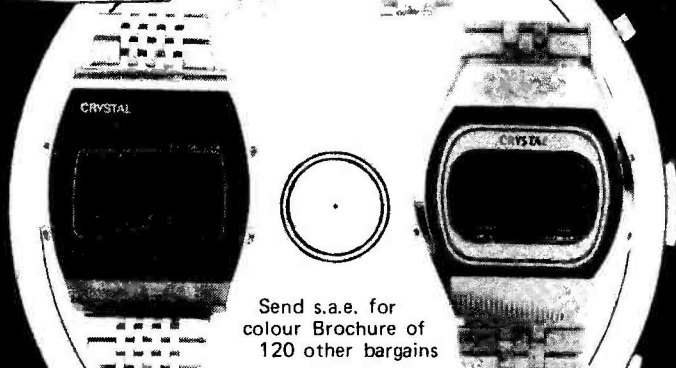

Send s.a.e. for
colour Brochure of
120 other bargains

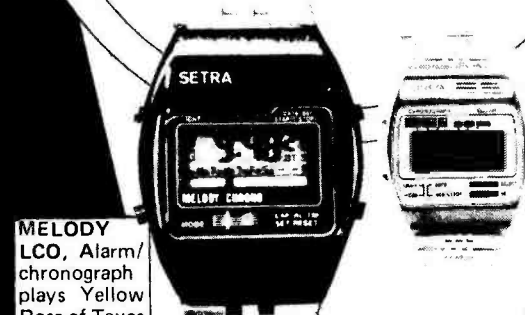

**MELODY
LCO, Alarm/
chronograph**
plays Yellow
Rose of Texas
date, stop-
watch, dual
time.
**ONLY
£14.95**

**ALL WATCHES CARRY A 1
YEAR GUARANTEE.** They come
complete with fully adjustable,
matching, stainless steel straps and
demonstration battery fitted (this
battery is not guaranteed). Please
add 60p for each spare battery
required. Send cheques/P.O.'s,
quoting watch/watches required to









**QUARTZ
LCD Slim
Chronograph.**
11 function.
hours, mins,
secs, 6 digit-
month, date,
day of week,
1/100 sec
stop watch
split and lap
modes, back-
light.
**ONLY
£7.95**

KEELMOOR LTD

78 CASTLE STREET,
MELBOURNE, DERBY,
DE7 1DY

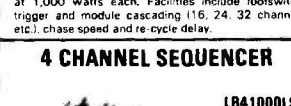
Please add 50p & p
per order.



<p>3 CHANNEL SOUND/LIGHT CHASER LB31000SLC £32.70</p>  <p>A high performance sound to light system which automatically switches to a chase when the music ceases. Super sensitive with an anti interference circuit. The unit will operate from practically any amp and control up to 1,000W/channel. 5Hz to 70K. Controls: bass/mid/treble/master sensitivity/chase speed.</p>	<p>STEREO DISCO MIXER/PREAMP LBPA3 M - Magnetic C - Ceramic £33.70</p>  <p>Magnetic or ceramic deck versions - please state</p> <p>All the requirements of a stereo disco preamp on one board, left and right deck mixers/tones control/mic. mixer/tones/mic. auto fade over decks and P.F.L. The unit can be used with either LB100/150/250</p> <p>Full set of pots - £8.83</p>								
<p>3 CHANNEL SOUND/LIGHT LB31000SL £22.70</p>  <p>All the advantages of the SLC without chase. Controls: bass/mid/treble/master sensitivity.</p>	<p>LPBA2 £17.20 A four channel mixer and tone stage for mics, guitars, etc. Can be used with any LB amps. Set of pots £2.74.</p> <p>LBPA1 £19.50 A stereo high preamp and tone stage for mag. p.u./tape/tuner, etc. Set of pots £3.27.</p>								
<p>2/4/8 CHANNEL CHASER LB81000LC £28.00</p>  <p>An all logic chaser system for use with up to 8 channels at 1,000 watts each. Facilities include footswitch trigger and module cascading (16, 24, 32 channel, etc.), chase speed and re-cycle delay.</p>	<p>3-WAY ACTIVE CROSSOVER LBAC01 £17.90</p>  <p>Bass/mid/treble active crossover with stage booster! Available with crossover points of 200 or 300Hz, and 2K or 3KHz (please specify) LBPSU1 supply for LBAC01 (1 or 2).</p>								
<p>4 CHANNEL SEQUENCER LB41000LS £19.20</p>  <p>A 4 channel sequence generator for banks of lamps up to 1,000W per channel. Two speed controls, cross effect to provide settings between seconds and rapid burst.</p>	<p>POWER AMPLIFIERS Tough dealing power amps for use in sound systems. Open/short circuit protection and fused. Heavy gauge heatinks and rugged o/p devices (all operate down to 4 ohms).</p> <table border="1"> <tr> <th>25W R.M.S.</th> <th>100W R.M.S.</th> <th>150W R.M.S.</th> <th>250W R.M.S.</th> </tr> <tr> <td>20Hz to 80K 0.07% THD 98DB S/N LB75</td> <td>5Hz to 25K 0.1% THD 110DB S/N LB100</td> <td>5Hz to 25K 0.1% THD 110DB S/N LB150</td> <td>5Hz to 25K 0.1% THD 110DB S/N LB250</td> </tr> </table> <p>£11.20 £19.70 £29.20 £43.50 Note all models are available with either 500mV or 775mV sensitivity. Price stable when ordering.</p> <p>LBRLD1 £6.20 A de-thump unit for use with any LB power amps.</p>	25W R.M.S.	100W R.M.S.	150W R.M.S.	250W R.M.S.	20Hz to 80K 0.07% THD 98DB S/N LB75	5Hz to 25K 0.1% THD 110DB S/N LB100	5Hz to 25K 0.1% THD 110DB S/N LB150	5Hz to 25K 0.1% THD 110DB S/N LB250
25W R.M.S.	100W R.M.S.	150W R.M.S.	250W R.M.S.						
20Hz to 80K 0.07% THD 98DB S/N LB75	5Hz to 25K 0.1% THD 110DB S/N LB100	5Hz to 25K 0.1% THD 110DB S/N LB150	5Hz to 25K 0.1% THD 110DB S/N LB250						
<p>1 AND 3 CHANNEL DIMMERS LB31000LD £16.20</p>  <p>Single channel version LB11000LD £7.20</p> <p>Power dimmer units for theatre/stage applications up to 1,000W per channel with on board potentiometer. The unit is also available without rotary pots for use with sliders. LB31000LD (no pots) £15.00 Sliders 75p each.</p>	<p>POWER SUPPLIES</p> <table border="1"> <tr> <th>LB25PS</th> <th>LB100PS</th> <th>LB150PS</th> <th>LB250PS</th> </tr> <tr> <td>£11.20 P/P £1.20</td> <td>£16.20 P/P £1.40</td> <td>£19.00 P/P £1.40</td> <td>£26.50 P/P £1.70</td> </tr> </table>	LB25PS	LB100PS	LB150PS	LB250PS	£11.20 P/P £1.20	£16.20 P/P £1.40	£19.00 P/P £1.40	£26.50 P/P £1.70
LB25PS	LB100PS	LB150PS	LB250PS						
£11.20 P/P £1.20	£16.20 P/P £1.40	£19.00 P/P £1.40	£26.50 P/P £1.70						
<p>ROPE LIGHTS/DRIVER LB41000LC-S £24.20</p>  <p>24 feet ropes Red/Yellow Blue/Green</p> <p>ROPE LIGHTS £45.40</p> <p>A four channel chaser up to 1,000W per channel, with a sound trigger facility. The music input signal modulates the speed of the chase giving an excellent sound/light effect. The unit will control up to 10 ropes with chase speed and trigger level control.</p>	<p>PIEZO HORNS £5.75 P/P 50p</p>  <p>CELESTION LOUSPEAKERS (8 ohms)</p> <table border="1"> <tr> <th>G12-85 (12 inch 85W)</th> <th>G12-100 (12 inch 100W)</th> <th>G10-60 (10 inch 50W)</th> </tr> <tr> <td>£20.70 P/P £1.70</td> <td>£26.45 P/P £1.70</td> <td>£14.70 P/P £1.70</td> </tr> </table>	G12-85 (12 inch 85W)	G12-100 (12 inch 100W)	G10-60 (10 inch 50W)	£20.70 P/P £1.70	£26.45 P/P £1.70	£14.70 P/P £1.70		
G12-85 (12 inch 85W)	G12-100 (12 inch 100W)	G10-60 (10 inch 50W)							
£20.70 P/P £1.70	£26.45 P/P £1.70	£14.70 P/P £1.70							
<p>L & B ELECTRONIC MODULES PROFESSIONAL ENGINEERING BY PROFESSIONALS 45 Wortley Road, West Croydon, Surrey CRO 3EB. Tel. 01-689 4138</p>	<p>NEW - MINI MODULES - NEW Ingeniously designed mini pre-amplifier building blocks for use in music and P.A. applications. You choose the type and number of units you require for your particular system and mount each module via its control direct onto your panel.</p> <p>LBMM1 Pre-amp for mics, guitars etc. LBMM2 Mixer for up to 6 LBMM1/2/3/4/5 LBMM3 Bass/boost/cut for either LBMM1/2/3/4/5 LBMM4 Mid-boost/cut for either LBMM1/2/3/4/5 LBMM5 Treble boost/cut for either LBMM1/2/3/4/5 LBPSU1 ± 15V supply for up to 12 modules LBPSU2 ± 15V regulated for up to 50 modules MM1 £4.50; MM2 £5.20; MM3 £5.70; MM4 £5.70; MM5 £5.70; PSU1 £7.20; RPSU £14.50.</p> <p>Mini Module Discount. Any types between 10 and 24 (quantity) - 20%. 25+ - 30%.</p> <p>Each module is manufactured from the highest quality components, fully tested, supplied with a connection and circuit diagram and guaranteed for twelve months.</p> <p>All prices shown are VAT inclusive. Please include 50p post/packing except where individually stated. To mail order, send cheque/P.O. / registered cash or Access number. C.O.D. service £1 extra. For the new Autumn catalogue send 50p (Full spec. shown).</p>								

THE ZX80 COMPANION

Second Edition—THE MONITOR REVEALED

This best-selling Sinclair ZX80 manual has now been extended to include a detailed explanation of the monitor, routines and entry points. Send £10 cheque / P.O. to:

LINSAC
68 Barker Road, Middlesbrough
Cleveland TS5 5ES

Send s.a.e. for latest catalogue of ZX80 programs — games, educational and utilities — in lower-priced packages.

Also available: ZX80 Monitor Listing

TV SOUND TUNER ETI SEP 80 PROJECT

All parts available / send for list

ALSO

No. 1 for Teletext Kits TV Spare Parts and Components

Callers welcome at Shop Premises

MANOR SUPPLIES

172 WEST END LANE, LONDON NW6 1SD
TELEPHONE: 01-794 8751

Near West Hampstead Jubilee & British Rail Stations

Codespeed Electronics

P.O. Box 23, 34 Seafield Road, Copnor, Portsmouth, Hants. PO3 5BJ
New, full spec. devices

SPECIAL OFFER

★ **LED ALARM CLOCK MODULE** with bright 0.7" LED display and switched alarm output. Just add mains transformer and time setting switches for operational clock. At the special price of **£4.99** whilst stocks last. With data sheet. Cat. No. 205.

★ **SOUND EFFECTS MODULE** Brand new, designed for 'Spaceman' toy. Gives 5 audio/visual programs. Requires 8 ohm speaker (not supplied). **85p**. Cat. No. 108

★ **SIMULATED LASER CANNON** for spaceman toy. LED on moulded 6" lead with mini jack plug. Fits socket on Sound Effects Module. Only **20p** each

★ **GIANT LED DISPLAY** Common cathode, non-Multiplexed super 4 digit LED clock display. Lots of other uses too. Only **£3.95** each. Cat. No. 204.

★ **DIGITAL MULTIMETER CHIP** Builds into high accuracy dvm or panel meter. Requires additional circuitry. With data and circuit. **MM533** Only **£3.55**. Cat. No. 404

★ **POLARISING FILTER MATERIAL** 0.006" thick plastic film. Any size cut — even 1 sq. inch. Max. width 19", any length. Only **3p** per sq. inch. Cat. No. 701

★ **DIGITAL ALARM CLOCK CHIP** MM5316 alarm clock chip. With data **£2.35**. Cat. No. 203

★ **LED DISPLAY** Red, common anode. 0.3" digits with crisp, bright segments. 14 pin DIL package. Super value at **82p**. Cat. No. 313

★ **MINI 8 DIGIT LED DISPLAY** 8 digit, 7 segment calculator style display. Common cathode, multiplexed, with 0.1" high digits. **99p** each. Cat. No. 312

★ **20 KEY KEYBOARDS**. Calculator keyboards, excellent key action. 20 keys per board. 2 keyboards for **99p**. Cat. No. 101

★ **0.1" LED WRISTWATCH DISPLAY**. High brightness display in legless flatpack style package. Requires fairly fine soldering. With data. **99p** each or 2 for **£1.50**. Cat. No. 209

★ **MOMENTARY SWITCHES** Miniature push button switches (spring loaded) with one normally open contact. Super value at **15p** each. Cat. No. 703

★ **SLIDER SWITCHES** A miniature slide switch with 2 pole change-over contacts. All brand new. **16p** each. Cat. No. 702

★ **210Z MEMORIES** (static RAM's). A snip at **99p** each. With data. Cat. No. 102

★ **RESISTORS** 1 ohm to 10 megohms E12 series. 2 ohms to 1 megohm E24 series. 1/4w, 5% 2 1/2p each or 8p for five of same value

★ **CAPACITORS 25V electrolytics** 1.0, 2.2, 4.7, 10uF. **6p** each. 22, 47uF. **8p** each. 100uF. **10p** each. 220uF. **12p** each. 470uF. **18p** each.

★ **100v Mylar** 0.001, 0.002, 0.0033, 0.0039, 0.0047uF. **8p** each. 0.01, 0.022, 0.025, 0.033uF. **7p** each. 0.04, 0.05, 0.1uF. **8p** each.

★ **100v ceramic plate** 1.8pf to 47pf. **5p** each. 56pf to 4700pf. **6p** each

★ **TRANSISTORS** BC207. **15p** each. BC251B. **15p** each. BD135. **28p** each. BD136. **28p** each.

★ **DIODES** 1N3470. **4p** each or 25 for **50p**. 1N4003. **6p** each. 1N4148. **3p** each. 1N4151. **6p** each or 10 for **35p**.

★ **CALCULATOR CHIP** Nortec 4204. 4 function and constant. Not compatible with our calc. kybds. With data and calculator circuit. **80p**. Cat. No. 408

★ **BRIGHT ORANGE DISPLAY** 9 digit, 7 segment gas discharge display. 0.25" high digits. With data. only **75p** each. Cat. No. 310.

Untested Items
★ **FLUORESCENT CALCULATORS** Manufacturers rejects. Most repairable but no guarantees. 10 function with full memory. With 'repairing calculator' info **£2.50**. Cat. No. 107

★ **LED DISPLAYS** (untested — no guarantees) 10 seven segment LED displays. 0.127" digits. common cathode. 10 for **85p**. Cat. No. 311

★ **POST AND PACKING PLEASE ADD 40p (OVERSEAS ORDERS ADD £1)**

★ **LOTS MORE GOODIES IN OUR CATALOGUE, SEND MEDIUM SIZED SAE FOR YOUR FREE COPY**

★ **SATISFACTION GUARANTEED ON ALL ITEMS OR FULL CASH REFUNDED**

VAT PLEASE ADD 15% TO THE TOTAL COST OF YOUR ORDER (INCLUDING POST AND PACKING).

Join the Professionals...

Crimson modular audio amplifiers feature: ★ *Low values of transient and steady-state distortions* ★ *Envelope distortion (below 500 Hz) less than 0.05%* ★ *on-board electronic protection* ★ *P.C.B. pin and edge connector termination* ★ *Full range of complimentary components, i.e. P.S.U.'s, heatsinks etc. available from Crimson.*

The Crimson range of amplifier modules are built to very high standards and have earned an enviable reputation in every field to which they have been applied. The boards come ready built and tested (guaranteed for two years) and can be used to advantage where high quality signal amplification is required. The power amplifier modules range from 60WRMS to 310WRMS with up to twice this amount in bridge mode. All feature substantial heatsink brackets which can be bolted to any available heatsink or the Crimson purpose designed types. Input sensitivity is set at 775mV and power supply requirements are catered for by one of the three Crimson toroidal power supplies. The Pre-amplifier module (CPR1) is basically a phono amplifier with sophisticated circuitry incorporating R.I.A. equalisation. Also on board is auxiliary amplification for tape and tuner inputs. A separate module (MCI) is also available and gives the required boost for low output moving coil type cartridges. External components required are potentiometers for volume and balance, switches for signal routing and a regulated ±15V D.C. power source (REG1). Complimenting this range, are the electronic crossover modules X02/X03 which, with a special muting board (MU1) can be incorporated in all types of active speaker systems.

Numerous applications are possible with Crimson modules. For example, a complete Hi-Fi Pre & Power amplifier of 40-125WRMS/channel can be built using our Hardware kits (see Hobby Electronics review, August 1980). Alternatively, Mono or Stereo slave amps of up to 500WRMS can be built into proprietary flight cases, while other uses include active loudspeaker systems such as designed by R.I. Harcourt in Wireless World October/November 1980. Further details of how to use the modules are contained in the Users/Application Manual available at £0.50.

SPECIFICATIONS

Type	O/P8ohms*	O/P4ohms*	PSU	H/Sinks	Slew	S/N	Sensitivity	T.H.D. (typ)	FR	Size
CE 608	38		CP51	50mm	30V/μs	110dB	775mV	0.0035%	1.5Hz-50kHz (3dB)	80 - 120 - 25
CE1004	44	70	CP53	100mm	30V/μs	110dB	775mV	0.0035%	1.5Hz-50kHz (3dB)	80 - 120 - 25
CE1008	66		CP53	100mm	30V/μs	110dB	775mV	0.0035%	1.5Hz-50kHz (3dB)	80 - 120 - 25
CE1704	85	121	CP56	150mm (F.M1)	30V/μs	110dB	775mV	0.0035%	1.5Hz-50kHz (3dB)	80 - 120 - 25
CE1708	125		CP56	150mm (F.M1)	30V/μs	110dB	775mV	0.0035%	1.5Hz-50kHz (3dB)	80 - 120 - 25
CP3000		250	CP56	F.M2	30V/μs	110dB	775mV	0.0035%	1.5Hz-50kHz (3dB)	161 - 102 - 35
CPR1S1	Output	775mV	REG1	20V/μs	70dB	2.8mV/RMS	0.008%		20Hz-20kHz	138 - 80 - 35
MCI1S1	Output	2mV	REG1	65dB	70dB	2.8mV/RMS	0.008%		20Hz-20kHz	80 - 120 - 35
X02 X03	Output	775-250mV	REG1	90dB	30dB	775mV	0.01%		20Hz-20kHz	150 - 50 - 30

*Power output is quoted WRMS and is given for two modules run off the same power supply. Higher powers are obtainable if using one module per P.S.U. or if using a stabilised P.S.U.

PRICES HELD FROM MAY — TO FEB '80

Power Amplifier Modules	Power Supply Modules	Heatsinks
CE 608	£21.00 CP51 (80VA)	50mm 11.70
CE1004	£24.50 CP53 (150VA)	100mm 12.20
CE1008	£27.50 CP56 (250VA)	130mm 13.50
CE1704	£35.00 REG1	15.30 F.M1
CE1708	£36.00 REG1	12.50 F.M2

Pre-Amplifier Modules	Active Crossovers	Hardware
CPR1	£34.00 X02	19.00 Pre. Amp.
CPR1S1	£44.50 X03	128.30 Power Amp.
MCI	£26.00 Mut	1.75 Thermal Cutouts
MCI1S1	£37.00	

Barclaycard
VISA
Master Charge
Card or write to proforma

PLEASE SEND ME MORE DETAILS OF ALL CRIMSON ELEKTRIK AMPLIFIERS
Name _____ Address _____

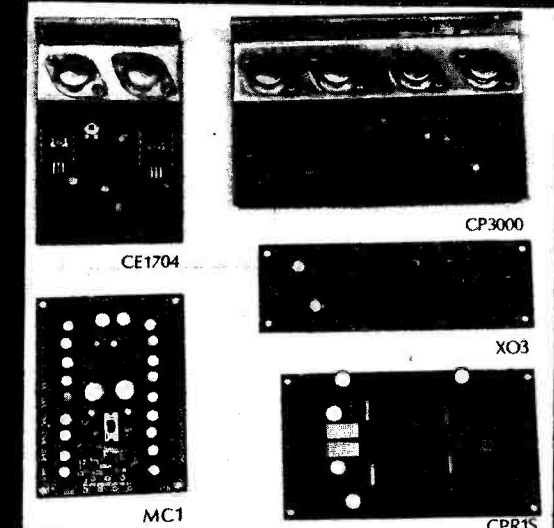

Crimson Elektrik

9 CLAYMILL ROAD, LEICESTER LE4 7JJ, ENGLAND. Tel 0533 761920 Telex 34694 Chanco G CRIMLEK

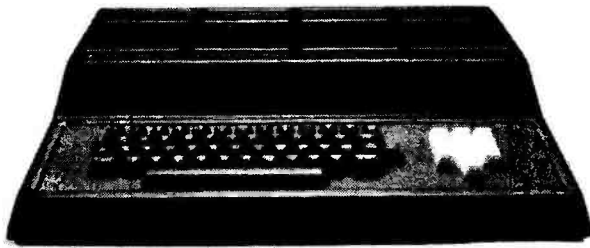

MICROTYPE MODEL 3 CASE

Ready cut for SUPERBOARD/UK 101, NASCOM 2 and blank for HOMEBREWS

Produced in black ABS Plastic, complete with fixings and instructions, space for PSU, expansion, force feed fan, numeric pad and additional keys.

£24.50 + p&p + VAT



NPS1 NUMERIC PAD

for SUPERBOARD/UK101 only

A 0-9 numeric pad in kit form, complete with switches, caps, PCB, plug and socket, cable and full instructions.

£11.95 + p&p + VAT

- Please send me a Model 3 case at £29.90 inc. My micro is _____
- Please send me a NPS1 numeric pad for my Superboard/UK101 at £14.32 inc.
- Please send me your full literature. I enclose SAE.
- (Please enclose your name and address with cheque or P/O)



MICROTYPE
PO BOX 104 HEMEL HEMPSTEAD HP2 7QZ



Wilmslow Audio

THE firm for speakers!

SEND 50P FOR THE WORLD'S BEST CATALOGUE OF SPEAKERS, DRIVE UNITS, KITS, CROSSOVERS ETC, AND DISCOUNT PRICE LIST

AUDAX - AUDIOMASTER - BAKER - BOWERS & WILKINS
CASTLE - CELESTION - CHARTWELL - COLES - DALESFORD
DECCA - EAGLE - ELAC - EMI - FANE - GAUSS - GOODMAN
HARBETH - ISOPHON - I.M.F. - JORDON - JORDAN WATTS
KEF - LOWTHER - MCKENZIE - MISSION - MONITOR AUDIO
MOTOROLA - PEERLESS - RADFORD - RAM - ROGERS
RICHARD ALLAN - SEAS - SHACKMAN - STAG - TANNON
VIDEOTONE - WHARFEDALE

WILMSLOW AUDIO

35/39 CHURCH STREET
WILMSLOW, CHESHIRE

Tel. 0625-529599 FOR MAIL ORDER AND EXPORT OF DRIVE UNITS, KITS, ETC.

Tel. 0625-526213 (SWIFT OF WILMSLOW) FOR HI-FI AND COMPLETE SPEAKERS.

ELECTRONIC GAMES

ATARI



SPECIAL PRICE

£86 + VAT

SPACE INVADERS

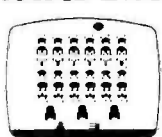

HAND HELDS + CARTRIDGES
ATARI - ACETRONIC
PRINZTRONIC
RADOFIN - DATABASE etc.

We keep a full range!
Send for cartridge lists stating which machine you own.

INTELLIVISION MATTEL



Available August 1980
This is the most advanced TV game in the world.
Expandable next year into a full microcomputer.
COLOUR CATALOGUE AVAILABLE WITH DETAILS ON ALL THE CARTRIDGES

£173.87 + VAT



BRIDGE

COMPUTER

- * Plays 1/2/3 or 4 Hands
- * Problem Mode
- * Audio Feedback
- * Instant Response
- * Auto scorekeeping

DRAUGHTS

COMPUTER

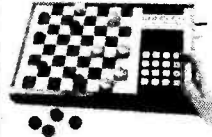

- * Solves Problems
- * Rejects illegal moves
- 2 level machine £43 + VAT
- 4 level machine £77.78 + VAT

CHESS

COMPUTERS



NEW RANGE AVAILABLE AUGUST 1980
We specialise in computer chess machines & stock over 13 different models from £20 to £300

Send for further details.

BACKGAMMON

COMPUTERS



OMAR 1
OMAR 2
CHALLENGER
GAMMONMASTER

From £38 to £108. Send for further details.

LEISURE

- * CHEAP TV GAMES
- * TELEPHONE ANSWERING MACHINES
- * AUTO DIALERS
- * CALCULATORS
- * DIGITAL WATCHES
- * PRESTEL
- * HAND HELD GAMES

TELETEXT



RADOFIN
TELETEXT
Add on Adaptor

£173 + VAT

24-TUNE DOOR BELL



£13.65 + VAT

FREE CATALOGUE

For a free copy of our 32 page catalogue, send a 12p stamp to Silica Shop Ltd or Telephone 01-301 1111

MAIL ORDER SERVICE - Free postage & Packing

TELEPHONE & MAIL ORDERS - accepted on Access * Barclaycard * American Express * Diners Club

CALLERS WELCOME - at our shop in Welwyn - Demonstrations daily
Open 10am-9pm Mon-Sat (9am-1pm Wed)

GUARANTEE - Full 12 months + After Sales Support!

We have comprehensive brochures on all products. Please let us know what you are interested in and we will send you details on features AND our 32 page catalogue covering most games on the market.

SILICA SHOP

SILICA SHOP LTD., Dept. ETI.1
1-4 The Mews, Hatherley Road
Sidcup, Kent, DA14 4DX
Tel: 01-301 1111

ETIPRINTS

ETIPRINTS offer you the easy way to produce high quality printed circuit boards. Each ETIPRINTS sheet contains a set of etch resistant rub down transfers of the printed circuit board designs for several of our projects.

ETIPRINTS are made from our original artwork ensuring a neat and accurate board. We thought ETIPRINTS were such a good idea that we have patented the system (patent numbers 1445171 and 1445172).

PARTS LIST

040A	ETI 80 VCO/VCLFO	Feb 80	Speed Control
040B	ETI 80 PSU Tuning Fork Hi-Lo Filter Coin Toss	Feb 80	DTM Switching Board RIAA Preamp
041A	Audiophile Driver Amp VCA Signal Tracer Heater Controller Main Board Electromyogram	Mar 80	047C ETI 80 Envelope Shaper TV Sound Survival
041B	ETI 80 VCM Heater Controller Sensor	Mar 80	048A Sustain/Fuzz Box Flash Trigger FM Radio Control Receiver: (Top side) (Bottom side) FM Radio Control Transmitter
046A	ETI 80 Dual VCA 100 W Power Amplifier	Aug 80	048B Vocoder Slew Rate Control Vocoder Output Amp Vocoder Input Amp Vocoder PSU Vocoder LED PPM Display
046B	Capacitance Meter US Alarm BGM 100 W Amplifier Logic Tester 100 W Power Amp	Aug 80	048C Cassette Interface ETI 80 Monitor Amp
047A	Digital Test Meter	Sep 80	049 AF Generator Multi-Option Board Space Invasion PSU
047B	Vocoder Internal Excitation	Sep 80	

BUYLINES

Sheets for Sep 79, Dec 79, Jan 80 and April - July 80 are temporarily out of stock. Earlier ETIPRINT sheets are available.

Send a cheque for PO (payable to ETI) for £1.20 per sheet with details of the project for which you require an ETIPRINT, and the month and year of publication to:

ETIPRINTS,
ETI,
145 Charing Cross Road,
London WC2H 0EE.

HOW IT WORKS

Lay down the ETIPRINT and rub over with a soft pencil until the pattern is transferred to the board. Peel off the backing sheet carefully making sure that the resist has transferred. If you've been a bit careless there's even a 'repair kit' on the sheet to correct any breaks!

ETIPRINTS



Pocket Printer

Hanimex have launched what they believe to be the smallest and most versatile print and display calculator in the world. The Micro 1226T features a 12 digit green display plus full print-out capability in a 140 x 72.4 x 23.5 mm package weighing only 260 g.

It uses standard 38 mm thermal paper from its own paper store or from a larger paper holder. The keyboard includes a fully addressable four key memory, percentage key, item count key and single and double zero input key. Print-out speed is 1.8 lines per second.

Ultrasound

A new series of matched, low-cost ultrasonic transducers from Impectron are small, light and highly sensitive. They offer excellent performance in applications such as industrial control and intruder detection systems.

The EFR-OCB25K5 and EFR-RCB25K5 are transmitter and receiver respectively, with a nominal centre frequency of 25 kHz. Sensitivity is around -60 dBV/uBar with mini-

mum bandwidth of 3 kHz. Overall dimensions are 1" long (body length 0.37") by 0.95" diameter for both transducers.

Their internal construction incorporates a compound vibrator (ceramic chip plus conical aluminium resonator) providing sensitivity and bandwidth.

Delivery is ex-stock and application notes for designers are available from Impectron Ltd, Foundry Lane, Horsham, W Sussex RH13 5PX.



Crystal Clear

Ambit International's four new compact modules combine a data decoder and LCD display for only £19.95. Two versions (DM180/DM181), based on the ICM 7211, provide simultaneous decoding and display from multiplexed BCD inputs. Hex or Code B displays are also available. Power consumption is 3V5 to 6 V at typically 20 uA in either four or 3 1/2 digit formats.

All the modules measure 60 x 30 x 7 mm (12.5 mm LCDs with integral incandescent backlighting) and can be supplied with a panel mounting bezel. For further details contact Ambit International, 200 North Service Road, Brentwood, Essex CM14 4SG.

Beckman Instruments' new model 740 and 742 large area LCDs feature as standard pin connectors bonded to the display. The connectors are also available separately.

The 740 features six digits (1/2" high) with colons and decimal points in a 2.75" x 1.2" package. The 742 offers eight digits, also 1/2" high with colons and decimal points, in a 3.7" x 1.2" package.

Power consumption is very low - 50 uW for the 740. Both models offer a wide operating voltage range (3-20 V RMS) and are compatible with available CMOS drive circuits.

For further information contact Beckman Instruments Ltd, Queensway, Glenrothes, Fife, Scotland KY7 5PU.

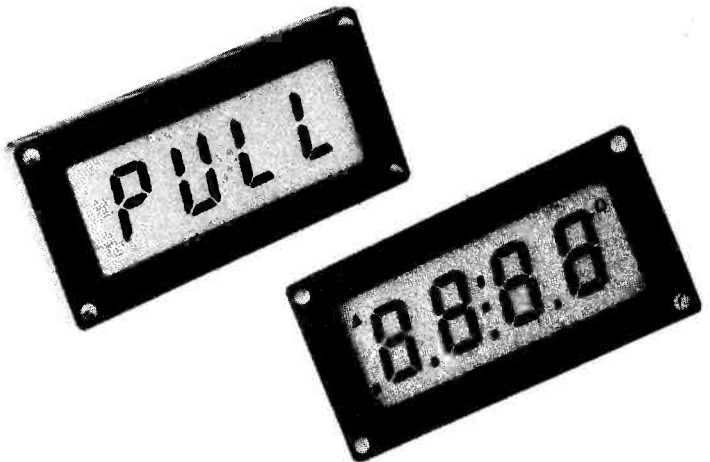

Ambit International (above) and Beckman (below) displaying themselves.



Autel

EMIDATA and Autelca Ag, the Swiss pay-phone manufacturer, have got together to produce a new pay-phone credit card system. When the customer buys a card, its magnetic strip is pre-coded with an agreed credit value (a number of time units).

To pay for a call you simply insert the card in a slot in the telephone. Its value is displayed on a digital read-out and reduced unit-by-unit at the appropriate rate during the call. When you hang up, the card is returned coded with its reduced value. If the value should fall to zero



during a call, the card is returned and the display flashes for a few seconds before automatic disconnection. The card is then disposed of and a new one purchased.

PCB FOIL PATTERNS

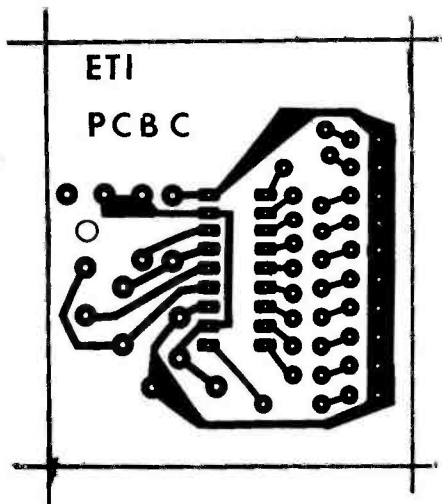
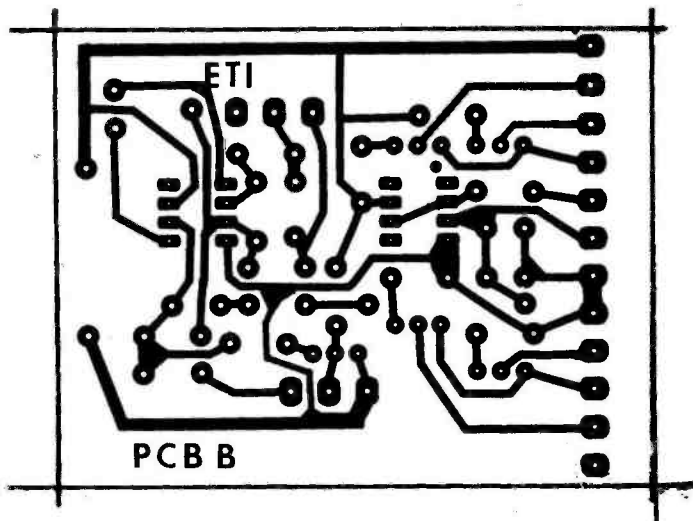

The FM Tuner boards B (above), C (left) and D (below).

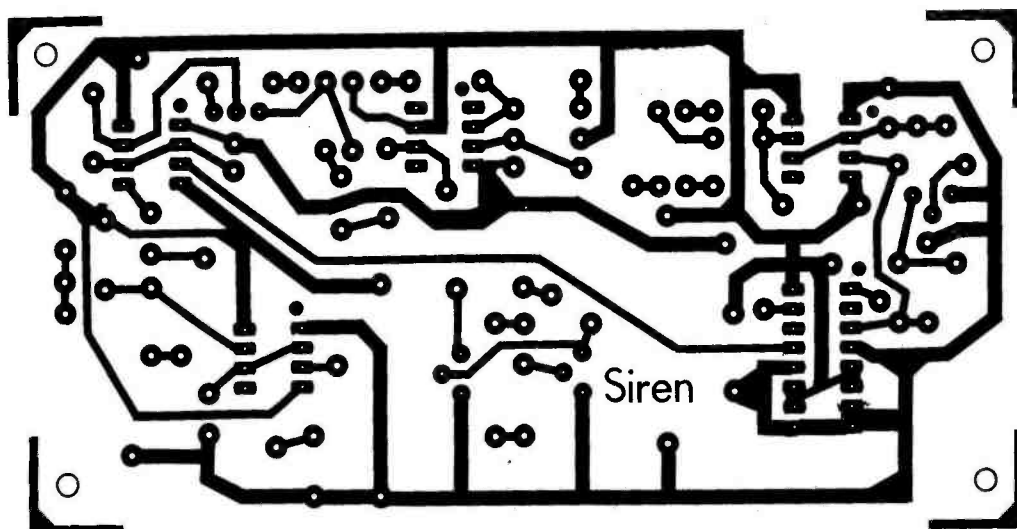
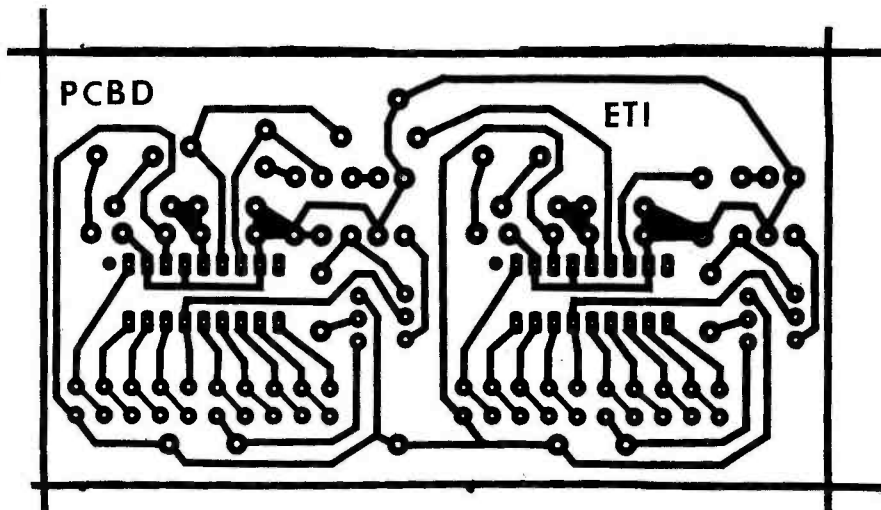

(Above) Multi-Option Siren.

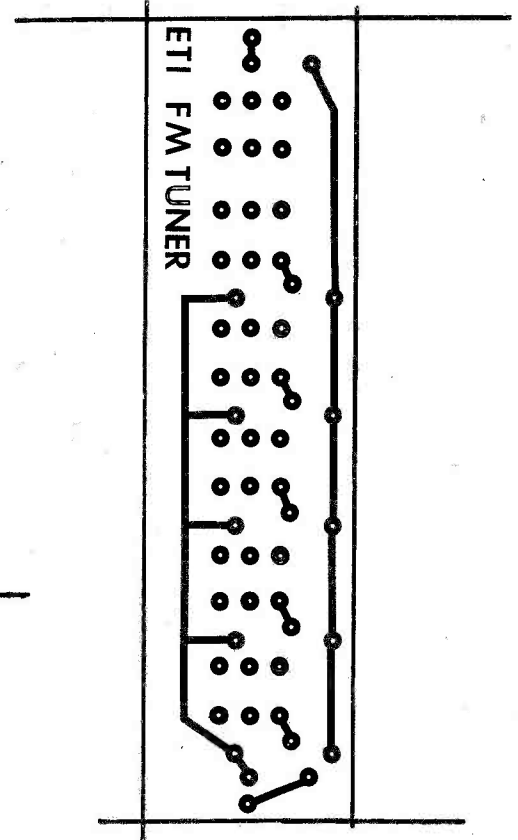
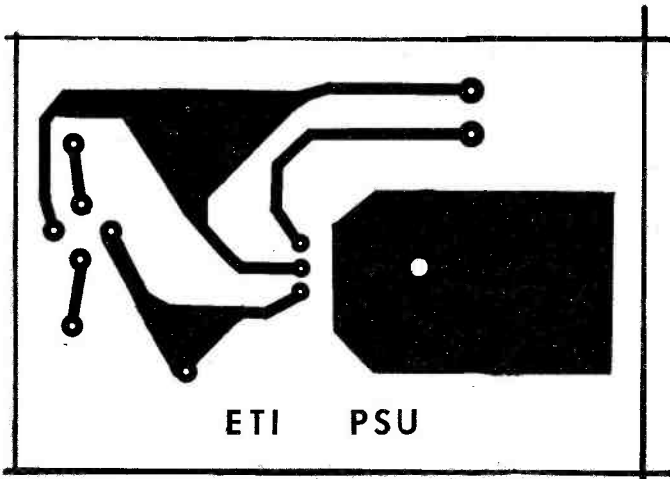

The FM Tuner PSU (above), switch assembly board (right) and PCB A (below).

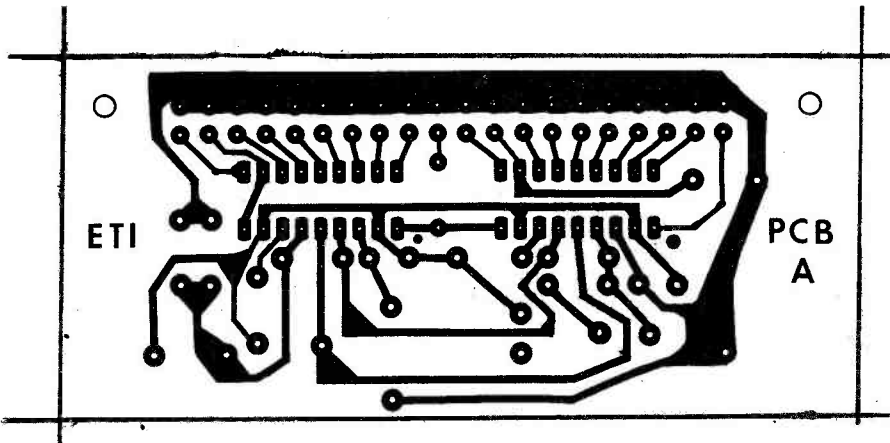

(Below) LED Tacho.

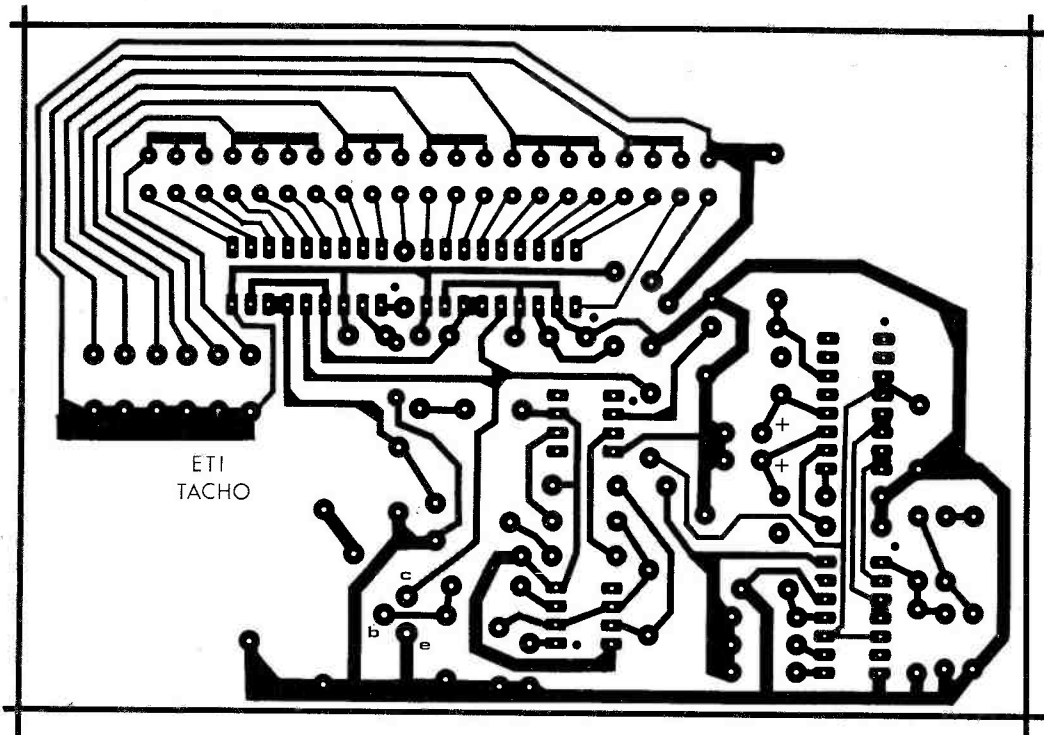

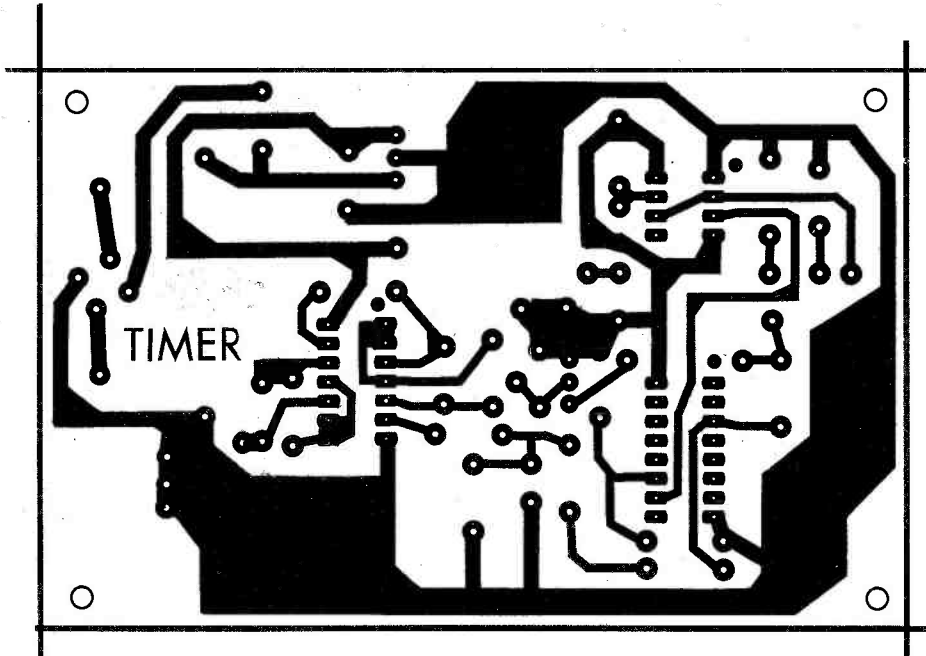

(Above) Universal Timer.



MODMAGS LTD
Publishers of:
ELECTRONICS TODAY INTERNATIONAL
HOBBY ELECTRONICS
COMPUTING TODAY
VIDEO TODAY

MM Design & Print, one of London's youngest and most progressive graphics agencies, urgently requires an experienced process camera operator for its rapidly expanding magazine and publicity work. There will be an opportunity for the right person to get involved in other aspects of production.

An attractive salary is offered, depending on age and experience.

If you're young, eager to learn and don't mind hard work, then ring Diego Rincón on 01-437 1002.

PARNDON ELECTRONICS LTD.

Dept. No 22, 44 Paddock Mead, Harlow, Essex CM18 7RR. Tel: 0279 32700

RESISTORS: 1/4 Watt Carbon Film E24 range $\pm 5\%$ tolerance. High quality resistors made under strictly controlled conditions by automatic machines. Banded and colour coded.

£1.00 per hundred mixed. (Min 10 per value)

£8.50 per thousand mixed. (Min 50 per value)

Special stock pack 60 values, 10 off each £5.50



DIODES: IN4148 3p each. Min order quantity - 15 items.
£1.60 per hundred

DIL SWITCHES: Gold plated contact in fully sealed base - solve those programming problems.
4 Way 86p each. 6 Way £1.00 each. 8 Way £1.20 each.



DIL SOCKETS: High quality, low profile sockets:
8 pin - 10p. 14 pin - 13p. 16 pin - 15p. 18 pin - 19p. 20 pin - 25p.
22 pin - 29p. 24 pin - 35p. 28 pin - 39p. 40 pin - 57p.

ALL PRICES INCLUDE V.A.T. & POST & PACKING — NO EXTRAS
MIN ORDER - U.K. £1.00. OVERSEAS £5. CASH WITH ORDER PLEASE

Electronic Kits for the Thrifty!

Build 50 Interesting Projects on a P.C. Chassis with surplus components from your "Spares-Box."

EXPERIMENTER'S PRINTED CIRCUIT KIT

Contents: 4 small boards to suit the enclosed designs. Etching Powder, Resist Paint, Solvent, Degreaser and Etching Instructions, also 50 Circuit Diagrams, Chassis Plans and Layouts for simple Crystal Sets, Transistor Radios, Transmitters, Amplifiers, Intercoms, Radio Control, Metal Detector, Photoelectric and Ultrasonic Alarms, "Perpetual Motions", Light-Beam Telephone Instruments, Testers, Gadgets, etc. You can build at negligible cost with "Surplus" or reclaimed parts and transistors you already have.

Price: £1.70. Postage and Packing 30p.

PHOTOELECTRIC KIT

A kit of basic parts to build a simple I.R.-sensitive Photoelectric Switch. Contents: Phototransistor, Transistors, Diode, Resistors, Connector, Latching Relay, Chassis Board, Case, Screws and full instructions.

Price: £4.50. Postage and Packing 50p.

OPTICAL KIT

A kit of parts to build an I.R. folded-beam Projector and Receiver to suit the above kit. Contents: 2 Lenses, 2 Mirrors, 2 45-deg. blocks, Infra-Red Filter, Lampholder, Building Plans. Price £3.70. Postage and Packing 30p. Both kits together make an Invisible-Beam Alarm.

EXPERIMENTAL ELECTRONICS

335 Battersea Park Road, London, SW11 4SL

Send s.a.e. for full details of all kits and circuits

PROTON ELECTRONICS

SAME-DAY SERVICE

TTL		CMOS		LINEAR		BC109C		TIP30	
7400	12p	74LS04	16p	LM301A-B	26p	BC147/8	10p	TIP30	35p
7401	13p	74LS10	21p	555	21p	BC149	7p	2N3054	45p
7402	13p	4000	15p	555	15p	BC159	8p	2N3055	40p
7403	13p	4001	16p	709-14	28p	BL158	8p		
7404	14p	4002	15p	710-14	38p	BC182/3	8p		
7405	18p	4006	75p	741-8	17p	BC184	8p		
7408	18p	4007	18p	747-14	80p	BC212/3	8p		
7410	15p	4011	18p	748-8	38p	BC214	8p	IN914	3p
7414	50p	4012	18p	723-14	35p	ZX214	18p	IN4148	2p
7428	40p	4014	85p	CA3046	85p	BC327	16p	IN4001	4p
7442	82p	4016	42p	CA3080	75p	BC328	14p	IN4004	5p
7475	38p	4017	69p	CA3140	50p	BC337	15p	IN4007	7p
7476	38p	4017	69p	LM3900	48p	BC338	14p	IN5401	14p
7476	38p	4024	60p	MC1310P	110p	BC557	8p	OA91	7p
7485	98p	4030	50p	MC1458	40p	BC557	8p		
7489	35p	4035	88p	TBA800	80p	BCY70/71	13p		
7489	38p	4043	80p	TBA800	80p	BL72	13p		
7494	76p	4044	80p	TL081	33p	BD131/2	38p		
74100	110p	4047	95p	TL082	60p	BD135/6	38p		
74121	32p	4D51	78p			BD139/40	38p		
74150	88p	4066	85p			BFY50151	19p		
74150	18p	4069	20p			BFY52	19p		
741502	18p	4085/6	70p			AD161/2	40p		

0.5W Res. Carb. Film 51. E12 range 100-10m 1 1/2 p. Polyester Caps 0.015-0.068 4p. 0 1-0 1.33 6p. 0.47 8p. 0.68 8p. 1.0 13p.

All Full Spec. Guaranteed. C.W.O. 30p P&P. Mail order only
70 BRIGGS FOLD ROAD, EGERTON, BOLTON BL7 9SC

THE ZX80 MAGIC BOOK £4.75

For machines with 1-K RAM. New edition 3 contains 20 plus programs including one which allows you to make music with your ZX80, and games such as Moon Lander, Hamurabi, Othello, Hexpawn and Animals. Also sections on How it Works, Plotting, Using USB, Converting other BASICS, and Hardware Notes including circuits for static and dynamic memory extensions and I/O.

23 + 23 WAY ZX80 EDGE CONNECTOR. £3 MICROPROCESSOR POWER SUPPLY. £29.30

Cased, assembled and tested. 240V AC input. Stabilised outputs + & - 12V @ 350mA total, +5V @ 1A.

ASCII KEYBOARD. £39 inc. VAT, P&P

Brand new, assembled and tested. 60 keys arranged in typewriter style stepped rows. auto repeat function. UC + LC coded. S.A.E. FOR DETAILS

ALL PRICES INCLUDE UK DELIVERY & 15% VAT

TIMEDATA LTD.

57 Swallowdale, Basildon, Essex

ADVENTURES with ELECTRONICS



Similar to... of fun... with...

- 3 Rain
- 3 Motors
- 3 Three Input
- 3 Flashing Lamp
- 3 Electronic Organ
- 3 Electric
- 3 Fire Alarm

A complete Kit, including S-Dec, wire & battery, for the 16 projects described in Tom Duncan's book 'Adventures in Electronics' published by John Murray. No soldering. Adopted for class use in many schools: and a welcome gift for ages 11 upwards.

With book, £21.69
Without book, £19.84

Clear pictorial instructions for making the following: RAIN DETECTOR, INTERCOM, MORSE BUZZER, BURGALAR ALARM, 3 TYPES OF RADIO, PARKING LIGHT, FLASHING LAMP, ELECTRONIC ORGAN, METRONOME, SIREN, TIMER, COUNTER, FIRE ALARM.

ADVENTURES WITH MICROELECTRONICS

A similar Kit including 'Bimboard' and Integrated Circuits. Suitable for the complete beginner, or those who have already enjoyed 'Adventures with Electronics'.

With book, £33.11
Without book, £31.11

Conversion Kit: With book, £26.90
Without book, £24.90

Cash or cheque with order, please, to

UNILAB LTD. Clarendon Road, Blackburn, BB1 9TA, England.
Telephone (0254) 57643

Prices include carriage and VAT and are correct at time of going to press.

MAIL ORDER ONLY DELTA TECH & CO.

62 NAYLOR ROAD, LONDON, N20 0HN
Tel. 445 8224 VAT Inclusive Prices
Please add 35p for P&P

CERAMIC CAP (50V)		NE555	28p
33 pF to 4700 pF	4p	NE556	*45p
POLYSTYRENE CAP (50V)		NE566	140p
10 pF to 10000 pF	5p	SN76115N	*80p
POLYESTER CAP (100V)		TBA641B	200p
1 nF to 68 nF 8p; 100 nF 15 nF 8p; 220 nF 9p; 330 nF 10p; 470 nF 11p; 680 nF 12p; 1uF 14p; 1.5 uF 16p; 2.2 uF 20p; 3.3uF 18p; 4.7uF 15p*		TBA800	75p
ELECTROLYTIC CAP (uF/V)		TBA B10S	110p
1/25 to 47/25 6p; 68/25 7p; 100/35, 150/25 8p, 160/25 8p*; 200/12 6p; 250/12 7p; 220/25 10p; 470/25, 500/30 10p*; 470/40 mini 15p; 640/16 8p; 1000/10 8p*; 1000/25 24p; 1500/25 24p*; 2200/6.3 10p*		ZN414	90p
ZENER DIODES (400mW)		ZN1034E	220p
2V7 to 33V 8p			
VEROBORDS (1" copper)			
2.5" x 5"	65p		
3.75" x 5"	75p		
RESISTORS (5% E12)			
10 Ohms to 10Mohms	1.5p		
PRESETS (1.5W HORIZONTAL)			
100 Ohms to 2 Mohms	7p		
POTENTIOMETERS (1/2W)			
Linear & Log Scales			
4K7 to 2M2	33p		
LINEAR CIRCUITS		DIODES	
709-B	28p	OA47	8p
710-14	35p	OA91	7p
741-8	22p	OA200	6p
747-14	50p	OA202	9p
748-8	35p	IN916	5p
7490B	70p	IN4148	4p
CA302BA	85p	IN4001/2	4p
CA304E	50p	IN4003	5p
CA305A	40p	IN4004/5	6p
CA3080E	90p	IN4006/7	8p
CA3130E	75p	IN5400	13p
CA3140E	40p	IN5401	14p
CA3090AQ	50p	IN5402	15p
		IN5404	16p
LF351N	*200p		
	44p	BRIDGE RECTIFIERS	
		W02M	20p
		W06M	30p
		1A/50V	22p
		1.5A/75V	22p
		1A/200V	32p
		1A/400V	45p
		2A/100V	40p
		2A/400V	55p
		3A/100V	55p
		3A/600V	65p
		VOLTAGE REGULATORS	
		7805	70p
		7812/15	70p
		7818/24	70p
		7905	80p
		7912/15	80p
		7918/24	80p
		NE531	120p

OPTO/ELECTRONIC	4041	85p	7473	*18p	AC151	17p	BD121/3	75p	TIP36A	200p
2N5777	65p	4042	80p	*25p	AC153	25p	BD124	81p	TIP36B	210p
OCF71	65p	4043/4	99p	*25p	AC176	22p	BD131/2	40p	TIP41A	60p
ORP12	80p	4047	105p	30p	AC187/8	22p	BD135 to	40p	TIP42A	60p
DL704	110p	4048	60p	32p	AC187K	30p	BD140	40p	TIP2955	70p
DL707	110p	4049	50p	30p	AD149	+50p	BF178	30p	ZTX109	12p
0.125" & 0.2"		4050B	50p	18p	AD161/2	40p	BF179	19p	ZTX107/B	12p
		4066	60p	+25p	AF114	30p	BF180	34p	ZTX109	12p
		4068/9	22p	57p	AF124	35p	BF181	8p	ZTX300/1	14p
		4070B/1	22p	7492/3	AF125/6	35p	BF183	34p	ZTX302/3	18p
		4072/3	22p	7494	AF127	35p	BF184/5	25p	ZTX304	23p
		4081/2	26p	7495	AF139	40p	BF194/5	12p	ZTX311	18p
		4086	80p	7496	AF239	44p	BF196/7	12p	ZTX500/1	15p
		4510	100p	7497	BC107/B	10p	BF198	10p	ZTX502	20p
		4511B	100p	74100	BC109	10p	BF200	23p	ZTX503	17p
		4516/B	105p	74105	BC117	23p	BF224B	14p	ZTX504	24p
		4520/B	105p	74107	BC140	20p	BF244B	+22p	ZN696/7	20p
				74109	BC142/3	30p	BF258	26p	ZN698	20p
				74110	BC147/8	10p	BF259	40p	ZN706	14p
				74111	BC149	10p	BF259	30p	ZN914	20p
				74121	BC157/8	12p	BF260	20p	ZN918	35p
				74122	BC159	12p	BF261	32p	ZN1302/3	35p
				74123	BC167	14p	BF262	20p	ZN1304	35p
				74125/6	BC169C	13p	BF263	25p	ZN1306	30p
				74132	BC171	10p	BF264	25p	ZN1308	35p
				74141/5	BC173	6p	BF265/6	20p	ZN1613	25p
				74150	BC177/8	16p	BF266/7	25p	ZN1711	13p
				74151	BC179	16p	BF267	25p	ZN1893	25p
				74153	BC182	10p	BF268	20p	ZN2217	18p
				74154	BC182L	+8p	BF269	22p	ZN2219	23p
				74155	BC183B	10p	BF270	50p	ZN2222A	23p
				74156	BC184	10p	BF271	12p	ZN2369	17p
				74157	BC186	25p	BF272	22p	ZN2484	25p
				74160	BC187	25p	BF273	150p	ZN2646	48p
				74161	BC188	15p	BF274	210p	ZN2904/5	21p
				74162/3	BC207/9	13p	BF275	110p	ZN2906/7	21p
				74164/5	BC212	10p	BF276	52p	ZN2926G	10p
				74166	BC212L	+6p	BF277	110p	ZN3053	20p
				74173	BC213L	10p	BF278	10p	ZN3054	40p
				74174/5	BC214	+8p	BF279	10p	ZN3055	45p
				74176/7	BC238	18p	BF280	40p	ZN3442	140p
				74180	BC261B	25p	BF281	45p	ZN3702	20p
				74181	BC301/3	32p	BF282	45p	ZN3711	11p
				74182	BC328	17p	BF283	25p	ZN3772	+80p
				74190	BC338	17p	BF284	60p	ZN3773	250p
				74191	BC346	40p	BF285	92p	ZN3819	21p
				74192/3	BC477	35p	BF286	40p	ZN3820	40p
				74194	BC478	20p	BF287	42p	ZN3823	70p
				74195	BC479	23p	BF288	40p	ZN3866	65p
				74196	BC547/8	12p	BF289	42p	ZN3903/4	15p
				74197	BC557/8	14p	BF290	40p	ZN3906	15p
				74198	BC559	14p	BF291	40p	ZN4037	45p
				74199	BCY70	18p	BF292	65p	ZN5457/8	

CLEF KITS

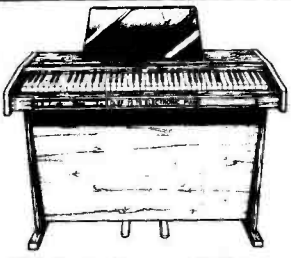

P.E. MASTER RHYTHM
A User Programmable Rhythm Generator for up to 24 selectable patterns on Eight tracks. Three instrumentation settings select from twelve instruments, and sequence operation gives up to 16 Bar pattern groups.

COMPONENT KIT—£79.00

ELECTRONIC ROTOR
Two-speed organ rotor simulator plus a three-phase chorus generator. Easily integrated with existing organ.
COMPONENT KIT £89.00.

KEYBOARDS (SQUARE FRONT)
49 NOTE C-C **£23.80**
73 NOTE F-F **£37.00**
88 NOTE A-C **£45.00**
All Keyboards are easily cut to provide your required length and compass. Quantity enquiries welcome.

BUILDING SERVICE
We are specialists in Electronic Piano Manufacture and can build your Piano for you — see lists.

INFORMATION
Please send S.A.E. quoting items of interest. Telephone BARCLAYCARD orders can be accepted. All prices include V.A.T., carriage & insurance.

Showroom:
44a Bramhall Lane South

EXPORT
Enquiries welcome — in Australia please contact JAYCAR (Sydney).

High Quality Electronic Musical Instruments under the personal supervision of Specialist Designer A. J. BOOTHMAN.

JOANNA 72 & 88 PIANOS
Six and 7/4 Octave Electronic Pianos with unique Touch Sensitive Action as used in the P. E. JOANNA, which electronically simulates piano key inertia — a feature not available in any other design. Build this widely acclaimed professional instrument, for either Domestic or Stage use, from our top quality Component kits.

SIX OCTAVES — £207.00
7 1/4 OCTAVES — £232.00

P.E. STRING ENSEMBLE
The versatile String Synthesizer with a fantastic sound at an economic price. Split Keyboard facility with a range of impressive voices.

COMPONENT KIT — £169.00
Back up TELEPHONE advice is available from the designer to supplement the clear instructions included with the above Kits.

P.A.s — SPEAKERS — CABINETS

Units can be supplied to add to the Component Kits, including Domestic or Stage Cabinets and portable tubular legs.

CLEF PRODUCTS (ELECTRONICS) LIMITED
(Dept. E.T.I.), 16 Mayfield Road, Bramhall, Cheshire, SK7 1JU, 061-439 3297

X10 Battery Tester Charger

Tests all sizes of batteries including watch and camera types. Also tests lamps, fuses and continuity. The addition of a 4.5 to 9, volt DC adaptor converts the X10 into a useful charger for all sizes of NICAD batteries.

Complete with test leads, instructions and 9 volt battery

£13.55
(incl postage and VAT)

Suitable AC/DC adaptor **£3.95**

N.T.C. SERVICES
331 East Prescott Road
Liverpool L14 2DD
051 228 4690

NTC

<p>MOTORS. 1.5V Model motors 22P. Sub. min. 'Big Inch' 115V DC 3 rpm motor 32p. Replacement B track 12V DC motor 55p. 115V AC 4 rpm motor 95p. 9V DC Cassette motor 55p. 6V Cassette motor, new standard jap. type £1.25.</p>	<p>S.W.A./FIELDSTRENGTH + POWER METER. S.W.A. 1:1 to 1:3. R.F. power 8-100 watts freq. range 1.5 MHz to 144 MHz. 152 (4) IMPERANCE. PL256 termination size 8" x 2" x 2" £9.95. JACKBOARD CROA 50 PE variable tuning condensers. Standard 1/4" spindle. 50p each.</p>	<p>SPECIAL OFFER DEC TYPE WREAR-BOARDS. Micro DEC "A" with 2 1/6 pin OIL carriers £3.95. Approximately half original selling price.</p> <p>SURPLUS P.C. BOARD with 15 C106 B CR. 4 road relays, 22 numbered transistors, various diodes, resistors, etc. £1.10.</p>	<p>MOTOROLA PIEZO ELECTRIC TWEETERS 3" direct radiating type £3.65</p> <p>PIEZO TWEETERS. require no crossover and can be used with systems up to 100 watts. Frequency response 3.8 to 28KHz.</p> <p>SUPER NORM version, flash range 315", £4.50.</p>	<p>TRANSFORMERS. All 240V DC primary (postage per transformer is shown in brackets after price). MINIATURE RANGE 6.0-6V 100ma, 9.0-9V 15ma, 12.0-12V 50ma all 70p each (15p), 12V 200ma 75p (15p), 0-5 0-5 200ma £1.20 (20p), 6V 500ma £1.10 (22p), 12V 2A £2.35 (45p), 12-0-12 2A £2.75 (50p), 15-0-15V 1A £2.25 (45p), 30-0-30V 1A £2.85 (54p), 20-0-20V 2A £3.65 (54p), 0-12-15-20-30V 2A £4.75 (54p)</p>	<p>KRT101 M/METER. 1,000 opv. 1KV AC/DC Volts, 150ma DC current, Resistance 0-2.5K, 0-100K, £4.35.</p>
<p>BUZZERS. Miniature solid state type, 2 voltages available, 8 or 12 vdc 75p each. LD10 12 volt buzzer, 50 x 30mm 55p. Carriers 12V DC Miniature alarm siren £7.85, 12V DC SIREN, all metal rotary type, high pitched wail, £8.50. Rotary alarm siren, 12V DC, red plastic unit with mounting bracket, 68 x 75mm £4.50.</p>	<p>TOOLS. SOLDER Sucker, good suction, ultra nozzle £4.99. Side cutters 5" £1.45. Pliers 5" £1.45. WRENCH DRIVER 8" LONG 50p. INTAMA 16 pin IC test clip £1.85. 5 PIECE precision screwdriver sets, individual handles, £1.05. JUMPER TEST LEAD SETS 19 pairs all leads with insulated cores each end 90p. CROWDING TOOL, a combination type for crimping red, blue and yellow terminations also incorporates a wire stripper (6 gauges) and wire cutter, insulated handles, only £2.30.</p>	<p>COPPER LAMINATED PRINTED CIRCUIT BOARD. Fibreglass Single Sided type (approx. 2mm thick) 150x95mm 40p, 200x90mm 55p. Double-sided Fibreglass 1mm thick, 180x135mm 45p. PAXOLIN BASED TYPE: (2mm thick), 180x135mm 40p, 200x200mm 50p.</p>	<p>RANK ARENA stereo cartridge pre-amplifier modules, suitable for magnetic cartridges, new, supplied with connection details, £1.95.</p>	<p>PROJECT BOXES. Sturdy ABS black plastic boxes with brass levers and lid. 75x96x35mm 65p, 95x7x35mm 75p, 115x9x37mm 87p.</p> <p>VERO HAND HELD BOX. 60p each. 24in x 3.7 in tapered, with screws 65p each.</p> <p>VERO POTTING PLASTIC Boxes with lid and screws 70x50x20mm, black, 43p each.</p>	<p>NH55 M/METER. 2,000 opv. 1KV AC/DC Volts, 100ma DC, Resistance 0-10K, 0-1 Meg, £5.50.</p>
<p>RELAYS. 2 types both operate on 12V DC, sealed plastic case types, 1-350 ohm with 2 make 5 amp contacts 75p, 2-1,000 ohm with 2 changeover, 1 amp contacts 75p.</p>	<p>MICROPHONES. Min. Tie pin. Del. used with cassette (suggested) £4.95. Low cost condenser ECM105 Omel, 600Hzms, on/off switch standard jack plug £2.95. EMS07 Condenser, uni, 600Hzms, 30-10kHz, highly polished metal body, £7.95. EM704 stereo condenser, mkt, UNI-DIR, 6000Hzms, 50-15000 Hz, internal variable, 212 ohm/imp, £12.25. EMS08 Condenser, cardioid, uni, 600Hzms or 50k, heavy chromed copper case, £12.95. DYNAMIC P.A. Mkt, mobile radio etc., 10mm switch 50k imp, £3.75. CASSETTE replacement microphones with replacement 35-10mm 40p. GRUNING Electrical inserts, with built in FET preamp 3.6V DC, £10.00.</p>	<p>TAPE HEADS. Mono cassette, £1.75. Stereo cassette £3.90. Standard B track stereo £1.95. 8SH MM 1330 1/2 track 50p. BSR SP90 1/2 track £2.10. TD10 dual head assembly 2 heads both 1/2 track R/P with built in erase £1.25.</p>	<p>FINNED HEATSINKS. Supplied indented 4mm thick, 27mm high, 75x124mm 60p, 150x124mm 95p. Smaller version 2.7mm thick, 75x108mm 48p. TRANSISTOR SOCKETS T05 or T018 9p each, T03 type 15p each.</p>	<p>35 WATT RMS STEREO SPEAKER SYSTEM. Monitor, Speaker, Tweeter (controlled) in black heavy alloy cabinet, 7 1/2" x 4 1/2" x 4" £35.75 pair P&P £1.95.</p>	<p>YN360 M/METER. 20,000 opv., 1KV AC/DC Volts, 250ma DC, Resistance ranges to 20 Meg, also has built-in transistor tester with leakage and gain ranges £12.50.</p>
<p>SPECIAL OFFER SEMICONDUCTORS. 2N6582 SCR 10p. 6X504 opto isolator 25p. CA3130 95p. CA3020 45p. TDA1151 25p. 741 22p. 723 35p. NE555 24p. NE555 50p. CD4069 15p. IN4005 10 for 30p. 00238 20p. 90438 20p. 7415 35p. 7414 75p. 91A33A 3mm LED displays 45p. Mkt. LDH 30p. LEDS 0.2" CLEAR 15p. GREEN 12p. RED 10p. Infra-red clear LED 30p. MPU131 PUTs, 40V, 200ma, 375mW 15p. 2K3773 £1.70. Texas R102B T103 Power trans. 50p. T64343 SCR 45p.</p>	<p>NEW STOCK ITEM — We are now stocking Expo metal hand-held drills, these are a precision British-made tool. Ideal for P.C. board drilling, model makers etc. They operate on 12V DC. Drill bit supplied in plastic hinged case, with drill and 21 accessories, drills, sanders, rasers, buffers, etc. complete kit only £17.25. Drill only £7.25. Drill stand in sail varnished drill press £12.95 (postage 65p).</p>	<p>SWITCHES. Sub. min. Toggles. SPST 8x5x7mm, 42p. DPDT (8x7x7) 55p. DPDT Centre off (12x11x9mm) 77p.</p> <p>PUSH SWITCHES (16x6mm), red top, push in make 15p each, push on break version black vinyl 17p each.</p> <p>SLIDE SWITCHES all OPDT 15x8x12mm 13p, 10x11x9mm 13p, 22x13x8mm 13p, 22x12x8 centre off 14p. Multiple slider double action (12 tags) 29x9x9x1mm 25p.</p>	<p>ALUMINIUM PROJECT BOXES. 18 SW.G. with fitted lid and screws. AB1 3x2x1 52p. AB2 4x3x1 50p. AB3 4x3x2 66p. AB4 6x4x2 74p. AB5 6x4x3 92p. AB6 8x6x2 105p. AB7 8x6x3 112p.</p>	<p>SPECIAL OFFER DEMAGNETIZER. Curved probe type, suitable for reel to reel or cassette machines, operates on 240V AC only £1.95.</p>	<p>HANDY BENCH VICE. 1" jaw opening £2.95, 6" £12.95.</p> <p>MOTORISED ALARM BELLS. 65ma, 80dB £7.95.</p> <p>AUDIOSONIC CAR STEREO CASSETTE PLAYERS. 3 watts per channel output, HiFi output amp., auto-stop mechanism (Japanese) £12.50.</p>
<p>LED VU METERS. Unlike sophisticated logic control circuit with adjustable rise and decay times via external capacitor. Spec: Response — 20Hz to 100kHz. Tolerance within ± 10%. Operates on 12-15V DC, 82mm long. Same high.</p> <p>MONO VERSION £6.95 STEREO VERSION £10.95</p>	<p>10 pin D.I.J. SWITCHES only 42p each.</p> <p>RIBBON CABLE 8-way single core miniature 22p per metre.</p>	<p>ROTARY SWITCHES (water) 3P4W, 4P2W, 2P6W and 1P12W all 35p each.</p> <p>INCADS. AA size 1.2 volts 500ma £1.10 each.</p>	<p>ANTEX SOLDERING IRONS. All 240V AC. Model C 15 watts £3.95. Model ICX 17 watts £3.95p. Model X25 25 watts £3.95p. ST3 SOLDERING IRON STAND, suits all Antex irons £1.65.</p>	<p>POWER SUPPLIES. Switched type plugs into a 13 amp socket has 3-4, 5.6, 7.5 and 9 volts 0 c out at either 100 or 400ma switchable £3.45. HC244H stabilised power supply 3-6 7.5-9V DC at 400ma, has polarity reversing and on off switch and is fully regulated to give exact voltage from no load to maximum current £5.50.</p>	<p>TRANSISTORS, REC/SENDER. 40KHz £3.50 pair.</p>

Terms. Cash with order (official orders welcomed from colleges etc) 30p postage please unless otherwise shown. VAT inclusive prices. S.A.E. for illustrated lists.

PROGRESSIVE RADIO
31 CHEAPSIDE, LIVERPOOL L2 2JD
ALL ORDERS DESPATCHED BY RETURN POST

MPA 200 100 WATT (rms into 8Ω) MIXER / AMPLIFIER

Featured as a constructional article in ETI, the MPA 200 is an exceptionally low priced — but professionally finished — general purpose high power amplifier. It features an adaptable input mixer which accepts a wide range of sources such as a microphone, guitar, etc. There are wide range tone controls and a master volume control. Mechanically the MPA 200 is simplicity itself with minimal wiring needed making construction very straightforward.

The kit includes fully finished metalwork, fibreglass PCBs, controls, wire, etc. — complete down to the last nut and bolt.

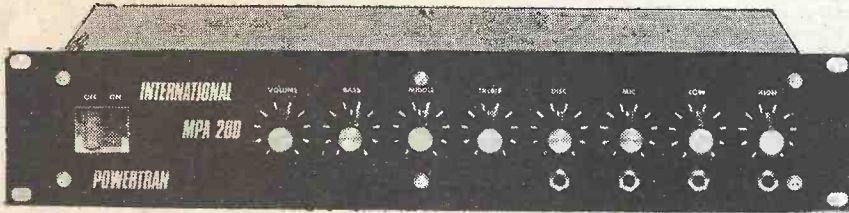

Panel size 19.0" x 3.5". Depth 7.3"

**COMPLETE KIT
ONLY**

£49.90 + VAT!

**MATCHES THE
CHROMATHEQUE 5000
PERFECTLY!**

CHROMATHEQUE 5000 5 CHANNEL LIGHTING EFFECTS SYSTEM

This versatile system featured as a constructional article in ELECTRONICS TODAY INTERNATIONAL has 5 frequency channels with individual level controls on each channel. Control of the lights is comprehensive to say the least. You can run the unit as a straightforward sound-to-light or have it strobe all the lights at a speed dependent upon music level or front panel control and construction very straightforward.

Kit includes fully finished metalwork, fibreglass PCB controls, wire, etc. — Complete right down to the last nut and bolt!



Panel size 19.0" x 3.5". Depth 7.3"

**COMPLETE KIT
ONLY**
£49.50 + VAT!

POWERTRAN

**SYNTHESIZER KITS ON PAGE 8. MORE KITS AND ORDERING
INFORMATION ON INSIDE FRONT COVER.**

All kits also available as separate packs (e.g. PCB, component sets, hardware sets, etc.). Prices in our FREE CATALOGUE.



**DE LUXE EASY TO BUILD LINSLEY HOOD
75W STEREO AMPLIFIER £85.00 + VAT**

This easy to build version of our world-wide acclaimed 75W amplifier kit based upon circuit boards interconnected with gold plated contacts resulting in minimal wiring and construction delightfully straightforward. The design was published in Hi-Fi News and Record Review and features include rumble filter, variable scratch filter, versatile tone controls and tape monitoring while distortion is less than 0.01%.



T20 + 20 20W STEREO AMPLIFIER £33.10 + VAT

This kit, based upon a design published in Practical Wireless, uses a single printed circuit board and offers at very low cost, ease of construction and all the normal facilities found on quality amplifiers. A 30 watt version of this kit (T30 + 30) is also available for £38.40 + VAT.

MATCHING TUNERS — See our FREE CATALOGUE!

Above 2 kits are supplied with fully finished metalwork, ready assembled high quality teak veneer cabinet, cable, nuts, bolts, etc. and full instructions — in fact everything!

BLACK HOLE

**MUSIC EFFECTS DEVICE — AS FEATURED
IN ELECTRONICS TODAY INTERNATIONAL!**

The BLACK HOLE designed by Tim Orr, is a powerful new musical effects device for processing both natural and electronic instruments, offering genuine VIBRATO (pitch modulation) and a CHORUS mode which gives a "spacey" feel to the sound achieved by delaying the input signal and mixing it back with the original. Notches (HOLES), introduced in the frequency response, move up and down as the time delay is modulated by the chorus sweep generator. An optional double chorus mode allows exciting antiphase effects to be added. The device is floor standing with foot switch controls, LED effect selection indicators, has variable sensitivity, has high signal/noise ratio obtained by an audio compander and is mains powered — no batteries to change! Like all our kits everything is provided including a highly superior, rugged steel, beautifully finished enclosure.

COMPLETE KIT ONLY £49.80 + VAT (single delay line system)

De Luxe version (dual delay line system) also available for **£59.80 + VAT**

Cabinet size 10.0" x 8.5" x 2.5" (rear) 1.8" (front)



GREENWELD

443A Millbrook Road Southampton SO1 0HX

All prices include VAT @ 15% — just add 40p post

THE SPECTACULAR 1981 GREENWELD

Component Catalogue

Bigger and better than ever!!!

- ★ 60p discount vouchers
- ★ First Class reply paid envelope
- ★ Free Bargain List
- ★ Priority Order Form
- ★ VAT inclusive prices
- ★ Quantity prices for bulk buyers
- ★ Free Data Sheet

— SEND 75p FOR YOUR COPY NOW!!

BUY A COMPLETE RANGE OF COMPONENTS AND THESE PACKS WILL HELP YOU

ALL PACKS CONTAIN FULL SPEC. BRAND NEW MARKED DEVICES — 50p FT. BY RETURN OF POST, VAT INCLUSIVE PRICES.

K001 50V ceramic plate capacitors. 5%, 10 of each value 22pF to 1,000pF. Total 210. **£3.69.**
K002 Extended range 22pF to 0.1µF. 330 values **£5.53.**

K003 Polyester capacitors. 10 each of these values 0.01, 0.015, 0.022, 0.033, 0.047, 0.068, 0.1, 0.15, 0.22, 0.33, 0.47µ. 110 altogether for **£5.07.**

K004 Mylar capacitors. min 100V type 10 each all values from 1,000pF to 10,000pF. Total 130 for **£4.05.**

K007 Electrolytic capacitors 25V working small physical size. 10 each of these popular values 1, 2, 4, 7, 10, 22, 47, 100µF. Total 70 for **£3.59.**

K008 Extended range, as above, also including 220, 470 and 1000µF. Total of 100 for **£6.05.**

K021 Miniature carbon film 5% resistors CR25 or similar. 10 of each value from 10R to 1M. E12 series. Total 810 resistors **£6.15.**

K022 Extended range. Total 850 resistors from 1R to 10M **£8.50.**

K041 Zener diodes 400mW 5% BZY88. etc. 10 of each value from 2.7V to 36V. E24 series. Total 280 for **£16.37.**

NEW K051 LED's — 10 each red, green & yellow 3mm & 5mm, with clips. Total 60 LED's for **£8.95.**

BUZZERS, MOTORS & RELAYS

Z401 Powerful 6V DC buzzer, all metal construction. 50mm dia x 20mm **85p.**

Z402 Miniature type buzzer, 6, 9 or 12V, only 22 x 15 x 16mm. Very neat **65p.**

Z450 Miniature 6V DC motor, high quality type 32mm dia x 25mm high, with 12mm spindle. Only **£1.**

A372 Audible Warning device — solid state circuit drives high efficiency transducer to give high output. Voltage read 4-18V. Can also be driven direct from TTL or CMOS. Module size 45 x 21 x 12mm. Comprehensive data supplied **£1.50.**

WH82 Heavy Duty 12V relay, ideal for car use — single 15A make contact. Coil 25R in sealed metal can with mounting bracket **85p.**

WH90 D.L. Reed relay SPCO 2.4-10V. 200R coil. Only **£2.20.**

FSRA60 Latching relay 2 x 10A contacts, 1M² 1B. Coil is 250R, and rated 60V ac, but works on 18-24 DC. Solid Encapsulation with screw terminals makes it ideal for use. **£1.20.**

REGULATED PSU PANEL

Exclusive Greenweld design — better spec than anything on the market being offered at the price. Panel 110 x 82 x 33mm high contains all components including bridge rectifier and smoothing capacitor. Ready built and tested — just add a 30V 2A transformer and two pots for a fully variable voltage and current supply.

SPEC Output voltage 0-28V
Output current 20mA-2A
Source impedance OR1
Open circuit ripple 10mV

Send SAE for full details of the many ways this useful module can be used, together with price list of parts for various options. Only **£7.75.**

IN4004 & 6 DIODES

Special purchase of 1A recs. Russian made. Packed in boxes of 300, **£8.50** per box, 4 boxes **£30.00**; 10 boxes **£75.00.**

DISC CERAMICS

0.22µF 12V 8mm dia. Ideal for decoupling 100 for **£2.75**; 1000 **£20.00.**
0.05µF 12V 15mm dia 100 **£1.50**; 1000 **£12.00.** Pack of disc ceramics, assorted values and voltages — 200 for **£1.00.**

TRANSFORMERS

Mains primary 50V 20A sec **£20.00.** Mains pri 110V 15A sec **£30.00**; 20A **£40.00.**

SLIDER POT SCOOP!!!

Made by Piber. types PL40CP & PL60C. Silty prices for superb goods!!!

PL40CP — 69 x 16 x 9mm, 40mm slide length 20R, 2k or 10k in only. Prices (any mix) 1-24 20p; 25-99 17p; 100+ 14p.

PL60C — 84 x 10 x 7mm, 60mm slide length. 5k, log, only. Prices 1-24 25p; 25-99 22p; 100+ 17p.

CALC CHIPS 60p!!!

New full spec. supplied with data. Type MK50321 — full function inc memory. Only 60p

DISPLAYS

8 and 9 digit 7-segment bubble type for above chips — most have minor faults, dud segment, etc. Mixture of 2 or 3 different types with data. 5 for **£1.00.**

NICADS

Ex-equip size C approx. **£1 each**; 10 for **£8.00.**

COMPONENT PANELS

Z525 Contain: 11 800mA 60V 2N5061 SCRs, 11 6VB zeners, 11 1N4004 diodes plus Rs, Cs, etc. Only **£1.**

Z529 74 Series ICs — Gates and complex logic, 20 asstd. ICs on panels **£1**; 100 ICs **£4.**

Z527 2x6V reed relays, 6x 25030 or 2S230 6x400V reeds, plus Rs. Only **50p.**

TTL, LINEAR, OPTO

All new full spec — Fairchild/SGS: TTL: 5400, 5401, 5402, 5403, 5404, 5405, 5410, 5421, 5430, 5450, 5451, 5453, 5460

— All 12p ea. 5470, 5472, 5474, 5475, 5476, 5480, 5486, 5490, 54107, 54121, 54122 — all 20p ea. 5482, 54126 — 40p ea. Others (74S, H) on B/L 12 (SAE please).

LINEAR: 9665 or 9666, 7 x 50V Darlingtons in 16 DIL 60p; 75452 or 4 dual periph driver 70p; XK1444 7 CMOS P-channel buffers, 15V 16 DIL 24p.

OPTO: Isolators, FCD831 60p; TLL115/118 60p; FPE100/106 Infra red LED **£2.50**; FND847 7 seg 8" CA **£2.00**; FND850 CC **£2.00.** (Data on request for linear & opto devices).

VEROBLOC BREADBOARD

New from Verobloc, this versatile aid for building and testing circuits can accommodate any size of IC. Blocs can be joined together. Bus strips on X & Y axis — total 360 connexion points for just **£4.15.**

BULK SUPPLIES

All new full spec. devices. Prices are for a minimum of 100 of any one device and exclude VAT, which must be added at 15%. Minimum order value from this section is **£10+VAT+post.** VAT receipt on request.

RESISTORS

Min. ¼W 5% carbon film 1R-10M (10% over 1M), all **£8.00/1,000.**

The following values only at **£3.50/1,000**, per value 47R, 82R, 18R, 39R, 56R, 220R, 1k, 4k7, 18k, 33k, 39k, 47k, 220k, 390k, 560k, 880k, 820k.

MIN. PRESETS

0.1W miniature type, open construction. All values from 100R to 1M, vertical or horizontal mounting. All at **£0.42.**

The following values only at **£0.3**: 470R, 470R^{1/2}, 500R, 1k, 1k5, 2k, 2k2, 2k5, 4k7, 10k. Also some PVR enclosed type at **£0.42**: 150R, 200R, 2kV.

POTS

5k lin, 100k lin; 220k lin; 500k log; 1M lin. All with std. bush and spindle. **14.**

ELECTROLYTICS—PC RADIAL LEAD

All 5mm pitch. Value/Voltage			
0.47/50	.022	47/40	.026
1/50	.024	100/16	.022
2.2/50	.024	100/40	.027
4.7/25	.042	220/63	.048
10/16	.021	330/25	.048
10/40	.023	1000/16	.06
22/25	.023	2200/40	.32
47/25	.025	8mm 16mm pitch.	

MiniBox Polysters

Value/Voltage/Pitch			
1/100/7.5	.024	033/250/10	.028
068/250/10	.024	22/100/15	.036
022/400/10	.024	33/100/15	.046
01/630/7.5	.022	47/100/15	.052
01/100/7.5	.022		

ZENERS. 400mW 5% 2V4 3V6 4V7 6V2 6V8 7V5 8V2 11V 12V 14V 18V 24V. All at **£0.3**

LED'S

3mm red	.065	5mm yellow	.09
3mm yellow	.08	5mm green	.09
3mm green	.08	3mm clips	.02
5mm red	.06	5mm clips	.02

MINIATURE CERAMIC CAPS

Thompson; CSF miniature type in the following values

3.9pF,	4.7pF,	22pF,	33pF,
47pF,	47pF,	47pF,	68pF,
82pF,	100pF,	560pF,	2700pF.
All 5% except 10%, 120%.			

Prices, up to 200pF **£7/1000**
100pF **£9/1000**
560pF **£6/1000**
2700pF **£9/1000**
Samples on request (see please).

Mullard min. ceramics:

33pF 5% 100V			£7/1000
330pF 2% 100V			£8/1000
3300pF 10% 100V			£13/1000

Stettner min. ceramics

330pF 5% 63V			£7/1000
022µF 63V			£14/1000
Lenco 047µF 63V			£16/1000

SEMICONDUCTORS

741, 12, 655, 19, 740, 108, 7405 09; 74L74, 21, 4001, 17, 4011, 17, S1 signal diode like

IN4148 by T10g bandoleried reeds of 10k **£80/1k** **£10k**; IN4002 **£25/k**; IN4006 **£34/k**; IN4007 **£36/k**; Ge signal diode DK14 **£20/k**; SCRs 2P4M (C10BD) 4A 400V. 26 2N5060, BA 30V

.15 CR201 1A 200V. 18. Send see for latest bulk buyers list.

CALCULATORS

ALL EQUIPMENT NEW, BOXED AND FULLY GUARANTEED
Order with confidence and pay no more

PROGRAMMABLE SCIENTIFIC

Casio FX501P	£46.95
Casio FX502P	£66.95
Casio FA1 Adaptor-Cassette Interface	£19.95
Casio FX501P with FA1	£64.95
Casio FX502P with FA1	£84.95
Texas T157	£28.91
Texas T158	£67.95
Texas T158C	£86.95
Texas T159	£176.95
Texas PC100C	£176.95
Sharp EL5101 16 Digit	£46.95
Sharp EL5100 24 Digit	£56.95

SPECIAL OFFER

Texas T158C with PC100C **£250.00**
Texas T159 with PC100C **£350.00**

Includes mains adaptor/charger

TEXAS ACCESSORIES in stock e.g. Libraries, etc.

Maths/Utilities, Applied Stats/Electrical Engineering	Each £25.95
Surveying, Structural Engineering	Each £62.95
PL100C Rolls 10 off	£21.95
Battery Packs. State model or BP number	£6.95
Texas T1 Programmer	£51.95
Texas T151 111	£28.95

QUALITY WITH FULL GUARANTEE

See Page 11 September E.T.I.



CASIO CLOCK CALCULATORS

MQ6	£17.95	AQ 2200	£18.95
AC1600 new model	£15.95	MQ 12	£18.95

CASIO SCIENTIFICS

		8 DIGIT		10 DIGIT	
FX68	£18.95	FX100	£14.95		
FX81	£13.95	FX510	£18.95		
FX330	£15.95	FX3200	£20.95		
FX2600	£18.95	National NS108	£17.95		

* ALL PRICES NOW INCLUDE V.A.T., POST AND PACKING *

Cheque with order or C.O.D. 75p. Extra up to **£100**

FREEPOST NO STAMP NEEDED. S.A.E. WITH ENQUIRIES PLEASE
CALCULATOR SALES & SERVICE, Redditch, Worcs. FREE POST
B98 OBR

MIGHTY NINETY PACKS

SUPER VALUE PACKS ALL AT 90p EACH

POSTAGE 15p PER PACK UP TO FOUR PACKS

FIVE OR MORE POST FREE

BUY SIX PACKS AND GET A SEVENTH PACK FREE!

MN1. 300 ¼-watt Resistors pre-formed for P&C Mtg.	MN23. 116 asstd. screws, nuts, washers, self-tappers etc.
MN2. 200 ¼ & ½-watt Resistors.	MN24. 100 asstd. small springs.
MN3. 100 1 & 2-watt Resistors.	MN25. 50 asstd. pop rivets.
MN4. 50 Wirewound Resistors.	MN26. 50 asstd. insulated crimps.
MN5. 100 metal oxide Resistors. 1%, 2% and 5%.	MN27. 200 items, grommets, spacers, cable markers, plastic screws, sleeving, tie wraps etc.
MN6. 12 asstd. potentiometers.	MN28. 20 asstd. fuses 1¼" 20mm etc.
MN7. 25 asstd. skeleton pre-set Resistors.	MN29. 75mts equipment, wire, asstd. colours and sizes.
MN8. 50 asstd. Electrolytic Capacitors.	MN30. 3 x 2m length, 3 core, mains cable.
MN9. 100 asstd. Ceramic Capacitors. P1te, disc, tub and monolithic etc	MN31. 12 asstd. trimmer capacitors, compression film. Air-spaced etc.
MN10. 100 mixed capacitors. Polyester, Polystyrene, Metallised, Radial and Axial types.	MN32. 15 30pF Beehive trimmers.
MN11. 20 asstd. Silver Mica Capacitors.	MN33. 20 coil formers, ceramic, plastic, reed relay etc.
MN12. 8 Tantalum Bead Capacitors (useful values).	MN34. 25 min. glass reed switch.
MN13. 20 asstd. Transistors. BC, 2N Series + Power etc.	MN35. 10 asstd. switches, toggle, slide, micro etc.
MN14. 40 IN4148 Diodes.	MN36. 10 ex equipment panel lamps (no rubbish).
MN15. 5 Light Sensitive Devices.	MN37. 10 asstd. audio connectors. Din phone etc.
MN16. 20 min. wire-ended Neons.	MN38. 1 PCB with triac control IC data inc.
MN17. 2 12-volt Relays. Ex nearly new equip.	MN39. 1 oscillator PCB loads of components. (no data).
MN18. 3 Encapsulated Reed Relays, 9-12v. coil, d-pole and t-pole.	MN40. 50 Polystyrene capacitors.
MN19. 2 24-volt Relays. Ex nearly new equip.	MN41. 10 asstd. T.L.L. I/Cs.
MN20. 1 240-110 to 12-volt, 100mA Transformer	MN42. 10 BC107 Transistors.
MN21. 1 240-110 to 24-volt 100mA Transformer	MN43. 10 BC108 Transistors.
MN22. 8 2" Led's with clips, 4 red, 2 yellow, 2 green.	MN44. 10 Screwfix S.P.C.O. min slide switches.

CHORDGATE LTD.

75 FARINGDON ROAD, SWINDON, WILTS
TEL: SWINDON (0793) 33877

RETAIL SHOP AT ABOVE ADDRESS

PLEASE QUOTE NO. OF PACKS WHEN ORDERING

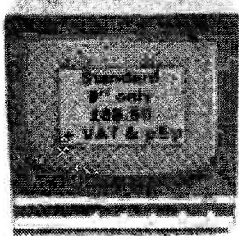

VIDEO MONITORS

for CCTV or Character Display

P4 (White) P31 (Green) and P39 (Green, Long Persistence) available as standard.

MONITOR DRIVE BOARDS

for OEM's available for both 90° and 110° Tubes.

PHONE OR WRITE FOR DETAILS

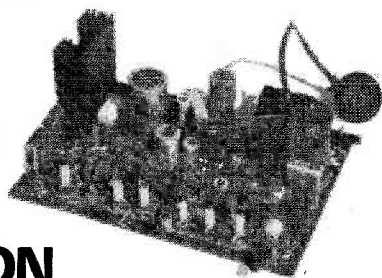

CROFTON ELECTRONICS LIMITED

35 Grosvenor Road, Twickenham Middlesex TW1 4AD.

Telephones: 01 891 1923/1513

HAND HELD GAMES

- Supersonic Mastermind £21.00
 - Galaxy Invaders £22.95
 - Mattel Soccer £21.50
 - ENTERPRISE 4 in 1 £24.95
 - 3 Games and calculator in one
 - *Electronic Mastermind £12.90
 - U.F.O. Master Blaster £24.95
 - Amaze-A-Tron maze game £18.95
 - Touch Me by ATARI (like Simon) £26.95
 - Football (two players) £24.95
 - ZAP missile game £11.95
 - *DIGITS (like Mastermind) £14.95
 - Space Invaders £21.95
- ALL GAMES HAVE SOUND EFFECTS EXCEPT ***

PINBALL WIZARD

The latest from the U.S.A.
 *Still available *
 Featured in Nov. issue of E.T.I.
 Home TV Game — B/W Kit
 Basic Kit **£28.90**
 Contains everything except box and controls
 Box & Controls — **£6.50**. Mains Adaptor — **£3.90**
 Play 7 games with 4 options on each game
 4-Pinball games 2-Basket, 1-Breakout
 Versatile car alarm kit **£18.90**
 See review in Hobby Electronics November
 CHROMA CHIME 24 tune door chimes kit **£10.75** Built **£15.95**
 C.B. Aerials and Accessories

ATARI video computer £99.95

- Sargon 2 5 Chess £278.00
- Super System 3 Chess £149.95
- SPACE INVADERS CART £29.95**
- STAR CHESS T.V. Game £63.35
- DATABASE Prog. T.V. Game
- NEW £89.95**
- NEW £59.95**
- CHESSMATE 8 Level **NEW £84.00**
- CHESS CHALLENGER 7 **£84.00**
- CHESS CHALLENGER 10 **£155.00**
- VOICE CHALLENGER **£219.00**
- CHECKER CHALLENGER 2 **£54.00**
- *CHECKER CHALLENGER 4 **£90.00**
- ZODIAC Astrol Computer **NEW £29.95**
- Snooze Alarm **£14.90**
- EL-MAC 5MHz Scope **£139.90**
- EL-MAC 3" 5MHz Scope **£115.00**
- RADAT 10MHz Scope **£169.00**
- PDM35 **£36.50**
- PFM **£52.30**

COMPUTERS — Home, Business etc.

- Videogenie System 16k £368.00
 - PET 8K **£458.85**
 - PET 16K **£573.85**
 - SORCERER 16K **£861.35**
 - SORCERER 32K **£918.85**
 - SUPERBOARD II 4K **£180.00**
 - UK 101 Kit 4K **£205.85**
 - Built 4K **£286.35**
 - TRSBO Level 2 16K **£409.40**
 - 5 1/4" Floppy Drive **£271.40**
 - Dual Drive **£506.00**
 - NASCOM 2 Kit **£339.25**
 - HEATH WH89 **£1,805.00**
 - HEATH WH14 Printer **£586.50**
 - Softy Kit **£115.00**
 - Softy Built **£138.00**
 - Intelligent EPROM Programmer
 - Sharp Software
- PRINTERS : FLOPPY DISCS : BOOKS**

S.a.e. Enquiries. Please allow up to 21 days for delivery. All prices inc. of VAT.

N.I.C.
 UNIT 5
 61 BROAD LANE, LONDON N.15 4DJ
 Day 01-808 0377; Eve 01-889 9736

OHIO SCIENTIFIC SUPERBOARDS WITH 32 x 32 DISPLAYS

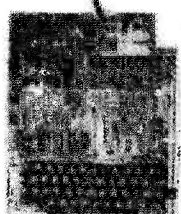

Announcing the new 50Hz guard band models with 1.5MHz clocks giving 50% more speed, a full 32 x 32 display and a multi-speed tape interface.

BLACK AND WHITE £159 + 15% post free
COLOUR VERSION £225 + 15% VAT

THE UNIQUE SPECIAL OFFER YOU CANNOT RESIST

If bought with Superboard these items are at the reduced prices shown first. Also sold separately at the bracketed prices. Add 15% VAT. Guard band kit £0 (EB). Modulator and power supply kit £1 (£25). 4K extra ram £20 (£24). Display expansion kit, approx. 30 lines x 54 characters, £15 (£20). Case £23 (£28). Colour conversion board kit £35 (£45) or built £65 (£65). Cassette recorder £14 (£16). CEGMON improved monitor rom poa. Extended monitor (tape) £20 (£20). Assembler/Editor £25 (£25). Word processor £10 (£10).

CHEAPO EXPANSION OFFER

Buy a 610 expansion board with 8K ram on board and space for another 16K for £159 + 15% and get a free 5V 2A power kit and any extra ram you want for £3.50/K + 15%. Buy a minifloppy + case + power supply + 2 copies dos for £275 + 15% with the 610 and we will do the extra ram for £2/K + 15% (up to 16K).

PRINTERS



The best value in matrix printers and a fantastic cheap offer to boot, OKI Microline 80 (illustrated) £359 + 15% BASE 2 8008 (new improved version of the 800MST) £359 + 15%. BASE 2 850 Model price by secret quotation only. Anacorn 150 £699 + 15%. Buy any of the above and we will supply an interface kit and word processor program for Superboard for only £1.

THE NEW OHIO SERIES 2 CHALLENGER CIP



Program selectable 24 x 24 or 12 x 48 displays. Sound, music and voice output. 8K ram expandable to 32K. 8K basic. We dare not publish our cheap price for fear of being gunned down in the street by desperate rivals. Send a highly oblique sae for a stunning quote from the masters of cheap and freebie trading. We also stock the CIPMF Series 2 disc version. Again, secret quotations only.

SWANLEY ELECTRONICS

Dept. ETI, 32 Goldsel Rd., Swanley, Kent BR8 8EZ

Telephone Swanley 64851. Please add 40p postage. Prices include VAT unless stated. Lists 27p post free. Overseas customers deduct 13%. Official credit orders welcome.

TV GAMES

- AY-3-8550 chip £4.00, kit £5.26
- Stunt cycle AY-3-8755 chip + kit £20.95
- 10 game paddle 2AY-3-8600 chip £5.95, kit £7.03
- Modified stool kit £5.25
- Col. our generator kit £9.95

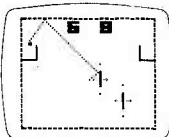

MAINS TRANSFORMERS

- 6-0-6V 100ma 96p, 1 1/2a £3.32, 9-0-9V 75ma 96p, 1a £3.08, 2a £4.93, 12-0-12V 100ma £1.20, 1a £3.70, 15-0-15V £3.98

JC12 and JC20

Integrated circuit audio amplifier chips with data and printed circuits. JC12 6 watts £2.50. JC20 10 watts £3.54.

CONTINENTAL SPECIALTIES PRODUCTS

- EXP300 £6.61, EXP350 £3.62, EXP325 £1.84, EXP650 £4.14, EXP4B £2.64.

STABILIZED POWER KITS

TTL computer supplies 5v 2a £8.30, 5v 4a £14.16, 8-way types 3/4v/6/7v/9/12/15/18v 100 ma, £3.12, 1a £8, 2a £12.11. Variable voltage models 2-18v 100ma £3.12, 1-30v 1a £8.30, 1-30v 2a £14.82.

PRINTED CIRCUIT MATERIALS

PC etching kits: economy £2.92, standard £5.26, 40 sq in pcb 50p, 1 lb FeCl £1.70. Etc resist pens: economy 50p, dolo 90p, drill bits 1/32nd in or 1mm 35p. Etching dish 92p. Laminated cutter £1.30.

BI-PAK AUDIO MODULES

- AL30A £4.53, PA12 £9.31, PS12 £1.75, T538 £2.90, S450 £27.90, AL50 £5.62, PA100 £19.24, SPMB0 £5.26, BMT80 £6.36, Stereo 30 £24.14, AL80 £8.56.

COMPUTER GAMES

New Sensory Chess Challenger 8 £119, Chess Challenger 7 £79, Chess Champion 6 £49.95, Checker Challenger 2 £33, Star chess £62, Atari video computer £107, Cartridges £14.85 (except chess £43.95, backgammon £33.95 and space invaders £27.50).

S-DEC AND T-DECS

S-Dec £3.79, T-Dec £4.59, 16 dif adaptor £2.31.

COMPONENTS

1N4148 8.9p, 1N4002 3.7p, 2114 memory chips, low current 300ns £3.45, 723 14 di 36p, NE555 8 di 7p, 741 8 di 20p, bc 547, bc549, bc182, bc184, bc212, bc214, 6.1p, tip 32c 43p, tip41c 48p, bd132, 32p. Fuses 20mm x 5mm cartridge, 15, 25, 5, 1, 2, 3, 5a quickflow 2p. Resistors, 5% 1/4W E12 10R to 10M 1.5p, 0.5p for 50+ of one value. Polyester capacitors 160v, 0.15, .068mf, 2.5p, .047, 1m 4p, .01mf 3p, .022, .033mf 3.3p, .15, .22, .33mf 4.9p, .47mf 6p. Polystyrene capacitors E12 63v 10 to 1000pf 4p, 1n2 to 10n 5p. Ceramic capacitors 50V E6 22pf to 47n 2.5p, electrolytic capacitors 50v, 5, 1, 2mf 6p, 25v 5, 10mf 6p, 16v 22, 33mf 6p, 47, 68mf 5p, 100mf 7p, 330 470mf 5p, 1000mf 11p. Zeners 400mW E24 2v7 to 33v 7p. Preset pot subminiature 0.1W horiz or vert 100 to 2M2 8p. Potentiometers 1/4W 4K7 to 2M2 single 29p, dual 71p, 1/2" red LEDs 11p, IC sockets 8 di 8.7p, 14 di 10.1p, 16 di 12p.

BATTERY ELIMINATORS

3-way types with switched output and 4 way multi jack: 3/4v/6v 100ma £2.99, 6/7v/9v 300ma £3.50. 100ma radio types with press-stud connectors 9v £4.77, 6v £4.77, 4.5v £4.77, 9 + 9v £5.99, 6 + 6v £5.99, 4.5 + 4.5v £5.99. Cassette recorder mains unit 75v, 100ma with 5 pin di plug £4.77. Fully stabilised type 3/6/7v/9v 400ma £7.15. Car converters 12v dc input, output 75v 300ma £1.18; output 3/4v/6/7v/9/12v 800ma £3.04.

BATTERY ELIMINATOR KITS

100ma radio types with press-studs connectors 4 1/2v £1.64, 6v £1.64, 9v £1.64, 4 1/2 + 4 1/2v £2.30, 6 + 6v £2.30, 9 + 9v £2.30. Cassette type 75v 100ma with di plug £1.64. Heavy duty 13-way types 4 1/2/6/7/8v/11/13/14/17/21/25/28/34/42v 1a £6.82, 2a £10.86. Car converter input 12v dc, output 6/7 1/2/9v 1A stabilised £1.62.

SINCLAIR PRODUCTS



SC110 10MHz oscilloscope £144.95, PFM200 £51.95, case £2.07, adaptor £4.20, connector kit £13.95, Microvision TV £89, adaptor £6.88, PDM35 £34.25, adaptor £4.20, case £2.07, DM350 £88.21, DM450 £109.11, DM235 £59.95. Accessories for all 3 models: rechargeable batteries £7.99, mains adaptor/charger £4.20, case £8.90. Enterprise prog calculator £19.95, TG105 £87, TF200 £150.

★

2

Special Offer.
£2 OFF!

SUPERB NEW KITS!

1st
Top of all systems tested by independent national authority July '79

C300/ES200

high performance electronic ignition, to add power, economy, reliability, sustained smooth peak performance, instant all weather starting, to your car.

Surefire has sold in its thousands in ready made form from big name accessory firms, but it is now available in quality kit form to fit all vehicles with coil ignition up to 8 cylinders.

ES200. A high performance inductive discharge ignition incorporating a power integrated circuit (special selection); electronic variable dwell circuit (maximises spark energy at all speeds); pulse processor (overcomes contact breaker problems). Coil governor (protects coil). Long burn output. Negative earth only. Compatible with all rev. counters.

C300. In it's ready built form (C3000) it came top of all systems tested by an independent national authority July '79. A high energy capacitive discharge ignition incorporating a high output short circuit proof inverter, top grade Swedish output capacitor, pulse processor circuit, transient overload protection. Fast rise bidirectional output ideal for fuel injection, sports carburation, oily engines. Compatible with most rev. counters. (Low cost adaptors available for rare cases). Application list enclosed with each kit. Note: Vehicles with Smiths/Jaeger rev. counters code RVI on dial will require adaptor type TC1).

What's in the kits. Surefire's own precision anodised aluminium extruded case. P.C. mounted security changeover switch, static timing light. Special selection Motorola semi-conductors. Capacitors, resistors etc. selected after 5 years experience. Glass fibre pcb, solder, complete down to last washer. Fully illustrated comprehensive instructions and full technical back up service.

SUREFIRE
ELECTRONIC IGNITION

Suretron Systems (UK) Ltd.
Bayer Buildings, Lower Bristol Road, Bath, BA2 3EF. Tel: Bath (0225) 332317

Dept. ETI 11

Name _____

Address _____

*Phone order with Access Barclaycard
VAT and P & P inc

Quantity
required

ES200: Neg	£13.95	£11.95	
C300: Pos	£17.95	£15.95	
C300: Neg	£17.95	£15.95	
Tacho Adapt. TC1		£3.90	

I enclose
chq. PO's
£
Chq No

Quantum Electronics

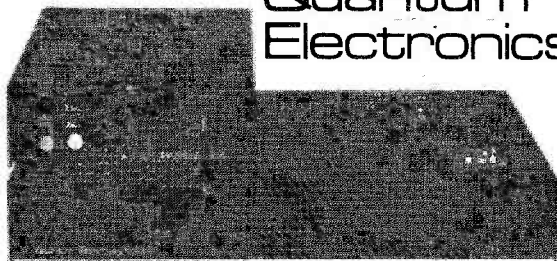

The 102, shown above, must be the most cost-effective pre-amp available, catering for auxiliary, 2 or 3 head tape and providing a perfect match for any cartridge, moving coil or magnetic, by using our unique low-cost matching card to define the sensitivity and cartridge loading. Prudent choice of components and elegant circuitry give outstanding objective and subjective performance (see Popular Hi-Fi August). The module used in the 102 is available separately, as are suitable mains supplies and moving coil head amp/modules. There are two matching stereo power amp kits which are supplied with built and tested circuit boards, requiring only straightforward assembly and point to point wiring. The new ready-built 'D' versions feature separate d.c. supplies for each channel and other refinements which elevate their performance into the super-fi class but which are not incorporated in the kits. Our power amp modules and supplies below enable an amp of high specification to be constructed.

★ **COMING SOON: ACTIVE CROSSOVERS ★**
102 pre-amp: module only £63.50; built £92.00

45W channel: kit, P2, £100.50; built, 202D £151.00
110W/channel: kit, P4, £126.00; built, 204D £185.00

POWER AMP MODULES AND SUPPLIES

QE 1708, 1704 £31.96 QE 3003 £46.29*
QE 1004 (688) £20.69 QE 3008 £49.97*

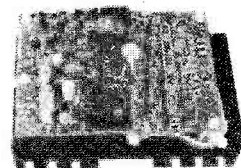

M1504, 1508 £35.79. M3003 £50.28. M854
£26.00. M3008 £53.96. M4002, 5004 £82.60*

6 NEW MODULES ★ NOW UP TO 500W r.m.s.!

We offer a wide range of modules to suit virtually any application with an honest specification unbeatable at the price. They are available in both the popular medium duty 'L' bracket format for up to 300W r.m.s. (M3008, M56, 80hms) and also in high dissipation versions using various heatsink combinations. Correct choice of modules allows reliable continuous operation at up to 500W r.m.s. (M5004, 1756, 40hms) without premature cut off or the need for external circuitry. Matching toroidal power supplies with single and double d.c. sections are available. Exemplary specifications include i.h.d. less than .01% at 1kHz; 30 V/μs slow rate; noise below 110dB; integrity protected against overload and high d.c. output offset; stable into any load.

★ **EXCELLENT TRADE PRICES ★**

NEW DELUXE SPEAKER KITS



SYSTEM 1
£69.00

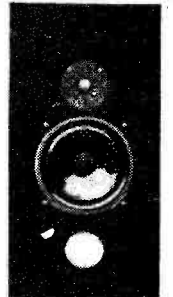

SYSTEM 2
£89.00



SYSTEM 3
£159.00



SYSTEM 4
£359.00

PRICES PER PAIR INC. BAFFLES

Have you wondered why the existing sources of speaker kits offer a bewildering choice of systems, particularly combinations of 200mm bass unit and tweeter? Don't they know which ones are best? If so, why bother with the rest? Well we have sorted out these super kits so you can order in confidence, knowing you get our full endorsement of their performance and value. The kits incorporate professionally finished front baffles with the drive units already mounted so all the fiddly work is done for you. All that is left to do is to make a simple box. Crossover networks, foam and terminals are included. Systems 1 and 2 use a 200mm bass and 25mm dome tweeter from Son Audax, System 2 being a reflex design that we enthusiastically recommend. System 3 is a competitive 3-way I.B. using Seas bass and mid with a Son Audax tweeter, cleverly incorporating a stand at the bottom of the enclosure, as does System 4, undoubtedly the best kit on the market, using a Volt 250mm bass driver with a 250mm ABR on the rear baffle (also supplied), a modified Peerless mid and Son Audax tweeter. We will also be retailing selected drive units at competitive prices, e.g. Son Audax 200mm bass, 20B25J4 £13.50; 25mm tweeter, HD100D25, £9.00.

All our prices include V.A.T. and delivery. Export no problem — please send for a specific quote by return. All equipment can be wired for 110V mains. Please send a large S.A.E. or dollar bill for our full information and review reprints.

SWEDEN: BLN LJUD HI-FI, SÖDRA KASERNGATAN 14 B, S291 33 KRISTIANSTAD
U.S.A.: OX DISCO, BOX 123, CLAYMONT, DELAWARE 19703
8 ALBION STREET, LEICESTER. Tel. 546198

CLASSIFIEDS

RATES

1-3 insertions £7 per scc
 4-11 insertions £6.50 per scc
 12 insertions £6 per scc
 24p per word (min. 15 words)
 Box No. of application

All advertisements in this section must be pre-paid
 Closing Date:- 1st Fri. month preceding publication

Advertisements are accepted subject to the terms and conditions printed on the advertisement rate card (available on request).

SEND TO:- ETI CLASSIFIED, 145, CHARING CROSS ROAD, LONDON WC2H 0EE. TEL: 01-437 1002

TELEPHONE ANSWERING MACHINES,

Super Phones, Radio Phones, etc. Ring C.W.A.S. 0274 682674.

150 ASSORTED RESISTORS £1.100
 assorted capacitors £1, 100 IN4148 £1. P. and P. 20p. S.a.e. lists of components, mikes, meters. Dept. T, D.B. Products, 1 Holly Tce., York, YO1 4DS.

Earn £20-£100 p.w. in your spare time

by introducing the revolutionary new Flip-Caller telephone to your friends. Features micro-chip controlled push-button dialling and memory recall. Sells itself. Generous commission. For details write to Dept. ETI

IDL SUPERPHONE
 P.O. Box 31, Twickenham TW2 5RL

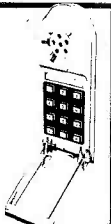

COLOUR MODULATOR

- R G B inputs, PAL/UHF output
- Unlimited colour combinations
- TTL etc interface details supplied
- 1000's already in use!



KIT: only **£12** Built & Tested: only **£18**

— please add VAT at 15% to all prices
 — Barclay/Access orders accepted by telephone

WILLIAM STUART SYSTEMS Ltd

Dower House, Billericay Road, Herongate, Brentwood, Essex CM13 3SD. Telephone: Brentwood (0277) 810244

BURGLAR ALARM Component Catalogue out now. Ring: C.W.A.S. 0274 682674.

£99 SYNTHESISER DIY. Professional results, easy-build. S.a.e. Dewton, 254 Ringwood Road, Ferndown, Dorset BH22 9AR.

CIRCUIT DESIGN, Prototype construction? Analogue or Digital. Single Circuits or Complete Instruments/Systems. Write A. J. ATTWOOD, C.Eng., MIERE, Heathercote, Heatherthorn Park, Taunton, Somerset, TA4 1ET or Phone Bradford-on-Tone (082-346) 536.

SHARP COMPUTERS NEW LOW PRICES

Pocket Computer PC1211, complete with cassette interface. CE 121 **£108.95**
 M280 Computer 20K **£504.85-48K £573.85**
 M280 P3 Line Printer **£585.50**. M280FD Disc Drive **£885.50**.

M280 I/O Expansion Interface **£109.25**. All prices include VAT and UK delivery

ELKAN ELECTRONICS
 28 Bury New Road, Prestwich Manchester M25 8LD

TTL CMOS 74LS LEDs

LB ELECTRONICS

LINEAR RAMS EPROMS SURPLUS

TELEPHONE: UXBRIDGE 55399

PCB OFFERS

(1A) 100 bit shift register PCB, 115mm x 94mm containing 9 x 7491, 6 x 7496 and 1 x 7441. Terrific bargain 85p, p&p 30p.
 Data General Nova 3 PCB 4K memory **£40 each** + £2 p&p

MPU CORNER

2122 (200ns), **£3**. 2114 (450ns) **£4.50**.

Texas Instruments: 2716 single rail. Brand new. Full spec. **£6.95 each** p&p 25p. 2708 (400ns) **£4.50**.

MK 1002P (dual 128 bit Shift Reg) **35p**.

LM711CH (Voltage Comparator) **30p**.

(All Full Spec)

2526 Character Generator (64 x 9 x 9) **£2.95** + data & p&p 25p.
 MM5240 AA/J Character Generator **£3.50** + data. p/p 25p.

International rectifier **SOLID STATE RELAY** type A2402. Output 240 VAC 2.5 amps input 90-240 VAC/45-200 VDC **£6.00** p/p 25p.

D TYPE CONNECTORS

9 Way: sockets (solder) **55p**.
 15 Way: wirewrap plugs only **75p**.
 50 Way: skt (wirewrap) **£1.65**.
 50 Way: skt **£1.45**, p&p 25p.
 25 Way Male to Female with covers plus minimum 1 metre of cable (12 way) **£4.00 each** p/p 35p.
 25 Way plug (solder/cail), 25 Way socket **£1.20 each**.

COVERS

25 Way: **75p** (plastic), p&p 25p.
 37 Way: **90p** (plastic), p&p 25p.

DISPLAYS

HP 5082 4 digit DIL display full spec **£1.50 each**, p&p 25p. Large quantities POA.
 MAN 72 7 seg CC **£1.25**, p&p 25p. Burroughs Panaplex 9 Dig. + skt and bezel **£1.00**, p&p 25p.
 LED 3 Digit DIL **55p**, p&p 25p.
 Bowmar 9 digit .1 in LED with red bezel. (As used in calculators). **£1.00** + 25p p&p.

SUPERSAVER 1
 Ribbon Cable Headers 16 DIL Jernyn, gold plated, with cover **45p**, p&p 25p.

Ansley Header plugs. 14 Way **75p**, 16 Way **95p**, 24 Way **£1.80**. (Insulation piercing type), p/p 25p.

Ansley I/O Header plugs. .1in 26 Way **65p**, 26 Way (right-angled) **85p**. 40 Way **£1.00** p/p 25p.

SUPERSAVER 2
 Tantalum Capacitors 25 volt. 4.7 uF, 14 for **£1.00**, p&p 25p.

SUPERSAVER 3
PRICE SMASH FND 500 .5in. LED displays, full spec **50p each**, p&p 25p, large quantities POA.

SUPERSAVER 5
Battery eliminator 6VDC 200MA 240V AC input ideal for calculators, radio, etc., give away price 95p each. Large quantities P.O.A. p&p 35p.

SUPERSAVER 6
 RS 338-383 Miniature Decade Thumbwheelswitch. **£1.65**, p&p 25p.

SUPERSAVER 7
 SN74116 Dual 4 Bit latch **75p**, p&p 25p.
 SN7418 Arithmetic Logic Unit, **80p**, p&p 25p.
 SN74194 4 Bit Register, **50p** p&p 25p.
 SN74198 8 Bit Shift Register, **75p** p&p 25p.

SUPERSAVER 8
ITT 4cx 250b brand new full spec £7.50 each p&p 25p.

SUPERSAVER 9
 5 digit 7 segment DIL LED. 11" displays 4 for **£1.50** p/p 25p.

SUPERSAVER 10
 9 way male/female connector, ELCO 8129, 0.1 inch pitch, gold-plated PCB mounting, ideal for bussing two PCBs together. Superb value. **35p**, p&p 25p.

SUPERSAVER 11
 74LS266 **50p**. 74LS245 **£2.40**. 74LS240 **£1.00**. 74S260 **35p**. P&P on all above 25p.

SUPERSAVER 12
 TMS 3128NC Static shift register, **£1.50**, p&p 25p.

SUPERSAVER 14
 Recording Designs Ltd digital cassette deck. 50-100 Baud RS232 240V input. A professional superb deck. **£68.00**, p&p £2.00.

SUPERSAVER 15
 5K multitrans trimmots, PCB mounting, per box of 14 **£2.50**, p&p 25p.

SUPERSAVER 16
 Qmax chassis punch 1/4" **£3.25**, p&p 45p.

LEDs (Full spec.)

TIL209, red **10p**. 0.2in, red **12p**. 0.2in, green **28p**. 0.2in, yellow **28p**.

RL54 red Axial lead. **15p**. P&P on all above 25p.

VERNITRON Ceramic filters type FM4 10 MHz **45p**, p&p 25p.
TRANSISTORS, BD236 **40p**. BC183L **10p**, BF195 **10p**.

TBA 810S, with data, **85p**, 4-way DIL switches, **75p**. MC1303 Dual Stereo preamp with data, **£1.25**. 7in. Nylon cable ties 100 for **£1.50**. All p&p 25p.

NEW SN76477 (Yes, back in stock). Sound Generator IC (Train, plane, explosion, laser gun, etc.), with data **£3.25**, p&p 25p.

PCB KEYBOARD, 65mm x 82mm, 18 key Clickers less Key tops, ideal Hexadecimal use **35p**, p&p 25p.

CAPACITOR SCOOP. 1.600uF at 10v, 160uF at 25v. Axial lead. 2 dozen for **£1** + 25p p&p.

MINI FANS 80mm x 80mm approx. 115v. Brand new, **£4.50** + £1.00 p&p.
 IEC mains chassis plug **75p** suitable socket **35p**, p&p 25p.

GIVEAWAY
22 pin low profile dil socket, gold plated.

12p EACH
p&p 25p

Just arrived. **ITT 2082 Data Modem**. Brand new and boxed, with manual. **600/1200 Baud**. Data Modem to CC ITT. V24/RS232C. Channel centre frequencies 1300 and 1700Hz (600 Baud) or 1300 and 2100Hz (1200 Baud). Synchronous or asynchronous operation over 2 or 4 wire, switch or dedicated lines, built in self and lines test functions. Some of the best equipment we have ever obtained. **£115.00 each**, p&p **£3.00**. (Fraction of original cost).

IC HOLDERS (Low-profile)
 8 DIL **12p** 14 DIL **15p**
 16 DIL **17p** 18 DIL **20p**
 22 DIL **28p** 24 DIL **35p**
 28 DIL **45p** All p&p 35p

WE STOCK a vast range of TTL, CMOS, some 74LS. MINIATURE TOGGLES, etc.

PSUs. We have a large stock of power supplies at very realistic prices (callers).

RELAYS
 Banor resettable double pole changeover 12V **£1**. Both p&p 25p.

CIRCUIT BREAKERS
 4450V AC 65v DC 0.5A **50p**; ditto 7A **80p**, p&p 25p.

ALLEN KEYS, 7/16in **5p**; 12 for **50p**; p&p 25p.
ASR33 (with tape punch reader), generally overhauled. **£185.00** inc. VAT.

CENTRONICS 101A Dot Matrix printer. Fully overhauled. **185 char/sec**. **£450.00 inc. VAT**. Carriage at cost. As above dual headed **300 char/sec** **£650 inc. VAT**.

C.P.U. type 10660. These devices are brand new, supplied with comprehensive, data sheet for experimental use or hang them on your Christmas tree! **4 for £1**, p&p 25p.

ICL POWER SUPPLY (exchange units) 240V AC input. Output +24V at 2 amps DC, -24V at 2 amps DC (adjustable to 12V) +5V at 4 amps DC -100V DC and 6.3V AC. £12.00. Callers only.

Terms cash with order (official orders welcomed from colleges, etc). All enquiries s.a.e. please. All prices inclusive of VAT, unless otherwise stated. Postage as shown per item.

FOR THE PROFESSIONAL USER. CP Clare Keyboard switches with buttons (blank) **65p each** p&p 25p.

BURROUGHS keyboard, 96 key station. On-board crystal and TTL. Brand new and boxed. **500mm x 190mm**. At the time of advert no data. No keytops at all. Clare pender. Read switches. Bargain **£12.00 each**, p&p **£1.50**.

PLEASE DO NOT ORDER GOODS FROM OLD ADVERTS. PHONE BEFORE ORDERING.

SURPLUS STOCKS PURCHASED FOR CASH

LB ELECTRONICS
 11 HERCIES ROAD
 HILLINGDON, MIDDLESEX
 UB10 9LS, ENGLAND

All enquiries s.a.e. please Telephone answering machine service out of business hours.

New retail premises, now open Mon, Tues, Thurs, Fri, and Sat, 9.30-6.00 Lunch 1-2.15 weekdays. Closed all day Wednesday. We are situated just off the A40 opposite Master Brewer.

ALL PRICES INCLUSIVE OF VAT

UXBRIDGE 55399

All components full spec.

MERRY CHRISTMAS TO ALL OUR CUSTOMERS AND ETI STAFF

MICROS

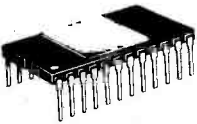

Micros, memory and support

MC1489	85	74S287	2.80
MC1488	85	74S288	2.80
MC14411	11.85	74S471	1.95
MC14412	11.85	74S472	1.95
1702	8.85	74S474	11.85
2101	2.58	81T26	1.80
2102	8.8	81T28	1.80
2111	2.32	81T95	1.80
2112	2.32	81T97	1.80
2114	3.45	81T98	1.80
2114L	3.75	SC/MP2	9.95
2142	10.40	80B0	5.49
2376	11.80	80B5	11.85
2513	5.80	80B6	8.00
2516(5v)	13.85	81B4	11.85
2522	28.80	81B5	12.80
2708	8.50	81L S95	1.30
4027	2.85	81L S96	1.30
4116	4.85	81L S97	1.30
4118	14.85	81L S98	1.30
5204	7.85	8212	2.45
57109	12.43	8216	2.80
57161	9.85	8224	2.80
8011	4.85	8228	4.20
8402	4.85	8251	4.85
8502	7.85	8253	10.85
8520	4.80	8255	4.85
8522	7.85	8257	10.85
8532	8.80	8259	11.85
8545	17.80	8678	12.85
8576	14.85	8602	2.20
8600	7.85	96364	10.85
8602	12.49	Z80-2MHz	7.80
8609	19.85	Z80-PIO	6.85
8610	3.85	Z80-CTC	6.85
8621	4.85	Z80-4MHz	9.85
8645	18.80	Z80-FIC	7.80
8650	3.85	Z80-CTC	7.80
8652	6.85	Z8000	120.00
74S00	88	ADC0817	14.47
74S04	88	DG300	3.80
74S201	3.85	F8	9.85
74S188	2.80	F8SMI	9.85
74S262	8.85		

74LS00

LS00	13	LS366	85
LS01	13	LS367	85
LS02	18	LS368	85
LS03	18	LS373	180
LS04	20	LS374	180
LS05	23	LS375	180
LS06	23	LS377	180
LS08	23	LS378	185
LS09	23	LS379	215
LS10	23	LS386	85
LS11	32	LS386	85
LS12	32	LS393	140
LS13	40	LS393	140
LS14	40	LS395	210
LS15	40	LS396	180
LS20	40	LS396	276
LS21	32	LS399	230
LS22	40	LS445	140
LS26	40	LS447	185
LS27	45	LS490	150
LS28	48	LS668	105
LS30	24	LS669	105
LS32	30	LS670	105
LS33	38		
LS37	38		
LS38	38	4000	18
LS40	40	4001	24
LS42	80	4002	24
LS44	80	4003	82
LS47	85	4007	22
LS48	120	4008	82
LS49	120	4009	48
LS51	25	4010	48
LS54	30	4011	24
LS55	70	4012	24
LS56	180	4013	45
LS57	40	4014	45
LS74	40	4015	85
LS75	48	4016	85
LS76	45	4017	82
LS78	45	4018	28
LS83	105	4019	48
LS85	105	4020	48
LS86	45	4021	105
LS90	80	4022	95
LS91	125	4023	25
LS93	75	4024	75
LS96	115	4025	25
LS98	180	4026	180
LS107	45	4027	48
LS109	75	4028	82
LS110	80	4029	105
LS113	80	4030	105
LS114	45	4031	82
LS122	70	4034	175
LS123	85	4035	210
LS124	180	4040	105
LS125	80	4041	80
LS126	80	4042	80
LS132	85	4043	80
LS133	30	4044	85
LS136	65	4046	130
LS138	70	4047	95
LS139	90	4049	45
LS145	80	4050	48
LS148	175	4051	80
LS151	85	4052	80
LS153	85	4053	80
LS155	85	4054	130
LS156	95	4055	135
LS157	95	4058	28
LS158	85	4059	28
LS160	120	4060	30
LS161	95	4071	25
LS162	110	4072	25
LS163	100	4073	25
LS164	105	4074	25
LS165	115	4075	25
LS166	175	4076	95
LS168	210	4081	25
LS169	210	4093	85
LS170	285	4502	125
LS173	147	4507	30
LS174	147	4508	325
LS175	110	4510	95
LS181	285	4511	150
LS190	120	4512	65
LS191	120	4514	195
LS192	125	4515	295
LS193	125	4516	120
LS194	125	4518	105
LS195	125	4519	70
LS196	120	4520	115
LS202	345	4521	250
LS221	120	4522	180
LS240	225	4522	180
LS241	225	4526	150
LS242	232	4527	180
LS243	232	4528	120
LS244	232		
LS246	340		
LS247	135	T03	+
LS248	135	7805	145
LS249	135	7812	145
LS251	130	7815	145
LS253	130	7818	145
LS257	115	-ve	
LS258	120	7905	220
LS259	180	7912	220
LS261	480	10220	plast
LS266	75	7805	80
LS273	180	7812	80
LS275	180	7815	80
LS279	88	7818	80
LS280	250	7824	80
LS283	180	7905	80
LS290	130	7912	85
LS293	130	7915	85
LS295	215	7918	85
LS296	215		
LS298	420		
LS324	200		
LS325	200		
LS326	330		
LS327	315		
LS352	185		
LS353	185		
LS355	85		

**74XX
74CXX
LINEARS**
Many other types in stock. Tel for details

WE HAVE MOVED TO OUR NEW CENTRAL LONDON SHOWROOM
59/61 THEOBALDS RD, WC1 TUBE HOLBORN.

FLOPPY DISK DRIVES



We sell all you need cased or uncased. Cables & connectors. Brand new fully guaranteed.

Price

Single 5 1/4 Drive £195
Single 8" S A800 £395
Dual 5 1/4 PSU £59
Dual 8" PSU £76
Dual Cabinet & PSU 1x8" £565
Dual 8" Drive Unit £945
Dual 5 1/4 Drive Unit £440

VIDEO TERMINAL

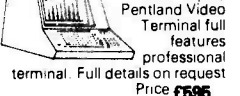

24x80 display
Pentland Video Terminal full features professional terminal. Full details on request Price £595

S100 CARDS

NEW LOW PRICES

16K STATIC KIT ASSM
with no RAM(2114) £ 62 £ 82
" 8K RAM " £109 £130
" 16K RAM " £157 £178
8K static (16x2114 chips) £ 48

64K DYNAMIC (4116)
with 16K RAM £149 £165
with 32K RAM £189 £205
with 48K RAM £229 £245
with 64K RAM £269 £285
16K upgrade 8x4116 £ 40

16/32K EPROM CARD
Without EPROMS
2708/2516 £63 £ 89

FDC DOUBLE DENSITY
Double Density for 5 1/4" or 8" Drives £ - £195

VAT

ALL OUR PRICES EXCLUDE VAT & P/P

CENTRONICS 737 PRINTER
LETTER QUALITY FOR £425

Uses any paper roll, fanfold, single sheets, 96 character ASCII, 7 x 7 dot matrix, 50 CPS, RS232 or parallel I/O

OK TOOLS

Full range of wire wrapping accessories & boards & dip jumpers etc. Visit our showroom or send for our catalogue.

VERO

S100 prototyping boards and full range of accessories.

BOOKS

Complete range of microcomputer books and magazines on sale in our showroom.

CATALOGUE AVAILABLE

Catalogue available. Send 50p & S.A.E. (A4 size).

TUSCAN S100
A Z80 based S100 Computer

Single board will hold up to 8K RAM, 8K ROM, Video interface Z80 processor - I/O and cassette interface 5 spare S100 expansion sockets for memory/disc expansion. System monitor, resident BASIC or CP/M system option. All components available separately or ready-built

NEW LOW PRICES

TUSCAN MAIN BOARD KIT ONLY £235 + VAT
SAE FOR DETAILS



TRITON SINGLE BOARD PERSONAL COMPUTER

8080 BASED SINGLE BOARD system with EUROCARD EXPANSION

Complete Kit incl. PSU/Case/Keybd £286
Expansion Motherboard Kit £ 50
8K (2114) RAM Card Kit £ 97
8K (2708) ROM Card Kit £ 97

Expandable up to CP/M Disc System. SAE for details.



TCL PASCAL FOR PET & CP/M systems

Put Pascal on your PET now
Pascal conversion ROM £ 20
Pascal manual £ 9
Complete package including compiler £120



Edge Connectors S100



Zero Insertion Force Sockets

DIP Switches
4 way £1.20
7 way £1.75
8 way £1.80

DIP Plugs
14 DIL £ 65
24 DIL £2.20
40 DIL £3.60

25W Male £2.80
25W Female £3.80
25W Cover £1.80

Edge Connectors
156
2x 6 way - 1.75
2x 12 way - 3.00
2x 10 way - 2.20
2x 15 way - 2.20
2x 18 way - 3.50
2x 22 way 3.203.65
2x 25 way 3.60 - 26 1.40
2x 30 way 4.15 - 34 2.40
2x 36 way 4.753.90 - 40 2.80
2x 40 way 5.00 - 503.30
2x 43 way 5.504.60 - 60 4.00

D-Types
14 DIL £ 65
24 DIL £2.20
40 DIL £3.60

Insulation Piercing Edge Connectors
20 way £3.60 40 way £5.30
26 way £4.00 50 way £6.00
34 way £4.60

Insulation Piercing DIP Plug
14 way DIP Plug £1.30
16 way DIP Plug £1.50
24 way DIP Plug £2.80

Ribbon Cable PRICE/M
Grey Coloured
10 65 10 90
14 90 14 1.20
16 1.20 16 1.40
18 1.40 20 1.60
20 1.60 26 2.40
34 2.40 40 3.30
50 3.30 60 4.00
60 4.00 60 5.50

CRYSTALS FOR MICROS

32 768KHz	3.00	4.00MHz	2.70	10.00MHz	2.70
100KHz	3.00	4.43MHz	1.00	10.7MHz	2.70
200KHz	3.70	5.00MHz	2.70	16.00MHz	2.90
1.0MHz	3.60	6.0MHz	2.70	18.00MHz	2.90
1.008MHz	3.50	6.144MHz	2.70	18.432	2.90
1.8432MHz	3.00	7.0MHz	2.70	36MHz	2.90
2.00MHz	1.50	7.168MHz	2.50	48.00MHz	2.70
2.45760MHz	3.05	8.00MHz	2.70	100MHz	2.90
3.276MHz	2.70				

SOFTWARE

CP/M DISK WITH I/MAN MANUAL

Available on 8" IBM format & 5 1/4 for TUSCAN & TRITON

TCL SOFTWARE

TCL Disc Basic £55/£9
TCL Pascal £120/£9

MICROSOFT

Basic-80 £155/£15
Basic Compiler £195/£15
Fortran-80 £205/£15
Cobol-80 £325/£15
Edit-80 £45/£10
Macro-80 £75/£10

MICROPRO

Word Star £255/£15
Word-Star/Mail-Merge £315/£15
Data Star £195/£25
Word-Master £75/£15

DIGITAL RESEARCH

CP/M 1-4 £75/£18
CP/M 2-2 £95/£18
MAC £55/£10
SID £45/£10

OTHERS

KISS £190/£15
SUPER SORT I £125/£15
C BASIC 2 £75/£10
Z80 Dev Pack £50/£12
ZSID £60/£7
POSTMASTER £85/£10

MEDIA

5 1/4 S/Sided D/D £3.50
" per 10 £29.50
8" S/Sided D/D £4.50
" per 10 £35.00
C12 Data Cassettes 50p

MAIL ORDER

TEL & MAIL ORDERS ACCEPTED



59/61 THEOBALDS RD
LONDON WC1
TEL: 405 5240/2113
TELEX 444198.



PRINTED CIRCUITS and HARDWARE

Comprehensive range Constructors Hardware and accessories.

Selected range of popular components Full range of HE printed circuit boards normally ex-stock, same day despatch at competitive prices
P.C. Boards to individual designs
Resist-coated epoxy glass laminate for the d.i.y. man with full processing instructions (no unusual chemicals required)

Alfalfa range of etch resist transfers, and other drawing materials for p.c. boards

Send 15p for catalogue.

RAMAR CONSTRUCTOR SERVICES
MASON'S ROAD
STRATFORD-ON-AVON
WARWICKS, Tel. 4879

ZX80 SPACE INTRUDERS—zap the intruders as they attempt to land, £4. Movies—7x8 character pictures displayed in rapid movement, gives animation effect, £3. Both are continuous programs with no loss of T.V. Sync. Inclusive prices for listing and details, or send s.a.e. for list of all ZX80 Specials to—K. Macdonald, 26 Spiers Close, Knowle, Solihull B93 9ES.

XMAS PRESENT FOR ZX80 OWNERS. Stockmarket, Hangman with unlimited words, day of week, nim and others. 7 programs on cassette for £5, or send s.a.e. for list. — Cadsoft, 24 St. James Street, Cheltenham, Glos.

PRINTED CIRCUITS. Make your own simply, cheaply and quickly! Golden Fotolak Light Sensitive Lacquer — now greatly improved and very much faster. Aerosol cans with full instructions. £2.25. Developer 35p. Ferric Chloride 55p. Clear Acetate sheet for master 14p. Copper-clad Fibre-glass Board approx. 1mm thick £1.75 sq. ft. Post/packing 60p. White House Electronics, Castle Drive, Praa Sands, Penzance, Cornwall.

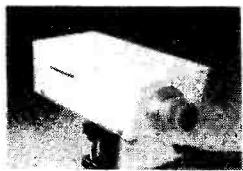

**C
C
T
V
C
A
M
E
R
A**

£110.00 + P/P £3.45 (inc. VAT)
Optional extra manual
£6. Total £129.95

BEST OFFER EVER
Camera Kit, Lens,
Vidicon & Modulator

CROFTON

Tel: 01-891 1923 For full details

ADAM HALL

Cabinet & Flightcase Fittings, fretcloths, coverings, handles, castors etc., Jacks & sockets, Cannons, Bulgins, reverb trays, Emilar compression drivers, AKG mics, Celestion speakers, ASS glassfibre horns.

Send 30p postal order for illustrated catalogues to:
ADAM HALL (E T SUPPLIES)
Unit B, Charlton Court
Grainger Road, Southend-on-Sea
Essex SS2 5BZ

LAMP STRINGS

Kit LS-1. Each Kit contains: 200 Lamps (50 each Red, Blue, Yellow, Green). 200 Pre Cut Leads, 400 Sleeves plus Instructions.

Easy to Construct. Ideal for

**DISCOS, SHOPS, DISPLAYS,
XMAS DECORATIONS ETC.**

LS-1 c/w Instructions £10.00
SL-1 100 Spare Lamps (25 each colour) £5.75

Prices include VAT and P&P

J & H ASSOCIATES LTD.

The Maltings
Station Road
Sawbridgeworth, Herts
Tel: 0279-723156 Telex: 81675
JLamps-G
Trade Enquiries Invited

A SUPERB VALUE STEREO POWER AMPLIFIER OFFER ● Stabilised PSU; 2N 3055 output ● Stereo 60-watt RMS; ● I.C. Preamp. Case includes, controls volume, selector etc., din output/inputs for magnetic pick-up/microphone (3.mv) + Tuner + Tape/Aux. 26 transistors — 2 IC Screened Douglas Transformer, 240V AC mains lead. New—tested—data £19.95 (inclusive). — Klifco Electronics, 1 Regent Road, Ilkley, W. Yorkshire LS29 9EA.

ZX80 BUILT BY SINCLAIR. Complete with manual and power supply. Cost £110, only £85. Must sell because of new Micron. — Phone Geoff Peach, evenings, 01-804 0642 (Enfield).

NASCOM OWNERS — 16 gauge Aluminium Console, will support portable T.V. or monitor. Enough space inside for 3A PSU, CPU Board and two expansion boards. Size 14" x 20" x 3" with sloping front for keyboard. Price includes keyboard cut-out, rubber feet, carry handle. Send cheques or P.O.s for £25.30 to — Cyber Electronics Co. Ltd., Pavement Square, Addiscombe, Croydon CRO 6RD. Tel. 01-651 0388, any time.

DIGITAL WATCH BATTERY REPLACEMENT KIT



These watches all require battery (power cell) replacement at regular intervals. This kit provides the means. We supply eyeglass, non-magnetic tweezers, watch screwdriver, case knife and screwback case opener. Also one doz. assort. push-pieces, full instructions and battery identification chart. We then supply replacement batteries — you fit them. Begin now. Send £9 for complete kit and get into a fast-growing business. Prompt despatch.



BOLSTER INSTRUMENT CO. (ET20)
11 Percy Avenue, Ashford, Middx. TW15 2PB

VIDEO MUSIC



The amazing Videograph, as featured recently in EElectronics Today International, links your Hi-Fi with any Colour TV to produce a Fantasia of hypnotic visual effects. The system displays stereo music as brilliantly coloured waveforms against an ever changing background. For the technically-minded, a square-wave signal generator is built-in, permitting advanced demonstrations of transient response etc. Truly the ultimate accessory for any Hi-Fi system!

DIY KIT ONLY **£33.95**
Case & Controls £15.95
or READY BUILT £69.95

All prices include VAT and postage

WILLIAM STUART SYSTEMS Ltd

Dower House, Billericay Road, Brentwood, Essex CM13 3SD
Telephone: Brentwood (0277) 810244

STABILISED POWER SUPPLIES. Variable 5-15V. 1A. Encased. Require leads. £8. Mains Transformers 9-21V. 10A. £6. Used room thermostats £1. P.&P. £1.50 per item. — D. Hingston, 12 Meadow Lane, Westbury, Wilts. Tel. 823726.

GENTLEMAN SEEKS MANUFACTURER for two patented inventions: Electronic football pools forecaster and electronic chord finder. Box No. 202, ETI, 145 Charing Cross Road, London, WC2H 0EE.

NUCLEAR RADIATION MONITOR. Essential for the survivor of a nuclear attack. Measures up to 100 rads/hour. S.a.e. details: Ray Nucleonics, 13 Rosemead Gardens, Brentwood CM13 1HZ.

PROGRAMMING, SINGLE/TRIPLE RAIL UVEPROMS. £3/1K. 2516 (2716) 2708, 2532, 2758, 2508, 2704. Petron Electronics, Dept. E, 1 Courtlands Road, Newton Abbot, Devon, TQ12 2JA.

U.V. EPROMS. 1024 x 8 type 2708. Full specification devices, with data. £3.50 each, four or more only £3.25. Post free. S.A.E. for details. Box No. 203, ETI, 145 Charing Cross Road, London WC2H 0EE.

CENTURION ALARMS

**BURGLAR ALARM EQUIPMENT
AT UNBEATABLE VALUE
JUST LOOK!**

Order No
100 ALARM TRIGGER MODULE, 100% Solid State. Battery operation. Pos. & Neg. Rings. N.C. for 4-wire contacts. N/O for Mts. etc. One Amp Switching Capacity. Only £9.95
210 Quality White Flush fitting 4-wire **MAGNETIC REED CONTACT** + matching magnet £1.10
220 Surface 4-wire **MAGNETIC REED CONTACT** £1.50
240 **PRESSURE MAT**, Standard size 4-wire 30"x15" £2.20
250 **PRESSURE MAT**, Star size 4-wire 23"x6 1/2" £1.73
260 **VIBRATION DETECTOR**, Pendulum type in Ivory Case with contacted lid + self-adhesive backing. Adjustable sensitivity £3.50
360 **SIX INCH UNDER DOME BELL** £9.95
390 **BEST QUALITY BELL HOUSING**. PVC coated metal, not to be confused with the cheaper decry covers. Fully signwritten with our Centurion Insignia £9.50
400 **DECAY P.V.C. BELL COVER** £6.60
NEW TWO-TONE U.S.A. POLICE SOUNDERS, complete with weatherproof horn £14.50
SOUNDER PCB Module, only £4.95
WEATHERPROOF Louspeaker. 8 ohm horn, only £9.55
Note: All equipment operates on 12 Volts DC.

Terms: Add 15% VAT to Prices + 60p Postage & Packing.
No Minimum Order.
Access telephone orders welcome on: 0484-35527 or send S.A.E. for Full List to:
CENTURION ALARMS & ELECTRONIC SALES, Dept. ETI, 265 Wakefield Road, Huddersfield, W. Yorks HD5 9BE.

PANELS

Give your project the professional finish it deserves. Blend in with existing equipment with these tough 2mm thick anodised aluminium fascia panels, matt black or brushed silver finish. Stock sizes: 44 x 16 cm **£4.75**, 35 x 15 cm **£4.25**, 30 x 12 cm **£3.90**. Other sizes available in quantity to order. Prices incl. c.w.o.

PROJECT FINISHERS

P.O. Box 2, Buntingford, Herts.

TIME EXACT?

MSF CLOCK is ALWAYS CORRECT—never gains or loses, self-setting at switch-on. 8 digits show Date, Hours, Minutes and Seconds, auto. GMT/BST and Leap Year, also parallel BCD output and audio to record and show time on playback, receives Rugby 60KHz atomic time signals, built-in antenna, 1000Km range, **ABSOLUTE TIME, £54.80**.

V.L.F.7 EXPLORE 10-150KHz Receiver, £13.70. **60KHz. RUGBY RECEIVER**, as in MSF Clock, serial data and audio outputs, **£15.70**.

Each fun-to-build kit includes all parts, printed circuit case, instructions, postage, etc., money-back assurance, so **GET one NOW!**

CAMBRIDGE KITS

45 (TN) Old School Lane, Milton, Cambridge

C.B.S.

If you are in Business and considering an application of a Minicomputer or Microprocessor based System and are a little confused why not attend one of our courses.

- A. Microcomputer Application — BUSINESS
- B. Microcomputer Application — ENGINEERING AND CONTROL
- C. Programming in BASIC — INTRODUCTION
- D. Programming in BASIC — ADVANCED

We are an independent consultative organisation specialising in business and engineering application, prepared to recommend systems when required and provide full software and programming support.

Courses are available for individual or group instruction, and may be arranged to suit your specific applications.

For full details and dates available write or phone:

CLEVELAND BUSINESS SERVICES

Cleveland House
Routh, Near Beverley
North Humberside. HU17 9SR
Tel: Leven 0401-43139

SPEED — VERSATILITY — ECONOMY



Designed originally for logic wiring applications, it is now accepted and used extensively throughout industry, education and research. ROADRUNNER is used by hobbyists, students, technicians, designers and engineers, to carry out work on:— *P.C.B. REPAIRS *ANALOGUE BREADBOARDING *SIMPLE LOGIC WIRING *COMPLEX INTERCONNECTING OF MICROS AND MEMORIES.

EURO INTROKIT **£16.70**. PROJECT KIT **£8.18**. MINIKIT (A) **£7**. PENCIL WITH LOADED 'OSE' BOBBIN **£2.81** WITH T.C.W. BOBBIN **£2.76**. STRIPS, GLUE FIX 20/PKT. 6" LONG **£3.20**. HIGH DENSITY GLUEFIX 20/PKT. 6" LONG **£3.20**. PRESS FIX 20/PKT. **£3.20**. SINGLE HIGH DENSITY D-SIDED EUROCARD **£5.18**. SINGLE SIDED **£3.80**. DOUBLE HIGH DENSITY D-SIDED EUROCARD **£8.60**. PROJECT CARD **£2.50**. BOBBINS: BLUE 4/PKT. **£2.12**. GREEN 4/PKT. **£2.12**. GOLD 4/PKT. **£2.12**. PINK 4/PKT. **£2.12**. 1 OF EACH COLOUR **£2.20**. TINNED COPPER 2/PKT. **£0.96**. ADHESIVE **£0.41**. SOLDERING IRON 420°C **£5.52**. REPLACEMENT WELDER TIPS — PTAAS 430°C **£1.40**. PTAAS 480°C **£1.40**.

Please add 40p for P&P + VAT to all orders

FOR FURTHER INFORMATION ON ROADRUNNER PRODUCTS SEND LARGE S.A.E. TO:

T. J. BRINE ASSOCIATES
FREEPOST, Haslemere, Surrey GU27 3BL

ETI PCB
Buy it with Access
BARCLAYCARD

TRS 80 SOFTWARE NOW AVAILABLE

CROFTON ELECTRONICS LIMITED

35 GROSVENOR ROAD, TWICKENHAM MIDDLESEX TW1 4AD · Tel: 01-891 1923

TELEPHONE ANSWERING MACHINE.

Build your own for under £10 plus any Cassette Recorder. Send £3 for circuit and plans. S. D. Cross, 24 Thorney Road, Streetly, Sutton Coldfield, West Midlands.

DIGISCOPE DS2 LOGIC MONITORS. 16

channel CMOS/TTL, £27.40. Free leaflet: J. E. Sinclair & Co., 82 Plumstead Common Road, SE18 3RE.

£1 BARGAIN PACKS

All packs **£1 each**; any 12 for **£10**. Post 25p. All top-grade new components — no rubbish.

PC1 12 BC107	PC9 10 TO3 sockets
PC2 14 BC108	PC10 15 0.1/35V tants
PC3 12BBC109	PC11 14 3mm red LEDs
PC4 3 2N3055	PC12 12 5mm red LEDs
PC5 7 BFY51	PC13 8 741
PC6 18 BC182	PC14 6 555
PC7 60 1N4148	PC15 15 12V zeners
PC8 25 1N4003	PC16 100 1k 1/4W 5% Rs

Send S.A.E. for 8-page list/enquiries. Mail only.
PC ELECTRONICS, 1 Thornhill, Romsey Road Whiteparish, Salisbury, SP5 2SD

EFFECTS UNITS FOR GUITAR, Key-

boards and vocals. A.D.T. Chorus **£44.25**. Flanger **£36.75**. Phaser **£27.75**. Fuzz-Overdrive **£21.75**. Echo-Analog Delay **£48.75**. For details send S.A.E. to Druzyczy Taylor Electronics, 148 Coventry Road, Warwick, CU34 5HL. Tel: (0926) 499300.

FREQUENCY COUNTER TIMER. 1Hz-

50MHz **£60** ono. Teletext Decoder Bk/w display, not remote control. Plugs into aerial **£100** o.n.o. Crawley, Sussex 884606.

U.K. AIRPORT FREQUENCIES LIST. £1.

U.K. coast station frequencies list **£1**. PLH Electronics, 20 Vallis Road, Frome, Somerset.

PARAPHYSICS JOURNAL. Russian /

Czech translations. Autogenics (self-training) improves vitality. Psychotronic Generators, UFOs, contacting extraterrestrials, Kirlian-anography, telelinese, levitation, gravity lasers. S.A.E. 4x9": Paralab, Downton, Wilts.

ETI ADVERTISEMENT INDEX

AITKEN BROS	86	L & B ELECTRONICS	106
ALTEK INSTRUMENTS	42	LINSAC	107
AMBIT INTERNATIONAL	53	MACLIN-ZAND	27
AUDIO ELECTRONICS	14, 28 & 42	MANOR SUPPLIES	107
AURA SOUNDS	85	MAPLIN	124
BAYDIS	33	MARSHALLS	52
BI-PAK SEMICONDUCTORS	48	MAYWARE LTD	70
BK ELECTRONICS	71	MICROCIRCUITS	99
BNRS	41	MICRODIGITAL	14
BOSS INDUSTRIAL	47	MICROTYPE	108
BUTTERWORTHS	76	MINKITS	70
CALCULATOR SALES & SERVICE	116	MINIM AUDIO	93
CAMBRIDGE LEARNING	69	MITRAD	34 & 35
CASTLE ELECTRONICS	16	MOUNTAINDENE	103
CHILTMead	61	NIC MODELS	117
CHORDGATE	116	NTC	114
CHROMASONICS	46 & 47	PARNDON ELECTRONICS	112
CHROMATRONICS	7	T. POWELL	93
CLEF PRODUCTS	114	POWERTRAIN	2, 8 & 115
CODESPEED	107	PROGRESSIVE RADIO	114
COMP, COMP, COMP	122 & 123	PROTON ELECTRONICS	113
CRIMSON ELEKTRIK	107	QUANTUM ELECTRONICS	118
CROFTON ELECTRONICS	117	RAPID ELECTRONICS	100
C.S.C.	33, 39	J. W. RIMMER	76
DELTA TECH & CO	113	RISCOMP LTD	76
DISPLAY ELECTRONICS	40	R.T.V.C.	10
DORAM ELECTRONICS	75	SAXON ENTERTAINMENTS	100
EDA	33	SCIENCE OF CAMBRIDGE	4 & 5
ELECTRONIZE DESIGN	42	SILICA SHOP	108
ELECTRO SUPPLIES	60	SURETRON SYSTEMS	118
ELECTROVALUE	100	SWANLEY ELECTRONICS	117
EXPERIMENTAL ELECTRONICS	112	TANGERINE	94 & 95
GENERAL NORTHERN MICROCOMPUTERS	52	TECHNOMATIC	26
GREENBANK	87	TEMPUS	56
GREENWELD	116	TIMEDATA	113
HAPPY MEMORIES	60	TK ELECTRONICS	104
HEATH ELECTRONICS	86	TRANSAM COMPONENTS	12
HENRY'S RADIO	52, 60, 101	UNILAB	113
ILS	93	VIDEOTONE	25
ILP	20, 21, 70	WATFORD ELECTRONICS	6 & 7
KEELMORE LTD	106	WEST HYDE DEVELOPMENTS	105
LB ELECTRONICS	119	WILMSLOW AUDIO	108

JUST COMPARE OUR CASH AND CARRY PRICES!

NEW REDUCED PRICES

8K **£399**
 16K **£499**
 32K **£599**
 RRP £795 for 32K



EXTENDED WARRANTY BY COMPUKARE

The PEDIGREE PETS Very popular for home & business use 8K Microsoft Basic in ROM 8K Pet 32K & 16K with new improved keyboard All with green screen Cassette Deck **£55** extra Full range of software available Interface PET IEEE — Centronics Parallel Decoded **£77.00** + VAT

NOW IN STOCK

SUPER 80 COLUMN PET
 only **£825** + VAT

SPECIAL SCOOP GET YOURSELF A PRINTER FOR YOUR PET AND SAVE A FORTUNE

only **£299** + VAT



EXTENDED WARRANTY BY COMPUKARE

Interface Cards **£49**
 Full Pet Graphics including cables. Ready to go. **EX-STOCK.**
 Interfaces with APPLE, PET, EXIDY, TRS80, COMPUKIT and NASCOM.

NASCOM 2 DISC DRIVES

EXTENDED WARRANTY BY COMPUKARE

Add a powerful, double density, mini floppy disc to your Nascom system.



- Disc Controller Card includes Nasbus 6 S100 interface
 - Will control 4 Drives.
 - CPM operating system.
 - Extended Disc Basic Compiler.
 - Power supply included
- One Disc System — **£499** + VAT
 Additional Disc Unit — **£299** + VAT

NASCOM 2 GAMES TAPE

featuring Space Invaders and Android Nim, Re-numbering program and other goodies!
£7.50 + VAT

NEC SPINWRITER

only **£1490** + VAT



NEC's high quality printer uses a print "thimble" that has less diameter and inertia than a daisy wheel, giving a quieter, faster, more reliable printer that can cope with plotting and printing (128 ASCII characters) with up to five copies, friction or tractor fed. The ribbon and thimble can be changed in seconds. 55 characters per second bidirectional printing — with red/black, bold, subscript, superscript, proportional spacing, tabbing, and much, much more.

COMP POCKET COMPUTER GREATEST BREAKTHROUGH YET



£99.90 + VAT

COMPUTER POWER THAT ONCE FILLED A ROOM CAN NOW BE CARRIED IN YOUR POCKET!

- Programs in BASIC ● "QWERTY" Alphabetic Keyboard ● 1.9K Random Access Memory ● Long Battery Life.

Computer power that once filled a room can now be carried in your pocket! It's easy to load with ready-to-run software from cassette tape (interface and recorder optional) or program it yourself in easy-to-learn BASIC. 24-character liquid crystal readout displays one line at a time. Special feature is advanced non-volatile memory allows you to power on and off without losing the contents of memory. Note: Memory must be transferred to tape before changing batteries. Automatic statement compaction squeezes every ounce of memory space. Features power-off retention of programs and data. Powerful resident BASIC language includes multiple statements, math functions, editing, strings, arrays and much more. Multiple program loading capability subject to RAM availability. Carrying case and batteries included.

Program	Each	Program	Each
Real Estate	£13.95	Games 1	£8.95
Civil Engineering	£13.95	Business Statistics	£10.95
Aviation	£13.95	Business Financial	£10.95
Math Drill	£8.95	Personal Financial	£10.95

EXTENDED WARRANTY BY COMPUKARE



ACULAB FLOPPY TAPE

The tape that behaves like a disc, for TRS-80 LEVEL 2.

only **£169** + VAT

Connects directly to TRS-80 Level 2 Keyboard. Operating and file handling software in ROM. 8 commands add 12 powerful functions to Level 2 BASIC.



EXTENDED WARRANTY BY COMPUKARE

COMING SOON
 26 megabyte Hard Disc multi-user DOS

WE USE THIS MACHINE IN OUR BUSINESS

1 DISK EXPANSION Room for 3

500K per Drive gives total of 1.5M Byte — 1 Drive plus Cabinet **£799** + VAT



CP/M2 **£95.00**
 CIS COBOL **£400.00**

COMMERCIAL • EXPANDABLE • COMPLETE TRS 80 • MODEL II

This new unit from the world's most successful micro company is now available immediately with software.

The basic unit comes complete with 64 thousand characters (bytes) of Memory. The built in 8" Floppy disc adds another 1/2 million extra characters including the disc operating system. More disc expansion is now available. The Model II is a complete unit with a full keyboard including a numeric pad and 12" screen which gives 24 lines of 80 characters. The computer is supplied with both the disc operating system and the Level III Basic. A full self test routine is written into the power up procedure to eliminate incorrect operation. Both serial and parallel expansion sockets are standard. A printer is a plug-in operation. Both hardware and software necessary to talk to a mainframe are included. Terminal usage is very possible. With the addition of CPM2 you can operate with COBOL, FORTRAN, MBASIC, CBASIC in which languages are many other applications packages i.e. accounting, payroll stock etc.

64K 1-Disk Model II **£1995.00** + VAT
 RRP £2250.00

C BASIC **£75.00** FORTRAN **£220.00**
 M BASIC **£155.00** WORDSTAR **£255.00**

EPROM 2716 **£12.50** + VAT

EXTENDED WARRANTY BY COMPUKARE



only **£325** - VAT

TRS80 LEVEL 2 16K

Fully converted to UK T.V. Standard Comes complete with easy to follow manuals UK Power Supply Cassette Leads Sample tapes Special box to enable you to plug into your own TV Recommended for first time buyers Just plug in and go Full Range of Software Available

Interface to Centronics Parallel for TRS80 **£75.00** + VAT

only **£295** - VAT

Expand your TRS80 by 32K 32K Memory on board Centronics parallel port Disk controller card Real time clock Requires Level II Basic interface for 2 cassette decks complete with power supply.

TRS80 EXPANSION INTERFACE

THE VIDEO GENIE SYSTEM

EG3000 Series

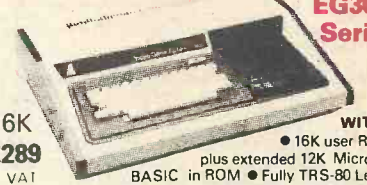

16K **£289** - VAT

WITH ● 16K user RAM plus extended 12K Microsoft BASIC in ROM ● Fully TRS-80 Level II software compatible ● Huge range of software already available ● Self contained, PSU, UHF modulator, and cassette ● Simply plugs into video monitor or UHF TV ● Full expansion to disks and printer ● Absolutely complete — just fit into mains plug.

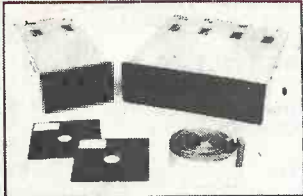

TEAC DISK DRIVES

- TEAC FD-50A has 40 tracks giving 125K Bytes unformatted single density capacity.
- The FD-50A can be used in double density recording mode.
- The FD-50A is Shugart SA400 interface compatible.
- Directly compatible with Tandy TRS80 expansion interface.
- Also interfaces with Video Genie, SWTP, Heathkit, North Star Horizon, Superbrain, Nascom, etc, etc.
- Address selection for Daisy chaining up to 4 Disks.
- Disks plus power supply housed in an attractive grey case.

Single Disk Drive **£225** + VAT Double Disk Drive **£389** + VAT

COMING SOON THE MARTELL TV GAME

NOBODY CAN GET NEAR OUR PRICES EXCEPT OUR CUSTOMERS

RRP £540 only **£399** + VAT
ANADIX DP8000

Super Quality — Low cost Printer. Tractor Feed with full 96 ASCII character set. Accepts RS232C at band rates between 100 and 9600 and Parallel Bit data. Attaches either directly or through interfaces to Pet, Apple, TRS80, Sorcerer, Nascom, CompuKit etc.

EXTENDED WARRANTY BY COMPUKARE

THE NEW ANADIX DP9501 A PROFESSIONAL PRINTER

● Bi-directional printing
 ● Up to 220 chars/line with 4 print densities
 ● 500 char buffer
 ● RS232C and Centronics Parallel interface built in
 ● Full software control of matrix needles allowing graphics capability
 ● 200 chars/sec ● Adjustable width tractor feed.

All this for only **£895** + VAT.

EXTENDED WARRANTY BY COMPUKARE

THE ATARI VIDEO COMPUTER GAMES SYSTEM **£83.00** + VAT

Atari's Video Computer System now offers more than 1300 different game variations and options in twenty Game Program™ cartridges! Most Cartridges only **£13.90** + VAT. Prices may vary with special editions Basic Maths, Airsea Battle, Black Jack, Breakout, Surround, Spacewar, Video Olympics, Outlaw, Basketball, Hunt & Score*, Space War, Sky Diver, Air Sea Battle, Codebreaker*, Miniature Golf.

Extra Paddle Controllers — **£14.90** + VAT
 *Keyboard Controllers — **£16.90** + VAT

SPACE INVADERS NOW IN STOCK £25

EXTENDED WARRANTY BY COMPUKARE

NEW TV GAME BREAK OUT

Has got to be one of the world's greatest TV games. You really get hooked. As featured in ETI. Has also 4 other pinball games and lots of options. Good kit for up-grading old amusement games.

MINI KIT — PCB, sound & vision modulator, memory chip and de-code chip. Very simple to construct. **£14.90** + VAT
OR PCB **£2.90** MAIN LSI **£8.50** Both plus VAT

EXTENDED WARRANTY BY COMPUKARE

WE ARE NOW STOCKING THE APPLE II EUROPLUS AT REDUCED PRICES

16K **£599**
 32K **£649**
 48K **£659** + VAT

Getting Started APPLE II is faster, smaller, and more powerful than its predecessors. And it's more fun to use too because of built-in features like:

- BASIC — The Language that Makes Programming Fun.
- High-Resolution Graphics (in a 54,000-Point Array) for Finely-Detailed Displays.
- Sound Capability that Brings Programs to Life.
- Hand Controls for Games and Other Human-Input Applications.
- Internal Memory Capacity of 48K Bytes of RAM, 12K Bytes of ROM; for Big-System Performance in a Small Package.
- Eight Accessory Expansion Slots to let the System Grow With Your Needs.

You don't need to be an expert to enjoy APPLE II. It is a complete, ready-to-run computer. Just connect it to a video display and start using programs (or writing your own) the first day. You'll find that its tutorial manuals help you make it your own personal problem solver.

EXTENDED WARRANTY BY COMPUKARE

EUROPE'S FASTEST SELLING ONE BOARD COMPUTER

COMPUKIT UK101

★ 6502 based system — best value for money on the market. ★ Powerful 8K Basic — Fastest around ★ Full Qwerty Keyboard ★ 4K RAM Expandable to 8K on board. ★ Power supply and RF Modulator on board. ★ No Extras needed — Plug-in and go. ★ Kansas City Tape Interface on board. ★ Free Sampler Tape including powerful Disassembler and Monitor with each Kit. ★ If you want to learn about Micros, but didn't know which machine to buy then **this is the machine for you.**

40 pin Expansion Jumper Cable for CompuKit expansion **£8.50** + VAT

Build, Understand and Program your own Computer for only a small outlay. **KIT ONLY £179** + VAT **NO EXTRAS NEEDED**

Available ready assembled, tested & ready to go **£229** + VAT

NEW MONITOR FOR COMPUKIT UK101
 ● In 2K Eprom 2716 ● Allows screen editing ● Saves data on tape ● Flashing cursor ● Text scrolls down **£22.00** + VAT

FOR THE COMPUKIT

Assembler/Editor	£14.90
Screen Editor Tape	£5.90

All Prices exclusive VAT

Game Packs

1. Four Games	£5.00
2. Four Games	£5.00
3. Three Games 8K only	£5.00

Super Space Invaders (8K) **£8.50**
 Space Invaders **£5.00**
 Chequers **£3.00**
 Real Time Clock **£3.00**
 Case for CompuKit **£29.50**

HITACHI PROFESSIONAL MONITORS

9" — ~~£129~~ **£99.95**
 12" — ~~£199~~ **£149**

- **Reliability** Solid state circuitry using an IC and silicon transistors ensures high reliability.
- **500 lines horizontal resolution** Horizontal resolution in excess of 500 lines is achieved in picture center.
- **Stable picture** Even played back pictures of VTR can be displayed without jittering.
- **Looping video input** Video input can be looped through with built-in termination switch.
- **External sync operation** (available as option for U and C types)
- **Compact construction** Two monitors are mountable side by side in a standard 19-inch rack.

EXTENDED WARRANTY BY COMPUKARE

ENGLISH COLOUR TV/ AMERICAN NTSC COLOUR MONITOR

Suitable for Apple, Atari and Texas 99/4 **£295** + VAT

8MHz Super Quality Modulators	£4.90
6MHz Standard Modulators	£2.90
C12 Computer Grade Cassettes	10 for £4.00
Anadex Printer Paper — 2000 sheets	£25.00
Floppy Discs 5 1/4" Hard and Soft Sector	£3.50
Floppy Disc Library Case 5 1/4"	£3.50
Verocases for Nascom 1 & 2 etc.	£24.90
Keyboard Cases	£9.90

MEMORY UPGRADES

16K (8 x 4116) **£29.90** + VAT
 4K CompuKit (8 x 2114) **£29.90** + VAT

SPECIAL OFFER

We will part exchange your Sinclair ZX80 for any of our products.

Refurbished ZX80's—fully guaranteed **£69.90** + VAT
 (Supply dependant upon stocks).

EXTENDED WARRANTY BY COMPUKARE

We have one of the largest collections of Computer Books under one roof, along with racks of software for the PET and TRS80. **Come and see for yourself.**

NOW OPEN

OUR NEW SHOWROOM & SALES CENTRE AT

311 Edgware Road, London W2.
 Telephone: 01-441 2922

SPECIAL—ONCE IN A LIFETIME OFFER!

RRP £740 + VAT

16K **£399**
 32K **£449**
 48K **£499** + VAT

EXIDY SORCERER

For Personal or Business Use.
 32K or 48K memory. 8K Microsoft Basic in ROM. Dual Cassette I/O, RS232 I/O. Parallel I/O (Centronics). Expansion available through optional extra S100 Motherboard. 69 Key keyboard including 16 key numeric pad.

EXTENDED WARRANTY BY COMPUKARE

Please add VAT to all prices — including delivery. Please make cheques and postal orders payable to **COMP SHOP LTD.**, or phone your order quoting **BARCLAYCARD, ACCESS, DINERS CLUB** or **AMERICAN EXPRESS** number.

MAIL ORDER AND SHOP:
 14 Station Road, New Barnet, Hertfordshire, EN5 1QW (Close to New Barnet BR Station — Moorgate Line).
 Telephone: 01-441 2922 (Sales) 01-449 6596 Telex: 298755 TELCOM G

NEW WEST END SHOWROOM:
 311 Edgware Road, London W2. Telephone: 01-262 0387

OPEN — 10am - 7pm — Monday to Saturday

- ★ **IRELAND:** 80 Marlborough Street, Dublin 1. Telephone: Dublin 749933
- ★ **COMP SHOP USA,** 1348 East Edinger, Santa Ana, California, Zip Code 92705. Telephone: 0101 714 5472526

COMP SHOP "Europe's Largest Discount Personal Computer Stores"

COMP COMPUTER COMPONENTS (Part of the Compshop Ltd. Group)

BARCLAYCARD VISA DINERS CLUB INTERNATIONAL AMERICAN EXPRESS

The new MAPLIN CATALOGUE is out on December 5th

A massive new catalogue from Maplin that's bigger and better than ever before. If you ever buy electronic components this is the one catalogue you must not be without. Over 300 pages, it's a comprehensive guide to electronic components with thousands of photographs and illustrations and page after page of invaluable data. We stock just about every useful component you can think of. In fact, well over 5000 different lines, many of them hard to get from anywhere else. Hundreds and hundreds of fascinating new lines, more data, more pictures and a new layout to help you find things more quickly.

MAPLIN

Maplin Electronic Supplies Ltd.
All mail to: P.O. Box 3, Rayleigh, Essex SS6 8LR.
Telephone: Southend (0702) 554155. Sales (0702) 552911.
Shops:
159-161 King Street, Hammersmith, London W6. Telephone: (01) 748 0926.
284 London Road, Westcliff-on-Sea, Essex. Telephone: Southend (0702) 554000.
Both shops closed Mondays.

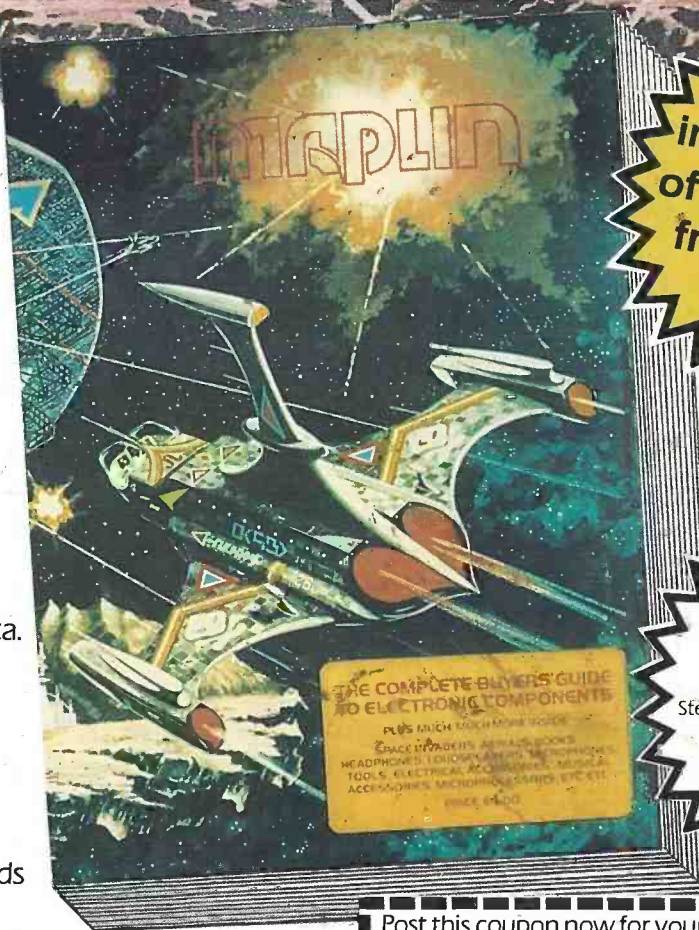

On sale
in all branches
of W H Smith
from Dec 5th
price £1

**PLUS
LOW PRICES**
such as
Resistors from 1 1/2p
Multimeters from £4.25
Ni-Cads from £1.15
Stereo Headphones from £3.49
Radios from £2.95
Over 300 Books
21 Different ranges
of capacitors, etc.,
etc., etc.,

Post this coupon now for your copy of our 1981 catalogue price £1.
Please send me a copy of your 320 page catalogue. I enclose £1 (Plus 25p p&p). If I am not completely satisfied I may return the catalogue to you and have my money refunded. If you live outside the UK send £1.68 or 12 International Reply Coupons.
I enclose £1.25

Name _____

Address _____

ET1181



Compu-copy

Rank Xerox's new baby, the Xerox 9700, offers the first direct link between computers and the xerographic process. From a digital input, the 9700 can simultaneously produce a business form and the computer-generated text to go on the form.

The input data can be received on-line from an IBM mainframe or off-line via nine-track magnetic tape. Laser technology converts this data into the selected typeface. At the same time, the standard letter or form is called from memory and the two combined, using the same process, printing on both sides of the paper at the rate of two copies per second. Output on A4 paper can be vertical or horizontal, as necessary.

A variety of standard type sizes and faces are available, but the 9700 can also print company logos, signatures and any other shape that can be converted into a digital code using the 90,000 dots per square inch printing format.

Graham Clark, Managing Director of Rank Xerox (UK), said that he hoped to see 100 of the 9700s installed in the UK within three years. Xerox believe a 9700 installation to be feasible in applications where computer technology is linked to a demand for more than 700,000 high quality prints per month.

The system will be available with a range of software for sale, lease or rental, a 24 hour service support and free operator training from January 1st 1981. The minimum sale price will be £184,650 and rental options from £5,900 per month (including 700,000 impressions).

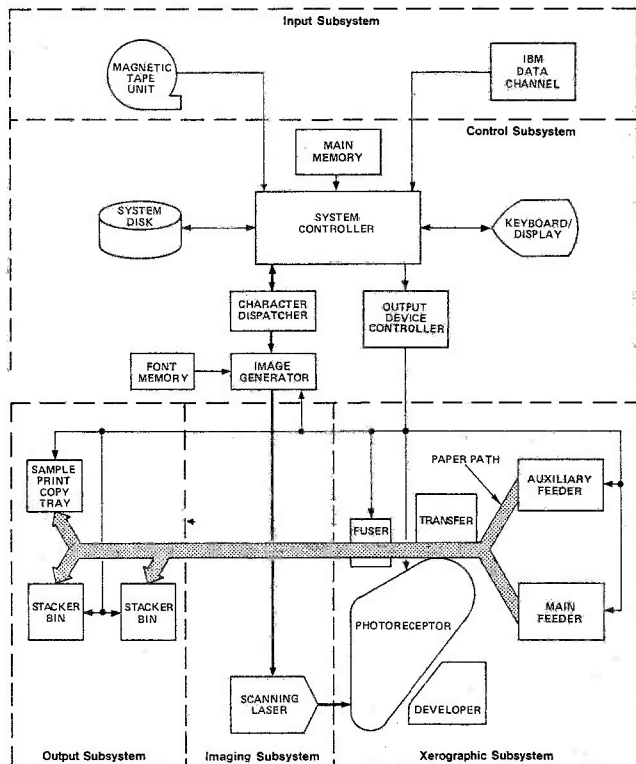

Functional Diagram of Xerox 9700 Electronic Printing System

OOPS Tech-Tips

Last month you may have noticed that the circuit diagram for the Direct-Conversion Receiver made a

brave attempt to escape off the edge of the page. We've reprinted the offending end of the diagram, which also shows the values of the capacitors in parallel with ZD1 and a recommended change to the capacitor in series with coil L2.

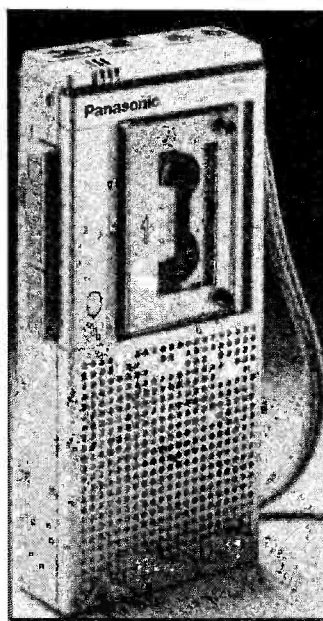
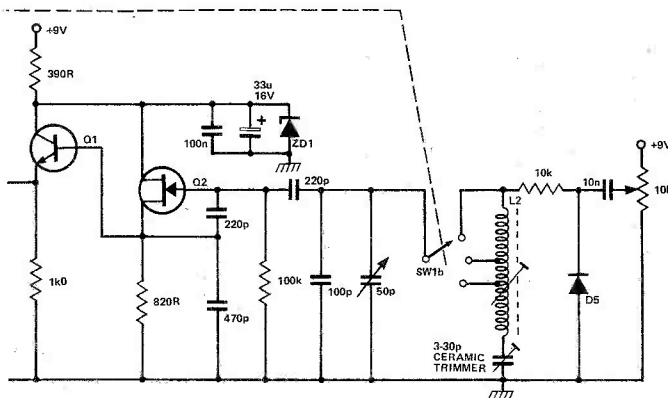

Micro-Taping

Panasonic Business Equipment has announced the introduction of the Panasonic RN-Z01, a new low-priced, mains/battery, two-speed micro-cassette recorder. Features include one-touch recording with cue and review controls, which allow the tape to be rewound or played on to locate a particular piece of recording. There is also a 'follow-up' feature, which lets you start recording during playback without having to stop the recorder first.

The RN-Z01 measures only 14.25 x 64 x 2.58 cm, weighs only 270g, is fully compatible with the Panasonic RN-195 transcription machine and comes complete with a cassette and carrying case for only £49.42 plus VAT. It is only available through distributors of Panasonic Business Equipment. For details of local stockists contact Panasonic Business Equipment Ltd, 9 Connaught Street, London W2.

Colour Tuning

Mitsubishi Electric have introduced a new FM/LW/MW tuner, the DA-F630, with an unusual method of tuning indication. When you tune into a mono station, the scale illumination changes from white to orange. When you tune into a stereo station it changes from white to green. As soon as you let go of the tuning control, a locking circuit automatically engages to prevent drift.

The front panel features soft-touch switching for MW, LW, FM, muting/mode and power, a five-LED signal strength indicator and a single tuning LED.

Sensitivity (FM stereo, 40 kHz dev) is 16 uV, S/N (stereo, 40 kHz unweighted) is 70 dB, THD (stereo, 1 kHz, 40 kHz dev) is 0.4% and frequency response is 40 Hz to 15 kHz (± 3 dB). The DA-F630 measures 42.4 x 14 x 25 cm.

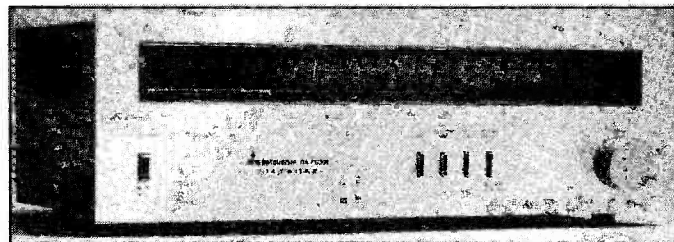

SHARP MZ-80K

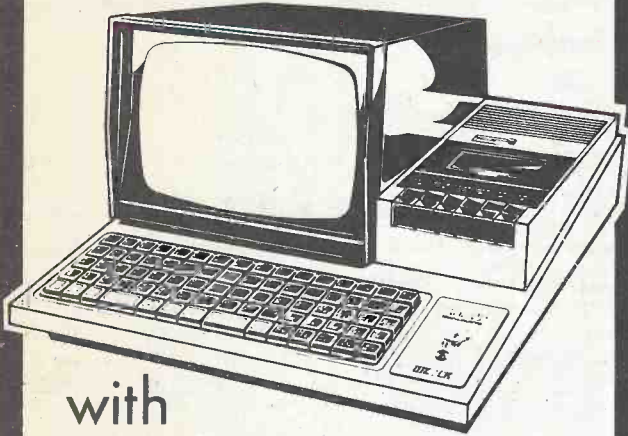

with
48K RAM

£460 + VAT.

- * includes delivery within Mainland U.K.
- * includes 12 months guarantee.
- * tested before despatch
- * bona fide official orders welcome

Prices.	Nett	VAT	Total
MZ 80k Computer 48k RAM	460.00	69.00	529.00
MZ 80I/O Interface unit	82.00	12.30	94.30
MZ 80 FD Dual Disk Drive	650.00	97.50	747.50
MZ 80 P3 Printer	430.00	64.50	494.50
CP/M Operating System	200.00	30.00	230.00
PC 1211 Pocket Computer	82.00	12.30	94.30
CE 121 Cassette Interface	12.00	1.80	13.80

ledger and stock control available free with full system purchases.

I enclose cheque/P.O. for:

Access: 5224

Barclaycard 4929

Name

Address:

Post Code

Goods required

24 Hour - 7 Day ANSAPHONE SERVICE on 051-236 0707



25 BRUNSWICK STREET,
LIVERPOOL L2 0PJ.
Tel. 051-227 2535/6/7



Mail Orders to:
MICRODIGITAL LIMITED
FREEPOST (No stamp required)
Liverpool L2 2AB.

MICRODIGITAL

QUALITY DOES NOT HAVE TO COST VERY MUCH!

ALL
PRICES
INCLUDE
VAT

BECKER
Hi-Fi Speakers

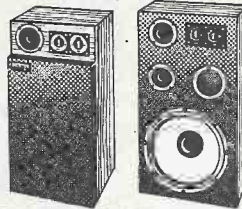

All models
multi-speaker systems

With controls, attractive woodgrain finish.
RMS ratings for 8 ohm.
10.35 10" 3 speaker system 35 watts 23" x 13" x 10 1/2" £79.95 pair
12.45 12" 4 speaker system 45 watts 26 1/2" x 14 1/2" x 11" £89.95 pair
12.60 12" 4 speaker system 60 watts 26 1/2" x 14 1/2" x 11" £115.95 pair
15.90 15" 5 speaker system 90 watts 28" x 17 1/2" x 11 1/2" £135.95 pair
(UK c/p £5.45 pair).

On Demonstration to callers.

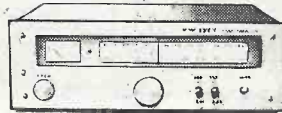

SCOTT T516 STEREO FM/AM TUNER

HIGH QUALITY STEREO FM/AM
TUNER BY SCOTT OF USA.

Overall size 5" x 14 1/2" x 12". Brand new and fully
guaranteed at a special low price.
(C/P £1.55)

£38.95

On demonstration for callers.



JVC BELT DRIVE TURNTABLE

JVC TURNTABLE WITH FREE AUDIO
TECHNICA AT100 STEREO CARTRIDGE.

- * S' shaped tone arm
- * Belt drive
- * 12" Platter * Calibrated counter-balance weight
- * Anti-static device
- Size 12 3/4" x 15 3/4"

£29.95

TV SOUND FROM YOUR HI-FI

High quality TV sound converter plugs into aerial
socket of your FM tuner. 9 volt battery operated
(battery not supplied). Nothing to look at ... but just
listen!

(UK Post etc. 50p)

On Demonstration for callers.

(As reviewed in 'Popular Hi-Fi July 1979) **£8.50**

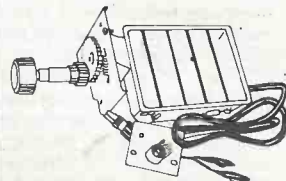

1000's SOLD

SEAS SPEAKER KITS



Professional sound hi-fi speaker kits with high
sensitivity (89-92dB). Extended frequency response
(223' 50-20kHz, 253' 35-25kHz). Designed and
made in Scandinavia to the highest quality. All
supplied with complete cabinet plans, tweeters/
crossovers/leads etc. * On Demonstration to
callers.

- * Hi-Fi 223. 30/45 watt 3 speaker 8" system £43.50 pair
- * Hi-Fi 253. 60/100 watt 3 speaker 8" system £34.50 each
- * Hi-Fi 403. 60/100 watt 3 speaker 10" system £44.50 each
- * Hi-Fi 603. 80/150 watt 3 speaker 12" system £64.50 each

(UK C/P £2.50)

COMPLETE RANGE OF SEAS
CHASSIS SPEAKERS ETC
ALWAYS IN STOCK
ALSO STOCKISTS FOR
AUDAX, GOODMAN'S, KEF, PEERLESS ETC.

PIEZO TWEETERS



New low prices
Clean sound, very low distortion tweeters. No
crossover required. Suitable up to 100 watts - more
in series.

- 1 Mid-range horn for disco/pa/groups ... £6.95
- 2 Tweeter horn for hi-fi/disco/pa ... £5.50
- 3 Popular hi-fi and disco ... £4.40
- 4 Flat type hi-fi ... £3.50

On Demonstration to callers.

C/P 50p (up to 4 items)

STEREO ACCESSORIES

- * 1987 Hi-Fi Frequency Equaliser £49.95
- * APM 200 Peak programme meter (twin scale) £39.95
- * MS3219 Twin Scale audio output meter £12.95
- * MC350 Tape echo chamber £58.95

FREE CATALOGUE

Large range of
speakers/stereophones/microphones/mixers/PA
equipment etc - and much more!
Plus huge range of test equipment.

ALL PRICES INCLUDE VAT

SEND LARGE 17 1/2 SAE

ALL PRICES CORRECT AT 1.12.80 £80E

AUDIO ELECTRONICS Limited

301 EDGWARE ROAD, LONDON, W2 1BN, ENGLAND.

TELEPHONE 01-724 3564 OPEN 9-6 Mon-Sat

ORDER BY POST OR TELEPHONE WITH BARCLAYCARD/ACCESS
OR CALL IN AND SEE FOR YOURSELF



**NEXT
MONTH**

electronics today

INTERNATIONAL

Look out for the February issue
on sale January 2nd



IR Beam Alarm

Our IR Beam Alarm features a dual beam IR link. The two beams, a few inches apart, must be broken simultaneously to activate the alarm. So, you won't have any false-triggering problems when a fly lands on the transmitter or receiver. Mind you, if you are visited by the East Lothian formation fly ensemble, you've got problems. The link will operate over 10m range and could form the basis of a comprehensive house alarm system.

Digital Designers' Circuit Supplement

Only 10 years ago, relatively simple digital circuits occupied acres of boards bristling with components. Now, very often, there's a single, special-purpose chip to do it all. Even if there isn't, a microprocessor can handle most contingencies. So, digital designers face increasingly complex problems as more and more functions are condensed into chip-size logic. Tim Orr's Digital Designers' Circuit Supplement starts you off on the road to making sense of it all.

Drum Sequencer

If you need a lot of banging in your life (perhaps you're a musician), try your hand at the ETI Drum Sequencer. It's designed in two distinct sections. The drum effects unit will simulate high/low tom-tom and bass and snare drum voices, manually triggered by, say, a loudspeaker sensor. The clever bit is the sequential programmer, which will reproduce the drum rhythm of your choice from the effects unit.

Crystal Calibrator

If you need a frequency standard for calibration purposes anywhere in the 100 Hz to 1 MHz range, then you need the February issue of ETI. Our Crystal Calibrator lets you determine the frequency of an unknown crystal or produce an accurate calibration signal for setting up and test applications — a useful piece of test gear.

SPL Meter

For the first time in a UK electronics magazine, ETI features an accurate, calibrated Sound Pressure Level Meter design based on a special-purpose, but modestly priced, precision microphone insert.

Use it to check absolute values of sound level or loudness at home or work — Crossroads at 96dB can damage your health! Use it to set up the graphic equaliser in your hi-fi system — check that sound levels at all frequencies are equal in your deep-pile, luxuriously upholstered, sound absorbing penthouse. Build the ETI SPL Meter at a fraction of the cost of commercial units.

Stethoscope

ETI February also features our engineers' stethoscope design. This useful instrument can be used in a variety of engineering applications to check for faults in moving parts — pistons in cylinders, for example.

The ETI Roulette game
— the home casino.

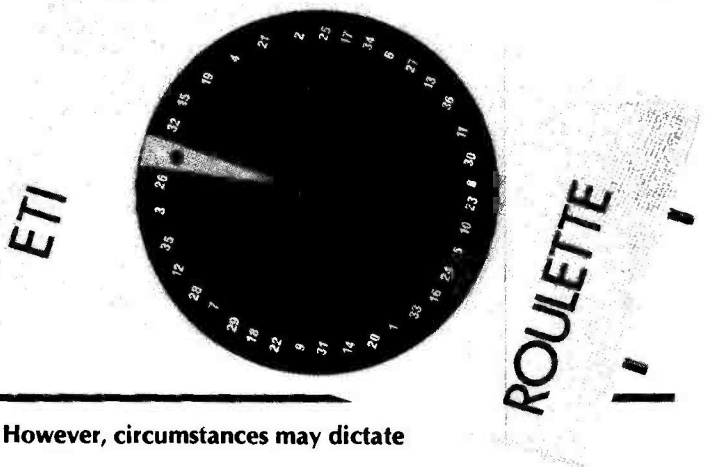

Articles described here are in an advanced state of preparation. However, circumstances may dictate changes to the final contents.

CASTLE ELECTRONICS MICRO COMPUTER CENTRE

Now out of twelve years' experience in electronics and communication comes the South Coast's own Computer Centre. Choose from our wide range of micro-computers and support material. Ideally suited to the hobbyist about to enter the fascinating world of computers. Personal callers or mail order welcome.

NASCOM

Nascom 2—£225. Comprehensive starter system that grows with you. Powerful Z80A 57 KeyLicon solid-state keyboard, TV or monitor. On board UART (6402) Parallel 1/0 with 16 lines. Kit fully documented. 8K microsoft basic in ROM.

Nascom Imp—£325. Plain paper with standard specification. Features: 60 lines/minute. Bidirectional printing. Baud rate 110-9600.

Nascom 1—£125 Kitform —£140 readybuilt. Full range of Nascom accessories are normally held in stock. Detailed specification and full list available.

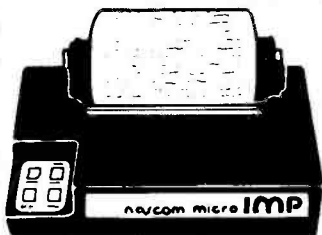

£125

TANGERINE

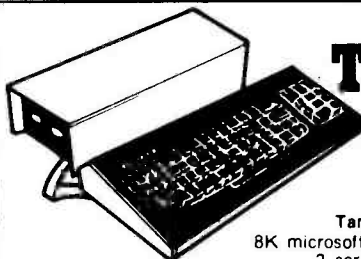

Microtan 65—£69 6502 microprocessor. 1K Tanbug. 1K user RAM. Full TV display. 20-way keypad. **£10.00**

Tanex—£43 7K RAM, 6K RAM, 8K microsoft basic. 32 parallel 1/0 lines. 2 serial. 1 x 20mA serial.

Cassette interface and motherboard. **System Rack** —£49 in black/tangerine brushed aluminium. Full Ascii keyboard with numeric keypad. **£56.35**.

Cabinet available at **£20**

Optional lower case pack—**£9.48** Chunky Graphics Pack—**£6.52**

£69

COMMODORE PET

Everything has been said about PET. A full range of accessories and software (both games and business) is held in stock.

8K Small Keyboard: £399.00
8K Large Keyboard: £425.00
16K: £499.00
External Cassette: £55.00



£399



Apple 16K video output only—**£695.00**. Disc drive without controller—**£299.00**. Disc drive with controller—**£349.00**. 16K add-on—**£69.00**.

CARDS: Prototype/hobby card—**£15.00**. Parallel Printer Interface Card—**£104.00**. Communications Card—**£130.00**. High-speed serial Interface Card—**£113.00**. Pascal Language System—**£299.00**.

Epson T80 Printer: **£349.00**

+ FREE £695
32K RAM

SHARP

MZ80—Sharp's dynamic entry into microcomputers. Floppy disc units plus printer now available.

Dual Discs: £715.00
Printer: £475.00

£449

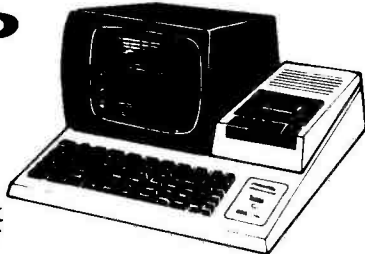

video genie system

Easy-to-use BASIC language means that programmes are easily written for specific applications. Many pre-recorded programme tapes are available. TRS80 software compatible. Great scope for the home, introducing the whole family to the computer age.

9" Monitor only £85.00
Epson 80 Printer £349.00

£299

SALE OF DEMONSTRATION EQUIPMENT

Centronics 779 with stand was **£995.00** now **£699.00** Computhink 800K Dual Disc was **£1145.00** now **£895.00** 32K PET was **£695.00** now **£599.00** 16K Apple 11 was **£695.00** now **£599.00** All items sold with warranty.

BOOKS

Basic Computer Game—**£5.50**. Instant Basic—**£7.20**. Pet Revealed—**£10.00**. Library of Pet Subroutines—**£10.00**. Your First Computer—**£5.95**. Guide to Basic Programming—**£8.85**. Basic Basic—**£8.50**. Advanced Basic—**£8.00**. Programming Z80—**£8.95**. 6520 Applications Book—**£7.95**. And lots more. Send for full list of microcomputer and electronics books.

Media C12 Cassettes—£5.00 for 10. 10x5 1/4" mini floppy discs—**£25.00** Kybe or Memorex. Listing paper—**£15 per box**, 2000 sheets 11 x 9 1/2".

Printers: Commodore 3022, Epson 80, Anadex DP8000, Qume. **Service:** Full service and spares for all equipment. Microprocessor components 6502, Z80A, 2716, 2114, etc., etc. Large range of CMOS, TTL, Linear, Transistors, Capacitors, Sockets, Rectifiers, LEDs, Resistors—full list available. **Monitors:** Range of direct import U.S. monitors 12" b/w **£139.95**, 12" green/black **£149.95**. Hitachi 12" **£197**, 9" **£127**. **Under development—**IEEE Intelligent Interface for Nascom, IEEE Controller, to operate Nascom or Commodore discs. Delivery January 1981.

ALL PRICES—ADD 15% VAT. DELIVERY: POSTAGE/PACKING WILL BE NOTIFIED
BARCLAYCARD AND ACCESS ORDERS TAKEN BY PHONE

Send for free brochures and price list

CASTLE ELECTRONICS

7 CASTLE ST., HASTINGS, EAST SUSSEX TN34 3DY
Shop hours 0900 to 1730 Mondays to Saturdays

Telephone: Hastings (0424) 437875
Personal callers welcome

MICROBASICS

'Speak to me only with thine software'. Henry Budgett discusses the monitor program that ties together the hardware from previous Microbasics.

If, at this point in the series, you feel that you have got yourself a real microcomputer, then think again. What you have is a collection of hardware that will process, store and transmit data but it has not yet been told how it should do it. Whilst the average person will usually be working in a high level language such as BASIC the actual CPU can only understand binary numbers. Quite apart from the Interpreter that translates the high level language instructions into the appropriate binary codes there has to be a piece of software called the monitor.

The name 'monitor' is synonymous with the operating system in bigger machines and performs the same tasks as the front panel used to in the days when computers had pretty lights and knobs all over them. The term 'software front panel' is still used in some literature to imply something special.

Monitoring The Situation

Before we take a detailed look at one particular monitor and what it does it is necessary to understand the tasks that should be done first. The monitor must be aware of the size and location of the memory, the location of the I/O devices and, most important of all, how to start everything up in the right way.

If we have informed the computer of these facts by writing a short machine code routine and a look-up table that details the various devices and their functions, we can now proceed.

We will assume that our microprocessor is being driven by an ASCII keyboard and that it will display the information on a TV screen. How does the monitor know when a key has been hit on the keyboard? The usual procedure is to operate under interrupts. This is done by causing a special bit in the CPU's status word to be set whenever a key is pressed. The monitor is continually looking at this bit, even if it's doing something else, and when it detects it, whatever is currently happening is suspended and the I/O port that caused the interrupt to occur is examined. It knows which one this is by means of a wonderful device known as the interrupt vector. It can now read the value of the key that was pressed.

What the monitor does with this piece of information depends on the type of monitor that you have. Some are very complex and allow all manner of special things to be done in the way of machine code programming. The one I am going to take a close look at is a good example of the kind of complexity that you can achieve within a very small space.

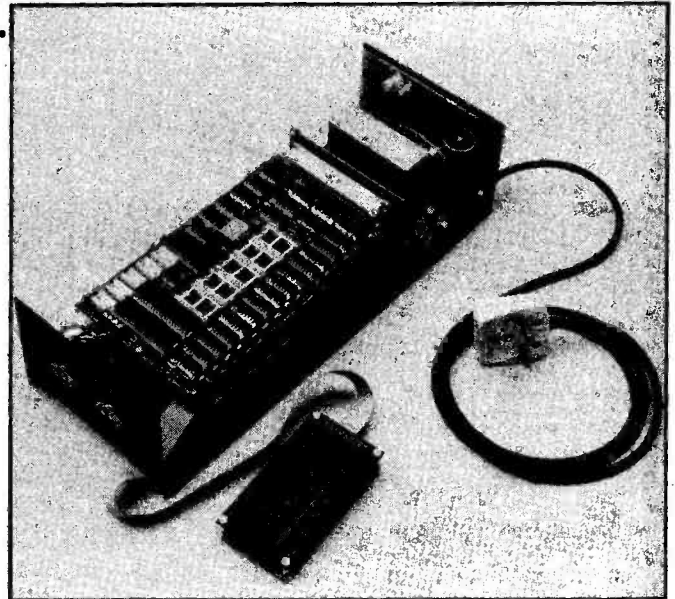

Microtan 65 with TANBUG and XBUG.

Bugging Your Micro

For historical reasons monitors are generally given BUG as part of their name. TANBUG is the standard monitor supplied with the Microtan 65 computer and, along with its enhancement XBUG, is the basis of the rest of this article.

TANBUG is rather special in that you can plug in either a simple Hex keypad or a full ASCII keyboard and it will detect which one is being used. For the sake of simplicity, assume that the ASCII keyboard is used. As soon as the machine is reset by means of the hardware switch, the internal hardware reset vector jumps straight into the start of the monitor. Being polite, 'user friendly' to use the jargon, the monitor announces its existence and gives you a character on the screen known as a prompt. Within the context of a monitor, the prompt and the cursor can be regarded as the same unless an error has occurred and then a '?' is displayed.

Before we can run any programs we first have to write them and thus we need a means of getting information into the memory and changing it if necessary. This is achieved by the M <addr> command which opens the specified address and displays its contents on the screen followed by a prompt. We can now type in the code that we require to replace that currently stored, step back to the previous location, step forward to the next location or go back to the monitor by pressing respectively ESC, LF or CR. These apparently meaningless mnemonics are ESCape, Line Feed and Carriage Return respectively and are interrupted in various ways by the monitor. Let us assume that you have written a program into the memory of your micro using the monitor and that you now wish to run it. In the case of TANBUG simply type 'G <addr> CR'. This tells the CPU to load the CPU's program counter with the specified address, to load the stack pointer with the beginning of the stack area in RAM and to start obeying the instructions. Clever stuff. →

Doing It Slowly

The trouble with programs written in machine code is that they tend to run extremely quickly. We can slow them down by writing delay loops but we can also use a monitor command which gives us single steps. Keying S sets the process into one-step-at-a-time mode. After each step has been processed the program stops and goes back to the monitor with a full display of the CPU's registers. You can execute the next step by keying P for proceed. It must be noted that a program step is not just the contents of one address but the complete instruction such as 'jump to address A000'.

Because the main cause of programs crashing is the wrong interpretation of information in the registers, the monitor allows you to adjust their values in much the same way as you can alter the contents of the memory. Even more common than that is the occasional 'bug' that lurks within the code and only jumps out at obscure times. We can catch this by setting a trap for it called a breakpoint. We generally know where the bug comes from but we don't know what causes it to appear so we set the breakpoint to the relevant position in the program and leave it running. When the bug appears and takes the trapped route it trips the breakpoint and this causes a complete printout of all the registers allowing you to find the reasons for its sudden emergence. With the TANBUG monitor you can set up to eight different traps, allowing bug catching on a lavish scale.

Display Your Contents

Keeping track of the program in the depths of the memory is made easy by having a list command. This allows you to display memory contents on the screen in a regular format, making the checking and copying on to paper easy. As the final option in the TANBUG repertoire, we can calculate offsets. Because it is quicker to tell a program to jump back ten steps rather than to tell it the absolute address, there is a relative jump command which allows you to move up to 127 steps in either direction. To use this, merely key in the address of the jump command, the address you wish to get back to and CR. The monitor then gives you the HEX value for the relative jump.

Saving The Day

The basic Microtan 65 is equipped with only 1K of RAM and out of this must be taken the stack requirements for the CPU and the monitor, the 512 bytes of video RAM and some working space. The user is left with about 430 bytes for his programs although it is possible to use the video RAM area to some extent. Because of this limited area it was not thought necessary to include any cassette storage capability on the CPU card; there isn't any space left anyway! Once one enters the realms of expansion with the TANEX card, cassette I/O is essential and the enhanced monitor package, XBUG, supplies this and more.

XBUG is packaged in a 2K EPROM and gives the user three extra functions. These are cassette handling, a line-by-line assembler and a line-by-line translator. The latter two are almost unique and, at this price level, give the system a distinct edge.

The cassette-handling software allows the saving and loading of named files as well as the verification of saved files against the memory at two speeds. The slow CUTS (Computer Users Tape Standard) 300 baud speed is generally used for important system files, and for any back-up copies because the recordings made are inherently less prone to corruptions. That

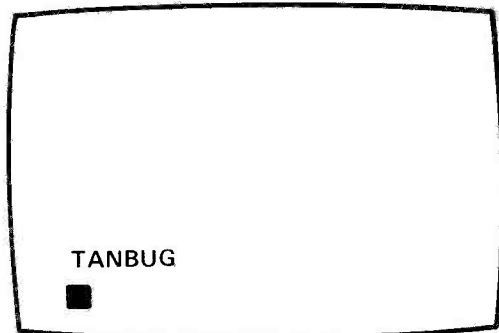

Fig 1. The monitor announces itself to the world and 'prompts' the user to do something. The ■ is replaced by a '?' in the event of an error.

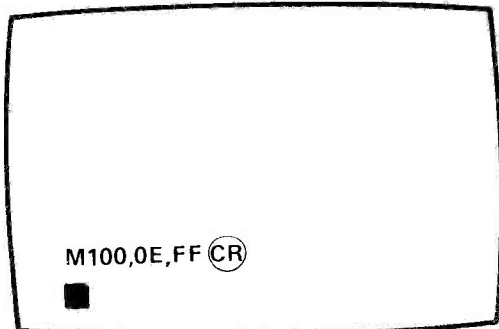

Fig 2. Typing M100 CR opens the specified location and reveals the current value 0E. We have replaced this with FF and closed the location but we could have stepped forward or back through memory by using other commands.

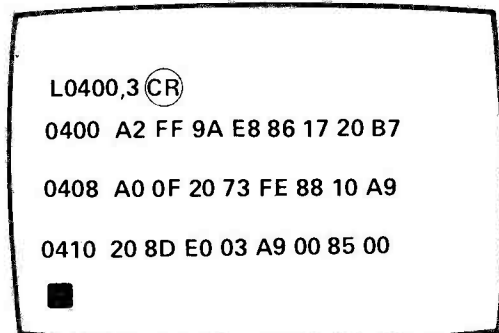

Fig 3. The monitor will list the program from any given address in blocks of eight bytes per line for up to 256 lines. Here we have selected three.

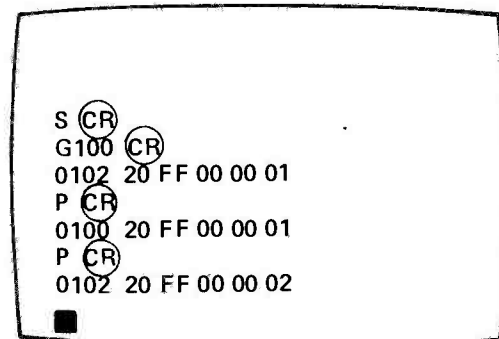
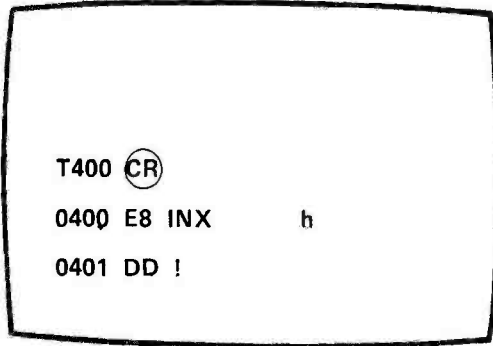

Fig 4. By setting the monitor to operate in single steps, we can inspect the contents of each register in the CPU after each step before proceeding with the P command. The registers are; next address to be executed, CPU status value, low byte of the stack pointer, index X register value, index Y register value and the accumulator value.



©COPYRIGHT MODMAGS Ltd

Fig 5. Using the assembler, we define the starting address and the current memory value is displayed. We have overwritten this by keying INX which has been translated into its correct Hex code and the assembler has stepped to the next location in memory. The prompt symbol '!' is used to identify the fact that you are in the assembler mode and the 'h' to the extreme right is the ASCII character that corresponds to the Hex code. This acts as a check.

is not to say that the fast speed, of approximately 2400 baud, is unreliable — one generally uses this for the convenience of loading programs quickly; a program takes eight times longer to load using the CUTS format. The manual gives the setting up information in two programs which should be tried at each tape speed. I use a manual level control tape recorder which also allows the tape speed to be varied slightly, but the system works perfectly on virtually any cassette recorder. The reason that I chose a rather more expensive machine is not because I've got money to burn, but because I receive programs for a wide variety of machines and sometimes the speeds or recording settings vary, hence the need to be able to adjust my system to that of the person who is supplying the tape.

Interpretations Supplied

As mentioned earlier the XBUG monitor is equipped with a simple assembler and dis-assembler. This allows the budding machine code programmer to use assembly language mnemonics rather than the actual Hex codes. The mnemonics are effectively one step towards high level language programming. They allow the programmer to think in logically sounding 'words' rather than in specific Hex codes.

Given a starting address and the appropriate commands, the assembler will convert the op-code and its associated operands into the proper Hex codes. It is quite intelligent too; most common errors are trapped before they can be entered.

As a direct complement to the assembler there is a line-by-line translator, which converts the stored Hex into the more meaningful assembly language mnemonics. It is called a 'line-by-line' system because it needs to know the correct start or else it will try to convert Hex data into assembly language mnemonics. In some cases you can have enormous fun dis-assembling a program to reveal another program which, according to the translator, is complete nonsense! Don't get me wrong, I'm not criticising the limited capability of the translator but rather pointing out that, for a 2K package, it packs one heck of a punch. The nearest equivalent system that I can recall is one supplied with the Rockwell AIM 65 and that takes about 2K on its own just to give an equivalent assembler.

The Next Step

Nowadays the almost universal introduction to high level language programming is through BASIC. With a language like this, a new piece of software is required — the Interpreter. This is, if you like, equivalent to the mnemonic assembler in that it converts the 'English' of the BASIC commands into the Hex code that the CPU needs. To avoid wasteful repetitions of the code, the BASIC will use routines that are already written in the monitor, the cassette-handling routines for example.

This use of standard routines allows the BASIC programmer to call machine code programs from this BASIC program. This is often done to speed execution of a program or to perform a repetitive chore. On my system there is no 'Clear Screen' command in BASIC, so I have a standard machine code routine for this stored in memory, which I call as required.

A Close Encounter

I hope to be taking a very close look at one specific computer in the next two episodes. As yet the computer hasn't arrived, but with luck next month will see the first part. The reason for taking a look at a complete computer is to try to explain the systems aspect, ie how all the bits and pieces fit together, rather than continue to inspect the individual elements.

ETI

Bind it

It's so easy and tidy with the Easibind binder to file your copies away. Each binder is designed to hold approximately twelve issues and is attractively bound and blocked with the ELECTRONICS TODAY INTERNATIONAL logo.

Price U.K. £3.95 including postage, packing and V.A.T., overseas orders add 30p. Why not place your order now and send the completed coupon with remittance to:-

EASIBIND LTD., 4 UXBRIDGE STREET, LONDON W8 7SZ. Tel: 01-727 0686

Please allow 3/4 weeks for fulfillment of order.

it's easy with EASIBIND

Easibind Ltd., 4 Uxbridge St., London, W8 7SZ.

Nat. Giro No. 5157552.

Order Form

ELECTRONICS TODAY INTERNATIONAL

I enclose p.o./cheque value

for binders

Years required

BLOCK LETTERS PLEASE

Name

Address

.....

.....

.....

Date

Registration No. 307469





SIMPLY AHEAD
and staying there

The range grows bigger... better...

New Profile Amplifiers - Two New Series

MOSFET

CHOOSE AN I.L.P. MOSFET POWER AMP when it is advantageous to have a laser cut rate, lower distortion at higher frequencies, enhanced reliability, the ability to work with complex loads without difficulty and complete absence of crossover distortion. I.L.P.'s exclusive encapsulation technique within fully adequate heatinks has been taken a stage further with specially developed computer-verified 'New Profile' extrusions. These ensure optimum operating efficiency from our new MOSFETs, and superior reliability. Connections are via five pins on the underside. **I.L.P. MOSFETS ARE THE ONLY AMPLIFIERS TO BE CONTESTED IN THIS EXCITING NEW CATEGORY BUT AT ONLY A FRACTION OF PRICES CHARGED ELSEWHERE.**

Model	Output Power RMS	Distortion Typical at 1KHz	Slew Rate	Rise Time	Signal/Noise Ratio DIN AUDIO	Price & VAT
MOS120	60W into 4-8Ω	0.005%	20V/μs	3μs	100dB	£25.88 + £3.88
MOS200	120W into 4-8Ω	0.005%	20V/μs	3μs	100dB	£33.46 + £5.02

BIPOLAR

CHOOSE AN I.L.P. BIPOLAR POWER AMP where power and price are first consideration while maintaining optimum performance with hi-fi quality and wide choice of models. From domestic hi-fi to disco and P.A., for instrument amplification, there is an I.L.P. Bipolar to fill the bill, and as with our new Mosfets, we have encapsulated Bipolars within our New Profile extrusions with their computer-verified thermal efficiency and improved mounting shoulders. Connections are simple, via five pins on the underside and with our newest pre-amps and power supply units, it becomes easier than ever to have a system layout housed the way you want it.

Model	Output Power RMS	Distortion Typical at 1KHz	Slew Rate	Rise Time	Signal/Noise Ratio DIN AUDIO	Price & VAT
HY30	15W into 4-8Ω	0.015%	15V/μs	5μs	100dB	£6.34 + 95p
HY60	30W into 4-8Ω	0.015%	15V/μs	5μs	100dB	£7.24 + £1.09
HY120	60W into 4-8Ω	0.01%	15V/μs	5μs	100dB	£15.20 + £2.28
HY200	120W into 4-8Ω	0.01%	15V/μs	5μs	100dB	£18.44 + £2.77
HY400	240W into 4Ω	0.01%	15V/μs	5μs	100dB	£27.68 + £4.15

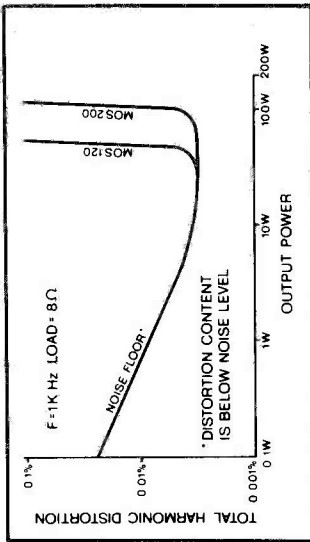
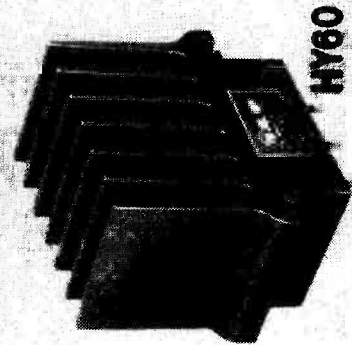
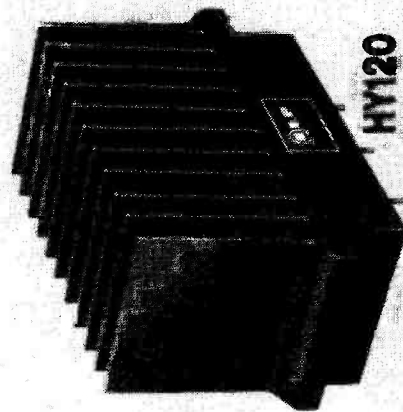

Load impedance both models 4Ω; -∞ Input sensitivity both models 500mV
Input impedance both models 100KΩ
Frequency response both models 15Hz-100KHz-3dB

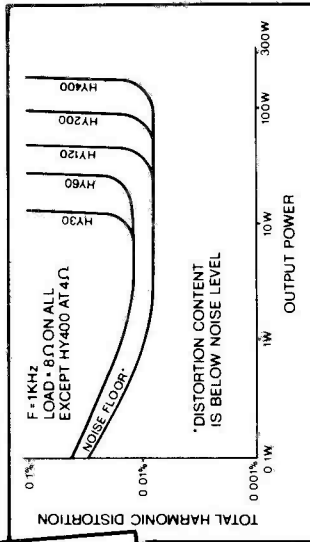

Load impedance all models 4Ω; -∞ Input impedance all models 100KΩ
Input sensitivity all models 500mV
Frequency response all models 15Hz-50KHz-3dB

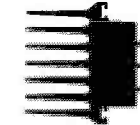

THE NEW PROFILE EXTRUSIONS
The introduction of standard heatsink extrusion for all I.L.P. power amplifiers achieves many advantages: - Research shows they provide optimum thermal dissipation and stability. Slotted shoulders allow easy mounting; standardisation enables us to keep our prices competitive. Surfaces are matt black, anodised for lower thermal conductivity. Extrusions vary in size according to module number.

I.L.P. POWER AMPS ARE ENCAPSULATED FOR THERMAL STABILITY AND LONGER LIFE

NEW PRE-AMPS

HY6 (mono) and HY66 (stereo) are new to I.L.P.'s range of advanced audio modules. Their improved characteristics and styling ensure their being compatible with all I.L.P. power-amps both MOSFET and BIPOLAR, giving you chance to get the best possible reproduction from your equipment. HY6 and HY66 pre-amps are protected against short circuit and wrong polarity. Full assembly instructions are provided. Mounting boards are available as below.

Sizes - HY6 - 45 x 20 x 40 mm. HY66 - 90 x 20 x 40 mm. Active Tone Control circuits provide ± 12 dB cut and boost. Inputs Sensitivity - Mag. PU. - 3mV; Mic. - selectable 1-12mV; All others 100mV. Tape O/P - 100mV. Main O/P - 500mV. Frequency response - D.C. to 100KHz - 3dB.

HY6 mono £5.60 + 84p VAT Connectors included

HY66 stereo £10.60 + £1.59 VAT Connectors included

B6 Mounting Board for one HY6 78p + 12p VAT

B66 Mounting Board for one HY66 99p + 15p VAT

NEW POWER SUPPLY UNITS

Of the eleven power supply units which comprise our current range, nine have toroidal transformers made in our own factory. Thus these I.L.P. power supply units are space-saving, more efficient and their better overall design helps enormously when assembly building. All models in the range are compatible with all I.L.P. amps and pre-amps with types to match whatever I.L.P. power amps you choose.

PSU30 ± 15 V at 100mA to drive up to 12 x HY6 or 6 x HY66 £4.50 + 0.68p VAT

• THE FOLLOWING WILL ALSO DRIVE I.L.P. PRE-AMPS

PSU36 for use with 1 or 2 HY30's £8.10 + £1.22 VAT

• ALL THE FOLLOWING USE TOROIDAL TRANSFORMERS

PSU50 for use with 1 or 2 HY60's £9.75 + £1.46 VAT

PSU60 for use with 1 HY120 £9.75 + £1.46 VAT

PSU65 for use with 1 MOS120 £13.61 + £2.04 VAT

PSU70 for use with 1 or 2 HY120's £13.61 + £2.04 VAT

PSU75 for use with 1 or 2 MOS120 £13.61 + £2.04 VAT

PSU90 for use with 1 HY200 £14.75 + £2.21 VAT

PSU95 for use with 1 MOS200 £23.02 + £3.45 VAT

PSU180 for use with 1 HY400 or 2 HY200 £24.20 + £3.63 VAT

★ Freepost facility

When ordering or writing about I.L.P. products, you do not need to stamp the envelope. Mark it FREEPOST plus the code shown in the address below. We pay the postage for you.

★ TO ORDER

Send cheque or money order payable to I.L.P. Electronics Ltd and crossed. Or pay by ACCESS or BARCLAYCARD. Cash payments must be in registered envelope; if C.O.D. payment is wanted, please add £1.00 to TOTAL value of order.

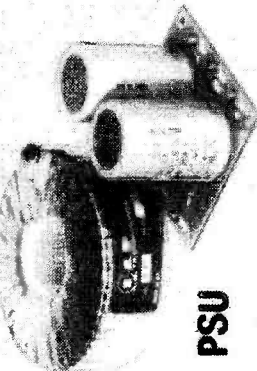
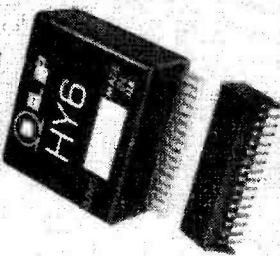
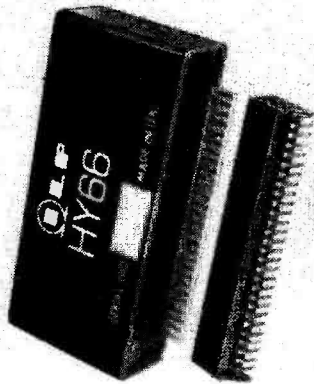

PSU

**NO QUIBBLE 5 YEAR GUARANTEE
7-DAY DESPATCH ON ALL ORDERS
BRITISH DESIGN AND MANUFACTURE
FREEPOST SERVICE**

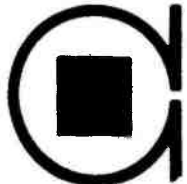

ELECTRONICS LTD.

FREEPOST 4 Graham Bell House, Roper Close, Canterbury, Kent CT2 7EP.
Telephone (0227) 54778 | Technical (0227) 64723 | Telex 965780

Available also from: MARSHALLS, WATFORD ELECTRONICS and certain other selected retailers

**COMPATIBLE
WITH ALL
I.L.P. MODULES**

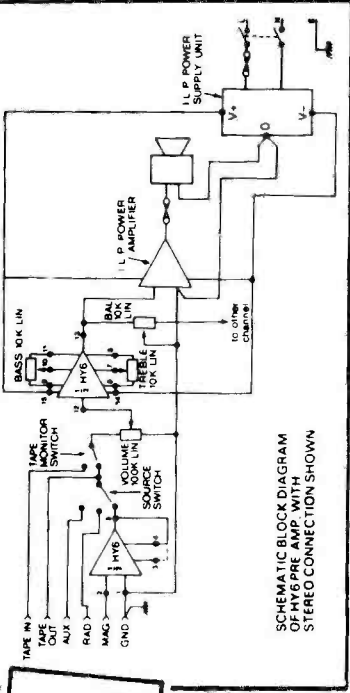

SCHEMATIC BLOCK DIAGRAM OF HY6 PRE-AMP WITH STEREO CONNECTION SHOWN

- **DISORTION TYPICALLY 0.005%**
- **S/N RATIO - 90dB (Mag. P.U. - 68 dB)**
- **38 dB overload margin on Mag. P.U.**
- **LATEST DESIGN HIGH QUALITY CONNECTORS**
- **ONLY POTS, SWITCHES AND PLUGS/SOCKETS NEED ADDING**
- **NEEDS ONLY UNREGULATED POWER SUPPLY ± 15 to ± 60 V**

IN A RANGE OF 11 MODELS USING LATEST TOROIDAL TRANSFORMERS

1971-1980 TEN YEARS OF PLANNED PROGRESS

When, in 1971, Ian L. Potts founded his now world-famous company, he saw the need for a different and more rational approach to exploiting to the full, the potential that lay in modular construction. New thinking was badly needed. The result was a range of modules revolutionary in concept. The rightness of this new thinking is shown by the size of the company today, its new factory, its vast exports, its acceptance by constructors as the modules to build with. The range grows bigger and better. Exciting new lines (in no way conflicting with existing ones) are well past drawing board stage. This is why I.L.P. are simply ahead and staying there.

BRITAIN'S FASTEST GROWING MODULE SUPPLIERS

To: I.L.P. ELECTRONICS LTD. CANTERBURY CT2 7EP

Please supply.....

..... Total purchase price £.

I enclose Cheque Postal Orders International Money Order

Please debit my Access/Barclaycard Account No.

NAME

ADDRESS

Signature

**ALL UK ORDERS
DESPATCHED
POST FREE**

MULTI~OPTION SIREN

Warbles, bleeps, rising tones, falling tones and key-shifted tones, with or without vibrato — just a few of the near-infinite variety of sounds generated by our Multi-option Siren. Design by Ray Marston. Project development by Steve Ramsahadeo.

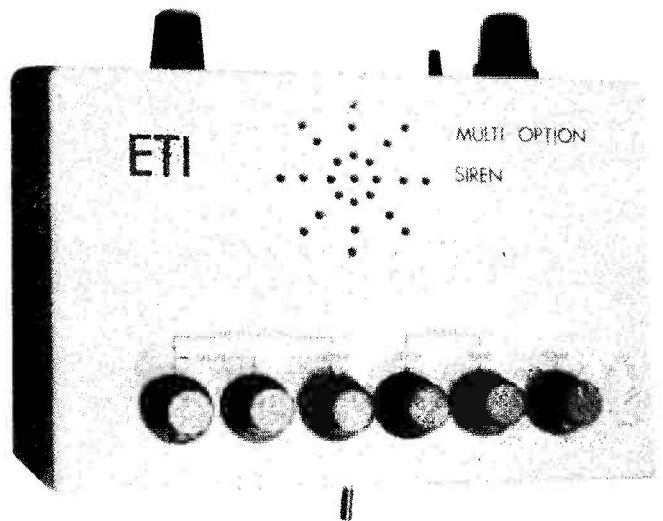

This design has a total of seven variable controls plus six switch-selectable operating modes and can generate such a vast range of different sounds that it is quite difficult to adequately give a written impression of the full capabilities of the project.

The heart of the unit is a tone generator that can have its operating frequency varied over virtually the full audio range by a single tone control. The frequency of this tone generator can also be modulated by either or both of two more generators, the first of these being a vibrato square wave oscillator. Both the vibrato rate and vibrato depth can be varied by individual controls. Thus, a little bit of fast vibrato imposes a 'buzz' sound on the tone, while lots of slow vibrato produces a sound like that of a tinkling piano key.

The second frequency-modulation generator is a very-low-frequency (VLF) oscillator that can produce either a pulse or a ramp waveform. Two mod shape controls allow the rise and fall times of the ramp or the on and off times of the pulse to be independently varied over a wide range to produce a wide variety of frequency-modulation waveforms. The depth of modulation is fully variable by a mod depth control.

Thus, with lots of symmetrical VLF ramp modulation applied, the circuit produces a 'wailing' American police-car sound without vibrato, or the sound of a repeatedly scaled (up and down) piano when lots of slow vibrato is applied. With a little bit of symmetrical VLF pulse modulation applied, the circuit produces the familiar 'dee-dah' British police-car sound without vibrato, or the alternate sounds of the repeated hammering of one piano key followed by the similar hammering of a different key when lots of slow vibrato is applied. The circuit can, of course, generate a virtually infinite variety of sounds between these extremes.

Gating Facilities

In addition to all the above sound generating facilities we've provided the ETI Siren with a number of gating functions. The gate is driven by the VLF oscillator and can be used

to disable the audio output signal during either the leading or the trailing part of the VLF waveform or on alternate VLF-generator cycles. To gain an insight into the functional effect of this gating facility, imagine that the siren controls are set to produce a symmetrical VLF ramp waveform with lots of mod depth and no vibrato.

With the gating circuit turned off, the siren produces the familiar wailing sound. With leading gating applied the siren repeatedly produces a 'peeow' or falling tone sound followed by a blank period. With trailing gating the siren repeatedly produces a 'wheep' or rising tone sound followed by a blank period. With alternate gating the siren repeatedly produces a wail sound followed by a blank period of equal length.

Thus, the gating facility effectively trebles the variety of sounds that our siren can produce — and three times a 'near-infinite variety of sounds' should be enough to satisfy anyone!

The Multi-option Siren circuit needs a 12 V supply, which can be derived either from batteries or from the mains via a suitable supply circuit.

All components are mounted on a single PCB to ease construction. Begin by inserting all low profile components, ie wire links and sockets, followed by resistors, diodes, capacitors and transistors, observing the orientation of all polarised components. Fit the ICs last, taking care when handling the CMOS 555.

If you decide to use the recommended Vero case, drill all the holes to accommodate the potentiometers, switches and loudspeaker vent. Fix the loudspeaker in the upper half of the case and hold it in place with a few drops of the ever faithful Super-glue. The PCB must be centralised, so that the two battery holders can be placed either side. To enable the holders to fit in this way the battery connectors are not used. The power connections are soldered directly onto the studs, so take care not to apply excessive heat. A piece of insulating tape can then be stuck across the connections to stop interference with the front panel.

After a visual check, you will now be able to produce a variety of sound effects that will span the galaxy; yes, you too can have the best battery-powered bird caller in the land.

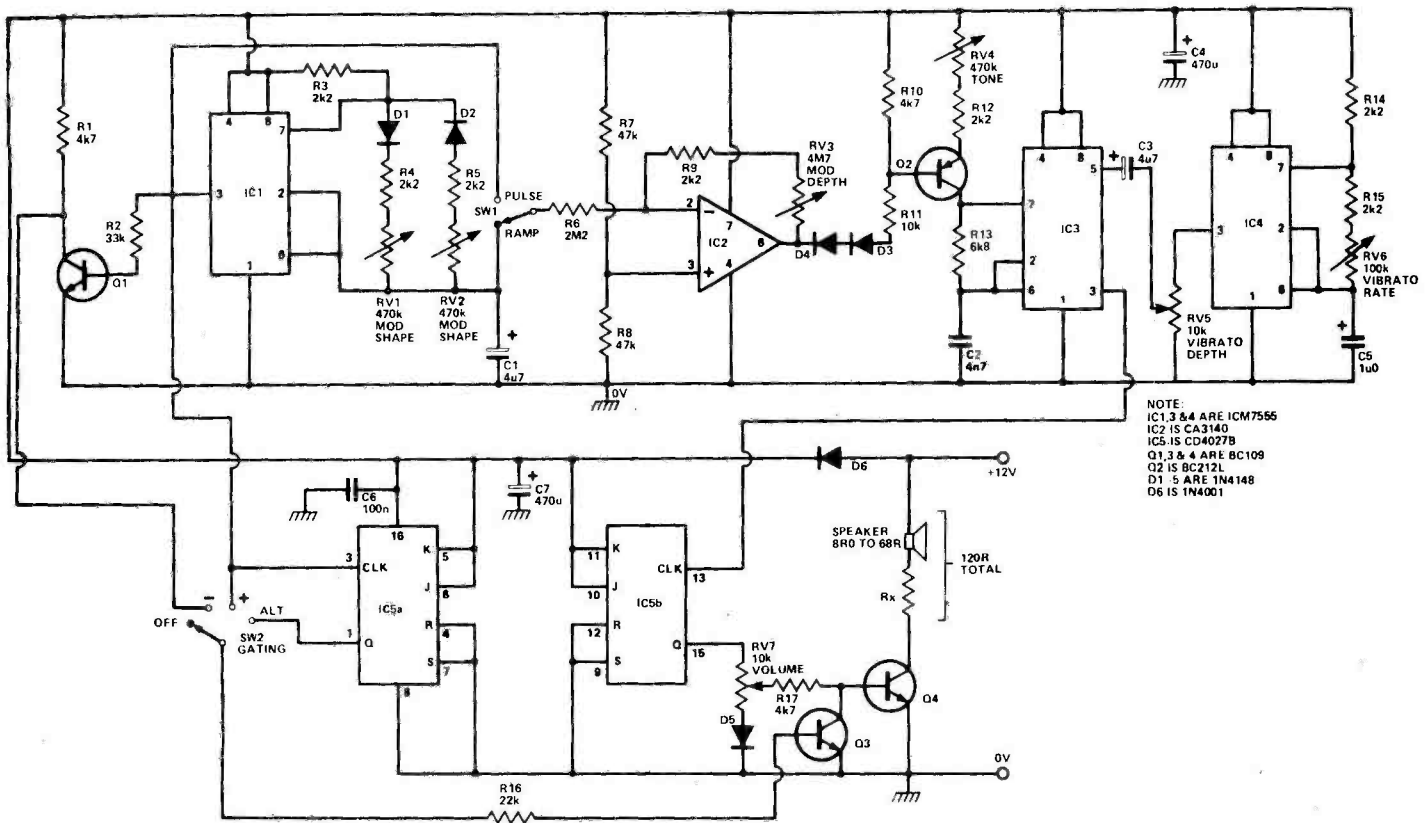

Fig. 1 Circuit diagram.

HOW IT WORKS

The heart of the project is the tone generator designed around IC3. This is a fairly conventional 555-type astable, except that C2 charges via R13 and the constant current generator formed by Q2 and its associated resistor and diode networks. Normally, the output of IC2 (feeding D4) is at half-supply volts, so Q2 base is at a couple of volts below the positive supply value. The operating frequency of IC3 is variable via tone control RV4. The output (pin 3) of the IC3 tone generator is divided-by-two to provide a symmetrical waveform (via IC5b) and the resulting audio signal is fed to the speaker via Q4-R17 and volume control RV7.

IC4 is wired as a perfectly conventional 555 type astable and is used as a vibrato generator, with its square wave output being used to frequency modulate the IC3 tone generator via pin 5. The vibrato rate is variable via RV6 and the vibrato depth is variable via RV5.

IC1 is also wired as a 555-type astable, but in this case the charge and discharge times of C1 are independently varied by RV1 and RV2 respectively and the circuit operates at a very low frequency (VLF). The output of the VLF oscillator can be used to frequency-modulate tone-generator IC3 via IC2 and constant-current generator Q2, the pin 3 output being used to provide pulse modulation and the C1 output to provide ramp modulation. The depth of modulation can be varied by mod depth control RV3, which enables the gain of IC2 to be varied from near-zero (RV3 = zero) to approximately x2 (RV3 = 4M7).

The square wave (pin 3) output of the VLF oscillator can also be used to synchronously gate the audio output signal of the siren on and off via Q3. When this transistor is driven to saturation (by a high bias to R16) it kills the input signal to amplifier Q4. If R16 is driven directly from pin 3 of IC1, the audio signal is killed (gated off) when the VLF output is high. If R16 is driven from the collector of inverter Q1, the audio signal is killed when the VLF output is low. If R16 is driven from the output of divide-by-two flip-flop IC5a, the audio signal is killed on alternate VLF cycles.

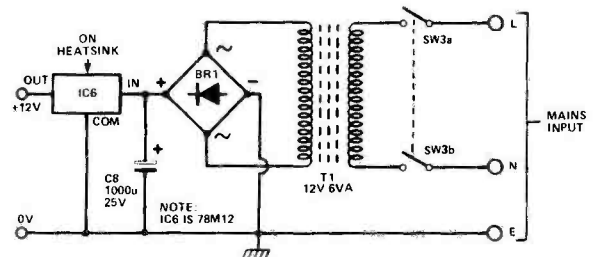
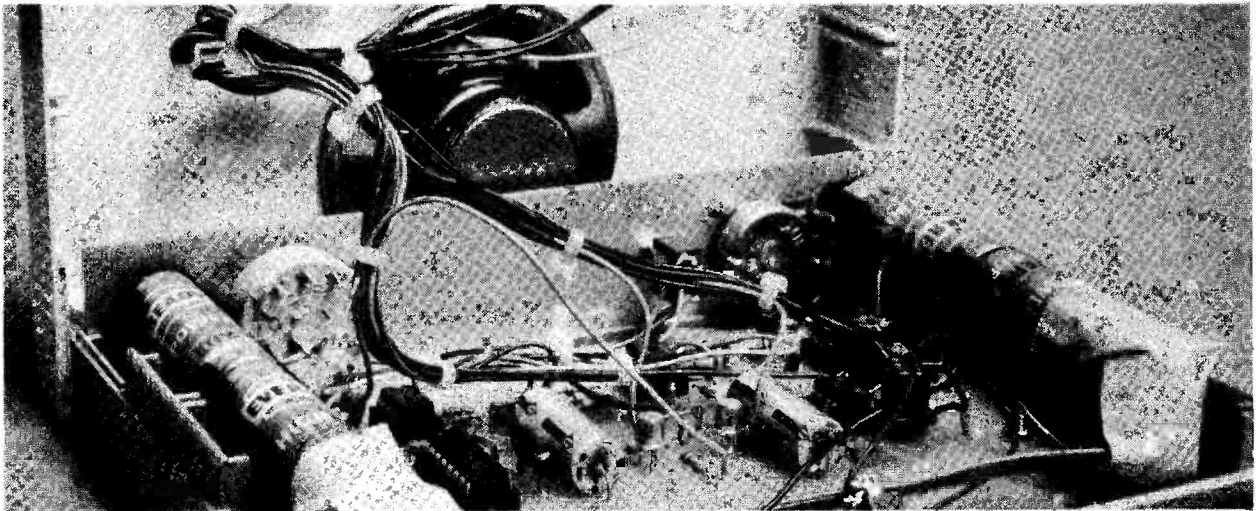

Fig. 2 Alternative battery and mains power supply options.

BUYLINES

There should be no problem in obtaining any of the components used in the ET1 Siren. All should be available from mail order suppliers advertising in this issue. If you have trouble obtaining a 68R loudspeaker, Technomatic should be able to help.



PARTS LIST

Resistors all 1/4W 5%		C3	4u7 63 V electrolytic PCB type
R1,10,17	4k7	C4,7	470u 25 V axial electrolytic
R2	33k	C5	1u0 63 V electrolytic PCB type
R3,4,5,9,12,14,15	2k2	C6	100n polyester Mullard C280
R6	2M2	Semiconductors	
R7,8	47k	IC1,3,4	ICM7555
R11	10k	IC2	CA3140
R13	6k8	IC5	4027B
R16	22k	Q1,3,4	BC109
Potentiometers		Q2	BC212L
RV1,2,4	470k linear	D1-5	1N4148
RV3	4M7 linear	D6	1N4001
RV5	10k linear	Miscellaneous	
RV6	100k linear	SW1,3	DPST miniature toggle
RV7	10k logarithmic	SW2	1 pole 4 way rotary switch
Capacitors		LS1	68R
C1	4u7 35 V tantalum	4 Section battery holders (HP7 type) (2 off)	
C2	4n7 ceramic	Vero Case (order code 202-21037L)	
		Knobs to suit (8 off)	

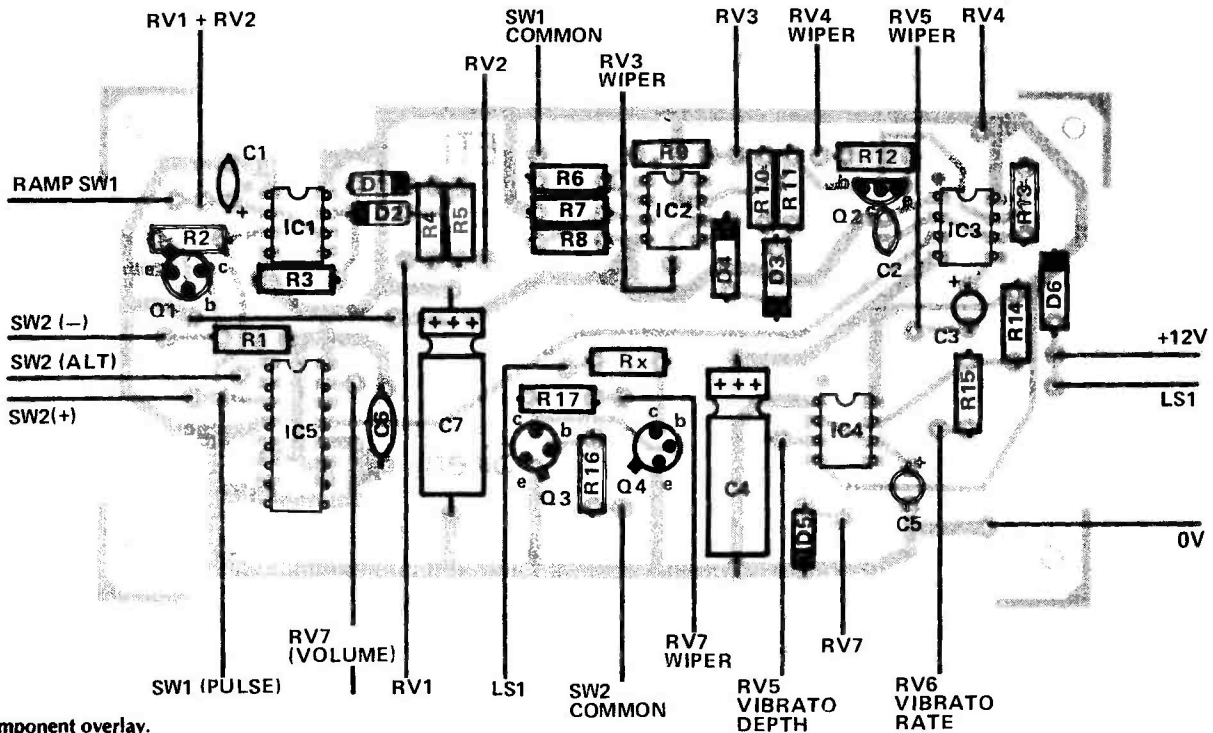

Fig.3 Component overlay.

ETI

The NEW

VIDEOTONE

YOU CANNOT BUY CHEAPER - YOU CAN ONLY GET LESS FOR YOUR MONEY!

Introduces DIRECT SELLING - the Ultimate Discount!!!

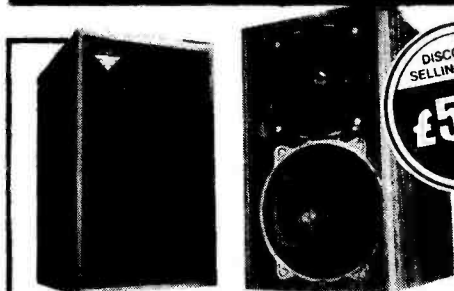

LOUDSPEAKERS

The complete fully reviewed range of Videotone Speakers which dominate within their class. Now at lowest ever prices.

D 100	£38
Minimax 11	£44
GB3	£50
GB2	£60
GBS	£207
D 93	£40

DISCOUNT SELLING PRICE
£50.00



CORAL CARTRIDGES

Fast becoming one of the top names

MOVING COIL

UK's No. 1 Cartridge

MC 81	£48.87
777EX	£35
777E	£25

HEAD AMP

H300	£51.75
T100	£24.75

MOVING MAGNET

555SX	£7.28
555E	£14.22
666E	£32.48

HEADSHELLS

S100	£6
S101	£7
S200	£4



MICROPHONES

MU 105-22	£29.30
MU 105-12	£22.25
MU 25 C	£17.39

TURNTABLES

Sansui SR222 Mk2	£69.00
JVC LA 11	£64.00
JVC SLQ 3	£140.00



ELECTRONICS

This new range of Electronics from Videotone redefines the words quality and value for money to a new high.

30 watt amp MC input SA4130	£75.00
Stereo Tuner ST4120	£68.00
Cassette full features SC3200	£98.00
50 Watt amplifier WA7700	£77.00
20 Watt amplifier LA2020	£58.00

DISCOUNT SELLING PRICE
£68.00

DISCOUNT SELLING PRICE
£75.00

A MESSAGE FROM VIDEOTONE

Dear Customer

You will find that the products advertised on this page are the best possible value for money. They are only low in price because we have eliminated large amounts of selling costs that other brands have to suffer. These savings are passed directly on to you. We have full brochures on any specific item you may be interested in and a competent realistic staff of engineers at our London Showrooms to help you in your choice. Our consumer protection packages are comprehensive and we offer every form of financing you may require. We carry out our own servicing and are dedicated to giving Value for Money. We are confident our products are unbeatable. You may purchase with confidence because our Engineers have specially selected them from competitive sources throughout the world and we import them directly ourselves. Remember, you have 21 days trial period on all products. That is the measure of our confidence.

Bill Handcastle
Managing Director



DISCOUNT SELLING PRICE
£9.69

HEADPHONES

HP 90 Headphone	£12.65
HP 80 Headphone	£9.69

Superbly made with top flight performance.

SEND FOR OUR LATEST FREE BROCHURE

AND DETAIL LIST OF LOCAL SALES OUTLETS IN THE U.K.



VIDEOTONE
98 CROFTON PARK ROAD,
CROFTON PARK, LONDON SE4
Tel: 01-690 8511/2

Please send me your Direct Selling Brochure and list of sales outlets.

Name _____
Address _____

ETI 1/81

ALL PRODUCTS ON DISPLAY & CONTINUOUS DEMONSTRATIONS

ALL PRICES INCLUDE VAT

<p>TTLs by TEXAS</p> <table border="1"> <tr><td>7400</td><td>11p</td><td>74293</td><td>150p</td><td>4020</td><td>100p</td></tr> <tr><td>7400</td><td>11p</td><td>74293</td><td>150p</td><td>4021</td><td>110p</td></tr> <tr><td>7400</td><td>11p</td><td>74293</td><td>150p</td><td>4022</td><td>110p</td></tr> <tr><td>7400</td><td>11p</td><td>74293</td><td>150p</td><td>4023</td><td>27p</td></tr> <tr><td>7402</td><td>12p</td><td>74366</td><td>100p</td><td>4024</td><td>50p</td></tr> <tr><td>7403</td><td>14p</td><td>74367</td><td>100p</td><td>4025</td><td>20p</td></tr> <tr><td>7404</td><td>14p</td><td>74368</td><td>100p</td><td>4026</td><td>130p</td></tr> <tr><td>7405</td><td>18p</td><td>74390</td><td>200p</td><td>4027</td><td>50p</td></tr> <tr><td>7406</td><td>38p</td><td>74392</td><td>200p</td><td>4028</td><td>25p</td></tr> <tr><td>7407</td><td>38p</td><td>74490</td><td>225p</td><td>4029</td><td>100p</td></tr> <tr><td>7408</td><td>17p</td><td>7445</td><td>225p</td><td>4030</td><td>55p</td></tr> <tr><td>7409</td><td>19p</td><td>74500</td><td>14p</td><td>4031</td><td>200p</td></tr> <tr><td>7410</td><td>15p</td><td>74502</td><td>16p</td><td>4034</td><td>200p</td></tr> <tr><td>7411</td><td>24p</td><td>74504</td><td>18p</td><td>4035</td><td>110p</td></tr> <tr><td>7412</td><td>24p</td><td>74504</td><td>18p</td><td>4036</td><td>25p</td></tr> <tr><td>7413</td><td>40p</td><td>74505</td><td>20p</td><td>4039</td><td>285p</td></tr> <tr><td>7414</td><td>40p</td><td>74508</td><td>22p</td><td>4040</td><td>100p</td></tr> <tr><td>7414</td><td>40p</td><td>74509</td><td>21p</td><td>4041</td><td>80p</td></tr> <tr><td>7416</td><td>27p</td><td>74510</td><td>20p</td><td>4042</td><td>80p</td></tr> <tr><td>7417</td><td>27p</td><td>74511</td><td>20p</td><td>4043</td><td>90p</td></tr> <tr><td>7421</td><td>40p</td><td>74513</td><td>40p</td><td>4044</td><td>90p</td></tr> <tr><td>7422</td><td>22p</td><td>74520</td><td>50p</td><td>4046</td><td>110p</td></tr> <tr><td>7423</td><td>34p</td><td>74521</td><td>40p</td><td>4048</td><td>55p</td></tr> <tr><td>7425</td><td>30p</td><td>74527</td><td>38p</td><td>4049</td><td>45p</td></tr> <tr><td>7426</td><td>34p</td><td>74530</td><td>20p</td><td>4050</td><td>45p</td></tr> <tr><td>7427</td><td>34p</td><td>74532</td><td>20p</td><td>4051</td><td>110p</td></tr> <tr><td>7428</td><td>38p</td><td>74537</td><td>30p</td><td>4052</td><td>80p</td></tr> <tr><td>7430</td><td>17p</td><td>74538</td><td>38p</td><td>4053</td><td>80p</td></tr> <tr><td>7432</td><td>30p</td><td>74542</td><td>70p</td><td>4054</td><td>150p</td></tr> <tr><td>7433</td><td>40p</td><td>74547</td><td>75p</td><td>4055</td><td>125p</td></tr> <tr><td>7437</td><td>35p</td><td>74555</td><td>24p</td><td>4059</td><td>600p</td></tr> <tr><td>7438</td><td>35p</td><td>74555</td><td>24p</td><td>4059</td><td>600p</td></tr> <tr><td>7440</td><td>17p</td><td>74573</td><td>50p</td><td>4060</td><td>115p</td></tr> <tr><td>7441</td><td>70p</td><td>74574</td><td>27p</td><td>4063</td><td>120p</td></tr> <tr><td>7442</td><td>60p</td><td>74575</td><td>36p</td><td>4066</td><td>50p</td></tr> <tr><td>7443</td><td>112p</td><td>74576</td><td>45p</td><td>4066</td><td>450p</td></tr> <tr><td>7444</td><td>112p</td><td>74578</td><td>40p</td><td>4067</td><td>450p</td></tr> <tr><td>7445</td><td>100p</td><td>74588</td><td>40p</td><td>4069</td><td>20p</td></tr> <tr><td>7446</td><td>93p</td><td>74586</td><td>40p</td><td>4070</td><td>30p</td></tr> <tr><td>7447</td><td>75p</td><td>74590</td><td>40p</td><td>4071</td><td>25p</td></tr> <tr><td>7448</td><td>80p</td><td>74592</td><td>70p</td><td>4072</td><td>25p</td></tr> <tr><td>7450</td><td>17p</td><td>74593</td><td>60p</td><td>4075</td><td>25p</td></tr> <tr><td>7451</td><td>17p</td><td>74593</td><td>60p</td><td>4075</td><td>25p</td></tr> <tr><td>7453</td><td>17p</td><td>74597</td><td>110p</td><td>4076</td><td>107p</td></tr> <tr><td>7454</td><td>17p</td><td>74597</td><td>110p</td><td>4076</td><td>107p</td></tr> <tr><td>7456</td><td>17p</td><td>74597</td><td>110p</td><td>4076</td><td>107p</td></tr> <tr><td>7470</td><td>36p</td><td>745113</td><td>90p</td><td>4086</td><td>72p</td></tr> <tr><td>7472</td><td>30p</td><td>745114</td><td>45p</td><td>4093</td><td>180p</td></tr> <tr><td>7473</td><td>30p</td><td>745122</td><td>45p</td><td>4093</td><td>180p</td></tr> <tr><td>7474</td><td>30p</td><td>745123</td><td>45p</td><td>4094</td><td>250p</td></tr> <tr><td>7475</td><td>38p</td><td>745124</td><td>180p</td><td>4095</td><td>95p</td></tr> <tr><td>7476</td><td>32p</td><td>745125</td><td>60p</td><td>4096</td><td>95p</td></tr> <tr><td>7480</td><td>50p</td><td>745126</td><td>60p</td><td>4097</td><td>340p</td></tr> <tr><td>7481</td><td>100p</td><td>745132</td><td>60p</td><td>4099</td><td>200p</td></tr> <tr><td>7482</td><td>80p</td><td>745133</td><td>60p</td><td>4099</td><td>200p</td></tr> <tr><td>7483a</td><td>90p</td><td>745136</td><td>65p</td><td>40100</td><td>220p</td></tr> <tr><td>7484</td><td>100p</td><td>745138</td><td>65p</td><td>40101</td><td>132p</td></tr> <tr><td>7485</td><td>110p</td><td>745139</td><td>75p</td><td>40102</td><td>180p</td></tr> <tr><td>7486</td><td>34p</td><td>745145</td><td>110p</td><td>40103</td><td>180p</td></tr> <tr><td>7489</td><td>210p</td><td>745147</td><td>220p</td><td>40104</td><td>95p</td></tr> <tr><td>7490A</td><td>30p</td><td>745148</td><td>175p</td><td>40105</td><td>120p</td></tr> <tr><td>7491</td><td>80p</td><td>745151</td><td>80p</td><td>40106</td><td>90p</td></tr> <tr><td>7492A</td><td>46p</td><td>745153</td><td>60p</td><td>40107</td><td>60p</td></tr> <tr><td>7493A</td><td>36p</td><td>745154</td><td>200p</td><td>40108</td><td>470p</td></tr> <tr><td>7494</td><td>84p</td><td>745155</td><td>40p</td><td>40109</td><td>80p</td></tr> <tr><td>7495A</td><td>70p</td><td>745156</td><td>90p</td><td>40110</td><td>300p</td></tr> <tr><td>7496</td><td>65p</td><td>745157</td><td>60p</td><td>40114</td><td>250p</td></tr> <tr><td>7497</td><td>180p</td><td>745158</td><td>60p</td><td>4502</td><td>120p</td></tr> <tr><td>74100</td><td>130p</td><td>745160</td><td>90p</td><td>4503</td><td>70p</td></tr> <tr><td>74107</td><td>34p</td><td>745161</td><td>75p</td><td>4507</td><td>55p</td></tr> <tr><td>74109</td><td>58p</td><td>745162</td><td>110p</td><td>4508</td><td>120p</td></tr> <tr><td>74116</td><td>200p</td><td>745163</td><td>100p</td><td>4510</td><td>95p</td></tr> <tr><td>74118</td><td>130p</td><td>745164</td><td>90p</td><td>4511</td><td>120p</td></tr> <tr><td>74119</td><td>210p</td><td>745165</td><td>140p</td><td>4512</td><td>80p</td></tr> <tr><td>74120</td><td>110p</td><td>745166</td><td>180p</td><td>4514</td><td>250p</td></tr> <tr><td>74121</td><td>34p</td><td>745173</td><td>110p</td><td>4515</td><td>300p</td></tr> <tr><td>74122</td><td>48p</td><td>745174</td><td>100p</td><td>4518</td><td>100p</td></tr> <tr><td>74123</td><td>60p</td><td>745175</td><td>100p</td><td>4518</td><td>100p</td></tr> <tr><td>74125</td><td>75p</td><td>745181</td><td>320p</td><td>4520</td><td>100p</td></tr> <tr><td>74126</td><td>60p</td><td>745190</td><td>100p</td><td>4521</td><td>250p</td></tr> <tr><td>74128</td><td>75p</td><td>745191</td><td>100p</td><td>4526</td><td>108p</td></tr> <tr><td>74132</td><td>75p</td><td>745192</td><td>100p</td><td>4527</td><td>150p</td></tr> <tr><td>74136</td><td>75p</td><td>745193</td><td>100p</td><td>4532</td><td>140p</td></tr> <tr><td>74137</td><td>50p</td><td>745194</td><td>100p</td><td>4532</td><td>140p</td></tr> <tr><td>74141</td><td>50p</td><td>745196</td><td>120p</td><td>4534</td><td>550p</td></tr> <tr><td>74142</td><td>200p</td><td>745197</td><td>90p</td><td>4536</td><td>375p</td></tr> <tr><td>74145</td><td>90p</td><td>745221</td><td>120p</td><td>4538</td><td>120p</td></tr> <tr><td>74147</td><td>190p</td><td>745240</td><td>175p</td><td>4543</td><td>180p</td></tr> <tr><td>74148</td><td>130p</td><td>745241</td><td>175p</td><td>4543</td><td>320p</td></tr> <tr><td>74150</td><td>130p</td><td>745242</td><td>175p</td><td>4543</td><td>320p</td></tr> <tr><td>74151A</td><td>70p</td><td>745243</td><td>170p</td><td>4560</td><td>200p</td></tr> <tr><td>74153</td><td>70p</td><td>745244</td><td>150p</td><td>4569</td><td>250p</td></tr> <tr><td>74154</td><td>120p</td><td>745245</td><td>260p</td><td>4572</td><td>40p</td></tr> <tr><td>74155</td><td>90p</td><td>745247</td><td>140p</td><td>4583</td><td>110p</td></tr> <tr><td>74156</td><td>90p</td><td>745251</td><td>140p</td><td>4585</td><td>150p</td></tr> <tr><td>74157</td><td>70p</td><td>745252</td><td>90p</td><td>4724</td><td>250p</td></tr> <tr><td>74159</td><td>190p</td><td>745257</td><td>160p</td><td>40097</td><td>90p</td></tr> <tr><td>74160</td><td>100p</td><td>745258</td><td>160p</td><td>14411</td><td>1100p</td></tr> <tr><td>74161</td><td>100p</td><td>745259</td><td>160p</td><td>14411</td><td>1100p</td></tr> <tr><td>74162</td><td>100p</td><td>745266</td><td>100p</td><td>14412</td><td>1100p</td></tr> <tr><td>74163</td><td>100p</td><td>745273</td><td>170p</td><td>14500</td><td>700p</td></tr> <tr><td>74164</td><td>120p</td><td>745279</td><td>60p</td><td>14500</td><td>700p</td></tr> <tr><td>74165</td><td>130p</td><td>745283</td><td>90p</td><td>14589</td><td>290p</td></tr> <tr><td>74166</td><td>120p</td><td>745298</td><td>160p</td><td>AD536</td><td>£13</td></tr> <tr><td>74167</td><td>200p</td><td>745323</td><td>400p</td><td>AD581J</td><td>1400p</td></tr> <tr><td>74170</td><td>240p</td><td>745348</td><td>200p</td><td>AD752A</td><td>600p</td></tr> <tr><td>74172</td><td>450p</td><td>745348</td><td>200p</td><td>DM8123</td><td>175p</td></tr> <tr><td>74173</td><td>120p</td><td>745367</td><td>70p</td><td>DM8131</td><td>375p</td></tr> <tr><td>74174</td><td>90p</td><td>745367</td><td>70p</td><td>DM8131</td><td>375p</td></tr> <tr><td>74175</td><td>85p</td><td>745368</td><td>100p</td><td>DM8131</td><td>375p</td></tr> <tr><td>74176</td><td>90p</td><td>745373</td><td>150p</td><td>DM8131</td><td>375p</td></tr> <tr><td>74177</td><td>90p</td><td>745374</td><td>150p</td><td>DM8131</td><td>375p</td></tr> <tr><td>74178</td><td>160p</td><td>745375</td><td>120p</td><td>DM8131</td><td>375p</td></tr> <tr><td>74180</td><td>93p</td><td>745377</td><td>160p</td><td>DM8131</td><td>375p</td></tr> <tr><td>74181</td><td>160p</td><td>745378</td><td>140p</td><td>DM8131</td><td>375p</td></tr> <tr><td>74182</td><td>90p</td><td>745390</td><td>120p</td><td>DM8131</td><td>375p</td></tr> <tr><td>74184A</td><td>150p</td><td>745393</td><td>120p</td><td>DM8131</td><td>375p</td></tr> <tr><td>74185</td><td>150p</td><td>745399</td><td>200p</td><td>DM8131</td><td>375p</td></tr> <tr><td>74186</td><td>500p</td><td>745445</td><td>400p</td><td>DM8131</td><td>375p</td></tr> <tr><td>74188</td><td>325p</td><td>745670</td><td>140p</td><td>DM8131</td><td>375p</td></tr> <tr><td>74190</td><td>120p</td><td>745670</td><td>140p</td><td>DM8131</td><td>375p</td></tr> <tr><td>74191</td><td>120p</td><td>745670</td><td>140p</td><td>DM8131</td><td>375p</td></tr> <tr><td>74192</td><td>100p</td><td>4001</td><td>15p</td><td>75322</td><td>300p</td></tr> <tr><td>74193</td><td>100p</td><td>4002</td><td>20p</td><td>75324</td><td>375p</td></tr> <tr><td>74194</td><td>120p</td><td>4006</td><td>95p</td><td>75325</td><td>375p</td></tr> <tr><td>74195</td><td>95p</td><td>4007</td><td>20p</td><td>75361</td><td>300p</td></tr> <tr><td>74196</td><td>95p</td><td>4008</td><td>80p</td><td>75365</td><td>200p</td></tr> <tr><td>74197</td><td>80p</td><td>4009</td><td>12p</td><td>75451-2</td><td>72p</td></tr> <tr><td>74198</td><td>150p</td><td>4010</td><td>50p</td><td>75451-2</td><td>72p</td></tr> <tr><td>74199</td><td>150p</td><td>4011</td><td>20p</td><td>8726</td><td>160p</td></tr> <tr><td>74201</td><td>160p</td><td>4012</td><td>25p</td><td>8728</td><td>250p</td></tr> <tr><td>74251</td><td>140p</td><td>4013</td><td>50p</td><td>8795</td><td>180p</td></tr> <tr><td>74252</td><td>250p</td><td>4014</td><td>84p</td><td>8797</td><td>180p</td></tr> <tr><td>74278</td><td>290p</td><td>4015</td><td>84p</td><td>81195</td><td>120p</td></tr> <tr><td>74279</td><td>110p</td><td>4016</td><td>45p</td><td>81196</td><td>140p</td></tr> <tr><td>74283</td><td>140p</td><td>4017</td><td>89p</td><td>81197</td><td>140p</td></tr> <tr><td>74284</td><td>360p</td><td>4018</td><td>89p</td><td>81198</td><td>140p</td></tr> <tr><td>74285</td><td>360p</td><td>4019</td><td>45p</td><td>9602</td><td>220p</td></tr> </table>	7400	11p	74293	150p	4020	100p	7400	11p	74293	150p	4021	110p	7400	11p	74293	150p	4022	110p	7400	11p	74293	150p	4023	27p	7402	12p	74366	100p	4024	50p	7403	14p	74367	100p	4025	20p	7404	14p	74368	100p	4026	130p	7405	18p	74390	200p	4027	50p	7406	38p	74392	200p	4028	25p	7407	38p	74490	225p	4029	100p	7408	17p	7445	225p	4030	55p	7409	19p	74500	14p	4031	200p	7410	15p	74502	16p	4034	200p	7411	24p	74504	18p	4035	110p	7412	24p	74504	18p	4036	25p	7413	40p	74505	20p	4039	285p	7414	40p	74508	22p	4040	100p	7414	40p	74509	21p	4041	80p	7416	27p	74510	20p	4042	80p	7417	27p	74511	20p	4043	90p	7421	40p	74513	40p	4044	90p	7422	22p	74520	50p	4046	110p	7423	34p	74521	40p	4048	55p	7425	30p	74527	38p	4049	45p	7426	34p	74530	20p	4050	45p	7427	34p	74532	20p	4051	110p	7428	38p	74537	30p	4052	80p	7430	17p	74538	38p	4053	80p	7432	30p	74542	70p	4054	150p	7433	40p	74547	75p	4055	125p	7437	35p	74555	24p	4059	600p	7438	35p	74555	24p	4059	600p	7440	17p	74573	50p	4060	115p	7441	70p	74574	27p	4063	120p	7442	60p	74575	36p	4066	50p	7443	112p	74576	45p	4066	450p	7444	112p	74578	40p	4067	450p	7445	100p	74588	40p	4069	20p	7446	93p	74586	40p	4070	30p	7447	75p	74590	40p	4071	25p	7448	80p	74592	70p	4072	25p	7450	17p	74593	60p	4075	25p	7451	17p	74593	60p	4075	25p	7453	17p	74597	110p	4076	107p	7454	17p	74597	110p	4076	107p	7456	17p	74597	110p	4076	107p	7470	36p	745113	90p	4086	72p	7472	30p	745114	45p	4093	180p	7473	30p	745122	45p	4093	180p	7474	30p	745123	45p	4094	250p	7475	38p	745124	180p	4095	95p	7476	32p	745125	60p	4096	95p	7480	50p	745126	60p	4097	340p	7481	100p	745132	60p	4099	200p	7482	80p	745133	60p	4099	200p	7483a	90p	745136	65p	40100	220p	7484	100p	745138	65p	40101	132p	7485	110p	745139	75p	40102	180p	7486	34p	745145	110p	40103	180p	7489	210p	745147	220p	40104	95p	7490A	30p	745148	175p	40105	120p	7491	80p	745151	80p	40106	90p	7492A	46p	745153	60p	40107	60p	7493A	36p	745154	200p	40108	470p	7494	84p	745155	40p	40109	80p	7495A	70p	745156	90p	40110	300p	7496	65p	745157	60p	40114	250p	7497	180p	745158	60p	4502	120p	74100	130p	745160	90p	4503	70p	74107	34p	745161	75p	4507	55p	74109	58p	745162	110p	4508	120p	74116	200p	745163	100p	4510	95p	74118	130p	745164	90p	4511	120p	74119	210p	745165	140p	4512	80p	74120	110p	745166	180p	4514	250p	74121	34p	745173	110p	4515	300p	74122	48p	745174	100p	4518	100p	74123	60p	745175	100p	4518	100p	74125	75p	745181	320p	4520	100p	74126	60p	745190	100p	4521	250p	74128	75p	745191	100p	4526	108p	74132	75p	745192	100p	4527	150p	74136	75p	745193	100p	4532	140p	74137	50p	745194	100p	4532	140p	74141	50p	745196	120p	4534	550p	74142	200p	745197	90p	4536	375p	74145	90p	745221	120p	4538	120p	74147	190p	745240	175p	4543	180p	74148	130p	745241	175p	4543	320p	74150	130p	745242	175p	4543	320p	74151A	70p	745243	170p	4560	200p	74153	70p	745244	150p	4569	250p	74154	120p	745245	260p	4572	40p	74155	90p	745247	140p	4583	110p	74156	90p	745251	140p	4585	150p	74157	70p	745252	90p	4724	250p	74159	190p	745257	160p	40097	90p	74160	100p	745258	160p	14411	1100p	74161	100p	745259	160p	14411	1100p	74162	100p	745266	100p	14412	1100p	74163	100p	745273	170p	14500	700p	74164	120p	745279	60p	14500	700p	74165	130p	745283	90p	14589	290p	74166	120p	745298	160p	AD536	£13	74167	200p	745323	400p	AD581J	1400p	74170	240p	745348	200p	AD752A	600p	74172	450p	745348	200p	DM8123	175p	74173	120p	745367	70p	DM8131	375p	74174	90p	745367	70p	DM8131	375p	74175	85p	745368	100p	DM8131	375p	74176	90p	745373	150p	DM8131	375p	74177	90p	745374	150p	DM8131	375p	74178	160p	745375	120p	DM8131	375p	74180	93p	745377	160p	DM8131	375p	74181	160p	745378	140p	DM8131	375p	74182	90p	745390	120p	DM8131	375p	74184A	150p	745393	120p	DM8131	375p	74185	150p	745399	200p	DM8131	375p	74186	500p	745445	400p	DM8131	375p	74188	325p	745670	140p	DM8131	375p	74190	120p	745670	140p	DM8131	375p	74191	120p	745670	140p	DM8131	375p	74192	100p	4001	15p	75322	300p	74193	100p	4002	20p	75324	375p	74194	120p	4006	95p	75325	375p	74195	95p	4007	20p	75361	300p	74196	95p	4008	80p	75365	200p	74197	80p	4009	12p	75451-2	72p	74198	150p	4010	50p	75451-2	72p	74199	150p	4011	20p	8726	160p	74201	160p	4012	25p	8728	250p	74251	140p	4013	50p	8795	180p	74252	250p	4014	84p	8797	180p	74278	290p	4015	84p	81195	120p	74279	110p	4016	45p	81196	140p	74283	140p	4017	89p	81197	140p	74284	360p	4018	89p	81198	140p	74285	360p	4019	45p	9602	220p	<p>93 SERIES</p> <table border="1"> <tr><td>9302</td><td>160p</td><td>74504</td><td>80p</td><td>745114</td><td>120p</td></tr> <tr><td>9302</td><td>160p</td><td>74504</td><td>80p</td><td>745124</td><td>120p</td></tr> <tr><td>9308</td><td>310p</td><td>74505</td><td>75p</td><td>745132</td><td>160p</td></tr> <tr><td>9310</td><td>275p</td><td>74508</td><td>75p</td><td>745133</td><td>75p</td></tr> <tr><td>9311</td><td>275p</td><td>74510</td><td>75p</td><td>745138</td><td>225p</td></tr> <tr><td>9312</td><td>180p</td><td>74520</td><td>80p</td><td>745139</td><td>225p</td></tr> <tr><td>9313</td><td>180p</td><td>74525</td><td>80p</td><td>745174</td><td>250p</td></tr> <tr><td>9316</td><td>225p</td><td>74532</td><td>90p</td><td>745174</td><td>250p</td></tr> <tr><td>9321</td><td>225p</td><td>74537</td><td>90p</td><td>745175</td><td>320p</td></tr> <tr><td>9322</td><td>150p</td><td>74564</td><td>80p</td><td>745194</td><td>350p</td></tr> <tr><td>9334</td><td>360p</td><td>74574</td><td>80p</td><td>745241</td><td>450p</td></tr> <tr><td>9368</td><td>260p</td><td>74585</td><td>300p</td><td>745260</td><td>70p</td></tr> <tr><td>9370</td><td>300p</td><td>74586</td><td>180p</td><td>745373</td><td>500p</td></tr> <tr><td>9374</td><td>200p</td><td>745112</td><td>120p</td><td>745374</td><td>500p</td></tr> </table> <p>74S SERIES</p> <table border="1"> <tr><td>74S00</td><td>80p</td><td>MC13600</td><td>125p</td></tr> <tr><td>74S01</td><td>80p</td><td>MC1310P</td><td>150p</td></tr> <tr><td>74S02</td><td>160p</td><td>MC1458</td><td>45p</td></tr> <tr><td>74S03</td><td>160p</td><td>MC1495L</td><td>35p</td></tr> <tr><td>74S04</td><td>160p</td><td>MC1496</td><td>35p</td></tr> <tr><td>74S05</td><td>160p</td><td>MC1496</td><td>35p</td></tr> <tr><td>74S06</td><td>160p</td><td>MC1496</td><td>35p</td></tr> <tr><td>74S07</td><td>160p</td><td>MC1496</td><td>35p</td></tr> <tr><td>74S08</td><td>160p</td><td>MC1496</td><td>35p</td></tr> <tr><td>74S09</td><td>160p</td><td>MC1496</td><td>35p</td></tr> <tr><td>74S10</td><td>160p</td><td>MC1496</td><td>35p</td></tr> <tr><td>74S11</td><td>160p</td><td>MC1496</td><td>35p</td></tr> <tr><td>74S12</td><td>160p</td><td>MC1496</td><td>35p</td></tr> <tr><td>74S13</td><td>160p</td><td>MC1496</td><td>35p</td></tr> <tr><td>74S14</td><td>160p</td><td>MC1496</td><td>35p</td></tr> <tr><td>74S15</td><td>160p</td><td>MC1496</td><td>35p</td></tr> <tr><td>74S16</td><td>160p</td><td>MC1496</td><td>35p</td></tr> <tr><td>74S17</td><td>160p</td><td>MC1496</td><td>35p</td></tr> <tr><td>74S18</td><td>160p</td><td>MC1496</td><td>35p</td></tr> <tr><td>74S19</td><td>160p</td><td>MC1496</td><td>35p</td></tr> <tr><td>74S20</td><td>160p</td><td>MC1496</td><td>35p</td></tr> <tr><td>74S21</td><td>160p</td><td>MC1496</td><td>35p</td></tr> <tr><td>74S22</td><td>160p</td><td>MC1496</td><td>35p</td></tr> <tr><td>74S23</td><td>160p</td><td>MC1496</td><td>35p</td></tr> <tr><td>74S24</td><td>160p</td><td>MC1496</td><td>35p</td></tr> <tr><td>74S25</td><td>160p</td><td>MC1496</td><td>35p</td></tr> <tr><td>74S26</td><td>160p</td><td>MC1496</td><td>35p</td></tr> <tr><td>74S27</td><td>160p</td><td>MC1496</td><td>35p</td></tr> <tr><td>74S28</td><td>160p</td><td>MC1496</td><td>35p</td></tr> <tr><td>74S29</td><td>160p</td><td>MC1496</td><td>35p</td></tr> <tr><td>74S30</td><td>160p</td><td>MC1496</td><td>35p</td></tr> <tr><td>74S31</td><td>160p</td><td>MC1496</td><td>35p</td></tr> <tr><td>74S32</td><td>160p</td><td>MC1496</td><td>35p</td></tr> <tr><td>74S33</td><td>160p</td><td>MC1496</td><td>35p</td></tr> <tr><td>74S34</td><td>160p</td><td>MC1496</td><td>35p</td></tr> <tr><td>74S35</td><td>160p</td><td>MC1496</td><td>35p</td></tr> <tr><td>74S36</td><td>160p</td><td>MC1496</td><td>35p</td></tr> <tr><td>74S37</td><td>160p</td><td>MC1496</td><td>35p</td></tr> <tr><td>74S38</td><td>160p</td><td>MC1496</td><td>35p</td></tr> <tr><td>74S39</td><td>160p</td><td>MC1496</td><td>35p</td></tr> <tr><td>74S40</td><td>160p</td><td>MC1496</td><td>35p</td></tr> <tr><td>74S41</td><td>160p</td><td>MC1496</td><td>35p</td></tr> <tr><td>74S42</td><td>160p</td><td>MC1496</td><td>35p</td></tr> <tr><td>74S43</td><td>160p</td><td>MC1496</td><td>35p</td></tr> <tr><td>74S44</td><td>160p</td><td>MC1496</td><td>35p</td></tr> <tr><td>74S45</td><td>160p</td><td>MC1496</td><td>35p</td></tr> <tr><td>74S46</td><td>160p</td><td>MC1496</td><td>35p</td></tr> <tr><td>74S47</td><td>160p</td><td>MC1496</td><td>35p</td></tr> <tr><td>74S48</td><td>160p</td><td>MC1496</td><td>35p</td></tr> <tr><td>74S49</td><td>160p</td><td>MC1496</td><td>35p</td></tr> <tr><td>74S50</td><td>160p</td><td>MC1496</td><td>35p</td></tr> </table>	9302	160p	74504	80p	745114	120p	9302	160p	74504	80p	745124	120p	9308	310p	74505	75p	745132	160p	9310	275p	74508	75p	745133	75p	9311	275p	74510	75p	745138	225p	9312	180p	74520	80p	745139	225p	9313	180p	74525	80p	745174	250p	9316	225p	74532	90p	745174	250p	9321	225p	74537	90p	745175	320p	9322	150p	74564	80p	745194	350p	9334	360p	74574	80p	745241	450p	9368	260p	74585	300p	745260	70p	9370	300p	74586	180p	745373	500p	9374	200p	745112	120p	745374	500p	74S00	80p	MC13600	125p	74S01	80p	MC1310P	150p	74S02	160p	MC1458	45p	74S03	160p	MC1495L	35p	74S04	160p	MC1496	35p	74S05	160p	MC1496	35p	74S06	160p	MC1496	35p	74S07	160p	MC1496	35p	74S08	160p	MC1496	35p	74S09	160p	MC1496	35p	74S10	160p	MC1496	35p	74S11	160p	MC1496	35p	74S12	160p	MC1496	35p	74S13	160p	MC1496	35p	74S14	160p	MC1496	35p	74S15	160p	MC1496	35p	74S16	160p	MC1496	35p	74S17	160p	MC1496	35p	74S18	160p	MC1496	35p	74S19	160p	MC1496	35p	74S20	160p	MC1496	35p	74S21	160p	MC1496	35p	74S22	160p	MC1496	35p	74S23	160p	MC1496	35p	74S24	160p	MC1496	35p	74S25	160p	MC1496	35p	74S26	160p	MC1496	35p	74S27	160p	MC1496	35p	74S28	160p	MC1496	35p	74S29	160p	MC1496	35p	74S30	160p	MC1496	35p	74S31	160p	MC1496	35p	74S32	160p	MC1496	35p	74S33	160p	MC1496	35p	74S34	160p	MC1496	35p	74S35	160p	MC1496	35p	74S36	160p	MC1496	35p	74S37	160p	MC1496	35p	74S38	160p	MC1496	35p	74S39	160p	MC1496	35p	74S40	160p	MC1496	35p	74S41	160p	MC1496	35p	74S42	160p	MC1496	35p	74S43	160p	MC1496	35p	74S44	160p	MC1496	35p	74S45	160p	MC1496	35p	74S46	160p	MC1496	35p	74S47	160p	MC1496	35p	74S48	160p	MC1496	35p	74S49	160p	MC1496	35p	74S50	160p	MC1496	35p	<p>TRANSISTORS</p> <table border="1"> <tr><td>BF40</td><td>25p</td><td>TIP30A</td><td>48p</td></tr> <tr><td>BF41</td><td>25p</td><td>TIP30C</td><td>48p</td></tr> <tr><td>BF42</td><td>25p</td><td>TIP31A</td><td>52p</td></tr> <tr><td>BF43</td><td>25p</td><td>TIP31B</td><td>52p</td></tr> <tr><td>BF44</td><td>25p</td><td>TIP31C</td><td>62p</td></tr> <tr><td>BF45</td><td>25p</td><td>TIP32A</td><td>62p</td></tr> <tr><td>BF46</td><td>25p</td><td>TIP32C</td><td>62p</td></tr> <tr><td>BF47</td><td>25p</td><td>TIP33A</td><td>90p</td></tr> <tr><td>BF48</td><td>25p</td><td>TIP33B</td><td>90p</td></tr> <tr><td>BF49</td><td>25p</td><td>TIP33C</td><td>90p</td></tr> <tr><td>BF50</td><td>25p</td><td>TIP34A</td><td>115p</td></tr> <tr><td>BF51</td><td>25p</td><td>TIP34B</td><td>115p</td></tr> <tr><td>BF52</td><td>25p</td><td>TIP34C</td><td>115p</td></tr> <tr><td>BF53</td><td>25p</td><td>TIP35A</td><td>125p</td></tr> <tr><td>BF54</td><td>25p</td><td>TIP35B</td><td>125p</td></tr> <tr><td>BF55</td><td>25p</td><td>TIP35C</td><td>200p</td></tr> <tr><td>BF56</td><td>25p</td><td>TIP36A</td><td>270p</td></tr> <tr><td>BF57</td><td>25p</td><td>TIP36B</td><td>270p</td></tr> <tr><td>BF58</td><td>25p</td><td>TIP36C</td><td>340p</td></tr> <tr><td>BF59</td><td>25p</td><td>TIP41A</td><td>65p</td></tr> <tr><td>BF60</td><td>25p</td><td>TIP41B</td><td>65p</td></tr> <tr><td>BF61</td><td>25p</td><td>TIP41C</td><td>75p</td></tr> <tr><td>BF62</td><td>25p</td><td>TIP42A</td><td>82p</td></tr> <tr><td>BF63</td><td>25p</td><td>TIP42B</td><td>82p</td></tr> <tr><td>BF64</td><td>25p</td><td>TIP42C</td><td>82p</td></tr> <tr><td>BF65</td><</tr></table>	BF40	25p	TIP30A	48p	BF41	25p	TIP30C	48p	BF42	25p	TIP31A	52p	BF43	25p	TIP31B	52p	BF44	25p	TIP31C	62p	BF45	25p	TIP32A	62p	BF46	25p	TIP32C	62p	BF47	25p	TIP33A	90p	BF48	25p	TIP33B	90p	BF49	25p	TIP33C	90p	BF50	25p	TIP34A	115p	BF51	25p	TIP34B	115p	BF52	25p	TIP34C	115p	BF53	25p	TIP35A	125p	BF54	25p	TIP35B	125p	BF55	25p	TIP35C	200p	BF56	25p	TIP36A	270p	BF57	25p	TIP36B	270p	BF58	25p	TIP36C	340p	BF59	25p	TIP41A	65p	BF60	25p	TIP41B	65p	BF61	25p	TIP41C	75p	BF62	25p	TIP42A	82p	BF63	25p	TIP42B	82p	BF64	25p	TIP42C	82p	BF65
7400	11p	74293	150p	4020	100p																																																																																																																																																																																																																																																																																																																																																																																																																																																																																																																																																																																																																																																																																																																																																																																																																																																																																																																																																																																																																																																																																																																																																																																																																																																														
7400	11p	74293	150p	4021	110p																																																																																																																																																																																																																																																																																																																																																																																																																																																																																																																																																																																																																																																																																																																																																																																																																																																																																																																																																																																																																																																																																																																																																																																																																																																														
7400	11p	74293	150p	4022	110p																																																																																																																																																																																																																																																																																																																																																																																																																																																																																																																																																																																																																																																																																																																																																																																																																																																																																																																																																																																																																																																																																																																																																																																																																																																														
7400	11p	74293	150p	4023	27p																																																																																																																																																																																																																																																																																																																																																																																																																																																																																																																																																																																																																																																																																																																																																																																																																																																																																																																																																																																																																																																																																																																																																																																																																																																														
7402	12p	74366	100p	4024	50p																																																																																																																																																																																																																																																																																																																																																																																																																																																																																																																																																																																																																																																																																																																																																																																																																																																																																																																																																																																																																																																																																																																																																																																																																																																														
7403	14p	74367	100p	4025	20p																																																																																																																																																																																																																																																																																																																																																																																																																																																																																																																																																																																																																																																																																																																																																																																																																																																																																																																																																																																																																																																																																																																																																																																																																																																														
7404	14p	74368	100p	4026	130p																																																																																																																																																																																																																																																																																																																																																																																																																																																																																																																																																																																																																																																																																																																																																																																																																																																																																																																																																																																																																																																																																																																																																																																																																																																														
7405	18p	74390	200p	4027	50p																																																																																																																																																																																																																																																																																																																																																																																																																																																																																																																																																																																																																																																																																																																																																																																																																																																																																																																																																																																																																																																																																																																																																																																																																																																														
7406	38p	74392	200p	4028	25p																																																																																																																																																																																																																																																																																																																																																																																																																																																																																																																																																																																																																																																																																																																																																																																																																																																																																																																																																																																																																																																																																																																																																																																																																																																														
7407	38p	74490	225p	4029	100p																																																																																																																																																																																																																																																																																																																																																																																																																																																																																																																																																																																																																																																																																																																																																																																																																																																																																																																																																																																																																																																																																																																																																																																																																																																														
7408	17p	7445	225p	4030	55p																																																																																																																																																																																																																																																																																																																																																																																																																																																																																																																																																																																																																																																																																																																																																																																																																																																																																																																																																																																																																																																																																																																																																																																																																																																														
7409	19p	74500	14p	4031	200p																																																																																																																																																																																																																																																																																																																																																																																																																																																																																																																																																																																																																																																																																																																																																																																																																																																																																																																																																																																																																																																																																																																																																																																																																																																														
7410	15p	74502	16p	4034	200p																																																																																																																																																																																																																																																																																																																																																																																																																																																																																																																																																																																																																																																																																																																																																																																																																																																																																																																																																																																																																																																																																																																																																																																																																																																														
7411	24p	74504	18p	4035	110p																																																																																																																																																																																																																																																																																																																																																																																																																																																																																																																																																																																																																																																																																																																																																																																																																																																																																																																																																																																																																																																																																																																																																																																																																																																														
7412	24p	74504	18p	4036	25p																																																																																																																																																																																																																																																																																																																																																																																																																																																																																																																																																																																																																																																																																																																																																																																																																																																																																																																																																																																																																																																																																																																																																																																																																																																														
7413	40p	74505	20p	4039	285p																																																																																																																																																																																																																																																																																																																																																																																																																																																																																																																																																																																																																																																																																																																																																																																																																																																																																																																																																																																																																																																																																																																																																																																																																																																														
7414	40p	74508	22p	4040	100p																																																																																																																																																																																																																																																																																																																																																																																																																																																																																																																																																																																																																																																																																																																																																																																																																																																																																																																																																																																																																																																																																																																																																																																																																																																														
7414	40p	74509	21p	4041	80p																																																																																																																																																																																																																																																																																																																																																																																																																																																																																																																																																																																																																																																																																																																																																																																																																																																																																																																																																																																																																																																																																																																																																																																																																																																														
7416	27p	74510	20p	4042	80p																																																																																																																																																																																																																																																																																																																																																																																																																																																																																																																																																																																																																																																																																																																																																																																																																																																																																																																																																																																																																																																																																																																																																																																																																																																														
7417	27p	74511	20p	4043	90p																																																																																																																																																																																																																																																																																																																																																																																																																																																																																																																																																																																																																																																																																																																																																																																																																																																																																																																																																																																																																																																																																																																																																																																																																																																														
7421	40p	74513	40p	4044	90p																																																																																																																																																																																																																																																																																																																																																																																																																																																																																																																																																																																																																																																																																																																																																																																																																																																																																																																																																																																																																																																																																																																																																																																																																																																														
7422	22p	74520	50p	4046	110p																																																																																																																																																																																																																																																																																																																																																																																																																																																																																																																																																																																																																																																																																																																																																																																																																																																																																																																																																																																																																																																																																																																																																																																																																																																														
7423	34p	74521	40p	4048	55p																																																																																																																																																																																																																																																																																																																																																																																																																																																																																																																																																																																																																																																																																																																																																																																																																																																																																																																																																																																																																																																																																																																																																																																																																																																														
7425	30p	74527	38p	4049	45p																																																																																																																																																																																																																																																																																																																																																																																																																																																																																																																																																																																																																																																																																																																																																																																																																																																																																																																																																																																																																																																																																																																																																																																																																																																														
7426	34p	74530	20p	4050	45p																																																																																																																																																																																																																																																																																																																																																																																																																																																																																																																																																																																																																																																																																																																																																																																																																																																																																																																																																																																																																																																																																																																																																																																																																																																														
7427	34p	74532	20p	4051	110p																																																																																																																																																																																																																																																																																																																																																																																																																																																																																																																																																																																																																																																																																																																																																																																																																																																																																																																																																																																																																																																																																																																																																																																																																																																														
7428	38p	74537	30p	4052	80p																																																																																																																																																																																																																																																																																																																																																																																																																																																																																																																																																																																																																																																																																																																																																																																																																																																																																																																																																																																																																																																																																																																																																																																																																																																														
7430	17p	74538	38p	4053	80p																																																																																																																																																																																																																																																																																																																																																																																																																																																																																																																																																																																																																																																																																																																																																																																																																																																																																																																																																																																																																																																																																																																																																																																																																																																														
7432	30p	74542	70p	4054	150p																																																																																																																																																																																																																																																																																																																																																																																																																																																																																																																																																																																																																																																																																																																																																																																																																																																																																																																																																																																																																																																																																																																																																																																																																																																														
7433	40p	74547	75p	4055	125p																																																																																																																																																																																																																																																																																																																																																																																																																																																																																																																																																																																																																																																																																																																																																																																																																																																																																																																																																																																																																																																																																																																																																																																																																																																														
7437	35p	74555	24p	4059	600p																																																																																																																																																																																																																																																																																																																																																																																																																																																																																																																																																																																																																																																																																																																																																																																																																																																																																																																																																																																																																																																																																																																																																																																																																																																														
7438	35p	74555	24p	4059	600p																																																																																																																																																																																																																																																																																																																																																																																																																																																																																																																																																																																																																																																																																																																																																																																																																																																																																																																																																																																																																																																																																																																																																																																																																																																														
7440	17p	74573	50p	4060	115p																																																																																																																																																																																																																																																																																																																																																																																																																																																																																																																																																																																																																																																																																																																																																																																																																																																																																																																																																																																																																																																																																																																																																																																																																																																														
7441	70p	74574	27p	4063	120p																																																																																																																																																																																																																																																																																																																																																																																																																																																																																																																																																																																																																																																																																																																																																																																																																																																																																																																																																																																																																																																																																																																																																																																																																																																														
7442	60p	74575	36p	4066	50p																																																																																																																																																																																																																																																																																																																																																																																																																																																																																																																																																																																																																																																																																																																																																																																																																																																																																																																																																																																																																																																																																																																																																																																																																																																														
7443	112p	74576	45p	4066	450p																																																																																																																																																																																																																																																																																																																																																																																																																																																																																																																																																																																																																																																																																																																																																																																																																																																																																																																																																																																																																																																																																																																																																																																																																																																														
7444	112p	74578	40p	4067	450p																																																																																																																																																																																																																																																																																																																																																																																																																																																																																																																																																																																																																																																																																																																																																																																																																																																																																																																																																																																																																																																																																																																																																																																																																																																														
7445	100p	74588	40p	4069	20p																																																																																																																																																																																																																																																																																																																																																																																																																																																																																																																																																																																																																																																																																																																																																																																																																																																																																																																																																																																																																																																																																																																																																																																																																																																														
7446	93p	74586	40p	4070	30p																																																																																																																																																																																																																																																																																																																																																																																																																																																																																																																																																																																																																																																																																																																																																																																																																																																																																																																																																																																																																																																																																																																																																																																																																																																														
7447	75p	74590	40p	4071	25p																																																																																																																																																																																																																																																																																																																																																																																																																																																																																																																																																																																																																																																																																																																																																																																																																																																																																																																																																																																																																																																																																																																																																																																																																																																														
7448	80p	74592	70p	4072	25p																																																																																																																																																																																																																																																																																																																																																																																																																																																																																																																																																																																																																																																																																																																																																																																																																																																																																																																																																																																																																																																																																																																																																																																																																																																														
7450	17p	74593	60p	4075	25p																																																																																																																																																																																																																																																																																																																																																																																																																																																																																																																																																																																																																																																																																																																																																																																																																																																																																																																																																																																																																																																																																																																																																																																																																																																														
7451	17p	74593	60p	4075	25p																																																																																																																																																																																																																																																																																																																																																																																																																																																																																																																																																																																																																																																																																																																																																																																																																																																																																																																																																																																																																																																																																																																																																																																																																																																														
7453	17p	74597	110p	4076	107p																																																																																																																																																																																																																																																																																																																																																																																																																																																																																																																																																																																																																																																																																																																																																																																																																																																																																																																																																																																																																																																																																																																																																																																																																																																														
7454	17p	74597	110p	4076	107p																																																																																																																																																																																																																																																																																																																																																																																																																																																																																																																																																																																																																																																																																																																																																																																																																																																																																																																																																																																																																																																																																																																																																																																																																																																														
7456	17p	74597	110p	4076	107p																																																																																																																																																																																																																																																																																																																																																																																																																																																																																																																																																																																																																																																																																																																																																																																																																																																																																																																																																																																																																																																																																																																																																																																																																																																														
7470	36p	745113	90p	4086	72p																																																																																																																																																																																																																																																																																																																																																																																																																																																																																																																																																																																																																																																																																																																																																																																																																																																																																																																																																																																																																																																																																																																																																																																																																																																														
7472	30p	745114	45p	4093	180p																																																																																																																																																																																																																																																																																																																																																																																																																																																																																																																																																																																																																																																																																																																																																																																																																																																																																																																																																																																																																																																																																																																																																																																																																																																														
7473	30p	745122	45p	4093	180p																																																																																																																																																																																																																																																																																																																																																																																																																																																																																																																																																																																																																																																																																																																																																																																																																																																																																																																																																																																																																																																																																																																																																																																																																																																														
7474	30p	745123	45p	4094	250p																																																																																																																																																																																																																																																																																																																																																																																																																																																																																																																																																																																																																																																																																																																																																																																																																																																																																																																																																																																																																																																																																																																																																																																																																																																														
7475	38p	745124	180p	4095	95p																																																																																																																																																																																																																																																																																																																																																																																																																																																																																																																																																																																																																																																																																																																																																																																																																																																																																																																																																																																																																																																																																																																																																																																																																																																														
7476	32p	745125	60p	4096	95p																																																																																																																																																																																																																																																																																																																																																																																																																																																																																																																																																																																																																																																																																																																																																																																																																																																																																																																																																																																																																																																																																																																																																																																																																																																														
7480	50p	745126	60p	4097	340p																																																																																																																																																																																																																																																																																																																																																																																																																																																																																																																																																																																																																																																																																																																																																																																																																																																																																																																																																																																																																																																																																																																																																																																																																																																														
7481	100p	745132	60p	4099	200p																																																																																																																																																																																																																																																																																																																																																																																																																																																																																																																																																																																																																																																																																																																																																																																																																																																																																																																																																																																																																																																																																																																																																																																																																																																														
7482	80p	745133	60p	4099	200p																																																																																																																																																																																																																																																																																																																																																																																																																																																																																																																																																																																																																																																																																																																																																																																																																																																																																																																																																																																																																																																																																																																																																																																																																																																														
7483a	90p	745136	65p	40100	220p																																																																																																																																																																																																																																																																																																																																																																																																																																																																																																																																																																																																																																																																																																																																																																																																																																																																																																																																																																																																																																																																																																																																																																																																																																																														
7484	100p	745138	65p	40101	132p																																																																																																																																																																																																																																																																																																																																																																																																																																																																																																																																																																																																																																																																																																																																																																																																																																																																																																																																																																																																																																																																																																																																																																																																																																																														
7485	110p	745139	75p	40102	180p																																																																																																																																																																																																																																																																																																																																																																																																																																																																																																																																																																																																																																																																																																																																																																																																																																																																																																																																																																																																																																																																																																																																																																																																																																																														
7486	34p	745145	110p	40103	180p																																																																																																																																																																																																																																																																																																																																																																																																																																																																																																																																																																																																																																																																																																																																																																																																																																																																																																																																																																																																																																																																																																																																																																																																																																																														
7489	210p	745147	220p	40104	95p																																																																																																																																																																																																																																																																																																																																																																																																																																																																																																																																																																																																																																																																																																																																																																																																																																																																																																																																																																																																																																																																																																																																																																																																																																																														
7490A	30p	745148	175p	40105	120p																																																																																																																																																																																																																																																																																																																																																																																																																																																																																																																																																																																																																																																																																																																																																																																																																																																																																																																																																																																																																																																																																																																																																																																																																																																														
7491	80p	745151	80p	40106	90p																																																																																																																																																																																																																																																																																																																																																																																																																																																																																																																																																																																																																																																																																																																																																																																																																																																																																																																																																																																																																																																																																																																																																																																																																																																														
7492A	46p	745153	60p	40107	60p																																																																																																																																																																																																																																																																																																																																																																																																																																																																																																																																																																																																																																																																																																																																																																																																																																																																																																																																																																																																																																																																																																																																																																																																																																																														
7493A	36p	745154	200p	40108	470p																																																																																																																																																																																																																																																																																																																																																																																																																																																																																																																																																																																																																																																																																																																																																																																																																																																																																																																																																																																																																																																																																																																																																																																																																																																														
7494	84p	745155	40p	40109	80p																																																																																																																																																																																																																																																																																																																																																																																																																																																																																																																																																																																																																																																																																																																																																																																																																																																																																																																																																																																																																																																																																																																																																																																																																																																														
7495A	70p	745156	90p	40110	300p																																																																																																																																																																																																																																																																																																																																																																																																																																																																																																																																																																																																																																																																																																																																																																																																																																																																																																																																																																																																																																																																																																																																																																																																																																																														
7496	65p	745157	60p	40114	250p																																																																																																																																																																																																																																																																																																																																																																																																																																																																																																																																																																																																																																																																																																																																																																																																																																																																																																																																																																																																																																																																																																																																																																																																																																																														
7497	180p	745158	60p	4502	120p																																																																																																																																																																																																																																																																																																																																																																																																																																																																																																																																																																																																																																																																																																																																																																																																																																																																																																																																																																																																																																																																																																																																																																																																																																																														
74100	130p	745160	90p	4503	70p																																																																																																																																																																																																																																																																																																																																																																																																																																																																																																																																																																																																																																																																																																																																																																																																																																																																																																																																																																																																																																																																																																																																																																																																																																																														
74107	34p	745161	75p	4507	55p																																																																																																																																																																																																																																																																																																																																																																																																																																																																																																																																																																																																																																																																																																																																																																																																																																																																																																																																																																																																																																																																																																																																																																																																																																																														
74109	58p	745162	110p	4508	120p																																																																																																																																																																																																																																																																																																																																																																																																																																																																																																																																																																																																																																																																																																																																																																																																																																																																																																																																																																																																																																																																																																																																																																																																																																																														
74116	200p	745163	100p	4510	95p																																																																																																																																																																																																																																																																																																																																																																																																																																																																																																																																																																																																																																																																																																																																																																																																																																																																																																																																																																																																																																																																																																																																																																																																																																																														
74118	130p	745164	90p	4511	120p																																																																																																																																																																																																																																																																																																																																																																																																																																																																																																																																																																																																																																																																																																																																																																																																																																																																																																																																																																																																																																																																																																																																																																																																																																																														
74119	210p	745165	140p	4512	80p																																																																																																																																																																																																																																																																																																																																																																																																																																																																																																																																																																																																																																																																																																																																																																																																																																																																																																																																																																																																																																																																																																																																																																																																																																																														
74120	110p	745166	180p	4514	250p																																																																																																																																																																																																																																																																																																																																																																																																																																																																																																																																																																																																																																																																																																																																																																																																																																																																																																																																																																																																																																																																																																																																																																																																																																																														
74121	34p	745173	110p	4515	300p																																																																																																																																																																																																																																																																																																																																																																																																																																																																																																																																																																																																																																																																																																																																																																																																																																																																																																																																																																																																																																																																																																																																																																																																																																																														
74122	48p	745174	100p	4518	100p																																																																																																																																																																																																																																																																																																																																																																																																																																																																																																																																																																																																																																																																																																																																																																																																																																																																																																																																																																																																																																																																																																																																																																																																																																																														
74123	60p	745175	100p	4518	100p																																																																																																																																																																																																																																																																																																																																																																																																																																																																																																																																																																																																																																																																																																																																																																																																																																																																																																																																																																																																																																																																																																																																																																																																																																																														
74125	75p	745181	320p	4520	100p																																																																																																																																																																																																																																																																																																																																																																																																																																																																																																																																																																																																																																																																																																																																																																																																																																																																																																																																																																																																																																																																																																																																																																																																																																																														
74126	60p	745190	100p	4521	250p																																																																																																																																																																																																																																																																																																																																																																																																																																																																																																																																																																																																																																																																																																																																																																																																																																																																																																																																																																																																																																																																																																																																																																																																																																																														
74128	75p	745191	100p	4526	108p																																																																																																																																																																																																																																																																																																																																																																																																																																																																																																																																																																																																																																																																																																																																																																																																																																																																																																																																																																																																																																																																																																																																																																																																																																																														
74132	75p	745192	100p	4527	150p																																																																																																																																																																																																																																																																																																																																																																																																																																																																																																																																																																																																																																																																																																																																																																																																																																																																																																																																																																																																																																																																																																																																																																																																																																																														
74136	75p	745193	100p	4532	140p																																																																																																																																																																																																																																																																																																																																																																																																																																																																																																																																																																																																																																																																																																																																																																																																																																																																																																																																																																																																																																																																																																																																																																																																																																																														
74137	50p	745194	100p	4532	140p																																																																																																																																																																																																																																																																																																																																																																																																																																																																																																																																																																																																																																																																																																																																																																																																																																																																																																																																																																																																																																																																																																																																																																																																																																																														
74141	50p	745196	120p	4534	550p																																																																																																																																																																																																																																																																																																																																																																																																																																																																																																																																																																																																																																																																																																																																																																																																																																																																																																																																																																																																																																																																																																																																																																																																																																																														
74142	200p	745197	90p	4536	375p																																																																																																																																																																																																																																																																																																																																																																																																																																																																																																																																																																																																																																																																																																																																																																																																																																																																																																																																																																																																																																																																																																																																																																																																																																																														
74145	90p	745221	120p	4538	120p																																																																																																																																																																																																																																																																																																																																																																																																																																																																																																																																																																																																																																																																																																																																																																																																																																																																																																																																																																																																																																																																																																																																																																																																																																																														
74147	190p	745240	175p	4543	180p																																																																																																																																																																																																																																																																																																																																																																																																																																																																																																																																																																																																																																																																																																																																																																																																																																																																																																																																																																																																																																																																																																																																																																																																																																																														
74148	130p	745241	175p	4543	320p																																																																																																																																																																																																																																																																																																																																																																																																																																																																																																																																																																																																																																																																																																																																																																																																																																																																																																																																																																																																																																																																																																																																																																																																																																																														
74150	130p	745242	175p	4543	320p																																																																																																																																																																																																																																																																																																																																																																																																																																																																																																																																																																																																																																																																																																																																																																																																																																																																																																																																																																																																																																																																																																																																																																																																																																																														
74151A	70p	745243	170p	4560	200p																																																																																																																																																																																																																																																																																																																																																																																																																																																																																																																																																																																																																																																																																																																																																																																																																																																																																																																																																																																																																																																																																																																																																																																																																																																														
74153	70p	745244	150p	4569	250p																																																																																																																																																																																																																																																																																																																																																																																																																																																																																																																																																																																																																																																																																																																																																																																																																																																																																																																																																																																																																																																																																																																																																																																																																																																														
74154	120p	745245	260p	4572	40p																																																																																																																																																																																																																																																																																																																																																																																																																																																																																																																																																																																																																																																																																																																																																																																																																																																																																																																																																																																																																																																																																																																																																																																																																																																														
74155	90p	745247	140p	4583	110p																																																																																																																																																																																																																																																																																																																																																																																																																																																																																																																																																																																																																																																																																																																																																																																																																																																																																																																																																																																																																																																																																																																																																																																																																																																														
74156	90p	745251	140p	4585	150p																																																																																																																																																																																																																																																																																																																																																																																																																																																																																																																																																																																																																																																																																																																																																																																																																																																																																																																																																																																																																																																																																																																																																																																																																																																														
74157	70p	745252	90p	4724	250p																																																																																																																																																																																																																																																																																																																																																																																																																																																																																																																																																																																																																																																																																																																																																																																																																																																																																																																																																																																																																																																																																																																																																																																																																																																														
74159	190p	745257	160p	40097	90p																																																																																																																																																																																																																																																																																																																																																																																																																																																																																																																																																																																																																																																																																																																																																																																																																																																																																																																																																																																																																																																																																																																																																																																																																																																														
74160	100p	745258	160p	14411	1100p																																																																																																																																																																																																																																																																																																																																																																																																																																																																																																																																																																																																																																																																																																																																																																																																																																																																																																																																																																																																																																																																																																																																																																																																																																																														
74161	100p	745259	160p	14411	1100p																																																																																																																																																																																																																																																																																																																																																																																																																																																																																																																																																																																																																																																																																																																																																																																																																																																																																																																																																																																																																																																																																																																																																																																																																																																														
74162	100p	745266	100p	14412	1100p																																																																																																																																																																																																																																																																																																																																																																																																																																																																																																																																																																																																																																																																																																																																																																																																																																																																																																																																																																																																																																																																																																																																																																																																																																																														
74163	100p	745273	170p	14500	700p																																																																																																																																																																																																																																																																																																																																																																																																																																																																																																																																																																																																																																																																																																																																																																																																																																																																																																																																																																																																																																																																																																																																																																																																																																																														
74164	120p	745279	60p	14500	700p																																																																																																																																																																																																																																																																																																																																																																																																																																																																																																																																																																																																																																																																																																																																																																																																																																																																																																																																																																																																																																																																																																																																																																																																																																																														
74165	130p	745283	90p	14589	290p																																																																																																																																																																																																																																																																																																																																																																																																																																																																																																																																																																																																																																																																																																																																																																																																																																																																																																																																																																																																																																																																																																																																																																																																																																																														
74166	120p	745298	160p	AD536	£13																																																																																																																																																																																																																																																																																																																																																																																																																																																																																																																																																																																																																																																																																																																																																																																																																																																																																																																																																																																																																																																																																																																																																																																																																																																														
74167	200p	745323	400p	AD581J	1400p																																																																																																																																																																																																																																																																																																																																																																																																																																																																																																																																																																																																																																																																																																																																																																																																																																																																																																																																																																																																																																																																																																																																																																																																																																																														
74170	240p	745348	200p	AD752A	600p																																																																																																																																																																																																																																																																																																																																																																																																																																																																																																																																																																																																																																																																																																																																																																																																																																																																																																																																																																																																																																																																																																																																																																																																																																																														
74172	450p	745348	200p	DM8123	175p																																																																																																																																																																																																																																																																																																																																																																																																																																																																																																																																																																																																																																																																																																																																																																																																																																																																																																																																																																																																																																																																																																																																																																																																																																																														
74173	120p	745367	70p	DM8131	375p																																																																																																																																																																																																																																																																																																																																																																																																																																																																																																																																																																																																																																																																																																																																																																																																																																																																																																																																																																																																																																																																																																																																																																																																																																																														
74174	90p	745367	70p	DM8131	375p																																																																																																																																																																																																																																																																																																																																																																																																																																																																																																																																																																																																																																																																																																																																																																																																																																																																																																																																																																																																																																																																																																																																																																																																																																																														
74175	85p	745368	100p	DM8131	375p																																																																																																																																																																																																																																																																																																																																																																																																																																																																																																																																																																																																																																																																																																																																																																																																																																																																																																																																																																																																																																																																																																																																																																																																																																																														
74176	90p	745373	150p	DM8131	375p																																																																																																																																																																																																																																																																																																																																																																																																																																																																																																																																																																																																																																																																																																																																																																																																																																																																																																																																																																																																																																																																																																																																																																																																																																																														
74177	90p	745374	150p	DM8131	375p																																																																																																																																																																																																																																																																																																																																																																																																																																																																																																																																																																																																																																																																																																																																																																																																																																																																																																																																																																																																																																																																																																																																																																																																																																																														
74178	160p	745375	120p	DM8131	375p																																																																																																																																																																																																																																																																																																																																																																																																																																																																																																																																																																																																																																																																																																																																																																																																																																																																																																																																																																																																																																																																																																																																																																																																																																																														
74180	93p	745377	160p	DM8131	375p																																																																																																																																																																																																																																																																																																																																																																																																																																																																																																																																																																																																																																																																																																																																																																																																																																																																																																																																																																																																																																																																																																																																																																																																																																																														
74181	160p	745378	140p	DM8131	375p																																																																																																																																																																																																																																																																																																																																																																																																																																																																																																																																																																																																																																																																																																																																																																																																																																																																																																																																																																																																																																																																																																																																																																																																																																																														
74182	90p	745390	120p	DM8131	375p																																																																																																																																																																																																																																																																																																																																																																																																																																																																																																																																																																																																																																																																																																																																																																																																																																																																																																																																																																																																																																																																																																																																																																																																																																																														
74184A	150p	745393	120p	DM8131	375p																																																																																																																																																																																																																																																																																																																																																																																																																																																																																																																																																																																																																																																																																																																																																																																																																																																																																																																																																																																																																																																																																																																																																																																																																																																														
74185	150p	745399	200p	DM8131	375p																																																																																																																																																																																																																																																																																																																																																																																																																																																																																																																																																																																																																																																																																																																																																																																																																																																																																																																																																																																																																																																																																																																																																																																																																																																														
74186	500p	745445	400p	DM8131	375p																																																																																																																																																																																																																																																																																																																																																																																																																																																																																																																																																																																																																																																																																																																																																																																																																																																																																																																																																																																																																																																																																																																																																																																																																																																														
74188	325p	745670	140p	DM8131	375p																																																																																																																																																																																																																																																																																																																																																																																																																																																																																																																																																																																																																																																																																																																																																																																																																																																																																																																																																																																																																																																																																																																																																																																																																																																														
74190	120p	745670	140p	DM8131	375p																																																																																																																																																																																																																																																																																																																																																																																																																																																																																																																																																																																																																																																																																																																																																																																																																																																																																																																																																																																																																																																																																																																																																																																																																																																														
74191	120p	745670	140p	DM8131	375p																																																																																																																																																																																																																																																																																																																																																																																																																																																																																																																																																																																																																																																																																																																																																																																																																																																																																																																																																																																																																																																																																																																																																																																																																																																														
74192	100p	4001	15p	75322	300p																																																																																																																																																																																																																																																																																																																																																																																																																																																																																																																																																																																																																																																																																																																																																																																																																																																																																																																																																																																																																																																																																																																																																																																																																																																														
74193	100p	4002	20p	75324	375p																																																																																																																																																																																																																																																																																																																																																																																																																																																																																																																																																																																																																																																																																																																																																																																																																																																																																																																																																																																																																																																																																																																																																																																																																																																														
74194	120p	4006	95p	75325	375p																																																																																																																																																																																																																																																																																																																																																																																																																																																																																																																																																																																																																																																																																																																																																																																																																																																																																																																																																																																																																																																																																																																																																																																																																																																														
74195	95p	4007	20p	75361	300p																																																																																																																																																																																																																																																																																																																																																																																																																																																																																																																																																																																																																																																																																																																																																																																																																																																																																																																																																																																																																																																																																																																																																																																																																																																														
74196	95p	4008	80p	75365	200p																																																																																																																																																																																																																																																																																																																																																																																																																																																																																																																																																																																																																																																																																																																																																																																																																																																																																																																																																																																																																																																																																																																																																																																																																																																														
74197	80p	4009	12p	75451-2	72p																																																																																																																																																																																																																																																																																																																																																																																																																																																																																																																																																																																																																																																																																																																																																																																																																																																																																																																																																																																																																																																																																																																																																																																																																																																														
74198	150p	4010	50p	75451-2	72p																																																																																																																																																																																																																																																																																																																																																																																																																																																																																																																																																																																																																																																																																																																																																																																																																																																																																																																																																																																																																																																																																																																																																																																																																																																														
74199	150p	4011	20p	8726	160p																																																																																																																																																																																																																																																																																																																																																																																																																																																																																																																																																																																																																																																																																																																																																																																																																																																																																																																																																																																																																																																																																																																																																																																																																																																														
74201	160p	4012	25p	8728	250p																																																																																																																																																																																																																																																																																																																																																																																																																																																																																																																																																																																																																																																																																																																																																																																																																																																																																																																																																																																																																																																																																																																																																																																																																																																														
74251	140p	4013	50p	8795	180p																																																																																																																																																																																																																																																																																																																																																																																																																																																																																																																																																																																																																																																																																																																																																																																																																																																																																																																																																																																																																																																																																																																																																																																																																																																														
74252	250p	4014	84p	8797	180p																																																																																																																																																																																																																																																																																																																																																																																																																																																																																																																																																																																																																																																																																																																																																																																																																																																																																																																																																																																																																																																																																																																																																																																																																																																														
74278	290p	4015	84p	81195	120p																																																																																																																																																																																																																																																																																																																																																																																																																																																																																																																																																																																																																																																																																																																																																																																																																																																																																																																																																																																																																																																																																																																																																																																																																																																														
74279	110p	4016	45p	81196	140p																																																																																																																																																																																																																																																																																																																																																																																																																																																																																																																																																																																																																																																																																																																																																																																																																																																																																																																																																																																																																																																																																																																																																																																																																																																														
74283	140p	4017	89p	81197	140p																																																																																																																																																																																																																																																																																																																																																																																																																																																																																																																																																																																																																																																																																																																																																																																																																																																																																																																																																																																																																																																																																																																																																																																																																																																														
74284	360p	4018	89p	81198	140p																																																																																																																																																																																																																																																																																																																																																																																																																																																																																																																																																																																																																																																																																																																																																																																																																																																																																																																																																																																																																																																																																																																																																																																																																																																														
74285	360p	4019	45p	9602	220p																																																																																																																																																																																																																																																																																																																																																																																																																																																																																																																																																																																																																																																																																																																																																																																																																																																																																																																																																																																																																																																																																																																																																																																																																																																														
9302	160p	74504	80p	745114	120p																																																																																																																																																																																																																																																																																																																																																																																																																																																																																																																																																																																																																																																																																																																																																																																																																																																																																																																																																																																																																																																																																																																																																																																																																																																														
9302	160p	74504	80p	745124	120p																																																																																																																																																																																																																																																																																																																																																																																																																																																																																																																																																																																																																																																																																																																																																																																																																																																																																																																																																																																																																																																																																																																																																																																																																																																														
9308	310p	74505	75p	745132	160p																																																																																																																																																																																																																																																																																																																																																																																																																																																																																																																																																																																																																																																																																																																																																																																																																																																																																																																																																																																																																																																																																																																																																																																																																																																														
9310	275p	74508	75p	745133	75p																																																																																																																																																																																																																																																																																																																																																																																																																																																																																																																																																																																																																																																																																																																																																																																																																																																																																																																																																																																																																																																																																																																																																																																																																																																														
9311	275p	74510	75p	745138	225p																																																																																																																																																																																																																																																																																																																																																																																																																																																																																																																																																																																																																																																																																																																																																																																																																																																																																																																																																																																																																																																																																																																																																																																																																																																														
9312	180p	74520	80p	745139	225p																																																																																																																																																																																																																																																																																																																																																																																																																																																																																																																																																																																																																																																																																																																																																																																																																																																																																																																																																																																																																																																																																																																																																																																																																																																														
9313	180p	74525	80p	745174	250p																																																																																																																																																																																																																																																																																																																																																																																																																																																																																																																																																																																																																																																																																																																																																																																																																																																																																																																																																																																																																																																																																																																																																																																																																																																														
9316	225p	74532	90p	745174	250p																																																																																																																																																																																																																																																																																																																																																																																																																																																																																																																																																																																																																																																																																																																																																																																																																																																																																																																																																																																																																																																																																																																																																																																																																																																														
9321	225p	74537	90p	745175	320p																																																																																																																																																																																																																																																																																																																																																																																																																																																																																																																																																																																																																																																																																																																																																																																																																																																																																																																																																																																																																																																																																																																																																																																																																																																														
9322	150p	74564	80p	745194	350p																																																																																																																																																																																																																																																																																																																																																																																																																																																																																																																																																																																																																																																																																																																																																																																																																																																																																																																																																																																																																																																																																																																																																																																																																																																														
9334	360p	74574	80p	745241	450p																																																																																																																																																																																																																																																																																																																																																																																																																																																																																																																																																																																																																																																																																																																																																																																																																																																																																																																																																																																																																																																																																																																																																																																																																																																														
9368	260p	74585	300p	745260	70p																																																																																																																																																																																																																																																																																																																																																																																																																																																																																																																																																																																																																																																																																																																																																																																																																																																																																																																																																																																																																																																																																																																																																																																																																																																														
9370	300p	74586	180p	745373	500p																																																																																																																																																																																																																																																																																																																																																																																																																																																																																																																																																																																																																																																																																																																																																																																																																																																																																																																																																																																																																																																																																																																																																																																																																																																														
9374	200p	745112	120p	745374	500p																																																																																																																																																																																																																																																																																																																																																																																																																																																																																																																																																																																																																																																																																																																																																																																																																																																																																																																																																																																																																																																																																																																																																																																																																																																														
74S00	80p	MC13600	125p																																																																																																																																																																																																																																																																																																																																																																																																																																																																																																																																																																																																																																																																																																																																																																																																																																																																																																																																																																																																																																																																																																																																																																																																																																																																
74S01	80p	MC1310P	150p																																																																																																																																																																																																																																																																																																																																																																																																																																																																																																																																																																																																																																																																																																																																																																																																																																																																																																																																																																																																																																																																																																																																																																																																																																																																
74S02	160p	MC1458	45p																																																																																																																																																																																																																																																																																																																																																																																																																																																																																																																																																																																																																																																																																																																																																																																																																																																																																																																																																																																																																																																																																																																																																																																																																																																																
74S03	160p	MC1495L	35p																																																																																																																																																																																																																																																																																																																																																																																																																																																																																																																																																																																																																																																																																																																																																																																																																																																																																																																																																																																																																																																																																																																																																																																																																																																																
74S04	160p	MC1496	35p																																																																																																																																																																																																																																																																																																																																																																																																																																																																																																																																																																																																																																																																																																																																																																																																																																																																																																																																																																																																																																																																																																																																																																																																																																																																
74S05	160p	MC1496	35p																																																																																																																																																																																																																																																																																																																																																																																																																																																																																																																																																																																																																																																																																																																																																																																																																																																																																																																																																																																																																																																																																																																																																																																																																																																																
74S06	160p	MC1496	35p																																																																																																																																																																																																																																																																																																																																																																																																																																																																																																																																																																																																																																																																																																																																																																																																																																																																																																																																																																																																																																																																																																																																																																																																																																																																
74S07	160p	MC1496	35p																																																																																																																																																																																																																																																																																																																																																																																																																																																																																																																																																																																																																																																																																																																																																																																																																																																																																																																																																																																																																																																																																																																																																																																																																																																																
74S08	160p	MC1496	35p																																																																																																																																																																																																																																																																																																																																																																																																																																																																																																																																																																																																																																																																																																																																																																																																																																																																																																																																																																																																																																																																																																																																																																																																																																																																
74S09	160p	MC1496	35p																																																																																																																																																																																																																																																																																																																																																																																																																																																																																																																																																																																																																																																																																																																																																																																																																																																																																																																																																																																																																																																																																																																																																																																																																																																																
74S10	160p	MC1496	35p																																																																																																																																																																																																																																																																																																																																																																																																																																																																																																																																																																																																																																																																																																																																																																																																																																																																																																																																																																																																																																																																																																																																																																																																																																																																
74S11	160p	MC1496	35p																																																																																																																																																																																																																																																																																																																																																																																																																																																																																																																																																																																																																																																																																																																																																																																																																																																																																																																																																																																																																																																																																																																																																																																																																																																																
74S12	160p	MC1496	35p																																																																																																																																																																																																																																																																																																																																																																																																																																																																																																																																																																																																																																																																																																																																																																																																																																																																																																																																																																																																																																																																																																																																																																																																																																																																
74S13	160p	MC1496	35p																																																																																																																																																																																																																																																																																																																																																																																																																																																																																																																																																																																																																																																																																																																																																																																																																																																																																																																																																																																																																																																																																																																																																																																																																																																																
74S14	160p	MC1496	35p																																																																																																																																																																																																																																																																																																																																																																																																																																																																																																																																																																																																																																																																																																																																																																																																																																																																																																																																																																																																																																																																																																																																																																																																																																																																
74S15	160p	MC1496	35p																																																																																																																																																																																																																																																																																																																																																																																																																																																																																																																																																																																																																																																																																																																																																																																																																																																																																																																																																																																																																																																																																																																																																																																																																																																																
74S16	160p	MC1496	35p																																																																																																																																																																																																																																																																																																																																																																																																																																																																																																																																																																																																																																																																																																																																																																																																																																																																																																																																																																																																																																																																																																																																																																																																																																																																
74S17	160p	MC1496	35p																																																																																																																																																																																																																																																																																																																																																																																																																																																																																																																																																																																																																																																																																																																																																																																																																																																																																																																																																																																																																																																																																																																																																																																																																																																																
74S18	160p	MC1496	35p																																																																																																																																																																																																																																																																																																																																																																																																																																																																																																																																																																																																																																																																																																																																																																																																																																																																																																																																																																																																																																																																																																																																																																																																																																																																
74S19	160p	MC1496	35p																																																																																																																																																																																																																																																																																																																																																																																																																																																																																																																																																																																																																																																																																																																																																																																																																																																																																																																																																																																																																																																																																																																																																																																																																																																																
74S20	160p	MC1496	35p																																																																																																																																																																																																																																																																																																																																																																																																																																																																																																																																																																																																																																																																																																																																																																																																																																																																																																																																																																																																																																																																																																																																																																																																																																																																
74S21	160p	MC1496	35p																																																																																																																																																																																																																																																																																																																																																																																																																																																																																																																																																																																																																																																																																																																																																																																																																																																																																																																																																																																																																																																																																																																																																																																																																																																																
74S22	160p	MC1496	35p																																																																																																																																																																																																																																																																																																																																																																																																																																																																																																																																																																																																																																																																																																																																																																																																																																																																																																																																																																																																																																																																																																																																																																																																																																																																
74S23	160p	MC1496	35p																																																																																																																																																																																																																																																																																																																																																																																																																																																																																																																																																																																																																																																																																																																																																																																																																																																																																																																																																																																																																																																																																																																																																																																																																																																																
74S24	160p	MC1496	35p																																																																																																																																																																																																																																																																																																																																																																																																																																																																																																																																																																																																																																																																																																																																																																																																																																																																																																																																																																																																																																																																																																																																																																																																																																																																
74S25	160p	MC1496	35p																																																																																																																																																																																																																																																																																																																																																																																																																																																																																																																																																																																																																																																																																																																																																																																																																																																																																																																																																																																																																																																																																																																																																																																																																																																																
74S26	160p	MC1496	35p																																																																																																																																																																																																																																																																																																																																																																																																																																																																																																																																																																																																																																																																																																																																																																																																																																																																																																																																																																																																																																																																																																																																																																																																																																																																
74S27	160p	MC1496	35p																																																																																																																																																																																																																																																																																																																																																																																																																																																																																																																																																																																																																																																																																																																																																																																																																																																																																																																																																																																																																																																																																																																																																																																																																																																																
74S28	160p	MC1496	35p																																																																																																																																																																																																																																																																																																																																																																																																																																																																																																																																																																																																																																																																																																																																																																																																																																																																																																																																																																																																																																																																																																																																																																																																																																																																
74S29	160p	MC1496	35p																																																																																																																																																																																																																																																																																																																																																																																																																																																																																																																																																																																																																																																																																																																																																																																																																																																																																																																																																																																																																																																																																																																																																																																																																																																																
74S30	160p	MC1496	35p																																																																																																																																																																																																																																																																																																																																																																																																																																																																																																																																																																																																																																																																																																																																																																																																																																																																																																																																																																																																																																																																																																																																																																																																																																																																
74S31	160p	MC1496	35p																																																																																																																																																																																																																																																																																																																																																																																																																																																																																																																																																																																																																																																																																																																																																																																																																																																																																																																																																																																																																																																																																																																																																																																																																																																																
74S32	160p	MC1496	35p																																																																																																																																																																																																																																																																																																																																																																																																																																																																																																																																																																																																																																																																																																																																																																																																																																																																																																																																																																																																																																																																																																																																																																																																																																																																
74S33	160p	MC1496	35p																																																																																																																																																																																																																																																																																																																																																																																																																																																																																																																																																																																																																																																																																																																																																																																																																																																																																																																																																																																																																																																																																																																																																																																																																																																																
74S34	160p	MC1496	35p																																																																																																																																																																																																																																																																																																																																																																																																																																																																																																																																																																																																																																																																																																																																																																																																																																																																																																																																																																																																																																																																																																																																																																																																																																																																
74S35	160p	MC1496	35p																																																																																																																																																																																																																																																																																																																																																																																																																																																																																																																																																																																																																																																																																																																																																																																																																																																																																																																																																																																																																																																																																																																																																																																																																																																																
74S36	160p	MC1496	35p																																																																																																																																																																																																																																																																																																																																																																																																																																																																																																																																																																																																																																																																																																																																																																																																																																																																																																																																																																																																																																																																																																																																																																																																																																																																
74S37	160p	MC1496	35p																																																																																																																																																																																																																																																																																																																																																																																																																																																																																																																																																																																																																																																																																																																																																																																																																																																																																																																																																																																																																																																																																																																																																																																																																																																																
74S38	160p	MC1496	35p																																																																																																																																																																																																																																																																																																																																																																																																																																																																																																																																																																																																																																																																																																																																																																																																																																																																																																																																																																																																																																																																																																																																																																																																																																																																
74S39	160p	MC1496	35p																																																																																																																																																																																																																																																																																																																																																																																																																																																																																																																																																																																																																																																																																																																																																																																																																																																																																																																																																																																																																																																																																																																																																																																																																																																																
74S40	160p	MC1496	35p																																																																																																																																																																																																																																																																																																																																																																																																																																																																																																																																																																																																																																																																																																																																																																																																																																																																																																																																																																																																																																																																																																																																																																																																																																																																
74S41	160p	MC1496	35p																																																																																																																																																																																																																																																																																																																																																																																																																																																																																																																																																																																																																																																																																																																																																																																																																																																																																																																																																																																																																																																																																																																																																																																																																																																																
74S42	160p	MC1496	35p																																																																																																																																																																																																																																																																																																																																																																																																																																																																																																																																																																																																																																																																																																																																																																																																																																																																																																																																																																																																																																																																																																																																																																																																																																																																
74S43	160p	MC1496	35p																																																																																																																																																																																																																																																																																																																																																																																																																																																																																																																																																																																																																																																																																																																																																																																																																																																																																																																																																																																																																																																																																																																																																																																																																																																																
74S44	160p	MC1496	35p																																																																																																																																																																																																																																																																																																																																																																																																																																																																																																																																																																																																																																																																																																																																																																																																																																																																																																																																																																																																																																																																																																																																																																																																																																																																
74S45	160p	MC1496	35p																																																																																																																																																																																																																																																																																																																																																																																																																																																																																																																																																																																																																																																																																																																																																																																																																																																																																																																																																																																																																																																																																																																																																																																																																																																																
74S46	160p	MC1496	35p																																																																																																																																																																																																																																																																																																																																																																																																																																																																																																																																																																																																																																																																																																																																																																																																																																																																																																																																																																																																																																																																																																																																																																																																																																																																
74S47	160p	MC1496	35p																																																																																																																																																																																																																																																																																																																																																																																																																																																																																																																																																																																																																																																																																																																																																																																																																																																																																																																																																																																																																																																																																																																																																																																																																																																																
74S48	160p	MC1496	35p																																																																																																																																																																																																																																																																																																																																																																																																																																																																																																																																																																																																																																																																																																																																																																																																																																																																																																																																																																																																																																																																																																																																																																																																																																																																
74S49	160p	MC1496	35p																																																																																																																																																																																																																																																																																																																																																																																																																																																																																																																																																																																																																																																																																																																																																																																																																																																																																																																																																																																																																																																																																																																																																																																																																																																																
74S50	160p	MC1496	35p																																																																																																																																																																																																																																																																																																																																																																																																																																																																																																																																																																																																																																																																																																																																																																																																																																																																																																																																																																																																																																																																																																																																																																																																																																																																
BF40	25p	TIP30A	48p																																																																																																																																																																																																																																																																																																																																																																																																																																																																																																																																																																																																																																																																																																																																																																																																																																																																																																																																																																																																																																																																																																																																																																																																																																																																
BF41	25p	TIP30C	48p																																																																																																																																																																																																																																																																																																																																																																																																																																																																																																																																																																																																																																																																																																																																																																																																																																																																																																																																																																																																																																																																																																																																																																																																																																																																
BF42	25p	TIP31A	52p																																																																																																																																																																																																																																																																																																																																																																																																																																																																																																																																																																																																																																																																																																																																																																																																																																																																																																																																																																																																																																																																																																																																																																																																																																																																
BF43	25p	TIP31B	52p																																																																																																																																																																																																																																																																																																																																																																																																																																																																																																																																																																																																																																																																																																																																																																																																																																																																																																																																																																																																																																																																																																																																																																																																																																																																
BF44	25p	TIP31C	62p																																																																																																																																																																																																																																																																																																																																																																																																																																																																																																																																																																																																																																																																																																																																																																																																																																																																																																																																																																																																																																																																																																																																																																																																																																																																
BF45	25p	TIP32A	62p																																																																																																																																																																																																																																																																																																																																																																																																																																																																																																																																																																																																																																																																																																																																																																																																																																																																																																																																																																																																																																																																																																																																																																																																																																																																
BF46	25p	TIP32C	62p																																																																																																																																																																																																																																																																																																																																																																																																																																																																																																																																																																																																																																																																																																																																																																																																																																																																																																																																																																																																																																																																																																																																																																																																																																																																
BF47	25p	TIP33A	90p																																																																																																																																																																																																																																																																																																																																																																																																																																																																																																																																																																																																																																																																																																																																																																																																																																																																																																																																																																																																																																																																																																																																																																																																																																																																
BF48	25p	TIP33B	90p																																																																																																																																																																																																																																																																																																																																																																																																																																																																																																																																																																																																																																																																																																																																																																																																																																																																																																																																																																																																																																																																																																																																																																																																																																																																
BF49	25p	TIP33C	90p																																																																																																																																																																																																																																																																																																																																																																																																																																																																																																																																																																																																																																																																																																																																																																																																																																																																																																																																																																																																																																																																																																																																																																																																																																																																
BF50	25p	TIP34A	115p																																																																																																																																																																																																																																																																																																																																																																																																																																																																																																																																																																																																																																																																																																																																																																																																																																																																																																																																																																																																																																																																																																																																																																																																																																																																
BF51	25p	TIP34B	115p																																																																																																																																																																																																																																																																																																																																																																																																																																																																																																																																																																																																																																																																																																																																																																																																																																																																																																																																																																																																																																																																																																																																																																																																																																																																
BF52	25p	TIP34C	115p																																																																																																																																																																																																																																																																																																																																																																																																																																																																																																																																																																																																																																																																																																																																																																																																																																																																																																																																																																																																																																																																																																																																																																																																																																																																
BF53	25p	TIP35A	125p																																																																																																																																																																																																																																																																																																																																																																																																																																																																																																																																																																																																																																																																																																																																																																																																																																																																																																																																																																																																																																																																																																																																																																																																																																																																
BF54	25p	TIP35B	125p																																																																																																																																																																																																																																																																																																																																																																																																																																																																																																																																																																																																																																																																																																																																																																																																																																																																																																																																																																																																																																																																																																																																																																																																																																																																
BF55	25p	TIP35C	200p																																																																																																																																																																																																																																																																																																																																																																																																																																																																																																																																																																																																																																																																																																																																																																																																																																																																																																																																																																																																																																																																																																																																																																																																																																																																
BF56	25p	TIP36A	270p																																																																																																																																																																																																																																																																																																																																																																																																																																																																																																																																																																																																																																																																																																																																																																																																																																																																																																																																																																																																																																																																																																																																																																																																																																																																
BF57	25p	TIP36B	270p																																																																																																																																																																																																																																																																																																																																																																																																																																																																																																																																																																																																																																																																																																																																																																																																																																																																																																																																																																																																																																																																																																																																																																																																																																																																
BF58	25p	TIP36C	340p																																																																																																																																																																																																																																																																																																																																																																																																																																																																																																																																																																																																																																																																																																																																																																																																																																																																																																																																																																																																																																																																																																																																																																																																																																																																
BF59	25p	TIP41A	65p																																																																																																																																																																																																																																																																																																																																																																																																																																																																																																																																																																																																																																																																																																																																																																																																																																																																																																																																																																																																																																																																																																																																																																																																																																																																
BF60	25p	TIP41B	65p																																																																																																																																																																																																																																																																																																																																																																																																																																																																																																																																																																																																																																																																																																																																																																																																																																																																																																																																																																																																																																																																																																																																																																																																																																																																
BF61	25p	TIP41C	75p																																																																																																																																																																																																																																																																																																																																																																																																																																																																																																																																																																																																																																																																																																																																																																																																																																																																																																																																																																																																																																																																																																																																																																																																																																																																
BF62	25p	TIP42A	82p																																																																																																																																																																																																																																																																																																																																																																																																																																																																																																																																																																																																																																																																																																																																																																																																																																																																																																																																																																																																																																																																																																																																																																																																																																																																
BF63	25p	TIP42B	82p																																																																																																																																																																																																																																																																																																																																																																																																																																																																																																																																																																																																																																																																																																																																																																																																																																																																																																																																																																																																																																																																																																																																																																																																																																																																
BF64	25p	TIP42C	82p																																																																																																																																																																																																																																																																																																																																																																																																																																																																																																																																																																																																																																																																																																																																																																																																																																																																																																																																																																																																																																																																																																																																																																																																																																																																
BF65																																																																																																																																																																																																																																																																																																																																																																																																																																																																																																																																																																																																																																																																																																																																																																																																																																																																																																																																																																																																																																																																																																																																																																																																																																																																			

CW Filter

One of the most desirable features of a communications receiver is a set of really good IF filters for the various modes of modulation. Presumably due to the expense and complexity of such circuitry, this is lacking in many sets. In such cases it is often possible to obtain a worthwhile improvement in performance by using an audio filter with a response tailored to suit the required mode of reception. A filter of this type is of most help for CW (Morse) reception, where only a very narrow bandwidth is needed. In fact, an infinitely narrow bandwidth is the theoretical ideal, since the CW signal is just a single frequency! In practice, a bandwidth of a few hundred Hertz is necessary, since it is very difficult to tune to a signal and stay accurately tuned to it with a narrower bandwidth.

The circuit uses an integrated circuit audio amplifier (TDA2006) in the non-inverting mode, with R2 and R3 being used to bias the non-

inverting input. C4 to C7, R4,5 and PR1 form a T-notch filter, which provides frequency selective negative feedback over IC1. R4 and R5 also bias the inverting input of the device. A T-notch filter allows most frequencies to pass readily, but at and close to its operating frequency it gives a high level of attenuation. Thus, in this case it gives virtually 100% negative feedback and only about unity voltage gain at most frequencies. However, at its operating frequency there is little feedback and high voltage gain. This gives the required narrow passband.

PR1 controls the bandwidth of the filter and a fairly flat response will be obtained at maximum resistance. Decreasing its resistance gives a sharper and narrower response, but too low a resistance will give an unusably sharp response. The circuit might even start to oscillate. R1 attenuates the input signal to a level that gives roughly unity gain at the centre of the passband, but the exact voltage gain depends on the setting of PR1. The output can be fed to low, medium, or high impedance headphones, or a loudspeaker. Current consumption is about 15 mA.

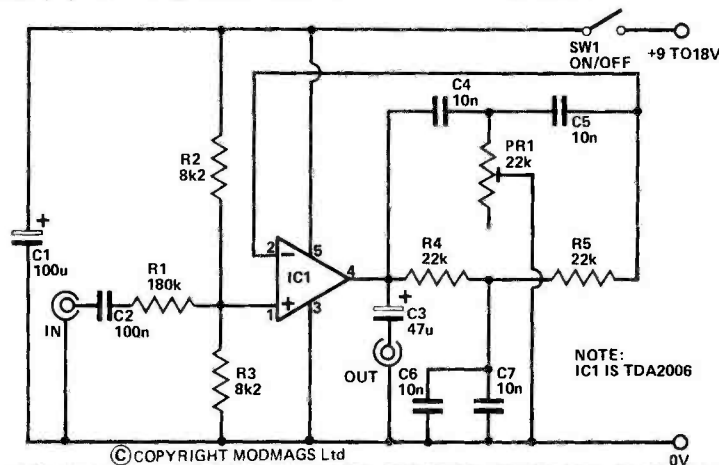

NEW! DMM
BREAK THROUGH!

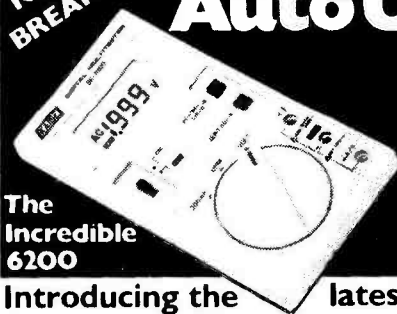

The Incredible 6200

If you want an Autoranging, Auto Unit Display, 3½ digit LCD DMM.

For only £39.95 (inc VAT)

We've got to hand it to you!

Introducing the latest professional state-of-the-art 3½-digit DMM – at really old-fashioned prices! From just an unbelievable £39.95 inc. VAT, plus £1.15 p&p!

- * 1mV, 100µA and 0.1Ω resolution!
- * Measures AC voltage to 600V!
- * Measures DC voltage to 1000V!
- * Measures resistance to 2 Megohms!
- * Low power Ohm ranges!
- * Displays mV, V and mA!
- * 0.8% accuracy!
- * Zero adjustment!
- * 3 other models too!

This one-off price is so unbelievably low because the A/D converter and display are custom-built. This is a genuine, no corners cut top-spec DMM, that gives you all the features above and 200 hrs continuous battery life on the 3½-digit LCD display, auto 'Batt' warning, pair of test leads, batteries, spare fuse and 6 months' guarantee! This offer can't last for ever, so buy now. Remember, a DMM in the hand

Plus three other DMMs in the range!

- 6220 As the 6200, plus 10 Amp AC DC measurement! ONLY £49.95 inc. VAT!
 - 6100 With Continuity check! ONLY £64.95 inc. VAT!
 - 6110 As 6100, plus 10 Amp AC DC measurement! ONLY £74.95 inc. VAT!
- Add £1.15 p&p please

I believe you! Please send me the DMM's as marked

- _____ 6200 @ £41.10 each, inc. VAT, p&p Total price £_____
- _____ 6220 @ £51.10 each, inc. VAT, p&p Total price £_____
- _____ 6100 @ £66.10 each, inc. VAT, p&p Total price £_____
- _____ 6110 @ £76.10 each, inc. VAT, p&p Total price £_____

Total cash cheque enclosed £_____

Cheques payable to
Maclin-Zand Electronics Ltd., please
38 Mount Pleasant, London WC1X 0AP
Tel 01-278 7369 01-837 1165



Maclin-Zand

Making state-of-the-art affordable

ACCESS orders taken. Please write card no. and signature:

ACCESS NO _____

Name _____

Address _____

Signed _____

To: Maclin-Zand Electronics Ltd., 38 Mount Pleasant, London WC1X 0AP.
For overseas orders, please add £5 to cost of total order package. 4 ETI

- ORDER BY POST OR TELEPHONE WITH BARCLAYCARD/ACCESS
- ELECTRONIC TEST EQUIPMENT SPECIALISTS
- CALL IN AND SEE FOR YOURSELF

AUDIO ELECTRONICS

- ALL MODELS ON DISPLAY
- RETAIL - MAIL ORDER EXPORT INDUSTRIAL
- OPEN SIX DAYS A WEEK

ALL PRICES INCLUDE VAT

SCOPES

A range of Scopes in stock from 5mHZ Single Trace to 50mHZ Dualtrace. Mains and battery/mains portables.

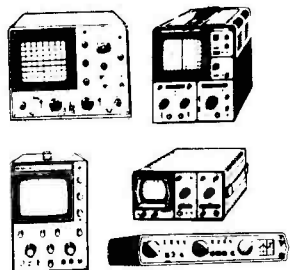

SINGLE TRACE

Many on demonstration. (UK c/p etc £2.50)

- Hm 307-3** 10mHZ, 5mV, 6 x 7cm display plus component test **£170.00**
CO1303D 5mHZ, 10mHZ, 7 x 7cm display **£109.25**
SC110 10mHZ Battery portable, 10mV 3.2 x 2.6cm display (Optional case £8.80, Nicads £7.95. Mains unit £4) **£149.95**
LB0512A 10mHZ, 10mV, 5" display **£195.50**
CS1559A 10mHZ, 10mV, 5" display **£198.50**
V151 15mHZ 1mV, 5" display **£241.50**

OPTIONAL PROBES (ALL MODELS!)
X1 £6.50, **X10** £8.50, **X100** £12.95, **X1-X10** £10.95

All Scopes now with Free Probe(s)

HAMEG ● TRIO ● LEADER ● SINCLAIR ● HITACHI

DUAL TRACE

(UK c/p etc £3.50)

- CS1562A** 10mHZ, 10mV, 5" display **£227.00**
CS1575 5mHZ, 5" 1mV display **£270.00**
Hm312-8 20mHZ, 5mV, 8x10cm display **£253.00**
CS1566A 20mHZ, 5mV, 5" display **£232.15**
LBO 3085 70mHZ 2mV 5 x 6.3cm display, Battery/mains Portable, built in Nicads **£482.00**
Hm412-4 20mHZ, 5mV, 8 x 10cm display plus sweep Delay **£399.50**
CS1577A 30mHZ, 2mV, 5" display **£455.40**
CS1830 30mHZ, 2mV, 5" display plus sweep delay **£507.15**
Hm512-8 50mHZ, 5mV, 10 x 8cm display, Delay Sweep **£667.00**
LB0514 10mHZ, 1mV (5mV), 5" display **£294.00**
V152 15mHZ 1mV, 5" display **£325.60**
V302 30mHZ 1mV, 5" display **£447.35**
V550 50mHZ 1mV 10 x 8cm Delay sweep + 3 channel display **£799.25**

GENERATORS

(UK c/p £1.75)

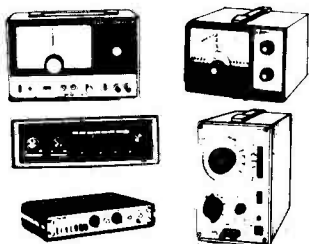

TRIO ● LEADER ● CSC
SINCLAIR ● LEVELL

RF

- SG402** 100KHZ - 30mHZ with AM modulation **£64.40**
LSG16 100kHz-100mHZ (300mHZ on Harmonics) **£56.50**
SG2030 250KHZ - 100mHZ low cost range **£46.95**
ARF 300 18HZ-200mHZ low cost range audio and RF **£76.95**

PULSE

- 2001** 1HZ-100KHZ Function **£86.00**
TG105 5HZ-5mHZ **£92.50**
4001 0.5HZ-5mHZ **£105.00**

A range of Signal Generators to cover Audio, RF and Pulsing. Mains operated (TG series Battery).

AUDIO

- (All sine/square)
AG202A 20HZ-200KHZ **£65.55**
LAG26 20HZ-200KHZ **£69.00**
AG203 10HZ-1mHZ sine/square **£120.75**
LAG120A 10HZ-1mHZ **£137.00**

LEVELL

- (M' with Meter)
152 SERIES 3HZ - 300KHZ Sine/Square **£92.00**
200 SERIES 1HZ - 1mHZ Sine/Square **£113.85**
TG152D **£124.20**
TG152DM **£149.50**
TG200D **£155.25**
TG200DM

SWR/FS AND POWER METERS



Range in stock covering up to 150mHZ and up to 1 K watt power. PL259 sockets. Also 250 UHZ Grid Dipmeter **£3.50**
SWR5 SWR: S 3-150mHZ **£13.95**
SWR50 SWR/Power meter 3/2-150mHZ 0-1000 watts **£11.50**
110 SWR/Power 1/2-144mHZ 0/10/100 watts **£11.50**
171 As 110 Twin meter plus F/S **£14.50**
Plus large range of 5mV/PL259/ATC leads/plugs/adaptors/connectors always in stock.
176 SWR/Power/F/S 1/2-144mHZ, 5-50 watt Plus 25-40mHZ AC match **£16.00**
KDM6 Grid Dip 1/2-250mHZ **£20.50**

DIGITAL MULTIMETERS

KAISE ● SINCLAIR ● LASCAR ● THURLBY

A range of LED and LCD Bench and Hand DMM's battery operated with optional Mains Adaptors - some with optional Nicads. All supplied with batteries and leads.

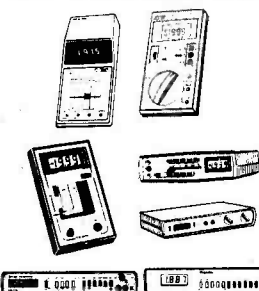

HAND HELD

- (UK post etc. 85p)
TM352 3 1/2 Digit LCD plus 10 ADC and Hfe checker **£54.95**
PDM35 3 1/2 Digit 16 range LED (no AC current) **£32.95**
ME502 3 1/2 Digit LED plus 10A DC and Hfe checker **£43.95**
LM2001 3 1/2 Digit LCD 2 amp AC/DC 0.1% **£51.70**
6200 3 1/2 Digit LCD 0.2A AC/DC, Auto range **£39.95**
6220 As 6200 plus 10A AC/DC **£49.95**
6100 As 6200 plus Cont. test/range hold **£59.95**
6110 As 6100 plus 10A AC/DC **£74.95**

BENCH PORTABLES

- (UK c/p £1.00)
DM235 3 1/2 Digit LED 21 ranges, 0.5% AC/DC 2A **£56.50**
DM350 3 1/2 Digit LED 34 ranges AC/DC 10A **£78.50**
TM353 3 1/2 Digit LCD AC/DC 2 amp **£86.50**
TM351 3 1/2 Digit LCD AC/DC 10 amp **£107.95**
LM100 3 1/2 Digit LCD AC/DC 2 amp **£86.50**
DM450 4 1/2 Digit LED 34 ranges AC/DC 10 amp (DM series options, Carry case £8.80, Nicads £7.95, Mains adaptc £4.00).

MULTIMETERS

(UK post etc 75p)

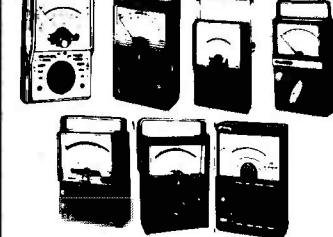

- KRT101** 1K/Volt 10 range pocket **£4.50**
ATM1/LT1 1K/Volt 12 range pocket **£5.95**
NH55 2K/Volt 10 range pocket **£6.95**
AT1 2K/Volt 12 range pocket de luxe **£7.95**
NH56 20K/Volt 22 range pocket **£10.95**
YN360TR 20K/Volt 19 range pocket plus hfe test **£13.95**
AT1020 20K/Volt 19 range de luxe plus hfe test **£16.95**
7081 50K/Volt 36 range plus 10 amp DC **£19.95**
TMK500 30K/Volt 23 range plus 12A DC/Cont. test **£21.50**
AT20 20K/Volt 21 range de luxe plus 10A DC and 5KV DC **£21.95**
AT205 50K/Volt 21 range de luxe plus 10A DC **£24.95**
7080 20K/Volt 26 range large scale, 10A DC plus 5KV AC/DC **£26.95**
AT2050 50K/Volt 18 range de luxe plus hfe test **£28.50**
AT210 100K/Volt 21 range de luxe plus 12A AC/DC **£29.95**
360TR 100K/Volt 23 range plus hfe checker and AC/DC 10 amps **£34.95**

CHOOSE FROM THE UK'S LARGEST SELECTION

FREQUENCY COUNTERS



Portable and Bench LCD and LED Counters up to 600mHZ. Prices include batteries and leads.

HAND HELD

- (UK post etc 85p)
PFM200 20HZ to 200mHZ 8 Digit LED **£54.50**
MAX50 100HZ to 50mHZ 6 Digit LED **£61.00**
MAX550 30KHZ to 550mHZ 6 Digit LED **£106.00**

BENCH PORTABLES

- (UK c/p £1.00)
MAX100 8 Digit LED 5HZ to 100mHZ **£89.00**
TF200 8 Digit LCD 10HZ to 200mHZ **£158.95**
7010A 9 Digit LED 10HZ to 600mHZ **£169.00**
TP600 600mHZ Pre-Scaler for TF200 **£41.00**
200SPC 6 Digit 100mHZ LED built into 0.002 HZ to 5.5mHZ pulse generator **£437.00**

CSC ● SINCLAIR ● OPTO ELECTRONICS

LOGIC PROBES MONITORS

Logic probes indicating high/low etc states that scopes can miss. all circuit powered for all IC's.

- LP3** 50 mHZ logic probe **£56.95**
LP1 10 mHZ logic probe **£35.50**
LP2 1 1/2 mHZ logic probe **£19.95**
LM1 logic monitor **£33.00**
LDP076 50 mHZ logic probe with case **£51.00**

Also in stock range of Protoboard kits and breadboards.

MINI DRILLS AND KITS

- (8-12 Volt 1/8" chucks)
Small Drill plus 3 collets **£7.25**
Medium Drill plus 3 collets **£10.50**
Small Drill plus 20 tools **£14.95**
Medium Drill plus 20 tools **£17.95**
Mains Drill plus 20 tools **£13.95**
Mains Drill plus 20 tools **£21.50**

Stockists of electronic equipment, speakers/kits, PA equipment plus huge range of accessories ● UK carriage/packing as indicated ● Export - prices on request ● All prices correct at 1.12.80 E & OE ● All prices include V.A.T.

AUDIO ELECTRONICS Cubegate Limited

OPEN SIX DAYS A WEEK

301 EDGWARE ROAD, LONDON, W2 1BN, ENGLAND. TELEPHONE 01 724 3564



FREE CATALOGUE!

Send large SAE (175p UK) Schools, Companies, etc. free on request.

AUDIOPHILE

It's almost time for Rudolph the red-nosed guinea pig (everyone's had to economise) to drag his sleigh across your roof. If you haven't sent your letter to Santa yet, Ron Harris offers a few sound suggestions.

It's that time of the year again, is it not? Out with the plastic holly, stale booze and cast-iron fruit cake. At work everyone goes around smiling and saying "cheers" too often, all the time checking people over with hungry eyes to see who is gonna grab who at this year's booze-up. Goodwill to all men and all that.

Another quaint little custom widely practised in some social circles is that of spending money that doesn't exist upon things which are totally unnecessary and giving them away to people who don't want them anyway, in return for which you are guaranteed to receive several pieces of ultra-modern junk yourself. Sheer unadulterated lunacy really.

Why not change things this year? As you are most unlikely to get Felicity Kendal, regardless of who you ask (I've written to Santa seven years running with no luck, so far — why should you be any different, eh?), something remotely hi-fi might make the pain and heartache of disappointment a little less hard to bear. Now, unless you're friends with a few dozen Arab Sheiks it is also unlikely that, on the morning of the 25th, you will awaken to find a neatly packaged Meridan, SME or Linn sat sitting beneath the Woolies tree . . .

Audiophile this month is dedicated to providing a few dozen or so ideas for additions and improvements to hi-fi systems of all denominations that are financially feasible, be it your intention to give or to receive. It is especially more blessed to give when you can afford it.

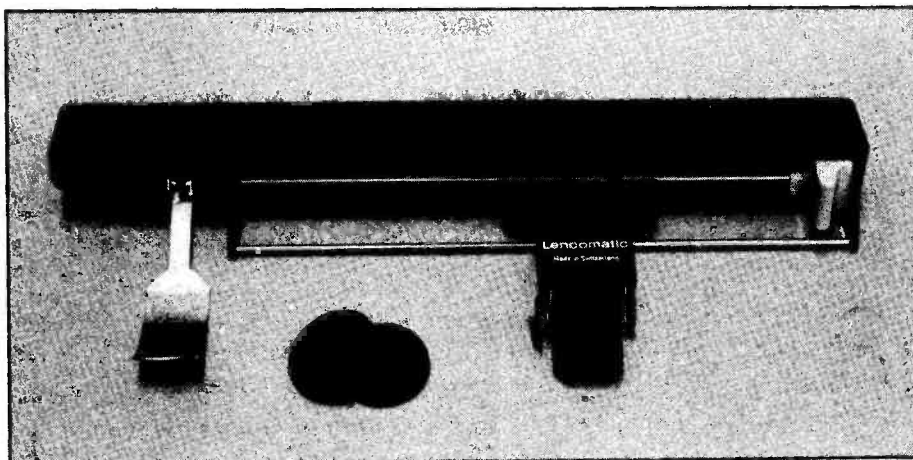

Above the Lencomatic record cleaner. This is the most unusual of the hordes of tracking cleaners around the shops these days. Rather than fit it to the deck on a nice plain, ordinary, boring pillar it attaches to the perspex lid and that evil looking tongue rests on the spindle to locate the device! There is a little carbon-fibre brush and a large pad on the business end. Perfect for lazy people or those who wish to aspire to such heights of inaction. The only drawback is the somewhat odd appearance. Price:- £8.93.

Format For Mats And Things

A glance at any audio emporium will show you that there are more than just a few accessories and gadgets to choose from these days and it would have been totally impossible to cover them all; by the time we published this, someone would have released a hundred more. Beside which, not all the vended items can even remotely meet their manufacturer's claims. I've been very selective, therefore, about which items to include. If you don't find a particular item here, that in itself is no condemnation. However, everything which is included, is recommended!

There is in addition a 'special' section for what I think are 'special' items and these are written up in more detail than the rest. Prices appended to each are typical prices you can expect to pay in the shops, inclusive of VAT. It might be an idea to leave this article lying around with certain items heavily ringed in fluorescent yellow, or something. Alternatively be direct and hit a few friends over the head with it — you never know, as well as broken bones you *might* just get a stylus cleaner or two.

Items appear in no particular order of merit or anything else.

(Oh yes, Merry Thingy and all that.)



Above: Discguard. I'm always suspicious of things to spray onto records, but this seems harmless enough — if I can overcome the hidebound conservative attitude that the less stuff I put under the stylus, the less will end up stuck all over it! Discguard is a permanent anti-static treatment which is undetectable audibly (we tried it!) and greatly reduces the LP's ability to attract dust. Price:- £4.50. →

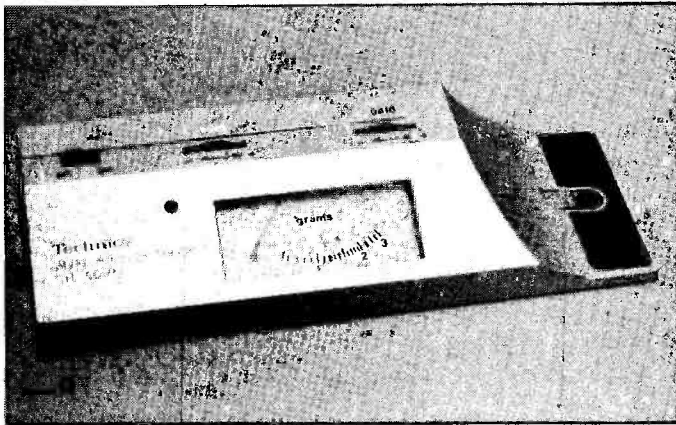

Above: Technics SH-50P1 stylus pressure gauge. A long way from little weights this. A strain gauge measures the downforce present and reads out the tracking weight on a meter. It is accurate to about 0.1g if set-up properly — a reference weight is provided — and looks very very flashy in use. Just the thing to impress the neighbours — and yourself! I like this idea — how about a digital version eh, Technics? Price:- £17.95.



Above (and below!): Now this has got to be the Idea Of The Year! Without passing any comments — and you mucky minded lot out there can keep quiet too — this is a vibrating stylus cleaner from Audio Technica. There is a pad at the end, attached to a vibrator within the body of the device. You lower the stylus onto the pad and leave it alone for a few seconds. The clever little widget meanwhile proceeds to shake all the muck off the stylus!

Ingenious in the extreme and it works superbly. Sheer magic. Never in the field of human grooves has so much been cleaned so well by so little. There is a bottle of cleaner supplied to deal with really bad cases of encrustation. Thoroughly and totally recommended. Every home should have two. Price:- £9.95.

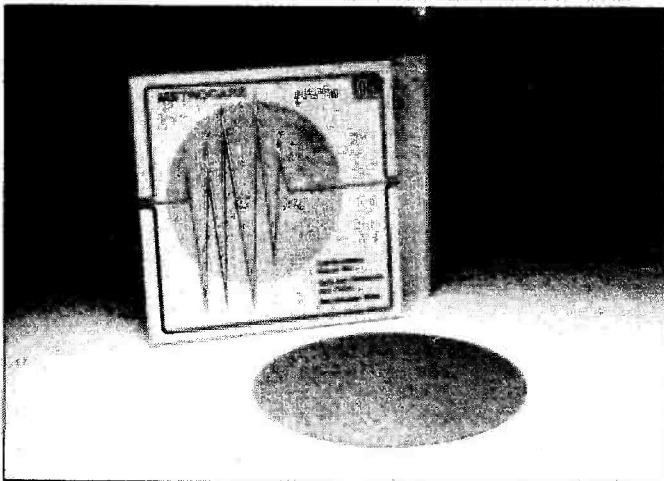

Above: Turntable mats are a favourite tune-up these days and these are consequently a large number of them around. This is one of the newest. The Metrocare has a very high surface tension — VERY high. It grips an LP like a Scotsman grips his drink and thus provide an excellent bond. Price:- £16.75.

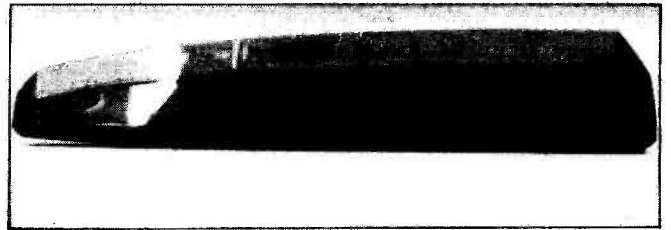

Not all turntable mats are designed to be anti-resonance à la the Metrocare. This Goldring is primarily anti-static and is composed of carbon fibres to provide a leak-path to earth for the charge present on the LP.

Price:- £3.90.

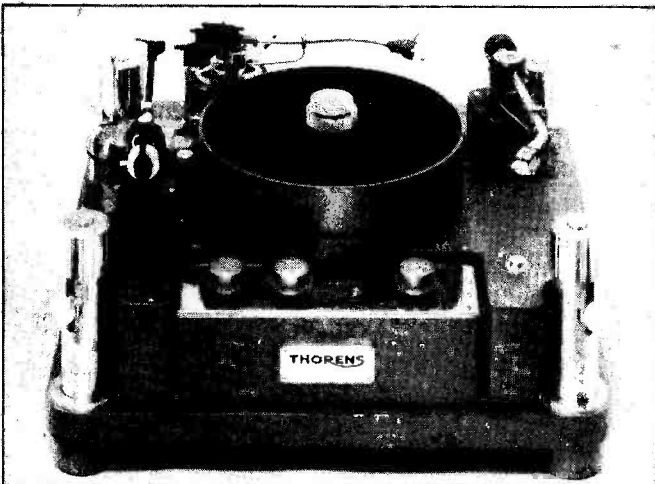
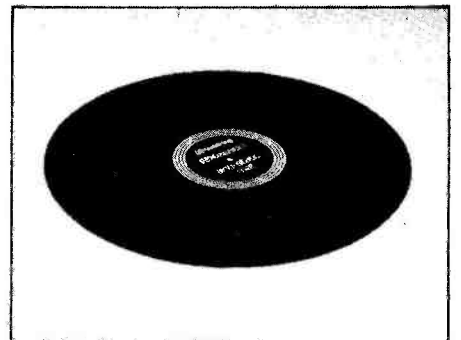

The ultimate accessory? The Thorens Reference deck, built with no compromise whatsoever to price. It weighs 90 kgs, claims to possess unmeasurable rumble and w/f at 0.02%, is a subtle 620 x 360 x 510 mm in size. The chassis is aluminium cast, filled with iron grain. In other words it is very big, very heavy, and very expensive (circa £4,000). Supposed to sound pretty good too.

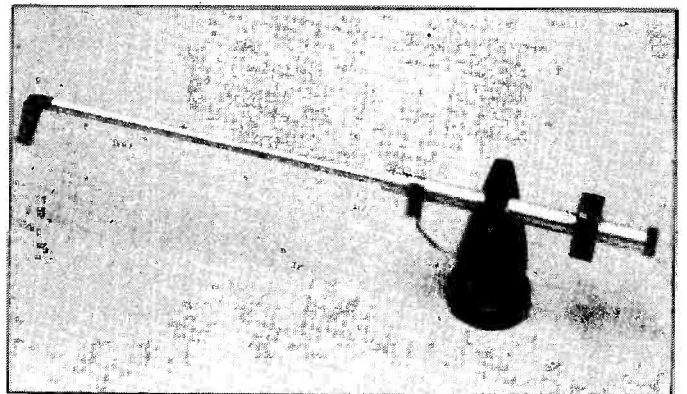

Above: the Exstatic carbon fibre sweep arm. Of all the millions of Dust-Bug descendents available this is my favourite. It looks very classy indeed and does the job better than most. An earthing lead is provided to form a conductive path to ground static encountered in mid-sweep and the counterweight provides playing weight adjustment to optimise tracking. Price:- £8.40.

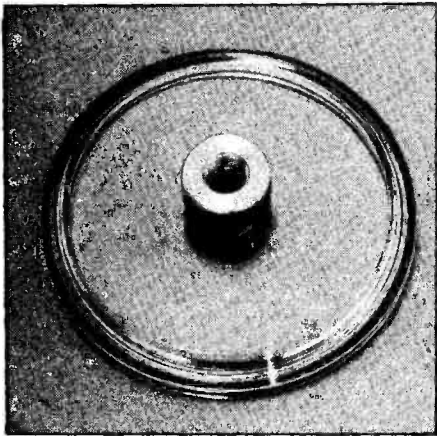

Above: the Metrocare anti-resonance clamp. This is formed of clear perspex with a brass center. The idea being that it is fitted over the spindle atop your records, to clamp them firmly onto the mat, thus de-warping warps and suppressing resonance. Used together with a good turntable mat the clamp can offer a worthwhile improvement in sound quality, especially in the bass. Price:- £4.54

Below: a neat little notion this. As the cleaning tape passes the heads, it rotates a cunningly placed rotary magnet which simultaneously de-magnetises them. The magnet is moved away automatically within the cassette by the spooling action.

Price:- £3.50.



Above: one for those always in the dark. A light from Goldring, which fits onto the dust-cover (or cupboard door) wherein lurks the record deck and switches on as you open the door! A little mercury switch does the work, leaving you free to return to whatever it is you were doing in the dark

Price:- £12.00.

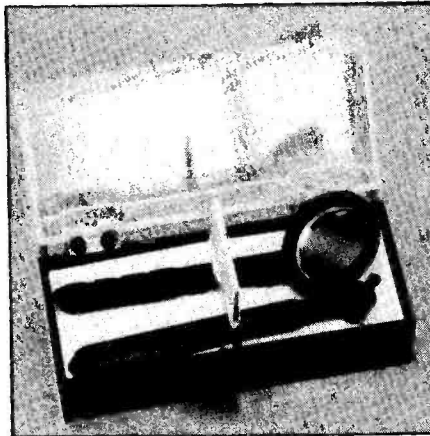

Above: a smallie-but-goodie. Just the thing to buy with the change from an LP! The Exstatic stylus care kit only costs 90p and will earn that back with the first wipe of the brush! Go on — you know it makes sense. Make a good present for the person that bought your Des O'Connor Greatest Hits last year. If he plays that sort of stuff, SOMEONE better take care of his stylus and quick!

Price:- £0.90.



Above: Triple Checker! Well, it is. A record weight, spirit level and 45 RPM adaptor all in one. That little ball bearing you can see lurking under the glass rolls around in a shallow dish to indicate how level the deck is (inaudibly I might add) and the thing is so heavy no warp will dare defy it! The Triple Checker comes from Goldring and costs;

Price:- £6.00

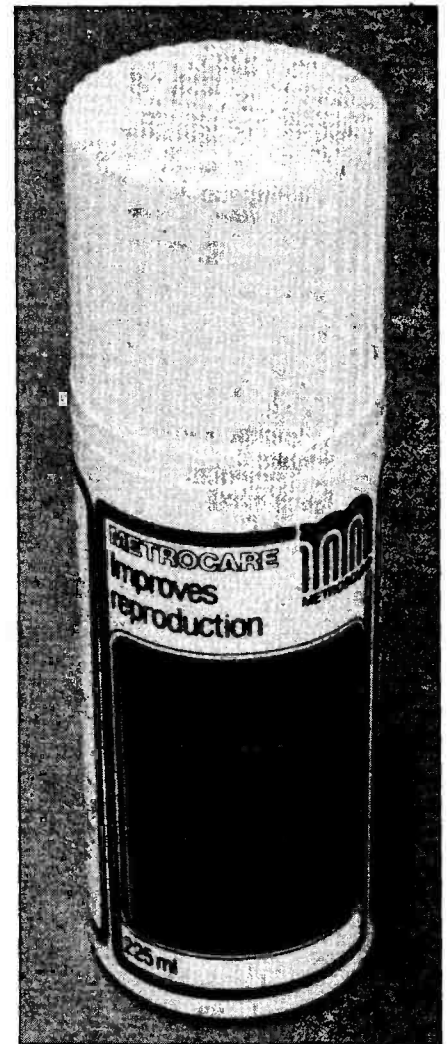

Above: do you suffer from dirty, ingrained, groove dust? Do your records lack that new-look sparkle? Are your highs too low and your lows distorted? Give your LPs a face-lift with the Metrocare Rejuvenating Fluid!

This is literally applied like a face-pack from the bottle, being smeared across the surface and allowed to dry into a thin plastic film. This is then peeled away, taking most of the gunge with it! Price:- £4.24.

Below and left: the Exstatic record brushes. Both consist of carbon fibre bristles, with the wiper possessing a pad down the centre for better dust collection. Both come with a stand.

Prices:- £6.00 and £7.50 (super).



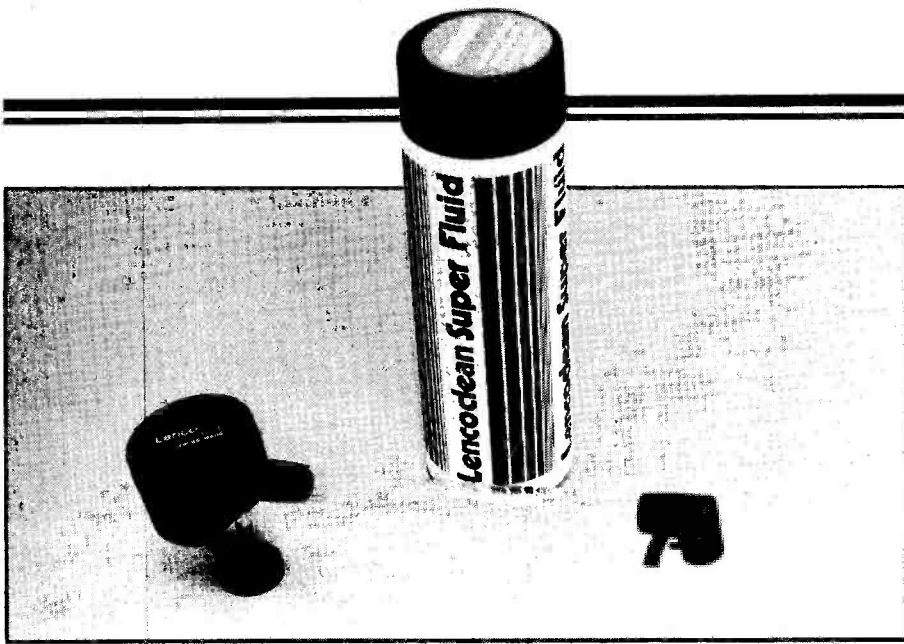

Above: how about playing your record under water? Or under liquid anyway. The Lencoclean has been around a long time and continues to have its followers. It is a wet-playing system, which means that the arm (filled with fluid) tracks ahead of the stylus, dispensing a band of liquid into the groove. Any matter present is held in suspension when the stylus arrives and has minimal effect. No more snap, crackle and pop. No more static. Quiet backgrounds guaranteed.

The penalty to be paid is that once used, always used. Dry playing becomes impossible because the mud in the grooves has to be suspended else it gathers around the stylus somewhat rapidly. As I said, the system has a lot of followers and works superbly. It is up to you whether you take the plunge!

Price:- £5.93.

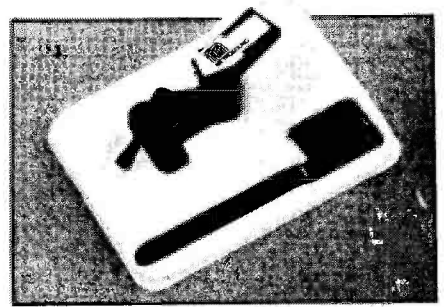

Above: the tracking cleaner for automatic record players. It attaches to the headshell. From Metrocare at Price:- £1.68.



Left and below: TDK make two head demagnetisers, one very pretty cassette unit (left) which is fully automatic and absolutely beautiful! The conventional unit below (not to scale!) is designed for reel-to-reel mainly and is superbly constructed.

Price:- £11.25 (cassette)
£21 (reel-to-reel).

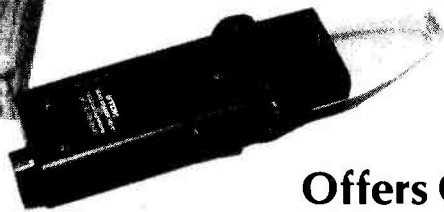

Below: the Metrocare 'cling' cleaner. A permanent 'sticky' roller which never needs replacing. Just wash it when dirty and start again!

Price:- £5.87.

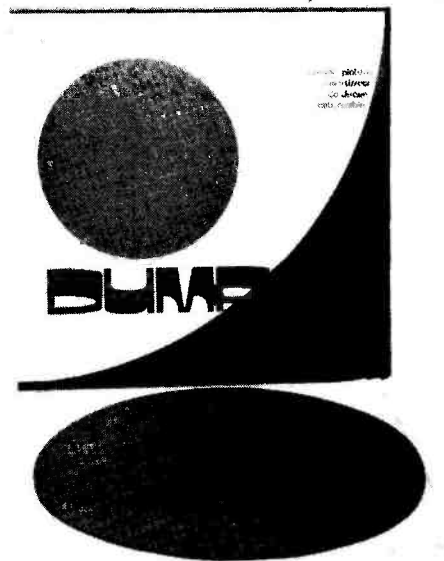

Above: the renamed Spectra mat. Dumpa it is called now apparently, but it is still one of the very best of the turntable mats to be purchased working well on a wide range of decks.

Price:- £19.80.

Offers On Offer

The ETI switchboard has glowed red in the night since we ran our hi-fi system offer a couple of issues back. The most oft asked questions were whether the equipment was purchasable separately and where it could be heard.

The answers are yes — prices below — and at Videotone's showroom in Crofton Park Road (see advert in this issue). We chose the system for its sound vs price performance and if you make the trip to Videotone you'll see what we mean. Take a copy of ETI along and you can buy at the prices quoted below. But be quick about it as time, tide and stock levels wait for no man!

- | | |
|-------------------------|---|
| ST 4120 tuner | £55 + £3 p&p |
| ST 4130 amplifier | £50 + £3 p&p |
| SC 3200 cassette deck | £75 + £3 p&p |
| | (reduced again from £88. Too good to our readers we are!) |
| GB2 loudspeakers (pair) | £45 + £7 p&p |

Incidentally, since Audiophile uses a Coral MC81 quite extensively as a reference, Videotone are prepared to let ETI readers buy one at a good discount on normal prices. An MC81 and H300 head-amp will cost you £44.50 and £45.00 respectively instead of £48.87 (+ p&p) and £51.75 (+ p&p). Add a quid to each for postage as usual and tell them ETI sent you!

ETI

ETI JANUARY 1981

TRANSFORMERS

Panel Meters, Bridge Rectifiers, Power Supply Units
Multimeters - Semi Conductors - Timers - Safeloc

Minimum & Sub Miniature

Volts	Milli-amps	Ref. No.	Price £	P&P
3.0-3	200	238	2.60	.70
0.6-0.6	1A 1A	212	3.00	.75
0.9-0.9	100	13	2.30	.70
0.9-0.9	330 330	235	2.15	.70
0.9-0.8-9	500 500	207	2.75	.75
0.8-9-0.8-9	1A 1A	208	3.85	.75
0.15-0.15	200 200	236	2.15	.70
0.20-0.20	300 300	214	2.75	.90
20.12-0.12-20	700(DC)	221	3.50	.90
0.15-20, 0.15-20	1A 1A	206	4.60	1.05
0.15-27, 0.15-27	500 500	203	4.05	.85
0.15-27, 0.15-27	1A, 1A	204	6.10	1.05

12 AND/OR 24 VOLT

Pri: 220-240 Volts

12v	Amps	24V	Ref.	Price £	P&P
0.5	0.25	111		2.30	.75
1.0	0.5	213		2.75	.90
2	1	71		3.25	.90
4	2	18		4.05	.85
6	3	70		5.60	.95
8	4	108		7.40	1.20
10	5	72		8.25	1.20
12	6	116		8.85	1.20
16	8	17		10.85	1.30
20	10	115		13.85	1.50
30	15	187		16.85	1.50
60	30	226		33.35	1.80

30 VOLT (Pri: 220-240V)

Sec: 0.12-15-20-24-30V

Amps	Ref. No.	Price £	P&P
0.5	112	2.85	.90
1.0	79	3.60	.90
2.0	3	5.80	1.05
3.0	20	6.30	1.20
4.0	21	6.80	1.20
5.0	51	9.60	1.20
6.0	117	11.10	1.20
8.0	88	14.35	1.50
10.0	89	16.60	1.50

Please add VAT at 15%
Barclaycard and Access facilities
available
Trade and Education Welcome

50 VOLT (Pri: 220-240V)

Sec: 0.19-25 33-40-50V

Amps	Ref. No.	Price £	P&P
0.5	102	3.60	.90
1.0	103	4.60	1.05
2.0	104	7.30	1.20
3.0	105	8.60	1.20
4.0	106	10.85	1.30
6.0	107	15.10	1.50
8.0	118	20.20	1.70
10.0	119	24.10	2.20

60 VOLT (Pri: 220-240V)

Sec: 0.24-30 40-48-60

Amps	Ref. No.	Price £	P&P
0.5	124	3.85	.90
1.0	126	5.60	1.05
2.0	127	7.55	1.20
3.0	125	11.10	1.30
4.0	123	12.35	1.50
5.0	40	14.15	1.60
6.0	120	17.60	1.60

AUTO TRANSFORMERS

Input/Output Tapped 0-115-210-240V

VA (Watts)	Ref. No.	Price £	P&P
20	113	2.85	.90
75	64	4.10	.90
150	4	5.60	1.05

Input/Output Tapped

0-115-210-220-240V

300	53	10.10	1.20
500	67	10.85	1.50
1000	84	18.60	1.60

Also 1500/2000/3000VA

MAINS ISOLATING (Centre Tapped & Screened)

Pri: 120/240V Sec: 120/240V

VA (Watts)	Ref. No.	Price £	P&P
60	149	6.60	1.05
100	150	7.60	1.30
200	151	11.10	1.30
250	152	13.30	1.50
350	153	16.30	1.60
1000	156	37.10	3.20

BAYDIS

7a William Street
Herne Bay, Kent
Herne Bay GA458B6

JUMP TO IT!

Climb aboard the breadboarding bandwagon with CSC's new WK-1 wire jumper kit - just what you've always wanted to make breadboarding easier and quicker than ever before. Here, in one neatly compartmented box, are all those different lengths of insulated hook-up wire you need - 25 pieces of each, in 14 lengths ranging from 0.1 inch to 4 inches. What's more, the CSC kit makes your job even easier by colour-coding all the different lengths and providing a quarter-inch length at each end with the insulation stripped off and bent through 90°. So CSC jumper wires come ready to plug straight into your quick-test sockets, bus strips or breadboard system. No more fiddling around with wire cutters, strippers or pliers - everything you need in one box. Take the plunge right now by filling in the CSC coupon.

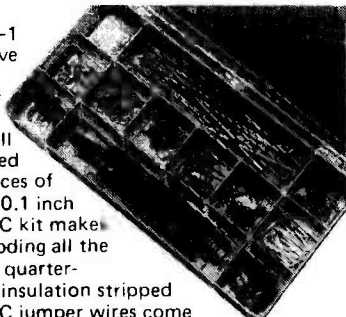

CSC (UK) Ltd., Unit 1, Shire Hill Industrial Estate, Saffron Walden, Essex CB11 3AQ. Telephone: (0799) 21682. Telex: 817477.

WK-1	Jumper Kit	£5.00 Nett.	Unit price inc. P&P 15% VAT £6.90	Qty. Req'd
------	------------	-------------	-----------------------------------	------------

Please deduct £1 postage from each additional order.

I enclose cheque/PO for £.....
or Debit my Barclaycard, Access, American Express card
No..... Exp. date.....
or Tel: (0799) 21682 with your card number and your order
will be in the post immediately.

NAME.....
ADDRESS.....

CONTINENTAL SPECIALTIES CORPORATION
CSC FREE catalogue tick box

Continental Specialties Corporation (UK) Limited, Dept. 9RR
Unit 1, Shire Hill Industrial Estate, Saffron Walden, Essex CB11 3AQ.

TOMORROW'S TOOLS TODAY

All these advantages...

- Instant all-weather starting
- Smoother running
- Continual peak performance
- Longer battery & plug life
- Improved fuel consumption
- Improved acceleration/top speed
- Extended energy storage

..in kit form

SPARKRITE X5 is a high performance, top quality inductive discharge electronic ignition system designed for the electronics D.I.Y. world. It has been tried, tested and proven to be utterly reliable. Assembly only takes 1-2 hours and installation even less due to the patented 'clip on' easy fitting.

The superb technical design of the Sparkrite circuit eliminates problems of the contact breaker. There is no misfire due to contact breaker bounce which is eliminated electronically by a pulse suppression circuit which prevents the unit firing if the points bounce open at high R.P.M. Contact breaker burn is eliminated by reducing the current by 95% of the normal.

There is also a unique extended dwell circuit which allows the coil a longer period of time to store its energy before discharging to the plugs. The unit includes built-in static timing light, systems function light, and security changeover switch. Will work all rev counters.

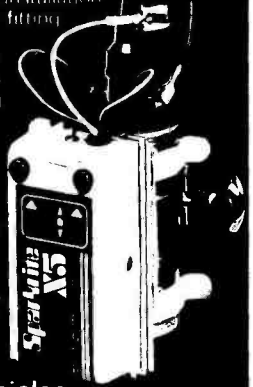

Fits all 12v negative-earth vehicles with coil/distributor ignition up to 8 cylinders.

THE KIT COMPRISE EVERYTHING NEEDED

Die pressed case. Ready drilled, aluminium extruded base and heat sink, coil mounting clips and accessories. All kit components are guaranteed for a period of 2 years from date of purchase. Fully illustrated assembly and installation instructions are included.



Roger Clark the world famous rally driver says "Sparkrite electronic ignition systems are the best you can buy."

Sparkrite

HIGH PERFORMANCE
ELECTRONIC IGNITION

Electronics Design Associates, Dept. ETI/1
2 Bath Street, Walsall, WS1 3DE
Phone: (0922) 614791

Name.....
Address.....

Phone your order with Access or Barclaycard

Inc. V.A.T. and P.P.

QUANTITY REQ'D.

I enclose cheque/PO's for

X5KIT £16.95

£

Cheque No.

ACCESS OR BARCLAY CARD No.

Send SAE if brochure only required.

MITRAD

The premier mail order house
specialising in quality products and
superior after-sales care.

SEIKO QUARTZ LCD MEMORY-BANK CALENDAR WATCH

SPECIAL PRICE **ONLY £29.95**
plus 85p p&p. Usually £89 or over.

- Displays hour, minute, second, month, day of the week and date in 12 hour indication – or 24 hour at the touch of a button.
- Button touch also displays month and year and dates for a designated month with Sunday dates flashing.
- Stores dates in memory up to 11 ahead, flashes 'MEMO' on designated dates.
- Illuminated time and calendar display.
- Display flashes when battery nears life end.
- Stainless steel case and wrist strap (adjustable).

In presentation case with instructions.

A LIFETIME WATCH AT A BARGAIN-OF-A- LIFETIME PRICE

Full refund if not
completely satisfied.



Mitrad, 68-70 High Street,
Kettering, Northants.
Tel: 0536 522024

This is a representative selection from
the collection of guaranteed leading
make and own brand watches offered
through Mitrad's 7 day distribution
system and backed by Mitrad's own
service organisation.
For complete product range, ring
or write for catalogue.
Trade price list available for
bulk orders.

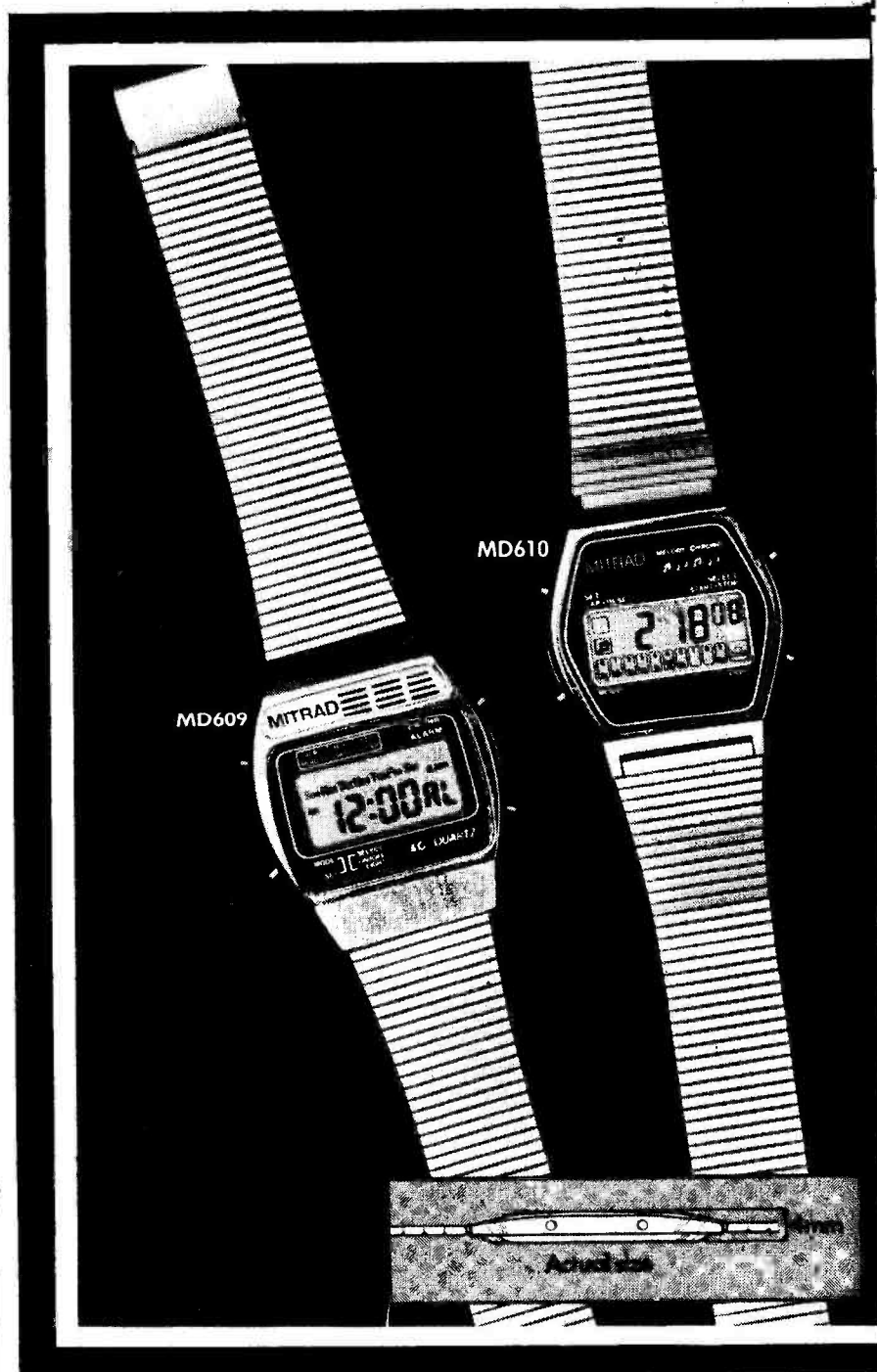

To Mitrad, 68-70 High Street, Kettering, Northants.
Please send me:

- | | |
|---|--|
| <input type="checkbox"/> MD609 watch(es) at £11.80 inc p&p | <input type="checkbox"/> MD606 watch(es) at £10.80 inc p&p |
| <input type="checkbox"/> MD610 watch(es) at £17.80 inc p&p | <input type="checkbox"/> MD607 watch(es) at £10.80 inc p&p |
| <input type="checkbox"/> Seiko Quartz watch(es) at £30.80 inc p&p | <input type="checkbox"/> MD608 watch(es) at £16.35 inc p&p |
| <input type="checkbox"/> MD605 watch(es) at £12.80 inc p&p | |



Total value of my order £ _____

I enclose cheque/PO or debit my Access/Barclaycard No. _____

Name _____ Signature _____

Address _____ (block letters please)

☎ Credit Card holders may telephone (0536) 522024 24 hours a day stating Card Number for immediate attention. All orders
despatched within seven days, subject to availability. Full refund if not completely satisfied.
Mitrad Registered in England No. 2554356.

ETI 1 / 81

ETI JANUARY 1981



MD609 Gentleman's **super slim** flag date alarm. Only 4mm case thickness. Continuous display of hours, minutes, seconds and day; optional display of date, month, year. 24 hour alarm, alarm mode indication. Back light. Infinitely adjustable stainless steel strap. Very latest technology.
£10.95 + 85p p&p

MD610 Gentleman's dual time melody alarm chrono. Only 5mm case thickness. Continuous display of hours, minutes, seconds plus date and mode indications. 'Running horse' chrono to 1/10 sec, 12 hour alarm plays 30 seconds of 'Yellow Rose of Texas'. Infinitely adjustable stainless steel strap.
£16.95 + 85p p&p

MD605 Ladies musical alarm chrono. Continuous display of hours, minutes, seconds; optional display of day, date, month. Auto calendar. Chronograph with lap timing facilities, to 1/10 sec. 24 hour alarm plays 30 seconds of Beethoven's 'Fur Elise'. Back light. Infinitely adjustable stainless steel strap.
£11.95 + 85p p&p

MD606 Ladies five function fashion LCD watch with 3 year battery. Continuous display of hours and minutes, with month/date and date/seconds available. Auto calendar. Only 6mm case thickness. Back light. Infinitely adjustable stainless steel strap.
£9.95 + 85p p&p

MD607 Ladies slim 'sugar coated' dress watch. Continuous display of hours and minutes; optional display of month and date. Auto calendar. Back light. Integral watch and strap. In gold or silver finish.
£9.95 + 85p p&p

MD608 Gentleman's musical alarm chrono. Continuous display of hours, minutes, seconds, plus day indication. Also month and date. Chronograph with lap timing facilities, to 1/10 sec. 24 hour alarm plays 30 seconds of Beethoven's 'Fur Elise' or can be set to awaken to a single note. Back light. Infinitely adjustable stainless steel strap.
£15.50 + 85p p&p

UNIVERSAL TIMER

Our two-range (1-10 and 10-100 min) timer has excellent stability and produces a 30 S pulsed alarm sound at the end of each timing period.

The unit is mains powered, can switch 15 A mains loads and can give either make or break timing operation.

Design by

Ray Marston.

**Project development by
Steve Ramsahadeo.**

Most analogue (pot controlled) long-period timers published in hobby magazines use a 555 one-shot IC and a large electrolytic capacitor as their main timing elements. Unfortunately, conventional electrolytic capacitors have very wide tolerances (typically -50% to +100%) and suffer from relatively large and unpredictable leakage currents. Consequently, these simple circuits cannot be relied upon to give accurate or repeatable timing periods or to give periods significantly exceeding 15 minutes or so.

Our ETI Universal Timer gets away from the conventional design approach, with its inherent disadvantages, by using an astable clock generator and a divide-by-8192 CMOS counter as its main timing elements, the astable period being controlled by a pot and a highly stable polyester capacitor. Consequently, our timer has excellent accuracy and stability and can fully span the 1 min to 100 mins timing range in two switch-selected decade ranges.

Our timer has a few other unusual features. It is mains powered and has a relay-switched mains output lead that can be used to feed power to external loads (heaters, lamps, etc); the relay can switch mains currents of up to 15 A and a mode switch enables the timer to give either make or break timing operations of the external loads.

Timing operations are initiated by a push-button start switch and a pulsed-tone alarm sounds for 30 S to give an audible warning on the completion of each timing cycle. The unit has a variety of practical uses in the home, workshop, darkroom, etc.

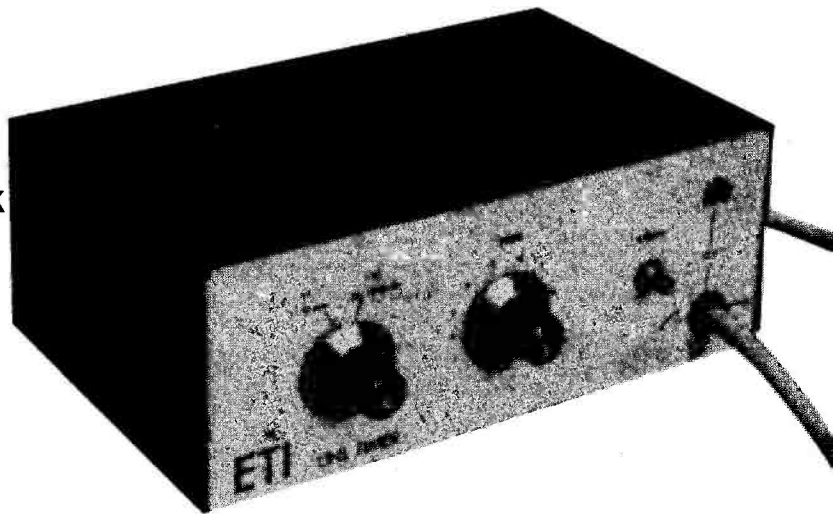

Construction

Most of the circuitry (with the exception of T1, the relay, the switches and pot) is mounted on a single PCB, the construction of which should present few problems. Note that IC1-3 (CMOS types) should be mounted in suitable sockets and voltage regulator IC4 needs to be fitted with a small heat-sink.

When construction is complete, fit the PCB in a suitable case, together with the mains transformer and the heavy-duty relay (which MUST be fitted in the specified socket) and proceed with the interwiring. Take special care over the interwiring of the relay contacts and SW2 and the mains connections. Finally, drill a small hole (roughly 4 mm) in the top of the case, bond the PB-2720 acoustic transducer below it and connect it to the rest of the circuitry.

Testing

When the unit is complete, give it a functional test as follows. First, connect the unit to the mains and check that its neon indicator illuminates when SW2 is set to TIMED BREAK position and turns off when SW2 is set to TIMED MAKE. Now set RV1 to its minimum position, set SW1 to the '1-10 min' range and firmly operate PB1. Check that the neon immediately changes state, indicating that the relay has turned on and

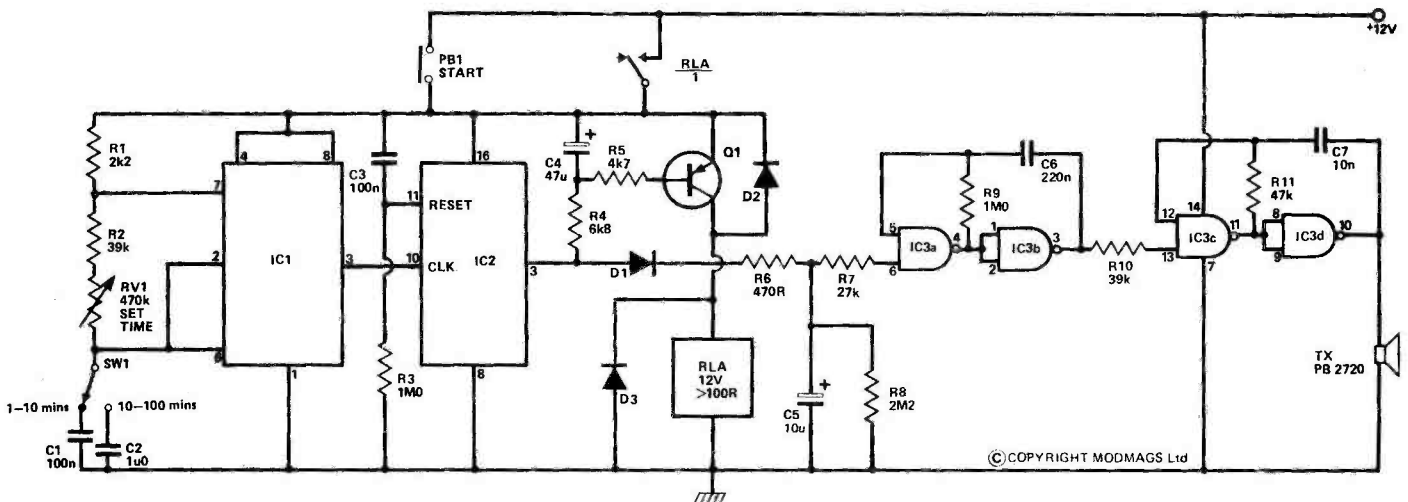
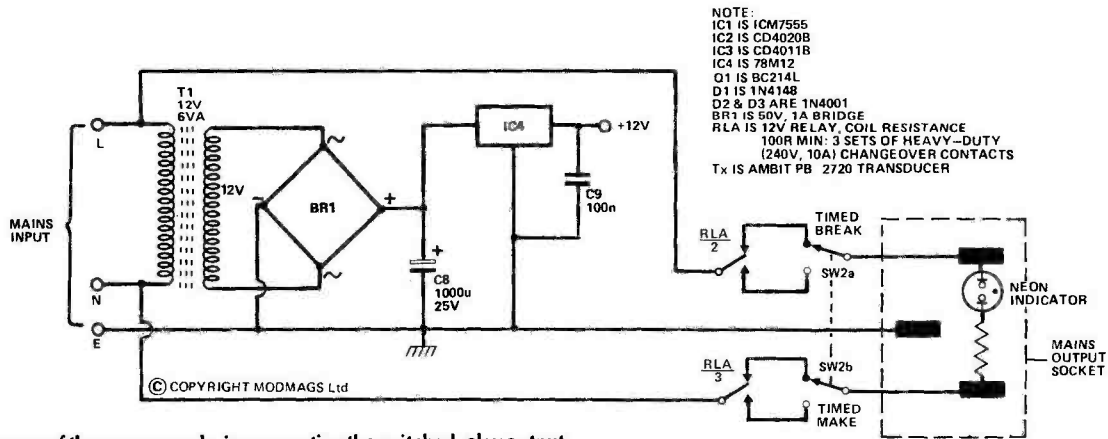

Fig.1 Circuit diagram.



NOTE:
 IC1 IS ICM7555
 IC2 IS CD4020B
 IC3 IS CD4011B
 IC4 IS 78M12
 Q1 IS BC214L
 D1 IS 1N4148
 D2 & D3 ARE 1N4001
 BR1 IS 60V, 1A BRIDGE
 RLA IS 12V RELAY, COIL RESISTANCE
 100R MIN; 3 SETS OF HEAVY-DUTY
 (240V, 10A) CHANGE-OVER CONTACTS
 TX IS AMBIT PB-2720 TRANSDUCER

Fig.2 Circuit diagram of the power supply, incorporating the switched relay output.

the timing period has begun; also check that the relay turns off again at the end of the timing period (roughly one minute) and that the acoustic alarm operates and generates a pulsed-tone signal for roughly 30 S when the timing period is complete.

BUYLINES

Most of the components used are readily available from suppliers advertising in this issue. In case of difficulty, Watford Electronics can supply the relay specified.

HOW IT WORKS

The circuit comprises four main blocks, these being an astable clock generator (IC1), a multi-stage binary divider (IC2), a relay driver (Q1) and a gated alarm-call generator (IC3), all powered from a 12 V regulated line provided by IC4.

The clock generator is designed around IC1, a CMOS version of the 555 timer. The chip is wired in the astable mode and generates clock signals with periods variable over the 7.3 mS to 732 mS range via RV1 and SW1. The output of IC1 is used to clock the multi-stage CMOS binary counter designed around IC2, which is effectively wired in the 'divide-by-8192' mode; the output (pin 3) of this counter is normally low but goes high on the arrival of the 8192nd clock pulse.

The output of IC2 is used to drive relay RLA on via Q1 and to gate on the alarm-call generator (IC3) via the D1-R6-C5-R8-R7 network. This generator comprises a fast astable (IC3c-IC3d) and a slow astable (IC3a-IC3b). The slow astable is gated on by a momentary high output from IC2 and then gates the fast astable on and off at a rate of about 2 Hz.

The alarm-call generator part of the circuit is permanently connected to the 12 V supply lines, but the IC1-IC2-Q1 parts of the circuit are only connected to the supply rails when PB1 or relay contacts RLA/1 are closed. The complete circuit functions as follows.

Timing operations are initiated by momentarily closing PB1, thereby connecting the supply to the IC1-IC2-Q1 circuitry. As PB1 is closed, a reset pulse is fed to pin 11 of IC2 via C3 and causes the counter's registers to set to zero, driving the output of IC2 low. As IC2's output goes low it drives Q1 and the relay on via R4-R5, thereby causing contacts RLA/1 to close and maintain the supply to the circuitry once PB1 is released.

As soon as PB1 is closed, IC1 starts to oscillate and generate clock pulses, which are then counted by IC2. On the arrival of the 8192nd clock pulse the output of IC2 switches high, turning Q1 and the relay off and causing contacts RLA/1 to open and break the supply connections to IC1-IC2-Q1. The timing sequence is then complete.

C4 imposes a slight turn-off delay on Q1, so that the output of IC2 remains high for 100 ms or so before the relay turns off. This brief high period is sufficient for the IC2 output to fully charge C5 via D1 and R6, thereby activating the IC3 alarm-call generator, which produces an audible pulsed-tone signal in the PB-2720 transducer. Once the relay has turned off, the charge on C5 slowly leaks away via R8 until, after about 30 S, insufficient charge remains to gate IC3a on, at which point the alarm-call generator turns off. The entire operating sequence is then complete.

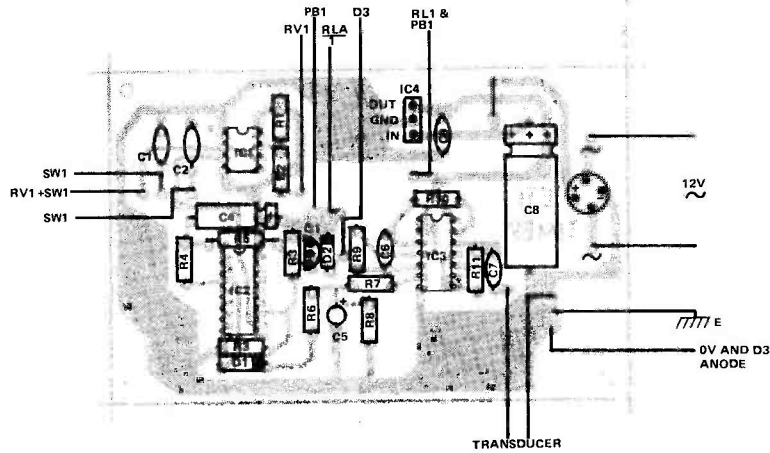

Fig.3 Component overlay.

PARTS LIST

Resistors all 1/4 W 5%

R1	2k2
R2,10	39k
R3,9	1M0
R4	6k8
R5	4k7
R6	470R
R7	27k
R8	2M2
R11	47k

Potentiometer

RV1 470k Linear

Capacitors

C1,3,9	100n polycarbonate
C2	1u0 polycarbonate
C4	47u 25 V axial electrolytic
C5	10u 63 V electrolytic PCB type
C6	220n polycarbonate
C7	10n polycarbonate
C8	1000u 25 V axial electrolytic

Semiconductors

IC1	ICM7555
IC2	CD4020B
IC3	CD4011B
IC4	78M12 or 7812
Q1	BC214L
BR1	50 V, 1 A bridge rectifier
D1	1N4148
D2,3	1N4001

Miscellaneous

SW1	1 pole rotary switch
SW2	DPDT toggle 15 A 240 V
PB1	momentary push button
Tx1	transducer PB 2720
RLA	12 V coil resistance > 100R. 3 pole changeover, contacts rated at 240 V, 10 A and 11 pin relay base 15 A rated (see Buylines).
T1	12 V, 6 VA

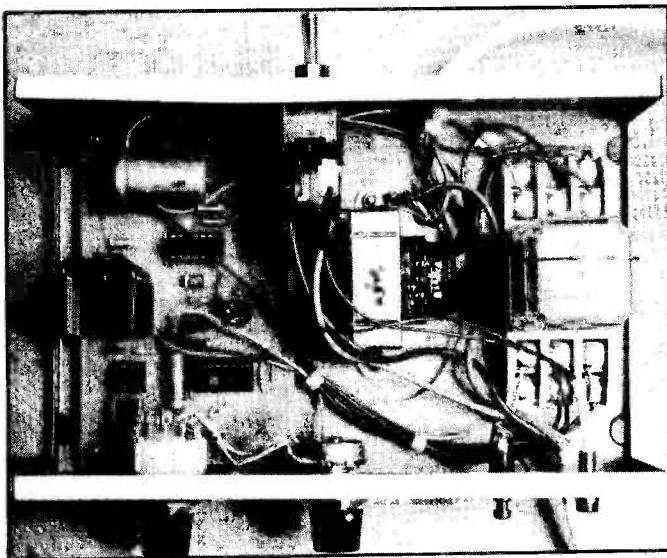

Construction is fairly straightforward. IC4 needs a small heatsink and CMOS ICs 1-3 should be mounted in sockets.

Calibration

Once the unit is functioning correctly, you can proceed with the scale calibration. The obvious (and very time consuming) way to do this is to check the timing periods obtained by varying RV1 against a stop watch, by trial and error, until suitable RV1 calibration points are found.

Alternatively

If you have access to a reasonably accurate 'scope, a far easier way to calibrate the timing scale is to directly measure the period of the IC1 clock waveform, noting that a period of 7.32 mS corresponds to a timing period of precisely one minute. Thus, 1 min = 7.32 mS, 5 mins = 36.6 mS, 10 mins = 73.2 mS, etc.

The upper timing range of SW1 is approximately a decade up on the lower range, so a single calibration scale can serve for both ranges. The tracking accuracy of the two ranges depends on the relative accuracies of C1 and C2 and will typically be within 10% if good polyester components are used. If you want precise tracking, you can achieve it by replacing C2 with a 820nF polyester capacitor and then padding its value up by trial and error, until precise coincidence of the '5 min' and '50 min' points is obtained on the two range scales. **ETI**

THREE FOR FREE FROM CSC



Electronics by Numbers
Projects No 7, No 8, No 9

Available from selected stockists ELECTRONICS BY NUMBERS

No. 7 DIGITAL DICE

Roll the dice — the electronic way! The digital dice gives you an instant score randomly chosen from 1 to 6, every time you press the button. No losing this under the table!

No. 8 QUIZ MASTER

Play your own 'Sale of the Century'! Up to four contestants pit their wits, the first one to get the answer lights up his 'win' light, and stops anybody else from having a go.

No. 9 MOVING TARGET GAME

Test your reactions! A moving 'line of light' travels along from left to right, over and over again. You've got to 'fire' at just the right moment to score a hit. Fun for all the family!

Want to get started on building exciting projects, but don't know how? Now using EXPERIMENTOR BREADBOARDS and following the instructions in our FREE 'Electronics By Numbers' leaflets, ANYBODY can build electronic projects. For example, take one of our earlier projects, a L.E.D. Bar Graph;

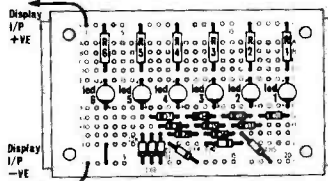

You will need: One EXP 300 or EXP 350 breadboard, 15 silicon diodes, 6 resistors, 6 Light Emitting Diodes.

Just look at the diagram, Select R1, plug it into the lettered and numbered holes on the EXPERIMENTOR BREADBOARD, do the same with all the other components, connect to the battery, and your project's finished. All you have to do is follow the large, clear layouts on the 'Electronics by Numbers' leaflets, and ANYBODY can build a perfect working project.

For full detailed instructions and layouts of Projects, 7, 8 and 9, simply take the coupon to your nearest CSC stockist, or send direct to us, and you will receive the latest 'ELECTRONICS BY NUMBERS' leaflet.

If you missed projects, 1, 2 and 3, or 4, 5 and 6, please tick the appropriate box in the coupon.

PROTO-BOARDS

The ultimate in breadboards for the minimum of cost. Two easily assembled kits.



PB6 Kit, 630 contacts, four 5-way binding posts accepts up to six 14-pin Dips.

PROTO-BOARD 6 KIT £9.20

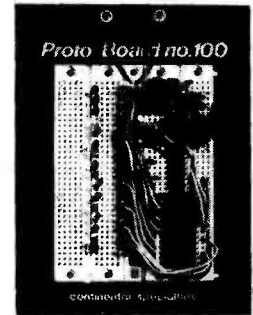

PB 100 Kit complete with 760 contacts accepts up to ten 14-pin Dips, with two binding posts and sturdy base. Large capacity with Kit economy.

PROTO-BOARD 100 KIT £11.80

EXPERIMENTOR BREADBOARDS

No soldering modular breadboards, simply plug components in and out of letter number identified nickel-silver contact holes. Start small and simply snap-lock boards together to build a breadboard of any size.

All EXP Breadboards have two bus-bars as an integral part of the board, if you need more than 2 buses simply snap on 4 more bus-bars with the aid of an EXP 4B.

EXP 325 £1.60 The ideal breadboard for 1 chip circuits. Accepts 8, 14, 16 and up to 22 pin ICs. Has 130 contact points including two 10 point bus-bars.



EXP 350 £3.15 Specially designed for working with up to 40 pin ICs perfect for 3 & 14 pin ICs. Has 270 contact points including two 20 point bus-bars.



EXP 300 £5.75 The most widely bought bread-board in the UK. With 550 contact points, two 40 point bus-bars, the EXP 300 will accept any size IC and up to 6 x 14 pin DIPS. Use this breadboard with Adventures in Microelectronics.



EXP 600 £6.30 Most MICROPROCESSOR projects in magazines and educational books are built on the EXP 600



EXP 650 £3.60 Has .6" centre spacing so is perfect for MICROPROCESSOR applications.



EXP 4B £2.30 Four more bus-bars in "snap-on" unit.



The above prices are exclusive of P&P and 15% VAT.

THE CSC 24 HOUR SERVICE TELEPHONE (0799) 21682

With your Access, American Express, Barclaycard number and your order will be in the post immediately

CONTINENTAL SPECIALTIES CORPORATION



C.S.C. (UK) LTD Dept. 9PP
Unit 1, Shire Hill Industrial Estate,
Saffron Walden, Essex CB11 3AQ.
Tel: Saffron Walden (0799) 21682 Telex: 817477

IT'S EASY WITH C.S.C. TO RECEIVE YOUR FREE COPY OF PROJECTS 7, 8 and 9

Just clip the coupon

Give us your name and full postal address (in block capitals). Enclose cheque, postal order or credit card number and expiry date, indicating in the appropriate box(es) the breadboard(s) you require.

For immediate action

The C.S.C. 24 hour, 5 day a week service. Telephone 0799 21682 and give us your Access, American Express or Barclaycard number and your order will be in the post immediately

EXPERIMENTOR BREADBOARDS	CONTACT	IC CAPACITY 14 PIN DIP	UNIT PRICE INC P&P & 15% VAT	Qty req
EXP 325	130	1	£ 2.70	
EXP 350	270	3	£ 4.48	
EXP 300	550	6	£ 7.76	
EXP 600			£ 8.39	
EXP 650	270	use with 0.6 pitch Dip's Strip Bus Bar	£ 5.00	
EXP 4B	Four 40 Point Bus-Bars		£ 3.60	

PROTO-BOARDS	CONTACT	IC CAPACITY 14 PIN DIP	UNIT PRICE INC P&P & 15% VAT	Qty req
PB6	630	6	£11.73	
PB100	760	10	£14.72	

C.S.C. (UK) Limited, Dept. 9PP, Unit 1, Shire Hill Industrial Estate, Saffron Walden, Essex CB11 3AQ.

Tel: Saffron Walden (0799) 21682 Telex: 817477

NAME

ADDRESS

I enclose cheque/P.O. for £.....

Debit my Barclaycard, Access,

American Express card No.

Expiry date

If you missed project No's

1, 2, 3, 4, 5, and 6, tick box.

For Free catalogue tick box



COMPUTER WAREHOUSE

NOW OPEN
MONDAY-SATURDAY
9.30-5.30

In stock now test equipment, microprocessors, teletypes, transformers, power supplies, scopes, sig. gen's, motors, peripheral equipment, I.C.'s, tools, components, variacs, keyboards, transistors, microswitches, V.D.U.'s sub-assemblies + thousands of other stock lines. Just a mere fraction of our vast range, is displayed below: 100's of bargains for callers.

2716 EPROM 5v Rail . £10.25
2716 EPROM 3 Rail ... £8.50
2708 EPROM £4.95

4116 16k x 1 200ns .. 8 for £27.50
2114L-31k x 4 300ns .. 8 for £22.50
2102L-31k x 1 650ns ... 8 for £5.50

TELETYPE ASR33 I/O TERMINALS

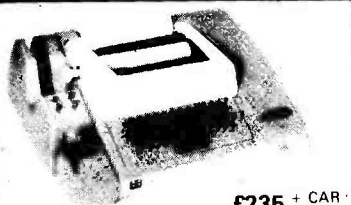

£235 + CAR + VAT

Fully fledged industry standard ASR33 data terminal. Many features including: ASCII keyboard and printer for data I/O, auto data detect circuitry, RS232 serial interface, 110 baud, 8 bit paper tape punch and reader for off line data preparation and ridiculously cheap and reliable data storage. Supplied in good condition and in working order. Options: Floor stand £12.50 + VAT
Sound proof enclosure £25.00 + VAT

ICL TERMIPRINTER 300 BAUD TERMINALS



£325 + CAR + VAT

Made under licence from the world famous GE Co. The ICL Termiprinter is a small attractive unit with so many features it is impossible to list them in the space available! Brief spec. as follows; RS232 serial interface, switchable baud rates 110, 150, 300, (30 cps), upper and lower case correspondence type face, standard paper, almost silent running, form feed, electronic tab settings, suited for word processor applications plus many more features. Supplied in good condition and in working order. Limited quantity.

SCOOP PURCHASE 9" VIDEO MONITORS



ONLY £57.50 + VAT

Made by the famous MOTOROLA CO. The 9" video monitor type XM226-16 is a self contained unit featuring a quoted bandwidth of 10Hz to 10MHz with 800 lines resolution at the screen centre. The printed circuit board and power transistors are both plug-in for ease of servicing. All controls are easily accessible from the rear. By connection of any 75Ω composite video signal and 12v D.C. you have a professional monitor to do any MPU/CCTV system proud!
Supplied BRAND NEW complete with circuits at only **£57.50 + VAT**
Specialist carriage and insurance £7.50 + VAT.

EX STOCK SOFTY

SOFTWARE DEVELOPMENT SYSTEM, INVALUABLE TOOL FOR DESIGNERS, HOBBYISTS ETC.
Enables "open heart surgery" on 2708, 2716, etc. Blows, Copies, Reads EPROMs or emulates EPROM/ROM IN-SITU whilst displaying contents off ROM/RAM on a domestic TV receiver. A host of other features.
Write or phone for more details.

£115 + VAT & CARR
PSU £20 + VAT

You'll never regret buying a SOFTY!

EQUIPMENT CASES

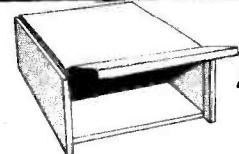

GIVE YOUR M.P.U. A HOME ONLY £9.95 + 18p pp

Superb professional fully enclosed, made for the G.P.O. to the highest standard, offered at a fraction of their original cost they feature aluminium sides, hinged removable front panel, which can be secured by 2 screws to prevent prying fingers. All are finished in two tone G.P.O. grey and although believed brand new may have minor scuff marks/scratches due to bad storage. Dimensions 16" D x 6 1/2" H x 14 3/4" W

MAKE YOUR COMPUTER TALK!!!

VIA OUR EX-GPO MODEM UNITS

Well, not exactly talk, but communicate over a standard dial-up G.P.O. line with any other modem. The modem unit 2A is housed in an attractive fibre glass case measuring only 15" w x 13" d x 5" h, inside are the electronics and mains power supply which enable serial duplex data communication between terminal/computer etc. at any speed up to and in excess of 250 baud (300 at a push). Made to the most stringent, exacting specification for the G.P.O. These units feature Modular plug in P.C.B.'s, internal test points, Standard tone frequencies, Configurable to terminal or computer end, Auto unattended answer, RS232/V24 interface on standard 25 way 'D' socket, etc. etc., supplied complete with diags., at a fraction of their original cost at only **£55.00 + £4.50 CARR.**

NOTE: Units believed working, but untested, unguaranteed. Permission may be required for connection to G.P.O. lines.

SEMICONDUCTOR 'GRAB BAGS'

Amazing value mixed semiconductors, include transistors, digital, linear I.C.'s, triacs, diodes, bridge recs. etc. etc. All devices guaranteed brand new, full spec. with manufacturers markings, fully guaranteed.
50 + BAG £2.95 100 + BAGS £5.15

MUFFIN FANS

Keep your equipment Cool and Reliable with our tested ex-equipment "Muffin Fans" almost silent running and easily mounted. Available in two voltages. 110 V.A.C. £5.05 + pp 90p OR 240v A.C. £6.15 + pp 90p. DIMENSIONS 4 1/2" x 4 1/2" x 1 1/2"

ELECTRONIC COMPONENTS & EQUIPMENT

66% DISCOUNT

Due to our massive bulk purchasing programme which enables us to bring you the best possible bargains, we have thousands of I.C.'s, Transistors, Relays, Cap's., P.C.B.'s, Sub-assemblies, Switches, etc. etc. surplus to our requirements. Because we don't have sufficient stocks of any one item to include in our ads., we are packing all these items into the "BARGAIN PARCEL OF A LIFETIME" Thousands of components at giveaway prices! Guaranteed to be worth at least 3 times what you pay plus we always include something from our ads. for unbeatable value!! Sold by weight

2.5kls £ 4.75 + pp £1.25 **5kls £ 6.75 + pp £1.80**
10kls £11.75 + pp £2.25 **20kls £19.99 + pp £4.75**

LED DIGITAL ALARM CLOCK MODULE

★ 12 HOUR ★ 50/60 HZ ★ LARGE DISPLAY ★ 100's OF USES

The same module, NATIONAL MA1012, used in most alarm clock/radios on the market today, the only difference is our price! GIANT 1" LED characters give extremely clear viewing and readability. All electronics are self-contained on a P.C.B. measuring only 3" x 1 1/2". By addition of a few switches and 5/16 volts A.C. you have a multi-function alarm clock at a mere fraction of cost. Dozens of functions include snooze timer, am-pm, alarm set, power fail indicators, flashing seconds cursor, modulated alarm output, dimmer control, etc. etc. Supplied brand new with full data at only **£5.25**



suitable transformer for mains operation £1.75

Save Over £1200!!

Logabax DZM180 High Speed Matrix Printers

This must be one of our greatest bulk saving deals this year. This fabulous printer is listed at over £1800 and judging by the quality workmanship we are not surprised. The Logabax DZM180 Matrix printer, capable of printing up to 132 characters per line on any size (via variable tractor unit) sprocket fed fanfold paper. A precision matrix head utilising ruby bearings gives exceptionally clear uniform legible characters via standard ribbon. Many other features include internal buffer, for high throughput, in excess of 180 characters per second, software controllable form and tab functions, standard TTL parallel interface, etc. etc.

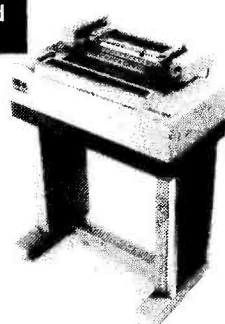

£599.00 plus VAT*

Optional extras
Floor stand (as picture) £30.00 plus VAT Paper handler £18.00 plus VAT
*Carriage - please enquire for specific quote.

THE "MULTIVOLT" MULTI RAIL P.S.U.

This has got to be the power supply to end all your M.P.U./LAB supply requirements. Recently made by the famous "WIER" Co Ltd to the highest professional specifications. With an original cost of over £200 the supply features every possible form of protection, full regulation, over voltage and current limit and just look at these outputs; it may have been made to your specifications!
+ 5V at 12 Amps + 30V at 2 Amps + 5V at 4.5 Amps
+ 5V at 4 Amps + 12V at 2.5 Amps + 12V at 2.5 Amps
+ 9V at 1 Amp

you agree! then order now whilst stocks last.
Supplied BRAND NEW at only **£59.99** CARR & INSUR. £6.75 complete with diagrams.

KEYBOARDS

★ LOW PRICE CHASSIS ★



A special bulk purchase enables us to offer the above keyboard at a lowest ever price 49 coded keys encoded into a direct TTL compatible 7 bit output. Features such as delayed strobe, 5 volt D.C. single rail operation and rollover protection make this an absolute must for the MPU constructor! Supplied complete with connection diagram and edge connector, at a secondhand

"no time to test" price of only **£20.00 + P.P. £1.60**

SUPER CASED VERSION Same as above spec. but housed in attractive two tone moulded, free standing case. Unit also includes an all TTL parallel to serial converter (no details) etc.

£27.50 + P.P. £1.85

TOROIDAL TRANSFORMERS

PR 240v pri. sec. 150 15 @ 2 amps dimensions 3" x 2 1/2" £4.95 + pp 95p
TM 240v/110v pri. sec. 45 0 15 Bva dimensions 2 1/2" x 1" £1.95 + pp 30p
All voltages measured off load.

Plugs, Sockets & Connectors Cannon 'D' Range

Ways	Plug	Socket
9	£1.03	£1.26
15	£1.17	£2.01
25	£1.72	£2.58
37	£2.35	£4.14
50	£2.90	£5.46

25 way ex-equip. plug or socket £1.25

Edge connectors, gold plated

0.1" DS	40 way	£2.45
0.1" DS	85 way	£3.99
0.15" DS	56 way	£3.25
0.156DS	36 way	£2.00

All connectors easily cut to size
1000's of other connectors ex stock

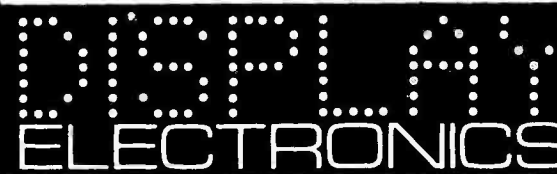

Dept. E.T.I. 64-66 Melfort Rd., Thornton Heath, Croydon, Surrey. Tel: 01-689 7702 or 01-689 6800

MAIL ORDER INFORMATION

Unless otherwise stated all prices inclusive of V.A.T. Cash with order. Minimum order value £2.00. Prices and Postage quoted for UK only. Where post and packing not indicated please add 50p per order. Bona Fida account orders minimum £10.00. Export and trade enquiries welcome. Orders despatched same day where possible. Access and Barclaycard Visa welcome.

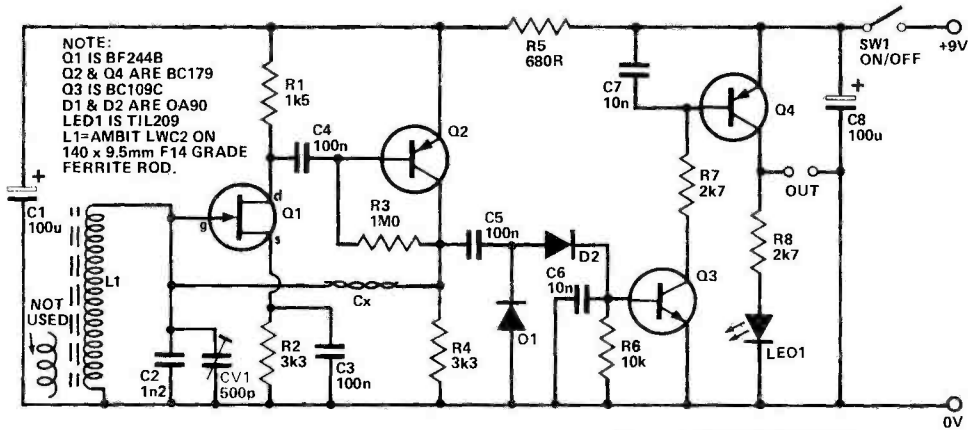

© COPYRIGHT MOOMAGS Ltd

60 kHz Time Receiver

This receiver gives reception of the atomic clock time signals transmitted by the Rugby MSF transmitter on 60 kHz. At this very low radio frequency it is not necessary to use a superhet. A ferrite aerial is used with L1, an ordinary LW broadcast band aerial coil, and the relatively high tuning capacitance of C2 and C3 is used to reduce the resonant frequency to the appropriate figure. The receiver is tuned by CV1 and by adjusting the position of L1 on the ferrite rod.

The output of L1 is direct-coupled to a straightforward common source JFET stage and this in turn feeds a simple common emitter stage. Due to the relatively low frequency involved these can both provide good voltage gain without using tuned circuit loads. The collector

of Q2 is in-phase with the gate of Q1 and if necessary, "twisted pair" Cx can be used to provide regeneration between these two points to boost the sensitivity of the set.

The output from Q2's collector is coupled by C5 to a simple diode modulator circuit which consists of D1, D2, C6 and R6. When the 60 kHz carrier is present a strong DC bias is produced across R6, but this potential quickly decays during the gaps in the carrier (the 1 S markers and other signals are modulated onto the carrier wave in the form of brief pauses in the signal).

Thus Q3 is switched on when the carrier is present, so that Q4 is in turn switched on, giving a high output and causing LED 1 to light up. In the absence of the carrier wave Q3, Q4 and LED 1 all switch off and the output of the receiver goes low.

When initially adjusting the set it is helpful to monitor the output of the detector using a crystal earpiece connected across R6.

Conquer the chip.

Be it a career, hobby or interest, like it or not the Silicon Chip will revolutionise every human activity over the next ten years.

Knowledge of its operation and its use is vital. Knowledge you can attain, through us, in simple, easy to understand stages.

Learn the technology of the future today in your own home.

MASTER ELECTRONICS

LEARN THE PRACTICAL WAY BY SEEING AND DOING

- Building an oscilloscope. ● Recognition of components.
- Understanding circuit diagrams. ● Handling all types Solid State 'Chips'.
- Carry out over 40 experiments on basic circuits and on digital electronics.
- Testing and servicing of Radio, T.V., Hi-Fi and all types of modern computerised equipment.

MASTER COMPUTERS

LEARN HOW TO REALLY UNDERSTAND COMPUTERS, HOW THEY WORK - THEIR 'LANGUAGE' AND HOW TO DO PROGRAMS.

- Complete Home Study library. ● Special educational Mini-Computer supplied ready for use. ● Self Test program exercise.
- Services of skilled tutor available.

MASTER THE REST

- Radio Amateurs Licence. ● Logic/Digital techniques.
- Examination courses (City & Guilds etc.) in electronics.
- Semi-conductor technology.
- Kits for Signal Generators - Digital Meters etc.



FREE	Please send your FREE brochure to this address only	I am interested in:
	Name	PRACTICAL ELECTRONICS
	Address	COMPUTER TECHNOLOGY
	OTHER SUBJECTS (please state your interest)
BLOCK CAPITALS PLEASE		
BRITISH NATIONAL RADIO & ELECTRONICS SCHOOL		
4 CLEVELAND ROAD, JERSEY, CHANNEL ISLANDS. ETI/1/813		

SPECIAL PURCHASE



OF TOP QUALITY LCD MULTIMETERS

AC/DC
CURRENT
22
RANGES

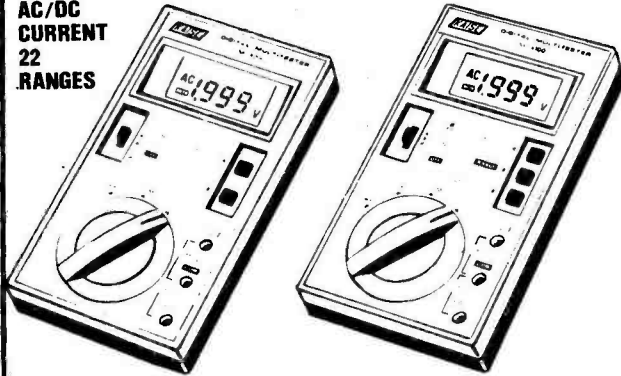

6100

6200

CHOOSE FROM FOUR MODELS

- ★ 3½ digit autoranging (volts / ohms)
- ★ 200 hours battery life (2 pencils)
- ★ 10 amp AC/DC (6220 & 6110) ★ 1000v DC 600v AC
- ★ 200mA AC/DC (6200 & 6100)
- ★ Range hold facility (6100 & 6110)
- ★ Unit and range sign (6110 & 6220)
- ★ Continuity buzzer (6100 & 6110)

RESOLUTION

100 µVDC, 1 mVAC
10 µA AC/DC 0.1 Ωm
10 mA on 10A, AC/DC

OTHER FEATURES (ALL MODELS)

Low power Ohms Range
Zero Adjust key
Battery Warning
In circuit resistance test
Size 155 x 85 x 28mm, 250g.

ACCURACY

6100/6110
0.5% DC Volts
1% DC Current
1.2% AC Current
0.5% Resistance

6200/6220
0.8% DC Volts
1.3% DC Current
1.4% AC Current
0.8% Resistance

6200 **£39.95**

6220 **£49.95**

6100 **£59.95**

6110 **£74.95**

- ★ All prices include batteries / leads and UK Vat (UK c/p 65p)
- ★ Order by Post or Telephone with Barclay or Access

OR CALL IN AND SEE FOR YOURSELF

Prices correct at 1.12.80 E&OE

Cubegate Limited OPEN 9-6 SIX DAYS A WEEK

AUDIO ELECTRONICS

301 EDGWARE ROAD, LONDON, W2 1BN

TELEPHONE 01 724 3564



FREE CATALOGUE!

Send large SAE (17½p UK) Schools, Companies, etc. free on request.

Ref. ETI

From Mr / Mrs / Miss
(Block capitals please)

Address

Please supply Qty.

Models

I/We enclose (incl. 65p post)

Cheq./PO value

Or debit Barclay/Access No.

BUILD YOUR OWN METAL DETECTOR VLF/TR VCO/TR IB/TR BFO . . .

Pre-aligned search heads — test equipment not required. Literature available in return for SAE. Manuals and parts sold separately: write or phone for price. Export welcome: write for quote.



Shadow VLF/TR. Full specification discriminator, not just ferrous/nonferrous indication. It works by measuring the conductivity of the target; now you can reject nails bottle caps even aluminium foil and ring pull tabs! Full ground effect exclusion over normal or high permeability soils.
The head is thermally and capacitively shielded.
4 modes: deepseeking VLF plus 3 TR discriminating ranges.
Push button "memory" tuning. Performance equals commercial detectors costing £200! As described in ETI.
Complete kit now only **£87.87 inc. VAT & post!**

Shadow TR/IB

Individual parts: Search head **£21.33** PCB **£6.80** Case **£5.33** Adjustable shaft Assy. **£5.10** LM393 **£1.12** Manual (gives more info. than ETI article — and extra function) **£1.12**. All inc. VAT & post! (Other parts also available separately)

Shadow TR/IB (illustrated). A true transmit receive/induction balance detector at a budget price for anyone who doesn't need discrimination. Waterproof and thermally insulated search head. Good sensitivity. Built-in speaker and headset jack. Complete kit **£33.80 inc. VAT and Post.**

Shadow TR/VCO. An advanced version of the TR/IB. Use as a sensitive IB machine or switch to VCO mode when the sound changes to a varying pitch, allowing easier use over mineralised ground and enabling detection of negative, high permeability anomalies. Kit price **£36.87 inc. VAT and Post.**

Matching stereo headphones for all Shadow models **£5.85 inc. VAT and Post.**

Shell Kit. Consists of the (hard to find) hardware items, for detectors of your own design. Fully adjustable shaft with handle, search head mouldings (int. diam. 185mm) with hinge assembly, special clips to mount your own control housing (any box is suitable). Completely non-metallic and undrilled. With assembly instructions **£14.48 inc. VAT and Post.**

ALTEK

(ETI), 1 Green Lane
Walton-on-Thames Surrey

Order by post or phone (24 hours). Access & Visa Cards quote number. Callers by appointment only please. Phone (093 22) 44110 anytime!

ELECTRONIC IGNITION SAVES PETROL

More and more new cars use electronic ignition to give the best performance and economy. Bring YOUR CAR up to top specification by fitting the latest TOTAL ENERGY DISCHARGE electronic system.

TOTAL ENERGY DISCHARGE gives all the advantages of the best capacitive discharge ignitions;

- ★ **Peak Performance**—higher output voltage.
- ★ **Improved Economy**—consistent high ignition performance.
- ★ **Better Starting**—full spark power even with low battery.
- ★ **Accurate Timing**—prevents contact wear without 'contactless' errors.
- ★ **Smooth Performance**—immune to contact bounce effects.

PLUS

- ★ **SUPER HIGH POWER SPARK**—3½ times the energy of ordinary C.D. systems.
- ★ **OPTIMUM SPARK DURATION**—to get the very best performance and economy with today's lean carburettor settings.
- ★ **DESIGNED IN RELIABILITY**—with the 'ultimate insurance' of a changeover switch to revert instantly to standard ignition.

TECHNICAL DETAILS

HIGH EFFICIENCY INVERTER. A high-power, high efficiency, regulated inverter provides a 400-volt energy source—powerful enough to store twice the energy of other designs and regulated to provide full output even with the battery down to 4 volts.

SUPERB DISCHARGE CIRCUIT. A brand new technique prevents energy being reflected back to the storage capacitor, giving 3½ times the spark energy and 3 times the spark duration of ordinary C.D. systems, generating a spark powerful enough to cause rapid ignition of even the weakest fuel mixtures without the ignition delay associated with lower power 'long burn' inductive systems. In addition this circuit maintains the correct output polarity, thereby preventing unnecessary stress on the H.T. system.

SOPHISTICATED TRIGGER CIRCUIT. This circuit removes all unwanted signals caused by contact volt drop, contact shuffle, contact bounce, and external transients which, in many designs, can cause timing errors or damaging un-timed sparks. Only at the correct and precise contact opening is a spark produced. Contact wear is almost eliminated by reducing the contact breaker current to a low level — just sufficient to keep the contacts clean.

IN MONEY-SAVING KIT FORM at £14.85 inc. V.A.T. and P. & P.

All you need is a small soldering iron and a few basic tools — everything else is supplied with easy-to-follow instructions.

FITS ALL 6/12-volt NEGATIVE EARTH cars

ELECTRONIZE DESIGN

2 Hillside Road, Four Oaks
Sutton Coldfield, West Midlands, B74 4DQ
Phone 021-308 5877

I/O INTERFACE

Computers share a common failing with man (and woman) — they use a variety of different languages and dialects. This design by Clive Cartledge lets the CompuColor II talk to a whole new family of computers.

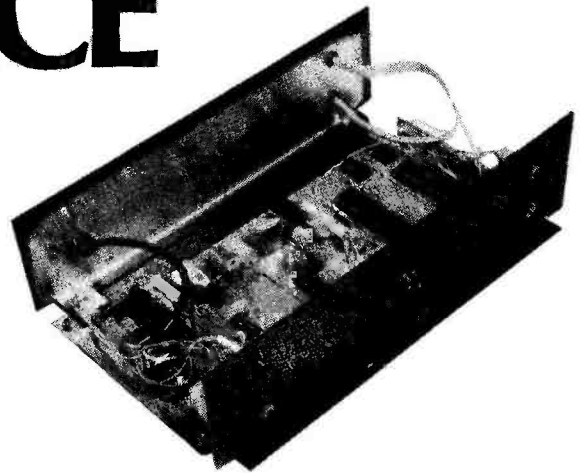

The interface described here was originally built to allow a CompuColor II microcomputer to be connected to any one of four "mainframes" at North Staffordshire Polytechnic. The mainframes in question were a GEC 4082, an HP 2000E, an ICL 2960 and an ICL 2904; both of the latter machines being front ended by 7502 processors. After construction, however, it became obvious that the device had a much wider appeal and could be used in a variety of applications where bit length and parity changes were necessary.

This device was required to overcome the problem that the CompuColor II transmits and receives eight bit characters from its RS232 port, whereas the mainframes mentioned above all transmit and receive seven bits with an even parity bit added.

The UART is an LSI sub-system which accepts binary characters from either a terminal or a computer and transmits/receives this character with appended control and error detecting bits. All characters contain a start bit, five to eight data bits, one or two stop bits and either an even/odd or a no parity bit. This is all hard wire selectable on the UART together with an operating speed of up to 30 kbaud.

The UART Receiver

The UART requires a clock signal 16 times the designed baud rate. Initialisation is performed by applying a reset pulse to pin 21. This sets the Data Available flag, pin 19, to a logic 0. Reception of data starts when the serial input signal changes from a marking state (logic 1) to a spacing stage (logic 0). This condition constitutes a start bit and it is valid if the serial input line continues to be at logic 0, when centre sampled, eight clock pulses later. If this is not the case, however, and the serial line has returned to logic 1 when sampled, the start bit verification process will be reset. After a genuine start bit has been received and verified by the process above, data bits, parity bit if used and stop bits are received.

On receiving parity and stop bits, the receiver will compare the transmitted parity and stop bits with the 'expected' pattern and indicate any errors by changing the parity error flip-flop and/or the framing error flip-flop to a logic 1.

When a full character has been received, internal logic examines the 'Data Available' line to see if data has been read out. If the line is at a logic 1, the receiver will assume that data has not been read out and the over-run flip-flop will be set to logic 1, indicating an over-run error. If 'Data Available' is set to logic 0, the receiver will assume that data has been read out.

After the Data Available line goes to logic 1, indicating a character has been received, the receiver shift register is ready to accept the next character and has one full character time to remove the first character received.

The Transmitter

The same clock signal may be used for the transmitter as for the receiver. The external reset pulse is also common. When this is applied the 'Transmitter Buffer Empty', End of Character and the Serial Output lines of the device are driven to logic 1. Data occurring on the Data Input lines, pins 26-33, is strobed into the device by a pulse on pin 23, the Data Strobe. Once this has occurred, the Transmitter Buffer Empty (TBMT) flag goes to a logic 0, indicating that a character is being transmitted and the device is unable to accept further characters until this flag returns again to logic 1. The device is double buffered and so when the TBMT flag returns to logic 1, one full character time is available for loading the next character without any loss in transmission speed.

Data transmission is initiated with the transmission of a start bit, data bits, parity bit if required and stop bits. When the last stop bit has been on the line for one bit time, the End of Character flag will go to a logic 1 indicating that a new character is ready for transmission.

Control bits

The number of bits per character (five through eight) together with a parity bit (odd, even or none) and one or two stop bits can be selected by strapping appropriate pins on the UART to logic 1 or logic 0. These selections apply to both the receiver section and transmitter of the chip.

Code Converter

One particular problem encountered when using this interface was that most of the logging-in data received from the mainframes was in lower case ASCII code. While most terminal devices would simply display this as upper case, the CompuColor II treats lower case code as graphics display information. This difficulty is overcome by the NAND gate code converter (IC10). The circuit's logical function simply drops bit six when bit seven is set to a logic 1, effectively converting lower case code to upper case before it emerges from the interface.

A second problem was encountered when using the device with the HP 2000 Basic system. This was the need for a break key. Break not being a valid ASCII character, it cannot be implemented through the UART. This is easily cured by fitting a push button switch on to the computer side of the interface as shown. →

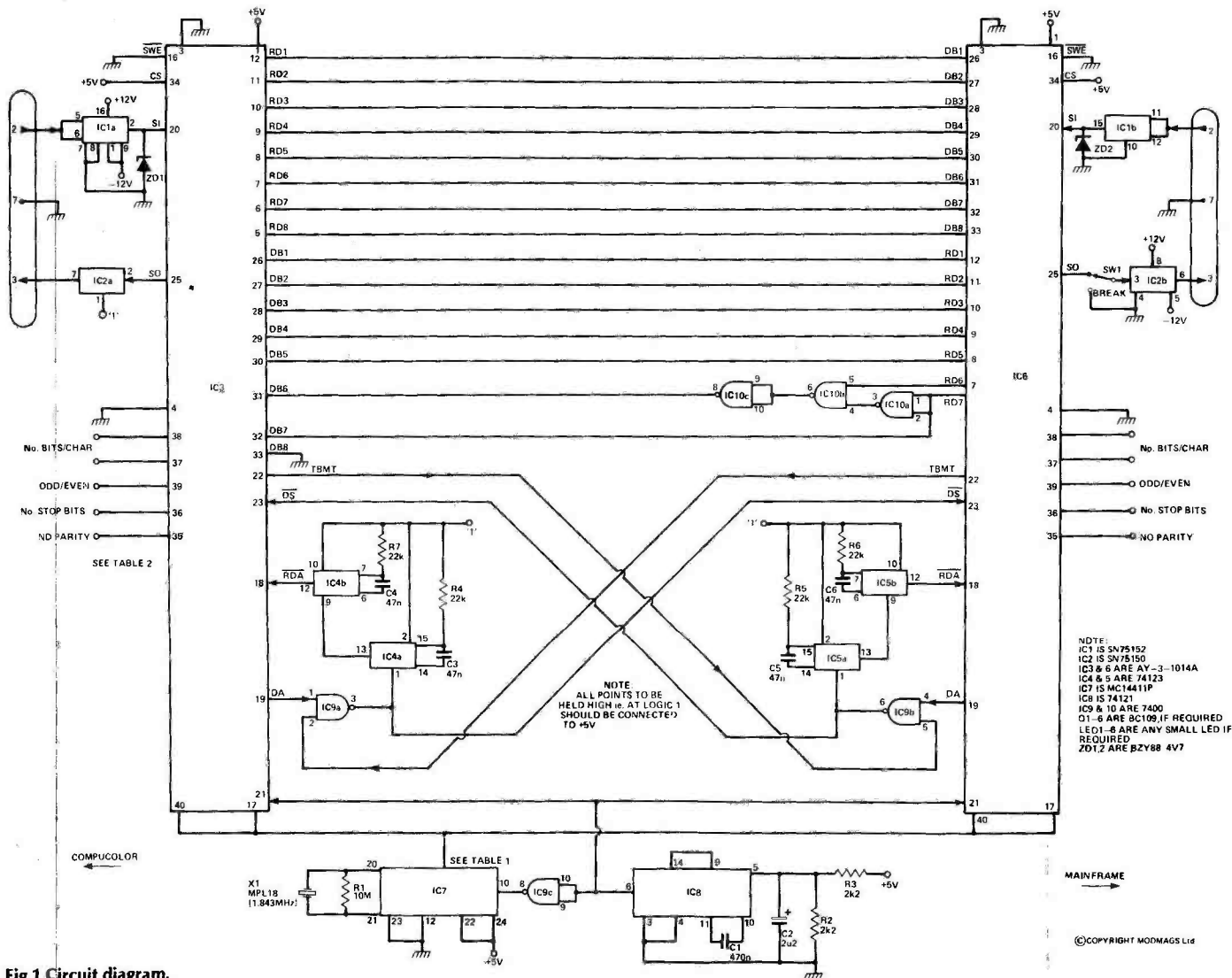

Fig.1 Circuit diagram.

HOW IT WORKS

On switching on the power, the monostable multivibrator IC8 gives a 100 μ s positive-going pulse at its 'Q' output, pin 6. This is applied to both UARTs at their reset inputs, pins 21. This pulse is also inverted by the NAND gate IC9b and used to reset the baud rate generator chip IC7 at pin 10. The clock signal is applied to both UARTs at pins 40 and 17 at 16 times the baud rate required. Referring now to Fig. 2, the pulse timing diagram, it will be seen that at T_0 pin 2 of IC9a is at logic 1 (derived from the Transmitter Buffer Empty flag of IC6). Assuming reception of a character by UART IC3, pin 1 of IC9a will go to logic 1 when data becomes available on the reception of a complete character. This is shown on Fig. 2 at T_1 . The output of the NAND gate, pin 3 of IC9a will, therefore, go to logic 0.

This negative-going pulse is used to strobe the received character into the transmit buffer of the second UART at pin 23 (Data Strobe) and to trigger monostable multivibrator IC4a whose output, pin 9, will go to a logic 1. NAND gate IC9 pin 2 is now returned to logic 0 as the Transmitter Buffer Empty flag of UART IC6 will be driven to logic 0, having been 'filled' with a character. The time delay shown on the diagram is due to chip propagation which proves ample in the design shown. After a timing delay in the first monostable set by timing components C3 and R4, pin 9 on IC4b goes to logic 0 (T_2 on the timing diagram). Pin 12 on IC4 follows it and this signal is used to reset the Data Available flag on UART IC3. At this stage, once the Transmitter Buffer Empty line of UART IC6 has returned to logic 1, the circuits are back in their original states and ready to accept the next character.

This description also applies to characters flowing through the interface in the opposite direction. IC1 and IC2 are both dual level converter chips which convert RS232 levels (usually ± 12 V) to TTL levels of 0 V and 5 V.

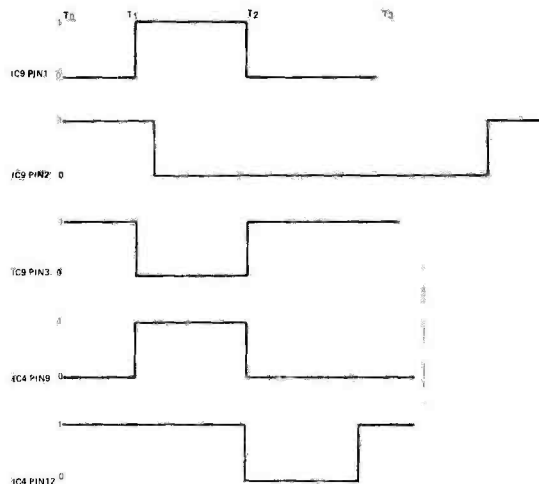

Fig.2 Pulse timing diagram.

BUYLINES

Most of the components required can be ordered from suppliers advertising in this issue. In case of difficulty, advertisers specialising in computer hardware may be of assistance.

The variable regulator (RC4149D) is a Radiospares component — RS No. 306-011.

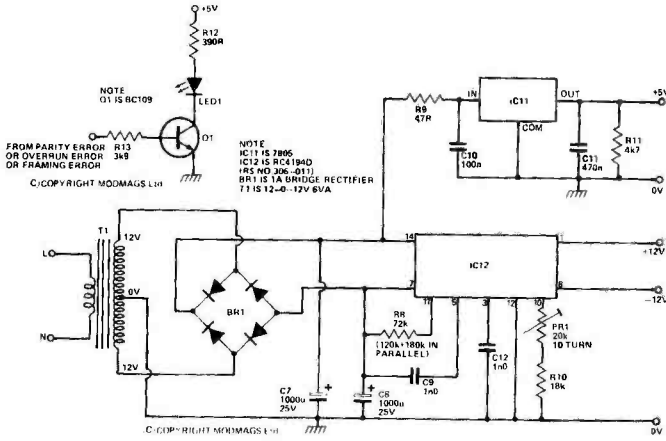

Fig.3 Circuit diagram of the power supply and LED indicators if required.

PARTS LIST

Resistors all 1/4 W 5% unless otherwise stated

- R1 10M
- R2, 3 2k2
- R4, 5, 6, 7 22k
- R8 72k (120k + 180k in parallel)
- R9 47R 2 W
- R10 18k
- R11 4k7
- R12 390R (six if required)
- R13 3k9 (six if required)

Potentiometer

- PR1 20k 10-turn preset

Capacitors

- C1, 11 470n polyester
- C2 2u2 35 V tantalum
- C3, 4, 5, 6 47n ceramic
- C7, 8 1000u 25 V axial electrolytic
- C9, 12 1n0 ceramic
- C10 100n ceramic

Semiconductors

- IC1 75152
- IC2 75150
- IC3, 6 AY-3-1014A
- IC4, 5 74123
- IC7 MC14411P
- IC8 74121
- IC9, 10 7400
- IC11 7805
- IC12 RC4194D
- Q1 BC109 (six if required)
- ZD1, 2 BZY88 4V7
- BR1 1 A bridge rectifier
- LED1 0.2" LED (six if required)

Miscellaneous

- XTAL MPL18 (1.843 MHz), 12-0-12 6 VA transformer, Veroboard, SW1 SPCO pushbutton, SW2 DPDT toggle, case.

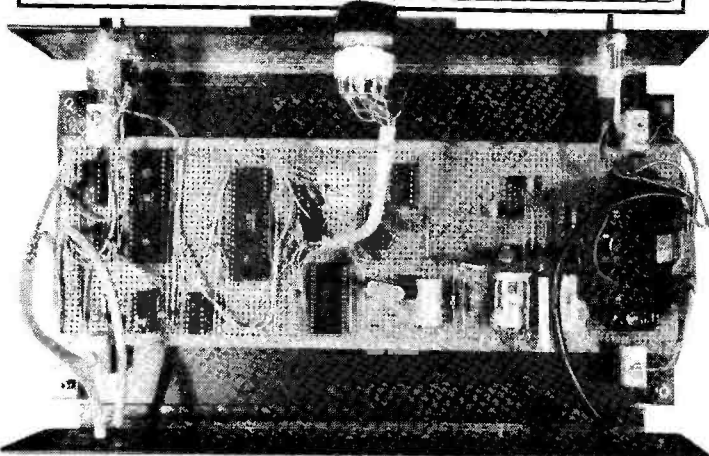

The method of construction is not critical. The author's board is shown above.

Pin No.	Function	User Baud Rate
1	F1	9600
2	F3	4800
3	F5	2400
4	F7	1200
5	F8	600
6	F10	200
7	F9	300
8	F11	150
9	F14	75
10	Reset	
11	NC	
12	Ground	
13	F13	109.9
14	F12	134.5
15	F6	1800
16	F4	3600
17	F2	7200
18	F15	921.6 kHz
19	F16	1.843 MHz
20	Crystal	
21	Crystal	
22	rate select	
23	rate select	
24	+5 V	

Table 1

MC14411P pin connections and clock speeds

Pins	Logic 0	Logic 1
35	Parity	No parity
39	Odd parity	Even parity
36	One stop bit	Two stop bits

Character Lengths

Character Lengths	Pin 37	Pin 38
5 bits	Logic 0	Logic 0
5 bits	Logic 0	Logic 1
7 bits	Logic 1	Logic 0
8 bits	Logic 1	Logic 1

Table 2.

UART control connections (IC3,6).

1	Vcc Power Supply (+5 V)	
2	NC	
3	Ground	
4	Received Data Enable	RDE
5-12	Received Data Bits	(RD8-RD1)
13	Parity Error	(PE)
14	Framing Error	(FE)
15	Over run	(OR)
16	Status Word Enable	SWE
17	Receiver Clock	(RCP)
18	Reset Data Available	RDAV
19	Data Available	(DAV)
20	Serial Input	(SI)
21	External Reset	(XR)
22	Transmitter Buffer Empty	(TBMT)
23	Data Strobe	DS
24	End Of Character	(EOC)
25	Serial Output	(SO)
26-33	Data Bit inputs	(DB1-DB8)
34	Control Strobe	(CS)
35	No Parity	(NP)
36	Number of stop bits	(TSB)
37-38	Number of bits per character	
39	Odd/Even parity select	
40	Transmitter Clock	(TCP)

Table 3.

AY-3-1014A pin connections.

CHROMASONIC electronics

48 JUNCTION ROAD, ARCHWAY, LONDON N19 5RD — 50 yards from Archway Station & 9 Bus Routes
 TELEPHONE: 01-263 9493/01-263 9495

YOUR SOUNDEST CONNECTION IN THE WORLD OF COMPONENTS AND COMPUTERS

PETS & SYSTEMS

8N 8K RAM — £399
16N 16K RAM — £499
32N 32K RAM £599
CASSETTE DECK — £55

343K Twin Floppy Disk
£695

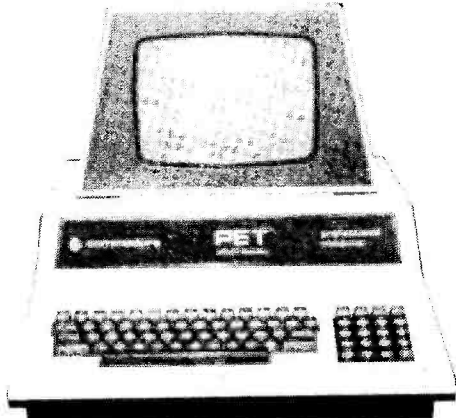

COMPLETE 32K SYSTEM £1789

NEW 32K with 80 col Screen
 Twin Disk Drive 950K

£825
£895

**All with new keyboard
 and green screen**

FRICTION FEED PRINTER
£376
Tractor Feed Printer
£426

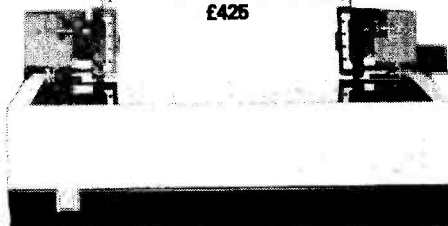

MEMORY EXPANSION KIT

Suitable for UK101, Super-board expansion using 2114's each board has 16K ram capacity kit contains:

- ★ On board power supply
- ★ 4K Eprom expansion
- ★ Fully buffered for easy expansion via 40 pin socket
- ★ 8K kit **£89.95**
- ★ 16K kit **£122.95**
- ★ Printed Circuit Board **£29.95**
- ★ 40 pin-40 pin header plug **£8.50**

NEW SHOP

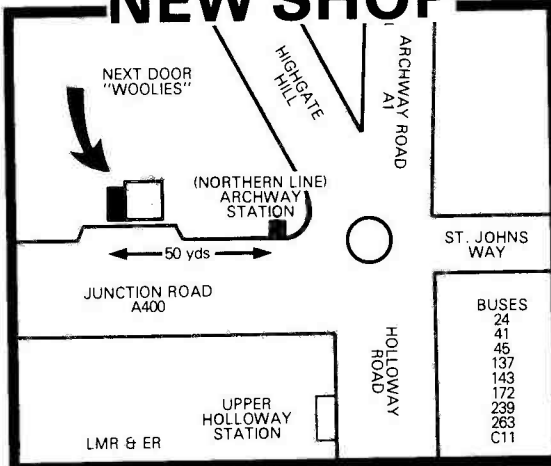

VIDEO GENIE

VIDEO GENIE based on TRS80



Utilises Z80, 12k level II Basic, Integral Cassette Deck, UHF O/P 16k RAM, all TRS80 features

£289

CASES

Available for UK101, Superboard, Nascom. Appx. DIM 17" x 15" 435 x 384 mm

PRICE £24.50
 Post & Packing £1.50

UK101 P.P.I

Built & tested. Interfaces TX80 Printer direct. Can be programmed to operate relays, motors, various other peripherals "CENTRONICS COMPATABLE" Plugs into IC socket. LED binary display fully documented.

£29.95

U K 1 0 1

£179 IN KIT FORM
£229 READY BUILT & TESTED
£255 COMPLETE IN CASE

4K Expansion (8x2114)
NOW ONLY £18.00

- No extras required
- ★ Free sampler tape
 - ★ Full Qwerty keyboard
 - ★ 8K basic
 - ★ Ram expandable to 8K on on board (4K inc)
 - ★ Kansas City tape interface
 - ★ NEW MONITOR ALLOWS FULL EDITING & CURSOR CONTROL **£22.00**



PRINTERS

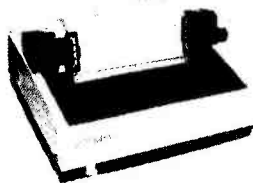

EPSON TX-80
£349

Dot-matrix printer with Pet graphics interface: Centronics parallel and serial: Pet and Apple compatible.



Please add VAT 15% to all prices. Postage on computers, printers and cassette decks charged at cost, all other items P&P 30p. Place your order using your Access or Barclaycard (Min. tel order £5). Trade and export enquiries welcome. credit facilities arranged.



NEW SHOP & SHOWROOM NOW OPEN

Telephone: 01-263 9493/01-263 9495

UK101 SOUND

Sound Generator and combined parallel in out port kit, containing P.C.B., AY-3-8910, 6820 PIA. Fully documented and demo tape. £29.95. AY-3-8910 £8.50.

UK101 SOFTWARE

	£
Space Invaders	6.50
Real Time Clock	5.00
Chequers	3.00
Othello	4.00
Game Pack I	5.00
Game Pack II	5.00
Game Pack III	5.00
Screen Monitor	4.00
Assembler Editor	14.90
10x12 Blank Tapes	4.00

CPUs

Z80 2.5Meg	7.95
Z80A 4Meg	9.95
6502	6.95
6800	6.50
8080	4.75
9900	25.95

SUPPORT CHIPS

Z80 CTC	5.95
Z80A CTC	6.95
Z80 P10	5.95
Z80A P10	6.95
6520	3.95
6522	6.85
6532	8.50
6821	4.25
6850	3.60
6852	4.35
8212	1.95
8216	1.95
9224	2.75
8228	
8251	4.95
8253	£9.75
8255	4.50
TMS9901	13.16
TMS9902	11.18
TMS9904 (74LS362)	4.21

I.C. SOCKETS

	D.I.L.	W/W
8 pin	.09	.25
14 pin	.11	.35
16 pin	.12	.42
18 pin	.16	.50
20 pin	.20	.62
22 pin	.22	.65
24 pin	.24	.70
28 pin	.30	.80
36 pin	—	.99
40 pin	.40	1.10

MEMORY

D.RAMS	£ p
4027	2.75
4050 (350NS)	2.35
4060 (300NS)	2.39
4116	3.95

S.RAMS	
2102A	1.30
2102A2	1.69
2112A	2.75
2114/4045	2.75
4035	1.07
4044-5257	6.93
6810	3.50

BULK PURCHASE	
8x2114	18.00
8x4116	27.50
16x2114	34.00

EPROMs

2708	4.25
2716 (5v)	6.95
2532	29.95

ROM

2513 (UC)	5.95
-----------	------

BUFFERS

81LS95	1.25
81LS96	1.25
81LS97	1.25
81LS98	1.25
SN74365	.52
SN74366	.52
SN74367	.52
SN74368	.52
8T26	1.50
8T28	1.50
8T95	1.50
8T96	£1.50
8T97	1.50
8T98	1.50

BAUD RATE GENS

MC14411	8.75
MM5307	8.75

UARTS

AY-5-1013	3.95
AY-3-1015	4.75
MM5303	4.75
TMS6011	3.55

SEND S.A.E. FOR COMPLETE PRICE LIST OR PHONE 01-263 9493

If you're into
MICROPROCESSORS
then they should be into an
MP UroBreadBoard

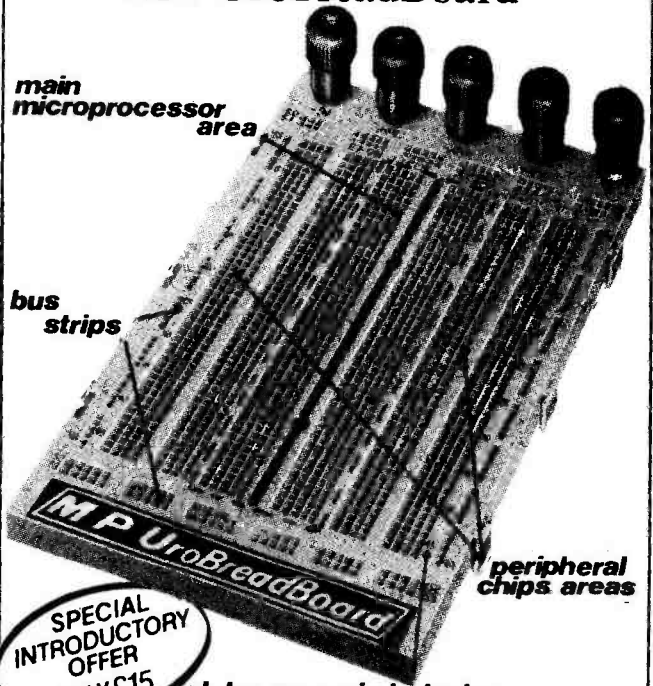

SPECIAL
INTRODUCTORY
OFFER
ONLY £15

alpha numeric indexing

- * MPU Section accepts 24, 28, 40 & 64 pin DIL microprocessors
- * Auxiliary Areas accept any .3" or .6" RAM, ROM or peripheral chip
- * Power Bus Strips on all sides
- * 5 incoming turret Power Terminals
- * Component Support Bracket included
- * Over 1400 contact points
- * Alpha-Numeric column and row indexing
- * Eurocard size (160mm x 100mm)
- * Slots onto all BIMBOARDS
- * Non-Slip rubber backing
- * Ideal for schools and colleges
- * Long life, <10m.ohms, nickel silver contacts

The PROFESSIONALS breadboard
that BEGINNERS can start on

BOSS INDUSTRIAL MOULDINGS LTD

2 Herne Hill Rd, London SE24 0AU, England
Telephone 01-737 2383 Telex 919693
Cables & Telegrams: LITZEN LONDON SE24

Please send me MPUroBreadBoard(s) at the special, limited period, introductory offer price of £15.00. This price includes VAT & PP, is applicable from Sept 1 1980 but please add 15% for Overseas Orders, make cheques/P.O. payable to BOSS Industrial Mouldings Ltd and allow 10 days for order processing and cheque clearance etc.

I enclose a cheque/P.O. to the value of £.....

Name
Company
Address
.....
Telephone Number

ETI 1/81

BI-PAK

SEMICONDUCTORS SEND YOUR ORDERS TO
DEPT. ET11, PO BOX 6, WARE, HERTS.
VISIT OUR SHOP AT: 3 BALDOCK ST., WARE, HERTS.
TEL 0920 3182. TELEX: 817861

EXPERIMENTOR BREADBOARDS

FROM **CSC**

No soldering breadboards. Simply plug components in and out of letter number identified. Nickel-silver contact holes. Start small and simply snap-lock boards together to build a breadboard of any size. All EXP Breadboards have two bus-bars as an integral part of the board. If you need more than two buses, simply snap on 4 more bus-bars with the aid of an EXP 4B.

- EXP 325 The ideal breadboard for 1 chip circuits. Accepts 8, 14, 16 and up to 22-pin IC's. **ONLY £1.84**
48mm (1.9")
 - EXP 350 270 contact points with two 20-point bus-bars. **ONLY £3.62**
91mm (3.6")
 - EXP 300 550 contacts with two 40-point bus-bars. **ONLY £6.61**
152mm (6.0")
 - EXP 650 For Micro-processors. **ONLY £4.14**
91mm (3.6")
 - EXP 4B More bus-bars. **ONLY £2.65**
152mm (6.0")
 - EXP 600 As EXP 300 but accepts 24 pin DIL and over. **ONLY £7.25**
152mm (6.0")
- All EXP 300 Breadboards mix and match with 600 series.

ANTEX IRONS

- 1943 15 watt quality soldering iron with 3/32" bit **£4.88**
- 1947 Replacement element for 1943 **£2.18**
- 1944 Iron coated bit 3/32" for 1943 **£0.53**
- 1945 Iron coated bit 1/8" for 1943 **£0.53**
- 1946 Iron coated bit 3/16" for 1943 **£0.53**
- 1948 18 watt iron with iron coated bit **£4.59**
- 1952 Replacement element for 1948 **£2.18**
- 1949 Iron coated bit 3/32" for 1948 **£0.53**
- 1950 Iron coated bit 1/8" for 1948 **£0.53**
- 1951 Iron coated bit 3/16" for 1948 **£0.53**
- 1931 X25 25 watt iron, ceramic shaft and another shaft of stainless steel to ensure strength **£4.88**
- 1935 Replacement element for 1931 **£1.84**
- 1932 Iron coated bit 1/8" for 1931 **£0.57**
- 1933 Iron coated bit 2/16" for 1931 **£0.57**
- 1934 Iron coated bit 3/32" for 1931 **£0.57**
- 1953 SK 1 soldering Kit - contains 15 watt soldering iron with 3/16" bit plus two spare bits, a reel of solder, heat-sink and a booklet 'How to Solder' **£6.38**
- 1939 ST3 iron stand made from high grade bakelite chrom plated steel spring, suit all models - includes accommodation for six bits and two sponges to keep the iron bits clean **£1.86**
- 1724 Model MLX as X25 iron but 12 volts **£5.29**

CASES AND BOXES

VERO plastic case box. These boxes consist of top and bottom sections which include fixings points for horizontal mounting PC boards/chassis plates, the two sections are held together by four screws which enter through the base and are concealed by plastic feet.

No.	Length	Width	Height	Price
170	140mm	40mm	205mm	£4.35
171	140mm	75mm	205mm	£4.85
172	140mm	110mm	205mm	£6.30

INSTRUMENT CASES in two sections vinyl covered top and sides, aluminium bottom, front and back.

No.	Length	Width	Height	Price
155	8in	5in	2in	£2.01
156	11in	6in	3in	£3.10
157	6in	4in	1 1/2in	£1.93
158	9in	5in	2 1/2in	£2.59

ALUMINIUM BOXES made from bright all, folded construction each box complete with half inch deep lid and screws.

No.	Length	Width	Height	Price
159	5 1/2in	2 1/2in	1 1/2in	£0.98
160	4in	4in	1in	£0.98
161	4in	2 1/2in	1in	£0.98
162	5 1/2in	4in	1 1/2in	£1.10
163	4in	2 1/2in	2in	£0.98
164	3in	2in	1in	£0.67
165	7in	5in	2 1/2in	£1.54
166	8in	6in	3in	£1.98
167	6in	4in	2in	£1.32

SLOPE front aluminium boxes with black vinyl base and sides & aluminium back, top & front - strong construction easily accessible.

169	2 1/2in	5 1/2in	2 1/2in	12in	3in	8in	£5.45
168	2 1/2in	7in	4in	16in	4 1/2in	11in	£8.21

AUDIO MODULES

AMPLIFIERS

AL10	3 watt Audio Amplifier Module 22-32v supply	£3.63
AL20	5 watt Audio Amplifier Module 22-32v supply	£4.73
AL30A	7-10 watt Audio Amplifier Module 22-32v supply	£5.51
AL60	15-25 watt Audio Amplifier Module 30-50v supply	£6.81
AL80	35 watt Audio Amplifier Module 40-60v supply	£10.67
AL120	50 watt Audio Amplifier Module 50-70v supply	£17.38
AL250	125 watt Audio Amplifier Module 50-80v supply	£26.91

STEREO PRE-AMPLIFIERS

PA12	Supply voltage 22-32v input sensitivity 300mv suit. AL10/AL20/AL30	£9.63
PA100	Supply voltage 24-36v inputs - Tape, Tuner, Mag P.U., Suit: AL60/AL80	£20.30
PA200	Supply voltage 35-70v inputs - Tape, Tuner, Mag P.U., Suit: AL80/AL120/AL250	£20.98

MONO PRE-AMPLIFIERS

MM100	Supply voltage 40-65v inputs: Mag, P.U., Tape Microphone Max. output 500mv	£14.29
MM100G	Supply voltage 40-65v inputs: 2 Guitars, Microphones Max. output 500mv	£14.29

POWER SUPPLIES

PS12	24v Supply suit 2 - AL10, 2 - AL20, 2 - AL30 & PA12/25/450	£1.90
SPM80	33v Stabilised supply - suit 2 - AL60, PA100 to 15 watts	£5.57
SPM120/45	45v Stabilised supply - suit 2 - AL60, PA100 to 25 watts	£7.34
SPM120/55	55v Stabilised supply - suit 2 - AL80, PA200	£7.34
SPM120/65	65v Stabilised supply - suit 2 - AL120, PA200, 1 - AL250, PA200	£7.34
SG30	15-0-15 Stabilised power supply for 2 - GE100MKII	£4.37

MISCELLANEOUS

MPA30	Stereo Magnetic Cartridge Pre-Amplifier - input 3.5mv Output 100mv	£3.76
S 450	Stereo FM Tuner Supply Voltage 20-30v - Varicap tuned	£29.39
STEREO30	Complete 7 watt per Channel Stereo Amplifier Board - includes amps, pre-amp, power supply, front panel, knobs etc - requires 2050 Transformer	£24.25
BP124	5 watt 12v max. - Siren Alarm Module	£4.43
GE100MKII	10 channel mono-graphic equaliser complete with sliders and knobs	£26.45
VPS30	Variable regulated stabilised power supply 2-30v 0-2 amps	£8.74

TRANSFORMERS

2034	1.7 amp 35v suit SPM80	£6.21	P&P £1.21
2035	2 amp 55v	£7.30	£1.47
2036	750mA 17v suit PS12	£3.68	
2040	1.5 amp 0-45v-55v suit SPM120/45, SPM120/55v	£5.98	£1.21
2041	2 amp 0-55v-65v suit SPM120/55, SPM120/65v	£7.82	£1.47
2050	1 amp 0-20v suit Stereo 30	£3.74	£0.75
1725	150mA 15-0-15v suit SG30	£2.04	

ACCESSORIES

139	Teak Cabinet suit Stereo 30, 320 - 235 - 81mm	£9.72
140	Teak Cabinet suit STA15 425 - 280 - 95mm	£8.97
FP100	Front Panel for PA100 & PA200	£2.07
BP100	Back Panel for PA100 & PA200	£1.84
GE100FP	Front Panel for one GE100MKII	£2.05
2240	Kit of parts including Teak Cabinet, chassis sockets, knobs to build 15 watt stereo amplifier	£22.94

VEROBOARD

2201	2.5" x 5" x .1 copper	£0.71	2211	2.5" x 3.75" x .15 copper	£0.53
2202	2.5" x 3.75" x .1 copper	£0.61	2212	3.75" x 1.7" x .15 copper	£2.39
2203	2.5" x 1.7" x .1 copper	£2.14	2213	3.75" x 5" x .15 copper	£0.90
2205	3.75" x 3.75" x .1 copper	£0.71	2217	3.75" x 1.7" x .1 Plain	£1.79
2206	3.75" x 1.7" x .1 copper	£2.76	2218	3.75" x 2.5" x .1 Plain	£0.44
2207	4.75" x 1.7" x .1 copper	£3.61	2219	5" x 3.75" x .1 Plain	£0.68
2208	2.5" x 1.5" in pack	£0.85	2223	2.5" x 5" x .15 Plain	£0.37
2204	3.75" x 5" x .1 copper	£0.79	2225	5" x 7.5" x .15 Plain	£0.56
2210	2.5" x 5" x .15 copper	£0.84			

METAL FOIL CAPACITOR PAKS

16204 - Containing 50 metal foil capacitor like Mullard C280 series - Mixed values ranging from 01uf - 2.2uf. Complete with identification sheet **£1.38**

TRIACS

2 amp	T05 case	Price	10 amp		
100	TR12A/100	£0.38	100	TR110A/100	£0.88
200	TR12A/200	£0.89	200	TR110A/200	£1.06
400	TR12A/400	£0.82	400	TR110A/400	£1.29

6 amp	10 amp				
100	TR16A/100	£0.59	400	TR110A/400P	£1.29
200	TR16A/200	£0.75			
400	TR16A/400	£0.88			

DIACS

BR100	£0.23	D32	£0.23
-------	--------------	-----	--------------

SILICON RECTIFIERS

200mA					
IS920 50V	£0.07	3 Amp	IN5400 50V	£0.16	
IS921 100V	£0.08		IN5401 100V	£0.17	
IS922 150V	£0.09		IN5402 200V	£0.18	
IS923 200V	£0.10		IN5404 400V	£0.19	
IS924 300V	£0.11		IN5406 600V	£0.24	
			IN5407 800V	£0.28	
			IN5408 1000V	£0.34	

1 Amp					
IN4001 50V	£0.05	10 Amp	IS10/50 50V	£0.21	
IN4002 100V	£0.05		IS10/100 100V	£0.24	
IN4003 200V	£0.07		IS10/200 200V	£0.26	
IN4004 400V	£0.08		IS10/400 400V	£0.40	
IN4005 600V	£0.09		IS10/600 600V	£0.48	
IN4006 800V	£0.10		IS10/800 800V	£0.58	
IN4007 1000V	£0.11		IS10/1000 1000V	£0.69	
			IS10/1200 1200V	£0.79	

1.5 Amp					
IS020 150V	£0.10	30 Amp	IS30/50 50V	£0.64	
IS021 200V	£0.11		IS30/100 100V	£0.79	
IS022 300V	£0.12		IS30/200 200V	£1.06	
IS023 400V	£0.14		IS30/400 400V	£1.43	
IS025 600V	£0.16		IS30/600 600V	£2.02	
IS027 800V	£0.18		IS30/800 800V	£2.23	
IS029 1000V	£0.23		IS30/1000 1000V	£2.65	
IS031 1200V	£0.28		IS30/1200 1200V	£3.31	

60 Amp					
IS70/50 50V	£0.86		IS70/400 400V	£2.01	
IS70/100 100V	£0.96		IS70/600 600V	£2.56	
IS70/200 200V	£1.38		IS70/800 800V	£2.87	
			IS70/1000 1000V	£3.45	

THYRISTORS

600ma	TO 18 Case	Price	7 amp	TO 48 Case	Price
10 THY600/10		£0.17	50 THY7A/50		£0.55
20 THY600/20		£0.18	100 THY7A/100		£0.59
30 THY600/30		£0.23	200 THY7A/200		£0.65
50 THY600/50		£0.25	400 THY7A/400		£0.71
100 THY600/100		£0.29	600 THY7A/600		£0.90
200 THY600/200		£0.44	800 THY7A/800		£1.06
400 THY600/400		£0.51			

1 amp	TO 86 Case	Price	10 amp	TO 48 Case	Price
50 THY1A/50		£0.30	100 THY10A/50		£0.59
100 THY1A/100		£0.32	100 THY10A/100		£0.66
200 THY1A/200		£0.37	200 THY10A/200		£0.71
400 THY1A/400		£0.44	400 THY10A/400		£1.14
600 THY1A/600		£0.52	600 THY10A/600		£1.40
800 THY1A/800		£0.67			

3 amp	TO 66 Case	Price	16 amp	TO 48 Case	Price
50 THY3A/50		£0.32	50 THY16A/50		£0.62
100 THY3A/100		£0.35	100 THY16A/100		£0.67
200 THY3A/200		£0.38	200 THY16A/200		£0.71
400 THY3A/400		£0.48	400 THY16A/400		£0.89
600 THY3A/600		£0.55	600 THY16A/600		£1.04
800 THY3					

LED TACHO

A unique two-range tacho that gives an analogue RPM display on a bar of 21 LEDs. The display flashes to indicate an alarm condition when the RPM exceed a preset limit. Design by Ray Marston. Project development by Steve Ramsahadeo.

The ET1 Tacho/Alarm is an all solid-state project. It displays engine speed in analogue form (like a conventional tacho) as an illuminated section of a line of 21 LEDs. The length of the illuminated section is proportional to the engine speed, so that half of the scale is illuminated at half of full-scale speed, and so on. In other words, the display is in bar rather than dot form.

The Tacho/Alarm can be used with virtually any type of multi-cylinder petrol engine. It has two speed ranges, each of which can be calibrated by a preset pot to give any full-scale speed range required by the individual owner. Our prototype is calibrated to give full scale readings of 10,000 RPM and 1,000 RPM on a four-cylinder, four-stroke engine. The lower range is of great value when adjusting the engine's ignition and carburation for recommended tick-over speeds. The upper range has adequate resolution (500 RPM per step in our case).

A unique feature of our product is the provision of a visual over-speed alarm facility, which causes the LED display to rapidly flash on and off when the RPM exceed a preset level; the tacho continues to indicate the actual RPM under the alarm condition. Tachos are normally placed directly in front of the driver in sports/racing cars, so this visual alarm system is a highly effective 'attention getter' in such vehicles.

The unit is designed for use only on vehicles fitted with 12 V electrical systems. It can be used with conventional or capacitor-discharge (CD) ignition systems and is wired into the vehicle with three connecting leads. It can be used on vehicles fitted with either negative or positive earth electrical systems.

Construction

The complete unit, including the 21 LED display, is mounted on a single PCB. Take care over the construction, paying special attention to the following points:

(1) Our prototype uses a display comprising a linear row of 21 square LEDs, mounted horizontally on the PCB. You may prefer to use a semicircular display of LEDs, in which case you can mount the display on a separate board of your own design, with suitable connections to our board. In either case confirm the polarity and functioning of each of the 21 LEDs, by connecting in series with a 1k Ω resistor and testing across a 12 V supply, before wiring into place on the PCB. Note that the LED colours can be mixed, if required.

If you use the same display form as our prototype, bend and adjust the LED leads so that each LED slightly overhangs the edge of the PCB when soldered into place.

(2) Seven link connections are made on the PCB. Also note that the external connections to the unit (0 V, +ve and CB) are made via solder terminals (Veropins).

(3) Range-changing is achieved via a three-pole two-way

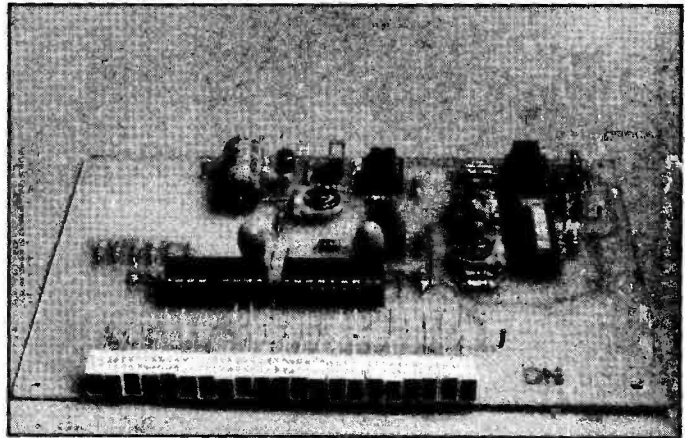

switch. On our prototype we've used a DIL slide switch, mounted directly on the PCB, for this purpose. Some readers may prefer to mount this switch off-board.

(4) Note that the values of C2 and C3 must be chosen to suit the engine type and full-scale RPM ranges required (see the conversion graph). Our prototype, calibrated to read 10,000 RPM and 1,000 RPM on a four-cylinder four-stroke engine, uses C2 and C3 values of 22nF and 220nF respectively.

When the construction is complete, connect the unit to a 12 V supply and check that only LED 1 illuminates. If all LEDs illuminate, suspect a fault in the wiring of IC1.

Calibration

The unit can be calibrated against either a precision tachometer or against an accurate (2% better) audio generator that gives a square wave output of at least 3 V peak-to-peak. The method of calibration against an audio generator is as follows.

Connect the tacho to a 12 V supply and connect the square wave output of the audio generator between the 0 V and CB terminals of the unit. Check against the conversion graph to find the frequency needed to give the required high range full-scale RPM reading on the type of engine in question and feed this frequency into the tacho input. Switch SW1 to its high range (10,000 RPM on our prototype) and adjust PR1 for full-scale reading. Now set the generator to the alarm frequency and adjust PR3 so that the display flashes. Recheck both adjustments.

Now switch SW1 to its low range (1,000 RPM on our prototype), set the required full-scale frequency and adjust PR2 for a full-scale reading on the tacho. Note that the alarm facility is inoperative on this range. →

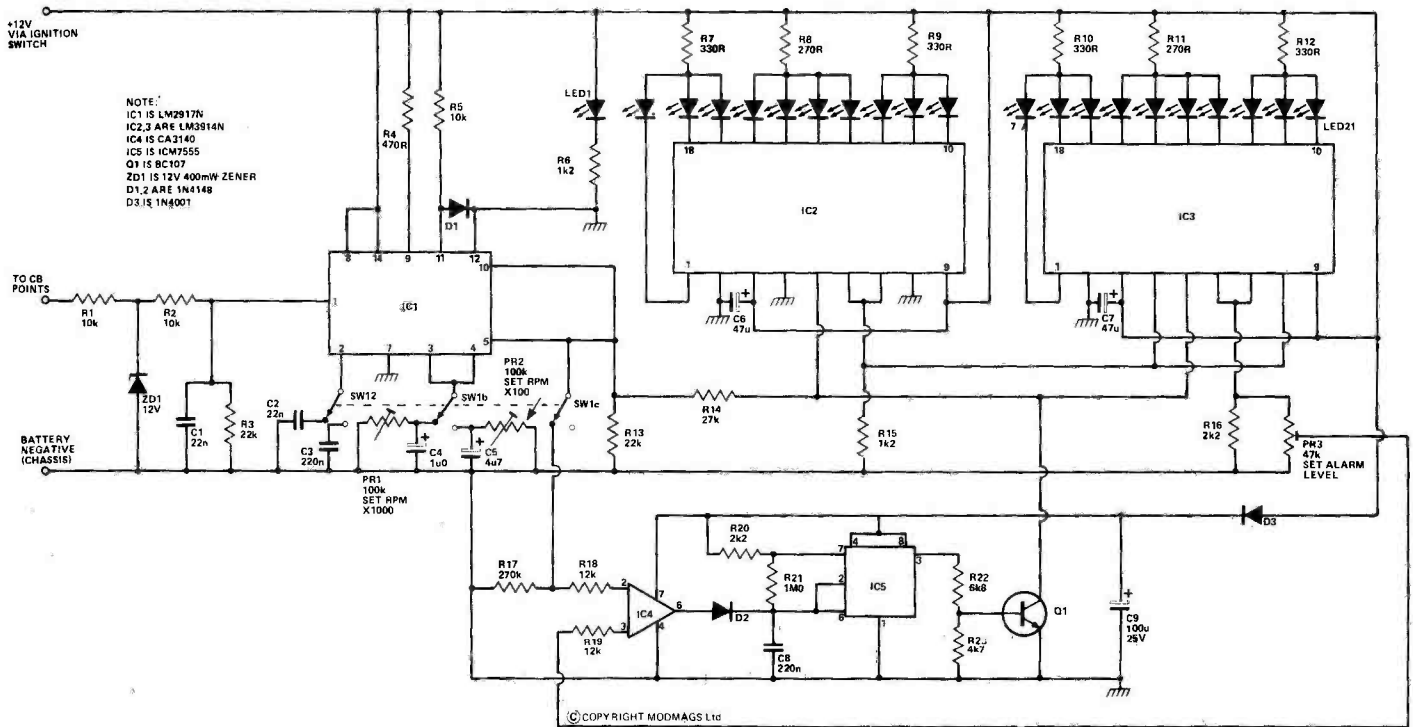

Fig. 1 Circuit diagram.

HOW IT WORKS

The ignition signal appearing on a vehicle's contact-breaker (CB) points has a basic frequency that is directly proportional to the RPM of the engine. Our tachometer works by picking up the CB signal, extracting its basic frequency, converting the frequency to a linearly-related DC voltage and then displaying this voltage (and thus the RPM) on a line of 21 LEDs. The basic tachometer can thus be broken down, for descriptive purposes, into an input signal conditioner section, a frequency-to-voltage converter section and a LED voltmeter display section.

The input signal conditioner section comprises R1-R3-ZD1-C1. The CB signal of a conventional ignition system consists of a basic RPM-related rectangular waveform that switches alternately between zero and 12 V, onto which various ringing waveforms with typical peak amplitudes of 250 V and frequencies up to 10 kHz are superimposed. The purpose of the input signal conditioner is to cleanly filter out the basic rectangular waveform and pass it on to the F-to-V converter. It does this first by limiting the peak amplitude of the signal to 12 V via R1 and ZD1 and then filtering out any remaining high frequency components via R2-R3-C1. The resulting clean signal is passed on to the input (pin 1) of IC1.

IC1 is a frequency-to-voltage converter chip with a built-in supply voltage regulator. The operating range of the IC is determined by the value of a capacitor connected to pin 2 and by a timing resistor and smoothing capacitor connected to pins 3-4. In our application, two switch-selected presettable ranges are provided. The DC output of the IC is made available across R13 and is passed on to the high-impedance input terminals of the IC2-IC3 LED voltmeter circuit via series resistor R14. R14 is essential to the operation of the alarm section of the tachometer.

IC2 and IC3 are LED display drivers. Each IC can drive a chain of 10 LEDs, the number of LEDs illuminated being proportional to the magnitude of the IC's input signal. Put simply, the ICs act as LED voltmeters.

In our application, the two LM3914 ICs are cascaded in such a way

that they perform as a single 20-LED voltmeter with a full-scale range of 2V4. This full-scale value is determined by precision voltage references built into the ICs. The full-scale reference voltage (2V4) is generated across R16 and PR3. The configuration of our voltmeter is such that it gives a bar display, in which LEDs 1 to 11 are illuminated at half-scale or LEDs 1 to 21 are illuminated at full-scale. R7 to R12 are wired in series with the display LEDs to reduce the power dissipation of the two ICs. LED 1 is permanently illuminated so that the RPM display does not blank out completely when the engine is stationary with the ignition turned on.

The alarm section of the tachometer is fairly simple. IC4 is wired as a voltage comparator with a stable reference voltage fed to its non-inverting (pin 3) input from PR3 and with an RPM-related voltage fed to its inverting (pin 2) input from R13 via SW1c. The output of IC4 is used to enable or disable an astable multivibrator IC5 and the output of IC5 is used to enable or disable the inputs to the IC2-IC3 voltmeter via Q1 and R14.

At low engine speeds (below the alarm level) the input of IC4 is driven high, thereby disabling the IC5 astable by preventing C8 from discharging. Under this condition the output of IC5 is driven low, cutting off Q1 and enabling the tachometer circuit to operate in the normal way.

At high engine speeds (at or above the alarm level) the output of IC4 is driven low, thereby enabling the IC5 astable to operate at a rate of roughly 2 Hz and alternately drive Q1 on and off. In the moments that Q1 is cut off, the tachometer operates in the normal way, but in the moments that Q1 is driven on its collector pulls the pin 5 input terminals of IC2 and IC3 to near-zero volts and thereby effectively blanks the LED displays. The LEDs flash rapidly under the alarm condition, but continue to indicate RPM values.

The alarm point can be set in any position on the tachometer scale by PR3. SW1c is used to disable the alarm section when the tachometer is set to its low (1,000 RPM in our prototype) range. Note that the power supply to the alarm is decoupled from the main supply by D3 and C9.

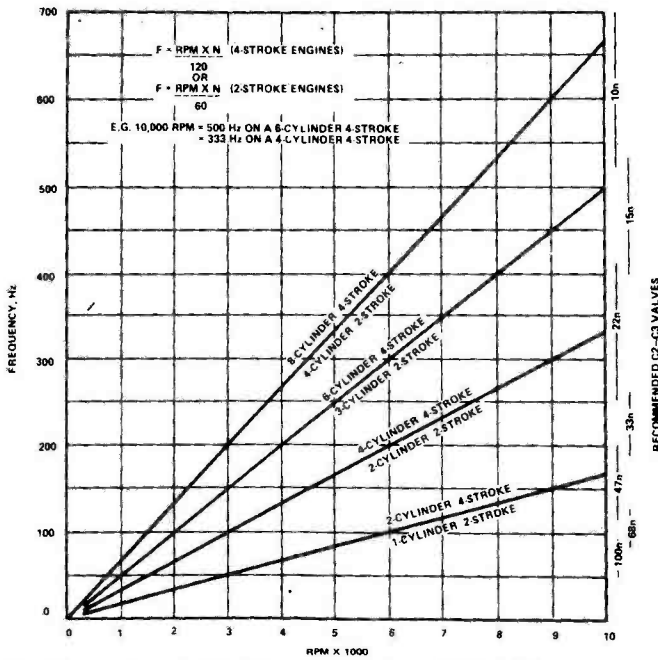

Fig. 2 Conversion graph to determine the values of C2 and C3.

Installation

The completed unit can either be mounted in a special cut-out in the vehicle's instrument panel or (preferably) can be assembled in a home-made housing and clipped on top of the instrument panel. In either case try to fit some kind of light shield to the face of the unit, so that the LEDs are shielded from direct sunlight.

To wire the unit into place, connect the supply leads to the tacho via the vehicle's ignition switch and connect the unit's CB terminal to the CB terminal on the vehicle's distributor. Note that the unit can be fitted to vehicles using either positive or negative earth systems.

The lower range of the tacho is of great value when adjusting the engine for correct tick-over. It is thus advantageous to arrange the tacho housing so that it can be easily dismounted from the instrument panel.

BUYLINES

All components used in the LED Tacho are common types and should present few problems. The dual-in-line slide switch is stocked by the major mail order companies that advertise in this issue.

PARTS LIST

Resistors all 1/4 W 5%

R1,2,5	10k
R3,13	22k
R4	470R
R6,15	1k2
R7,9,10,12	330R
R8,11	270R
R14	27k
R16,20	2k2
R17	270k
R18,19	12k
R21	1M0
R22	6k8
R23	4k7

Potentiometers

PR1,2	100k miniature horizontal preset
PR3	47k miniature horizontal preset

Capacitors

C1,2	22n polycarbonate
------	-------------------

C3,8

C3,8	220n polycarbonate
C4	1u0 35 V tantalum
C5	4u7 35 V tantalum
C6,7	47u 16 V tantalum
C9	100u 25 V electrolytic

Semiconductors

IC1	LM2917N
IC2,3	LM3914
IC4	CA3140
IC5	ICM7555
Q1	BC107
ZD1	BZY88 12 V
D1,2	1N4148
D3	1N4001
LED1-21	Red, square type.

Miscellaneous

SW1	4-pole 2-way dual-in-line slide switch
PCB, case.	

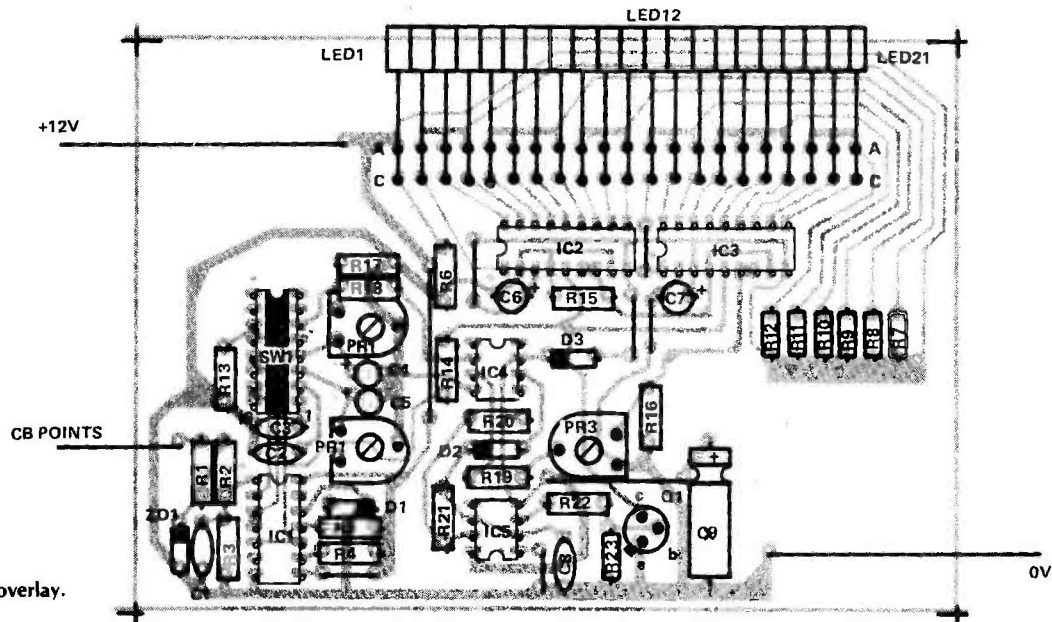

Fig. 3 Component overlay.

enter the computer age video genie system

- 12K MICROSOFT BASIC
- 16K RAM, UHF MODULATOR
- INTERNAL CASSETTE
- SECOND CASSETTE INTERFACE

£330
+ VAT



- 80 COLUMNS
- 70 LINES PER MINUTE
- GRAPHICS CHARACTERS
- INTERFACES TO MOST MACHINES

£395
+ VAT

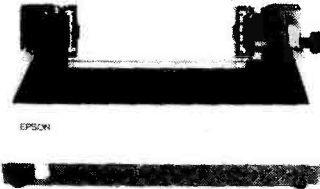

- 100's OF PROGRAMS AVAILABLE
- TRS-80 LEVEL II SOFTWARE COMPATIBLE

GENERAL NORTHERN MICROCOMPUTERS
46 Middle Street, Blackhall
Hartlepool, Cleveland
Tel: Peterlee (0783) 863871

ACCESS AND BARCLAYCARD ACCEPTED

<p>7 SEGMENT DISPLAYS HEWLETT-PACKARD High Efficiency "Ultra bright" half inch. red. Common anode type 5082-7650 (similar to DL707). Common Cathode version 5082-7653 (similar to DL704). OUR PRICE BRAND NEW £1. Set of six of either type. ES incl. VAT.</p>		<p>HALF PRICE OFFER</p>																																				
<p>FAMCHILD FMD10 0.25" Mini red 7 segment display. Common anode. 50p 5 for £2.50</p>																																						
<p>LP1171 & LP1179 MODULES MULLARD LP1171 and LP1179 tuning heart and IF modules which form the basis of a quality AM/FM tuner. Full medium long-wave and YIF coverage. May be used as the basis of a quality portable or tower. Supply 8V at 15mA output 70mV at 20K. Pair ES.75. SUPPLIED COMPLETE WITH DATA LP1157 Medium & Long Wave Tuner, module-board £2.50 LP1186 Varicap ES.60</p>																																						
<p>3+3 Watt Car Stereo Amplifier made for Motorola</p> <ul style="list-style-type: none"> ★ WITH pre-amplifier and M. & Long Wave assembly. ★ Supplied as two built and tested units. ★ R.F. and L.F. stereo preamplifier and radio 4 x 2 x 1". ★ 5 + 5 watt stereo amplifier 12/14 volt 4 x 2 x 1". ★ Complete with circuit, data and connection diagrams. ★ Limited quantity available, ex-stock. <p>EX-8007000LA Only £5. Post 50p</p>																																						
<p>PRO M25 Professional capacitor boom-arm microphone by Eagle. A graceful 80 cm boom-arm capacitor studio microphone using a carmel capsule. A high standard of finish for its value and build yet robust enough to withstand long periods between maintenance. Supplied complete with 1 red and 1 black windshield and 6 metres of twin screened cable terminating at the microphone end in an XLR connector. Impedance: 600 ohms (Testing). Response: 20-18,000 Hz. Sensitivity: -70 dBV. Cable: 6 metres two conductor shielded. Connector: XLR 3-11C. Battery type: HP7.</p>		<p>LIST PRICE £37.40 OUR PRICE £19.95 inc. VAT POST £1.50</p>																																				
<p>12VHT RE-CHARGEABLE BATTERY. 6 volt 4.5 amp/h. Size 8" x 3 1/4" x 1 1/4" at full price. Brand new £7.50, post 50p. MIN. EDGE INDICATORS WITH LAMP. 0-100 MICRO AMP 6 for £6.50 INDICATOR METERS. 200 Micro. 1 1/4" x 1 1/4" x 1/4". 8 for £5</p>																																						
<p>TRANS. AMPLIFIERS. Contains two Foster type moving coil, mikes/earphones, V/C and switches as used on aircraft for SANGAMO HOUR METER. 6000 h new round. £4.50. 1 1/2" sq. 2" deep.</p>																																						
<p>MAINS TRANSFORMERS 0/200/250V input.</p> <table border="1"> <thead> <tr> <th>Type</th> <th>Current</th> <th>Size</th> <th>Price</th> </tr> </thead> <tbody> <tr> <td>12V</td> <td>100mA</td> <td>1 1/2 x 1 1/2 x 1 1/2</td> <td>£6.95</td> </tr> <tr> <td>12V</td> <td>500mA</td> <td>1 1/2 x 1 1/2 x 1 1/2</td> <td>£1.25</td> </tr> <tr> <td>0-6-6</td> <td>300mA</td> <td>2 x 2 x 2</td> <td>£1.50</td> </tr> <tr> <td>12V</td> <td>2 amps</td> <td>3 x 2 1/2 x 2 1/2</td> <td>£2.95</td> </tr> <tr> <td>0-20V</td> <td>1 amp</td> <td></td> <td>£2.50</td> </tr> <tr> <td>12-20V</td> <td>1 amp</td> <td></td> <td>£2.50</td> </tr> <tr> <td>14-0-14V</td> <td>1.5 amp</td> <td></td> <td>£2.50</td> </tr> <tr> <td>12V</td> <td>1 amp</td> <td></td> <td>£2.50</td> </tr> </tbody> </table> <p>Size 6x3x5cm. Postage 50p each</p>		Type	Current	Size	Price	12V	100mA	1 1/2 x 1 1/2 x 1 1/2	£6.95	12V	500mA	1 1/2 x 1 1/2 x 1 1/2	£1.25	0-6-6	300mA	2 x 2 x 2	£1.50	12V	2 amps	3 x 2 1/2 x 2 1/2	£2.95	0-20V	1 amp		£2.50	12-20V	1 amp		£2.50	14-0-14V	1.5 amp		£2.50	12V	1 amp		£2.50	<p>MULLARD TR2000. Hi audio amplifier. £1. NCA CA2000A. FM IF £1.50. NCA CA2000A. FM decoder £2.50. BUZES TEXAS. £1.50 each. 10 for £15. BUZES TEXAS TV power Transformers. 10 for £15. 100 for £120. MULLARD AD101-AD102. Matched pair 80p. 10 pairs £8. 100 pairs £30. Carbons of 600 pairs £250 EX-STOCK. 5 or 12 volts TR2025 ATES voltage regulators 50p each. 100m/amp (T099) pair 10 £4.50. CA2000 NCA POSITIVE VARIABLE 5 volt 100m amp variable. 18-24V 50p each. TEXAS 10 WATT, IC. AMP SM70010 5-pin package £1.25. 10 for £10. TAB010 (14 pin DIL) IC TV sound amplifier-detector by ATES as a circuit, other parts. Complete with data. 60p. 10 for £5. 100 for £40.</p>
Type	Current	Size	Price																																			
12V	100mA	1 1/2 x 1 1/2 x 1 1/2	£6.95																																			
12V	500mA	1 1/2 x 1 1/2 x 1 1/2	£1.25																																			
0-6-6	300mA	2 x 2 x 2	£1.50																																			
12V	2 amps	3 x 2 1/2 x 2 1/2	£2.95																																			
0-20V	1 amp		£2.50																																			
12-20V	1 amp		£2.50																																			
14-0-14V	1.5 amp		£2.50																																			
12V	1 amp		£2.50																																			
<p>2W MIN. W/W VOL. CONTROLS 10R-47K. 10 for £6</p> <p>10 TURN POTS. 47K-100K. 10 for £17.50</p>																																						
<p>STEREO CASSETTE TAPE HEAD. High quality replacement for most machines record/replay with mounting bracket.</p> <table border="1"> <tbody> <tr> <td>XRPS (X240P) 100 1/2 track Rec./Play medium imp.</td> <td>£2.95</td> </tr> <tr> <td>XRPS (X240P) 50 1/2 track Record/Play low imp.</td> <td>£4.00</td> </tr> <tr> <td>XRPS (X240P) 10 1/2 track erase for XRP series</td> <td>£1.25</td> </tr> <tr> <td>EX 10P 100 1/2 track Record/Play Head (black/rim)</td> <td>£2.25</td> </tr> <tr> <td>EX 12E 343 1/2 track Erase Head for above</td> <td>£1.25</td> </tr> <tr> <td>EX 11 E 800 Erase 075 ohms 2mA</td> <td>£8.60</td> </tr> </tbody> </table>		XRPS (X240P) 100 1/2 track Rec./Play medium imp.	£2.95	XRPS (X240P) 50 1/2 track Record/Play low imp.	£4.00	XRPS (X240P) 10 1/2 track erase for XRP series	£1.25	EX 10P 100 1/2 track Record/Play Head (black/rim)	£2.25	EX 12E 343 1/2 track Erase Head for above	£1.25	EX 11 E 800 Erase 075 ohms 2mA	£8.60	<table border="1"> <tbody> <tr> <td>GX12 E807 Erase 075 ohms 2mA</td> <td>£8.60</td> </tr> <tr> <td>GX20 E802 Erase 80 ohms 10mA</td> <td>£9.80</td> </tr> <tr> <td>WMS-T Type Heads 1/2 Track AMP Erase</td> <td>£2.50</td> </tr> <tr> <td>WMS-T with 1/2" metal screen</td> <td>£2.50</td> </tr> <tr> <td>WMS-T with 1/2" metal screen</td> <td>£2.50</td> </tr> <tr> <td>LPE Erase head</td> <td>50p</td> </tr> <tr> <td>R/MP/1/3 Record/Play 1/2 track head</td> <td>£3.85</td> </tr> <tr> <td>WMS-T Single track Record/Play head. 0.2V 5mA/4.00 Ohms impedance of 50 kc/s. Bias current 200SA</td> <td>£9.50</td> </tr> </tbody> </table>	GX12 E807 Erase 075 ohms 2mA	£8.60	GX20 E802 Erase 80 ohms 10mA	£9.80	WMS-T Type Heads 1/2 Track AMP Erase	£2.50	WMS-T with 1/2" metal screen	£2.50	WMS-T with 1/2" metal screen	£2.50	LPE Erase head	50p	R/MP/1/3 Record/Play 1/2 track head	£3.85	WMS-T Single track Record/Play head. 0.2V 5mA/4.00 Ohms impedance of 50 kc/s. Bias current 200SA	£9.50								
XRPS (X240P) 100 1/2 track Rec./Play medium imp.	£2.95																																					
XRPS (X240P) 50 1/2 track Record/Play low imp.	£4.00																																					
XRPS (X240P) 10 1/2 track erase for XRP series	£1.25																																					
EX 10P 100 1/2 track Record/Play Head (black/rim)	£2.25																																					
EX 12E 343 1/2 track Erase Head for above	£1.25																																					
EX 11 E 800 Erase 075 ohms 2mA	£8.60																																					
GX12 E807 Erase 075 ohms 2mA	£8.60																																					
GX20 E802 Erase 80 ohms 10mA	£9.80																																					
WMS-T Type Heads 1/2 Track AMP Erase	£2.50																																					
WMS-T with 1/2" metal screen	£2.50																																					
WMS-T with 1/2" metal screen	£2.50																																					
LPE Erase head	50p																																					
R/MP/1/3 Record/Play 1/2 track head	£3.85																																					
WMS-T Single track Record/Play head. 0.2V 5mA/4.00 Ohms impedance of 50 kc/s. Bias current 200SA	£9.50																																					
<p>ADD VAT TO ALL PRICES</p> <p>HENRY'S</p> <p>404 Edgware Road, London, W2, England 01-723 1008/9</p>																																						

Marshall's

A. Marshall (London) Ltd., Kingsgate House,
Kingsgate Place, London NW6 4TA
Industrial Sales: 01-328 1009
Mail Order: 01-624 8582 24hr. service
Any retail shops: 325 Edgware Road, London W2
40 Cricklewood Broadway, London NW2 85 West Hanger St. Glasgow
106A Stokes Croft, Bristol

We now supply the extremely reliable and cost conscious LEADER range of testgear.

SINGLE TRACE OSCILLOSCOPES	
LBO 510A 5" 4MHz 20mV	£125.00
LBO 512A 5" 10MHz 10mV	£170.00
LBO 513A 5" 10MHz 10mV	£175.00
LBO 507A 5" 20MHz 10mV	£239.00
DUAL TRACE OSCILLOSCOPES	
LBO 308S 3" 20MHz 2mV	£419.00
LBO 508A 5" 20MHz 10mV	£229.00
LBO 520A 5" 35MHz 5mV	£475.00
LBO 514 5" 10MHz 5mV	£255.00
T.V. RADIO TEST GEAR	
LSG 16 Signal Generator	£ 49.00
LSG 231 FM Stereo Signal Generator	£169.00
LCG 397U PAL B Pattern Generator	£189.00
AUDIO TEST GEAR	
LAG 26 Audio Generator	£ 60.00
LAG 170A Audio Generator	£119.00
LDM 170 Distortion Meter	£225.00
LFM 39A Wow/Flutter Meter (Dist)	£249.00
LFM 39A Wow/Flutter Meter (Dist)	£299.00
LAV 191 Audio Tester	£249.00
LAG 125 Low Distortion Audio Generator	£229.00
GENERAL TEST GEAR	
LCR 740 LCR Bridge	£135.00
LTC 906A Transistor Checker	£ 90.00
LVT 72 Fet Transistor Checker	£119.00
LTC 907 Transistor Checker	£139.00
LAT 47 Attenuator	£135.00
LAT 45 Attenuator	£ 75.00
LFG 1300 Sweep/Function Generator	£299.00
AMATEUR RADIO	
LDM 815 DIP Meter	£ 43.00
LIM 870A Antenna Impedance Meter	£ 41.00
LPM 880 RF Power Meter	£ 69.00
LPM 885 SWR/Watt Meter	£ 44.00
LAC 895 Antenna Coupler	£ 85.00
LAC 896 Antenna Coupler	£ 41.00
LAC 897 Antenna Coupler	£ 41.00

The new Marshall's 80/81 catalogue is now available. A veritable treasure house of components, test gear, tools, etc.



Lots of old friends, but also many new products including leader test gear, Crimson Hi Fi Modules, Rechargeable Ni Cad batteries and chargers (very competitive). More components including SN74ALS series, new tools etc. Available by post, UK 75p post paid: Europe 95p post paid: Rest of world £1.35 post paid.

SINCLAIR INSTRUMENTS

Digital Multimeter	
PDM35	£ 34.50
DM235	£ 52.50
DM350	£ 72.50
DM450	£ 99.00
Digital Frequency Meter	
PFM200	£ 49.80
Low Power Oscilloscope	
SC110	£139.00

NEW

TF200	Frequency Meter	£145.00
TGF105	Pulse Generator	£ 85.00

CRIMSON ELEKTRIK HI FI MODULES

CE608	Power Amp	£20.09
CE1004	"	£23.43
CE1008	"	£26.30
CE1704	"	£33.48
CE1708	"	£33.48
CPS1	Power Unit	£19.52
CPS3	"	£23.52
CPS6	"	£30.00
CPR1	Pre Amp	£32.17
CPR1S	Pre Amp	£42.52

All Prices + VAT + postage/packaging

Don't forget! We also carry an impressive range of semi-conductors, passive components, electro-mechanical components, tools etc.

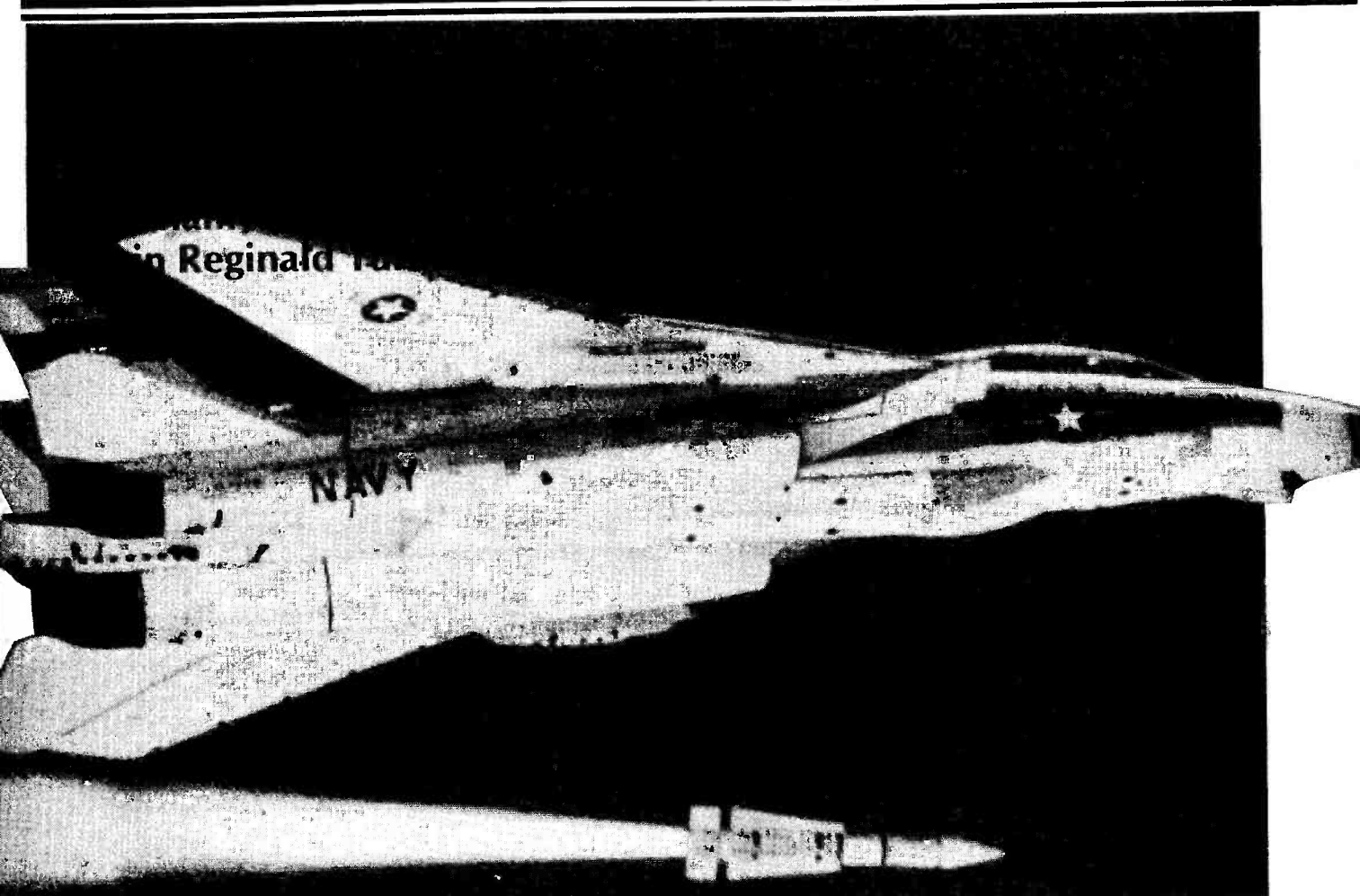

The cause of the Ariane rocket accident in May 1980 has been found. As I reported in October's *Astrologue*, the second test flight of the European launcher lasted only two minutes. The vehicle broke up in flight and exploded.

Extensive tests, simulation and examination of wreckage recovered from the sea were necessary to narrow down the range of hypotheses and eventually reproduce on the test-stand the behaviour of the faulty engine.

It was proved that the cause of the engine failure was not external to the engine itself, or due to a foreign body present at ignition or an acoustic 'ground effect' during lift-off.

Accident investigators have found that the failure was due to combustion instability at high frequency (above 2 kHz) in one of the four first stage engines 5.75 S after ignition. The vibration lasted only 0.3 S, but it was so violent that it abruptly altered the characteristics of the fuel injector. Damage to the injector destroyed the engine 64 S after ignition, starting a propulsion bay fire, which destroyed the vehicle 108 S after lift-off.

Fuel Injection

The fuel injector is a very complex element of the rocket design. It is used to deliver almost 250 kg of fuel and oxidant to the combustion chamber through nearly 1,000 orifices. Its failure was probably due to slight variations in component manufacture, although the injectors behaved normally in nearly 200 engine development tests. To resolve the problem, injector manufacturing tolerances are to be altered and injectors will be selected by static firings on the engine test-stand.

The third Ariane vehicle should be equipped with the new injectors and ready for launch by the end of March 1981, if

Trials of the improved AIM-54C Phoenix missile continue. This US Navy photo shows an engineering development model being fired from an F-14 Tomcat fighter at the Pacific Missile Range. Once again, the new model, teamed with the Hughes' AWG-9 RADAR fire control system, behaved perfectly, passing well within the lethal distance of the drone target. The Phoenix is regarded as one of the world's most technologically advanced tactical missiles.

testing proceeds satisfactorily. The fourth and last test flight would then be scheduled for June 1981. The first operational launch could take place in October.

AWOL Satellite

Late last year, RCA's multi-million dollar Satcom III satellite disappeared 14.5 S into the 28 S apogee kick motor burn (to place the satellite in geostationary orbit). A study of the incident has suggested two possible causes.

If, when the motor fired, the exhaust cone broke, hot gases would have melted the back end of the satellite, destroying the communications equipment. Alternatively, if, after the motor fired, the solar array was deployed prematurely, suffering structural damage due to thrust, a total power loss would ensue. As exhaust overheating was observed prior to loss of contact, the review board has opted for the first alternative.

In addition to the cost of the launch and hardware involved, RCA may lose a further \$20 million in expected revenue. However, the venture was insured for around \$77 million.

In the meantime, Satcom III's customers can use 11 transponders on another satellite (Comstar D-2) for \$40,000 per transponder — the same as the Satcom usage charge. Comstar D-2's full charge is normally \$70,000 per transponder. RCA will launch a replacement satellite in June 1981.



In Print

Reginald Turnill has been covering spaceflight since the Soviet-US missile race in the post-war years, which developed into the race to land a man on the moon. He reported for the BBC on every manned spaceflight from Gagarin to the joint Apollo-Soyuz mission in 1975, including the first moon landing. His wealth of first-hand knowledge of the major space

projects reflects in his authoritative writing on the subject. In nearly 400 pages, The Observer's Spaceflight Directory updates and augments the smaller Observer's books on manned and unmanned spaceflight. It includes sections on space programmes in 14 countries, tabulations of manned and unmanned flights and blow by blow accounts of satellites and launch vehicles from Oscar to Skylab and Surveyor to the Space Shuttle. Soviet projects are also covered extensively.

Prize Day

You can win a copy of this magnificent handbook by trying your hand at our simple, free-entry competition. All you have to do is complete the crossword by solving the cryptic clues. Most of them offer two means of arriving at the solution and most are fairly simple.

When you've solved all the clues (here's the nasty bit), give each letter of the alphabet a number (A-1, B-2, . . . Y-25, Z-26), add up the numerical value of all the solutions, write that number in the space provided on the coupon and send your entry to:

ASTROLOGUE CROSSWORD,
ETI,
145 Charing Cross Road,
London WC2H 0EE

Closing date for entries — January 31st 1981.

If you don't win the competition, you can get hold of your own copy of The Observer's Spaceflight Directory by Reginald Turnill, published by Frederick Warne, for £7.50 from any good bookshop.

CROSSWORD CLUES

Across

1. Messenger of the Gods, first in line from the Sun. (7)
4. Car step seen through prisms. (7)
7. One of those returned from the Moon in a rocket. (4)
8. Such a wing on a variable geometry aircraft. (5)
10. Major or minor, a friend of Goldilocks. (4)
11. In Scorpio and in plant a resistor. (7)
13. Benny's friends in the sky send out streams of gas. (4)
15. Getting up and down shortly giving lots back. (4)
17. Getting on course for the Moon initially in fast limousines. (3)
18. LEM — 4: Neil Armstrong — 2, giving support. (4)
22. Imitates Bonny and Sam. (4)
24. Troubled SOS in grim for first Mercurial Gemini man. (7)
27. National Oceanic and Atmospheric Administration. (4)
28. Peenemunde led to Saturn for him. (5)
31. Join Oriental take-off for one. (4)
32. The seriousness of the downward pull. (7)
33. Enterprise will never be this, Columbia. (7)

Down

1. The Vikings headed here and returned in express ramjets. (4)
2. Company trek carrying a payload. (6)
3. Plane turn about vertical axis way back. (3)
4. In part, it's unlikely to provide a shining example. (3)
5. Propulsive force through American street. (6)
6. Shepard or Bean in a Lancaster bomber. (4)
8. Liberty Bell did this, we hear — five across the channel. (4)
9. Geostationary Operational Environmental Satellite leaves. (4)
12. At Los Angeles south missile. (5)
13. Pasadena's famous laboratories — tenth, sixteenth and twelfth. (3)
14. So, point to call for help. (3)
15. A damp reception for astronauts partly due to phase angle. (3)
16. The French southern Launch Escape System. (3)
19. French place of departure for Ariane. (6)
20. Graduate back with credit for nebula. (4)
21. Brief moment on our satellite. (4)
23. Scheme and French celestial body. (6)
25. A single letter pulling down at sea level. (3,1)
26. Southern seaman only coming out at night. (4)
29. Narrow beam fired by futuristic gun. (3)
30. Nameless aircraft alias airborne crockery. (3)

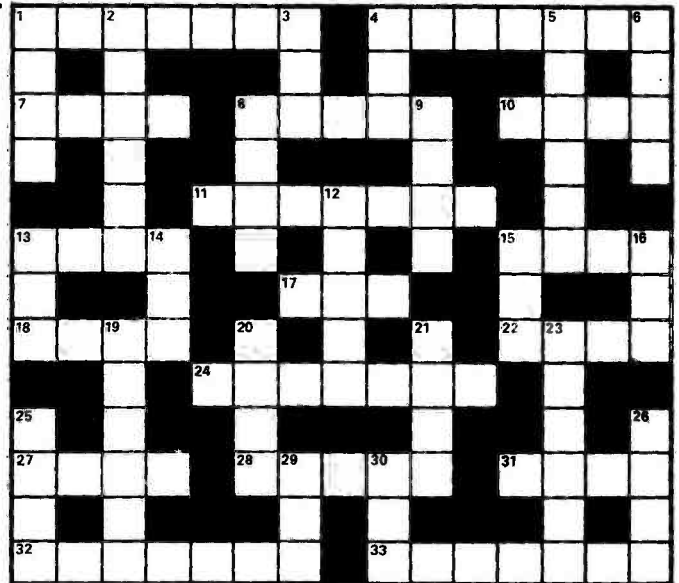

NAME

ADDRESS

NUMERICAL VALUE

ETI

Now you can have **LINEAR REGRESSION** at your fingertips!

With the **FX-3500P**, Casio's new low-cost programmable scientific. An abundance of built-in functions, including Linear Regression. Prov. price: **UNDER £30.**

THE ULTIMATE WATCHES

★ **STAR BUY FOR 1980** ★

Our best selling watch

LCD ANALOGUE/DIGITAL

Alarm Chronograph with countdown
Analogue. Independent hours and minutes with synchronous digital seconds. Dual time ability.
Digital. Hours, minutes, seconds, day and date.

Stopwatch. 1/100 second to 12 hours. Net lap and 1st and 2nd place. Start/stop and 10 minute signals.
Alarm. For 30 seconds with carousel display.
Countdown Alarm. Normal and net times to 1 hour with amazing "Star Burst" flashing display.

Time Signal. Half-hourly and hourly chimes. Tone control. Lithium battery. Light. Water-resistant case. 8.65mm thick. Mineral glass.



AAB1
Analogue Display



AAB2
Digital Display

AAB1 Chrome plated **£29.95**

AA81G gold plated **£49.95**

AA82 stainless steel **£39.95**

AA83 Dress watch, s/s **£44.95**

12 MELODY ALARM CHRONOGRAPHS

Countdown alarm. Date memories.

Hours, minutes, seconds, am/pm, 12 or 24 hour. Day, date and month auto calendar.

Alarm. 7 melodies, one for each day of the week.

Hourly time signal. With "Big Ben" type tune.

Date memory. Select either "Wedding March" or "Trinkled" to be played.

Birthdays and Christmas Memory.

Countdown alarm. From 1 second to 1 hour. After zero count continues positively.

Stopwatch. 1/10 second to 1 hour. Net, lap, etc.

Picturesque moving display of notes played. Light. Lithium. Glass. Water-resistant cases.

M-12 Resin, s/s trim **M-1200** all s/s 9.0 mm thick.



£19.95



£32.50

A250. As above but with standard water-resistant case

£24.95

£25.00

F300 Sports Chronograph (right). 8 digits, hours, minutes, seconds, date and day indicator. 1/100 second stopwatch; net, lap and 1st and 2nd place times, to 12 hours. Resin case, s/s trim. Water-resistant. Glass. Light.

£17.95

110QS-37B Metal version

£17.95

F81 Alarm Chronograph (far right). 8 digit display of hours, minutes, seconds, am/pm and date. 24-hour alarm, hourly chimes, 1/10 second stopwatch to 12 hours; net, lap, 1st & 2nd place. Resin case/strap. Water resist. Mineral glass. Nightlight.

£19.95

£12.95

£15.95

£19.95

£12.95

£15.95

£19.95

£12.95

£15.95

£19.95

£12.95

£15.95

£19.95

£12.95

£15.95

£19.95

£12.95

£15.95

£19.95

£12.95

£15.95

£19.95

£12.95

£15.95

£19.95

£12.95

£15.95

£19.95

£12.95

£15.95

£19.95

£12.95

£15.95

100 METRE WATER RESISTANT

Alarm chronographs with countdown
 Amazing 5-year lithium battery life. Hours, minutes, seconds, am/pm, day, date and month. 12 or 24 hour. Time is always visible regardless of display mode.

Stopwatch. 1/100 second to 1 hour. Net, lap, and 1st and 2nd. Start/stop signal. 10 minute signal.

Alarm. Sounds for 30 seconds.

Countdown Alarm. Normal and net times to 12 hours. Start/stop and 10 minute signals.

Time signal. Half-hourly and hourly chimes.

W-100. All resin. **W-150B** All s/s. **W-150C** (not illustrated) s/s case/resin strap. **£29.95**



£24.95



£25.00

RETURN OF THE SUPERCALCS!

★ **NEW MODEL! FX-6100**

Clock. Hours, minutes, seconds, am/pm.

Alarm. Alarm signal at pre-set time.

Hourly chimes. Every hour, on the hour. Easily switched off.

Countdown alarm. (Repeater time).

Stopwatch. Normal, net, and lap times to 1/100 second.

Calculator. 39 scientific functions. True algebraic logic. 5 level parenthesis, cube roots, standard deviations, R-P and P-R coordinate conversions, sexagesimal conversions, full memory, %

Approx. 14 months on 2 penlight batteries (AA type). 3/4 x 3 x 5 1/2 inches. (RRP £22.95) **£19.95**

FX-7100. Card version of above with kiss-touch keys. 3/16 x 2 1/2 x 3 3/8. (E27.95) **£24.95**

FX-8100. Specifications as above plus permanently programmed calendar (1976-1999), day, date, month and year. Also has hyperbolics. 1/4 x 2 3/4 x 5 1/2. **£24.95**

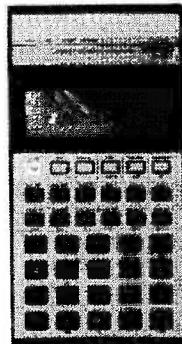

CASIOTONE KEYBOARDS

★ **NEW MODEL! CT-301 Domestic Keyboard**

Polyphonic playing of 14 instruments plus 16 rhythm voices. Dimensions, etc are similar to the CT-201. Woodgrain only. **Provisional price; under £300.**

CT-201. 29 polyphonic instruments over 4 octaves, 4-sound memory function. 3 x 33 1/2 x 9 3/8. Weight 15 lbs. Integral amplifier and speaker. AC only. (E285) **£245**

THE SPACE INVADERS ARE BACK!

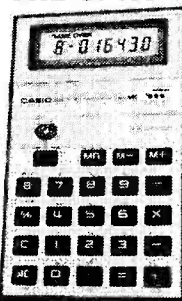

This time right in your pocket. An action-packed speed game that will give you hours of skilful entertainment and chair-gripping excitement. Never another dull spare moment. Also an 11-note melody calculator, pre-programmed "When The Saints Go Marching In". Full memory, %. Auto power-off facility.

MG-880 (left)

1/2 x 2 1/2 x 4 1/2"

£10.95

(£12.95)

MG-770 (right)

Kiss touch keys

5/32 x 3 3/8 x 2 1/2"

£12.95

(£14.95)

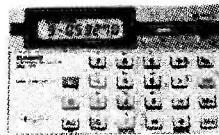

12 PRE-PROGRAMMED MELODIES

Clock, calendar, 11-note melody maker, calculator, square roots, %. Alarm 1; 7 tunes, one for each day. Alarm 2; a fixed tune. Hourly chimes. Date memories; 4 anniversary tunes.

MQ-1200 (below). Desk or bedside. Built-in speaker, Volume control. Nightlight. Powered by three AA size batteries. 1 9/16 x 6 x 2 1/4 inches.

£19.95

(£22.95)



ML-90 (right)

Kiss keys

Stopwatch

7/32 x 2 1/2 x 4 1/2"

£19.95

(£22.95)

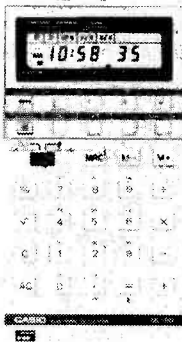

Other Casio calculators, P.O.A. Remember, we will **BEAT** lower prices by 5%

SEIKO ALARM CHRONOGRAPHS FROM **£37.50**



£37.50

DFT 048 (left) Alarm, countdown alarm, hourly chimes, stopwatch to 1/100 second, net, lap, 1st & 2nd.

DFT 038 100 metre water-resistant version

£49.95

DER 048 Solar powered (right). Weekly programmable alarm, 16-hour interval countdown alarm timer, hourly chimes, 1/100 second stopwatch.

DER 018 100 metre water-resistant version.

£69.95



£52.50

DUO DISPLAY Analogue/digital watches from £57.50

CHRISTMAS POST Our return of post service means that orders received by 18th December should reach you in time for Christmas, subject to availability.

Send 25p for our illustrated catalogue of latest Casio and Seiko products. Offers are subject to availability.

Price includes VAT and P&P. Send your company order, cheque, P.O. or phone your ACCESS or BARCLAYCARD number to:

TEMPUS

Dept. ETI, FREEPOST
 164-167 East Road
 Cambridge CB1 1DB
 Tel: 0223 312866

ETI READER SURVEY

Time for the big one again — our annual nationwide survey of ETI readers. It's your chance to say what you think of us and do your bit to influence what we publish.

All you have to do is fill in the questionnaire overleaf and consign it to its fate at the hands of the Royal Mail. Even now we're preparing for office life to grind to a halt as thousands of questionnaire-laden pigeons start arriving.

Your replies are read and your comments noted. They all go towards shaping ETI in the eighties.

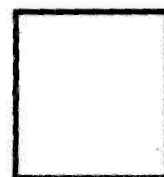

ETI Survey,
Modmags Ltd.,
145 Charing Cross Road,
London WC2H 0EE.

1) Please rate the following articles on a scale of 1 (awful to 9 (brilliant)). If you didn't read the feature, please score 0.

	SCORE	READ FULLY	SCANNED OVER	COMMENTS?
FM TUNER				
LED TACHO				
MULTI-OPTION SIREN				
POLYSYNTH				
UNIVERSAL TIMER				
ELECTRONICS TOMORROW				
I/O INTERFACE				
DESIGNER'S NOTEBOOK				
MICROBASICS				
ASTROLOGUE				
TECH TIPS				
SLR ELECTRONICS				
SPOT DESIGNS				
DIGEST				
AUDIOPHILE				

Asterisk the single best feature in your estimation.

In addition please make any comments you would like to in the space provided. (Go on — don't be shy!)

ISSUE ISSUES

2) Do you consider yourself a regular reader?
If yes — how long?

Yes/No

Six months or less / 1 year / 2 years / 3 years / longer.

3) If you've been a reader for longer than a year, how does ETI now compare with ETI a year ago? Circle appropriate comment.

Much better Slightly better No different Slightly worse Much worse Oh my God!

4) How long do you keep your past copies of ETI?
1 month 3 months 6 months 1 year longer

5) How did you become a reader of ETI?

By accident Friend's copy Impulse buy Advertisement Other (please specify)

6) How many people read your copy?

PROJECTS

7) Have you ever built a project from ETI?
If yes which did you construct in the last year — please list

Yes/No

- 1.
- 2.
- 3.
- 4.
- 5.
- 6.

16) Which of ETI's special offers did you purchase in the past year?

Is there anything you'd like to see appear as an offer in ETI?
If yes, please specify

Yes/No

17) Have you ever bought any goods from ETI mail order?
If yes how was the service you received?

Yes/No

Good Fair OK Poor Bad Atrocious

Any problems? (Please specify below)

ADVERTISING

18) Do you read advertisements in ETI?
Frequently Occasionally Never

19) Do you find the advertisements in ETI useful when purchasing goods?
Yes No Neither

20) Have you ever purchased goods from mail order advertisements in ETI?

Yes/No

21) If so:-

(a) Approx. how many times in the last year have you ordered goods from a mail order company?
(b) How many mail order companies have you used during that period?

22) Approx. how much have you spent on electronics in the last year?

£

23) Approx. how much of this amount was spent as a direct result of seeing an advertisement in ETI?

£

AUDIO

24) Do you own a stereo system?

Yes/No

25) If yes, how much did your present system cost?

£

26) Approx. how much do you spend annually on audio equipment?

£

27) Please list your present system

VIDEO

28) Do you own or rent a videocassette recorder?

Yes/No

29) If not, do you intend owning or renting a VCR within the next year?

Yes/No

HOME COMPUTING

30) Do you own a home computer or microprocessor system?

Yes/No

31) If yes, how much did it cost?

£

32) Did you buy it through:-

- (a) Recommendation by other/shop
 - (b) Article in ETI/other magazine
 - (c) Advertisement in ETI/other magazine.
- Delete where not applicable.

READER PROFILE

These are personal questions which you may find objectionable. Please feel free to tell us to mind our business in that case. Answering them would help us greatly, however, and your co-operation would be appreciated. All info treated strictly as statistics and in confidence.

8) Are there any you intend to build from this issue?
If yes which? Yes/No

9) Is there anything you would especially like to see as a project in ETI?
Please specify. Yes/No

10) In general, if there is a kit available for a project would you purchase that rather than assembling the components yourself? Yes/No

11) Do you construct using PCBs?
If yes, do you etch your own? Yes/No

12) In general again, do projects constructed from ETI work first time? Yes/No

SUBJECTIVE MATTER

13) Please read the list of topics below and indicate how you think coverage of them measures up in the appropriate box

	About right now	Should cover less in future	Should cover more in future	Totally ignore
PROJECTS				
FEATURES				
HOME COMPUTING				
AUDIO				
EQUIPMENT REVIEWS				
SPACE FACT				
SCIENCE FICTION				
GENERAL SCIENCE				
MILITARY ELECTRONICS				
ANY OTHER (SPECIFY)				

13) More specifically, there are many types of project we can present in ETI. What is your interest in these examples, and what sort of emphasis should we place on each?

	LESS NEEDED	RIGHT NUMBER NOW	LET'S HAVE MORE
TEST GEAR			
SOUND EFFECTS			
GAMES			
MUSIC			
AUDIO			
BIOFEEDBACK			
MOTORING			
COMPUTING			

15) Have you ever used the ETI postal enquiry service?
If yes how did you find it? Yes/No

Brilliant Good Fair Atrocious Non-existent
Please outline below any problems you have encountered when dealing with us below

33) How old are you? £

34) Sex (Male/Female/Undecided)

35) Total annual income (if in full time employment)

36) What is your job title?

37) Do you hold any of these credit cards?
Barclaycard Access American Express

38) To what level were you in full time education?
CSE 'O' Level 'A' Level ONC HNC Degree

39) What do you like about ETI?

40) and dislike?

41) Any suggestions for improvement?

42) Any comments to make? (Please include separate sheet if necessary!)

43) The competition. (Otherwise known as the Bad Guys!)

On an arbitrary scale of 100 with ETI scoring 50, please rate the competition against us.

	REGULAR	READ SOMETIMES	USED TO	NEVER	RATING
RADIO CONSTRUCTOR					
WIRELESS WORLD					
TELEVISION					
VIDEO					
PRACTICAL COMPUTING					
COMPUTER AGE					
PRACTICAL WIRELESS					
PRACTICAL ELECTRONICS					
PERSONAL COMPUTER WORLD					
BYTE					
ELEKTOR					
EVERYDAY ELECTRONICS					
COMPUTING TODAY					
HOBBY ELECTRONICS					
VIDEO TODAY					
WHAT VIDEO					
ETI					50

Thank you for your time and patience!

Name
Address

SPECIAL OFFERS

TO LAUNCH OUR MAIL ORDER DEPT.

SEMI CONDUCTORS: 2N2222A 8 for £1, 2N6385 50p, 2N5061 15p, BC182 (TO5) 15 for £1, BC212L (TO5) 15 for £1, BC714L (TO5) 15 for £1, BF245 fet 20p, BU208 £1.50, MJE340AT 50p, 741 (8 pin DIL) 8 for £1, 555 5 for £1, 723 Reg. 25p, Dual 741 30p. **EXTRA SPECIAL LIMITED OFFERS:** 2708 450ns £3.50, 8080A £3, EM4402 (4k Static Ram) £2.

RESISTORS: Carbon Film 1/4w 5% £3/1000 Our Mix. Metal Oxide 1/2w 2% £2/Our Mix. Rectangular Presets (W/W and Cermet) 10/£1 Our Mix. Wirewounds 2w, 4w, 6w, 10w, 40/£1 Our Mix.

CAPACITORS: 100 Disc Ceramic (40 values) £1.50. 100µf 63 volt Radial 12p each 15/£1, 1µf 100 volt Radial Polyester 20p. Can Electrolytic. 680µf 63 volt 25p, 10,000µf 25 volt £1, 3300µf 63 volt £1, 4700µf 63 volt £1.50, 12000µf 25 volt 75p. Computer Type. 1000µf 160 volt £1.50, 1500µf 100 volt £1.50, 11000µf 25 volt £1.25, 21000µf 40 volt £2, 47000µf 25 volt £2.

MISC ITEMS: Pack of 9 Slide Switches 50p, 10 Clear Mains Neons £1, .1" Pitch Edge Connectors Double sided 43 way £1, 48 way £1.50, 500R Ten Turn Pots £1, 15 Turn Dials £1.50, 16 way Low Profile i/c Sockets 10/£1, 7 way DIL Switch 80p.

All prices include VAT. Please add 30p P&P. Large S.A.E. for List

ELECTRO SUPPLIES

MAIL ORDER DEPT.
(Callers please phone first)
Bowness Mill, Shawclough Road
Waterfoot, Rossendale, Lancs.
Tel: Rossendale 5556

RETAIL SHOP
(Open 6 days)
6A Todd Street
Manchester
(next to Victoria Stn.)
Tel: 061-834 1185

Happy Memories

4116 200ns	£2.95	2114 200ns	£3.45
2114 450ns	£2.95	2716 5 volt	£7.95
2708 450ns	£4.75		

MEMOREX SOFT-SECTORED MINI-DISCS for PET, TRS-80, etc. Supplied in **Free Library Case**
£19.95 per 10

Low Profile I.C. Sockets by Texas

Pins	8	14	16	18	20	22	24	28	40
Pence	10	11	12	16	17	20	21	28	37

Memory Upgrade Kits for Apple, 2020, TRS-80, etc. **from £30** please phone

Quantity prices available on request. Government and Educational Orders welcome. Trade accounts opened.

ALL PRICES INCLUDE V.A.T. POSTAGE FREE ON ORDERS OVER £10, OTHERWISE ADD 30p.

Access and Barclaycard Welcome

HAPPY MEMORIES

Dept. ET1

Gladestry, Kington
Herefordshire HR5 3NY
Telephone (054422) 618

AVOID DANGER from RADIATION WITH OUR RADIATION DETECTOR

Recommended for: Civil Defence, Fire, Hospital, Medical and general use

General Information:

Pocket dosimeters provide an accurate, reliable and immediate method of measuring the integrated dose of radiation received by those exposed to ionising radiation. The dose may be read at any time and in any place, providing a source of light is available.

Principle:

The dosimeter is an ionisation chamber type using a quartz fibre electroscope as the indicating element. A microscope is used to project the image of the moving quartz fibre element on to a graticule scale. The quartz fibre is mounted on a wire electrode, which in turn is supported by a high quality insulator. When the instrument is charged, positive charges distribute themselves over the wire electrode and quartz fibre causing the fibre to bend away from the electrode. The fibre will take up a position depending on the amount of charge on the system.

When the surrounding air in the ionisation chamber is ionised negative ions will be attracted to the positively charged electrode thereby reducing its charge. The resulting fibre movement will be related directly to the quantity of radiation producing the ionisation. The fibre movement can thus be calibrated directly in roentgen units and the rate of movement of the fibre will be proportional to the roentgens received per unit time.

Construction:

The microscope, electroscope and ionisation chamber are housed in an outer skin which may be of brass or aluminium. At one end of the tubular case is fixed a charging assembly, and at the other an eye-piece window.

Each dosimeter is provided with protective end cap translucent window so that the cap need not be removed for reading.

Dosimeters meet vibration, drop, salt spray, humidity, water immersion and temperature tests.

- BE PREPARED, EVERY HOME SHOULD HAVE ONE ●

YOU CAN'T SEE IT
HEAR IT
FEEL IT
BUT YOU CAN DETECT IT

WILL READ X-RAY & GAMMA RADIATION

Features:

- THESE UNITS WILL READ AUTOMATICALLY THE AMOUNT OF RADIATION IN THE AIR
- THIS INSTRUMENT IS ONLY A LITTLE LARGER THAN A FOUNTAIN PEN
- CLIPS ON TO YOUR TOP POCKET
- WEIGHT LESS THAN 3 OZ.
- CONTAINS THREE LENSES
- FULLY CHARGED, TESTED AND GUARANTEED
- BRITISH DESIGN AND MANUFACTURE, RUGGED CONSTRUCTION
- MANUFACTURER'S LIST PRICE OF SIMILAR MODEL IS OVER £25
- BUY NOW WHILST STOCKS AVAILABLE. DELIVERY BY RETURN POST

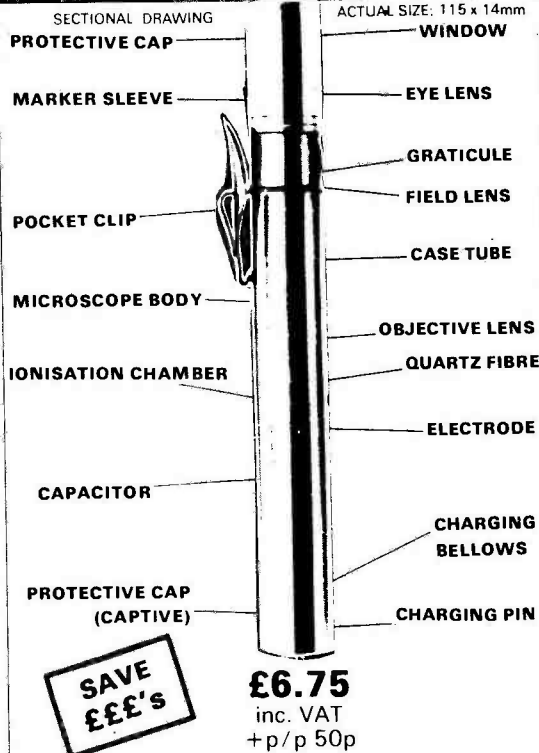

Manufacturer's current list price similar model is over £25



HENRY'S

Mail Order Division
404 Edgware Road, London W2, England I.E.D.

TELEX 262284
REF. 1400



Supplied complete with Data and Information on radiation and detectors.

All units are checked and tested just prior to despatch by first-class mail in proper protective packing.

VIEW THRU LENS



TEKTRONIX STORAGE OSCILLOSCOPE. Type 434, as new. 12 months' warranty £1,950.

TEKTRONIX OSCILLOSCOPE. Type 647, with 10A2 and 3B11. £500

TEKTRONIX STORAGE OSCILLOSCOPE. Type 564 with 3A6 and 3B4 £350.

TELEQUIPMENT STORAGE OSCILLOSCOPE. Type DM53A £285.

TELEQUIPMENT OSCILLOSCOPE. Type O32. Portable, mains/battery. £275.

HAMEG OSCILLOSCOPE. Type 512 DB, 50MHz £350.

TELEQUIPMENT OSCILLOSCOPE. Type S54A SB 10MHz, £190.

SE LABS OSCILLOSCOPE. Type SM111 DB 20MHz, £325.

ADVANCE OSCILLOSCOPE. Type OS1000 DB 15MHz, £250.

TEKTRONIX OSCILLOSCOPE. Type 547 with 1A1 plug-in Dual TB. 50MHz £375.

TEKTRONIX OSCILLOSCOPE. Type 561A with 3A1 and 2B67 10MHz, £300.

TEKTRONIX OSCILLOSCOPE. Type 533A with CA. DB 24MHz, £140.

HEWLETT PACKARD AC CONVERTOR. Type 3461A £120.

MARCONI FM SIG. GEN. Type TF1066B/ES. £295.

G. B. & BRADLEY LTD. R.F. MILLIVOLTMETER. Type 112 £75

ADVANCE A.C. VOLTMETER. Type VM77 £60

MARCONI WAVE ANALYSER. Type VM30. Good condition. £150

AVO R.F. SIG. GEN. Model HF135. £75

MARCONI WIDE RANGE R.C. OSCILLATOR. TF1370. £95.

MARCONI AM/FM SIG. GEN. Type TF1066/1. £225

MARCONI SENSITIVE VALVE VOLTMETER. TF2600. £50.

MARCONI SIG. GEN. MK2. TF995A/3/S (CT402) £275.

PHILIPS F.M. STEREO GENERATOR. Type PM645B. £120

TEKTRONIX type 1130 SPECTRUM ANALYSER PLUG-IN. (works, slight corrosion) £225

AIRMEG SIGNAL GENERATOR. Type 204 AM/FM 320MHz £150

WAYNE KERR UNIVERSAL BRIDGE. Type B221 £50

B&K AUTOMATIC VIBRATION EXCITER CONTROL. Type 1018 £50

B&K AUTOMATIC VIBRATION EXCITER CONTROL. Type 1019 £50

MARCONI UNIVERSAL BRIDGE. Type TF868B £100

SOLARTRON TRUE RMS VOLTMETER. Type VM1484 £75

TAYLOR VALVE TESTER. Type 45D £85

ADVANCE LF OSCILLATOR. Type HIE £45

ADVANCE SIGNAL GENERATOR. S628 150KHz-220MHz £60

MARCONI UNIVERSAL BRIDGE. Type TF868A £60

TAYLOR METER MODEL 128. £15

R&S SELEKTOMAT USNY. BN 15221/2 £100

R&S LEVEL RECORDER. TD 2300 £50

RACAL HF SELECTIVE ANALYSER. Type 9056 £375

SCHLUMBERGER AUTO COUNTER. Type FB2602. £150

MARCONI F.E.T. MULTIMETER. Type TF2650 (new) £95

AVO MULTIMETER 9 Mk 11. £80

LEVEL MULTIMETER. Type TM 11 £50

ICE MULTIMETER SUPERTESTER 680R £18

AVO MULTIMETER 8 MK111 £45

MARCONI SIGNAL GENERATOR. Type TF144H. £225

MARCONI SIGNAL GENERATOR. Type TF801D/1/S. £195

MARCONI UNIVERSAL BRIDGE. Type TF1313. £260

MARCONI SIGNAL GENERATOR. Type 365A. 1 to 320MHz AM/FM. £175

R&S Z-G DIAGRAPH BN3582 300-2400MHz £85

R&S POLYSCOPE 1 SWOB BN 4244/2/50 £350

WAYNE KERR COMPONENT BRIDGE. CT375 (BS21) £75

R&S UNBALANCED STANDARD ATTENUATOR 500ohm. BN 8942/50 £45

STODDART AIRCRAFT Radio Interference and Field Intensity Meter. type NM-52A 375-1000MHz (2 pieces) £325

MARCONI SIGNAL GENERATOR. Type TF801B £85

R&S DIRECT CAPACITANCE METER £50

B&K HETERODYNE VOLTMETER (RECEIVER) Type 2005 £250

MARCONI VARIABLE VOLTAGE GENERATOR. Type TF1073A/25 £60

MARCONI DOUBLE PULSE GENERATOR. Type TF1400/S £50

RADIOMETER (COPENHAGEN) WAVE ANALYSER. Type FRA 20T3a £80

SOLARTRON DIGITAL VOLTMETER. Type LM1867 £75

HEWLETT PACKARD DIGITAL RECORDER. Type 5050B £50

HATTFIELD P50PHOTOMETER. Type DRC 657167A £30

ADVANCE DUAL STABILISED D.C. SUPPLY PP3. 0-30V 1A £25

MARCONI COUNTER FREQUENCY METER TF1417/2 with 10-500MHz Converter TF2400. The Pair £50

PICTURE MONITOR MODEL PM-52T (5in screen) As new £55

HEWLETT PACKARD POWER SUPPLY 6214A. 0-12V. 0-1.2A. new, boxed. £85

H.P. TRIPLE OUTPUT POWER SUPPLY 6236A. 0-6V. 0-2.5A/0-20V. 0-0.5A. new, boxed £175

H.P. DC POWER SUPPLY 6209B. 0-320V. 0-0.1A. new, boxed. £140

T.O.A. ELECTRONICS LTD Electronic Polyrecorder EPR-2T Mains £120

THE JAMES KING COMPANY FS-11007 FREQUENCY STANDARD £50

MARCONI CARRIER DEVIATION METER. Type TF891D £50

SOLARTRON PULSE GENERATOR. Type G01101 £240

MI SANDERS LEVELLING AMPLIFIER. Type 6587 £175

SICOPEX OSCILLOSCOPE. Type 4D10 DB 10MHz £170

ADVANCE OSCILLOSCOPE. Type OS240 DB 10MHz £175

COSOR OSCILLOSCOPE. Type CDU150 DB 35MHz £225

TELEQUIPMENT OSCILLOSCOPE. Type D61 DB 10MHz £195

HEWLETT PACKARD OSCILLOSCOPE. Type 1209 X/V. From £85

FLUKE DIFFERENTIAL AC/DC VOLTMETER. Model 832A £60

ADVANCE AUDIO SIGNAL GENERATOR. Type H1. Sine/Square £25

R & S TUNABLE INDICATING AMP. BN 12121/2 45-600MHz £100

LYONS PULSE GENERATOR PG718 Bipolar. £85

MUIRHEAD WAVE METER. Type G01101 £240

HEWLETT PACKARD DIGITAL VOLTMETER. Type 3460B £75

WAYNE KERR THERMOMETER. Type LT1100 with probe. £50

HATTFIELD RADIO FREQUENCY BRIDGE. Type LE300A/1. £50

SOLARTRON OSCILLOSCOPE. Type CD1400. DB 15MHz. From £75

HARD OSCILLOSCOPE. Type HM4 12. £250

KNIGHT RF SIG. GEN. KG686 with Sweep Marker Gen. KG687. The Pair £100.

HEWLETT PACKARD DISPLAY 143A with 1424A Sampling Timebase and 1411A Sampling Vertical Amplifier. Up to 4GHz. Large Display. £350.

H.P. MEMORY DISPLAY 5480B with 5486A Control TB and 5488A Y System. £275

H.P. MEMORY DISPLAY 5480A with 5486A Control TB and 5485A two channel input. £225.

R&S UHF TEST RECEIVER 0.9-2.7GHz. BN1524 £150

EDDYSON RECEIVER. Type 9805 250-850MHz. £450

R&S UHF TEST RECEIVER. BN1523 280-940 MHz. £120

KEITHLEY REGULATED HIGH VOLTAGE SUPPLY. Type 241. £250

HEWLETT PACKARD D.C. CURRENT SOURCE. Type 6181B £175

MARCONI XY MEMORY Type TK2214. £140

R&S UHF SIGNAL GENERATOR. BN41022 300-1000MHz £80

PHILIPS PAL COLOUR TV PATTERN GENERATOR. PM5508. £150

GPO DATEL WAVE METER. £100

LEVEL BROADBAND VOLTMETER. Type TM6B. £40.

DAWE AF ANALYSER. Type 1461A. £30

R&S UHF/VHF FREQUENCY METER. BN442 30-3000MHz £60

R&S UHF MILLIVOLTMETER. BN1091. £70

GEROLD SWEEP FREQUENCY GENERATOR. Model 602. £40

TELEFONIC SWEEP GENERATOR. Type SB-3 450-900 MHz £75.

H.P. VHF SIGNAL GENERATOR. Type 608D. Case damaged hence £50

MARCONI VALVE VOLTMETER. Type TF1300. £15

SOLARTRON DIGITAL VOLTMETER. Type LM1420. £2. £30

GEROLD SWEEP TESTER. Type V33. £30

LABEARG COLOURMATCH 625 PATTERN GENERATOR. Type CM6004. PG. £30

B & K BEAT FREQUENCY OSCILLATOR. Type 1014. £175

B & K AUDIO FREQUENCY SPECTROMETER. Type 2112. £225

ADVANCE OSCILLOSCOPE. Type OS1000A. DB 20MHz. £300

JUST IN TORODIAL TRANSFORMER

Input 0-120-240 Volts. Output 0-12V; 0-12V, 10VA per winding. Encapsulated, identical to R.S. Components at £8.90.

OUR SPECIAL PRICE. P&P £1.50

TANTALUM CAPACITORS — all at 10p each 22mf 6V; 39mf 10V; 22mf 35V; 1mf 35V.

TANDY TRS 80

Level 2 Microprocessor System comprising of Display, Keyboard with processor and 16K memory; Expansion Interface with 32K additional memory; two Floppy Disk Drives; Tandy Printer; manuals, books, disks, etc. — including Updated DOS Disks. Hardly used. EXCEPTIONAL CONDITION. Will separate off

THE LOT £1,600

INFRA RED IMAGE CONVERTER Type 9606 (CV 144)

1 3/4in diameter. Requires single low current 3KV to 6KV supply individually boxed. With data.

£12.50 each

Infra Red Lamps also advertised

GARRARD DIRECT DRIVE TURNTABLE MOTORS

Made in Japan. With internal electronic speed control. 24 volt. Connections supplied.

£3.50 each. P&P £1.50

EX-MINISTRY SOLID STATE 400 Hz INVERTER

28 VDC input, 115V output. Size 7 x 2 1/2 x 1 1/2in approx. Connection details supplied.

£18 each. P&P £2

TRANSISTOR INVERTOR

115V AC 1.7 Amp Input. Switching is at 20KHz. Output windings from Pot Core. Can be rewound to suit own purpose or unit can be broken for host of components. Circuits supplied.

£1.25 each. P&P £2

CONVERT THIS UNIT TO A SUPER BATTERY CHARGER

Attractive green ministry quality case with removable top and bottom plates — heavy duty power switches, high powered resistors to control current, good quality centre mounted amp meter, strip of wing nut terminals on front panel which can be used for connecting leads. All this for **£3.50. P&P £2.** Four units £12. Carriage £5

STEPPING MOTORS

6/12 position with additional where the rotor is coils. Device can be used as a tacho. Diagram supplied. Will actually work on 5 volts. 12/24 recommended.

£1.50 each P&P 75p
or 5 for **£5 P&P £1.50.**

STEPPING MOTORS

200 Steps. 20 oz/in. torque. 12/24 volt input 4-wire

£12 each. P&P £1.50

KEYBOARD PAD

Size 3x2 1/2 x 2 1/2" high with 12 Alma Reed Switches. Blue keys marked in green 0-9 and a star with one blank.

£4 each. P&P £1. or 5 for **£15 P&P £2.**

MINIATURE KEYBOARD

Push contacts, marked 0-9 and A-F and 3 optional function keys. **£1.75 each.**

CRYSTALS 50p each.

Flat metal case — 19.2KHZ; 844.8KHZ; B7G — 10MHZ.

LOUDHAILERS. Transistorised hand-held. no leads. Standard internal batteries supplied. Howl Switch. **£20 ea.** P&P £2

INFRA RED QUARTZ LAMPS. 230V 620 Watts. Size 1 1/2" x 1 1/2" dia. **£1.50 ea.** 240V 1650 Watts. Size 2 1/4" x 1 1/2" dia., **£3 ea.**

BRIDGE RECTIFIER. 2 Amp 50p ea.

PHOTODIODE DETECTOR 4" fly leads. 25p ea.

AMPHENOL. 17-way chassis mount edge connectors 0.1 spacing. 15p ea.

I.E.C. Standard MAINS LEAD. Moulded (3 vertical flat pins centre offset) 60p ea.

DELAY LINE. 50 nanoseconds. 3 connections — ground-in-out Size 2 x 7/16 x 5/16" New 25p ea.

Miniature MOTORS. 2V with geared wheel (8 teeth 3/16" dia). Size 1 1/4 x 1/4" dia. New 30p ea.

MOTOR 12V DC with pulley and integral semiconductor. Speed Control. New £1 ea.

LEDEX ROTARY SOLENOIDS. 115V DC. No switch assembly. 15p ea.

SOME TEKTRONIX 500 range oscilloscopes

with Single Trace Plug-ins. Working.

From £100. Phone for details

DIAMOND H CONTROLS ROTARY SWITCH. Single pole 10-way. Printed Circuit Mount. New 10p ea. 100 for **£7.50**

PULSE TRANSFORMER. Sub. min. Size 1/2 x 5/16 x 1/4". Secondary centre tapped. New 20p ea.

MOTOR by Inland Motor Corp. DC High Torque. Reversible. Usable torque at 5V. Max voltage 24V **£2.50 ea.** P&P £2

REMO TV TYPE MULTIPLIER. Two high voltage outputs and focus. **£1 each**

DON'T TAKE CHANCES. Use the proper EHT CABLE. 10p per metre or **£7.50 per 100 metres/drum.** P&P £2

PHOTOGRAPHIC LAMPS. Pearl 230V 500 watt. Screw cap 75p ea. Box of 12 **£5.50.** P&P £1.50.

RAPID DISCHARGE capacitors 8mfid 4kV £5 each. P&P £2

MYSTERY IC PACK. Some 40 pin — good mixture — all new devices. 25 10c for £1. P&P 50p.

VACUUM PUMPS — TRAPS. ETC. Send for list

DECOUPLING CAPACITORS 0.05mfid 10V; 0.01mfid; 0.04mfid 250V; 33K; 330pF. All values 100 for **£1.50.**

E.H.T. Capacitor 500pf 8KV 20p each.

10-way MULTI COLOUR RIBBON CABLE. New 40p per metre. 10 metres for **£3.**

GEC UHF 4 button tuner £1.50 each.

CENTAUR 115V FANS 4 1/2 x 4 x 1 1/2" £4.50 ea.

EX-USED equipment, tested. 60p each.

CONTACTORS. Heavy Duty 24V DC 5 make **£1 each.**

GEC UHF/VHF 6-button tuner £2 each.

DIGITAL 24-HOUR CLOCK with built-in alarm as used in Braun Digital clocks. Silent running. Large illuminated numerals. AC mains. Size 6 1/2 x 2 1/4 x 2 1/4". **ONLY £3.75 each.**

931A PHOTO MULTIPLIER £2 each. P&P £1.

RANCO 260V 18A THERMOSTATS with Control knobs calibrated 50-200 degree C. **£2.50 each.**

SOLID STATE UHF TUNERS. 30 acs **£1 each.**

BRAND REK blue wire wrap. 30 metres for **£1.** P&P 25p.

SLIDER CONTROL 500K Log. Single track. Complete with knob. Length 3 1/2". **25p each.**

TRANSFORMERS

AUTO 240V input 115 V. 1 amp output £1.25 each. P&P £1 25.

240V input. Soc. 6V. 1.86A. Size 2 1/2 x 2 x 2 1/2". Good quality. **£1.50 ea.** P&P £1

240V input Soc. 12V 0.92A. Size 2 1/2 x 2 x 2 1/2". Good quality. **£1.50 ea.** P&P £1.

240V input 12V 100MA. Size 60 x 40 x 42mm. **50p each.**

240V input. Soc. 12-0-12V 50MA. Size 53 x 45 x 40mm. **£1 ea.**

115V input. Soc. 5V 250MA. Size 1 1/16 x 1.5 x 1 1/2" **2 for 50p.**

115V input. Soc. 10-0-10V 1A. Size 2 1/2 x 2 x 2 1/2" **2 for £1.50.**

SEMICONDUCTORS 1N4005 — 5p; 1N4002 — 3p.

At 5p each:

BC147, BC148B, BC157, BC158, BC237, BF197, OA90, OA81, BA154, BA243

DIODES

All new full spec. devices IN3063

BAX 13 1S44, 1N4148;

1N3470; 1N4151;

100 off **£1.50.** 1,000 off **£10**

At 25p each:

1P31; 1P41A, 2N5396, AF139, 2TX341

BY127 10p; BF181 20p; BD239 40p; BD241 40p; MA334AT

40p; BD228 50p; BD233 & BD234 Comp Pair 25V — 80p per pr. at 50p each.

REGULATOR TBA625 8to 20V in — 5V out 100MA T05 Con. **50p each** BF256C 20p.

TV AMPLIFIER TBA 120 20p each.

Integrated Circuits

7453	5p	74H74	12p	75325	£1
7451	5p	74H51	7p	SN15862	4p
7402	12p	74538	10p	MC4028	60p
7476	20p	74502	12p	7417	14p
7495	35p	74154	70p	7441	40p
74122	12p	74C02	16p	74C86	60p
74C00	17p	74C04	18p	74C161	24p
		74C74	18p		

MOTOROLA DUAL in Line 6 pin Opto Coupler **30p each.** Gold plate tester version **50p each.**

PROMS 2708 £50 each.

SMITHS encapsulated transistorised AUDIBLE WARNING DEVICES 4V-12V. Can be driven from TTL **85p each.**

ELECTROSTATIC VOLTMETER. 7.5KV **£8. ea.** P&P £1.50

Other ranges available — please enquire.

TRIMMERS. Sub.min. 0.25 to 1.25pF. 1 to 4.5pF. 7 to 45pF. All at 6p each.

HONEYWELL humidity controllers **50p each.**

THYRISTOR TIMER. Solid State. 15 secs adjustable (reset) in plastic relay case. Standard 7pin base. Series delay **60p each.**

MINIATURE PC MOUNT SLIDE SWITCH. Single pole 3-way **10p each.**

4 D1G17 SEGMENT per digit plus a figure one to the left plus a centre minus sign to the left of the figure one with decimal places between digits. Good brilliance at 1.5V. 15 connections **£2.50 each.** Some E.H.T. Transformers and Capacitors available. Please enquire.

TELEPHONES 706 style black; grey or blue **£5.60 ea.** 746 style black or grey **£7.80.** Older style black **£2.60 each.** Discoloured grey **706 £4 ea.** P&P £1.50 per telephone.

DC SERVO MOTOR 110V 2.5Amp continuous. Double shaft. Brand new. 4 wire. 4 brush **£25 ea.** Plus carriage.

PC Mount POTS. Wire wound with knob 200 ohm & 10ohm **10p ea.**

MIN. RELAY 24V. 2 pole c/o. Brand new. **75p each.**

TIME DELAY RELAY 0.1 to 10 secs. 115V AC. DPDT. **£5 each.**

CAPACITORS at 5p each. 0.1uf 400V. Small rec. block PC Mount German class; 3300pF; 220n/250V; 0.01mfid 160V.

INSERT can be used as Microphone/Earpiece (Like used as insert in telephone but superior quality) Ex-Min. Brand new wrapped **75p each** or 10 for **£8.**

LARGE EX-MINISTRY SPEAKERS. OUTSIDE 15 ohm or 500 ohm. Tested. **£25 each** or 5 for **£100.**

MINIMUM ORDER £3 VALUE OF GOODS. MINIMUM P&P £1 — where P&P not stated please use own discretion — excess refunded.

£5 CARRIAGE ON ALL UNITS. P&P OR CARRIAGE AND VAT at 15% on total MUST BE ADDED TO ALL ORDERS.

CALLERS VERY WELCOME STRICTLY BETWEEN 9am-1pm and 2-5pm Monday to Saturday inc.

BARCLAYCARD (VISA) and ACCESS taken. Official orders welcome.

CHILTEHEAD LTD

NORWOOD ROAD, READING **TELEPHONE NO. READING 66956**

(2nd turning left past Reading Technical College in King's Road then first right — look on right for door with "Spoked Wheel")

AUDIOPHILE FM TUNER



A high performance stereo tuner with preset and manual tuning facilities, LED tuning and signal strength scales. Optional extras are an automatic search-and-lock tuning facility and a stereo LED audio level indicator. Design by Ray Marston. Development by Steve Ramsahadeo.

The heart of this unusual FM stereo tuner project is a ready-built type 7254 tuner module available from Ambit International. This module has built-in varicap diodes and is tuned by an externally applied DC voltage. It requires a mere handful of external components, plus a regulated 12 V power supply, to make a ready-to-run tuner unit with switch selection of muting, AFC and mono/stereo functioning. The audio output of the module (about 200 mV RMS) can be fed directly to the input of any stereo audio preamp.

Construction

We strongly recommend that you build up the individual units of this project one at a time and interconnect and test them on the open bench before fitting the full set of modules (with or without the optional 'extras') into the final case. Start off by building the power supply unit and check that a stable 12 V is available at the output of IC1.

Next, refer to the basic wiring and interconnection diagram and temporarily wire up the 7254 module as shown,

Spot the Tune

In our Audiophile tuner unit we've provided the basic 7254 module with switch-selected tuning either with one of four preset pots for fixed station selection, or with a 10-turn pot for normal manual tuning. As an optional extra, you can also tune with a special search-and-lock circuit which automatically locates and locks on to strong FM broadcast stations. This circuit is provided with 'search' buttons that can be used to rapidly find the approximate location of a wanted station or reject an unwanted station.

We've designed our FM tuner to cover the 87.5 MHz to 104.5 MHz frequency range, with tuning indication provided on a linear 20-LED frequency scale. We've also provided the unit with a 10-LED signal-strength meter and with an optional stereo audio level indicator with 10 LEDs on each channel. The completed 'full option' unit is exceptionally attractive, with lots of fixed and moving lights, and gives a very impressive performance in the automatic 'search-and-lock' mode.

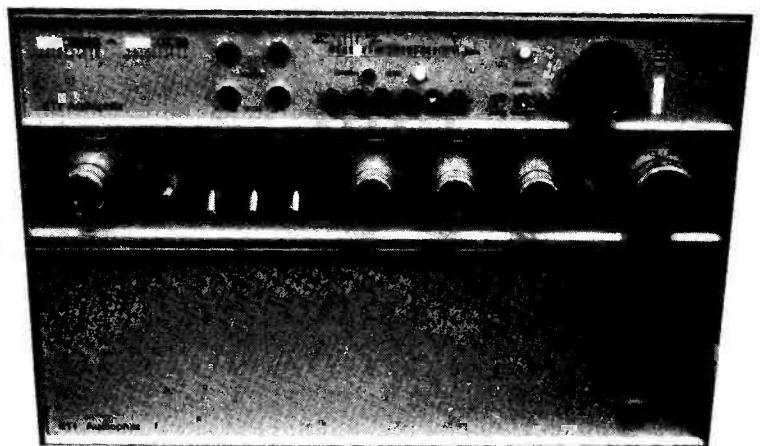

The Audiophile FM Tuner has been designed to match the Audiophile 4000 preamp and power amplifier (featured in ETI October 1979).

connecting the following components in place: R1, R2, R3, LED 1, SW1, SW2, SW3, SW4, PR1 to PR4, RV1, R4, R5. Note that on our prototype unit we used six interlocking push buttons (including one for the 'automatic' tuning mode) to make SW4 and mounted them on their own PCB, together with multi-turn preset pots PR1-4. Connect the unit to the 12 V power supply, connect an antenna (a few feet of wire should be adequate) and connect the audio outputs of the module to a preamp/power amplifier combination.

Switch the unit on, turn SW4 to position five (manual tuning), SW1 (muting) on, SW2 (AFC) off, SW3 (mono/stereo) to mono and check that the unit can be tuned with RV1. Check that interstation noise is suppressed to a reasonable level when mute switch SW1 is on. If necessary, trim the 100k pot on the 7254 module to obtain satisfactory muting. Check that the unit is functional in the four preset positions of SW4. Finally switch SW3 to the stereo mode and check that LED 1 turns on when a stereo station is tuned in and that stereo noise is not excessive. If necessary, trim the 10k pot on the 7254 to obtain the correct stereo operation.

Now make up the 20-LED frequency scale on PCB 'A'. Note that this board uses square LEDs, mounted horizontally. Fit the LEDs in place with great care, ensuring that their front faces are all in line and overhang the edge of the PCB by the thickness of the front panel of your proposed tuner case. When construction is complete, make the connections to the power supply and to pin 1 of the 7254 module. Switch on and adjust PR2 to set 1V75 between point 'A' and ground. Check that the frequency scale can be fully scanned via RV1 in the manual tuning mode, noting that the PCB is fitted upside down in the final tuner case, so that the display moves to the right with increasing tuning voltage and frequency.

Signal Strength Meter

Next, build up the optional LED signal strength meter on PCB 'C', noting that R39 is mounted on the underside of the PCB and that square LEDs are again used. In this instance the LEDs are mounted vertically on the PCB and special care must be taken to establish the LED heights, as follows. Make a mock-up of the signal strength meter section of your final front panel, complete with a cut-out for the 10-LED display, temporarily fit the PCB in its final 'fixed' position behind the front panel, push the two end LEDs into position on the PCB with their faces flush with the front of the panel and then solder into place. Now fix the remaining eight LEDs in place, using a straight edge across the two end LEDs to give the correct height adjustment. When construction is complete, connect the unit to the power supply and to the 7254 module, scan the band in the manual mode and adjust PR3 so that the lowest signal strength LED is barely on with the weakest of input signals; you'll find that only the lowest three to seven LEDs illuminate under most signal conditions.

Auto Search And Lock

The search and lock circuit is an optional 'extra' and requires some care in setting up. Construct the PCB as shown in the overlay, taking care to use good quality (low leakage) tantalum components in the C7 position. Temporarily remove the link from the completed PCB, connect the board into the tuner circuit, TURN THE AFC OFF (SW2), turn SW4 to auto position and switch the unit on. Check that the frequency scale can be scanned up and down using the fast and slow search buttons (PB1-4) and that a selected station remains in tune for a

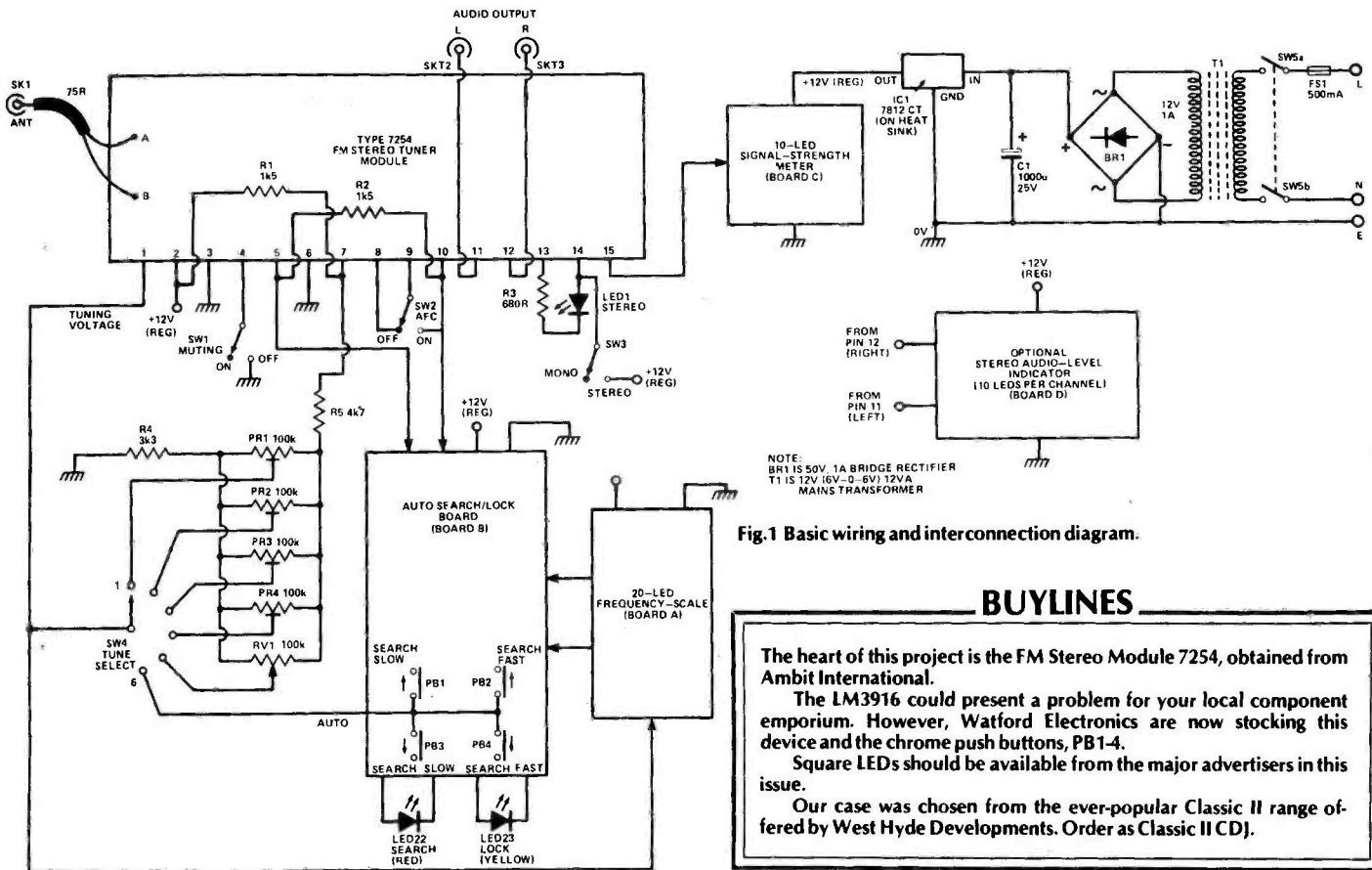

Fig.1 Basic wiring and interconnection diagram.

BUYLINES

The heart of this project is the FM Stereo Module 7254, obtained from Ambit International.

The LM3916 could present a problem for your local component emporium. However, Watford Electronics are now stocking this device and the chrome push buttons, PB1-4.

Square LEDs should be available from the major advertisers in this issue.

Our case was chosen from the ever-popular Classic II range offered by West Hyde Developments. Order as Classic II CDJ.

reasonable time (at least a minute) when the buttons are released. If all is well, insert the link on the PCB.

Switch SW4 to the manual tuning position, tune upwards (with RV1) towards a reasonably strong station and very carefully adjust PR2 so that the search LED (LED 22) is normally on, but turns off and switches lock LED 23 on just as the signal strength indicator goes past its peak reading position. Repeat the action several times, checking that the lock LED acts as an effective 'optimum tuning' indicator.

Now switch SW4 to the auto tuning position, drive the tuning scale fully to the left with the PB4 fast left button and then release PB4. The circuit will now start slowly scanning up the band (to the right), looking for a strong station. When a suitable station is located, the circuit will scan fractionally past the peak signal strength position and then lock on, driving on LED 23. The search LED will subsequently give an occasional flash as a correction pulse is generated to maintain correct tuning. If necessary, trim PR2 very slightly to obtain the same action.

The design is built around the assembled 7254 timer module (below).

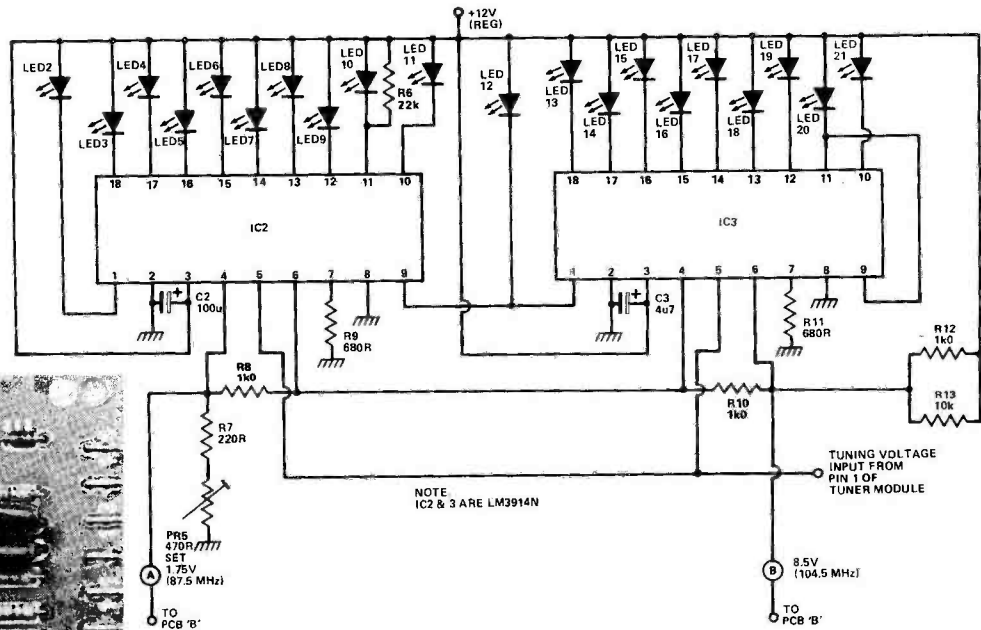
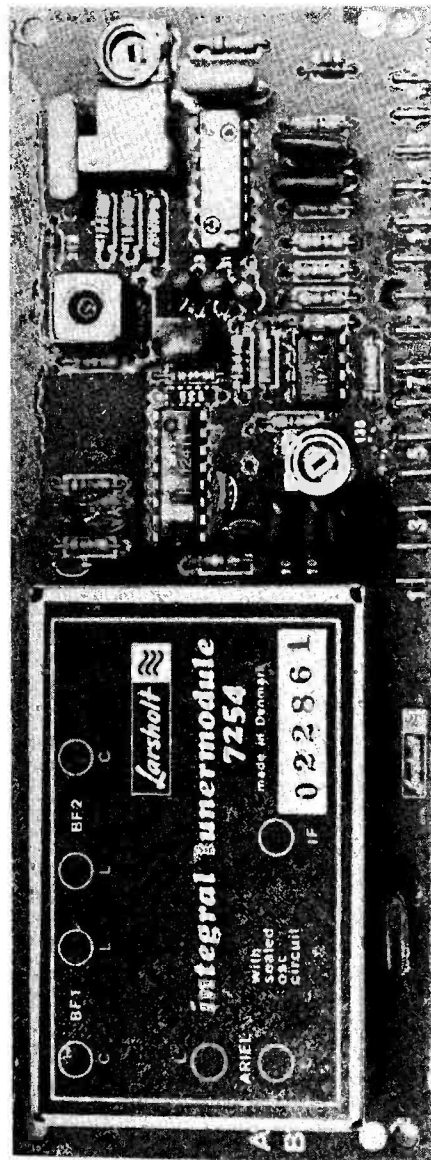

Fig.2 Circuit diagram of the 20 LED frequency scale. This circuit is driven by the timer module (with its ancillary components) and so the component numbering follows on from the module.

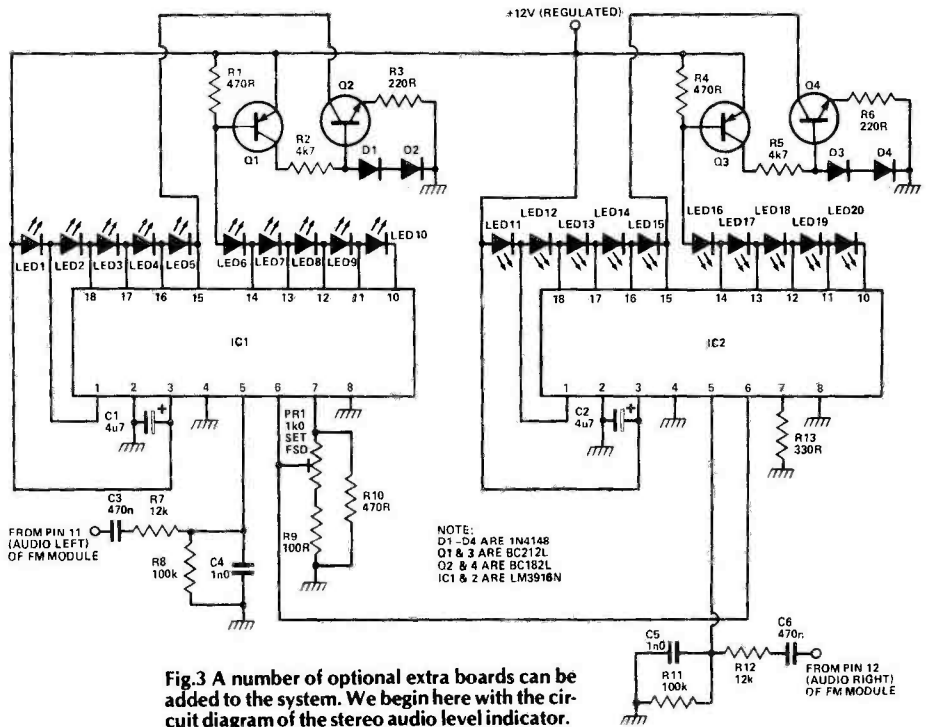

Fig.3 A number of optional extra boards can be added to the system. We begin here with the circuit diagram of the stereo audio level indicator.

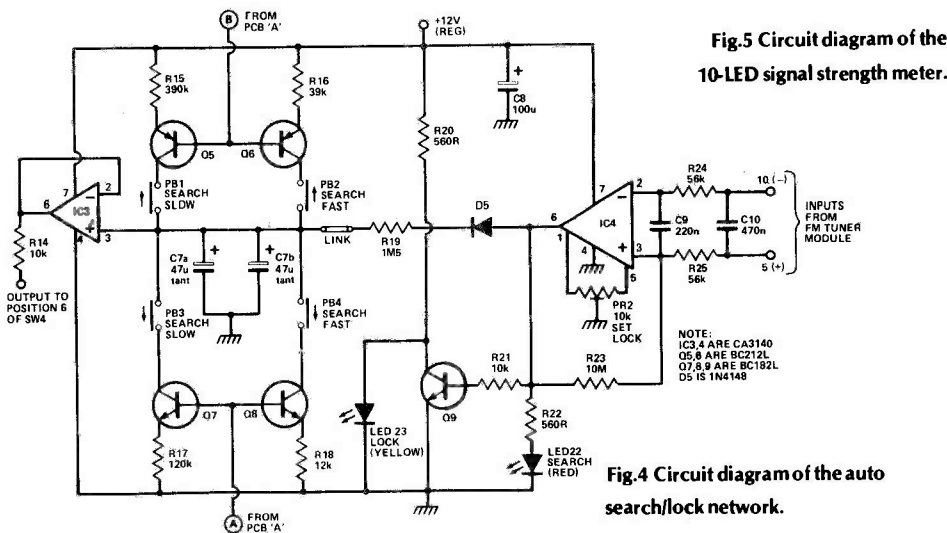

Fig.4 Circuit diagram of the auto search/lock network.

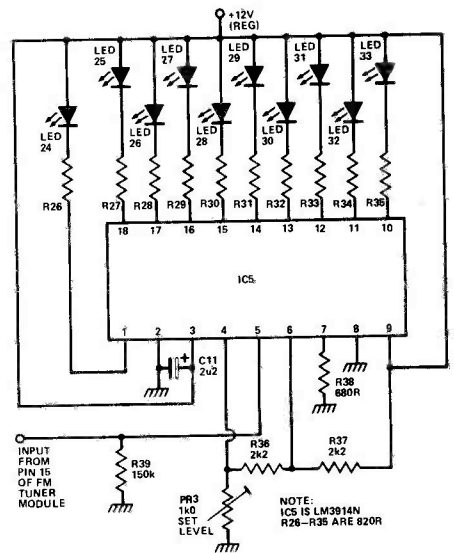

Fig.5 Circuit diagram of the 10-LED signal strength meter.

HOW IT WORKS

The heart of the ETI Audiophile FM Tuner is a ready-built type 7254 FM stereo tuner module with built-in varicap diodes, designed to be tuned with an external DC voltage applied to pin 1. In our application this tuning voltage can be derived from the 12 V regulated power supply line via the R1-R5-PR1-to-PR4-RV1-R4 potential divider or via an auto search-and-lock board. In either case, we use a 20-LED 'voltmeter' circuit to monitor the pin 1 voltage and to thus act as an effective frequency or tuning scale.

The 7254 tuner module has a number of useful output pins. Pin 7 includes an AFC voltage which can be used (via the tuning potential divider) to hold stations on-tune. A voltage proportional to the tuned signal strength is generated at pin 15 and is used in our circuit to drive a 10-LED indicating meter. Tuning meter 'nulling' signals are generated between pins 5 and 10 and are used in our application to control an automatic search-and-lock circuit. Decoded stereo output signals are available at pins 11 and 12 and can be used to drive an optional stereo audio-level indicator as well as for feeding audio signals to an external preamp power amplifier combination. The 20-LED frequency scale is simply an expanded scale LED voltmeter circuit designed around two series-connected LM3914 bargraph ICs operated in the 'dot' mode. The lower and upper limits of the voltmeter scale are determined by fixed reference voltages fed to pin 4 of IC2 (1V75) and pin 6 of IC3 (8V5) respectively via the PR6-R7-R8-R10-R12-R13 potential divider. The input to the voltmeter is fed to pin 5 of the two ICs from the pin 1 tuning voltage of the FM tuner module. This voltage is directly proportional to the tuned frequency, so the voltmeter acts as an effective tuning scale.

The 10-LED signal strength meter is also an expanded scale LED voltmeter designed around an LM3914 bargraph IC, but in this case the IC is operated in the 'bar' mode. The lower and upper limits of the voltmeter scale are determined by fixed reference voltages fed to pins 4 and 6 respectively of the IC. The input voltage to the meter is derived from the pin 15 'signal-strength' output of the FM tuner module.

The stereo audio-level indicators take the form of a pair of virtually identical 10-LED voltmeters with semi-log scales. Each voltmeter is designed around an LM3916 bargraph IC, a VU-scaled version of the LM3914. The full-scale sensitivity of the meters is set at a few hundred millivolts peak (to suit individual tastes) by preset PR1 and audio inputs are fed to pin 5 of each IC from the outputs of the 7254 tuner module via a simple filter network. The audio signals are AC-coupled and the meters respond to the positive halves of the waveform only.

The LEDs are connected to the LM3916 ICs in a most unusual manner in this particular application. The actual ICs are operated in the 'dot' mode, with only one output being low at any moment of time, but the LEDs are connected to each IC in two series-connected groups of five and produce a 'bar' form of display. The purpose of this configuration is to provide current conservation. In a normal 'bar' display, if all 10 LEDs are on and each LED consumes 10 mA, the total current consumption is 100 mA. In the configuration shown in the diagram the currents of each group of five LEDs pass through the series-connected LEDs, so that the circuit consumes a total of only 20 mA when all 10 LEDs are on and consuming 10 mA each.

To understand the operation of the circuit, let's take the example of IC1, remembering that only one output pin can be low at any moment. If pin 1 is driven low by an audio output signal, LED 1 goes on and draws (say) 10 mA from the supply. If pin 18 goes low, series-

connected LEDs 1 and 2 both go on and each passes the same 10 mA of current. Similarly, if pin 15 goes low, series-connected LEDs 1-5 all go on and each passes the total of 10 mA that flows into pin 15 of the IC. If pin 14 goes low only LED 6 is turned on by the IC and passes 10 mA into the chip. This current flows via R1 and Q1 base, however, so Q1 conducts and turns on constant-current generator Q2, which, in turn, draws 20 mA (say) through the whole of the series-connected LED 1 to LED 5 'bar'; six LEDs are thus driven on under this condition and the circuit consumes a total of 20 mA. Similarly, if pin 10 goes low the whole LED 6 to LED 10 'bar' is driven on by the chip and the LED 1 to LED 5 'bar' is driven on by the constant-current generator, so all 10 LEDs are on and the circuit consumes a total of only 20 mA.

The search circuit is quite simple. To understand its operation, assume that the link is broken. Capacitor(s) C7 is a low-leakage tantalum type and is used to store a tuning voltage that can be fed to pin 1 of the 7254 tuner module via the IC3 high-impedance unity-gain buffer amplifier and via SW4. Transistors Q5 to Q8 are all wired as low-level constant-current generators and can be used to charge or discharge C7 via 'search' buttons PB1 to PB4 and thus scan the frequency band of the tuner module. When the buttons are released, C7 tries to store the tuning voltage, but in practice the voltage slowly leaks away via the capacitor imperfections and the operating frequency of the tuner very slowly decays downwards. The 'lock' section of the circuit is driven from the pin 5 and pin 10 outputs of the 7254 module. These pins are intended to drive an analogue tuning meter. If you connect a sensitive volt or current meter between these pins in the polarity shown (it is recommended that you do so to check circuit operation) you'll find that the meter will normally give a positive reading, but that the reading will null or go slightly negative when the 7254 module is precisely tuned to a reasonably strong broadcast station. In our circuit, the pin 5 and 10 outputs of the tuner module are fed to voltage comparator IC4 via a simple filter network in such a way that the IC4 output goes high when a station is not present or is off-tune, but switches low when a reasonably strong station is correctly tuned. Thus, when a station is not present the high output of IC4 slowly charges C7 via R19 and D5 and causes the 7254 tuning voltage to slowly increase as the module 'searches' for a station. Under this condition search LED 22 is driven on via R22. Q9 is also driven on via R21 and turns lock LED 23 off. When a reasonably powerful station is located and correctly tuned the output of IC4 switches low, so C7 is no longer charged by R19. D5 is back-biased under this condition, so C7 does not discharge back into IC4. Simultaneously, LED 22 and Q9 are disabled and lock LED 23 is driven on via R20. Once a station is 'locked' in this manner, C7 very slowly discharges via leakage currents, so the tuning voltage slowly decreases. As soon as a station goes fractionally off-tune, however, the IC4 output switches momentarily high and generates a brief 'correction' or 're-charge' pulse which brings the C7 tuning voltage back up to the correct value. This action is indicated by a brief flash of LED 22.

Note in the IC4 comparator circuit that a small amount of hysteresis is provided by R23. Also note that the trip point of IC4 can be varied over a narrow range with PR2, to compensate for slight offsets in the pin 5 to 10 outputs of the 7254 module and allow correct locking to be obtained. If a circuit fails to lock correctly, it may be that the offset of these outputs is excessive. This effect may be overcome by wiring a shunt resistor (value determined by experiment) between the relevant pins of the tuner module.

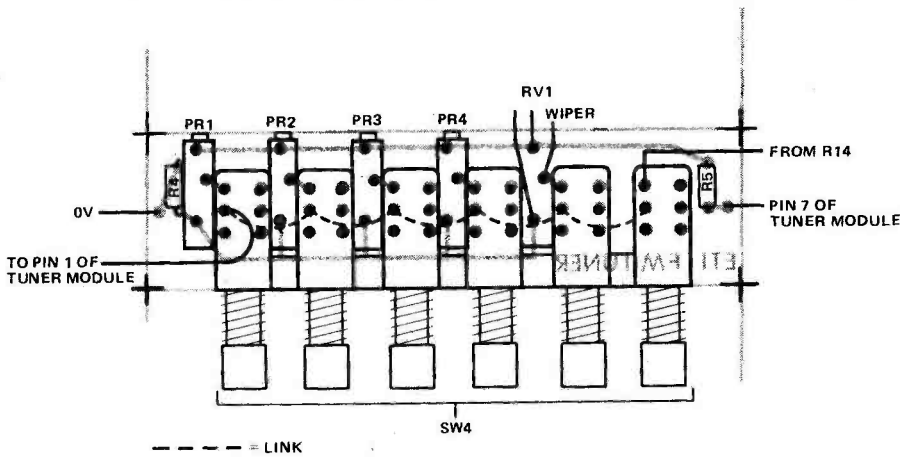
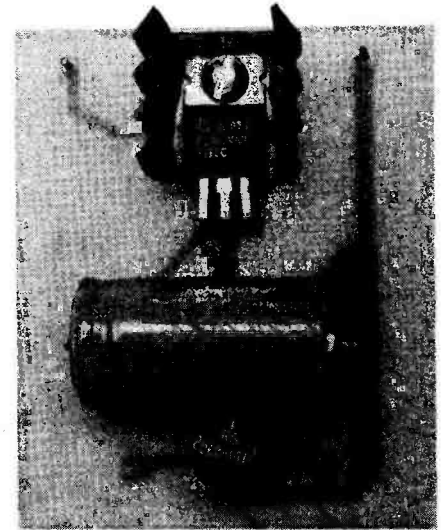

Fig.6 (above) Component overlay of the SW4 six-way switch assembly.



The power supply board — couldn't be simpler.

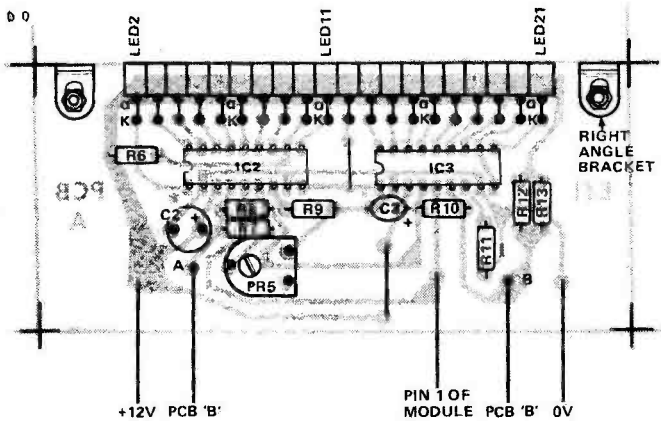

Fig.7 (above) Component overlay of the LED tuning scale.

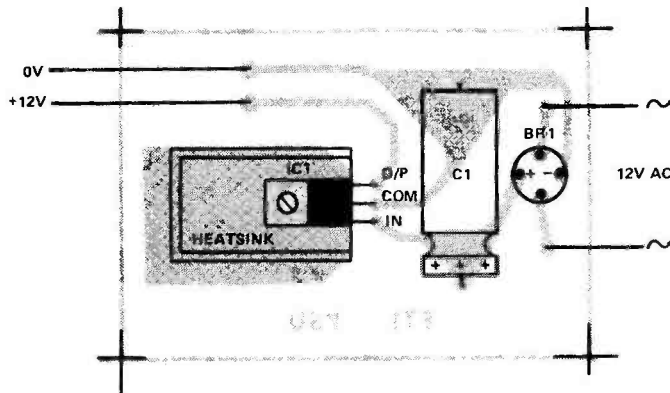

Fig.8 (above) Component overlay of the PSU.

And this is how the whole jigsaw goes together (below).

PARTS LIST

FM Module and Tuning Scale

Resistors all ¼ W 5%

R1,2	1k5
R3,9,11	680R
R4	3k3
R5	4k7
R6	22k
R7	220R
R8,10,12	1k0
R13	10k

Potentiometers

PR1-4	100k ¼ in. 20-turn cermet preset
PR5	470R miniature horizontal preset
RV1	100k 10 turn linear

Capacitors

C1	1000u 25 V electrolytic
C2	100u 16 V electrolytic PCB type
C3	4u7 35 V tantalum

Semiconductors

IC1	7812
IC2,3	LM3914N
BR1	50 V 1A bridge rectifier
LED 1	T1L209
LED 2-21	square LEDs (yellow)

Miscellaneous

T1	6-0-6 12 VA transformer
SW1-3	SPDT miniature toggle
SW4	2 pole changover interlocking push button (6-way assembly)
SW5	DPDT miniature toggle (optional)
7254 FM module	(see Buylines), PCB 'A', fuse and holder, phono sockets (X2).

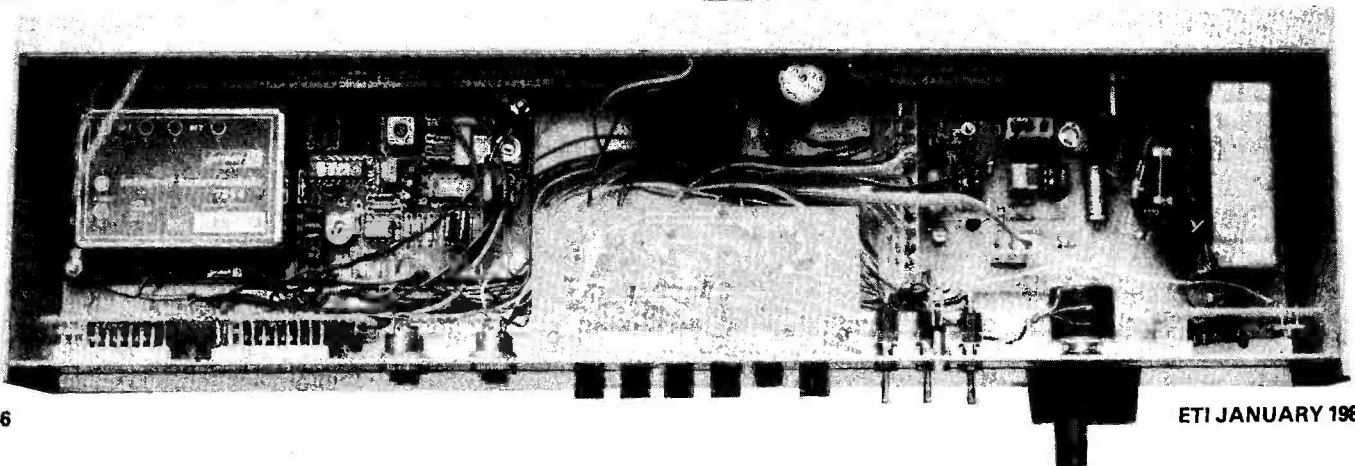

PARTS LIST

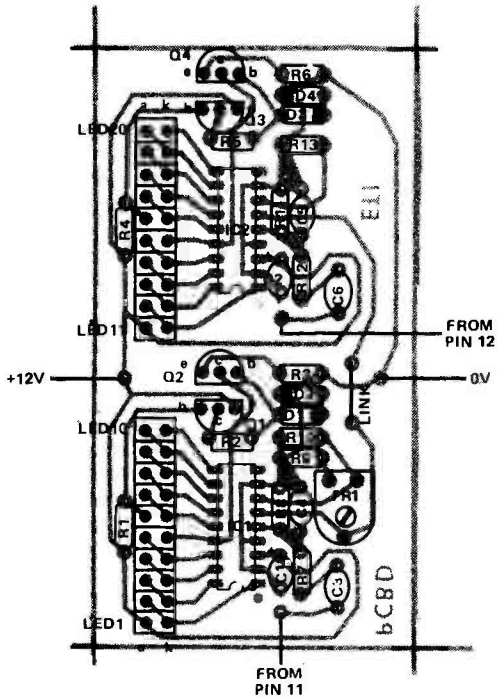

Fig.9 Component overlay of the stereo audio level indicator.

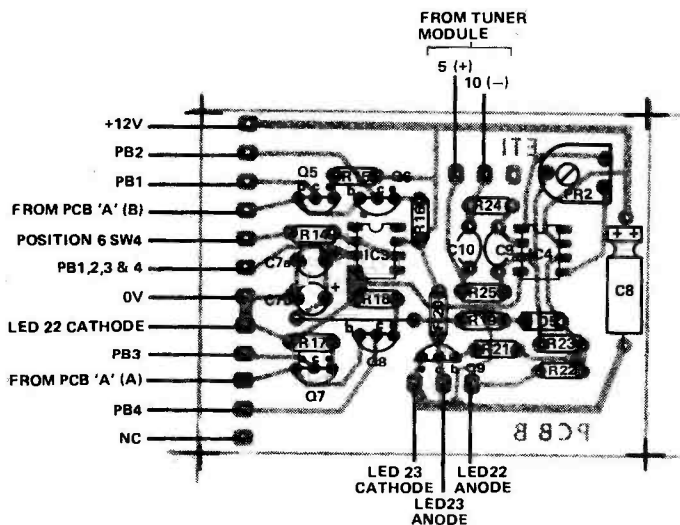

Fig.10 Component overlay of the auto search-lock network.

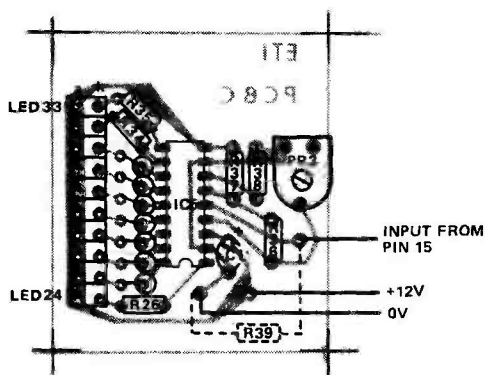

Fig.11 Component overlay of the signal strength meter.

Stereo audio level indicator

Resistors all 1/4 W 5%

R1,4,10	470R
R2,5	4k7
R3,6	220R
R7,12	12k
R8,11	100k
R9	100R
R13	330R

Potentiometers

PR1	1k0 miniature horizontal preset
-----	---------------------------------

Capacitors

C1,2	4u7 35 V tantalum
C3,6	470n polycarbonate
C4,5	1n0 polycarbonate

Semiconductors

IC1,2	LM3916N (see Buylines)
Q1,3	BC212L
Q2,4	BC182L
D1-D4	1N4148
LED 1-20	square LEDs (red)

Miscellaneous

PCB 'D'

Auto search/lock

Resistors all 1/4 W 5%

R14,21	10k
R15	390k
R16	39k
R17	120k
R18	12k
R19	1M5
R20,22	560R
R23	10M
R24,25	56k

Potentiometers

PR2	10k miniature horizontal preset
-----	---------------------------------

Capacitors

C7,a,b	47u 16 V tantalum
C8	100u 25 V electrolytic
C9	220n polycarbonate
C10	470n polycarbonate

Semiconductors

IC3,4	CA3140
Q5,6	BC212L
Q7,8,9	BC182L
D5	1N4148
LED 22,23	TIL209

Miscellaneous

PB1-4 momentary push buttons (see Buylines)

PCB 'B'

Signal Strength Meter

Resistors all 1/4 W 5%

R26-35	820R
R36,37	2k2
R38	680R
R39	150k

Potentiometers

PR3	1k0 miniature horizontal preset
-----	---------------------------------

Capacitors

C11	2u2 35 V tantalum
-----	-------------------

Semiconductors

IC5	LM3914N
LED 24-33	square LEDs (green)

Miscellaneous

PCB 'C'

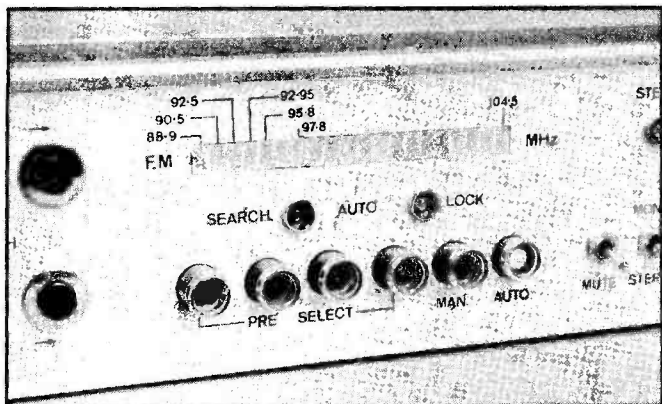

The tuning scale is mounted above the switch assembly, which takes care of manual and auto timing. The search and lock indicators can also be seen.

When using the auto search-and-lock facility, note that the circuit always scans (searches) to the right and will only fully lock on to signals of reasonable strength (it may temporarily lock to weak signals). To rapidly locate a required station, the search buttons may be used to set the tuning scale slightly to the left of the known position. The search buttons can also be used to unlock from an unwanted station. Also note that the AFC facility must be turned off when the auto search-and-lock circuit is in use.

Stereo Audio Level Indicator

The stereo audio level indicator is an optional item and gives an attractive visual indication of the tuner's audio output signals. The circuit is built on PCB 'D' and uses 10 square LEDs on each channel. These LEDs are mounted vertically on the PCB, their heights being adjusted in the same way as for the signal strength indicator board. When construction is complete, wire the unit into place (connect its 0 V rail directly to the power supply common terminal) and give the unit a functional check. PR1 (on PCB 'D') is simply adjusted so that the display does not run off the scale when strong peak audio signals are present.

Casing The Tuner

When all of the modules have been fully tested on the open bench they can be fitted together in a suitable cabinet, noting that all supply connections must be taken directly to the power supply module (to avoid hum loops, etc.). If you decide to use the 'Classic II' case that we have used in our prototype, note the following constructional points.

The 'Classic II' case is provided with PCB mounting slots and these are used to hold the power supply and the signal strength and audio level boards in place. The basic 7254 tuner module, the SW4 PCB, the search-and-lock board (PCB 'B') and mains transformer T1 are all mounted on the case baseplate with 1/4 inch stand-off pillars. The tuning scale (PCB 'A') is mounted on the front panel with angle brackets that are epoxied to the rear face of the panel.

ETI

SUBSCRIPTIONS

ETI 1980 available from your newsagent every month.

Forget to buy it this month? Or is your newsagent sold out?

Why worry when ETI gets to the shop? Sit back and wait for it to come to you.

Take out an ETI Subscription. For only £10.00 we'll send you twelve issues of ETI

To claim your year's supply of ETI, send your PO or cheque direct to

ETI Subscriptions
MAP Publications
PO Box 35
Bridge Street
Hemel Hempstead
Herts.



It's faster and more thorough than classroom learning: you pace yourself and answer questions on each new aspect as you go. This gives rare satisfaction - you know that you are really learning and without mindless drudgery. With a good self-instruction course you become your own best teacher.

Understand Digital Electronics

In the years ahead digital electronics will play an increasing part in your life. Calculators and digital watches mushroomed in the 1970's - soon we will have digital car instrumentation, cash cards, TV messages from friends and electronic mail. After completing these books you will have broadened your career prospects and increased your knowledge of the fast-changing world around you.

DIGITAL COMPUTER LOGIC AND ELECTRONICS £7.50

This course is designed as an introduction to digital electronics and is written at a pace that suits the raw beginner. No mathematical knowledge is assumed other than the use of simple arithmetic and decimals and no electronic knowledge is expected at all. The course moves painstakingly through all the basic concepts of digital electronics in a simple and concise fashion: questions and answers on every page make sure that the points are understood.

Everyone can learn from it - students, engineers, hobbyists, housewives, scientists. Its four A4 volumes consist of:

- Book 1** Binary, octal and decimal number systems; conversion between number systems; conversion of fractions; octal decimal conversion tables.
- Book 2** AND, OR gates; inverters; NOR and NAND gates; truth tables; introduction to Boolean algebra.
- Book 3** Positive ECL; De Morgans Laws; designing logic circuits using NOR gates; dual-input gates.
- Book 4** Introduction to pulse driven circuits; R-S and J-K flip flops; binary counters; shift registers; half-adders.



Microcomputers are coming - ride the wave! Learn to program.

Millions of jobs are threatened but millions more will be created. Learn BASIC - the language of the small computer and the most easy-to-learn computer language in widespread use. Teach yourself with a course which takes you from complete ignorance step-by-step to real proficiency with a unique style of graded hints. In 60 straightforward lessons you will learn the five essentials of programming: problem definition, flowcharting, coding the program, debugging, clear documentation. Harder problems are provided with a series of hints so you never sit glassy-eyed with your mind a blank. You soon learn to tackle really tough tasks such as programs for graphs, cost estimates, compound interest and computer games.

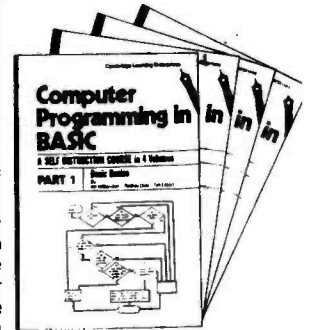

COMPUTER PROGRAMMING IN BASIC

£10.00

- Book 1** Computers and what they do well; READ, DATA, PRINT, powers, brackets, variable names; LET; errors; coding simple programs.
- Book 2** High and low level languages; flowcharting; functions; REM and documentation; INPUT, IF...THEN, GO TO; limitations of computers, problem definition.
- Book 3** Compilers and interpreters; loops, FOR...NEXT, RESTORE; debugging; arrays; bubble sorting; TAB.
- Book 4** Advanced BASIC; subroutines; string variables; files; complex programming; examples; glossary.

THE BASIC HANDBOOK £11.50

This best-selling American title usefully supplements our BASIC course with an alphabetical guide to the many variations that occur in BASIC terminology. The dozens of BASIC 'dialects' in use today mean programmers often need to translate instructions so that they can be RUN on their system. The BASIC Handbook is clear, easy to use and should save hours of your time and computer time. A must for all users of BASIC throughout the world.

A.N.S. COBOL £5.90

The indispensable guide to the world's No. 1 business language. After 25 hours with this course, one beginner took a consulting job, documenting oil company programs and did invaluable work from the first day. Need we say more?

DESIGN OF DIGITAL SYSTEMS £13.50

This course takes the reader to real proficiency. Written in a similar question and answer style to Digital Computer Logic and Electronics, this course moves at a much faster pace and goes into the subject in greater depth. Ideally suited for scientists or engineers wanting to know more about digital electronics, its six A4 volumes lead step by step through number systems and Boolean algebra to memories, counters and arithmetic circuits and finally to an understanding of calculator and computer design.



- Book 1** Octal, hexadecimal and binary number systems; conversion between number systems; representation of negative numbers; complementary systems; binary multiplication and division.
- Book 2** OR and AND functions; logic gates; NOT, exclusive OR, NAND, NOR and exclusive-NOR functions; multiple input gates; truth tables; De Morgans Laws; canonical forms; logic conventions; karnaugh mapping; three state and wired logic.
- Book 3** Half adders and full adders; subtractors; serial and parallel adders; processors and arithmetic logic units (ALUs); multiplication and division systems.
- Book 4** Flip flops; shift registers; asynchronous and synchronous counters; ring, Johnson and exclusive-OR feedback counters; random access memories (RAMs) and read only memories (ROMs).
- Book 5** Structure of calculators; keyboard encoding; decoding display data; register systems; control unit; program ROM; address decoding; instruction sets; instruction decoding; control programme structure.
- Book 6** Central processing unit (CPU); memory organization; character representation; program storage; address modes; input/output systems; program interrupts; interrupt priorities; programming; assemblers; computers; executive programs; operating systems and time sharing.

Flow Charts and Algorithms

are the essential logical procedures used in all computer programming and mastering them is the key to success here as well as being a priceless tool in all administrative areas - presenting safety regulations, government legislation, office procedures etc.

THE ALGORITHM WRITER'S GUIDE £4.00

explains how to define questions, put them in the best order and draw the flow chart, with numerous examples.

GUARANTEE No risk to you.

If you are not completely satisfied, your money will be refunded upon return of the books in good condition.

**CAMBRIDGE LEARNING LIMITED, UNIT 17
RIVERMILL SITE, FREEPOST, ST. IVES, HUNTINGDON,
CAMBS., PE18 4BR, ENGLAND.
TELEPHONE: ST. IVES (0480) 67446**

All prices include worldwide postage (airmail is extra - please ask for prepayment invoice).
Please allow 28 days for delivery in U.K.

ORDER FORM

Please send me the following books:-

- Digital Computer Logic & Electronics @ £7.50
- Design of Digital Systems @ £13.50
- Algorithm Writer's Guide @ £4.00
- Computer Programming in BASIC @ £10.00
- BASIC Handbook @ £11.50
- ANS COBOL @ £5.90
- Your Bookist (Free)

I enclose a *cheque/PO payable to Cambridge Learning Ltd.

for £..... (*delete where applicable)

Please charge my:

*Access/American Express/Barclaycard/Diners Club/Eurocard/Visa/
Mastercharge/Trustcard

Credit Card No.....

Signature.....

Telephone orders from credit card holders accepted on 0480 67446 (Ansafone).

Overseas customers (incl. Eire) should send a bank draft in sterling drawn on a London bank, or quote credit card number.

Name.....

Address.....

Cambridge Learning Limited, Unit 17, Rivermill Site
FREEPOST, St. Ives, Huntingdon, Cambs PE18 4BR, England.
(Registered in England, No. 1328762)

L.P. Toroidal

**TRANSFORMERS
IN A RANGE OF
75
TYPES**

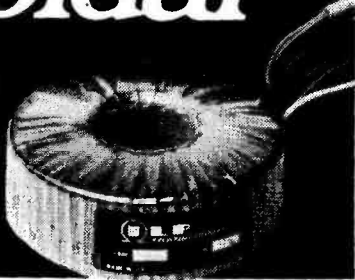

We use advanced winding technology to make our toroidal transformers. They have only half the weight and height of their laminated equivalents and are appreciably more efficient. Our toroids cost virtually the same as the older types which they are rapidly replacing. Induced hum is reduced by a factor of ten. Supplied with rigid mounting kit with centre bolt, steel and neoprene washers.

30VA 70mm dia. x 30mm
Weight 0.45 Kg **£4.71**
(+£1.00 p.p. + 0.86 VAT)

TYPE	SECONDARY RMS VOLTS	SECONDARY RMS CURRENT
1X010	6+6	2.50
1X011	9+9	1.66
1X012	12+12	1.25
1X013	15+15	1.00
1X014	18+18	0.83
1X015	22+22	0.68
1X016	25+25	0.60
1X017	30+30	0.50

50VA 80mm dia. x 35mm
Weight 0.9 Kg **£5.19**
(+£1.10 p.p. + 0.94 VAT)

TYPE	SECONDARY RMS VOLTS	SECONDARY RMS CURRENT
2X010	6+6	4.16
2X011	9+9	2.77
2X012	12+12	2.08
2X013	15+15	1.66
2X014	18+18	1.38
2X015	22+22	1.13
2X016	25+25	1.00
2X017	30+30	0.83
2X028	110	0.45
2X029	220	0.22
2X030	240	0.20

80VA 90mm dia. x 30mm
Weight 1 Kg **£5.76**
(+£1.20 p.p. + £1.04 VAT)

TYPE	SECONDARY RMS VOLTS	SECONDARY RMS CURRENT
3X010	6+6	6.64
3X011	9+9	4.44
3X012	12+12	3.33
3X013	15+15	2.66
3X014	18+18	2.22
3X015	22+22	1.81
3X016	25+25	1.60
3X017	30+30	1.33
3X028	110	0.72
3X029	220	0.36
3X030	240	0.33

120VA 90mm dia. x 40mm
Weight 1.2 Kg **£6.72**
(+£1.30 p.p. + £1.20 VAT)

TYPE	SECONDARY RMS VOLTS	SECONDARY RMS CURRENT
4X011	9+9	6.66
4X012	12+12	5.00
4X013	15+15	4.00
4X014	18+18	3.33
4X015	22+22	2.72
4X016	25+25	2.40
4X017	30+30	2.00
4X028	110	1.09
4X029	220	0.54
4X030	240	0.50

160VA 110mm dia. x 40mm
Weight 1.8 Kg **£8.88**
(+£1.40 p.p. + £1.54 VAT)

TYPE	SECONDARY RMS VOLTS	SECONDARY RMS CURRENT
5X012	12+12	6.66
5X013	15+15	5.33
5X014	18+18	4.44
5X015	22+22	3.63
5X016	25+25	3.20
5X017	30+30	2.66
5X018	35+35	2.28
5X028	110	1.45
5X029	220	0.72
5X030	240	0.66

225VA 110mm dia. x 45mm
Weight 2.2 Kg **£10.59**
(+£1.50 p.p. + £1.81 VAT)

TYPE	SECONDARY RMS VOLTS	SECONDARY RMS CURRENT
6X014	18+18	6.25
6X015	22+22	5.11
6X016	25+25	4.50
6X017	30+30	3.75
6X018	35+35	3.21
6X026	40+40	2.81
6X028	110	2.04
6X029	220	1.02
6X030	240	0.93

300VA 110mm dia. x 50mm
Weight 2.6 Kg **£12.27**
(+£1.60 p.p. + £2.08 VAT)

TYPE	SECONDARY RMS VOLTS	SECONDARY RMS CURRENT
7X016	25+25	6.00
7X017	30+30	5.00
7X018	35+35	4.28
7X026	40+40	3.75
7X028	45+45	3.33
7X028	110	2.72
7X029	220	1.36
7X030	240	1.25

500VA 140mm dia. x 60mm
Weight 4 Kg **£16.35**
(£1.70 p.p. + £2.71 VAT)

TYPE	SECONDARY RMS VOLTS	SECONDARY RMS CURRENT
8X017	30+30	8.33
8X018	35+35	7.14
8X026	40+40	6.25
8X025	45+45	5.55
8X033	50+50	5.00
8X028	110	4.54
8X029	220	2.27
8X030	240	2.08

• I.L.P. TOROIDAL TRANSFORMERS
ARE GUARANTEED FOR 5 YEARS

CHOICE OF 3 PRIMARY INPUTS

I.L.P. Toroidal Transformers are available in choice of 110V, 220V, 240V, coded as follows: (Secondaries can be connected in series or parallel)

For 110V Primary insert 0 in place of "X" in type number.
For 220V Primary (Europe) insert 1 in place of "X" in type number.
For 240V Primary (U.K.) insert 2 in place of "X" in type number.

Example - 120VA 240V 15+15V, 4A = 42013.

+ CUSTOMER DESIGN ENQUIRIES INVITED.
QUANTITY PRICE LIST AVAILABLE.

FREEPOST facility. (U.K. only).

Simply address envelope to **FREEPOST** to address below. NO STAMP REQUIRED.

TO ORDER Enclose cheque/Postal Order/Money Order payable to I.L.P. Electronics Ltd or quote your ACCESS or BARCLAYCARD account No. To pay C.O.D. add £1 extra to TOTAL value of order. Also available from ELECTROVALUE and MARSHALLS.



I.L.P. TRANSFORMERS

A division of I.L.P. ELECTRONICS LTD.

FREEPOST T4 GRAHAM BELL HOUSE ROPER CLOSE
CANTERBURY CT2 1EP
Phone (0227) 54778 Technical (0227) 64723 Telex 965 780

CAR ENTERTAINMENT BARGAINS

Show us that you could have purchased for less within one month of your purchase and we will refund the difference!

STEREO CASSETTE/RADIO.

MW and Stereo FM radio and Stereo Cassette Player, 8 watts per channel, lockable fast forward and autostop. Includes fitting kit and **FREE SPEAKERS**. Sold elsewhere for up to £85 (believe it or not). **OUR PRICE £45 (+ £1.50 post)**. (For negative earth cars only).



PYE 7-CHANNEL STEREO GRAPHIC EQUALISER/BOOSTER AMPLIFIER.

17 watts R.M.S. per channel. Frequency response 20Hz to 30,000Hz ± 12dB cut/boost on each channel. Complete with fitting kit. You would pay at least £45 elsewhere. **OUR PRICE £28 (+ £1.20 post)**.



SUITABLE SPEAKERS FOR EQUALISER. Adjustable angle, shelf-mounting, power handling 30 watts max. **OUR PRICE £16 per pair (+ £1.20 post)**.



ELECTRIC ANTENNA. Wing mounting, including switch and fitting kit. **OUR PRICE £10 (+ £1.20 post)**.



PLEASE NOTE: These goods are ready built units. All goods guaranteed one year. 10-day money back offer on all undamaged goods. Goods ex-stock at time of going to press. Send SAE for details.

MINIKITS ELECTRONICS LTD.

88H Hainault Road, Leytonstone, London E11 1EH

MC-3L + FORMULA 4 Mk III

The best value in state-of-the-art pickup

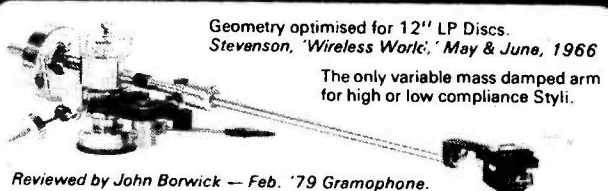

Geometry optimised for 12" LP Discs.
Stevenson, 'Wireless World', May & June, 1966

The only variable mass damped arm for high or low compliance Styli.

Reviewed by John Borwick - Feb. '79 Gramophone.



MC-2C MOVING COIL CARTRIDGE
T24 Universal MC Transformer, the quietest best step-up available.

NEW
High Output Moving Coil Cartridge MC-3L.
No step-up required.
Super-polished special line contact nude diamond stylus for maximum information retrieval.

REVIEWED BY REG. WILLIAMSON, SEPT. '79 'HI-FI FOR PLEASURE' and GEOFF GILES DEC. '79 'PRACTICAL HI-FI'

Alignment Protractor Mk. II

Improve your stereo image. Enables correct setting of all pick-up arm and cartridge combinations. Measures tracking accuracy over entire disc surface with Stevenson zero error points for minimum distortion.

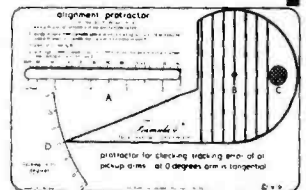

Devised by Percy Wilson M.A., Original 'Hi-Fi News' Review available.

MAYWARE LTD. (Dept. ET1)
P.O. Box 58, Edgware, Middlesex HA8 9UH
Tel: 01-958 9421

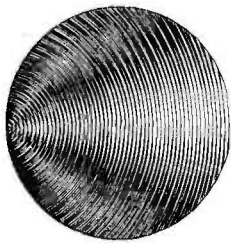

thandar
STOCKIST

B.K. ELECTRONICS

A SOUND CHOICE

thandar
STOCKIST

★ PROMPT DELIVERY ★ PRICES INCLUDE V.A.T. ★ AMPLE STOCKS
A PERSONAL SERVICE FROM A SMALL EXPANDING COMPANY

STEREO CASSETTE TAPE DECK ASSEMBLY. Comprising of a top panel assembly and tape mechanism coupled to a record/play back printed board assembly. Supplied as one complete unit for horizontal installation into cabinet or console of own choice. Brand new, ready built and tested. **Features:** Pause, control, auto stop, 3 digit tape counter, illuminated twin VU meters with individual record, level controls, secondary inputs for twin microphones. **Input Sensitivity:** 6 MV (with level control set at max). **Input Impedance:** 47 kOhms. **Output Level:** To both left and right hand channels 150 MV. **Output Impedance:** < 10k. **Signal to noise ratio:** 45 dB nominal. **Power Supply Requirements:** 12V AC at 300M/A. **Connections:** All connections to the unit are via a wander lead terminated with a nine pin plug (socket provided). **Dimensions:** Top panel — 11 1/2 in x 6 1/2 in. Mechanism fits through a cut out 5 3/4 in x 10 1/2 in. Clearance required under top panel 2 1/4 in. Supplied complete with circuit diagram etc. **Price £30.50** plus £2.50 postage and packing. Suitable mains 12-volt transformer, **£3.00.**

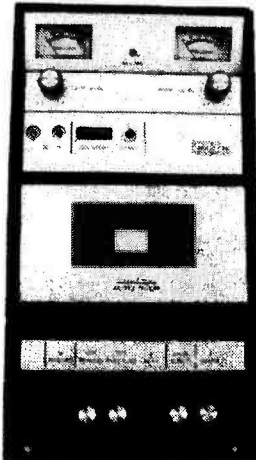

6 piano type keys

NEW RANGE QUALITY POWER LOUDSPEAKERS (15", 12" and 8"). These loudspeakers are ideal for both hi-fi and disco applications. Both the 12" and 15" units have heavy duty die-cast chassis and aluminium centre domes. All three units have white speaker cones and are fitted with attractive cast aluminium (ground finish) fixing escutcheons. Specification and Price —

15" 100 watt. Impedance 8ohm. 50 oz. magnet. 2" aluminium voice coil. Resonant Frequency 20Hz. Frequency Response to 2.5KHz. Sensitivity 97dB. **Price £32 each.** £2.00 Packing and Carriage each.

12" 100 watt. Impedance 8 ohm. 50 oz. magnet. 2" aluminium voice coil. Resonant Frequency 25Hz. Frequency Response to 4KHz. Sensitivity 95dB. **Price £23.70 each.** £2.00 Packing and Carriage each.

8" 50 watt. Impedance 8 ohm. 20 oz. magnet. 1" aluminium voice coil. Resonant Frequency 40Hz. Frequency Response to 6KHz. Sensitivity 92dB. **Price £8.90 each.** £1.00 Packing and Carriage each.



PIEZO ELECTRIC TWEETERS — MOTOROLA

Join the Piezo revolution. The low dynamic mass (no voice coil) of a Piezo tweeter produces an improved transient response with a lower distortion level than ordinary dynamic tweeters. As a crossover is not required these units can be added to existing speaker systems of up to 100 watts (more if 2 put in series). **FREE EXPLANATORY LEAFLETS SUPPLIED WITH EACH TWEETER.**

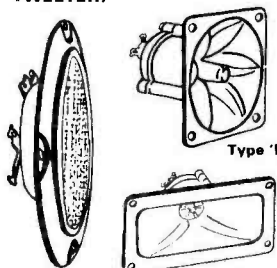

Type 'A' 3in round with removable wire mesh. Ideal for bookshelf hi-fi speakers. **Price (Type 'A') £3.45 each.**
Type 'B' 3 1/2 in super horn. For general purpose speakers disco and PA systems, etc. **Price £4.35 each.**
Type 'C' 2in x 5in wide dispersion horn. For hi-fi systems and quality disco etc. **Price £5.45 each.**
Type 'D' 2in x 6in wide dispersion horn. Frequency response extending down to mid-range (2000 c/s) suitable for hi-fi systems and quality disco. **Price £6.90 each.**
Post and Packing, all types, 15p each (or SAE for Piezo leaflets).

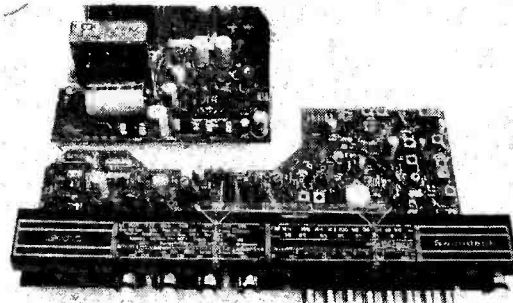

GEC AM/FM STEREO TUNER AMPLIFIER CHASSIS. Originally designed for installation into a music centre. Supplied as two separate built and tested units which are easily wired together. **Note:** Circuit diagram and interconnecting wiring diagrams supplied. **Rotary Controls:** Tuning, on/off volume, balance, treble, bass. **Push-button controls:** Mono, Tape, Disc, AFC, FM (VHF), LW, MW, SW. **Power Output:** 7 watts RMS per channel, at better than 2% THD into 8 ohms. 10 watts speech and music. **Frequency Response:** 60Hz-20kHz within ±3dB.

Tape Sensitivity: Output — typically 150 mV. Input — 300 mV for rated output. **Disc Sensitivity:** 100mV (ceramic cartridge). **Radio:** FM (VHF), 87.5MHz — 108MHz. Long wave 145kHz — 108kHz. Medium wave. 520kHz — 1620kHz. Short wave. 5.8MHz — 16MHz. **Size:** Tuner — 2 1/4 in x 15 in x 7 1/2 in approx. Power amplifier — 2 in x 7 1/2 in x 4 1/2 in approx. 240V AC operation. Supplied complete with fuses, knobs and pushbuttons, and LED stereo beacon indicator. **Price £23.50** plus £2.50 postage and packing.

JVC TURNTABLE. JVC Turntable supplied complete with an Audio Technica AT10 stereo magnetic cartridge. ★ 'S' shaped tone arm. ★ Belt driven. ★ Full size 12in platter. ★ Precision calibrated counterbalance weight (0.3 grms.) ★ Anti-skate (bias) device. Nylon thread weight. ★ Damped cueing lever. ★ 240V AC operation, (50Hz). ★ Cut-out template supplied. **Size — 12 1/4 in x 15 1/4 in (approx).** **Price £28.50** plus £2.50 postage and packing.

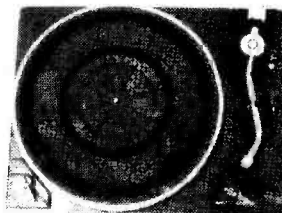

thandar
BY SINCLAIR

AVAILABLE EX STOCK
PHONE (0702) 527572
or large s.a.e. for leaflets etc.

FIRE ALARM CENTRAL CONTROL UNIT (S.T.C.)

Ideal for Fire or Burglar Alarm Systems

- ★ Responds to normally open or closed switches (or smoke detectors etc.)
 - ★ Complete with an internal EXIDE lead acid accumulator (dry charged) as a back-up for mains failure. This is trickle charged
 - ★ 6v-2 amp output for Fire/Burglar alarm, etc.
 - ★ Re-set button for silencing Fire/Burglar alarm.
 - ★ Internal buzzer which sounds if re-set button if pressed until initiating switch is cleared.
 - ★ Wall mounting, complete with red case, approx. 11" x 7 1/2" x 4".
 - ★ 240v AC operation.
- Price £18.50** + £3 postage and packing.

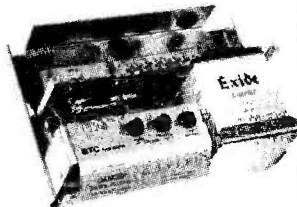

LOUDSPEAKER
High quality full range 8" loudspeaker. 15 watts RMS 8 ohm. Rolled surround with aluminium centre dome. **Price £3.75 each** + 75p Postage and Packing each.

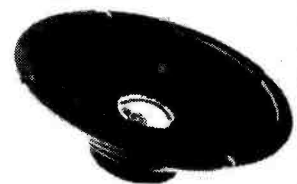

B.K. ELECTRONICS

37 Whitehouse Meadows, Eastwood, Leigh-on-Sea, Essex SS9 5TY

★ SAE for current lists. ★ Official orders welcome. ★ All prices include VAT. ★ Mail order only. ★ All items packed (where applicable) in special energy absorbing PU foam. Callers welcome by prior appointment, please phone 0702-527572.

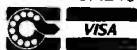

DESIGNER'S NOTEBOOK

Ray Marston devotes this month's Notebook to a discussion of special applications for 555 or 7555 astable circuits.

The old-fashioned 555 timer, or its modern CMOS counterpart, the ICM7555, can readily be used as a highly stable and cost-effective astable multivibrator. Usually, the device is merely used to generate simple square waves, but in practice it is readily capable of performing some fairly fancy tricks: it can, for example, be used to generate useful ramp and sine waveforms and can be gated on and off in a variety of ways.

Gating The 555/7555 Astable

The 555/7555 astable can be gated on and off in a variety of ways, to produce a variety of output waveforms. Figure 1 shows the basic connections and the equivalent circuit of the standard 555/7555 astable, it is necessary to understand the operation of this basic circuit in order to appreciate the action of the various gating methods. In the following discussions, a 12 V supply rail is assumed in all circuits.

The first point to note about the Fig. 1 equivalent circuit is that the IC contains a three-resistor potential divider, two voltage comparators, a flip-flop, a transistor and an output buffer. The divider ratios are such that one-third of the supply voltage (ie. 4 V) is set on the lower comparator and two-thirds of the supply voltage (ie. 8 V) is set on the upper comparator. The circuit action is such that, in each operating cycle, C1 first charges up to 8 V through R1-R2, at which point the upper comparator activates the flip-flop and turns the pin 7 transistor on; the transistor then discharges C1 through R2 until the C1 voltage falls to 4 V, at which point the lower comparator activates the flip-flop and turns the pin 7 transistor off, causing C1 to recharge through R1-R2. The operating cycle is then complete and repeats ad infinitum. A ramp waveform with an amplitude that swings between 4 V and 8 V is generated across C1 and a rectangular waveform is generated at output pin 3.

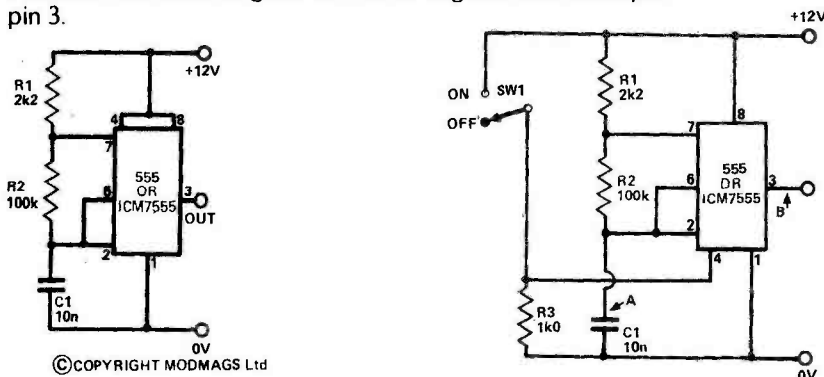

Fig.1a Basic circuit of the 55-type astable multivibrator.

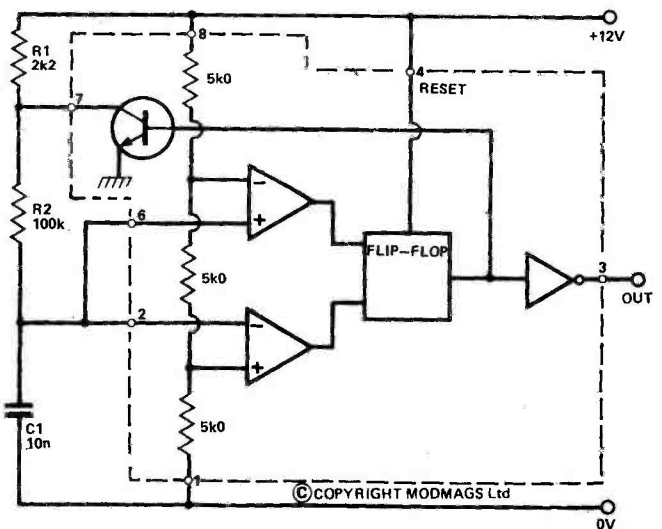

Fig.1b Equivalent circuit of the 555-type astable multivibrator.

The conventional way of gating the 555/7555 astable is with the pin 4 reset terminal, as shown in Fig. 2. When this pin is pulled to ground (by a 1k resistor), the flip-flop output is driven high, thus discharging C1 through R2 and the transistor and also driving the pin 3 output low. Note that, when the astable is gated on, the first half cycle is considerably longer than the succeeding half cycles. Also note that, when the astable is first gated off, the C1 voltage takes a substantial time to decay to zero. The pin 3 output is zero under the off condition.

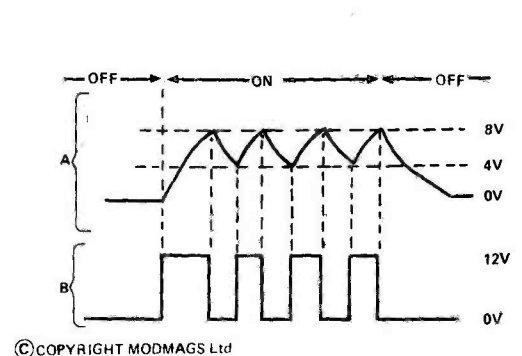

Fig.2 Conventional way of gating the 555 astable, with resultant waveforms.

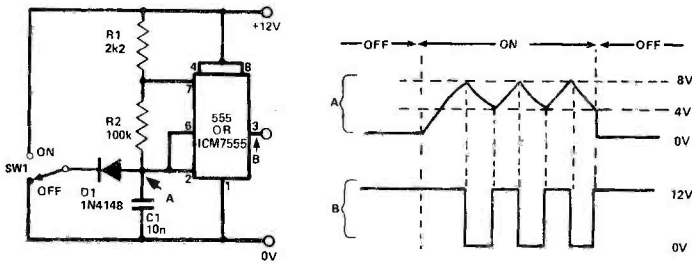

Fig.3 Basic method of gating the 555 astable using C1, with resultant waveforms. Note that the period of the first half-cycle is longer than that of the succeeding half-cycles.

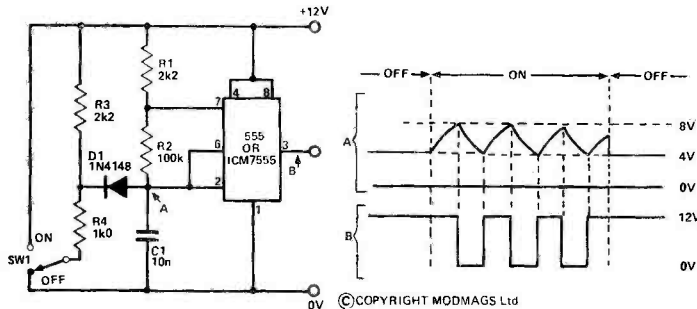

Fig.4 Modification of the C1 gating scheme, giving constant-period half-cycles.

Alternative Methods

One alternative method of gating the 555/7555 is shown in Fig. 3. Here, when the circuit is gated on, D1 is back-biased and the astable operates in the normal way, but when the circuit is gated off D1 shorts out C1 and pulls point A to ground; in practice, of course, SW1 can be replaced by an electronic switching waveform (the output of a CMOS gate, etc.) Note in this circuit that, when the astable is gated on, the first half cycle is again considerably longer than the succeeding half cycles, but that the C1 voltage falls abruptly to zero at gate-off. Also note that the pin 3 output is high in the off state.

Figure 4 shows how the above circuit can be modified so that the duration of the first half cycle is almost equal to that of the succeeding half cycles. This is achieved by choosing the R3-R4 values so that the C1 voltage is only a fraction below 4 V (one-third of supply volts) under the off condition. A substantially different set of waveforms can be obtained by choosing the R3-R4 values so that the C1 voltage is a fraction below 8 V (two-thirds of supply volts) under the off condition, as shown in Fig. 5.

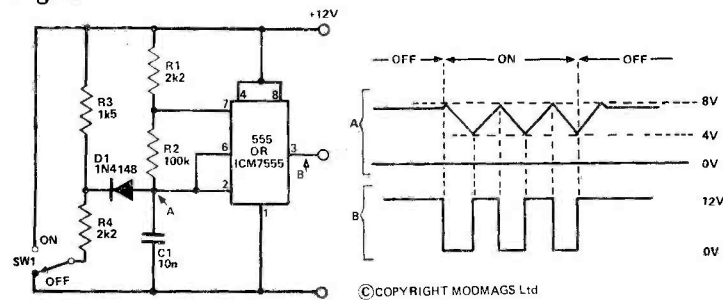

Fig.5 This slight modification of the C1 gating scheme produces a considerable change in the circuit output waveforms.

It should be appreciated that the 555/7555 astable can only oscillate if its timing capacitor (C1) is free to swing between the 4 V and 8 V switching levels. This simple fact makes it possible to voltage-gate the astable by using the circuit of

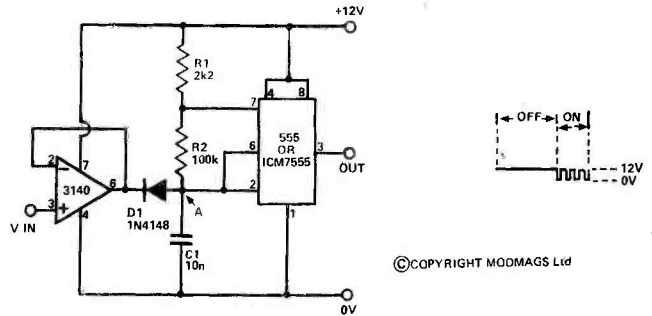

Fig.6 The voltage-controlled astable produces an output only when V_{IN} exceeds two-thirds supply (8 V in this example).

Fig. 6. Here, the circuit produces output waveforms only when the input voltage exceeds 8 V. The circuit can be made to trigger at other levels by giving the op-amp an appropriate voltage gain factor.

Finally, an alternative method of gating the 555/7555 astable is shown in Fig. 7. Here, the circuit is gated off by driving the C1 voltage above 8 V by D1. A feature of this circuit is that its 'B' output is low under the off condition.

Asymmetrical Astables

The basic 555/7555 astable generates near-symmetrical output waveforms, provided that R2 is large relative to R1 (giving near-equal C1 charge and discharge time constants). Figures 8 to 10 show alternative methods of generating non-symmetrical waveforms. In Fig. 8, C1 charges through R1-R2 but discharges through R2 in parallel with R3-D1, to produce the waveforms shown. In Fig. 9, C1 charges through R1 and R2 in parallel with R3-D1, but discharges through R2 only; this circuit is useful for providing narrow output pulses at the 'B' terminal.

Finally, in Fig. 10, C1 charges through R1-R3-D2 and discharges through D1-RV1-R1-R2, to produce narrow output pulses at the 'B' terminal. This circuit is useful for generating variable-frequency constant-width pulses.

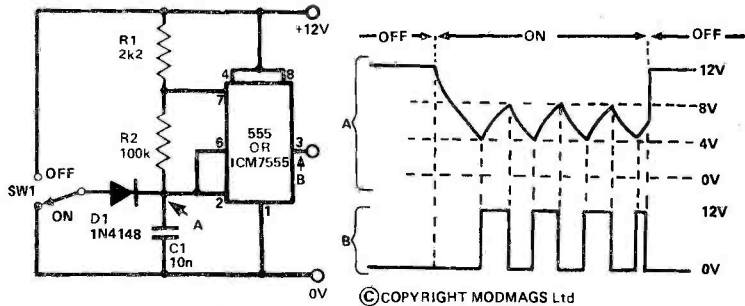

Fig.7 This C1 gating scheme produces a 'B' output that is low in the off condition.

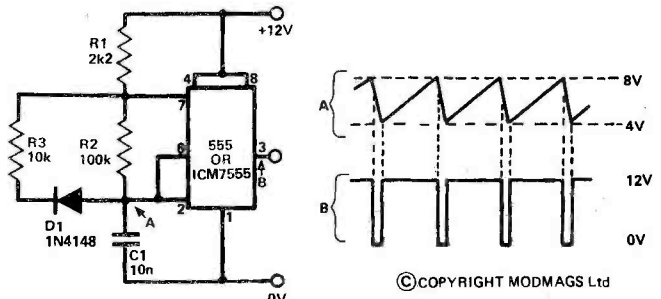

Fig.8 A method of producing a non-symmetrical fixed-ratio from the 555 astable.

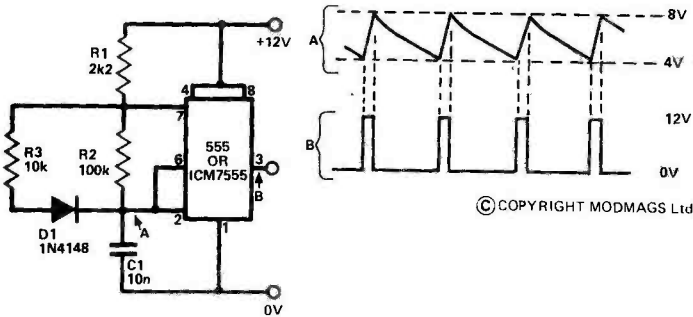

Fig.9 Alternative method of producing a non-symmetrical fixed-ratio output from the 555 astable.

555/7555 Sine Wave Generation

Figure 11 shows how a sine wave signal can be obtained from a 555/7555 astable. Here, the symmetrical ramp waveform of C2 is buffered by Q1 and then AC coupled to the R1-R2-D1-D2 divider/limiter network. This network attenuates the ramp signal and then non-linearly removes the ramp's positive and negative peaks, to produce a sine-shaped waveform of about 1 V peak-to-peak amplitude at the output terminal. The distortion level of the resulting sine wave is typically of the order of 3% and its frequency can be varied from a few cycles per minute to several hundred kilohertz by suitable choice of the C2 value.

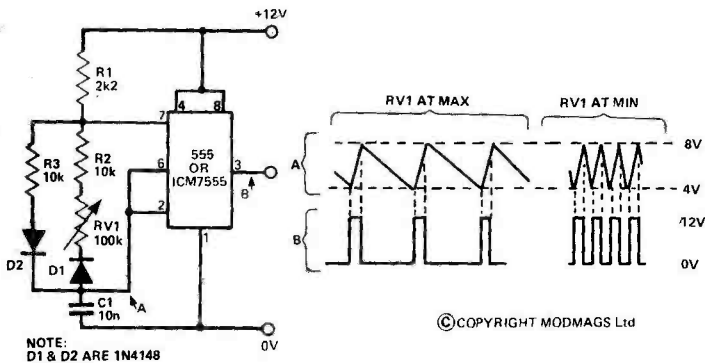
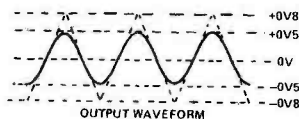
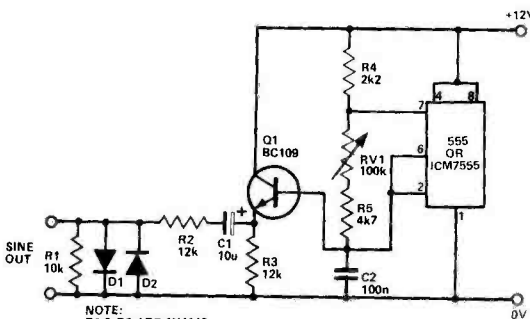
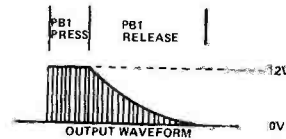
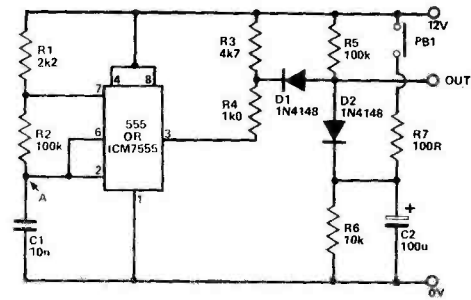

Fig.10 A method of producing a non-symmetrical variable-ratio output from the 555 astable.



©COPYRIGHT MODMAGS Ltd

Fig.11 A 555 sine-wave generator with a range of 83 Hz to 1.4 kHz (via R1).



©COPYRIGHT MODMAGS Ltd

Fig.12 A method of amplitude-modulating the pin 3 output of the 555 astable in music and sound generator applications.

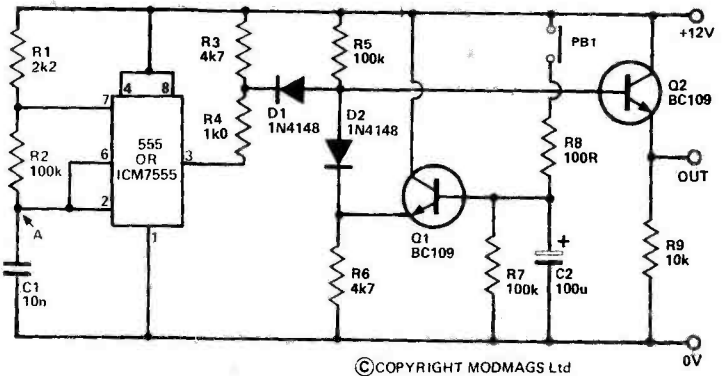

Fig.13 A modification of the Fig.12 circuit to give extended decay times and a buffered output.

AM Output

Figure 12 shows how the pin 3 square wave output of the 555/7555 astable can be amplitude-modulated to produce the typical attack-hold-decay envelope of a simple musical instrument or of a special-effects sound generator. The heart of the unit is the diode AND gate, or mixer, formed by D1-D2-R5. One input of this gate is fed from the output of the astable via R3-R4 and the other from across R6. The basic action of this gate is such that (ignoring the diode volt drops) its output amplitude is equal to the lesser of the two inputs.

Thus, when D1 is fed with the square wave output of the astable, the peak output of the unit will be zero when the R6 voltage is zero, or 5 V when the R6 voltage is 5 V, etc. In our circuit, R6 is shunted by electrolytic capacitor C2. Thus, when PB1 is pressed, a large voltage is applied to R6 and a large-amplitude square wave output is available. When PB1 is released, the R6 voltage and the square wave output amplitude decay exponentially to zero (with a time constant of R6-C2), as shown in the diagram. The R3-R4 network is used to apply a slight offset bias to the rectangular input waveform, to ensure a full cut-off of the output waveform after PB1 is released.

Finally, Fig. 13 shows how the above circuit can be modified to give extended display times (via emitter follower Q1) and a buffered audio output (via emitter follower Q2). **ETI**

DORAM

DORAM ELECTRONICS LTD

Fitzroy House, Market Place,
Swaffham, Norfolk, PE37 7QH.

TEL: (0760) 21627 TELEX 817912
VAT Reg: 324 5604 75

Projects for beginners

Clap switch (79026) Responds from a hand clap to switch on an electrical appliance	£6.60
Simple Sound effects (79077) Strange noises from a very simple circuit, loudspeaker included.	£5.70
Pools predictor (79053) An analogue computer that may win you a fortune.	£8.15
Talk Funny (80052) A ring modulator circuit that produces very strange results when fed with a human voice.	£9.60
Pest Pester (80130) An electronic insect repellent.	£2.35
Steam train sound effects (80019) Simulates the sound of steam and whistle.	£6.50
Electronic Nuisance (80016) Makes an annoying noise, but only in the dark!	£3.85
Cackling Egg timer (9985) An egg timer with a difference, it clucks like a hen.	£7.20

New projects

Melody Maker (80502) An electronic musical box that can play 27 tunes with organ or piano-like quality.	£23.50
LCD Counter (80117) Simple to construct frequency display for AM and FM bands.	£41.20
Linear Thermometer (80127) Simple but effective meter reading thermometer using a diode as sensor.	£13.45
Precision Power Unit (80514) Produces accurate reference voltages at presettable current limits up to 2 Amps.	£48.65
Programmable Slide Fader (81002) Mixes audio signals on tape with operation of two slide projectors.	£46.50

Audio projects

Top-preamp (80031) Mini, all IC preamplifier for use with most power amplifiers.	£34.40
Topamp (80031) Hybrid audio power amplifier uses Philips modules for high fidelity performance. Two power levels: OM931 (output 30 Watt)	£18.50
OM961 (output 60 Watt)	£33.40
Stentor (79070) A high power portable amplifier for PA use.	£30.00
Assistant (79071) A preamplifier designed for Stentor which can also be used as a speech compressor for radio transmission.	£7.00
Parametric Equalizer (9897) A modular system of construction to suit your equalisation requirements. Filter section (9897-1) Tone section (9897-2)	£6.45
	£5.20
Elektornado (9897) A single board design that can be used as either a single 100 Watt amplifier or two 50 Watt amplifiers.	£19.50
UAA180 LED meter (9817) A two channel voltage display unit.	£13.00
Peak Programme Meter (9860) To be used with UAA180 LED meter to give PPM display.	£3.70
Audio Analyser (9932) An analyser that can pin point the deficiencies in an audio chain.	£14.80
Stereo dynamic Preamp (80532) A low noise high quality disc preamplifier.	£5.20
STAMP (80543) Super tiny amplifier with up to 1 Watt output.	£3.75
Consonant (9945) A high quality audio control amplifier.	£34.65
Preconsonant (9954) A preamplifier for the disc input of the Consonant.	£5.75
Luminant (9949) A two channel LED display designed to show output levels in the Consonant system.	£20.70

Car projects

Car Battery Charger (79517) Reliable and safe charger for all types of lead-acid batteries.	£21.70
Transistor Ignition (80082) The most significant advantages of other systems combined in one.	£20.45
Dipstick Probe (80102) Direct warning of high oil temperature. State long or short dipstick required.	£11.25
Intelligent Wiper Delay (80086) Can be set to produce delayed wipes at any predetermined interval.	£15.85
Battery Protection (80109) Automatically switches off the head lamps of a parked car.	£5.15
Battery Voltage Indicator (80101) LEDs indicate the condition of your battery.	£6.85
Active Car Aerial (80018) Improves the sensitivity of AM and FM radio reception in your car.	£13.85

Music projects

Chorosynth (80060) A cheap mini synthesizer. Send for details.	
Elektor Vocoder (80060) The first Vocoder designed to be built in kit form. 10 Channel modular construction.	£57.90
Analogue Reverberation Unit (9973) Uses a SAD1024 which can produce a delay up to 100mS.	£162.50
Guitar Preamp (77020) With three tone controls.	£27.70
	£6.50

Projects for the home

Touch Dimmer (78065) Room lighting controlled by a single touch.	£6.80
Ioniser (9823) Produces a high concentration of negative ions.	£9.55
Loudspeaking telephone amplifier (9987) Amplifies without direct connection.	£11.50
Proximity Detector (9974) Detects by electric field change movement in a room.	£9.80

Our Project Packs include the electronic components, the PCB, sockets and solder together with assembly instructions. Cases, knobs etc can be supplied as extra items if required. This is only part of our wide range of projects. See our catalogue for details of other projects that we can supply. You can also ring our number between 12.30 p.m. and 1.30 p.m. any weekday for a recorded announcement of any new items we have available.

Send 40p for catalogue

HOW TO ORDER

Send a cheque or postal order to DORAM ELECTRONICS LTD or write or ring with your Access account number. All our prices include VAT. Overseas customers please deduct 15%. Please add 40p to your order for postage and packing. An answering service is available to take your orders outside our normal office hours. Mail Order service only.

a de boer company



NAME _____

ADDRESS _____

DIGITAL VOLTMETER MODULE



Fully built and tested, ONLY

£11.95 +VAT

- * Reads positive and negative voltages with a sensitivity of 0 - +999mV and 0 - -99mV
- * Requires only single supply between 7 & 12 volts (220mA)
- * High accuracy +0.1% +1 digit
- * Large bright 0.43" high efficiency displays
- * 4 readings per second sampling rate
- * Size only 41 x 95 x 10mm
- * Supplied with full data & applications information

This brand new, quality module manufactured by Autona Limited (who are one of the U.K.'s largest module manufacturers) means you can build accurate test equipment, multi-meters, thermometers, etc. easily and at a fraction of the cost of ready-made equipment. Full details are provided showing how to measure A.C. voltage, current, resistance and temperature.

Send your cheque or P.O. (£11.95 + £1.79 V.A.T. + 50p p. & p. = £14.24) now to:-

**Dept. ET14
RISCOMP LIMITED
21 Duke Street
Princes Risborough
Bucks. HP17 0AT**

**BUCKINGHAMSHIRE'S NEW
ELECTRONICS CENTRE
8 miles off the M40
50 minutes from London**
Telephone: (084 44) 6326



EX-STOCK DELIVERY

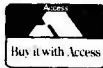

POWERFET AMPLIFIERS

Some day all power amps will be made this way!

Very high quality 80 watt and 120 watt designs (by Hitachi) offering wide bandwidths and very low distortions. Both are conservatively rated and can be used with supplies up to ±70V. One P.C.B. serves both designs, and an 80 watt unit can be upgraded by the simple addition of components. All units come with substantial heatsink/mounting brackets.

PFA80

80w into 8Ω (Vs = ± 50V)
†THD ≤ 0.008%
S/N 120dB

KIT £11.95. BUILT £13.95

PFA120

120W into 8Ω. (Vs = ± 55V)
†THD ≤ 0.005%
S/N 120dB

KIT £18.85. BUILT £20.85

‡ from 1W to rated output at all audio frequencies. PFA120.

recommended for 4Ω loads.

45v-0-45v, 300Va Toroidal Transformer **£15** (£2 p&p)

	CHAN	VDS max V	ID max A	PDISS max W	Price			
BD512	P	60	1.5	10	85p	CA3045	70p	2114
BD522	N	60	1.5	10	80p	CA3080E	70p	4001B
VMP4	N	60	2.0	25	1250p	CA3086	65p	4007
VN10KM	*N	60	0.5	1.0	55p	CA3140E	45p	4011B
VN64GA	N	60	2.5	80	750p	DAC08EN	280p	4013B
VN67AF	*N	60	2.0	15	75p	DM2502	555p	4016B
2SJ49	P	140	7.0	100	340p	LM3900	43p	4069
2SK134	N	140	7.0	100	340p	MC3401	30p	709
						NE529	145p	710
						NE555	25p	733
						SAD1024	1050p	741
						TL081	29p	78L05
						TL082	65p	78L12
						2102	80p	78L705
								78L172

†/p protected. ‡our selection. VN/VM 120-page Design Cat. 45p. Heat clips/sink T0202 12p. T092 8p. T03 35p.

HI-FI ON TWO CHIPS

HA12017 (Preamp 0.001% distortion 83dB S/N in phone application) 80p. HA1397 (Poweramp 20 watts in 8Ω) 0.02% distortion (typ) 195p.

Both with data and circuits. VCA High quality design offers attenuation from 0dB to -90dB. S/N 90dB, THD 0.01%, B.W. DC to 100KHz. Complete component set and circuit £2.50.

I.C. Sockets (low prof.)
8 pin 10p, 14 pin 12p, 16 pin 13p.
Low noise Resistor set 10 off each E12, value from 10R to 10M 730.
¼W, 5% CF resistors 650p.

SCOPE TRACE DOUBLER P.C.B.

Built. C/W shift, chan select, choprate controls and instructions. Useful display from DC to 10MHz. Runs from 9v battery £9.95.
2µS ADC chip set (DAC08, DM2502, NE529) with data £9.
HA1388 (Bridge amp, 18w from car battery). With data 195p.
Heatsink for HA1388/1397 40p.

30p post and packing. Mail order only to

J. W. RIMMER

148 Quarry Street
Liverpool L25 6HQ
Tel. 051-428 2651

Technical enquiries to 367 Green Lanes, London N4 1DY. Telephone. 01-800 6667
Overseas orders. Payment in sterling £1.00 p&p

110 projects in every book!!

The '110' books have been acclaimed by enthusiasts, students and engineers. Each contains 110 different circuit applications. Use them as project books or as source books for circuit ideas.

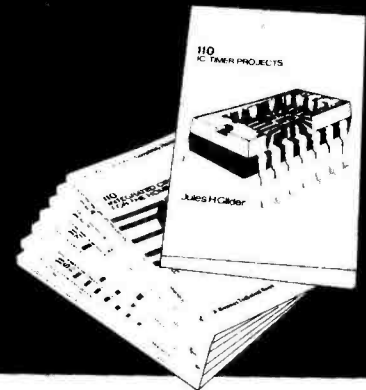

110 CMOS Digital IC Projects for the Home Constructor
R. M. MARSTON 0 408 00216 6 £3.95

110 Electronic Alarm Projects for the Home Constructor
R. M. MARSTON 0 408 00269 7 £3.95

110 IC Timer Projects for the Home Constructor
JULES H. GILDER 0 408 00480 0 £3.95

110 Integrated Circuit Projects for the Home Constructor -
Second Edition
R. M. MARSTON 0 408 00309 X £3.95

110 Operational Amplifier Projects for the Home Constructor
R. M. MARSTON 0 408 00153 4 £3.95

110 Semiconductor Projects for the Home Constructor
Second Edition
R. M. MARSTON 0 408 00322 7 £3.95

110 Thyristor Projects using SCRs and Triacs
R. M. MARSTON 0 408 0074 5 £3.95

110 Waveform Generator Projects for the Home Constructor
R. M. MARSTON 0 408 00353 7 £3.95

Available from your bookshop or in case of difficulty direct from the publishers.

Newnes Technical Books

Borough Green, Sevenoaks, Kent TN15 8PH

POLYSYNTH

Part 2: This month we continue the Polysynth project with details of the motherboard and control boards. Design and development by Tim Orr



Polyphonic portamento has been provided by using a voltage controlled slew limiter for each pitch voltage (Fig.10,11). The slew rate is controlled by the I_{ABC} current and the timing capacitor C_B .

$$\text{Slew Rate} = \frac{I_{ABC}}{C_B} \text{ VS}^{-1}$$

An LM13600 OTA is used to charge and discharge C_B . The OTA is contained in a feedback loop of two op-amps to reduce the differential offset voltage change between the input and the output. The circuit generates a voltage change of about 100 μV over its full range of 0 to -4V at all slew rate settings.

With the portamento pot fully clockwise, the pitch of the notes will not be noticeably slewed. As the pot is rotated anticlockwise the slew limiting will become very obvious. At its slowest rate, a four octave transition will take about 2 S.

Volume Control

The audio outputs from all voices are mixed into IC13, Fig.10. This is a voltage controlled amplifier. With the master volume control anticlockwise the output will be fully off.

Pitch Bend

The pitch bend joystick is shown in Fig.12. Note that the offset lever has to be cut short to avoid fouling the pitch bend plate. This lever is adjusted so that with the joystick in the centre, the voltage on the pot wiper is zero.

Panel Boards

Board PS5 generates all the common synthesiser parameters and PS6 the individual parameters. Most of the panel controls merely generate DC voltages. However, there are three modulation oscillators which are used to produce VCO vibrato, VCF sweep and pulse width modulation of the VCO square wave output. Note that the pulse width modulation pots (RV2,4) are dual function.

Clockwise they are connected to the modulation oscillator and anticlockwise they produce a manual control ranging from one-to-one square wave to a very thin pulse. In the centre of the pot movement there is a mechanical 'click'.

A pseudo-random noise source (IC5,6) with a low frequency boost has also been included as a sound source. Boards PS5 and PS6 connect to PS4 via preformed 12" flexible jumper links. Make certain that these links are clamped to the boards with self-adhesive ribbon cable clamps, as these will take the strain of the cables as they are flexed.

BUYLINES

Powertran Electronics can supply a complete kit of parts for each option of the Transcendent Polysynth

1 voice	£320
2 voices	£368
4 voices	£464
4 voice expansion kit	£295

All prices are exclusive of VAT.

Powertran Electronics, Portway Industrial Estate, Andover, Hants SP10 3NM

Note: The price of the 4 voice expansion kit was shown incorrectly last month. The correct price is £295.

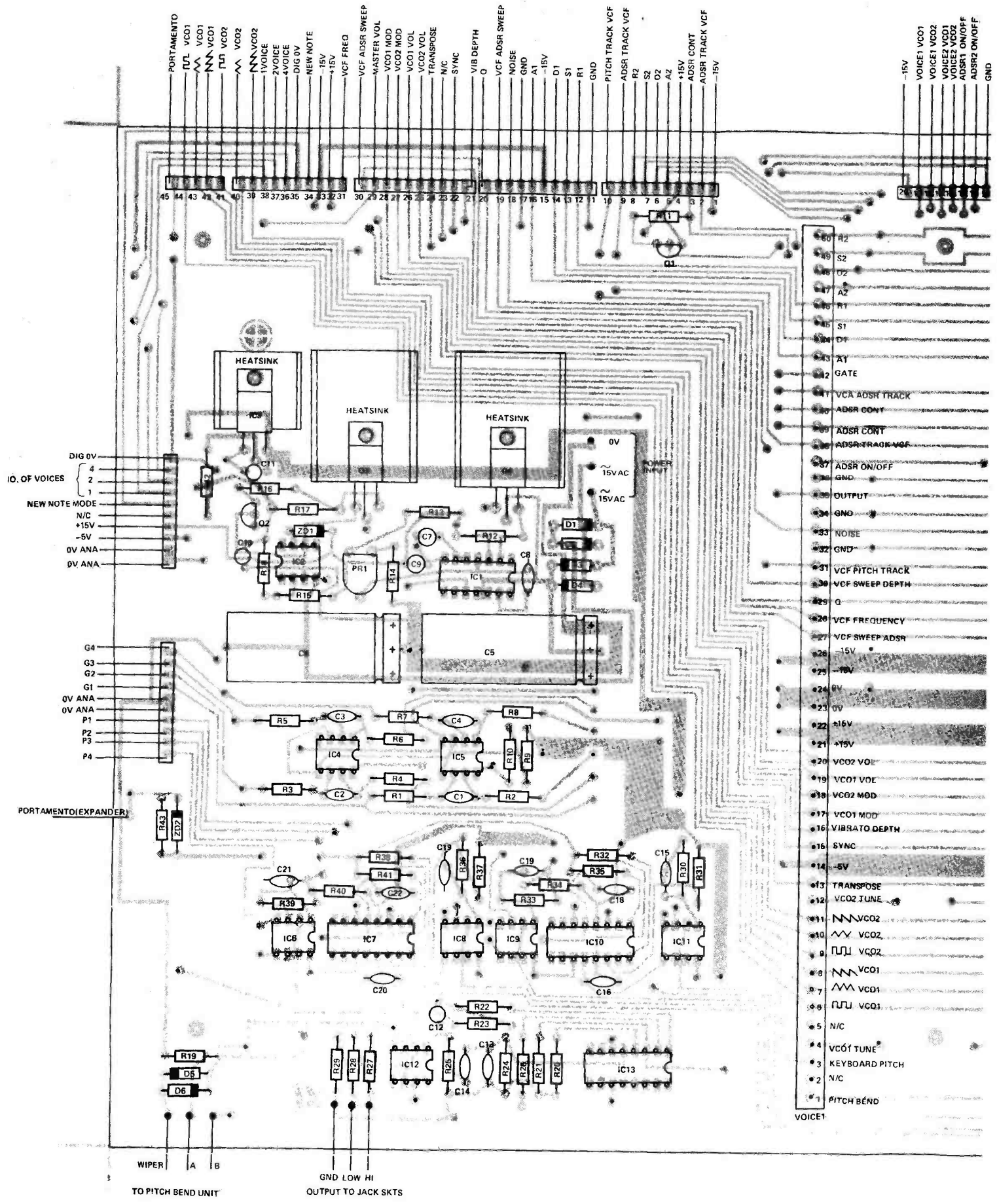
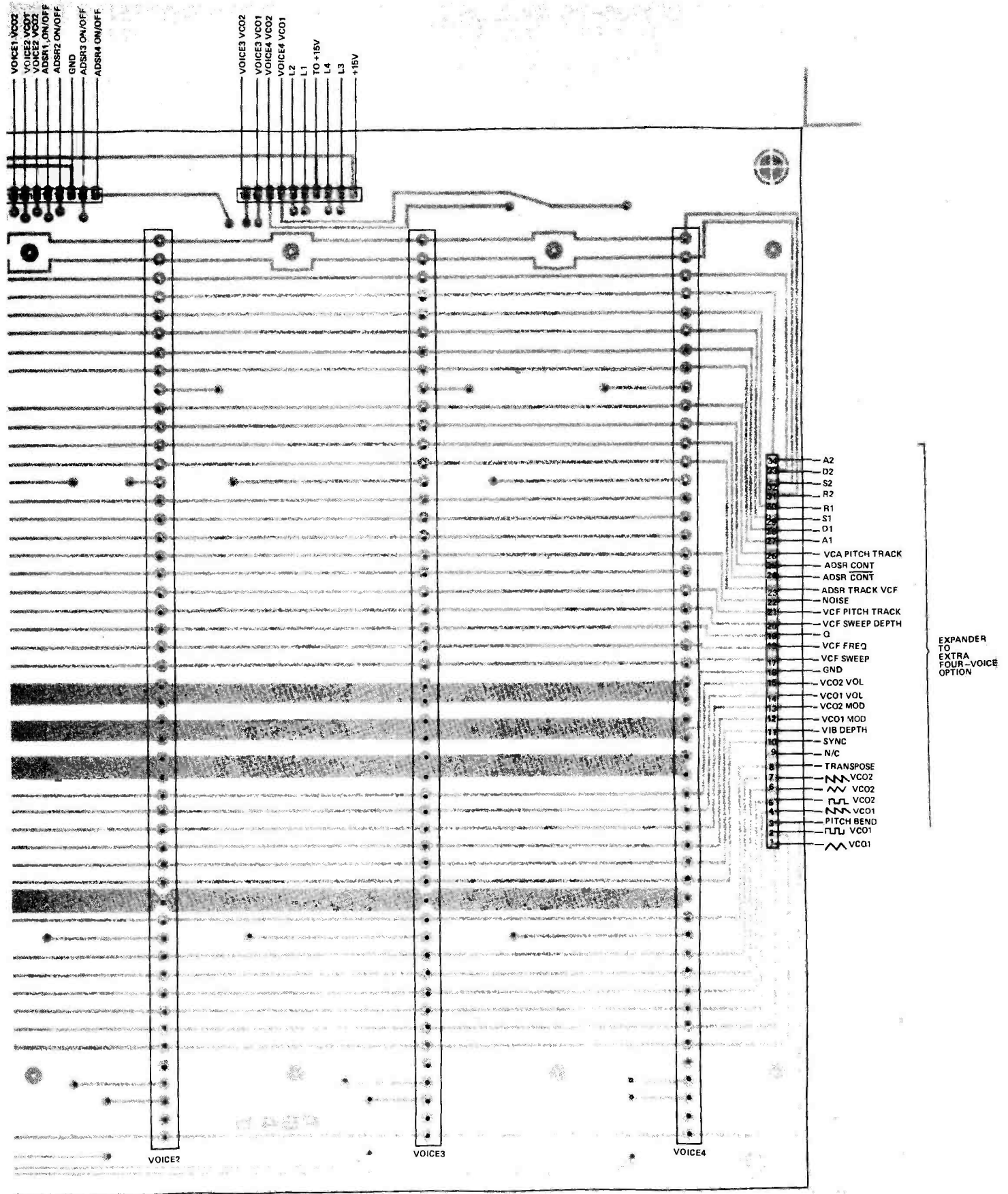

Fig.1 Component overlay of the motherboard (PS4). The circuit diagram was published last month.



PARTS LIST : PS4

Resistors all 1/4 W 5% unless otherwise stated

R1,3,5,7	1M0
R2,4,6,8	1k5
R9	1k2
R10,26,30,33,36,39	15k
R11,32,35,38,41	100k
R12,17	1R0 2 W
R13	12k 2% metal oxide
R14	10k 2% metal oxide
R15,18	10k 0.5% metal film
R16,20,21,27,29,31, 34,37,40	1k0
R22,23,25	22k
R19,24,28	10k
R42	100R 1 W
R43	270k

Potentiometers

RV33	10k linear (single axis joystick)
PR1	10k cermet preset

Capacitors

C1,2,3,4	1n0 ceramic
C5,6	2200u 25 V electrolytic
C7,9,10,11,12	10u 16 V tantalum

C8

C13	330p ceramic
C14,16,18,20,22	1n0 polycarbonate
C15,17,19,21	220n polycarbonate
	470p ceramic

Semiconductors

IC1	723 (DIL)
IC2,12	741
IC3	7905
IC4,5	1458
IC6,8,9,11	LF353
IC7,10,13	LM13600
Q1,2	BC212L
Q3	TIP30A
Q4	TIP29A
ZD1	10 V
ZD2	5V1
D1,2,3,4	1N4002
D5,6	1N4148

Miscellaneous

PCB PS4, 8 off 8 pin DIL sockets, 14 pin DIL socket, 3 off 16 pin DIL sockets, 2 off heatsinks (RS 401-964 or equivalent), TV5 heatsink, connecting pins, self-adhesive clips.

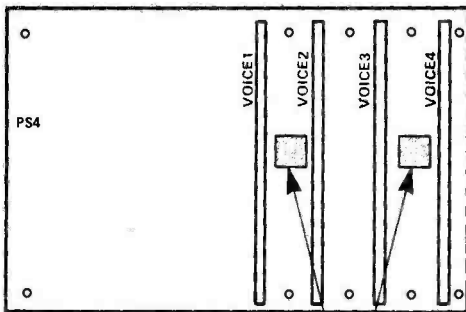

STICK TWO SELF ADHESIVE RUBBER FEET ONTO THE METAL BASE OF THE SYNTHESIZER UNDERNEATH PS4. THESE WILL HELP TO LIMIT THE CONSIDERABLE FORCES GENERATED WHEN THE VOICE BOARDS ARE INSERTED OR REMOVED FROM PS4
© COPYRIGHT MODMAGS Ltd

Fig.2 Plugging in the voice boards could damage the motherboard if it is not cushioned as shown.

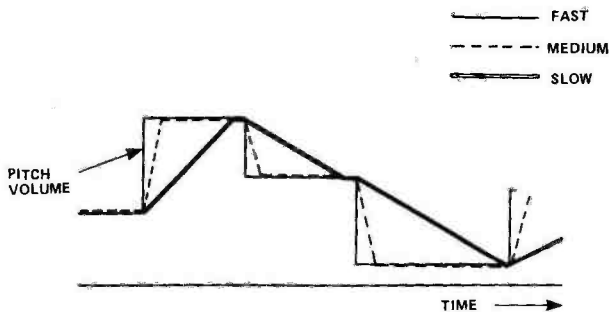

Fig.3 The effect of variable slew limiting (portamento) on pitch voltage.

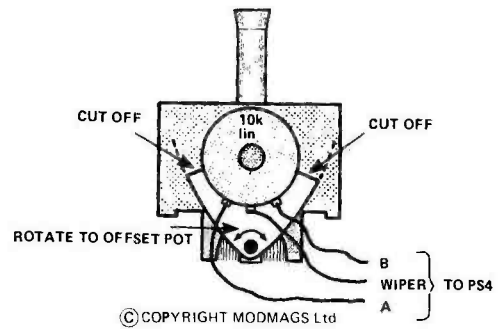

Fig.4 Mechanical details of the joystick pitch bend control.

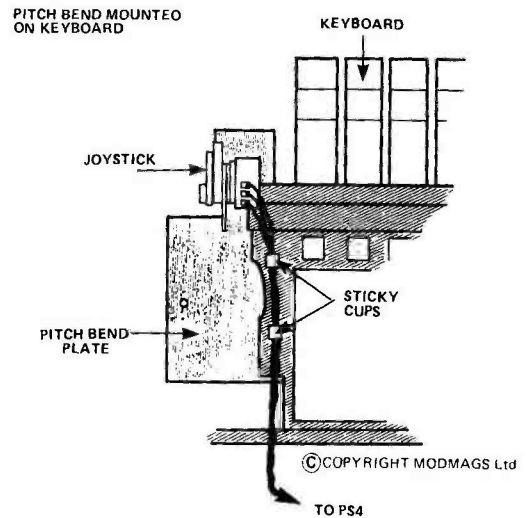

Fig.5 Mounting the joystick pitch bend control (RV33) on the end of the keyboard.

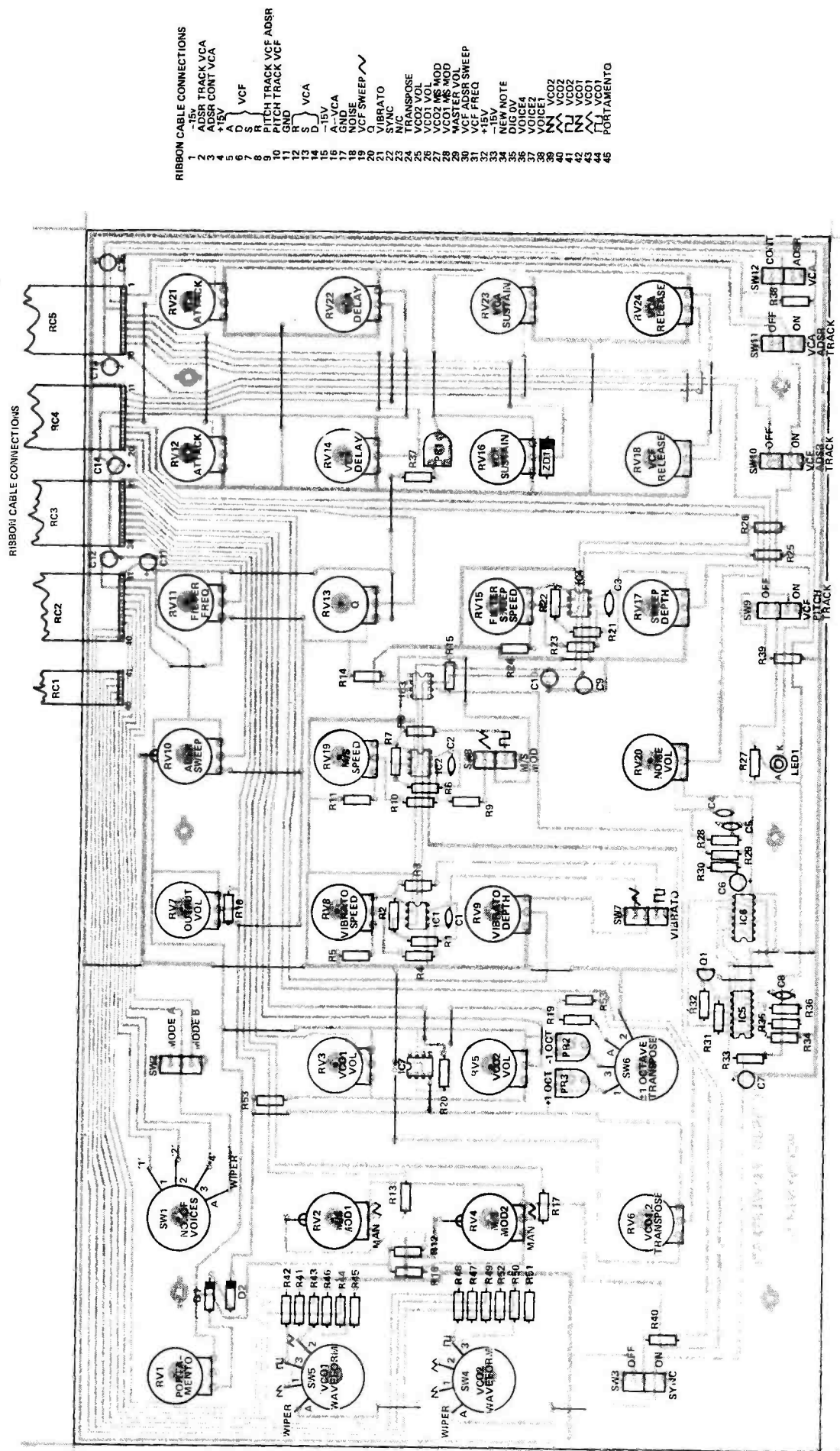

Fig.10 Component overlay of control board PSS.

PARTS LIST : PS5

Resistors all 1/4 W 5% unless otherwise stated

- R1,6,21,39 47k
- R2,7,22,29,38,40,52 100k
- R3,9,30 10k
- R4,12,16 56k
- R5,11,24,33 100R
- R8,13,14,17,32 22k
- R10,23 270k
- R15 3k9
- R18,31 4k7
- R19 100k 2% metal oxide
- R20 10k 2% metal oxide
- R25,26,53 47R
- R27 1k5
- R28 1k0
- R34 2M2
- R35 150k
- R36 12k
- R37 6k8

Potentiometers

- RV1,8,15,19,20 10k logarithmic
- RV2,4,10 22k linear with central click and central tapping

- RV3,6,5,7,9,11,13,16,17,23 10k linear

- RV12,14,18,21,22,24 4k7 linear

- PR1 10k preset

- PR2,3 10k cermet preset

Capacitors

- C1,2,3 150n polycarbonate
- C4 10n polycarbonate
- C5 330n polycarbonate
- C6,7,9,10-15 10u 16 V tantalum
- C8 1n0 polycarbonate

Semiconductors

- IC1,2,4 1458
- IC3,7 741
- IC5 40708
- IC6 4006B
- Q1 BC182L
- D1,2 1N4148
- ZD1 5V1
- LED1 0.2" green

Switches

- SW1 3-pole 4-way rotary
- SW2,3,7,8,9,10,11,12 Single-pole double-throw slide
- SW4,5,6 4-pole 3-way rotary

Miscellaneous

- PCB PS5, connectors, self-adhesive clips

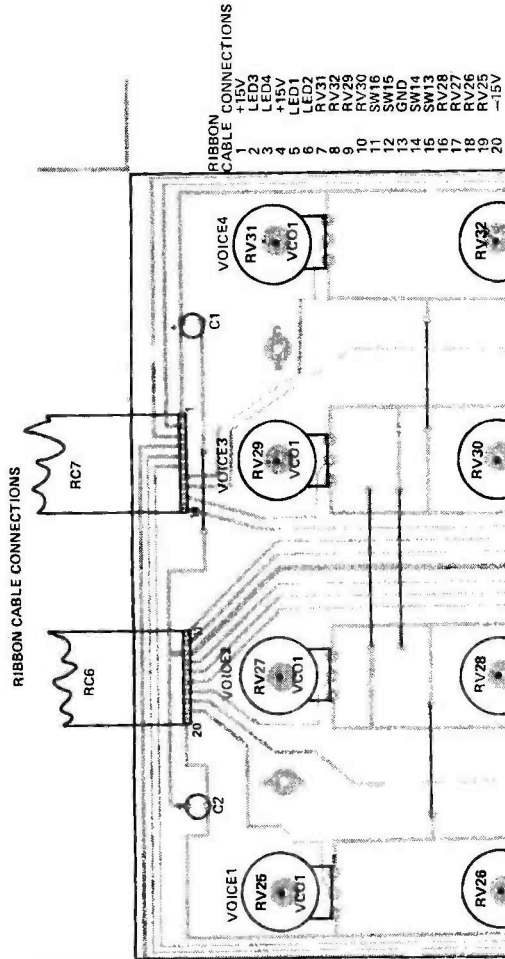

PARTS LIST : PS6

Potentiometers

- RV25-32 10k linear

Capacitors

- C1,2 10u 16 V tantalum

Semiconductors

- ZD1 10 V
- LED1-4 0.2" red

Switches

- SW13-16 Single-pole double-throw slide

Miscellaneous

- PCB PS6, ribbon cable connectors, self-adhesive cable clamps

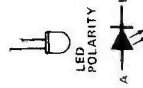

Fig.11 Component overlay of control board PS6.

NOTE:
 IC1, 2, 4 ARE 1458
 IC3, 7 ARE 741
 IC5 IS 4070B
 IC6 IS 4006B
 Q1 IS BC182L
 D1, 2 ARE 1N4148
 ZD1 IS 5V1
 LED1 IS 0.2" GREEN

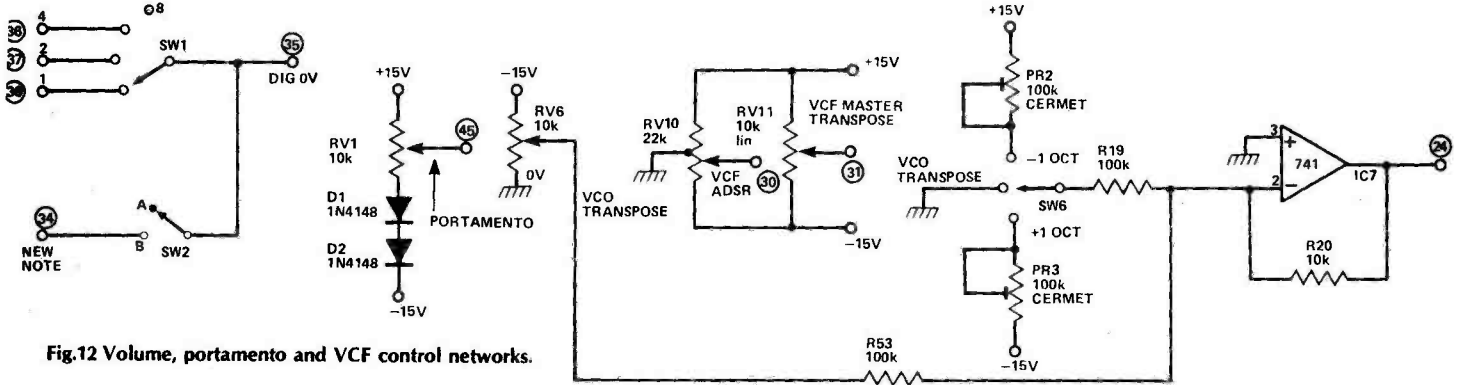
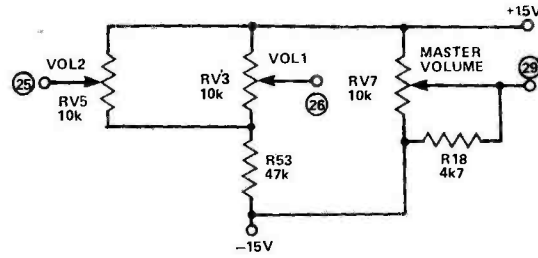

Fig.12 Volume, portamento and VCF control networks.

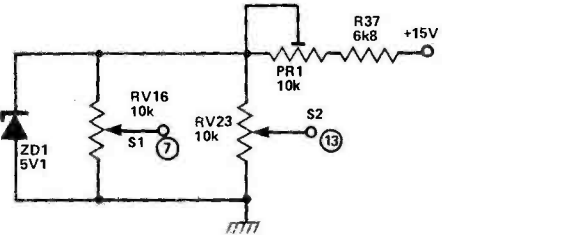
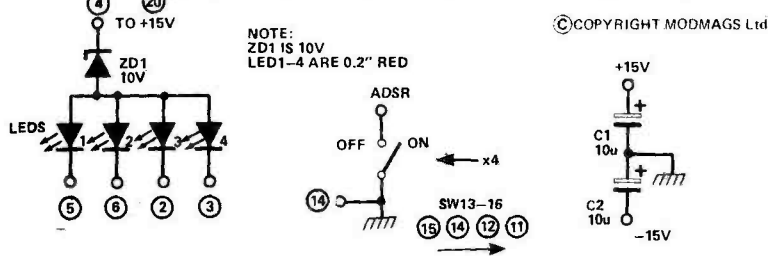
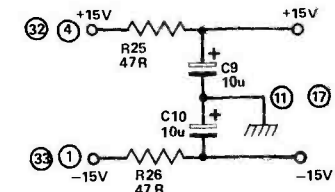
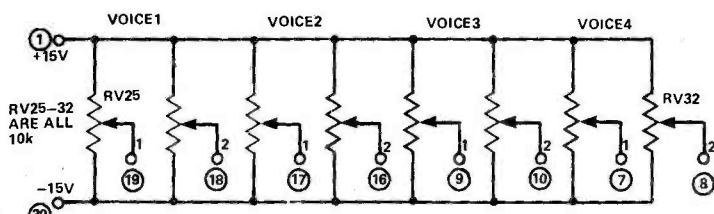

Fig.13 RV25 to RV32 are the VCO1,2 controls on control board PS6.

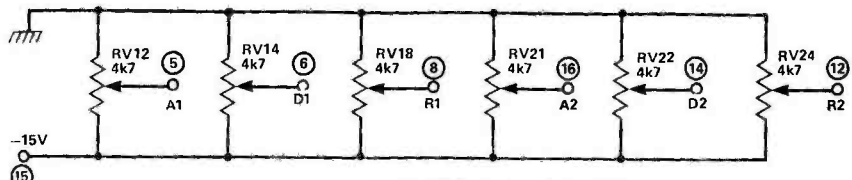

Fig.14 ADSR networks on PS5.

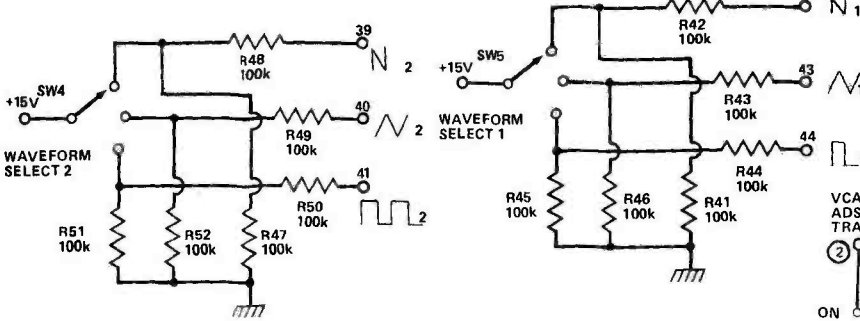
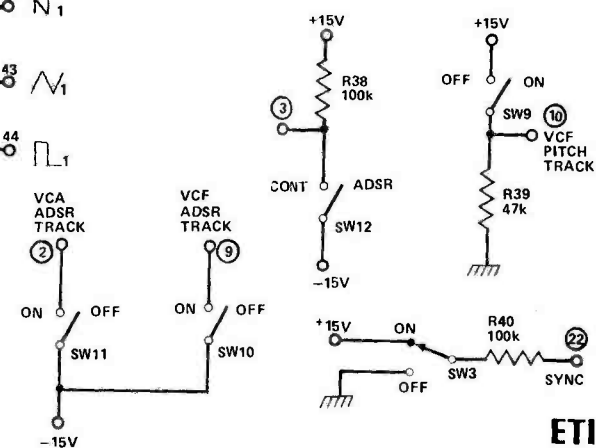

Fig.15 Waveform select networks for VCO1,2.



Next month: The Polysynth continues with constructional details of the voice boards.

WERSI

Aura Sounds are the first company to successfully market Wersi Organs and Kits in the United Kingdom. Operating from modern Showrooms, we offer a complete, unique evening and weekend telephone support advice. We pride ourselves on our friendly and individual service. We market Wersi products because we feel they are simply the best, both in terms of quality and reliability. These factors, together with a fresh approach, are what have made Wersi one of the leading organ manufacturers in the world today. AURA SOUNDS AND WERSI - THE WINNING COMBINATION. Illustrated below are just a few of the wide range of organs in stock.

NOW THE MIDLANDS!

Our Birmingham Showroom opens mid-November. See Wersi organs and Heath hobbykits at:

1729 Coventry Road, Sheldon
(midway between the City and Airport)

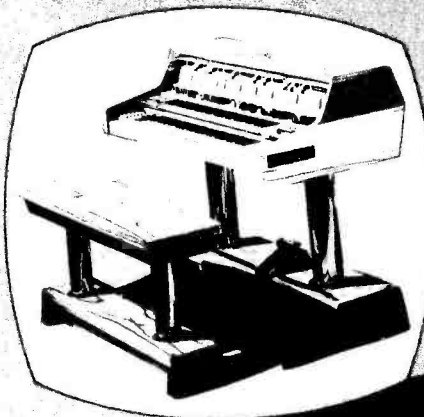

The SATURN W3T.

The ultimate transportable organ, featuring sophisticated rhythm unit and built-in WERSI Voice. 30 or 61 note Keyboards and 30 pedals.



The COSMOS W5S

The baby of the range, a great instrument at a great price. There are many optional extras and Cosmos can be easily assembled at home by the average handyman.

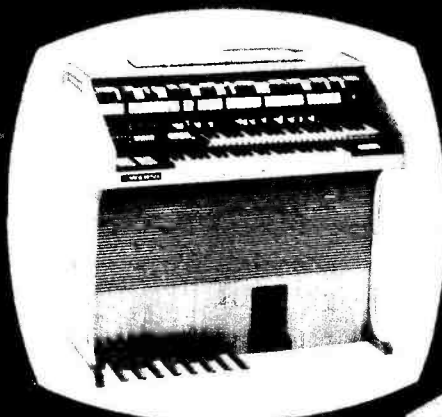

The HELIOS. For home or professional use. Available as a transportable model with various options including 25-pedal clavier.

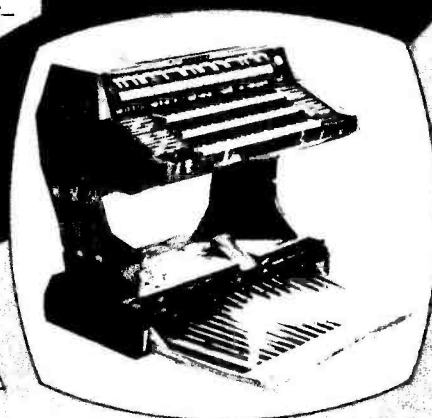

The GALAXY.

The top model of the range with 3 full manuals and a 30 note pedalboard. For looks and sound, the effects are first class.

IMPORTANT

AURA SOUNDS have just been appointed marketing agents for the range of Heath Electronic Kits in the U.K. This exciting range of 'up-market' Kits makes AURA SOUNDS, more than ever before, the company to come to for advice and product choice.

AURA SOUNDS 14-15 Royal Oak Centre, Brighton Road, Purley, Surrey. Telephone 01-668 9733 and at 17 Upper Charter Arcade, Barnsley, West Yorks. Telephone (0226) 5248
THE PROFESSIONALS

Please send me the 104 page colour WERSI catalogue plus the NEW HEATHKIT BROCHURE & price lists I enclose a cheque/P.O. for £1.00

Name _____

Address _____

Send to Aura Sounds Ltd. 14/15 Royal Oak Centre, Brighton Road, Purley, Surrey.

ETI.1.81

Make sure of your Heathkit catalogue... write now.

HEATHKIT

**New
Winter 1980/81
catalogue out now.**

Keep up to date with the world's finest electronic kits—with the Heathkit catalogue. 48 product packed pages contain photographs and specifications of the widest possible range of kits. Everything from doorbells to digital clocks, multimeters to microcomputers. Heathkit make it easy to build, easy on your pocket, and as with 13 million Heathkit builders over 34 years, your success is guaranteed. Make sure of your copy of the Heathkit catalogue. Send the coupon today, plus 25p in stamps and beat the demand.

To: Heath Electronics (U.K.) Limited, Dept (ETI)
Bristol Road, Gloucester, GL2 6EE.

Please send me a copy of the Heathkit catalogue.

I enclose 25p in stamps.

Name _____

Address _____

**Soldering
Iron offer
FREE**

N.B. If you are already on the Heathkit mailing list you will automatically receive a copy of the Heathkit catalogue without having to use this coupon. When you receive your catalogue you will get details of this free offer.

HEATHKIT

HEATH
ELECTRONICS

AITKEN BROS.

35 High Bridge,
Newcastle upon Tyne
Tel: 0632 26729

thandar

Test Equipment from Sinclair Electronics

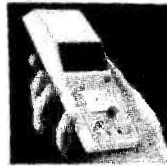

PDM35 DIGITAL POCKET MULTI-METER

LED DISPLAY. DC volts (4 ranges) 1mV to 1000V. AC volts 1v to 500V. DC current (6 ranges) 1nA to 200mA. Resistance (5 ranges) 1Ω to 20MEGΩ. £39.95. AC adaptor £4.25. Padded carrying case £1.95. MN1604 Battery £1.28. Size 157x76x32mm.



PFM200 frequency meter.

LED display. Range 20Hz to 200MHz. Accessories as for PDM35. Size 157x76x32mm. £57.95.



DM235 BENCH-PORTABLE DIGITAL MULTIMETER

LED display. DC volts (4 ranges) 1mV to 1000V. AC volts (4 ranges) 1mV to 750V. DC current 1µA to 1000mA. Resistance (5 ranges) 1Ω to 20MEGΩ. £60.98. Carrying case £8.95. AC Adaptor/Charger £4.25. Rechargeable battery pack £8.95. Size 255x148x40mm.



DM350 & DM450. BENCH-PORTABLE DIGITAL MULTIMETERS

DM350 3½ digit LED display £83.95. DM450 4½ digit LED display £114.95. Both provide six functions in 34 ranges. DC voltage 10µV to 1200V (100µV on DM350). AC voltage 100µV to 750V. DC current 1nA to 10A. AC current 1nA to 10A. Resistance 10mΩ to 20mΩ (100mΩ on DM350). Carrying case £8.95. AC adaptor/charger £4.25. Rechargeable battery pack £8.95. Size 255x148x40mm.



SC110 LOW POWER PORTABLE OSCILLOSCOPE

The SC110 has a 10MHz bandwidth and sensitivity down to 10mV per division. Full trigger facilities are provided, including Bright line and Auto with TV line and frame filtering. £159.85.



TF200 FREQUENCY METER

LCD display. The TF200 measures frequencies from 10Hz to 200MHz with a resolution of at least 1ppm (typically better) across the whole measurement range. £166.75.



TG105 PULSE GENERATOR

The TG105 is a mains operated 5Hz to 5MHz pulse generator with independent TTL and 50Ω variable outputs. Period and pulse width are each selected by a 6 position range switch plus vernier control. £98.75.

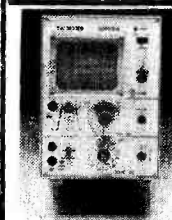

CALSCOPE SUPER 6 £186.30

A portable single beam 6MHz bandwidth oscilloscope with easy to use controls. High gain to 10 mv/cm and wide time base range from 1µs to 100 ms/cm. Full specification to request. Professional scopes you can afford.

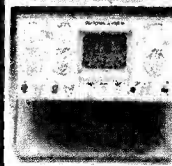

CALSCOPE SUPER 10 £251.85.

A dual trace 10MHz instrument of the very highest performance and quality. It has an accuracy of 3% which is achieved by the use of built-in stabilised power supplies which keep the trace rock steady over a wide range of mains fluctuations. Full specification on request.

Please write or phone for illustrated brochure giving full technical specifications, for any of the 'thandar' products.



Education Establishment Orders Accepted
PHONE OR SEND YOUR ACCESS OR
BARCLAYCARD NUMBER
ALL PRICES INCLUDE POSTAGE AND VAT

Greenbank

Greenbank Electronics
(Dept T1E) 92 New Chester Road, New Ferry
Wirral, Merseyside L62 5AG
(Tel: 051-645 2391)



TERMS, VAT, C.W.D. Cheques etc payable to Greenbank Electronics and crossed. Add VAT to all prices at 15% except where stated otherwise. Post etc: (UK 35p + 5p VAT = 40p) per order. Export: NO VAT but add 35p (Eira), 75p (Europe) and £2.50 elsewhere. Access, Barclaycard, Visa, telephone orders accepted. [Polys, universities, gov't depts, etc can telephone their orders for immediate despatch on account.]



QUARTZ

32.768KHz	£3.23	2 1/2" x 1" pitch with copper strips	74p
80 KHz	£9.95	2 1/2" x 3"	53p
100.0 KHz	£3.82	2 1/2" x 5"	£2.80
200.0 KHz	£3.82	2 1/2" x 17"	£1.60
204.8 KHz	£3.82	3 1/2" x 3 1/2"	62p
307.2 KHz	£3.82	3 1/2" x 5"	86p
312.5 KHz	£3.82	3 1/2" x 17"	£2.40
455.0 KHz	£3.82	4 1/2" x 17"	£4.10
1.000 MHz	£3.82	0.1" Holeboard	
1.000 MHz	£3.82	(no strips)	
1.200 MHz	£3.82	3 1/2" x 2 1/2"	58p
1.8 MHz	£4.25	3 1/2" x 5"	51p
1.8432 MHz	£3.82	3 1/2" x 17.0"	£1.50
2.000 MHz	£3.82	Terminal pins E1.50/500	
2.097152 MHz	£3.82	4-g 00P board	£1.17
2.4576 MHz	£3.82	10P brassboard	£2.81
2.500 MHz	£3.82	Split face carrier	83p
2.52525 MHz	£3.82	Pin insertion tool	£1.20
3.000 MHz	£3.82		
3.2768 MHz	£3.82		
3.579545 MHz	£1.95		
3.93216 MHz	£1.92		
4.000 MHz	£2.80		
4.032 MHz	£3.23		
4.096 MHz	£2.38		
4.194336 MHz	£3.23		
4.43319 MHz	£1.25		
4.800 MHz	£3.23		
4.800 MHz	£3.23		
4.9152 MHz	£3.23		
5.000 MHz	£3.23		
5.8580 MHz	£3.23		
5.120 MHz	£3.23		
5.185 MHz	£3.23		
6.000 MHz	£3.23		
6.144 MHz	£3.23		
6.400 MHz	£3.23		
6.5580 MHz	£3.23		
7.000 MHz	£3.23		
7.168 MHz	£3.23		
7.680 MHz	£3.23		
7.86432 MHz	£3.23		
8.000 MHz	£3.23		
8.06353 MHz	£3.23		
8.38800 MHz	£3.23		
8.86723 MHz	£3.23		
9.375 MHz	£3.82		
9.800 MHz	£3.82		
9.900 MHz	£3.82		
10.000 MHz	£3.23		
10.245 MHz	£3.23		
10.700 MHz	£3.23		
10.92 MHz	£3.82		
11.000 MHz	£3.82		
11.318 MHz	£3.82		
12.000 MHz	£3.82		
16.000 MHz	£3.82		
18.432 MHz	£3.23		
20.000 MHz	£3.82		
20.134 MHz	£3.23		
24.0 MHz	£3.82		
27.0 MHz	£3.82		
27.145 MHz	£2.10		
27.648 MHz	£3.82		
38.0666 MHz	£3.23		
100.000 MHz	£3.23		
116.000 MHz	£3.23		

VEROBORD

0.1" Pitch with copper strips

2 1/2" x 1"	74p
2 1/2" x 3"	53p
2 1/2" x 5"	£2.80
2 1/2" x 17"	£1.60
3 1/2" x 3 1/2"	62p
3 1/2" x 5"	86p
3 1/2" x 17"	£2.40
4 1/2" x 17"	£4.10

SOLDERCON PINS

100 50p	1000 £3.95
---------	------------

DIL SOCKETS

8/14/18 pin	10p/12p/13p
16/20/22 pin	10p/20p/25p
24 pin	Terminal level type
24 pin	Surface type

EDGE CONNECTORS

43 way, 0.1" pitch, wire wrap, polarizing slots

Single sided (1 x 47)	£3.11
Double sided (1 x 47)	£4.10

TIMER ICs

NE555/556	20p/40p
-----------	---------

OP-AMPS

(Dual opamp)

CA 3130E	84p
CA 3140E	35p
UA 741 (Texas)	22p

LED DISPLAYS

DL 704E	90p
DL 727E/728E	£2.00
DL 747E/750E	£1.80
HL 500/500	£1.80

LIQUID CRYSTAL DISPLAY

4 x 0.5" Digits 4 pin DIL

	£9.95
--	-------

CLOCK CHIPS

AY-1224A	£2.80
NK 50253	£5.90
NK 50566	£8.90

SIX DECADE COUNTER

NK 50965/6/7	£9.80
NK 50966/9	£7.50

SWITCH MODE PSUs



AC 220V 50/60 Hz
AC 220V 50/60 Hz 12V/1A - 12V/1A - 5V/0.1A
AC 240V 50/60 Hz 12V/1A - 12V/1A - 5V/0.1A
AC 240V 50/60 Hz 12V/2A - 12V/2A - 5V/0.1A 12V/1A
Type AC92151

OPEN CARB SWITCH MODE PSU
FULLY ASSEMBLED P.C.B. CARD 197 x 108 x 52mm. Outputs +5V/6A - 5V/0.5A + 12V/1A - 12V/1A

AY-5-1013	£4.00
AY-5-1013A	£4.70
AY-3-1015A	£5.80
AY-3-1015	£5.80

UNF MODULATORS

UM1111 E30 Video modulator	£4.00
T.V. game or cheap computer type	£2.80
UM1221 E30 wide bandwidth computer VDU type, sep./reg. transfer characteristic	£4.95
UM1223 E30 wide bandwidth computer VDU type	£4.70
UM1228 E30 Combined wide bandwidth video modulator with intercarrier sound. High performance	£8.25

CHAR. GEN. KEYBOARD ENCODER

NK 2302	£15.20
RD-3-2513 (5w Uppercase)	£6.00
NK 0678 CAR/8W	£14.27
AY-5-2376	£5.75

VOLTAGE REGULATORS

7805	75p
7805	£1.00
7812	£1.00
7812	97p
7805	£5.81

VOLTAGE CONVERTER MODULES

Ideal for use in otherwise 5V only systems. Inverts +12V, -12V, or dual - 12V power for ASCII keyboard, ADAM-12A1B, dynamic RAM etc. All types need +5V input.

Size of each module (excluding pins) 3 1/2 x 2 1/2 x 1 1/2"	
Type ADMP-12A10	£19.95
+12V output, (25-50mA)	£4.95
-12V output, (25-50mA)	£4.95
Type ADMP-12A10	£14.95
-12V dual output, 2 x (12-42mA)	£3.25

CMOS

These cut prices for Amateur Users and Export. Note: Industrial users - quantity prices available. Mostly Motorola, RCA

4000	18p	4042	80p	4095	£1.97	4531	£1.45
4001	25p	4043	90p	4096	£1.97	4532	£1.30
4002	25p	4044	90p	4097	£5.98	4533	£5.90
4006	95p	4045	£2.63	4098	£1.92	4534	£1.30
4007	10p	4046	£1.10	4099	£2.00	4537	£26.10
4008	90p	4047	£1.71	4100	£1.92	4538	£1.20
4009	40p	4048	77p	4101	£1.69	445V	£3.40
4010	50p	4049	45p	4102	£3.67	445V	£3.81
4011	25p	4050	45p	4103	£3.67	4451	£3.81
4012	18p	4051	80p	4104	£1.85	4451	£3.95
4013	50p	4052	90p	4105	£1.85	4482	£4.81
4014	94p	4053	90p	4106	£1.25	4482	£4.81
4015	40p	4054	£2.18	4107	£2.08	4482P	£4.20
4016	45p	4055	£2.55	4108	£1.54	4482P	£4.20
4017	80p	4056	£2.55	4109	£1.28	4501	29p
4018	85p	4059	£3.23	4110	£3.00	4502	£1.20
4019	45p	4060	£2.10	4114	£1.77	4505	70p
4020	90p	4062	£10.00	4161	£1.54	4506	50p
4021	£1.10	4063	£1.85	4162	£1.54	4507	55p
4022	£1.00	4066	55p	40161	£1.54	4506	50p
4023	27p	4067	£7.21	40163	£1.54	4508	£2.90
4024	70p	4068	27p	40174	£1.54	4510	90p
4025	27p	4069	27p	40181	£3.03	4511	£1.50
4026	£3.25	4070	30p	40182	£3.03	4512	£1.50
4027	90p	4071	25p	40192	£2.41	4514	£2.65
4028	84p	4072	25p	40193	£2.41	4515	£3.00
4029	90p	4073	25p	40194	£3.27	4516	£1.10
4030	74p	4075	25p	40206	£2.54	4517	£4.46
4031	£4.31	4076	£1.07	40257	£2.31	4518	£1.00
4032	£1.31	4077	25p	4108	90p	4519	£1.80
4033	£2.63	4078	25p	4109	90p	4520	£1.80
4034	£2.00	4081	27p	4162	90p	4521	£2.50
4035	£1.10	4082	27p	4163	90p	4522	£1.11
4037	£1.99	4085	£1.35	4174	90p	4526	£1.00
4038	£1.20	4086	£1.35	4175	£1.15	4527	£1.90
4039	£2.78	4089	£2.91	4194	£1.16	4528	£1.20
4040	£1.00	4093	80p	4408	£9.37	4529	£1.90
4041	£1.59	4094	£2.90	4409	£9.37	4530	70p

74C

74C00	28p	74C16	57p	74C163	£1.15	74C903	57p	74C925	£5.01
74C01	28p	74C17	57p	74C164	£1.08	74C904	57p	74C926	£5.01
74C02	28p	74C18	57p	74C165	£1.08	74C905	£7.53	74C927	£5.01
74C04	28p	74C19	57p	74C166	£1.08	74C906	£7.53	74C928	£5.01
74C08	28p	74C20	57p	74C174	93p	74C907	57p	74C929	£17.90
74C10	28p	74C21	57p	74C175	93p	74C908	£1.00	74C930	£17.90
74C12	28p	74C22	57p	74C192	£1.15	74C909	£1.69	80C95	85p
74C14	28p	74C23	57p	74C193	£1.15	74C910	£1.69	80C96	92p
74C20	28p	74C24	57p	74C195	£1.08	74C911	£7.39	80C97	92p
74C30	28p	74C25	57p	74C201	£1.41	74C912	£7.39	80C98	92p
74C32	28p	74C26	57p	74C211	£1.41	74C914	£1.46	80C99	92p
74C42	95p	74C27	57p	74C221	£1.41	74C914	£1.46	80C99	92p
74C48	£1.43	74C28	57p	74C245	£2.98	74C915	£1.15	82C19	£5.20
74C73	57p	74C29	57p	74C273	£1.79	74C918	£1.10	88C29	£5.20
74C74	57p	74C30	57p	74C373	£1.79	74C919	£1.10	88C29	£5.20
		74C31	57p	74C374	£1.79	74C921	£17.07	18.432 MHz	£3.23
		74C32	57p	74C375	£1.79	74C922	£3.78	20.000 MHz	£3.82
		74C33	57p	74C376	£1.15	74C923	£3.86	20.134 MHz	£3.23

74LS

74LS00	14p	74LS16	30p	74LS151	90p	74LS244	£1.78	74LS374	£1.85
74LS01	14p	74LS17	30p	74LS153	70p	74LS245	£3.50	74LS375</	

SLR ELECTRONICS

The humble 35 mm SLR camera has changed a great deal in recent years. Ian Graham investigates one aspect of electronics in photography, the development of camera electronics.

The point and shoot' phenomenon was for many years associated with cheaper non-reflex cameras, designed to be idiotproof, with ease of film loading and exposure in mind. Now, however, most manufacturers have at least one automatic SLR (single lens reflex) model in their range.

The 35 mm SLR is the most popular and versatile camera type in use today. It's versatile, because a typical SLR offers a range of interchangeable lenses and matched add-ons — motor-drive, power winder, electronic flash, bulk film pack, databack, etc. Further, because the viewfinder shows the image seen through the lens, the effect of any lens can be seen immediately — the photographer sees what the film 'sees'.

Meter Manual

In a manual TTL (through the lens) meter, light passes through the lens and is reflected by a mirror up to a prism at the top of the camera and out through the viewfinder eyepiece. Photocells mounted on the prism measure the brightness of the incoming light. Film speed and, typically, shutter speed are preset by the photographer. Adjusting the aperture of the lens causes a needle visible in the viewfinder to move towards a + (over exposure) or a - (under exposure). When the needle is central, the film will be exposed correctly when the shutter release is pressed.

However, this system cannot be used to operate an automatic system. It's easy to see why. You switch on the meter and compose your picture. The automatic meter selects the appropriate shutter speed (in an aperture priority system). When you press the shutter release, the mirror up, it is not seeing the view through the lens any more. The end result is a wrongly exposed film. The answer is to provide some means of storing or remembering the meter measurement during the exposure. One method involves the use of a capacitor to store the meter control voltage.



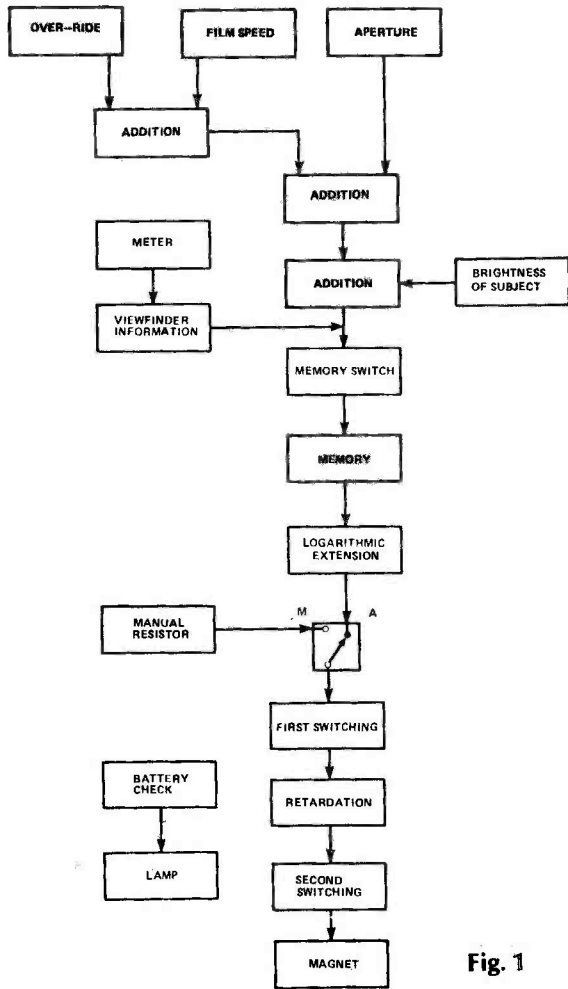

Fig. 1

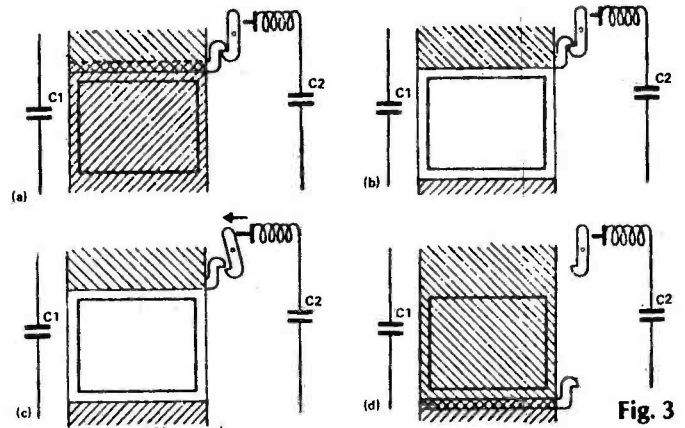

Fig. 3

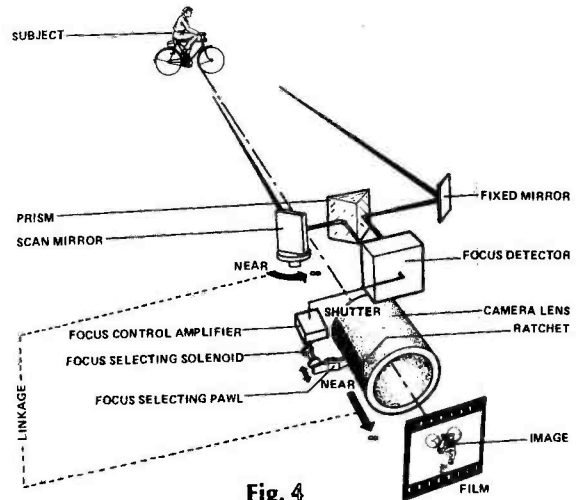

Fig. 4

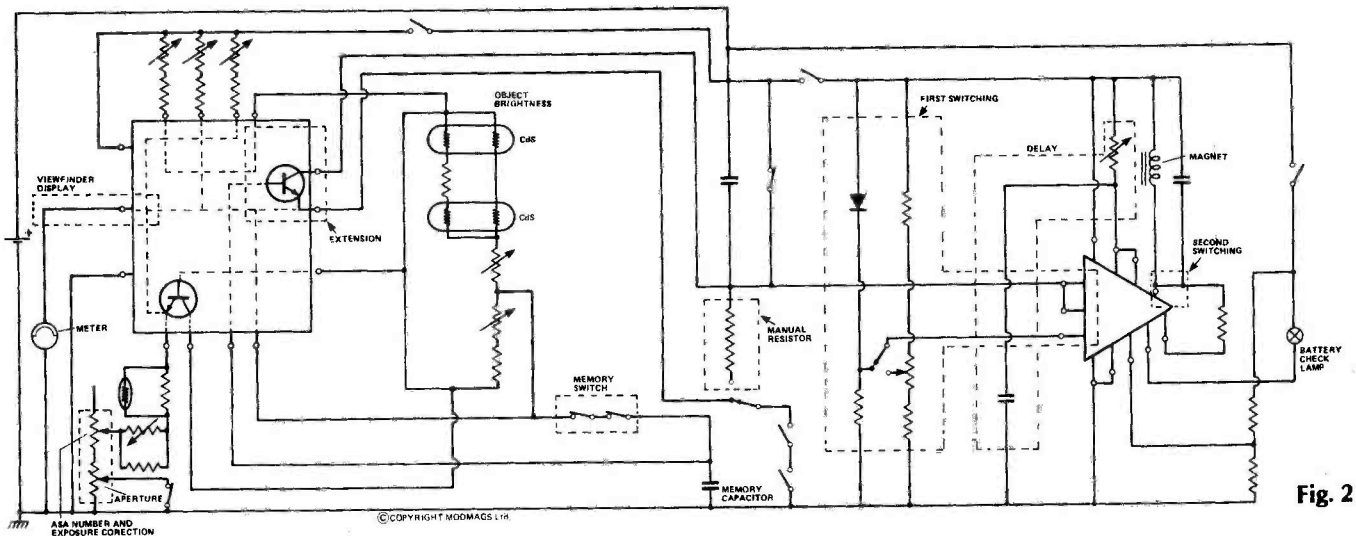

Fig. 2

Fig. 1 Block diagram of the manual/automatic exposure control employed by the Minolta XE-1.

Fig. 2 Circuit diagram of the exposure control system used by the Minolta XE-1.

Fig. 3 Mamiya's moving coil electronic shutter consumes a tenth the power of electromagnetic systems. In addition, the consumption remains constant whatever the shutter speed. Up to 100,000 exposures can be made with one 6 V silver oxide cell. (a) The shutter is closed. The moving coil energising capacitor (C1) is normally charged. Current is not flowing. (b) The first blind moves, opening the shutter when the shutter release button is pressed. The exposure time control capacitor (C1) begins to charge. The latch holds back the second

blind. The charge time of C1 is determined by the shutter speed. (c) The instant of exposure. When C1 reaches a preset voltage, C2 discharges, energising the moving coil. This releases the second blind. (d) The second shutter blind moves, closing the shutter. C2 charges in a very short time, consuming very little power — ready for the next exposure.

Fig. 4 Konica developed the first self-focusing camera — the C35 AF. Light from the subject passes through two windows on the front of the camera on to two mirrors, one fixed and one moveable. When the shutter release is pressed, the moveable mirror turns until the two images coincide on the focus detector. A focusing control signal is then used to focus the lens correctly — all within 80 mS.

Direct Measurement

The Olympus OM-2 uses TTL metering, but its SBC (Silicon Blue Cell) sensors face the film, and so they measure the light actually reaching the film emulsion during the exposure. This makes the memory device used in other cameras obsolete. The OM-2's system doesn't have to remember its light reading, because the reading is taken during the exposure itself. Its advantage is that it can compensate for changes in light levels after the beginning of the exposure. By eliminating a memory device power consumption is reduced.

Also, in flash photography, the sensors can follow the flash intensity as it increases in fractions of 1/10,000 S and cut off the camera's flash unit when the correct exposure is reached. Of course, a dedicated flash system is needed.

The OM-2 manages to combine centre and average exposure weighting. At high shutter speeds (over 1/60 S) the light level reading is taken from the shutter curtain. Its reflective coating pattern produces a centre-weighted reading. At lower speeds (below 1/15 S) the measurement is made directly from the whole film surface.

Logarithms

The shutter speed settings follow the simple geometric progression 1 S, 1/2 S, 1/4 S, . . . 1/250 S, 1/500S, 1/1000 S. If, for ease of calculation, we start with a meter circuit output of 0V1 and double it for each successive stop on the shutter speed dial, by the time we reach the last speed setting, the output voltage would be:

$$0V1 \times 2^{10} = 102V4$$

Because of the size, weight and expense of batteries, no camera can use a 100 V supply.

The answer is logarithmic compression of the voltage steps, so that the maximum power requirement is given by:

$$0V1 \times 10 = 1 V$$

In practice, most of the cameras available now derive their supply requirements from a single 6 V silver oxide cell or two 1V5 silver oxide cells.

Metering

One exception is the Konica FS-1, powered by four alkaline-manganese penlight cells. However, the FS-1 is no ordinary camera. It looks much the same as any other, except for the lack of a wind-on lever. It doesn't need one — it has its own built-in power winder, yet the combination is smaller and much lighter than a conventional SLR plus add-on winder.

The four size AA cells power the winder and camera electronics. The obvious advantage is that the photographer need carry only one spare set of batteries. Normally camera and winder batteries are not interchangeable.

Processing

The FS-1 employs a digital CPU (Central Processing Unit) together with support ICs to take care of light measurement, exposure calculation and motor control to provide total electronic control. The tiny CPU manages to pack in more than 1100 gates and 250 transistors, impossible to fit inside a camera just a few years ago.

Information from the Gallium Arsenide Phosphide photocell about the light level is compared with preset values for film speed and shutter speed to compute the appropriate aperture (f/stop). This analogue value is converted to a digital input for the f/stop register. The aperture information is also displayed in the viewfinder.

The Pentax ME Super has a wind-on lever, but no shutter

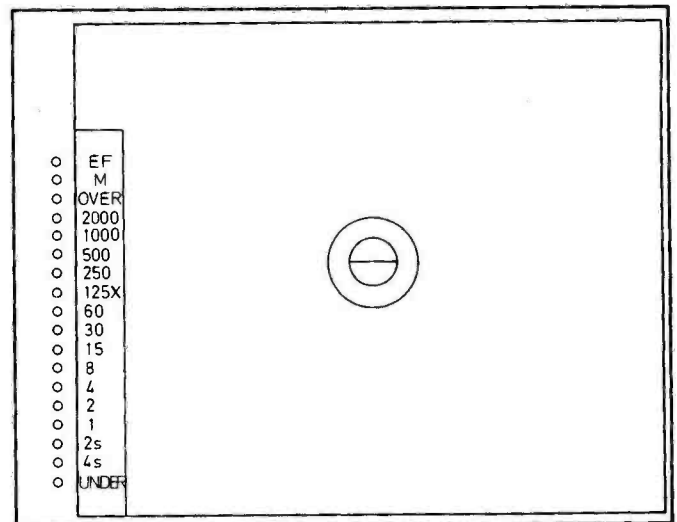

Fig. 5 The Pentax ME Super displays data by means of a three-colour line of LEDs. At 1/60 S and above, the speed selected by the camera will turn on the appropriate green LED. If you see green, it's OK to shoot. If the camera selects 1/30 S or below, the LED lit is yellow, warning you that, although the exposure is correct, there is a danger of blur due to camera shake. At each end of the scale there is a red LED to indicate under or over exposure. If exposure compensation is being used, a red EF LED comes on. Manual operation is similarly shown (green LED).

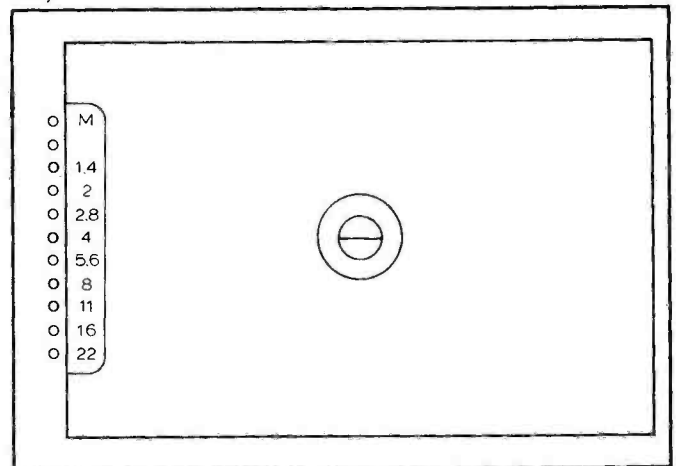

Fig. 6 The Konica FS-1 uses a simple all-red LED display to give details of aperture selected, under/over exposure, battery check, flash ready and manual mode.

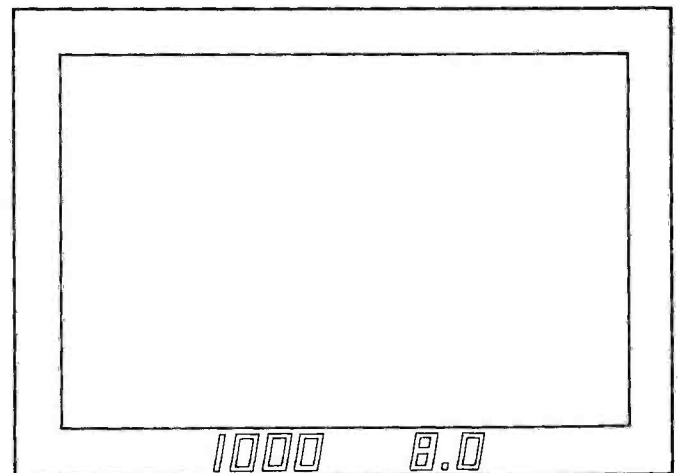

Fig. 7 The Canon A-1's alphanumeric LED display gives the photographer data on just about all the camera's functions — aperture, shutter speed, under/over exposure, flash ready, manual mode, B setting, out of range and operating error. There's even an automatic brightness control to match the display brightness to that of the image in the viewfinder.

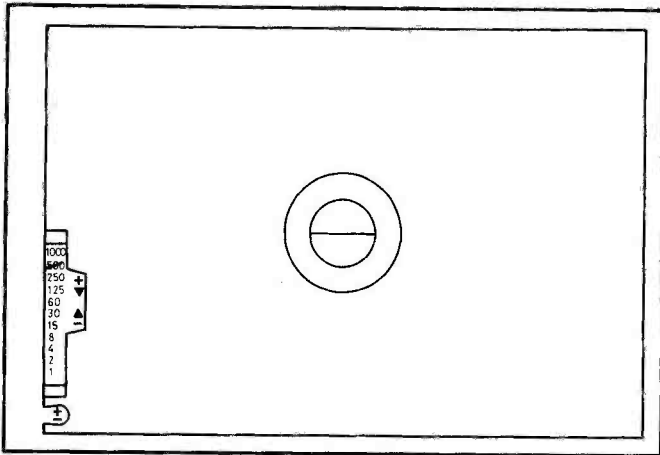

Fig. 8 The Olympus OM-2's bright viewfinder display shows the shutter speed by means of a needle on a scale. Information about under/over exposure, flash ready, exposure compensation, etc is also shown. When you switch to manual, the shutter speed scale disappears and you are left with the conventional needle display described earlier. When the camera is switched off, the viewfinder display disappears completely.

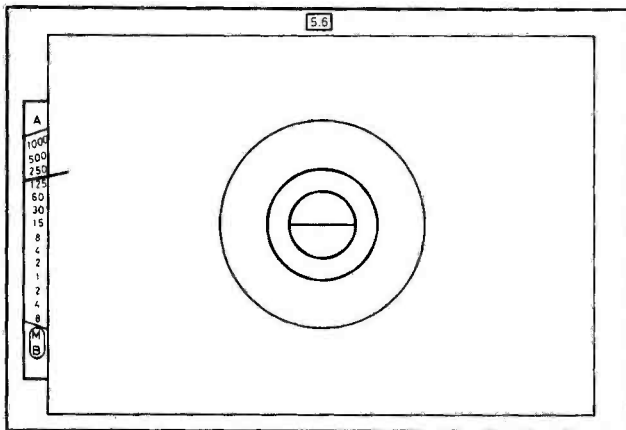

Fig. 9 Like the OM-2, the Nikon FE's display of shutter speed is a needle-on-scale type. The Silicon Photodiodes used in the FE are filtered to match the spectral response of the human eye.

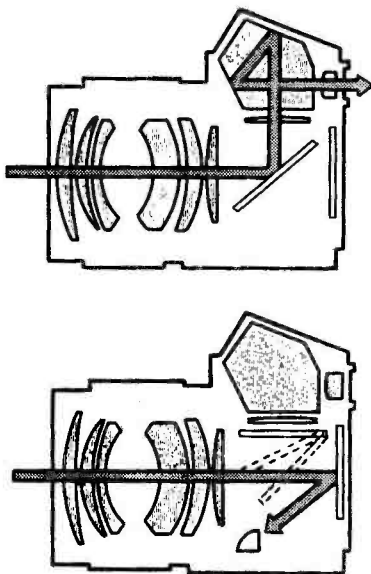

Fig. 10 With the mirror in the down position (top), the Nikon FE looks much the same as any other camera, but when the mirror flips up (above) a light reading is taken directly from the film plane.

speed dial. In manual mode, shutter speeds are selected by pressing one of two buttons on the top of the camera — one causes the shutter speed selected to increase one LED at a time, the other causes it to decrease, until the desired speed is reached.

Multi-mode

Up to now I have been describing cameras using either shutter speed priority or aperture priority. But, it is possible to have both. In fact, the Canon A-1 has no less than five automatic programmes:

1. Shutter speed priority — useful for action photography.
2. Aperture priority — useful if you know that your subject is not going to get up and run away.
3. Stopped down — with the meter reading the light entering the lens, accessories which don't couple directly to the camera electronics can be used.
4. Programmed — the camera decides the shutter speed and aperture.
5. Flash — using a flashgun which couples directly to the camera electronics, automatic flash photography is possible.

The viewfinder alphanumeric LED display gives a complete run-down on just about everything. The A-1's self-timer allows selection of a 2 S or 10 S delay. As the timer is completely electronic, it can be cancelled at the touch of a button, unlike most mechanical self-timers.

The A-1 and the Nikon FE (an aperture priority model) both have a memory lock facility. Suppose you are photographing your loved one (or wife) against a bright window. Click — and there you have an interesting silhouette. The meter has exposed the film for the bright window, not for the subject.

With the A-1 and FE, you can take a correct exposure reading from the subject's face, turn on the memory lock and take the picture. The meter will 'remember' the correct exposure until the lock is turned off.

Screen Data

The information displayed in the viewfinder and the method of display varies enormously from camera to camera. Some give full alphanumeric data on everything. Others rely on a very simple three-LED system — red, green, red meaning under-exposed, correct and over-exposed (manual TTL system).

Typically, slight pressure on the shutter release button switches the meter on. Some cameras still use an on/off switch mounted on the camera body. If yours does, remember to switch it off! The first-pressure type is foolproof, even with an absent-minded photographer to contend with. Table 1 is a quick guide to a few popular automatic mode 35 mm SLRs, giving details of the camera's electronic systems. It is by no means exhaustive and is not intended to be used as a buyers' guide.

The space available for components and PCBs inside the camera is severely limited. Nowadays the circuitry is commonly mounted on and in flexible, paper-thin, plastic film PCBs, which can be wrapped round the familiar shape of the major features of the camera under the thin metal skin. The flexible tracks greatly reduce the number of flying leads and solder joints necessary. The fewer connections, the less chance there is of a broken wire or a dry joint.

Finally . . .

The microprocessor is only now beginning to make an impression on amateur photography, so the camera is probably at the simple four-function pocket calculator stage. Look what has happened to calculators in a very few years — LCD displays, programmable, sound effects, talking displays, etc. It will be interesting to watch how the designers transfer this kind of technology to cameras.

Table 1 A comparison of the electronic systems used by some popular 35 mm SLRs with automatic programmes.

Camera	Model	Viewfinder Information	Shutter	Auto Exposure	Meter	Power
Canon	A-1	A-LED Aperture Shutter Speed Manual Override Flash Ready B Setting Over/Under Exposure Out of Range Operating Error	EHC	Aperture Priority Shutter priority Pre-Programmed Stopped Down Flash	TTL SPD Centre-Weighted Full Aperture	6 V Silver Oxide Cell
Fujica	AX-5	LED Aperture Exposure Mode Over/Under Exposure Battery Check	EHC	Aperture Priority Shutter Priority Pre-Programmed Stopped Down Flash	TTL SPD Centre-Weighted Full Aperture	6 V Silver Oxide Cell
Konica	FS-1	LED Aperture Flash Ready Over/Under Exposure Manual Override Automatic Mode Battery Check	EVM	Shutter Priority	TTL GaAsP Centre-Weighted Full Aperture	Four Alkaline-Manganese Cells
Minolta	XG9	Exposure LEDs Shutter Speeds	EHC	Aperture Priority	TTL CdS Centre-Weighted Full Aperture	Two 1V5 Silver Oxide Cells
Nikon	FE	Shutter Speed Scale Aperture/Meter Needle	EVM	Aperture Priority	TTL SPD Centre-Weighted Full Aperture	Two 1V5 Silver Oxide Cells
Olympus	OM-2N	Exposure Index (Manual) Shutter Speed (Auto)	EHC	Aperture Priority	TTL SPD + CdS Centre-Weighted Full Aperture	Two 1V5 Silver Oxide Cells
Pentax	ME Super	Aperture Shutter Speeds Exposure LEDs Over/Under Exposure Flash Ready	EVM	Aperture Priority	TTL GPD Centre-Weighted Full Aperture	Two 1V5 Silver Oxide Cells

KEY:

Viewfinder Information
Shutter

Meter

A-LED — alphanumeric LED
E — electronic
H — horizontal
V — vertical
C — cloth
M — metal
TTL — Through The Lens
SPD — Silicon Photodiode
GaAsP — Gallium Arsenide Phosphide
CdS — Cadmium Sulphide
GPD — Gallium Photodiode

IONISER KIT

This negative ion generator gives you power to saturate your home or office with millions of refreshing ions. Without fans or moving parts it puts out a pleasant breeze. A pure flow of ions pours out like water from a fountain, filling your room. The result? Your air feels like fresh ocean air, pure crisp and wonderfully refreshing.

All parts P.C.B. and full instructions £10. A suitable case including front panel, neon switch, etc. **Available at £8 extra.**

H.E. KITS

Car Booster ZD50 £18; Multi Option Siren ZD36 £10.50; Car Equaliser ZD52 £13.30; Envelope Generator ZD20 £11.79; R/C Speed Controller ZD3 £9.60; White Noise Effects Unit ZD18 £16.85; Track Cleaner ZD12 £7.75; Drill Speed Controller ZD21 £7.

All Hobby Kits supplied cases except ZD3. All kits contain components as specified plus Texas I.C. sockets where required. Also connecting wire. Special introductory offer to E.T.I. readers, a pack of nuts, bolts, washers, self-cutting, self-tapping screws supplied with each kit.

SPECIAL OFFERS

Texas / I.T.T. 1N4148, 100 for £1.50.

Fairchild FLV ISO Red '2 LEDs 10 for £1; 100 for £7.50.

Mullard Computer Electrolytics S/T 21,000 U.F. 40V £3.50

Daly Electrolytic Capacitors 2000µF. 100V £1.50

I.T.T. BCY 72 Transistors leads pre-formed 10 for 50p

Varicap Tuners ELC1042 £6.00

Varicap Tuner ELC1043 £6.00

Philips Scope Tube 5" CV2191/DG-13-2 £10.00

Thorn-Sylvania Scope Tube 5" SE5J £17.50 (Callers only)

Toshiba 12" TV Tube 310GAB4 £12.50 (Callers only)

If you do not have the issue of H.E. which contains the Project, we can supply a reprint at 40p extra orders. Please add 30p post and packing. Add 15% VAT to total order.

Callers please ring to check availability of Kits.

T. POWELL

306 ST. PAUL'S ROAD
HIGHBURY CORNER, LONDON, N.1.
TELEPHONE: 01-226 1489

Access/Visa accepted
Shop hours: Mon. to Fri. 9-5.30. Sat. 9-4.30

TELEVISION SOUND IS GOOD!

Yes it's true—but you'll need to listen through a Minim Television Sound Tuner to be convinced. Music, wildlife, even the news suddenly comes to life when you can hear all the detail that you expect from High Fidelity equipment.

Connect the Minim Television Sound Tuner to the amplifier or music centre or listen directly on headphones so as not to disturb others.

Further information will only cost you 12p — stamp out poor television sound!

Name

Address

ETI 1 81

Minim Audio Limited, Lent Rise Road, Burnham,
Slough SL1 7NY. Tel: Burnham 63724

Minim Audio

make a *note* of our name!

TRAIN FOR SUCCESS

in Radio, Television & Electronics

ICS have helped thousands of ambitious people to move up into higher paid more secure jobs in the field of electronics — now it can be your turn. Whether you are a newcomer to the field or already working in the industry, ICS can provide you with the specialised training so essential to success.

Personal Tuition and Guaranteed Success

The expert and personal guidance by fully qualified tutors, backed by the ICS guarantee of tuition until successful, is the key to our outstanding record in the technical training field. You study at the time and pace that suits you best and in your own home. In the words of one of our many successful students: "Since starting my course, my salary has trebled and I am expecting a further increase when my course is completed."

City and Guilds Certificates

Excellent job prospects await those who hold one of these recognised certificates. ICS can coach you for:

Telecommunications Technicians
Radio, T.V. Electronics Technicians
Radio Amateurs
Electrical Installation Work

Diploma Courses

Colour T.V. Servicing
CCTV Engineering
Electronic Engineering & Maintenance
Computer Engineering and Programming
Radio, T.V. and Audio, Engineering & Servicing
Electrical Engineering, Installations & Contracting

Other Career Courses

A wide range of other technical and professional courses are available including GCE.

FREE
BOOK

To ICS, Dept. Z263, Intertext House,
London SW8 4UU

Name

Address

Age

ICS

To ICS, Dept. 265C, Intertext House,
London SW8 4UJ
or telephone 01-622 9911 (all hours)

£395
incl.VAT& P&P

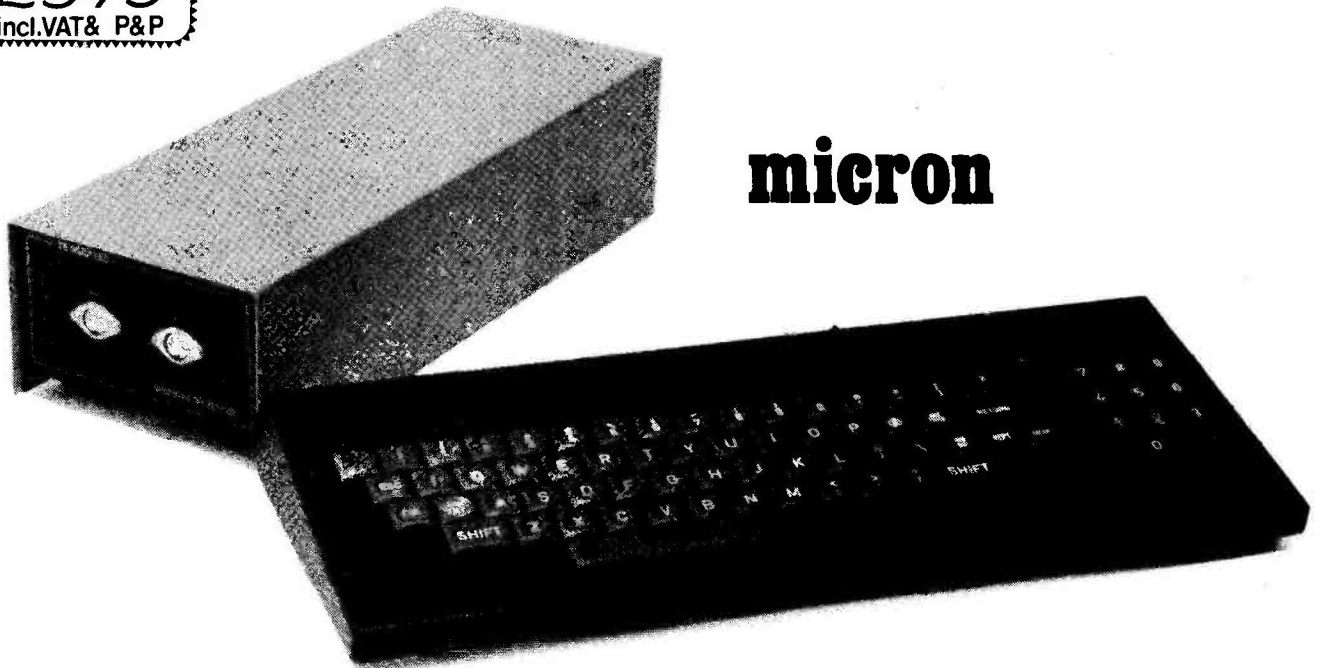

micron

'MICRON' may sound small - but we all know that it's much larger than an atom!

The un-beatable features of Microtan 65 and Tanex have been brought together to give you **Micron**, a ready built and tested computer of outstanding value. Fully supported by comprehensive documentation, **Micron** represents an ideal starting point in personal computing. We've taken a full O.E.M. licence for Microsoft Basic, which means that you'll have the support of the most popular Basic available, (as used on PET, APPLE, TANDY etc.). If you want to expand **Micron** there's no problem, just move into the system rack and choose from the range of Microtan modules. Read the information, study what the magazines have to say about us and compare what we have to offer with other systems, then we feel sure that you'll be convinced that we've produced an excellent product.

- FULLY BUILT, TESTED AND CASED.
- 6502 BASED MICROCOMPUTER.
- VDU ALPHA NUMERIC DISPLAY.
- 8K RAM.
- 32 PARALLEL I/O LINES.
- 2 TTL SERIAL I/O LINES.
- 1 SERIAL I/O PORT WITH RS232/20mA LOOP, AND 16 PROGRAMMABLE BAUD RATES.
- 300 / 2400 BAUD FILENAMED CASS. INTERFACE.
- DATA BUS BUFFERING.
- MEMORY MAPPING CONTROL.
- 71 KEY ASCII KEYBOARD, INCLUDING NUMERIC KEYPAD.
- POWER SUPPLY INCLUDED.

SOFTWARE

- 10K EXTENDED MICROSOFT BASIC.
- ALL THE USUAL BASIC COMMANDS.
- INTEGER AND REAL NUMBERS.
- INTEGER AND REAL ARRAYS.
- INTRINSIC FUNCTIONS: ABS, INT, RND, SGN, SIN, SQR, TAB, USR, ATN, COS, EXP, LOG, TAN.
- USER DEFINED FUNCTIONS.
- READ AND DATA STATEMENTS.
- DUMP AND LOAD PROGRAMS.
- PROGRAM EDITING COMMAND.
- STRING FUNCTION FOR TEXT I/O.
- BASIC CAN CALL MACHINE CODE SUB-ROUTINE.
- USER MACHINE CODE INTERRUPT HANDLER INTERFACES WITH BASIC.
- XBUG.
- DATA CASSETTE FILE HANDLING IN BASIC

TANGERINE
COMPUTER SYSTEMS LIMITED

Forehill Works
Forehill Ely Cambs England Tel: (0353)3633

microtan 65

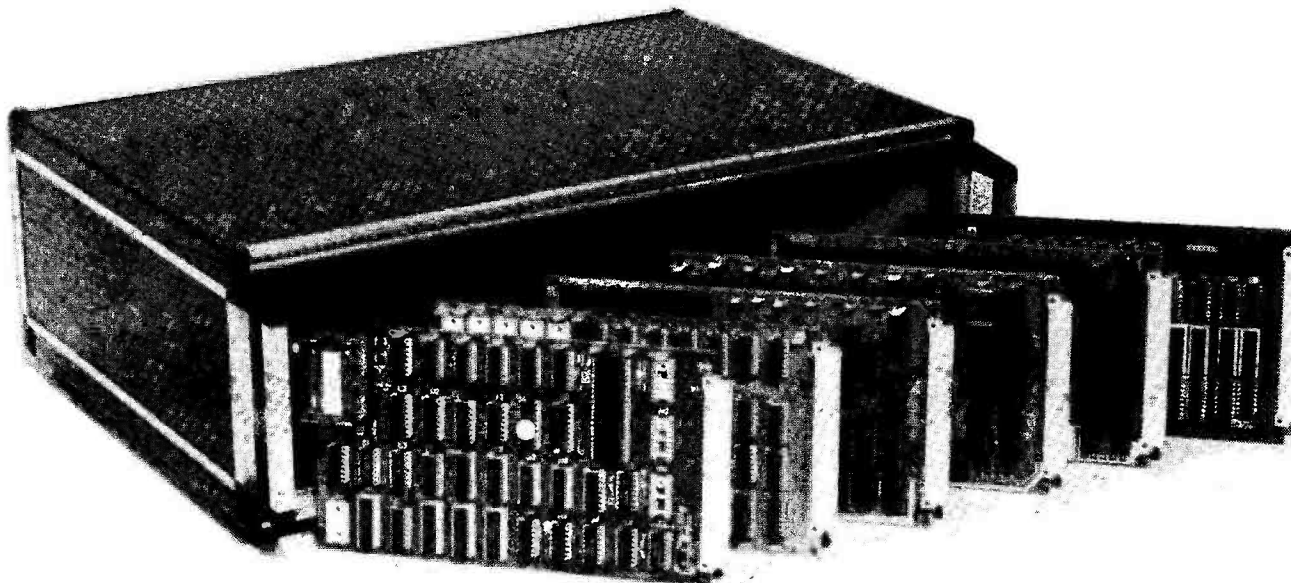

The **Microtan** system is rapidly becoming accepted as the ultimate approach to personal computing. Start with **Microtan 65**, a 6502 based single board computer, and expand to a powerful system in simple and in-expensive stages. The **Microtan** system is a concept and not an afterthought, this means expansion is easy and very efficient! Unlike many other systems, you'll find it difficult to outgrow **Microtan**, and you won't be wasting your money on a product that will only last you a few months! When you are ready to expand, **Tanex** is waiting. The features offered by **Tanex** are tremendous, and you can start into them for just £49.45! Cassette interface, 16 I/O lines, two 16 bit counter timers, data bus buffering, memory mapping and a further 1K of RAM are standard. From thereon expansion is simple, just plug in extra integrated circuits to get yourself 8K of RAM, a further 16 I/O lines and two more counter timers a serial I/O line with RS232/20mA loop and full modem control, **XBUG** - a firmware package containing cassette file handling routines, plus a line-by-line assembler (translator) and dis-assembler, **PLUS 10K EXTENDED MICROSOFT BASIC**, a suped-up version of the Basic as used by major manufacturers such as Apple, Tandy and Nascom, **NO OTHER LOW COST MICROCOMPUTER OFFERS YOU THIS SUPERB PACKAGE**. O.K. so you want more memory, try **Tanram** for size! Upto 40K bytes on one board starting for as little as £50.60. RAM freaks will be pleased to hear that our system mother board offers page memory logic which will support 277K Bytes, satisfied? To house these beautiful modules you can choose between our mini-rack (as used on **Micron**), which accepts **Microtan** and **Tanex**, or our system rack pictured above. The system rack will support 12 modules. What are these extra modules? Well for starters there's a couple of I/O modules, parallel and serial offering upto 128 I/O lines organised as 16 8 bit ports and 8 serial I/O ports respectively. Shortly we'll be introducing high definition (256x256) colour graphics, A to D and D to A modules, IEEE 488 Bus interface, a PROM programmer, disc controller and **TANDOS** - a 6502 CPM system. So there's plenty to keep you busy. Send for more details, and find out how you can get started for just £79.35!

ALL PRICES QUOTED INCLUDE V.A.T.

AIM 65, KIM 1, SIM 1 USERS- READ ON!

We have produced a T.V. interface module which simply connects to the expansion socket of your computer and produces a display of 16 rows by 40 characters! Of even more interest will be our Buffer module, which allows you to expand into our system rack, giving you access to the full range of **Microtan** modules.

Please underline the information required.

AIM T.V. INTERFACE. MICROTAN SYSTEM.

NAME: _____

ADDRESS: _____

PLEASE ENCLOSE 12p STAMP. THANK YOU. _____

TECH TIPS

Click Eliminator Auto Threshold

S.P. Cobbold, Cambridge

This circuit is designed to increase the versatility of the 'ETI Click Eliminator'. It automatically adjusts the threshold level for greater sensitivity during extended quiet passages, while

reducing the sensitivity during peak transient levels.

The left and right channels are added and amplified by the operational amplifier IC1, which largely cancels the antiphase signals of the click. C1 and C2 decouple any DC offset voltage from the input amplifiers. D1 and C4 hold the peak level of the higher frequency audio signals and pass this to C5 through Q1 and Q2, giving a rise time of

approximately 3mS and a hold time of the order of 5 S. No buffer is required for C5 as the comparator of the click detection circuit has a JFET input. R4 and R5 bias the peak integrating section to give a minimum of approximately 0V5 on C5 when the preset PR1 is adjusted for optimum click detection. This adjustment is best performed using a badly scratched record (borrow a friend's if necessary) and setting PR1 to the point where the loudest click is just removed from a section of loud music.

Q3 and LED1 give a visual indication of operation by changing from dull to bright with the music signal when switched to automatic.

It can be seen from the rise and hold times of the peak integrator that large transients in the middle of a quiet passage (eg a cymbal crash) may cause a single inappropriate click detection before the integrator charges up. Conversely, a series of clicks in very rapid succession may be ignored. However, I have found these two faults far more acceptable than the severe distortion caused by repeated spurious click detection when unexpectedly high transient levels pass the manually set threshold.

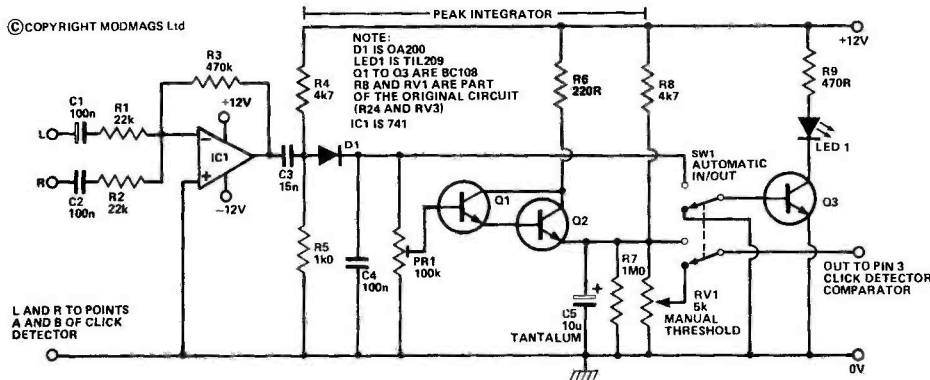

Shop Doorbell

R. Gamester, Chesham

This unit was designed to give a remote indication of a shop door opening. The bell rings once as the door opens and a flashing LED indicates that the door is open. To prevent the unit being repeatedly triggered, a time

delay operates from the closing of the door for a period of 20-30 S, during which time the LED is constantly illuminated.

When the door opens, C2 charges quickly through D1 and IC2b turns Q2 on. The oscillator (IC2d) is running and interrupts the LED by switching Q1 on and off.

When the door is closed the

oscillator is stopped, leaving Q1 on. This gives a constant indication until C2 discharges through R3, PR1 and R4.

The bell is a standard 3 V vibrator type and is powered by C4, this being discharged through the armature by Q3. IC2c generates the drive pulse, its duration being the charge time of C2.

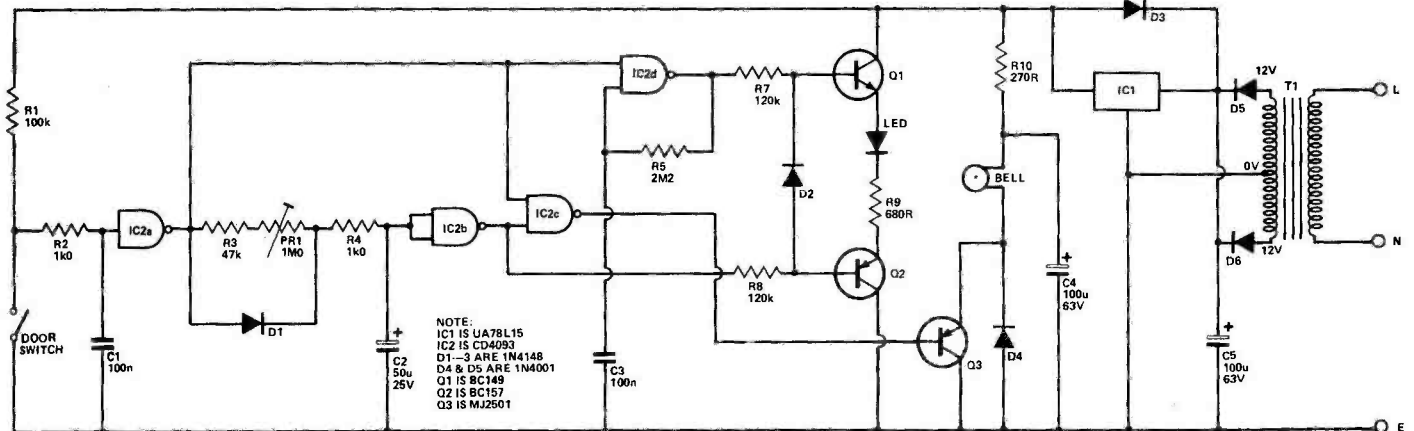

Tech-Tips is an ideas forum and is not aimed at the beginner. We regret we cannot answer queries on these items.

ETI is prepared to consider circuits or ideas submitted by readers for this page. All items used will be paid for. Drawings should be as clear as possible and the text should preferably be typed. Circuits must not be subject to copyright. Items for consideration should be sent to ETI TECH-TIPS, Electronics Today International, 145 Charing Cross Road, London WC2H 0EE.

Simple Combination Lock

M.D. Chapman, Sale

Although this circuit uses surprisingly few components, the unit provides up to nine code elements and a billion-to-one chance of random operation.

The first nine outputs of the decade counter (IC1) are fed via the diode OR gates (one for every different number used in the code) to the selected switches. As shown on the circuit diagram the combination sequence is 123412341. However, both the numbers and the sequence can be

modified by rewiring the output diodes (D1-9) to different switches. To change the number of active code switches (ie. numbers 1234 in this case), you will have to either remove or add to the number of diode OR gates.

Operation is very simple. As the counter sequences through its outputs 0-9 it provides a logic 1 to one of the four diode OR gates, thereby making one of the active switches live. When this live switch is pressed it provides the clock pulse to increment the counter one step. This, then, provides a logic 1 to the next OR gate, making the next digit in the code live, which in turn, when pressed, provides the next clock pulse and so on until the counter reaches its tenth output. Once output

nine goes high it turns on Q1, thereby switching the relay and desired load. Since only one of the outputs is high at any one time, only one of the keys will move the counter and, should any dud key (ie. keys 567890 in this case) be pressed, this will reset the counter to zero, making guesswork ineffectual.

When selecting the code sequence, it is worth remembering that in order to maintain a nine element code the effect of switch bounce should be minimised by avoiding the use of any number consecutively, ie. codes such 123343222. However, if necessary, the clock input can be debounced to allow such a sequence.

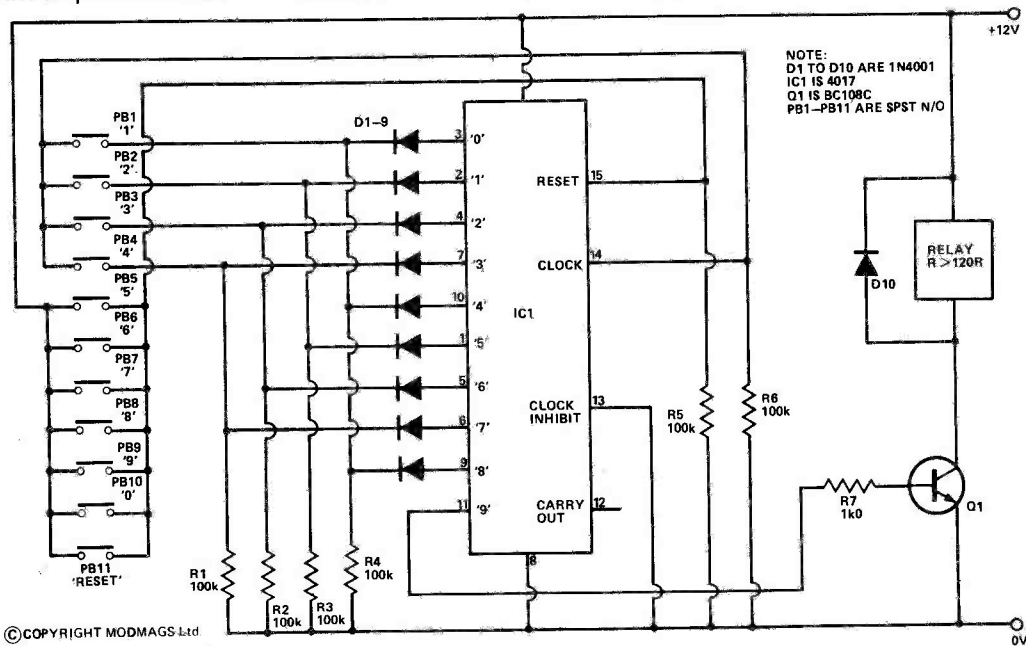

5 V TTL Supply

D. McIntyre, Camberley

The circuit shown was designed to eliminate expensive accidents with TTL caused by inadvertently turning up the knob on the (heavily smoothed) train controller normally used as a bench PSU. It is provided with crowbar protection just in case, though.

Power Darlington Q3 is biased to just over 5 V by ZD1 and Q2 (this does not have to be a Darlington, although the output will not be as stable if it is not). Any change in output voltage is sensed by Q2 and it adjusts ZD1's reference level accordingly. Any change in input voltage is adjusted by normal zener operation. The output level may be set using PR2 and it will

remain fairly stable ($\pm 0V5$) for a change in input from 8 V to 12 V. If, for some reason, the output voltage should rise above the preset level to, say, 6 V, SCR1 will be triggered and the

fuse will blow. This trigger level may be set by PR1. C1 reduces the (extreme) sensitivity to noise. SCR1 is not critical, but it should be capable of sinking the required current.

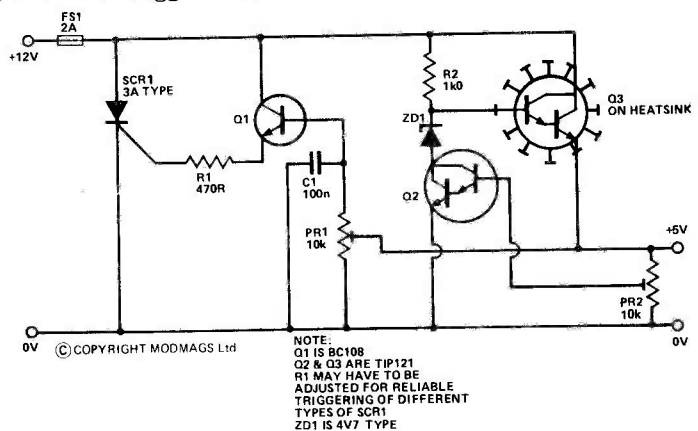

Accenting Metronome

P. Hill, London

The circuit consists of a clock generator determining the beat and a monostable producing the accent.

The clock is formed by IC1a,b configured as an astable. The frequency or tempo is adjusted by RV1. C1 must be a non-polarised type. The clock pulses are fed to IC2. This divides and decodes the clock to produce a high at each output in succession. By feeding one of the outputs via monostable IC1c,d to the reset input, division by one, two, three or four is possible, thus selecting the beat.

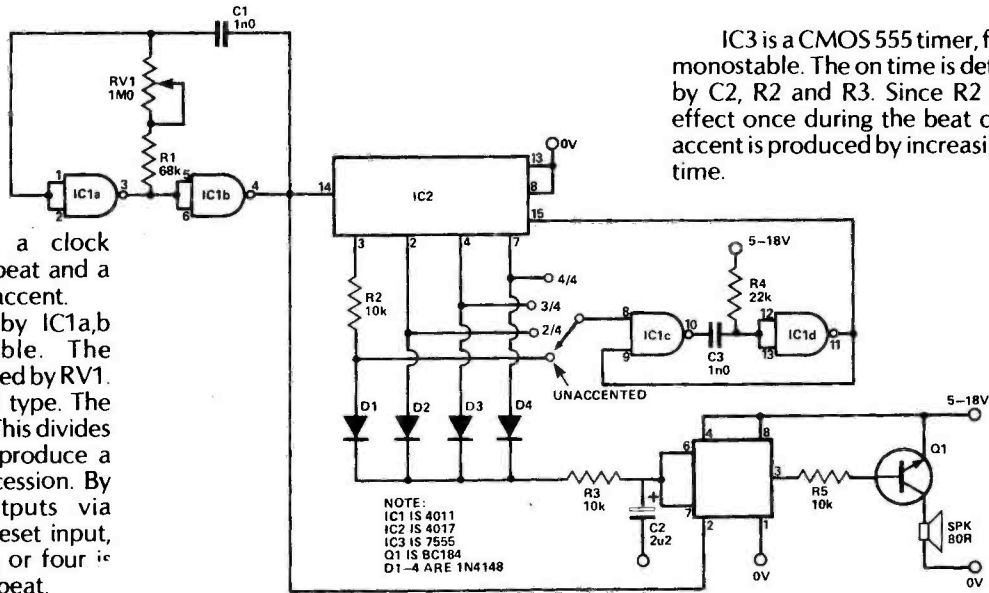

IC3 is a CMOS 555 timer, forming a monostable. The on time is determined by C2, R2 and R3. Since R2 only has effect once during the beat cycle, the accent is produced by increasing the on time.

NOTE:
IC1 IS 4011
IC2 IS 4017
IC3 IS 7555
Q1 IS BC184
D1-4 ARE 1N4148

Contact Breaker

E. P. Young, Plymouth

The contact breaker carries a mere 25mA when the ignition coil is charging up for the induction of high voltage to produce a spark in the spark plug. Further, without the induced EMF across the CB from the primary winding of the ignition coil, the life of the CB will be greatly increased.

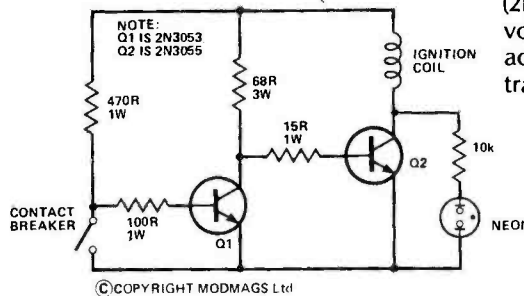

©COPYRIGHT MODMAGS Ltd

A cheaper power transistor (2N3055) is chosen instead of the high voltage type. A neon bulb is used across collector-emitter to protect the transistor from a high induced EMF.

Simple VCR

S. Draper, Sudbrooke

This circuit is a simple voltage-controlled resistor, which may be used in a variety of applications (it was originally designed as a portion of a voltage-controlled envelope generator). It has two big advantages over the often-used FET type circuit — a large control range (10,000:1) and a predictable voltage-current characteristic.

The voltage differential between terminals A and B is amplified and converted to a current by OTA IC1, the gain of which is controlled by the current flowing into it at pin 5. The resulting current is fed to current multiplier IC2, which multiplies it by a factor of R_x/R_y and feeds it to terminal B. This means that the current flowing into or out of terminal B is proportional to the voltage difference between terminals A and B and to the control current generated by voltage-current converter IC3.

The formula for the circuit resistance is as follows:

$$R = \frac{200R_{CON}R_y}{19.2V_{CON}R_x} + R_c$$

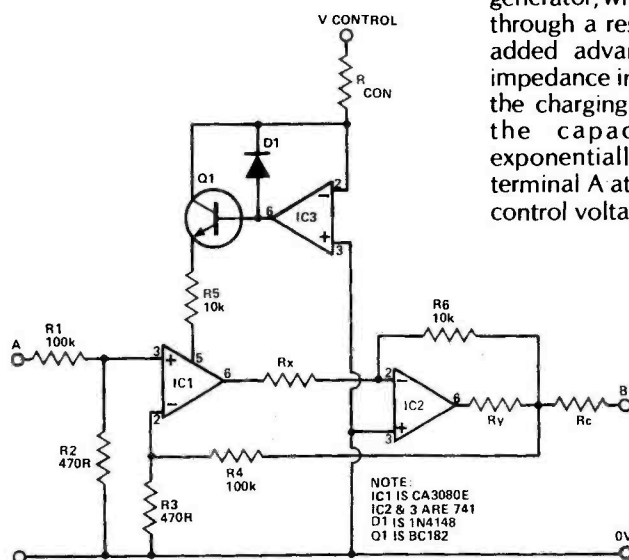

NOTE:
IC1 IS CA3080E
IC2 & 3 ARE 741
D1 IS 1N4148
Q1 IS BC182

©COPYRIGHT MODMAGS Ltd

This means that with a constant applied voltage, the output current will be proportional to the control voltage and the effective resistance is inversely proportional to same.

In circuits such as an envelope generator, where a capacitor is charged through a resistor, this circuit has the added advantage of having a high impedance input and so does not load the charging source. In this example, the capacitor would charge exponentially to the voltage on terminal A at a rate determined by the control voltage.

7400

Table listing various electronic components like resistors and capacitors with their specifications and prices.

74LS

Table listing integrated circuits such as 74LS00, 74LS01, 74LS02, etc., with their prices.

74C

Table listing CMOS integrated circuits like 74C00, 74C01, 74C02, etc.

CMOS

Table listing a wide variety of CMOS components and their prices.

PRIME COMPONENTS LOW PRICES

All our microchips are at micro prices. Don't be fooled by low prices. We do not offer for sale surplus, sub-spec or rebranded devices. All our parts are guaranteed new, first quality, factory fresh, full spec devices. It is also our policy to offer you the best of new devices that become available and these are featured regularly. Prices are exclusive of p&p and VAT - please refer to "Ordering Information" before ordering. Official orders from schools, colleges, universities and Gov. authorities accepted.

Table listing various microchips and components under categories like MEMORIES, UARTS, BIPOLAR RAMS, CPU'S, CHARACTER GENERATOR, EPROMS, VOLTAGE REGULATORS, KEYBOARD ENCODER, SUPPORT DEVICES, and INTERFACE LINEAR.

Table listing various integrated circuits and components under categories like LINEAR IC'S and INTERFACE LINEAR.

NEW, LOW, LOW PRICES ON MEMORIES

Table listing various memory chips like 2114 450 NS, 2114 L 300 NS, 4116 150 NS, etc., with prices.

Compare our prices before you buy elsewhere! All devices are brand new, factory fresh, full spec, and fully guaranteed!

NEW! EXCITING, ENTERTAINING SOFTWARE FOR THE APPLE II and APPLE II PLUS!! ASTEROIDS IN SPACE!!!

FROM INTERSIL ICL 7660 Voltage Converter

Table listing various bipolar and CMOS ICs, including voltage converters and logic chips.

SE 01 Sound Effects Kit

The SE-01 is a complete kit that contains all the parts to build a programmable sound effects generator. Designed around the new Texas Instruments SM76477 Sound Chip...

NEW STEREO! S100 SOUND COMPUTER BOARD!

At last, an S-100 Board that unleashes the full power of two unbelievable General Instruments AY-3-8910 NMOS Computer sound ICs. Allows you, under total computer control, to generate an infinite number of special effects for games or any other program...

NEW 6809 S-100 SINGLE-BOARD COMPUTER

Meets IEEE S-100 Standard! Uses Motorola's Powerful MC6809 CPU! 4K, 8K, 16K ROM! Manual includes: 11" x 7" Schematic, Parts List, User Notes, Software Listings and MORE!

Autoringed, Auto Unit Display, 3 1/2-digit LCD DMM for ONLY £39.95 inc. VAT!

The nationally advertised £200, giving 200mA AC/DC current measurement, AC voltage to 750V (CP to 1000V), 100A resolution and 0.1 Ohms - 2 Megohms. Accuracy is 0.8% and it displays mV, V and mA. You won't find a cheaper DMM with these features AND batteries, test leads, spare fuse and one year guarantee are INCLUDED in the low price of just £39.95 inc. VAT

Micro Circuits logo and address: Dept. ET15, 4 Meeting Street, Appledore, Nr. Bideford, North Devon EX39 1RY. Tel. Bideford (02372) 79507. Telex: 8953084.