

Wireless World

RADIO AND ELECTRONICS



DEC. 1947

1/6

Vol. LIII No. 12

IN THIS
ISSUE:

DESIGN FOR A "QUALITY" RECEIVER



The Research Engineer knows that the best speaker for any set is one that offers complete reliability plus true tonal fidelity. After exhaustive tests his advice is always the same —fit Rola and relax!

ROLA SPEAKERS
THEIR QUALITY SPEAKS FOR ITSELF

BRITISH ROLA LTD • 8 UPPER GROSVENOR STREET • LONDON W.1

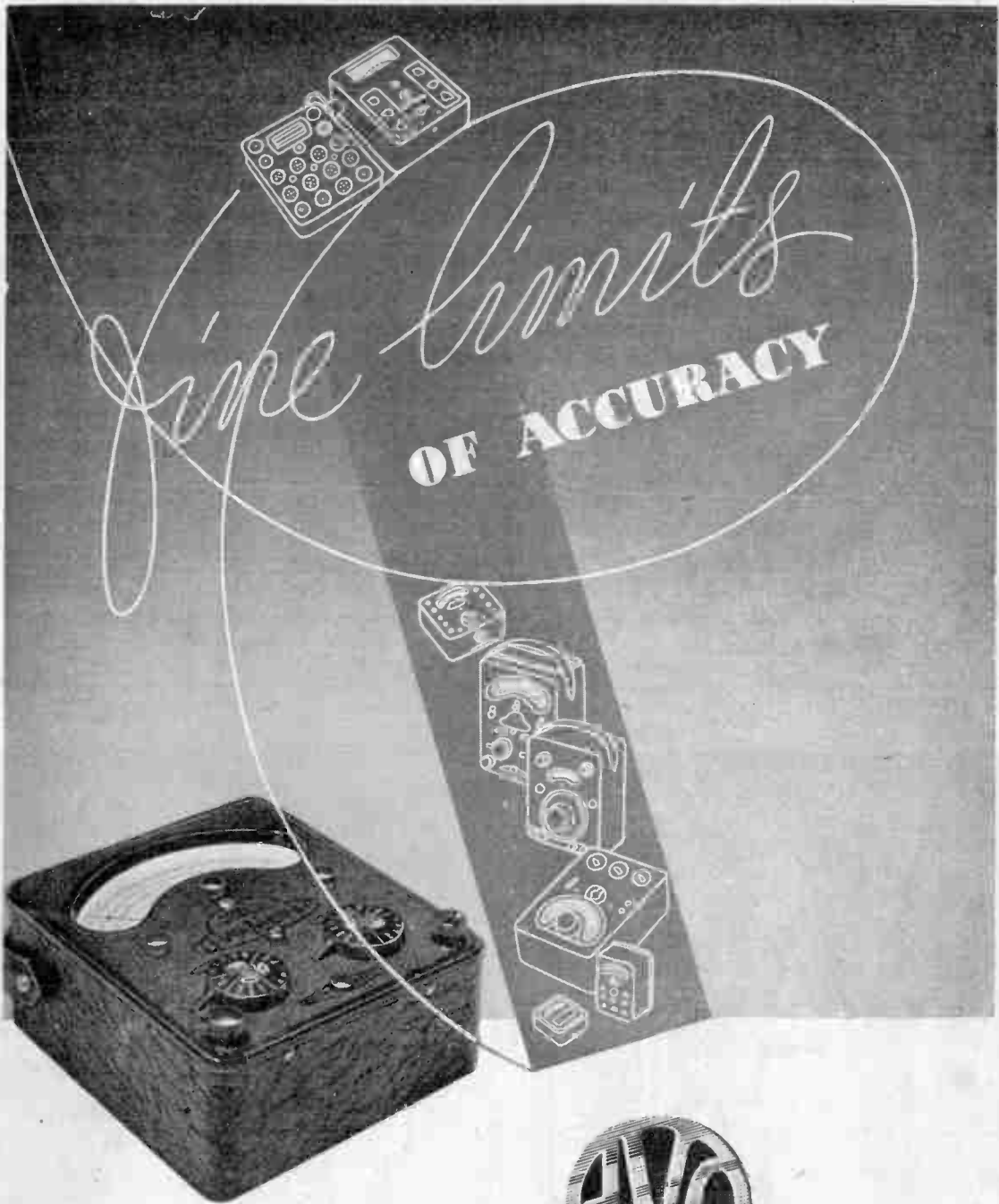

The 50-range Model 7 Universal AvoMeter, the pioneer of the comprehensive range of "Avo" Precision Instruments, is the world's most widely used combination electrical testing instrument. Fully descriptive pamphlet available from the Sole Proprietors and Manufacturers :-



Electrical Measuring Instruments

THE AUTOMATIC COIL WINDER & ELECTRICAL EQUIPMENT CO., LTD.
 WINDER HOUSE • DOUGLAS STREET • LONDON S.W.1 TELEPHONE: VICTORIA 3404/9

MARCONI Mastery of Measurement

is displayed in its unique range of Communications Test Gear

FOR IMMEDIATE DELIVERY 

IMPEDANCE COMPARISON BRIDGE

TYPE TF 202E

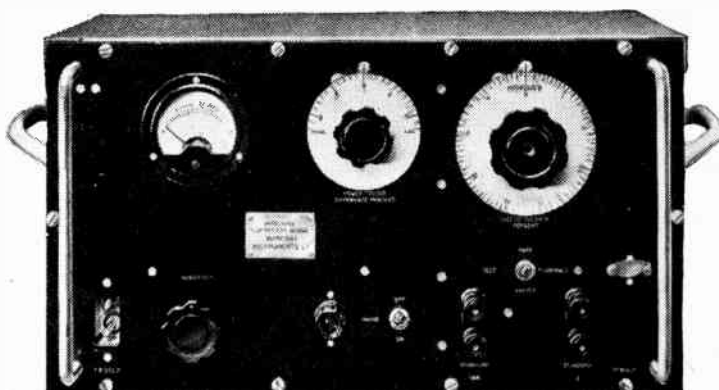

The instrument is a self-contained A.C. mains operated bridge for the rapid comparison of similar capacitors, inductors or resistors and comprises a 10 kc/s oscillator, a bridge network and a visual balance-indicating system. It is precision-made to give lasting, reliable service.

Brief Specification:

Operating Frequency - 10 kc/s;
 Range - - - L 250 μ H—1H;
 C 20 μ F—1 μ F;
 R 20 ohms—1M ohm;
 Accuracy - - - \pm 0.2%



MARCONI INSTRUMENTS LTD

ST. ALBANS, HERTFORDSHIRE

Phone: St. Albans 6161 5

Northern Office: 30 ALBION STREET, HULL. Hull 16144

Western Office: 10 PORTVIEW ROAD, AVONMOUTH, BRISTOL. Avonmouth 438

Southern Office: 109 EATON SQUARE, LONDON, S.W.1 Sloane 8615

THE *Quality* PRODUCTS OF

PAYNTON

VITREOUS RESISTORS FOR EVERY PURPOSE BY
 PAYNTON & CO LTD KINGSTHORPE NORTHAMPTON

A Spire fitting never leaves go!

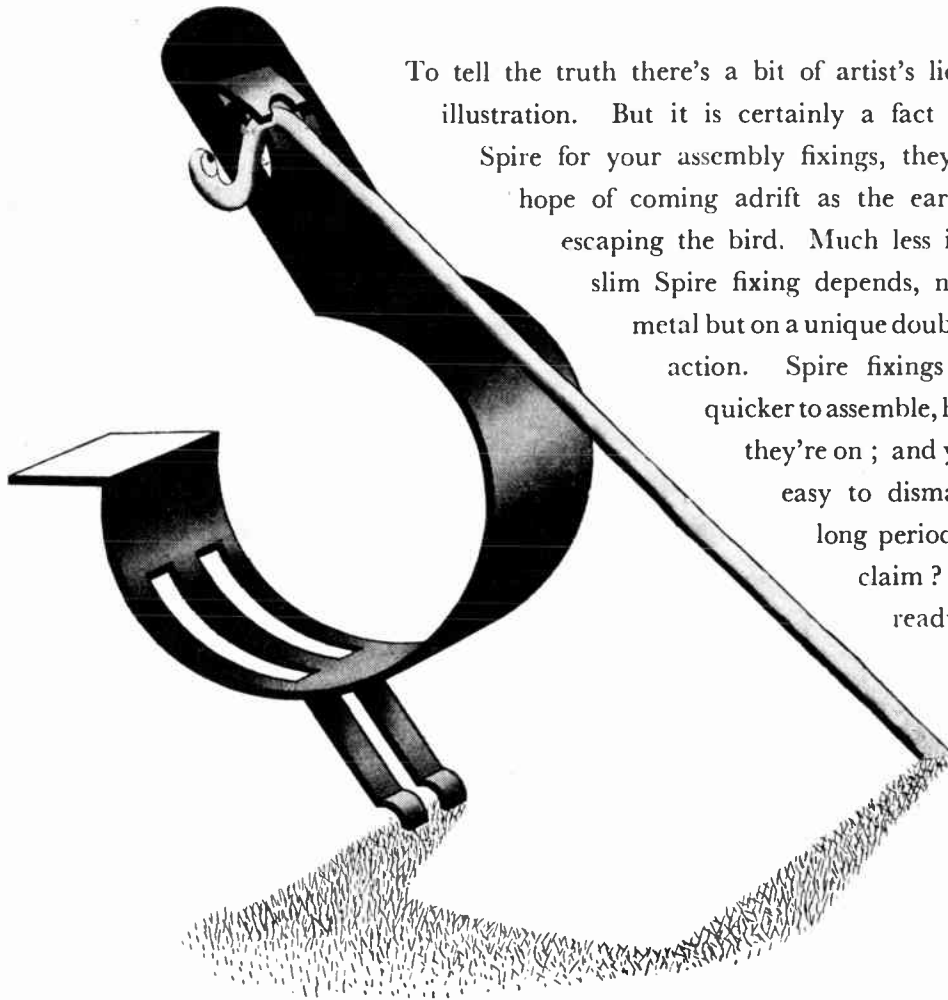

To tell the truth there's a bit of artist's licence about our illustration. But it is certainly a fact that if you use Spire for your assembly fixings, they have as much hope of coming adrift as the early worm has of escaping the bird. Much less in fact. For the slim Spire fixing depends, not on weight of metal but on a unique double-spring locking action. Spire fixings are easier and quicker to assemble, hold tighter when they're on ; and yet they are quite easy to dismantle even after long periods. Sounds a big claim? We're quite ready to prove it.

Spire

(Regd.)

★ A BETTER way of fixing

A Spire Fix — the simplest, quickest, firmest and most tolerant form of light assembly. The illustration shows our Spire Fix No. FR337 suitable for use with $\frac{3}{8}$ " diameter studs.



THAT'S Fixed THAT!

SIMMONDS AEROCESSORIES LIMITED · TREForest · GLAMORGAN



Nation-Wide Distribution

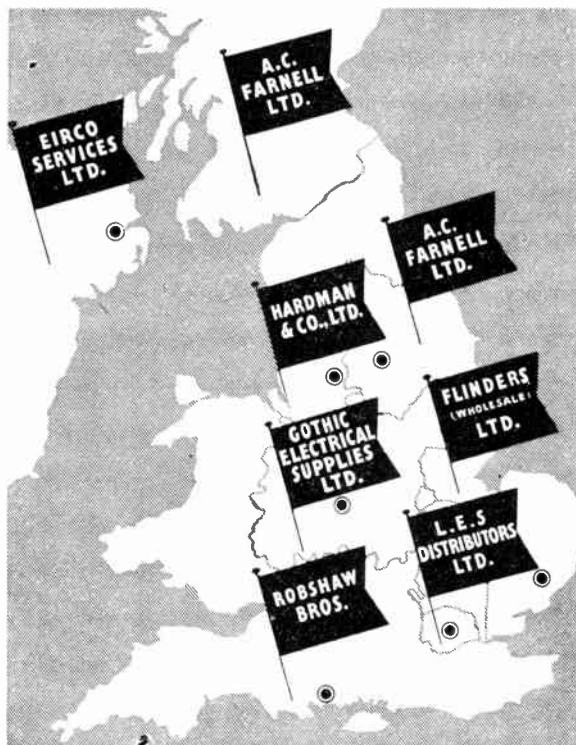

The following area Distributors for U.I.C. Silvered Mica and Ceramic Capacitors, have now been appointed to serve the requirements of Retailers, Wholesalers and Service Engineers.

NORTHERN IRELAND
Eirco Services Limited,
19, Ormeau Avenue, Belfast.

YORKSHIRE & SCOTLAND
A. C. Farnell Limited,
15, Park Place, Leeds.

LANCASHIRE & N. C.ESHIRE
Hardman & Company Limited,
The Baum, Yorkshire Street,
Rochdale.

MIDLANDS
Gothic Electrical Supplies Limited,
23-25, Constitution Hill,
Birmingham 19.

EAST ANGLIA
Flinders (Wholesale) Limited,
14-20, St. Peter's Street, Ipswich.

LONDON
L.E.S. Distributors Limited,
15-16, Alfred Place,
Tottenham Court Road, W.C.1.

SOUTHERN ENGLAND
Robshaw Brothers,
10, The Square,
Bournemouth.

UNITED INSULATOR CO. LTD
Oakcroft Road, Tolworth, Surbiton, Surrey
Telephone: Elmbridge 5241 Telegrams: Calanel, Surbiton

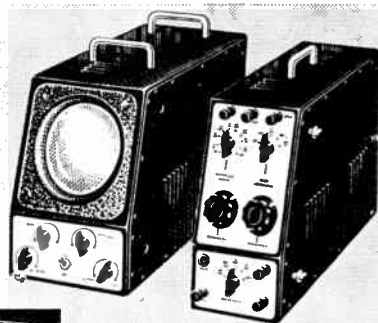

A new departure
in

OSCILLOSCOPE DESIGN

The L.A.L. UNIT OSCILLOSCOPE presents an entirely original approach to problems confronting the research engineer and industrial user.

Constructed on the Unit principle, we can supply apparatus for every need from D.C. to radio frequencies.

Built-in multiple plugs and sockets with mechanical couplers instantaneously complete all electrical circuits and secure a number of Units into a rigid assembly without the use of tools.

We suggest the following representative Units for general investigation.

Type 15. C.R.T. unit 6" tube and self-contained shift supplies.

Type 84. Time Base; 5-200,000 cps. with sweep expansion; automatic synchronizing; push-pull deflection; single or triggered sweep.

Type 84Y. Amplifier; gain 25 (cathode follower input) or 600; response level ± 1 db 10-100,000 cps., useful at 0.5 Mc.; push-pull deflection.

Also available:—

D.C. amplifiers, medium and high gain. Extra low frequency time base. Circular or spiral heptode time base. Voltage calibrator.

Fully described in our illustrated leaflets; your copies will be sent by return of post.



LYDIATE ASH · NR. BROMSGROVE · WORCS.

MODERN MASTERS OF REPRODUCTION

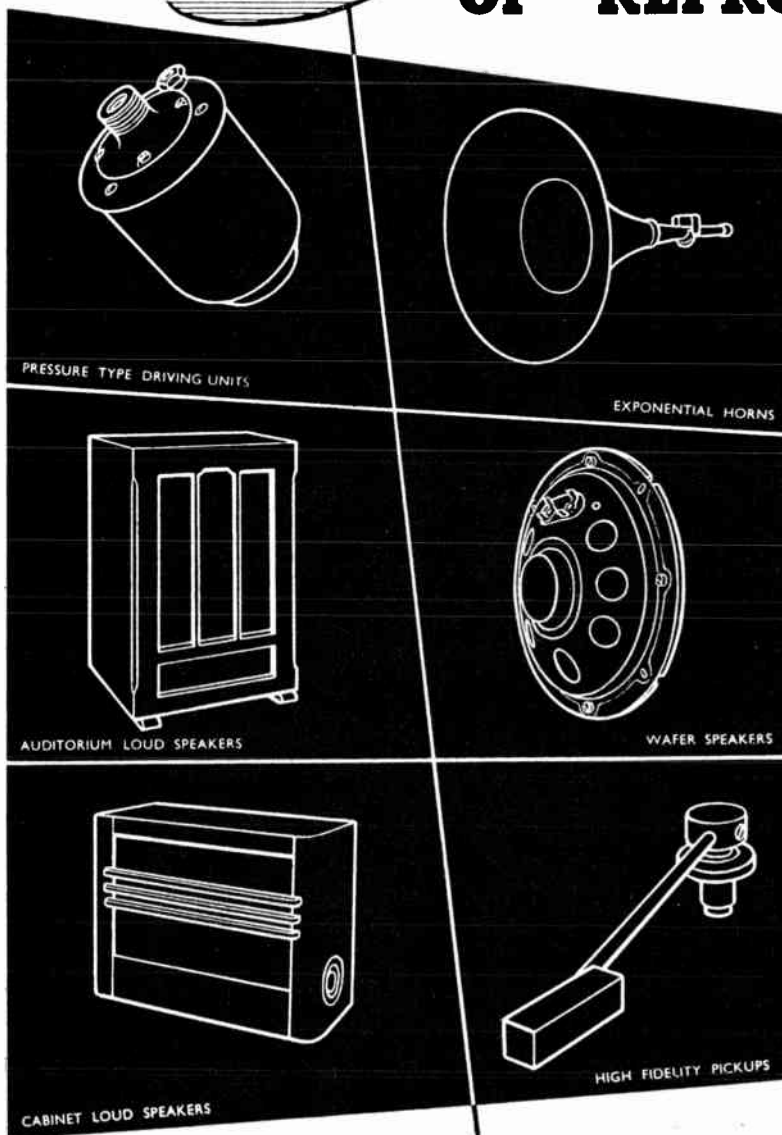

HERE are speakers that go higher and speakers that go lower : other speakers 50% shallower and 40% lighter ; a pickup which can reproduce up to 20,000 c.p.s. ; another pickup giving moving-coil quality with 1 volt output ; public address speakers for all occasions — designed and made by men with eighteen years' practical experience.

TRUVOX

Write for full technical details
— a postcard will do

TRUVOX ENGINEERING CO. LTD., TRUVOX HOUSE, EXHIBITION GROUNDS, WEMBLEY, MIDDLESEX

7.5.11

VIBRATORS FOR RELIABLE REPLACEMENTS



TYPE N.S. 6: 4-PIN U.X. BASE

Tested for radio-frequency
Proof against thermal mis-alignment of contacts.
HERMETICALLY SEALED
FULLY TROPICALLY TESTED.

Entirely British in design and construction, and fully approved for Government Service equipment, W.E. Vibrators are ready for all your replacements. They are fitted as standard components by leading radio manufacturers.

WIMBLEDON ENGINEERING CO. LTD.
GARTH ROAD · LOWER MORDEN · SURREY · TELEPHONE: DERWENT 4814, 5010.

C.R.C.2

YOUR CHOICE for QUALITY

Manufacturers of high quality Broadcast Receivers and Radiograms designed for Home and the Export Market. The Export Models have fully tropicalised components, achieving unsurpassed short-wave performance.

Special dials supplied for any country
PRICES AND FULL PARTICULARS ON REQUEST

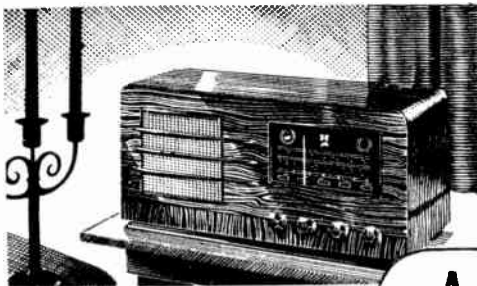

ALLANDER INDUSTRIES LTD.
48, Avenue St. Bridgeton, Glasgow, Scotland.

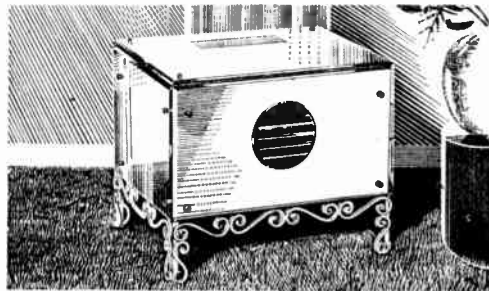

CHAIRSIDE MODEL A450

The housing of this Receiver is unique in that it is contained in a bevelled plate-glass mirror cabinet, fitted to a wrought iron framework finished in Cream enamel. It embodies all the latest technical developments for easy handling, range and clarity of reception, and provides not only a first-class radio but an attractive piece of furniture which can replace a Chairside Table and will harmonise with any surroundings.

SYMPHONY MODEL A420

This new Receiver embodies the very latest technique in construction. The cabinet is richly veneered in Walnut with a cross banding of Macassar Ebony. Clearly readable edge-lit dial with an 8 in. traverse magic eye and 2-gear control. Instant, unerring selection of the required frequency range. Automatic volume control and an I.F. trap are incorporated in the circuit. Sockets are provided for gramophone pick-up and extension speaker.

ALLANDER



METALLISED CERAMICS

Two new S.P. metallised bushes—
*one at either end of
the range*

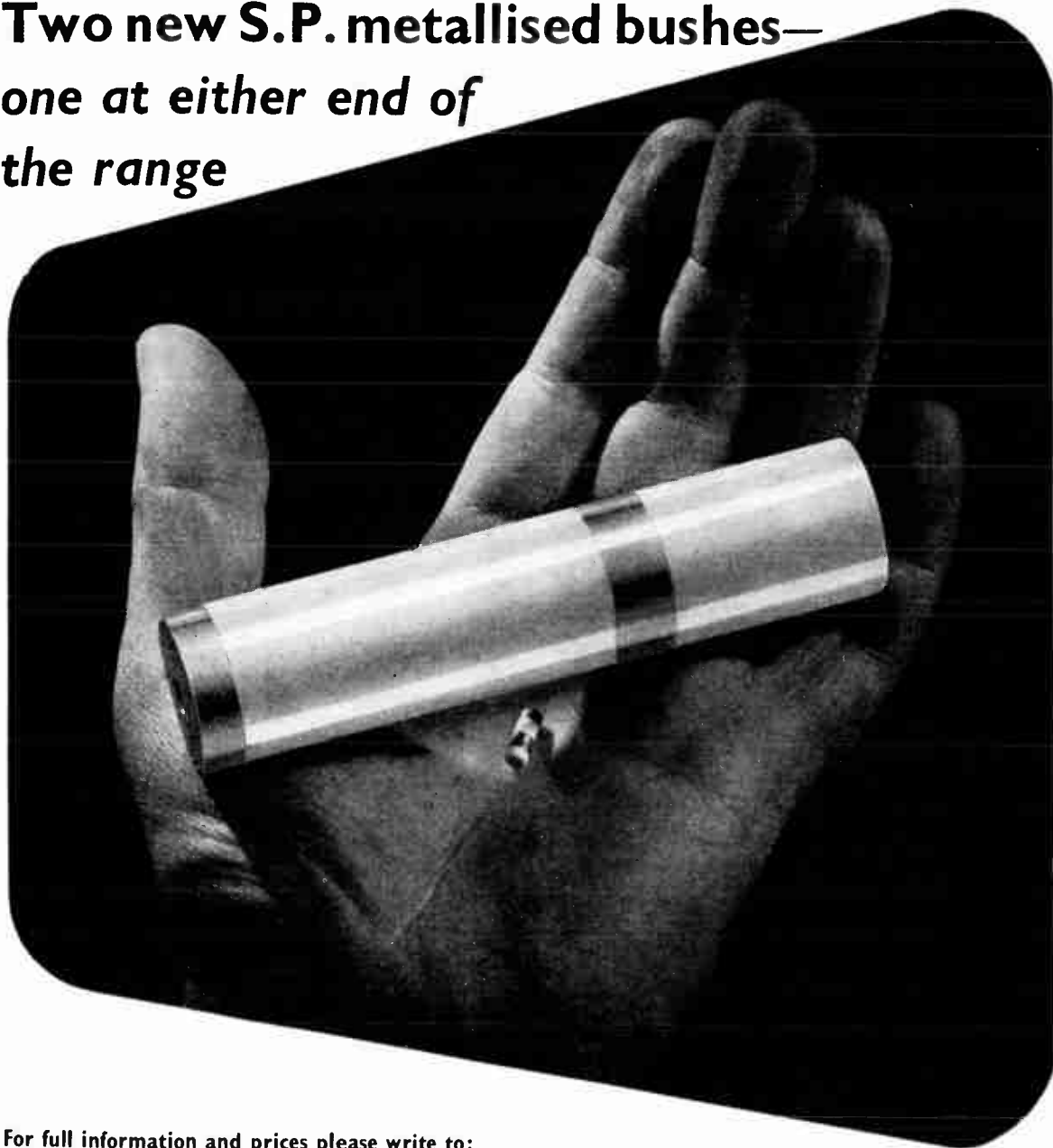

For full information and prices please write to:

STEATITE & PORCELAIN PRODUCTS LTD.

STOURPORT-ON-SEVERN, WORCS. Telephone: Stourport III. Telegrams: Steatoin, Stourport.



SP.42



★ **A.F. ATTENUATOR, TYPE 1358**
 Frequency Range, zero to 20Kc/s. Input Impedance, 600 ohms. Attenuation, 0-110 dB in steps of 1 dB, $\pm 1\%$ nominal voltage ratio. Internal Termination of 600 ohms at option. Dissipation, 2 watts.

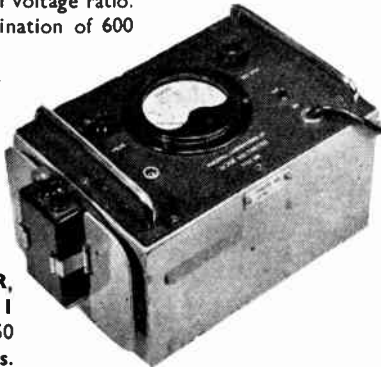

★ **DIODE VOLT METER, TYPE 281**
 0.1-150 volts, 50 c/s. to 250 Mc/s. $\pm 2\%$ of F.S.D. Stable zero setting. Alternative model having additional d.c. voltage ranges available.

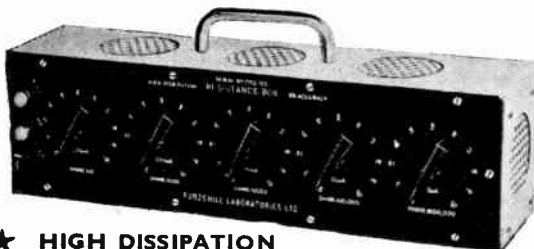

★ **HIGH DISSIPATION RESISTANCE BOX, TYPE 1752**
 0-1 meg. in 5 decades. 6 watts per resistor, 60 watts per decade, except last decade which is 20 watts. Accuracy $\pm 5\%$. Voltage limit 1,000 volts.

PRICES ON APPLICATION

Furzehill LABORATORIES LTD.
 BOREHAM WOOD, HERTS
 TELEPHONE, ELSTREE 1137

The "Connoisseur" is proved by trade tests

Exhaustive trade tests have substantiated our claims for the "CONNOISSEUR" pick-up. Below we give the response curve to which every "CONNOISSEUR" pick-up is individually tested.

Supplies are very limited but we invite trade enquiries to our distributors who will endeavour to meet your requirements.

RESPONSE CURVE *Connoisseur* PICK-UP

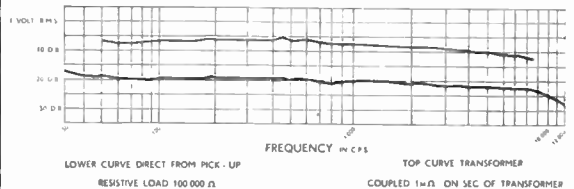

1. Every "Connoisseur" pick-up is hand tested and passed to ± 2 DB of above response curve.
2. Our new type damping material working in gap direct on to armature does not affect bass resonance point.
3. The required downward pressure is 1.1/3 ozs. which has been achieved without counter-balancing or springs.
4. Being a constant velocity device Bass compensation is required in the amplifier and alternation of high frequencies to suit individual recordings.
5. Output direct from pickup .1 volt. With transformer coupled .5 volt.

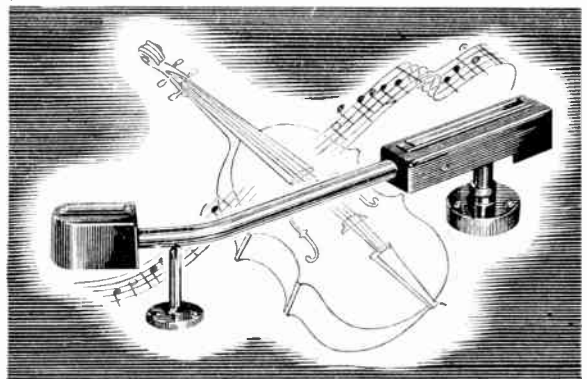

Apply to:—
 Albion Electric Stores, 125, Albion Street, Leeds 1, or to
 Lawton Brothers (Sales) Ltd., Henry Square, Ashton-under-Lyne.

Made by: A. R. SUGDEN AND CO. (ENGINEERS) LTD., BRIGHOUSE, YORKS.

TECHNICAL TOPICS

for Amplifier designers



● **Pentode (or beam Tetrode) or Triode output.**
 With the demand for high sensitivity the popularity of an output Pentode (or beam Tetrode) has grown. OSRAM output tetrodes, in particular type KT61, are therefore widely used where the maximum sensitivity is required. Type KT66 — a larger tetrode with aligned grids — is unsurpassed in combining high sensitivity with large power output and a long reliable life performance at maximum rating. For those who demand high quality, triode output is often preferred because of its lower impedance, and not only are directly heated triodes such as types PX4 and PX25 in wide demand, but the tetrode KT66 is also eminently suitable for wiring as a triode, giving similar characteristics to those of the PX25, but with a 6.3 volt indirectly heated cathode.

TYPE	FILAMENT OR HEATER		AS TETRODE					AS TRIODES PUSH PULL PAIR		
			V _a	V _{g2}	I _a	OUTPUT POWER*		V _a	I _a	OUTPUT POWER
						SINGLE	PUSH PULL			
KT61	6.3	0.95	250	250	40	4.3	—	not recommended		
			250	250	72	—	11.5			
KT66	6.3	1.27	400	300	85	7.25	—	400	125	14.5
			400	300	136	—	35			
KT33C	26	0.3	200	200	60	5.0	—	not recommended		
			200	200	113	—	15.5	300	100	13.5
PX4	4	1.0	—	—	—	—	—	300	100	13.5
PX25	4	2.0	—	—	—	—	—	500	100	20

* With auto-bias in every case.

Osram
PHOTO CELLS

S.E.C.
CATHODE RAY TUBES

Osram
VALVES

The General Electric Co., Ltd, Magnet House, Kingsway, W.C.2.

B

H. T. RECTIFIERS

for broadcast receivers

A range of rectifiers is now available which will meet **manufacturers'** general requirements for broadcast radio receivers. These units are very much smaller in bulk and weight, have a high efficiency and good regulation.

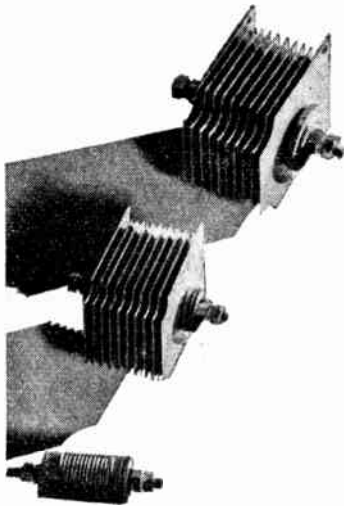

Type	Output		Max. input Volts	Overall dimensions		
	Volts	mA		Length	Width	Height
14A118	600	120	275	4 $\frac{1}{16}$	2 $\frac{1}{4}$	2 $\frac{1}{4}$
14A79	400	120	210	3 $\frac{1}{8}$	2 $\frac{1}{4}$	2 $\frac{1}{4}$
14A79	400	75	210	3 $\frac{1}{8}$	2 $\frac{1}{4}$	2 $\frac{1}{4}$
14A59	300	75	170	2 $\frac{3}{16}$	2 $\frac{1}{4}$	2 $\frac{1}{4}$
4A79*	245	120	250	3 $\frac{3}{8}$	2 $\frac{1}{4}$	2 $\frac{1}{4}$
14A46*	270	60	250	2 $\frac{3}{8}$	2 $\frac{1}{4}$	2 $\frac{1}{4}$
15B46*	270	30	250	1 $\frac{1}{8}$	1 $\frac{3}{8}$	1 $\frac{3}{8}$
5D28†	120	20	108	1 $\frac{9}{16}$	$\frac{5}{8}$	25/32

* For AC/DC receivers.

† For battery eliminators.

Write for full details to Dept. W.W.,
WESTINGHOUSE BRAKE & SIGNAL CO. LTD., 82 York Way, King's Cross,
London, N.

WESTINGHOUSE WESTALITE

METAL RECTIFIERS

RADIO IN EVERY ROOM

with these

NEW & BETTER EXTENSION SPEAKERS

Are you enjoying the pleasure and convenience of having your radio instantly available in any room? These moderately priced Stentorian extension speakers, with their handsome acoustically designed wooden cabinets, give such superb quality of reproduction that you will be amazed at the difference a Stentorian makes to your receiver.

Ask your dealer for a demonstration.

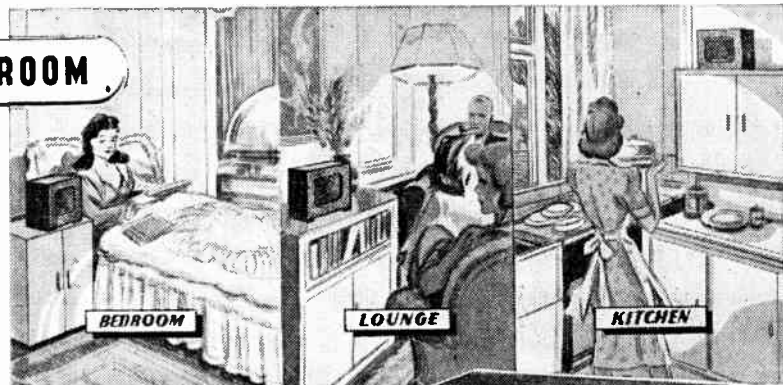

- SENIOR MODEL**
Type SC with Universal Transformer £5.15.6
" SX minus " " £5.2.6
- JUNIOR MODEL**
Type J with Universal Transformer £5.0.0
" JX minus " " £4.10.6
- CADET MODEL**
Type C with Universal Transformer £4.10.0
" CX minus " " £4.0.0
- Other Cabinet models available from 39/6*



Stentorian

THE FINEST EXTRA SPEAKER FOR ANY SET

WHITELEY ELECTRICAL RADIO CO. LTD., MANSFIELD, NOTTS.

WHY



CORE

SOLDER

Because only with a solder wire having more than one core of flux can you be sure that the flux is always present. The 3 cores of Ersin Multicore Solder are filled with Ersin—the extra active non-corrosive flux. Only Ersin Multicore Solder can guarantee you freedom from dry joints, elimination of waste, rapid melting and speedy soldering. Write for technical information and free samples to Multicore Solders Ltd., Mellier House, Albemarle Street, London, W.1 or phone REGent 1411 (P.B.X. 4 lines).

Technically

We believe that the only way to build a receiver is to begin at the beginning with a sound circuit design—a design that's been tested and re-tested—a design that will stand up to the most critical examination. From this design a prototype is constructed in which every component receives the some rigorous testing. We leave the experts to pass judgment on the resulting Sobell receivers. We are confident that for ease of control and absolute fidelity of reproduction these models will be found to have no equals—that, in fact, you will pronounce them to be 'technically outstanding'.

Outstanding



**SOBELL
MODEL 516
T.G. TABLE
RADIOGRAM**

Roll top gives easy access to gramophone turntable. The receiver is a 5-valve super-het. operating from 200/250 volts, 40/100 cycles per second A.C. supply. Wave range: 16-50 metres; 193-577 metres; 800-2, 140 metres.

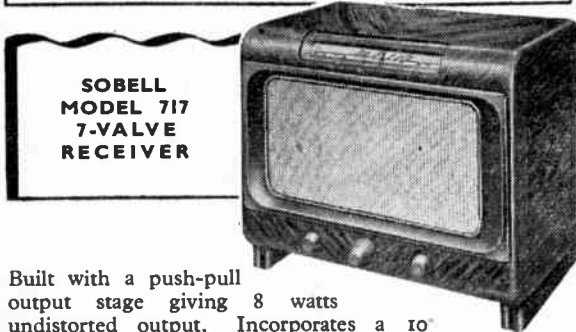

**SOBELL
MODEL 717
7-VALVE
RECEIVER**

Built with a push-pull output stage giving 8 watts undistorted output. Incorporates a 10" loudspeaker. Covers long, medium and two short wave ranges. Voltages as for 516 T.G.

SOBELL RADIO



TWO YEARS' FREE ALL-IN SERVICE IN THE HOME
 Advz. of Sobell Industries Ltd., Langley Park, near Slough, Bucks.



S.S. White

**FLEXIBLE
SHAFT
ASSEMBLIES**

for

**CAR RADIO
SPEEDOMETERS
TACHOMETERS
CHOKES**

STARTERS

THE S. S. WHITE COMPANY BRITANNIA WORKS
 ST. PANCRAS WAY · CAMDEN TOWN · LONDON N.W.1.
 Cable Address: WHICODENTA, WESDO, PHONE, LONDON
 Telephone: EUSTON 4758-4759

Robert Sharp & Partners

WT 55

PREMIER RADIO COMPANY

MORRIS & CO. (RADIO) LTD.

ALL POST ORDERS to 167 LOWER CLAPTON RD., LONDON, E.5. Phone: Amherst 4723.

ALL CALLERS to 169 FLEET STREET, LONDON, E.C.4. Phone: Central 2833.

Terms of Business: Cash with order or C.O.D. over £1. Send 2½d stamp for new Nov. 1947 list.

RADIOGRAM CABINETS

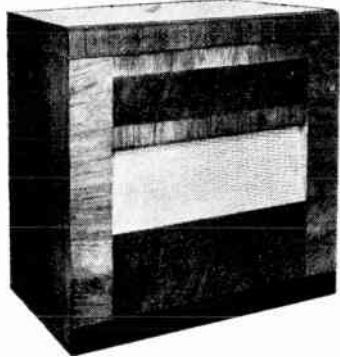

Dignified appearance and good workmanship. Size 31 1/2 in. high, 14 1/2 in. deep, 33 in. wide. French polished, veneered walnut. Price £26. Also available complete with electric motor, auto stop and magnetic pick-up. £34 5s. 0d.

Bitto with Rothermel Crystal Pick-up, £36 2s. 1d., or with 8 record-mixer changer, £45 7s. 6d.
SUPER OUTPUT TRANSFORMERS. By means of a series parallel arrangement wherein the maximum winding is used for each ratio extremely high efficiency is obtained. Any valve single or pushpull may be matched to any voice coil (2 to 30 ohms) type Mo. 15, 15 watts, 30-.

GOVERNMENT SURPLUS OFFERS

TEST UNIT AF53874 consists of a Test Unit for a U.H.F. T.N., incorporates a 230 v. 50 a. Power Pack, with a smoothed output of 240 v. up to 50 m/A and 6.3 v. 2 a., 2 EF50, 1 EC52, 1 EA50, 1 5Z4G, 1 Y63 Magic Eye, and a large quantity of Condensers, Resistors and Tuning Gear. Contained in an attractive steel case. Size 10 1/2 x 9 x 8 1/2. Price 45/-. Carriage and packing, 5/-.
TEST UNIT TYPE 73 consists of a special purpose Oscilloscope that requires only rewiring and the addition of a few condensers and resistors to convert into a standard Oscilloscope, input 230 v. 50 c. A 3 1/2 in. C.R. tube and 1 8U220A, 1 E1E34, 1 5Z4, 3 SP41, 2 EA50, are included. Controls are "Brightness," "Velocity," "X Shift," "Y Shift," Focus Amplifier, "In/out," "Calibrate," "on/off T.N.," Price £8 5s. 0d. Carriage and packing, 20/-.
RELAY UNIT Type 9, consists of a 24 v. operated relay unit incorporating 3 KT33C valves, a telephone line (unisolator) switch with 6 poles 20 contacts, 5 P.O. type relays, 2 high-speed relays and a quantity of other material. Contained in an attractive relay rack type metal case 19 x 9 x 9 1/2 deep. Price £4 5s. 0d., or without valves 30s. Carriage and packing 8s.
SIGNAL GENERATOR Type 33 consists of a battery-driven generator, with two separate units for approx. 1 metre and 5 metre operation. Includes two CV6 (VR135) "Horned" triodes and 1 diode. A large quantity of U.H.F. tuning gear. Contained in a teak case size 18 x 8 x 8. Price 30s.

OUTPUT TESTER Type 9 consists of a unit incorporating 3 separate diode detectors and a 3-valve amplifier, each diode with its separate U.H.F. tuning system. A retractable 1 1/2 in. aerial is fitted and three VR130 (HL23) valves, 3 DL diodes and a large quantity of U.H.F. tuning gear is included. Contained in a teak case size 18 x 8 x 8. Price 30s., or minus three HL23 valves, 15s.

METERS. A huge purchase of military surplus meters allows us to offer the following bargains. Best makes Bakelite cases, prices are approx. 1 original cost.

Range	Ext. Diam.	Basic Movement	Fitting Type	Price
300 v.	3 1/2"	5 M/A	Flush M/A/M/C	12/6
500 M/A	3 1/2"	5 M/A	Flush M/C/D/C	12/6
40 v.	2 1/2"	5 M/A	Flush M/C/D/C	7/6
2 1/2 A	2 1/2"	—	Flush Thermo	7/6
4A	2 1/2"	—	Port H. Wire	7/6
20 A	2 1/2"	25 M/A	Flush M/C/D/C	7/6
40 A	2 1/2"	12 1/2 M/A	Flush M/C/D/C	7/6
25 A	3 1/2"	5 M/A	Flush M/C/D/C	7/6
25 A	3 1/2"	25 M/A	Prof. M/C/D/C	7/6
1/4 M/A	2 1/2"	1 M/A	Flush M/C/D/C	7/6
150 M/A	3 1/2"	150 M/A	Flush M/C/D/C	12/6
200 M/A	3 1/2"	200 M/A	Flush M/C/D/C	12/6
1 M/A	3 1/2"	1 M/A	Flush M/C/D/C	12/6

MIDGET RADIO KITS

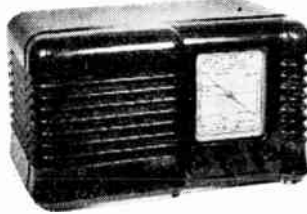

MIDGET RADIO KIT. Build your own midget radio. A complete set of parts, including valves, loudspeaker and instructions. In fact, everything except cabinet necessary to build 4-valve Medium and Long Wave T.R.F. radio operating on 200-250 v. mains. A.C. or D.C. Valve line-up: 6K7, 6J7, 25A6, 25V5. Wavelength covered 200-557 and 700-2,000. Size 10 x 6 x 6 in. Completely drilled chassis. Price, including tax, £7 7s. 6d.

SUPERHET MIDGET RADIO KIT. A complete kit of parts for a 5-valve superhet. Covers 16-50 and 200-557 metres, AC/DC 200-250 v. 6K8, 6K7, 6Q7 25A6, 25V5. Size, 10 x 6 x 6 in. Completely drilled chassis. Price including tax, £8 5s.

An attractive brown bakelite cabinet, as illustrated above, can be supplied for either kit at a cost of 25/-.

MAINS TRANSFORMERS. All input, 230 v. 50 c. Type 30, output 30 v. 4 a., 20 v. 2 a. Type 31, output 40 v. 3 a. and 104 v. 1 1/2 a. (auto-wound). 21 v. 2 a. Type 32, 700 + 700 150 m/A, 1,000 v. 30 m/A (half wave), 4 v. 1 a. 4 v. 3-5 a., 40/-; Type 33, 32, 34, 36, 38 v. at 2 a., 15/-.

GOVERNMENT SURPLUS OFFERS

R.A.F. 1155 Receivers. Complete with valves, £12 10s to callers. Packing and carriage, 30/- extra. 230 v. A/C powerpack for same, 50/-.

METAL RECTIFIERS.

Output Volt.	Current	Type	Price
600	40 m/a.	H.W.	5/-
280	40 m/a.	H.W. or V.D.	5/-
325	65 m/a.	H.W. or V.D.	5/-
36	75 m/a.	Bridge	1 1/6
16	1 amp.	Bridge	12/6
48	1 1/2 amp.	Bridge	25/-
16	5 amps.	Bridge	30/-
16	8 amps.	Bridge	37/6
4	1 amp.	H.W.	5/-

TEST SET Type 87. A specialised signal generator Type Unit covering 150-300 Mc/s. Input, 230 v. 50 c. Contains a completely smoothed power pack output 250 v. 100 m/A, 6.3 v. 4-6 a., 1 RL18, 8 VR65, 1 5Z4. Contained in a superb standard Sig. Gen. steel case, size 23 x 10 x 10. Price £4 10s. 0d., carriage and packing 10s

ALL-WAVE SUPERHET KIT. A complete kit of parts to build a 5-valve short (16-50) medium and long wave set, including valves, drilled chassis, OP trans 3 1/2 ohms and full instructions. Incorporates Weatite iron-core coil unit, 5 watts pushpull output. Valve line-up, 6K8, 6K7, 6Q7, 6J7, 25A6. Operates on A.C. or D.C. 200-250 v. The ideal radiogram chassis. Book yours for delivery December 1. Price £10 10s. 0d., without speaker.

GRAMOPHONE AMPLIFIER KIT. A complete kit of parts to construct a good quality mains-driven 21-watt gramophone amplifier. May be used with any pick-up. Complete with circuit, £3 5s.

OSCILLOGRAPH POWER UNIT KITS. Input 230 v. include transformer, metal rectifiers, voltage doubling hand smoothing condensers.

Type 409, output 300 v. 25/-
 Type 410, output 1,800 v. 25/-

BABY ALARM KIT. Consists of a complete kit of parts for a mains-driven amplifier, microphone and midget speaker, to enable sound of baby's breathing or crying to be heard in any room. Complete with circuit, 55/-

ALUMINIUM CHASSIS. Substantially made of bright aluminium, with four sides.

17 x 3 1/2 x 2 1/2 in.	4/6	9 1/2 x 4 1/2 x 2 1/2 in.	5/6
10 x 8 x 2 1/2 in.	7/-	12 x 9 x 2 1/2 in.	7/9
14 x 9 x 2 1/2 in.	8/3	16 x 8 x 2 1/2 in.	8/6
20 x 8 x 2 1/2 in.	10/6	22 x 10 x 2 1/2 in.	13/6

PREMIER

PEDESTAL PLAYING DESKS



A well made mahogany finished pedestal cabinet, containing a quality electric gramophone motor and pick-up in upper compartment, and record space in lower. Height, 30 in. Width, 16 in. Depth, 15 in. Price £18 18s.

2-VALVE SHORT-WAVE BATTERY KIT. A complete kit of parts for a 2-valve battery covered, covering 15-600 metres, including valves, coils, drilled chassis, H.T. and L.T. dry batteries to last approximately 6 to 12 months. A pair of double headphones and full instructions. Price £3 10s. An extra coil can be supplied covering 600-1,900 metres at 4/-.

SUPERHET TUNING PACKS. Completely wired and aligned. 15-10, 40-120, 180-570 metres. R.F. stage, 465 k/c., 9 connections only. Complete with 3-gang condenser, calibrated, engraved Perspex dial, and S.M. drive. Litz wound polystyrene insulation, permeability tuned I.F.s. 7 k/c. bandwidth. Price complete £3 17s. 6d.

SHORT-WAVE CONDENSERS. High-grade ceramic insulation, super midget type, single gangs available in 10, 20, 50, 75 (75 pf. has double spindle for ganging). Price 2/6. **2-GANG** in 4, 8, 9.6, 27.1, 50, 75 p.f. Price 6s/-.

PREMIER MAINS TRANSFORMERS.

All primaries are tapped for 200-230-250 v. minus 40-100 cycles. All primaries are screened. All L.T.s are centre tapped.

List No.	Output.	Price
SP.250A	250-0-250 v. 60 m/a. 6.3 v. 2-3 a., 5 v. 2 a.	25/-
SP.250B	250-0-250 v. 60 m/a. 4 v. 1-2 a., 4 v. 3-5 a.	25/-
SP.300A	300-0-300 v. 60 m/a. 6.3 v. 2-3 a., 5 v. 2 a.	25/-
SP.300B	300-0-300 v. 60 m/a. 4 v. 2-3 a., 4 v. 3-5 a., 4 v. 1-2 a.	25/-
SP.301A	300-0-300 v. 120 m/a. 5 v. 2-3 a., 6.3 v. 3-4 a.	28/-
SP.301B	300-0-300 v. 120 m/a. 4 v. 2-3 a., 4 v. 2-3 a., 4 v. 3-5 a.	28/-
SP.350A	350-0-350 v. 100 m/a. 5 v. 2-3 a., 6.3 v. 2-3 a.	28/-
SP.350B	350-0-350 v. 100 m/a. 4 v. 2-3 a., 4 v. 2-3 a., 4 v. 3-5 a.	29/-
SP.351	350-0-350 v. 150 m/a. 4 v. 1-2 a., 4 v. 2-3 a., 4 v. 3-6 a.	36/-
SP.351A	350-0-350 v. 150 m/a. 4 v. 2-3 a., 4 v. 3-6 a., 1 v. 1-2 a., 1 v. 1-2 a.	39/-
SP.352	350-0-350 v. 150 m/a. 5 v. 2-3 a., 6.3 v. 2-3 a., 6.3 v. 2-3 a.	36/-
SP.375A	375-0-375 v. 250 m/a. 6.3 v. 2-3 a., 6.3 v. 3-3 a., 5 v. 2-3 a.	46/-
SP.375B	375-0-375 v. 250 m/a. 4 v. 2-3 a., 4 v. 2-3 a., 4 v. 3-6 a.	46/-
SP.425A	425-0-425 v. 200 m/a. 6.3 v. 2-3 a., 6.3 v. 3-5 a., 5 v. 2-3 a.	47/-
SP.425B	425-0-425 v. 200 m/a. 4 v. 2-3 a., 4 v. 2-3 a., 4 v. 3-6 a.	47/-
SP.501	500-0-500 v. 150 m/a. 4 v. 2-3 a., 4 v. 2-3 a., 4 v. 2-3 a., 4 v. 3-6 a.	47/-
SP.501A	500-0-500 v. 150 m/a. 5 v. 2-3 a., 6.3 v. 2-3 a., 6.3 v. 2-3 a.	50/-
SP.503	600-0-600 v. 250 m/a. 5 v. 2-3 a., 6.3 v. 2-3 a., 6.3 v. 3-5 a.	65/-

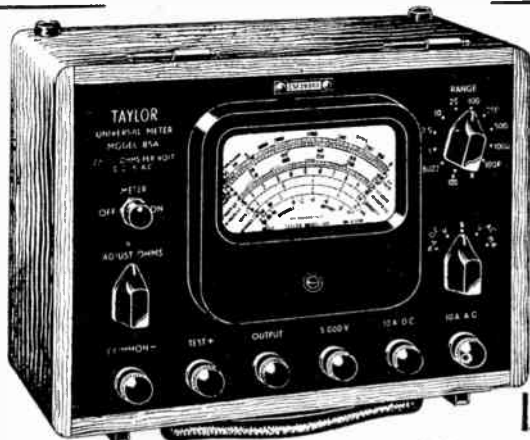

MODEL 85A

The UNIVERSAL TAYLORMETER

90 RANGES
Sensitivity 20,000 ohms per volt A.C. and D.C.

- Improved Taylor Model 400 Meter with 4in. scale and robust movement.
- Automatic Meter overload protection.
- Volt readings from .001 volt D.C. and 0.1 volt A.C. up to 5,000 volts D.C. and A.C.
- Current readings from 1 micro-ampere to 10 amperes D.C. and A.C.

- Resistance readings from 0.1 ohm to 20 megohms in three ranges with self-contained batteries.
- Capacity readings from .0002 to 100 mfd. and inductance readings from 0.2 to 1,000 Henries, with Adaptor.
- Buzzer for continuity tests.
- Size 10½ in. x 7½ in. x 4½ in. Weight 5 lbs.

Immediate Delivery Hire Purchase Terms Available

PRICE **£19 . 19 . 0**

We also manufacture a complete range of Radio Test Equipment including Multirange Instruments, Signal Generators, Valve Testers-Output Meters, Insulation Testers, Circuit Analysers, Oscilloscopes, A.C. Measuring Bridges, and Ohmmeters; also Moving Coil Instruments with scale lengths from 2in. to 5in.

Please write for technical brochure to:—

TAYLOR ELECTRICAL INSTRUMENTS, LTD., 419-424 MONTROSE AVENUE, SLOUGH, BUCKS.
Telegrams: TAYLINS, SLOUGH
Telephone: SLOUGH 21331



FOR THE RADIO SERVICEMAN DEALER AND OWNER

The man who enrolls for a I.C.S. Radio Course learns radio thoroughly, completely, practically. When he earns his Diploma, he will KNOW radio. We are not content merely to teach the principles of radio, we want to show our students how to apply that training in practical, every-day radio service work. We train them to be successful.

Write to the I.C.S. Advisory Dept. stating your requirements. Our advice is free.

-----You may use this coupon-----

INTERNATIONAL CORRESPONDENCE SCHOOL Ltd.

DEPT. 38, INTERNATIONAL BUILDINGS, KINGSWAY, LONDON, W.C.2

Please explain fully about your instruction in the subject marked X.

Complete Radio Engineering Radio Service Engineering
Radio Service and Sales Elementary Radio

And the following Radio Examinations:—

British Institution of Radio Engineers
P.M.G. Certificates for Wireless Operators
City and Guilds Telecommunications
Wireless Operators and Wireless Mechanics, R.A.F.

I.C.S. students for Examination are coached till successful.

Name..... Age.....

Address.....



M. R. SUPPLIES Ltd.

New and perfect material, fully and fairly described, for immediate delivery from Stock. A.I. prices nett.

THERMOSTATIC SWITCHES. Accurate Air Ministry pattern. Switch capacity 1.5 amp. Switch on at 32 deg. F. and off at 59 deg. F., therefore right for frost protection in garages, works, laboratories, greenhouses, etc. Operating temperature can be adjusted. 4/6 each, 45/- 30/-.

ELECTRO-MAGNETIC COILS. Counting up to 9999, operating from 6/24 v. D.C. (or mains voltage A.C.). We offer only brand new ones with case and window, at 7/6 each.

INSTRUMENT RECTIFIERS (Full-wave) 1 m.a. or 5 m.a., either 5/-.

TRANSMITTING COILS, sets of four coils for the B2 Mk. III Transmitter, 10/6 per set.

CENTRIFUGAL BLOWERS. Fine new offer of G.E.C. machines, operating from 6/12 v. D.C. or 12/15 v. A.C. Intake 2½ in., outlet 1½ in., height overall 8½ in. Very powerful suction and blast. Continuously rated to B.S.S. 170/1939, 5/7 6. Also a few left of the smaller model, 12 v. A.C./D.C., outlet ½ in. sq., height 5 in. overall, 35/-.

STEP-DOWN MAINS TRANSFORMERS to suit these Blowers: Prim. 200/220/240 v. Sec. 8 and 15 v. 4 amps. (for larger size), 38/6. Sec. 7 11 and 15 v. at 2 amps. (for smaller), 22/6. Also same prim., sec. 22 v. 2 amps., 21/-.

POWER TRANSFORMERS for amplifiers, etc. Prim. 200/220/240 v. Secs. 450/0/450 v. 150 m.a., 6.3 v. 5 a., 6.3 v. 2 a., 5 v. 3 a., weight 13 lbs., 49/6 (des. p.t. 2/-). Also (ex Govt. new) Prim. 200/240 v. in 10 v. taps, sec. 500/0 500 v. 120, 150 m.a., 4 v. 4 a., C.T., 4 v. 4 a. C.T., 4 v. 3.5 a. C.T. and 10 v. 1 a., in brackets with p. and s. terminal panels, 38/6 (des. 2/-).

L. UPSPEAKER CABINETS, well-made portable type with handle and top drop-flap compartment for leads, etc. Ideal for domestic or P.A. use. 17in. square by 6½ in. deep. Opening 9in. dia. Strongly made, sprayed warm brown, 27/6 (des. 2/-).

D.C./A.C. CONVERTERS, the new Vibrator type, fully smoothed and filtered for all wave-lengths. 200/240 v. D.C. to 200/240 v. 50 c. 100-watts (weight 4 lbs.), 29/- 200-watt (weight 22 lbs.), 214. NOTE:—For television we recommend the 75

input cycle model, same price. Very special offer of Admiralty Rotary Converters. Input 100/110 v. D.C., Output 230 v. 50 c. Rated at 200-watts but capable of heavier duty. Fully enclosed in housing 19in. long by 11½ in. high by 9in. dia. Weight approx. 100 lbs., 29/10/- (des. etc. 10/-).

EVERSHED "WEE-MEGGERS." The best portable insulation test instruments from stock. Pressure 500 v. reading 0/20 megohms and inf. with pocket and log book, £12 7/6.

VENER TIME SWITCHES (Process Timers). Precision spring-reserve instruments automatically rewound every 8 hours from mains but will run 72 hours on one wind. Pulsing: Four-second closed circuit every one (or two) minutes. In weatherproof housing, 9in. by 6in. by 4in. 25/-.

P.A. SPEAKERS. Brand new reflected horn type with 10-watt P.M. M/Coil pressure unit, 15-ohms imp. Flare 12in. long and 14in. dia. On swivel mount with pillar. Ideal for mobile use, 27/12/6 (des. 5/-).

STEEL TRIPDS for these and all P.A. speakers, ext. to 12ft., rigid under all conditions, the best type made, 55/- (des. 3/6).

B2 RT-WAVE RECEIVERS. The excellent B2 Mk. III Receiver and Power Pack. Operation any A.C. mains and 6-volt. Range 3.1 to 15.5 mc/s (1½ to 100 metres). Superhet with B.F.O. Receiver: 4½ in. sq. by 9½ in. Power Pack: 4in. by 6in. by 10½ in. With all leads, phones, etc., in waterproof steel transit case, 27/17/6 (des. p.t. 6/-).

(Please include sufficient for packing and despatch.)

M. R. SUPPLIES Ltd., 68, New Oxford Street, London, W.C.1

Telephone: MUSeum 2958

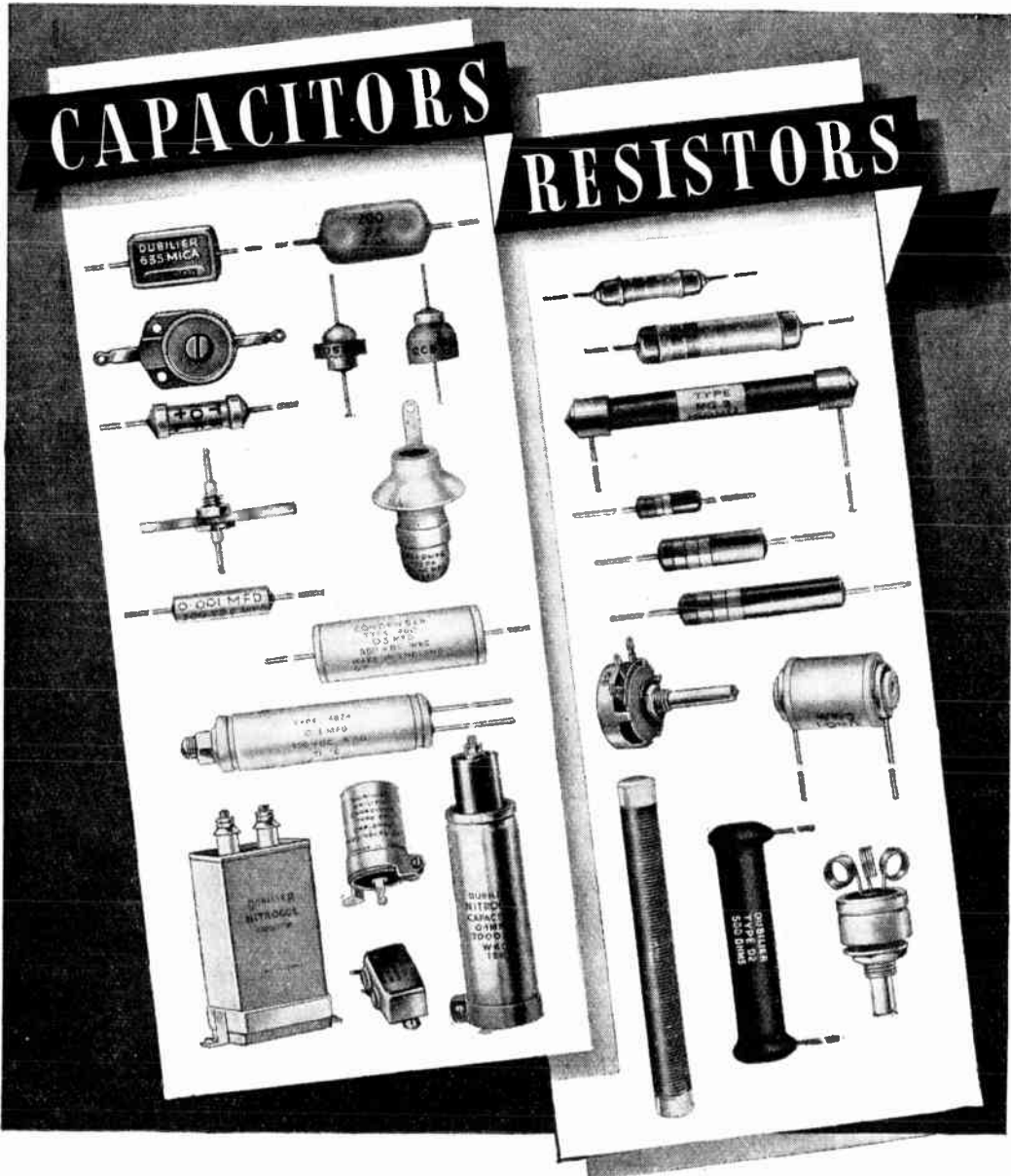

FOR more than 30 years, radio and electrical designers and engineers in all parts of the world have found their most exacting requirements met by the unrivalled Dubilier ranges of capacitors and resistors, renowned for their constancy and complete reliability under the most arduous operating conditions. These capacitors and resistors, so important in Radio, Radar and Television equipment, are being continuously developed and extended in order to provide for every conceivable application.

Dubilier capacitors and resistors owe their unvarying quality, technical excellence and high degree of stability to the close control which is maintained throughout all stages of their manufacture.

Full technical data and prices supplied upon request.

DUBILIER

CONDENSER CO. (1925) LTD.

DUBILIER CONDENSER CO. (1925) LTD., DUCON WORKS, VICTORIA ROAD, NORTH ACTON, W.3
 Telephone : Acorn 2241 (5 lines) Telegrams : Hivoltcon, Phone, London
 Cables : Hivoltcon, London Marconi International Code
 D12A

PULLIN

PORTABLE PATTERN INSTRUMENTS



Type PC — Moving Coil.
 " PR — Rectifier, Moving Coil.
 " PI — Moving Iron.

for
**SUSTAINED
 ACCURACY**
 •
**GOOD
 DAMPING**
 •
**ROBUST
 CONSTRUCTION**
 •
**MODERN
 APPEARANCE**

Each type is available in single or multi-range versions, and either an Industrial Model with First Grade Accuracy or a Precision Model with Sub-Standard Accuracy can be supplied. The movement is carefully shielded against extraneous magnetic fields. The case is of cast alloy with all black finish, carrying handle and resilient rubber feet.

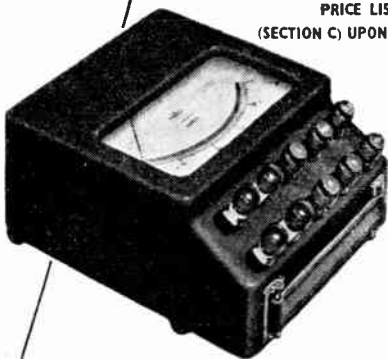

PRICE LIST
 (SECTION C) UPON REQUEST.

Type PD —
 Dynamometer
 Wattmeter.

MEASURING INSTRUMENTS (PULLIN) LTD

Address all enquiries to Dept. J, Electric Works,
 Winchester Street, Acton, London, W.3. Telephone: Acorn 4651-4

FOR RADIO, TELECOMMUNICATION AND GENERAL ELECTRICAL WORK

Superspeed

**ROBIN
 CORED
 SOLDER**

SPECIAL

Outstanding Characteristics of
 "SUPERSPEED SPECIAL" ROBIN CORED SOLDER

1. Chemically activated rosin core ensures high degree of "wetting."
2. Increased fluidity accelerates production.
3. Allows more moderate soldering iron bit temperatures, and minimises the risk of physical damage and alteration to the electrical values of small pre-calibrated components such as Capacitors, Resistors, Coil windings, etc.
4. Ensures complete mechanical bonding of joint
5. Reduces to a minimum the solder required per joint and cuts down waste.
6. Residue is non-corrosive, solidifies to a semi-transparent film of high electrical insulation value, is non-hygroscopic and unaffected under tropical conditions.
7. The heating of the activated rosin core does not cause any deleterious fume deposits, or unpleasant odour.

AIR MINISTRY APPROVED

Supplied in a wide range of Gauges and Alloys on 1lb. and 7lb. reels, works coils, or as required. Prices on application.

Sole Manufacturers:—

H. J. Enthoven & Sons Ltd., 230 Thornton Road, West Croydon, Surrey. THORnton Heath 2462. Enthoven Phone London

SYLMAR RADIO LTD.

are now distributors of

T.R.E.L. PRODUCTS

(Tolworth Radio & Electrics Ltd.)

SUPERHET TUNING UNIT. 16—50, 200—550, 1,000—2,000 m. Consisting of 2-gang Condenser, Silver Screen Dial, printed in blue, Drive, I.F.s., Coils, etc. Completely wired and aligned on Broadcast signals. Price with circuit, £5 5s. 0d. Obtainable through Retailers.

Wired for 6K8 & 6K7 Valves. Specials to order.

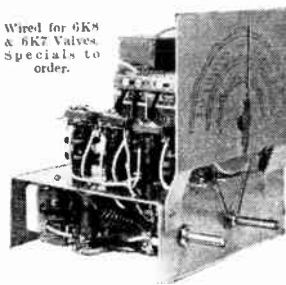

VIBRATOR PACKS.

12 volt Input, 210v. 70 mA. output consisting of Input Smoothing, Vibrator, Transformer, Rectifier, and two 20 mfd. Conds., etc. Size 8½ in. x 3½ in. x 4½ in. Limited quantity only, 32/6.

NOW IN PRODUCTION.

The inexpensive T.R.F. Battery Receiver, retailing at £7/17/6, Plus Tax £1/15/-.

ALSO

5 Valve AC/DC Med. and Long Wave Midget, in Handsome Bakelite Cabinet. Latest Superhet. circuit. Excellent performance and superb quality. £10/10/-, Plus Tax £2/6/8.

3-Wave Coil Packs. Complete with trimmers and wavechange switch, 30/-.

T.R.F. Coils, Medium and Long wave. Complete with circuit, 6/6 pair.

Superhet Coils. 3 Aer. and 3 Osc. Set of 6, 12/-.

Sin. P.M. Loudspeakers, 17/6.

Ex-Govt. Surplus. Condensers 0.1 mfd. 6d., 0.01 mfd. 6d., 10 mfd. 450 v. 2/9, 25 mfd. 25 v. 1/9, 50 mfd. 12 v. 1/9. Valveholders, Octal 6d., Mazda type 4d. Resistances, all values 2/6 doz.

SYLMAR RADIO LTD. 197 LOWER RICHMOND ROAD, RICHMOND, SURREY.

GET OUR QUOTATION for all your requirements.

Retailer's Enquiries welcomed.

Phone: PROspect 6651.

LONDON CENTRAL RADIO STORES

Special Offer of Ex-Govt. Receivers, etc.

10-VALVE COMMUNICATION RECEIVER—Type R1155

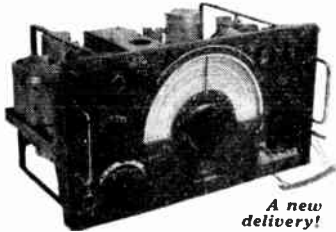

A new delivery!

These sets are equal to new, need only a power pack for immediate use (see "W.W." July, 1946). Freq. range 7.5 mc/s. or 1,500 kc/s., complete with 10 valves, including magic eye. Enclosed in strong metal box. Each receiver is aerial tested.

Complete with Power Pack and Loudspeaker, for A.C. mains 200-250v. **£20**
(Carr. and pkg. 10/6 extra)

POLARISED RELAYS

115 ohms + 115 ohms. 6in. x 3in. **6/-**

2-VALVE BATTERY AMPLIFIERS Type A1134

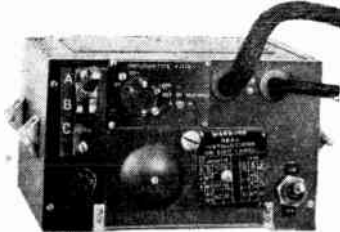

O.P.P. output. Complete with 2-volt valves. In strong wood transit case 10½ x 8 x 7in. New bargain offer. Carr. and pkg. 2/6 extra. **25/-**

ELECTRO MAGNETIC COUNTERS

Ex-G.P.O., every one perfect, electro-magnetic, 500 ohm coil, counting to 9,999, operated from 25v.-50v. D.C., many industrial and domestic applications **5/6**

VISUAL UNITS

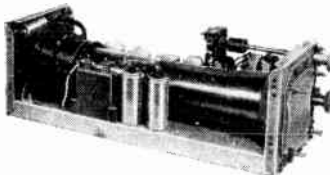

With 4in. Cathode Ray Tube, two EF30 and two VR34 valves, potentiometers, etc. Complete on chassis 15 x 5½ x 5in. Carr. and pkg. 5/- extra. **42/6**

Please Note: All carriage charges relate to the British Isles only

FRACTIONAL H.P. A.C. MOTORS Converted from ex-Govt. Generators

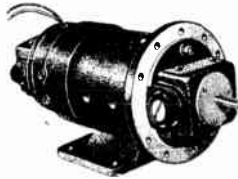

Brush type 220-250 v. 50 cycles approx. 5,000 r.p.m. Overall diam. 10 x 4in. ½in. spindle extends 1in. both ends. Post 2/6 extra **37/6**

RADAR VIEWING UNITS

Consisting of 6in. diameter Electrostatic C.R. Tube, 7 valves including four EF50, potentiometers, resistances and other associated components. In metal cabinet 10 x 8 x 7½in. **£3.7.6**

Bargain price (plus carr. and pkg. 7/6)

Type Demolition Mk. 1. Ex-ARMY TEST SET—NEW



For circuit continuity and general testing. In hardwood carrying case. Carriage paid **£3.10.0**

RUBBER COVERED 5-WAY CABLE

Heavy duty. 7/6 doz. yards.

PULSE MODULATOR AND MIXER W6331

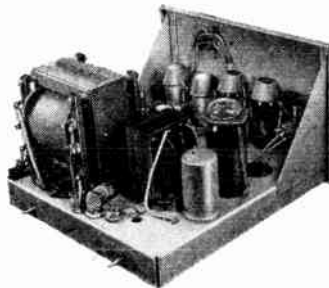

Valves: two 6J5, three VR66, one VR60, one EB34, and Rectifier 5U4. Transformers, resistances, condensers, etc. Carr. and pkg. 5/- extra **40/-**

Type R1147A 7-VALVE U.H.F. RECEIVER Range approx. 200 megacycles (with 4 Acorn valves)



A Real Opportunity!

Beautifully constructed and fitted with micro-condenser drive. Valve types: two EF36, one EBC33, three 954, one 955. In black metal case, 8 x 7 x 6in. Set complete with valves. Carr. paid. **£2.7.6**

Ex-R.A.F. CAMERA MOTORS

Dimensions 3" x 2" x 1½". 12v. and 24v. **8/6**

Model *AN/APA-1. Ex-U.S.A. AMERICAN AIRCRAFT RADAR UNIT



115v. 500 cycles. Complete with 5in. Cathode Ray Tube, 11 valves, Power pack, etc. In black crackle metal case. Brand new and boxed. With full instructions. Carr. paid. **£4.10.0**

Super Quality Heavy Duty TWIN-ELEMENT SLIDING RESISTANCES

5.4 ohm at 20 amp. **47/6**
12 ohm at 10 amp. **39/6**
70 ohm at 5 amp. **35/-**
Single Element 14 ohm at 5 amp. **13/6**

TELEPHONE LINE or UNISELECTOR SWITCHES

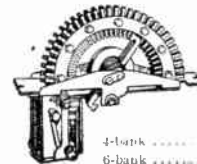

1- or G-bank, 26 constants. Have various applications including automatic tuning, circuit selection, etc. Operates on 25-50v.

4-bank **28/6**
6-bank **30/-**

We do not issue lists or catalogues

LONDON CENTRAL RADIO STORES, 23, LISLE ST. (GERrard 2969) LONDON, W.C.2

Closed Thursday 1 p.m. Open all day Saturday and weekdays 9 a.m.—6 p.m.

THE "BIG" SELLERS AT RADIOLYMPIA

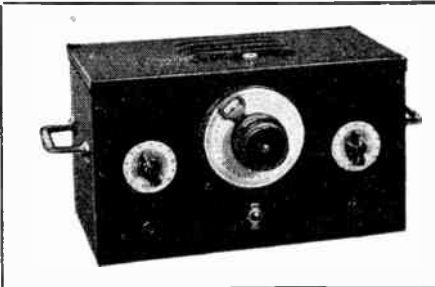

**THE "Q-MAX" ALL-DRY
4 VALVE SHORT WAVE
RECEIVER**

Coverage: 11-350 Metres.

12 GNS.

(P.T. £2. 17. 5)

Excluding Coils, Speaker & Bottery

**THE NEW "Q-MAX"
CHASSIS CUTTER**

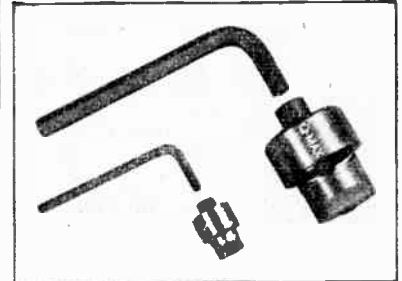

CUTS METAL EASILY AND CLEANLY

1 1/2" (Button Base) 10/3 with Key

1 1/4" 10/3 do.

1 1/8", 1 1/16", 1 1/32" 12/6 (Key 1/-)

(Postage 6d. extra).

N.B.—The same key fits 1 1/8", 1 1/16" and 1 1/32"

Catalogue 6d. Post Free.

BERRY'S

(SHORT WAVE) LTD.

25, HIGH HOLBORN,
LONDON, W.C.1

(Opp. Chancery Lane).

Tel. HOLborn 6231.

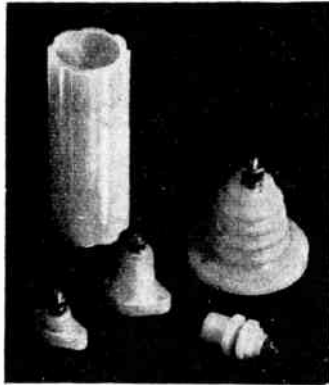

**'POLYMAX'
The
Unbreak-
able
Insulator**

Stand-offs

1/2" 6d.,

1" 9d.,

1 1/2" 1/-.

4"

Spreaders

1/3.

SPECIAL XMAS OFFERS

MUIRHEAD 50-1

S.M. Drives 17/6

CERAMIC SWITCHES

3b, 5w, 1p. 15/6

JONES 8-way Plug

and Socket 10/-

3-Pin FLUSH MOUNTING

Plug and Socket .. 5/-

5" CER. FORMER.... 5/-

METALPACK .01/1000v 1/6

.. .1/350v 1/6

MICROPACK 10mf/25v 2/6

.. 25mf/25v 2/6

.. 2mf/350v 2/9

.. 4mf/200v 2/9

METALMITE .002/1000v 1/6

.1mf/150v MIDGET .. 1/-

ALL BRAND NEW

THE NEW ARDENTE

Philomel

**A FINE
QUALITY
GRAMOPHONE
RECORD
REPRODUCER**

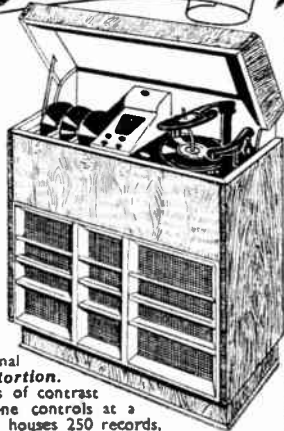

Features unique Ardente Con-
trast Expansion restoring original
dynamic range *without distortion*.
Illuminated dial shows readings of contrast
expansion, volume, separate tone controls at a
glance. Walnut console cabinet houses 250 records.
has auto-change, sapphire pointed P.U.
*Labyrinth Loudspeaker reproduces very wide range
of frequencies with utmost fidelity.*

Details, demonstration, trade terms from

ARDENTE ACOUSTIC LABORATORIES LTD.

GUILDFORD, SURREY, GUILDFORD 3278.

London Branch: 309 Oxford Street, W.1.

Mayfair 7917

*Miniature or
midget*

ACTUAL SIZE

30mm

10mm

XY 1-4A

24mm

10mm

XW 0-75A

NEW TYPES FOR
MIDGET RECEIVERS
HEARING AIDS
METEOROLOGICAL
INSTRUMENTS
ETC.

HIVAC

THE SCIENTIFIC
VALVE

BRITISH MADE

HIVAC LIMITED Greenhill Crescent. Phone HARROW
Harrow on the Hill, Middx. 0895



The Hadley Multicom

the Inter-Comm for which the public has been waiting, this marvel in miniature provides for complete communication between all points i.e. any one unit can communicate with any other unit at will.

The Hadley Intercommunicator

provides for two way calling and communication between master unit and any or all of the sub-stations and also incorporates the novel feature of a desk radio which can be relayed to the sub-stations.



The Hadley Industrial Unit

proved to be well in advance of any similar equipment. Provides all facilities for "Staff Location" "Music for the Workers" "Time Signals," etc.

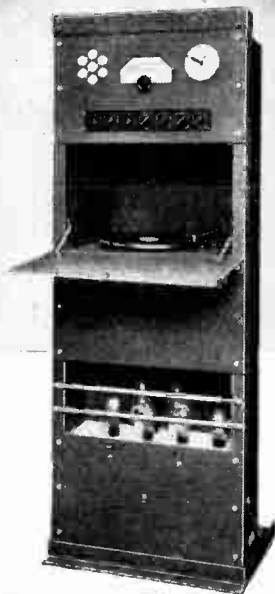

Firms with suitable sales, installation, and maintenance facilities, are invited to write for details of our agency scheme. Enquiries from overseas markets especially welcomed.

Hadley

SOUND EQUIPMENTS
BEARWOOD ROAD, SMETHWICK, STAFFS.
Phone: BEARwood 2575/6



Measuring a condenser in circuit

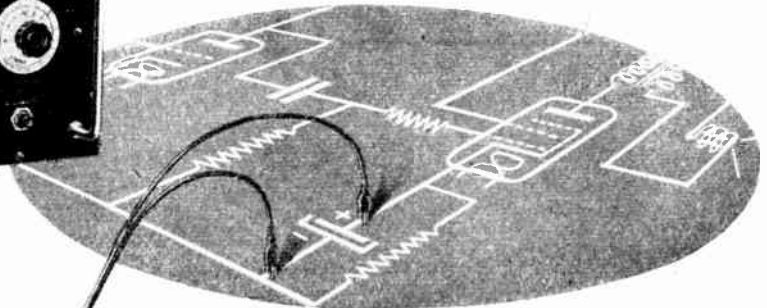

COMPONENT BRIDGE B101

5 pfd. to 500 mfd. - - in eight ranges
 5 ohms to 500 Megohms - in eight ranges
 0.1 Hy. to 5,000 Hys. - in four ranges
 Leakage 0 to 1.5 m/a. Q: 0 to 30.
 Precision Comparator. Price 26 Gns.

To examine this cathode bypass condenser *in situ*, the Power Factor control is used to balance out the parallel resistance and the main scale will then give an accurate measurement of capacity—one of the many unusual facilities provided by this flexible instrument.

Wayne Kerr

WAYNE KERR LABORATORIES LIMITED, NEW MALDEN SURREY · PHONE: MALDEN 2202

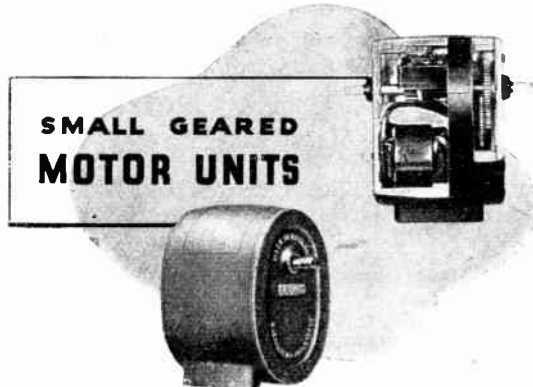

SMALL GEARED MOTOR UNITS

The Drayton "R.Q." is a 25-watt motor unit geared to a final shaft, to which may be fitted eccentrics, arms or cranks, gears, links or pulleys for actuating valves or dampers, movements, switchgear or other devices.

Unidirectional or reversing, with or without self-switching, for 100/110 or 200/250 volts A.C.

Both types are fitted with an auxiliary two-way switch actuated by movement of the final shaft, for operating auxiliary gear such as fan motors, pumps, interlocking devices, etc.

FINAL SHAFT SPEEDS

Reversing Max 600 R.P.M. 27 min. per rev.
 Unidirectional Max 280 R.P.M. 60 min. per rev.

TORQUE: Reversing 60 in. lbs. max.
 Unidirectional 37 in. lbs. max.

Send for List 302-1/N

Drayton Regulator & Instrument Co., Ltd., West Drayton, Mdx.

for

Operating Valves,
 Dampers or Rheostats,
 Cinema Projectors,
 Rotating Screens,
 Illuminated Signs,
 Small Working Models,
 Geneva Movements for
 Drum-type Switches,
 Rocking Baths, Work
 Movement, Soldering
 and Welding Fixtures,
 Continuous Turning,
 Feed of Light Strip
 Under Process.

**"You're CERTAIN to get
it at ARTHURS!"**

★ **VALVES** : We have probably the largest stock of valves in the Country.

Let us know your requirements.

AVOMETERS. NOW IN STOCK.

AVOMETER, Model 7 £19 10 0
 AVOMETER, Model 40 £17 10 0
 VALVE TESTER (Complete) £16 10 0
 TEST BRIDGE £11 0 0
 AVOMINOR, Universal Model £8 10 0
 AVOMINOR, D.C. Model £4 4 0
 SIGNAL GENERATORS, A.C. £13 0 0

TAYLORS' METERS. COMPLETE RANGE NOW IN STOCK.

All orders sent by return of Post. **STAGE EQUIPMENT PROJECTOR LAMPS** Terms C.O.D. or cash with order.

London's Oldest Leading Radio Dealers.

Arthur's
 PROPS: ARTHUR GRAY. LTD.

EST. 1919

Our Only Address: **Gray House, 150, Charing Cross Rd., London, W.C.2** TEMple Bar 5833/4.

ELECTRICAL, TELEVISION & RADIO ENGINEERS.

CANADA

World Market Place
in 1948



Attend the

CANADIAN INTERNATIONAL TRADE FAIR

Toronto, May 31—June 12, 1948

Follow the trade offerings of the world. Visit Canada in 1948. At the Canadian International Trade Fair, sponsored and directed by the Canadian Government, you will find the goods of many nations—hundreds of industries—on display.

You can meet manufacturers, exporters, importers—buyers and sellers. You will get new ideas, find new products, make valuable contacts.

Plan NOW to attend the Canadian International Trade Fair in 1948—or to send a representative. Full details, including information on transportation and accommodation, are available from—

LONDON: R. P. Bower, Commercial Secretary, Office of the High Commissioner for Canada, Canada House, Trafalgar Square, S.W.1.

LIVERPOOL: M. J. Vechsler, Canadian Government Trade Commissioner, Martins Bank Building, Water Street.

GLASGOW: G. F. G. Hughes, Acting Canadian Government Trade Commissioner, 200 St. Vincent Street.

DEPARTMENT OF TRADE AND COMMERCE

OTTAWA



CANADA

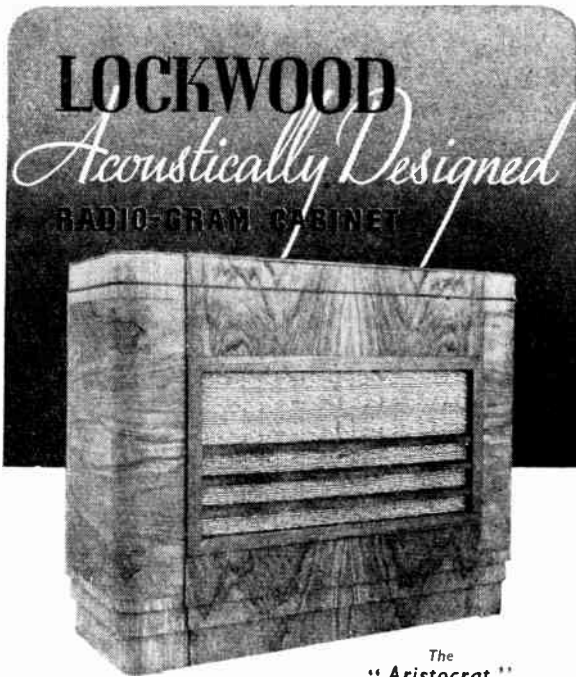

The "Aristocrat"

Planned for the connoisseur requiring a high quality cabinet suitable for a quality receiver. As good as pre-war and embodying all that is best in British craftsmanship and design. For export or for those holding or who can obtain timber permits. Private enquiries are invited and those interested will have their names entered on our lists. If in doubt we shall be pleased to render every assistance and advise where possible.

Dimensions: Length, 40 in., Height, 32 in., Depth, 17½ in. Capacity approx. 12 cu. ft. Weight, 1 cwt. approx. Concealed castors. Sloping baffle. Slag wool and felt lining. Felt lined lid. Ample accommodation for large receiver and amplifier and heavy duty speaker.

Interviews by appointment only.

Details and Prices ready November 1st, 1947

LOCKWOOD & CO.
 LOWLANDS ROAD, HARROW, MIDDX.
 Telephone: BYRon 3704

STABLE
to

Resistors produced by the cracked carbon process remain stable to $\pm 1\%$ of initial value.

★Tolerance $\pm 1\%$
 $\pm 2\% \pm 5\%$

Low temperature co-efficient.

Welwyn carbon resistor
 WELWYN ELECTRICAL LABORATORIES LTD.
 Welwyn Garden City, Herts. Telephone: Welwyn Garden 38168.

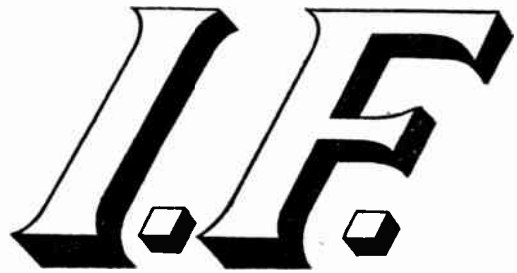

TRANSFORMERS

Litz wound. Adjusted by High Permeability Iron Dust Cores. High L/C ratio. High Q. Frequency 460/465 Kcs. Side or end tuning. Size $1\frac{7}{8} \times 1\frac{7}{8} \times 3\frac{1}{2}$ ins. long. Also available in miniature size.

LABORATORY

TESTED

H. C. ATKINS Laboratories, 32, Cumberland Road, Kew.
 Richmond 24:0

AK 102

S-T

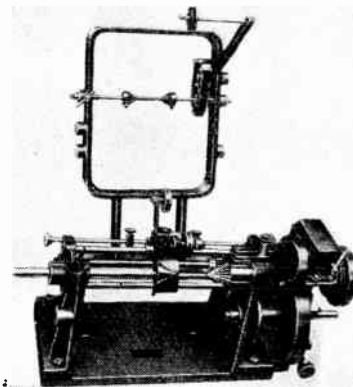

Model 'Q'

AUTOMATIC COIL WINDING MACHINES

A well designed and substantially built machine, for coils up to 6½" diameter to 6' long, also, a similar machine up to 6½" diameter to 14' long. ½ H.P. Motor drive with hand-drive handle supplied. Specification of the Model 'Q' illustrated and lists of the other machines on application.

ETA TOOL CO
 (LEICESTER) LTD.
 16½ METCALF STREET, LEICESTER.
 Phone—5386.

★ *You saw it at Radiolympia*

A Superb Instrument for the Perfect Reproduction of Gramophone Records

Here at last is an instrument which will give you the perfect record reproduction of which you have dreamed . . . the full beauty of the quiet passages . . . the excitement of the finale . . . the vigour of the bass . . . the trill of the soprano. And the Collaro Microgram is completely self contained . . . completely portable. Just plug in . . . and hear your records as they were *meant* to be heard. Ask to hear the Microgram at your usual dealer's . . . or write to address below for Illustrated Brochure.

The "De Luxe" Model illustrated is complete with 6½ inch Speaker, and lightweight Crystal Pick-up, neatly fitted into a handsome imitation lizard-skin case.

★ *The Microgram attracted much interest and favourable comment from both the trade and public, when exhibited at Radiolympia recently.*



The **COLLARO**
Microgram
Portable Electric Gramophone

PRICES :

De Luxe Model	£19 19 0
Plus Purchase Tax	£4 8 8
Standard Model	£16 16 0
Plus Purchase Tax	£3 14 8

Trade Enquiries to :—

COLLARO LTD., RIPPLE WORKS, BY-PASS RD., BARKING, ESSEX

Telephone :
Rippleway 3333

"Cyldon"

MICA DIELECTRIC TRIMMER Capacitors





Type No. 19
Type No. 22

SYDNEY S. BIRD & Sons, Ltd.

CAMBRIDGE ARTERIAL ROAD, ENFIELD, MIDDX.
Phone: Enfield 2071-2 Grams: Capacity, Enfield.

• ALL-POWER •

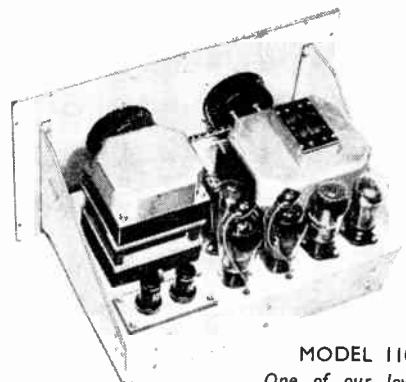
Constant Voltage Power Supplies



MODEL 1108-S
One of our low-priced industrial units.

LET ELECTRONIC STABILIZATION SOLVE YOUR POWER SUPPLY PROBLEMS

ALL-POWER TRANSFORMERS LTD.
8a Gladstone Rd., Wimbledon, S.W.19
Telephone: LIBerty 3303

**2, 5 and 10 Metre
CONVERTERS AND RECEIVERS**

Great Reduction of Prices

Due to a fortunate purchase we are now able to offer the type 25 and 27 Converters and the R1147 A and B Receivers at considerably reduced prices. Details of these are :

TYPE 25 CONVERTER 30-45 m/cs. 3-6 volt 5P41's, HF, Mixer, Osc., 7 m/cs. I.F. Output. 5 Pre-set Frequencies. Easily converted to tuneable 10 metre Converter by replacing ceramic switch with 3 ganging type 15 pf. Condensers. **PRICE 20/-**

TYPE 27 CONVERTER 60-80 m/cs. EF54 HF., EF54 Mixer ; EC52 Osc. 7 m/cs. I.F. Output. These Converters are tuneable and fitted with 3in. S/M Dial. Can be converted for use on 58.5/60 mc/s or 144 mc/s. Ham bands. **PRICE 30/-**

R1147 A and B Receiver. App. 150 mc/s. Model "A" 954 Mixer, 955 Osc., 2-954 I.F.'s. (25 mc/s.) EBC33 2nd Det. and B.F.O., 2 EF36's Audio stages. Model "B" EF54 Mixer, EC52 Osc. 2 EF50 I.F.'s. Audio stages as Model "A" Needs alteration after 2nd Det. for satisfactory results. Just the job for the new 144 mc/s band. **PRICE 45/-**

Packing and postage 2/6 extra on type 25 and 27 Converters. 5/- on R1147 A or B.

NOTE : A circuit diagram is supplied with each type 27 Converter, and R1147 Receiver.

RADIOMART
25th CHAM LTD.

48, HOLLOWAY HEAD, BIRMINGHAM, I.

Praise by every post



RADIO HEART

**FOR AMATEUR, TRADE OR SMALL MANUFACTURER
AS 5 VALVE QUALITY SUPER HET RECEIVER
OR AS R.F. TUNING UNIT WITH**



QUALITY AMPLIFIER KIT
(attractive Cabinets available)

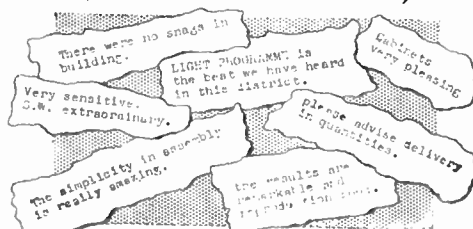

Let us send you details :-

**Sole Manufacturers:-
MORGAN, OSBORNE & CO. LTD**
Warlingham SURREY Upper Warlingham 2560

"NOTHING LIKE IT!"
 "Better than the Set itself!"
 "A CRAFTSMAN'S JOB!"



THAT'S what they're saying about this satisfying new Extension Speaker, the

"BAFFLETTE"

by

Richard Allan

Its fidelity is remarkable! That's because of unique design, entirely different from those resonant "box" types. Modern, streamlined Cabinet of Walnut Veneer; interior detail a masterpiece of precision!

What's YOUR opinion of the "Baffle" type? Experts agree that a baffle type is best. We ask you to hear this one and tell us what you think.

RETAIL PRICE
4 GNS.

Reputable Retailers have it (Mahogany £4 10 0)

EXPORT ENQUIRIES INVITED

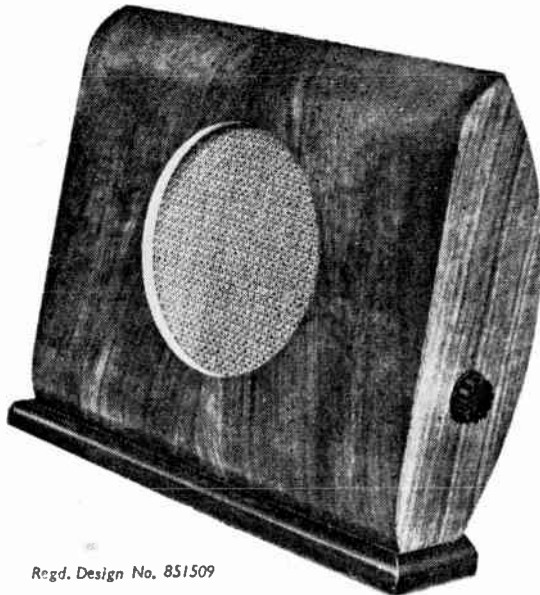

Regd. Design No. 851509

RICHARD ALLAN

RADIO LIMITED
 CALEDONIA ROAD
 Tel. : Batley 1123

BATLEY, YORKS

"Grams : "Acoustics, Batley"

*It's easy to make Pick-ups
 — if you know how.*

The know-how in the manufacture of

Lexington

MOVING COIL PICK-UPS

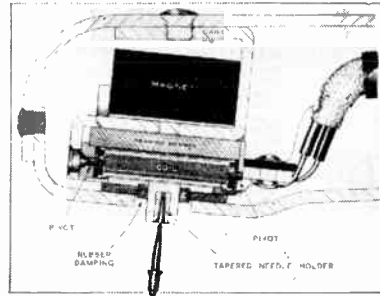

is the result of long experience and precision watch-making standards which give a finely constructed instrument the details of which are shown in the sectional diagram.

DE LUXE MODEL ● Robust design. Accidental dropping on record will not damage Pick-up ● Extremely low moment of inertia (80 milligrams total weight of movement) ● Pure sine wave with no harmonic distortion ● Automatic needle or sapphire changing opens new fidelity field to the amateur ● Can be used with normal record changer without fear of damage. Price (without sapphire) £5.10.0, plus 2/6 P.T.

PLUG-IN HEADS

Available in both junior and De Luxe types to fit Collaro and Garrard arms, thus providing easy change-over from Magnetic types. Input conversion may be required. (See our Technical Brochure.) Price 49/6, plus 11/- P.T. Separate Ejector for De Luxe type, 30/10, plus 6/10 P.T.



Sapphire Needle with specially tapered shank, 15/3 (incl. P.T.)

PRE-AMPLIFIERS having an inverse of the recording characteristic incorporated are available for use with pick-ups. These are necessary with some amplifiers. Price complete with valve and input Transformer, £6.1.0.

Announcing The NEW LEXINGTON

15-WATT HIGH FIDELITY

AMPLIFIER

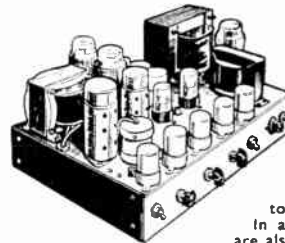

Designed in our laboratories for use with our own Pick-ups, also as an Audio-channel for high quality local station radio feeder units.

The amplifier is available completely constructed or the necessary circuit diagrams and technical details can be supplied to technical amateurs who prefer to do their own construction.

In addition technical details and circuit are also available showing the construction of a high quality **RADIO FEEDER UNIT**

incorporating local stations and television sound bands for use with the above amplifier, making a perfect combination for the connoisseur.

Prices and details of the above will be sent upon request.

This service is introduced at the request of the many satisfied users of our Pick-ups.

Illustrated Technical Brochure upon request.

Export and Trade Enquiries invited.

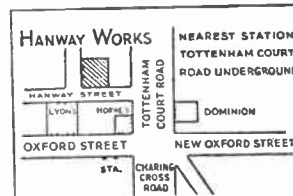

COOPER

MANUFACTURING CO.

HANWAY WORKS,

HANWAY ST., LONDON, W.1

Telephone : MUSEum 9779

SALES OFFICES—Top Floor

realism in sound recording

To the exclusive range of sound equipment produced by B.S.R. is now added the D.R.33 Direct Disc Recorder.

The D.R.33 incorporates the latest developments in recording technique and is the finest direct recording instrument available. It is supplied in attractive carrying case and is completely portable.

We should be pleased to send you further particulars of this latest production of the B.S.R. Research Laboratory.

Amplifiers, microphones, loudspeakers, and accessories.

BIRMINGHAM SOUND REPRODUCERS LTD.

Claremont Works, Old Hill,
Staffordshire.

Phone: Cradley Heath 6212/3

London Office:
115 Gower Street, W.C.1.

Phone: Euston 7515



... is it Rotary or Pushbutton or Slider? Is it wanted for circuit selection, band selection, tap switching? Is it for a new design or in quantities for a well proved circuit?

Whatever it is—the answer is always OAK!

The basic design of all Oak switches is one of strength and efficient functioning, including such exclusive features as the double-contact clip and the floating rotor, ensuring self-alignment of each section.

NSF AND **AB**
OAK SWITCHES

BRITISH N.S.F. CO. LTD., Keighley, Yorkshire
(Sole Licensees of OAK Manufacturing Co., Chicago)

A.B. METAL PRODUCTS LTD., Feltham, Middx.
(Sub-Licensees of N.S.F.)

The only Manufacturers of OAK Switches under Patent
Nos. 478391 & 478392

The best people

FOR HIGH FIDELITY ELECTRIC GRAMOPHONE EQUIPMENT

The Lexington moving coil pick-up. Senior model for use with sapphire needles ...	£6 14s. 6d.
Junior model for use with miniature steel needles ...	£4 5s. 0d.
Lexington plug-in heads for Garrard and Collaro arms. Senior or Junior models...	£3 0s. 6d.
Needle inserter for use with senior plug-in head...	£1 17s. 8d.
Sapphire needle ...	15s. 3d.
Matching transformer in mu-metal box ...	£1 13s. 2d.
Lexington pre-amplifier ...	£6 1s. 0d.
Wilkins & Wright Coil pick-up ...	£7 0s. 7d.
" " " Scratch filter ...	£1 16s. 8d.
Connoisseur miniature moving iron pick-up	£3 18s. 9d.
Martin Slater Amplifier specially built for use with Lexington pick-ups. Push-pull output ...	£29 15s. 0d.

Suppliers of Wharfedale, Goodman, Vitavox speakers. B.S.R., Trix, Lexington and Martin Slater amplifiers.

Call for a demonstration in our new sound demonstration room.

BY APPOINTMENT



TO H.M.
THE KING

WALLACE HEATON LTD

126-127 New Bond St., London,
W.1.

Telephone: MAYFAIR 7511

H. P. Radio Services Ltd. offer—

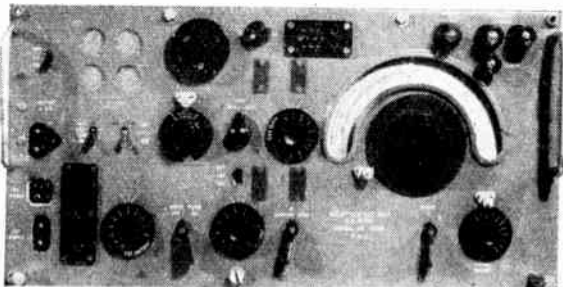

Ex-Army Reception Sets, Type R107. 9 Valve receiver designed for CW and RT signals. Weight 96 lbs. Length 24 ins. Height 13 ins. Depth 17½ ins. Frequency range 17.5-7 mcs., 7.25-2.9 mcs., 30-1.2 mcs. Highly Sensitive and Selective. A.C. mains 100-250 volts or 12 volt accum. Mains Consumption 31 watts Circuit RF Amplifier. Oscillator. Frequency Changer. Two IF stages (465kcs) Second detector AVC. AF amplifier. Output Stage and Heterodyne Oscillator (beat). Three types of valves used—EF39, EBC33, 6X5. 12 volt non sync. vibrator pack fitted. Monitor loud speaker built in. Amazing value £16 16 0 carr. paid.

We are still offering Ex-Govt. Combined Moving Coil Headphones and Moving Coil Hand Microphone. Guaranteed perfect 9/6. post. 8d.

— We guarantee —
satisfaction and safe delivery.

H. P. RADIO SERVICES LTD.

Britain's Leading Radio Mail Order House

55 County Rd., Walton, Liverpool, 4.

Tel.: Aintree 1445

A WOMAN'S INTUITION IS NOT ENOUGH

A woman's intuition will not help you to find a difficult fault in a wireless set. The easiest and quickest way to locate the trouble is to use a Weston Model E772 Analyser which is designed for systematic analysis. Its features include high sensitivity—20,000 ohms per volt on all D.C. ranges—wide range coverage, simplified controls, accuracy and robust construction. You will find this instrument universally useful—it will save you time, trouble and money and it is really reliable—it's a Weston.



SYSTEMATIC SERVICING STARTS WITH A

WESTON

SANGAMO WESTON LTD., ENFIELD, MIDDX. Telephone: Enfield 3434 & 1242

CLIX

make AND keep **GOOD CONTACTS**

A New Moulded

M.E.S. LAMPHOLDER

Designed to eliminate all possibility of intermittent contact through the lamp becoming loose in its holder. All parts are plated and keyed to the body. Alternative types available, i.e., bracket or clip-fixing.

Another outstanding example of **CLIX** design.

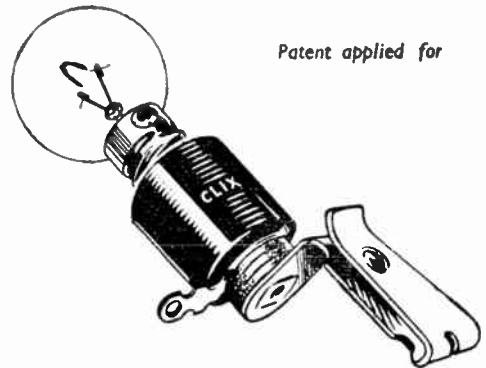

Patent applied for

BRITISH MECHANICAL PRODUCTIONS LTD. 21 BRUTON ST. LONDON W.1. MAYfair 5543



The World's largest
manufacturing, marketing and
contracting group concerned
with electrical transmission
and distribution, radio and
telecommunication equip-
ment.

BRITISH INSULATED CALLENDER'S CABLES LIMITED
NORFOLK HOUSE, NORFOLK STREET, LONDON, W.C.2

Wireless World

Radio and Electronics

Proprietors:
ILIFFE & SONS LTD.

Managing Editor:
HUGH S. POCKOCK,
M.I.E.E.

Editor:
H. F. SMITH

Editorial, Advertising
and Publishing Offices:
DORSET HOUSE,
STAMFORD STREET,
LONDON, S.E.1.

Telephone:
Waterloo 3333 (50 lines).

Telegrams:
"Ethaworld, Sedist, London."

△
PUBLISHED
MONTHLY

Price: 1/6

(Publication date 26th
of preceding month)

Subscription Rate:
Home and Abroad
20/- per annum.

37th YEAR OF PUBLICATION

DECEMBER 1947

MONTHLY COMMENTARY	453
BROADCASTING JUBILEE. By P. P. Eckersley	454
NEW POLICE RADIO	457
DEFLECTOR COIL EFFICIENCY. By W. T. Cocking	460
IGNITION INTERFERENCE—2. By W. Nethercot	463
UNBIASED. By "Free Grid"	467
SIDEBANDS AGAIN. By "Cathode Ray"	468
QUALITY SUPERHETERODYNE. By S. A. Knight	472
WORLD OF WIRELESS	477
TELEVISION RECEIVER CONSTRUCTION—10	481
NEW "ALL-STAGE" VALVE	483
CATHODE-RAY TUBE DATA	484
SHORT-WAVE CONDITIONS. By T. W. Bennington	485
ADDITIVE AND MULTIPLICATIVE MIXING. By J. W. Whitehead	486
LETTERS TO THE EDITOR	487
RANDOM RADIATIONS. By "Diallist"	490
NEW BOOKS	492

Branch Offices:

COVENTRY:
8-10, Corporation Street.
Telephone: Coventry 5210.

Telegrams:
"Autocar, Coventry."

BIRMINGHAM:
King Edward House,
New Street, 2.

Telephone:
Midland 7191 (7 lines).

Telegrams:
"Autopress, Birmingham."

MANCHESTER:
260, Deansgate, 3.
Telephone:
Blackfriars 4412 (4 lines).

Telegrams:
"Iliffe, Manchester."

GLASGOW:
26B, Renfield Street, C.2.
Telephone: Central 4857.
Telegrams: "Iliffe, Glasgow."

△
As many of the circuits and apparatus described in these pages are covered by patents, readers are advised, before making use of them, to satisfy themselves that they would not be infringing patents.

WEARITE

Components of undoubted

MERIT

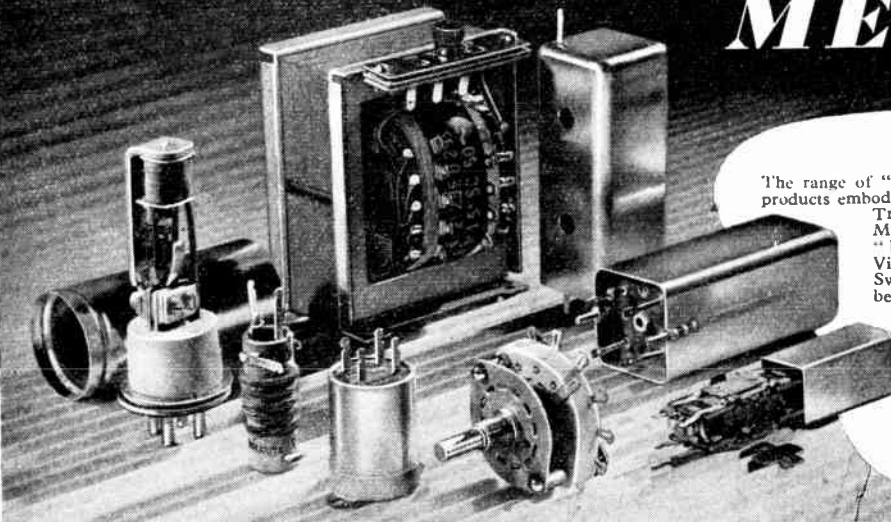

The range of "WEARITE" time-proven products embodies all your needs in Mains Transformers, I.F. and Miniature I.F. Transformers, "HYPERLOY" Chokes, Vibrators, Coils and Ceramic Switches. Your dealer should be able to supply from stock.

If any difficulty, write to us giving his name. If you haven't yet had our Catalogue giving full information on "WEARITE" Components, write to-day.

Wright and Weaire Limited

2 LORD NORTH ST., LONDON, S.W.1. TELEPHONE ABBEY 2126. FACTORY: SOUTH SHIELDS, CO. DURHAM



VALVES AND THEIR APPLICATIONS

By M. G. SCROGGIE, B.Sc., M.I.E.E.

No. 12: Mullard V.H.F. Power-Amplifier Double-Tetrode QV07-40

THE great advantage of a tetrode for r.f. amplification is the internal screening, which renders neutralizing almost (if not quite) unnecessary. The effectiveness of the screening is largely lost, however, if the screen grid is not tied down to a constant potential. For example, if there is an impedance in series with the screen, and no by-pass capacitor, its potential is free to vary, and it can do little to prevent r.f. potentials at the anode from affecting the control grid.

At moderate radio frequencies a by-pass capacitor effectively ties the screen grid to earth or cathode. But at v.h.f. the internal connection to the screen has an appreciable inductance. Even with careful valve design it is of the order of $0.015\mu\text{H}$, which at 200 Mc/s is an impedance of about 20Ω . The only way to reduce it by doing anything outside the valve is by tuning it to resonance as an acceptor circuit. The disadvantage then is that the by-pass is effective only at the one spot frequency, and there is nothing to prevent instability at other frequencies.

One of the merits of push-pull is that any variation of the screen potentials is in opposite phase, so that if the screens are connected together they help to keep one another steady. This object, of course, is defeated if the connection between them has a substantial impedance; but if the two valves are in one envelope the inductance of these leads can be kept very small. That is what is done in the QV07-40.

Still, it is not wise to trust entirely to balanced anti-phase for the screening, and as we have seen there are difficulties about the external

by-pass. So in the QV07-40 there is an internal by-pass of 65 pF, arranged so that the inductance is negligible. At 200 Mc/s its impedance is about 12Ω , and even less at the valve's maximum rated frequency, 250 Mc/s.

If the valve is used at comparatively low frequencies this internal by-pass is likely to be insufficient, and the usual external capacitor should be used. A little attention may be needed at frequencies of the order of 100-150 Mc/s to ensure that the inductance of the screen connection, internal and external, does not tune the internal by-pass as a rejector circuit.

Some QV07-40 Data:

Heaters: 1.125 A at 12.6 V (series)
 or 2.25 A at 6.3 V (parallel)
 Max. Anode Voltage: 750
 Max. Screen Voltage: 225
 Max. Anode Dissipation: 40 W
 Output at 200 Mc/s: 70-80 W



This is the twelfth of a series written by M. G. Scroggie, B.Sc., M.I.E.E., the well-known Consulting Radio Engineer. Reprints for schools and technical colleges may be obtained free of charge from the address below. Technical Data Sheets on the QV07-40 and other valves are also available.

**THE MULLARD WIRELESS SERVICE CO. LTD.,
 TECHNICAL PUBLICATIONS DEPARTMENT,
 CENTURY HOUSE, SHAFTESBURY AVE., W.C.2**

Wireless World

Radio and Electronics

Vol. LIII. No. 12

DECEMBER, 1947

Price 1s. 6d.

MONTHLY COMMENTARY

The "Elevated Electrode"

IN referring to the 50th anniversary of the foundation of the Marconi Company, we said (June issue) that Marconi's first great technical contribution was the addition of an elevated aerial to Hertz' oscillator. We had believed that Marconi's aerial priority was now beyond dispute.

In this belief we were wrong. Our statement has been questioned, and in particular it has been claimed that the Russian physicist Popov was the true originator, not only of wireless telegraphy but also of the aerial, with which we are here concerned. On this question we published (September issue) extracts from an article by the Marchese Solari, one of Marconi's earliest living associates, who also contributes a letter to the present issue. These communications, though lending support to our contentions, do not constitute documentary proof, and so we have delved into the half-forgotten literature of the dawn of wireless. Here are the results.

Exactly 50 years ago (November 26th, 1897) Popov wrote a letter to *The Electrician*, which was published in the issue of December 10th. He gave a translated *précis* of a paper of his that had appeared in the *Journal* of the Russian Physical and Chemical Society for January, 1896. In it was described the use of a coherer for recording atmospheric electric disturbances; a lightning conductor was connected to one side of the coherer and the other was earthed. The author expressed hopes that his apparatus would eventually be applied to signalling at great distances and went on to describe his use of a modified coherer for detecting electromagnetic waves at distances up to 5 km. Aerials for either transmitting or receiving were not mentioned here or in the specific claim that comes after the *précis*. This claim was that Marconi's receiver was a reproduction of Popov's "lightning recorder."

It seems highly significant that Popov made no claims to the aerial. His letter showed, by referring to a back number of November 12th, that he was a reader of *The Electrician*, and so he may be assumed to have known of the controversy on the origin of the aerial that had ended in the pages of that journal

only a fortnight before. This controversy seems to have been general in the English technical press of the time; and it was probably provoked by an editorial statement in the *Electrical Review* of October 8th, 1897, which read:—

"But we think there can be no doubt that Marconi is the true and first inventor of the elevated electrodes on the receiver and transmitter, and this detail appears to have contributed more to extend the possible distance of telegraphy by electric waves than anything that has been discovered."

That statement brought forward counter-claims by or on behalf of Minchin, Tesla and Edison—but not Popov. Those claims were apparently not regarded as entirely valid even at the time; now, with the accumulated knowledge of 50 years, we realize that the "elevated electrodes" devised by these early workers and used in the manner they described could not have contributed much to progress.

A True Pioneer

We do not belittle Popov's early work. On the contrary, some years ago we agreed that, subject to verification of the Russian documentation, he is to be regarded as the originator of the idea of using Hertzian waves for communication. Popov's published work pre-dated Marconi's first patent, but there is no record that he originated anything—including "elevated electrodes" on transmitter and receiver—which turned Hertz' oscillator and Branly's coherer into a practical means of communication.

Popov was essentially modest: such phrases as "my little work," and "repeating some of O. Lodge's experiments with the coherer . . ." which occur in his letter to *The Electrician* bear witness to that, and suggest that, were he alive to-day, he would hardly have been a party to the exaggerated claims made on his behalf.

He would probably have deplored as much as we do an intemperate article (containing, incidentally, a slighting reference to *Wireless World*) published recently in the U.S.S.R. journal *Culture and Life*.

Looking Backwards—and Forwards

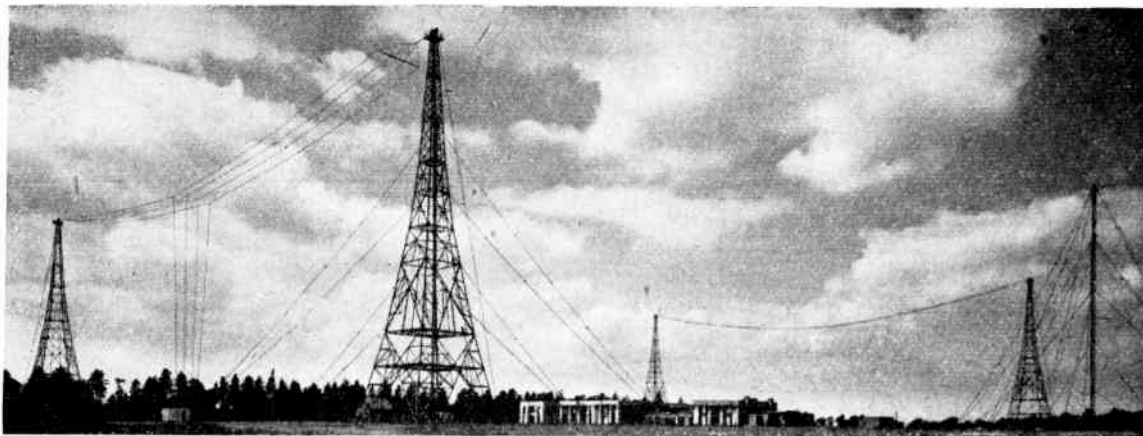

LOOKING back from a technical vantage-point over the broadcasting scene makes the far-away look very close; the view is clear because not obscured by any remarkable event. Perhaps the 25-year-old emergence of broadcasting shows some mazy detail, not so clear as the rest; on the whole, however, the more it changes the more it is the same thing. The programmes have shown a tremendous improvement; the senior people must have read my book and adopted some of its suggestions! However, the mutttons here are technical and it is this technical aspect that is so singularly flat and undramatic.

I listen to broadcasting on an ordinary set belonging to a friend. This was bought just as the ordinary non-technical person buys any household appliance, a vacuum cleaner, sewing machine or electric fire. I can "get" a large number of stations; I get the Home, Light and Third programmes. The first two are reasonably free from background, the last is annoyingly accompanied by sounds made by the electric lift. I can also hear ghosts of other programmes behind the highbrow elegancies of the distinguished Third. As to

the reproduction, I should doubt if I hear any frequency higher than 3,500 c/s, and I know that orchestral reproductions are muzzy and confused. I am sure that I got at least as much pleasure, apart from the physical discomfort, from a crystal and telephones, *circa* 1923. I dare say

ings in the service we offered. I set down the points of a policy which seemed to me to be sound and which I had determined, were I to be allowed to remain in the Corporation, to put into practice. These were (1) that the listener wherever he lived in Great Britain should be given the opportunity to hear B.B.C. programmes without extraneous interference; (2) that the conditions of transmission should be such that the reproduction should be a faithful copy of the original sounds; (3) that the conditions of transmission should permit the cost of the receiver to be within the

means of the lower wage earner; (4) that there should be a sufficient number of channels of programme distribution to allow the diffusion of as many different programmes as there were different programmes to diffuse.

The Regional Scheme initiated the policy: high-power senders gave to a majority that strong field essential to overcome interference and there were two programmes to choose between. The field strength was enough to permit the use of simple, and therefore cheap, receivers.

The adoption of the policy of using high-power senders by Continental broadcasting authorities

Broadcasting Jubilee

By P. P. ECKERSLEY, M.I.E.E.

(Formerly Chief Engineer, B.B.C.)

behind the obscuring screen of annoyances which mar my pleasure I can detect a better acoustical environment in the studios. But I do ask, without trying to be funny, what remarkable difference is there between the reproductions of programmes given to the public now and those given twenty years ago?

As chief engineer of the B.B.C. in the middle 'twenties I was conscious of manifold shortcomings

OLD AND NEW.—The original Brookmans Park masts for London regional station, with, on the right, the recently erected 500-ft mast radiator are shown in the title illustration.

was (and is) one which has made it impossible to carry out the policy in full. The too-small frequency separation between carriers causes sidebands to overlap and receivers are perforce designed with a narrow bandwidth of reception. High-fidelity reproduction becomes impossible. The obsolescent method of distributing programmes by modulating medium waves, with the consequent lack of enough channels,

given by a miserly employer to his workmen: "If it were any worse we couldn't a-drunk it; if it were any better we shouldn't a-got it."

What does the future hold? What tools do we possess which could fashion a more exciting structure than we have to-day?

The primary requirement is more channels of distribution. This technical provision would give to the listener a wider choice

pursued we still want more channels for the sake of quality. Some argue that the ordinary listener does not like high-fidelity reproduction. What is in fact true is that he does not like the harsh and glittering top that is, at present, an almost universal concomitant of wide-band reproduction. Given a constant service, encouraging true high fidelity, the rather difficult problems of top reproduction would, in time, be solved, and their solution would be welcomed by all.

There are two main methods available to give us more channels: short-wave radio and carrier-on-wire networks. I am not concerned which of the two methods is adopted, but I do most devoutly hope that some day soon we shall get at least an experimental service, somehow, somewhere.

On the short-wave side we have the new, exciting and revolutionary method of frequency modulation. There was once a doubt as to whether the extravagantly wide sidebands essential to F.M. would not be a relative disadvantage of the system. In other words, more A.M. senders than F.M. senders might give a more efficient national service. H. L.

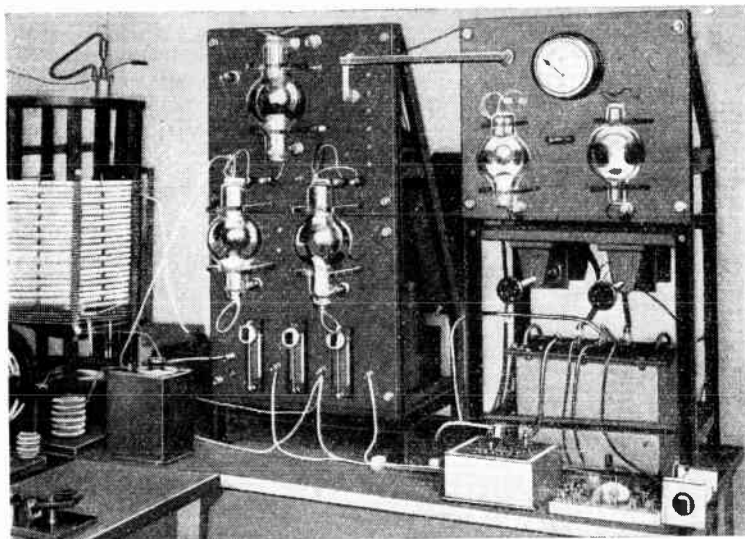

B.B.C. PROGRESS: 1922-1947. In striking contrast are these photographs of the original Writtle, Chelmsford, transmitter, 2MT, which operated from February 1922 to January 1923, and the modulated amplifier tank of the B.B.C.'s most powerful station at Ottringham, near Hull.

completely nullifies any possibility of giving the listener a wide range of choice between different and clearly heard programmes.

The efforts I made, after leaving the B.B.C., to develop a scheme of wire broadcasting were attempts to pursue the policy of giving the public a high-fidelity multi-programme service. The attempts were in part frustrated, but the relay services have gained a wide measure of support, in spite of every obstacle, chiefly bureaucratic, put in their way. But broadcasting remains much as it has always been—a public service satisfying a public which is refused an opportunity to be better satisfied. One remembers the story of the beer

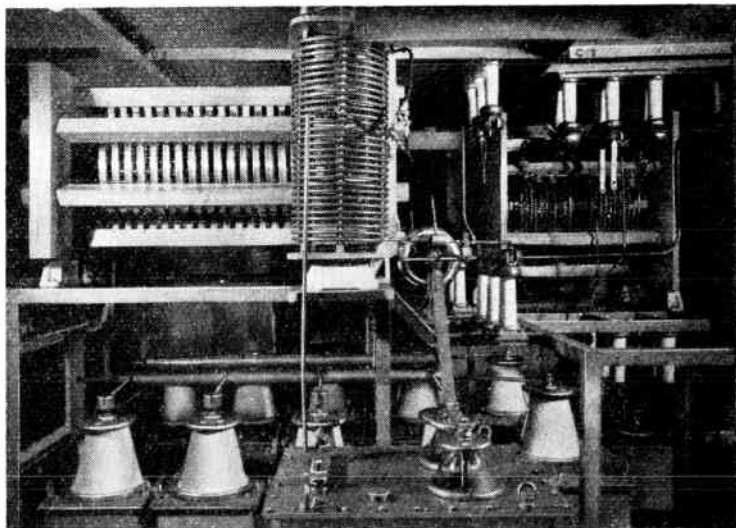

of programmes. I know the necessity for this is doubted by the pundits; it was doubted before the Third programme was born and given such a wide welcome. Even if the pusillanimous policy of denial of quantity is

Kirke has investigated and shows that, so far as distribution is concerned, F.M. is the better system. There is still, however, this doubt: the F.M. receiver is more complex than the A.M. type. Has this factor, throwing a

Broadcasting Jubilee—

greater burden on the public, been taken into account?

I happen to believe that wire broadcasting method is the better. Wire broadcasting receivers are cheap and efficient, the channels numerous, and no ether channels, so essential for mobile services, are used. The argument that wire broadcasting cuts off the listener from foreign-station listening is equally applicable to short-wave radio broadcasting. It was always a stupid argument; if "the people" watch "the Govern-

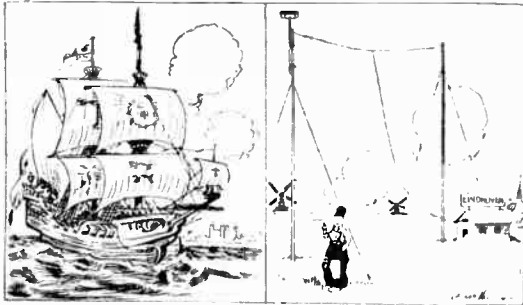

1927.—This cartoon appeared in *Wireless World* in June, 1927, when the Dutch station, PCJJ, having started short-wave overseas broadcasting some months prior to the introduction of Empire broadcasting by the B.B.C., emulated the Dutch commander Admiral Tromp.

ment" then no one need be cut off. If dictatorship comes, be sure that radio will be cut off whatever its technique. Quite likely the dictator would install a wire broadcasting system and confiscate all radio sets!

As to the network, probably in the long run the telephone wires are the most suitable. It is said, moreover, by competent authorities that it would be possible to distribute television programmes via subscribers' lines. I am as certain as I can be that the electric mains would be quite unsuitable for use in diffusing television programmes. Which leads to question about the future of television. I have little doubt that eventually the greater part of broadcasting will contain sound and vision images. The operative word here is "eventually." Today television is a technical marvel and a cultural horror. In its reportorial aspects it is useful to those who must know the latest at the earliest, to those who like to join in events, to sports enthusiasts maybe; but in its creative exhibitions it has hardly passed the standards of the embryonic cinema. This does not blame anyone; inevitably a new art has to find its new forms of expres-

sion. Early sound broadcasting was a mediocre business.

To my way of thinking, television should be developed as much by the cinema people as by the B.B.C. Some of the reasons are obvious—competition for service, widened experience and so forth—but one seems to be paramount. Apparently some of the imperfections of the images reproduced in the home to-day could be rubbed out by using a larger number of lines. On the other hand, the use of higher and higher frequency carrier waves,

essential to increased lines, would cause distortion because of reflections. This is a problem that could be solved, given a considerable expenditure, at any given reception location; i.e., at any particular cinema theatre. Ergo, the cinema reproductions could be better and the experience gained

OUR COVER illustration is this month devoted to an unusual view of the B.B.C.'s most powerful station at Ottringham, near Hull. It consists of four 200-kW transmitters, for operating in the long- or medium-wave bands, which can be coupled to give an output of 800 kW. The old 2LO transmitter had a power of 1 kW!

wider than by flogging the imperfect system essential at the moment as a public service.

There is an easy and delightful pastime in exaggerating the virtues of the good old days; what I think makes anecdotalage negligible is the existence of some better new ones. One therefore ends this brief looking-backwards looking-forwards with the specific hope that something may soon be done to give listeners a wider choice between faithfully reproduced programmes than they get to-day. Monopoly can never be justified; at least it might be admired for its courage and enthusiasm.



PIONEERS.—In this group of pioneers of the Writtle days are (seated, second from left) Sir Noel Ashbridge, now B.B.C. Deputy Director General, (standing, second and third from left) H. L. Kirke, head of B.B.C. Research Dept., and R. T. B. Wynn, B.B.C. Assistant Chief Engineer. P. P. Eckersley the author of this article is seated in the centre. (Courtesy, "London Calling.")



New Police Radio

Two-station Diversity System with Radio-link Control

Two steel towers support the Leverstock Green aeri-als. On the distant one is a 6-element array beamed on Hatfield for reception on the link frequency and a vertical half-wave aerial for reception from the patrol cars. The near tower supports similar aeri-als for transmitting.

reliability, since there are fewer pieces of equipment to develop defects.

The block diagram of the installation shows the arrangement of the equipment at the three main centres: Hatfield, Leverstock Green and Barkway.

The 10-watt transmitter at Hatfield operates on a frequency of the order of 150 Mc/s and feeds a half-wave horizontal aerial at the top of a 100-ft steel tower. This is the link over which the switching signals are sent for starting up the two 100-W transmitters and for conveying the outgoing speech signals which modulate these transmitters.

Leverstock Green and Barkway operate on two carrier frequencies

SOME of the early experiments made by the Home Office radio branch which finally produced a workable system of V.H.F. diversity transmission for telephonic communication with police cars have already been described in *Wireless World*.¹ Descriptions of the equipment used in these tests² or developed especially for services of this kind^{3, 4, 5} have already been published.

It is now possible to give details of the latest installation planned for the Hertfordshire county police. This is thought to be the first large-scale scheme of its kind employing diversity transmission with amplitude modulation.

The scheme employs two 100-watt V.H.F. transmitters one located at Barkway in the north-east corner of the county, and the

other at Leverstock Green, in the south-west corner. Both these unattended stations are controlled and operated by radio links from the county police headquarters at Hatfield.

In one of the earlier experimental installations the transmitter at the headquarters station was used to control an intermediate transmitter located at one of the main transmitting sites. This transmitter, of about 30 watts output, controlled and supplied modulation to the other two stations in the chain.

In the case of the Hertfordshire scheme the headquarters transmitter itself performs these functions. This not only reduces the amount of equipment needed; it also simplifies the installation and, incidentally, makes for greater

The equipment rack inside the Leverstock Green station building. The three racks contain the 100-watt and 10-watt transmitters, link and service receivers, modulation amplifiers and power supplies. Spare equipment for replacement in the event of a defect is also included.

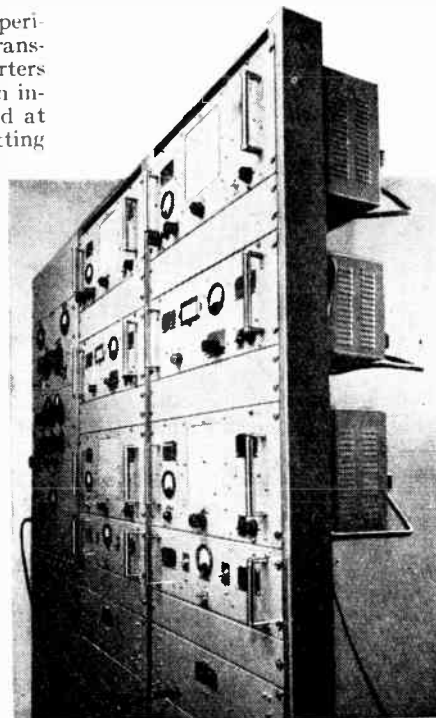

¹ Multi-carrier Communication System, *Wireless World*, February, 1946, pp. 59-61.

² V.H.F. Communication Equipment, *Wireless World*, June, 1946, pp. 180-181.

³ Mobile V.H.F. Gear, *Wireless World*, November, 1946, p. 368.

⁴ Miniature V.H.F. Transmitter-Receiver, *Wireless World*, July, 1947, p. 209.

⁵ Mobile Radio-telephone, *Wireless World*, October, 1947, p. 357.

New Police Radio—

of the order of 80 Mc/s, the frequency separation being, about 10 kc/s. This is considerably closer than the experimental systems already described for in those multi-carrier installations the carrier separation was 20 kc/s and since three stations were used the bandwidth of the operational signal receivers, mobile and fixed, was 100 kc/s. With the frequency spacing reduced to 10 kc/s and only two stations the receiver's bandwidth can be brought down to 40 kc/s. In order to prevent audible heterodyne of the two carriers the upper audio response is restricted to just below 5 kc/s. This provides good speech quality; indeed, this curtailment was certainly not suspected during the demonstration run at which time these details were not known.

It will be seen that a 50- μ sec delay network is inserted between the link receiver and the main transmitter at Leverstock Green, but not at Barkway. There is a difference of 10 miles in the dis-

miles to the radio path to Leverstock Green, thereby bringing the modulation at this station in phase with that of Barkway. Likewise a delay of the same amount is inserted in the incoming signal path at Leverstock Green.

The aerial system at Hatfield Police Headquarters consists of two 6-element horizontal receiving arrays beamed on Leverstock Green and Barkway respectively and a horizontal half-wave dipole for transmission.

Despite these delay networks some phase difference is bound to exist as the patrol car will not always be the same distance from both stations. Extensive use has shown, however, that such phase difference that may occur under normal conditions does not introduce noticeable distortion.

Four aerials are used at each main transmitting site, those at Leverstock Green consisting of



zontally polarized. The other two are vertical half-wave dipoles and are used for transmitting to and receiving from the patrol cars.

At Leverstock Green the aerials are supported on two 120-ft steel towers, but at Barkway an existing tower 240ft high has been used.

Details of the receivers and transmitters fitted in the patrol cars have appeared on previous occasions, so it will suffice here to say that the radiated power is about 10 watts at a frequency of the order of 100 Mc/s. A vertical roof aerial is used and the receiver is a superheterodyne. Both trans-

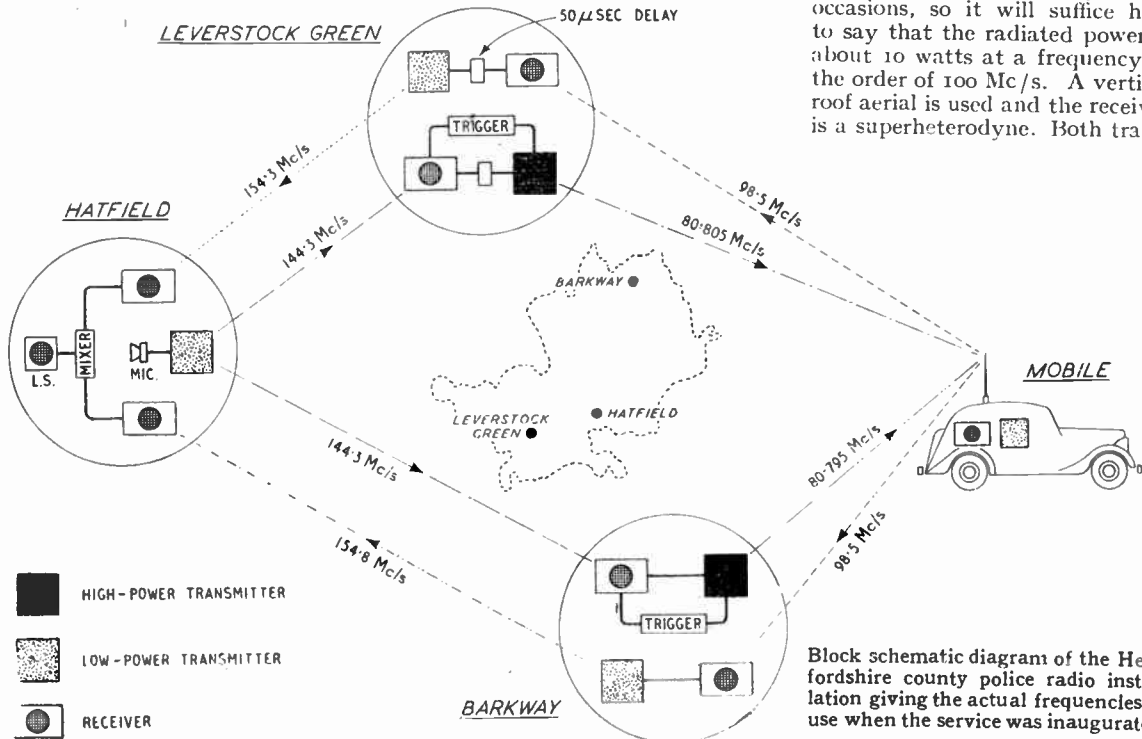

Block schematic diagram of the Hertfordshire county police radio installation giving the actual frequencies in use when the service was inaugurated.

tances of these stations from Hatfield, Leverstock Green being the nearer of the two. The 50- μ sec delay is equivalent to adding 10

two six-element Yagi arrays, one for the incoming and one for the outgoing link signals. These are beamed on Hatfield and are hori-

mitter and receiver are crystal controlled.

A point of interest of the Hertfordshire scheme is that the six

divisional police headquarters in the county are also included in the radio chain. These stations use the same transmitting and receiving frequencies as the patrol cars, and can therefore receive all outgoing messages, but they cannot receive from or transmit to the cars. They have communication by two-way radio-telephone with the main headquarters in

Hatfield in the same way as the patrol cars, small 10-watt transmitters being employed.

The actual frequencies at present employed are marked on the block schematic diagram of the installation, but it is understood that these will be amended shortly as some are outside the bands agreed on recently at Atlantic City.

Rotating Dual Aerial System

Electric Drive and Remote Indicators

SHOWN here is a remotely controlled dual beam-aerial system which has been erected by C. G. Allen at his amateur station, G8IG, in Bromley, Kent. It is mounted on a wooden tower 30 feet high and consists of a three-element array for 20 metres and a similar one above for 10 metres.

Close spacing is used in both aeri-als and this has resulted in a very low impedance—about 6 ohms—at the centre of the radiator.

In order to bring this up to match a 50-ohm coaxial feeder a folded radiator is used. It consists of a $\frac{3}{8}$ -in diameter tube with a $1\frac{1}{8}$ -in tube in parallel. The feeder is joined into the centre of the thinner tube.

The dimensions of the 20-metre array are:—reflector 36ft, radiator 35ft and director 32ft. The reflector is 10ft behind the radiator and the director 7ft in front. The boom carrying the elements, which are insulated from it, is 17ft long and 2-in diameter. Reflector and director are $1\frac{1}{8}$ -in diameter and the whole is made of duralumin "B" thin-walled tubing and it weighs 28lb complete.

Supported 7ft above the 20-metre array is a replica of it scaled down to half-size for 10 metres and using smaller diameter tubes.

The whole head is carried in ball bearings and is driven through a vertical shaft from the base of the

tower by an electric motor and reduction gearing.

Clamped to the driving shaft is

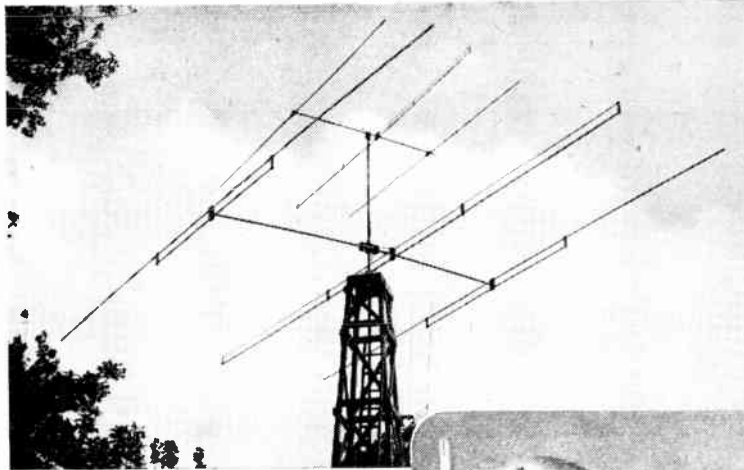

The two-band aerial array for 10 and 20 metres erected on a 30 ft tower with its electric driving mechanism shown in the insert.

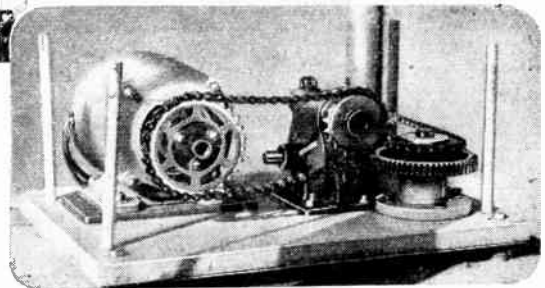

a rotary switch with 18 equally-spaced contact studs. In the transmitting room is a great-circle map of the world on a circular metal plate, with a 360-degree compass scale round the circumference and in which 18 radial slots are cut. Behind each slot, in a reflector, is a small lamp connected to the corresponding stud on the mast switch.

As the aerial rotates the lamps light up.

BOOKS RECEIVED

Television Explained.—By W. E. Miller. The various parts of a television set are simply explained and the book provides an introduction to television which is suited to those acquainted with ordinary wireless equipment. Covering the receiver stage-by-stage, it deals with aeri-als, R.F., I.F. and V.F. amplification, sync separation, time bases for electrostatic and electromagnetic tubes, cathode-ray tubes and power supplies. Pp. 50, with 56 illustrations. Iliffe and Sons, Ltd., Dorset House, Stamford Street, London, S.E.1. Price 3s 6d.

School Broadcasting in Britain.—By Richard Palmer. Claimed to be the first considerable contribution on the subject of school broadcasting to be published in this country, this book describes the growth and scope of the system introduced by the B.B.C. in 1924. 144 pages. British Broadcasting Corporation, London, W.1. Price 3s 6d.

Reference Data for Radio Engineers.—Second editions of two manuals with this title have been received from the associated companies Standard Tele-

phones & Cables (London) and Federal Telephone & Radio Corp. (New York). There is a marked similarity between them, but in the S.T.C. publication the material has been Anglicized. The books were originally compiled for the use of the staffs of the respective companies. The scope of the S.T.C. book, which was first made available

to the public in 1942, can be gathered from some of the chapter headings: General Engineering Tables; Engineering and Material Data; Audio and Radio Design in General; Rectifiers, Valves and Amplifiers; R.F. Transmission Lines; Radio Propagation and Aeri-als; Noise and Noise Measurement; Non-Sinusoidal Waveforms, Mathematical Formulae; Tables and General Information. British: 175 pages, Standard Telephones & Cables, Connaught House, Aldwych, London, W.C.2. Price 5s. The American edition costs \$2.

Deflector Coil

WHEN considering the problems associated with the electromagnetic deflection of a cathode-ray beam it is useful to have available information about the energy and power needed in the ideal case. It is useful because the ideal power requirement is one which can never be reached and it serves as a measure of the efficiency of a practical system and so indicates the possibility of improvement.

In a recent article^{1,*}, Schlesinger has given equations for the energy in the magnetic field and for the power needed to provide that energy once every scanning cycle. Similar equations are developed below and extended to a form which expresses the efficiency of a practical coil in relation to an ideal one.

The ideal deflecting field will be considered as a field of uniform magnetic intensity H, extending for a distance l_0 along the neck of the tube, and occupying a volume v of cylindrical shape. The diameter of the cylinder is d_0 and is assumed to be the external diameter of the C.R. tube neck.

When the field is zero the undeflected electron beam passes along the axis of the cylinder as shown by the dotted line of Fig. 1 (a). The field is assumed to be perpendicular to this axis and of uniform intensity throughout the cylinder; outside the cylinder it is assumed to be zero.

Practically, this is an impossible condition, for the field always falls off more or less gradually outside its main boundaries. Only the ideal case is considered here, however.

The general arrangement of a deflecting system on the neck of the C.R. tube is shown in Fig. 1 (b) and for deflection in the plane of

the paper the magnetic field is perpendicular to this plane over the area bounded by l_0 and d_0 , the cross-section being circular of diameter d_0 . If the total angle of deflection from one extreme to the other is ϕ , the maximum angle from the undeflected position is $\phi/2$ and the beam is shown in this position.

The path of the beam through the field follows an arc ABC of radius r and the path of the beam outside the field is tangential to the arc at the boundary. By inspection $\angle CDE = \phi/2 = (\text{arc } ABC)/r$ and $l_0/r = \sin \phi/2$.

Reference to

any book on electron optics gives the relations

$$r = mu/He$$

$$e E_{HT} = \frac{1}{2} mu^2$$

$$\frac{e}{m} = 1.76 \times 10^7 \text{ e.m.u./gm.}$$

Combining these relations gives

$$H = \frac{10^{-3}}{2.96} \frac{\sqrt{E_{HT}}}{l_0} \sin \frac{\phi}{2} \text{ oersteds.}$$

$$\Delta H = 213.5 \frac{\sqrt{E_{HT}}}{l_0} \sin \frac{\phi}{2} \text{ oersteds} \dots \dots \dots (5)$$

$$\text{Energy} = 1.425 \times 10^{-4} E_{HT} \frac{d_0^2}{l_0} \sin^2 \frac{\phi}{2} \text{ joules} \dots \dots \dots (6)$$

$$P = 0.1425 E_{HT} f \frac{d_0^2}{l_0} \sin^2 \frac{\phi}{2} \text{ watts} \dots \dots \dots (7)$$

$$I = 0.00169 d_0 \sin \frac{\phi}{2} \sqrt{\frac{E_{HT}}{l_0}} \text{ amperes} \dots \dots \dots (8)$$

The field for full deflection in one direction is $H_1 = H$ and in the other is $H_2 = -H$. The total change of field for full deflection through the angle ϕ is thus in oersteds $\Delta H = H_1 - H_2 = 2H$

$$= \frac{2 \times 10^{-3}}{2.96} \frac{\sqrt{E_{HT}}}{l_0} \sin \frac{\phi}{2} \quad (I)$$

Text-books on magnetism show that the energy stored in an elementary volume dv of a magnetic field H, uniform over that volume, is $BHdv/8\pi$. In this case H is uniform over the whole volume v and as the medium is air $B = H$. The total energy

stored in the field is $H^2v/8\pi$ ergs. The volume $v = \pi d_0^2 l_0/4$ and so energy = $1.425 \times 10^{-8} \times$

$$E_{HT} \frac{d_0^2}{l_0} \sin^2 \frac{\phi}{2} \text{ ergs} \dots (2)$$

If at the end of every scan this energy is dissipated during the fly-back in a resistance it must be supplied f times a second where f is the scanning frequency. Consequently, the power supplied is

$$P = 1.425 \times 10^{-15} \times E_{HT} f \frac{d_0^2}{l_0} \sin^2 \frac{\phi}{2} \text{ watts} \dots (3)$$

If the field H in the volume v were produced by a current I in a coil L, and if it were the only field produced by the coil, the energy in the field would be $\frac{1}{2} LI^2$. Equating this to the previous expression for energy gives

$$I = 1.69 \times 10^{-4} d_0 \sin \frac{\phi}{2} \sqrt{\frac{E_{HT}}{l_0}} \quad (4)$$

The foregoing expressions are all in fundamental electromagnetic units. Converting to the more convenient practical units of amperes, kilowatts, kilocycles per second, centimetres, oersteds, joules, watts, the expressions become:

A typical "9-in" C.R. tube has a maximum deflection angle of about 48° and gives a picture $7\frac{1}{2}$ in by 6 in. The maximum angle is obtained only in the corners and corresponds to the diagonal of 9.6 in. The half-angle is 24° and its sine is 0.406. Assuming that the deflection distance on the screen is proportional to the magnetic field, as it should be, $\sin \phi/2 = 0.406 \times 7.5/9.6 = 0.318$, or an angle of 18.55° , for the horizontal deflection.

Such a tube usually has a neck diameter of 3.55 cm and the deflection field can rarely exceed

Losses in Television Scanning

¹ "Magnetic Deflection of Kinescopes," by Kurt Schlesinger, *Proc. Inst. Radio Engrs*, August 1947, Vol. 35, p. 813.

* See also "Line Scanning Systems for Television," by A. M. Spooner and E. E. Shelton, *Electronic Engineering*, October 1946, Vol. 18, p. 302, but note that the "figure of merit" used is proportional to the square root of the power efficiency.

Efficiency

By
W. T. COCKING,
M.I.E.E.

5 cm in length. If $E_{HT} = 6$ kV the formulae give the following values:—

- H = 33.2 oersteds;
- P = 2.175 watts;
- Energy = 2.16×10^{-4} joules;
- I = 0.222 ampere;

assuming an inductance of 8.9 mH and $f = 10.125$ kc/s.

Now in any practical circuit the current I_L through the deflector coil needed to produce a given deflection d at a given final anode voltage E_{HT} is easily measured, as are also the inductance L_L and the resistance R_L of the coil. Following the same reasoning as before, if the energy in the magnetic field is dissipated in resistance during the fly-back, the power supplied to produce the field is:

$$P_{L_i} = \frac{I_L^2}{2} L_L f \times 10^3$$

and there is a loss in the resistance of

$$P_r = I_L^2 R_L / 12$$

Therefore the total power is

$$P_T = \frac{I^2}{2} L_L f \times 10^3$$

$$\{I + R_L / (6 \times 10^3 L_L f)\} \dots (9)$$

the units being watts, amperes, kc/s, Ω , henrys, kV.

It has been shown² that, in these units,

$$I_L = \frac{k_2 d \sqrt{E_{HT}}}{80.4} \dots (10)$$

where k_2 is a factor related to the deflection-coil efficiency which is easily determined in any practical case by measuring I_L and d , the deflection on the screen, for any convenient value of E_{HT} .

In terms of k_2 , then,

$$P_T = 7.78 k_2^2 d^2 L_L f E_{HT} \times$$

$$\{I + R_L / (6 \times 10^3 L_L f)\} \dots (11)$$

The efficiency of the practical deflector coil relative to the ideal is thus

$$\eta = \frac{P}{P_T} = 1.83 \frac{d_0^2 \sin^2 \frac{\phi}{2}}{k_2^2 l_0 d_0^2 L_L \{I + R_L / (6 \times 10^3 L_L f)\}} \dots (12)$$

In one practical case with $L_L = 8.9$ mH, and $R_L = 15 \Omega$, the factor k_2 was 1.08. Assuming the other

values to be unchanged the efficiency is 10.7 per cent. Instead of the input power being 2.175 W it must be 20.3 W.

It is instructive to examine the reasons for this low efficiency. In the first place, the effective diameter of the magnetic field is necessarily larger than the diameter of the tube neck. Allowing some clearance between the inside of the coils and the tube the mean diameter of the assembly can rarely be much less than 4.5 cm. Taking this as the real diameter of the field, the power is increased by $(4.5/3.55)^2 = 1.61$ times.

To obtain a uniform field the ends of the coils are usually bent

one-half of the total. The power needed is proportional to the square of the field; therefore the loss in the ends of the coils increases the power needed about 4 times.

These two factors make the input $4 \times 1.61 = 6.4$ times the ideal, or 14 W.

There is a loss in the resistance of the coils which amounts to some 2.7 per cent of the total, or 0.56 watt. All this brings the power up to 17.56 watts and leaves 2.74 watts so far unaccounted.

This represents the loss of field external to the coils. If no outer iron ring were used, one-half of the field produced by the sides would be wasted and a further increase of four times in the power would be needed! The usual outer iron ring provides a path of low reluctance for the

external flux and by so doing it increases the internal flux.

These various sources of loss are shown in the Table as per-

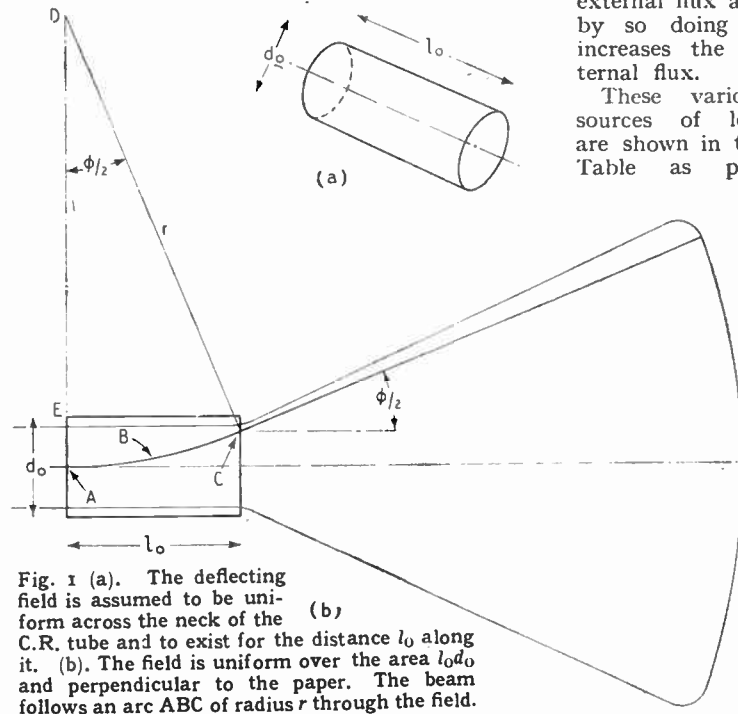

Fig. 1 (a). The deflecting field is assumed to be uniform across the neck of the C.R. tube and to exist for the distance l_0 along it. (b). The field is uniform over the area $l_0 d_0$ and perpendicular to the paper. The beam follows an arc ABC of radius r through the field.

centages of the total power so that it is easy to see their relative importance. It should, of course, be understood that this breakdown into components of loss is only approximate. The useful deflecting power is accurately calculable and the input power can be measured, so that the total loss is known accurately. The resistance loss can be com-

away from the neck of the tube and so the field from the ends contributes little or nothing to the useful field. The wire on the ends is about one-half the total wire in the coils and the field is also about

² "Television E.H.T. Supply," by W. T. Cocking, *Wireless World*, June 1947, Vol. 53, p. 207.

Deflector Coil Efficiency—

puted quite well from the known current and D.C. resistance of the windings. The loss remaining is apportioned among the three main causes largely by estimation and any individual one may be considerably in error.

What the breakdown does reveal is that there is one major source of loss—the end field of the coils—and a number of minor ones and that appreciable improvement in efficiency can be made only by attending to this major loss. Only when this loss can be reduced to a figure comparable with the others will it be profitable to spend much time in efforts to reduce them also.

The main problem in deflector coil design is clearly to obtain a uniform field in the neck of the tube without also producing a lot of waste field outside the tube.

It should be pointed out that

TABLE

	watts	per cent
Useful deflecting power	2.175	10.7
Wasted power in excess of mean diameter of coils over tube neck diameter	1.325	6.53
Wasted power in ends of coils	13.5	66.5
Wasted power in coil resistance	0.56	2.77
Wasted power in field external to coils	2.74	13.5
	20.3	100

the expression for the efficiency of the deflecting coil holds whether or not resistance damping is used. Both expressions for the power, in the ideal and in the practical cases, are based on the assumption that the energy in the field is dissipated in a resistance during each fly-back. These expressions do not hold, therefore, in cases where some of the energy is utilized to provide part of the next scan, but their ratio, which is the efficiency of the coils, does hold in all cases. Equation (12) is, therefore the most useful one.

Before concluding, it may be as well to consider very briefly conditions for the frame scan. In the ideal case, the power input required is proportional to frequency so that for a field of the

same dimensions and for the same deflection angle the power needed is $50/10,125 = 0.00495$ of that for the line scan; that is, 0.0108 W instead of 2.175 W.

However, the losses in the series resistance of the coils are much more important. With the same values as before, but taking $f = 0.05$ kc/s (50 c/s), Equ. (12) gives $\eta = 0.0166$. The same deflector coil has an efficiency of 1.66 per cent at frame frequency compared with 10.7 per cent at line. The difference occurs solely because the series resistance losses are independent of frequency whereas the "reactive losses" are greatly reduced at frame frequency, and consequently form a smaller proportion of the total.

In practice, of course, the absolute magnitude of the power needed is more important than the efficiency, and in the frame scan the power is so small that even the low value of 1.66 per cent is not very important. It means a power of about 0.65 W as compared with 20 W for the line scan.

For mechanical reasons it is usually necessary to make the frame coils rather shorter than the line, and this reduction of l_0 makes it necessary to increase the input somewhat. However, the amplitude of scan needed is only 80 per cent of that of the line and these two effects roughly cancel each other.

Because the line scan requires a much bigger power input than the frame the efficiency of the line coils is much more important than that of the frame. In spite of the fact that the latter is already by far the lower of the two, it would pay handsomely to improve the line efficiency even if it entailed a reduction of the frame efficiency. Thus, in the case considered, doubling the line efficiency would save 10 W input power to the coils. If this improvement could be made only by reducing the frame efficiency

to one-quarter, the increase of frame input would be no more than 2 W and the total saving would be as much as 8 W.

One cannot go too far in this way, of course, because the efficiencies of the valve and of the valve-to-coil coupling are often much lower at frame than at line frequency. Nevertheless, it may pay well to sacrifice frame coil efficiency if by so doing it is possible to improve the line coil efficiency.

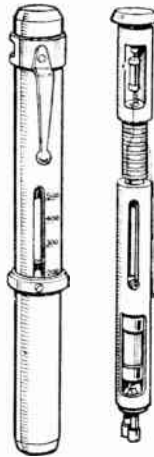

CRYSTAL SET:

New Version

This fountain-pen-sized receiver, which was shown at Olympia by B.T.H., employs a radar-type crystal detector and has permeability tuning.

Miniature Soldering Iron

A LIGHTWEIGHT soldering iron for fine work and instrument repairs has been introduced by Adcola Products, Alliance House, Caxton Street, London, S.W.1. The long copper bit ($\frac{1}{16}$ in dia.) is integral with the heater element.

Despite its diminutive size it develops a surprising amount of heat in the copper bit. A usable temperature was reached just over a minute after switching on and within two minutes it was possible to solder a No. 16 S.W.G. wire to a tag with ease.

Consumption is approximately 25 watts; supply voltages between 12 and 250. Price is 22s 6d; a replacement element, which includes the bit, costs 12s 6d.

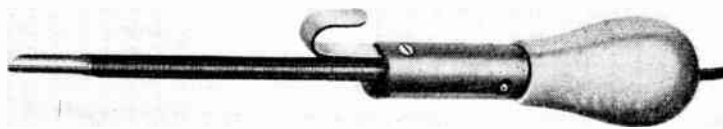

Adcola lightweight soldering iron.

IF YOU'RE SHORT OF 6F5's — SOLUTION IS TO **BRIMARIZE!**

TYPES 6F5 and 12F5 are high-mu triodes for which the triode portions of the double-diode-triode types 6Q7GT and 12Q7GT form efficient substitutes. These valves are International Octals and call for very little alteration to the wiring. Any connections to pins 3 and 5 of the 6F5 socket will be for anchoring purposes only and these must be removed before Brimarizing.

PUNCH HOLES HERE

TYPE	CHANGE SOCKET		CHANGE CONNECTIONS		PERFORMANCE CHANGE	REMARKS
	FROM	TO	FROM OLD SOCKET	TO NEW SOCKET		
6Q7GT	INT/OCTAL	NO CHANGE	PIN 3 .. 4 .. 5	REMOVE PIN 3 REMOVE	SLIGHTLY LESS GAIN	In certain sets pins 3 and 5 of the 6F5 may be used as soldering tags.
12Q7GT	INT/OCTAL	NO CHANGE	PIN 3 .. 4 .. 5	REMOVE PIN 3 REMOVE	SLIGHTLY LESS GAIN	Any connections to these tags must be removed before Brimarizing.

**6F5
12F5**

INSTRUCTIONS: Punch holes where indicated, cut away this portion and file sheets in order of appearance. This column will then form a quick reference index.

6F5
12F5

6Q7GT
12Q7GT

RATED CHARACTERISTICS		
	6F5	6Q7G/GT
Heater Voltage	6.3	6.3 volts
Heater Current	0.3	0.3 amp.
Anode Voltage	250	250 volts
Anode Current	0.9	1.1 mA
Amp. Factor	100	70
Bias Resistor	3,000	3,000 ohms

NOTE: The characteristics of types 12F5 and 12Q7GT are identical to those of types 6F5 and 6Q7G/GT respectively, except for the heater ratings, which are 12.6v., 0.15A.

BRIMAR

RADIO VALVES

★
BRIMARIZING — a service which first-class dealers can offer those customers whose radio sets have been designed round certain valves which are now in short supply

STANDARD TELEPHONES AND CABLES LIMITED, FOOTSCRAY, SIDCUP, KENT.

A SERVICE PLAN FOR THE SERVICE MAN

9

M. WILSON LTD

COIL UNITS IN KIT FORM

SMALL BOX TYPE 6-WAVEBAND SUPERHET UNIT

With R.F. Stage, 5-2,000 metres.

Designed by F. H. Wilson and used during the
PAST THREE YEARS in our Circuit No. 20.

BRIEF SPECIFICATION

Coil Screens in alum. 18 s.w.g. (Three sections R.F., H.F., and Osc.) Coils. These are dust iron-cored High "Q" with adjustable inductances sealed to suit the screening factor. Tuning Range from 5 to 2,000 metres with a gap between for the I.F. frequencies. A.V.C. is operative on all wave bands. A.V.C. and H.T., decoupling resistors and condensers are fitted to each section, the condensers being silver mica and non-inductive. The complete screening, short wiring, superb workmanship, together with the best obtainable components contribute to the magnificent performance achieved with this unit. Testimonials to this effect are being constantly received from distances as far as West Africa, Australia, America, and home users. The Switch is a two pole, six way, three bank, with Sporting Plates on both primary and secondary to short circuit coil windings not used. Two Aerial connections are provided, both screened, A.1 for Broadcast reception, A.2. Di-pole for short waves, all variable trimmers and padders are of the ceramic type, fixed padders being silver mica. Measurements when assembled, 5" deep x 5½" wide x 3" high.

Price **£5 10 0**

All connecting leads are colour coded and full-size practical and theoretical blue prints are supplied

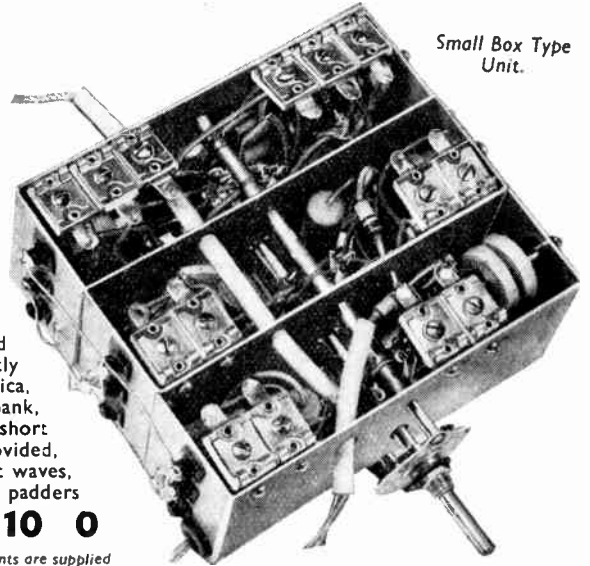

Small Box Type Unit.

FLAT TYPE 6-WAVEBAND SUPERHET UNIT

With R.F. Stage. 5—2,000 metres.

Designed by F. H. Wilson and used in our
UNIT SYSTEM OF CONSTRUCTION (No. 3 Unit) for over two years.

The specification is the same as for the Small Box type. Measurements when assembled, **£5 10 0**
5½" deep x 8½" wide x 3½" high.

SPECIAL NOTICE

Look out for our new circuit with the following outstanding features: (1) Two R.F. Stages. (2) Double Superheterodyne, 2 I.F. Frequencies. (3) Super-regenerative I.F. Stage. (4) Variable Selectivity. (5) Noise Suppressor. (6) Push-Pull triode output. (7) 6 Wave bands as above unit but extra R.F. Stage.

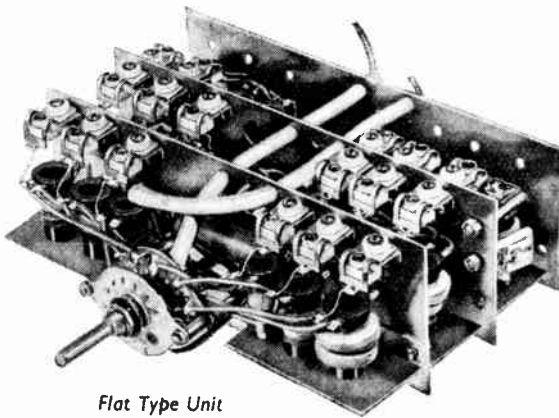

Flat Type Unit

● BLUE PRINTS ●

CIRCUIT No. 20. 9-VALVE SUPERHET, including magic eye and rectifier. 6-Wavebands with R.F. stage. 12 watts push-pull output with radiogram switch. R.F. and audio volume control. A.V.C. and negative feed-back. Full specification on application. 2 Full-size practical and one theoretical blue prints with detailed price list of components, 5/- per set.

6-VALVE SUPERHET CIRCUIT including magic eye and rectifier. 3-Wavebands 16-47m, 200-540m. and 800-2,000m. The few Long Wave Stations now operating are well received, with high fidelity on the Medium band and the performance on Short Waves is as good as obtained on some purely short-wave receivers. 2 Full-size practical and one theoretical blue prints with detailed price list of components, 3/6 per set.

Demonstrations of the above receivers can be heard during business hours.

M. WILSON LTD. 307, HIGH HOLBORN LONDON, W.C.1
HOLborn 4631

Ignition Interference

ATENTION to the design and layout of the engine ignition system, on the lines suggested in the first part of this article, may often reduce the interference considerably, but such reduction will not in general give the degree of protection to radio services specified in the old or envisaged in the new British Standard Specification for automobile interference.

Additional suppression is, therefore, necessary. The methods in common use are complete screening, and resistors in the high-tension leads. High-frequency chokes in the leads will reduce the interference and proprietary types were marketed at one time. If they are used it is essential to incorporate a small capacitor between earth and the point of attachment of the lead to the choke. Tests made on proprietary types at frequencies up to 50 Mc/s showed them to give rather less suppression than does the average resistor. It is to be expected that they would have a frequency characteristic and probably the suppression efficiency falls off at the higher frequencies. They are not used today because they compare unfavourably with resistors in size, cost and ease of fitting.

Complete Screening.—In complete screening the coil or magneto is encased in a metal box to which is attached, by a suitable gland, the screened harness. This consists of a flexible screened cable leading to the distributor, similarly encased in a metal box, and screened leads from the distributor to the sparking plugs. The screened sparking plugs are joined to the high-tension leads by metallic glands completely enclosing the plug leads. The screened cable is bonded at frequent intervals to the engine. With coil ignition the low-tension lead to the battery is fed through a screened choke-capacitance filter.

Complete screening, if properly designed, reduces the ignition interference to a level which is too low to be measured, at least over the frequency range in which most

military equipment operates. The method has, however, serious disadvantages; the capacitive load on the system reduces the voltage output and necessitates the use of high-energy coils and magnetos; there is increased wear on the contact points and the sparking plug electrodes erode rapidly unless erosion resistors are fitted. These resistors, of the order of 1,000 ohms, serve to limit the peak discharge current—and prevent arc-

that optimum results are obtained with such resistors suitably disposed in the H.T. circuit.

It is impossible to generalize about the degree of suppression to be expected with a given combination of resistors, as this varies with the particular vehicle under test, the frequency of measurement and the way in which the resistors are fitted in the ignition circuit. However, for the frequency band up to 100 Mc/s and more particularly around the television frequencies, the following statements hold.

Concentrated resistors, for optimum efficiency, must be placed as close as possible to the source of the spark, i.e., at the actual plug and distributor terminals. For equal values of resistance the distributed type gives rather more suppression than does the concentrated one. The resistance of an individual concentrated resistor or a distributed resistance lead should not usually be less than 5,000 ohms nor need be greater than 15,000 ohms. With some engines in which the distance between coil and the distributor is very short, it may not be possible to employ a distributed resistance lead of more than 1,000-2,000 ohms.

The increase of suppression with increase of the total resistance between the H.T. terminal of the coil or magneto and the sparking plug falls off as the value approaches 25,000 ohms. E.R.A. tests have shown that between 25,000 and 100,000 ohms the increase of suppression is never more than 6 db and often is quite negligible.

The maximum suppression likely to be achieved by resistors is 40-50 db, and at any frequency in the band 200 kc/s-100 Mc/s it is possible to obtain not less than about 20 db.

The simplest arrangement for coil ignition and for magnetos with separate distributors is one resistor (or resistive lead) between the coil and distributor. With this it is possible in some cases to reduce the interference at television frequencies to below the 50 μ V/m level at 30ft. It is usually ineffec-

2.—Methods of Suppression

By W. NETHERCOT,
M.A., B.Sc., F.Inst.P.

(British Electrical and Allied
Industries Research Association)

ing; they do not contribute materially to the suppression of interference.

Insulation problems are more acute due to the increased stress on the H.T. cables and terminations and moisture penetration into the harness has to be prevented. The equipment is expensive and inevitably the accessibility is much reduced. These disadvantages have to be tolerated in aircraft and for military and other purposes where radio reception is of paramount importance, but they rule out the method for general adoption on ordinary vehicles.

Resistor Suppression.—This is the method which is employed in all cases where the highest degree of suppression is not required. It is simple and inexpensive, but gives good suppression over much of the frequency range. The resistors may be of the concentrated or the distributed type; in the latter the central conductor of the ignition cable has a resistance of 5,000-15,000 ohms per foot. The concentrated types are made in values of 5,000, 10,000 and 15,000 ohms, experience having shown

Ignition Interference—

tive above 80 Mc/s and may even increase the interference level.

Tests made on about 40 different vehicles showed that the addition of a 15,000-ohm concentrated resistor in the coil lead reduced the interference at 45 Mc/s by 3 to 23 db. This is a wide range, and it means that the single resistor would easily reduce the interference from some vehicles to below 50µV/m and on others it would have practically no effect. On most of the vehicles the reduction was between 10 and 15 db as evidenced by the mean value of 14 db.

Further suppression is obtained by inserting resistors at the sparking plugs (essential for magnetos with integral distributors) and at the distributor end of the sparking plug leads. Alternatively distributed resistance plug leads can be used. In the above series of tests the effect of adding resistance up to 15,000 ohms between the distributor and sparking plugs was to increase the suppression by anything up to 20 db.

British military vehicles which were not carrying radio equipment were suppressed so that they did not cause interference to those that were. Concentrated resistors were used, 5,000 ohms at the coil and sparking-plug terminals of the distributor and 15,000 ohms at the sparking plugs. This is the combination of concentrated resistors which is likely to give optimum results, although often the plug resistance can be reduced to 5,000 ohms and those at the sparking-plug terminals of the distributor omitted without noticeable loss in suppression efficiency.

Table I shows the suppression achieved by such a combination on two 1940 Vauxhall cars.

20 db is attainable for frequencies up to 100 Mc/s.

The efficiency of distributed resistors can be increased considerably by covering a short length of the lead at the plug end by a screen of metal foil to form a small capacitor of about 20µµF, the foil being bonded to the cylinder block. This forms a network giving a high attenuation from the plug at high frequencies. Up to 10 db extra suppression may be obtained in this way, but as the method creates problems of cable insulation and earth termination it has so far been used only experimentally.

The use of iron wire as a resistance material for distributed resistors appears to offer some possibilities. Suppression of the order of 25 db has been obtained at television frequencies with

effective resistance at television frequencies was approximately 15,000 ohms. Such resistors might be of use in cases where engine performance is affected by the ordinary resistors as they present a low impedance to the low-frequency components of the ignition spark and so have little effect on the energy dissipated. It would be interesting to experiment with high permeability materials such as Mumetal.

The suppression efficiency of resistors at frequencies higher than 100 Mc/s was investigated in the series of tests described on page 355 of the October issue and quantitative estimates for both concentrated and distributed types were obtained over the frequency range 40-650 Mc/s. So far as the author is aware, these are the only measurements which

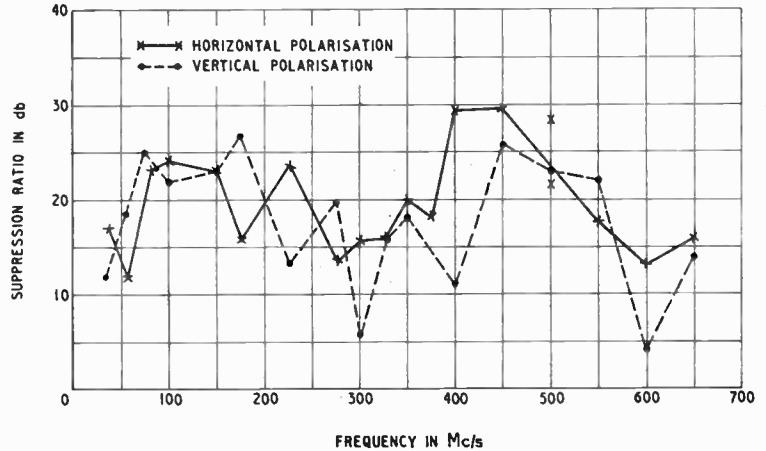

Fig. 1. Suppression efficiency of concentrated resistors on Vauxhall "14" car.

some cars fitted with distributed resistors comprising lengths of 30 S.W.G. iron wire wound in a single layer on a thin strip of in-

have been made over this frequency range.

Concentrated resistors, 5,000 ohms in the coil lead and 5,000 and 15,000 ohms at the distributor and sparking plugs respectively were tested together with a distributed resistor harness for the "14" car. This consisted of a coil lead of 1,800 ohms and sparking plug leads varying between 2,700 and 5,000 ohms.

Figs. 1 and 2 show the respective efficiencies of the concentrated and distributed resistors between 40 and 650 Mc/s for the "14" car. Fig. 3 shows the concentrated resistor results for the "12." These curves are exceed-

TABLE I

Vehicle	Suppression in db						
	30	35	40	45	50	80	100 Mc/s
Vauxhall 12	33	25	36	33	24	> 16	21
Vauxhall 14	21	27	25	27	35	23	22

This shows that the degree of suppression varies with the frequency but that a minimum of

insulating material. The D.C. resistance of these particular suppressors was 70 ohms but their

ingly peaky, part of which may be due to the difficulty of measurement. These cannot be

high frequencies are different and in some respects more serious than those at television frequencies.

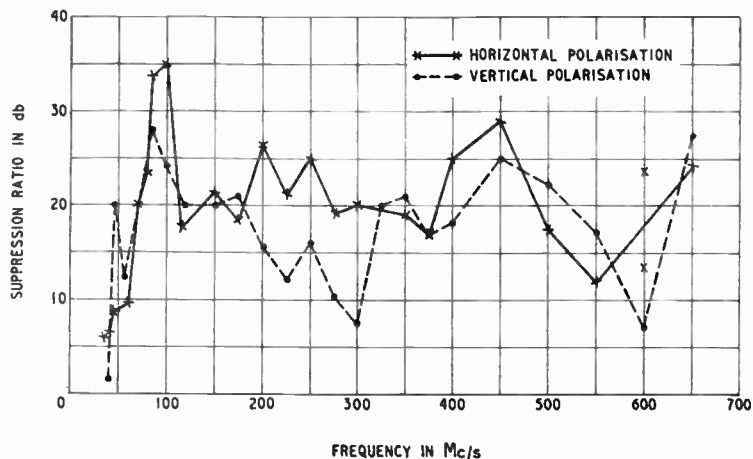

Fig. 2. Suppression ratios with distributed resistors on Vauxhall "14".

relied on to an accuracy better than 5 db and as the suppression curves were obtained by subtracting suppressed values from unsuppressed ones a maximum error of 10 db is possible. It is interesting to note, however, that there is no general falling off in suppression efficiency with increase of frequency, the average value being about 20 db.

The distributed resistors, of much lower resistance than the concentrated type, gave equally good suppression although the crests and troughs on the suppression frequency curves do not coincide. This could be due to the fact that the distributed suppressors are more efficient; on the other hand it might have been found that concentrated resistors, equal in resistance to the distributed, would have given equally good results.

It will be seen that the suppression efficiency is extremely low at frequencies around 300 Mc/s and 600 Mc/s, so low in fact that the measurements were repeated, but with the same results. In the region of 300 Mc/s the lengths of the H.T. leads or at least some of the longer ones, are approaching the half wavelength and so the possibility of standing waves on them has to be envisaged. If this be so it means that the problems of ignition interference suppression at very

Design of Resistor Suppressors.

In commercial types of concentrated suppressors the resistor element is enclosed within a sleeve of insulating material; the terminations for those intended for insertion in the coil lead or at the distributor ends of the plug leads consist of wood screw threads attached to each end of the resistor. Ignition cable is screwed into each end of the resistor, but with resistors intended for attachment to the sparking plugs one

trouble is experienced with the resistors themselves and electrical failures are fairly rare. The disadvantages are that it is not very easy to fit the plug type on some engines with jacketed plugs; furthermore the connections have a tendency to work loose and shorting may occur due to the exposed metal ends touching some part of the engine. With the coil lead type it is impossible to put them absolutely adjacent to the points of sparkover and so maximum efficiency may not be obtained.

In the event of general adoption of suppression for vehicles, either voluntarily by the motor manufacturers or as a result of legislation, the manufacturer will assume the responsibility of producing his vehicles suppressed to some specified level. If the suppression is obtained by resistors, then it will be maintained only for as long as the resistors are not removed, which might easily happen when servicing or replacing faulty components of the ignition system. The ideal solution is to incorporate the suppressors in the components themselves where they will be out of sight. There would be no difficulty in moulding the coil lead resistor in the distributor rotor, or resistors in the distributor terminals. The incorporation of the plug resistor in the body of the sparking plug does present difficulties due to the

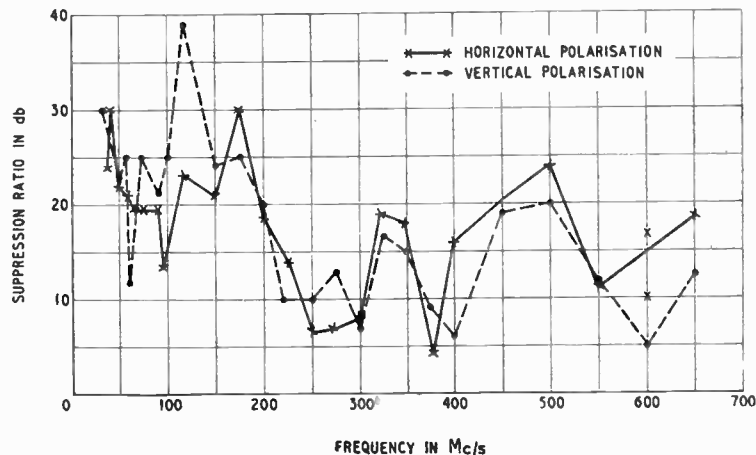

Fig. 3. Effect of concentrated resistors on interference from Vauxhall "12".

end at least has some form of spade or screw-type terminal for connection to the plug. Little

elevated working temperature (about 250°C). It is possible to incorporate erosion resistors of not

Ignition Interference—

more than 1,000 ohms satisfactorily, but it is not so easy to increase this to the 5,000-15,000-ohm value needed for suppression. It would seem that further research on this point is called for. Distributed resistance cable in its commercial form is a comparatively recent innovation. It consists of a central conducting core of graphited silk covered with a sheath of rubber.

Conducting rubber cable has been made but it is unsatisfactory on account of the variability of its resistance, which is very dependant on mechanical stress. It is also difficult to make the ohms per-foot low enough and to make satisfactory terminations.

The earlier forms of the graphited silk cable were unsatisfactory for the same reasons, but under the stimulus of the Fighting Vehicles Design and Development Department of the Ministry of Supply, a satisfactory form of cable was evolved. The method of termination used consists of cutting back the rubber sheath by about an inch and crimping the silk core to a single or multistrand copper wire of appropriate size. The whole termination is then moulded in rubber with the result that the cable end is completely sealed from the atmosphere and the mechanical stress is taken by the moulding and not by the silk core/copper wire joint.

This construction has proved eminently satisfactory for military purposes but it is hardly suitable for general civilian use. The leads are relatively expensive and the replacement problem is difficult as each lead is made, so to speak, to measure. Furthermore, the length of the moulding is such that on many vehicles, in which the coil-distributor distance is short, the actual length and, therefore, the resistance of the resistive part of the lead would be much too low unless cable with a higher ohms-per-foot were available. This means duplication of cable types which is undesirable.

What is wanted is a cheap and simple termination comparable in its ease of fitting with those used on normal ignition cable. If this difficulty can be overcome then the resistance cable becomes an

attractive alternative to the concentrated resistor.

Effect on Engine Performance.

—It was widely held at one time that the use of resistance suppressors on engines had detrimental effects on performance, e.g., that it may cause difficult starting from cold, poor slow running, bad acceleration and running at high speeds. Much of this was prejudice, and now the general opinion seems to be that on most popular types of engines there is no adverse effect, even with resistors considerably greater than those needed for suppression purposes.

In 1939 the Automobile Research Association carried out tests on behalf of the Society of Motor Manufacturers and Traders on a number of engines and vehicles of widely different types using resistors from 5,000 to 500,000 ohms.⁷ The conclusions were that there was no effect at moderate or high speed or under appreciable load and that side-valve engines in general were insensitive to the effect of suppressors. Some overhead-valve engines were affected by suppressors at the lower speeds, the maximum loss of power being 9 per cent. Generally the loss was much smaller than this. The effect was found to be due to insufficient turbulence and could be remedied by the fitting of shrouded inlet valves. Factors such as mixture strength, ignition advance, sparking plug gap, leaky plugs and spark energy were found only to have an effect if the predisposing condition of insufficient turbulence was present, and even then their effect was small. Additional evidence in confirmation of these conclusions is provided by long experience with army vehicles. Some of the manufacturers of popular low- and medium-power vehicles report similar results; on the other hand there is evidence that the performance of certain of the more expensive, high-powered vehicles is quite noticeably affected by resistors, even by those of low value. A detailed discussion on the reasons why resistance in the ignition circuit affects engine performance is outside the scope of this paper; furthermore, the quantitative evidence is not as extensive as one would wish. It would appear

however, that little or no trouble is to be expected in fitting resistors to the popular type low- and medium-power vehicle, but that difficulties may arise with some expensive, high-powered types.

Acknowledgment. — The measurements at frequencies above 100 Mc/s were made possible by the collaboration of the Radio Division of the National Physical Laboratory to whom acknowledgment is due; and in particular to Messrs. B. G. Pressey and G. E. Ashwell.

References.

- 1 Gill and Whitehead: "Electrical Interference with Radio Reception," *J.I.E.E.*, Vol. 83, 1938.
- 2 George: "Field Strength of Motor Car Ignition between 40 and 450 Mc/s." *Proc. I.R.E.*, September, 1940.
- 3 Eaglesfield: "Motor Car Ignition Interference." *Wireless Engineer*, October, 1946.
- 4 B.S.S. No. 833: "Radio Interference Suppression for Automobiles and Stationary Internal Combustion Engines."
- 5 B.S.S. No. 727: "The Characteristics and Performance of Apparatus for the Measurement of Radio Interference."
- 6 B.S. Code of Practice: "Reduction of Radio Interference Caused by Motor Vehicles and Internal Combustion Engines." 1946.
- 7 Hendry: "The Effect of Radio Interference Suppression on Engine Performance." I.A.E. Report, March, 1939.

E.R.A. Reports.

- Ref. M/T28: "The Suppression of Short-wave Radiations from Automobile Ignition Systems."
- Ref. M/T44: "The Properties and Performance of the E.R.A. Short-wave Receiver for Field Strength Measurements."
- Ref. M/T47: "Short-wave Interference from Ignition Systems."
- Ref. M/T62: "The Study of Capacity Spark in Automobile Ignition Systems with Special Reference to Short-wave Radio Interference."
- Ref. M/T63: "The Radiated Short-Wave Disturbance from Automobile Ignition Systems."
- Ref. M/T64: "Apparatus for the Measurement of Interference at Ultra High Frequencies."
- Ref. M/T75: "The Capacity Spark Discharge of Ignition Systems."
- Ref. M/T81: "Radio Interference from Automobiles in the Range 30-220 Mc/s."
- Ref. M/T82: "The Radiation from Automobile Ignition Systems at Ultra High Frequencies."



Radiolympressions

IT is far too late to say anything about Radiolympia but it is none too early to start thinking about the next show and what we should like to see there. As I cannot do that without some reference to the last show I have got to refer to it whether you like it or not.

Since one of the main objects of the show was to encourage the export trade, I entered it with the eye of the export buyer. My first impression was distinctly painful as I had the misfortune to sit down rather suddenly and heavily on that portion of my anatomy intended for that purpose. The cause of the trouble was apparently a banana-skin deposited by one of the many children one saw being reluctantly dragged around the show by interested parents.

In addition to this, however, I received a very painful mental impression in my self-appointed rôle of foreign visitor and buyer when I glanced aloft at the gaunt girders of Olympia unadorned by their usual array of bunting and gaily painted panels. I do not in the least blame the organizers of the exhibition as they doubtless had neither bunting nor labour with which to put it up. But all the same, if you are hoping to sell goods to a customer it does pay to dress well and put on a million-dollar look even if you have no shirt under your Palm Beach suit. Any commercial traveller of repute will bear me out in this.

If labour and materials are still short when the next show is held, then most of us, I feel sure, would be willing to lend the yards and yards of bunting, etc., which we hang out from time to time to celebrate the end of a war to end war and such like things. As for labour, well, I cannot help recollecting my early days before the mast in a whaler and feel sure that there are many more like me, as well as a good sprinkling of yachtsmen among us wireless men, who would be only too pleased to do the job gratis and waive all our rights under the Workman's Compensation Act.

Unbiased

With the exhibits I had no fault to find at all, but in the case of one or two of the exhibitors—and I would emphasize that it *was* only one or two—courtesy seemed to be in as short supply as their goods so far as the home market was concerned. In fact, in the case of one of them, it was only when I had gone round the corner and bashed my bowler into the semblance of a sombrero and adopted a lisping Castilian accent that I could get any attention. I concluded it was, even then, only because the young man on the stand was interested in bull-fights, of which I was fortunately able to give him a first-hand description. It is only fair to say, however, that at most of the stands I got all the information and help I wanted, no matter whether I spoke with a Castilian lisp or the idiom of sele Suffolk, so often debased by the ignorant into silly Suffolk.

Lastly, I definitely did not like the "Klystron-effect" manner in which we were bunched into Television Avenue from time to time and then ejected in gulps or waves after the principle of that famous tube. Moreover, the period between admission and emission was too short to give viewers the opportunity of making comparisons.

Lacteal Lessons

I WAS highly interested to read in the *Radio Times* some time ago (Oct. 10th) a letter from a farmer in which he claimed (I presume that it was "he") that his cows gave their highest yield of milk when listening to chamber music broadcast by the B.B.C. whereas certain other types of programme, such as swing, made them

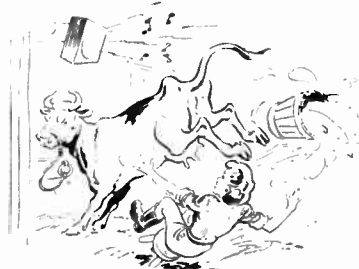

Kicking the bucket.

inclined to kick the bucket in a literal sense.

I am particularly interested in the matter since I have lately been

studying the effects of broadcast music on national output. These bovine statistics accord with my findings regarding humans, which is only to be expected as the cow is far more akin to us than Darwinian apes and monkeys. In infancy do we not fall back on the cow's output as our iron ration? There have, of course, been one or two notable exceptions to this rule, such as Romulus, Remus and Kipling's Mowgli.

As a result of my studies I am not in the least surprised to find that the cows' output is greater under the influence of chamber music. This is exactly what I should have predicted, for my colleague, a professor of industrial psychology, has

By FREE GRID

proved to me clearly that had this type of music been provided by the B.B.C. in their wartime music-while-you-work broadcasts, then it is not at all improbable that the war would have been over in half the time owing to the enormously increased tempo of munitions production. In fact, output might have risen to such proportions as to have enabled us to finish the war without outside help.

Music of the "step lively" kind which was actually broadcast tended to produce exactly the opposite effect to that desired. The workers, instead of getting on with the job, became interested in the music, whereas, had chamber music been provided they would have pressed on with their work with all speed, if only to finish the job and get away as quickly as possible.

The great thing, of course, is to get the Government to profit by the lessons to be learned from my researches and apply them to the present economic crisis. They should instruct the B.B.C. to make an immediate start in the urgent task of pumping out chamber music to the factories, thus enabling us to save both our bacon and our basic. I am, however, having tremendous difficulty in finding the correct Government department to approach. I have been referred from one to the other until I have completed the cycle and am well on in the second lap. But I have not yet lost hope of eventually getting a select committee to sit on this idea.

Sidebands Again

Why a Modulated Wave Must Have More Than One Frequency

By "CATHODE RAY"

IN "Channels of Communication" I referred to the old controversy about the physical reality of sidebands. If letters I have received are anything to go by, it seems that this controversy still rages, if not openly, then at least in the minds of some readers. The cause of the trouble, you remember, is the statement that it is impossible to modulate a carrier wave without producing waves of other frequencies. In particular, one cannot vary its amplitude without producing other frequencies.

It seems that many people are prepared to take the word of the wise that this is so, but just can't see it themselves. Others are frankly sceptical. They say "Fig. 1 depicts a portion of unmodulated carrier wave of a certain frequency; what is to prevent one from varying the amplitude as in Fig. 2, and so conveying information without affecting the frequency at all? This is *amplitude* modulation we are talking about; not frequency modulation!" Or they may show Fig. 3, in which the carrier wave is keyed to convey morse signals. Its cycles are obviously identical with those in the modulated carrier, and therefore of the same



Fig. 1. The familiar graphical representation of a pure unmodulated carrier wave.

frequency. Why drag in sidebands, which seem to be an entirely unnecessary and unreal complication?

They may also offer experimental evidence, saying that even when their receiver is tuned sharply to one frequency it can still receive morse.

To dispose of the last point first; it must be understood that hand-keyed or even machine-keyed morse represents quite a low frequency of modulation, so it is difficult to make a receiver selective enough to demonstrate loss of morse modulation due to loss of sidebands. But it can be done.

Although the sceptics can hardly deny that high modulation frequencies are lost when the receiver is made very selective, they reply that the sort of modulation used, say for broadcasting, no doubt does cause sidebands,



Fig. 2. Simplest amplitude modulation of Fig. 1, in which the modulating waveform itself is a pure sine of lower frequency.

which can be tuned out, but that just proves that it cannot really be pure amplitude modulation; see Figs. 1-3 again, etc.

What we have to find, then, is some convincing way of showing that you cannot do things like Fig. 2 or Fig. 3 on one frequency.

The usual book method is to add together waves of two or three different frequencies, which yield something like Fig. 2, and to say that therefore Fig. 2 must consist of waves of these different frequencies. If two parts of hydrogen combined with one part of oxygen are found to be water, then it is reasonable to suppose that water consists of two parts of hydrogen combined with one part of oxygen. Or isn't it? This back-to-front sort of proof doesn't seem to satisfy everybody.

Then there is the mathematical approach. This may have to be made very circumspectly, like a banker's approach to a communist. I shall try to render it a little less abstract than usual. But we are arguing about frequency, and so even the sceptics

must know what frequency means, although it is quite an abstract idea. One thing that surely must be granted is that in a pure



Fig. 3. Sample of carrier wave interrupted by morse keying. Here the carrier cycles that remain are identical with those in Fig. 1, so where do side frequencies come in?

wave train (that is, one having only a single frequency) every cycle occupies exactly the same time. The only other requirement is that every cycle must have a sine shape (that includes the cosine, of course, because it has exactly the same shape). Probably nearly everybody will grant that, too, but in case there is any hesitation it may be as well to offer some reason for preferring one particular shape to all others.

As Fourier pointed out, a repeating wave of any other shape can be analyzed into a combination of sine waves whose frequencies are exact multiples. But a sine wave itself cannot be broken up into any simpler form. This is not just a mathematical fancy. If an oscillation is of sine waveform it can be tuned in at only one frequency, whereas if the oscilloscope shows it to have any other shape, then the component frequencies calculated by Fourier analysis can be detected. They actually exist.

Another significant fact is that the natural way for things to oscillate, either electrically or mechanically, when complicating effects are absent, is according to a sine law. That is proved mathematically and confirmed by experiment.

There is one important condition in the second requirement

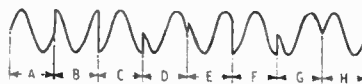

Fig. 4. Each of the equal time intervals is occupied by a single pure sine wave. But the wave train as a whole is not exactly sinusoidal!

¹ *Wireless World*, June and July 1947.

for singleness of frequency; the sine shape must hold for every cycle, no matter what part of the cycle one takes as the starting point. In Fig. 4 each of the equal time intervals A, B, C, D, etc., contains one cycle, and each has a sine shape, but I hope you will agree that the wave train as a whole cannot be called sinusoidal! It is certainly not a natural mode of oscillation, and in practice would not be found to be entirely free from harmonics.

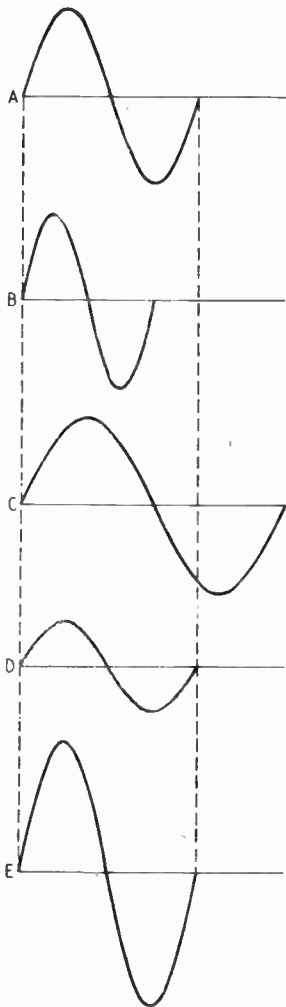

Fig. 5. A-E are all pure sine waves, and are assumed to repeat exactly and continuously. That being so, A, D, and E are equal in frequency though different in amplitude. B and C, though equal to A in amplitude, differ in frequency.

To deal with this simply, look at Fig. 5. A is a single sine-wave cycle; a sample from a continuous succession. If it is compressed or expanded along the time axis, as at B or C, then obviously the frequency is altered. If it is expanded or contracted along the amplitude axis only, strictly to

scale, as at D or E, then it is still a sine wave of the same frequency.

"Ha!" say the sceptics, "That is just our point! All you do in true amplitude modulation is to expand and contract the amplitude without altering the shape or the duration of any cycle, and the result, as you have just admitted, is a pure single-frequency wave train."

But is it? Look at Fig. 6, where two adjacent cycles of different amplitude are shown. Reckoning one whole cycle from either a or c, each has an immaculate sine shape. But what about reckoning from b? The unequal half-cycles and the nasty join between disqualify that cycle completely. So any wave train of which Fig. 6 forms any part fails to meet the requirements for a single frequency. It is no good saying that the two cycles in Fig. 6 are too different in amplitude, and that you can draw an amplitude-modulated train that doesn't show any faulty joints. The fact that the faults are too small to be seen by the eye does not mean that they are not there, or even that they are negligible in radio communication. Nor is it any good rounding off the sharp angles with a pencil, because that destroys the purity of waveform.

What we have shown, then, is that it is not possible to vary or modulate the amplitude of a carrier wave without spoiling the pure waveform of the whole: and by every test—mathematical, graphical, and experimental—departure from sine waveform is found to introduce new frequencies.

Bringing the mathematical approach to bear more directly: if the graph of a voltage v varies with time t according to the equation

$$v = V_0 \sin 2\pi ft,$$

then it is a pure unmodulated wave of peak value V_0 and frequency f . If you assume any constant values of V_0 and f , you can make a table, writing down as many different values of t as pos-

sible and calculating from a table of sines² the corresponding values of v ; when these pairs of v and t are plotted as a graph the result is a continuous pure unmodulated

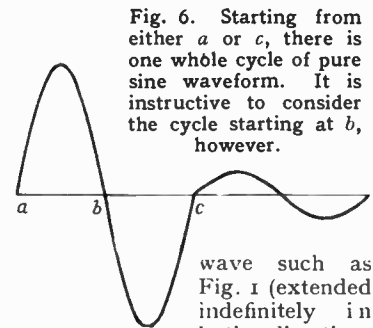

Fig. 6. Starting from either a or c, there is one whole cycle of pure sine waveform. It is instructive to consider the cycle starting at b, however.

wave such as Fig. 1 (extended indefinitely in both directions of time). If you plot cosines instead of sines, the result is the same except that it is a quarter of a cycle nearer along the time axis. You can complicate matters by adding together as many sine and cosine waves as you like, with as many different amplitudes and phases as you like, but so long as only one f is used for them all the result is invariably a pure unmodulated wave train. You cannot possibly obtain a graph like Fig. 2—still less Fig. 3—from an equation in which there is only one f .

But if you draw the graph of an equation in which v equals $V_0 \sin 2\pi ft$ plus equal-amplitude sines of two other frequencies equally above and below f , the result is Fig. 2—the simplest case of amplitude modulation. Perhaps it is because this is such a tedious job to do, and the drawing has to be done so accurately, that probably not many students have actually taken the trouble. If everybody who is still not happy about side frequencies would draw this graph, it might put an end to much of the uncertainty. It can be done either by drawing three pure sine wave graphs one above the other, the frequencies of the second and third being higher and lower than that of the first by an equal amount, and then adding them all together vertically to make a fourth, which comes out like Fig. 2. Or they can be added together numerically to give the data from which the final graph is drawn.

² If the table is made out in degrees (instead of radians), substitute 360 for 2π in the equation.

Sidebands Again—

by using a table of sines to evaluate the equation—

$$v = V_1 \sin 2\pi ft + V_2 \sin 2\pi(f + f_m)t + V_2 \sin 2\pi(f - f_m)t$$

You can use any numbers you like for V_1 , V_2 , f and f_m , so long

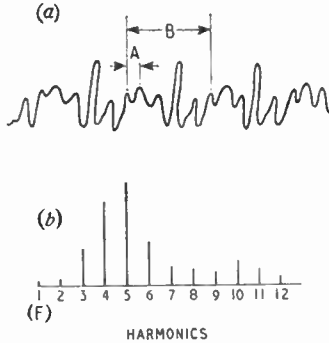

Fig. 7. In the waveform generated by an oboe (a) the fundamental cycle is not A, as might be supposed, but B. This appearance is because the fundamental amplitude (b) is nearly zero. Similarly in modulated waves the carrier frequency is not the fundamental, but a high harmonic, and the side frequencies are other harmonics.

as V_2 is not more than half V_1 . You will see why later; f_m , the modulating frequency, is, of course, normally much less than f , the carrier-wave frequency.

I hope that Fig. 6 has disposed of the fallacy that it is possible to modulate the amplitude of a sine-wave train without spoiling the purity of waveform and thereby introducing other frequencies. But while you may now see that there must be a slight (even if visually imperceptible) distortion of the cycles in order to make their amplitude vary as in Fig. 2, you may quote Fourier against me by pointing out that, according to him a distorted waveform can be analyzed into a fundamental and harmonics. Now the frequencies of harmonics are, of course, exact multiples of the fundamental frequency. Supposing Fig. 2 is the result of adding together pure sine waves whose frequencies are, say, 100, 94, and 106, it consists of these and no others. The harmonics of the carrier frequency, however, are 200, 300, 400, etc.; certainly not 94 or 106. So what price Fourier?

The answer to that one is the definition of frequency, namely, the rate at which a periodic wave repeats. If a 100-kc/s carrier wave is modulated at 6 kc/s, each successive cycle is slightly different, and one has to wait for 300 cycles of the 100 kc/s to be shown in order to see the programme round to where we came in. (300 is the lowest common multiple of 6 and 100.) By that time the carrier and modulating waves are in the same relative phase as at the beginning, and the whole thing repeats. Therefore, the fundamental frequency is $\frac{1}{3}$ kc/s, and the three component frequencies in the modulated wave, 100 and 106 kc/s, are respectively the 282nd, 300th and 318th harmonics. So everything is fully according to Fourier after all. A waveform consisting of harmonics without the fundamental is, in fact, of the Fig. 2 type. The sound waveform produced by an oboe (Fig. 7) is an approximate example.

So a typical amplitude modulator is—whether it knows it or not—a device for producing a combination of very high harmonics, all of which are grouped symmetrically around one fixed frequency, even although the absentee fundamental or fundamentals may be varying over a very wide range of frequency. The fact that the proprietor or designer of the modulator never really intended to achieve this curious result, and may even deny that it happens that way, doesn't make any difference to it. Actions that appear to be quite simple (such as varying the amplitude of a constant-frequency oscillation) often have unforeseen but inevitable results. The motives of an eater are generally much less complicated than the processes which subsequently go on inside him.

In common parlance one would say that in Fig. 2 there were 16 cycles, but, strictly speaking, every cycle of a periodic waveform must be exactly the same as every other, or frequency has no meaning. Remembering this, the fallacy of the "single-frequency modulated wave" cannot arise.

One can usually grasp difficult ideas more effectively by visualizing them in a number of different ways. There is a much neater way of demonstrating the multiple-frequency composition of a modulated carrier than by plotting the graphs, yet it seems to be much less used. It comes direct from the basic idea of vectors, shown in Fig. 8, where OA is a line representing by its length, V , the peak voltage (or whatnot) of the continuous oscillation, and its number of revs per second around O represents the frequency. The instantaneous voltage is then represented by the projection of OA on the vertical axis, YY'. At the moment shown by the full line it is zero, of course; but, as OA rotates, its projection oscillates up and down about O sinusoidally. In the dotted position OA₁, the voltage is v_1 .

Fig. 8. The simple vector principle.

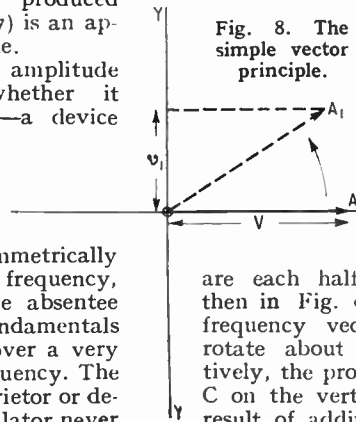

Assuming now that a pair of side frequencies is added, the vectors representing them must rotate respectively a little slower and a little faster than the carrier-wave vector OA. Supposing they are each half as long as OA, then in Fig. 9, where the side-frequency vectors AB and BC rotate about A and B respectively, the projection of the point C on the vertical axis gives the result of adding the three wave trains.

Well, of course, the task of trying to visualize the movements of the point C—to say nothing of its projection on YY'—with a mechanism consisting of three pivoted links all rotating at different speeds, is not one that I would wilfully inflict on readers. The difficulty can be removed by imagining oneself to be on vector OA, so that relatively it is stationary. Then, relative to OA and to oneself, AB is rotating in one direction at modulation frequency, and BC in the opposite direction at the same frequency. And now it is quite easy to see that C oscillates between its present position and O, as shown in Fig. 10, where it is performing one complete cycle at modulation

frequency. So the combination of a carrier-wave vector of fixed length and these two side-frequency vectors is equivalent to an amplitude-modulated carrier-wave vector. Bearing that in mind, we can now get off OA, so as to see that it is rotating at carrier-wave frequency, and we realize that the whole outfit represents a 100-per cent amplitude-modulated oscillation. Smaller depths of modulation are represented by shortening AB and BC.

Second Sideband Function

So the purpose of the second sideband is now quite clear, it is to balance out what would otherwise be a certain amount of phase modulation. Note, in Fig. 10, how the phase of OB varies relative to OA. And whereas the length of OC, representing the modulated carrier amplitude, can easily be shown to vary sinusoidally about A, the variation in length of OB is non-sinusoidal. The difference is not very serious if AB is small, but becomes more and more marked as single-sideband modulation approaches 100 per cent. So if one sideband is removed, as happens during certain types of fading, there is distortion.

It might look as if such distortion would be a drawback in the single-sideband system of communication, which economizes in transmitter power by omitting the carrier wave and one sideband. But as a carrier wave has in any case to be supplied locally at the receiving end in order to render the signals intelligible, it is quite easy to supply so much of it that the depth of modulation is always very small. Suppressed-carrier communication

does not prove that the ingredient is unnecessary. It can be left out temporarily because water and unmodulated carrier waves are the same on both sides of the

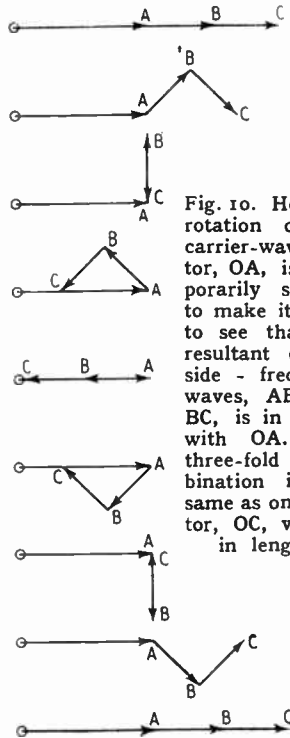

Fig. 10. Here the rotation of the carrier-wave vector, OA, is temporarily stopped to make it easier to see that the resultant of the side-frequency waves, AB and BC, is in phase with OA. The three-fold combination is the same as one vector, OC, varying in length.

Atlantic, and readily obtainable almost anywhere, so the original product can easily be reconstituted at the receiving end. Water alone contains no nourishment, and an unmodulated carrier wave no information. But they are needed to make the nourishment or information fit for reception.

What about Fig. 3? So far we have been considering the simplest case of amplitude modulation, with only one modulating frequency. Each "cycle" in Fig. 3 is admittedly a sine wave, so it may not be easy to see why merely stopping and starting a succession of them introduces other frequencies. But it is possible to discover a combination of continuous waves of different frequencies which, added together, give a keyed carrier wave like Fig. 3, whereas it is quite impos-

sible to arrive at Fig. 3 or anything remotely like it by adding together any number of continuous waves of the same frequency. In practice there is bound to be some rounding-off of the starts and stops, or an infinite number of side frequencies would be necessary. The neighbours of amateur transmitters sometimes observe that excessively abrupt keying causes a very wide range of frequencies to be radiated.

This is another example of the inexorable laws of nature. They always win against anyone who calls a process "amplitude modulation" and tries to ignore the fact that it is also sideband production. To insist that there is only one frequency in a Fig. 3 type of wave, and that therefore there is no limit to the selectivity of the receiver that could be used, is defeated by practical test. For although the connection with the mathematical theory of sidebands may not be obvious, tuning circuits that are made more and more selective do in fact show an increasing sluggishness and inability to respond to stops and starts in the signal wave, and the extent of this agrees exactly with the sideband calculations. Sluggishness in response, and tuning-out of sidebands, may seem to be two quite different things; but they are just two different ways of looking at exactly the same thing. Nothing can be done about the sluggishness except widen the tuning to the extent that mathematics indicates to be necessary to include the sidebands of the desired signal. In television, where stops and starts have to be very sudden, that means a considerable wideness.

"QUALITY" AMPLIFIERS

A BOOKLET "Amplifiers for High Quality Sound Reproduction" is obtainable from the General Electric Co., Magnet House, Kingsway, London, W.C.2. The information it contains is based on the articles by D. T. N. Williamson in our April and May issues. It also includes a design for an amplifier with PX4 output valves and a two-stage pre-amplifier with tone correction, suitable for gramophone pickups. A simplified alternative bias circuit is given for the 15-watt amplifier using KT66 valves as triodes.

Fig. 9. A simple amplitude-modulated wave is represented by the addition of three vectors, all rotating at different rates to represent the component frequencies. This is difficult to visualize all at once, but see Fig. 10.

cation is very much like the dried egg trade: for economy in transmission one ingredient is removed at the sending end. This

Quality Design for a Nine-valve Receiver

Superheterodyne

THE receiver described in this article is the result of a series of experiments spread over a period of several weeks. Their object was the development of a moderately priced quality receiver which, while possessing all the features of a modern design, did not contain "gadgets" and was simple to construct. The circuit which finally appeared to satisfy all the conditions proved quite conventional and the components used are types in plentiful supply (with the possible exception of

in a phase-splitting circuit, its outputs being passed directly to a pair of power triodes operating in Class A push-pull. The "magic eye" tuning indicator is fed from the A.G.C. diode in the ordinary manner through R_{28} .

By S. A. KNIGHT

The use of the superheterodyne principle in a "quality" receiver may cause some misgiving, in view of the high degree of selectivity normally associated with

interfere too seriously in one another's business.

The receiver is designed only for the medium and long wavebands, since in the writer's opinion the programmes of the B.B.C. and a few of the near Continental stations provide sufficient entertainment. For the enthusiastic S.W. listener there is, of course, the communications receiver, but that is certainly not our concern at the moment.

As already pointed out, the

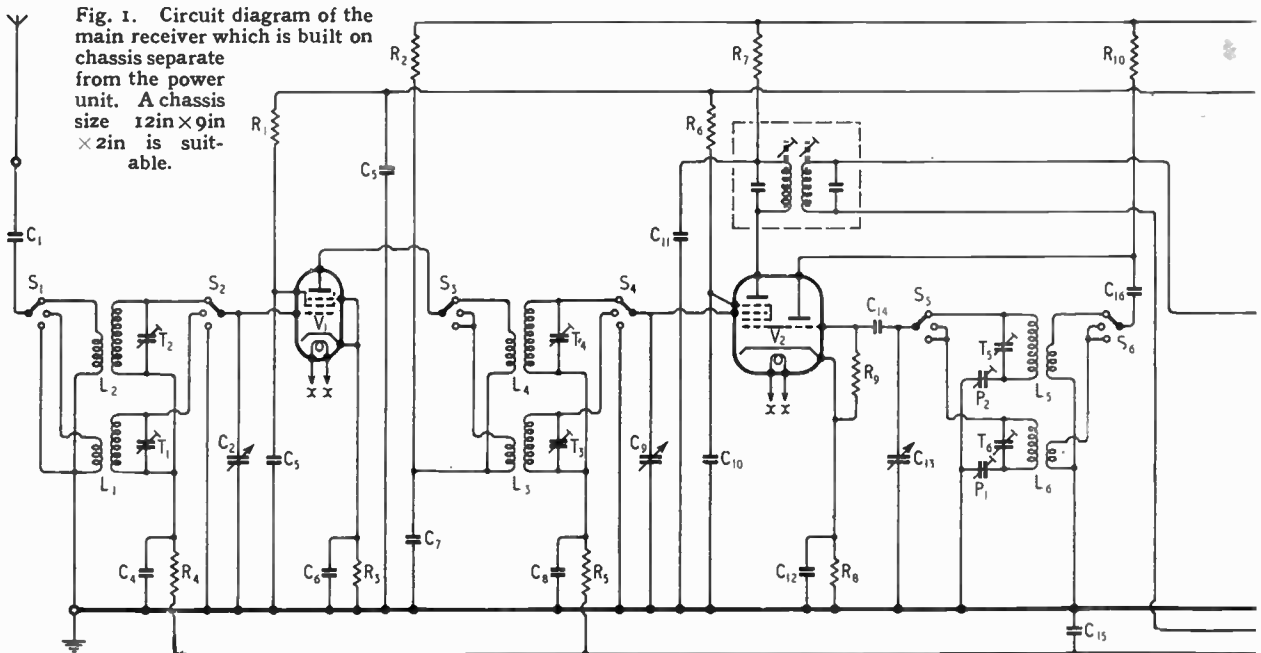

the output triodes, of which more will be said later).

On examination of the circuit of Fig. 1, it will be seen that the receiver consists of a conventional superheterodyne as far as the detector V_1 —that is, radio-frequency amplifier, triode-hexode frequency changer, I.F. amplifier and double-diode-triode for detection, A.G.C. and A.F. amplification. After this a medium impedance triode (6C5) is used

this type of receiver. In the present case, however, the selectivity is not sufficiently high to interfere seriously with the quality of the output, but it should not be thought that this results in interference. In actual fact a happy medium has been struck in the design of the apparatus, and selectivity and quality—the cats and dogs of the wireless world—seem to have settled down to an amicable agreement not to inter-

fer. The aerial input is applied through C_1 and S_1 to the primary windings of the aerial coils, where it is applied to the main grid windings, tuned by the first capacitor gang C_2 , by inductive coupling. A.G.C. is applied through the tuned windings to the grid of the R.F. amplifier, the lower ends of the coils being returned to chassis, from the point of view of R.F. through C_4 .

R_3 provides a standing bias of approximately 4 volts on the valve grid, and the screen is supplied through R_1 from the main screen-voltage line. The output of the stage is applied to the grid of the mixer through a further tuned circuit (second gang C_9), and A.G.C. voltage is again applied to the stage through the coil secondary windings. A standing bias of about 2.5 volts is developed across R_8 for the hexode section of the frequency changer, the screen being supplied through R_6 .

The oscillator section of this stage consists of the long- and medium-wave oscillator coils L_5 and L_6 respectively, switch banks S_5 and S_6 , and the third tuning gang C_{13} . The oscillator is of the tuned-grid variety, back-coupled from the anode through C_{16} and

tude is sufficiently well maintained over the wave ranges to avoid the need for including series or parallel damping resistances on the coils.

It will have been noted, no doubt, in considering these two stages that the wavechange switch is of the three-position variety. This is incorporated to enable the receiver to operate as a radio-gramophone, the third switch position being used for this purpose. The actual switch consists of a three-bank unit of the Yaxley or Oak type, each bank being three-pole, three position. S_1 and S_2 are located on the first bank, S_3 and S_4 on the second, and S_5 , S_6 and S_7 on the third. In the case of the former two banks the additional pole is not used. The circuit diagram is drawn so that the set is switched to LONG

first two stages on gramophone and there are no voltage changes on the receiver H.T. line. This may seem uneconomical at first sight, but the current drawn by the R.F. and I.F. stages is very small in comparison with the A.F. end of the set and there is little object in switching out the former when the apparatus is being used on gramophone. S_7 , located before the detector, automatically switches the pick-up into circuit when the switch is set to the third position.

The intermediate - frequency signal appears at the anode of the frequency-changer and is applied to the first I.F. transformer, this being of the permeability-tuned variety with fixed-tuning capacitors contained within the can. This type of transformer was chosen on account of the high

degree of tuning stability normally found with dust-iron cores for the adjusting elements. This is important in fixed tuned circuits, such as I.F. transformers, where the bulk of the receiver amplification is being carried out. The anode circuit is decoupled in the normal manner by R_7 and C_{11} . R_7 also serving to drop the H.T. to the required value of 250 volts. The I.F. amplifier valve is a variable- μ pentode, cathode-bias being obtained across R_{12} (4 volts), and the

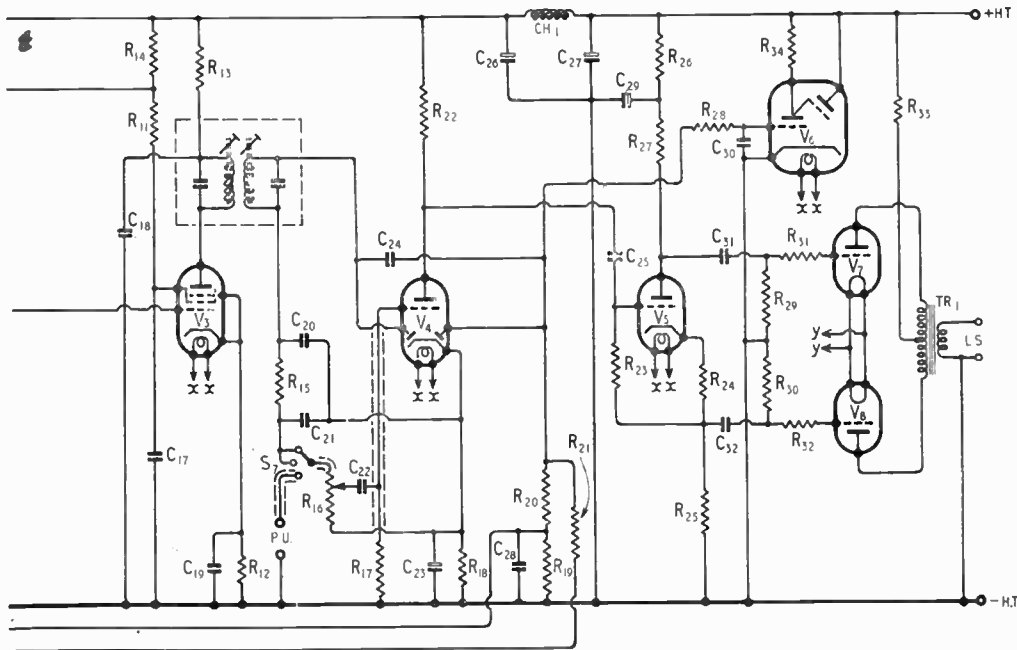

the coil primaries, and the grid capacitor and leak are respectively C_{14} and R_9 . The medium-wave padding capacitor P_1 and the long-wave padding capacitor P_2 are connected at the dead ends of the coil secondaries to avoid an increase in circuit minimum capacitance and also to ensure that their moving plates are at chassis potential. R_{10} is the anode load of the oscillator, and maintains the anode at about 105 volts. The oscillation ampli-

waves, the central position being MEDIUM waves, with the third position as GRAM. In this third position it should be noted that the aerial and signal grids of the R.F. and mixer valves are earthed, but that the anode of the former valve and the oscillator circuit connections are still virtually switched as for the medium waveband. This is arranged so that no changes occur in the normal operating conditions of the

screen voltage via R_{11} . A.G.C. voltage is obtained through the secondary winding of the I.F. transformer.

The second I.F. transformer is similar to the first, and the anode circuit of V_3 is decoupled in this case by R_{13} and C_{18} . The output of the secondary tuned winding is applied directly to the signal diode of V_4 , and also through C_{24} to the A.G.C. diode of the same valve. R_{15} , C_{20} and

Quality Superheterodyne—

C₂₁ form an I.F. filter circuit, and the diode load proper, consisting of the receiver volume control R₁₆, completes the signal-diode circuit back to the valve cathode. A part of the A.F. voltage available across R₁₆ is tapped off by the slider of the control and applied through C₂₂ and R₁₇ to the grid of the triode section of the valve, where normal A.F. amplification takes place. R₁₇ has a value of 2 MΩ so that the shunting effect on R₁₆ is small.

The value of C₂₄, the A.G.C. coupling capacitor is quite small (30 pF) since a larger value makes it difficult to peak the secondary of the I.F. transformer due to the damping of the tuned circuit. The A.G.C. diode load consists of R₁₉ and R₂₀ in series, a total value of 1.47 MΩ, and full A.G.C. is applied via R₂₁, R₄ and R₅ to the R.F. and F.C. control grids, C₁₅ providing decoupling. About two-thirds of the total A.G.C. voltage available (that developed across R₁₉) is applied to the I.F. amplifier through the I.F. transformer and reduces the possibility of harmonic distortion arising in this stage. Since the diode load is returned to chassis, a small delay voltage equal to that developed across R₁₈ is present upon the A.G.C. diode and A.G.C. is, therefore, inoperative on very

weak signals. The voltage across R₁₈, which is about 1.3 volts, is also bias for the valve triode section since the leak R₁₇ is returned to chassis. It is by-passed

COMPONENT VALUES	
C ₁ = 500 pF.	R ₁₅ = 91 kΩ
C ₂ , C ₉ , C ₁₃ = 3 ganged 500 pF tuning.	R ₁₆ = 0.5 MΩ; Vol. control (with switch)
C ₃ , C ₄ , C ₆ , C ₇ , C ₈ , C ₁₀ , C ₁₁ , C ₁₂ , C ₁₇ .	R ₁₇ = 2 MΩ
C ₁₈ , C ₁₉ , C ₃₁ , C ₃₂ = 0.1 μF.	R ₁₈ = 4 kΩ
C ₅ = 4 μF.	R ₁₉ , R ₂₄ = 1 MΩ
C ₁₄ = 50 pF.	R ₂₀ , R ₂₁ = 470 kΩ
C ₁₅ , C ₂₈ , C ₃₀ = 0.05 μF.	R ₂₂ = 220 kΩ
C ₁₆ = 200 pF.	R ₂₃ = 1.5 MΩ
C ₂₀ , C ₂₁ = 100 pF.	R ₂₄ = 1500 Ω
C ₂₂ = 0.006 μF.	R ₂₅ , R ₂₇ = 27 kΩ
C ₂₃ = 25 μF, 25 V wkg.	R ₂₆ = 22 kΩ
C ₂₄ = 30 pF.	R ₂₈ = 330 kΩ
C ₂₅ = 0.01 μF.	R ₃₃ = 350 Ω (5 watt)
C ₂₆ , C ₂₇ , C ₂₉ , C ₃₃ = 8 μF, 450 V wkg.	R ₃₅ = 500 Ω (5 watt)
C ₃₄ = 16 μF, 450 V wkg.	L ₁ , L ₂ , Wearite PA2, PA1
C ₃₅ = 50 μF, 50 V wkg.	L ₃ , L ₄ , Wearite PHF2, PHF1
P ₁ , M.W. Padder, max. 600 pF.	L ₅ , I ₆ , Wearite PO2, PO1
P ₂ , L.W. Padder, max. 250 pF.	Ch ₁ , Ch ₂ ; Suitable A.F. Chokes.
T ₁ , T ₂ , T ₃ , T ₄ = 70 pF; Aer. and R.F. Trimmers.	TR ₁ , Premier Radio, Type M.O.7
T ₅ , T ₆ = 100 pF; Osc. trimmers.	TR ₂ , Premier Radio, Type SP.351 (see text).
R ₁ = 2 kΩ	I.F. Transformers, 465 kc/s, permeability tuned.
R ₂ , R ₇ , R ₁₁ , R ₁₃ , R ₃₁ , R ₃₂ = 10 kΩ	V ₁ , V ₃ = 6K7G
R ₃ = 470 Ω	V ₂ = 6K8G
R ₄ , R ₆ , R ₂₉ , R ₃₀ = 270 kΩ	V ₄ = 6B6G
R ₅ = 5 kΩ	V ₅ = 6C5G
R ₈ = 250 Ω	V ₆ = Y03
R ₉ , R ₁₀ = 47 kΩ	V ₇ , V ₈ = PX4
R ₁₂ = 390 Ω	V ₉ = FW120/350
R ₁₄ = 22 kΩ (2 watt)	

by C₂₃, an electrolytic of 25-μF capacitance. Little need be said about the tuning indicator; the triode control grid is supplied from the A.G.C. diode through R₂₈, and is decoupled by C₃₀. The triode anode load is R₃₁, a resistance of 1 MΩ, and the target is returned directly to the main H.T. supply line.

The output of the triode section of V₄ is developed across R₂₂, and is applied to the phase-splitter

Outputs are taken from the anode and cathode circuits, and are consequently in antiphase, being approximately equal, since R₂₅ = R₂₇. R₂₄ is the anode decoupling resistance, and therefore does not enter into the matter of the anode load, and the small bias voltage developed across R₂₄ (about 3.5 volts) does nothing to upset the normal working of the stage. Some doubts were expressed during the design of this stage as to whether the proposed valve (6C5G) would stand the heater-cathode voltage developed across R₂₅, since one side of the heater has to be earthed to avoid hum. However, after several weeks faultless operation, the valve seems to stand up to the voltage quite successfully, and the performance and reliability have been entirely satisfactory.

The push-pull output circuit is necessary from a quality reproduction point of view, for it cleans out the unpleasant components of distortion present in the single-ended receiver and avoids the necessity for excessive decoupling. Directly heated triodes are used, despite the attractions of tetrodes from the point of view of power efficiency. The use of negative feed-back is

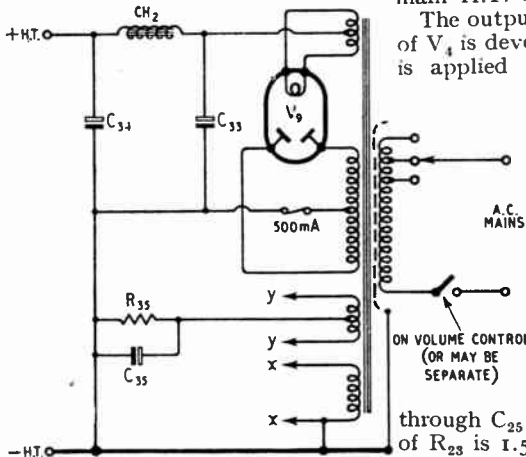

Fig. 2. Circuit diagram of the power unit. A chassis size of 9in x 4in x 2in is suitable for this unit which connects to the main chassis through a cable form.

through C₂₅ and R₂₃. The value of R₂₃ is 1.5 MΩ, but the impedance of the grid circuit is much more than this from the point of view of a voltage appearing between grid and earth. Such a stage is therefore liable to hum pick-up and short grid-lead wiring must be maintained at this point.

nearly always necessary with the latter (which offsets the advantage of a smaller drive), and the effect of a slight speaker mismatch is considerably worse with tetrodes than it is with triodes. In fact, a transformer ratio that is slightly high is preferable with triodes since, while reducing the power output, it actually improves the quality. The output transformer used is a multi-ratio type of generous dimensions and will match to almost any speaker impedance. The anode-to-anode load of PX4 or equivalent valves is 4,000-6,000 Ω , and the undistorted output obtainable is about 8 watts.

Components Employed

The power unit, which is built on a separate chassis, is shown in Fig. 2 and requires little comment. It is quite conventional, the mains transformer delivering 350-0-350 volts at 150 mA, as H.T. plus 6.3 volts at 3 to 4 A for the valve heaters, and 4 volts at 2 to 3 A for the output triodes, with a 4-volt winding for the H.T. rectifier. The heater winding for the output valves is centre-tapped for the inclusion of the bias resistance R_{35} . H.T. smoothing is carried out by C_{33} and C_{34} (8 + 16 μ F) and Ch_2 .

The characteristics of most of the components are given in the list of parts, and few additional notes are necessary. All resistors may be rated half-watt except where the table indicates otherwise, and for the A.G.C. circuits quarter-watt types are quite sufficient. Capacitors, with the exception again of the A.G.C. and cathode by-pass circuits where the voltages developed are negligible, should preferably be rated at 350 to 450 volts D.C. working. The coils are of the Wearite un-screened "P" types, each consisting of a primary and a secondary winding, and are available with tags to accommodate postage-stamp type trimmers directly across the tuned windings. They are Aerial, H.F. Transformer and Oscillator types for an I.F. of 465 kc/s, covering the ranges 200-600 and 800-2,000 metres. In Fig. 3 (b) is shown a skeleton layout of the underside of the main chassis, where it will be seen that the coils are divided

off from each other (in pairs) by aluminium screens, the switch banks being similarly spaced and placed as closely as possible to their respective coil sections.

The output triodes depend upon the valves available. If the 4-volt types (PX4 or equivalents) cannot be obtained, then the 2-volt types may be used. The only alteration in the receiver is then that of the bias resistance R_{35} and the fact that the heater must be rated at 2 V, 4 A. The mains transformer used by the

The first winding is stripped off in practice (it is a simple matter to strip these transformers of iron, and the heater windings are wound on the outside of the bobbin) and a 6.3-volt winding substituted from 18 S.W.G. enamelled wire. The number of turns-per-volt is easily determined when the 4-V winding is removed (it was 3 t.p.v. in the writer's case), and so no difficulty should be experienced in replacing it with a 6.3-V winding. This winding, which need not be centre-tapped,

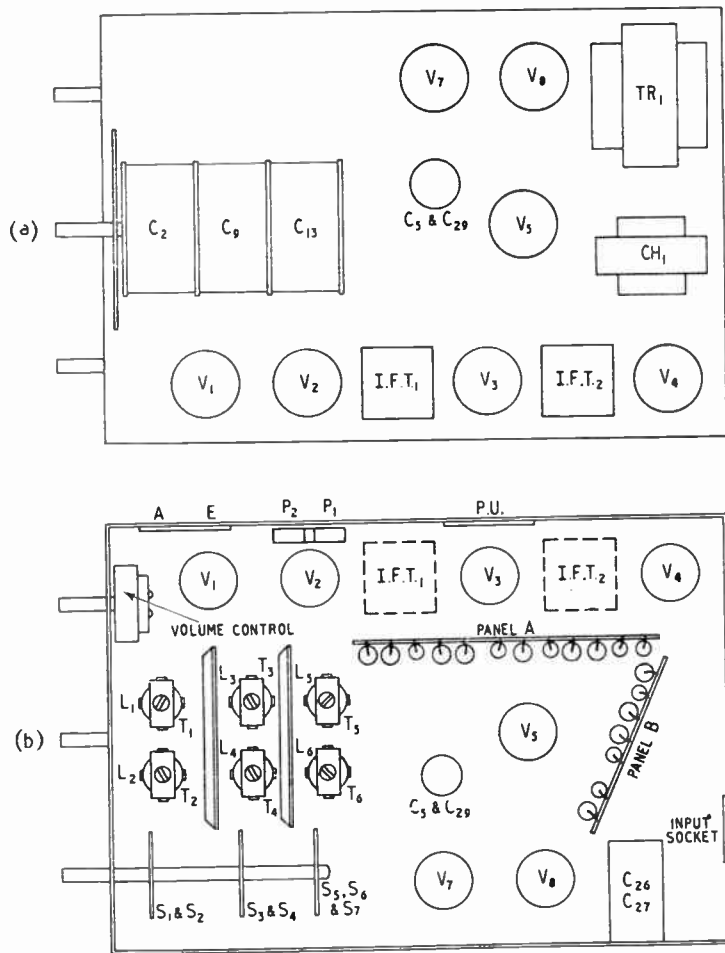

Fig. 3. (a) shows a convenient upper-chassis layout to: the main receiver. (b) shows the under-chassis layout. The panels A and B are ordinary resistance and capacitor tag boards of suitable size and hold all the appropriate resistances and capacitors. Cathode resistors, capacitors, etc. may be wired directly to the valveholders

writer is a Premier type SP 351 which delivers as L.T. 4 V at 1-2 A, 4 V at 2-3 A and 4 V at 3-6 A

then feeds the receiver valves as far as V_6 , the remaining 1 V at 2-3 A serving the rectifier

Quality Superheterodyne—

heater and the 4 V at 3.6 A supplying the output valves. These windings are ready centre-tapped. If 2-V output triodes are used, the latter winding must, of course, be halved and re-centre-tapped during the winding of the 6.3-V heater. It is therefore essential to get the output valves *before* modifying the mains transformer or specially buying one suitable for the purpose.

The output from the power unit is taken through a short cable form to an octal plug which connects to a valveholder socket mounted on the rear of the main chassis. The mains supply is also taken through this point to the switch on the receiver volume control.

Alignment

The trimming of the receiver is fairly critical, but calls for no special skill or apparatus. A good signal generator is recommended for I.F. alignment, but actual signals may be utilized for the aerial, R.F. and oscillator trimming and padding. In accordance with usual practice, the trimming order is: (a), I.F. circuits; (b), medium-wave oscillator, aerial and R.F. trimmers in that order at the high-frequency end of the band; (c), medium-wave padder capacitor at the low-frequency end of the band; (d), long-wave oscillator, aerial and R.F. trimmers in that order at the high-frequency end of the band; (e), long-wave

padder capacitor at the low-frequency end of the band. With a signal generator suitable frequencies for the medium waveband are 1,500 kc/s (200 m) and 600 kc/s (500 m), and for the long waveband, 300 kc/s (1,000 m) and 150 kc/s (2,000 m). With station alignment, the B.B.C. Light on 1,149 kc/s (261 m) and the B.B.C. Third on 583 kc/s (514 m) are suitable for the medium waveband, while the weather-forecast station on 250 kc/s (1,200 m) and the B.B.C. Light on 200 kc/s (1,500 m) are suitable for the long waveband. Each trimming operation should be rechecked as the opposite end of the wave range is adjusted. The tuning indicator makes a useful alignment "tool" for these purposes.

A table of voltages follows taken from the writer's receiver which will assist anyone who duplicates this receiver.

Valve	Anode	Screen	Cathode
V ₁	220	110	4.1
V ₂	Hex. 250 } Osc. 10 }	95	2.6
V ₃	220	100	3.8
V ₄	140	—	1.3
V ₅	40	—	—
V ₆	230	—	3.5
V ₇ ↓ V ₈ ↓	325	—	48.0*
V ₉	350 R.M.S.	—	—

* Across R₁₅ in power unit.

Readings taken with no signal, 1,000 Ω per volt meter, highest ranges in each case.

Barker Model 148 Speaker**Single-diaphragm Wide-range Reproducer**

DESIGNED primarily for high-quality sound reproduction in the home, this permanent-magnet loudspeaker is constructed on the original dual drive principle evolved by A. C. Barker. The main voice coil is coupled mechanically and electrically to a thin metal former which is cemented to the apex of the diaphragm. At low frequencies the system vibrates as a whole, but at high frequencies the metal former acts as a single turn of low inertia and vibrates independently of the comparatively heavy speech coil. A small concave area near the apex, which acts as the high-frequency

radiator, blends into the main diaphragm, which is a 10-inch cone of impregnated woven fabric with concentric corrugations.

The speakers are individually constructed and assembled, and each is subjected to critical aural tests, so that the number available is limited. The price is £15 15s, and enquiries should be addressed to BCM/A.L.D.U., London, W.C.1.

We have had an opportunity of listening to this loudspeaker and the e is little doubt that it ranks in performance with the best reproducers available today. In two respects it is outstandingly good.

namely, the excellent balance at comparatively low levels (below 1 watt), and the homogeneity of its high-frequency response. There is no marked focusing of high frequencies and none of the detached "featheriness" often associated with frequency responses up to 15,000 c/s. In a properly designed baffle the low frequency response is sensibly uniform down to 40c/s with no major bass resonance.

We can fully endorse the maker's claim to have achieved natural quality of reproduction at a volume level suited to the average living room.

Manufacturers' Literature

ILLUSTRATED catalogue of silvered mica condensers from Londex Electrical Manufacturing Co., 459, Fulham Road, London, S.W.10 (available to manufacturers only).

Revised leaflet (MV121) of Mullard Transmitting Valves for Amateur Communications from Mullard Wireless Service Co. (Transmitting and Industrial Valve Dept.), Century House, Shaftesbury Avenue, London, W.C.2.

Descriptive leaflets dealing with rectifiers Type 186A and Type 371A, from Philips Electrical, Century House, Shaftesbury Avenue, London, W.C.2.

Leaflet No. 32 (Insulating Beads) from Steatite and Porcelain Products, Stourport-on-Severn, Worcs.

Instruction sheets MR14 for use of rectifiers for H.T. supply to radio receivers (Supplement 1) and Westectors (Supplement 3); also data sheet No. 42 on "Westalite" rectifiers Types 16K and 16HT, from Westinghouse Brake and Signal Co., 82, York Way, King's Cross, London, N.1.

Leaflet describing the "Derwil" servicing cradle for receiver chassis from the Wilder Instrument Co., 75-81, Tooley Street, London, S.E.1.

Leaflet giving details of the "Reveille" combined clock and radio receiver from Thames Valley Products, 28, Camden Avenue, Feltham, Middlesex.

Illustrated catalogue of mica and ceramic capacitors, hermetic seals, metallized bushes and insulators for radio and electronic equipment, from United Insulator Company, Oakcroft Road, Tolworth, Surbiton, Surrey.

Electrothermal Valve Retainers

IT was stated in our Radiolympia show report that the valve retainers made by Electrothermal consist of moulded rubber and fibre-glass. This is incorrect as the former material is not used, fibre-glass being the main constituent employed.

BELLING-LEE QUIZ (No. 18)

Answers to questions we are often asked by letter and telephone

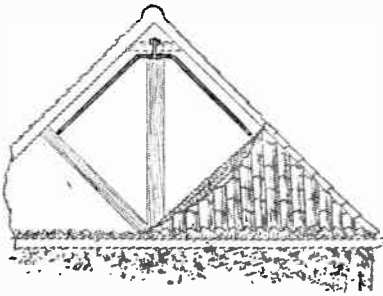

*1 Shows the Belling-Lee inverted "V" television aerial mounted in the attic. L.605 Attic Model sells at £2 7s. 6d.

Question 50. What sort of questions did you have to answer from Visitors to your stand at Radiolympia?

Answer 50. Radio dealers ask this one, and wholesalers want to know what questions the retailers ask. We had a conference—all hands on deck—on the stand on the last Friday of the show before opening time. The greatest number of enquiries related to television aerials, and the forms of interference most commonly associated with the reception of television programmes. This was followed by general questions on interference, and the third group was questions by amateurs. We will deal with them in this order.

Television. The interest in the inverted "V" loft or attic aerial L.605 surprised us all. In this series of questions, most came from people who already had television receivers, but who were situated at the outside edge, or beyond the useful service area of Alexandra Palace. In other words, people who had a weak or unstable picture and who were therefore liable to annoyance from most forms of interference. It really must be appreciated that whereas many liberties may be taken with a strong signal, a weak one requires not only the best possible aerial, but it must be erected with skill and not a little craftsmanship and cunning. Everybody, not only the viewer, must realise that the aerial must be paid for, its erection must be paid for, and generally speaking you don't get much for nothing these days.

Interference. These questions came from people whose enjoyment was spoilt by various kinds of interference. There are still people in the trade who are inclined to shut their eyes to this matter. We wish we could have had time to take names and addresses of enquirers but those who tried to get near our stand will appreciate that this was impossible. Our engineers found themselves "in conference" with four or five at a time, surrounded with interested listeners eager not to miss a word. It must be admitted that many complaints came from those who were using either an indoor aerial or none at all. In most cases, probably the cheapest way out would be the installation of a *2 "Winrod" window mounting aerial L.581. This is not an anti-interference aerial, but any outdoor aerial is better than none, and would be bound to improve the signal to noise ratio. In really bad cases, a "Skyrod" anti-interference aerial might be necessary.



A typical capacitor suppressor L.1118/CT for fitting at the source of interference, e.g., electrical motors, rectifiers, etc., or at the meter board. Price £1 7s. 6d.

When the interference is known to be coming from some appliance or machine under the control of the person complaining, or of a friendly neighbour, the obvious thing to do is to have a suppressor fitted to the appliance. If this is not practicable write to us or report the matter to the nearest post office who will give you form T.466G to fill up, and in due course a specially trained suppression engineer will get in touch with you to investigate the matter

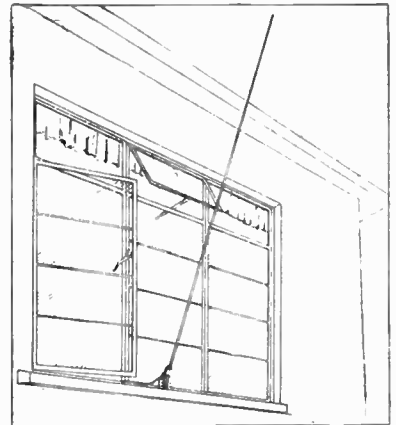

*2 The "Winrod" L.581 is in 3 sections and has a universal bracket providing several fixing arrangements. Price 19s. 6d.

The post office engineers take a very keen interest and are really efficient.

Growing Amateur Interest. The questions from the growing band of amateurs and their interest were most refreshing. Many had already seen our amateurs catalogue P.339 and came to us with queries. Many were complaints of long deliveries of our aerial array. We would like to emphasise that we are all out to help the radio amateur. He requires components of high quality such as were developed for war time radar and communications equipment and today are only applicable to the highest grade electronic equipment—and to the amateur. We are very interested in both.

We had very few enquiries from professional users of components, but most of them already know and use our products. An exhibition like Radiolympia is useful because it brings us in touch with those with whom we have no other contact except by letter—and after all, letters cannot take the place of a visit.

To be continued.

*1 "VIEWROD" (Regd. Trade Mark) television aerials see illustration top left.

*2 "WINROD" (Regd. Trade Mark) see illustration top right.

BELLING & LEE LTD
CAMBRIDGE ARTERIAL ROAD, ENFIELD, MIDD.



FOR FREQUENCY SUB-STANDARDS
 TYPE JCF/200, 100 KC/S
 Available from stock adjusted to $\pm 0.01\%$
 Higher accuracies supplied to special order
 PRICES ON APPLICATION

G.E.C.

QUARTZ CRYSTAL UNITS

FOR STABLE FREQUENCY GENERATION

FEATURES:

Low temperature coefficient—less than 2 in 10^6 per $^{\circ}\text{C}$.
 Patented nodal suspension. Mounted in vacuum;
 performance independent of climatic conditions.
 Exceptionally high Q value. High stability. Small size.
 3in. \times $\frac{5}{8}$ in. overall excluding pins. Fits standard miniature deaf aid valve socket.

V WIREMOUNTING
 BRITISH PATENT NO 576290

The type JCF/200 unit illustrated above is representative of the wide range of vacuum type units available for low and medium frequencies.

SALFORD ELECTRICAL INSTRUMENTS LTD.
 PEEL WORKS SALFORD 3
 Phone: BLA. 6688 (6 lines) Grams & Cables "Sparkless, Manchester"

Proprietors, THE GENERAL ELECTRIC CO. LTD. England.

1817

The Problem

The directional response characteristic of single unit loudspeakers is very pronounced at the higher audio frequencies which are audible only in a comparatively narrow channel directly in front of the reproducer with a corresponding lack of intelligibility and brilliance elsewhere.

This feature is particularly troublesome when high quality sound reproduction is required in public halls, theatres and small cinemas where the size and expense of a large dual channel loudspeaker system is often not justified.

The Solution

It is for such installations that the Vitavox Bitone Reproducer has been designed. High frequency reproduction in this instrument is handled by a small multicellular horn and moving coil pressure unit, this assembly providing adequate coverage and at the same time because of its high efficiency, a rising high note characteristic which is an advantage in auditorium reproduction. A 12" moving coil cone type loudspeaker operating in a vented enclosure reproduces low frequencies and a cross-over filter network is fitted to divide the frequency spectrum correctly between the two units. The whole assembly is mounted in a polished Walnut finished cabinet as standard, Oak and Mahogany veneered models being available to special order, and can be relied upon for applications where quality of performance rather than first cost is the main consideration.

SPECIFICATION AND PRICES

Power Handling Capacity: Model 610—10 watts; Model 620—20 watts. Size: 32" \times 21" \times 20". Terminating Impedance: 7.5 ohms. Filter Attenuation: 12 d.b. per octave. H. F. Distribution (appx): 60° \times 40°.

MODEL 610 — £42 0 0
 MODEL 620 — £50 0 0

VITAVOX LTD., WESTMORELAND ROAD, LONDON, N.W. 9. TEL: COLINDALE 8671-3

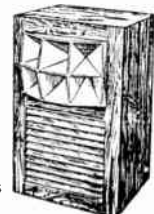

WORLD OF WIRELESS

Radar & D.F. Nomenclature ♦ Amateur Activities ♦ Reception of French Television

TERMINOLOGY

THE need for overhauling our terminology in the field of position-finding by radio was stressed by C. E. Strong, O.B.E., the new chairman of the I.E.E. Radio Section, in his inaugural address.

He suggested that there were two main branches of the tree of which radio is the root and trunk. The first, generally known as radio-communication, and the second, embracing the whole field of direction and range determination by radio, he suggested should be called "radiolocation." Whilst realizing that the term had been used before in a different sense and, too, that it had such "important historical associations," he felt it would be hard to find a more comprehensive one. We would then speak of "communication systems" and "location systems".

Developing still further the idea, Mr. Strong proceeded to sub-divide radiolocation itself so that from the main branch came on the one side all time-sum methods giving range, which he called "range determination," and on the other time-difference methods giving direction, which he called "direction determination." The latter is further divided into "direction giving" and "direction finding." The first would include Gee, Decca, omnirange beacons, overlapping beam course beacons and all systems transmitting azimuth information, while the second would embrace all the counterparts of the above. The branches were then further split into broad-based and narrow-based systems.

TELEVISION—S.B.A. INTERFERENCE

INTERFERENCE from the B.B.C. television sound transmissions with Standard Beam Approach reception in aircraft flying in the London area was reported recently.

The Ministry of Civil Aviation has now issued a notice to airmen (No. 267, 1947) outlining modifications to the marker beacon receiver R1125D which is particularly prone to the interference when using a horizontal aerial. No interference has been experienced with receivers R1125A, R1125B and R1125C when using a dipole aerial.

It is stated that even with the

suggested modifications the television transmissions may still break through in the immediate vicinity of Alexandra Palace.

COMPONENTS EXHIBITION

THE fifth annual private exhibition of components and test gear to be organized by the Radio Component Manufacturers' Federation will be held from March 2nd to 4th in the Great Room, Grosvenor House, Park Lane, London, W.1.

As in former years the exhibition, which is promoted to acquaint equipment manufacturers with the latest developments in the component and instrument section of the industry, will be open to visitors by invitation only.

EUROPEAN DX CONTEST

AN All-European DX contest has been arranged by the Netherlands amateur radio society (V.E.R.O.N.). During the contest, European stations will attempt to work as many different countries outside Europe, whilst amateurs in the other continents will endeavour to work European stations.

The telegraphy contest will be held from 1801 G.M.T. on November 28th to 2359 G.M.T. on November 30th, and the telephony contest during the same hours from December 12th to 14th. Full details and the rules for the contests are given in the October R.S.G.B. Bulletin.

Logs must be sent to the QSL Bureau, V.E.R.O.N., Post Office Box 400, Rotterdam, Holland, on or before December 31st.

AMATEURS AND THE INDUSTRY

THE principal guest and speaker at the October luncheon of the above Radio Industries Club was John Clarricoats, general secretary of the R.S.G.B. After a brief outline of amateur history and achievements he spoke of the pressing need for valves, components, sets and accessories for use on the wide range of frequencies allocated to amateurs at Atlantic City.

He estimated the present strength of the amateur movement in the British Isles at about 10,000 and that this represented a potential home market of at least £250,000 per annum. In addition, he pointed out that there is a considerable export market awaiting the right type of equipment.

FRENCH TELEVISION

THE suggestion that an attempt might shortly be made to link the British and French television services for an interchange of programmes lends added interest to an account of an R.A.F. wartime intelligence activity which has just come to light.

As a result of information received through Intelligence sources a television receiving centre was set up to intercept transmissions from Paris during the German occupation. Wing Cdr. G. T. Kelsey, O.B.E., who is now with E.M.I., secured two of the company's television sets and, with a curtain array consisting of 32 dipoles slung between two 150ft masts, successfully received the transmissions which were monitored

for two years. The special aerial was found to be necessary to eliminate the powerful signals from the nearby radar stations.

The transmissions, usually news reels of bomb damage in France, provided useful

PARIS interval signal received at Beachy Head—a distance of 180 miles—during the German occupation of France.



World of Wireless—

information on the success of R.A.F. raids.

RADIO AIDS TO NAVIGATION

A BROCHURE containing short technical descriptions of all the radio aids to civil aviation demonstrated by the Research and Development Establishments of the Ministry of Supply during last year's international conference has been issued by H.M. Stationery Office. Entitled "P.I.C.A.O. Demonstration of Radio Aids to Civil Aviation, September 1946," it is priced 5s

A complete set of the technical papers read before the London conference is available in three volumes entitled "P.I.C.A.O. Demonstrations—Technical Papers on Equipment and Systems." Price £4 4s the set. Individual papers, obtainable at 1s 6d each, or the bound volumes are available from the C.E.R.C.A. Central Office, Room 211, Ministry of Civil Aviation, Ariel House, Strand, W.C.2.

E.I.B.A.

THE annual report of the Electrical Industries Benevolent Association, which helps radio as well as electrical non-manual workers in times of misfortune, records that the number of cases dealt with last year (253) showed an increase of 25 per cent on the previous year.

The amount paid out to members of the radio industry last year was over £2,000. The income from the radio industry was, however, less than 25 per cent of that amount.

One regular source of income is from the collections taken at the Radio Industries Club luncheons, which last year amounted to £189. The proceeds (£218) from the Radio Industries Ball, held at the Royal Albert Hall during the Olympia show, were devoted to the E.I.B.A.

PERSONALITIES

Sir Ernest Fisk, managing director of E.M.I., Ltd., was elected president of the International Federation of the Phonographic Industry at the recent annual general meeting in Brussels attended by the representatives of twelve countries, including the U.S. and Germany.

C. R. Denny has resigned from the chairmanship of the U.S. Federal Communications Commission which he has held for the past three years. He served as chairman of the International Telecommunications Conferences, Atlantic City, during the four and a half months' duration of the three conferences which ended on October 2nd. He

is to become vice-president of the National Broadcasting Company.

F. T. Cotton, chief valve engineer of the Cossor valve and cathode-ray tube subsidiary, Electronic Tubes, Ltd., High Wycombe, has resigned to take up the position of head of the physics laboratory of Ekco-Ensign Electric, Ltd., the electric lamp subsidiary of E. K. Cole. He joined the Cossor organization in 1932.

Dr. Hilary Moss is assuming responsibility for the research and development engineering division of Electronic Tubes, Ltd.

B. N. MacLarty, O.B.E., M.I.E.E., head of the B.B.C. Design and Installation Dept., who has been with the corporation since 1926, has resigned to become a deputy engineer-in-chief of Marconi's W.I. Co. He was one of the band of Marconi engineers who started the broadcast transmissions from station 2MT at Writtle in 1922. He appears (standing left) in the photograph on page 456.

WHAT THEY SAY

Unanimous.—"I am pleased to be able to advise you that we feel that all three conferences [at Atlantic City] were successful and that the new International Telecommunications Treaty and the new International Radio Regulations, both of which were signed by all of the 78 countries participating in the conferences, are satisfactory in



working without exhausting the tube and without any loss of resonance than by using the arrangement in my registering apparatus."

From the foregoing remarks may be inferred that the arrangement of Marconi's receiver is a reproduction of my lightning recorder.—Yours, &c., A. Popoff.

Torpedo School, Cronstadt, Russia, Nov. 26, 1897.

Alexander Stepanovich Popov (born 1859, died 1906) with a facsimile of his claim made in a letter to *The Electrician* exactly 50 years ago. The significance of his early work is discussed in our leading article. The portrait is from an engraving issued by l'Union Internationale des Télécommunications.

every respect."—Charles R. Denny, chairman of the International Telecommunications Conferences, reporting to President Truman.

OBITUARY

We regret to record the deaths of:—
W. Densham, one of the small group of technicians which assisted Marconi during his early experiments in this country. He joined the Marconi Co. in 1899 and took part in the pioneer work in the Isle of Wight, at Poldhu, Clidden and in the U.S.A. He held technical and administrative posts in the company and retired in 1939, but returned for three years during the war. He was 70.

F. S. Hayburn, at the age of 69, He joined the Marconi International Marine Communication Co. in 1904 and became managing director in 1933. Two years later he relinquished that position in order to become foreign envoy for the Marconi group of companies. He retired in 1944.

Air Comdre. H. Leedham, C.B., O.B.E., managing director of Ericsson Telephones, Ltd. From 1929 until 1935 he was head of the Radio Division, Royal Aircraft Establishment. During the war he was successively director of radio production and director of radio research and development at the Ministry of Aircraft Production. He joined Ericsson's in September, 1945.

IN BRIEF

Nearly 11,000,000 broadcast receiving licences were in force in Gt. Britain and Northern Ireland at the end of September. 25,050 of the 10,950,650 licences were for television receivers.

Servicing Certificate.—Of the 65 entrants for the Radio Servicing Certificate Examination held in May, 41 passed in both written and practical sections. This examination was the first to be held jointly under the auspices of the Radio Trade's Examination Board and the City and Guilds of London Institute.

International Broadcasting.—According to a survey by the American State Department Great Britain leads the list of 55 nations as the biggest user of international short-wave broadcasting. The survey shows that at the end of last year the percentages of the world's international broadcasts used by the U.K., U.S., Russia and France were 16.56, 9.21, 6.09 and 3.83, respectively.

I.S.M.—A typographical error appeared in our summary of the Atlantic City frequency allocations in last month's issue. The last of the frequencies allocated to industrial, scientific and medical equipment should have been 5.850 Mc/s. This frequency, which comes at the top end of a new amateur band, will be used with a tolerance of ± 0.6 per cent.

School Broadcasting.—The Central Council for School Broadcasting has

been dissolved and a new body, the School Broadcasting Council for the United Kingdom, formed. Similar councils have also been formed in Scotland and Wales to guide the B.B.C. in undertaking broadcasts to schools. In an endeavour to raise the standard of reception in schools the Council is giving advice to local education authorities. It is of interest to recall that the recent McNair Committee's report on education stressed the need for teachers to be trained in the use of broadcast equipment in schools.

Poland.—A change of wavelength has been notified by the Polish broadcasting authorities. Warsaw II, which, since reopening last December, has been temporarily operating in the medium waveband, has returned to its pre-war wavelength of 1339.3 metres. Its power is 10 kW. Warsaw I is operating on 395.8 metres with a power of 50 kW.

Telecommunications Courses.—A syllabus of courses and examinations in telecommunications and electrical subjects has been issued by the City and Guilds of London Institute for the 1947-48 session. The courses include telecommunications engineering, electrical installation work, electrical engineering practice and radio service work. Details are also given of the final examination in radio service work, conducted jointly by City and Guilds and the Radio Trade's Examination Board, for the Radio Servicing Certificate.

Jamaican Broadcasting.—It has been decided by the Jamaican Government to discontinue broadcasting from its own transmitter in Kingston and to invite applications for private broadcasting under licence. Cable and Wireless has intimated that the company would be willing to provide the technical facilities but is not prepared to undertake the programme side.

International Television.—A meeting of television technicians of various countries was held at Cannes in September as part of the Comité International pour la Diffusion Artistique, Littéraire et Scientifique par la Cinéma. The British representative was A. G. D. West, past president of the British Kinetograph Society. The opportunity was taken to form a Comité International de Television (C.I.T.), with R. Barthelemy (France), Dr. A. Castellani (Italy), Professor F. Fischer (Switzerland), and A. G. D. West (Great Britain) as founder members.

Wire-to-Disc Transcriptions.—Equipment for the production of personal disc recordings installed by Modern Messages, Ltd., at their recently opened studio at 9, Piccadilly Arcade, London, S.W.1, includes wire recording apparatus for preliminary rehearsal. High-quality transcriptions from wire to disc afford the opportunity of selecting the optimum performance and effect considerable economies in recording materials.

Technical Literature Wanted.—Language classes in technical and scientific English are being started in Sweden; F. P. Thomson, A.M.Brit.I.R.E., has been appointed by the Stockholm educational



BELGIAN TELEVISION.—A Pye mobile television station recently toured Belgium. The only failures throughout the 500-mile tour, during which the station operated for 150 hours, were two miniature valves

authorities to arrange lectures and classes in polytechnics, clubs, etc. Mr. Thomson, whose address is Box 846, Stockholm 1, Sweden, is in urgent need of manufacturers' literature containing illustrations of modern electronic equipment as a help in explaining war-coined expressions or idioms which are quite unfamiliar to Swedish students.

Amateur Prefixes are given in alphabetical order on a card measuring 8½ x 10½ in published at sixpence by K. Martin and Co., Bridge Street, Work-sop, Notts.

B.W.I. Transmissions.—The Trinidad Broadcasting Company has arranged two special amateur transmissions from its short-wave station VP4RD. "Radio Trinidad," working on 9.625 Mc/s with a power of 500 watts, will radiate these programmes on November 30th from 1000 to 1100 G.M.T. and on December 1st from 0830 to 0930 G.M.T. Reception reports will be welcome by the Trinidad Broadcasting Co., Ltd., Broadcasting House, Port-of-Spain, Trinidad, B.W.I.

I.S.W.C. Broadcasts.—Details of the special short-wave transmissions from overseas broadcasting stations for amateurs, arranged by the International Short-Wave Club, are given in the club's duplicated four-page monthly news-sheet, "International Short-Wave Radio," issued from its headquarters, 100, Adams Gardens Estate, London, S.E.16.

Amateur F.M.—Australian amateurs have been granted permission to employ frequency modulation for transmissions between 27.185 and 27.455 Mc/s, on 50 Mc/s and above. Pulse transmission is permitted on, and above, 166 Mc/s.

R.S.G.B. Officers.—The following members have been nominated for election at the annual general meeting of the Radio Society of Great Britain to be held on December 19th: V. M.

Desmond (G5VM), president, and W. A. Scarr, M.A. (G2WS), executive vice-president.

B.I.O.S. now T.I.D.U.—Enquiries about reports in the B.I.O.S. series have in the past been made to the British Intelligence Objectives Sub-Committee, 32-37, Bryanston Square, London, W.1, and applications to examine the original documents made to Documents Unit, Board of Trade, Lansdowne House, Berkeley Square, London, W.1. These two units have been merged and are now known as the Technical Information and Documents Unit, German Division, Board of Trade, 40, Cadogan Square, London, S.W.1.

American Production.—According to figures given at the New York meeting of the U.S. Radio Manufacturers' Association the estimated production of broadcast and television receivers during 1948 will be between 13,000,000 and 15,000,000.

U.S. Radio Week.—America's third annual National Radio Week, which ended on November 1st, brought to a close the year's campaign organized by the U.S. Radio Manufacturers' Association to increase receiver sales, for which the slogan was "Radio in Every Room".

I.P.R.E.—At the first annual dinner of the Institute of Practical Radio Engineers, it was stated that there were now 800 members and 900 students. The raising of the standard and status of service technicians was given as one of the primary aims of the institute.

INDUSTRIAL NEWS

"**Cossor Courier**," the dealer journal of A. C. Cossor, Ltd., has reappeared after a break of over nine years. The first issue, dated Autumn, includes, in addition to details of the 1947-48 range of receivers, some interesting figures on Cossor's wartime production.

Decca.—A new publication, *Music*, has been produced by the Decca Record Co., and will be issued quarterly, price 2s. Its scope will not be confined to recorded music, but is intended to "bridge the gap between the essentially academic type of review and the 'popular' music paper".

"**Marconi Mariner**" is the title of a new journal to be published bi-monthly by the Marconi International Marine Communication Co. The first issue, July-August, of this purely staff journal includes details of Seamew and Seagraph equipment.

Multicore distributors in New York have ordered five tons of Ersin Multicore solder—sufficient for 100,000,000 joints.

CLUBS

Battersea.—The London Short-Wave Club now meets on Fridays at 8.0 at "The Crown," Battersea Park Road, London, S.W.11. It is affiliated to the International Short-Wave Club, the secretary of which is A. E. Bear, 100, Adams Gardens Estate, London, S.E.16.

World of Wireless—

Birkenhead.—The December meetings of the Wirral Amateur Radio Society will be held on the 3rd and 17th at 7.30 at the Y.M.C.A., Whetstone Lane, Birkenhead. Sec.: B. O'Brien, G2AMV, 26, Coombe Road, Irby, Heswall, Cheshire.

Birmingham.—The annual general meeting of Slade Radio will be held on November 28th at the Parochial Hall, Broomfield Road, Erdington. On December 12th the club will hold a D.F. contest. Sec.: C. N. Smart, 110, Woolmore Road, Erdington, Birmingham, 23, Warwick.

Birmingham.—Having obtained premises at 220, Moseley Road, Birmingham, 12, the Birmingham and District Short-Wave Society now meets on alternate Thursdays for practical work, in addition to the monthly meeting at the Hope and Anchor Hotel, Edmund Street, Birmingham. Sec.: N. Shirley, 14, Manor Road, Stechford, Birmingham, 9, Warwick.

Bradford.—A discussion on "who should be the members of the R.S.G.B." will be held by the Bradford Amateur Radio Society on December 9th at 7.30 at Cambridge House, Horton Lane, Bradford. A social evening is proposed for December 23rd. Sec.: W. S. Sykes, G2DJS, 287, Poplar Grove, Great Horton, Bradford, Yorks.

Brighton.—The December meetings of the Brighton and Hove Group of the R.S.G.B. will be held on the 1st and 15th at 7.30 at the Golden Cross Hotel, Western Road, Brighton, Sussex. Town Representative: J. R. D. Sainsbury, GSHV, 80, Lansdowne Place, Hove, Sussex.

Eastbourne.—The recently formed Eastbourne and District Group of the R.S.G.B. meets on the first Friday in the month at the Friends' Meeting House, Wish Road, Eastbourne. Sec.: R. F. Nugent, G3FTS, 12, St Anthony's Avenue, Eastbourne, Sussex.

Grimsby.—The Grimsby Amateur Radio Society has been granted a 150-watt licence (G3CNN) for its transmitter—a T1131. Meetings are held each Thursday at 7.45 at 115, Garden Street, Grimsby, Lincs. Sec.: R. F. Borrill, G3TZ, address as above.

Harrogate.—Premises have been obtained at the rear of 31, Park Parade, and the Harrogate and District Short-wave Radio Society now meets there every Wednesday at 7.30. Sec.: K. B. Moore, 2a, Wayside Crescent, Harrogate, Yorks.

Kentish Town.—The St. Pancras Radio Society now meets on Mondays and Thursdays at 7.0 at the L.C.C. Evening Institute, Holmes Road, Kentish Town, London, N.W.5. A third evening is being arranged for beginners. Sec.: H. Brown, 84, Blenheim Gardens, Willesden Green, London N.W.2

Leicester.—The subjects of the lectures at the December meetings of the Leicester Radio Society are: "Army Radar" (2nd) and "Dielectric Characteristics and their Importance" (16th)

Meetings are normally held at 7.30 at the Charles Street United Baptist Church, but that on December 2nd will be at the Drill Hall, Ulverscroft Road, in order that the radar equipment may be inspected. Sec.: O. D. Knight, 16, Berners Street, Leicester.

Romford.—Meetings of the Romford and District Amateur Radio Society are now held on Tuesdays at 8.0 at the Y.M.C.A., Western Road, Romford. Sec.: R. C. E. Beardow, G3FT, 3, Geneva Gardens, Chadwell Heath, Essex.

Sutton and Cheam.—Meetings of the Sutton and Cheam Radio Society are held on the first and third Tuesdays of the month at Ye Olde Red Lion, Cheam Village. Sec.: R. G. Finch, 26, Sunnymede Avenue, Carshalton Beeches, Surrey.

Walworth.—A radio club has been formed by the Walworth Men's Institute and meets at the Avenue School, John Ruskin Street, London, S.E.5, on Wednesdays and Fridays at 7.0. Sec.: P. Senchal, 92, Grove Park Road, Camberwell, London, S.E.5.

West Bromwich.—A series of talks covering many aspects of amateur radio has been arranged for the coming meetings of the West Bromwich and District Radio Society which are held on alternate Mondays at 7.30 at the Gough Arms Hotel, Jowett's Lane, West Bromwich. Sec.: R. G. Cousens, G3BCS, 38, Collins Road, Wednesbury, Staffs.

Wolverhampton.—Details of the winter's programme arranged by the Wolverhampton Amateur Radio Society, which meets on alternate Mondays, are obtainable from the secretary, H. Porter, G2YM, 221, Park Lane, Wolverhampton.



MURPHY RADIO is continuing the development of Service equipment. The latest Army set to be made is this WS31, a F.M. transmitter-receiver operating in the extra high-frequency band.

MEETINGS

Institution of Electrical Engineers

Ordinary Meeting.—"Speech Communication under Conditions of Deafness or Loud Noise," by W. G. Radley, C.B.E., Ph.D. (Eng.), on December 4th. (Joint meeting with the Physical Society.)

Radio Section.—"The Design and Operation of High-power Broadcast Transmitter Units with Their Outputs Combined in Parallel," by T. C. Macnamara, A. B. Howe, M.Sc., and P. A. T. Bevan, B.Sc., on December 3rd.

Informal lecture on "Commercial Disc Recording and Processing," by B. E. G. Mittell, on December 9th.

The above meetings will be held at 5.30 at Savoy Place, London, W.C.2.

Cambridge Radio Group.—"Industrial Applications of Electronic Techniques," by H. A. Thomas, D.Sc., on December 2nd, at 6.0, at the Cambridge-shire Technical College.

"New Possibilities in Speech Transmission," by D. Gabor, Dr. Ing., on December 16th at 8.15 at the Cavendish Laboratory

North-Western Measurements Group.—"The Design and Construction of a New Electron Microscope," by M. E. Haine, B.Sc., on December 16th, at 6.0, at the Engineers' Club, Albert Square, Manchester.

Rugby Sub-Centre.—"New Possibilities in Speech Transmission," by D. Gabor, Dr. Ing., on December 8th, at 6.45, at the Rugby Corporation Electricity Showrooms.

Radio Society of Great Britain

Annual general meeting on December 19th at 6.30 at the I.E.E., Savoy Place, London, W.C.2.

Institute of Physics

"The Travelling-Wave Tube," by R. Kompfner, on December 17th at 5.30 in the Rooms of the Royal Society, Burlington House, Piccadilly, London, W.1.

Institution of Electronics

North-West Branch.—"The Electron and other Constituents of Matter," by Prof. R. E. Peierls, F.R.S., on December 12th, at 6.30, at the Reynolds Hall, College of Technology, Manchester. Non-members may obtain tickets from L. F. Berry, 105, Birch Avenue, Chadlington, Lancs.

British Sound Recording Association

"Factors in the Reproduction of Gramophone Records," by W. J. Lloyd, B.Sc., on December 19th at 7.0 at the Royal Society of Arts, John Adam Street, London, W.C.2.

British Kinematograph Society

Manchester Section.—"Electronics in Industry," by J. Baggs on December 2nd, at 10.30, at the Manchester Geographical Society, 16, St. Mary's Parsonage, Manchester.

Television Society

"Impressions of American Television," by T. M. C. Lance, on November 28th at 6.0 at the I.E.E., Savoy Place, London, W.C.2.

Virtually Distortionless

A.D/47 AMPLIFIER

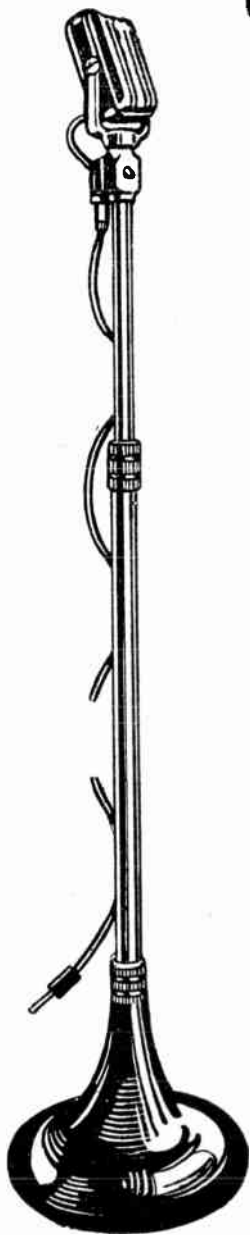

This is a 10-valve amplifier for recording and play-back purposes for which we claim an overall distortion of only 0.01 per cent., as measured on a distortion factor meter at middle frequencies for a 10-watt output

The internal noise and amplitude distortion are thus negligible and the response is flat plus or minus nothing from 50 to 20,000 c/s and a maximum of .5 db down at 20 c/s.

A triple-screened input transformer for $7\frac{1}{2}$ to 15 ohms is provided and the amplifier is push-pull throughout, terminating in cathode-follower triodes with additional feedback. The input needed for 15 watts output is only 0.7 millivolt on microphone and 7 millivolts on gramophone. The output transformer can be switched from 15 ohms to 2,000 ohms, for recording purposes, the measured damping factor being 40 times in each case.

Built-in switched record compensation networks are provided for each listening level on the front panel, together with overload indicator switch, scratch compensation control and fuse. All inputs and outputs are at the rear of the chassis.

Send for full details of Amplifier type AD/47

Vortexion
LIMITED

257/261, THE BROADWAY,
WIMBLEDON, LONDON,
S.W.19.

Telephones . LIBerty 2814 and 6242/4.
Telegrams : "VORTEXION. WIMBLE. LONDON."

The Polyphonic Electrogram



For record connoisseurs, the world over, we have the pleasure to announce the Polyphonic Electrogram, incorporating the Phase Inverter Speaker and a specially designed six valve paraphrase push-pull Amplifier with triode output and negative feedback, together with individually controlled tone compensating channels via electronic mixing giving up to 26db Bass Lift., 15db Treble Lift from linear response, as required. Control without raising the lid via finger tip instrument panel; this instrument compares favourably with anything on the market, regardless of cost, and is provided with ample space for a high fidelity Radio Feeder Unit.

PRICE: Non-Automatic model .. £65 plus P.T.
Automatic model £80 plus P.T.

AGENTS. Barnes & Avis, Reading; Bowers & Wilkins, Worthing; Binns Ltd., Newcastle; Dalton & Sons Ltd., Derby; Clark & Sons, Isle of Wight; C. C. Gerry, Newquay; Hickie & Hickie Ltd., Reading (and branches); Thomas Lynn & Sons, Andover; Merriotts Ltd., Bristol; Needham Engineering Ltd., Sheffield; Pank's Radio, Norwich; Sound Ltd., Cardiff; Bernhard Smith, Barnstaple; Sound Services, Jersey, C.I.; Precision Services, Edinburgh; Seals Ltd., Southsea; G. E. Samways, Hazel Grove; Weybridge Radio Electric, Weybridge; West End Radio, Farnham; Vallance & Davidson Ltd., Leeds (and Branches).

Sound Sales Ltd.

57, St. Martin's Lane, W.C.2

(Temple Bar 4284)

Works: Farnham, Surrey (Farnham 6461/2/3).

E.M.I. training for careers in

ELECTRONICS

There is increasing scope for ambitious men and women in the new fields opened up by Electronic Science. The Correspondence and College Courses provided by E.M.I. Institutes which cover recognised diplomas such as the City and Guilds, etc. are written and supervised by E.M.I. * scientists who are specialists in Electronic Science.

Courses are already available in such subjects as Basic Radio, Basic Television, etc., and the prospectus is being constantly extended.

E.M.I. basic training fits you for entry to CAREERS in such fields as:—SERVICE ENGINEERING, OPERATING, DESIGN AND DEVELOPMENT, TECHNICAL SALESMANSHIP, TEACHING, etc. With this basic training you can eventually become a specialist in Television, Radio Communications, Radar, Navigational Aids, Audio Frequency, Medical and various Electronic applications. There are also short courses for Executives, Amateurs, Students, etc.

For full details apply to your local "H.M.V." Radio dealer or direct to:—

The Principal: PROFESSOR H. F. TREWMAN, M.A. (Cantab), M.I.E.E., M.I.Mech.E., M.Brit. I.R.E.

E.M.I. INSTITUTES LTD

Dept. 16, 43, Grove Park Road, Chiswick, London, W.4

* The E.M.I. Group includes "H.M.V.", Marconiphone and other important electronic interests.

Television Receiver

Construction

DETAILS of all units comprising the television receiver have now been given, including those of the framework which carries them and links them with the C.R. tube, deflector and focus coils into a complete receiver. To conclude the description it remains only to describe the operation of the set as a whole and to deal with a few points which have arisen out of enquiries made by readers.

Of these last probably the commonest relates to the use of cathode-ray tubes other than the Mullard MW22-7. Some notes on this were given in Part 6, but there is a demand for some amplification of them. The MW22-7 has a tetrode gun and the heater is rated for 6.3 V and is run from the same heater winding as the other valves. The heater is thus earthed and as the V.F. signal is fed to the cathode of the tube the cathode is considerably positive with respect to the heater. Most other tubes have a triode gun. This occasions no difficulty, for it leads merely to the omission of a connection between +H.T.₂ and a tube electrode. Most other tubes have a heater rated for a voltage other than 6.3 V, usually 2 V. This again causes no difficulty for

10.—Operating Notes and Conclusion

nections to a low-voltage tube, since much less voltage drop in the leads is permissible. The MW22-7, for instance, takes 0.6 A at 6.3 V, and if a drop of 5 per cent in heater voltage is permissible, a resistance of 0.525 Ω can be allowed in the wiring. A 2-V tube may take 2 A heater current and the resistance for the same percentage drop must be no more than 0.05 Ω. The conductors used in the heater connections all the way back to the transformer must be of ten times the cross-sectional area in the case of these low-voltage tubes.

The next point arises out of the permissible heater-cathode voltage rating of the tube. With the connections given in the earlier description the heater-cathode voltage has a maximum of about 130 V. Some tubes are not rated for as much as this. When this is so, cathode feed can

rated for a voltage other than 6.3 V the separate winding is needed in any case. The floating-heater circuit is a simple way out of the difficulty and in no case in which the writer has tried it has it led to any undesirable effects.

There are a few tubes, notably pre-war ones, in which heater and cathode are joined internally. With these it is necessary to feed the signal to the grid. This entails the use of a phase-reversing stage and, of course, there must be a separate heater winding for the tube.

The phase-reverser, shown in Fig. 1, is an anode follower giving phase reversal and a gain of about unity. The direct connection to the grid of the tube is reasonably safe because of the use of the potential-divider output which limits the amount by which the grid can be carried positive in the event of a valve failure.

With this arrangement R_{23} , R_{21} and C_{21} of Fig. 1, Part 7, are no longer necessary, but their retention does no harm. If they are omitted L_5 must be joined directly to the anode of V_6 .

The "V.F. Output" socket is, of course, connected as usual through C_1 of Fig. 1, Part 6, to the frame time-base "Sync" socket.

Some alteration is needed to the wiring of the Brightness control. The leads to the two ends of R_1 , Fig. 1, Part 6, must be reversed, and its slider and C_5 must be taken to the cathode of the tube instead of to the grid. Resistor R_1 should be joined from grid to -H.T. instead of from cathode to +H.T.

These modified connections for a tube having heater and cathode joined internally can be used, of course, with any tube, but when heater and cathode are not joined it is much simpler to adopt cathode feed.

When all units are completed

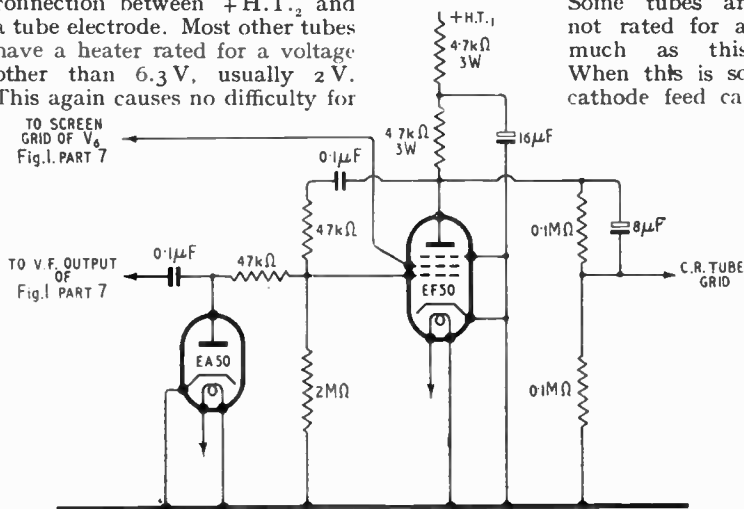

Fig. 1. Circuit diagram of anode-follower phase reverser for use with a C.R. tube having heater and cathode joined internally.

it can be met by providing an appropriately rated winding on the mains transformer.

It should be pointed out, however, that it is necessary to use heavy leads for the heater con-

nections to a low-voltage tube, since much less voltage drop in the leads is permissible. The MW22-7, for instance, takes 0.6 A at 6.3 V, and if a drop of 5 per cent in heater voltage is permissible, a resistance of 0.525 Ω can be allowed in the wiring. A 2-V tube may take 2 A heater current and the resistance for the same percentage drop must be no more than 0.05 Ω. The conductors used in the heater connections all the way back to the transformer must be of ten times the cross-sectional area in the case of these low-voltage tubes.

Television Receiver Construction— and connected together the time comes to receive a picture. If it is at all possible the individual units should be tested independently to make sure that there is nothing seriously wrong with any one. If the whole equipment is put into operation at once in an untried form the location of any fault may prove quite troublesome.

Start off with Brightness, Contrast and Picture Width turned right down (fully anti-clockwise); switch on and give the valves time to warm up. Turn up Picture Width gently until the time base is heard to sing quietly. Turn up the Brightness until the raster just appears. Now adjust Height and Width so that it is roughly of the right size and Focus for maximum line sharpness.

Adjustments

It is assumed that the receiver has previously been aligned with a signal generator, so the signal should appear when Contrast is turned up. It will probably be a confused jumble of black and white marks. Adjust Line Hold so that the line time base locks in. A recognizable picture should now be found but probably moving more or less rapidly vertically. Also the "singing" of the line-scan transformer will change from

a rough and ragged note to a clean one of lower intensity and probably higher pitch.

Incidentally, this note sounds very like an inter-station heterodyne whistle and it is extremely difficult to make it completely inaudible. It comes from the mechanical vibration of the line-scan transformer and can be reduced by putting the transformer into a heavy box packed with sound-absorbent material. Care must be taken to preserve insulation, however. The whistle is, of course, greatly reduced when the equipment is housed in a cabinet and these remarks about its audibility apply to the use of the set without a cabinet.

The next step is to adjust Frame Hold and the picture should then lock in and be seen as a complete steady picture. Now adjust Height, Width and Line Linearity for the proper picture size and for an even horizontal scan. Focus will probably need readjustment from time to time during this process.

When approximately right, turn down Contrast and adjust Brightness so that the raster is just not visible. Turn up Contrast so that the picture appears. It will now be found that the frame fly-back lines show in dark parts of the picture; therefore, turn down Brightness until they just disappear. Contrast must then be increased somewhat and Brightness turned down a little more. This is continued until the best picture is secured. Some Focus adjustment may be needed during this process.

If Contrast is not advanced far enough a clean picture will be obtained but it will be "thin" and either it will be very dim or the frame fly-back lines will show. If it is advanced too far the picture will become what is often termed "soot and whitewash." The scanning spot will defocus on whites and there will be no detail in the blacks.

Once the correct setting of Contrast is found, this control will rarely need readjustment, for the day-to-day variations are best controlled by Brightness. Having found it, final adjustments to Height, Width, Linearity and Focus can be made.

Normally, Focus and Bright-

ness are the only panel controls. The former because occasional readjustment during a programme may be necessary to compensate for the change of resistance of the focus coil as it warms up and the latter since it is advisable to black out the picture before switching off.

The focus drift is normally small and it is less with a C.R. tube having a tetrode gun than with one having a triode gun, since the latter usually needs a heavier focus current.

In normal operation the proper procedure is to see that the Brightness is right down, switch on and allow a couple of minutes for the valves to warm up. Then turn up Brightness to the required level. At the end of a programme, turn Brightness right down and switch off.

Before concluding, it may be as well to make some mention of the effect of mains voltage variations, since these can be sufficient nowadays appreciably to affect the performance. It is quite common for a nominally 240 V supply to be anything from 220 V to 260 V and at periods of heavy load it may well fall below 220 V. The most noticeable effect of a change of mains voltage will be on picture width and with any serious drop in voltage it may not be possible to obtain the full width.

It is inadvisable to alter the tapping on the mains transformer to correct for the drop, unless a voltmeter is used to keep a check on the voltage, since it can result in the valves being over-run when the voltage rises. Unless a voltage-regulating transformer is fitted, the best thing is to adjust the transformer tap for the average voltage.

WIRELESS WORLD DIARY

COPIES of the *Wireless World* Diary for 1948 will be distributed through stationers and booksellers shortly. Readers are advised to place their orders at once as supplies are limited.

The 80-page Reference Section of the Diary has been completely revised and now contains a considerable amount of additional information. Base connections for some 400 valves, including the new B.V.A. Standard B8A, are included.

The Diary, which shows one week at an opening, costs 3s 8d, including purchase tax.

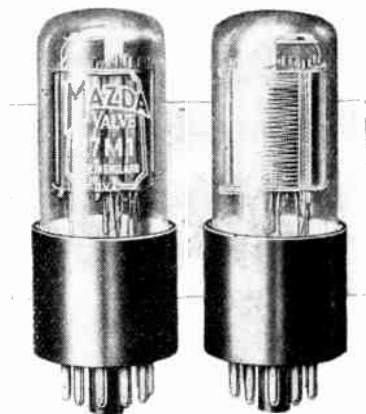

THE MAZDA TYPE 27M1 photoelectric electron multiplier has nine stages rated at 100 V per stage. At 50 V, the current amplification is one million times and the luminous sensitivity is $10 \mu\text{A/lumen}$. The base is a small shell 11-pin sub-magnal.

New "All-stage" Valve

Details of the
Sargrove-Tungram
Type UA-55



DESIGNED primarily to reduce the cost of valves used in receivers manufactured by the E.C.M.E. system (see *W.W.*, April, 1947) the Type UA-55 is capable of performing all the stage functions in a straight or superhet receiver and is yet of comparatively small dimensions and robust construction. Effective limitation of size has been achieved by accepting a reasonably small output (of the order of 1 watt) when the valve is used as a power amplifier.

The valve is a combination of two beam tetrodes disposed symmetrically on either side of a common cathode. The heater is rated at 55 V, 100 mA and is therefore convenient for series connection

grid wires are aligned behind the grid wires, and a method has been found of doing this without optical aids. It is claimed that a ratio of anode to screen current of the order of 10:1 is maintained throughout the life of the valve.

With a screen potential of +15 V a high-impedance voltage amplifier with a slope of 4.5 mA is obtained. The anode-grid inter-electrode capacity is of the order of 0.07 pF per section, and it is therefore necessary to use somewhat unconventional circuits for R.F. and I.F. amplification. A neutralized circuit using a capacity centre tap on the secondary of the input transformer may be employed with one half of the valve, the other half being used as second detec-

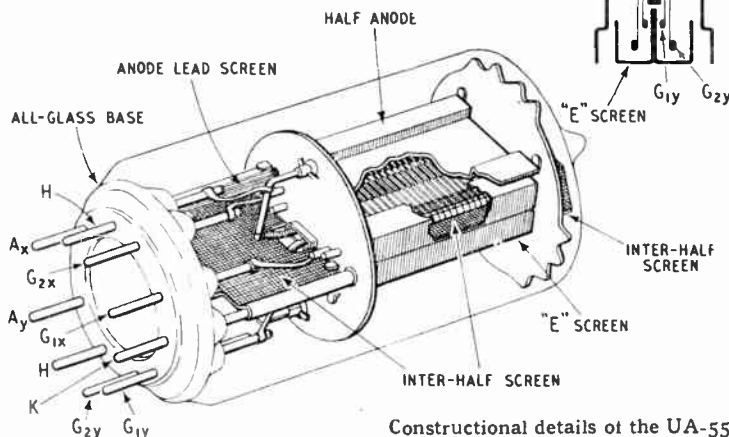

in 110- and 220-volt mains supply circuits. A central screening plate with extensions between the leads to each section of the valve is connected to the cathode and is shaped to act also as the beam-forming plates. In cross-section it is "E" shaped and shields the first and second grid supports from the anode. The accelerator

Constructional details of the UA-55 valve and (top right) section showing arrangement of electrodes

tor. Alternatively, the two halves may be arranged as an amplifier of the Colebrook R-C coupled type, when stable gains of the order of 300 can be obtained at 465 kc/s.

In circuits where the input can be applied to both control grids



SPEAKERS OF DISTINCTION

The extensive range of TANNOY Sound Equipment now available embodies the latest technical developments in design and performance.

Here are two examples of distinctive Loudspeakers. The one shown above is Type LSH/200/H a weather-proof Re-entrant Horn giving first-class quality reproduction.

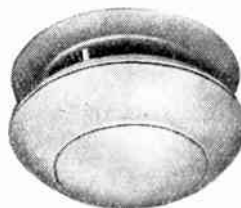

This is Type LS/CIR/5. A Bowl Loudspeaker suitable for Ceiling or wall mounting, combining the latest developments in speaker design with artistic appearance

TANNOY
—SOUND EQUIPMENT—
GUY R. FOUNTAIN LTD.,
"THE SOUND PEOPLE"

"TANNOY" is the registered trade mark of equipment manufactured by

GUY R. FOUNTAIN LTD.
WEST NORWOOD, S.E.27
GIPSY HILL 1131

The largest Organisation in Great Britain specialising SOLELY in Sound Equipment.

Branches at Manchester, Belfast, Newcastle-on-Tyne, Birmingham, Bristol, Glasgow, etc.

New "All-stage" Valve—

simultaneously, variable - mu characteristics can be obtained by applying dissimilar voltages to the screens. Otherwise, remote-cut-off characteristics can be obtained by supplying the accelerator grid potential through a comparatively high series resistance.

With anode and screen strapped, a high-slope low-impedance triode is obtained. One half of the valve can be used as an oscillator under these conditions, the other half being employed as a tetrode mixer. With this arrangement and a line voltage of only 90, a conversion conductance of 0.7 mA/V is claimed, with a cathode current of 9 mA.

When the two sections are connected in parallel and both screen and anode are supplied from a 90-volt H.T. line, the valve functions as a power amplifier with a slope of 7 mA/V at -5 volts bias and gives over one watt into a load of 2,500 ohms with an anode dissipation of 3½ watts.

It may seem rather wasteful to use a valve of this type as a power rectifier, but the makers consider that this is economically justified if specimens which do not meet the required standards for general circuit use, and which would normally be rejected, are earmarked for use as rectifiers. Resistors must be used in series with the first and second grids to limit current, and the D.C. output voltage is substantially the same as the R.M.S. input voltage for currents up to 20-25 mA, the value drawn by the simple two-valve receiver illustrated on page 438 of the November issue.

A special nine-pin valveholder is necessary. The possibility of using existing nine-pin holders was considered, but it was decided that it would be less expensive to go for optimum design in the valve and to call for a special holder. The pitch circle is 11/16in in diameter and the pins, 1mm in diameter and ¼in long, are spaced 36 degrees apart except the anode pins, which are spaced at 72 degrees.

Full characteristics of the UA-55 are given in a paper which will be read at the Brit. I.R.E. discussion meeting on Dec. 11th. Advance copies are obtainable from Sargrove Electronics, Sir Richard's Bridge, Walton-on-Thames.

Cathode-ray Tube Data

Characteristics of some Ex-Service Surplus Types

Compiled by D. W. Thomasson

THE following list gives some of the more important data on some of the C.R. tubes now available in the surplus market. All the types given have 4-V heaters, taking about 1 A, and are of the electrostatic focus and deflection type. The figures given are average values, but considerable variation may be

Type	Screen	Base	Size		Operating Conditions					Sensitivity	
			L	D	V ₁	V ₂	V ₃	V _{max}	I _b	X-axis	Y-axis
NC1	G. M.	9.1	160	25	0.8	0.135	0.8	—	3	100	90
NC6	G. —	12.1	350	75	1.45	0.6	3	4	10	320	480
NC7	G. S.	12.2	630	230	1.7	1	6	6	40	1490	1270
NC12	G. S.	12.3	420	160	1.8	0.8	5	6	3	550	1000
NC14	B. —	12.3	420	160	2	0.35	2	2.5	20	600	1140
NC16	G. M.	12.4	200	70	0.8	0.12	0.8	1.5	3	150	150
NC19	G. M.	9.1	160	25	0.8	0.135	0.8	—	3	100	90
VCR97	—	12.3	420	160	2	0.35	2	2.5	20	600	1140
VCR138	G. S.	12.3	340	85	2	0.35	2	2.5	—	750	350
VCR139A	G. M.	12.4	200	70	1.5	0.25	1.5	1.5	3	170	170
VCR522	G. M.	9.1	160	25	0.8	0.135	0.8	—	3	100	90

NOTES.—Screen type; G = Green, B = Blue, M = Medium persistence, S = Short persistence.

The connections given in the lists of bases are liable to alteration. The effective connections will usually be as shown, however, as the changes usually involve taking two leads to a common connection to avoid the necessity of strapping them externally. The addition of a suffix letter is sometimes used to indicate more extensive changes.

The dimensions given are the overall length and the effective screen diameter (mm). Symbols: V₁ = first anode, V₂ = focus anode, V₃ = final anode, V_{max} = maximum final anode potential in kilovolts; I_b, beam current (μA). The sensitivities are given in mm/V.

12-WAY S.C.

12-PIN SPIGOT

BRITISH 9-PIN

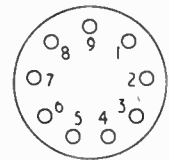
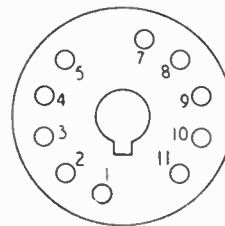
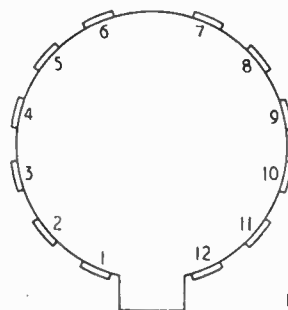

BASE CONNECTIONS

British Standard 9-pin Base

	1	2	3	4	5	6	7	8	9
9.1	X ₁	Y ₁	A ₂	H C	H	M	A ₁ A ₃	X ₂	Y ₂

Standard 12-way side contact (G.E.C. type)

	1	2	3	4	5	6	7	8	9	10	11	12	Caps	
12.1	M	—	H C	H	A ₁	A ₂	Coa.	X ₂	—	A ₃	—	X ₁	Y ₁	Y ₂
12.2	M	—	H C	H	A ₁	A ₂	Coa.	Y ₂	X ₂	A ₃	X ₁	Y ₁	—	—
12.3	M	C	H	H	A ₁	A ₂	Coa.	Y ₂	X ₂	A ₃	X ₁	Y ₁	—	—

12-pin spigot-type base

	1	2	3	4	5	6	7	8	9	10	11	12
12.4	C	M	H	H	A ₂	—	Y ₂	X ₂	A ₃	X ₁	Y ₁	—

SYMBOLS: M = Modulator (grid); H = Heater; C = Cathode; Coa. = Coating; X₁, X₂ = X-axis deflector plates; Y₁, Y₂ = Y-axis deflector plates; A₁, A₂, A₃ = Anodes numbered from the cathode. (Anodes one and three may be strapped internally, the A₁ connection being omitted. X₁ and Y₁ may be similarly treated. These variations are unpredictable.)

experienced between different tubes of the same type.

It may be noted that, while some of the types given are closely similar as far as the quoted characteristics are concerned, they

are not equivalents. This may be due to different minimum spot sizes or similar factors relatively unimportant for many applications, but is often a matter of construction.

Short-wave Conditions

Expectations for December

By T. W. BENNINGTON (Engineering Division, B.B.C.)

DURING October daytime maximum usable frequencies for this latitude increased very considerably, and during the last week of the month reached very high values, for example, a measured value of 47 Mc/s at 1200 G.M.T. on 31st. Contrary to expectation night-time M.U.F.s were, on the average, no lower than during September.

Had it not been for a large amount of ionosphere storminess daytime working frequencies would have been much higher than they were. Even so, frequencies like the 28-Mc/s amateur band were more or less regularly usable, while it is reported that a Dutch amateur established contact on 50 Mc/s with two amateur stations in Capetown. Night-time working frequencies were relatively high for the time of year. Sporadic E decreased very considerably in the frequency of its occurrence during the month.

Conditions were very disturbed during the first three weeks of the month, the worst periods of ionosphere storminess being 1st/3rd, 9th/16th, 18th/20th and 24th.

Forecast.—Daytime M.U.F.s are expected to be somewhat lower in December than in November, due to the peculiar "mid-winter" effect in the Northern Hemisphere. Daytime working frequencies will, however, still be relatively high, though the period when high frequencies are usable will be somewhat shorter than during November. The 28-Mc/s amateur band should still be regularly usable over daylight paths, but conditions will not be so favourable for long-distance contacts on 50 Mc/s, which is not to say, of course, that none will occur. Night-time M.U.F.s will fall to their lowest values for the winter, and night-time working frequencies, which will be as low as 7 Mc/s over some long-distance circuits, will remain in use for longer periods than at present.

Below are given, in terms of the broadcast bands, the working frequencies which should be regularly

usable during December for four long-distance circuits running in different directions from this country. *All times in this article are in G.M.T.* In addition, a figure in brackets is given for the use of those whose primary interest is the exploitation of certain frequency bands, and this indicates the highest frequency likely to be usable for about 25 per cent of the time during the month for communication by way of the regular layers:—

Montreal :	0000	9 Mc/s	(14 Mc/s)
	0300	7 "	(12 ")
	0900	9 " or 11 Mc/s	(16 ")
	1100	17 " or 21 Mc/s	(26 ")
	1300	26 "	(38 ")
	1800	21 "	(29 ")
	2000	17 " or 15 Mc/s	(22 ")
	2200	11 "	(18 ")
2300	9 "	(15 ")	
Buenos Aires :	0000	11 Mc/s	(16 Mc/s)
	0500	9 "	(14 ")
	0700	11 "	(18 ")
	0800	21 "	(28 ")
	0900	26 "	(40 ")
	1900	21 "	(32 ")
	2000	17 " or 15 Mc/s	(22 ")
	2200	11 "	(18 ")
Cape Town :	0000	11 Mc/s	(16 Mc/s)
	0300	9 "	(15 ")
	0500	11 "	(20 ")
	0600	17 "	(29 ")
	0700	26 "	(40 ")
	1700	21 " or 17 Mc/s	(29 ")
	2000	15 "	(21 ")
	2200	11 "	(18 ")
Chungking :	0000	7 Mc/s	(12 Mc/s)
	0400	9 "	(14 ")
	0500	11 "	(16 ")
	0600	17 " or 21 Mc/s	(23 ")
	0800	26 "	(36 ")
	1200	17 " or 15 Mc/s	(24 ")
	1700	11 " or 9 Mc/s	(15 ")
	2300	7 "	(13 ")

Ionosphere storms are not particularly frequent or of exceptionally long duration in December, though those which do occur are often particularly troublesome after darkness, because of the already low ionisation prevailing during the winter night. At the time of writing it would appear that disturbances are more likely to occur within the periods 2nd/5th, 8th/9th, 13th/14th, 22nd/23rd and 30th/31st than on the other days of the month.

Now available
NEW
TROUBLE TONE
REPRODUCER

Gramophone Cabinet Amplifier TP. 614 (RC)

(as illustrated) incorporates NEW Amplifier T.614, specially designed for High Fidelity reproduction of gramophone records. Variable frequency response. Separate control of bass, treble and middle frequencies. Inputs for mic. and gram. with mixing controls. Alternatively with single record player (TP. 614). Also available, new TWIN TWELVE speaker for use with this model.

Write for illustrated list of full Sound Equipment range, including AC/DC types.



TRIX
Quality
SOUND EQUIPMENT

THE TRIX ELECTRICAL CO. LTD.

1-5 MAPLE PLACE, TOTENHAM COURT ROAD, LONDON, W.1
TELEPHONE: MUSEUM 5817 GRAMS & CABLES: TRIXADIO, WESDO, LONDON.

Additive and Multiplicative Mixing

THE recent article¹ by C. J. Mitchell is a very useful contribution to a difficult subject. There can be very little doubt that the multiplicative and additive processes are the same thing. In each case the mixing is performed by a valve — by an “anode bend” or other device of non-linear current/voltage characteristic in the case of “additive” mixing, and by a “linear” modulator such as a tetrode, pentode, hexode or heptode, in the case of “multiplicative” mixing.

To take the first case first, it is worth while to examine closely the significance of the term “additive.” It is true that the two oscillations are added together in the input circuit of the non-linear device, but that is not all. The fact that the current/voltage characteristic is not linear indicates at once that multiplication must occur *within* the device.

For example, suppose we have a valve possessing a current/voltage characteristic of the form

$$i_a = a + bv + cv^2$$

where a and b are constants and v is the total signal input, and suppose this to be

$$v = A \sin pt + B \sin qt \quad (p > q)$$

Then $i_a = a + b(A \sin pt + B \sin qt) + c(A \sin pt + B \sin qt)^2$

Expanding this expression we obtain terms in $\sin pt$, $\sin qt$, $\sin^2 pt$, $\sin^2 qt$, and the product $\sin pt \sin qt$. The last-mentioned can be resolved, as Mr. Mitchell points out, into terms involving $(p - q)$ and $(p + q)$. In other words, *through the multiplying action of the valve*, the output current contains, amongst other things, components of angular frequencies $(p - q)$ and $(p + q)$, and also p . These represent a carrier wave of frequency $p/2\pi$ flanked by sidebands of respective frequencies $(p - q)/2\pi$ and $(p + q)/2\pi$. Or, if you like, the valve has modulated p with q .

If p is of radio frequency and q is of audio frequency, the output current contains what we generally regard as a normal modulated wave; but if p and q are both of radio frequency and are separated by a few hundred cycles per second, then the output current contains an audio frequency term $(p - q)/2\pi$ which is not present in the input circuit, and we have a case which is identical with the heterodyne reception of C.W. telegraphy. Similarly, if $p/2\pi$ represents an incoming signal

By J. W. WHITEHEAD,
B.Sc., M.I.E.E., A.Inst.P.

frequency, and $q/2\pi$ is a local oscillator frequency, then $(p - q)/2\pi$ can be the intermediate frequency of a superheterodyne receiver.

Let us now proceed to the “multiplicative” mixer. Consider a tetrode valve with two concentric grids. Each grid has its own effect on the anode current, but they will also produce, together, effects which neither of them can produce singly.

Let the mutual conductance of the portion comprising cathode,

Further Thoughts on Heterodyning and Modulation

inner grid and anode be g_1 , and let that of the cathode, outer grid and anode be g_2 , both slopes being measured at the same electrode potentials. Now suppose the bias to the inner grid to be made more negative by an extent V_{g1} . The anode current will fall and the outer part of the valve will behave as though the emissivity of the cathode is reduced, and accordingly its slope will be less, depending on the value of V_{g1} . By suitable design, it can be made directly proportional to V_{g1} , and we may write the new slope as $KV_{g1}g_1$. Now apply a steady voltage change V_{g2} to the outer grid. The anode current will change by $KV_{g1}g_1V_{g2}$, i.e. the anode current is proportional to the product of the voltages applied at the two grid circuits. But the voltages need not be steady ones. They are usually in the form of a fixed bias plus an alternating voltage, and so V_{g1} and V_{g2} could be written as $(C + A \sin pt)$ and $(D + B \sin qt)$. The resulting anode current will then be:

$$I_a = g_2 K (C + A \sin pt) (D + B \sin qt) \\ = g_2 K [CD + CB \sin qt + DA \sin pt + \frac{AB}{2} \cos(p - q)t - \frac{AB}{2} \cos(p + q)t]$$

Again we have our carrier p and its sidebands $(p - q)$ and $(p + q)$.

A point here is worthy of note. If the angular frequencies p and q are zero, then

$$I_a = g_2 KCD.$$

On applying signals of frequencies $p/2\pi$ and $q/2\pi$, the only additions to the anode current are alternating ones. *No rectification occurs.*

From the foregoing, therefore, it

is apparent that both types of mixing are multiplicative, the term “additive” being really a misnomer; and furthermore, it is clear that modulation, frequency changing, and the heterodyne reception of C.W. are all different versions of the same thing, the difference lying only in the relative values of p and q .

It could perhaps be appropriate to make constructive comments on a few points in Mr. Mitchell's article.

On p. 360 at the top of column 2 it is stated that the resultant frequency of two beating oscillations is the average of the two components. I feel that Mr. Mitchell should have

stated more clearly that this applies *only* to the case in which the component oscillations have equal amplitudes. It can be shown that the resultant oscillation is to some extent frequency modulated at the beat frequency between the limits (using my notation)

$$p \left[1 - \frac{B}{A} \left(\frac{p - q}{p} \right) \right] \text{ and } p \left[1 + \frac{B}{A} \left(\frac{p - q}{p} \right) \right]$$

i.e., the mean angular frequency tends to p rather than to $(p + q)/2$, and in fact is only equal to $(p + q)/2$ when $A = B$.

Mr. Mitchell further states (p. 361, col. 1) that a wave-form diagram of the resultant of two beating oscillations does not reveal a phase-shift. If such a diagram is drawn, a closing-up of successive half-cycles is revealed as we move from positions of maximum to minimum resultant amplitude, and the reverse as we move from resultant minima to maxima. Presumably, this could be regarded as both a progressive shift of phase and as an indication of frequency modulation.

We can derive an expression for the instantaneous phase ϕ by splitting $(A \sin pt + B \sin qt)$ into terms

$$+ \frac{AB}{2} \cos(p - q)t - \frac{AB}{2} \cos(p + q)t]$$

involving sums and differences of half-angles. It is that

$$\tan \phi = \frac{A - B}{A + B} \tan \frac{p - q}{2} t$$

Lastly, it is stated on p. 360, col. 2, that “the simple addition of two sinusoidal quantities results in multiplication.” This is not true, and I do not think that the author

¹ *Wireless World*, October, 1947.

Additive and Multiplicative Mixing—really means this. What I feel he means to say is that the resultant of two beating oscillations is another oscillation of varying amplitude and phase which can therefore be regarded as a modulated wave. Modulated waves, as we usually understand them, are composed of at least three oscillations, whereas heterodyne action need involve only two. Nevertheless, it is possible to derive mathematically an expression for a modulated waveform which approaches closely to that resulting from the superposition of two oscillations of roughly equal frequency.

Two tuning forks of almost equal frequency can be used in the follow-

ing manner readily to demonstrate the effect of the multiplying together of two oscillations.

Take two tuning forks of the same frequency and load one with a small piece of sealing wax or chewing gum. On sounding them simultaneously, the ear at first detects a beat tone of one or two cycles per second, but as the amplitudes decay and become very small, the beat tone vanishes. This is accounted for by the fact that the input/output characteristic of the ear is non-linear for large inputs, and so "multiplication" occurs and the difference frequency is apparent. For small inputs, the characteristic is sensibly linear and so no beats are heard.

LETTERS TO THE EDITOR

The First Aerial • Damping Speaker Coils • Modulation and Frequency-Changing

Who Invented the Aerial?

WITH reference to the article published in your September issue on the invention of the aerial, I beg to inform you that a group of Russian scientists has written an open letter of protest to the committee which is organizing in Italy the celebration of the 50th anniversary of Marconi's invention of wireless telegraphy. According to the Russian professors the real inventor of wireless telegraphy should be the Russian physicist Popov. I have replied to the above open letter, repeating the statements made by Popov himself on board the Italian cruiser *Carlo Alberto* in July, 1902 (statements already reproduced by *Wireless World*). But now I beg to add the following facts:—

At the first Berlin international wireless conference in 1903 a Russian delegation, which included Popov, was present. As one of the Italian Government delegates, I made during the conference an official statement about the invention of wireless telegraphy and about the long examination made by the patents offices of Russia, of Germany, of England and America upon Marconi's patent application for wireless telegraphy by electric waves. This examination lasted about one year and the fundamental patent for wireless was granted to Marconi on June 2nd, 1897. Nobody was able to contradict my statement, which made a clear reference to the aerial.

Rome. LUIGI SOLARI.

Loudspeaker Damping

I AM very pleased to note the increasing recognition of the advantages of a high intensity magnetic field for damping loudspeaker speech coils.

I, too, share the belief that when the effective resistance of the speech supply circuit is low relative to the D.C. speech coil resistance, then little is to be gained from the point of view of damping by further reducing the input resistance.

In the case of triodes operating at a higher load line than the usual makers' rating, for example, with a PX25 (at 400V; R_a approximately 1,100 Ω) operating at a 5,000- Ω load line, we have a drive-to-load ratio of about 1:4½. Even if the speaker is so efficient that its D.C. resistance is half the dynamic impedance, the ratio of drive-to-load D.C. resistance is still 1:2½, and this without circuit complications. If, by feedback, the input impedance is reduced to zero, the D.C. resistance of the speech coil still exists and currents due to back-E.M.F. cannot exceed $\frac{3\frac{1}{2}}{2\frac{1}{2}} = 1.45$ of their previous value.

A reduction of input resistance to one-third or one-quarter of its natural value will allow very nearly this maximum effect.

From the point of view of diminishing harmonic distortion, hum, etc., which in some circuits is reduced in the same ratio as the apparent amplifier output impedance, it will be obvious that it may well be desirable to use much more

1937

Record Storage



Here, to end your record storage problem once and for all, is the new lightweight portable 'IM RAK'. Holds up to 50 records, 10" and 12", yet requires little more space than a medium-sized table lamp

Is No Longer



Every record easy to get at. Every division individually numbered. Records held firmly in position by resilient, plastic covered, sprung-steel divisions and cushioned at points of contact.

Any Problem



Finished in a wide choice of gay colours. And you can add on new racks just like a unit bookcase. Now available at most record shops, price 29/6d., plus 6/5d. tax. Optional dust-proof plastic cover 7/9d., plus 1/8½d. tax.

The new



MADE BY THE MAKERS OF THE FAMOUS IM NEEDLES

For details of your nearest supplies write to Alfred Imhof, Ltd., Dept. W3, 112, New Oxford Street, London, W.C.1. Museum 5944.

Letters to the Editor—

feedback than that needed for damping purposes alone.

It is possible to overcome the damping limitation resulting from the D.C. speech coil resistance if this resistance is neutralized (in part) by something corresponding to radio-frequency reaction, only operating at A.F. and without tuning.

Such circuits naturally involve an element of possible instability in which frequency responses can "go crazy" and which may also lead to a region of overdamping.

Imagine a speech coil so solidly

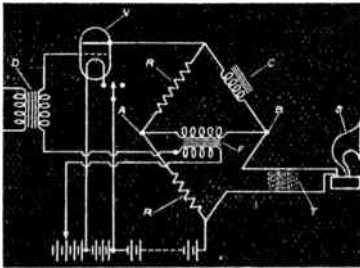

Diagram reproduced, by permission of the Patent Office, from Specification No. 231,972. (P. G. A. H. Voigt.)

damped that it becomes virtually a rigidly fixed object, the diaphragm vibration characteristics will then be quite different from those obtained when the coil is able to move. This may, or may not, be an improvement on the original design.

Circuits of the general type shown by D. T. N. Williamson in his letter (*Wireless World*, October, page 402) and evolved according to suggestions by P. d'E. Stowell and M. K. Taylor can produce such A.F. reaction effects if thrown slightly out of balance. It will be remembered that the circuit involved placing the loudspeaker in one arm of a bridge in which any unbalance voltage was fed back into the amplifier, so that if the back-E.M.F. due to coil vibration was excessive or deficient, this feedback remedied matters.

I have no doubt that the three gentlemen named would be interested to know that some years ago I patented a circuit in which the loudspeaker formed one arm of a bridge and in which unbalance voltage was fed back into the amplifier so that at resonance the appropriate frequency was automatically diminished, etc., etc. The circuit did actually work, the effect on multiple voices being to make them seem to go down the horn, and to sort themselves out better. The circuit, however, never went into

commercial production, as it was judged to be a little ahead of its time. This opinion you will understand when you look at the enclosed Specification [No. 231,972] and see that the application date is 29/1/1924.

P. G. A. H. VOIGT
London, S.E.19.

Heterodyning and Modulation

I WAS interested in the article by C. J. Mitchell on heterodyning and modulation, and the view he puts forward that modulation and frequency changing are the same process accords with my own.

The only difference between the two is that with modulation the output circuit is tuned to accept the carrier and both sidebands, whereas with frequency changing the output circuit is made selective to a band of frequencies centred about the lower sideband frequency.

I do not like his suggestion that addition can be shown to be multiplication as I think this view is apt to confuse the student. It is merely a mathematical wangle to change $\sin A + \sin B$ into

$$2 \sin \frac{(A+B)}{2} \cos \frac{(A-B)}{2}$$

and to say that addition is therefore multiplication. Multiplication, as I would understand it, is the multiplication of the original input frequencies; i.e. it would be represented by $\sin A \times \sin B$ and the result is the sum and difference and frequencies represented by $(A+B)$ and $(A-B)$. Pure addition cannot produce these sum and difference frequencies; if these are required addition must be followed by multiplication, and this is performed by the rectification process. Taking the simplest rectifier, the square law type, the expression for anode current is:

$$I_o = a_0 + a_1 E_o + a_2 E_o^2 \dots \quad (1)$$

If $E_o = E_1 \sin \omega_1 t + E_2 \sin \omega_2 t$ (we can neglect any bias voltage there may be) the second term in (1) gives $a_2 (E_1 \sin \omega_1 t + E_2 \sin \omega_2 t)^2$ which contains the term

$$2a_2 E_1 \sin \omega_1 t \times E_2 \sin \omega_2 t$$

thus providing the sum and difference angular frequencies $(\omega_1 \pm \omega_2)$. With the multiplicative frequency changer such as the pentode with suppressor grid injection, or the heptode, etc.

$$I_o = (a_0 + a_1 E_{o1}) (b_0 + b_1 E_{o2}) \dots \quad (2)$$

where neglecting bias

$$E_{o1} = E_1 \sin \omega_1 t$$

and

$$E_{o2} = E_2 \sin \omega_2 t$$

The term $b_1 b_2 E_1 \sin \omega_1 t \times E_2 \sin \omega_2 t$ will be obvious from the above. Incidentally, detection is by the same process as modulation and frequency

changing, and the output circuit is now tuned to the lower sideband frequency, (the audio difference frequency) produced by multiplying the carrier by the lower and upper sidebands. Rectification is also similar, the output circuit being tuned to the lower sideband frequency produced by multiplying the mains input voltage by itself. The difference frequency from this product will, of course, be zero frequency; i.e. it will be D.C.

Evesham. K. R. STURLEY

[This subject is also referred to on p. 486.—Ed.]

Effective Use of Amateur Frequencies

AT the present time we hear quite a lot about vicious spirals in connection with economic affairs. May I, as an old amateur, venture to suggest that amateur radio is at present in the throes of a vicious spiral of a rather different type, and it looks to me rather like this:

Every month between 100 and 150 new licences are issued in this country, which means that by 1950 there will probably be about 10,000 amateur transmitters in the small area of the British Isles—and there will be fewer channels for them.

More amateurs, fewer frequencies; this is by no means the whole story. British amateurs are now allowed inputs up to 150 watts (except for the first 'prentice year of operation). Increasing congestion in the amateur bands sorely tempts every amateur to go to the limit of the power and employ his full 150 watts (and some!), in order to make himself heard.

Even this is still not the whole story; much of this high-power operation in congested bands is by means of telephony, so that one powerful phone station spreads over enough kilocycles to accommodate twenty telegraphy stations.

The temptation to "pile on the watts" is aggravated by the present crazy Gadarene rush to work DX—a procedure which seems quite purposeless, since any individual with a good aerial, a good receiver and a few hundred watts can work any part of the world to order; there is little cleverness and no merit in doing so. I must also make mention of another abuse of the amateur bands: this is the selfish employment of high-power telephony for local or semi-local communication.

Two years ago you published an article from my pen forecasting, more or less, the state of affairs in the amateur bands as we see (or rather, hear) them to-day. I suggested there that if action were not taken among amateurs themselves

to rationalize their operation, then amateur radio would choke itself to death by sheer weight of numbers. To-day that is more true than ever. What it will be like by 1950, I shudder to think.

Can British amateurs discipline themselves in time? Or is amateur radio, as a pleasant scientific hobby, doomed to extinction?

That, flatly, is the choice before us. "ETHERIS."

Television Afloat

IT may be of interest to some of your readers to learn that a Pye D16T console television receiver has been successfully installed in a 35-foot four-berth cabin cruiser, "Golden Spray," on the River Cam.

Consistently excellent results have been obtained on the waterways in and around Cambridge and about 30 miles north at Redmere. Furthermore, a picture of reasonable entertainment value has been obtained whilst sailing in The Wash between King's Lynn and Hunstanton. Considering the aerial is mounted on a 20-foot telescopic steel mast, 6 feet of which is inside the boat, this could be regarded as a tribute to the sensitivity of the receiver used.

The Antiference aerial used lends itself admirably for this job due to the ease of dismantling when the mast is telescoped after use.

Apart from being telescopic, the mast is also rotatable, allowing the aerial to be swung for "maximum" irrespective of the orientation of the boat.

The power supply is obtained from a carbon pile regulated rotary converter which is driven by the boat's 24V D.C. battery supply.

If any of your readers have had experience of installations of a similar nature it will be most interesting to hear of the results obtained.

C. E. TATHAM.

Langham Radio Services,
Cambridge.

Aerial Aesthetics

JUDGING from the photograph of the model of the television relaying site appearing in your last issue, there is little wonder that the proposal, put forward earlier in the year, to erect a television relay station near White Horse Hill on the Berkshire Downs aroused so much antagonism.

The designers of these and other aerial masts and towers might do well to examine some of the long-span bridges. If the civil engineer can design bridges that are pleasing to the eye, why cannot the electrical engineer, justly proud of his circuit design, take interest in the appearance of the work as a whole?

Cambridge. P. G. BRIGGS.

RE-ENTRANT HORN TYPE 42 REH



The new 42REH has advantages of complete weather-proofness, smaller overall length, better weight distribution and consequently greater ease in handling, which make this one of the most popular of the new F.I. loud-speakers. The horn is designed for use with the standard F.I. L.S.7 Unit and allows for this unit to be driven to 12 watts input. A spun aluminium cover over the unit has room for housing a suitable matching transformer.

The construction has been designed so that the whole unit is assembled and held together with ONE LARGE NUT only. This construction enables a number of units to be packed for export in a space which is a fraction of that normally required; assembly is a matter of a few minutes unskilled labour.

This unique feature will recommend itself to all export buyers particularly.

The 42REH is not of the "loud-hailer" type of speaker, but is designed to cover a range of frequencies considerably greater than those needed for purely "announcing" purposes: i.e., it is suitable for all normal requirements of high power reproduction of music as well as speech.

Dimensions assembled	... 22in. dia. x 24in.
Bell diameter	... 22in.
Cut-off frequency	... 175
Effective Air Column	... 42in.
Weight Horn only	... 8 lbs.
Shipping space	... One—23in. x 23in. x 18in. 12—33in. x 33in. x 27in.

F.I. for P.A.
FILM INDUSTRIES LTD.
60, PADDINGTON ST., W.1
Telephone: WELbeck 2385

"CONCERTO" AMPLIFIER

DESIGNED for the reproduction of records, this amplifier has eight triode valves and a rectifier. The first stage is a pre-amplifier for moving-coil pickups, and can be switched out when the input is from moving-iron or crystal pickups. The output stage consists of two PX25s in push pull, and negative feedback is applied over three stages, including the phase-splitter.

Separate tone controls for "Treble" and "Bass" are provided. The

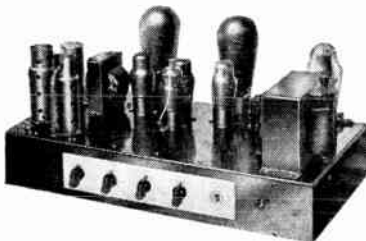

Separate "Treble" and "Bass" tone controls are provided in the "Concerto" model made by Charles Amplifiers.

"Treble" control provides both cut and boost, while the "Bass" has six steps, from linear to full boost at 8 db per octave.

It is claimed that the overall distortion for an output of 7 watts is 1.3

per cent, and 2 per cent at 13 watts. The price is £27 10s and the makers are Charles Amplifiers, 1e, Palace Gate, London, W.8.

RADIO'S ENEMY No. 1

A COMPREHENSIVE survey of existing knowledge on all kinds of radio noise is made in a special report (No. 15) just issued by the Department of Industrial and Scientific Research. The types of interference dealt with are summarized in the main chapter headings: receiver, thermal, cosmic, atmospheric and man-made. Two later chapters are on the influence of noise on reception and on measurements. Suppression is not treated at any length.

In the concluding "Recommendations" is stated, "The survey shows that in no section is the knowledge complete; in fact, it indicates a wide field for further investigation."

"Survey of Existing Information and Data on Radio Noise over the Frequency Range 1-30 Mc/s," contains 126 pages and 57 figures; it is issued by H. M. Stationery Office, Kingsway, London, W.C.2, at 3s (by post 3s 4d).

RANDOM RADIATIONS

By "DIALLIST"

The More the Merrier !

IT is a rather amazing thought that one person in every hundred of the whole population of Great Britain visited the Radio Exhibition during its ten days' run. Nevertheless it was so, for there are forty-four million-odd of us and the attendance at Radiolympia was 440,320. Had the show been held in school holiday time the figure might have been a good deal higher, for schoolboys (and schoolgirls too) are great wireless enthusiasts, as all of us know who either have children of our own or number other people's amongst our friends. That the attendance was so large—nearly double that of any pre-war exhibition—seems to me to be due to four main causes. The first, and possibly the most important, is that so many veteran receivers are now crying out to be placed on the retired list. The second, that many visitors rather expected to find breath-taking advances due to wartime progress. The third, that television was a prominent feature and that interest in this department of wireless is more lively than ever. The fourth, that it was a genuine radio exhibition and not just a show of broadcast receiving equipment. Whether or not that's a correct diagnosis, all the world and his wife were certainly there. On some of the most crowded days the hall became so packed that one could have believed almost any attendance figure!

Sound, but Not Spectacular

Of course there were those who crabbled the show. There always are. One cynic told me that the only important advance he'd been able to discover in broadcast receivers was in their prices—the kind of thing that has to be said by a fellow with a reputation for mordant wit, no matter how far it may be from expressing his real opinion. I agree that there weren't any spectacular developments—things to knock the non-technical visitor all of a heap, as did, for example, the all-mains receiver, the screen-grid valve, the pentode, the moving-coil loudspeaker, the ganged tuning condenser and the pickup in their respective years. But there were plenty of good things there, if you looked for them. What, perhaps, interested me most was the way in which so many makers had managed to turn out good jobs of work whilst making little or no use of

materials that are now scarce, though once they were plentiful enough. The spirit seemed to be: If we can't get *this*, we'll make do with *that* and jolly well see that the job's as good as ever it was. Another important point is that one of the things we had perforce to learn during the war was how to make sets of all kinds that were easy to handle and could be relied upon to stand up to hard wear. The knowledge gained in wartime has been put into the peacetime receiver, which at its best is a sound, well-designed piece of work mechanically as well as electrically.

What Next ?

Come to think of it, how and where are spectacular improvements possible in broadcast receivers today? Increased sensitivity? Today's receiver brings in pretty well all the stations that the ordinary listener is likely to want. Selectivity? Most respectable sets will separate stations with channels 9 kc/s apart. Unless we discover some new method of transmitting we can hardly ask the broadcast receiver to do more than that. Higher fidelity in reproduction? Here, perhaps, something might be

done, though with the present limited A.F. band imposed on short-, medium- and long-wave transmitters, I doubt whether the public would regard the results as spectacular. Something, again, might be achieved in the moderately priced sets in the way of lessening the content of 2nd or 3rd harmonic in the output: but would the man in the street be in raptures over that? Again I permit myself to be doubtful. More efficient valves? We already have quite a few three-valve-plus-rectifier superhets. Valves making a smaller drain on sources of H.T. and L.T. supply? Already the mains set costs no more to run than a single small electric light bulb. Battery users would be pleased; but such an improvement would hardly be as sensational nowadays as it might have been some years ago, for battery sets are fast becoming fewer and fewer. No, it's not easy to think of any likely improvement on existing methods of long- and medium-wave broadcast reception which could cause a furore. The most probable "sensational" of a future Radiolympia is F.M., of which the ordinary listener in this country has heard little as yet.

The Popular Te'visor

In television receivers, though, I feel that the improvement since the previous radio exhibition has been phenomenal. I'm thinking particularly of the moderately priced instruments, made up in compact form and with all but the most straightforward controls preset, which give an image of round about seven and a half inches by six. I have an idea that that size of image is going to make a very wide appeal, so long as our transmissions are limited to 405-line definition. People have begun to realize that it is about the largest you can do with comfortably in the average living room of to-day, if you're not to spoil results by viewing at too close quarters. Compare the best of the 7½×6 or 8½×6½ vision receivers of to-day with medium-priced sets of 1939, and I think you must agree that there has been a very remarkable advance. Their clear, contrasting, steady pictures; their effective limiting of the snow-storm effects due to ignition interference; their simplicity of operation—all these make them completely different things from most of the television of pre-war days.

A Moot Point

One thing the manufacturers do not yet seem to be at all certain about is the form that the great public is going to want its television receivers to take. Will the

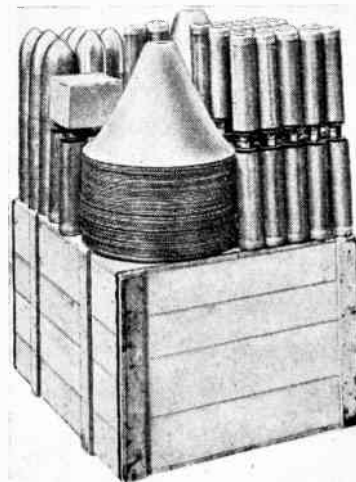

COMPRESSED SPEAKER HORNS. Film Industries have re-designed their re-entrant loudspeaker horns to save space in export packing; 80 of them now go in a case of 24 cubic feet

most popular set eventually prove to be the SV, the VML, the VAW, or the VAWRg? I'm beginning to change my mind about that. I used to think that Mr. and Mrs. Everyman's ideal was to have a single piece of furniture which would be the complete provider of entertainment in the home and that they would not really be satisfied with anything less than the television *cum* all-wave radio receiver *cum* gramophone unit. I still believe that there will be a big demand for such instruments by those who have the money to pay for them and living rooms large enough not to be overweighted by their necessarily rather large cabinets. But something tells me that the small vision *plus* accompanying sound only model is going to have bigger sales than any other in the immediate future. And it's not just its modest price and its small size that may be the deciding factors. Many people do not want to put all their eggs into one box, so to speak. They prefer to be able to have the broadcast receiver in one room and the television in another when they want to do so. Others, again, already have broadcast receivers or radiograms with which they are quite satisfied.

□ □ □

Another One On Magnets

YOU may recall that some months ago I suggested a simple little problem about two steel bars of exactly the same size and appearance, one of which was magnetized whilst the other was not. How could you quickly tell t'other from which, supposing that you had no instruments of any sort or kind, no other bits of iron or steel, not even a piece of string? The answer given was: arrange them like a T. Then if there is no attraction, the cross piece is the magnet. If there is, the magnet is the upright. I was surprised that no one wrote in to say that he could produce a pair of steel bars answering the description given on which this test would fail. Any offers?

MULLARD VALVE DATA

A REVISED edition of the Mullard Wall Catalogue has been issued for use by retailers by Mullard Wireless Service, Century House, Shaftesbury Avenue, London, W.C.2.

A very useful new section is that dealing with substitution types. Full details of alterations to base connections and associated circuits are given in cases where these are necessary.

TOGGLE-SWITCHES

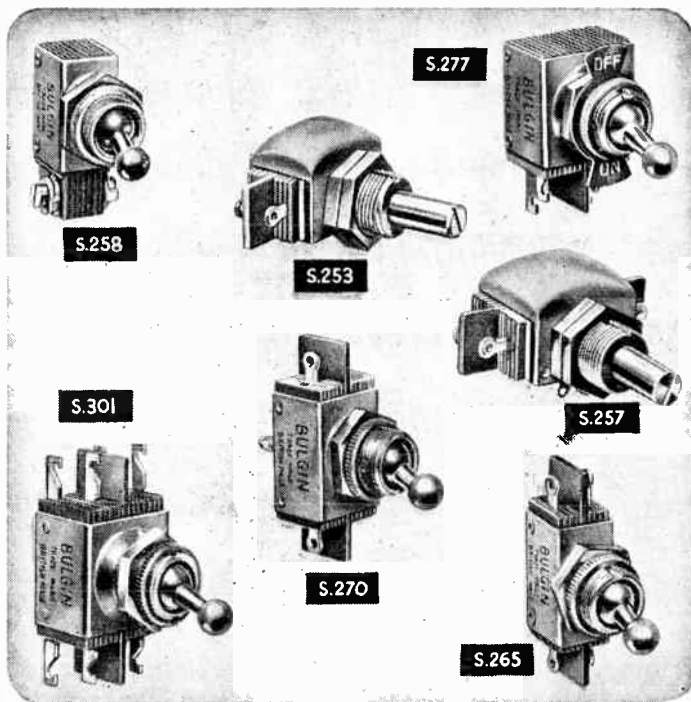

for every purpose . . .

FOR maximum reliability, experience has proved the need for separate switching in all types of apparatus. For this and many other requirements, over 200 types of BULGIN switches are available, including "ON-OFF," "CHANGE-OVER," single- and double-pole, dolly-, rotary-, key-operated, biased-action, rotary-selector and press-button models, suitable for a wide range of voltage and current ratings. Smooth, clean, rapid make-and-break actions and made from materials only of the highest grades obtainable. BULGIN switches are produced in nickel, Florentine-bronze and gun-metal finishes.

SELECTIONS ILLUSTRATED ARE :—

LIST NO.	DATA
S.253	Rotary-action, single-pole, make-and-break, for 6-250V. 3A. wkg.
S.257	" " double-pole, change-over, for 6-250V. 1A. wkg.
S.258	Toggle-action, single-pole, make-and-break, for 6-250V. 3A. wkg.
S.265	" " " " change-over, for 6-250V. 2A. wkg.
S.270	" " double-pole, change-over, for 6-250V. 1A. wkg.
S.277	" " " " make-and-break, for 6-250V. 3A. wkg.
S.301	" " " " change-over, for 6-250V. 2A. wkg.

"The Choice

BULGIN

of Critics"

A. F. BULGIN & CO. LTD. · BYE-PASS-RD. · BARKING

Telephone : RIPPleway 3474 (5 lines)

BOOK REVIEWS

Radar System Engineering. Edited by L. N. Ridenour. Pp. 748+xviii, with 446 illustrations. McGraw-Hill Publishing Co., Ltd., Aldwych House, London, W.C.2. Price 37s 6d.

THIS volume is the first in a monumental publication—a series of twenty-eight, recording the work of the Radiation Laboratory of the Massachusetts Institute of Technology, which was the great American wartime centre for radar research and development. Circumstances in this country having restricted systematic publication of our work in this field to Part III A of the I.E.E. Journal, appreciation will be felt for the acknowledgment in the Foreword that the Radiation Laboratory Series records the collective result of work done not only in the U.S.A. but also in Britain and in the Dominions, and that it is dedicated to all who contributed in any way, anywhere, to what was perhaps the most remarkable co-operative development enterprise ever carried out.

Most of the other volumes in the series are devoted to specialized principles and techniques, and since many of them have applications far beyond radar the aim has been to point out the general applicability of the work reported, avoiding any special emphasis on radar. The present volume is intended to apply this work specifically to radar.

The first eight chapters are devoted to the broad principles of radar, and include such matters as the radar range equation, the properties of radar targets, limitations of pulse radar, the alternative of c.w. radar, and the gathering, presentation and use of radar data. The last two deal with two special techniques which hitherto have not had much notice—moving target indication and radar relaying. The seven intervening chapters are on radar design, first in its components and then as complete systems.

This work has been divided among the team of experts responsible for the whole series, and has been ably carried out. In spite of an apologetic note about continued shortages, the volume is to British eyes a handsome one, doing credit to the ambitious scheme of which it forms a part.

While acknowledging the value of most of the material thus presented, the reviewer cannot help feeling that it does not quite fulfil expectations aroused by the title. The considerable sections on the tactical use of radar during the war seem completely out of place in an engineering work that claims to pro-

vide a basis for design. There is sufficient matter to make up what ought to have been a separate volume, of military and historical interest. Space would then have been released for filling in some passages which are somewhat superficial and descriptive, and for practical design data. Present-day radar engineers are more interested in present and future equipment than in what was done during the war, and may be disappointed at having to reorientate this for themselves instead of having it done for them. This criticism, applied to a work that announces itself as a record of war work, may on that account be a little unfair; but seeing that the general principles of radar have already been written—in some respects better—it is a pity that the Radiation Laboratory staff could not have been retained long enough for them to have reached a more forward-looking viewpoint, at which they would have turned their backs on details of merely historical interest and been able to concentrate on quantitative data of more use to the practical radar engineer.

M. G. S.

The Principles & Practice of Wave Guides. By L. G. H. Huxley. Pp. 328+xi; 148 figures. Cambridge University Press, 200, Euston Rd., London, N.W.1. Price 21s.

THIS is the first of a new series of monographs to be published by the Cambridge University Press under the heading "Modern Radio Technique," the aim of which is to describe the advances in radio technique made during the war. It is based on courses given by the author at the Radar School of the Telecommunications Research Establishment.

The fact that a single hollow conductor could act as an efficient transmission line for waves of suitably high frequency has been known for many years, but prior to the war this waveguide had hardly emerged from being a laboratory curiosity. The development of centimetre-wave radiolocation, however, required also intensive practical and theoretical work on waveguides, and it is with these developments that the book is mainly concerned.

The first three chapters describe the various modes possible in rectangular and circular guides and the simpler properties of wave propagation in them. Those who have previously been alarmed by the seemingly difficult mathematics required in the study of this subject

will be gratified to find that the author uses only simple mathematics, and deduces the wave properties mainly from physical reasoning. The student thus gets a good appreciation of general principles, in which he is aided by excellent diagrams. But this process is limited, and the reader has for the moment to take many results on trust.

The fourth chapter introduces one to the many practical devices which have been developed—terminations, couplings, bends, transformers, etc.—and to some associated microwave apparatus. Examples are drawn from equipment designed for use at 9-cm and 3-cm wavelengths, but it is a pity that so much reference is made to 3in × 1in and 2½in × 1in guides as standards for the 9-cm waveband; these have little to recommend them and are now obsolescent.

In the next chapter waveguide techniques of a more advanced character are described. Impedance in waveguides and its relation to corresponding ideas in coaxial lines is treated well, but the reader will not gain much idea of when he may use the formula for intrinsic impedance and when that for total impedance. He will be more troubled later (p. 196) when he finds the formula for total impedance used under the name of intrinsic impedance. Detailed treatment is given of series and shunt junctions, and of such elegant devices as ring switches and T.R. cells.

Chapter 5 treats the modes of oscillation and some of the applications of cavity resonators. The diagrams are good, but it is not made clear which characteristic numbers are allowable for the different modes, and the E_{111} and E_{011} are wrongly stated as being the fundamental E-modes for rectangular and circular resonators respectively.

Thus far the mathematical treatment has been deliberately kept simple in order not to obscure the physical arguments; in the final chapter a purely analytical treatment is given, supplying the basic mathematical theory of the subject. The change is abrupt, and may come as a shock to the reader who thinks that he has learned everything without much mathematics, but it certainly has to be tackled if he is to have a sound understanding of the subject.

It is a good book, thoroughly up to date, and comprehensive, but it is spoiled by quite a number of errors, both of a major and a minor nature; none appear to be printer's errors. The layout and production of the book are attractive, and the price is not at all excessive.

H. R. L. L.

1998

Quality

**ACKNOWLEDGED
THROUGHOUT
THE WORLD**



ERIE

Radio & Electronic Components

**RESISTORS • CERAMICONS • HI-K CERAMICONS • POTENTIOMETERS
SUPPRESSORS • VITREOUS ENAMELLED WIRE-WOUND RESISTORS**

Erie Resistor Ltd., The Hyde, London, N.W.9, England.

Telephone: COLindale 8011-4. Cables: RESISTOR, LONDON.
Factories: London & Gt. Yarmouth, England • Toronto, Canada • Erie, Pa., U.S.A.

Stabilised Insulation BY MODERN IMPREGNATION METHODS

HYMEG

HIGH-SPEED PRODUCTION

Now, special methods of continuous conveyor impregnation and baking developed with the use of HYMEG have still further reduced processing times to a fraction of those previously believed necessary. Often faster than infra-red baking with none of the defects, reduced handling, absence of special jigs, with complete freedom from blistering, bubbling and porosity, are some of the advantages claimed and substantiated for HYMEG High Speed Production methods.

HYMEGLAS

GLASS FIBRE INSULATION SYSTEM

This integrated system of development is successful in enabling machines to be designed and operated without weak links in the chain of insulation below 200°C. Thus the fullest advantage is taken of modern glass fibre insulation by providing a degree of bonding and insulation at every point in which the uniting of Hymeg impregnation with the Hymeg as used for subsidiary insulations gives a solid homogeneous winding of equally efficient characteristics and heat resistance throughout.

Hymeglas therefore virtually eliminates any risk of insulation failure and enables motors and the like to operate under abnormal conditions for long periods without risk of electrical breakdown.

Due to the excellent space factor of glass fibre as compared with the more usual asbestos and mica Class B insulations, it is often possible in redesigning with the Hymeglas system to employ larger copper sections with well-known advantages.

The Berger Technical Service—the research work of which produced "HYMEG" and "HYMEGLAS" is available to advise manufacturers on all problems of insulation. Get in touch now with—

LEWIS BERGER & SONS LTD. (Est. 1760)
35, BERKELEY SQUARE, LONDON, W.1.

Telephone: MAYfair 9171.

MANUFACTURERS OF HIGH-PERFORMANCE INSULATING VARNISHES AND ENAMELS

WEBB'S Radio



**WEBB'S RADIO, 14, SOHO STREET, OXFORD STREET,
LONDON, W.1**

Phone: GERard 2089

Shop hours 9 a.m.—5.15 p.m. Sats. 9 a.m.—1 p.m.

Five & Ten Metre Converter

AS DESCRIBED IN THE CONSTRUCTIONAL ARTICLE IN
THE No. 5 EDDYSTONE SHORT WAVE MANUAL

If your receiver covers the recommended I.F. of 1.6 Mc/s (187.5 metres) the Converter will allow efficient reception of

FIVE & TEN METRE AMATEURS AND TELEVISION SOUND

Uses modern V.H.F. Valves EF50, EF54 and EC52.

FROM STOCK

5 & 10 METRE CONVERTER UNIT	
Assembled and tested (less valves)	£10 10 0
VALVES Types EC52, EF50, EF54	3 0 11
	£13 10 11

The necessary power supply of 6.3 volts 1 amp. and 250v. H.T. can usually be supplied from your receiver. If this is inconvenient use WEBB'S Power Pack "230/30," size 6in. x 6in. x 4in. ... PRICE £4 10 0

Wharfedale

NEW GOLDEN 10 inch LOUDSPEAKER...

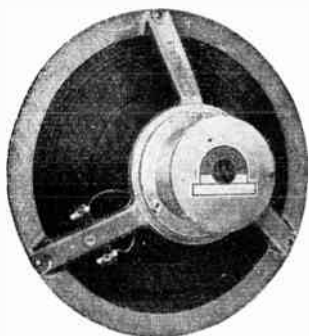

During the last six years hundreds of Wharfedale Golden Units have been supplied, and are still being supplied, to the B.B.C. and G.P.O.

It was selected by reason of its level response.

The new model is fitted with precision die-cast chassis, improved spider, and Alcomax 11 Magnet increasing the flux density from 10,000 to 12,500. Delivery 4-5 months.

Speech coil
3 or 15 ohms
impedance

PRICE 75/-

Made and Guaranteed by
WHARFEDALE WIRELESS WORKS

BRADFORD ROAD, IDLE, BRADFORD

Telephone: IDLE 461.

Telegrams: Wharfdel, Idle, Bradford

THE NEW **KOLECTRIC** HIGH SPEED PRECISION AUTOMATIC COIL WINDING MACHINE

Type A11

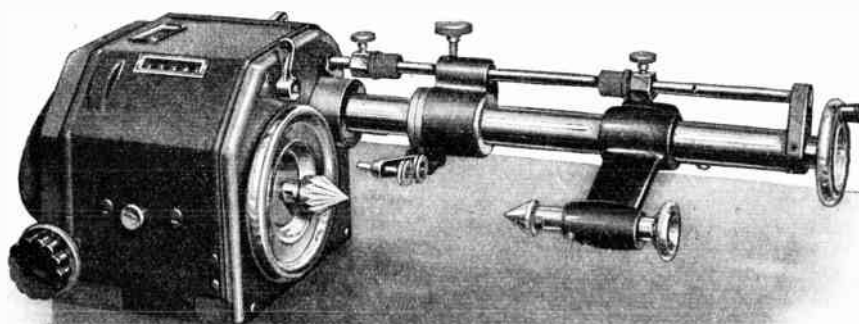

A few features:

Totally enclosed headstock.

Ease of operation and setting.

Winding of 2 coils simultaneously if required.

Infinitely variable micrometer wire gauge adjustment.

Wire gauges 25-50 S.W.G.

Winding Speeds up to 3,000 R.P.M.

Carriage setting handle.

Enclosed drive, with pedal control.

Write us for full information of this **NEW DEVELOPMENT IN COIL WINDING.**

KOLECTRIC LTD 20, Avonmore Road, LONDON, W.14

The Characteristics Tell!



TYPE "K."

S. G. BROWN, Type 'K' Moving Coil Headphones, with the following outstanding characteristics, supply that High Fidelity Reproduction demanded for DX work, monitoring and laboratory purposes, etc.

NOTE THESE CHARACTERISTICS.

O.C. RESISTANCE, 47 Ohms.

IMPEDANCE, 52 Ohms at 1,000 c.p.s.

SENSITIVITY, 1.2×10^{-12} Watts at 1 kc. = .0002 Dyne/cm².

Descriptive Literature on request.

PRICE **£5.0.0 PER PAIR.**

Supplies now available.

Order from your Local Dealer.

For details of other S. G. Brown Headphones (prices from 25/- to 60/-) ask for illustrated Brochure "W.W."

HEADPHONES WHICH UPHOLD BRITISH PRESTIGE.

Phone : ACO rn 5021.

S. G. Brown, Ltd.

VICTORIA RD., NORTH ACTON, LONDON, W.3



UNIVERSAL COUPLING

CONSTANT VELOCITY ★

TROPICAL BAKELITE INSULATION

FINEST QUALITY MATERIAL

★ Compensates for both axial and angular misalignment and provides accurate "ganging."

PRICE 2/9 RETAIL



JACKSON

BROS (LONDON) LIMITED

KINGSWAY · WADDON · SURREY

TELEPHONE: CROYDON 2754-5

TELEGRAMS: WALFILCO, PHONE, LONDON

THE BRIERLEY "RIBBON" PICK-UP

The high frequency resonance of this pick-up is over 20,000 c/s and is largely self-damped. These features have been realised by decreasing the mass of the moving parts rather than increasing their stiffness.

The frequency response is ± 2 dbs. up to 20,000 c/s with the coupling transformer in circuit. We do not however urge you to consider this a matter of very great importance. The important point is: how much of this frequency range can be used before the better tonal quality is marred by scratch, fizziness and even distortion which increase as the frequency range is extended?

Omitting for the moment the sad story of the "advance" in recording technique and other matters having considerable bearing on the subject, we ask you to consider the importance of ensuring distortionless reproduction not merely at a few selected frequencies, but over the whole frequency range.

Closely related to this is the question of longitudinal damping of the moving parts. It will readily be realised that to obtain a low point restoring force and negligible stiffness for lateral movement of the moving parts—essential where low point and record wear demand small downward pressure—and at the same time adequate longitudinal damping, presents a problem in itself far more important from a performance point of view and much more difficult to realise than a frequency response extending even to 200,000 c/s.

From time to time—as space permits—we propose to touch on the more interesting and the more relevant design features of pick-ups and to show why the BRIERLEY "RIBBON" PICK-UP has the widest useful frequency range.

For the moment we point out that this pick-up operates with a permanently fixed downward pressure of $\frac{1}{2}$ oz. It is entirely free from resonances throughout the whole range—due to a great extent to the exclusive use of the "Floating Element" design. The permanent point cannot be damaged by cracked records and will play 10,000 to 20,000 records (depending on the type and composition of the records).

The weight of the aluminium ribbon is about 0.15 milligram and the total mass of the moving parts is 6 to 8 milligrams most of which is concentrated near the axis of rotation giving a very low effective mass at the point. The output voltage is between 1/150 and 1/100th of a volt; there is no trouble whatsoever from hum and the instrument is not delicate. Price in U.K. complete with special Mumetal screened coupling transformer and including Purchase Tax, £8 16s. 10d.

Full information on "Ribbon" and "Armature" Pick-ups, Low Pass Filters, Pre-amplifiers and Amplifiers sent on request.

J. H. BRIERLEY (GRAMOPHONES & RECORDINGS) LTD.,
46 Tithebarn Street, LIVERPOOL, 2.

M. ALLEN (Radio) Ltd

113, CHARING CROSS ROAD, LONDON, W.C.2

SHORT WAVE COILS

FOR
BETTER
RESULTS
LARGE STOCKS
AVAILABLE



"IVALEK" INTERCHANGEABLE COIL SET comprising the following wave ranges:—12-24 Meters, 20-36 Meters, 30-80 Meters. 9/- per set of 3 coils. MEDIUM WAVE COILS 3/6 each. Call and see our exceptionally wide selection of Radio, Television, Electronic and Electrical instruments and components.

M. ALLEN (Radio) Ltd.

113, CHARING CROSS ROAD, LONDON, W.C.2.

Tel.: Gerrard 8734.

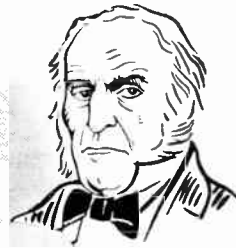

"DECISION BY MAJORITIES IS AS MUCH AN EXPEDIENT AS LIGHTING BY GAS."

Gladstone.

The majority of discerning people quote Lectrona Loudspeakers as the best on the market.

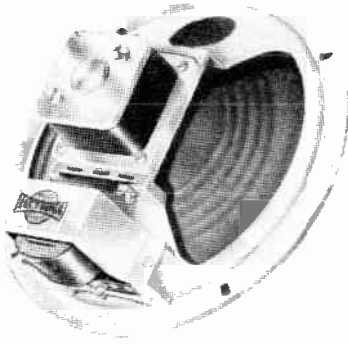

LECTRONA
 SALES
EDSTONE LTD
 7, PRINCES STREET
 WESTMINSTER · S.W. 1
 TELEPHONE · WHITEHALL · 0785/6

Difficult Problems?

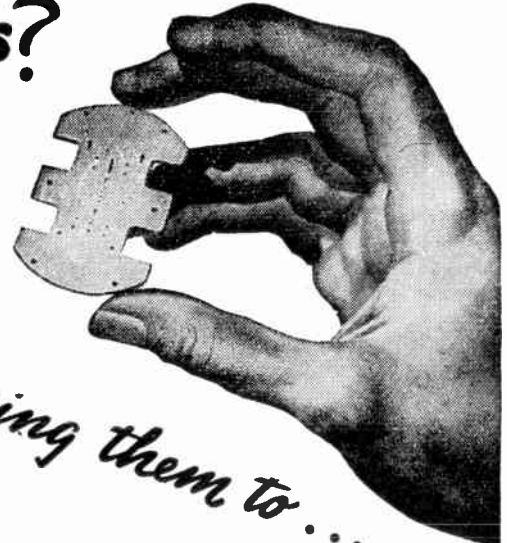
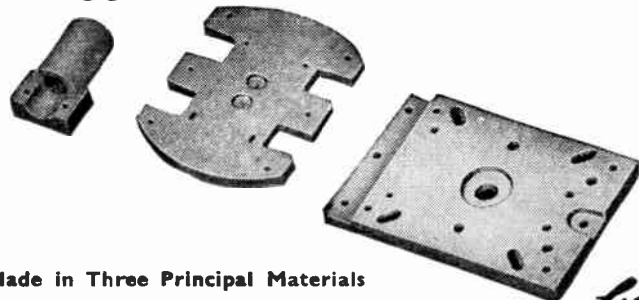

Made in Three Principal Materials

FREQUELEX
 An Insulating material of Low Di-electric Loss, for Coil Formers, Aerial Insulators, Valve Holders, etc.

PERMALEX
 A High Permittivity Material. For the construction of Condensers of the smallest possible dimensions.

TEMPLEX
 A Condenser material of medium permittivity. For the construction of Condensers having a constant capacity at all temperatures.



Bullers

BULLERS LOW LOSS CERAMICS

BULLERS LTD., 6, LAURENCE POUNTNEY HILL, LONDON, E.C.4

ISOLATION FROM VIBRATION

**NEW
VIBRATION
ELIMINATORS**

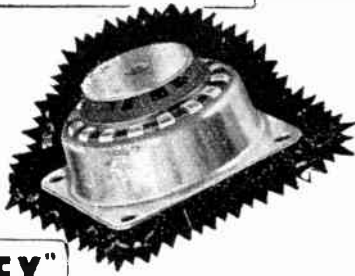

"EQUIFLEX"
REGISTERED AND FOREIGN PATENTS PENDING
MOUNTINGS

AN **AV** PRODUCT

"Equipflex" Mountings are invaluable for the mounting and suspension of machines, equipment, instruments.

electrical apparatus, motors, etc., and wherever elimination of vibration and shock is required.

SPECIAL FEATURES

Flexible in all directions at an equal deflection. Can be loaded on any side, thus eliminating vibration in Vertical, Horizontal and Longitudinal planes employing best quality natural rubber spring elements and complete with snubbing device. Special Fittings made to suit customers' requirements.

Also available as previously advertised, the ALL-METAL construction comprising an ingenious Damped Spring System. Write for illustrated brochure, and send us details of your requirements.

A. WELLS & CO. LTD. (Dept. W.W.),
STIRLING ROAD, WALTHAMSTOW, LONDON, E.17
Phone: Larkswood 2691

THE ROMAC MODEL 126
"Personal" RECEIVER

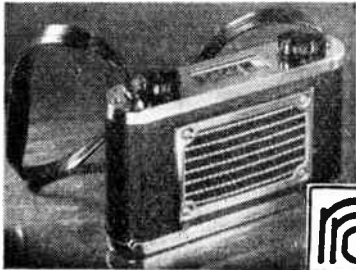

The Romac Personal Receiver is an entirely new departure in portable radio. The shoulder strap method of carrying has ingeniously been used to provide an "invisible" aerial. This convenient feature is exclusive to Romac Models.

Price £17 3s. 8d. Plus £3 16s. 4d. Purchase Tax
Complete with 1 H.T. and 2 L.T. Batteries.

Home and Export Enquiries should be directed to.

ROMAC RADIO CORPN. LTD.
THE HYDE · HENDON · LONDON, N.W.9.
Tel. No.: COLindale 5401 (Three lines).

EXCELLENT SELLING LINE

High Fidelity S.H.E.F.I. Moving Coil Pick-ups

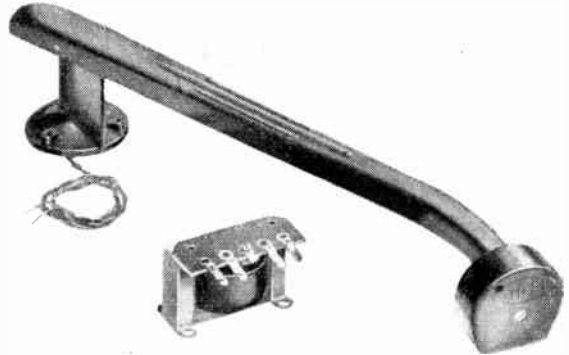

Retail Price, including Transformer - **£2.0.0**
Plus 8/11d. Purchase Tax. Generous Trade Discounts.

The only Moving Coil Pick-up with high level output. Will operate average receiver. No Pre-amplifier. No Shielded Transformer. No Hum Problem. Genuine High Fidelity reproduction flat to 1,200 c.p.s. with bass boost below 250 c.p.s. to allow for drop in recording level of 6 db. per octave.

Available for home trade and export. Immediate delivery in beautiful plastic finish.

This is one of many other electrical appliances. Overseas enquiries are invited. Agency arrangements may be made.

BROOKS & BOHM LTD.,
90, VICTORIA ST., LONDON, S.W.1. VIC. 9550-1441.



Manufacturers
of
LOUDSPEAKERS
•
LAMINATIONS
•
SCREENS
In
RADIOMETAL
•
PERMALLOY
•
SILICONALLOYS

ELECTRICAL SOUND & TELEVISION PATENTS LTD.
12, Pembroke Street, London, N.1. Terminus 4355
2/4, Manor Way, Boreham Wood, Herts Elstree 2138



We send you Greetings and Best Wishes for the New Year. The past months have been difficult for the trade, and we thank you for your patience and understanding. During the coming year we sincerely hope to meet the many demands for our receivers, and look forward to your continued co-operation.

McMichael Radio Ltd

London Office & Sales: 190 STRAND, W.C.2. Tel: TEMPLE BAR 2085.
 Grams: RADIETHER, LONDON. *McMichael Radio Ltd., Slough, Bucks.*
 Tel: Slough 22311

One megohm per volt!

The **MICOVAC**

SELF-CONTAINED BATTERY OPERATED
 ELECTRONIC TEST METER

A multi-range meter that will measure R.F. and A.F. signal voltages

The 17 ranges will give true readings of Bias and Screen, Anode and Mains voltages; D.C. currents to 1½ Amps, and Resistances to 100 Megohms.

Voltage multiplier 0-5000 v. D.C. and V.H.F. probe for 200 Mc/s also available.

PRICE £24.10s.

The versatile valve voltmeter for Experimenter and Serviceman



ELECTRONIC INSTRUMENTS LIMITED

17 PARADISE ROAD · RICHMOND · SURREY

Telephone: Richmond 4917

RAYTHEON CONTRIBUTIONS to development of Hearing Aids

Why batteries can now be little
instead of **BIG**

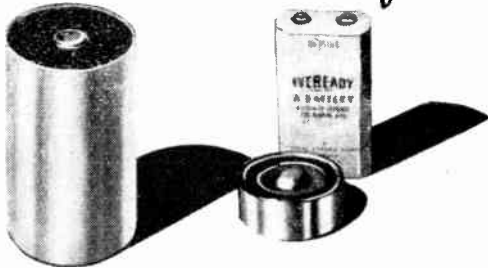

A big factor in making the modern Hearing Aid such a neat, compact instrument is the great reduction made possible in size of batteries. In 1939 valves used in the average Hearing Aid drew almost one-third of a watt from the "A" battery. Today, thanks to Raytheon developments in valve design and construction, drain on the "A" battery is 80 per cent less, battery life ten times greater, so that batteries can now be much smaller, with many times the life. Because of this and other important developments Raytheon is supplying more than 90 per cent of all Hearing Aid valves in use today.

Ask for complete information. Address your inquiry to Submarine Signal Company (London) Ltd., Artillery House, Artillery Row, London, S.W.1, England, or to:

South African Distributors:
Lynch-Wilde (Africa) (Pty) Ltd., Jo'burg.

RAYTHEON RAYTHEON MANUFACTURING COMPANY
INTERNATIONAL DIVISION
60 EAST 42nd STREET
NEW YORK 17, N. Y., U. S. A.
Excellence in Electronics

The **ROTHERMEL "Vibromike"**
for all Stringed Instruments

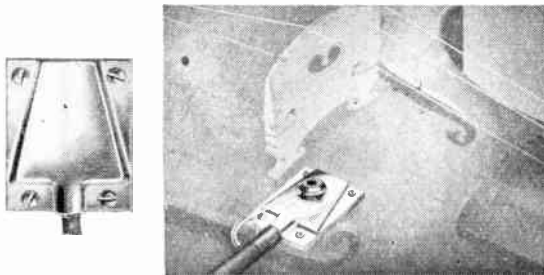

The ROTHERMEL 'Vibromike' is a contact microphone of the bender type designed for amplification of all stringed instruments, and is widely used for special orchestral effects. The crystal generating element is housed in a hermetically sealed case, and is therefore protected against adverse humidity conditions. When used with instruments such as violins, guitars, mandolins, etc., the output voltage is from .05 v to .1 v and higher. Any amplifier having high impedance input will be found satisfactory for use with the Vibromike.

● A full range of ROTHERMEL Crystal and other products in loose leaf catalogue form will be sent on receipt of 6d. to cover postage, etc.

PRICE £4 10 0 complete with 8ft. of flexible shielded cable. Plus Purchase Tax.

R. A. ROTHERMEL LTD.
Rothermel House, Canterbury Rd., London, N.W.6.

Telephone: MAIDVALE 6066 (3 lines)



THE COMPLETE SERVICE FOR SOUND RECORDING AND REPRODUCTION

- ★ Mobile and Static Continuous Recording Outfits.
- ★ Recording Amplifiers.
- ★ Moving Coil and Crystal Microphones
- ★★ Saophire Pointed Reproducing Styli and Cutters.
- ★ Blank Recording Discs from 5in. to 17in. Single or Double sided.
- ★ Light-weight moving iron, permanent sapphire and moving coil pick-ups.
- ★ Label and Envelope Service.
- ★ A comprehensive range of accessories to meet every requirement of the sound recording engineer.
- ★★ And our latest development (of special interest to users of sapphire or delicate pick-ups)—The Simtrol. This is a controlled micro-movement easily fitted for use with any type of pick-up to eliminate the danger of damage to the record or pick-up. This is achieved by a vernier lowering action of the pick-up head to the record.

Write for comprehensive lists or call at Recorder House for demonstration.

RECORDER HOUSE, 48/50 GEORGE ST. PORTMAN SQUARE, LONDON, W.1.

Telephone: WEL 2371/2 Telegrams: Simsole, Wesdo, London

SPHERE INSTRUMENTS



Introducing the **ALL WAVE SIGNAL GENERATOR** TYPE 505

A portable Signal Generator for AC Mains operation. Specially developed by SPHERE as a high class instrument, for general Laboratory and Workshop use, it is the ideal instrument for the aligning and testing of radio receivers and amplifiers.

This is a specially designed Generator embodying several new and unique features and improvements, which radio engineers will find invaluable.

All "SPHERE" Test-instruments are entirely British made with highest quality materials and workmanship and carry a SIX Months' guarantee.

- Continuous Frequency coverage from 110 Kilocycles to 56 Megacycles, in six bands.
- Exclusive "SPHERE" "SEE AT A GLANCE" Band and Attenuator indicators.
- Built in ladder attenuator, with fine control, giving 1 Volt maximum, in five steps, in multiples of 10 Microvolts.
- Radio and Audio Frequency Voltages can be switched via single Test-lead.
- Variable control of 400 C.P.S. audio, from 0 to 1 Volt.

FOR RADIO SERVICE, RADIO ENGINEERING AND LABORATORY USE.

Write for List No. 505 S.G.

SPHERE RADIO LIMITED

Radio Instrument Manufacturers

HEATH LANE, WEST BROMWICH

SPEAKING OF *Quality...*

The leading radiograms are fitted with Goodmans 12" loudspeakers.

Type No. T2/I205/15

GOODMANS

Loudspeakers
A TRADITION OF EXCELLENCE

GOODMANS INDUSTRIES LTD.
LANCELOT ROAD, WEMBLEY, MIDDX.



TWO OUTSTANDING MODELS

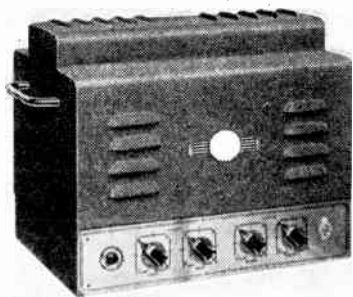

15 Watt Quality Amplifier Special Amplifier designed primarily for the high quality reproduction of Gramophone records. Incorporating a built-in variable scratch filter, bass and treble lift controls and negative feed back. A maximum output of 15 Watts is obtained, but low average listening levels may be run without deterioration in quality. The valve line up is:—2 ECC 32 Twin Triodes, 2 EF 50 Pentodes, 2 EL 37 Pentodes, 1 5U4G Rectifier.

Price £29.15.0

FROM THE



**RANGE OF
QUALITY
AMPLIFIERS**

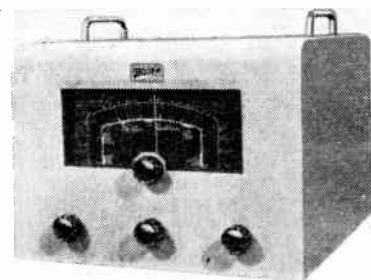

The Rad. 20 model illustrated is ideal for Schools, Clubs, Hotels, etc., where high quality reception of the normal broadcasting programmes is required. A Three wave band superhet radio unit of the very latest design is incorporated, and provision is also made for microphone and gramophone inputs. Available for 200 250v. A.C. mains.

Retail Price £44.15.0

**WODEN TRANSFORMER CO. LTD.,
MOXLEY ROAD, BILSTON, STAFFS. Phone: Bilston 41959**

J.T.L.

A "Laboratory" INSTRUMENT... but NOT "Laboratory" Price!

The newest addition to the "Advance" range of Signal Generators places an instrument of laboratory class within the financial scope of every radio service engineer and experimenter.

The discerning engineer will appreciate its accuracy and stability, its exceptionally wide range which covers all frequencies required for radio and television receivers, and its accurate attenuating system which enables sensitivity measurements to be made on highly sensitive receivers up to 60 Mc/s. Send for fully descriptive pamphlet.

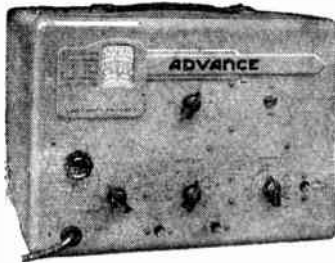

Range: 100 Kc/s—60 Mc/s on fundamentals (up to 120 Mc/s on Second Harmonic).

Accuracy: Guaranteed within $\pm 1\%$.
Attenuation: Constant impedance system embodying a matched 75 ohms transmission line.

Stray Field: Less than 3 microvolts at 60 mc/s; cles.
Illuminated Dial: Total scale length 30".

Power Supply: 110-210-230-250 volts.

Dimensions: 13" x 10 1/2" x 7 1/2" deep.
Weight: 15 lbs.

The New



ADVANCE COMPONENTS, LTD., Back Road, Shernhall Street, Walthamstow, London, E.17. Telephone: LARKSWOOD 4366/7

Specialists in 'SPECIAL' Waxes

Most applications of wax in the manufacture of electrical components demand special characteristics which can be met from the regular range of

OKERIN WAXES & COMPOUNDS

or designed to specification. Grades are available for arctic or tropical service—stable, moisture-proof—fungi-resisting.

For expert advice, samples, etc., please Telephone TEMple Bar 5927



(Sales Dept.)

Norfolk House, Norfolk St., Strand, London, W.C.2

Simple Arithmetic

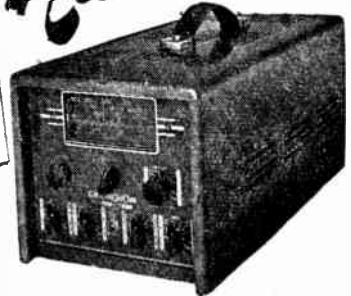

THE GRAMPAN 461 RECEIVER AMPLIFIER

This new high-grade reproducer has been specially designed for use in Small Factories, Hotels, Clubs, Swimming Pools, Municipal Buildings, etc., where it is desired to broadcast Radio or Gramophone Records and provide amplification of speech by use of a microphone. Let us send you further details.

A dual wave-band superheterodyne with Power Amplifier having an output of 15 watts. Provision is made for both pick-up and microphone inputs with separate volume controls and high and low impedance outputs. It is of extremely robust construction in an attractively finished metal case.

Price List £42 0 0
Plus £2 2 0
Purchase Tax
A.C. Mains ONLY

HAVE YOU HAD DETAILS OF OUR NEW LINES?

GRAMPIAN LOUDSPEAKERS

GRAMPIAN REPRODUCERS LTD. Hampton Road, Hanworth, Middlesex. Phone: Feltham 2657

Scientific G.6A.

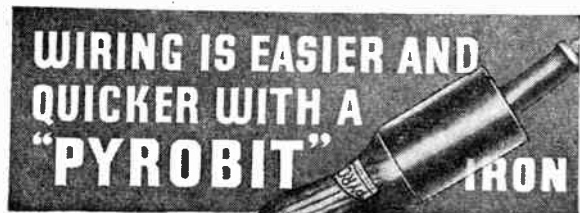

WIRING IS EASIER AND QUICKER WITH A "PYROBIT" IRON

To the amateur assembler, the "ham," the serviceman and the manufacturer, the Special Radio "PYROBIT" Electric Soldering Iron is the first essential tool. Light weight, perfect balance and handy shape double the pleasure and speed of wiring.

See one at your Radio, Electric or Hardware Shop or write for full details.

P.4

SPECIAL RADIO MODEL

7oz. 45watts

22/-

THE ACRU ELECTRIC TOOL MFG. CO. LTD.

123 HYDE ROAD, MANCHESTER 12. Tel: ARD. 4284

RM

PRODUCTS
INCLUDE

TRANSFORMERS, COILS AND CHOKES

R.M. ELECTRIC LTD., TEAM VALLEY, GATESHEAD 11, ENGLAND

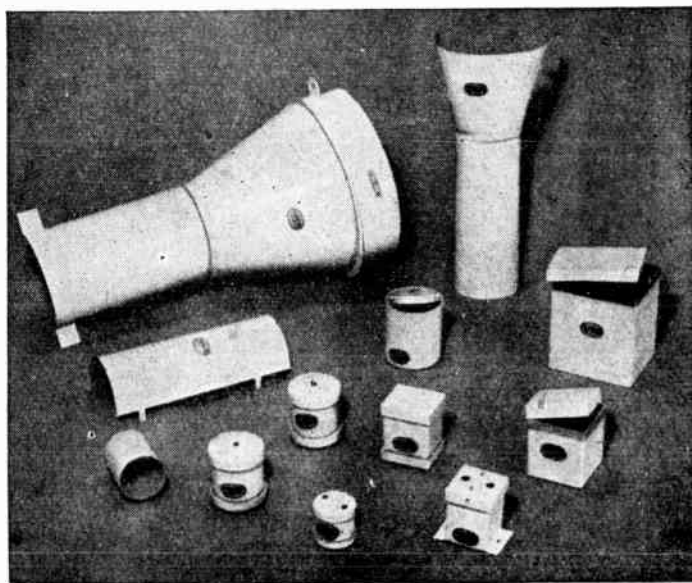

MUMETAL

REGD.

MAGNETIC SCREENS

The high permeability of MUMETAL makes it the outstanding material for the production of all types of magnetic screens. We are in a position to fabricate boxes and shields of practically any shape or size for the screening of delicate instruments and equipment from both uni-directional and alternating magnetic fluxes. A complete range of standard MUMETAL shields is available, examples of which are illustrated. Our technical experts will be pleased to assist in the solution of all screening problems. Your enquiries are invited.



TELCON METALS

THE TELEGRAPH CONSTRUCTION & MAINTENANCE CO. LTD.
Founded 1864

Head Office: 22 OLD BROAD ST., LONDON, E.C.2. Tel: LONdon Wall 3141
Enquiries to: TELCON WORKS, GREENWICH, S.E.10. Tel: GREenwich 1040

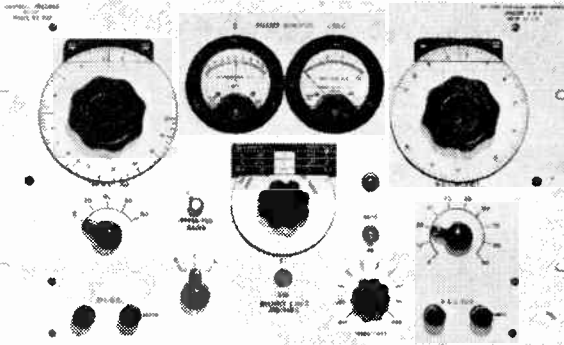

UNIVERSAL IMPEDANCE BRIDGE
MODEL UB 202

This is a self contained universal bridge which measures resistance at DC, Capacity and Inductance at 1000 Cycles. The necessary bridge voltage and null detectors are incorporated in the instrument. Measurements in condensers can be carried out with applied polarising voltage and inductances can be measured with superimposed DC.

Resistance Range .01 ohm to 1 megohm
Capacity Range 10 p.s. to 1000 m.S.d.s.
Inductance Range 10 μ H. to 1000 Henries

For particulars of this and our full range of measuring instruments write to:—

BRITISH PHYSICAL LABORATORIES
HOUSEBOAT WORKS, RADLETT, HERTS

Telephone: Radlett 5674-S-6

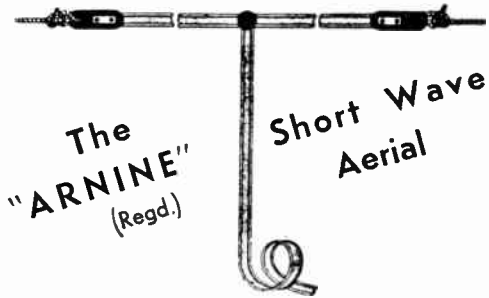

The "ARNINE"
(Regd.)

Short Wave
Aerial

For reception or transmission. Load factor 500 watts at 100 m/s. Aerial spans and down lead consist of twin parallel feeder of 300 ohm impedance, polythene insulated. Pack includes all the necessary insulators, fittings, etc., for easy erection.

Model FDA20 — £3 2 6
,, FDA40 — £3 12 6

ANTIFERRE
LIMITED

Sales Division:

67, Bryanston St., Marble Arch, London, W.1

Telephone: PADdington 7253/4/5

A5

Have you heard—

THE CONCERTO ?
FOR YOUR PICK-UP AND SPEAKER

This is the Finest Record Producer available because—

- | | |
|---|--|
| 1. Distortion is only 1½% at 6 watts, 2% at 12 watts. (Independently Certified Figures) | 4. Separate Bass and Treble Controls with a Double bass Boost Circuit. |
| 2. Hum Level is negligible. | 5. 12 months unconditional guarantee. |
| 3. It will take any type of pick-up—moving coil—moving iron—crystal. | 6. 9 Valve Circuit—8 Triodes plus Rectifier. |

PRICE £27 10/0

The "Concerto"—the Amplifier that is making itself heard
CHARLES AMPLIFIERS LTD., 1E, Palace Gate, Kensington, London, W.8. (Phone: WEStern 3350)



Products of
Quality & Reliability

MAINS TRANSFORMERS
A. F. TRANSFORMERS
THERMAL DELAY SWITCHES
SMOOTHING CHOKES
POWER RESISTANCES

Made by

OLIVER PELL CONTROL LTD

Telephone: WOOLWICH 1422-1426
CAMBRIDGE RDW • WOOLWICH • S-E-18

Subject to the provisions of the Control of Engagement Order, 1947.

A VACANCY occurs for the appointment of a Telecommunications Engineer in the States of Jersey Harbours and Airport Committee's Telecommunications Department.

Candidates must be of British parentage and be between the ages of 35 and 45 years, with administrative experience, possess a professional qualification in electrical or radio engineering or have equivalent experience, being accustomed to staff control and station organisation. Preference will be given to candidates having experience of the latest technical developments in connection with civil aviation ground station equipment and who have a knowledge of telephone systems and line work. A good knowledge of aeronautical, marine and line operational work is essential, an operational qualification being an advantage.

The commencing salary will be £460 per annum, rising by annual increments of £20 to the maximum of £560.

Applications in writing, giving full details of experience, should be addressed to the Superintending Engineer, Telecommunications Department, States Airport, Jersey, C.I.

R.A.F. MORSE OSCILLATORS

(Valve Buzzers Type 2). A 2 valve battery 15/- (Less Valves) operated Morse oscillator, ready for instant use without adaptation. Carr. and Packing 2/6

Incorporates note selector control, volume control, phone, key and interference jacks. Size 9" x 8" x 8½". Power supply required, HT 60v., GB 4½v., LT 2v. (Provision for internal fitting). Price complete with 2 valves (PM1LF and PM2A) 27/- (carriage and packing 2/6).

Government surplus stock, brand new condition. Complete kit consisting of oscillator, valves, heavy-duty Morse key and pair of S. G. Brown phones for 32/- plus carriage and packing. Wooden transit cases 2/6 extra.

Watch next month's announcement of the release of the Burgoyne Seven Second Solder Gun.



MAIL ORDER SUPPLY CO.
24 New Road, London, E.1.
Stepney Green 2760-3506.

Rate 6/- for 2 lines or less and 3/- for every additional line or part thereof, average lines 5-8 words. Box Numbers, 2 words plus 1/-. Press Day: January 1948 issue, first post Thursday, December 4th. No responsibility accepted for errors.

WARNING

Readers are warned that Government surplus components which may be offered for sale through our columns carry no manufacturer's guarantee. Many of these components will have been designed for special purposes making them unsuitable for civilian use, or may have deteriorated as a result of the conditions under which they have been stored. We cannot undertake to deal with any complaints regarding any such components purchased.

NEW RECEIVERS AND AMPLIFIERS

TWO-WAY amplifiers for inter-comm. or baby alarm, with speaker in attractive cabinet; £12/12.

D. E. WHITE, 95, Friern Rd., London, S.E.22. [8762]

2 WAVE-BAND radios, illuminated dial, choice of sprayed cabinets, £9; s.a.e. please.—Box 3909. [8707]

WAKE the easy way with the Reveille clock-radio, £12/12 retail; send for leaflet.—Thames Valley Products, 28, Camden Ave., Feltham, Middx. [8786]

AMPLIFIERS; new 1947 model Hi-Fi units, with triple tone controls, built to customer's specification.—Broadcast & Acoustic Equipment Co., Ltd., Broadcast House, Tomland, Norwich 2697. [6433]

POCKET size, all-dry s/w receivers, 11½ x 9¼ x 1½ in., brand new, c/w, 4 spare valves, phone and aerial, by Crosley's, U.S.A., weight approx. 7lb, price £7 each.—Carbot, Ltd., 201, Long Lane London, S.E.1.

OSMOR A.C.-D.C. 3-wave 5v superhet receivers, excellent reproduction and sensitivity, attractive cabinet, early delivery, shipping waveband if required; write for literature; trade enquiries invited.—Morgan, Osborne & Co., Ltd., Southview Rd., Warringham, Surrey. [7286]

BAKER'S—New 7-valve "Wireless World" Quality amplifier with tone control stage, 8 watts push-pull triode output, price includes super Quality triple cone, 12in permanent magnet speaker, with large output transformer and all valves; also as above but with 15 watts tetrode output, ideal for realistic reproduction or public address; 2½d stamp, parts, prices, etc.—Bakers Selhurst Radio, 75, Sussex Rd., S. Croydon, Croydon 42a.

BETTER finest amplifier I have yet heard;—This is what a satisfied customer states about our amplifier, built to "W.W." (May issue) design; quality parts only used, producing superb results; price £25/10; kits of parts can also be supplied; pre-amplifier, elec. motor and pick-up and 12in speaker extra.—Enquiries to Radio Trades Manufacturing Co., Laurel House, 141, Little Ealing Lane, W.5. East 6962. [8331]

GOODSELL, Ltd., 40, Gardner St., Brighton, 1.—For highest quality reproduction use the Williamson amplifier as per specification, £20/10; best quality components, including transformers and chokes, oil reservoir and smoothing condensers, per-amp for same, fitted E.F.37 valves in 4 position bass and treble control circuit, £2/10; special pre-amp for moving-coil pick-up using E.F.37 for first stage and E.F.37 in tone control as above. £2/4. [8791]

SPECIAL offer: Midget communication receiver and power pack (M.C.R.I.), 5-valve superhet, complete with aerial and earth equipment, lightweight headphones; range 20-3,000 metres in four bands, operates on any voltage between 97 and 250 A.C. or D.C.; £9/10; send for one now before stocks are exhausted; large stocks held of C.R.T. Units, metres, switches, fuse holders, etc.; low prices; send for 6-page list; trade supplied.—L. Wilkinson, Wholesalers, 204 Lower Addington Rd., Croydon, Add. 2027. [8624]

REDDYSTONE 504, complete speaker, as new; £52.—Box 4040. [8775]

A.R.77E, perfect condition, 550 kc/s to 30 mc/s; £25.—Box 3743. [8637]

WALKIE-TALKIE TX/RX, new, c/w all extras; 12gns.—Box 3746. [8647]

5 v ac/dc midget superhet, m & s wave, as new; £12.—BM/CXRJ, London, W.C.1. [8731]

AMPLIFIER, A.C., G.E.C. gram/mike, 15 watts; good condition, £10.—Box 4009.

H'CRATER Skychief, 37; 18-5, 5-1.5, 1.5-0.5 mc, 240v, £14.—Parker, 5, Wentworth Hill, Wembley. [8731]

H.R.O. receiver, fitted S. meter, crystal, etc., including 7 coils, spare valves, phones and power unit; new condition, £55.—Box 4029. [8757]

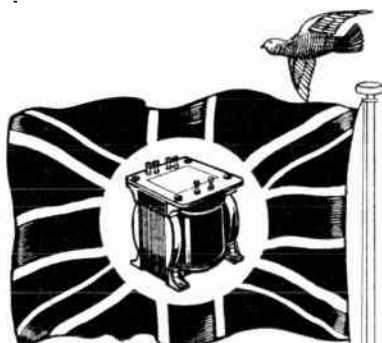

British to the Core

Known the world over as makers of the finest transformers, we export even to America and to New York component firms at that—convincing proof of the quality of British products and of PARTRIDGE transformers in particular.

OUR EXPORT DEPARTMENT

is at the service of all OVERSEAS BUYERS and we welcome your enquiries.



For Home Buyers our Consulting and Supply services are available as usual and we would remind you that PARTRIDGE Precision Built TRANSFORMERS would to suit your individual requirements are still available.



Catalogue will be sent on request, detailing components available from stock.

Telephone:  Abbey 2244

PARTRIDGE TRANSFORMERS LTD

76-8, PETTY FRANCE, LONDON, S.W.1

R.C.A. AR.88 II, in perfect condition; offers over £40.—Box 3902. [8671]

R1155, 6V6 output, mains power pack, £14; moved district without mains.—Tunstall Rectory, Sittingbourne. [8741]

15 WATT amplifier, Callaro turntable and pickup, 12in Goodman's speaker in cabinet; £25 lot.—Box 212. [7747]

WALKIE-TALKIE, 2 complete transmitter-receivers, as new; £5 ea, or nearest offer.—14, Commercial Rd., Totton, Southampton.

SHOP-SOLLED only—£44 Gramspan radio ampl. model 461, £29/10; £23/10 Vortexion 15watt ampl., £16/10.—Wilson, Alnwick.

RECEIVER, type BC348-Q, as new, 200 kc/s to 18 mc/s, 2 R.F., 2 I.F. Xtal gate, 100; 1 dial; best offer over £30.—Box 4012.

M West console, 18 valves, 5 wavebands, walnut case, £30; Howard Send receiver, 6 valves, 4 wavebands, metal case with instruction manual, £25.—Box 4010. [8725]

COMMUNICATION receivers, 8-valve R.109, as new in original packing case, complete with circuit and working instructions £6, plus 5/- cge. and pkg.—Box 4013. [8734]

WIRELESS WORLD 2-R.F. quality tuner for use with "Wireless World" quality amplifier, new, £5/10 less valves, which are easily obtainable.—Box 3538. [8589]

FOR sale, Hammarlund super pro-comm. receiver, recently overhauled completely by Webbs, perfect cond; best offer over £40.—Villiers, 45, Abbey Rd., Sompston, Sussex.

SOUND SALES console radio, 3 wavebands, variable selectivity, phase inverter speaker, slightly shop solled; reduced to £50.—Wallace Heaton, Ltd., 127, New Bond St., London, W.1.

7-VALVE "Wireless World" quality amplifier, with tone control, 15 watt tetrode output, by Bakers Selhurst Radio; used only few hours.—Jones, Motor House, Falcon Av., Edinburgh. [8708]

R.C.A. console receiver, 12 valves, p.p. output, 12in speaker, motor tuning, band-spread, cabinet 35½ x 37in, nice condition; £75; going abroad; other household items.—Please write, BM/GFX, London, W.1.

BC342 and BC312 communications receivers, B complete and in proper working order, £18, or for 230v A.C., £19/10 plus carriage and deposit on packing; send for details.—Barton, 41, Bedminster Down Rd., Bristol, 3.

QUALITY!!! Push-pull amplifier, PX4's, 6 watts output, 2 h.f. tuning unit bass boost 10 DB, on P.U.; 2 large oak Howe box baffles with Baker speakers; nearest to £40.—J. Richardson, 70, Norbury Hill, S.W.16, Pollards 2578. [8772]

A.C. 5-valve 8-watt push pull amplifier, A negative feedback, complete with large multi-ratio output transformer, £9; ditto 10-watt 6V6, £10; a range of feeder units T.R.F. and superhet from £5/5.—R.T., 64, St. Leonard's Rd., London S.W.14. [8253]

THREE-STAGE resistance capacity miniature amplifiers with three tested 1T4 midjet valves, 20/- each, post free; in aluminium case, 22/-; spare 1T4 valves, guaranteed 6/- each; holders, 6d each.—Littler 24, Stanley Rd., Whalley Range, Manchester.

DE luxe R.C.A. portable amplifier 50 watts, D for 2 controlled microphones, high and low impedance, Monitor phones, £50, 20 watt amplifier for superb gramophone reproduction, £20, 2 electric turntables with pick-ups, £5 each. Can be seen between 1 p.m.-2 p.m. or after 6 p.m.—Tel. Kensington 0808 or write 21, Sloane Avenue, S.W.3

CRYSTAL radio receiver, complete with headphones and aerial and earth wires, £1/1; extra phones, 4/11 pair; the set will comfortably work up to four pairs; self-energising telephones, no batteries required, sold separately at 2/6 each; four are needed for 2-way communication; twin wire, 3d yard; 60 microamp meters, two mounted in one case, 10/-; aerial dummy loads, 43 ohms 100 watts, standard 4-pin base, 2/- each; 0-3 amp thermo ampeters, basic movement 3.5 ma, 7/6 each; 0-6 amp thermo ampeters, basic movement 3.9 milliamps, 10/- each; 0-110-230v transformers, 4-0-4v at 6 amps output, 10/6; neon aerial current indicators, 3/6.—Park Radio of Manor Park, 676-B, Romford Rd., E.12.

MORSE EQUIPMENT

MORSE practice equipment for classroom or individual tuition; keys, audio oscillator for both batt. or main operation.—Webb's Radio, 14, Soho St., W.1. Ger. 2089. [2291]

TEST EQUIPMENT

INSTRUMENTS

MOST makes in stock, some on terms.—Write for details and list of radio and electrical spares, new and ex-Govt., to The Instrument Co., 244, Harrow Rd., London, W.2.

AVO ac oscillator, all-wave, as new; £10.—16, Thurlow Gds., Wembley. [8733]

OWING death owner, radio test equipment; £12.—67, Mill Rd., Leighton Buzzard.

SAPPHIRE JEWEL POINT



The
GOLDRING
PERMANENT NEEDLE

ERWIN SCHARF
49-51a, DE BEAUVOIR RD.,
LONDON, N.1.

Tel.: Clissold 7713-0941. Cables: Echovox, London.

GOVT. SURPLUS, UNUSED

CONDENSERS

of all types . . .

We can offer, FOR IMMEDIATE DELIVERY from very generous stocks, a wide range of ultra-high quality fixed paper Condensers, from .001 μ F to 8 μ F. Also STOCKS of small, genuine MICA Condensers from .00001 (10 pf) to .01 μ F (10,000pf). Prices are exceedingly moderate.

Enquiries are invited for manufacturers requirements, wholesale and export only for bulk quantities, and for scheduled deliveries over a period, as required. Condensers of close or very close tolerance can be supplied within about one week.

Please request our 4 page bulletin CONSEVEN 011147

CLAUDE LYONS LTD.
180, Tottenham Court Rd., London, W.1
and 76, Oldhall St., Liverpool 3, Lancs.

TAYLOR model 65b sig. gen., new; list price.—BM/CXRJ, London, W.C.1. [8804]
WESTON analyser, E772, perfect condition; £16/10.—Poole, Kenneth House, Dogpole, Shrewsbury. [8720]

TAYLOR model 30 C.R.O., as new; offers over £20.—Haworth, 98, Swinley Lane, Wigan Lancs. [8636]

FURZEHILL Laboratories oscilloscope, type 1936, as new, £33 or offers; owner going abroad.—Box 4038. [8770]

AVO mode 7 meter, as new, £16/10; Avo valve tester, overhauled by makers, £12.—R. K. Wilson, Alwicks. [8730]

COSSOR 339A oscillograph and Rola G12, 2,500 ohms.—Offers to Rushton, 8, Broad Walk, Wilmslow, Cheshire. [8656]

TAYLOR 65 oscillator, 100 service charts, valves, etc.; lot £20.—Driscoll, 13, Land Lane, Marston Green, Birmingham. [8753]

WESTON E772 20,000 OPV analyser, £8/15 spent on overhaul by makers in October, with circuit selector and English valve adaptors; offers.—Box 3907. [8704]

COMBINED signal tracer and V.V. meter in kit form, £10/10; lists of range of test instruments available.—L. A. MacLachlan & Co., 16, Thistle St., Stirling. [8578]

QIN thermocouple moving coil milliammeters, 0-350mA, new ex-Gov.; a bargain at 5/6 each, £3 per doz., post free.—J. McMillan, 5, Oakfield Road, Bristol, 8. [8717]

R-J RADIO SERVICE, of Birmingham, can supply from stock all Avo instruments, also Sphere and BPL signal generators; list prices.—R-J Radio Service, 264a, Rocky Lane, Birmingham, 22B. [8728]

AVO valve tester with latest type roller contact selector panel for 1.4-volt valves £16; B.P.L. all-wave mains oscillator with variable L.F. output in makers wrappings, £20 or best offer.—Box 3744. [8643]

DOUBLE reading voltmeters, moving coil, 0/15, 0/250, 2 1/2 in dial, standard pocket type; trade and wholesale only.—Harris & Russell, Ltd., 80, Tottenham Court Rd., London, W.1 (Museum 6061). [8724]

NOW ready!—New Nuplans multimeter, to measure AC/DC, V, mA and amps., resistance 0-1 meg., capacitance 1,000V, for 0-1 mA, 100 ohms M/C meters.—Full plans, 2/6.—Bradley, Winnie Knowe, Sennen, Cornwall.

DYNATRON audio oscillator, improved aerogic design, auto. osc. control, 45-18,000 cycles in 11 calibrated steps, metered output 0-2.5V, 0-25V, unused, £16. Baldwin "Muler" capacity tester 50uuf to 4uF, £4.—Gerry, 36, Bank Street, Newquay. [8784]

MICRO ampers.—Model 505, D.C., Turner Electrical Instruments, F.S.D. 100 0 100, moving coil, zero set screw, dead beat, 2 1/2 in dial, 3/4 in diameter, moulded bakelite case, Govt. surplus, new, in original cartons, 1st grade, 30/.—Below.

AMMETERS—Range 0-100, moving coil with leads and shunt, by Victoria Instrument Co., 3/4 in flush fitting, bakelite case, zero set screw, dead beat, Govt. surplus, new, in original cartons, 1st grade, 25/.—Below.

VOLT meters.—Range 0-120, moving coil, by Victoria Instrument Co., 3/4 in flush fitting bakelite case, zero set screw, dead beat, Govt. surplus, new, in original cartons, 1st grade, 22/6.—Below.

TEDDINGTON ENGINEERING Co., High St. Teddington, Middx Kin. 1193-4. [8583]

CLYDESDALE for bargains in ex-Services electronic equipment. Unused Wheatstone Bridge WA10771, 20-0-20 galvanometer range 0-210 can be extended, our price only 50/., carr. paid; unused AN/APA1 C.R. indicator and repeater amplifier unit 3BP1 C.R.T., in adjustable case, amplifier with 11 valves, etc., our price only 97/6, carr. paid; set of plugs for AN/APA1 at 7/6; as new, A1134, 2 valve, 2 stage, pre amp or intercom unit, our price only 15/., carr. paid.

CLYDESDALE SUPPLY Co., Ltd., 2, Bridge St., Glasgow, C.5. [8710]

WAVEMETERS—Special offer of ex-Govt. wavemeters, suitable for general use, all in working order and calibrated. Type G61 contains temperature controlled 1 mc/s crystal, and covers 1 to 25 mc/s with very high precision, £20 each; Type 10T/67 contains 100 kc/s and 1 mc/s crystals, with switched tuned circuits directly calibrated 30/86 mc/s, £4/10 each; Type 10T/69 contains 100 kc/s and 1 mc/s crystals with 2 sets switched tuned circuits directly calibrated 25/130 mc/s, main operated, £8/10 each; Type G57, 100 kc/s to 24 mc/s, £5 each; s.a.e. for details.—BM/RXBP, London, W.C.1. [8716]

NEW LOUDSPEAKERS

AMPLIFIERS, speakers at wholesale prices; example: 10 watt, push-pull, £8; 10 watt quality, £14; 15 watt, R.S. portable with twin speakers and microphone, £26; record-playing units of every description; Goodmans 12in speakers, £5/19; Rola 8in, 21/.; s.a.e. list.—Radio Unlimited, 16, Carnarvon Rd., Leyton.

RELIANCE POTENTIOMETERS

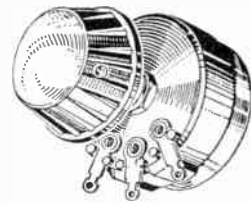

Types T.W. and S.G.

T.W. Wire-wound track—

Rating: 5 watts (linear) Max.
3 watts (graded) do.

Ranges: 10 Ω -100,000 Ω (linear)
100 Ω -50,000 Ω (graded)
100 Ω -10,000 Ω Non-inductive

S.G. Composition track—

Rating: 1 watt maximum.

Range: 2,000 ohms to 2 megohms.

Characteristics: (either type)

Linear, log., semi-log, inverse log., non-inductive, etc

Write for full details to:

RELIANCE

Manufacturing Co. (Southwark) L'd.

Sutherland Road, Higham Hill,
Walthamstow. E.17

Telephone: Larkwood 3245

EX-GOVT. EQUIPMENT OFFERS

LOUD HAIKER MICROPHONE, made by "Ardente." Has On-Off switch, and is complete with 50ft. cable. Ideal for remote control use. Only 7/6 (carriage, etc., 2/-).

EX-R.A.F. TX/RX UNITS. Operate between 155-185 mc/s. Complete with following valves: 2 type RK34, 1 type EF50, 4 type SP41, 3 type D1, and 20 watts rotary transformer. Only 37/6 (carriage, etc., 5/-).

EX-R.A.F. AMPLIFIERS. Contains valves types OP21 and 210 LF. Ideal for adding amplifier stage to take grammo. pick-up, etc. **BRAND NEW**. Only 25/- (carriage, etc., 2/6).

EX-R.A.F. MODULATOR UNITS, TYPE 2. Range 2400-6250 kc/s. Complete with 210 LF valve and 0-500 microamp D.C. moving coil meter calibrated for percentage modulation. **BRAND NEW**. Only 65/- (carriage, etc., 3/6).

WAVEMETERS, CLASS D, No. 1 MK. II. Frequency ranges 1.2-2 mc/s. with check frequencies up to 25 mc/s. Incorporates dual crystal 100/1000 kc/s, and is accurate to within 2 kc/s. Complete with valves and vibrators, crystal, instruction book, etc., in teak carrying case. **BRAND NEW**. Only £6/15/-, or a few only available without spares at 85/- (carriage, etc., 3/6).

T1154 TRANSMITTER KITS. The complete Master Oscillator Tuning Unit and the Output Unit for P.A. for the famous T1154 Transmitter. Add the valve assembly and build your own TX covering 10-5.5 mc/s, 5.5-3 mc/s, and 500-200 kc/s. Circuit details supplied. **BRAND NEW IN MAKERS' CARTONS**. Only 49/- (carriage, etc., 6/5). C.W.O. please. S.A.E. brings current lists.

THE RADIO CORNER

138 GRAY'S INN RD., LONDON, W.C.1
(Terminus 1931)

(2 mins. from High Holborn, 5 mins. from King's X)

Open until 1 p.m. Saturdays.

HIGH quality, precision-built speakers. Hi-Ticonal magnets, detachable diaphragms, die-cast chassis, twin cone.—Broad-cast & Acoustic Equipment Co., Ltd., Broad-cast House, Tombland, Norwich 26970. [6435]

MAGNAVOX 66, 2,000 ohm field. Voigt H.C. horn, Hartley Turner 750 ohms field, infinite baffle corner deflector with 12in 25w p.m. unit; latest types 12in R.K., Celestion, Wharfedale W10C.S.—Burley, Balaquava Rd., Derby. [9742]

£5 Auditorium permanent magnet speaker, with triple cone, manufactured by Bakers Selhurst Radio, the pioneer manufacturers of moving coil speakers since 1925, wide frequency range, even response, ideal for quality reproduction, fitted with magnet, having exceptionally high flux density in the air gap, suitable for public address equipment when quality reproduction is first consideration; send 2/6d stamp for leaflet giving details of above and constructional details of a new acoustic chamber designed to extend loud speaker frequency range.

£8/19/6. New Baker super power cinema permanent magnet speaker with 18in triple cone of new design, giving wide frequency response free from objectionable resonances; speech is clear and natural and music is reproduced with exceptional realism; fine engineering job, extremely sensitive; ideal for public address equipment when power handling capacity, plus realistic reproduction, is required; prompt delivery per pass. train.—Bakers Selhurst Radio, 75, Sussex Rd., S. Croydon. (Croydon 4226.)

LOUDSPEAKERS, SECOND-HAND

WESTERN Electric 555w 200v field, perfect; £10.—Clissold 5255. [8678]

TWO Goodmans T/12 loudspeakers, unused; £5/10 each.—BCM/Tech, London, W.C.1.

VOIGT unit, horn, power pack; £20, working.—Altham, Little Shelford, Cambridge.

A.E.C. twin-cone Hi-Fi 12in loudspeaker, new; £7.—Mellors, Highfield, Sidmouth.

VOIGT H.C. corner horn with bass chamber; £12, no offers.—Duffy, 93, Rutland Gardens, Harringay, N.4. [8695]

WHARFEDALE W10/C.S., £4; Voigt H.C. corner horn and base chamber, offers.—113, Hazel Rd., Huyton, Lancs. [8754]

BAKER 12-inch triple cone speaker, 15 ohms, complete with infinite baffle cabinet in the white, new, £6/10.—Box 3535. [8590]

EXCHANGE Goodman's Axiom 12 twin cone Hi-Fi, new for Hartley Turner 215; cash adjustment.—Furness, Braeknowe, Pitlochry, Perthshire. [8773]

TWO highest efficiency, quality American speakers, both perfect. Jensen M-10 auditorium 12in Bohm 15-25w in bass-reflex cabinet, pressure type unit 16ohm 5w 3in month, sound sales., P.P. 50w trans., pri., 6,000 and 3,000 A.A., esc., 2-4-8-16 250-500, feedback C.T. coil, as new unused. Tel. Finch. 2315.—W., 76, Holders Hill Rd., N.W.4.

DYNAMOS, MOTORS, ETC. Special offer of unused single phase marine type motor alternators, input 220v D.C., output 230v A.C. 50 c/s, 3.5 amp, £20 each; 220v D.C. to 230v A.C., 50 c/s, 0.87 amps, £9/10 each; 110v D.C. to 30v A.C. 50 c/s, 0.87 amps, £8 each; carriage extra; s.a.e. for details.—BM/ RXBF London, W.C.1. [8715]

SANGAMO synchronous motors, self starting, 200-250v, A.C. 50 c/s., consumption 2½ watts, size 2¼x1x2in, geared 1 rev. 60 mins. can be reset to zero by friction drive from front or back shaft, ¾x1¼in, to run clockwise, ideal movements for making electric clocks, time switches, etc., nickel-plated finish, price 22/6 ea.; 12 to 1 dial trains to fit above spindle, 2/6 per set extra; Chamberlain & Hookham synchronous motors with enclosed rotor, similar specification as Sangamo, consumption 3 wats, price 27/6 ea., complete with 12 to 1 dial train; 1/3.5 lenses, 2in. dia., by well-known makers, ex-factory stock, as now fitted in oxidized mount, flange, etc., ideal for projectors, enlargers, cameras, etc., price 27/6 each, postage 6d; to callers only, Bendix 6 wave-band receivers, type R.A.I.B., Bendix type R.A.10 receivers; receiving units, type 69; C.R. power units, type 526; performance meters, type 53874; A.C. mains wavemeters, type W1252; battery wavemeters, type W1095; receivers, type 1147; A.C. mains power packs for 1147; indicator modulators, auto transformers, receivers, type 76A; battery driven amplifiers, large assortments of volt. amp and milliammeters, neutralising units with R.F. meters, metal rectifiers, relays, vibrator packs, inter-com. sets, signal generators D.C. to A.C. converters; 12 and 24v D.C. to 230v A.C. Sun Vic delayed action control, 3,500 watts, blower motors, G.E.C. gas-filled mercury relays; Brown's A. type headphones; E.M.I. cathode-ray tubes; 6-valve receivers incorporating Clrstron unit, etc.—H. Franks, 58, New Oxford St., W.C.1, Tel. Mus. 9594. [8726]

ELECTRADIX BARGAINS

MOTORS. D.C. 230 volt, 1/12 h.p., 1,500/2,000 r.p.m., shunt wound, by Croydon, 25/-; a few needing minor repairs, 12/6 each, postage 2/6 extra.

MOTOR BLOWERS. Keith Blackman, 24 volts D.C., 5" inlet and outlet, a robust machine, £5.

METERS D.C.—Moving coil Weston Meters—2in. dia. flush fitting, full scale 500 micro amps-scale for 15 volts and 600 volts will measure 15 v. but need external resistors for high voltages, 20..

CIRCUIT BREAKERS. N.C.S., 7½ amps. A.C. enclosed type, 21/-. Ellison make mounted on sub-base, D.P.O./L 200/230 v. A.C. single phase, 200 amps. 15in. x 13in. x 12in., weight approx. 50 lbs., ditto 300 amps. 17½in. x 14in. x 15in., weight approx. 89 lbs., 220 volts, 1,000 amps., 5P, 50 cy. D.P. with no volt hold-on coil, loose handle, switchboard mounting oil switches by Ferguson & Palin. All offered at very low prices to clear.

SWITCHES.

Dewar key panel type, 8-pole C.O. flush fitting, 5/-. Yaxley 3-pole 3-way, 3/6; 8-pole, 1-way, 3/6. D.P.C.O. toggle switch 250 v. 1 amp., flush panel, 3/3; 8-way Lucas switchbox, 3/6; 6-way, 3/-. 

TRANSFORMERS. B.T.H. 200/230/250 v. 50 cy. input, 2 volts 20 amps. and 75 v. 6 amp. with 15 taps output, 9" x 6", weight 60 lbs., 70/-, carriage paid by England and Wales. Auto-transformers, 230 volts/110 volts, 85 watts, 25/-; 150 watts, 35/-; 300 watts, 65/-; 1 kW., £7 10s.



MOTORS. Electradix Micro Motors for Instrument work and models 2in. x 1½in., weight only 10 ozs., 12/24 volts; work from dry cells or A.C.

Mains through transformer, laminated fields, ball bearings, totally enclosed, small vee pulley, centrifugal relief speed governor on shaft removable for second shaft drive. Precision made ex-W.D. stock. Worth 45/-. Price 21/- each. Limited stocks.

TELEPHONES. Wall type constructors' parts, ex-G.P.O., comprising cabinet 8in. x 6in. x 3in., bracket mice, transformer and condenser, mag. bell, switchhook and contacts, hand mag., ringer P.O. type receiver terminals and connection diagram, 35/- per pair. G.P.O. Candlestick Telephone with receiver and cord, 15/-, postage 1/6. Spare mike inserts, 2/6 each.

BUTTON MICRO-PHONES

provide interesting experiments for making outside listeners, sound transmission, etc. These ex-G.P.O. Voice Units are under lin. diam., filled carbon granules and fitted mica diaphragm, 3/6 each. Special Transformer and Condenser, 5/-. Instruction Leaflet with each Button. G.P.O. Mike inserts, 2/6. 

CRYSTAL SETS. A charming production in Bakelite. The Lesdix Boudoir Crystal Set; neat bakelite case, fitted condenser, coil, semi-perm detector, terminals; all aerial tested before despatch, 15/-. Headphones sensitive to crystal reception with headband and cord, 12/6.

MAGNETS. D.C. Electric magnets, weight 10 oz., lift on 2 volts, 1½ lb., 4 volts 3 lb., 6 volts 4 lb., new, surplus, 7/6 each. Permanent powerful flat bar magnets, 2½in. x 1in. x ½in., drilled 2 holes each end, for any pole pieces, 2/- pair. The wonder Midgemagnets. Alni perm. steel disc; ½in. diam., ½in. thick, with 3/16in. centre hole, 3/6 each. Large stock of Horseshoe magnets. Send for special Magnet Leaflet "W.W."

ELECTRADIX RADIO

214, Queenstown Road London, S.W.8 (late Queen's Road) Telephone: MA Caulay 2159

ELECTRIC repeater motors, new, ideal experimenters, adaptable for A.C./D.C. 6/50 volt or remote control, Government surplus, 5/- each, post 8d; quotation for quantities.—F. R. Lucas, 22, Hengrove Rd., Bristol, 4.

BATTERY chargers for home and export, 4 models, 2-6-12v. 1, 2 or 4 amp dc. any mains voltage; generous trade terms; write for catalogue.—F.C.I. Hoddesdon, 2659.—The Banner Electric Co., Ltd., Hoddesdon, Herts.

ALL types of rotary converters, electric motors, battery chargers petrol-electric generator sets, etc., rotary transformers, input 12v dc, output 600v at 250ma; price £4/10 each nett, post paid; J.A.P. No. 2A engines, 1.2 b.h.p. at 2,600 r.p.m., complete and ready for use, £17 nett. ex works.—Ward, Lorderscroft Works, Haverhill, Suffolk. Haverhill 253/4.

VALUES

LARGEST and most comprehensive range in the country, British and U.S.A. types, at Board of Trade prices; send for lists (valves available), free, s.a.e.; valves sent c.o.d.; retailers not supplied.

RANSOM, Bond St., Brighton. [7223]

PHOTO electric cells, first grade, G.E.C., C.M.G.8. 4-pin, top cap, 35/- each; A.M. surplus, new condition, each tested in sound head circuit for full sensitivity.—Bryce Electrical Co., 246, Stockport Rd., Manchester, 19.

GRAMOPHONE AND SOUND EQUIPMENT SIMON SOUND SERVICE can supply your needs. [8712]

R1155—Customers assure us that our fully modified version is the best all-round set available to-day.

COMMUNICATION results with local station quality; 10 valves, 16-4,000 metres, d.f. removed, new front panel, P.X4 push-pull quality amplifier, bass and treble boost (separate controls), gram input, other refinements, complete with speaker; £35.

WRITE for full details, or call for demonstration. R1155 circuit and valves, 1'6 post free.

WE can offer to modify your R1155 in the same way, or to your special requirements; re-alignment, calibration and repairs to all communication and quality receivers; first-class work with first-class instruments by experts.—R.T.S., Ltd., 8, Glanton Rd., Wimbledon, S.W.19. Liberty 3301. [8795]

PARMECO 30-watt cinema amplifier; Vitavox Bi-tone; both items brand new; offers for both.—Box 4041. [8776]

TRANSFORMERS, tone control and filter chokes for all "W.W." circuits.—R. Clark, 30, Langland Crescent, Stanmore, Middx. Wor 5321. [7532]

RADIO, UNLIMITED, 16, Carnarvon Rd., Leyton.—Radiograms players, amplifiers, speakers, micrograms, cabinets, accessories; everything for radio and gram; s.a.e. list.

MICROPHONES—Quantity of S.T. & C. type M 402C for sale, very good condition; immediate despatch; price £6/10 each.—Douglas Price, Cottage, Claybrooke (Grange, Rugby).

RECORD player, Brum-Invar sync. motor with Marconiphone pick-up, Autostop, 110-250v in solid walnut case.—£10 or better offer; Sleaford, The Craige, Sennen, Cornwall.

TRANSPORTABLE, Hi. fidelity recorder and playback; 13-valve triple purpose amplifier; R.C.A. dynamic and ribbon microphones; sound investment; £125 or near offer. G3BNL 53, Old Steine, Brighton. [8782]

RADIOGRAM comprising W.W. Monodial receiver, 12-watt Quality amplifier, B.T.H. speaker, Garrard induction motor, and magnetic pick-up housed in high quality oak cabinet; best offer over £60.—Box 3741. [8633]

RECORDING equipment and accessories, to blank discs, cutters, radio units, mixer units, a complete recording equipment for £75; send 3d in stamps for descriptive catalogue to University Recording Co., 113, Milton Rd., Cambridge. [8476]

COMPLETE recording gear, previously used professional outside recordings, recording m/c 30w amp. 3-channel mixer and pre-amp. ribbon, mov. coil and Xtal mikes. playback equip., all accessories; £125 or will sell individual items.—Grimsdyke 1652 (Harrow).

GERMAN portable comm. receiver 12-120 metres, 3 wave bands, 100-230v a.c. or 12v d.c., Tuning range footless valves, built-in speaker, B.F.O., etc.; £22 or change transcription motor and ribbon mike.—Reynolds, Garden House Hotel, Cambridge. [8788]

S.H.E.F.I. moving-coil pick-up is now available for both home trade and export; it combines for the first time high fidelity with high output voltage, enabling it to directly replace normal moving iron pick-ups without any extra amplification; it has an exceptionally clear response with no undesirable resonances thereby reducing needle scratch, price including transformer, 40/- each retail plus 8/11 purchase tax; wholesale and retail enquiries invited; illustration sent on request.—Brooks & Bohn, Ltd., 90, Victoria St., S.W.1.

YOU can become a first-class RADIO ENGINEER

We are specialists in Home-Study Tuition in Radio, Television and Mathematics. Post coupon now for free booklet and learn how you can qualify for well-paid employment or profitable spare-time work.

T. & C. RADIO COLLEGE
North Road, Parkstone, Dorset

(Post in unsealed envelope, 1d. stamp)

Please send me free details of your Home-Study Mathematics and Radio courses.

NAME

ADDRESS

W.W.66.

Specialists in

HIGH POWER - HIGH QUALITY

**PUBLIC ADDRESS
SYSTEMS
★
AMPLIFIERS**
from 150 W to 1kW

W. Bryan Savage Ltd

WESTMORELAND ROAD, LONDON, N.W.9

Telephone: Colindale 7131

SIMON SOUND SERVICE have recorders in stock. [8713] **PROFESSIONAL** recording equipment; to the trade, recording machines, blank discs, cutters, trailer needles, etc., from stock; recording amplifiers, matching transformers, ribbon and m.c. microphones; full trade terms.—Sound Discs (Supplies), Ltd., 83a, Bold St., Liverpool.

C.D.P. Recorder with control panel, 2 extra cutting heads, high fidelity crystal playback pickup. Standard Telephones 4017C microphone and battery pre-amplifier, £60 or near offer; would consider selling separately.—Dimant, 21, Limes Ave., Mill Hill, London, N.W.7. [8685]

NEW U.S. microphones, R.C.A. ribbon on desk stand with grip switch, £7/10; Shure T.17 carbon with lead and plug, 15/-; Electrovoice 600 moving coil with lead and plug, £2; T.30 throat mikes, 6/- pair; T.45 mouth mikes, 5/-.—Harris, Strouds, Pangbourne, Berks. [8673]

BRITISH Sound Recording Association covers all interests of the professional and amateur recording engineer and quality reproduction enthusiast. Radiolympia edition of "The Sound Recording Journal", 2/8, post free.—Details of information bureau, meetings, publications and membership application form from Hon. Secretary BCM/B.S.R.A., London, W.C.1. [7772]

ARE you interested in reproducing sound as nearly as possible to the original and doing this at a reasonable cost? If so, we invite you to either come to our demonstrations or write for full particulars; demonstrations daily, 9.30-10.30 a.m., 6 p.m.-6.30 p.m., excepting Sat.—Rogers Developments Co., 12, Macclesfield St., Shaftesbury Ave., W.1. [8743]

TECHNIFON, Ltd., manufacturers of direct disc recording equipment and accessories, precision built traverse gear complete with first class cutting head, we manufacture and specialise in sapphire styli, our standard types fit the most popular pick-ups on the market and in a push-in model for lightweight pick-ups; we manufacture specials in quantity to specification.—Technifon, Ltd., 99, Belgrave Rd., London, S.W.1. Vic. 8814. [8706]

COMPONENTS—SECOND-HAND, SURPLUS VALUE! Matt has it.

SPECIAL offer: Headphones with lead and jack plug, 5/6 per pair (boxed 2 pairs); speakers, P.M. (less trans.), 4in 17/6, 5in 15/6, 8 in 22/6; output trans. to match 5/6 each; condensers, 0.1, 0.01, 9/- doz; 2, 4, 8, 16mf, 8+8 canned, 6/6; 6mf electrolytics (chassis mounting), 7/6 each; line cord, 0.3 amp (60 ohms per ft), 2-way 1/6 per yd, 3-way 2/6 per yd; volume controls (Centralab), various values, L/S 3/6, W/S 4/9; crystal pickups., Rothermel, de luxe, £2/16/3 (inc. P. tax); 2-gang condensers, 0.0005 (not midget), 5/6; television cable (aerial lead in), 1/6 per yard; large assortment of B.V.A. and U.S. valves always in stock; let us have your enquiries.

MATT Radio Service, 29, Castle St., Kingston-Thames, Kingston 8353. [8375]

BRITISH RADIOCRAFT, Ltd., The Leicester Specialists, offer from their comprehensive stocks:

TUNING gear drives as fitted to the famous American HRO communications receiver, complete with spindles and stator carriers, less dial, price £11/6/6; rotary converters, input 24v dc, output 230v ac, 50 cycles, 200 watts, in steel cases with carrying handle, ideal for mobile amplifiers, etc., the best converter we have ever offered, £3/15; battery communications receivers, R.A.P. Type 1224, 5v s/het, RF stage, 1 to 9 mc in 3 bands. Muirhead dials, Mazda Octal valves, guaranteed tested and in perfect order, £11; RCA modulation transformers, 250 watts, primary 10,400Ω, secondary 4,350Ω, for pair of 813s. £5; sleeving ½, 1, 1½, 2mm, 36 yds, 2/6. 144 yds 10/-; tuning condensers, standard 3-gang 0.0005 ceramic insulation, ½in spindles at both ends for clockwise or anti-clockwise operation, 7/6; midget 3-gang 0.0003 with SM drive and logging device, size only 1½in x 1½in x 3in, 8/6; meters 3in, flush type, 0-2v ac, 10-10ma dc, 1-0-1ma dc, 0-12a R.F. thermocouple, all at 12/6; ditto, 0-12a dc, 0-20a dc 350-0-350 millivolts dc, all at 15/-; owing to the impossibility of listing many separate items we offer a special bargain parcel of ex-Gov. components having a retail value of over £5 for only £1; over 50 useful items, our selection, but satisfaction guaranteed or money refunded; latest lists of many other items free on request; trade supplied.

FRITH RADIOCRAFT, Ltd., 69-71, Church Gate, Leicester. Tel. 58927. [8761]

GANG condensers, escutcheons, transformers etc., to be sold regardless of cost.—Send stamped addressed envelope for full particulars to Retail Sales, Ltd., 6, Chiltern Parade, Bymore Rd., Amersham, Bucks. [8670]

MIDLAND INSTRUMENT CO.

OFFER GOVT. SURPLUS STOCK

VIBRATOR PACKS, input 6-v., output 90-v. 20 m.A./A. contacts require cleaning, otherwise in perfect condition, 10/-. **VOLTAGE REGULATORS**, fitted H.T. rectifier, var. resistor etc., 3/6, 36/- doz. **SELECTOR SWITCHES**, 12/24-v. impulses and homes, operating waxley switch, brand new, 3/6, 30/- doz. **CGN-RECTORS**, 60/430, bakelite 2-way, 4d., boxes of 60, 12/6. **STATITE** interlocking beads, No. 2, 10/- lb. **ELIMINATORS**, 200/250-v. A.C. output 120-v. 30-m.A. D.C. fitted neon stabilizer, brand new, 40/- **ATTENUATOR** units type 17, fitted control knob with pointer, scale marked 0-100, brand new boxed, 3/6, 36/- doz. **MAGNIFIER** units type 2, consists of transmitting var. cond. and tapped plated coils, 2/6, 24/- doz. **CERAMIC** var. cond., 60-p.f., 1/-, 10/- doz. **VITREOUS** wirewound resistors, 2½ ohm. 15 amp., 5/-, 48/- doz. **MICROPHONE** transformers No. 2, 2/6, 20/- doz. **NO. 18 RECEIVERS** complete with 4 valves, 6 to 9 m/cs., 2-v. and 120-v. 35/- **NO. 81B RECEIVERS**, complete with 8-valves, 2.4 to 6.7 m/cs. 6.3-v. and 250-v. 60/- **JONES PLUGS** with sockets to fit, 10-way, 3/6, 36/- doz. 12-way, 4/6, 48/- doz. **ELECTRIC FANS**, 12-v. brand new boxed, 30/-, £15 doz. **MOTOR GENERATORS**, 4 types, 12-v. 500 or 750 watts, 24-v. 350 or 500 watts, 30/- each, plus 5/- carriage. **IRONCLAD** 8-amp. A.C. mains 4-position switches, 5/-, 48/- doz. **EX-GRV. ALL-DRY BATTERIES**, fully guaranteed by us, as previously advertised, 90-v. plus 1½-v. 5/-; sealed cartons of 8 batteries, 30/-; 45-v. batteries, 3½in. x 3½in. x 1½in. 3/-, 30/- doz. **NO. 19 SET AERIAL VARIOMETERS**, 3/6, 36/- doz. **D.B. MASTER UNIT**, 24-v. gyroscope compass, consists of three motors, one a converter supplying A.C. current to the motor gyro, fitted compass card, plus a wealth of other gear, originally cost over £80. Our price, 70/-, plus 7/6 for carriage and packing.

Hundreds of other interesting Radio and Electronic items, send for our Nov./Dec. lists, 2d. with a.s.c. Orders over 30/-, post free. No C.O.D. under 20/- please.

Moorpool Circle, Birmingham, 17

Tel.: HARborne 1308 or 2664

THE BRITISH NATIONAL RADIO SCHOOL

ESTD. 1940

A privately owned personally conducted coaching service by post

**SERVICE SATISFACTION
SINCERITY**

ORIGINATORS of the B.N.R.S.
FOUR YEAR PLAN

Covers full syllabus of A.M.I.E.E., A.M. Brit. I.R.E., and C. & G.

Radio and Telecommunications
Examinations at a cost of

8d. PER DAY

Free Booklet from:

**Studies Director, B.N.R.S.,
66, ADDISCOMBE Rd., CROYDON**

Phone: Addiscombe 3341



THE "FLUXITE QUINS" AT WORK

"What's all this soot?" came a yell.
 "Of's handiwork, I can tell,"
 Cried EE "Well, by jiminy!
 He's flopped down the chimney
 And taken our FLUXITE as well!"

See that FLUXITE is always by you—in the house—garage—workshop—wherever speedy soldering is needed. Used for over 40 years in Government works and by leading engineers and manufacturers. Of all Ironmongers—in tins, 10d., 1/6 & 3/-.

TO CYCLISTS! Your wheels will NOT keep round and true unless the spokes are tied with fine wire at the crossings AND SOLDERED. This makes a much stronger wheel. It's simple—with FLUXITE—but IMPORTANT.

The FLUXITE GUN puts FLUXITE where you want it by a simple pressure. Price 1/6, or filled, 2/6.



ALL MECHANICS WILL HAVE

FLUXITE

IT SIMPLIFIES ALL SOLDERING

Write for Book on the ART OF "SOFT" SOLDERING and for Leaflets on CASE-HARDENING STEEL and TEMPERING TOOLS with FLUXITE. Price 1d. each.

FLUXITE LTD.

Dept. W.W.), Bermondsey Street, S.E.1

CHARLES BRITAIN (RADIO), Ltd

TEST set No. 102 in grey metal case, size 10 1/2 x 9 3/4 x 8 3/4 in with hinged lid and snap fastener; contains a.c. mains, 200-250v 50 cps mains transformer, metal rectifier, two new valves DET19, 6J5, also numerous volume controls, Raymert knobs complete with all connectors, mains lead, spare fuses and lamps; the chassis is of the Cradle type and the whole outfit is just the job for making an instrument; brand new and unused with circuit diagram, only 27/6, plus 5/- carriage and packing.

RECEIVING set R1224.—Communications receiver for battery operation from 120v h.t., 2v l.t. frequency range 1 to 9 mc/s (30 to 300m); 5-valve superhet circuit, r.f. stage. Muirhead dials; brand new and complete with all valves, price £27/10; carriage and packing 10/-; order yours now as we only have a very limited supply; cash with order only.

SPECIAL parcels (enabling the amateur to obtain small components at less than wholesale prices).—No. 1, 12 assorted volume controls, new, less switch, 5,000 ohms to 3 meg 17/6 ea; No. 2, valvoholders, 24 asstd, incl octals, octals 5 and 7-pin, etc., 10/-; No. 3, mica condensers, 0.0001 to 0.01, 36 for 12/6; No. 4, metal cased condensers, 0.001 to 0.5, 72 for 27/6; No. 5 resistors, 1 and 1/2 watt 100 ohms to 6 meg, 72 for 12/-; callers always welcome; trade supplied; terms, cash with order, c.o.d. or pro forma.

FULL component list available on request; we are expecting many new bargains to be in stock before this advert appears; be sure to obtain our latest list of ex-Govt receivers, etc.—Charles Britain (Radio), Ltd., Radio House, 2, Wilson St., London, E.C.2. Tel. Bis 2966. [8760]

SOUTHERN RADIO'S wireless bargains;

latest radio publications. AMATEUR transmitters' construction manual, 2/6; radio repairs manual, 2/6; car and portable radio manual, 2/6; radio valve manual, alternative and equivalent British and American valve types, 3/6; radio circuits, receivers, transmitter, power packs, etc., illustrated, 2/-; short wave handbook, 2/-; ultra short wave handbook, 2/6; manual of direct disc recording, 2/6; test gear construction manual, 1/6; radio pocket book, colour code formulas, etc., 1/-; ten hows for radio constructors, 1/-; Bulgin radio service manual, 2/6; radio constructors manual, 3/-; television constructors manual, 3/-; radio aerial handbook, 2/6; radio hints manual, 2/6; amplifiers, fully illustrated circuits, 2/-; radio resistance chart, resistance values at a glance, 1/-; radio reference handbook, cloth bound, up to date information on all aspects of radio, 12/6.

AMERICAN service manuals, Crosley-Belmont, Sparton Emerson, Stewart-Warner Fada, 12/6 per volume; postage extra on all publications; send 2 1/2d stamp for complete list of publications.

EX-ARMY throat mikes, brand new, with lead and jack plug, 4/6 each, post 6d; Lufbra adjustable hole cutters, for use on wood, metal and plastics, list price 5/-, post 6d.

EX-R.A.F. Morse keys, 2/6, post 4d; Marconi naval pattern keys, 5/-, post 8d; mains transformers, 280-0-280 volts, tappings 5v and 6v, 17/6, post 1/2; input transformers, ratio 1:9.9 mu metal core, 4/6 post 1/-; ratio 1:7 mu metal core, 4/6, post 1/-. ex-Government pattern, brand new; A.C. motors (200/250 volts), constant speed, ideal for light work, approx. 1/2 hp, 2,000 rpm, consumption under 1/2 amp, weight 20lbs approx., 22/15 each plus 5/- carriage and packing; ex-Army headsets, carbon mikes and moving coil earphones, guaranteed perfect, 12/6 per set, post free.

SOUTHERN RADIO SUPPLY, Ltd., 46, Lisle St., London, W.C.2. [8735]

UNIVERSAL ELECTRONIC PRODUCTS,

36, Marylebone High St., London, W.1. Tel. Wel. 4058.

HIGH performance superhet tuning units covering 16.50, 200-550 and 800-2,000 metres, complete with i.f. transformers, dial and drive, completely wired, aligned and tested; Type "A," £5/8/6; Type "C," with R/F stage added, £8; postage 2/6 extra. Our works are available for the construction of transmitting or specialist type receiving equipment to specification. [8794]

RELAYS.—New boxed Govt surplus, 2,000 ohm, 1 make, 1 ch'over, 200ohm 2p make, 2/3; 500ohm 4p ch'over, 2/9.

YAXLEY types.—2p 6w ceramic, 8/6; 1p 2w, 1/-; 1p 3w, 1p 6w, 2p 3w, 1/9 each; 2p 9w, 3p 2w, 4p 2w, 2/3 each; 3p 3w 2b, 5p 4w, 3/-.—Brent & Balisbury, Regent St., Burnham-on-Sea, Som. [8739]

IRON dust cores, in various sizes, for disc L posal; send samples of your requirements for quotation.—John Downton & Co., 89, High St., Epping. Tel. 2163. [8700]

ARMSTRONG

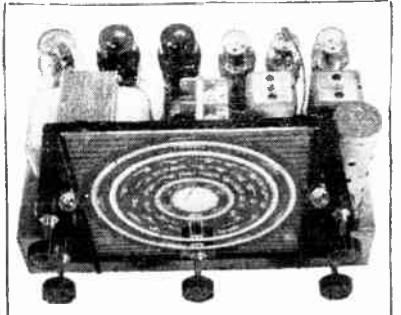

Model RF103

10 VALVE ALL-WAVE SUPERHET RADIOGRAM CHASSIS.

SPECIAL FEATURES

- ★ 10 VALVE CIRCUIT.
- ★ R.F. PRE-AMPLIFIER.
- ★ WAVE BAND EXPANSION.
- ★ LARGE GLASS SCALE.
- ★ 3 STAGES A.V.C.
- ★ TREBLE LIFT CONTROL. (Operates on both radio and gramophone.)
- ★ PLUS 6 db. BASS LIFT ON GRAMOPHONE. (To restore bass cut on some records.)
- ★ 10 WATT PUSH-PULL OUTPUT.

To export buyers we can confidently recommend RF103 to any firm abroad who contemplates making a high-grade Radiogram or Console radio receiver.

The lively short-wave performance coupled with the excellent quality reproduction ensure an outstanding performance.

We will gladly make any alterations to the specification to meet individual requirements.

To home buyers demonstration model now available to interested callers to hear, and technical specification now available on request.

It is hoped that a number (very limited unfortunately) will be available for early delivery.

The above model is for A.C. Mains.

We also have a similar model Type UNI 103 for DC/AC Mains.



ARMSTRONG WIRELESS & TELEVISION CO. LTD.
 WARTERS ROAD, HOLLOWAY, LONDON, N.
 Phone: NORth 3213

Wise Men Rush, Too!

The reception given to "New Notes in Radio" (5th edn.) has been most cordial. A very large number of readers have expressed surprise and gratification at the packing of so much useful knowledge into so little space, and the word has gone around that it is a wonderful three-and-sixpenceworth. *Wise men are hurrying to get their copies before the edition is exhausted.*

This compact guide to high-fidelity reproduction (3s. 8d. post free) is mainly valuable to you because it shows you how to assess the claims made by those who claim to be experts in the subject. Hartley-Turner were the world originators of high-fidelity reproduction, and we don't now need to shout the odds from the housetops.

But this being a reputed free country, others are at liberty to muscle in on our specialised field of endeavour—if they can. We do not mind at all; rather do we get a good deal of amusement from the remarks of those who have completed "Le grand tour des salons H.F. & Londres." These sound tourists can see and hear for themselves and are not deceived; but those who have to depend on the written word are in a position of some uncertainty.

"New Notes" helps you to choose wisely by explaining the necessary attributes of any high-fidelity equipment. Hartley-Turner speakers, amplifiers, radio tuners and pick-ups have these qualities because knowledge and experience showed them to be essential. Not all other equipment is so well designed, and it is desirable that you should know your way around.

To those still waiting for their Hartley-Turner leaflets—our apologies. We had not thought interest in our work would be so intense and widespread. But no one will be overlooked.

H. A. HARTLEY CO. LTD.

152 HAMMERSMITH RD. LONDON, W.6
TELEPHONE: RIVERSIDE 7387

RPL/P.50

HENRY'S

GUARANTEED SERVICE

ELECTROLYTICS. Single and multiple types, can and tubular, large stocks by leading manufacturers.

METERS. Complete range of AVO and TAYLOR instruments, including signal generators, can be supplied from stock.

ELECTROSTATIC VOLTMEETER. 0-5000 volts, panel mounting, by leading manufacturer, 3in. scale. Ex-Govt., but new and guaranteed, ready for use, 65/- only.

VALVES. We have a large stock of many difficult types, including 384, IR5, IS5, IT4, 6A8, 6K8GT, 3Q5GT, MKT4 5 pin, 3S16GGT, AC5 PEN DD, DDT, FC2A, 25A8G, 25Y6G, etc., etc., at current controlled prices.

VALVEHOLDERS. 4, 5, 6, 7, and Octal, English and American, Paxolin 5/- doz.; Amphenol 7/6 doz.

CERAMIC. Inter. Octal, and 5 pin U/X 1/6 each. Button type for IT4, etc. 1/- each. Acorn type 2/- each.

INTRODUCING THE RUCCO TUNING ASSEMBLY. 15-2000 m., includes chassis 465 k/c. 1.7" x 2in., 5 wave switching, trimmers, padders, drive and drum, dial, .0005 three gang with wide spaced osc. section, holders and small components necessary to complete the circuit of a 6K8 G Frequency changer, and 6K7G I.F. Amplifier. Provision is made for A.V.C. feed to I.F. and H.F. stages. Wired, tested and aligned. Complete with drawings, 25s. This Unit makes radio construction a very simple matter.

THE "Q" COIL PACK. A really midget pack of outstanding performance. Size 3 1/2in. x 2in. x 2in., employing 6 separate high "Q" coils, wound on ultra midget low loss plastic formers, with adjustable iron cores. Complete switch and trimmers, ready for use. With circuit, 33/- only.

A stamp will bring our comprehensive List.

Cash with order, or C.O.D. (over 21).

5, HARROW ROAD, W.2

PAD 1008/9

RADIO bargains of interest to constructors and Servicemen; send for list.—Kemp Radio Supplies BCM/KRAE, London, W.C.1. **AUTO COLLECTIONS, Ltd.**, 126, St. Albans Ave., W.4 (Chiswick 1601); or 15, Lawrence St., Northampton, offer the following ex-Govt. brand new goods:—5,000 ROTARY transformers T.29, inpt. 24v 16 amp, outpt. 1,230v 200 mA, lots of 100 @ £1; 10 @ 30/-; 5 @ £2; 1 @ 50/-; superposing transformers (4 windings), 50/- per 100; galv. earth rods, 12/- doz.—Above.

10,000 VOLTMEETERS, ammeters, electrostatic v./meters, 5,000v, lots of 12 @ £1; 6 @ 25/-; 1 @ 30/-; ammeters H.F., 200 mA or 350 mA. Ferranti & Weston 2in proj. m/coil, 5/6.—Above.

5,000 HYDROMETERS, unbreakable glass, size approx. 9in x 1 1/2in, worth 6/- retail, 144 @ 2/6; 12 @ 3/-; 1 @ 3/6.—Above.

WEE meggers, 250v, in leather case, few left, list £12, our price £8; enorm. quan. emery cloth (med.), U.S. Army "Wetordry" proofed (safety walk), in rolls 50 yds x 24in, £4 ea, or 12 @ £3; also large quan. lacquer, aircraft instruments, pressure gauges, steam gauge glasses, crowbars, climbing irons, prefocuss lamps and a1 sorts elec. lamps.—Above.

LARGE quantity condensers, resistors, H.F. and I.F. coils, service sheets and public address equipment for sale, cheap, owner going abroad.—Write Box 4021. [8738]

II-VALVE ex-R.A.F. units, rotary transformer, 450v 0.05a; gears, relays, parts, 2 chassis; in case 12in x 12in x 8in, wt 32lb, £3/10; cp 5/-—54, Station Rd., Countesthorpe.

B & H. RADIO carry comprehensive selection of component parts for the service engineers and components specialist; trade only; stamp for list.—Huntley St., Darlington.

BASIC kit for 4-valve a.c. T.R.F. M. and L. rec., incl. mains transformer, smoothing, 6in spkr., polished oak cabinet, 12in x 9in x 7in, coils, 2-rang condenser with drive, valves, drilled chassis; £6.—Box 4026. [8746]

TELEVISION aerial equipment, 6 types fully waterproofed aerials available, cables, lashings, all types of feeder in stock; send for brochures; aerials installed.—Wolsey Television, Ltd., 87, Brixton Hill, S.W.2. Tulse Hill 1240.

"YOU'LL probably get it at Smith's, Edgware Rd.!" Everything for the constructor, from a 1'10 watt resistor to a radiogram cabinet; lowest prices, biggest variety.—Near Metropolitan Music Hall, Paul. 5891. [8005]

SUPPLIERS of high-grade radio components including television and high fidelity radio equipment; all types of radio and electronic apparatus built to your specification; large stocks of close tolerance resistors.—Rogers Developments Co., 12, Macclesfield St., W.1.

A PERFECT joy to build!—The 5-valve ac or ac/dc 3-wave Superhet Assembly (all main components ready mounted on chassis), forms the foundation of a powerful receiver at a price you'll like; send postage now for full details.—N. R. N., 66, Parkhill Rd., N.W.3

15,000 Selenium rectifiers by S.T.C. and Westinghouse, 5 types, 30 m.a. to 220 m.a., 50 to 360 volts, all new tested stock, substantially discounted for quantities.—Apply for full technical data and prices. Partridge, Wilson & Co., Ltd., Davenset Electrical Works, Leicester. [8120]

PERMETEORIBILITY tuner, no tuning condenser required, single waveband, 2 or 3 bands, wire frequency coverage, small size. Send s.a.e. for full lists, including details of Midget iron-cored coils and 2 waveband 1/4 coils.—Meteor Electronics, Gloucester Row, Weymouth. [8800]

TELEVISION spares.—All new stock at manufacturers' list prices. Everything for the constructor. Valves, aerials indoor and outdoor, 80ohm feeder cable, focus and scanning coils, e.h.t. mains transformers, condensers, Mazda CRM 1171 12in and CRM 91 9in cathode ray tubes. Radio: 1,000 valves, condensers, cabinets, R/G and table types. write for lists, s.a.e.—E. A. Porritt, 13 & 27, Wastdale Rd., Forest Hill, S.E.23. For 1292.

HARRY JAMES PRODUCTIONS, 270, Leith Walk, Edinburgh, mail order specialists, cash with order or c.o.d.—Electronics B.I., 500; 8mids, 3/6; 8.8mids, 5/6; 16mids, 4/9; 16-8mids 6/6; bias 25v 25mids, 2/2; condensers, 0.01, 0.05, 0.1 500v, 8d; variable, 0.0005 2-rang, 12/-, with trimmers, 13/6; coils M. & L. with circuit, 8/6 pair; T.R.F. chassis, 4/6; loudspeakers, 5in P.M., 19/6; 6 1/2in energised, 29/6; volume controls, standard values, with switch, 5/6; less switch, 3/6; mains transformers, 350-0-350v 6.3 or 4v I.T., 80m/a, 30/-; output multi-ratio, 9/-; midget pentode, 5/6; valve holders, 5-, 7-pin and octal, 7d; Amphenol type, 9d; droppers with feet and sliders, 3a 800 ohms, 4/9; 2a 1,000 ohms, 3/9; line cord, 3-core, 3a 60-70 ohms, per ft, 9d; valves, large stock of English and American types; please order c.o.d.; give us your enquiries, s.a.e. for lists.



The **C.D.P. RECORDER** is of robust construction and is built to give years of service without the necessity of renewals

The C.D.P. recorder is suitable for studio and serious work, and will produce excellent piano recordings. The addition of a new balanced armature cutting head (now fitted as standard) places the machine in the highest category for workmanship, high quality recording and reliability

Price £32

with run-out groove device £5 extra. Should present users of the C.D.P. recorder experience trouble through low voltages in the present-day electricity difficulties, please contact us for advice to overcome this.

Complete recording unit supplied, Amplifier, Microphone Recorder. Please write for details.

BOURNE INSTRUMENTS
BOURNE, Lincs.

Phone 224

OPPORTUNITIES IN RADIO



Get this FREE Book!

"ENGINEERING OPPORTUNITIES"

reveals how you can become technically-qualified at home for a highly-paid key-appointment in the vast Radio and Television Industry. In 108 pages of intensely interesting matter, it includes full details of our up-to-the-minute home study courses in all branches of RADIO and TELEVISION, A.M. Brit. I.R.E., A.M.I.E.E., City & Guilds, Special Television, Servicing, Sound Film Projection, Short Wave, High Frequency, and General Wireless Courses.

We Definitely Guarantee "NO PASS—NO FEE"

If you're earning less than £10 a week, this enlightening book is for you. Write for your copy today. It will be sent FREE and without obligation.

BRITISH INSTITUTE OF ENGINEERING TECHNOLOGY
388b, Shakespear House,
17/19, Stratford Place, London, W.1.

★ Radio BOOKS

● Introducing Radio Receiver Servicing

By E. M. SQUIRE. Gives a useful working knowledge of receivers and servicing equipment. Second Edition. 7/6 net.

● Radio Simplified

By JOHN CLARRICOATS. A simple and well-illustrated introduction to radio for beginners. Second Edition. 7/6 net.

● Short Wave Radio

By J. H. REYNER, B.Sc. (Hons.), etc. This is a comprehensive survey of short waves and their application in radio and television. Fourth Edition. 10/6 net.

● Radio Upkeep and Repairs

By ALFRED T. WITTS, A.M.I.E.E. Full of useful hints on the location of faults and their correction. 6th Edition. 7/6 net.

● Cathode Ray Oscillographs

By J. H. REYNER, B.Sc., A.C.G.I., D.I.C., etc. A guide to the numerous practical applications of the cathode ray tube. 8/6 net.

● A Dictionary of Electrical Terms

By S. R. ROGET, M.A., A.M.Inst.C.E., A.M.I.E.E. Fourth Edition. 12/6 net.

PITMAN
Parker Street, Kingsway, London, W.C.2.

STOCKS won't last for ever; send 2½d s.a.e. for lists and see last two months' advts.; new extension speakers in cabinets, 32/-; mike transformers, 2/6; midget switched meter or 'phone jack sockets, 2/9; tool boxes, power units, meters, a.m. drives, etc. Dept. W.W., Barnes Radio & Wholesale, 2, Elm Dale Rd., Penn. Wolverhampton. [8662

At last, the coil pack that we have been looking for, a super efficient coil pack completely screened and fitted with an I.F. filter, 3 or 4 waveband, complete with circuits, test sheet, the Albion coil pack, new, delivery from stock, prices from 36/6; electrolytic condensers, 16x8x500 volts, 7/-; 8x450 volts, 4/-; 250mfdx12 volt, 2/-; 1,000mfdx6 volts, 4/-; 2 gang condensers, 9/6; full range of Summersby high gain coils, 3/3 each, I.F.s Q160, 15/- per pair; Weymouth constructional drawings, 1/6 per cent; 2-speed drives for 2 gangs, 1/6; speakers, etc. Send stamp for list; terms cash with order or c.o.d. over £2, plus 6d postage.—Castle Radio, 11, Mill Lane, Margate. [8693

A PERFECT joy to build! High-class 5A valve ac or ac/dc 3-wave superhet of unusual sensitivity and power, set of blueprints, 5/- (refundable), all parts available; special bargains: 2½in scale 0-1 ma 1st grade m/c meters, 27/6; 5 ma meter rectifiers, 7/6; selenium rectifiers, 250v 45ma, 5/-; 1st class p.m. speakers, R & A, 8in, 21/-; Rola 6½in, 19/-; 5in, 17/6; o.p. trans., 5/6; new high "Q" iron-cored coil packs, 3-wave, 33/-; shrouded mains transformers, 300-0-300, 6v and 5v, 27/6; filament trans., 6.3v 1.5 amp output, 12/6; postage extra under 2.5; terms c.w.o. or c.o.d. any value; send postage for special list.—N.R.S., 66, Parkhill Rd., London, N.W.3. [8664

SUPREME RADIO, 746b Romford Rd., 11 Manor Park, London, E.12. Phone 11. 1260. Manufacturers inquiries invited. 2 gang condensers with feet, 9/6; line cord 60-79 Ω ft, 20/- doz; tubular condensers, 0.1 0.01 0.05 500w, 4/6 doz; 8mfd can or cardboard, 39/- doz; can type 16mfd 4/3 ea, 16x8mfd 7/- ea, 16x16mfd 7/3 ea, 8x8x8 inld 7/3 ea, 24x8mfd 7/3 ea; 8x8mfd 6/- ea, 4mfd 15/- doz; condenser clips 4/6 doz; resistances: sizes from 220Ω to 2.2 meg 4w, 3/- doz; assorted ww, handy sizes 2/6 doz; volume controls 50k short spindle, 12/- doz; 2,000 ww 12/- doz; standard V/cs with sw 100k and 50k 42/- doz, doz lots only; 5k up to 2 meg, 4/6 ea; 250k less sw, 2/6 ea; all wave glass dials, 8inx5in, 3/6 ea; 1+1 condensers 350v w dc 250v ac 6/- doz; Midget knobs less grub screw, 1/- doz; Octal valve holders, 3/6 doz; 4 pin Ux Ceramic holders, 12/- doz; anchoring tags, 3/- Ceramic; grid caps with lead, 1/6 doz; ditto on panel with 57Ω res, 4/- doz; Paxalin panels with tags 3-4-8-11 ways, 3 ways 1d; 0.002 condensers 1,000v w short ends, 1/6 doz; 1 w carbon res. 27,000Ω 75,000Ω, 4/- doz; 10,000Ω 5w, 5/- doz; 10,000 and 20,000 2w short ends, 2/6 doz; coractical plug and socket, 1/6 ea; meter rectifiers 5ma, 5/6; Westectors 1/8; earphones 50Ω, 4/6 pr; earphone inserts or mikes, 3/-; test meters, etc. All service material; cash with order; no c.o.d.; s.a.e. all enquiries; 6d extra postage orders under 2.5. [8694

NEW selenium metal rectifiers, charger kits, etc. no surplus goods, all new stock, add postage 6d up to 15/-, 1/- above 15/-. Rectifiers, selenium cell, 12v 3amp 21/-, 12v 4amp 25/-, 12v 5amp 27/6; giant 12v 6amp, aluminium fins, fume proof finish, 33/6, 24v 2.5-amp 32/6, 24v 5amp 43/6, also 6v 0.5amp 6/-, 6v 2amp 9/6, 12v 2amp 12/6, 12v 1.5amp 10/6, 12v 0.2amp 7/6; interesting data and circuit supplied; many other L.T. types, including rectifiers for converting valve type garage charger to metal rectifier. H.T. rectifiers, new small selenium type, 250v 60ma 9/6, fit any ac/dc receiver, for 350-0-350v 60ma 13/6, 120v 20ma 7/6, 110v 60ma 9/6; crystal diodes 2/6; 5ma instrument rectifiers for Avo-Avomitor 12/6; charger kits, 2v 0.5-amp rectifier with transformer for 2v trickle charger, ideal trickle charger for 2v cell, 13/6, guaranteed one year; 12v 3amp rectifier with 50watt transformer and ballast bulb for 2v to 12v charger weight 7lb 45/-, ditto with 2amp rect., 35/-; ditto with 4amp rect. and 75watt transformer, £3/2; ditto 12v 5amp rect. and 120watt trans, £4; heavy duty type chargers for commercial charging, transformer, rectifier, ballast bulb for one to 20-cell lamp charger, 95/-; ditto one to 12 cells 2amp, £6/5, guaranteed one year; slider resistance 0.5ohm 10amp, 14/-; ammeters, 0-6amp, 12/6; eliminator kit, transformer, 2 condensers, 2 rectifiers for 120v 20ma and 2v trickle charge, 39/6; Rothermel "Bullet" microphones, 58/6; Lustraphone m/c mikes 78/6; 80watt fluorescent chokes, boxed and bitumen filled, 230v, 19/6; tapped 21/-.—Champion, 43, Uplands Way, N.21. Lab. 4457.

RANSOM FOR RADIO VALVES

At B.O.T. prices, British and American, these are only a selection of our 10,000 valves held in stock. Please send for our comprehensive Valves Available List, free, enclosing S.A.E. for reply. Postage 6d extra, C.W.O. or C.O.D.

MULLARD.—KK32, KF35, KBC32, KL35, FC2, PC2A, VP2B, SP2, PM12M, TDD2A, PM2A, PM202, PM2H1, PM22D, QP22B, EM1, EM4, BM34, EM35, EC135, ER32, EP6, EF9, EF22, EF36, EF37, EF39, EF50, LP54, EC31, RC52, EC53, EB34, EB35, EC33, EC31, EL2, EL3, FL33, EL35, FL37, EL38, EL50, EC335, EOC32, PM24A, TT4, TH4B, VP4, VP4A, VP4R, SP4B, 2D4A, 2D4B, TDD4, 354V, 904V, 104V, PEN4A, PEN4A, PEN4B, PEN4DD, TH30C, F113, F13C, VP13A, VP13G, SP13, SP13C, 2D13C, HL13, HL13C, CL33, PEN498, CB11, CB131, EB211, EB121, UB121, UCH21, UY21.

MAZDA.—P220, SP22, VP23, HL22, TP22, TP25, TP26, PEN230A, PEN25, PEN220, QP230, QP25, HL23, SG215, 8215VM, HL21DD, HL23DD, HL42DD, AC/PEN, AC3/PEN, AC6/PEND, AC6/PEN, PEN44, PEN45, PEN45DD, PEN46, MB20, HL132D, TH233, TP134A, DD207, DD101, SP2220, SP1920, Y914, DD41, AOHL, ACPHL, 4HL, ACP, AC3, AC3GM, AC6G, ACVP1, VP41, SP41, SP42, P41, SP61, ACPH1, TH41, AOHL/DDD, HLA1DD, PEN463DD, M691, P68/400.

AMERICAN RANGE.—15, 18, 26, 30, 31, 32, 34, 37, 39/44, 41, 42, 43, 45, 71A, 76, 77, 78, 79, 80, 83, 84, 89, 91, 92, 93, 94, 95, 96, 97, 98, 99, 100, 101, 102, 103, 104, 105, 106, 107, 108, 109, 110, 111, 112, 113, 114, 115, 116, 117, 118, 119, 120, 121, 122, 123, 124, 125, 126, 127, 128, 129, 130, 131, 132, 133, 134, 135, 136, 137, 138, 139, 140, 141, 142, 143, 144, 145, 146, 147, 148, 149, 150, 151, 152, 153, 154, 155, 156, 157, 158, 159, 160, 161, 162, 163, 164, 165, 166, 167, 168, 169, 170, 171, 172, 173, 174, 175, 176, 177, 178, 179, 180, 181, 182, 183, 184, 185, 186, 187, 188, 189, 190, 191, 192, 193, 194, 195, 196, 197, 198, 199, 200, 201, 202, 203, 204, 205, 206, 207, 208, 209, 210, 211, 212, 213, 214, 215, 216, 217, 218, 219, 220, 221, 222, 223, 224, 225, 226, 227, 228, 229, 230, 231, 232, 233, 234, 235, 236, 237, 238, 239, 240, 241, 242, 243, 244, 245, 246, 247, 248, 249, 250, 251, 252, 253, 254, 255, 256, 257, 258, 259, 260, 261, 262, 263, 264, 265, 266, 267, 268, 269, 270, 271, 272, 273, 274, 275, 276, 277, 278, 279, 280, 281, 282, 283, 284, 285, 286, 287, 288, 289, 290, 291, 292, 293, 294, 295, 296, 297, 298, 299, 300, 301, 302, 303, 304, 305, 306, 307, 308, 309, 310, 311, 312, 313, 314, 315, 316, 317, 318, 319, 320, 321, 322, 323, 324, 325, 326, 327, 328, 329, 330, 331, 332, 333, 334, 335, 336, 337, 338, 339, 340, 341, 342, 343, 344, 345, 346, 347, 348, 349, 350, 351, 352, 353, 354, 355, 356, 357, 358, 359, 360, 361, 362, 363, 364, 365, 366, 367, 368, 369, 370, 371, 372, 373, 374, 375, 376, 377, 378, 379, 380, 381, 382, 383, 384, 385, 386, 387, 388, 389, 390, 391, 392, 393, 394, 395, 396, 397, 398, 399, 400, 401, 402, 403, 404, 405, 406, 407, 408, 409, 410, 411, 412, 413, 414, 415, 416, 417, 418, 419, 420, 421, 422, 423, 424, 425, 426, 427, 428, 429, 430, 431, 432, 433, 434, 435, 436, 437, 438, 439, 440, 441, 442, 443, 444, 445, 446, 447, 448, 449, 450, 451, 452, 453, 454, 455, 456, 457, 458, 459, 460, 461, 462, 463, 464, 465, 466, 467, 468, 469, 470, 471, 472, 473, 474, 475, 476, 477, 478, 479, 480, 481, 482, 483, 484, 485, 486, 487, 488, 489, 490, 491, 492, 493, 494, 495, 496, 497, 498, 499, 500, 501, 502, 503, 504, 505, 506, 507, 508, 509, 510, 511, 512, 513, 514, 515, 516, 517, 518, 519, 520, 521, 522, 523, 524, 525, 526, 527, 528, 529, 530, 531, 532, 533, 534, 535, 536, 537, 538, 539, 540, 541, 542, 543, 544, 545, 546, 547, 548, 549, 550, 551, 552, 553, 554, 555, 556, 557, 558, 559, 560, 561, 562, 563, 564, 565, 566, 567, 568, 569, 570, 571, 572, 573, 574, 575, 576, 577, 578, 579, 580, 581, 582, 583, 584, 585, 586, 587, 588, 589, 590, 591, 592, 593, 594, 595, 596, 597, 598, 599, 600, 601, 602, 603, 604, 605, 606, 607, 608, 609, 610, 611, 612, 613, 614, 615, 616, 617, 618, 619, 620, 621, 622, 623, 624, 625, 626, 627, 628, 629, 630, 631, 632, 633, 634, 635, 636, 637, 638, 639, 640, 641, 642, 643, 644, 645, 646, 647, 648, 649, 650, 651, 652, 653, 654, 655, 656, 657, 658, 659, 660, 661, 662, 663, 664, 665, 666, 667, 668, 669, 670, 671, 672, 673, 674, 675, 676, 677, 678, 679, 680, 681, 682, 683, 684, 685, 686, 687, 688, 689, 690, 691, 692, 693, 694, 695, 696, 697, 698, 699, 700, 701, 702, 703, 704, 705, 706, 707, 708, 709, 710, 711, 712, 713, 714, 715, 716, 717, 718, 719, 720, 721, 722, 723, 724, 725, 726, 727, 728, 729, 730, 731, 732, 733, 734, 735, 736, 737, 738, 739, 740, 741, 742, 743, 744, 745, 746, 747, 748, 749, 750, 751, 752, 753, 754, 755, 756, 757, 758, 759, 760, 761, 762, 763, 764, 765, 766, 767, 768, 769, 770, 771, 772, 773, 774, 775, 776, 777, 778, 779, 780, 781, 782, 783, 784, 785, 786, 787, 788, 789, 790, 791, 792, 793, 794, 795, 796, 797, 798, 799, 800, 801, 802, 803, 804, 805, 806, 807, 808, 809, 810, 811, 812, 813, 814, 815, 816, 817, 818, 819, 820, 821, 822, 823, 824, 825, 826, 827, 828, 829, 830, 831, 832, 833, 834, 835, 836, 837, 838, 839, 840, 841, 842, 843, 844, 845, 846, 847, 848, 849, 850, 851, 852, 853, 854, 855, 856, 857, 858, 859, 860, 861, 862, 863, 864, 865, 866, 867, 868, 869, 870, 871, 872, 873, 874, 875, 876, 877, 878, 879, 880, 881, 882, 883, 884, 885, 886, 887, 888, 889, 890, 891, 892, 893, 894, 895, 896, 897, 898, 899, 900, 901, 902, 903, 904, 905, 906, 907, 908, 909, 910, 911, 912, 913, 914, 915, 916, 917, 918, 919, 920, 921, 922, 923, 924, 925, 926, 927, 928, 929, 930, 931, 932, 933, 934, 935, 936, 937, 938, 939, 940, 941, 942, 943, 944, 945, 946, 947, 948, 949, 950, 951, 952, 953, 954, 955, 956, 957, 958, 959, 960, 961, 962, 963, 964, 965, 966, 967, 968, 969, 970, 971, 972, 973, 974, 975, 976, 977, 978, 979, 980, 981, 982, 983, 984, 985, 986, 987, 988, 989, 990, 991, 992, 993, 994, 995, 996, 997, 998, 999, 1000.

H. RANSOM,
34, BOND STREET, BRIGHTON. Phone Brighton 5603



A New GRAMOPHONE UNIT
Specially designed for use with Lightweight pickups

- ★ Heavy cast, non-magnetic, 12 in. turn-table
- ★ High torque, frequency controlled motor, 200-250 volts 50 cps.
- ★ Robust direct mounting plate 14 in. x 12 in.

Price (Exl. Pickup) £6 0 0
Purchase Tax Extra £1 6 0

Audix B.B. LTD.
39/43, WEST HILL, S.W.18
PUT 8765

WINDING REWINDING

AND

LOUDSPEAKER REPAIRS

BY

"TELECRAFT"

(TRADE MARK)

chokes, transformers,
fields, etc.

Southern Trade Services Ltd.

297/299, HIGH STREET
CROYDON

'Phone: CRO 4870

G. A. RYALI, 65, Nightingale Lane, London, S.W.12.—Mail order only; postages extra, o.o.d. £1 or over, please send large envelope for our full list; U.S.A. make metal cased 500v tubular 0.1mf, 7/6 dozen; Silver mica, 200pf, 300pf, 400pf, 500pf, 4/6 dozen; 500v wkg. Micamoulded 0.004mf, 4/- dozen; Mica 0.01mf, 3-2/-; Mansbridge 1mf 500v wkg., 3-2/-; all condensers guaranteed; Amphenol type British 5-pin valve holders, 4/6 dozen; U.S.A. paxolin 4-5-6-pin, 3/6 dozen; Volume controls, 10,000 medium spindle, 1/6; 250,000ohm short spindle, 1/6; Bar type 3 gangs, 0.0004mf, short spindle, 5/-; Twin ceramic 0.0003mf, 5/6; Bar type 4 gang 0.0004mf, 5/-; Resistors, 1/2 watt, 1/2 watt, 100 ohms to 2 meg level assortment, 405/-; Plastic group boards, drilled, less tags, 9w, types, 3-1/6; Switches SB.2P. 6w, 2/-; 3B.2P. 6w, 2/6; 2B.3P. 3w, 2/3; Res. panels, 5-way with 25mf and three res., 1/3; Twelve-way group boards with 9-1watt and 1/2watt res., 2/1 all new; twenty types in stock; Octal plugs, cap and socket, 2/6; with tags 3-3/-; [8579] **ELECTROR** switches, 5-bank, 25-way, per bank 20/- each; toggle switches, telephone jacks, press switches, 20-way tag boards, E.S. holders, lead ends, E.S. holders, screwed, Yaxley type switch, 3-pole 2-way, each 18/- per dozen; voltmeters, 0-40, ampimeters, 0-50, 15/- per pair; condensers, 8mf 700 volt, 6/- each; condensers, 4+4, 500 volt, 3/6 each; condensers, 1mf 250 volt, 6/- per dozen; Sintered fuses, 15amp, 15/- per doz; rotary switches, 5-section, 10-pole, 15/- each; 10-section, 20-pole, 25/- each; 0.0003 tuning condensers, 3/- each; relays, 200 ohm, 3/- each; Octal plug tops, 1/- each; postage extra; delivery by return.—Particulars, H. S. F. Dentford, Box Trees Mill, Wheatley, Halifax, Yorks. [8221]

RADIO CLEARANCES, Ltd., 27, Tottenham Court Rd., W.1. Mus. 9188.—Electrolytics, 8mf 170v 2/3, 8mf 450v 3/3, 16/24mf 250v 5/6, 16+16mf 350v 5/6, 32mf 350v 4/-, 250mf 25v 2/-, 50mf 12v 1/9, 100mf 12v 1/-, 100mf 6v 1/-. Meters, 0-750 micro amp plug in 2 1/2in scale 9/6, calibrated for use with thermocouple. EX-R.A.F. visual indicators, 2 types still available type 3 containing 2 complete Weston 300 micro amp movements 5/-, cross-over needle type, as used with R1155 with 2 60 micro amp movements 5/11. P.M. speakers, brand new and boxed, 5in less trans, 16/11; 5in with trans, 19/11; 8in with trans, 25/-; 10in with trans, 39/6. Ex-Admiralty S.M. dials, ratio 100/1, fit 7/6in spindle, 7/6. Epicyclic B.M. drives 6-1 ratio, fit standard 1/4in spindle, 2/-; 0-300 D.P. bakelite, 2/3. Metal rect. 12v 1a bridge, 4/6; 250v 60ma H.W., 4/6; tuning condensers 0.0005 2 gang small size, 11/6 volume controls wirewound, no switch, 3w type, 150Ω, 200Ω, 400Ω, 500Ω, 1K, 2K, 10K, 20K, 50K, 2/6 2 gang wirewound, 500/500Ω, 2.5K/2.5K, 5/50K, 3/6 6w, 2w 30Ω mini, 2/-; 500Ω 15w, 4/-; 50K, 10w, fully shielded precision type, 7/6; volume controls, carbon, no switch, 10K, 20K, 50K, 100K, 1M, 2 gang, 1M/1M, 3/6; miniature carb. 1K, 20K, 100K, 500K, 1/6. Switches, 4-bank with 9in locator and 2 1/2in spindle, 3-wafers 2p 4w and 1 wafers 1p 4w, 6/-; 1p 3w, 1/9; 1p 9w, 2/6; 2p 2w, 2/-; 1p 10w 2B, 3/6; 2p 4w 3B with long spindle, 3/6; 2p 5w 3B short spindle, 2/9. Tubular cond., 0.01 1000v 6d, 0.02 350v 6d, 0.04 350v 6d, 0.05 500v 6d, 0.1 350v 7d, 0.1 500v 9d, 0.1 600v bakelite 6d, 0.25 350v 1/-, 0.25 500v metal cased 1/- Meter rectifiers: Westinghouse bridge 1ma 6/11; selenium 400v 60ma 5/6, mica cond., 0.0001-2-3-5 ad, 0.001-2-5 5d, 0/1 6d, 0.0001 3000v wkg. 9d, 0.005 1000v 7d, silver mica max values 10-6000pf 6d, ceramic cond., 2-10-25-50-100pf 6d. Valveholders 4p UX, 5p Brit., Mazda Octal, 6d; Int. Oct. Pax., 6d; amp., 8d; EF50 type Pax. 6d, Micalex 1/-, ceramic 1/6; special offer Int. Oct. amp. with 2 1/2w res. (100K and 680Ω) wired across pins 8d; smoothing chokes, 2.5H 200ma, 7/6; high voltage condensers, 0.1 12,000v test oil filled, 6/-; 0.0005 2 gang tuning condensers with epicyclic drive, 10/6; mansbridge condensers 1mf 350v 8d, 1,000v 1/3, 2mf 300v 10d, 4mf 600v 4/6, 0.25mf 2,000v 1/9; 0.25 2,500v 2/-, all working V. cathode ray indicator units with 6in tube (non-persistent), 7 valves (4 EF50 and 3 EB34) available to callers only at £2/19/6; ex-army 38 sets, 5-valve trans-rec. complete with 5 2v valves and junction box (as used in tanks with 19 sets), 45/-; 2 section aerials for same, 7/6; throat mikes, 3/6; carbon mikes, power type with switch in handle, 6/-; power units with rotary trans. and carbon pile voltage reg., input 24v, output 300v 30ma, 6.5v 3.5a with 12v in will give 200v 30ma, 15/-; Vit. res. 10w 500Ω 1/6, 20w with clips 2K, 8K, 2/-; 40w 14K tapped at 2K, 3/-; metal rect. 12v 1/2a, bridge, 3/6; mains droppers 0.2a 1,000Ω, 3/6 (with 2 adjustable taps). [8790]

GALPINS

ELECTRICAL STORES

408 HIGH STREET, LEWISHAM, LONDON, S.E.13

Telephone: Lee Green 0309. Near Lewisham Hospital.

TERMS: CASH WITH ORDER. NO C.O.D.

EX-R.A.F. CALIBRATOR UNITS TYPE 18. These units consist of 1-100 k/c Xstal 2-EF 50 valves and numerous other components (new boxed), 35/- each, P.F.

EX-U.S.A. ARMY HAND DRIVEN GENERATORS (as new). Output 162 volts at 60 m/a, 3.1 volts at 3 a., complete with all smoothing and circuit diagram, 35/- each. Ditto, 425 volts at 115 m/a, 105 volts, 32 m/a, 6.3 volts at 2.5 amps, 6.3 v. at 43 amps, at 55/- each.

A SPECIAL LINE OF VOLTMETERS. First-grade Moving Coil 0 to 20 volts, 2in. square face, new boxed, 10/- each, in lots of 3, 25/-.

EX-R.A.F. MICROPHONE TESTERS. These consist of a Ferranti 2 1/2in. m/coil 0 to 1 m/a meter with Westinghouse Rectifier incorporated, calibrated at present 0 to 10 volts, microphone transformer, jacks, etc., all contained in polished oak case, size 6 1/2in. x 5 1/2in. Condition as new. Price 32/6 each.

LARGE RECTIFIERS FOR CHARGING. 6 or 12 volts at 6/8 amps. Complete with mains transformer for 200/250 volts 50 cy. 1 ph., £5/2 6, carriage paid.

EX-GOVT. NEW MAINS DIMMER RESISTANCE, worm wheel control, 700 watts variation from full to Blackout. Price £3/10/- each.

EX-GOVT. VARIABLE RESISTANCES (new), 4,000 ohms, carry 7 amp., 30/- each, 4,000 ohms, carry 1 amp., 37/6 each.

MAINS TRANSFORMERS. (New). Tapped input 200/250 volts 50 cys. 1 ph. Output 350/0/350 v, 180 m/a, 6.3 v, 4 a., 5 v, 3 a., 4 v, 4 a., 37/6 each, 1/6 post. Another 500/0/500 v, 150 m/a, 6.3 v, 1/6 post. Another 4 a., 47/6, post 1/6. Another 6, 12 and 24 volts, 10/12 amps, 45/- each, post 2/-. Another 14 1/2 and 17 1/2 volts at 30 amps (auto wound), £4/15/-, post 2/6. Another 700/0/700 v, 80 m/a, 12 v, 1 a., 4 v, 2 a., 30/-. Another 4, 6.3 v, and 12.6 volts at 12 amps, 45/-, post 2/6. Another 17 1/2 and 20 volts at 30 amps, 95/-, post 3/6.

VOLTAGE CHARGER TRANSFORMERS (Auto Wound), tapped 0, 110, 200, 220 and 240 volts, 350 watts, 55/-, post 1/6. 500 watts, 70/-, post 2/-. 1,000 watts, £5/5/-, post 2/6. 1,500 watts, £7/15/-, post 3/6. 2,000 watts, £8/15/-, post 5/-. Double Wound, 2 to 1 ratio (120/240 or vice-versa), 4,000 watts, £12/10/-, C/F.

AUTO WOUND TRANSFORMERS (Mains Boosters) tapped 0, 6, 10, 19, 175, 200, 220, 225, 240 and 250 volts at 1,500 watts (new ex-Govt.), £5/10/-, post 5/.

AUTO WOUND TRANSFORMERS (Voltage Changer) tapped 0, 10, 20, 25, 90, 130, 150, 190, 210 and 230 volts at 1,000 watts. (It will be seen that almost any voltage can be obtained from this transformer.) Price £5/10/-, post 5/-.

EX-R.A.F. I.F.F. UNIT (Model 3002), complete with 10 valves, types 3X70E, 1EF50, 4YR65, 2XYT61A and rotary converter 12 volts input, 450 volts 40 m/a. output. These units are as new. Price complete, 57/6 each, carriage paid.

MAINS TRANSFORMERS, EX-GOVT. Input 230 volts 50 cys. 1 ph. Output 12 1/2 volts C.T. at 25 amps, 45/- each, carriage 5/-.

METERS ALL BY WELL-KNOWN MAKERS EX-Govt. new boxed 1st Grade Moving Coil, 0 to 1 m/a, 21/-; 0 to 40 volts, 15/-; 0 to 10 amps, 15/-; 0 to 5 m/a., 17/6; 0 to 10 m/a., 17/6; 0 to 50 m/a., 20/-; all 2in. fsd. 0 to 3 m/a., 22/6; 0 to 50 m/a., 22/6; 0 to 200 m/a., 22/6; 0 to 4 amp. Thermo Coupled, 30/-; 0 to 20 volts A.C., calibrated 50 cys., 25/-; 0 to 3,500 volts Electrostatic, 35/-, All 2 1/2in. fsd.

L.T. RECTIFIERS (new), 6 volts, 1 1/2 amp., 7/6 each, 12 v. 1 1/2 amp., 10/6 each, 9d. post. Instrument Rectifiers, 5.H., 10 to 20 v/a. types, 4/6 each.

MAINS CHOKES, 9 hy., 100 m/a., 6/6; 20 hy., 120 m/a., 10/6 each; 30 hy., 150 m/a., 22/6 each.

MAINS TRANSFORMERS, 230 volts, 50 cys. 1 ph. input, Output 500/0/500 volts at 250 m/a., 5 v, 3 a., 47/6 each. Another with two windings of 6 1/2 volts 5 amps., 30/- each; another with 350/0/350 v., 180 m/a., twice three 6.3 volt windings and two 5 volt windings, 42/6 each; another 50 volts at approx. 50 amps., also a 5 volt winding, £3/15/-, each C/F. All the above Transformers are very large type, so please allow 3/6 for carriage.

D.C. TO A.C. ROTARY CONVERTERS. 24 volts input, 50 or 100 volts 500 cycles at 300 watts output. Condition as new, 75/- each, C/F.

EX-NAVAL CATHODE RAY RECTIFIER UNITS. New and unused, sold for components which consist of:—2 x .5 mf, 2,500 v., 1 x 1 5,000 v., 6 x 2 mf, 800 v., 2 x 8 mf, 800 v. 15 volume controls, various values, approx. 100 small condensers and resistance, smoothing choke and 9 v. holders, including 3 EF50 and 1 tube base. All components wired and with the addition of mains transformer would make a good oscilloscope. Price 45/-, carriage paid.

LARGE RECTIFIERS FOR CHARGING. 6 or 12 volts at 6/8 amps. Complete with mains transformer for 200/250 volts 50 cy. 1 ph., £5/2 6, carriage paid.

EX-GOVT. VARIOMETER for No. 19 sets; these contain C.T. Westector, .001, 5,000 v., condenser, etc., price 7/6 each. Complete in metal case with graduated dial.

EX-R.A.F. R.F. UNITS TYPE 110A. New and unused, consisting of 5 valves, including grounded grid 750 m/cy. tube, small 12 volt motor and numerous other components, would make very useful crakers, 45/- each, 5/- carriage.

EX-R.A.F. RADAR IMPULSE TRANSFORMERS (new, boxed). We have no actual data on these, but believe them to have an output of 15,000 volts at 3 kVv. for a micro second. A bargain for the experimenter at 7/6 each. P.F.

SHUNT WOUND D.C. 110 volt motors, 1,500 r.p.m. approx 1/2 h.p., condition as new, 17/6 each, post 2/-.

EDDYSTONE '640'

We are now booking orders for this first-class communications receiver.

Demonstration model on view at our Show Room.

EDDYSTONE '504' in stock.

52 Page Catalogue of Components & Accessories 1/- Post Paid.

B.T.S.

The Radio Firm of the South.

63, London Road, Brighton 1, Sussex.

CALLING AMATEURS

with **BUCCLEUGH**

Precision Built Equipment

STEEL CHASSIS SMOOTH BLACK

17 1/2" x 10" x 2 1/2" 9/9.

17" x 10" x 2" 8/9

PANELS-CRACKLE

19" x 3 1/2" 4/-

19" x 7" 6/9

19" x 8 1/2" 7/9

19" x 10 1/2" 8/9

ANGLE BRACKETS, 12 1/2" long, pr. 7/6.

(All in Bright Aluminium, same coat.)

COMPLETE RACK ASSEMBLY

(Rigid 4-Pillar), 63", 23 5/8", 31 1/2", 22 5/8".

Chassis, etc. to order, 1d sq. Inch.

(Include slides when costing.)

PUNCHING CHARGES UP TO 1 1/2".

VALVE HOLES, 1", 1 1/4" or 1 1/2", 6d.

METER HOLES, etc., 1/6.

SQUARE HOLES, 2/-.

BUCCLEUGH RADIO MANUFACTURERS

1 & 2 MELVILLE TERRACE, EDINBURGH, 9

'Grams' Therm., Edinburgh.

Factory: Wheatfield St., Edinburgh.

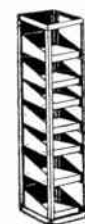

LASKY'S RADIO DECEMBER SPECIALS

Ex-A.M. Receivers, Type R1626, brand new and unused, consisting of 4 units.

Receiver Unit 165. Containing ten valves, 7 EP50, 3 EA34, 1 Neon, 2 relays, 6 Pot/meters, dozens of resistances 1, 1/2, 1 watt, condensers, toggle switches, valveholders, and other components.

Receiver Unit Type 170. Containing three valves EP50's, 1 relay, 2 pot/meters, resistances, condensers and other components.

Power Unit Type 565. Consisting of Motor generator, 20 watts 24 volts, 1.74 amps to 10 volts .04 amps, 1 relay, 1 power regulator, type 6, condensers and resistances.

R.F. Unit Type 108. Consisting of Lecher Bars and coaxial sockets.

The four units completely housed in strong metal box. Size: length, 19 1/2 in.; width, 8 in.; depth, 7 1/2 in. Original cost over £30. Weight, 35 lbs. Lasky's price £7/6, carriage 5/- extra.

TEST SET TYPE 230

Consisting of calibrator unit type 115, containing 9 EP50 and 3 EA50 valves, ceramic valveholders, resistances and condensers, coils, switches, 250 volt 50 cycles power pack including mains transformer 325-0-325, 250 mA, 5 v. 2 a., 6.3 v. 4 a., 250 mA smoothing choke, 8 mfd. 500 v and 16 mfd. 500 v condensers, 5Z4 Rec. valve, screened cable and connecting plugs, pot/meters and dozens of other components. Amazing value. Totally enclosed in strong metal cabinet. Size: length, 19 1/2 in.; width, 8 in.; depth, 7 1/2 in. Entire set and leads in wood carrying case with handles and hinged lid. Total weight, 55 lbs. Brand new and unused. Can never be repeated.

Lasky's price 90/- carriage 5/- extra.

Send 1d. for our latest bulletin of other ex-Service bargains, also our current list of radio components. We guarantee satisfaction. It will pay you to pay us a visit.

LASKY'S RADIO

370, Harrow Road, Paddington, W.9

(Opposite Paddington Hospital.) Phone: CUN 1979
Hours: 9 a.m. to 8 p.m. Thurs. close half-day



THIS USEFUL NEW FOLDER

... tells you all about the complete range of Henley SOLON Electric Soldering Irons, for the standard voltage ranges of 200/220 and 230/250: 65 watt and 125 watt models fitted with oval-tapered bits or pencil bits and 240 watt model, fitted with oval-tapered bits are available.

Write to-day for the new folder ref. Y.10 describing



W. T. HENLEY'S
TELEGRAPH WORKS CO. LTD.
(Engineering Dept.)
51-53 Hatton Garden, London, E.C.1

J. V. NEWSON, G3GY, 28, Market Place, North Walsham, Norfolk.—Everything for transmitter, constructor and short wave enthusiast. Components by Eddystone, Denco, Labgear, Hamrad, Raymart and other well-known makers from stock. All new goods. Wide range of transmitting and receiver valves at list prices. S.a.e. with enquiries please. Rapid post svce. c.w.o. or c.o.d.—Tel. 219.

THE American I.F.F. responder unit with 6 6BH7 all-metal I.F. pentode valves, 2 6HG all-metal double diode valves, and 2 type 7193 valves; also includes 2 200 ohm multicontact mechanically cam operated relays, various pie sockets, and a host of fixed condensers and 1/2, 1 and 2 watt high-grade carbon and wire wound resistances; the above also includes a 12 volt dynamotor with an output of 400 volts complete with step-down gear ratios suitable for driving instrument lathes; a real bargain at 50/- each plus 4/- packing and carriage.—For further details of other Government surplus bargains send 2d stamp to Uncle Tom's Radio Cabin, 5, Seven Stars Court, Manchester, 4. [8680]

SPEAKER trans. tapped output, ultra midget, 5/-; midget 5/6, standard 8/-; P.P. output (6L6 valves, A/A load 6,600 ohms), output 7.5 and 15ohms, 21/-; P.P. modulation trans. for 807 valves, audio power 350 watts, 2-1, at 12/6; chokes, ultra-midget 40ma 5/-, midget 50ma 5/6, standard 100ma 8/6; by duty 150/200ma 12/6; tuning assembly, assembled and fully wired for a.m.l. waves. On chassis, dial, pointer, I.F.s coils, padders, etc. Series heater wiring for use with 6k8g, 6k7g valves, complete, factory tested and aligned, with circuit 85/-; 5v superhet fully drilled chassis, 1 1/2 x 5 1/2 x 2 1/2 in., 7/-; AVO capacity bridge, £11; single core screened cable, per yard 9d; twin ditto 1/-; nuts/screws, 4, 6, 8 BA 6/- gross (2 gross in all); Centralab volume controls with switch, 5,000-ohms to 1 meg, 6/-; English and American maxon valveholder, 11/6 per doz; slow motion drum drives, 3/-; Epicurel drives 3/3; S.M.I. dials, coloured 4 x 3/2 2/-, 5 x 5/2 2/6; 2-gang condensers, 0.0005mfd 11/-, ditto Tiny Tim fitted trimmers, perspex dust cover, 2 x 1 1/2 x 1 1/2 in., 17/6; 2-gang, 0.0001mfd 6/-, 2-gang split stator, 0.00017mfd, 6/-; 3-gang, 0.0001mfd, 7/6; condensers: Electrolytics, 24 plus 8mfd, 350v, 7/6; 450v, 7/6; 20 plus 20mfd, 150v, 7/6; 32mfd, 350v, 5/-; 25mfd, 25v, 2/6; paper, 2mfd, 1,000v, 3/-; 4mfd, 100v, 9d; drive assemblies; square plane M/1, with escutcheon, glass, pointer, etc., 11/6; ditto full vision, S.M.I. 12/6; relays, 400ohm 12v 3/-, 100-250hm 6 or 12v 3/6; line cord, Sway 0.3amp per yd 3/-; ditto 2 way 2/-; Weymouth all wave coil pack with circuit, brand new, 36/6; Weymouth midget i.e. I.F. trans. 465 Kes, brand new, pr. 18/9; standard I.F. trans., pr. 15/-; ditto I.F.s 2Mcs, each 2/-; M/1, t.r.f. coils with reaction, circuit, pr. 7/6; M/1 i.c. t.d.f. pr. 10/6; S.M.I., aer & osc. pr. 10/6; sleeving, all colours, 1/1.5 mills. 35/10 yard reels 1/6; Bernard's publication stockist, television constructors' manual, 3/6; car and portable radio, ditto, 2/6; radio constructors, 3/-; etc.; comprehensive lists monthly; 2d stamp enquiries; postage extra all orders.

O. GREENLICK, Ltd., 34, Bancroft Road, Cambridge Heath Road, London, E.1. Tel. Stepney Green 1334. [8799]

WANTED, EXCHANGE, ETC.

WANTED, Sound Sales tri-channel amplifier.—Box 4019. [8740]

W.W., Oct., 47; state price.—Stutfield, Bowdown Farmhouse, Greenham, Newbury. [8740]

WANTED, double or triple spring gramophone motor; details, price.—Box 4043. £1 paid for data. R102 (Murphy), 1940.—Watt, 19, Willowbank Gdns., Belfast. [8740]

WANTED, electrical A.C. 230-volt disc recording turntable, Simpson type preferred.—Box 3898. [8657]

WANTED, Voigt corner reflector speaker.—Webb, 32, Kenuinghall Rd., Benchill, Manchester. [8781]

WANTED, Proc. I.R.E., Jan., Feb., March, 1945, for binding.—Waterson, 245a, Magdalen Rd., S.W.15. [8641]

WANTED, service sheets, any type, price offered.—Offers to Thompson, Rose St., Old Pen-shaw, Co. Durham. [8765]

WANTED, universal record-changer, new or second-hand; good price paid.—Brandon, 428, Upper Richmond Rd., S.W.15. [8721]

WANTED second-hand Cossor oscilloscope, model 339.—Write with full details regarding age and condition to Box 3910. [8664a]

QUANTITIES of ex-Gov. valves, types VR55, VR56 and VT52 or equivalents, wanted for cash.—N.R.S., 86, Parkhill Road, London, N.W.3. [8768]

URGENTLY required, half hard 0.002 or 0.003 phosphor bronze strip, 2in wide or multiples.—Price, samples and quantity available, to Rev Motors, Ltd., Lever Bridge, Bolton. [8674]

ARE YOU LOOKING FOR THESE?

PICKUPS.
Connaisseur, with transformer, 79/9. S.E.1, moving coil with transformer, 79/9. Rothermel, crystal, senior model 66/-, 8/12 62/6. Amphion, crystal, 51/7. Magnetic, 36/-, B.T.H., Piezo electric, 61/8. Magnetic 33/9. Goldring super magnetic 30/7. Pickup head fits all tone arms, 25/7. Cosmocon, crystal, 44/-, All prices include tax. Delivery immediately from stock.

MICROPHONES.
Crystal type, Shaftesbury, 135/-, Rothermel, 12 gns Carbon type, Mico, 70/-, Hand mike, 30/-, Moving coil type, Mico, 105/-, Lustraphone, 104/-, Revo, 110/-.

Ribbon type, Shaftesbury, 12 gns.
Microphone stands, Trix spring action, heavily chromium plated, heavy base, 95/-.

SOLDERING IRONS.
Pyrobit, 200/220 v. 45 watts, Instrument type, 22/-, Wireless type, 22/-, Model 6GB, 200/220 v. 65 watts, 22/-.

Solon, 200/220 v. or 230/250 v. 65 watts, Pencil Bit, 18/9, Straight Bit, 17/3.
Elco, 200/220 v. 60 watts, 18/4.
L.L.P., 230/250 v. 60 watts, 18/9.

PYROBIT SPARES.
Elements, Instrument 230 v. 45 w, 3/6.
Wireless, 230 v. 45 watt, 4/6.
Universal, Fits either 200/220 v. or 230/250 v. 50 watt, 4/6.

BITS.
Large Instrument, 4/-, Small pencil, 6d.
Sundries, Boreed cable, single 7 1/2 yard, twin 1-1/2 yard, heavy twin covered 2/9 yard. Wander plugs, red or black, 2d. Banana plugs, 4d. Crocodile clips, 4d. Alligator clips, 25 amp, 9d. Jack plugs, 2 1/2. Double circuit jacks, 2/3, insulated. Tone or volume plates 2 1/2 in. square, chrome or black, 6d. Indicator plates, chrome or black, 1 1/2 in. x 1 1/2 in. Output Gram, Input Mike, Aerial, Key, filaments, 6d. Jack discs chrome, marked Gram, Mike or radio, 1/-, And all other lines you need or are ever likely to need in radio. Prompt C.O.D. or C.W.O. Service.

Please include extra for packing and postage.

VALLANCE'S

144, BRIGGATE, LEEDS, 1

Phone: 29428 and 29429.
Staff call signs: G2HFV, G8SX, G2AHV, G3BDD, G3ABD.



'MINOR' INSULATION TEST SET

Compact and inexpensive without sacrificing accuracy and reliability. Weighs only 4lb. Height allows for full swing of generator handle. Ranges up to 20 megohms 500 volts.



CONTINUITY TESTER

This latest addition to the Record Ohmmeter range is enclosed in a moulded bakelite case of pleasing appearance. Equipped with self-contained dry battery. Specially designed test spikes and leads can be supplied, also a "test and carry" case in which the instrument may be used without removal. Ranges:— 0/3—0/30 ohms, 0/30—0/300 ohms, 0/500—0/50,000 ohms, 0/1000—0/200,000 ohms.

THE RECORD ELECTRICAL CO., LTD., Broadheath, Altrincham, Cheshire. Tel.: Altrincham 3291/2, Grange. Infusion, Altrincham. LONDON: 28, Victoria St., S.W.1. Phone: Abbey 5148

U.S.A. RADIO Aircraft RECEIVERS

Type CCT-46145

Made by Stromberg-Carlson

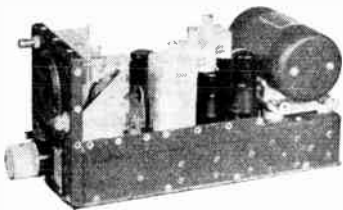

£6

Plus 5/- Carr. and pkg.

Medium Waveband, 520-1,500 Kc/s

These Ex-Government 6-valve receivers are brand new in original cartons. Overall dimensions approx. 10 1/2" x 4 1/2" x 5 1/2" high containing removable plug-in dynamotor for 24/28 volts with an output of 250 volts. Valves are one 12K8, three 12K7, one 12A6 and one 12A6, three Permeability-tuned I.F. transformers, input aligning condenser and main tuning condenser originally intended for use with remote control but easily adapted for direct tuning. Illustration shows metal cover and Condenser screen removed.

We have also the **U.S. R-1/ARR-1 AIRCRAFT RADIO HONING ADAPTOR EQUIPMENT** which can be used in conjunction with the above receiver on 234 258 mcs. This contains 4 acorn tubes type 954 and all permeability tuning. It is for use on 12 or 24 volts. Price **35/-** Plus 5/- carr. and pkg.

Other Indicators and Receivers in stock are:
R.1147 30/- plus 5/- carr. & pkg.
A.M. 6A Indicator
A.M. 62A £2.15 plus 5/- carr. & pkg.
 £10 plus 6/3 carr. & pkg.

ALEC DAVIS

8, PERCY STREET, LONDON, W.1.

*Phons: MUSeum 2453

THESE ARE IN STOCK

- Radar Engineering, by Donald G. Fink. 35s. Postage 8d.
- The Mathematics of Wireless, by R. Stranger. 7s. 6d. Postage 5d.
- Television Explained by W. E. Miller. 3s. 6d. Postage 2d.
- Television Today, by Roy C. Norris. 21s. Postage 6d.
- Wireless Servicing Manual, by W. T. Cocking. 10s. 6d. Postage 6d.
- Radio Aids to Navigation, by R. A. Smith. 9s. Postage 5d.
- The Wireless World Valve Data. 2s. Postage 2d.
- Electronics and Their Application in Industry and Research. 42s. Postage 9d.
- Mathematics Applied to Electrical Engineering, by A. G. Warren. 21s. Postage 6d.
- Foundations of Wireless, by M. G. Scroggie. 7s. 6d. Postage 4d.

We have the finest stock of British and American Radio Books. Complete list on application.

THE MODERN BOOK CO.
 (Dept. W29)

19-21, Praed Street, London, W.2.

URGENTLY needed for export, M.E.A. patterns 72, 74 and 4a laminations; Scott's pattern 130 and 4a laminations or equivalent in iron; 39s gauge copper wire, enamelled.—Offers to A.W.F. Radio Products, Ltd., Borough Mills, Bradford. [8526]

WE buy for cash, new, used, radio, electrical equipment, all types; especially wanted, radios, radiograms, test equipment, motors, chargers, recording gear, etc.—If you want to sell at the maximum price, call, write or phone to University Radio, Ltd., 22, Lisle St., Leicester Sq., W.C.2. (Ger. 4447)

WANTED to complete files, "Wireless World," 1940, May, Aug., Dec.; 1941, Feb., Mar., Apr., May, July, Aug., Sept.; 1943, Apr., Oct.; furthermore QST, 1940, May; 1941, whole year except May and Aug.; 1942, whole year; 1943, Oct., Nov., Dec.; 1944, whole year; 1945, whole year except Nov. and Dec.; offers, including postage, and stating condition of copies, to James Steffensen, Ehlersvej 8, Hellerup, Denmark. [8703]

REPAIRS AND SERVICE
MAINS transformers rewound, new transformers to any specification.
MOTOR rewinds and complete overhauls; first class workmanship, fully guaranteed.
F. M. ELECTRIC Co., Ltd., Potters Bldgs, Warser Gate, Nottingham. Est. 1917. Tel. 3855

MAINS transformer rewound and constructed to any specification; prompt delivery.—**Brown, 3, Bede Burn Rd., Jarrow.** [3460]
LOUDSPEAKER repairs, British, American. Any make, moderate prices.—**Sinclair Speakers, 12, Pembroke St., London, N.** [3508]
FERMINUS 4355.

TEST instrument repairs. Electrical test instruments repaired and recalibrated. Quick service guaranteed work.—**Electrico, 99 George St., Croydon.** [8698]

LOUDSPEAKERS repaired; transformers, clock coils, chokes, rewound; prompt attention; prices quoted.—**E. Mason, 5, Balham Grove, Balham, London, S.W.** [7667]

ELECTRICAL measuring instruments skillfully repaired and recalibrated.—**Electrical Instrument Repair Service, 329, Kilburn Lane, London, W.9** Tel. Lad. 4168. [6935]

REWINDS and conversions to mains and motor output transformers from 4/6; pp equip ment a speciality.—**N.I. Rewinds, 4, Brecknock Rd., N.7.** Tel. Arnold 3390. [6283]

"SERVICE with a Smile."—Repairs of all types of British and American receivers; coil rewinds; American valves, spares, line cord.—**F.R.L., Ltd., 22, Howland St., W.1.** Museum 5675

REPAIRS to moving coil speakers, cones, coils fitted field rewind or altered; speaker transformers, clock coils rewound; guaranteed satisfaction, prompt service; no mains trans. accepted.

L.S. REPAIR SERVICE, 49, Trinity Rd., Upper Tooting, London, S.W.17. Balham 2359.

LOUDSPEAKER repairs, valve rewinds, electric clocks, gram motors and pick-ups rewound and repaired; for real service send to **Laycock Bros. 36, St. Stephens Rd., Manchester Rd., Bradford, Yorks.** [8507]

STURDY rewinds, mains transformers, chokes and fields; we give prompt delivery and guarantee satisfaction; 14 years' experience; prices on request.—**Sturdy Electric Co., Ltd., Dipton, Newcastle-on-Tyne.** [4316]

REWINDING of all types of transformers, chokes, etc.; quick service; motor rewinds of all types; replacement bobbins supplied; new transformers to any specification.—**Radio & Transformer Services, 570, Manchester Rd., Hollinwood, Lancs.** [8638]

LOUDSPEAKER and transformer repairs "almost by return of post"; we offer the quickest service in the trade, at competitive prices. Send 1d for our monthly service bulletin, Dept. W.—**A.W.F. Radio Products, Ltd., Borough Mills, Bradford, Yorks.** Tel. 22838.

LOUDSPEAKER repairs, any make, reasonable prices, prompt delivery, to the trade and quality fans; 25 years' combined experience with Rola, Magnavox, Goodmans, Celestion.—**Sound Service Radio, 80, Richmond Rd., Kingston-on-Thames, Kin. 8008.** [4977]

REWINDS mains transformers, speaker field and coil chokes; high-grade workmanship, 7-day delivery; new transformers constructed to customers' specification, singly or in quantities.—**Metropolitan Radio Service Co., 1021, Finchley Rd., N.W.11.** Speedwell 3000. [3719]

24-HOUR service, 6 months' guarantee, any transformer rewind, mains outputs and i.f.s., etc., all types of new transf., etc., supplied to specification; business heading or service card for trade prices.—**Majestic Winding Co., 180, Windham Rd., Bournemouth.**

COIL specialists.—Tuning and oscillator coils, i.f.s., L.F. and mains transformers rewound and wound to specification; wavewinding, L.S. repair.—**Electronic Services (R.T.R.A.), 17, Arwenack St., Falmouth, Cornwall; and 49, Uxbridge Rd., Ealing, W.5.**

You're SURE to get it at
STERN'S
 ESTABLISHED 25 YEARS

Weymouth M. & L. Waves Permeability Tuning Unit, with integral W/Band switching, s/het or TR.F, 2 1/2" x 3 1/2" x 4 1/2", 48/9. S/Het Coil Pack, S.M. & L. Waves, 36/6. Screened Iron Cored Coils, A, HF or Osc., 5 ranges cover between 33 to 2,000 metres, 4/9 each. Complete Perm. Trim I.F. Filter, 1" sq. x 1", 465 k/cs. 4/9.
 *00035 MFD. Midget Variable Twin Gang Cond., 12/9.

Varley L.F. Choke, 20 Hy. 250 ohms 120 m/A, 18/6. Mains Transf. 350-0-350 130 m/A, 6.3 v. 4 a., 5 v. 2 a. (both tapped at 4 v.). 40/-; 425-0-425 150 m/A, 6.3 v. (C.T.) 4 a., 5 v. 3 a., 4 v. (C.T.) 4 a., 55/- Thermal Delay Switch, 4 v. and 6 v., 10/6.

Wearite I.F. Transf. 465 k/cs. Standard, 20/- pair. Midget iron-core, 21/- pair. "P" Coils, all ranges, A, HF, Osc. or P.F.O. 3/- each. S/Het iron-core Coil Packs, S.M. & L. Waves or 13-35, 34-120, 200-550 metres, 42/-.

Electrolytics Dubilier 8 mfd. 500 v., 4/-; 8-8 mfd. 500 v., 6/6; 16 mfd. 500 v., 6/6; 8-16 mfd. 500 v., 8/6. T.M.C. 8-16 mfd. 450 v., 7/6; 32 mfd. 500 v., 5/9.

Westinghouse 0-1 m/A Meter Rectifier, 10/6.

Ex-Govt. O/Put Transf. 60-1, 1 1/2" x 1 1/2", 3/-; P/Pull Interval Transf. 2.5-1 each half, 1 1/2" x 1 1/2" x 1 1/2", 3/-; Midget O/Put 32-1, 1" x 1" x 3", 3/-; L.F. Chokes, 5 Hy., 100 ohms, 150 m/A, 6/9; 15 Hy., 100 ohms, 300 m/A, 12/6. Double-spaced Transmuting Condensers, split-stator, 150 PF each half, 4/9. Straight type 200PF, 4/9. Mains Transf. 250-0-250, 70 m/A, 6 v. 1 1/2 a., 5 v. 3 a., 19/6.
 *0001 MFD. Twin Gang Midget Variable Cond., 5/-.

★ Send 2d. stamp for Catalogue—November Supplement now available. When ordering, please cover packing and postage.

STERN RADIO LTD.

115, FLEET STREET, E.C.4.

Telephone: CENTral 5814

WARD ROTARY CONVERTERS

For Radio, Neon Signs, Television, Fluorescent Lighting, X-ray, Cinema Equipment and innumerable other applications

We also manufacture:—

Petrol Electric Generating Plants, H.T. Generators. D.C. Motors, etc., up to 25 K.V.A.

CHAS. F. WARD

LERDSGROFT WORKS, HAVERHILL, SUFFOLK
 Telephone: Haverhill 253 & 4.

CRYSTAL PICK-UP

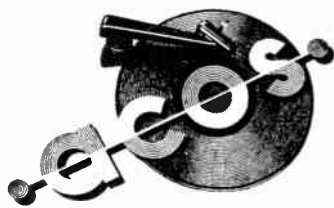
WITH *Unbreakable* CRYSTAL

The ACOS G.P.10 combines purity of reproduction with extreme reliability. A unique flexible assembly renders the crystal virtually unbreakable, while a needle-pressure adjustment is incorporated in the base. Resonance-free response from 50-8,000 cps. Output 1.5v. at 1,000 cps. Needle pressure 1½ ozs. (adjustable). Vibration-free arm movement. Screened lead. Price in Great Britain 44/- (including P.T.).



Flexible coupling A protects crystal B against breakage. (Brit. Pat. 579,524. Pats. Brush Radio Co. Ltd.

Obtainable only from Radio Dealers

COSMOCORD LTD
ENFIELD: MIDDLESEX

'ENGINEERING OPPORTUNITIES'



This unique handbook shows the easy way to secure A.M.I. Mech. E., A.M.Brit.I.R.E., A.M.I.E.E., City and Guilds, etc.

WE GUARANTEE—
"NO PASS—NO FEE."

Details are given of over 150 Dipl. ma courses in all branches of Civil, Mech., Elec., Motor, Aero., Radio, Television and Production Engineering, Tracing, Building, Govt. Employment, R.A.F. Maths., Matriculation, etc.

Safeguard your future; send for your copy at once—FREE.

B.J.E.T., 387, SHAKESPEARE HOUSE,
7, STRATFORD PLACE, LONDON, W.1.

THE "WILLIAMSON" AMPLIFIER

If you are very critical of the reproduction from the average "quality" amplifier, this is the instrument for you. The designer claims this to be "virtually distortionless," to which we would add that the "attack" and transient response sets quite a new standard. We are now producing this amplifier to specification with first-grade components in chassis form at:—

£27. 10. 0

We shall be happy to arrange demonstrations by appointment.

Orders are being handled strictly in rotation. A limited number of acoustically designed cabinets are also available.

MORTON & DISMORE
52c Oldchurch Rd., Chingford, E.4
Phone: SIL 4987.

A REWIND service which duplicates or modifies as required; transformers, loudspeakers, etc; prompt returns.—Radel Services, 49, Lr. Addiscombe Rd., Croydon. Cro. 6537.

PICK-UPS, replacement coils for Garrard type, etc., 5/3; rewinds to clock coils, fields, transformers, etc., replacement Marconi, H.M.V., mains transformer coils, 18/-; 48-hour service; trade enquiries.—Radiocrafts, 40, Goodmayes Rd., Goodmayes, Essex. Tel. Seven Kings 4557.

COILS and transformers manufactured to specification single or quantity; rewinds to all types of coils, transformers, etc.; qualified consulting engineers available to help solve your problems; first-class service and delivery.—Millett & Holden, Ltd., 2, Pembury Rd., Westcliff-on-Sea, Essex. [8480]

REWINDS.—Armatures, fields, transformers, pickups, vacuum cleaners, gram. motors, speakers fitted new cones and speech coils, All guaranteed and promptly executed. New vacuum cleaners, most popular makes. Send stamped addressed envelope for list of radio spares and c.o.d. service.—A.D.S. Co., 261-3-5 Iichfield Road Aston, Birmingham. 6. [8238]

NATIONAL RADIO SERVICE & TELEVISION CO.—Trade service engineers; immediate service any district; rewinds to all types transformers, armatures, motors, loudspeaker cones, speech coils fitted, British and American components and valves; enquiries invited for contract trade service; multiple transformer winding.—63, High St., St. John's Wood, N.W.8. Primrose 6725. [6752]

DEGALLIERS, Ltd.—Service with a guarantee. If you cannot get your receiver serviced, let American specialists do the job; first-class workmanship only; specialising in Air-King, Belmont, Challenger, Delco, Detrola, de Wald, Emerson, Ferguson, Gard, Hammerlund, Hallicrafter, Lucille, McMurdo, Silver, Midwest, Majestic, Pilot, Philco, Scott, Sparson, Zenith, R.C.A., etc., also any British set; due to lack of accommodation our service branches are still dispersed; therefore apply for forwarding instructions before despatching sets; s.a.e. with all enquiries.—Degalliers, Ltd., BCM/DEGS, London, W.C.1. [8043]

MISCELLANEOUS

SPEECH disability; Mr. H. V. Hemery consults at Wigmore Hall Studios, W.1.

W.W., Feb. 43, Dec. 46; offers.—K. Oliver

5, Ennismore Ave., Guildford. [8747]

LARGE quantities of new unused Uni-Radio cables, various patterns, for disposal.—Box 2984. [8471]

70 up-to-date beautifully kept 10in records, all in covers; £9/10, or near offer.—Box 3748. [8653]

FOR sale, "W.W." Jan., '41—Dec., '46.—Offers to Thompson, Rose St., Old Pen

shaw, Durham. [8765a]

EX-A.M. battery units, insert, 60v 5/9, 120v 10/9, post free.—Bulls (W.W.), 246, High St., Harlesden, N.W.10. [8652]

VOLUMES 1 to 6 "Wireless World," bound publisher's covers; offers.—12, Grove Park Avenue, Bristol, 4. [8766]

MIDGET set cabinets, inside 10¼inx5inx5½in, whitewood to finish yourself, uncut; 8/- post free.—9, Wicklow Av., Stockport

2BA steel, fibre ring, locknuts, single and twin flange fixing, 2/6 gross (minimum 20 gross).—John Downton & Co., 89, High St., Epping. Tel. 2163. [8701]

H M.V. console cabinet, 45inx25inx23in, heavily built; £10; can be seen by appointment; buyer to collect.—Sculley, 52, Ridgeway, Hayes, Kent. [8646]

REPLACEMENT radiogram chassis, cabinets, speakers, amps, pick-ups; also mobile and static P.A. equipment.—Radio, Unlimited, 16, Carnarvon Rd., Leyton. [8631]

W.W., 20 clean bound vols. from Vol. 18 (1926-1935), £9/10; massive condenser, 100 p.f., 7,000v flashover, £2/15.—Tranmer, Wandsworth, Burniston, Scarborough.

YOUR the Continent; D5 scarbor'boy coil, crystal 1, 2 and 3 valve, circuit enclosed; 5/- each from your dealer.—If unobtainable, write Douglas Electronic Industries, Ltd., Brinklow, Rugby. [8639a]

ALUMINIUM chassis and panels, any size, plain or punched to your requirements, chassis 18 s.w.g., 4 sides, 6x4x2 3/9, 10x6x2 4/6; also in 16 s.w.g.—Mead, 13, Bence Lane, Darton, Barnsley. [8650]

LARGE quantity of 6BAx1¼in r.h. plated steels screws; also 6BA brass locknuts; other sizes 2, 4, 6 8BA brass also in stock; send us a note of your requirements.—John Downton & Co., 89, High St., Epping. Tel. 2163. [8699]

ALWAYS sure of a good reception.—Radio Craft, 19/6; C.Q., 21/6; Radio News Q.S.T. 21/6; Life (International), 40/-; Look, 25/-; Saturday E. Post, 55/-, etc.—For full list of all other American magazines, send s.a.e. to Willen, Ltd. (Dept. 52), 120, St. Georges Rd., London, E.10. [8679]

A.C.S. RADIO

SPECIALISTS IN SHORT WAVE and high-class broadcast equipment offer a wide range of components for the constructor and enthusiastic amateur.

In addition to our range of equipment bearing the well-known Trademarks of Eddystone, Raymart, Hamrad, Labgear, etc., we have a large and varied stock too numerous to detail in the space available. For example we are usually able to offer Communications Receiver, tested and realigned in our workshops, including such well-known types as the NATIONAL H.R.O., R.C.A. AR88, etc. Your enquiry for any particular item will receive our careful attention. In P.A. Equipment we can offer a complete outfit comprising A.C. operated Amplifier with Push-Pull D.A.100 output, two 12in. P.M. Speakers in Cabinets with detachable horns and stands, Mixer Panel, Gramophone Turntable and microphone. Complete outfit £75.

For the Short Wave Amateur we stock several types of transmitting and receiving valves including the EIMAC 100TH at £6, 5.T.4074A(RK34) at £2, 5C/100(813) at £7/15/-. Mullard RG1/240A M.V. Rectifiers at 20/-. V.H.F. receiving types include 9002-12/10, 5001, 6AK5—15/-.

New component list "W.W." sent on request.

44 WIDMORE RD BROMLEY, KENT
Phone Ravensbourne 0156

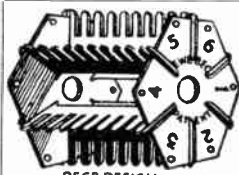

The Popular "U-BEC" Universal Coil Former again available by return of post! Send 2/6 & 2½d. post
E. W. EVANS
5, Beckingham Rd., LEICESTER

REG'D DESIGN

• Radiospares •
Quality Parts

THE
SERVICE ENGINEER'S
FIRST CHOICE

TELERADIO.
Announce
2 NEW KITS

Model 55. 4 valve highly sensitive, 3 wave, battery superhet. Components £6, plus P.T. 25/6. Valves 36/-. B'prints 4/-.
MODEL 88. Distortionless 5 valve 14 watt quality amplifier. Components £13 approx. Valves 4 gns. B'prints 4/-.
For full details of these new designs send 2½d. stamp to

The TELERADIO Co.,
157, Fore Street, Edmonton, N.18
*Phone: Tottenham 3386.

Ex-M.O.S. BARGAIN
NEW AND UNUSED
Head and Microphone Sets
POST FREE 12'6

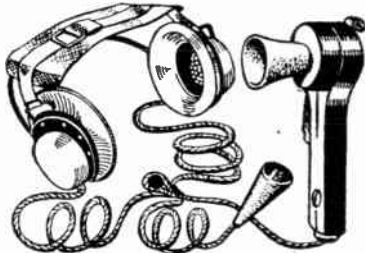

MOVING COIL EARPIECES

Made to the stringent specification of the Tank Regiment by the leading British manufacturer. Ordinarily would cost several pounds retail. Despatched in their original packings.

Send for our lists of new and unused ex-Govt. Radio Equipment.

WIRELESS INSTRUMENTS

(LEEDS) LTD.
 54-56, THE HEADROW, LEEDS, 1
 Tel. 22262.

"We Were Greatly Impressed"

This phrase was used by a leading Electrical Instrument concern in connection with

TRANSFORMERS and CHOKES

supplied by us, and is praise to which we have become accustomed. Our modern factory is fully equipped with vacuum and pressure impregnators, and all the latest test equipment.

POWER RATINGS 8 V.A. to 8 K.V.A.

AUDIO RATINGS 3 watts to 200 watts.

AUSTIN MILLS LTD. LOWER CARRS, STOCKPORT

Established 20 years. Phone: STO 3791

RADIO cabinets (midget), hand-made, french polished, chrome speaker grill, exclusive design, 12x7x6 internal, dial-cut to right, 4x3 1/4; 32/6 inc dial; c.w.o.; photo on request to interested buyers.—Burmans, 64, Bighton Rd., Clapton, London, E.5. (8599)
AMERICAN magazines available.—F.M. and A Television, 30/; Radio Craft, 19/6; C.Q. (Amateur Radio), 18/6; Q.S.T. (Amateur Radio), 21/6; Radio News, 25/-; Audio Engineering, 17/6. incl. one year.—For full list of radio and other magazines s.a.e. Willen, Ltd. (Dept. 52), 120, St. George's Rd., E.10. (8239)

PLASTIC precision moulding.—Lustroid, Ltd., Coatbridge, can offer to manufacturers almost all materials; injection and compression moulding, free technical advice and design, prompt quotation, minimum production delay.—Apply to sole representatives in England and Wales; Foreman & Ellams, Ltd., 91-3, Charterhouse St., London, E.C.1. Tel. Clerkenwell 3735 and 5, Rumford Place, Liverpool, 3. Tel. Central 1701 (3 lines).

ELECTRIC hand drilling machines, independent of mains, 57/6, operates from any 6v or 12v battery, 1,250 r.p.m., on 6v and 2,000 on 12v; can be used for drilling or easily screwed to bench and used with standard chuck attachments (rotary wire brush, grinder, polishing mop, etc.), fitted with Reliance chuck 0 to 1/4 in capacity, ex-Government ball race motor, stout leads and quick-grip clips, weight 7 1/2 lb, numerous modifications available for inspection, carriage 1/8. —E. A. Mason, 153, Manchester Drive, Leigh-on-Sea, Essex. (8642)

WORK WANTED

INSTRUMENT gear cutting capacity.—Lloyd & Ramsden, Huntingdon St., Nottingham.
LIGHT press capacity available up to 25 tons, and assembly, in London area.—Box 1437. (8074)

CAPACITY available for assembly, wiring, testing radio chassis; large or small quantities.—Box 4028. (8755)

WE can undertake design, research and construction of radio and electronic equipment; let us quote you first.—Box 4030.

SMALL firm has capacity for manufacturing radio chassis, metal cabinets and metal fittings; presswork a speciality; individual or quantity orders.—Box 3742. (8634)

WE make wireless and radiogram cabinets for home and export; immediate deliveries.—Radic, Ltd., 26, Brondesbury Rd., London, N.W.6. Maida Vale 8792. (8025)

FOXWINDERS, 74a East Hill, Wandsworth, S.W.18, are now able to quote you for your light press work, blank form or piercings, milling, turning and gulltoting. (8382)

CABINETS—Large modern factory now has capacity available for additional radio cabinet manufacture; we have every facility for large-scale production; let us quote you.—Box 3745. (8645)

LET us build that new radio for you; each receiver is specially designed, under laboratory conditions, to fulfil your most exacting requirements.—For further details: E.D.C.O. 24 Belmont Circle Harrow Middx

LARGE old-established public company in London with extensive experience of mass-production woodwork and exceptional facilities and resources for the production of radio and gramophone cabinets would welcome enquiries from the trade.—Enquiries to Box 3900. (8665)

DRAWING and tracing work for radio and electrical engineering, jig and tool and light engineering, photoprinting; full sets of drawings undertaken to commercial or Ministry standards.—Drawing & Tracing Ltd., 456a, Ewell Rd., Tolworth, Surbiton. Phone Elmbridge 7206 (7703)

CAPACITY available for large quantities of electrical and radio instrument assembly, wiring, and final test; 1-10,000 instruments efficiently produced; collection and delivery of components and completed instruments.—E. A. Porritt, 13 and 27, Wastdale Rd., Forest Hill, S.E.23. For. 1292. (8635)

RESearch engineers with well equipped electrical and mechanical laboratories and drawing office, are prepared to undertake the design and/or fabrication of special scientific and industrial equipment; the organisation is suited to the design or research on the industrial electronic and other fields, also the design and construction of specialised and ancillary apparatus.—Box 3525. (8559)

LARGE firm of woodworkers are developing mills, machining, veneering, assembly and finishing shops for specialised production; these are controlled by men of long technical and practical experience; these services will be available shortly, and we invite enquiries from firms of good standing or their accredited agents; the plant is most modern and capable of fabrication of a high-class production; technical service available to prospective clients immediately.—Box 2594. (8325)

COULPHONE RADIO

"The Return of Post Mail Order Service."
58 DERBY STREET, ORMSKIRK, LANCs.
 Phone: Ormskirk 498. Grams: Coulphone, Ormskirk
NEW GOODS ONLY
 C.W.O. or C.C.D. Post Free over 5/-

MAINS TRANSFORMERS
 PRIMARIES for 200/30, 50 volts. Universal 4, 5 and 6.3 v. L.T. 300-0-300 v. 60 mA. 23/6; 350-0-350 v. 100 mA. 23/6; 450-0-450 v. 200 mA. 4 v. 8 a. C.T., 4 v. 4 a. C.T., 4 v. 4 a. 45/-; 450-0-450 v. 200 mA. 6.3 v. 4 a. C.T., 6.3 v. 4 a. C.T. 5 v. 3 a. 45/-; 480-0-480 v. 200 mA., 6.3 v. 6 a. C.T., 4 v. 2 a. C.T., 4 v. 2 a. C.T., 5 v. 3 a., 47/6; 1,250-1,000-750-0-750-1,000-1,250 v. 300 mA. (no L.T.s), 118/-; 4 or 6.3 v. 8 a. C.T. (Filament), 17/6 Auto (Filament), 4v. to 6.3v. 4a. (or vice versa) 13/6

SHOOTING CHOSES
 15 H. 40 mA. 350 ohm. 5/-
 20 H. 60 mA. 425 ohm. 6/6
 15 H. 90 mA. 240 ohm. 7/-
 20 H. 100 mA. 425 ohm. 13/6
 20 H. 200 mA. 150 ohm. 22/6
 30 H. 200 mA. 350 ohm. 25/-

OUTPUT TRANSFORMERS
 Midget Power Pen, 5/6. Std. Univ., with C.T., 7/6. Large Univ., with C.T., 12/6. Heavy Duty Univ. for 8, 8 and 15C., 22/6. Extra Heavy Duty, 37/6. SPECIAL (to author's specification), for quality amplifier, described in April and May issues of "The Wireless World," 67/6.

COILS, COIL PACKS, etc.
WEYMOUTH TRF. COILS M. and L., with cct., pair 9/6. "F" Type, 2/9 ea.

SUPERHET 3 W.B., with cct., 465 kc/s., pair 11/6.
WEYMOUTH TRF. COIL PACKS. Completely allied. 36/6.
SUPER FEEDER UNIT. 5 waveband. R.F. Stage Magic Eye. Complete with 5 valves 218 13s.
I.F. TRANSF. 81uget. 18/8 pr. standard, 17/6 pr. J.B. MIDGET 2-GANG CONDENSERS. 0.000 u/Lt. 11/6; W/T.r., 12 G. 3-gang L/T.r., 15/6
KITE. 4v. Batt. 8/H. 5v. A.C./D.C. or A.C. 8/H. 11/6; 12 G. Full Vision, 3: 1, 12/6.

SUNDRIES
LINE CORD. 3 amp. 60Ω per ft., 2 w., 2/3 yd.; 3 w., 2/6 yd. P.B. Wire, 3d. yd.
MAINS DROPPERS. 3 a. 800Ω. 4/6; 2 a. 1,000Ω. 4/3. CARBON RESISTORS (50Ω to 5 MΩ), 4 w. 6d.; 1 w., 9d.

EDDYSTONE SHORT WAVE GEAR.
ROMAC SUPER CAR RADIO. VIDOR PORTABLES.
 Send 2d. stamp for new 24-page Catalogue.



ALL-WAVE SIGNAL-GENERATORS Type 5 & 6

These high-quality precision instruments 200-240 volts AC Type 5, 100-250 volts AC/DC Type 6, have a coverage of 100 Kc/s to 30 Mc/s in 5 ranges. Calibrated by hand against a standard frequency accurate to 0.01%. Constructed in B.A.60 alloy and finished black and cream. Price 14 Gns. Type 5 or 6. Immediate delivery.

Illustrated leaflets on application to:

R.R. DEVELOPMENT LABORATORIES LTD
 BARNARD ROAD • BRADFORD

AMERICAN COMMUNICATION RECEIVERS B.C.312 - BRAND NEW

Here is your chance to obtain a super communication receiver of American design and manufacture. These sets are absolutely new and still in the Makers' original waterproof packing cases. Each case contains

- A—One brand new B.C.312 Receiver.
- B—A complete set of nine spare Valves.
- C—A set of eight spare Brushes for the Dynamotor.
- D—Four spare Fuses and two spare Dial Lamps.
- E—Complete Technical and Operating Manual.

BRIEF SPECIFICATION.

SIX WAVE BANDS. VALVE LINE UP
With illuminated Dial. 6E7-1st R.F. Valve,
6E7-2nd R.F. Valve,
6C5-R.F. Osc. Valve,
6B7-Mixer Valve,
6E7-1st I.F. Valve,
6E7-2nd I.F. Valve,
6B7-2nd Det. and A.V.C.
6C5-C.W. Osc. Valve,
6B7-6. Audio Output.

The set receives its power from a D.C. Dynamotor operating on 12-14 volts, the input power being 50-60 watts. This generator compartment is conveniently mounted on hinges and can easily be removed so that a mains power pack can be fitted in its place if necessary. Two sets of 'phones and a speaker can be plugged into the front panel.

INCLUSIVE PRICE FOR THE COMPLETE SET.

£25

10/- carriage extra.

BULL'S "EX-GOVERNMENT" DEPOT.

42-46, WINDMILL HILL, BUISLIP MANOR, MIDDX.

TRANSFORMERS & COILS TO SPECIFICATION.

MANUFACTURED OR REWOUND
JOHN FACTOR LTD.,

(Formerly Stanley Cattell Ltd.)

9-11 East Street, TORQUAY, Devon

'Phone: Torquay 2162

BROOKES CRYSTALS EST. 1929—LTD.

FOR YOUR
Crystal
requirements

51/53, GREENWICH CHURCH STREET,
LONDON, S.E.10. 'Phone: GRE. 1828

IRON DUST CORED COILS

of Exceptional Efficiency and Stability

AERIAL AND OSCILLATOR, short, medium, or long

wave, size 1in. x 1in. 7/8 pair.

AERIAL AND OSCILLATOR, medium or long wave,

size 2in. x 1in. 6/8 pair.

DUAL WAVE COILS, medium and long wave aerial

and l.f. 9/6 pair.

I.F. TRANSFORMERS, Standard Frequency 465

Kc/s. Size, 1in. diam. x 1 1/2in. high. 9/6 each.

MINIATURE ROTARY SWITCH, 4 pole, 3 way, 3/9

each.

CONDENSERS, Silvered Mica, .0001 mfd., 4/- doz.

AVOMETER, Model 7, £19/10/-.

All coils fitted with adjustable iron cores, and supplied

with circuit diagram.

TERMS: Cash with order or C.O.D. on orders over £1.

MONOCHORD RADIO

(Established 1929)

17 Streatham Hill, London, S.W.2

'Phone: Tulse Hill 1051/2.

BUSINESSES FOR SALE OR WANTED
RADIO, television, musical instruments and records; sound, well-established business. N.W. London, excellent position, large premises, held on long lease at low rent, increasing turnover; only substantial principals need apply.—Box 3901. [8669]

LANCASHIRE coast.—Old-established radio and electrical business with excellent living accommodation included. Sole agent for leading makers; £3,000 plus s.a.v. Vacant possession on completion.—General Business Transfer Co., 88, Mosley St., Manchester, 2.

SITUATIONS VACANT
Vacancies advertised are restricted to persons or employments excepted from the provisions of the Control of Engagement Order, 1947.

CROWN Agents for the Colonies.—Applications from qualified candidates are invited for the following post:—

INSPECTOR of Wireless Telegraphs required for Post Office Department, Hong Kong, for 3 years with prospect of permanency. Commencing salary in scale £475

£575 a year according to age and experience. Cost of living allowance on salary of £475 is £200 for single man and £270 for married man. Outfit allowance £60. Free passages and quarters. Candidates, 27-35

years, must be conversant with ship station survey, inspection and licensing, and radio legislation generally. Must be able to read

Berne correspondence in French and be familiar with British Post Office methods. Experience of radio traffic desirable. Preference given to candidates possessing City and

Guilds certificates in radio communication and P.M.G. first-class certificate.—Apply at once

by letter, stating age, whether married or single, and full particulars of qualifications and experience and mentioning this paper to the Crown Agents for the Colonies, 2, Millbank, London, S.W.1, quoting M/N/18571 on

both letter and envelope. Applications from General Post Office employees should be submitted through official channels. [8801]

EXPERIENCED radio service engineer required; television an advantage.—State age, experience, salary to Cropley, 8, Upper High St., Epsom. [8723]

ENGINEERS wanted to test television receivers in accessible West London area.—Please write, stating age, experience, and salary required, to Box 4045. [8787]

JUNIOR engineer required for development of radio components by progressive company in Surbiton area; degree or equivalent in electrical engineering essential.—Box 3903.

JUNIOR laboratory assistant with some knowledge of physics and some electrical training.—Write, giving details of experience, age, etc., to: A. H. Hunt, Ltd., Bendon Valley, S.W.18. [8354]

WORKING manager required for test department; must be conversant with the complete testing of marine and commercial radio apparatus; only those with experience need apply.—Box 3999. [8663]

JUNIOR laboratory assistant, 20-22, with some knowledge of chemistry, preferably up to Inter-B.Sc. standard, for raw material and process testing.—Write, giving details of experience, age etc., to: A. H. Hunt, Ltd., Bendon Valley, S.W.18. [8353]

CHARGE-HAND required for coilwinding and transformer assembly department; previous experience of coilwinding essential; excellent opening for keen and enthusiastic worker.—Apply to Personnel Department, E.M.I. Factories, Ltd., Blyth Rd., Hayes, Middx. [8654]

GRADUATE development engineer, with laboratory experience in electronic development; preferably of amplifiers for very low frequencies, biological amplifiers and electronic instruments; eastern outskirts of London.—Write full details and salary required to Box 3747. [8651]

SERVICE engineer with good basic theory and mechanical sense required for trade repairs to quality radios, sound projection and recording equipment, P.A. installations, etc.; small private workshop with latest electronic and mechanical equipment.—Precision Services, Ltd., 8, Hill St., Edinburgh, 2. Tel. 34311-2.

RADIO trade.—Representatives wanted in Midlands, Eastern and South Eastern counties, already calling upon wholesalers and retailers, to carry fast-selling, established line; generous commission terms; technical knowledge desirable; particularly suited to component representative.—Write Box A.C.23547, Samson Clarke, 57-61, Mortimer St., W.1.

MURPHY RADIO, Ltd have a vacancy for a senior engineer having considerable experience in the development and design of communication receivers and allied equipment.—Apply in the first place in writing, giving full particulars and stating salary required, to: Personnel Department, Murphy Radio, Ltd., Welwyn Garden City, Herts

100 kcs
QUARTZ
CRYSTAL
UNIT
Type
Q5/100



for Secondary Frequency Standards

★ Accuracy better than 0.01%. ★ New angles of cut give a temperature coefficient of 2 parts in a million per degree Centigrade temperature change. ★ Vitreous silver electrodes fired direct on to the faces of the crystal itself, giving permanence of calibration. ★ Simple single valve circuit gives strong harmonics at 100 kcs. intervals up to 20 Mcs. ★ Octal based mount of compact dimensions. PRICE 45/- Post Free

Full details of the Q5/100, including circuit are contained in our leaflet Q1. Send stamp to-day for your copy.

THE QUARTZ CRYSTAL Co., Ltd.

63-71 Kingston Road,

NEW MALDEN, SURREY

Telephone: MALden 0334

Beethoven
ROTARY CONVERTORS
220 D.C. to 220 A.C.
Details from—
BEEHOVEN ELECTRIC EQUIPMENT LTD.
Beethoven Works, Chase Road London, N.W.10

TELEVISION

The advance in Radio Technique offers unlimited opportunities of high pay and secure posts for those Radio Engineers who have had the foresight to become technically qualified. How you can do this quickly and easily in your spare time is fully explained in our unique handbook.

Full details are given of A.M.I.E.E., A.M.Bri.L.R.E. City & Guilds Exams, and particulars of up-to-date courses in Wireless Engineering, Radio Servicing, Short Waves, Television, Mathematics, etc., etc.

We Guarantee "NO PASS—NO FEE"

Prepare for to-morrow's opportunities and post-war competition by sending for your copy of this very informative 112-page guide NOW—FREE.

BRITISH INSTITUTE OF ENGINEERING TECHNOLOGY (Dept. 388)
17, Stratford Place, London, W.1

COVENTRY RADIO

COMPONENT SPECIALISTS SINCE 1925

1948

LIST OF RADIO COMPONENTS
NOW READY

Send for your copy to-day, PRICE 3d. post paid. Contains details of hundreds of latest new components.

COVENTRY RADIO
DUNSTABLE ROAD, LUTON, BEDS.

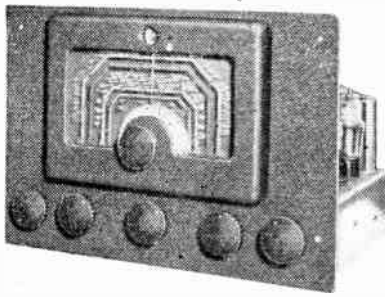

PEERLESS TYPE 1047 RADIO CHASSIS

Those who visited our stand at Radiolympia were quick to appreciate that this chassis, with its workmanlike design and generous specification, provides the enthusiast with something out of the ordinary at a reasonable price.

Among its principal features are:—

- 10 stage superhet circuit.
- 10 valves (including magic eye).
- RF amplifier.
- 2 IF stages.
- 4 wave bands.
- 10 Watts push-pull output.
- Tropicalised components.

Communications enthusiasts should write for details of our 1546 Chassis.

PEERLESS RADIO LIMITED
374, Kensington High St., LONDON, W.14
Phone: WEstern 1221

THE "PERIMET" ELECTRODE Soldering and Brazing Tool

Gives perfect joints on all electrical and instrument work. Operates from 4 or 6 volt Accumulator or Triac former. Price Complete with cable and spare Electrodes, 15/- post free, Mains Transformer with tappings for 3 heats, 100 Va output. Price 35/- deivered.

Details on request.
HOLBOROW & CO.,
71, Weymouth Bay Avenue, Weymouth,

Precision Woodwork

FOR EXPORT ORDERS

We are well equipped for the production of high grade veneered cabinets in quantity. We invite enquiries for Radio-Gram Cabinets, Consoles, and other repetition woodwork.

Timber Licence required

BAXTER STAVRIDI & CRAIES Ltd.

9 Commercial Road, Edmonton, London, N.18

SENIOR development engineer required in television design laboratory; good honours degree in Physics or Engineering and at least 4 years industrial experience of television receiver development essential.—Applications, giving full particulars of training and experience, to Personnel Manager (Laboratory) Murphy Radio Ltd., Welwyn Garden City, Herts. [8352]

LONDON appointment offered to assistant physicist with a leaning to radio and electrical circuits; applicants should have appropriate theoretical qualifications, and not less than two years' experience, and will be required to develop the electrical aspects of plastics evaluation in a large chemical manufacturing company; the work offers prospects for promotion; commencing salary range £375-£500.—Box 3526. [8560]

RADAR company in the Manchester area require engineer to supervise preparation of technical handbooks on radar and similar apparatus; technical grade required is at least equivalent of C. and G. final; ability to write technical descriptions and initiate development and use new ideas are essential; some knowledge of drafting and printing is desirable.—Reply, giving full particulars of experience, age and salary required, to Box 3905. [8691]

ELECTRONIC circuit and electro-mechanical engineers required for research and development work; good academic qualifications essential, apprenticeship or industrial or research experience desirable; knowledge of any of the following subjects would be of assistance: radar and television pulse techniques, centrimetric components, time-base generators, ac and dc amplifiers, feedback amplifiers, servos especially low power electro-mechanical, stabilised power supply units, data transmission systems gyroscopic applications, table form layouts; some mathematical ability is desirable.—Write, with full details of qualifications, experience, age and salary required, to the Personnel Manager, Sperry Gyroscope Co. Ltd., Great West Rd., Brentford, Middx.

E.M.I. ENGINEERING DEVELOPMENT Ltd., have several vacancies for junior engineers, and engineers mainly between the ages of 22 and 28; the work requires qualifications of degree standard, or very definite practical experience in the development field; the particular vacancies are for laboratory development and design work at Hayes on various electronic products, including (a) civilian radar equipment, (b) commercial communication receivers and transmitters, (c) R.F. generators for heating purposes, (d) high-quality sound reproduction, (e) car radio receivers, (f) radio receiver component, (g) cathode ray tubes, etc.; please state clearly your age, qualifications and experience, salary required and the vacancy or type of work in which you are interested, addressed to: Personnel Department, E.M.I. Factories, Ltd., Blyth Rd., Hayes, Middx.

SITUATIONS WANTED
ASSISTANT works manager or similar post wanted by chief engineer of development company.—Box 3549 [8603]

RADIO engineer, 29, seeks post design or supervisory, experienced electronic & mechanical design; adaptable.—Box 4039.

ASSISTANT works manager or similar position, 18 years with leading radio manfrs, all branches of production; London area preferred; age 34.—Box 3906. [8697]

EX-ARMY wireless mechanic seeks opening in radio or electronics (little civilian experience, but keenly interested.—L. A. Law, Bentham, Purton Swindon. [8692]

R.A.F. F./Sgt., experienced radar mech., seeks progressive post in development of civilian radar and television; certificates Radio-Comm., 1 and 2, City and Guilds; released Dec.—Box 4121. [8798a]

ENGINEER executive, 43, with 26 yrs. radio experience all branches manufacture, specialised knowledge large scale servicing, seeks change; 14 yrs. present employer, highest refs.—Box 4027. [8749]

EXPERT service engineer, 10 years exp. with large firm, 5 years exp. public address design, installation and repairs, factory trained, car radio installation and repairs, seeks position abroad, South Africa preferred.—Box 4020. [8737]

TUITION
RADIO Engineering, Television and Wireless Telegraphy, comprehensive postal courses of instruction.—Apply British School of Telegraphy, Ltd., 179, Clapham Rd., London, S.W.9 (Estd. 1906). Also instruction at school in wireless for H.M. Merchant Navy and R.A.F. [9240]

ENGINEERING opportunities.—Have you had your copy of this free guide to A.M.I.Mech.E., A.M.I.E.E., and all branches of engineering, building and plastics? Become technically trained on "no pass—no fee" terms for higher pay and security.—For free copy write B.I.E.T. (Dept. 387B), 17, Stratford Place, London, W.1. [6939]

QUALITY REPRODUCERS



PORTABLE AMPLIFIERS. P.P.

AC/18	Twin gram inputs, 15w. ...	13½ gns.
AC/18HG	With mic stage ...	15½ gns.
AC/25	Mic and Gram, 25w. ...	18½ gns.

CHASSIS AMPLIFIERS

AC/10	Single 6L6, twin gram. ...	8½ gns.
AC/8Q	Quality recording, P.P. ...	15½ gns.
AC/WW	Wireless World Spec. ...	21½ gns.

All these, and many others, described on separate leaflets, available upon request.

TO THOSE INTERESTED IN HOME CONSTRUCTING

A new impedance matching Transformer. Twelve ratio for quality output stages in single or P.P. Type OP4. 37/6.

FULL CATALOGUES DEALING WITH AMPLIFIERS, TRANSFORMERS, SPARES. If your name is not on our register send 3d. in stamps at once.

HOME — EXPORT — DEALERS

GENERAL LAMINATION PRODUCTS LTD.
264, BROADWAY, BEXLEYHEATH, KENT.

SPECIALITY GRINDING

of
TUNGSTEN CARBIDE

to high precision limits including fine grooves, forms surface and cylindrical grinding.

S.T. Ltd., 24, Upper Mulgrave Rd., Cheam, Surrey. Vig. 4250

HILL & CHURCHILL LTD. BOOKSELLERS SWANAGE, DORSET

Available from Stock :

Van Nostrand's "SCIENTIFIC ENCYCLOPÆDIA" (a complete science library in one volume) 2nd edition completely revised 1946 - - - - - **65/-**

Williams	"Thermionic Valve Circuits" 12/6
	"A.R.R.L. Handbook 1947" 13/-
Lewis	"Radio Receiver Servicing and Maintenance" - - - 8/6
Sarbacher & Fdson	"Hyper & Ultra High Frequency Engineering" - - 36/-
Rider	"Inside the Vacuum Tube" 30/-
	"Cathode Ray Tube at Work" - - - - - 25/-
Harrison	"Klystron Tubes" - - - 17/6

Postage extra.

CATALOGUE ON APPLICATION

WE CAN SUPPLY PERMEABILITY TUNERS

SUPERHET OR T.R.F.
AS EXHIBITED AT
RADIOLYMPIA

SEND FOR
DETAILS

**WEYMOUTH RADIO
MFG. CO., LTD.
CRESCENT WORKS, WEYMOUTH**

WIRELESS CABINETS

Manufacturing capacity available with speedy delivery of Cabinets and Speakers of all sizes and designs to individual requirements. (Trade enquiries only.)

BIRNEY SMALLWOOD PRODUCTS LTD.,
"Swan Works," Fishers Lane, London W.4.

LONDEX for RELAYS

AERIAL CHANGE-OVER RELAY

for Radio Frequency

Type AECO 4.

3 V.A. Coil Consumption, especially designed for Transmitters, High Frequency Heating, Amateur Stations, etc.

Ask for leaflet
112/WW

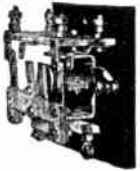

LONDEX LTD SYDNEY
MANUFACTURERS OF RELAYS 6258-9
207 ANERLEY ROAD LONDON S.E.20

"TAKE THE DOUBT" OUT OF HIGH-FIDELITY REPRODUCTION BY FITTING LOWTHER UNITS

Daily demonstrations at
THE LOWTHER MANUFACTURING CO.
Lowther House, St. Mark's Road,
BROMLEY, KENT.
Rav. 5225

THE British National Radio School

OFFERS you a career. WRITE to-day for free booklet describing our wide range of training courses in radio, Radar, telecommunications, principles, mathematics, physics, and mechanics; correspondence and day classes for the new series of C. & G. examinations; we specialise in turning "operators" into "engineers" and for this purpose our "Four Year Plan" (leading to A.M.I.E.E. and A.M.Brit. I.R.E., with 9 C. and G. Certificates as interim rewards) is unsurpassed; "our guarantee has no strings attached."—Studies Director. B.Sc. A.M.I.E.E., M.Brit. I.R.E. 66, Addiscombe Rd., Croydon, Surrey. [6811]

ENGINEERING careers and qualifications. BOTH Government and industry have announced and emphasised that young men with technical knowledge and qualifications must receive every chance to rise to the highest positions within their capacity, in post-war engineering and allied industry; write to-day for "The Engineer's Guide to Success"—200 courses free—which shows you how you can become A.M.I.E.E., A.M.I.A.E., A.M.I.Mech.E., A.P.R.A.S., etc., and covers all branches in radio, automobile, mechanical, electrical, production, aeronautical, etc. THE Technological Institute of Great Britain, 82, Temple Bar House, London, E.C.4. [4918]

RADIO training.—P.M.G. exams, and I.E.F. Diploma; prospectus free.—Technical College, Hull. [0611]

THE Institute of Practical Radio Engineers have available Home Study Courses covering elementary, theoretical, mathematical, practical and laboratory tuition in radio and television engineering; the text is suitable coaching matter for I.R.E. Service entry and progressive exams; tuition fees at pre-war rates—are moderate.—The Syllabus of Instructional Text may be obtained, post free, from the Secretary, 20, Fairfield Rd., Crouch End, N.8. [6722]

TECHNICAL TRAINING
A.M.I.E.E., City of Guilds, etc., on "No Pass—No Fee" terms; over 95% successes; for full details of modern courses in all branches of electrical technology send for our 112-page handbook, free and post free.—B.I.E.T. Dept. 388A, 17, Stratford Place, London, W.1 [6270]

PATENT NOTICES
THE owner of British Patent No. 554,812 is desirous of exploiting his invention for "producing magnetic cores and the like from pulverulent iron" by way of licence or sale of the patent outright.—Enquiries should be directed to Jensen & Son, Chartered Patent Agents, 77, Chancery Lane, London, W.C.2.

BUSINESS OPPORTUNITIES
LARGE woodworking and assembly factory will consider amalgamation or working arrangement with engineering or similar firm who have sound export proposition.—Box 4011, [8727]

MUSIC relay.—Tenders are invited for the installation of music relay apparatus at West Road Cemetery and Crematorium, Newcastle-upon-Tyne.—Further particulars from the City Engineer, Newcastle-upon-Tyne.

FINANCIAL PARTNERSHIPS
KEEN young man, with sales ability and servicing experience, seeks small partnership in radio electrical business.—Box 4042.

Our original post-war plans have met many man-made setbacks.



REVISED PLANS are evolving. Please don't write, phone, or call. We will advise when ready.

VOIGT PATENTS LTD.

THIS → Does these →



ACCURATELY and QUICKLY Chassis, Brackets, Shrouds, Condenser and Transformer clips—TREPANNING Steel or Aluminium. Five sizes—12" to 36" Full particulars from
A. A. TOOLS, (W),
197a, WHITEAGRE ROAD
ABSTON-UNDER-LYNE

TELEPHONE HANDSETS

Made by T.M.C. for Government use, and incorporate self-energising inserts (permanent magnet balanced armature). Ideal for house, office, works, shop or house-to-shack communication. Whilst stocks last, price only 11/6d. each or 22/6d. pair, with diagram, plus 2/- packing and postage.

Fantastic value, dont miss them!

WIRELESS SUPPLIES UNLIMITED

(Proprs. Unlimitex Radio Ltd.)
264-266, Old Christchurch Road,
BOURNEMOUTH, Hants.

VIBRO-ARC ELECTRIC METAL ENGRAVING PEN

Engraves, etches, marks writes . . . on

Operates from 4 or 6 volt Accumulator or A.C. Transformer Sole Distributors

BRASS, COPPER, SILVER, NICKEL, ALUMINIUM, CHROMIUM, Hardened Steel

BULLS 246 High St., Harlesden N.W.10 with full instructions

Retail 15/-

BATTERY CHARGERS and TRICKLE CHARGERS

Trouble-free Chargers fitted with selenium all-metal rectification. Good allowance on your old Charger. Thirty years experience behind every Runbaken product. Booklet R.15 describing 12 Models, on request.

RUNBAKEN-MANCHESTER!

PHOTO-ELECTRIC CELLS

for Talking Picture Apparatus. Caesium Photo-Emissive Cells Only.
RADIO-ELECTRONICS LTD.,
St. George's Works, South Norwood, London, S.E.25.

MORSE CODE TRAINING



There are Candler Morse Code Courses for **BEGINNERS AND OPERATORS.** Send for this Free "BOOK OF FACTS" It gives full details concerning all Courses.

THE CANDLER SYSTEM CO.,
(Room 55W), 121 Kingsway, London, W.C.2
Candler System Co., Denver, Colorado, U.S.A.

The **T.C.C.**
Tough Guys
are endowed with almost
Perpetual Life!

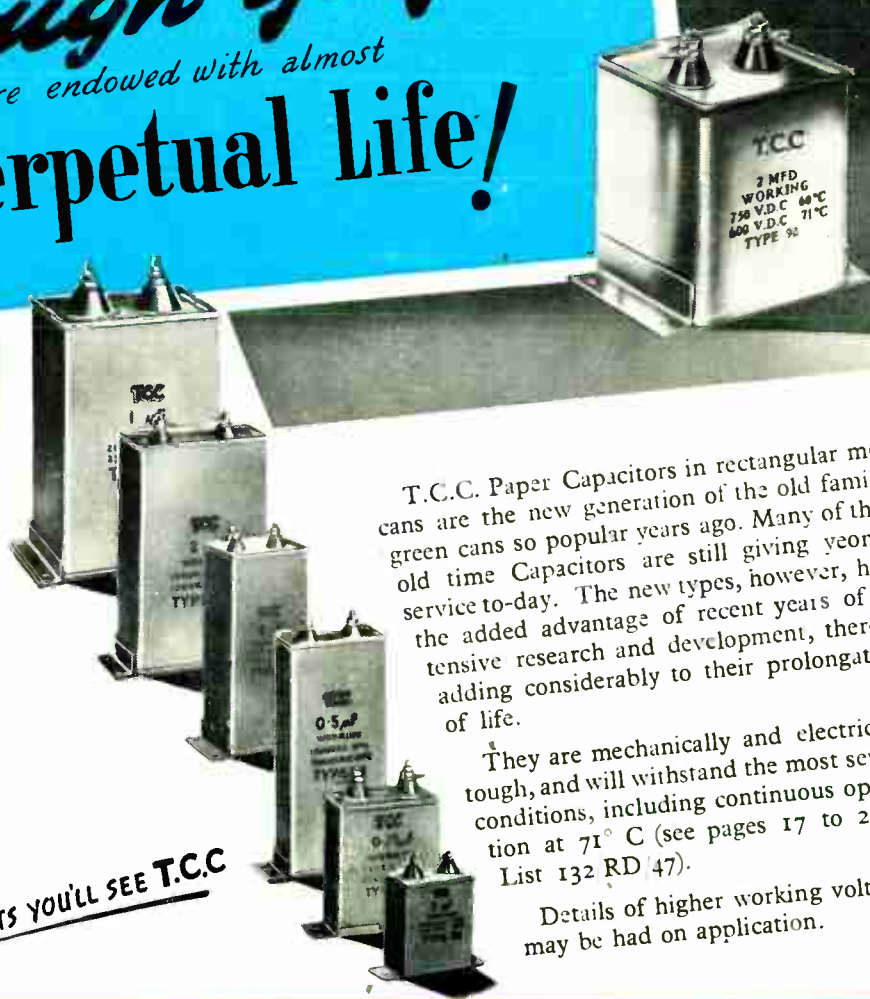

T.C.C. Paper Capacitors in rectangular metal cans are the new generation of the old familiar green cans so popular years ago. Many of these old time Capacitors are still giving yeoman service to-day. The new types, however, have the added advantage of recent years of intensive research and development, thereby adding considerably to their prolongation of life.

They are mechanically and electrically tough, and will withstand the most severe conditions, including continuous operation at 71° C (see pages 17 to 21 of List 132 RD 47).

Details of higher working voltages may be had on application.

IN THE BEST SETS YOU'LL SEE T.C.C.

THE TELEGRAPH CONDENSER CO. LTD.

RADIO DIVISION

NORTH ACTON · LONDON · W · 3

TELEPHONE: ACORN 0061

KING OF THE SET

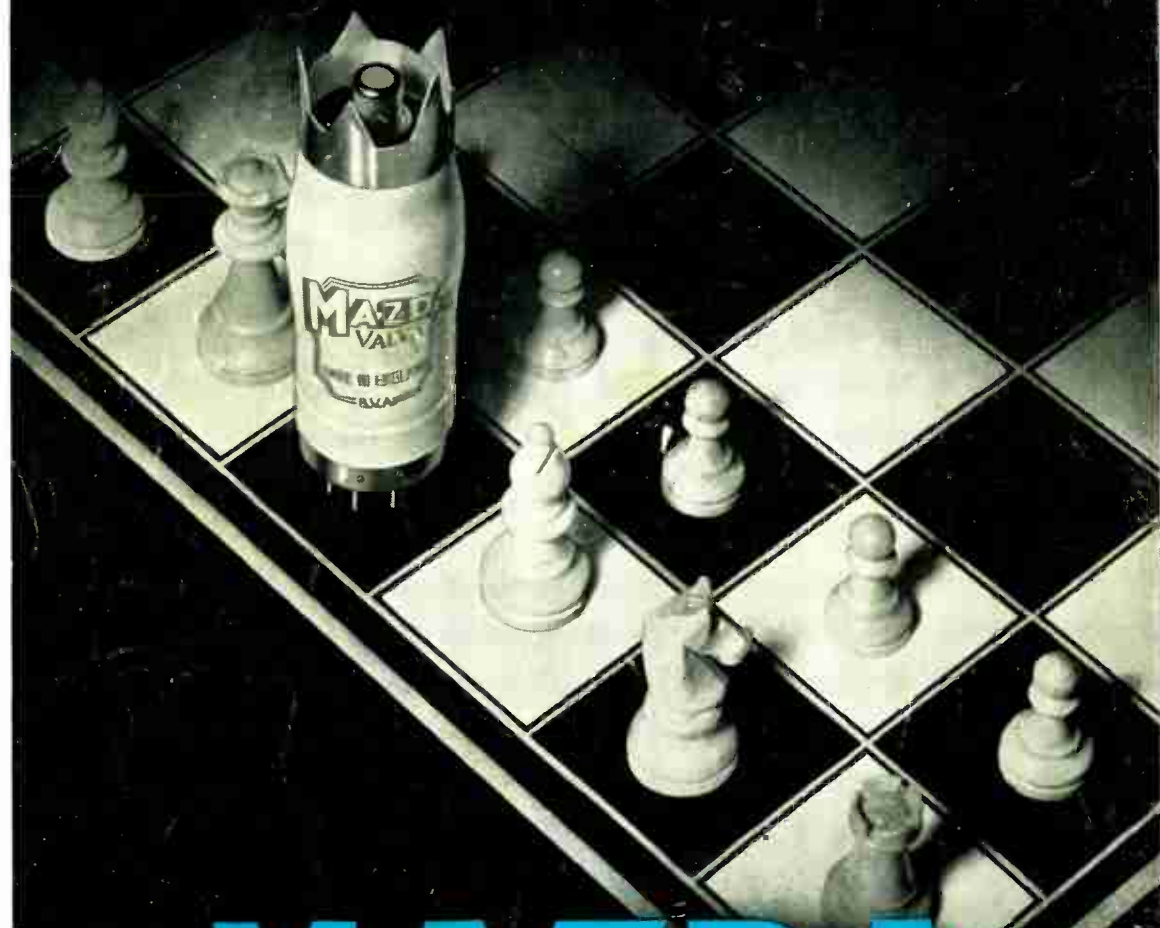

MAZDA

RADIO VALVES AND CATHODE RAY TUBES

THE EDISON SWAN ELECTRIC CO. LTD.  155 CHARING CROSS RD., LONDON W.C.2
(R.M. 42)